

# Plumb Supply

COMPANY

2018

**HVAC Products**

Vol. 4

# BRANCH LOCATIONS

|                         | Location                 | Address  | Phone                                  | Fax          |
|-------------------------|--------------------------|--|--|--------------|
| Iowa . . .              | Ames                     | 2408 E Lincoln Way Ames, IA 50010              | 515-233-5737                           | 515-233-5539 |
|                         | Cedar Rapids             | 4700 J St. SW Cedar Rapids, IA 52404           | 319-366-7891                           | 319-366-8758 |
|                         | Davenport                | 4601 Grand Ave Davenport, IA 52807             | 563-391-0240                           | 563-391-0695 |
|                         | Des Moines               | 1622 NE 51st Ave Des Moines, IA 50306          | 515-262-9511                           | 515-262-9790 |
|                         | Dubuque                  | 600 Cedar Cross Rd Dubuque, IA 52003           | 563-556-2827                           | 563-556-5693 |
|                         | Fort Dodge               | 1565 Cardinal Ave Fort Dodge, IA 50501         | 515-573-8161                           | 515-573-7558 |
|                         | Iowa City                | 1925 Boyrum St. Iowa City, IA 52240            | 319-351-1004                           | 319-354-3169 |
|                         | Iowa City Showroom       | 214 Southgate Ave Iowa City, IA 52240          | 319-351-5010                           | 319-351-4995 |
|                         | Le Mars                  | 436 2nd Ave NE Le Mars, IA 51031               | 712-546-8129                           | 515-957-5334 |
|                         | Marshalltown             | 207 Iowa Ave E Marshalltown, IA 50158          | 641-753-2847                           | 641-753-2856 |
|                         | Mason City               | 45 19th St. SW Mason City, IA 50401            | 641-423-0164                           | 641-423-0462 |
|                         | Muscatine                | 1418 S Houser Muscatine, IA 52761              | 563-264-8655                           | 563-264-5898 |
|                         | North Cedar Rapids       | 1716 Blairs Ferry Rd NE Cedar Rapids, IA 52402 | 319-393-1441                           | 319-393-1211 |
|                         | Ottumwa                  | 420 Gateway Dr Ottumwa, IA 52501               | 641-682-8357                           | 641-628-2307 |
|                         | Pella                    | 208 SE 9th St. Pella, IA 50219                 | 641-620-1406                           | 641-620-8204 |
|                         | Red Oak                  | 1949 G Ave Red Oak, IA 51566                   | 712-623-4841                           | 712-623-4843 |
|                         | Spirit Lake              | 3010 Hwy 9 W Spirit Lake, IA 51360             | 712-336-0787                           | 712-336-3609 |
|                         | Waterloo                 | 3338 W Airline Hwy Waterloo, IA 50703          | 319-236-1511                           | 319-236-0218 |
|                         | Waukee                   | 920 Frontier Ave Waukee IA 50263               | 515-987-2802                           | 515-987-3579 |
|                         | Kansas . .<br>Missouri . | Lenexa   | 14936 W 101st Terrace Lenexa, KS 66215 | 913-782-7455 |
| Branson                 |                          | 110 Warehouse Rd Branson, MO 65616             | 417-335-4554                           | 417-335-4572 |
| Columbia                |                          | 2412 Bus Loop 70 E Columbia, MO 65201          | 573-875-3131                           | 573-449-8738 |
| Columbia HVAC           |                          | 1112 Smith St. Columbia MO 65201               | 573-874-5661                           | 573-874-5677 |
| Columbia Showroom       |                          | 1729 W Broadway Columbia, MO 65203             | 573-445-4481                           | 573-446-2058 |
| Hannibal                |                          | 4385 Paris Gravel Rd Hannibal, MO 63401        | 573-221-0142                           | 573-221-0148 |
| Jefferson City          |                          | 912 W McCarty Jefferson City, MO 65109         | 573-415-9173                           | 573-634-7260 |
| Jefferson City Showroom |                          | 2027 Christy Dr Jefferson City, MO 65101       | 573-634-4515                           | 573-634-6017 |
| Kirkville               |                          | 405 W Hickory St. Kirkville, MO 63501          | 660-665-2626                           | 660-665-9997 |
| Laurie                  |                          | 203 S Main Laurie, MO 65038                    | 573-374-8899                           | 573-374-8893 |
| Liberty                 |                          | 2108 Kara Ct. Suite D Liberty, MO 64068        | 816-335-3020                           | 813-781-8555 |
| Marshall                |                          | 735 N Miami Marshall, MO 65340                 | 660-886-5151                           | 660-886-5854 |
| Mexico                  |                          | 622 E Liberty Mexico, MO 65265                 | 573-581-6842                           | 573-581-7712 |
| Moberly                 |                          | 807 W Hwy 24 Moberly, MO 65270                 | 660-263-1280                           | 660-263-0929 |
| Osage Beach             |                          | 924 Hwy 42 Osage Beach, MO 65065               | 573-348-2253                           | 573-348-2443 |
| Rolla                   |                          | 11208 Twitty Dr Rolla, MO 65401                | 573-364-5211                           | 573-341-5446 |
| Springfield             |                          | 2234 E Olive Court Springfield, MO 65802       | 417-865-8770                           | 417-865-1056 |
| Warrensburg             |                          | 133 Railroad Warrensburg, MO 64093             | 660-429-3555                           | 660-429-3581 |
| Washington              |                          | 205 E 8th St. Washington, MO 63090             | 636-239-1969                           | 636-239-2045 |

**Plumb Supply**  
 COMPANY

Plumbing • HVAC • PVF



## Table of Contents

### Air Treatment & Filters

|                            |    |
|----------------------------|----|
| Air Cleaners               | 1  |
| Air-to-Air Heat Exchangers | 7  |
| Humidifiers/Dehumidifiers  | 13 |
| Throwaway Filters          | 20 |

### Cooling - Equipment & Rooftop Units

|                                     |     |
|-------------------------------------|-----|
| Air Handlers                        | 29  |
| Coils                               | 40  |
| Condensing Units                    | 53  |
| Heat Pumps                          | 68  |
| Electric Heat Kits                  | 82  |
| Mini-Split Components & Accessories | 83  |
| Mini-Splits/Multi Zone Systems      | 89  |
| Mini-Splits/Single Zone Systems     | 93  |
| Packaged Terminal Air Conditioners  | 100 |
| Roof Top Units                      | 103 |
| VRF Equipment                       | 111 |

### Cooling - Accessories

|                                     |     |
|-------------------------------------|-----|
| Brass Sealing Caps                  | 115 |
| Chemicals                           | 116 |
| Leak Detection                      | 119 |
| Chemicals                           | 120 |
| Condensate Neutralizers             | 127 |
| Condensate Drain Guns               | 128 |
| Condensate Drain Pan Switches       | 129 |
| Condensate Traps                    | 130 |
| Condenser Pads                      | 132 |
| Defrost Controls                    | 136 |
| Electrical                          | 140 |
| Spade & Other Electrical Connectors | 143 |
| Electrical                          | 147 |
| Crankcase Heaters                   | 149 |
| Filter Driers                       | 150 |
| Leak Detection                      | 157 |
| Linesets                            | 165 |
| Mounting Systems                    | 168 |
| Refrigerant Components              | 170 |
| Secondary Drain Pans                | 172 |
| Site Glasses                        | 173 |

# Table of Contents



## Cooling - Accessories (Continued)

|                              |     |
|------------------------------|-----|
| Tap Valves & Piercing Valves | 175 |
|------------------------------|-----|

## Ducts, Fittings & Accessories

|  |     |
|--|-----|
| Aluminum Faced Board Panning & Grille Frames | 176 |
| Canvas Duct Connectors                       | 177 |
| Chimney & Vent                               | 178 |
| Duct Boosters                                | 184 |
| Duct Tape                                    | 186 |
| Duct Fasteners                               | 189 |
| Duct Sealants                                | 196 |
| Duct Hangers                                 | 197 |
| Flexible Duct                                | 198 |
| Galvanized Sheet Metal                       | 204 |
| Oval Pipe & Fittings                         | 207 |
| Plenum & Return Air Drops                    | 210 |
| PVD/PVC Air Duct                             | 213 |
| Rectangular Collars                          | 216 |
| Rectangular Duct                             | 218 |
| Rectangular Elbows                           | 220 |
| Rectangular Miscellaneous                    | 224 |
| Round Boots                                  | 230 |
| Round Collars                                | 234 |
| Round Elbows                                 | 239 |
| Round Pipe                                   | 241 |
| Round Takeoffs                               | 244 |
| Round Tees & Wyes                            | 247 |
| Round Miscellaneous                          | 250 |
| Spiral Pipe & Fittings                       | 254 |
| Wall Stack Duct                              | 260 |
| Wall Stack Fittings                          | 262 |

## Fire Safety

|                     |     |
|---------------------|-----|
| Fire Safety         | 264 |
| Screwdrivers & Bits | 266 |
| Sheet Metal Tools   | 267 |
| Soldering & Brazing | 268 |

## Geothermal Supplies

|                        |     |
|------------------------|-----|
| Geothermal Accessories | 269 |
|------------------------|-----|



## Table of Contents

### Grilles & Registers

|                                |     |
|--------------------------------|-----|
| Ceiling Grilles & Registers    | 272 |
| Commercial Grilles & Registers | 276 |
| Deflectors                     | 284 |
| Floor Grilles & Registers      | 285 |
| Grille & Register Accessories  | 289 |
| Sidewall Grilles & Registers   | 290 |

### Heating - Forced Air

|                                |     |
|--------------------------------|-----|
| Electric Furnaces              | 297 |
| Gas Downflow Furnaces          | 298 |
| Gas Multi-Position Furnaces    | 320 |
| Gas Upflow/Horizontal Furnaces | 323 |
| Gas Unit Heaters               | 347 |
| Gas Fireplaces                 | 349 |
| Kickspace Heaters              | 350 |
| Furnace Accessories            | 351 |

### Heating - Hydronic

|                                  |     |
|----------------------------------|-----|
| Maxifold Manifolds & Accessories | 355 |
| Navien Boilers                   | 356 |
| Thermolec Boilers                | 358 |
| Triangle Tube (Prestige) Boilers | 359 |
| Weil McLain Boilers              | 361 |
| Uponor (Wirsbo) Heating          | 368 |
| Watts Heating                    | 377 |

### Heating - Hydronic Accessories

|                              |     |
|------------------------------|-----|
| Air Purgers                  | 378 |
| Air Vents                    | 379 |
| Antifreeze & Other Chemicals | 386 |
| Aquastats                    | 393 |
| Baseboard Radiation          | 396 |
| Boiler & Zone Controls       | 398 |
| Boiler Accessories           | 404 |
| Circulator Pumps             | 407 |
| Flow Valves                  | 416 |
| Heat Exchangers              | 417 |
| Isolation Flanges            | 419 |
| Low Water Cut-Offs & Feeders | 422 |
| Pressure Reducing Valves     | 426 |

# Table of Contents



## Heating - Hydronic Accessories (Continued)

|                              |     |
|------------------------------|-----|
| Radiator Traps & Valves      | 429 |
| Spiralink Couplings          | 433 |
| Thermal Expansion Tanks      | 434 |
| Water Gauges & Sight Glasses | 436 |
| Zone Valves                  | 439 |

## Heating - Infrared

|                             |     |
|-----------------------------|-----|
| Reznor Infrared Accessories | 443 |
| Schwank Infrared Heating    | 444 |

## HVAC - General Accessories

|   |     |
|---|-----|
| Adjustable Pressure Switches            | 446 |
| Capacitors                              | 447 |
| Chemicals                               | 455 |
| Condensate Pumps                        | 456 |
| Disconnects/Fuses/Electrical Box Covers | 462 |
| Electrical Tape                         | 465 |
| Gas Valves                              | 468 |
| Heat Shrink Tubing                      | 474 |
| Igniters                                | 475 |
| Limit Controls                          | 478 |
| Oil Furnace Accessories                 | 479 |
| Pilot Assemblies                        | 483 |
| Pressure Regulators - Gas               | 484 |
| Relays                                  | 486 |
| Smoke Bombs                             | 487 |
| Spades & Other Electrical Connectors    | 488 |
| Temporary Construction Thermostats      | 493 |
| Thermocouples                           | 495 |
| Thermostats: Honeywell                  | 498 |
| Thermostats: Honeywell (Private Label)  | 518 |
| Thermostats: Pro1                       | 526 |
| Thermostats: Protech                    | 529 |
| Thermostats: Ruud                       | 531 |
| Thermostats: White-Rodgers              | 532 |
| Thermostat Wire                         | 536 |
| Transformers                            | 538 |
| Universal Ignition Modules              | 541 |
| Wire Nuts & Leads                       | 544 |
| Wire Ties & Connectors                  | 545 |



## Table of Contents

### HVAC - General Accessories (Continued)

|                            |     |
|----------------------------|-----|
| Vibration Pads             | 546 |
| Zone Dampers & Accessories | 547 |

### Insulation

|                            |     |
|----------------------------|-----|
| Adhesives & Coatings       | 552 |
| Duct Liner                 | 553 |
| Duct Wrap                  | 554 |
| Duct Liner                 | 555 |
| Foam Board                 | 557 |
| Fiberglass Pipe Insulation | 558 |
| Insulation Tape            | 559 |
| Mechanical Fasteners       | 562 |
| R-Foil Insulation          | 564 |
| Rubber Pipe Insulation     | 565 |

### Cleaners & Lubricants

|            |     |
|------------|-----|
| Cleaners   | 567 |
| Lubricants | 571 |

### Radon Equipment & Supplies

|                     |     |
|---------------------|-----|
| Radon Fans          | 575 |
| Radon Pits and Lids | 576 |

### Repair Parts

|                                    |     |
|------------------------------------|-----|
| Airease Repair Parts & Accessories | 578 |
| American Standard Repair Parts     | 579 |
| Basco Repair Parts                 | 580 |
| Bell & Gossett Repair Parts        | 581 |
| Bradley Washfountain Repair Parts  | 583 |
| Chicago Faucet Repair Parts        | 584 |
| Dearborn Brass Repair Parts        | 589 |
| Delta Faucet Repair Parts          | 590 |
| Elkay Repair Parts                 | 610 |
| Empire Comfort Repair Parts        | 612 |
| Fenner Drives Repair Parts         | 613 |
| Franklin Electric Repair Parts     | 614 |
| General Filter Repair Parts        | 615 |
| Gerber Repair Parts                | 616 |
| Gibson Repair Parts & Accessories  | 618 |

# Table of Contents



## Repair Parts (Continued)

|  |     |
|--|-----|
| Hi-Velocity (Energy Savings Products) Repair Parts | 619 |
| Honeywell Repair Parts                             | 620 |
| Jones Stephens Repair Parts                        | 623 |
| Kohler Repair Parts                                | 624 |
| Malco Repair Parts                                 | 637 |
| McDonnell & Miller Repair Parts                    | 638 |
| Moen Repair Parts                                  | 639 |
| EL Mustee Repair Parts                             | 643 |
| Navien Repair Parts                                | 644 |
| Reznor Repair Parts                                | 647 |
| Ruud Water Heater Repair Parts                     | 650 |
| Schwank Repair Parts                               | 655 |
| Sloan Repair Parts                                 | 656 |
| Speakman Repair Parts                              | 664 |
| T & S Brass Repair Parts                           | 665 |
| Taco Repair Parts                                  | 667 |
| Thermolec Repair Parts                             | 668 |
| Triangle Tube Repair Parts                         | 669 |
| Union Brass Repair Parts                           | 670 |
| Ruud Heating & AC Repair Parts                     | 671 |
| Water Right Repair Parts                           | 699 |
| Watts Regulator Repair Parts                       | 700 |
| Weil McLain Repair Parts                           | 701 |
| Westinghouse/Philco Repair Parts                   | 706 |
| Repair Parts: White Rodgers                        | 710 |
| Woodford Repair Parts                              | 718 |
| Yellow Jacket Repair Parts                         | 721 |
| Zoeller Repair Parts                               | 722 |

## Tools

|                             |     |
|-----------------------------|-----|
| Drill Bits                  | 723 |
| Flaring Tools               | 737 |
| Work Lights                 | 741 |
| Flashlights                 | 746 |
| Hammers                     | 750 |
| Hole Saws                   | 753 |
| HVAC Testing Tools          | 758 |
| Knives & Replacement Blades | 769 |
| Levels                      | 775 |
| Miscellaneous Tools         | 782 |
| Pipe Cutters - Copper       | 809 |



### Tools (Continued)

|                                |     |
|--------------------------------|-----|
| Pipe Cutters - PEX             | 816 |
| Pipe Cutters - Plastic         | 817 |
| Pipe Cutters - Soil Pipe       | 822 |
| Pipe Cutters - Steel           | 823 |
| Pipe Taps                      | 825 |
| Pipe Threaders                 | 827 |
| Pliers & Wire Strippers        | 831 |
| Power Tools - M12 and Misc     | 841 |
| Power Tools - M18              | 859 |
| Power Tool Accessories         | 883 |
| Power Tools                    | 888 |
| Refrigeration Tools            | 889 |
| Rulers & Tape Measures         | 897 |
| Saws & Blades                  | 900 |
| Screwdrivers & Bits            | 915 |
| Hand Sewer Machines            | 933 |
| Power Sewer Machines           | 940 |
| Refrigeration Tools            | 943 |
| Sheet Metal Tools              | 949 |
| Shovels                        | 960 |
| Trouble Lights/Extension Cords | 962 |
| Wrenches                       | 965 |

### Venting

|                                   |      |
|-----------------------------------|------|
| Aluminum Venting                  | 981  |
| Chimney Liners                    | 984  |
| Draft Diverters                   | 985  |
| Dryer Venting                     | 986  |
| Exhaust Fans                      | 988  |
| Power Venters                     | 994  |
| QC Round Venting                  | 995  |
| RV Round Venting                  | 996  |
| Stainless Steel All Fuel Venting  | 998  |
| WV Oval Venting                   | 1000 |
| Roof & Chimney Caps               | 1001 |
| Plastic High Temperature Sealants | 1002 |
| Sealants                          | 1003 |
| Stainless Steel Venting           | 1004 |

# Table of Contents



## Work Wear

|                                 |      |
|---------------------------------|------|
| Gloves, Ear Plugs, Goggles, ETC | 1005 |
| Work Gear                       | 1012 |
| Heated Gear                     | 1014 |
| Safety Glasses                  | 1018 |
| Shoe Covers                     | 1020 |

**Air Cleaners**

**Air Cleaners**

**F100 Media Air Cleaner**

- High efficiency media filter captures particles as small as 0.3 microns
- Applicable to all gas, oil and electric forced air furnaces and to compressor cooling up to 5 tons
- Mounts in the return air duct
- Rugged zinc-coated, roll-formed cabinet resists corrosion
- Requires no electrical connections
- Mounts in any position
- Requires no maintenance except periodic media filter replacement
- Quick and easy media filter replacement



Air Treatment & Filters

| Part # | Mfg #     | Description                               | Price |
|--------|-----------|---|-------|
| 186814 | F100F2010 | Media Air Cleaner, 20" x 25" x 4", MERV11 |       |
| 144637 | F100F2002 | Media Air Cleaner, 16" x 25"              |       |

**F300 Electronic Air Cleaner**

- Media post-filter provides enhanced filtration on select models
- Solid state power supply is self-regulating and maintains peak efficiency during a wide range of cell dirt loading conditions
- Low-profile door with test button to check system operation
- Helps filter efficiency-robbing "gunk" before it coats critical system parts
- Very low pressure drop
- Exclusive 10-year Clean Coil Guarantee
- Rugged zinc-coated, roll-formed cabinet provides superior strength and corrosion protection



| Part # | Mfg #       | Description  | Price |
|--------|-------------|--|-------|
| 174188 | F300E1019/U | Electronic Air Cleaner, 16"x25" w/ Performance Enhancing Post-Filter |       |
| 174189 | F300E1027/U | Electronic Air Cleaner, 20"x20" w/ Performance Enhancing Post-Filter |       |

**Merv 11 Air Cleaner**

- Replacement filter for DR65A1000



| Part # | Mfg #        | Description                | Price |
|--------|--------------|----------------------------|-------|
| 135480 | 50049537-005 | Media Air Cleaner, Merv 11 |       |

**Air Cleaners**

Air Treatment & Filters

**Ultraviolet Air Treatment**

**UV Air Purifier with AirBRIGHT Odor Absorption**

- installed in the ductwork of your central air system and is designed to help reduce airborne odors, toxic chemical vapors, germs and mold in your home
- Lamp is Always On
- Replace Lamp Annually
- AirBRIGHT Odor Absorber never needs replacing
- SnapLamp™ features replacement lamp handle with detachable replacement lamp.
- Universal Installation with a single product
  - UV Only
  - UV + Odor Removal
  - Internal Mount
  - External Mount



| Part # | Mfg #       | Description  | Price |
|--------|-------------|--|-------|
| 163862 | UV2400U5000 | 24V UV Air Purifier with AirBRIGHT Odor Absorption |       |

**120V Ultraviolet Treatment**

- Return air application
- Operating temperature range:  
Outside duct -- 30°F to 104°F  
Inside duct -- 30°F to 140°F
- Reduces contaminants like airborne bacteria



| Part # | Mfg #      | Description      | Price |
|--------|------------|------------------|-------|
| 110564 | UV100E2009 | 120VAC, 36W Each |       |

**Sail Switches**

**S688 Sail Switch**

- Used in forced air systems to activate electronic air cleaners, humidifiers or other auxiliary equipment in response to air flow from system fan
- Polyester film sail mounted on a micro switch snap switch
- SPDT Switching
- Top and bottom conduit knockouts for wiring convenience
- Low air velocity switch operation makes at 250 fpm and breaks at 75 fpm



| Part # | Mfg #     | Description  | Price |
|--------|-----------|--|-------|
| 006785 | S688A1007 | 5" Wide Sail, 26.2 sq in of Area, 10" Insertion Length |       |

**Air Cleaners**

**Air Cleaners**

**Ruud Media Air Cleaner**

- Fits a wide variety of equipment
- Platinum metallic paint
- Rugged cabinet construction



| Part # | Mfg #       | Description   | Price |
|--------|-------------|---|-------|
| 086516 | 84-25050-01 | O/A Dimension: 20-1/4"H x 24-7/8"D x 7-1/8"W MERV8 2000 cfm |       |
| 035230 | 84-25050-03 | O/A Dimension: 23-1/2"H x 25-5/8"D x 15-1/2"W, Right Angle  |       |
| 088498 | 84-25050-06 | O/A Dimension: 16-1/4"H x 24-7/8"D x 7-1/8"W MERV8 1400 cfm |       |

**Electronic Air Cleaner**



| Part # | Mfg #       | Description   | Price |
|--------|-------------|---|-------|
| 129583 | 84-25052-07 | Dimensions: 20-1/4"H x 24-7/8"D x 7-1/8"W, 1400 cfm |       |

**IAQ Chemicals**

**ClenAir Gel Tub**

- Place open tub in HVAC ductwork or in room near source of odor
- Available in regular or cherry



| Part # | Mfg #   | Description            | Price |
|--------|---------|------------------------|-------|
| 041980 | 851500  | 1/2 lb Clenair Gel Tub |       |
| 042554 | 851501  | 1 lb Clenair Gel Tub   |       |
| 042555 | 85-1503 | 3 lb Clenair Gel Tub   |       |

Air Treatment & Filters



## Air Cleaners

### Air Cleaners Media Air Filter

| Part # | Mfg #      | Description               | Price |
|--------|------------|---------------------------|-------|
| 042237 | 84-16X20-1 | 16" x 20" x 1", Polarized |       |
| 042238 | 84-16X25-1 | 16" x 25" x 1", Polarized |       |
| 045033 | 84-20X20-1 | 20" x 20" x 1", Polarized |       |
| 042239 | 84-20X25-1 | 20" x 25" x 1", Polarized |       |
| 109749 | 84-28X32-1 | 28" x 32" x 1"            |       |

### Filter Base - ACG Series

- Uses standard filter sizes
- Gasketed door
- Fully insulated
- Upflow with hinged door



| Part # | Mfg #      | Outside Dim (W x L x H)    | Price |
|--------|------------|----------------------------|-------|
| 077769 | 54-1625-G6 | 17-3/8" x 28-1/2" x 5-3/4" |       |

## UV Air Cleaners

### Ultraviolet Air Disinfection Systems

#### UltraMAX™ UMX Remote UV Lamp Series with UltraVation® T3™

- T3™ is a patented lamp system that maximizes performance, safety and economy
- Unique interlock that safely turns off UV before lamp removal



| Part # | Mfg #       | Description                          | Price |
|--------|-------------|--------------------------------------|-------|
| 112482 | UMX-2412-EZ | (1) 12" Enhanced High Output UV Lamp |       |

#### UltraMAX™ UME Single Remote UV Lamp Series with UltraVation T3™

- T3™ is a patented lamp system that maximizes performance, safety and economy
- Unique interlock that safely turns off UV before lamp removal



| Part # | Mfg #     | Description   | Price |
|--------|-----------|---|-------|
| 125775 | UME-1900T | (1) 17" 110V Remote Mount UV Lamp with Odor Control |       |
| 125781 | UME-1902T | (2) 17" 110V Remote Mount UV Lamp with Odor Control |       |

### UV Replacement Lamps



AS-IH-1001



LPPP-0002



AS-IH-1003

| Part # | Mfg #      | Description             | Fits Model  | Price |
|--------|------------|-------------------------|---|-------|
| 112052 | AS-IH-1001 | 12" T3 Remote UV-C Lamp |   |       |
| 060697 | LPPP-0002  | 16" "U" Shaped UV Lamp  | UME-1036, 2036 UVS-1036, 2036 UVE-1036, 2036                                    |       |
| 126917 | AS-IH-1003 | 17" UV, UV-C Lamp       | All UltraMax, UVS, UVE Germicidal UV Series, and Phototronic Air Cleaner Models |       |

### Indoor Air Cleaners

#### Progressive® Media Air Cleaner

- Pleated, layered design
- Produces no ozone
- Filters electrostatically charged
- Custom color match available
- Private label options available
- Includes rails that accepts most major brands of media

| Part # | Mfg #     | Description         | Size           | Color | Price |
|--------|-----------|---------------------|----------------|-------|-------|
| 239006 | 90-064P04 | Right Angle MERV 11 | 20" x 25" x 5" | Gray  |       |

Air Treatment & Filters

**UV Air Cleaners**

Air Treatment & Filters

**Air Purifiers**

**P900GX Portable UV Air Purifier**

- Dual zone 19mm UVC/UVV Quartz lamp destroys biological and chemical contaminants
- 9 Electronically controlled speeds
- Touch-pad digital controls with count-down timer
- Purifies up to 900 square feet
- 85 Watts
- Weight: 11 lbs
- Includes integral stand and handle
- Wall mountable
- 3-Year warranty on parts including UV lamp

| Part # | Mfg #  | Description               | Price |
|--------|--------|---------------------------|-------|
| 141942 | P900GX | Dual UVC/UVV Air Purifier |       |

**Sanuvox SR+ In-Duct UV Air Treatment System**

- Whole-home system designed to destroy viruses, germs, bacteria, mold, chemicals, odors, allergens & VOCs
- Patented process includes 19mm Quartz UVC/UVV 'J' Lamp
- Multi-color LED Status Display provides important user information
- Most advanced air treatment system available
- 110 / 220V operation
- Microprocessor controlled Thermistor for automatic operation
- UV Chamber rotates for up-flow or down-flow systems
- 3 year warranty including UV Lamp
- ETL



| Part # | Mfg # | Description   | Price |
|--------|-------|---|-------|
| 161214 | SR+   | In-Duct UV Whole-Home (up to 2,000 sq ft) Air Purification System |       |

**Sanuvox R+ In-Duct UV Air Purification System**

- Whole-home system designed to destroy viruses, bacteria, mold, chemicals, odors, allergens and VOCs
- High-intensity UV 'J' lamp (18" arc length), turbulator and reflecting chamber parallel to the airflow
- Microprocessor controlled for automatic operation
- UV Chamber rotates 360° for up or down-flow systems
- Fiber board kit included
- 3-Year warranty including UV lamp



| Part # | Mfg #    | Description                                   | Price |
|--------|----------|---|-------|
| 139088 | R PLUS + | In-Duct UV Whole-Home Air Purification System |       |

**UV Replacement Bulbs**

**T6 Dual Zone High Intensity Replacement Lamp**

- UVC/UVV Germicidal/oxidizing

| Part # | Mfg #     | Description                          | Price |
|--------|-----------|--------------------------------------|-------|
| 141941 | LMPHGJ105 | 10.5" UV J Lamp for R4000GX, S300HFX |       |



## Air-to-Air Heat Exchangers

### Heat Recovery Ventilators

#### MAX Series Residential HRV

- 5-Speed electronics
- Lifestyle MAX digital control included
- Compact electrically powered
- Aluminum heat exchange core
- Built-in dehumidistat
- Easy installation
- Increases air exchange rate when humidity rises
- Easy clean filters
- Quiet and reliable five speed motor
- 5-Year warranty on parts, lifetime on heat exchange core



95MAX



155MAX



200MAX

| Part # | Mfg #   | Dimensions<br>H x W x D    | Defrost<br>Type | Electrical | CFM @<br>0.1" ESP | Ship<br>Wt | Price |
|--------|---------|----------------------------|-----------------|------------|-------------------|------------|-------|
| 033812 | 95MAX   | 24-1/2" x 18-1/2" x 16"    | Recirculating   | 120-1-60   | 76                | 56 lbs     |       |
| 027707 | 155MAX  | 19" x 33-5/8" x 14-3/4"    | Damper          | 120-1-60   | 144               | 73 lbs     |       |
| 166054 | 100-ECM | 18-3/4" x 33.62" x 14-3/4" | Recirculating   |            |                   |            |       |

#### RNC Series Residential HRV

- 2-Speed electronics
- Each air stream has one centrifugal blower driven by a common PSC motor
- Compact electrically powered
- Patented aluminum core
- Built-in dehumidistat
- Built-in relay for interfacing to furnace
- Damper defrost system
- Cross-flow heat recovery core transfers heat between two air streams, removable for cleaning
- Washable air filters
- Suffix: DX = with 99-DX01 digital control
- 5-Year warranty on parts, lifetime on heat exchange core



RNC200

| Part # | Mfg #       | Dimensions<br>H x W x D | Defrost<br>Type | Electrical | CFM @<br>0.1" ESP | Ship<br>Wt | Price |
|--------|-------------|-------------------------|-----------------|------------|-------------------|------------|-------|
| 188379 | RNC-155BC02 | 19" x 33-5/8" x 14-3/4" | Recirculating   | 120-1-60   | 144               | 67 lbs     |       |
| 188380 | RNC-200BC02 | 19" x 33-5/8" x 14-3/4" | Recirculating   | 120-1-60   | 207               | 67 lbs     |       |

## Air-to-Air Heat Exchangers

Air Treatment & Filters

### Turbulent Flow Precipitators Whole House Air Cleaner

- Removes close to 99.4% of coarser particles such as pollen, fungus spores, dust, animal dander and dirt
- Removes close to 90% of tobacco smoke and wood smoke particles and some bacteria
- Filters down to 1/10 of a micron
- Motor: 2-speed, high efficiency PSC motor
- Filters: (1) replaceable TFP collector and (1) replaceable HEPA filter



### Turbulent Flow Precipitators Parts

| Part # | Mfg #   | Description                   | Price |
|--------|---------|-------------------------------|-------|
| 118135 | 65-502R | (1) Replacement HEPA Filter   |       |
| 080808 | 65-503R | (1) Replacement TFP Collector |       |

### Indoor Pool and Spa Heat Recover Ventilators

- Controls humidity in wet areas such as pools, spas, whirlpools, saunas, and personal gyms



| Part # | Mfg #       | Description  | Price |
|--------|-------------|--|-------|
| 077178 | 700 DD POOL | (2) Air Stream Sections: Each w/PSC, 3-Speed, Sngl Shaft, 120VAC, 4.5A, 1/4 hp, 1450 rpm Motor |       |

### Optional Remote Controls

#### Digital Electronic Timers

- Can be mounted up to 60' from HRV
- Can override the base module and activate high speed operation
- Easy to install and operate
- Works well in bathrooms, laundries, and other high moisture areas
- Touch pad operation
- Childproof lockout feature
- 20/40/60 Minute status lights
- 60' (18 m) maximum wire length only, may be wired in parallel if no other controls are used



| Part # | Mfg #   | Connects To            | Color | Price |
|--------|---------|------------------------|-------|-------|
| 039208 | 99-107W | Cover Plate for 99-104 | White |       |

### Timers

#### Crank Timer

| Part # | Mfg #  | Description  | Color | Price |
|--------|--------|--|-------|-------|
| 030653 | 99-101 | Rotate the Dial for up to 60 Minutes of High Speed Operation | White |       |

## Air-to-Air Heat Exchangers

### Lifestyle Controls and Timers MAX Series Digital Wall Control

- Slim-line design
- Service indicator
- 5-Speed fan setting
- Electronic dehumidistat
- Standby setting (fan speed 0)
- 20/40/60 High speed override button
- Compatible with 99-DET02 wireless timers
- Connects to 3 wire 20 gauge low voltage wire
- Five modes of operation
  - Continuous ventilation
  - 20 min. ventilation / 40 min. recirculation
  - 20 min. ventilation / 40 min. off
  - 10 min. ventilation / 50 min. off
  - Continuous recirculation



Air Treatment & Filters

| Part # | Mfg #     | Description                                   | Color | Price |
|--------|-----------|---|-------|-------|
| 190256 | 99-DXPL02 | (5) Selectable modes, Electronic Dehumidistat | White |       |

### Lifestyle RNC Dehumidistat

- Initiates high speed when the indoor humidity level is above the setpoint
- Optional on RNC



| Part # | Mfg #   | Description             | Color | Price |
|--------|---------|-------------------------|-------|-------|
| 125855 | 99-DH01 | RNC Series Dehumidistat | White |       |

### Lifestyle RNC Ventilation Control

- 2-Speed operation
- Standby
- Dehumidistat
- Optional on RNC



| Part # | Mfg #   | Description                    | Color | Price |
|--------|---------|--------------------------------|-------|-------|
| 125856 | 99-BC01 | RNC Series Ventilation Control | White |       |

## Air-to-Air Heat Exchangers

Air Treatment & Filters

### Lifestyle 20/40/60 Minute Timer

- Initiates high speed operation for 20, 40, or 60 minutes
- Compatible with MAX and RNC Series



| Part # | Mfg #    | Description           | Color | Price |
|--------|----------|-----------------------|-------|-------|
| 125858 | 99-DET01 | 20/40/60 Minute Timer | White |       |

### Wireless 20/40/60 Minute Timer

- Estimated range of 40 feet
- Initiates high speed operation for 20, 40, or 60 minutes
- Compatible with Repeater (99-RX02)
- Can be surface or E-box mounted
- Includes battery



Wireless timer is not backwards compatible

| Part # | Mfg #    | Description           | Color | Price |
|--------|----------|-----------------------|-------|-------|
| 240371 | 99-DET02 | 20/40/60 Minute Timer | Grey  |       |

## Dampers

| Part # | Mfg #   | Description             | Price |
|--------|---------|-------------------------|-------|
| 092347 | 99-RSK6 | 6" Spring Loaded Damper |       |

## Weatherhood Kits

- Ideal for HRV/ERV and in-line applications
- High density polyethylene for a durable, long life even in severe climate
- No moving parts, eliminates freezing or sticking potential
- Includes:
  - (2) Hoods
  - 12" Wall sleeve
  - Duct collar
  - Insect/animal screens



| Part # | Mfg #  | Size        | Color | Price |
|--------|--------|-------------|-------|-------|
| 027708 | 99-186 | 6" Diameter | White |       |
| 028790 | 99-187 | 7" Diameter | White |       |

## Air-to-Air Heat Exchangers

### Dual Vent Hoods

- Requires only (1) 6" opening for intake/exhaust
- Damage-resistant metal construction for exterior wall connection
- Durable rigid plastic
- Suitable for 5" or 6" connections
- Maximized airflow with lower pressure drop
- Fire-rated, UV-resistant materials
- Ideal for space-constrained HRV or ERV applications
- Includes:
  - Hood assembly
  - Duct splitter
  - Duct insulator (2 pieces)
  - Retainer screw assembly
  - Nylon cable tie
  - Screen



Air Treatment & Filters

| Part # | Mfg #  | Description                         | Color | Price |
|--------|--------|-------------------------------------|-------|-------|
| 141190 | 99-190 | Fully Adjustable Thermal Insulation | White |       |

### Accessories

| Part # | Mfg #   | Description                     | Price |
|--------|---------|---------------------------------|-------|
| 037748 | 99-110  | HRV/TFP/CAF Interface Relay Kit |       |
| 240372 | 99-RX02 | Wireless Repeater               |       |

### Optional 3-Speed Control

- 3-Speed high/medium/high
- On/off
- 4-Wire, 20 gauge wire

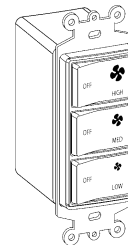

| Part # | Mfg #  | Description     | Price |
|--------|--------|-----------------|-------|
| 077599 | 99-500 | 3-Speed Control |       |

**Air-to-Air Heat Exchangers**

**Ventilation**

**TrueFRESH Energy Recovery Ventilator**

- TrueFRESH eliminates the need for overhead ducting, and balance without adjusting dampers, they change everything when it comes to time consuming installation
- Removable duct collars
- Damperless balancing
- Adjustable hanging straps
- Centralized wiring and speed control
- Customizable
- Compact size
- Meets ASHRAE 62.2 standards
- 5-Year warranty



| Part # | Mfg #         | Description  | Price |
|--------|---------------|--|-------|
| 152253 | VNT5200E1000U | 200 cfm Energy Recovery Ventilator, 120 VAC, 60 Hz |       |

**TrueFRESH Heat Recovery Ventilator**

- TrueFRESH eliminates the need for overhead ducting, and balance without adjusting dampers, they change everything when it comes to time consuming installation
- Removable Duct Collars
- Damperless Balancing
- Adjustable Hanging Straps
- Centralized Wiring and Speed Control
- Customizable
- Compact Size
- Meets ASHRAE 62.2 Standards
- 5-Year Warranty



| Part # | Mfg #         | Description  | Price |
|--------|---------------|--|-------|
| 244778 | VNT5070H1000U | 120 VAC, 60 Hz, 70 cfm at external static pressure 0.4" wc |       |
| 243914 | VNT5150H1000U | 120 VAC, 60 Hz 150 cfm at external static pressure 0.4" wc |       |

Air Treatment & Filters

**Humidifiers/Dehumidifiers**

**Humidifiers**

**TrueEASE™ Flow-Through Humidifier**

- Up to 30% water savings, up to 50% water savings with fan-powered model
- PerfectFLO™ water distribution tray
- Common-sense interface
- AgION® humidifier pads with anti-microbial coating
- User-friendly pad access
- Interchangeable bypass
- Integrated wiring and quick-connect plumbing
- Includes humidifier, saddle valve, water supply line, 10' drain hose, H8908 manual humidity control, hardware, mounting template and owner's manual



Advanced Bypass



Fan-Powered

Air Treatment & Filters

| Part # | Mfg #      | Description           | Output | Price |
|--------|------------|-----------------------|--------|-------|
| 134722 | HE100A1000 | Bypass Small Basic    | 12 gpd |       |
| 134723 | HE150A1005 | Bypass Small Advanced | 12 gpd |       |
| 134724 | HE200A1000 | Bypass Large Basic    | 17 gpd |       |
| 134725 | HE250A1005 | Bypass Large Advanced | 17 gpd |       |
| 134726 | HE300A1005 | Fan-Powered Advanced  | 18 gpd |       |

**Humidifier Replacement Pads**



HC22A

| Part # | Mfg #     | Description   | Price |
|--------|-----------|---|-------|
| 030568 | HC22A1007 | HE220 Pad for HE220, HE225, Aprilaire 110,220,550,558   |       |
| 034029 | HC26A1008 | HE260, HE360 Pad for HE260, HE265, HE360, HE365, Aprilaire 350,360,560,568, 600,700,760,768       |       |
| 144661 | HC26E1004 | HE200, HE250, HE260, HE265, HE300, HE360, HE365, Aprilaire 350, 360, 560, 568, 600, 700, 760, 769 |       |
| 146138 | HC22E1003 | HE225 Pad with AGION™ Coating for HE220, HE225, Aprilaire 110,220,550,558                         |       |

**Remote Mount Kit**

| Part # | Mfg #               | Description  | Price |
|--------|---------------------|--|-------|
| 111236 | 50024917-001        | 10' Remote Mount Kit for All TrueSTEAM Humidifiers                 |       |
| 111237 | 50024917-002        | 20' Remote Mount Kit for HM512 and HM509R TrueSTEAM Humidifiers    |       |
| 185466 | HM700ADISTKIT/<br>U | 5' Stainless Steel Remote Mount Kit for H6062 HumidPRO™ Humidifier |       |

**Reverse Osmosis Water Filter for Honeywell Steam Humidifier**

- TrueSTEAM
- 40°F - 100°F

| Part # | Mfg #       | Description                               | Price |
|--------|-------------|---|-------|
| 216297 | HM600XROF1U | RO Water Filter for TrueSTEAM Humidifiers |       |

**Humidifiers/Dehumidifiers**

**Humidity Controllers**

**H1008 Automatic Humidity Controller**

- Provides automatic control for by-pass, flow-through, powered flow-through, steam and drum humidifiers in central heating systems
- Patented Honeywell HumidiCalc+™ software
- Combination temperature and humidity sensor
- Automatically adjusts humidity level based on frost factor set by user
- Duct-mounted
- System status light indicates normal operation, test mode and fault



| Part # | Mfg #      | Description   | Price |
|--------|------------|---|-------|
| 037361 | H1008A1008 | Humidifier, 95% RH@95°F (Non-Condensing), Dew Point Control |       |

**H8908 Humidistat/Dehumidistat**

- Provides automatic low voltage control of humidifier and dehumidifiers or ventilators
- SPST, snap-acting, dust-proof switch designed for wall or surface duct mounting
- Positive on and off settings
- 12" Moisture sensitive nylon ribbon wound around three bobbins effectively gives optimum control for reliable operation under changing ambient conditions



H8908ASPST H8908DSPST

| Part # | Mfg #      | Application      | Color | Price |
|--------|------------|------------------|-------|-------|
| 111239 | H8908ASPST | Humidification   | White |       |
| 134079 | H8908DSPST | Dehumidification | White |       |

**H6062 HumidPRO™ Digital Humidity Control**

- Automatic humidification (window protection) with included outdoor sensor
- Manual humidification control
- Manual dehumidification control
- Dehumidifier compressor protection
- Large, digital backlit display
- Simple, intuitive programming
- RH% and outdoor temperature calibration
- Adjustable high and low range stops (10-90%)
- Automatically detects presence of outdoor sensor to set control to Automatic or Manual Mode



| Part # | Mfg #      | Description  | Price |
|--------|------------|--|-------|
| 171473 | H6062A1000 | Manual Mode: 10% to 90% RH% (Adjustable) Auto Mode: 10% to 60% RH% (35% Default) |       |

Air Treatment & Filters



## Humidifiers/Dehumidifiers

### Power Humidifiers - Drain Type

#### 1042 Legacy Series - By-Pass Flow-Through Power Humidifier

- Installs on vertical warm air supply or cold air plenum
- 6" Diameter side bypass duct (collar supplied)
- Plenum opening: 10-1/4"W x 9-1/2"H
- Replacement filter: 990-13 evaporator pad
- Order 1/4" tubing separately
- 5-Year limited warranty



| Part # | Mfg #  | Description                         | GPD  | Unit Size          | Electrical | Price |
|--------|--------|-------------------------------------|------|--------------------|------------|-------|
| 004860 | 1042LH | Recirculating Type, MHX3 Humidistat | 19.2 | 11-1/2" x 15" x 9" | 115V/60Hz  |       |

**Humidifiers/Dehumidifiers**

Air Treatment & Filters

**Dehumidifiers**

**Dehumidifier - 50 Point**

- Chevalier 11
- Large capacity water tank
- Smart Dehumidifying mode
- 115/60/1 Power supply
- Moisture removal at 30°C, 80% R.H. : 50
- Moisture removal at 27.2°C, 60%R.H. : 530



| Part # | Mfg #          | Description           | Price |
|--------|----------------|-----------------------|-------|
| 225580 | CBD-50H1A-D11L | 50 Point Dehumidifier |       |

**Humidifier Parts & Accessories**

**Evaporator Pads**



84-25055-01

| Part # | Mfg #       | Description                      | Price |
|--------|-------------|----------------------------------|-------|
| 089995 | 84-A97      | Autoflo Drum Type Evaporator Pad |       |
| 090002 | 84-4EP      | Autoflo Metal Evaporator Pad     |       |
| 059586 | 84-25055-01 | 9"x14"x2" Evaporator Pad         |       |
| 044159 | 84-25055-02 | 9"x11"x2" Evaporator Pad         |       |

**Humidifiers/Dehumidifiers**

**Dehumidifiers**

**TrueDRY DH65 Whole-House Dehumidifier**

- Removes up to 65 pints of water from the indoor air
- Built-in humidity control requires no additional wiring to an external control
- Choice of external control options also available for centrally ducted control
- Feedback on operation and maintenance provided via intuitive on-board LED light interface
- MERV 11 Filtration



| Part # | Mfg #     | Description   | Price |
|--------|-----------|---|-------|
| 148234 | DR65A2000 | 8" Diameter Plenum Opening w/o Controls Uses R-410A Refrigerant |       |

**TrueDRY DR90 Whole-House Dehumidifier**

- Removes up to 90 pints of water from the indoor air
- Built-in fresh air supply
- Uses only 6.7 amps for energy efficiency
- MERV 11 Filtration
- R-410A compliant
- 5-Year warranty
- Energy Star® rated



| Part # | Mfg #     | Description   | Price |
|--------|-----------|---|-------|
| 131281 | DR90A3000 | 10" Plenum Opening with 6" Ventilation Collar, less Control |       |

**DR90/DR120 Filter**

| Part # | Mfg #        | Description                                 | Price |
|--------|--------------|---|-------|
| 153194 | 50070171-002 | TruDry Filter used with DR90A2000 and DR120 |       |

**TrueDRY DR120 Whole-House Dehumidifier**

- Removes 120 pints of water per day from the indoor air
- Built-in fresh air supply
- Energy Star Rated
- E-Coated Coil delivers longer life and increased efficiency
- Certifications include UL474, CSA, C22.2 No 92



| Part # | Mfg #      | Description                                   | Price |
|--------|------------|---|-------|
| 241584 | DR120A3000 | 10" Plenum Opening with 6" Ventilation Collar |       |

**Humidifiers/Dehumidifiers**

Air Treatment & Filters

**Humidifiers**

**Advanced Electrode Humidifier**

- On-demand steam humidification solution
- 60Hz frequency
- 120v or 240v voltage
- 11 or 22 gallons per day
- Duct or wall mounting
- Communtion with a variety of thermostat options including Lyric, PrestigeIAQ, and VisionPRO™ HumidiPRO™ included
- Humidifier replacement cylinder designed for Rapid, simplified, DIY replacement —Recommended annually dependent on water quality



| Part # | Mfg #        | Size              | Color  | Price |
|--------|--------------|-------------------|--------|-------|
| 240934 | HM750A1000/U | 10"W x 7"H x 20"L | Silver |       |

**HM750 Advanced Electrode Humidifier Replacement Cylind**

- On-demand steam humidification solution
- 11 or 22 gallons per day
- Used with HM750 Honeywell electrode steam humidifier
- Communtion with a variety of thermostat options including Lyric, PrestigeIAQ, and VisionPRO™ HumidiPRO™ included
- Humidifier replacement cylinder designed for Rapid, simplified, DIY replacement —Recommended annually dependent on water quality



| Part # | Mfg #       | Size                | Color | Price |
|--------|-------------|---------------------|-------|-------|
| 240939 | HM750ACYL/U | 6"W x 13"H x 5.57"L | White |       |

**HM750 Advanced Electrode Humidifier Steam Hose**

- On-demand steam humidification solution
- Used with HM750 Honeywell electrode steam humidifier
- Communtion with a variety of thermostat options including Lyric, PrestigeIAQ, and VisionPRO™ HumidiPRO™ included
- Humidifier replacement cylinder designed for Rapid, simplified, DIY replacement —Recommended annually dependent on water quality

| Part # | Mfg #           | Size  | Color | Price |
|--------|-----------------|-------|-------|-------|
| 240940 | HM750AHOSEKIT/U | 15 ft | Black |       |

**Humidifiers/Dehumidifiers**

Air Treatment & Filters

**HM750 Advanced Electrode Humidifier Nozzle Kit**

- Kit includes:
  - Steam hose
  - Condensate hose
  - Steam distributor
  - Installation hardware
- On-demand steam humidification solution
- Used with HM750 Honeywell electrode steam humidifier
- Communtion with a variety of thermostat options including Lyric, PrestigeIAQ, and VisionPRO™ HumidiPRO™ included
- Humidifier replacement cylinder designed for Rapid, simplified, DIY replacement —Recommndded annually dependent on water quality

| Part # | Mfg #        | Size             | Color | Price |
|--------|--------------|------------------|-------|-------|
| 240941 | HM750ANKIT/U | 5"W x 15"H x 5"L | -     |       |

**HM750 Advanced Electrode Humidifier Replacement PC Board**

- 60Hz frequency
- 120v or 240v voltage
- Communtion with a variety of thermostat options including Lyric, PrestigeIAQ, and VisionPRO™ HumidiPRO™ included
- Humidifier replacement cylinder designed for Rapid, simplified, DIY replacement —Recommndded annually dependent on water quality

| Part # | Mfg #       | Size                 | Color | Price |
|--------|-------------|----------------------|-------|-------|
| 240942 | HM750APCB/U | 5"W x 1.65"H x 9.5"L | Green |       |

**HM750 Advanced Electrode Humidifier Valve Kit**

- Use with HM750 Honeywell electrode steam humidifier
- Communtion with a variety of thermostat options including Lyric, PrestigeIAQ, and VisionPRO™ HumidiPRO™ included
- Humidifier replacement cylinder designed for Rapid, simplified, DIY replacement —Recommndded annually dependent on water quality

| Part # | Mfg #        | Size            | Color | Price |
|--------|--------------|-----------------|-------|-------|
| 240943 | HM750AVKIT/U | 4"W x 5"H x 4"L | -     |       |

## Throwaway Filters

Air Treatment & Filters

### Z-Line Pleated Series Filters

- Ideal in high velocity systems where maximum square footage of media is necessary
- Features 100% synthetic fibers laminated to galvanized metal backing
- Designed to be utilized as either pre-filters or primary filters in virtually every commercial, industrial, and residential HVAC application
- **MERV 7**
- 100% Synthetic, charged media



#### 1" ZL Z-Line Series Pleated Filter

| Part # | Mfg #        | Size                   | Price |
|--------|--------------|------------------------|-------|
| 102089 | ZLP10201     | 10" x 20" x 1"         |       |
| 004301 | ZLP12121     | 12" x 12" x 1"         |       |
| 102091 | ZLP12201     | 12" x 20" x 1"         |       |
| 102092 | ZLP12241     | 12" x 24" x 1"         |       |
| 102094 | ZLP14201     | 14" x 20" x 1"         |       |
| 042535 | ZLP14251     | 14" x 25" x 1"         |       |
| 112438 | ZLP14301     | 14" x 30" x 1"         |       |
| 102095 | ZLP15201     | 15" x 20" x 1"         |       |
| 035858 | ZLP16201     | 16" x 20" x 1"         |       |
| 102093 | ZLPSP1E      | 16" x 22" x 1"         |       |
| 036832 | ZLP16251     | 16" x 25" x 1"         |       |
| 110862 | ZLP18181     | 18" x 18" x 1"         |       |
| 070781 | ZLP18201     | 18" x 20" x 1"         |       |
| 109164 | ZLP18241     | 18" x 24" x 1"         |       |
| 038324 | ZLP20201     | 20" x 20" x 1"         |       |
| 102099 | ZLP20241     | 20" x 24" x 1"         |       |
| 038325 | ZLP20251     | 20" x 25" x 1"         |       |
| 115791 | ZLPSP22D29H1 | 22.25" x 29.5" x 1"    |       |
| 102096 | ZLP24241     | 24" x 24" x 1"         |       |
| 053645 | ZLP25251     | 25" x 25" x 1"         |       |
| 115787 | ZLPSP27M31M1 | 27-3/4" x 31-3/4" x 1" |       |
| 115788 | ZLPSP27M35M1 | 27-3/4" x 35-3/4" x 1" |       |
| 131831 | ZLPSP1K28341 | 28" x 34" x 1"         |       |
| 115793 | ZLPSP28D30H1 | 28.25" x 30.5" x 1"    |       |
| 121768 | ZLP30361     | 30" x 36" x 1"         |       |
| 115794 | ZLPSP30B32H1 | 30.125" x 32.5" x 1"   |       |

#### 2" ZL Z-Line Series Pleated Filter

| Part # | Mfg #    | Size           | Price |
|--------|----------|----------------|-------|
| 004314 | ZLP16162 | 16" x 16" x 2" |       |
| 031788 | ZLP16202 | 16" x 20" x 2" |       |
| 159073 | ZLP16242 | 16" x 24" x 2" |       |

### Z-Line Pleated Series Filters (Continued)

#### 2" ZL Z-Line Series Pleated Filter

| Part # | Mfg #    | Size           | Price |
|--------|----------|----------------|-------|
| 027336 | ZLP16252 | 16" x 25" x 2" |       |
| 047466 | ZLP18182 | 18" x 18" x 2" |       |
| 042085 | ZLP18242 | 18" x 24" x 2" |       |
| 030585 | ZLP20202 | 20" x 20" x 2" |       |
| 121378 | ZLP20242 | 20" x 24" x 2" |       |
| 034676 | ZLP20252 | 20" x 25" x 2" |       |
| 094283 | ZLP24242 | 24" x 24" x 2" |       |
| 040794 | ZLP25252 | 25" x 25" x 2" |       |

#### 4" ZL Z-Line Series Pleated Filter

| Part # | Mfg #    | Size           | Price |
|--------|----------|----------------|-------|
| 083372 | ZLP16204 | 16" x 20" x 4" |       |
| 063647 | ZLP16254 | 16" x 25" x 4" |       |
| 071312 | ZLP20204 | 20" x 20" x 4" |       |
| 023474 | ZLP20254 | 20" x 25" x 4" |       |
| 050395 | ZLP24244 | 24" x 24" x 4" |       |

### Z-Line Series Media Replacement Filters

#### Z-Line Series 500AB and 300AB Air Cleaner Media

- Replacement options for Trion Air Bear® and Air Cub® filters
- 100% Synthetic, charged media



| Part # | Mfg #    | Size                    | Price |
|--------|----------|-------------------------|-------|
| 080685 | ABP16255 | 16" x 25" x 5", Merv 10 |       |
| 102417 | ABP20255 | 20" x 25" x 5"          |       |

### Filter Pads & Bulk Media

- UL Class 2

#### FSR Fiberglass Service Roll



| Part # | Mfg #    | Size           | Price |
|--------|----------|----------------|-------|
| 004334 | FSR30201 | 30" x 20' x 1" |       |
| 004336 | FSR36201 | 36" x 20' x 1" |       |

---

---

## Throwaway Filters

---

---

### Carbon Media Filters

- *MERV 13*
- *Activated carbon core*
- *Rated life cycle: 30 - 90 days*



#### Replacement Carbon Media Filter Pad

| Part # | Mfg #   | Size      | Qty  | Price |
|--------|---------|-----------|------|-------|
| 109748 | C3P2832 | 28" x 32" | 3/Pk |       |
| 099419 | C3P2836 | 28" x 36" | 3/Pk |       |



## Throwaway Filters

Air Treatment & Filters

### Disposable Media Filters

#### Filter Media

| Part # | Mfg #       | Description     | Price |
|--------|-------------|-----------------|-------|
| 045070 | 54-25051-02 | Filter Media 3" |       |

#### Media Air Filter

| Part # | Mfg #  | Description      | Price |
|--------|--------|------------------|-------|
| 131298 | 540013 | 4-1/2" 2,000 CFM |       |



**Throwaway Filters**

**Air Filters**  
**Media Air Filters**



| Part # | Mfg #      | Description     | Price |
|--------|------------|-----------------|-------|
| 062226 | 54-14X25-R | 14" x 25", 3/Pk |       |
| 042240 | 54-16X20-R | 16" x 20", 3/Pk |       |
| 042241 | 54-16X25-R | 16" x 25", 3/Pk |       |
| 048021 | 54-20X20-R | 20" x 20", 3/Pk |       |
| 042242 | 54-20X25-R | 20" x 25", 3/Pk |       |

*Air Treatment & Filters*

## Throwaway Filters

Air Treatment & Filters

### Commercial & Industrial Disposable Panel Filters

- Economical air filters designed for light-to-medium duty air filtration applications
- Durable construction for all types of industrial and commercial applications
- Progressive density glass or poly filter media
- Heavy-duty frame and corners for added strength and durability
- Environmentally friendly
- Special sizes available
- Easy to install



#### 1" Polyester Media

- Dual-layered high performance media for applications where synthetic filter media is specified

| Part # | Mfg #   | Size           | Price |
|--------|---------|----------------|-------|
| 196132 | FF10101 | 10" x 10" x 1" |       |
| 192104 | FF10201 | 10" x 20" x 1" |       |
| 192116 | FF10251 | 10" x 25" x 1" |       |
| 193946 | FF10301 | 10" x 30" x 1" |       |
| 192100 | FF12121 | 12" x 12" x 1" |       |
| 192105 | FF12201 | 12" x 20" x 1" |       |
| 194254 | FF12161 | 12" x 16" x 1" |       |
| 192113 | FF12241 | 12" x 24" x 1" |       |
| 192117 | FF12251 | 12" x 25" x 1" |       |
| 193638 | FF12301 | 12" x 30" x 1" |       |
| 192101 | FF14141 | 14" x 14" x 1" |       |
| 192103 | FF14181 | 14" x 18" x 1" |       |
| 192106 | FF14201 | 14" x 20" x 1" |       |
| 193455 | FF14241 | 14" x 24" x 1" |       |
| 192118 | FF14251 | 14" x 25" x 1" |       |
| 192126 | FF14301 | 14" x 30" x 1" |       |
| 192107 | FF15201 | 15" x 20" x 1" |       |
| 192119 | FF15251 | 15" x 25" x 1" |       |
| 192102 | FF16161 | 16" x 16" x 1" |       |
| 192108 | FF16201 | 16" x 20" x 1" |       |
| 194314 | FF16241 | 16" x 24" x 1" |       |
| 192121 | FF16251 | 16" x 25" x 1" |       |
| 192127 | FF16301 | 16" x 30" x 1" |       |
| 194330 | FF18181 | 18" x 18" x 1" |       |
| 193758 | FF18201 | 18" x 20" x 1" |       |
| 193280 | FF18241 | 18" x 24" x 1" |       |
| 192122 | FF18251 | 18" x 25" x 1" |       |
| 193639 | FF18301 | 18" x 30" x 1" |       |
| 192110 | FF20201 | 20" x 20" x 1" |       |

### Commercial & Industrial (Continued) 1" Polyester Media

| Part # | Mfg #   | Size           | Price |
|--------|---------|----------------|-------|
| 192114 | FF20241 | 20" x 24" x 1" |       |
| 192123 | FF20251 | 20" x 25" x 1" |       |
| 193195 | FF20301 | 20" x 30" x 1" |       |
| 192111 | FF22221 | 22" x 22" x 1" |       |
| 192115 | FF24241 | 24" x 24" x 1" |       |
| 192128 | FF24301 | 24" x 30" x 1" |       |
| 192124 | FF25251 | 25" x 25" x 1" |       |

#### 2" Polyester Media

- Dual-layered high performance media for applications where synthetic filter media is specified

| Part # | Mfg #   | Size           | Price |
|--------|---------|----------------|-------|
| 192133 | FF12242 | 12" x 24" x 2" |       |
| 193471 | FF14202 | 14" x 20" x 2" |       |
| 194405 | FF14252 | 14" x 25" x 2" |       |
| 192132 | FF16162 | 16" x 16" x 2" |       |
| 192135 | FF16202 | 16" x 20" x 2" |       |
| 193431 | FF16242 | 16" x 24" x 2" |       |
| 192140 | FF16252 | 16" x 25" x 2" |       |
| 193430 | FF18242 | 18" x 24" x 2" |       |
| 199327 | FF18252 | 18" x 25" x 2" |       |
| 192136 | FF20202 | 20" x 20" x 2" |       |
| 193618 | FF20242 | 20" x 24" x 2" |       |
| 192141 | FF20252 | 20" x 25" x 2" |       |
| 194346 | FF24242 | 24" x 24" x 2" |       |
| 192142 | FF25252 | 25" x 25" x 2" |       |

### Special Size Polyester Disposable Filters

#### 1" Filters

| Part # | Mfg #       | Size                   | Price |
|--------|-------------|------------------------|-------|
| 201112 | FF10161     | 10" x 16" x 1"         |       |
| 213283 | FF11201     | 11" x 20" x 1"         |       |
| 196940 | FF12141     | 12" x 14" x 1"         |       |
| 204077 | FF12211     | 12" x 21" x 1"         |       |
| 202132 | FF12221     | 12" x 22" x 1"         |       |
| 197497 | FF13201     | 13" x 20" x 1"         |       |
| 202021 | FF13211     | 13" x 21" x 1"         |       |
| 196090 | FF1321121   | 13" x 21-1/2" x 1"     |       |
| 199595 | FF131221121 | 13-1/2" x 21-1/2" x 1" |       |
| 194345 | FF14161     | 14" x 16" x 1"         |       |
| 201093 | FF15151     | 15" x 15" x 1"         |       |
| 196210 | FF15221     | 15" x 22" x 1"         |       |
| 203341 | FF15241     | 15" x 24" x 1"         |       |

**Throwaway Filters**

**Commercial & Industrial (Continued)  
Special Size Polyester Disposable Filters  
1" Filters**

| Part # | Mfg #       | Size                   | Price |
|--------|-------------|------------------------|-------|
| 192120 | FF16221     | 16" x 22" x 1"         |       |
| 204616 | FF1621121   | 16" x 21-1/2" x 1"     |       |
| 196089 | FF163821121 | 16-3/8" x 21-1/2" x 1" |       |
| 203344 | FF161421121 | 16-1/4" x 2-1/2" x 1"  |       |
| 198758 | FF1712201   | 17-1/2" x 20" x 1"     |       |
| 194677 | FF18221     | 18" x 22" x 1"         |       |
| 193115 | FF20221     | 20" x 20" x 1"         |       |
| 196088 | FF2021121   | 20" x 21-1/2" x 1"     |       |
| 202535 | FF211223121 | 21-1/2" x 23-1/2" x 1" |       |
| 197777 | FF211223341 | 21-1/2" x 23-3/4" x 1" |       |

**2" Filters**

| Part # | Mfg #   | Size           | Price |
|--------|---------|----------------|-------|
| 206602 | FF10252 | 10" x 25" x 2" |       |
| 213059 | FF14262 | 14" x 26" x 2" |       |
| 195987 | FF15202 | 15" x 20" x 2" |       |
| 204378 | FF16302 | 16" x 30" x 2" |       |
| 193668 | FF18182 | 18" x 18" x 2" |       |

**Special Size Fiberglass Disposable Filters  
1" Filters**

| Part # | Mfg #       | Size                   | Price |
|--------|-------------|------------------------|-------|
| 204439 | FG163821121 | 16-3/8" x 21-1/2" x 1" |       |
| 205127 | FG2021121   | 20" x 21-1/2" x 1"     |       |
| 205129 | FG18201     | 18" x 20" x 1"         |       |

**Multi-Pleat XL8™ MERV 8 Extended  
Surface Pleated Panel Filters**

- Mechanical Media
- Mechanical MERV 8 media is not reliant on electrostatic charge for efficiency
- Low resistance to airflow
- High Dust Holding Capacity
- Sturdy double-wall frame design
- Moisture resistant beverage board frame
- Standard and High Capacity models
- Available in 1", 2", and 4" depths



**1" Filters**

| Part # | Mfg #   | Size           | Price |
|--------|---------|----------------|-------|
| 193419 | PF10201 | 10" x 20" x 1" |       |

**Multi-Pleat XL8™ MERV 8 Extended  
Surface Pleated Panel Filters (Continued)  
Special Size Fiberglass Disposable Filters  
1" Filters**

| Part # | Mfg #   | Size           | Price |
|--------|---------|----------------|-------|
| 197849 | PF10241 | 10" x 24" x 1" |       |
| 195274 | PF12121 | 12" x 12" x 1" |       |
| 193317 | PF12201 | 12" x 20" x 1" |       |
| 194026 | PF12241 | 12" x 24" x 1" |       |
| 193315 | PF14141 | 14" x 14" x 1" |       |
| 193767 | PF14201 | 14" x 20" x 1" |       |
| 196429 | PF14221 | 14" x 22" x 1" |       |
| 193417 | PF14241 | 14" x 24" x 1" |       |
| 193768 | PF14251 | 14" x 25" x 1" |       |
| 193756 | PF15201 | 15" x 20" x 1" |       |
| 193769 | PF15251 | 15" x 25" x 1" |       |
| 194025 | PF16161 | 16" x 16" x 1" |       |
| 193418 | PF16201 | 16" x 20" x 1" |       |
| 196905 | PF16241 | 16" x 24" x 1" |       |
| 193421 | PF16251 | 16" x 25" x 1" |       |
| 193312 | PF16301 | 16" x 30" x 1" |       |
| 195983 | PF18181 | 18" x 18" x 1" |       |
| 195651 | PF18251 | 18" x 25" x 1" |       |
| 193757 | PF20201 | 20" x 20" x 1" |       |
| 194597 | PF20221 | 20" x 22" x 1" |       |
| 193414 | PF20241 | 20" x 24" x 1" |       |
| 193318 | PF20251 | 20" x 25" x 1" |       |
| 194660 | PF20301 | 20" x 30" x 1" |       |
| 193313 | PF24241 | 24" x 24" x 1" |       |
| 193420 | PF24301 | 24" x 30" x 1" |       |
| 193844 | PF25251 | 25" x 25" x 1" |       |

**2" Filters**

| Part # | Mfg #   | Size           | Price |
|--------|---------|----------------|-------|
| 194812 | PF12202 | 12" x 20" x 2" |       |
| 193755 | PF12242 | 12" x 24" x 2" |       |
| 193771 | PF14202 | 14" x 20" x 2" |       |
| 193772 | PF14252 | 14" x 25" x 2" |       |
| 199514 | PF15202 | 15" x 20" x 2" |       |
| 193770 | PF16202 | 16" x 20" x 2" |       |
| 195885 | PF16242 | 16" x 24" x 2" |       |
| 193754 | PF16252 | 16" x 25" x 2" |       |
| 194243 | PF18182 | 18" x 18" x 2" |       |
| 195623 | PF18202 | 18" x 20" x 2" |       |
| 193753 | PF18242 | 18" x 24" x 2" |       |
| 193319 | PF20202 | 20" x 20" x 2" |       |

Air Treatment & Filters

## Throwaway Filters

Air Treatment & Filters

### Multi-Pleat XL8™ MERV 8 Extended Surface Pleated Panel Filters (Continued)

#### Special Size Fiberglass Disposable Filters

##### 2" Filters

| Part # | Mfg #   | Size           | Price |
|--------|---------|----------------|-------|
| 195272 | PF20242 | 20" x 24" x 2" |       |
| 193773 | PF20252 | 20" x 25" x 2" |       |
| 197608 | PF20302 | 20" x 30" x 2" |       |
| 193874 | PF24242 | 24" x 24" x 2" |       |
| 194199 | PF25252 | 25" x 25" x 2" |       |

##### 4" Filters

| Part # | Mfg #   | Size           | Price |
|--------|---------|----------------|-------|
| 194418 | PF16254 | 16" x 25" x 4" |       |
| 198920 | PF20204 | 20" x 20" x 4" |       |
| 197791 | PF20254 | 20" x 25" x 4" |       |
| 200913 | PF16204 | 16" x 20" x 4" |       |

#### Special Size XL MERV 8 Pleated Filters

##### 1" Filters

| Part # | Mfg #       | Size                   | Price |
|--------|-------------|------------------------|-------|
| 196429 | PF14221     | 14" x 22" x 1"         |       |
| 195235 | PF14301     | 14" x 30" x 1"         |       |
| 194301 | PF16181     | 16" x 18" x 1"         |       |
| 196377 | PF163821121 | 16-3/8" x 21-1/2" x 1" |       |
| 193316 | PF18201     | 18" x 20" x 1"         |       |
| 193415 | PF18241     | 18" x 24" x 1"         |       |
| 193314 | PF22221     | 22" x 22" x 1"         |       |

##### 2" Filters

| Part # | Mfg #   | Size           | Price |
|--------|---------|----------------|-------|
| 194944 | PF16162 | 16" x 16" x 2" |       |

#### Honeywell Replacement Filter for MERV 8

| Part # | Mfg #     | Size           | Price |
|--------|-----------|----------------|-------|
| 194289 | PF16255HW | 16" x 25" x 5" |       |

**Throwaway Filters**

**Residential Media Air Cleaners  
Pop-Up Replacement Media Air Filter**

- Stores flat and pops into shape for installation
- Store (5) pop-up filters in the space of (1) standard replacement cartridge
- Additional 1" of filtration depth compared to standard replacement cartridges
- No combs, pleat spacers or end caps



| Part # | Mfg #     | Size                       | Efficiency | Used With                       | Price |
|--------|-----------|----------------------------|------------|---------------------------------|-------|
| 101237 | POPUP2200 | 20-1/4" x 24-1/4" x 5-7/8" | MERV 11    | Space-Gard® 2200                |       |
| 103142 | POPUP2400 | 26" x 27-1/8" x 5-7/8"     | MERV 11    | Space-Gard® 2400, Lennox PMAC12 |       |

**Residential Air Cleaner Replacement High Efficiency Media Filter**



| Part # | Mfg #       | Size      | Efficiency | Used With                  | Price |
|--------|-------------|-----------|------------|----------------------------|-------|
| 052258 | FC100A1029  | 16" x 25" | MERV 10    | F100, F200                 |       |
| 052773 | FC100A1037  | 20" x 25" | MERV 10    | F100, F200, SpaceGard 2200 |       |
| 054468 | FC100A1011U | 20" x 20" | MERV 10    | F100, F200                 |       |
| 054467 | FC100A1003  | 16" x 20" | MERV 10    | F100, F200                 |       |

Air Treatment & Filters

## Throwaway Filters

Air Treatment & Filters

### High Efficiency Media Air Cleaners Replacement Filter Media



| Part # | Mfg # | Description                                       | Price |
|--------|-------|---|-------|
| 019291 | 12880 | MERV 11 Replacement Media for Aprilaire 2200/2250 |       |

### MERV 10 Replacement Filter Media

- MERV 10



| Part # | Mfg # | Description   | GPD | Unit Size | Electrical | Price |
|--------|-------|---|-----|-----------|------------|-------|
| 205149 | 4501  | 20" x 25" x 5", Replaces TRION media part #255649-102 |     |           |            |       |
| 211223 | 4511  | 16" x 25" x 5", MERV 10                               |     |           |            |       |



## Air Handlers

### Air Handlers

- 4-Way Convertible Upflow, Downflow, Horizontal Left and Horizontal Right Applications
- Factory-Installed Indoor Coil
- Field Installed Auxiliary Heater Kits Available



**Warranties**  
10-Yr Parts Warranty

### RH2T Two-Stage Air Handler - Constant Torque Motor (ECM) 230 Volt

| Part # | Mfg #          | Tons  | Max Kw | CFM Lo | CFM Hi | H x L x W                   | Price |
|--------|----------------|-------|--------|--------|--------|-----------------------------|-------|
| 171738 | RH2T2421MTANJA | 2 Ton | 10     | 525    | 700    | 42-1/2" x 21-3/4" x 21"     |       |
| 171739 | RH2T3621MTANJA | 3 Ton | 18     | 800    | 1050   | 50-1/2" x 21-3/4" x 21"     |       |
| 171740 | RH2T4824MTANJA | 4 Ton | 25     | 1050   | 1400   | 55-1/2" x 21-3/4" x 24-1/2" |       |
| 171741 | RH2T6024STANJA | 5 Ton | 25     | 1200   | 1600   | 55-1/2" x 21-3/4" x 24-1/2" |       |

### RH2T Two-Stage Air Handler - Constant Torque Motor (ECM)

EcoNet Enabled

| Part # | Mfg #          | Tons  | Max Kw | CFM Lo | CFM Hi | H x L x W                   | Price |
|--------|----------------|-------|--------|--------|--------|-----------------------------|-------|
| 185067 | RH2T2417SEACJA | 2 Ton | 18     | 600    | 1200   | 42-1/2" x 21-3/4" x 17-1/2" |       |
| 178002 | RH2T2421MEACJA | 2 Ton | 25     | 800    | 1600   | 42-1/2" x 21-3/4" x 21"     |       |
| 185069 | RH2T3617SEACJA | 3 Ton | 18     | 600    | 1200   | 42-1/2" x 21-3/4" x 21"     |       |
| 178003 | RH2T3621MEACJA | 3 Ton | 25     | 800    | 1600   | 50-1/2" x 21-3/4" x 21"     |       |
| 178004 | RH2T4821MEACJA | 4 Ton | 25     | 800    | 1600   | 57" x 21-3/4" x 21"         |       |
| 178005 | RH2T6024MEACJA | 5 Ton | 30     | 1400   | 1800   | 55-1/2" x 21-3/4" x 24-1/2" |       |

### RH1T Single-Stage Air Handler - Constant Torque Motor (ECM) 230 Volt

| Part # | Mfg #          | Tons  | Max Kw | CFM Lo | CFM Hi | H x L x W                   | Price |
|--------|----------------|-------|--------|--------|--------|-----------------------------|-------|
| 171725 | RH1T2417STANJA | 2 Ton | 10     | 600    | 800    | 42-1/2" x 21-3/4" x 17-1/2" |       |
| 171727 | RH1T3617STANJA | 3 Ton | 18     | 1,000  | 1,200  | 42-1/2" x 21-3/4" x 17-1/2" |       |
| 171731 | RH1T3621HTANJA | 3 Ton | 18     | 1,000  | 1,200  | 57" x 21-3/4" x 21"         |       |
| 171729 | RH1T3621MTANJA | 3 Ton | 18     | 1,000  | 1,200  | 50-1/2" x 21-3/4" x 21"     |       |
| 171733 | RH1T4821STANJA | 4 Ton | 25     | 1,400  | 1,600  | 50-1/2" x 21-3/4" x 21"     |       |
| 171735 | RH1T4824STANJA | 4 Ton | 25     | 1,400  | 1,600  | 50-1/2" x 21-3/4" x 24-1/2" |       |
| 176251 | RH1T6021STANJA | 5 Ton | 25     | 1,600  | -      | 50-1/2" x 21-3/4" x 24-1/2" |       |
| 171737 | RH1T6024STANJA | 5 Ton | 25     | 1,800  | -      | 55-1/2" x 21-3/4" x 24-1/2" |       |

### RH1T Single-Stage Air Handler - Constant Torque Motor (ECM) 115 Volt

| Part # | Mfg #          | Tons  | Max Kw | CFM Lo | CFM Hi | H x L x W                   | Price |
|--------|----------------|-------|--------|--------|--------|-----------------------------|-------|
| 171724 | RH1T2417STANAA | 2 Ton | 10     | 600    | 800    | 42-1/2" x 21-3/4" x 17-1/2" |       |
| 171726 | RH1T3617STANAA | 3 Ton | 18     | 1,000  | 1,200  | 42-1/2" x 21-3/4" x 17-1/2" |       |
| 171732 | RH1T4821STANAA | 4 Ton | 25     | 1,000  | 1,400  | 50-1/2" x 21-3/4" x 21"     |       |
| 171734 | RH1T4824STANAA | 4 Ton | 25     | 1,600  | -      | 50-1/2" x 21-3/4" x 24-1/2" |       |
| 176250 | RH1T6021STANAA | 5 Ton | 25     | 1600   | 1725   | 57" x 21-3/4" x 21"         |       |

[www.plumbsupply.com](http://www.plumbsupply.com) • Serving our Customers Since 1946 • [www.waterconcepts.net](http://www.waterconcepts.net)



## Air Handlers

### Air Handlers (Continued)

#### RH1T Single-Stage Air Handler - Constant Torque Motor (ECM) 115 Volt

| Part # | Mfg #          | Tons  | Max Kw | CFM Lo | CFM Hi | H x L x W                   | Price |
|--------|----------------|-------|--------|--------|--------|-----------------------------|-------|
| 171736 | RH1T6024STANAA | 5 Ton | 25     | 1,800  | -      | 55-1/2" x 21-3/4" x 24-1/2" |       |

#### RH1P Single-Stage Air Handler - (PSC Motor) 230 Volt

| Part # | Mfg #          | Tons    | Max Kw | CFM Lo | CFM Hi | H x L x W                   | Price |
|--------|----------------|---------|--------|--------|--------|-----------------------------|-------|
| 171696 | RH1P1817STANJA | 1.5 Ton | 10     | 600    | 800    | 42-1/2" x 21-3/4" x 17-1/2" |       |
| 171698 | RH1P2417STANJA | 2 Ton   | 10     | 600    | 800    | 42-1/2" x 21-3/4" x 17-1/2" |       |
| 171702 | RH1P3617STANJA | 3 Ton   | 18     | 1,000  | 1,200  | 42-1/2" x 21-3/4" x 17-1/2" |       |
| 171703 | RH1P3621STANJA | 3 Ton   | 18     | 1,200  | -      | 42-1/2" x 21-3/4" x 21"     |       |
| 171707 | RH1P4821STANJA | 4 Ton   | 25     | 1,600  | -      | 50-1/2" x 21-3/4" x 21"     |       |
| 171708 | RH1P4824STANJA | 4 Ton   | 25     | 1,600  | 1,800  | 55-1/2" x 21-3/4" x 24-1/2" |       |
| 171709 | RH1P6024STANJA | 5 Ton   | 25     | 1,600  | 1,800  | 55-1/2" x 21-3/4" x 24-1/2" |       |

#### RH1P Single-Stage Air Handler - (PSC Motor) 115 Volt

| Part # | Mfg #          | Tons    | Max Kw | CFM Lo | CFM Hi | H x L x W                   | Price |
|--------|----------------|---------|--------|--------|--------|-----------------------------|-------|
| 171695 | RH1P1817STANAA | 2 Ton   | N/A    | 600    | 800    | 42-1/2" x 21-3/4" x 17-1/2" |       |
| 171697 | RH1P2417STANAA | 2 Ton   | N/A    | 600    | 800    | 42-1/2" x 21-3/4" x 17-1/2" |       |
| 171699 | RH1P3017STANAA | 2.5 Ton | N/A    | 1,000  | 1,200  | 42-1/2" x 21-3/4" x 17-1/2" |       |
| 171701 | RH1P3617STANAA | 3 Ton   | N/A    | 1,000  | 1,200  | 42-1/2" x 21-3/4" x 17-1/2" |       |
| 171705 | RH1P4821STANAA | 4 Ton   | N/A    | 1,600  | -      | 50-1/2" x 21-3/4" x 21"     |       |

#### RHMV High Efficiency Modulating Air Handler (CFM Motor)

| Part # | Mfg #          | Tons  | Max Kw | CFM Lo | CFM Hi | H x L x W                     | Price |
|--------|----------------|-------|--------|--------|--------|-------------------------------|-------|
| 188642 | RHMV2417SEACJA | 2 Ton | N/A    | 550    | 750    | 42-1/2" x 21-11/16" x 17-1/2" |       |
| 188647 | RHMV6021SEACJA | 5 Ton | N/A    | 830    | 1565   | 57" x 21-11/16" x 21"         |       |
| 188648 | RHMV6024MEACJA | 5 Ton | N/A    | 890    | 1665   | 55-1/2" x 21-11/16" x 24-1/2" |       |

Cooling - Equipment & Rooftop Units





## Air Handlers

### Hydronic Air Handlers

#### RW1P/RW1T Series Hydronic Air Handler Powered by Tankless Technology

- **Hydronic Air Handler**
  - Low profile 34-inch design is lighter, easier to handle and leaves room for optional accessories
  - Left or right side electric connections
  - Integrated control board features diagnostics, manages all operational functions and provides hookups for humidifier and electronic air cleaner
  - An insulated blower compartment
  - Pre-paint galvanized steel cabinet
  - Molded permanent filter(s)
  - Transformer and control fuse protection
  - Solid bottom is standard
  - A variety of cooling coils and plenums designed to use with the Hydronic Air Handler are available as optional accessories for air conditioning models
  - Stainless steel water pump

#### Tankless Water Heater

- Industry best! Minimum flow rate of .26 GPM, minimum activation flow rate of .40 GPM
- ENERGY STAR® rated models available
- Next generation burner technology
- UMC-117 remote control and 10 ft. of thermostat wire is included
- EZ-Link™ cable available for high demand applications to connect two tankless units to operate as one
- High-altitude capability – up to 9,840 ft. elevation above sea level (no chip required)
- Intelligent electronic controls designed to increase energy efficiency and safety
- Self Diagnostic System



Cooling - Equipment & Rooftop Units

| Part # | Mfg #          | Tons  | Max Kw | CFM Lo | CFM Hi | H x L x W       | Price |
|--------|----------------|-------|--------|--------|--------|-----------------|-------|
| 227225 | RW1T08A4821NAA | 4 Ton | 80,000 | 900    | 1625   | 34" x 22" x 21" |       |

**Air Handlers**

**Air Handlers**

**B6BMM0 Air Handler**

- Durable, Attractive Cabinet
- Multi-poised
- Multi-speed
- Ease-of-Service
- Plug-in Heater Kits
- Circuit Board
- Air Handler Control Board
- Breaker Accessibility
- No Fasteners on Sides or Back
- Designed to Meet the Requirements 610.2.A.2
- Micro-Channel Evaporator Coil
- Cabinet Insulation



| Part # | Mfg #      | Blower Size | Motor Type | Dimensions (H x W)   | Price |
|--------|------------|-------------|------------|----------------------|-------|
| 205641 | B6BMM024KA | 10" x 6"    | PSC        | 43 5/16" x 14 3/16"  |       |
| 205642 | B6BMM024KB | 10" x 6"    | PSC        | 43 5/16" x 19 11/16" |       |
| 205643 | B6BMM030KA | 10" x 8"    | PSC        | 43 5/16" x 14 3/16"  |       |
| 205644 | B6BMM030KB | 10" x 8"    | PSC        | 43 5/16" x 19 11/16" |       |
| 205645 | B6BMM036KB | 10" x 8"    | PSC        | 43 5/16" x 19 11/16" |       |
| 205646 | B6BMM042KB | 10" x 8"    | PSC        | 49 5/16" x 19 11/16" |       |
| 205647 | B6BMM048KB | 10" x 8"    | PSC        | 49 5/16" x 19 11/16" |       |
| 205648 | B6BMM048KC | 10" x 10"   | PSC        | 55 15/16" x 22 7/16" |       |
| 205649 | B6BMM060KC | 11" x 10"   | PSC        | 55 15/16" x 22 7/16" |       |

**B6BMMX Air Handler**

- Durable, Attractive Cabinet
- Multi-poised:
- Multi-speed:
- Ease-of-Service
- Plug-in Heater Kits:
- Circuit Board
- Air Handler Control Board
- Breaker Accessibility
- No Fasteners on Sides or Back
- Cabinet Insulation
- Designed to meet the requirements 610.2.A.2
- Micro-Channel Evaporator Coil



| Part # | Mfg #      | Blower Size | Motor Type | Dimensions (H x W)   | Price |
|--------|------------|-------------|------------|----------------------|-------|
| 231847 | B6BMMX24KA | 10" x 6"    | PSC        | 43 5/16" x 14 3/16"  |       |
| 231848 | B6BMMX24KB | 10" x 8"    | PSC        | 43 5/16" x 19 11/16" |       |
| 231850 | B6BMMX30KA | 10" x 6"    | PSC        | 43 5/16" x 14 3/16"  |       |
| 231851 | B6BMMX30KB | 10" x 8"    | PSC        | 43 5/16" x 19 11/16" |       |

**Air Handlers**

**B6EMMX Air Handler**

- Energy Efficient Fixed Speed ECM Motor
- Quiet Blower Operation
- Reduced air stratification
- Multi-poised
- Built in Filter Rack
- Plug-in Heater Kit
- Circuit Board
- Breaker Accessibility
- Plastic Drain Pan
- Designed to meet the requirements 610.2.A.2
- Thermal Expansion Valve
- Cabinet Insulation
- Anteater MCTM Micro-Channel Coil Technology



| Part # | Mfg #      | Blower Size | Motor Type | Dimensions (H x W) | Price |
|--------|------------|-------------|------------|--------------------|-------|
| 205330 | B6EMMX24KA | 10" x 6"    | Variable   | 43 1/2" x 14 1/4"  |       |
| 205331 | B6EMMX24KB | 11" x 8"    | Variable   | 43 1/2" x 19 3/4"  |       |
| 205332 | B6EMMX30KA | 10" x 6"    | Variable   | 43 1/2" x 14 1/4"  |       |
| 205333 | B6EMMX30KB | 11" x 8"    | Variable   | 43 1/2" x 19 3/4"  |       |
| 205334 | B6EMMX36KB | 11" x 8"    | Variable   | 49 1/2" x 19 3/4"  |       |
| 205335 | B6EMMX42KB | 11" x 8"    | Variable   | 49 1/2" x 19 3/4"  |       |
| 205336 | B6EMMX48KC | 11" x 10"   | Variable   | 56" x 22 1/2"      |       |
| 205337 | B6EMMX60KC | 11" x 10"   | Variable   | 56" x 22 1/2"      |       |

**B6VMMX Air Handler**

- Energy Efficient Variable Speed ECM Motor
- Quiet Blower Operation
- Constant airflow
- Reduced air stratification
- Multi-poised
- Built in Filter Rack
- Plug-in Heater Kit
- Circuit Board
- Breaker Accessibility
- Plastic Drain Pan
- Designed to meet the requirements 610.2.A.2
- Thermal Expansion Valve
- Cabinet Insulation
- Anteater MCTM Micro-Channel Coil Technology



| Part # | Mfg #      | Blower Size | Motor Type | Dimensions (H x W) | Price |
|--------|------------|-------------|------------|--------------------|-------|
| 213108 | B6VMMX24KA | 10" x 6"    | Variable   | 43 1/2" x 14 1/4"  |       |
| 213109 | B6VMMX30KA | 10" x 6"    | Variable   | 43 1/2" x 14 1/4"  |       |
| 213110 | B6VMMX30KB | 11" x 8"    | Variable   | 43 1/2" x 19 3/4"  |       |
| 225687 | B6VMMX36KB | 11" x 8"    | Variable   | 43 1/2" x 19 3/4"  |       |
| 213111 | B6VMMX42KB | 11" x 8"    | Variable   | 43 1/2" x 19 3/4"  |       |

Cooling - Equipment & Rooftop Units

**Air Handlers**

**B6VMAX Air Handler**

- Energy Efficient Variable Speed ECM Motor
- Quiet Blower Operation
- Constant airflow
- Reduced air stratification
- Multi-poised
- Built in Filter Rack
- Plug-in Heater Kit
- Circuit Board
- Breaker Accessibility
- Plastic Drain Pan
- Durable Cabinet
- Designed to meet the requirements 610.2.A.2
- Thermal Expansion Valve
- Cabinet Insulation
- Anteatertm Coil Technology



| Part # | Mfg #      | Blower Size | Motor Type | Dimensions (H x W) | Price |
|--------|------------|-------------|------------|--------------------|-------|
| 205654 | B6VMAX24KB | 10" x 6"    | Variable   | 49 1/2" x 19 3/4"  |       |
| 205657 | B6VMAX36KB | 11" x 8"    | Variable   | 49 1/2" x 19 3/4"  |       |
| 205659 | B6VMAX48KC | 11" x 10"   | Variable   | 56" x 22 1/2"      |       |
| 205660 | B6VMAX60KC | 11" x 10"   | Variable   | 56" x 22 1/2"      |       |

**Vertical Wall Mount Air Handler**

**B6BW Air Handler**

- Durable, Attractive Cabinet
- Multi-speed.
- Blower Control Board
- Ease-of-Service
- Heater Kits Installed
- Breaker Accessibility
- Fully insulated Cabinet
- Front and/or Bottom Return air
- Offset Hanging Bracket for Easy



| Part # | Mfg #      | Blower Size | Motor Type | Dimensions (H x W) | Price |
|--------|------------|-------------|------------|--------------------|-------|
| 208607 | B6BW018K05 | 10" x 6"    | PSC        | 36 3/8" x 15"      |       |
| 214445 | B6BW018K08 | 10" x 6"    | PSC        | 36 3/8" x 15"      |       |
| 202181 | B6BW024K08 | 10" x 6"    | PSC        | 36 3/8" x 15"      |       |
| 202182 | B6BW024K10 | 10" x 6"    | PSC        | 36 3/8" x 15"      |       |
| 202184 | B6BW030K08 | 10" x 6"    | PSC        | 43 1/2" x 21"      |       |
| 231844 | B6BW036K05 | 10" x 8"    | PSC        | 43 1/2" x 15"      |       |
| 231845 | B6BW036K08 | 10" x 8"    | PSC        | 43 1/2" x 15"      |       |
| 214754 | B6BW036K10 | 10" x 8"    | PSC        | 43 1/2" x 15"      |       |

**Air Handlers**

**B6EW Air Handler**

- Energy Efficient Fixed Speed ECM Motor
- Thermal Expansion Valve
- Micro-Channel Coil Technology
- Durable, Attractive Cabinet
- Multi-speed
- Ease-of-Service
- Heater Kits Installed
- Breaker Accessibility
- Fully insulated Cabinet
- Front and/or Bottom Return air
- Offset Hanging Bracket for Easy Installation



| Part # | Mfg #      | Blower Size | Motor Type | Dimensions (H x W) | Price |
|--------|------------|-------------|------------|--------------------|-------|
| 230799 | B6EWX18K05 | 10" x 6"    | ECM        | 36 3/8" x 15"      |       |
| 207994 | B6EW25K10  | 10" x 6"    | ECM        | 43 1/2" x 15"      |       |
| 213115 | B6EWX24K08 | 10" x 6"    | ECM        | 36 3/8" x 15"      |       |
| 213141 | B6EWX30K10 | 10" x 6"    | ECM        | 43 1/2" x 15"      |       |

Cooling - Equipment & Rooftop Units

**Air Handlers**

**Air Handlers**

**BCE4S Variable Speed Air Handler**

- 2 - 5 ton sizes
- Upflow, horizontal, and downflow capable
- Sequenced for demand management
- External access to heater circuit breakers
- Shipped in one piece, but may be disassembled into two separate pieces for ease of installation
- Multiposition - Factory ready for upflow, downflow, and horizontal left/right applications
- No external screw heads on the sides of the unit to fit in tight spaces
- Thick fiberglass insulation
- Painted, heavy-gauge galvanized cabinet
- Filter rack built into every air handler
- Dual position drain pans designed for upflow, downflow or horizontal applications
- Deep, corrosion resistant plastic drain pans have dual pipe drains
- 2% or less air leakage
- Microban antimicrobial drain pans protect from mold, mildew, and other harmful microbes
- Thick rubber gaskets between each section insure tight seal when converted to downflow
- Communicating control enabled
- Thermostat flexibility: works with the Comfort T-Stat or a conventional 24V T-Stat
- Self diagnostics saves last 10 fault codes regardless of power interruption



Cooling - Equipment & Rooftop Units

| Part # | Mfg #           | Tons | Max Kw | Motor | H x L x W                   | Price |
|--------|-----------------|------|--------|-------|-----------------------------|-------|
| 216944 | ABCE4M30S00NA4X | 2.5  | 15     | VSB   | 49-1/4" x 21-1/4" x 20-5/8" |       |
| 216943 | ABCE4M24S00NA4X | 2    | 9      | VSB   | 45-1/4" x 16-1/4" x 20-5/8" |       |
| 216945 | ABCE4M36S00NA4X | 3    | 20     | VSB   | 51" x 21-1/4" x 22-5/8"     |       |
| 216946 | ABCE4M48S00NA4X | 4    | 20     | VSB   | 58-1/2" x 21-1/4" x 24-7/8" |       |
| 216947 | ABCE4M60S00NA4X | 5    | 20     | VSB   | 58-1/2" x 21-1/4" x 24-7/8" |       |

**Air Handlers**

**BCE3E Constant Torque Air Handler**

- 2 - 5 ton systems
- Upflow and horizontal
- Sequenced for demand management
- External access to heater circuit breakers
- 1 Piece design for easier installation
- Multiposition - Upflow/Horizontal Left/Right
- Unit approved for installation in manufactured housing and mobile homes
- Foil faced insulation
- Painted, heavy-gauge galvanized cabinet
- Filter rack built into every air handler
- High-strength, UV- and heat-resistant plastic drain pan for corrosion resistance
- Microban® antimicrobial built in to drain pan to resist mold and mildew growth and fouling of the drain
- 2% or less air leakage
- Efficient Constant Torque blower motors
- Standard transformer and blower relay
- Field-installed 2.5-20 kW electric heat kits with easy plug connections
- Built-in indoor time delay for increased efficiency
- Sleeves on distributor tubing to protect tubing



Cooling - Equipment & Rooftop Units

| Part # | Mfg #           | Tons | Max Kw | Motor | H x L x W                   | Price |
|--------|-----------------|------|--------|-------|-----------------------------|-------|
| 230844 | ABCE3M24E00NAX2 | 2    | 10     | CT    | 40-1/2" x 18-1/2" x 22"     |       |
| 230845 | ABCE3M30E00NAX2 | 2.5  | 15     | CT    | 43" x 18-1/2" x 22"         |       |
| 230846 | ABCE3M36E00NAX2 | 3    | 15     | CT    | 48" x 21-7/8" x 22"         |       |
| 230847 | ABCE3M42E00NAX2 | 3.5  | 15     | CT    | 48" x 21-7/8" x 26-1/4"     |       |
| 230848 | ABCE3M48E00NAX2 | 4    | 20     | CT    | 52-1/2" x 21-7/8" x 26-1/4" |       |
| 213504 | ABCE3M60E00NAX2 | 5    | 20     | CT    | 52-1/2" x 21-7/8" x 26-1/4" |       |

## Air Handlers

### BCE3C Efficient Air Handler

- 1 1/2 - 5 ton systems
- Upflow and horizontal (counterflow capable with kits)
- Sequenced for demand management
- External access to heater circuit breakers
- 1 Piece design for easier installation
- Multiposition - Upflow/Horizontal Left/Right
- Unit approved for installation in manufactured housing and mobile homes
- Foil faced insulation
- Painted, heavy-gauge galvanized cabinet
- Filter rack built into every air handler
- High-strength, UV- and heat-resistant plastic drain pan for corrosion resistance
- Microban® antimicrobial built in to drain pan to resist mold and mildew growth and fouling of the drain
- 2% or less air leakage
- Efficient PSC blower motors
- Standard transformer and blower relay
- Field-installed 2.5-20 kW electric heat kits with easy plug connections
- Built-in indoor time delay for increased efficiency
- Sleeves on distributor tubing to protect tubing



Cooling - Equipment & Rooftop Units

| Part # | Mfg #           | Tons | Max Kw | Motor | H x L x W                   | Price |
|--------|-----------------|------|--------|-------|-----------------------------|-------|
| 230836 | ABCE3M18C00NAP2 | 1.5  | 7.5    | PSC   | 38" x 15" x 22"             |       |
| 230837 | ABCE3M24C00NAP2 | 2    | 10     | PSC   | 40-1/2" x 18-1/2" x 22"     |       |
| 230838 | ABCE3M30C00NAP2 | 2.5  | 15     | PSC   | 40-1/2" x 18-1/2" x 22"     |       |
| 230839 | ABCE3M36C00NAP2 | 3    | 15     | PSC   | 52-1/2" x 21-7/8" x 22"     |       |
| 230840 | ABCE3M42C00NAP2 | 3.5  | 15     | PSC   | 48" x 21-7/8" x 26-1/4"     |       |
| 230841 | ABCE3M48C00NAP2 | 4    | 20     | PSC   | 52-1/2" x 21-7/8" x 26-1/4" |       |
| 230842 | ABCE3M60C00NAP2 | 5    | 20     | PSC   | 52-1/2" x 21-7/8" x 26-1/4" |       |

### Electronic Furnace Modular Air System

- Upflow, counterflow and horizontal positions
- Cabinet dimensions match standard furnace widths
- Painted galvanized cabinet
- EFC models feature PSC motors
- EFV models feature ECM™ variable speed motors
- Field installed 5-20 kW heat strips
- Factory installed fan relays for non-heat strip installations



#### EFC Constant PSC Motor

| Part # | Mfg #      | Tons    | Max Kw | CFM  | Blower Motor | H x L x W           | Price |
|--------|------------|---------|--------|------|--------------|---------------------|-------|
| 211991 | EFC08BCP1A | 1.5 - 2 | 10     | 800  | 1/4 hp       | 25" x 21" x 17-1/2" |       |
| 211624 | EFC12BCP1A | 2.5 - 3 | 15     | 1200 | 1/3 hp       | 25" x 21" x 17-1/2" |       |
| 212048 | EFC16CCP1A | 4       | 20     | 1600 | 3/4 hp       | 26" x 21" x 21"     |       |
| 212049 | EFC20DCP1A | 5       | 20     | 2000 | 3/4 hp       | 26" x 21" x 21"     |       |



**Air Handlers**

**EFV Variable Speed ECM Motor**

| Part # | Mfg #      | Tons    | Max Kw | CFM  | Blower Motor | H x L x W           | Price |
|--------|------------|---------|--------|------|--------------|---------------------|-------|
| 213904 | EFV08BCP1A | 1.5 - 2 | 10     | 800  | 1/3 hp       | 25" x 21" x 17-1/2" |       |
| 213900 | EFV12BCP1A | 2.5 - 3 | 15     | 1200 | 1/2 hp       | 25" x 21" x 17-1/2" |       |
| 213901 | EFV16CCP1A | 4       | 20     | 1600 | 3/4 hp       | 26" x 21" x 21"     |       |
| 213902 | EFV20CCP1A | 5       | 20     | 2000 | 3/4 hp       | 26" x 21" x 21"     |       |

*Cooling - Equipment & Rooftop Units*



## Coils

### Classic® Series MultiFlex® Indoor Coils

- Available in upflow, downflow, and horizontal configurations
- Patented single-row, single-coil pleated concept results in extremely low pressure drops and ease of cleaning
- Constructed of enhanced aluminum fins bonded to inner grooved copper tubing
- Front refrigerant and drain connections for ease of installation
- Coils have sweat fitting refrigerant connections
- Primary condensate drain connections 3/4" FNPT
- Internal check valves
- Double-wall construction offers sturdiness, dead air space insulation
- 5-Year warranty on all parts



Classic  
SERIES

#### 10 SEER Classic® Series Flow check Standard Cooling/Heat Pump Coil - RCBA

- X Suffix - Unit has insulation
- I Suffix - Revised horizontal with insulation

| Part # | Mfg #       | Type    | Tons      | Connection | Air Flow          | Width   | Price |
|--------|-------------|---------|-----------|------------|-------------------|---------|-------|
| 055327 | RCBA-2457GP | Uncased | 1.5 - 2.0 | Front      | 600 - 800 cfm     | 12-1/4" |       |
| 055328 | RCBA-3765GP | Uncased | 2.5 - 3.0 | Front      | 1,000 - 1,200 cfm | 15-3/4" |       |
| 055329 | RCBA-4882GP | Uncased | 4.0       | Front      | 1,400 - 1,600 cfm | 19-1/4" |       |
| 055330 | RCBA-6089GP | Uncased | 5.0       | Front      | 2,000 cfm         | 22-3/4" |       |



## Coils

### Achiever® Series Coils for Gas & Oil Furnaces

- Constructed of aluminum fins bonded to internally grooved copper tubing
- Coils are factory leak tested & have sweat refrigerant connections
- (2) Sets of 3/4" NPT condensate drain connections for easy connection
- Coils are ARI certified for system application with variety of Ruud Value Series outdoor units
- Condensate drain pan is constructed of high grade, heat resistant corrosion free thermal-set material
- Compatible with Germicidal Light System (UV resistant)
- Bi-directional airflow eliminates need to switch any internal components from horizontal left to right
- Universal duct flanges are included with all coil models
- Conditional parts warranty equal to limited parts warranty of outdoor model (registration required)
- 5-Year limited parts warranty



Cased

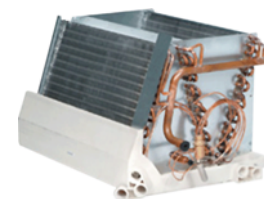

Uncased

ACHIEVER

#### 18 SEER R-410A High Efficiency A/C or Heat Pump Multi-Position Coil for Gas & Oil Furnaces - RCFN

| Part # | Mfg #         | Type  | Tons | Air-Flow CFM Range | Nominal Capacity BTUH | Face Area Sq Ft | Coil Size | Line Sets Liq, Suction | Ship Wt | Price |
|--------|---------------|-------|------|--------------------|-----------------------|-----------------|-----------|------------------------|---------|-------|
| 129888 | RCFN-HM2417CC | Cased | 2.0  | 600/800            | 24,000                | 5.70            | 17-1/2"   | 3/8", 3/4"             | 57 lbs  |       |
| 129891 | RCFN-HM3624CC | Cased | 3.0  | 825/1,175          | 36,000                | 9.98            | 24-1/2"   | 3/8", 7/8"             | 118 lbs |       |
| 129892 | RCFN-HM4824CC | Cased | 4.0  | 1,000/1,600        | 48,000                | 9.98            | 24-1/2"   | 3/8", 7/8"             | 118 lbs |       |
| 129893 | RCFN-HM6024CC | Cased | 5.0  | 1,050/1,700        | 60,000                | 9.98            | 24-1/2"   | 3/8", 7/8"             | 118 lbs |       |

#### 16 SEER R-410A High Efficiency A/C or Heat Pump Multi-Position Coil for Gas & Oil Furnaces - RCFM

| Part # | Mfg #         | Type  | Tons | Air-Flow CFM Range | Nominal Capacity BTUH | Face Area Sq Ft | Coil Size | Line Sets Liq, Suction | Ship Wt | Price |
|--------|---------------|-------|------|--------------------|-----------------------|-----------------|-----------|------------------------|---------|-------|
| 112102 | RCFM-HM2421AC | Cased | 2.0  | 600/800            | 24,000                | 5.70            | 21"       | 3/8", 3/4"             | 57 lbs  |       |
| 112107 | RCFM-HM6024AC | Cased | 5.0  | 1,300/1,700        | 60,000                | 9.98            | 24-1/2"   | 3/8", 7/8"             | 118 lbs |       |

#### 13-16 SEER R-410A A/C or Heat Pump Multi-Position Coil for Gas & Oil Furnaces - RCFL

| Part # | Mfg #         | Type   | Tons    | Air-Flow CFM Range | Nominal Capacity BTUH | Face Area Sq Ft | Coil Size | Line Sets Liq, Suction | Ship Wt | Price |
|--------|---------------|--------|---------|--------------------|-----------------------|-----------------|-----------|------------------------|---------|-------|
| 090461 | RCFL-HM2414AC | Cased* | 1.5-2.0 | 600/1,000          | 18,000-24,000         | 4.56            | 14"       | 3/8", 3/4"             | 50 lbs  |       |
| 090462 | RCFL-HM2417AC | Cased  | 1.5-2.0 | 600/1,000          | 18,000-24,000         | 4.56            | 17-1/2"   | 3/8", 3/4"             | 51 lbs  |       |
| 159504 | RCFL-HM2514CC | Cased  | 2.0     | 600/1000           | 18,000-24,000         | 4.56            | 14"       | 3/8", 3/4"             | 50 lbs  |       |
| 140773 | RCFL-HM2617CC | Cased  | 1.5-2.0 | 900/1,400          | 18,000-24,000         | 5.70            | 17-1/2"   | 3/8", 3/4"             | 57 lbs  |       |
| 090464 | RCFL-HM3617AC | Cased  | 2.5-3.0 | 900/1400           | 30,000-36,000         | 5.70            | 17-1/2"   | 3/8", 3/4"             | 57 lbs  |       |
| 090465 | RCFL-HM3621AC | Cased  | 3.0     | 900/1,400          | 30,000-36,000         | 5.70            | 21"       | 3/8", 3/4"             | 60 lbs  |       |
| 131741 | RCFL-HM3821CC | Cased  | 3.0     | 1,200/1,800        | 30,000-36,000         | 8.55            | 21"       | 3/8", 7/8"             | 83 lbs  |       |
| 131742 | RCFL-HM3824CC | Cased  | 3.0     | 1,200/1,800        | 30,000-36,000         | 8.55            | 24-1/2"   | 3/8", 7/8"             | 99 lbs  |       |
| 090466 | RCFL-HM4821AC | Cased  | 3.5-4.0 | 1,200/1,800        | 42,000-48,000         | 8.55            | 21"       | 3/8", 7/8"             | 83 lbs  |       |
| 090467 | RCFL-HM4824AC | Cased  | 4.0     | 1,200/1,800        | 42,000-48,000         | 8.55            | 24-1/2"   | 3/8", 7/8"             | 99 lbs  |       |
| 090468 | RCFL-HM6024AC | Cased  | 5.0     | 1,600/1,900        | 60,000                | 9.98            | 24-1/2"   | 3/8", 7/8"             | 118 lbs |       |

\* 14" 2-Ton is part of the "N-Coil" design series, even though the coil shape resembles an "A" coil design

www.plumbsupply.com • Serving our Customers Since 1946 • www.waterconcepts.net

## Coils

### R-410A Cased/Uncased Coils - Gas & Oil Furnaces - RCF

- Rheem® Indoor Replacement Coils are designed for use with Rheem outdoor units and are available for vertical upflow or downflow, and horizontal left or horizontal right airflow. When matched with Rheem outdoor units, the coils provide a nominal capacity range from 18,000 BTU/HR [5.24 kW] to 60,000 BTU/HR [17.6 kW].
- Constructed of aluminum fins bonded to internally grooved aluminum tubing.
- Coils are tested at the factory with an extensive refrigerant leak check.
- Coils have copper sweat refrigerant connections.
- Feature two sets of 3/4" [14.1 mm] N.P.T. Condensate drain connections for ease of connection.
- Chatleff metering device connections, at inlet and outlet of TXV or EEV and equalizer connections (TXV only).
- Approved for system application with variety of Rheem outdoor units.
- Condensate drain pan is constructed of high grade, heat resistant, corrosion free thermal-set material.
- Compatible with Germicidal Light System (UV resistant).
- Bi-Directional airflow eliminates the need to switch any internal components from horizontal left to right.
- Unique drain pan design maximizes application flexibility and condensate removal.
- N-Coil design maximizes performance and minimizes height required at installation.



#### Standard Efficiency

| Part # | Mfg #         | Type  | Tons | Air-Flow CFM Range | Nominal Capacity BTUH | Face Area Sq Ft | Coil Size | Line Sets Liq, Suction | Ship Wt | Price |
|--------|---------------|-------|------|--------------------|-----------------------|-----------------|-----------|------------------------|---------|-------|
| 171742 | RCF2414STAMCA | Cased | 2.0  | 600/900            | 24,000                | 4.56            | 14"       | 3/8", 3/4"             | 47 lbs  |       |
| 171743 | RCF2417STAMCA | Cased | 2.0  | 600/900            | 24,000                | 4.56            | 17-1/2"   | 3/8", 3/4"             | 48 lbs  |       |
| 171747 | RCF3617STAMCA | Cased | 3.0  | 700/1300           | 36,000                | 5.70            | 17-1/2"   | 3/8", 3/4"             | 54 lbs  |       |
| 171748 | RCF3621STAMCA | Cased | 3.0  | 700/1300           | 36,000                | 5.70            | 21"       | 3/8", 3/4"             | 60 lbs  |       |
| 171750 | RCF4821STAMCA | Cased | 4.0  | 600/1900           | 48,000                | 8.55            | 21"       | 3/8", 3/4"             | 78 lbs  |       |
| 171752 | RCF4824STAMCA | Cased | 4.0  | 1100/1800          | 48,000                | 8.55            | 24"       | 3/8", 3/4"             | 93 lbs  |       |
| 171753 | RCF6021STAMCA | Cased | 5.0  | 1400/1600          | 60,000                | 7.60            | 21"       | 3/8", 7/8"             | 86 lbs  |       |
| 171754 | RCF6024STAMCA | Cased | 5.0  | 1400/1800          | 60,000                | 9.98            | 24.5"     | 3/8", 3/4"             | 108 lbs |       |
| 177565 | RCF6021SEAMCA | Cased | 5.0  | 1400/1600          | 60,000                | 7.60            | 21"       | 3/8", 3/4"             | 108 lbs |       |

#### Mid. Efficiency

| Part # | Mfg #         | Type  | Tons | Air-Flow CFM Range | Nominal Capacity BTUH | Face Area Sq Ft | Coil Size | Line Sets Liq, Suction | Ship Wt | Price |
|--------|---------------|-------|------|--------------------|-----------------------|-----------------|-----------|------------------------|---------|-------|
| 171745 | RCF2417MTAMCA | Cased | 2.0  | 600/900            | 24,000                | 4.56            | 17"       | 3/8", 3/4"             | 54 lbs  |       |
| 171746 | RCF2421MTAMCA | Cased | 2.0  | 600/900            | 24,000                | 5.70            | 21"       | 3/8", 3/4"             | 60 lbs  |       |
| 172854 | RCF3621MTAMCA | Cased | 3.0  | 600/1900           | 36,000                | 8.55            | 21"       | 3/8", 3/4"             | 78 lbs  |       |
| 171749 | RCF3624MTAMCA | Cased | 3.0  | 700/1300           | 36,000                | 8.55            | 24"       | 3/8", 3/4"             | 93 lbs  |       |
| 171751 | RCF4821MTAMCA | Cased | 4.0  | 1100/1800          | 48,000                | 7.60            | 21"       | 3/8", 7/8"             | 86 lbs  |       |
| 177563 | RCF2421MEAMCA | Cased | 2.0  | 600/900            | 24,000                | 5.70            | 21"       | 3/8", 3/4"             | 60 lbs  |       |
| 177564 | RCF3621MEAMCA | Cased | 3.0  | 600/1900           | 36,000                | 8.55            | 21"       | 3/8", 3/4"             | 78 lbs  |       |
| 177566 | RCF6024MEAMCA | Cased | 5.0  | 1400/1800          | 60,000                | 9.98            | 24.5"     | 3/8", 3/4"             | 108 lbs |       |

Cooling - Equipment & Rooftop Units



## Coils

### High Efficiency

| Part # | Mfg #         | Type  | Tons | Air-Flow<br>CFM<br>Range | Nominal<br>Capacity<br>BTUH | Face<br>Area<br>Sq Ft | Coil<br>Size | Line Sets<br>Liq, Suction | Ship<br>Wt | Price |
|--------|---------------|-------|------|--------------------------|-----------------------------|-----------------------|--------------|---------------------------|------------|-------|
| 171755 | RCF2417HTAMCA | Cased | 2.0  | 600/900                  | 24,000                      | 4.56                  | 17-1/2"      | 3/8", 3/4"                | 54 lbs     |       |
| 171756 | RCF2421HTAMCA | Cased | 2.0  | 600/900                  | 24,000                      | 5.70                  | 21"          | 3/8", 3/4"                | 60 lbs     |       |
| 171757 | RCF3621HTAMCA | Cased | 3.0  | 700/1300                 | 36,000                      | 7.60                  | 21"          | 3/8", 7/8"                | 86 lbs     |       |
| 171758 | RCF3624HTAMCA | Cased | 3.0  | 700/1300                 | 36,000                      | 9.98                  | 24"          | 3/8", 3/4"                | 108 lbs    |       |
| 171759 | RCF4824HTAMCA | Cased | 4.0  | 1100/1800                | 48,000                      | 9.98                  | 24"          | 3/8", 3/4"                | 108 lbs    |       |
| 171760 | RCF6024HTAMCA | Cased | 5.0  | 1400/1800                | 60,000                      | 9.98                  | 24"          | 3/8", 3/4"                | 108 lbs    |       |

### EEV Models

#### 2 Ton

| Part # | Mfg #         | Efficiency | Tons  | CFM     | BTUH   | H x L x W                 | Price |
|--------|---------------|------------|-------|---------|--------|---------------------------|-------|
| 185065 | RCF2417SEAMCA | Standard   | 2 Ton | 600/900 | 24,000 | 20" x 21-11/16" x 17-1/2" |       |

#### 3 Ton

| Part # | Mfg #         | Efficiency | Tons  | CFM      | BTUH   | H x L x W                 | Price |
|--------|---------------|------------|-------|----------|--------|---------------------------|-------|
| 185066 | RCF3617SEAMCA | Standard   | 3 Ton | 700/1300 | 36,000 | 20" x 21-11/16" x 17-1/2" |       |
| 229040 | RCF3621SEAMCA | Standard   | 3 Ton | 700/1300 | 36,000 | 20" x 21-11/16" x 21"     |       |

### Coil Accessories

| Part # | Mfg #   | Type  | Tons | Air-Flow<br>CFM<br>Range | Nominal<br>Capacity<br>BTUH | Face<br>Area<br>Sq Ft | Coil<br>Size | Line Sets<br>Liq, Suction | Ship<br>Wt | Price |
|--------|---------|---|------|--------------------------|-----------------------------|-----------------------|--------------|---------------------------|------------|-------|
| 009020 | RXBA-AC | Coupler/Adapter To Match Coil to Furnace One Size Smaller |      |                          |                             |                       |              |                           |            |       |

Cooling - Equipment & Rooftop Units

## Coils

### CA Series DX-Treme Uncased Upflow/Downflow Coils

- Rifled copper tubing, enhanced aluminum fins
- Immersion-tested at 500 psi, then nitrogen-pressurized and sealed
- Left or right-hand refrigerant and plumbing connections
- Liquid line - 3/8" ODS, suction line - 7/8" ODS
- Externally mounted flowrater body with Schrader valve for hiss-testing
- Heavy duty polypropylene drain pans on most models
- Drain connection: 177L pans have single LH 3/4" MPT
- Upflow without field modification
- Downflow plate kit included
- ARI Certifiable with all brands of A/C and heat pump systems
- ETL Listed for use with R-22 and R-410A when proper metering device is used
- 10-Year limited warranty

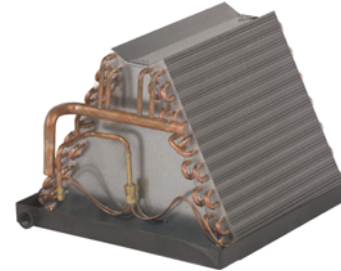

| Part # | Mfg #            | Tons | Pan Widths | Dimensions<br>Pan Depth | Bare Slab Height | Refrig      | Price |
|--------|------------------|------|------------|-------------------------|------------------|-------------|-------|
| 104089 | CA24A2F-160R     | 2.0  | 16"        | 19-3/8"                 | 12"              | R-410A/R-22 |       |
| 239295 | CA24A34-160R     | 2.5  | 16"        | 19-3/8"                 | 21-1/2"          | R-410a/R-22 |       |
| 108690 | CA24B3F-130R     | 2.0  | 13"        | 19-3/8"                 | 14"              | R-410A/R-22 |       |
| 108692 | CA24B3F-160R     | 2.0  | 16"        | 19-3/8"                 | 14"              | R-410A/R-22 |       |
| 104090 | CA30A2F-160R     | 2.5  | 16"        | 19-3/8"                 | 14"              | R-410A/R-22 |       |
| 108693 | CA30B3F-160R     | 2.5  | 16"        | 19-3/8"                 | 16"              | R-410A/R-22 |       |
| 104091 | CA36A2F-160R     | 3.0  | 16"        | 19-3/8"                 | 16"              | R-410A/R-22 |       |
| 239296 | CA36A34-160R     | 3.0  | 16"        | 19-3/8"                 | 16"              | R-410A/R-22 |       |
| 108694 | CA36B3F-160R     | 3.0  | 16"        | 19-3/8"                 | 18"              | R-410A/R-22 |       |
| 108695 | CA36B3F-195R     | 3.0  | 19-1/2"    | 19-3/8"                 | 18"              | R-410A/R-22 |       |
| 227803 | CA48A2F-195R-000 | 4.0  | 19-1/2"    | 19-3/8"                 | 21-1/2"          | R-410A/R-22 |       |
| 227805 | CA60A2F-230R-000 | 5.0  | 23"        | 19-3/8"                 | 25-1/2"          | R-410A/R-22 |       |

### CC Series DX-Treme Cased Upflow/Downflow Coils

- Rifled copper tubing, enhanced aluminum fins
- Immersion-tested at 500 psi, then nitrogen-pressurized and sealed
- Left or right-hand refrigerant and plumbing connections, L: Left-hand & R: Right-hand
- Liquid line - 3/8" ODS, suction line - 7/8" ODS
- Externally mounted Flowrater body with Schrader valve for hiss-testing
- Heavy-duty polypropylene drain pans on most models
- Embossed galvanized cabinets standard - cabinets feature furnace connectors
- Split access doors in front for easy service
- Fully insulated cabinets with faced insulation
- ARI Certifiable with all brands of A/C and heat pump systems
- ETL Listed for use with R-22 and R-410A when proper metering device is used
- 10-Year limited warranty
- Option codes:
  - (023) - Flanged top duct opening
  - (056) - Painted cabinet and flange top opening

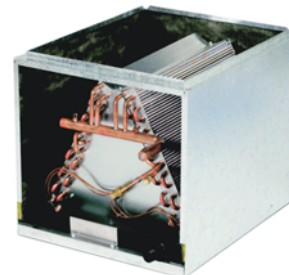

| Part # | Mfg #        | Tons | Min Width | Dimensions<br>Max Width | Depth   | Height | Metering<br>Device | Price |
|--------|--------------|------|-----------|-------------------------|---------|--------|--------------------|-------|
| 110828 | CC24B34-140L | 2    | 14"       | 23"                     | 21-1/2" | 16"    | NB TXV R-410       |       |

## Coils

### CC Series DX-Treme Cased Upflow/Downflow Coils (Continued)

| Part # | Mfg #              | Tons | Min Width  | Dimensions<br>Max Width | Depth   | Height | Metering<br>Device | Price |
|--------|--------------------|------|------------|-------------------------|---------|--------|--------------------|-------|
| 110829 | CC24B34-175L       | 2    | 14"        | 23"                     | 21-1/2" | 16"    | NB TXV R-410       |       |
| 110830 | CC24D44-175L       | 2    | 14"        | 23"                     | 21-1/2" | 20"    | NB TXV R-410       |       |
| 133511 | CC30B44-175L1      | 2.5  | 14"        | 23"                     | 21-1/2" | 20"    | NB TXV R-410       |       |
| 126429 | CC30C44-175L       | 2.5  | 14"        | 23"                     | 21-1/2" | 20"    | NB TXV R-410       |       |
| 110831 | CC30D44-175L       | 2.5  | 14"        | 23"                     | 21-1/2" | 24"    | NB TXV R-410       |       |
| 099999 | CC30D4X-210R       | 2.5  | 14"        | 23"                     | 21-1/2" | 24"    | NB TXV R-22        |       |
| 110833 | CC36B34-175L       | 3    | 14" or 17" | 23"                     | 21-1/2" | 20"    | NB TXV R-410       |       |
| 110834 | CC36B34-210L       | 3    | 14" or 17" | 23"                     | 21-1/2" | 20"    | NB TXV R-410       |       |
| 115251 | CC36C44-175L       | 3    | 14" or 17" | 23"                     | 21-1/2" | 24"    | NB TXV R-410       |       |
| 110835 | CC36D44-175L       | 3    | 14" or 17" | 23"                     | 21-1/2" | 24"    | NB TXV R-410       |       |
| 110836 | CC36D44-210L       | 3    | 14" or 17" | 23"                     | 21-1/2" | 24"    | NB TXV R-410       |       |
| 110837 | CC48B34-210L       | 4    | 17"        | 26-1/2"                 | 21-1/2" | 24"    | NB TXV R-410       |       |
| 110838 | CC48D44-210L       | 4    | 17"        | 26-1/2"                 | 21-1/2" | 28"    | NB TXV R-410       |       |
| 110839 | CC48D44-245L       | 4    | 17"        | 26-1/2"                 | 21-1/2" | 28"    | NB TXV R-410       |       |
| 110840 | CC60B34-210L       | 5    | 20-1/2"    | 26-1/2"                 | 21-1/2" | 28"    | NB TXV R-410       |       |
| 110841 | CC60B34-245L       | 5    | 20-1/2"    | 26-1/2"                 | 21-1/2" | 28"    | NB TXV R-410       |       |
| 125034 | CC60E-44-245L-023* | 5    | 24-1/2"    | 26-1/2"                 | 21-1/2" | 28"    | NB TXV R-410       |       |

### CE Series DX-Treme Cased Multi-Position A-Coil

- Rifled copper tubing, enhanced aluminum fins
- Immersion-tested at 500 psi, then nitrogen-pressurized and sealed
- Left- or right-hand refrigerant and plumbing connections
- Liquid line - 3/8" ODS, suction line - 7/8" ODS
- Externally mounted Flowrater body with Schrader valve for hiss-testing
- Heavy duty polypropylene upflow drains pans on most models, powder coated galvanized steel horizontal drain pans standard on all
- Embossed galvanized cabinets standard
- Cabinets feature furnace connectors (patent pending)
- Upflow, horizontal right, or horizontal left without field modification  
Downflow applications require plate kit, included
- Split access doors in front for easy service
- Fully insulated cabinets with faced insulation
- ARI Certifiable with all brands of A/C and heat pump systems
- ETL Listed for use with R-22 and R-410A when proper metering device is used
- 10-Year limited warranty

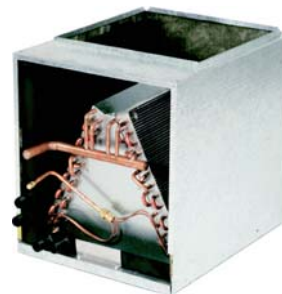

| Part # | Mfg #        | Tons | Min Width  | Dimensions<br>Max Width | Depth   | Height | Metering<br>Device | Price |
|--------|--------------|------|------------|-------------------------|---------|--------|--------------------|-------|
| 112852 | CE24D44-175L | 2    | 14"        | 23"                     | 21-1/2" | 23"    | NB TXV R-410       |       |
| 112860 | CE36D44-210L | 3    | 14" or 17" | 23"                     | 21-1/2" | 27"    | NB TXV R-410       |       |
| 112859 | CE36D44175L0 | 3    | 14" or 17" | 23"                     | 21-1/2" | 27"    | NB TXV R-410       |       |
| 112862 | CE48D44-210L | 4    | 17"        | 26-1/2"                 | 21-1/2" | 30"    | NB TXV R-410       |       |
| 112865 | CE48D44-245L | 4    | 17"        | 26-1/2"                 | 21-1/2" | 30"    | NB TXV R-410       |       |
| 112866 | CE60B34-210L | 5    | 20-1/2"    | 26-1/2"                 | 21-1/2" | 30"    | NB TXV R-410       |       |



## Coils

### CE Series DX-Treme Cased Multi-Position A-Coil (Continued)

| Part # | Mfg #        | Tons | Min Width | Dimensions<br>Max Width | Depth   | Height | Metering<br>Device | Price |
|--------|--------------|------|-----------|-------------------------|---------|--------|--------------------|-------|
| 112867 | CE60B34-245L | 5    | 20-1/2"   | 26-1/2"                 | 21-1/2" | 30"    | NB TXV R-410       |       |

### Thermostatic Expansion Valves (TXV)

| Part # | Mfg #    | Refrigerant | Tons           | Bleed Port | For:                             | Price |
|--------|----------|-------------|----------------|------------|----------------------------------|-------|
| 095918 | 4190X2-3 | R-22        | 1.5 to 3.5 Ton | No         | Kit for B Coils & F Air Handlers |       |
| 106976 | 4195X2-5 | R-22        | 4, 5 & 6 Ton   | No         | Kit for B Coils & F Air Handlers |       |
| 094022 | 4200X5-3 | R-22        | 1.5 to 3.5 Ton | No         | Kit for B Coils & F Air Handlers |       |
| 094023 | 4202X5-5 | R-22        | 4, 5 & 6 Ton   | No         | Kit for B Coils & F Air Handlers |       |

### R-22 Coils

| Part # | Mfg #          | Description       | Price |
|--------|----------------|-------------------|-------|
| 147402 | 22A2F-130R-003 | 2.0 Ton R-22 Coil |       |
| 147403 | 22A2F-160R-003 | 2.0 Ton R-22 Coil |       |
| 147404 | 22A3F-160R-003 | 3.0 Ton R-22 Coil |       |
| 147405 | 22A3F-195R-003 | 3.0 Ton R-22 Coil |       |
| 147406 | 22A4F-195R-003 | 4.0 Ton R-22 Coil |       |
| 147407 | 22A5F-230R-003 | 5.0 Ton R-22 Coil |       |

### Pistons

| Part # | Mfg # | Description                        | Price |
|--------|-------|------------------------------------|-------|
| 125462 | 3960  | .089 Orifice R-410A 5.0 Ton Piston |       |
| 125459 | 3987  | .068 Orifice R-22 2.5 Ton Piston   |       |
| 179307 | 3991  | .084 Orifice R-22 5.0 Ton Piston   |       |
| 179306 | 3998  | .092 Orifice R-22 5.0 Ton Piston   |       |
| 125457 | 3999  | .055 Orifice R-22 1.5 Ton Piston   |       |
| 125458 | 4000  | .059 Orifice R-22 2.0 Ton Piston   |       |
| 125460 | 4001  | .074 Orifice R-22 3.0 Ton Piston   |       |
| 125456 | 4006  | .049 Orifice R-410A 1.5 Ton Piston |       |



**Coils**

**C7 Microchannel Cased Indoor Coils**



**Piston Metering R-410A - "A" Vertical Cased Coil - C7BAM Series**

| Part # | Mfg #          | Order # | Nominal Capacity MBTUH | Refrigerant Sizes Liquid, Suction | Dimensions H x W x D        | Price |
|--------|----------------|---------|------------------------|-----------------------------------|-----------------------------|-------|
| 146441 | C7BAM-01824C-A | 921515  | 1.5 - 2.0 Ton          | 3/8", 3/4"                        | 20-3/4" x 14-1/2" x 20-3/4" |       |
| 146443 | C7BAM-01824C-B | 921519  | 1.5 - 2.0 Ton          | 3/8", 3/4"                        | 20-3/4" x 17-1/2" x 20-3/4" |       |
| 146444 | C7BAM-03036C-A | 921517  | 2.5 - 3.0 Ton          | 3/8", 3/4"                        | 20-3/4" x 14-1/4" x 20-3/4" |       |
| 146445 | C7BAM-03036C-B | 921521  | 2.5 - 3.0 Ton          | 3/8", 3/4"                        | 20-3/4" x 17-1/2" x 20-3/4" |       |
| 146446 | C7BAM-030C-C   | 921700  | 2.5 Ton                | 3/8", 3/4"                        | 26-3/4" x 21" x 20-3/4"     |       |
| 146447 | C7BAM-03642C-B | 921523  | 3.0 - 3.5 Ton          | 3/8", 7/8"                        | 26-3/4" x 17-1/2" x 20-3/4" |       |
| 146448 | C7BAM-03648C-C | 921525  | 3.0 - 4.0 Ton          | 3/8", 7/8"                        | 26-3/4" x 21" x 20-3/4"     |       |
| 146449 | C7BAM-042C-D   | 921529  | 3.5 Ton                | 3/8", 7/8"                        | 30-1/4" x 24-1/2" x 20-3/4" |       |
| 146452 | C7BAM-048C-C   | 921838  | 4.0 Ton                | 3/8", 7/8"                        | 30-1/4" x 21" x 20-3/4"     |       |
| 146453 | C7BAM-048C-D   | 921841  | 4.0 Ton                | 3/8", 7/8"                        | 30-1/4" x 24-1/2" x 20-3/4" |       |
| 162851 | C7BAM-060C-C   | 922116  | 5 Ton                  | 3/8", 7/8"                        | 30-1/4" x 21" x 20-3/4"     |       |
| 162852 | C7BAM-060C-D   | 922119  | 5 Ton                  | 3/8", 7/8"                        | 30-1/4" x 21" x 20-3/4"     |       |

Cooling - Equipment & Rooftop Units

**Coil Accessories**

**R-410A TXV Kits**

| Part # | Mfg #   | Tons | Refrigerant | Connection | Price |
|--------|---------|------|-------------|------------|-------|
| 146841 | 920668A | 2.0  | R-410A      | Mechanical |       |
| 146842 | 920669A | 2.5  | R-410A      | Mechanical |       |
| 146843 | 920670A | 3.0  | R-410A      | Mechanical |       |
| 146844 | 920671A | 3.5  | R-410A      | Mechanical |       |
| 146845 | 920672A | 4.0  | R-410A      | Mechanical |       |
| 146846 | 920673A | 5.0  | R-410A      | Mechanical |       |

**C7 Flex Tube Kit**

| Part # | Mfg #  | Fits Coil Size (S) | Price |
|--------|--------|--------------------|-------|
| 150341 | 921824 | 1824A, 3036A       |       |
| 150342 | 921825 | 1824B, 3036B       |       |
| 150343 | 921826 | 3642B              |       |
| 150344 | 921827 | 30C                |       |
| 150345 | 921828 | 3648C              |       |
| 150346 | 921829 | 48C, 60C           |       |
| 150347 | 921830 | 42D                |       |
| 150348 | 921831 | 48D, 60D           |       |

**Coils**

**Horizontal Drain Pan Kit**

| Part # | Mfg #  | Fits Coil Size (S)         | Price |
|--------|--------|----------------------------|-------|
| 198694 | 920265 | 1824A, 3036A, 1824B, 3036B |       |
| 198695 | 920266 | 3642B, 30C, 3648C          |       |
| 198696 | 920267 | 48C, 60C, 48D, 60D         |       |

Cooling - Equipment &  
Rooftop Units

## Coils

### Intertherm Coils C8 Uncased Coils



|        |                 | Type    | Connections | Nominal Capacity<br>BTUH | Cabinet Width | Line Sets<br>Liq, Suction |  |
|--------|-----------------|---------|-------------|--------------------------|---------------|---------------------------|--|
| 177314 | INTC8BAM01830B  | Uncased | Downturn    | 18,000-30,000            | 14-1/2"       | 3/8", 3/4"                |  |
| 177313 | INTC8BAM036UB   | Uncased | Downturn    | 36,000                   | 14-1/2"       | 3/8", 3/4"                |  |
| 221533 | INTC8DAM048UB   | Uncased | Downturn    | 48,000                   | 14-1/2"       | 3/8", 7/8"                |  |
| 214895 | INTC8DAM01830UB | Uncased | Downturn    | 18,000-30,000            | 17-1/2"       | 3/8", 3/8"                |  |
| 213953 | INTC8DAM036UB   | Uncased | Downturn    | 36,000                   | 17-1/2"       | 3/8", 3/8"                |  |

### Mortex Coils CM Uncased Coils



| Part # | Mfg #      | Type    | Air-Flow<br>CFM<br>Range | Nominal Capacity<br>BTUH | Cabinet Width | Line Sets<br>Liq, Suction | Price |
|--------|------------|---------|--------------------------|--------------------------|---------------|---------------------------|-------|
| 232900 | INTCM4B53U | Uncased | 1310                     | 53,000                   | 19-5/8"       | 3/8", 7/8"                |       |
| 231026 | INTCM4B54U | Uncased | 1400                     | 54,000                   | 19-5/8"       | 3/8", 7/8"                |       |

Cooling - Equipment & Rooftop Units

**Coils**

**Coils**

**EC1P Upflow/Counterflow Coil**

- External cabinet mounted distributor body designed for easy changing of orifice sizes and fast TXV connections
- Two dual drain on front of coil for install flexibility of drain lines around furnace vent and utility connections.
- Microban® antimicrobial additive in the drain pan to resist mold and mildew growth.
- One of the lowest water retention drain pans in the industry to minimize mold and mildew growth.
- Interlocking door assemblies and snug line seal grommets to minimize air leakage
- Foil-face insulation for easy cleaning
- Tubing located at door split for easy coil service or cleaning
- All drain pans are compatible with UV lights
- All piston coils are compatible with R22 or R410a



Cooling - Equipment & Rooftop Units

| Part # | Mfg #        | Type  | Tons  | Nominal Capacity BTUH | Coil Size               | Line Sets Liq, Suction | Price |
|--------|--------------|-------|-------|-----------------------|-------------------------|------------------------|-------|
| 208904 | AIREC1P18AG1 | Cased | 1.5   | 18,000                | 14-1/2" x 16-1/2" x 13" | 3/8", 3/4"             |       |
| 208905 | AIREC1P19AG1 | Cased | 1.5   | 19,000                | 14-1/2" x 16-1/2" x 13" | 3/8", 3/4"             |       |
| 208908 | AIREC1P23AG1 | Cased | 2     | 23,000                | 14-1/2" x 18-1/2" x 13" | 3/8", 3/4"             |       |
| 208909 | AIREC1P23BG1 | Cased | 1.5-2 | 23,000                | 17-1/2" x 18-1/2" x 16" | 3/8", 3/4"             |       |
| 208906 | AIREC1P24AG1 | Cased | 2     | 24,000                | 14-1/2" x 20-1/2" x 13" | 3/8", 3/4"             |       |
| 208907 | AIREC1P24BG1 | Cased | 2     | 24,000                | 17-1/2" x 20-1/2" x 16" | 3/8", 3/4"             |       |
| 208910 | AIREC1P29AG1 | Cased | 2.5   | 29,000                | 14-1/2" x 25-1/2" x 13" | 3/8", 3/4"             |       |
| 208911 | AIREC1P29BG1 | Cased | 2.5   | 29,000                | 17-1/2" x 25-1/2" x 16" | 3/8", 3/4"             |       |
| 208912 | AIREC1P30AG1 | Cased | 2.5   | 30,000                | 14-1/2" x 24-1/2" x 13" | 3/8", 3/4"             |       |
| 208913 | AIREC1P30BG1 | Cased | 2.5   | 30,000                | 17-1/2" x 24-1/2" x 16" | 3/8", 3/4"             |       |
| 208914 | AIREC1P30CG1 | Cased | 2.5   | 30,000                | 21" x 24-1/2" x 19-1/2" | 3/8", 3/4"             |       |
| 208915 | AIREC1P36AG1 | Cased | 3     | 36,000                | 14-1/2" x 24-1/2" x 13" | 3/8", 3/4"             |       |
| 208916 | AIREC1P36BG1 | Cased | 3     | 36,000                | 17-1/2" x 24-1/2" x 16" | 3/8", 3/4"             |       |
| 208917 | AIREC1P36CG1 | Cased | 3     | 36,000                | 21" x 24-1/2" x 19-1/2" | 3/8", 3/4"             |       |
| 208918 | AIREC1P43BG1 | Cased | 3.5   | 43,000                | 17-1/2" x 29-1/2" x 16" | 3/8", 7/8"             |       |
| 208919 | AIREC1P43CG1 | Cased | 3.5   | 43,000                | 21" x 29-1/2" x 19-1/2" | 3/8", 7/8"             |       |
| 208920 | AIREC1P48BG1 | Cased | 4     | 48,000                | 17-1/2" x 24-1/2" x 16" | 3/8", 7/8"             |       |
| 208921 | AIREC1P48CG1 | Cased | 4     | 48,000                | 21" x 24-1/2" x 19-1/2" | 3/8", 7/8"             |       |
| 208922 | AIREC1P49CG1 | Cased | 3.5-5 | 60,000                | 21" x 29-1/2" x 19-1/2" | 3/8", 7/8"             |       |
| 208923 | AIREC1P50CG1 | Cased | 4     | 50,000                | 21" x 27-1/2" 19-1/2"   | 3/8", 7/8"             |       |
| 208926 | AIREC1P60DG1 | Cased | 5     | 60,000                | 24-1/2" x 25-1/2" x 23" | 3/8", 7/8"             |       |
| 208925 | AIREC1P62CG1 | Cased | 3.5-5 | 62,000                | 21" x 31-1/2" x 19-1/2" | 3/8", 7/8"             |       |
| 208927 | AIREC1P62DG1 | Cased | 3.5-5 | 62,000                | 24-1/2" x 29-1/2" x 23" | 3/8", 7/8"             |       |

**Coils**

**EH1P Dedicated Horizontal Coil**

- Microban® antimicrobial additive in the drain pan to resist mold and mildew growth.
- One of the lowest water retention drain pans in the industry to minimize mold and mildew growth.
- Interlocking door assemblies and snug line seal grommets to minimize air leakage
- Foil-face insulation for easy cleaning
- Tubing located at door split for easy coil service or cleaning
- All drain pans are compatible with UV lights
- All piston coils are compatible with R22 or R410a
- See limited warranty document for details.
- Dedicated horizontal
- Insulated galvanized steel case with durable embossed finish
- Removable top panels for easy service or cleaning
- Dual condensate drains on front and back of coil allows flexibility of placement to accommodate left or right airflow furnaces
- Refrigerant connections on top of coil for ease of installation in left or right airflow furnaces



| Part # | Mfg #        | Type  | Tons | Nominal Capacity BTUH | Coil Size               | Line Sets Liq, Suction | Price |
|--------|--------------|-------|------|-----------------------|-------------------------|------------------------|-------|
| 208938 | AIREH1P23AM1 | Cased | 2    | 23,000                | 14-1/2" x 26-1/2"       | 3/8", 7/8"             |       |
| 208939 | AIREH1P23BM1 | Cased | 2    | 23,000                | 17-1/2" x 26-1/2"       | 3/8", 7/8"             |       |
| 210763 | AIREH1P29BM1 | Cased | 2.5  | 29,000                | 17-1/2" x 26-1/2" x 16" | 3/8", 7/8"             |       |
| 208940 | AIREH1P36BM1 | Cased | 3    | 36,000                | 17-1/2" x 26-1/2"       | 3/8", 7/8"             |       |
| 208941 | AIREH1P36CM1 | Cased | 3    | 36,000                | 21" x 26-1/2"           | 3/8", 7/8"             |       |
| 208942 | AIREH1P49CM1 | Cased | 4    | 49,000                | 21" x 31-1/2"           | 3/8", 7/8"             |       |
| 208943 | AIREH1P49DM1 | Cased | 4    | 49,000                | 24-1/2" x 31-1/2"       | 3/8", 7/8"             |       |
| 208944 | AIREH1P62CM1 | Cased | 5    | 62,000                | 21" x 31-1/2"           | 3/8", 7/8"             |       |
| 208945 | AIREH1P62DM1 | Cased | 5    | 62,000                | 24-1/2" x 31-1/2"       | 3/8", 7/8"             |       |

**EM1P Upflow/Horizontal Coil**

- Upflow/ Horizontal for application flexibility
- Side drain pan built in for easy horizontal installations
- Microban® antimicrobial additive in the drain pan to resist mold and mildew growth.
- One of the lowest water retention drain pans in the industry to minimize mold and mildew growth.
- Interlocking door assemblies and snug line seal grommets to minimize air leakage
- Foil-face insulation for easy cleaning
- Tubing located at door split for easy coil service or cleaning
- All drain pans are compatible with UV lights
- All piston coils are compatible with R22 or R410a



| Part # | Mfg #        | Type  | Tons | Nominal Capacity BTUH | Coil Size               | Line Sets Liq, Suction | Price |
|--------|--------------|-------|------|-----------------------|-------------------------|------------------------|-------|
| 208455 | AIREM1P19AG1 | Cased | 1.5  | 19,000                | 14-1/2" x 25-1/2" x 13" | 3/8", 3/4"             |       |

Cooling - Equipment & Rooftop Units

**Coils**

**Coils (Continued)**  
**EM1P Upflow/Horizontal Coil**

| Part # | Mfg #        | Type  | Tons  | Nominal Capacity BTUH | Coil Size               | Line Sets Liq, Suction | Price |
|--------|--------------|-------|-------|-----------------------|-------------------------|------------------------|-------|
| 208459 | AIREM1P23AG1 | Cased | 1.5-2 | 23,000                | 14-1/2" x 25-1/2" x 13  | 3/8", 3/4"             |       |
| 208460 | AIREM1P23BG1 | Cased | 1.5-2 | 23,000                | 17-1/2" x 25-1/2" x 16" | 3/8", 3/4"             |       |
| 208461 | AIREM1P24AG1 | Cased | 2     | 24,000                | 14-1/2" x 25-1/2" x 13" | 3/8", 3/4"             |       |
| 208462 | AIREM1P24BG1 | Cased | 2     | 24,000                | 17-1/2" x 25-1/2" x 16" | 3/8", 3/4"             |       |
| 208463 | AIREM1P29AG1 | Cased | 2     | 29,000                | 14-1/2" x 25-1/2" x 13" | 3/8", 3/4"             |       |
| 208464 | AIREM1P29BG1 | Cased | 2.5   | 29,000                | 17-1/2" x 25-1/2" x 16" | 3/8", 3/4"             |       |
| 208465 | AIREM1P30AG1 | Cased | 2.5   | 30,000                | 14-1/2" x 25-1/2" x 13" | 3/8", 3/4"             |       |
| 208466 | AIREM1P30BG1 | Cased | 2.5   | 30,000                | 17-1/2" x 25-1/2" x 16" | 3/8", 3/4"             |       |
| 208467 | AIREM1P36AG1 | Cased | 3     | 36,000                | 14-1/2" x 25-1/2" x 13" | 3/8", 3/4"             |       |
| 208468 | AIREM1P36BG1 | Cased | 3     | 36,000                | 17-1/2" x 25-1/2" x 16" | 3/8", 3/4"             |       |
| 208469 | AIREM1P36CG1 | Cased | 3     | 36,000                | 21" x 25-1/2" x 19-1/2" | 3/8", 7/8"             |       |
| 208470 | AIREM1P43BG1 | Cased | 3.5   | 43,000                | 17-1/2" x 27-1/2" x 16" | 3/8", 7/8"             |       |
| 208471 | AIREM1P43CG1 | Cased | 3.5   | 43,000                | 21" x 27-1/2" x 19-1/2" | 3/8", 7/8"             |       |
| 208472 | AIREM1P48BG1 | Cased | 4     | 48,000                | 17-1/2" x 25-1/2" x 16" | 3/8", 7/8"             |       |
| 208473 | AIREM1P48CG1 | Cased | 4     | 48,000                | 21" x 25-1/2" x 19-1/2" | 3/8", 7/8"             |       |
| 208474 | AIREM1P50CG1 | Cased | 5     | 50,000                | 21" x 27-1/2" x 19-1/2" | 3/8", 7/8"             |       |

Cooling - Equipment & Rooftop Units



## Condensing Units

### Air Conditioners



- Scroll compressor
- Composite base pan
- Powder coat paint
- External haug ports
- Single row coil
- Top can be removed without disconnecting motor
- Quick-Release Louver panel design



#### Warranties

10-Yr Parts Warranty

### RA16 Single Stage Condensing Unit

| Part # | Mfg #       | Tons | Liq Conn. | Suction Conn. | CFM  | RPM  | H x L x W               | Price |
|--------|-------------|------|-----------|---------------|------|------|-------------------------|-------|
| 171657 | RA1618AJ1NA | 1.5  | 3/8"      | 3/4"          | 2404 | 1095 | 27" x 29-3/4" x 29-3/4" |       |
| 171658 | RA1624AJ1NA | 2.0  | 3/8"      | 3/4"          | 2851 | 851  | 27" x 33-3/4" x 33-3/4" |       |
| 171659 | RA1630AJ1NA | 2.5  | 3/8"      | 3/4"          | 3914 | 840  | 27" x 35-3/4" x 35-3/4" |       |
| 171660 | RA1636AJ1NA | 3.0  | 3/8"      | 3/4"          | 4340 | 819  | 31" x 35-3/4" x 35-3/4" |       |
| 171661 | RA1642AJ1NA | 3.5  | 3/8"      | 7/8"          | 4450 | 829  | 39" x 35-3/4" x 35-3/4" |       |
| 171662 | RA1648AJ1NA | 4.0  | 3/8"      | 7/8"          | 4658 | 828  | 45" x 35-3/4" x 35-3/4" |       |
| 173277 | RA1660AJ1NA | 5.0  | 3/8"      | 7/8"          | 1775 | 795  | 51" x 35-3/4" x 35-3/4" |       |

### RA14 Single Stage Condensing Unit

| Part # | Mfg #       | Tons | Liq Conn. | Suction Conn. | CFM  | RPM  | H x L x W               | Price |
|--------|-------------|------|-----------|---------------|------|------|-------------------------|-------|
| 171646 | RA1418AJ1NA | 1.5  | 3/8"      | 3/4"          | 2225 | 1075 | 25" x 29-3/4" x 29-3/4" |       |
| 171647 | RA1424AJ1NA | 2.0  | 3/8"      | 3/4"          | 2505 | 1070 | 25" x 29-3/4" x 29-3/4" |       |
| 171648 | RA1430AJ1NA | 2.5  | 3/8"      | 3/4"          | 2605 | 1075 | 27" x 29-3/4" x 29-3/4" |       |
| 171649 | RA1436AJ1NA | 3.0  | 3/8"      | 3/4"          | 3105 | 805  | 27" x 33-3/4" x 33-3/4" |       |
| 171650 | RA1442AJ1NA | 3.5  | 3/8"      | 7/8"          | 4265 | 820  | 27" x 35-3/4" x 35-3/4" |       |
| 171651 | RA1448AJ1NA | 4.0  | 3/8"      | 7/8"          | 4265 | 820  | 31" x 35-3/4" x 35-3/4" |       |
| 171652 | RA1460AJ1NA | 5.0  | 3/8"      | 7/8"          | 4140 | 850  | 35" x 35-3/4" x 35-3/4" |       |

### RA13 Single Stage Condensing Unit

| Part # | Mfg #       | Tons | Liq Conn. | Suction Conn. | CFM  | RPM  | H x L x W               | Price |
|--------|-------------|------|-----------|---------------|------|------|-------------------------|-------|
| 171633 | RA1318AJ1NA | 1.5  | 3/8"      | 3/4"          | 2040 | 1075 | 27" x 29-3/4" x 29-3/4" |       |
| 171634 | RA1324AJ1NA | 2.0  | 3/8"      | 3/4"          | 2325 | 1075 | 25" x 29-3/4" x 29-3/4" |       |
| 171635 | RA1330AJ1NA | 2.5  | 3/8"      | 3/4"          | 2795 | 1075 | 25" x 29-3/4" x 29-3/4" |       |
| 171636 | RA1336AJ1NA | 3.0  | 3/8"      | 3/4"          | 2900 | 1075 | 27" x 29-3/4" x 29-3/4" |       |
| 171637 | RA1342AJ1NA | 3.5  | 3/8"      | 7/8"          | 2465 | 1075 | 31" x 29-3/4" x 29-3/4" |       |
| 171638 | RA1348AJ1NA | 4.0  | 3/8"      | 7/8"          | 4145 | 850  | 27" x 33-3/4" x 33-3/4" |       |
| 171639 | RA1360AJ1NA | 5.0  | 3/8"      | 7/8"          | 3870 | 820  | 31" x 35-3/4" x 35-3/4" |       |

Cooling - Equipment & Rooftop Units



## Condensing Units

### RA16 Single Stage Condensing Unit High/Low Pressure

| Part # | Mfg #       | Tons | Liq Conn. | Suction Conn. | CFM  | RPM | H x L x W               | Price |
|--------|-------------|------|-----------|---------------|------|-----|-------------------------|-------|
| 171663 | RA1636AC1NB | 3.0  | 3/4"      | 3/8"          | 4340 | 819 | 31" x 35-3/4" x 35-3/4" |       |
| 171664 | RA1642AC1NB | 3.5  | 3/4"      | 7/8"          | 4450 | 829 | 39" x 35-3/4" x 35-3/4" |       |
| 171665 | RA1648AC1NB | 4.0  | 3/4"      | 7/8"          | 4658 | 828 | 45" x 35-3/4" x 35-3/4" |       |
| 171666 | RA1660AC1NB | 5.0  | 3/8"      | 7/8"          | 4776 | 795 | 51" x 35-3/4" x 35-3/4" |       |

### RA14 Single Stage Condensing Unit High/Low Pressure

| Part # | Mfg #       | Tons | Liq Conn. | Suction Conn. | CFM  | RPM | H x L x W               | Price |
|--------|-------------|------|-----------|---------------|------|-----|-------------------------|-------|
| 171653 | RA1436AC1NB | 3.0  | 3/8"      | 3/4"          | 3105 | 850 | 27" x 33-3/4" x 33-3/4" |       |
| 171654 | RA1442AC1NB | 3.5  | 3/8"      | 7/8"          | 4265 | 820 | 27" x 35-3/4" x 35-3/4" |       |
| 171655 | RA1448AC1NB | 4.0  | 3/8"      | 7/8"          | 4265 | 820 | 1" x 35-3/4" x 35-3/4"  |       |
| 171656 | RA1460AC1NB | 5.0  | 3/8"      | 7/8"          | 4140 | 850 | 35" x 35-3/4" x 35-3/4" |       |

### RA13 Single Stage Condensing Unit High/Low Pressure

| Part # | Mfg #       | Tons | Liq Conn. | Suction Conn. | CFM  | RPM  | H x L x W               | Price |
|--------|-------------|------|-----------|---------------|------|------|-------------------------|-------|
| 171641 | RA1336AC1NB | 3.0  | 3/8"      | 3/4"          | 2900 | 1075 | 27" x 29-3/4" x 29-3/4" |       |
| 171643 | RA1342AC1NB | 3.5  | 3/8"      | 7/8"          | 2465 | 1075 | 25" x 29-3/4" x 29-3/4" |       |
| 171644 | RA1348AC1NB | 4.0  | 3/8"      | 7/8"          | 4145 | 850  | 27" x 33-3/4" x 33-3/4" |       |
| 171645 | RA1360AC1NB | 5.0  | 3/8"      | 7/8"          | 3870 | 820  | 31" x 35-3/4" x 35-3/4" |       |
| 185055 | RA1360AD1NB | 5.00 | 3/8"      | 7/8"          | 3870 | 820  | 31" x 35-3/4" x 35-3/4" |       |

Cooling - Equipment & Rooftop Units





## Condensing Units

### Achiever Plus™ Series



- Efficiencies up to 17 SEER/13 EER
- EcoNet™ enabled
- Two-Stage
- Scroll compressor
- Optimized fan orifice
- Rust resistant screws
- PlusOne™ Expanded Valve Space
- PlusOne™ Triple Service Access
- New composite base pan
- Two Stage Copeland Scroll™ UltraTech™ Compressor

#### Warranties

Conditional Unit Replacement - 10 Years (Registration Required)

Parts - 10 Years

### UA17 Two Stage Condensing Unit

| Part # | Mfg #       | Tons | Liq Conn. | Suction Conn. | CFM  | RPM | H x L x W               | Price |
|--------|-------------|------|-----------|---------------|------|-----|-------------------------|-------|
| 177559 | UA1724AJ2CB | 2.0  | 3/8"      | 3/4"          | 3326 | 850 | 35" x 33-3/4" x 33-3/4" |       |
| 177560 | UA1736AJ2CB | 3.0  | 3/8"      | 3/4"          | 3540 | 820 | 39" x 33-3/4" x 33-3/4" |       |
| 177561 | UA1748AJ2CB | 4.0  | 3/8"      | 7/8"          | 4521 | 646 | 51" x 35-3/4" x 35-3/4" |       |
| 177562 | UA1760AJ2CB | 5.0  | 3/8"      | 7/8"          | 5133 | 825 | 51" x 35-3/4" x 35-3/4" |       |

### Air Conditioners



- Scroll compressor
- Composite base pan
- Powder coat paint
- External gauge ports
- Single Row Coil
- Top can be removed without disconnecting motor
- Quick Release louver panel design

#### Warranties

10-Yr Parts Warranty

### UA20 Variable Speed Condensing Unit

| Part # | Mfg #       | Tons | Liq Conn. | Suction Conn. | CFM  | RPM | H x L x W               | Price |
|--------|-------------|------|-----------|---------------|------|-----|-------------------------|-------|
| 188639 | UA2024AJVCB | 2.0  | 3/8"      | 3/4"          | 3330 | 772 | 39" x 33-3/4" x 33-3/4" |       |
| 188640 | UA2036AJVCB | 3.0  | 3/8"      | 3/4"          | 4315 | 825 | 39" x 33-3/4" x 33-3/4" |       |
| 188641 | UA2048AJVCB | 4.0  | 3/8"      | 7/8"          | 6240 | 935 | 51" x 35-3/4" x 35-3/4" |       |
| 188999 | UA2060AJVCB | 5.0  | 3/8"      | 7/8"          | 6175 | 900 | 51" x 35-3/4" x 35-3/4" |       |

Cooling - Equipment & Rooftop Units

## Condensing Units

### Condensing Units

- Single phase
- Composite base pan
- Permanently lubricated motor
- Durable, attractive cabinet
- Removable top grille assembly
- High pressure switch
- Liquid line filter drier
- One piece Top/Orifice
- Easy compressor and control access
- Complete metal wrapper
- Micro-Channel coils: rows - FPI 1-18
- Operating voltage range: 187v min - 253v max  
208/230-60-1
- PSC fan motor
- Liquid line in 3/8" O.D.



#### JS4BD R-410A 13 Seer Condensator A/C

| Part # | Mfg #      | Tons | Delay Fuse Max | Suction 0-24' | Suction 25-39' | Suction 40-75' | Pad Size | Unit Height | Price |
|--------|------------|------|----------------|---------------|----------------|----------------|----------|-------------|-------|
| 118705 | JS4BD018KB | 1.5  | 20             | 3/4"          | 3/4"           | 3/4"           | 24 x 24  | 23-1/2"     |       |
| 118706 | JS4BD024KB | 2    | 25             | 3/4"          | 3/4"           | 3/4"           | 24 x 24  | 23-1/2"     |       |
| 118707 | JS4BD030KB | 2.5  | 30             | 3/4"          | 3/4"           | 3/4"           | 24 x 24  | 27-1/2"     |       |
| 118708 | JS4BD036KB | 3    | 35             | 3/4"          | 7/8"           | 7/8"           | 24 x 24  | 27-1/2"     |       |
| 118710 | JS4BD042KB | 3.5  | 40             | 7/8"          | 7/8"           | 7/8"           | 32 x 32  | 27-1/2"     |       |
| 118711 | JS4BD048KB | 4    | 50             | 7/8"          | 7/8"           | 7/8"           | 32 x 32  | 27-1/2"     |       |
| 118712 | JS4BD060KB | 5    | 60             | 7/8"          | 1-1/8"         | 1-1/8"         | 32 x 32  | 31-1/2"     |       |

#### JS4BE R-410A 14 Seer Condensator A/C

| Part # | Mfg #      | Tons | Delay Fuse Max | Suction 0-24' | Suction 25-39' | Suction 40-75' | Pad Size | Unit Height | Price |
|--------|------------|------|----------------|---------------|----------------|----------------|----------|-------------|-------|
| 118698 | JS4BE018KA | 1.5  | 20             | 3/4"          | 3/4"           | 3/4"           | 24 x 24  | 27"         |       |
| 118699 | JS4BE024KA | 2    | 30             | 3/4"          | 3/4"           | 3/4"           | 24 x 24  | 31"         |       |
| 118700 | JS4BE030KA | 2.5  | 30             | 3/4"          | 3/4"           | 3/4"           | 32 x 32  | 27"         |       |
| 118701 | JS4BE036KA | 3    | 30             | 3/4"          | 7/8"           | 7/8"           | 32 x 32  | 35"         |       |
| 118702 | JS4BE042KA | 3.5  | 40             | 7/8"          | 7/8"           | 7/8"           | 32 x 32  | 39"         |       |
| 118703 | JS4BE048KA | 4    | 45             | 7/8"          | 7/8"           | 7/8"           | 32 x 32  | 39"         |       |
| 118704 | JS4BE060KA | 5    | 60             | 7/8"          | 1-1/8"         | 1-1/8"         | 32 x 32  | 43"         |       |

#### JS6BD R-410A 13 Seer Builder Series Condensator Unit

| Part # | Mfg #     | Tons | Delay Fuse Max | Suction 0-24' | Suction 25-39' | Suction 40-75' | Pad Size  | Unit Height | Price |
|--------|-----------|------|----------------|---------------|----------------|----------------|-----------|-------------|-------|
| 202344 | JS6BD024K | 2    | 20             | 3/4"          | 3/4"           | 3/4"           | 24" x 24" | 27"         |       |
| 202345 | JS6BD030K | 2.5  | 25             | 3/4"          | 3/4"           | 3/4"           | 24" x 24" | 27"         |       |
| 202346 | JS6BD036K | 3    | 25             | 3/4"          | 7/8"           | 7/8"           | 24" x 24" | 35"         |       |

## Condensing Units

### Condensing Units

#### FS4BD-KB 13 Seer \* Condensing Unit

- Designed using galvanized steel
- Permanently Lubricated Motor
- Louvered Condenser Guard
- Removable Top Grille Assembly
- High Pressure Switch
- Liquid Line Filter Drier
- Easy Compressor and Control Access
- Composite Base Pan
- Swept Wing Fan Blade
- Micro-Channel Coils



| Part # | Mfg #         | Tons | Liq Conn | Suction Conn   | Dimensions (H x W) | Price |
|--------|---------------|------|----------|----------------|--------------------|-------|
| 118771 | FRIFS4BD018KA | 1.5  | 3/8"     | 3/4" (0-24 ft) | 25" x 22 3/4"      |       |
| 118772 | FRIFS4BD024KA | 2    | 3/8"     | 3/4" (0-24 ft) | 25" x 22 3/4"      |       |
| 118773 | FRIFS4BD030KA | 2.5  | 3/8"     | 3/4" (0-24 ft) | 29" x 22 3/4"      |       |
| 118774 | FRIFS4BD036KA | 3    | 3/8"     | 3/4" (0-24 ft) | 29" x 22 3/4"      |       |
| 118775 | FRIFS4BD042KB | 3.5  | 3/8"     | 7/8" (0-24 ft) | 29 1/2" x 30 3/4"  |       |
| 118776 | FRIFS4BD048KA | 4    | 3/8"     | 7/8" (0-24 ft) | 29 1/2" x 30 3/4"  |       |
| 118777 | FRIFS4BD060KA | 5    | 3/8"     | 7/8" (0-24 ft) | 33 1/2" x 30 3/4"  |       |

#### FS4BE 14 Seer \* Condensing Unit

- Designed using galvanized steel
- Permanently Lubricated Motor
- Swept-Wing Fan Blade
- Louvered Condenser Guard
- Removable Top Grille Assembly
- High Pressure Switch-
- Liquid Line Filter Drier
- One Piece Top/Orifice
- Easy Compressor and Control Access
- Composite Base Pan
- Micro-Channel Coils



| Part # | Mfg #         | Tons | Liq Conn | Suction Conn   | Dimensions (H x W) | Price |
|--------|---------------|------|----------|----------------|--------------------|-------|
| 118778 | FRIFS4BE018KA | 1.5  | 3/8"     | 3/4" (0-24 ft) | 29" x 22 3/4"      |       |
| 118779 | FRIFS4BE024KA | 2    | 3/8"     | 3/4" (0-24 ft) | 33" x 22 3/4"      |       |
| 118780 | FRIFS4BE030KA | 2.5  | 3/8"     | 3/4" (0-24 ft) | 29" x 30 3/4"      |       |
| 118781 | FRIFS4BE036KA | 3    | 3/8"     | 3/4" (0-24 ft) | 37" X 30 3/4"      |       |
| 118782 | FRIFS4BE042KA | 3.5  | 3/8"     | 7/8" (0-24 ft) | 41" x 30 3/4"      |       |
| 118783 | FRIFS4BE048KA | 4    | 3/8"     | 7/8" (0-24 ft) | 41" x 30 3/4"      |       |
| 118784 | FRIFS4BE060K  | 5    | 3/8"     | 7/8" (0-24 ft) | 45" x 30 3/4"      |       |

\* When Combined with Proper AHRI Matchup

[www.plumbsupply.com](http://www.plumbsupply.com) • Serving our Customers Since 1946 • [www.waterconcepts.net](http://www.waterconcepts.net)

**Condensing Units**

**FS4BF-K (B,C) 16 Seer \* Condensing Unit**

- CoreSense™ Compressor Protection
- Copeland Scroll UltraTech™ Compressor
- Durable, Attractive Cabinet
- Composite Base Pan
- Swept-Wing Fan Blade
- Louvered Condenser Guard
- Removable Top Grille Assembly
- Low Pressure Switch
- High Pressure Switch
- Liquid Line Filter Drier
- One Piece Top/Orifice
- Easy Compressor and Control Access
- Micro-Channel



| Part # | Mfg #         | Tons | Liq Conn | Suction Conn   | Dimensions (H x W) | Price |
|--------|---------------|------|----------|----------------|--------------------|-------|
| 118785 | FRIFS4BF024KB | 2    | 3/8"     | 3/4" (0-24 ft) | 37" x 22 3/4"      |       |
| 118786 | FRIFS4BF036KB | 3    | 3/8"     | 7/8" (0-24 ft) | 37" x 30 3/4"      |       |
| 118787 | FRIFS4BF048KC | 4    | 3/8"     | 7/8" (0-24 ft) | 41" x 30 3/4"      |       |
| 118788 | FRIFS4BF060KB | 5    | 3/8"     | 7/8" (0-24 ft) | 45" x 30 3/4"      |       |

**FS4BG Inventor 20 Seer \* Condensing Unit**

- iQ Drive®
- Interface Control Board
- System Control
- System Protection
- Cooling operating temperature range
- Five Minute Restart Time Delay
- Compressor and Component Access
- High Efficiency with the low Sound Levels
- Compressor Sound Blanket
- Variable Speed Condenser Motor and Swept-Wing Fan Blade
- Service Port
- High Pressure Switch
- Low Pressure Switch
- Liquid Line Filter Drier
- Louvered Condenser Guard
- Composite Base Pan
- Corrosion Resistance
- One Piece Top/Orifice
- Removable Top Grille Assembly



| Part # | Mfg #        | Tons | Liq Conn | Suction Conn   | Dimensions (H x W) | Price |
|--------|--------------|------|----------|----------------|--------------------|-------|
| 216523 | WSHFS4BG024K | 2    | 3/8"     | 3/4" (0-24 ft) | 37" x 22 1/2"      |       |
| 216524 | FRIFS4BG036K | 3    | 3/8"     | 7/8" (0-24 ft) | 37" x 30 1/2"      |       |
| 216525 | FRIFS4BG048K | 4    | 3/8"     | 7/8" (0-24 ft) | 45" x 30 1/2"      |       |
| 216526 | WSHFS4BG060K | 5    | 3/8"     | 7/8" (0-24 ft) | 45" x 30 1/2"      |       |

\* When Combined with Proper AHRI Matchup

## Condensing Units - New

### Condensing Units

#### ES4BD High Efficiency 13 SEER Single Stage Air Conditioner

- Designed using galvanized steel
- Composite base pan
- Permanently lubricated motor
- Louvered condenser guard
- Removable top grille assembly
- High pressure switch
- Liquid line filter drier
- One piece top/orifice
- Easy compressor and control access
- Mico-channel coils



| Part # | Mfg #         | Tons | Liq Conn | Suction Conn             | Dimensions (H x W) | Price |
|--------|---------------|------|----------|--------------------------|--------------------|-------|
| 202319 | FRIES4BD018KA | 1.5  | 3/8"     | 3/4"                     | 23-1/2" x 22-3/4"  |       |
| 202320 | FRIES4BD024KB | 2    | 3/8"     | 3/4"                     | 23-1/2" x 22-3/4"  |       |
| 202321 | FRIES4BD030KB | 2.4  | 3/8"     | 3/4"                     | 27-1/2" x 22-3/4"  |       |
| 202322 | FRIES4BD036KB | 3    | 3/8"     | 3/4"(0-24ft) 7/8"(24+ft) | 27-1/2" x 22-3/4"  |       |
| 202323 | FRIES4BD042KA | 3.5  | 3/8"     | 7/8"                     | 27-1/2" x 30-3/4"  |       |

#### ES4BE High Efficiency 14 SEER Single Stage Air Conditioner

- Designed using galvanized steel
- Composite base pan
- Permanently lubricated motor
- Louvered condenser guard
- Removable top grille assembly
- High pressure switch
- Liquid line filter drier
- One piece top/orifice
- Easy compressor and control access
- Mico-channel coils



| Part # | Mfg #        | Tons | Liq Conn | Suction Conn | Dimensions (H x W) | Price |
|--------|--------------|------|----------|--------------|--------------------|-------|
| 202331 | FRIES4BE048K | 4    | 3/8"     | 7/8"         | 39" x 30-3/4"      |       |

\* When Combined with Proper AHRI Matchup

[www.plumbsupply.com](http://www.plumbsupply.com) • Serving our Customers Since 1946 • [www.waterconcepts.net](http://www.waterconcepts.net)

**Condensing Units - New**

**FSA1BD High Efficiency 13 Seer Single Stage Air Conditioner**

- *Designed Using Galvanized Steel*
- *Permanently Lubricated Motor:*
- *Removable Top Grille Assembly*
- *High Pressure Switch*
- *Liquid Line Filter Drier*
- *One Piece Top/Orifice*
- *Easy Compressor and Control Access*
- *Composite Base Pan*
- *Swept Wing Fan Blade*
- *Micro-Channel Coils*
- *Servicer-Friendly Jacket*



| Part # | Mfg #          | Tons | Liq Conn | Suction Conn | Dimensions (H x W) | Price |
|--------|----------------|------|----------|--------------|--------------------|-------|
| 232013 | FSA1BD4M1SN18K | 1.5  | 3/8"     | 3/4"         | 24.5" x 23.75"     |       |
| 232015 | FSA1BD4M1SN24K | 2    | 3/8"     | 3/4"         | 24.5" x 23.75"     |       |
| 232016 | FSA1BD4M1SN30K | 2.5  | 3/8"     | 3/4"         | 28.5" x 23.75"     |       |
| 232017 | FSA1BD4M1SN36K | 3    | 3/8"     | 3/4"         | 28.5" x 23.75"     |       |
| 232018 | FSA1BD4M1SN42K | 3.5  | 3/8"     | 7/8"         | 29.25" x 31.75"    |       |
| 232019 | FSA1BD4M1SN48K | 4    | 3/8"     | 7/8"         | 29.25" x 31.75"    |       |
| 232020 | FSA1BD4M1SN60K | 5    | 3/8"     | 7/8"         | 33.25" x 31.75"    |       |

**FSA1BE High Efficiency 14 SEER Single Stage Air Conditioner**

- *Designed Using Galvanized Steel*
- *Permanently Lubricated Motor*
- *Removable Top Grille Assembly*
- *High Pressure Switch*
- *Liquid Line Filter Drier*
- *One Piece Top/Orifice*
- *Easy Compressor and Control Access*
- *Composite Base Pan*
- *Swept Wing Fan Blade*
- *Micro-Channel Coils*
- *Servicer-Friendly Jacket*



| Part # | Mfg #          | Tons | Liq Conn | Suction Conn | Dimensions (H x W) | Price |
|--------|----------------|------|----------|--------------|--------------------|-------|
| 232022 | FSA1BE4M1SN18K | 1.5  | 3/8"     | 3/4"         | 28.5" x 23.75"     |       |
| 232023 | FSA1BE4M1SN24K | 2    | 3/8"     | 3/4"         | 32.5" x 23.75"     |       |
| 232024 | FSA1BE4M1SN30K | 2.5  | 3/8"     | 3/4"         | 29.25" x 31.75"    |       |
| 232025 | FSA1BE4M1SN36K | 3    | 3/8"     | 3/4"         | 37.25" x 31.75"    |       |
| 232026 | FSA1BE4M1SN42K | 3.5  | 3/8"     | 7/8"         | 41.25" x 31.75"    |       |
| 232027 | FSA1BE4M1SN48K | 4    | 3/8"     | 7/8"         | 41.25" x 31.75"    |       |
| 232028 | FSA1BE4M1SN60K | 5    | 3/8"     | 7/8"         | 45.25" x 31.75"    |       |

\* When Combined with Proper AHRI Matchup

[www.waterconcepts.net](http://www.waterconcepts.net) • Serving our Customers Since 1946 • [www.plumbsupply.com](http://www.plumbsupply.com)

## Condensing Units - New

### FSA1BF Extra High Efficiency 16 SEER 2 Stage Air Conditioner

- CoreSense™ Compressor Protection
- Copeland Scroll UltraTech™ Compressor
- Designed Using Galvanized Steel
- Composite Base Pan
- Compressor Sound Blanket
- Swept-Wing Fan Blade
- Removable Top Grille Assembly
- Low Pressure Switch
- High Pressure Switch
- One Piece Top/Orifice
- Easy Compressor and Control Access
- Micro-Channel
- Servicer-Friendly Jacket



| Part # | Mfg #          | Tons | Liq Conn | Suction Conn | Dimensions (H x W) | Price |
|--------|----------------|------|----------|--------------|--------------------|-------|
| 232029 | FSA1BF4M2SN24K | 2    | 3/8"     | 3/4"         | 36.5" x 23.75"     |       |
| 232030 | FSA1BF4M2SN36K | 3    | 3/8"     | 7/8"         | 37.25" x 31.75"    |       |
| 232031 | FSA1BF4M2SN48K | 4    | 3/8"     | 7/8"         | 41.25" x 31.75"    |       |
| 232032 | FSA1BF4M2SN60K | 5    | 3/8"     | 7/8"         | 45.25" x 31.75"    |       |

### FSA1BG iQ Drive Ultra High Efficiency 20 Seer Variable Stage Air Conditioner

- iQ Drive®: Inverter driven Samsung rotary compressor provides five capacities in modulating operation from a two stage thermostat.
- Cooling operating temperature range: 50 °F to 125 °F.
- Five Minute Restart Time Delay
- Compressor Sound Blanket
- Variable Speed Condenser Motor and Swept-Wing Fan Blade
- High Pressure Switch
- Low Pressure Switch
- Micro-Channel Coils
- Composite Base Pan
- Designed Using Galvanized Steel
- One Piece Top/Orifice
- Removable Top Grille Assembly
- Servicer-Friendly Jacket



| Part # | Mfg #          | Tons | Liq Conn | Suction Conn | Dimensions (H x W) | Price |
|--------|----------------|------|----------|--------------|--------------------|-------|
| 232033 | FSA1BG4MVRN24K | 2    | 3/8"     | 3/4"         | 37" x 22 1/2"      |       |
| 232034 | FSA1BG4MVRN36K | 3    | 3/8"     | 7/8"         | 37" x 30 1/2"      |       |
| 232035 | FSA1BG4MVRN48K | 4    | 3/8"     | 7/8"         | 45" x 30 1/2"      |       |
| 232036 | FSA1BG4MVRN60K | 5    | 3/8"     | 7/8"         | 45" x 30 1/2"      |       |

\* When Combined with Proper AHRI Matchup

[www.plumbsupply.com](http://www.plumbsupply.com) • Serving our Customers Since 1946 • [www.waterconcepts.net](http://www.waterconcepts.net)

## Condensing Units

### Condensing Units

#### 4SCU13LE Standard-Efficiency, Single-Stage Air Conditioner

- Filter drier shipped loose for installation flexibility
- Service valves positioned for quick installation and easy service
- Indoor coil orifice shipped with outdoor unit for optimum efficiency and capacity
- Charged for 15 ft. of line set
- Trade available components
- High and low pressure switches
- Sealed contactor with lugs



| Part # | Mfg #          | Tons | Liq Conn. | Suction Conn. | CFM  | RPM  | H x L x W                | Price |
|--------|----------------|------|-----------|---------------|------|------|--------------------------|-------|
| 208383 | A4SCU13LE118P2 | 1.5  | 3/8"      | 3/4"          | 650  | 1010 | 25.75" x 26.75" x 24.75" |       |
| 208384 | A4SCU13LE124P2 | 2    | 3/8"      | 3/4"          | 800  | 1010 | 25.75" x 26.75" x 24.75" |       |
| 208385 | A4SCU13LE130P2 | 2.5  | 3/8"      | 3/4"          | 1000 | 1090 | 29.75" x 26.75" x 24.75" |       |
| 208386 | A4SCU13LE136P2 | 3    | 3/8"      | 3/4"          | 1200 | 1090 | 29.75" x 26.75" x 24.75" |       |
| 208387 | A4SCU13LE142P2 | 3.5  | 3/8"      | 7/8"          | 1400 | 825  | 29.75" x 31.25" x 29.38" |       |
| 208388 | A4SCU13LE148P2 | 4    | 3/8"      | 7/8"          | 1600 | 825  | 33.75" x 31.25" x 29.38" |       |
| 208389 | A4SCU13LE160P2 | 5    | 3/8"      | 7/8"          | 1800 | 830  | 29.75" x 31.25" x 29.38" |       |

#### 4SCU14LE Quiet, Single Stage Air Conditioner

- Filter drier shipped loose for installation flexibility
- Service valves positioned for quick installation and easy service
- Charged for 15 ft. of line set
- Trade available components
- High and low pressure switches factory installed



| Part # | Mfg #          | Tons | Liq Conn. | Suction Conn. | CFM  | RPM  | H x L x W                | Price |
|--------|----------------|------|-----------|---------------|------|------|--------------------------|-------|
| 208393 | A4SCU14LE118P1 | 1.5  | 3/8"      | 3/4"          | 650  | 1075 | 29.75" x 26.75" x 24.75" |       |
| 208394 | A4SCU14LE124P1 | 2    | 3/8"      | 3/4"          | 850  | 825  | 29.75" x 31.25" x 29.38" |       |
| 208395 | A4SCU14LE130P1 | 2.5  | 3/8"      | 3/4"          | 1000 | 825  | 37.75" x 31.25" x 29.38" |       |
| 208396 | A4SCU14LE136P1 | 3    | 3/8"      | 7/8"          | 1200 | 825  | 37.75" x 31.25" x 29.38" |       |
| 208398 | A4SCU14LE142P1 | 3.5  | 3/8"      | 7/8"          | 1400 | 825  | 33.75" x 31.25" x 29.38" |       |
| 208400 | A4SCU14LE148P1 | 4    | 3/8"      | 7/8"          | 1600 | 825  | 33.75" x 31.25" x 29.38" |       |
| 208401 | A4SCU14LE160P1 | 5    | 3/8"      | 7/8"          | 1800 | 825  | 37.75" x 37.75" x 35.75" |       |



**Condensing Units**

**4SCU16LE Quiet, Single-Stage Air Conditioner**

- Filter drier shipped loose for installation flexibility
- Service valves positioned for quick installation and easy service
- Charged for 15 ft. of line set
- Trade available components
- High and low pressure switches factory installed



| Part # | Mfg #          | Tons | Liq Conn. | Suction Conn. | CFM  | RPM  | H x L x W                | Price |
|--------|----------------|------|-----------|---------------|------|------|--------------------------|-------|
| 246809 | A4SCU16LE118P1 | 1.5  | 3/8"      | 3/4"          | 650  | 1075 | 29.75" x 26.75" x 24.75" |       |
| 246812 | A4SCU16LE124P1 | 2    | 3/8"      | 3/4"          | 850  | 825  | 29.75" x 31.35" x 29.38" |       |
| 246813 | A4SCU16LE130P1 | 2.5  | 3/8"      | 3/4"          | 1000 | 825  | 37.75" x 31.25" x 29.38" |       |
| 246814 | A4SCU16LE136P1 | 3    | 3/8"      | 7/8"          | 1200 | 825  | 37.75" x 31.25" x 29.38" |       |
| 246815 | A4SCU16LE142P1 | 3.5  | 3/8"      | 7/8"          | 1400 | 825  | 33.75" x 31.25" x 29.38" |       |
| 246818 | A4SCU16LE148P1 | 4    | 3/8"      | 7/8"          | 1600 | 825  | 33.75" x 31.25" x 29.38" |       |
| 246819 | A4SCU16LE160P1 | 5    | 3/8"      | 7/8"          | 1800 | 825  | 37.75" x 37.75" x 35.75" |       |

**4SCU16LS High-Efficiency Two-Stage Conditioner**

- Communicating capable control board works with "Comfort Sync" thermostat (or conventional thermostat)
- Self diagnostics control board for quick trouble shooting; saves up to 10 fault codes regardless of power interrupt
- Factory installed high and low pressure switches
- Thread-on type pressure switches with valve core for quick service
- Service valves mounted for easy brazing and service
- Factory installed crankcase heater
- Factory installed TXV for excellent refrigeration control
- Fan orifice for sound reduction and efficient performance
- Charged for 15 feet of line set
- Can be matched with Comfort Sync™ enabled or conventional indoor unit



| Part # | Mfg #          | Tons | Liq Conn. | Suction Conn. | CFM | RPM | H x L x W                | Price |
|--------|----------------|------|-----------|---------------|-----|-----|--------------------------|-------|
| 208402 | A4SCU16LS124P1 | 2    | 3/8"      | 3/7"          |     | 825 | 43.75" x 31.25" x 29.25" |       |
| 208403 | A4SCU16LS136P1 | 3    | 3/8"      | 7/8"          |     | 825 | 29.75" x 31.25" x 29.25" |       |
| 208404 | A4SCU16LS148P1 | 4    | 3/8"      | 7/8"          |     | 825 | 37.75" x 31.25" x 29.25" |       |
| 208405 | A4SCU16LS160P1 | 5    | 3/8"      | 7/8"          |     | 825 | 43.75" x 37.75" x 35.75" |       |

Cooling - Equipment & Rooftop Units

## Condensing Units

### 4SCU20LX High-Efficiency Variable-Capacity Air Conditioner

- 45-degree offset gauge ports for easy service
- Service valves positioned for quick installation and service
- Variable speed condenser fan motor
- Swept wing fan blade for quiet operation
- Factory installed crankcase heater
- Factory installed high and low pressure switches
- Thread-on pressure switches for simple, quick service
- Fan orifice for smoother airflow and sound level reduction
- Specialized sensors monitor ambient, liquid line, and coil temperatures for precision system control
- Charged for 15 feet of line set
- Requires Comfort Sync™ thermostat and a Comfort Sync™
- enabled matching indoor unit



| Part # | Mfg #         | Tons | Liq Conn. | Suction Conn. | CFM | RPM | H x L x W                | Price |
|--------|---------------|------|-----------|---------------|-----|-----|--------------------------|-------|
| 225324 | A4SCU20LX124P | 2    | 3/8"      | 3/4"          |     | VS  | 37.5" x 35.75" x 37.75"  |       |
| 225325 | A4SCU20LX136P | 3    | 3/8"      | 7/8"          |     | VS  | 37.5" x 35.75" x 37.75"  |       |
| 225326 | A4SCU20LX148P | 4    | 3/8"      | 7/8"          |     | VS  | 43.75" x 35.75" x 37.75" |       |
| 225327 | A4SCU20LX160P | 5    | 3/8"      | 7/8"          |     | VS  | 43.75" x 35.75" x 37.75" |       |

Cooling - Equipment &  
Roof-top Units

**Condensing Units**

**Condensing Units**

**4AC13L 13 SEER Split System Air Conditioner**

- R410a Refrigerant
- High-quality condenser coil with copper tubing and enhanced louvered fin for maximum heat transfer capacity
- Top discharge directs hot air away from living area and shrubbery
- All units factory run tested
- Available with louvered panel or wire guard coil protection
- Easy access to electrical panels
- Corner mounted service valves for easy hook-up and service
- Liquid line filter drier shipped loose
- Charged for 15 feet of interconnecting tubing
- All units ETL and ETLC approved and AHRI certified
- Louvered



| Part # | Mfg #        | Tons | Liq Conn. | Suction Conn. | CFM  | RPM  | H x L x W             | Price |
|--------|--------------|------|-----------|---------------|------|------|-----------------------|-------|
| 208719 | DUC4AC13L18P | 1.5  | 3/8"      | 3/4"          | 650  | 1010 | 25" x 24.25" x 24.25" |       |
| 208720 | DUC4AC13L24P | 2    | 3/8"      | 3/4"          | 800  | 1010 | 25" x 24.25" x 24.25" |       |
| 208721 | DUC4AC13L30P | 2.5  | 3/8"      | 3/4"          | 1000 | 1090 | 29" x 24.25" x 24.25" |       |
| 208722 | DUC4AC13L36P | 3    | 3/8"      | 7/8"          | 1200 | 1090 | 29" x 24.25" x 24.25" |       |
| 208723 | DUC4AC13L42P | 3.5  | 3/8"      | 7/8"          | 1400 | 825  | 29" x 28.25" x 28.25" |       |
| 208724 | DUC4AC13L48P | 4    | 3/8"      | 7/8"          | 1600 | 825  | 33" x 28.25" x 28.25" |       |
| 208725 | DUC4AC13L60P | 5    | 3/8"      | 7/8"          | 1800 | 830  | 29" x 28.25" x 28.25" |       |

**4AC14L 14 SEER Split System Air Conditioner**

- R410A Refrigerant
- High-quality condenser coil with copper tubing and enhanced lanced fin for maximum heat transfer capacity
- Top discharge directs hot air and sound away from living area and shrubbery
- All units factory run tested
- Easy access to electrical panels, pre-wired for easy hook-up
- Liquid line drier shipped loose
- All units ETL and ETLC approved and AHRI Certified
- Charged for 15 feet of interconnecting tubing
- High pressure switch factory installed
- Louvered



| Part # | Mfg #        | Tons | Liq Conn. | Suction Conn. | CFM  | RPM  | H x L x W             | Price |
|--------|--------------|------|-----------|---------------|------|------|-----------------------|-------|
| 208726 | DUC4AC14L18P | 1.5  | 3/8"      | 3/4"          | 650  | 1075 | 29" x 24.25" x 24.25" |       |
| 208727 | DUC4AC14L24P | 2    | 3/8"      | 3/4"          | 850  | 825  | 29" x 28.25" x 28.25" |       |
| 208728 | DUC4AC14L30P | 2.5  | 3/8"      | 3/4"          | 1000 | 825  | 37" x 28.25" x 28.25" |       |
| 208729 | DUC4AC14L36P | 3    | 3/8"      | 7/8"          | 1200 | 825  | 37" x 28.25" x 28.25" |       |
| 208731 | DUC4AC14L42P | 3.5  | 3/8"      | 7/8"          | 1400 | 825  | 33" x 28.25" x 28.25" |       |
| 208733 | DUC4AC14L48P | 4    | 3/8"      | 7/8"          | 1600 | 825  | 33" x 28.25" x 28.25" |       |
| 208734 | DUC4AC14L60P | 5    | 3/8"      | 7/8"          | 1800 | 825  | 37" x 32.25" x 32.25" |       |

Cooling - Equipment & Rooftop Units

**Condensing Units**

**4AC16L 16 SEER Split System Air Conditioner**

- R410A Refrigerant
- High-quality condenser coil with copper tubing and enhanced lanced fin for maximum heat transfer capacity
- Top discharge directs hot air and sound away from living area and shrubbery
- All units factory run tested
- Easy access to electrical panels, pre-wired for easy hook-up
- Liquid line drier shipped loose
- All units ETL and ETL approved and AHRI Certified
- Charged for 15 feet of interconnecting tubing
- High pressure switch factory installed



| Part # | Mfg #        | Tons | Liq Conn. | Suction Conn. | CFM  | RPM  | H x L x W             | Price |
|--------|--------------|------|-----------|---------------|------|------|-----------------------|-------|
| 246843 | DUC4AC16L18P | 1.5  | 3/8"      | 3/4"          | 650  | 1075 | 29" x 24.25" x 24.25" |       |
| 246846 | DUC4AC16L24P | 2    | 3/8"      | 3/4"          | 850  | 825  | 29" x 24.25" x 24.25" |       |
| 246847 | DUC4AC16L30P | 2.5  | 3/8"      | 3/4"          | 1000 | 825  | 37" x 28.25" x 28.25" |       |
| 246849 | DUC4AC16L36P | 3    | 3/8"      | 7/8"          | 1200 | 825  | 37" x 28.25" x 28.25" |       |
| 246850 | DUC4AC16L42P | 3.5  | 3/8"      | 7/8"          | 1400 | 825  | 33" x 28.25" x 28.25" |       |
| 246851 | DUC4AC16L48P | 4    | 3/8"      | 7/8"          | 1600 | 825  | 33" x 28.25" x 28.25" |       |
| 246852 | DUC4AC16L60P | 5    | 3/8"      | 7/8"          | 1800 | 825  | 37" x 32.25" x 32.25" |       |

Cooling - Equipment &  
Roof-top Units

**Condensing Units**

**4AC16LT 16 SEER Split System Air Conditioner**

- Designed for ambients up to 125°F
- All units ETL and ETLC approved and AHRI listed
- Service valves positioned for quick installation and easy service
- High and low pressure switches factory installed
- Comfort Alert 2™ diagnostics is factory installed
- Trade available components
- Factory installed crank case heater
- Charged for 15 ft. of line set
- High-efficiency 2 stage Copeland
- UltraTech™ scroll compressor
- R410a refrigerant
- Grommet-mounted compressor for quiet operation
- Internally protected against high temperature motor overload conditions
- Heavy-duty compressor sound blanket for quiet operation
- Full metal louvered panels remove for easy coil cleaning and service
- Controls located in corner post for easy installation and service
- Rounded corners for safety and attractive, clean appearance
- Baked polyester paint finish over galvanized steel for maximum durability
- PVC-coated wire fan discharge grill
- External gauge ports for easy service
- Enhanced aluminum fins and copper tubing for higher efficiency and capacity
- Raised coil prevents debris from collecting in bottom of coil and causing loss of airflow



Cooling - Equipment & Rooftop Units

| Part # | Mfg #         | Tons | Liq Conn. | Suction Conn. | CFM  | RPM  | H x L x W                   | Price |
|--------|---------------|------|-----------|---------------|------|------|-----------------------------|-------|
| 228357 | DUC4AC16LT24P | 2    | 3/8"      | 3/4"          | 800  | 1075 | 29-3/4" x 24-3/4" x 26-3/4" |       |
| 228359 | DUC4AC16LT36P | 3    | 3/8"      | 3/4"          | 1200 | 825  | 29-3/4" x 29-3/8" x 31-1/4" |       |
| 228360 | DUC4AC16LT48P | 4    | 3/8"      | 7/8"          | 1600 | 825  | 37-3/4" x 29-3/8" x 31-1/4" |       |
| 228361 | DUC4AC16LT60P | 5    | 3/8"      | 7/8"          | 1800 | 825  | 43-3/4" x 29-3/8" x 31-1/4" |       |



## Heat Pumps

### Achiever Series Heat Pumps



- Scroll Compressor
- High & Low Pressure Switches
- Composite Base Pan
- Powder Coat Paint
- External Gauge Ports
- Single Row Coil
- Top Can be Removed without Disconnecting Motor
- Quick Release Louver Panel Design

**Warranties**  
**10-Yr Parts Warranty**

#### R15 Heat Pump

R-410A

| Part # | Mfg #       | Tons | BTUH   | Liquid Conn | Suction Conn | H x L x W               | Price |
|--------|-------------|------|--------|-------------|--------------|-------------------------|-------|
| 171675 | RP1518AJ1NA | 1.5  | 18,000 | 3/8"        | 3/4"         | 25" x 29-3/4" x 29-3/4" |       |
| 171676 | RP1524AJ1NA | 2.0  | 24,000 | 3/8"        | 3/4"         | 25" x 29-3/4" x 29-3/4" |       |
| 171677 | RP1530AJ1NA | 2.5  | 30,000 | 3/8"        | 3/4"         | 31" x 33-3/4" x 33-3/4" |       |
| 171678 | RP1536AJ1NA | 3.0  | 36,000 | 3/8"        | 3/4"         | 35" x 33-3/4" x 33-3/4" |       |
| 171679 | RP1542AJ1NA | 3.5  | 42,000 | 3/8"        | 7/8"         | 35" x 33-3/4" x 33-3/4" |       |
| 171680 | RP1548AJ1NA | 4.0  | 48,000 | 3/8"        | 7/8"         | 39" x 35-3/4" x 35-3/4" |       |
| 171681 | RP1560AJ1NA | 5.0  | 60,000 | 3/8"        | 7/8"         | 45" x 35-3/4" x 35-3/4" |       |

#### RP14 Heat Pump

R-410A

| Part # | Mfg #       | Tons | BTUH   | Liquid Conn | Suction Conn | H x L x W               | Price |
|--------|-------------|------|--------|-------------|--------------|-------------------------|-------|
| 234447 | RP1418FJ1NA | 1.5  | 18,000 | 3/8"        | 3/4"         | 25" x 29-3/4" x 29-3/4" |       |
| 234448 | RP1424FJ1NA | 2.0  | 24,000 | 3/8"        | 3/4"         | 25" x 29-3/4" x 29-3/4" |       |
| 234449 | RP1430FJ1NA | 2.5  | 30,000 | 3/8"        | 3/4"         | 25" x 29-3/4" x 29-3/4" |       |
| 234450 | RP1436FJ1NA | 3.0  | 36,000 | 3/8"        | 3/4"         | 27" x 33-3/4" x 33-3/4" |       |
| 234451 | RP1442FJ1NA | 3.5  | 42,000 | 3/8"        | 7/8"         | 27" x 33-3/4" x 33-3/4" |       |
| 234452 | RP1448FJ1NA | 4.0  | 48,000 | 3/8"        | 7/8"         | 35" x 33-3/4" x 33-3/4" |       |
| 234453 | RP1460FJ1NA | 5.0  | 60,000 | 3/8"        | 7/8"         | 39" x 35-3/4" x 35-3/4" |       |



## Heat Pumps

### Achiever Plus Series Heat Pumps

- EcoNet™ Enables
- Variable speed scroll compressor
- High pressure switch
- Low pressure transducer
- Powder coat paint
- Field installed filter drier
- Front seating service valves
- Electronic expansion valve

ACHIEVER  
SERIES



#### Warranties

10-Yr Parts Warranty

#### UP17 Variable Speed Heat Pump 3-Stage R-410A

| Part # | Mfg #       | Tons | BTUH   | Liquid Conn | Suction Conn | H x L x W               | Price |
|--------|-------------|------|--------|-------------|--------------|-------------------------|-------|
| 185061 | UP1724AJVCA | 2    | 24,000 | 3/8"        | 3/4"         | 35" x 33-3/4" x 33-3/4" |       |
| 185062 | UP1736AJVCA | 3    | 36,000 | 3/8"        | 3/4"         | 35" x 33-3/4" x 33-3/4" |       |
| 185063 | UP1748AJVCA | 4    | 48,000 | 3/8"        | 7/8"         | 39" x 35-3/4" x 35-3/4" |       |
| 185064 | UP1760AJVCA | 5    | 60,000 | 3/8"        | 7/8"         | 45" x 35-3/4" x 35-3/4" |       |

### Ultra Series Heat Pumps

- Scroll compressor
- High & Low pressure switches
- Composite base pan
- Powder coat paint
- External gauge ports
- Single row coil
- Top can be removed without disconnecting motor
- Quick release louver panel design
- R-410A Refrigerant

ULTRA  
SERIES



#### Warranties

10-Yr Parts Warranty

#### UP20 Variable Speed Heat Pump R-410A

| Part # | Mfg #       | Tons | BTUH   | Liquid Conn | Suction Conn | H x L x W               | Price |
|--------|-------------|------|--------|-------------|--------------|-------------------------|-------|
| 189000 | UP2024AJVCA | 2.0  | 24,000 | 3/8"        | 3/4"         | 35" x 35-3/4" x 35-3/4" |       |
| 222340 | UP2036AJVCA | 3.0  | 36,000 | 3/8"        | 3/4"         | 39" x 35-3/4" x 35-3/4" |       |
| 189001 | UP2048AJVCA | 4.0  | 48,000 | 3/8"        | 7/8"         | 51" x 35-3/4" x 35-3/4" |       |
| 222820 | UP2060AJVCA | 5.0  | 60,000 | 3/8"        | 7/8"         | 51" x 35-3/4" x 35-3/4" |       |

Cooling - Equipment &  
Roof-top Units

## Heat Pumps

### Heat Pumps

#### JT4BE Series 14 SEER High Efficiency Heat Pump

- Single-stage
- Composite base pan
- Permanently lubricated motor
- Durable, attractive cabinet
- Removable top grill assembly
- High pressure switch
- Liquid line filter drier
- One-piece filter top/orifice
- Five minute restart time delay
- Suction accumulator
- Hot gas muffler
- Easy compressor and control access
- Complete metal wrapper
- Fixed orifice
- Micro-channel coils



| Part # | Mfg #      | Tons | Delay Fuse Max | Suction 0-24' | Suction 25-39' | Suction 40-75' | Pad Size | Unit Height | Price |
|--------|------------|------|----------------|---------------|----------------|----------------|----------|-------------|-------|
| 211094 | JT4BE018KA | 1.5  | 20             | 3/4"          | 3/4"           | 3/4"           | 32 x 32  | 31-1/2"     |       |
| 211095 | JT4BE024KA | 2    | 30             | 3/4"          | 3/4"           | 3/4"           | 32 x 32  | 31-1/2"     |       |
| 211096 | JT4BE030KA | 2.5  | 25             | 3/4"          | 3/4"           | 3/4"           | 32 x 32  | 39-1/2"     |       |
| 211097 | JT4BE036KA | 3    | 30             | 7/8"          | 7/8"           | 7/8"           | 32 x 32  | 43-1/2"     |       |
| 211098 | JT4BE042KA | 3.5  | 40             | 7/8"          | 7/8"           | 7/8"           | 32 x 32  | 43-1/2"     |       |
| 211099 | JT4BE048KA | 4    | 45             | 7/8"          | 7/8"           | 7/8"           | 32 x 32  | 43-1/2"     |       |
| 211100 | JT4BE060KA | 5    | 60             | 7/8"          | 1-1/8"         | 1-1/8"         | 32 x 32  | 43-1/2"     |       |



**Heat Pumps**

**Heat Pumps**

**FT4BE 14 Seer \* Heat Pump**

- *Designed using galvanized steel*
- *Permanently Lubricated Motor*
- *Composite Base Pan*
- *Louvered Condenser Guard*
- *Removable Top Grille Assembly*
- *Swept-Wing Fan Blade*
- *High Pressure Switch*
- *Low Pressure Switch*
- *Liquid Line Filter Drier*
- *One Piece Top/Orifice*
- *Five Minute Restart Time Delay*
- *Easy Compressor and Control Access*
- *Fixed Orifice*
- *Micro-Channel Coils*



| Part # | Mfg #        | Tons | Liq Conn | Suction Conn   | Dimensions (H x W) | Price |
|--------|--------------|------|----------|----------------|--------------------|-------|
| 118823 | FRIFT4BE018K | 1.5  | 3/8"     | 3/4" (0-24 ft) | 33 1/2" x 30 3/4"  |       |
| 118824 | FRIFT4BE024K | 2    | 3/8"     | 3/4" (0-24 ft) | 33 1/2" x 30 3/4"  |       |
| 118825 | FRIFT4BE030K | 2.5  | 3/8"     | 3/4" (0-24 ft) | 41 1/2" x 30 3/4"  |       |
| 118826 | FRIFT4BE036K | 3    | 3/8"     | 7/8" (0-24 ft) | 45 1/2" x 30 3/4"  |       |
| 118827 | FRIFT4BE042K | 3.5  | 3/8"     | 7/8" (0-24 ft) | 45 1/2" x 30 3/4"  |       |
| 118828 | FRIFT4BE048K | 4    | 3/8"     | 7/8" (0-24 ft) | 45 1/2" x 30 3/4"  |       |
| 118829 | FRIFT4BE060K | 5    | 3/8"     | 7/8" (0-24 ft) | 45 1/2" x 30 3/4"  |       |

Cooling - Equipment & Rooftop Units

\* When Combined with Proper AHRI Matchup

[www.plumbsupply.com](http://www.plumbsupply.com) • Serving our Customers Since 1946 • [www.waterconcepts.net](http://www.waterconcepts.net)

**Heat Pumps**

**FT4BF 16 Seer \* Heat Pump**

- CoreSense™ Compressor Protection
- Copeland Scroll UltraTech™ Compressor
- Durable, Attractive Cabinet
- Composite Base Pan
- Copper Tube / Aluminum Fin Coils
- Demand Defrost
- Louvered Condenser Guard
- Removable Top Grille Assembly
- Compressor Sound Blanket
- Swept-Wing Fan Blade
- Low Pressure Switch
- High Pressure Switch
- Liquid Line Filter Drier
- One Piece Top/Orifice
- Common Suction Service Port
- Three Minute Restart Time Delay
- Suction Accumulator
- Hot Gas Muffler
- Easy Compressor and Control Access



Cooling - Equipment & Rooftop Units

| Part # | Mfg #         | Tons | Liq Conn | Suction Conn   | Dimensions (H x W) | Price |
|--------|---------------|------|----------|----------------|--------------------|-------|
| 118812 | FRIFT4BF024KA | 2    | 3/8"     | 3/4" (0-24 ft) | 45 1/2" x 31 1/4"  |       |
| 118813 | FRIFT4BF036KA | 3    | 3/8"     | 7/8" (0-24 ft) | 45 1/2" x 31 1/4"  |       |
| 118814 | FRIFT4BF048KA | 4    | 3/8"     | 7/8" (0-24 ft) | 45 1/2" x 31 1/4"  |       |
| 118815 | FRIFT4BF060KA | 5    | 3/8"     | 7/8" (0-24 ft) | 45 1/2" x 31 1/4"  |       |

\* When Combined with Proper AHRI Matchup

[www.waterconcepts.net](http://www.waterconcepts.net) • Serving our Customers Since 1946 • [www.plumbsupply.com](http://www.plumbsupply.com)

## Heat Pumps

### FT4BG 19 Seer \* Heat Pump

- iQ Drive
- Interface control board
- Utilizes a Nortek Global HVAC
- System Protection
- Cooling operating temperature range:
- Locks out heat pump heating
- Adaptive demand defrost
- Five Minute Restart Time Delay
- Suction Accumulator
- Compressor and Component Access
- High Efficiency with the low Sound Levels
- Compressor Sound Blanket
- Variable Speed Condenser
- Common Suction Service Port
- Discharge muffler
- High Pressure Switch
- Low Pressure Switch
- Liquid Line Filter Drier:
- Copper Tube / Aluminum Fin Coils
- Louvered Condenser Guard
- Composite Base Pan
- Designed using galvanized steel
- One Piece Top/Orifice
- Removable Top Grille Assembly



| Part # | Mfg #        | Tons | Liq Conn | Suction Conn   | Dimensions (H x W) | Price |
|--------|--------------|------|----------|----------------|--------------------|-------|
| 206889 | FRIFT4BG024K | 2    | 3/8"     | 3/4" (0-24 ft) | 37" x 31 1/4"      |       |
| 206890 | FRIFT4BG036K | 3    | 3/8"     | 7/8" (0-24 ft) | 41" x 31 1/4"      |       |
| 206891 | FRIFT4BG048K | 4    | 3/8"     | 7/8" (0-24 ft) | 41" x 31 1/4"      |       |
| 206892 | FRIFT4BG060K | 5    | 3/8"     | 7/8" (0-24 ft) | 45" x 31 1/4"      |       |

\* When Combined with Proper AHRI Matchup

[www.plumbsupply.com](http://www.plumbsupply.com) • Serving our Customers Since 1946 • [www.waterconcepts.net](http://www.waterconcepts.net)

**Heat Pumps - New**

**Heat Pumps**

**FSH1BE High Efficiency 14 Seer Single Stage Heat Pump**

- Permanently Lubricated Motor
- Composite Base Pan
- Removable Top Grille Assembly
- Swept-Wing Fan Blade
- High Pressure Switch
- Low Pressure Switch
- Liquid Line Filter Drier
- One Piece Top/Orifice
- Five Minute Restart Time Delay
- Easy Compressor and Control Access
- Fixed Orifice
- Micro-Channel Coils
- Servicer-Friendly Jacket



Cooling - Equipment & Rooftop Units

| Part # | Mfg #          | Tons | Liq Conn | Suction Conn | Dimensions (H x W) | Price |
|--------|----------------|------|----------|--------------|--------------------|-------|
| 232043 | FSH1BE4M1SP18K | 1.5  | 3/8"     | 3/4"         | 33.25" x 31.75"    |       |
| 232044 | FSH1BE4M1SP24K | 2    | 3/8"     | 3/4"         | 33.25" x 31.75"    |       |
| 232045 | FSH1BE4M1SP30K | 2.5  | 3/8"     | 3/4"         | 41.25" x 31.75"    |       |
| 232046 | FSH1BE4M1SP36K | 3    | 3/8"     | 7/8"         | 45.25" x 31.75"    |       |
| 232047 | FSH1BE4M1SP42K | 3.5  | 3/8"     | 7/8"         | 45.25" x 31.75"    |       |
| 232048 | FSH1BE4M1SP48K | 4    | 3/8"     | 7/8"         | 45.25" x 31.75"    |       |
| 232049 | FSH1BE4M1SP60K | 5    | 3/8"     | 7/8"         | 45.25" x 31.75"    |       |

\* When Combined with Proper AHRI Matchup

[www.waterconcepts.net](http://www.waterconcepts.net) • Serving our Customers Since 1946 • [www.plumbsupply.com](http://www.plumbsupply.com)

## Heat Pumps - New

### FSH1BF Extra High Efficiency 16 Seer 2 Stage Heat Pump

- CoreSense™ Compressor Protection
- Copeland Scroll UltraTech™ Compressor
- Copeland's proven and simple design equates to years of comfort and reliability for the homeowner with virtually silent operation.
- Designed Using Galvanized Steel
- Composite Base Pan
- Micro-Channel Coils
- Demand Defrost
- Removable Top Grille Assembly
- Compressor Sound Blanket
- Swept-Wing Fan Blade
- Low Pressure Switch
- High Pressure Switch
- Liquid Line Filter Drier
- One Piece Top/Orifice
- Common Suction Service Port
- Five Minute Restart Time Delay
- Suction Accumulator
- Hot Gas Muffler
- Easy Compressor and Control Access
- Servicer-Friendly Jacket



| Part # | Mfg #          | Tons | Liq Conn | Suction Conn | Dimensions (H x W) | Price |
|--------|----------------|------|----------|--------------|--------------------|-------|
| 232050 | FSH1BF4M2SX24K | 2    | 3/8"     | 3/4"         | 37.25" x 31.75"    |       |
| 232051 | FSH1BF4M2SX36K | 3    | 3/8"     | 7/8"         | 45.25" x 31.75"    |       |
| 232052 | FSH1BF4M2SX48K | 4    | 3/8"     | 7/8"         | 45.25" x 31.75"    |       |
| 232053 | FSH1BF4M2SX60K | 5    | 3/8"     | 7/8"         | 45.25" x 31.75"    |       |

\* When Combined with Proper AHRI Matchup

[www.plumbsupply.com](http://www.plumbsupply.com) • Serving our Customers Since 1946 • [www.waterconcepts.net](http://www.waterconcepts.net)

**Heat Pumps - New**

**FSH1BG iQ Drive Ultra High Efficiency 19 Seer Variable Stage Heat Pump**

- *iQ Drive: Inverter driven Samsung rotary compressor provides five capacities in modulating operation from a two stage thermostat.*
- *Interface control board*
- *System Protection*
- *Cooling operating temperature range: 50 °F to 125 °F.*
- *Locks out heat pump heating: below 0 °F.*
- *Adaptive demand defrost*
- *Five Minute Restart Time Delay*
- *Suction Accumulator*
- *Compressor and Component Access*
- *High Efficiency with the low Sound Levels*
- *Compressor Sound Blanket*
- *Variable Speed Condenser Motor and Swept-Wing Fan Blade*
- *Common Suction Service Port*
- *Dischargemuffler: Reduces compressor noise and vibration.*
- *High Pressure Switch*
- *Low Pressure Switch*
- *Liquid Line Filter Drier:*
- *Copper Tube / Aluminum Fin Coils*
- *Composite Base Pan*
- *One Piece Top/Orifice*
- *Removable Top Grille Assembly*
- *Servicer-Friendly Jacket*



Cooling - Equipment & Rooftop Units

| Part # | Mfg #          | Tons | Liq Conn | Suction Conn | Dimensions (H x W) | Price |
|--------|----------------|------|----------|--------------|--------------------|-------|
| 232054 | FSH1BG4CVRX24K | 2    | 3/8"     | 3/4"         | 37.25" x 31.75"    |       |
| 232055 | FSH1BG4CVRX36K | 3    | 3/8"     | 7/8"         | 41.25" x 31.75"    |       |
| 232056 | FSH1BG4CVRX48K | 4    | 3/8"     | 7/8"         | 41.25" x 31.75"    |       |
| 232057 | FSH1BG4CVRX60K | 5    | 3/8"     | 7/8"         | 45.25" x 31.75"    |       |

**ET4BE High Efficiency 14 SEER Single Stage Heat Pump**

- *Designed using galvanized steel*
- *Permanently lubricated motor*
- *Composite base pan*
- *Permanently lubricated motor*
- *Louvered condenser guard*
- *Removable top grille assembly*
- *High pressure switch*
- *Liquid line filter drier*
- *One piece top/orifice*
- *Easy compressor and control access*
- *Mico-channel coils*



| Part # | Mfg #         | Tons | Liq Conn | Suction Conn | Dimensions (H x W) | Price |
|--------|---------------|------|----------|--------------|--------------------|-------|
| 202451 | FRIET4BE030KA | 2.5  | 3/8"     | 3/4"         | 27" x 30-3/4"      |       |
| 202452 | FRIET4BE036KA | 3    | 3/8"     | 7/8"         | 35" x 30-3/4"      |       |

\* When Combined with Proper AHRI Matchup

[www.waterconcepts.net](http://www.waterconcepts.net) • Serving our Customers Since 1946 • [www.plumbsupply.com](http://www.plumbsupply.com)

**Heat Pumps - New**

**Heat Pumps (Continued)**

**ET4BE High Efficiency 14 SEER Single Stage Heat Pump**

| Part # | Mfg #         | Tons | Liq Conn | Suction Conn | Dimensions (H x W) | Price |
|--------|---------------|------|----------|--------------|--------------------|-------|
| 202453 | FRIET4BE042KA | 3.5  | 3/8"     | 7/8"         | 39" x 30-3/4"      |       |

Cooling - Equipment & Rooftop Units

\* When Combined with Proper AHRI Matchup

[www.plumbsupply.com](http://www.plumbsupply.com) • Serving our Customers Since 1946 • [www.waterconcepts.net](http://www.waterconcepts.net)

## Heat Pumps

### Heat Pumps

#### 4SHP14LE Quiet, Single-Stage Heat Pump

- Filter drier shipped loose for installation flexibility
- Discharge muffler for quiet operation
- High Pressure switch
- Low pressure switch for loss of charge system protection
- Reliable, solid state, time-initiated, temperature terminated defrost system
- Service valves positioned for quick installation and easy service
- Trade-available components
- Defrost control features built-in diagnostics for easier service
- Defrost control has short cycle protection to protect compressor
- Defrost control is Quiet Shift™ capable
- Defrost cycle is field selectable 30/60/90 minutes
- Sealed contactor with lugs
- Sound cover



| Part # | Mfg #          | Tons | BTUH   | Liquid Conn | Suction Conn | H x L x W                | Price |
|--------|----------------|------|--------|-------------|--------------|--------------------------|-------|
| 208418 | A4SHP14LE118P1 | 1.5  | 18,000 | 3/8"        | 3/4"         | 37.75" x 29.25" x 31.25" |       |
| 208419 | A4SHP14LE124P1 | 2    | 24,000 | 3/8"        | 3/4"         | 37.75" x 31.25" x 29.25" |       |
| 208420 | A4SHP14LE130P1 | 2.5  | 30,000 | 3/8"        | 3/4"         | 37.75" x 31.25" x 29.25" |       |
| 208421 | A4SHP14LE136P1 | 3    | 36,000 | 3/8"        | 7/8"         | 33.75" x 29.25" x 31.25" |       |
| 208422 | A4SHP14LE142P1 | 3.5  | 42,000 | 3/8"        | 7/8"         | 37.75" x 35.75" x 37.75" |       |
| 208423 | A4SHP14LE148P1 | 4    | 48,000 | 3/8"        | 7/8"         | 37.75" x 35.75" x 37.75" |       |
| 208424 | A4SHP14LE160P1 | 5    | 60,000 | 3/8"        | 7/8"         | 43.75" x 35.75" x 37.75" |       |

#### 4SHP16LS High-Efficiency Two-Stage Heat Pump

- 45-degree offset service valves ports for easy service
- Factory installed crankcase heater
- Factory installed TXV for excellent refrigeration control
- Factory installed high and low pressure switches
- Thread-on-pressure switches for simple, quick service
- Fan orifice for smoother airflow and sound level reduction
- Specialized sensors monitor ambient, liquid line, and discharge temperatures for precision system control
- Charged for 15 feet of line set
- Discharge muffler for quiet operation
- Demand defrost for increased energy efficiency
- Quiet Shift capable to reduce noise during defrost
- Operates most efficiently with Comfort Sync™ thermostat and communicating indoor unit
- Operates with standard thermostat and non-communicating indoor unit



| Part # | Mfg #          | Tons | BTUH   | Liquid Conn | Suction Conn | H x L x W                | Price |
|--------|----------------|------|--------|-------------|--------------|--------------------------|-------|
| 208425 | A4SHP16LS124P2 | 2    | 24,000 | 3/8"        | 3/4"         | 33.75" x 24.75" x 26.75" |       |
| 208426 | A4SHP16LS136P2 | 3    | 36,000 | 3/8"        | 7/8"         | 43.75" x 29.25" x 31.25" |       |
| 208427 | A4SHP16LS148P2 | 4    | 48,000 | 3/8"        | 7/8"         | 37.75" x 35.75" x 37.75" |       |
| 208428 | A4SHP16LS160P2 | 5    | 60,000 | 3/8"        | 1-1/8"       | 43.75" x 35.75" x 37.75" |       |



## Heat Pumps

### 4SHP15LE Quiet, Single-Stage Heat Pump

- Filter drier shipped loose for installation flexibility
- Discharge muffler for quiet operation
- High Pressure switch
- Low pressure switch for loss of charge system protection
- Reliable, solid state, time-initiated, temperature terminated defrost system
- Service valves positioned for quick installation and easy service
- Trade-available components
- Defrost control features built-in diagnostics for easier service
- Defrost control has short cycle protection to protect compressor
- Defrost control is Quiet Shift™ capable
- Defrost cycle is field selectable 30/60/90 minutes
- Sealed contactor with lugs
- Sound cover



| Part # | Mfg #          | Tons | BTUH   | Liquid Conn | Suction Conn | H x L x W                | Price |
|--------|----------------|------|--------|-------------|--------------|--------------------------|-------|
| 246821 | A4SHP15LE118P1 | 1.5  | 18,000 | 3/8"        | 3/4"         | 37.75" x 31.25" x 29.25" |       |
| 246823 | A4SHP15LE124P1 | 2    | 24,000 | 3/8"        | 3/4"         | 37.75" x 31.25" x 29.25" |       |
| 246824 | A4SHP15LE130P1 | 2.5  | 30,000 | 3/8"        | 3/4"         | 37.75" x 31.25" x 29.25" |       |
| 246827 | A4SHP15LE136P1 | 3    | 36,000 | 3/8"        | 7/8"         | 33.75" x 31.25" x 29.25" |       |
| 246828 | A4SHP15LE142P1 | 3.5  | 42,000 | 3/8"        | 7/8"         | 37.75" x 37.75" x 35.75" |       |
| 246830 | A4SHP15LE148P1 | 4    | 48,000 | 3/8"        | 7/8"         | 37.75" x 37.75" x 35.75" |       |
| 246831 | A4SHP15LE160P1 | 5    | 60,000 | 3/8"        | 1-1/8"       | 43.75" x 37.75" x 35.75" |       |

### 4SHP20LX High-Efficiency Variable-Capacity Heat Pump

- 45-degree offset gauge ports for easy service
- Service valves positioned for quick installation and service
- Variable speed condenser fan motor
- Swept wing fan blade for quiet operation
- Factory installed crankcase heater
- Factory installed TXV for excellent refrigeration control
- Factory installed high and low pressure switches
- Thread-on pressure switches for simple, quick service
- Fan orifice for smoother airflow and sound level reduction
- Specialized sensors monitor ambient, liquid line, and coil temperatures for precision system control
- Charged for 15 feet of line set
- Discharge muffler for quiet operation
- Demand defrost for increased energy efficiency
- Quiet Shift™ capable to reduce noise during defrost
- Requires Comfort Sync™ thermostat and a Comfort Sync enabled matching indoor unit



| Part # | Mfg #         | Tons | BTUH   | Liquid Conn | Suction Conn | H x L x W                | Price |
|--------|---------------|------|--------|-------------|--------------|--------------------------|-------|
| 225319 | A4SHP20LX124P | 2    | 24,000 | 3/8"        | 3/4"         | 37.75" x 37.75" x 35.75" |       |
| 225321 | A4SHP20LX136P | 3    | 36,000 | 3/8"        | 7/8"         | 37.75" x 37.75" x 35.75" |       |
| 225322 | A4SHP20LX148P | 4    | 48,000 | 3/8"        | 7/8"         | 43.75" x 37.75" x 35.75" |       |
| 225323 | A4SHP20LX160P | 5    | 60,000 | 3/8"        | 1-1/8"       | 43.75" x 37.75" x 35.75" |       |

Cooling - Equipment & Rooftop Units

## Heat Pumps

### Heat Pumps

#### 4HP14L 14 SEER Split System Heat Pump

- R410A Refrigerant
- High-quality condenser coil with copper tubing and enhanced louvered fin for maximum heat transfer capacity
- Top discharge directs hot air and sound away from living area and shrubbery
- Louvered panel coil protection (14L series only)
- Easy access to electrical panels, pre-wired for easy hook-up
- Bi-directional liquid line filter drier factory installed
- Discharge muffler for quiet operation
- Integrated control with LED diagnostics
- Short cycle protection factory installed
- All units ETL and ETLC approved and AHRI Certified
- Charged for 15 feet of interconnecting tubing
- Louvered



| Part # | Mfg #        | Tons | BTUH   | Liquid Conn | Suction Conn | H x L x W             | Price |
|--------|--------------|------|--------|-------------|--------------|-----------------------|-------|
| 208743 | DUC4HP14L18P | 1.5  | 18,000 | 3/8"        | 3/4"         | 37" x 28.25" x 28.25" |       |
| 208744 | DUC4HP14L24P | 2    | 24,000 | 3/8"        | 3/4"         | 37" x 28.25" x 28.25" |       |
| 208745 | DUC4HP14L30P | 2.5  | 30,000 | 3/8"        | 3/4"         | 37" x 28.25" x 28.25" |       |
| 208746 | DUC4HP14L36P | 3    | 36,000 | 3/8"        | 3/4"         | 33" x 28.25" x 28.25" |       |
| 208747 | DUC4HP14L42P | 3.5  | 42,000 | 3/8"        | 7/8"         | 37" x 32.25" x 32.25" |       |
| 208748 | DUC4HP14L48P | 4    | 48,000 | 3/8"        | 7/8"         | 37" x 32.25" x 32.25" |       |
| 208749 | DUC4HP14L60P | 5    | 60,000 | 3/8"        | 7/8"         | 43" x 32.25" x 32.25" |       |

#### 4HP15L 15 SEER Split System Heat Pump

- R410A Refrigerant
- High-quality condenser coil with copper tubing and enhanced louvered fin for maximum heat transfer capacity
- Top discharge directs hot air and sound away from living area and shrubbery
- All units run tested
- Louvered panel coil protection
- Easy access to electrical panels, pre-wired for easy hook-up
- Bi-directional liquid line filter drier factory installed
- Discharge muffler for quiet operation
- Reliable, solid state defrost control
- Defrost control is Quiet Shift™ capable
- Low pressure switch factory installed for loss of charge protection
- Integrated control with LED diagnostics
- Short cycle protection factory installed
- All units ETL and ETLC approved and AHRI Certified
- Charged for 15 feet of interconnecting tubing



| Part # | Mfg #        | Tons | BTUH   | Liquid Conn | Suction Conn | H x L x W             | Price |
|--------|--------------|------|--------|-------------|--------------|-----------------------|-------|
| 246854 | DUC4HP15L18P | 1.5  | 18,000 | 3/8"        | 3/4"         | 37" x 28.25" x 28.28" |       |
| 246856 | DUC4HP15L24P | 2    | 24,000 | 3/8"        | 3/4"         | 37" x 28.25" x 28.28" |       |
| 246857 | DUC4HP15L30P | 2.5  | 30,000 | 3/8"        | 3/4"         | 37" x 28.25" x 28.28" |       |
| 246858 | DUC4HP15L36P | 3    | 36,000 | 3/8"        | 3/4"         | 33" x 28.25" x 28.25" |       |

**Heat Pumps**

**Heat Pumps (Continued)**

**4HP15L 15 SEER Split System Heat Pump**

| Part # | Mfg #        | Tons | BTUH   | Liquid Conn | Suction Conn | H x L x W             | Price |
|--------|--------------|------|--------|-------------|--------------|-----------------------|-------|
| 246859 | DUC4HP15L42P | 3.5  | 42,000 | 3/8"        | 7/8"         | 37" x 32.25" x 32.25" |       |
| 246860 | DUC4HP15L48P | 4    | 48,000 | 3/8"        | 7/8"         | 37" x 32.25" x 32.25" |       |
| 246861 | DUC4HP15L60P | 5    | 60,000 | 3/8"        | 7/8"         | 43" x 32.25" x 32.25" |       |

**4HP16LT 16 SEER Split System Heat Pump**

- Service valves positioned for quick installation and easy service
- Comfort Alert 2 diagnostics factory installed
- Reliable, solid state defrost control
- Defrost control is Quiet Shift™ capable
- Designed for ambients up to 125°F
- All units ETL and ETLC approved and AHRI certified
- High pressure switch
- Low pressure switch for loss of charge protection
- High-efficiency 2 stage Copeland Ultra Tech™ scroll compressor
- R410a refrigerant
- Full metal louvered panel coil guard protection



| Part # | Mfg #         | Tons | BTUH   | Liquid Conn | Suction Conn | H x L x W                   | Price |
|--------|---------------|------|--------|-------------|--------------|-----------------------------|-------|
| 228364 | DUC4HP16LT24P | 2    | 24,000 | 3/8"        | 3/4"         | 33-3/4" x 26-3/4" x 24-3/4" |       |
| 228365 | DUC4HP16LT36P | 3    | 36,000 | 3/8"        | 3/4"         | 37-3/4" x 31-1/4" x 29-3/8" |       |
| 217361 | DUC4HP16LT48P | 4    | 48,000 | 3/8"        | 7/8"         | 37-3/4" x 37-3/4" x 35-3/4" |       |
| 228366 | DUC4HP16LT60P | 5    | 60,000 | 3/8"        | 7/8"         | 43-3/4" x 37-3/4" x 35-3/4" |       |

Cooling - Equipment &  
Roof-top Units

**Electric Heat Kits**

**Electric Heat Kits**

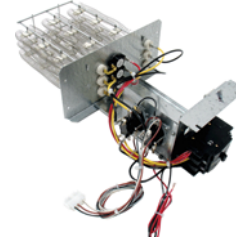

**Electric Heat Kit for Air Handlers**

| Part # | Mfg #         | kW Heat | Electrical   | Size          | Price |
|--------|---------------|---------|--------------|---------------|-------|
| 091408 | RXBH-24A20J   | 20kW    | 208/240-1-60 | 3.5 - 5.0 Ton |       |
| 091409 | RXBH-24A25J   | 25kW    | 258/240-1-60 | 3.5 - 5.0 Ton |       |
| 133871 | RXBH-24A30J   | 30kW    | 208/240-1-60 | 3.5 - 5.0 Ton |       |
| 133869 | RXBH-1724A05J | 5Kw     | 208/240-1-60 | 1.5 - 5.0 Ton |       |
| 133433 | RXBH-1724A07J | 7kW     | 208/240-1-60 | 1.5 - 5.0 Ton |       |
| 133643 | RXBH-1724A10J | 10kW    | 208/240-1-60 | 1.5 - 5.0 Ton |       |
| 133644 | RXBH-1724A15J | 15kW    | 208/240-1-60 | 1.5 - 5.0 Ton |       |

Cooling - Equipment & Rooftop Units

## Mini-Split Components & Accessories

### Single Zone Indoor Air Handler Units

- Model Nomenclature Prefix
  - **ASU** Wall Mount
  - **ABU** Universal Mount
  - **ARU** Slim Duct
  - **AUU** Cassette Mount
  - **AGU** Floor Mount
  - **Y** Models are Wi-Fi capable

| Part # | Mfg #      | Nom Cool BTUH | Nom Heat BTUH | SEER | HSPF  | Indoor/Outdoor Combo           | Price |
|--------|------------|---------------|---------------|------|-------|--------------------------------|-------|
| 172855 | ASU18RLB   | 18,000        | 24,000        | 19.0 | 10.6  | 12-5/8"H x 39-5/16"W x 9"D     |       |
| 172858 | ASU24RLB   | 24,000        | 24,000        | 18.0 | 10.6  | 12-5/8"H x 39-5/16"W x 9"D     |       |
| 172861 | ASU30RLXB  | 30,700        | 30,000        | 16.5 | 9.0   | 12-5/8"H x 39-5/16"W x 9"D     |       |
| 172864 | ASU36RLXB  | 33,000        | 34,000        | 15.5 | 9.0   | 12-5/8"H x 39-1/2"W x 9"D      |       |
| 231323 | ASU9RLS3Y  | 9,000         | 12,000        | 33.0 | 14.00 | 11-5/8"H x 37"W x 10-5/8"D     |       |
| 228370 | ASU12RLS3Y | 12,000        | 16,000        | 33.0 | 13.8  | 11-5/8"H x 37"W x 10-5/8"D     |       |
| 230063 | ASU15RLS3Y | 14,500        | 18,000        | 33.0 | 13.3  | 11-5/8"H x 37"W x 10-5/8"D     |       |
| 114270 | ASU30RLX   | 36,000        | 32,000        | 17.5 | 8.5   | 12-5/8"H x 39-1/2"W x 9"D      |       |
| 110547 | ABU18RULX  | 17,800        | 21,500        | 16.0 | 8.5   | 25-7/8"H x 39-1/8"W x 7-7/8"D  |       |
| 127976 | ABU24RULX  | 22,200        | 24,000        | 15.0 | 8.5   | 25-7/8"H x 39-1/8"W x 7-7/8"D  |       |
| 132067 | ABU36RSLX  | 34,100        | 36,500        | 14.0 | 8.5   | 27-5/8"H x 65-1/2"W x 9-1/2"D  |       |
| 103316 | AUU18RCLX  | 17,800        | 21,000        | 16.0 | 8.5   | 9-3/4"H x 32-3/4"W x 32-3/4"D  |       |
| 103314 | AUU24RCLX  | 22,200        | 24,200        | 15.0 | 8.5   | 9-3/4"H x 32-3/4"W x 32-3/4"D  |       |
| 111987 | AUU36RCLX  | 34,100        | 36,000        | 14.0 | 8.5   | 11-5/8"H x 32-3/4"W x 32-3/4"D |       |
| 120771 | AUU42RCLX  | 42,700        | 45,200        | 15.0 | 8.5   | 11-5/8"H x 32-3/4"W x 32-3/4"D |       |

### Single Zone Outdoor Condenser Units

| Part # | Mfg #       | Nom Cool BTUH | Nom Heat BTUH | SEER       | HSPF     | Indoor/Outdoor Combo                | Price |
|--------|-------------|---------------|---------------|------------|----------|-------------------------------------|-------|
| 172856 | AOU18RLB    | 18,000        | 24,000        | 19.0       | 10.6     | 24-7/16"H x 31-1/8"W x 11-7/16"D    |       |
| 172859 | AOU24RLB    | 24,000        | 24,000        | 18.0       | 10.6     | 24-7/16"H x 31-1/8"W x 11-7/16"D    |       |
| 172862 | AOU30RLXB   | 30,700        | 30,000        | 16.5       | 9.0      | 32-3/4"H x 35-1/2"W x 15-3/4"D      |       |
| 172865 | AOU36RLXB   | 33,000        | 34,000        | 15.5       | 9.0      | 32-3/4"H x 35-1/2"W x 15-3/4"D      |       |
| 163986 | AOU9RLFW1   | 9,000         | 12,000        | 23         | 11.0     | 21-1/4"H x 26"W x 11-7/16"D         |       |
| 163991 | AOU12RLFW1  | 12,000        | 16,000        | 22.0       | 11.0     | 21-1/4"H x 31-1/8"W x 11-7/16"D     |       |
| 136262 | AOU18RLXFW  | 18,000        | 18,000        | Up to 19.2 | Up to 10 | 32-3/4"H x 35-3/8"W x 13"D          |       |
| 224794 | AOU24RLXFW1 | 24,000        | 24,000        | Up to 18.0 | Up to 10 | 32-3/4"H x 35-3/8"W x 13"D          |       |
| 189831 | AOU24RLXFWH | 22,000        | 25,200        | 23         |          | 32-11/16" x 35-7/16" x 13"          |       |
| 172181 | AOU9RLS3H   | 9,000         | 12,000        | 33         | 14.00    | 24-7/16"H x 31-1/8"W x 11-11/32"D   |       |
| 172186 | AOU12RLS3H  | 12,000        | 16,000        | 33         | 13.8     | 24-7/16"H x 31-1/8"W x 11-11/32"D   |       |
| 172192 | AOU15RLS3H  | 14,500        | 18,000        | 33         | 13.3     | 24-7/16"H x 31-1/8"W x 11-11/32"D   |       |
| 172178 | AOU9RLS3    | 9,000         | 12,000        | 27.2       | 12.5     | 24-13/32"H x 31-3/32"W x 13-27/32"D |       |
| 172184 | AOU12RLS3   | 12,000        | 16,000        | 25.0       | 12.0     | 24-13/32"H x 31-3/32"W x 13-27/32"D |       |
| 172190 | AOU15RLS3   | 14,500        | 18,000        | 21.5       | 12.0     | 24-13/32"H x 31-3/32"W x 13-27/32"D |       |
| 103317 | AOU18RLX    | 17,800        | 21,000        | 16.0       | 8.5      | 32-3/4"H x 35-1/2"W x 13"D          |       |

**Mini-Split Components & Accessories**

**Single Zone Outdoor Condenser Units (Continued)**

| Part # | Mfg #      | Nom Cool BTUH | Nom Heat BTUH | SEER | HSPF | Indoor/Outdoor Combo                | Price |
|--------|------------|---------------|---------------|------|------|-------------------------------------|-------|
| 103315 | AOU24RLX   | 22,200        | 24,200        | 15.0 | 8.5  | 32-3/4"H x 35-1/2"W x 13"D          |       |
| 114272 | AOU30RLX   | 36,000        | 32,000        | 17.5 | 8.5  | 32-3/4"H x 35-1/2"W x 13"D          |       |
| 111988 | AOU36RLX   | 34,100        | 36,500        | 14.0 | 8.5  | 32-3/4"H x 35-1/2"W x 13"D          |       |
| 120772 | AOU42RLX   | 42,700        | 45,200        | 15.0 | 8.5  | 50-7/8"H x 35-1/2"W x 13"D          |       |
| 163994 | AOU9RLFF   | 9,000         | 12,000        | 26   | 12.6 | 24-7/16"H x 31-1/8"W x 11-7/16"D    |       |
| 164000 | AOU12RLFF  | 12,000        | 16,000        | 22.7 | 11.6 | 24-7/16"H x 31-1/8"W x 11-7/16"D    |       |
| 164005 | AOU15RLFF  | 14,200        | 18,000        | 20.3 | 11.2 | 24-7/16"H x 31-1/8"W x 11-7/16"D    |       |
| 163995 | AOU9RLFFH  | 9,000         | 12,000        | 26.0 | 12.6 | 24-7/16"H x 31-1/8"W x 11-7/16"D    |       |
| 164001 | AOU12RLFFH | 12,000        | 16,000        | 22.7 | 11.6 | 24-7/16"H x 31-1/8"W x 11-7/16"D    |       |
| 164006 | AOU15RLFFH | 14,200        | 18,000        | 20.3 | 11.2 | 24-7/16"H x 31-1/8"W x 11-7/16"D    |       |
| 154467 | AOU9RLFC   | 9,000         | 12,000        | 21.5 | 12.2 | 24-13/32"H x 31-3/32"W x 11-11/32"D |       |
| 154468 | AOU12RLFC  | 12,000        | 16,000        | 20.0 | 11.5 | 24-13/32"H x 31-3/32"W x 11-11/32"D |       |
| 154469 | AOU18RLFC  | 18,000        | 21,600        | 19.7 | 11.3 | 24-13/32"H x 31-3/32"W x 13-27/32"D |       |

Cooling - Equipment & Rooftop Units

**Mini Split System Remotes**

**UTY-DMMUM Central Remote Controller**



| Part # | Mfg #     | Description        | Price |
|--------|-----------|--------------------|-------|
| 133357 | UTY-DMMUM | HFI Central Remote |       |

**UTY-RVNUM Wired Remote Controller**

- Large backlit LCD display
- Displays room temperature
- Provides full feature access to property managers, building owners, and facility maintenance, as well as providing basic comfort features to tenants, employees, and teachers



| Part # | Mfg #     | Description             | Price |
|--------|-----------|-------------------------|-------|
| 160489 | UTY-RVNUM | Wired Remote Controller |       |

**UTY-RNNUM Remote Control for Wall Mounts**

- Full function wired remote
- Unique lock function



| Part # | Mfg #     | Description                                   | Price |
|--------|-----------|---|-------|
| 133358 | UTY-RNNUM | HFI Wired Remote Control for Flex Wall Mounts |       |

## Mini-Split Components & Accessories

### UTY-LNHUM Wireless Remote Control

| Part # | Mfg #     | Description                 | Price |
|--------|-----------|-----------------------------|-------|
| 133360 | UTY-LNHUM | HFI Wireless Remote Control |       |

### UTY-RNBYU Wired Remote Control for Wall-Mounted Units

- Remote control thermo sensor
- Child lock capable

| Part # | Mfg #     | Description                                 | Price |
|--------|-----------|---|-------|
| 129542 | UTY-RNBYU | Wired Remote Control for Wall-Mounted Units |       |

### UTY-RSNUM Simple Wired Remote Control

| Part # | Mfg #     | Description                     | Price |
|--------|-----------|---------------------------------|-------|
| 133359 | UTY-RSNUM | HFI Simple Wired Remote Control |       |

### RC Wired Module

| Part # | Mfg #          | Description   | Price |
|--------|----------------|---|-------|
| 177221 | FJ-RC-WIFI-1NA | RC Wired Module for Cassette, Slim Duct, Ceiling, Universal |       |

### IR Wireless Module

| Part # | Mfg #          | Description                                       | Price |
|--------|----------------|---|-------|
| 177218 | FJ-IR-WIFI-1NA | IR Wireless Module for Wall Mounts & Floor Mounts |       |

### External Connect Kit

| Part # | Mfg #     | Description      | Price |
|--------|-----------|------------------|-------|
| 157680 | UTD-ECS5A | For Indoor Unit  |       |
| 138785 | UTY-XWZX  | For Outdoor Unit |       |

### Interface Kit

- Required to connect the ASU9RLS2, ASU12RLS2 and ASU15RLS2 to wired remote UTY-RNNUM, Dry contact wire kit UTY-XWZXZ5, and simple remote control UTY-RSNUM

| Part # | Mfg #      | Description   | Price |
|--------|------------|---------------|-------|
| 154241 | UTY-TWBXF1 | Interface Kit |       |

### Fujitsu Halcyon Parts & Accessories

| Part # | Mfg #       | Description                  | Price |
|--------|-------------|------------------------------|-------|
| 215120 | K9601847014 | Motor Fan                    |       |
| 218871 | K9708713427 | 12RLS2 PSCB Control          |       |
| 210496 | K9970101038 | TXV Coil B=White             |       |
| 133362 | UTY-LRHUM   | HFI Receiver Unit            |       |
| 239432 | UTY-TFNXZ2  | WIFI Interface Module        |       |
| 154501 | UTY-XSZX    | Remote Sensor                |       |
| 213095 | UTY-XWZXZ5  | Dry Contact Wire Kit         |       |
| 213098 | UTZ-KXGC    | High Humidity Insulation Kit |       |

**Mini-Split Components & Accessories**

**Fujitsu Halcyon Parts & Accessories (Continued)**

| Part # | Mfg #      | Description                    | Price |
|--------|------------|--------------------------------|-------|
| 147843 | UTD-GXSB-W | Auto Louver Grille Kit (ARU18) |       |

**Branch Box**



UTP-PU03A

| Part # | Mfg #     | Description                  | Price |
|--------|-----------|------------------------------|-------|
| 133354 | UTP-PU03A | Flex Primary Branch Box      |       |
| 133355 | UTP-PU03B | Flex Secondary Branch Box    |       |
| 158380 | UTP-PX-A  | Branch Box Outdoor Enclosure |       |

**Fresh Air Intake Kit**

- Mixes room air then passes it through a heat exchanger
- Allows for a 4-inch flex duct connection
- Requires a field supplied duct booster fan capable of 60 CFM at 2"W.C. or 90 CFM 4"W.C.



| Part # | Mfg #    | Description          | Price |
|--------|----------|----------------------|-------|
| 151930 | UTZ-VXAA | Fresh Air Intake Kit |       |

**Condensate Pump**

- For ABU36RSLX
- Raises the drain/discharge point of your unit by 11.8"



| Part # | Mfg #      | Description                   | Price |
|--------|------------|-------------------------------|-------|
| 141456 | UTR-DPB24T | Condensate Pump for ABU36RSLX |       |

**Fitting Kit for 18 and 18 Indoor Combination**

| Part # | Mfg #    | Description | Price |
|--------|----------|-------------|-------|
| 141472 | K9FZ1818 | Fitting Kit |       |



**Mini-Split Components & Accessories**

**Parts & Accessories**

| Part # | Mfg #       | Description                      | Price |
|--------|-------------|----------------------------------|-------|
| 124548 | K9R410A55   | Halcyon Access Fitting (K9R410A) |       |
| 213848 | K9372266144 | Remote Sensor                    |       |
| 242748 | K9708511511 | Controller PCB AOU30RLX          |       |
| 232462 | K9708513072 | Power Supply                     |       |
| 242749 | K9708513041 | Power Filter PCB RLXS            |       |
| 241532 | K9710621802 | Controller PCB                   |       |
| 237164 | K9709427347 | PCB Board ASU12RLF1              |       |
| 141252 | K9379853002 | Cond Fan Motor                   |       |

Cooling - Equipment & Rooftop Units

## Mini-Split Components & Accessories

### Mini-Split Accessories

#### Desolv™ Cleaning Kit

- *Kit Includes:*
- Desolv Cleaning Solution (1 gal.)
- C-Band Frame Assembly
- Single Use Funnel Bags (2)
- Cleaning Brush (1)
- Drain Pail (5 gal)
- Installation Instructions



| Part # | Mfg # | Description                             | Price |
|--------|-------|---|-------|
| 173866 | 82560 | Mini-Split Evaporator Coil Cleaning Kit |       |

#### Mighty Bracket™ Mini-Split Installation Support Tool

- *Allows single person installation*
- *Simple clip on support*
- *Does not damage walls*
- *Use on all brands of mini-splits*



| Part # | Mfg # | Description                          | Price |
|--------|-------|--------------------------------------|-------|
| 172977 | 97705 | Clips to Mini-Split Mounting Bracket |       |

#### NoKink™ Flexible Refrigerant Line Connector

- *Eliminates kinking of copper refrigerant tubing when wall-mounting mini-split evaporators*
- *Easy flaring*
- *Quick connection*
- *Corrugated 300 Series stainless steel flexible piping*



| Part # | Mfg # | Size                | Price |
|--------|-------|---------------------|-------|
| 172973 | 66731 | 1/4" x 3' Flex Hose |       |
| 172974 | 66733 | 3/8" x 3' Flex Hose |       |
| 172976 | 66737 | 1/2" x 3' Flex Hose |       |
| 172975 | 66735 | 5/8" x 3' Flex Hose |       |

**Multi Zone Mini-Split Systems**

**Multi Zone Mini-Splits - Outdoor Units**

**Multi-Zone Outdoor Units**

- Seven year compressor warranty
- Five year parts warranty
- Energy Star Qualified
- Auto Restart/Reset
- Refrigerant R410A
- Quiet Mode
- Sleep Timer



AOU18, 24RLXFZ



AOU36RLXFZ1



AOU45RLXFZ

| Part#  | Mfg#        | Nom Cool | Nom Heat | SEER | HSPF | Dimensions                        |
|--------|-------------|----------|----------|------|------|-----------------------------------|
| 136565 | AOU18RLXFZ  | 18,000   | 18,000   | 19.2 | 10   | 27-9/16"H x 35-7/16"W x 13"D      |
| 136566 | AOU24RLXFZ  | 24,000   | 24,000   | 18.0 | 10   | 27-9/16 "H x 35-7/16"W x 13"D     |
| 173774 | AOU36RLXFZ1 | 36,000   | 36,000   | 18.0 | 9.4  | 32-11/16"H x 35-7/16"W x 13"D     |
| 189472 | AOU45RLXFZ  | 48,000   | 48,000   | 19.7 | 10.3 | 39-5/16"H x 38-3/16"W x 14-9/16"D |

**Multi-Zone XLTH Outdoor Units**

- Individual zoning
- Inverter technology
- Inverter control
- Extra low temperature heating
- Base freeze prevention
- Cassette model fits into standard ceiling tile
- Hidden or showcased indoor unit
- Stable and comfortable



| Part#  | Mfg#        | Nom Cool | Nom Heat | SEER | HSPF | Dimensions                        |
|--------|-------------|----------|----------|------|------|-----------------------------------|
| 173696 | AOU18RLXFZH | 18,000   | 22,000   | 21.5 | 10.3 | 32-11/16"H x 35-7/16"W x 13"D     |
| 173697 | AOU24RLXFZH | 22,000   | 25,000   | 20.0 | 10.3 | 32-11/16"H x 35-7/16"W x 13"D     |
| 189473 | AOU36RLXFZH | 35,200   | 36,400   | 20.0 | 10.3 | 39-5/16"H x 38-3/16"W x 14-9/16"D |

**Flex Zone Outdoor Unit**

- Individual zoning
- Inverter technology
- Inverter control
- 130% Connectable capacity
- Cassette model fits into standard ceiling tile
- Central remote control (optional accessory part #UTY-DMMUM)
- Hidden or showcased indoor unit
- Stable and comfortable
- Flex provides the ability to connect up to 8-zones



| Part#  | Mfg#        | Nom Cool | Nom Heat | SEER | HSPF | Dimensions                 |
|--------|-------------|----------|----------|------|------|----------------------------|
| 133340 | AOU48RLXFZ1 | 48,000   | 54,000   | 17.0 | 9.8  | 36"H x 38-1/4"W x 14-5/8"D |

Cooling - Equipment & Rooftop Units

**Multi Zone Mini-Split Systems**

**Multi Zone Mini-Splits - Indoor Units**

**Compact Wall-Mounted Indoor Heat Pump**

- Auto Restart/Reset
- Minimum Heat Mode
- Auto Mode
- Dry Mode
- 24-Hour Timer
- Sleep Timer
- Ion Deodorizing Filter
- Apple Catechin Filter



| Part#  | Mfg#      | Nom Cool | Nom Heat | SEER | HSPF | Dimensions                 | Price |
|--------|-----------|----------|----------|------|------|----------------------------|-------|
| 164013 | ASU7RLF1  | 7,000    | 8,100    | 17.0 | 9.8  | 10-1/2"H x 33-1/16"W x 8"D |       |
| 163984 | ASU9RLF1  | 9,000    | 10,200   | 17.0 | 9.8  | 10-1/2"H x 33-1/16"W x 8"D |       |
| 163989 | ASU12RLF1 | 12,000   | 13,500   | 17.0 | 9.8  | 10-1/2"H x 33-1/16"W x 8"D |       |

**Large Wall-Mounted Indoor Heat Pump**

- Auto Restart/Reset
- Minimum Heat Mode
- Auto Mode
- Dry Mode
- 24-Hour Timer
- Sleep Timer
- Ion Deodorizing Filter
- Apple Catechin Filter



| Part#  | Mfg#     | Nom Cool | Nom Heat | SEER | HSPF | Dimensions                | Price |
|--------|----------|----------|----------|------|------|---------------------------|-------|
| 133344 | ASU18RLF | 16,200   | 20,000   | 17.0 | 9.8  | 12-5/8"H x 39-1/4"W x 9"D |       |
| 133345 | ASU24RLF | 24,000   | 27,000   | 17.0 | 9.8  | 12-5/8"H x 39-1/4"W x 9"D |       |

**Designer Series Wall-Mounted Indoor Heat Pump**

- Auto Restart/Reset
- Minimum Heat Mode
- Auto Mode
- Dry Mode
- 24-Hour Timer
- Sleep Timer
- Ion Deodorizing Filter
- Apple Catechin Filter



| Part#  | Mfg#      | Nom Cool | Nom Heat | SEER | HSPF | Dimensions                    | Price |
|--------|-----------|----------|----------|------|------|-------------------------------|-------|
| 229612 | ASU15RLF1 | 14,000   | 16,300   | 21.5 | -    | 11-1/8"H x 34-1/4"W x 7-1/4"D |       |

Cooling - Equipment & Rooftop Units

## Multi Zone Mini-Split Systems

### Slim Duct Ducted Indoor Heat Pump

- Fresh Air Intake
- Condensate Pump
- Auto Changeover
- Auto Restart/Reset
- Quiet Mode
- Auto Mode
- Weekly Timer
- Dry Mode



| Part#  | Mfg#     | Nom Cool | Nom Heat | SEER | HSPF | Dimensions                         |
|--------|----------|----------|----------|------|------|------------------------------------|
| 167720 | ARU7RLF  | 7,000    | 8,100    | 14.7 | 9.3  | 7-25/32"H x 27-9/16"W x 24-13/32"D |
| 133350 | ARU9RLF  | 9,000    | 12,000   | 21.5 | 12.2 | 7-25/32"H x 27-9/16"W x 24-13/32"D |
| 133351 | ARU12RLF | 12,000   | 16,000   | 20.0 | 11.5 | 7-25/32"H x 27-9/16"W x 24-13/32"D |
| 133352 | ARU18RLF | 18,000   | 21,600   | 19.7 | 11.3 | 7-25/32"H x 35-7/16"W x 24-13/32"D |
| 133353 | ARU24RLF | 24,000   | 27,000   | 14.7 | 9.3  | 7-25/32"H x 43-5/16"W x 24-13/32"D |

### Compact Cassette Indoor Heat Pump

- 2-Stage Turbo Fan
- Condensate Pump
- High Ceiling Mode
- Remote Temperature Sensor
- Auto Changeover
- Auto Restart/Reset
- Quiet Mode
- Auto Louver: Up/ Down
- Dry Mode
- Sleep Timer



Required compact cassette grille UTG-CCGF sold separately

| Part#  | Mfg#     | Nom Cool | Nom Heat | SEER | HSPF | Dimensions                        |
|--------|----------|----------|----------|------|------|-----------------------------------|
| 167719 | AUU7RLF  | 7,000    | 8,100    | --   | --   | 9-11/16"H x 22-7/16"W x 22-7/16"D |
| 133346 | AUU9RLF  | 9,000    | 10,200   | 17.0 | 9.8  | 9-11/16"H x 22-7/16"W x 22-7/16"D |
| 133347 | AUU12RLF | 12,000   | 13,500   | 17.0 | 9.8  | 9-11/16"H x 22-7/16"W x 22-7/16"D |
| 133348 | AUU18RLF | 18,000   | 20,000   | 17.0 | 9.8  | 9-11/16"H x 22-7/16"W x 22-7/16"D |

Cooling - Equipment & Rooftop Units

**Multi Zone Mini-Split Systems**

**Floor-Mounted Indoor Heat Pump**

- *Wireless Remote Control*
- *Apple Catechin Filter*
- *Ion Deodorizing Filter*
- *Sleep Timer*
- *24-Hour Timer*
- *Auto Louver: Up/Down*
- *Auto Mode*
- *Minimum Heat Mode*
- *Economy Mode*
- *Auto Restart/Reset*
- *Auto Changeover*
- *Powerful Mode*



| Part#  | Mfg#     | Nom Cool | Nom Heat | SEER | HSPF | Dimensions                    |
|--------|----------|----------|----------|------|------|-------------------------------|
| 163993 | AGU9RLF  | 9,000    | 12,000   | 26.0 | 12.6 | 23-5/8"H x 29-1/8"W x 7-7/8"D |
| 163998 | AGU12RLF | 12,000   | 16,000   | 22.7 | 11.6 | 23-5/8"H x 29-1/8"W x 7-7/8"D |
| 164004 | AGU15RLF | 14,200   | 18,000   | 20.3 | 11.2 | 23-5/8"H x 29-1/8"W x 7-7/8"D |

Cooling - Equipment & Rooftop Units

**Single Zone Mini-Split Systems**

**Single Zone Wall-Mounted Type Mini-Split Systems**

**RL2 Wall-Mounted Mini-Split System**

- 115V
- Up to 16 SEER
- Inverter technology
- Quiet operation
- Wireless remote controller
- Washable panel filter
- Smart system: auto mode
- Humidity control



**Indoor Unit: ASU\*RL2**  
**Outdoor Unit: AOU\*RL2**

| Part # | Mfg # | Nom Cool | Nom Heat | HSPF | SEER | EER  | Components                | Price |
|--------|-------|----------|----------|------|------|------|---------------------------|-------|
| 154248 | 9RL2  | 9,000    | 12,000   | 9.0  | 16   | 10.8 | ASU9RL2 In, AOU9RL2 Out   |       |
| 154249 | 12RL2 | 12,000   | 14,000   | 9.0  | 16   | 10   | ASU12RL2 In, AOU12RL2 Out |       |

**RLS3Y Wall-Mounted High-SEER Mini Split System**

- 208/230V
- Up to 33 SEER
- Energy saving program (ESP)
- Programmable remote
- Powerful heating
- World class performance
- Quiet operation
- Inverter technology
- Wi-Fi compatible



**Indoor Unit: ASU\*RLS3Y**  
**Outdoor Unit: AOU\*RLS3**

| Part # | Mfg #   | Nom Cool | Nom Heat | HSPF | SEER | EER  | Components                   | Price |
|--------|---------|----------|----------|------|------|------|------------------------------|-------|
| 231324 | 9RLS3Y  | 9,000    | 12,000   | 14.2 | 33.0 | 18.0 | ASU9RLS3Y In, AOU9RLS3 Out   |       |
| 230103 | 12RLS3Y | 12,000   | 16,000   | 14.0 | 29.3 | 15.2 | ASU12RLS3Y In, AOU12RLS3 Out |       |
| 230102 | 15RLS3Y | 14,500   | 18,000   | 13.4 | 25.3 | 13.9 | ASU15RLS3Y In, AOU15RLS3 Out |       |

Cooling - Equipment & Rooftop Units

**Single Zone Mini-Split Systems**

**RLS3H Wall-Mounted High-Heat Mini Split System**

- 208/230V
- Up to 33 SEER
- Powerful heating down to -15°F outdoor temperatures
- Base freeze prevention
- Energy saving program (ESP)
- Programmable remote
- World class performance
- Quiet operation
- Inverter technology
- Wi-Fi compatible



Indoor Unit: ASU\*RLS3Y  
Outdoor Unit: AOU\*RLS3H

| Part # | Mfg #    | Nom Cool | Nom Heat | HSPF | SEER | EER  | Components                    | Price |
|--------|----------|----------|----------|------|------|------|-------------------------------|-------|
| 231325 | 9RLS3YH  | 9,000    | 12,000   | 14.0 | 33.0 | 18.0 | ASU9RLS3Y In, AOU9RLS3H Out   |       |
| 230101 | 12RLS3YH | 12,000   | 16,000   | 13.8 | 29.3 | 15.2 | ASU12RLS3Y In, AOU12RLS3H Out |       |
| 230100 | 15RLS3YH | 14,500   | 18,000   | 13.3 | 25.3 | 13.9 | ASU15RLS3Y In, AOU15RLS3H Out |       |

**RLFW1 Wall-Mounted HFI Mini Split System**

- 208/230V
- Up to 23 SEER
- Inverter technology
- ENERGY STAR® qualified
- Clean air
- Quiet operation
- Wireless remote controller
- Washable panel filter
- Smart system: auto mode
- Humidity control



Indoor Unit: ASU\*RLF1  
Outdoor Unit: AOU\*RLFW1

| Part # | Mfg #   | Nom Cool | Nom Heat | HSPF | SEER | EER  | Components                   | Price |
|--------|---------|----------|----------|------|------|------|------------------------------|-------|
| 163988 | 9RLFW1  | 9,000    | 12,000   | 11.0 | 23.0 | 13.8 | ASU9RLF1 In, AOU9RLFW1 Out   |       |
| 163992 | 12RLFW1 | 12,000   | 16,000   | 11.0 | 22.0 | 12.5 | ASU12RLF1 In, AOU12RLFW1 Out |       |

Cooling - Equipment & Rooftop Units



**Single Zone Mini-Split Systems**

**RLXFW1 Wall-Mounted High SEER Mini Split System**

- 208/230V
- Up to 20 SEER
- Inverter technology
- ENERGY STAR® qualified
- Clean air
- Quiet operation
- Wireless remote controller
- Washable panel filter
- Smart system: auto mode
- Humidity control



Indoor Unit: ASU\*RLF  
Outdoor Unit: AOU\*RLXFW1

| Part # | Mfg #    | Nom Cool | Nom Heat | HSPF | SEER | EER  | Components                   | Price |
|--------|----------|----------|----------|------|------|------|------------------------------|-------|
| 230099 | 18RLXFW1 | 18,000   | 21,600   | 10.4 | 20.0 | 13.3 | ASU18RLF In, AOU18RLXFW1 Out |       |
| 224795 | 24RLXFW1 | 22,000   | 25,200   | 10.6 | 19.5 | 12.5 | ASU24RLF In, AOU24RLXFW1 Out |       |

**RLXFWH Wall-Mounted High-Heat Mini Split System**

- 208/230V
- Up to 20 SEER
- Inverter technology
- ENERGY STAR® qualified
- Clean air
- Quiet operation
- Wireless remote controller
- Washable panel filter
- Smart system: auto mode
- Humidity control



Indoor Unit: ASU\*RLF  
Outdoor Unit: AOU\*RLXFWH

| Part # | Mfg #    | Nom Cool | Nom Heat | HSPF | SEER | EER  | Components                   | Price |
|--------|----------|----------|----------|------|------|------|------------------------------|-------|
| 222876 | 18RLXFWH | 18,000   | 21,600   | 10.4 | 20.0 | 13.3 | ASU18RLF In, AOU18RLXFWH Out |       |
| 222879 | 24RLXFWH | 22,000   | 25,200   | 10.5 | 19.5 | 12.5 | ASU24RLF In, AOU24RLXFWH Out |       |

Cooling - Equipment & Rooftop Units

**Single Zone Mini-Split Systems**

**RLXEH Wall-Mounted High-Heat Mini Split System**

- 208/230V
- Up to 18.7 SEER
- Powerful heating down to -15°F outdoor temperatures
- Base freeze prevention
- Energy saving program (ESP)
- Programmable remote
- World class performance
- Quiet operation
- Inverter technology



Indoor Unit: ASU30RLE  
Outdoor Unit: AOU30RLXEH

| Part # | Mfg #   | Nom Cool | Nom Heat | HSPF | SEER | EER  | Components                  | Price |
|--------|---------|----------|----------|------|------|------|-----------------------------|-------|
| 223027 | 30RLXEH | 30,000   | 32,000   | 11.7 | 18.7 | 12.5 | ASU30RLE In, AOU30RLXEH Out |       |

**RLB/RLXB Wall-Mounted Mini Split System**

- 208/230V
- Up to 19 SEER
- Inverter technology
- System 18RLB is ENERGY STAR® qualified
- Clean air
- Quiet operation
- Wireless remote controller
- Washable panel filter
- Smart system: auto mode
- Humidity control



Indoor Unit: ASU\*RL(X)B  
Outdoor Unit: AOU\*RL(X)B

| Part # | Mfg #  | Nom Cool | Nom Heat | HSPF | SEER | EER  | Components                  | Price |
|--------|--------|----------|----------|------|------|------|-----------------------------|-------|
| 172857 | 18RLB  | 18,000   | 18,000   | 10.6 | 19.0 | 12.5 | ASU18RLB In, AOU18RLB Out   |       |
| 172860 | 24RLB  | 24,000   | 24,000   | 10.6 | 18.0 | 10.0 | ASU24RLB In, AOU24RLB Out   |       |
| 172863 | 30RLXB | 30,000   | 30,000   | 9.0  | 16.5 | 9.5  | ASU30RLXB In, AOU30RLXB Out |       |
| 172866 | 36RLXB | 33,000   | 34,000   | 9.0  | 15.5 | 8.5  | ASU36RLXB In, AOU36RLXB Out |       |

Cooling - Equipment & Rooftop Units

**Single Zone Mini-Split Systems**

**Single Zone Floor/Ceiling Mount Type Multi-Split Systems**

**RULX Universal Floor/Ceiling-Mounted Mini Split System**

- 208/230V
- Up to 16 SEER
- Can be mounted low on the wall or transverse mount the ceiling
- Inverter technology
- Wired remote controller UTY-RNBYU (optional)
- 4-Way auto louver for balanced comfort
- Smart system: auto mode
- Humidity control
- Fresh air intake



Indoor Unit: ABU\*RULX  
Outdoor Unit: AOU\*RLX

| Part # | Mfg #  | Nom Cool | Nom Heat | HSPF | SEER | EER  | Components                 | Price |
|--------|--------|----------|----------|------|------|------|----------------------------|-------|
| 185923 | 18RULX | 17,800   | 21,500   | 8.5  | 16.0 | 10.9 | ABU18RULX In, AOU18RLX Out |       |
| 100489 | 24RULX | 22,200   | 24,000   | 8.5  | 15.0 | 9.9  | ABU24RULX In, AOU24RLX Out |       |

**RSLX Ceiling-Mount Mini Split System**

- 208/230V
- Up to 14 SEER
- Inverter technology
- 4-Way auto louver for balanced comfort
- Smart system: auto mode
- Humidity control
- Fresh air intake
- Wired remote controller UTY-RNBYU (optional)



Indoor Unit: ABU36RSLX  
Outdoor Unit: AOU36RLX

| Part # | Mfg #  | Nom Cool | Nom Heat | HSPF | SEER | EER | Components             | Price |
|--------|--------|----------|----------|------|------|-----|------------------------|-------|
| 132106 | 36RSLX | 34,100   | 36,500   | 8.5  | 14.0 | 8.1 | ABU36RSLX In, AOU36RLX |       |

**RLFF Floor-Mounted Mini Split System**

- 208/230V
- Up to 26 SEER
- Compact size
- Energy efficient
- 2-Fan and wide airflow
- High performance heating
- Flexible and easy installation



Indoor Unit: AGU\*RLF  
Outdoor Unit: AOU\*RLFF

| Part # | Mfg #  | Nom Cool | Nom Heat | HSPF | SEER | EER  | Components                 | Price |
|--------|--------|----------|----------|------|------|------|----------------------------|-------|
| 163996 | 9RLFF  | 9,000    | 12,000   | 12.6 | 26.0 | 16.0 | AGU9RLF In, AOU9RLFF Out   |       |
| 164002 | 12RLFF | 12,000   | 16,000   | 11.6 | 22.7 | 13.1 | AGU12RLF In, AOU12RLFF Out |       |

Cooling - Equipment & Rooftop Units

**Single Zone Mini-Split Systems**

**Single Zone Floor/Ceiling Mount Type Multi-Split Systems (Continued)**

**RLFF Floor-Mounted Mini Split System**

| Part # | Mfg #  | Nom Cool | Nom Heat | HSPF | SEER | EER  | Components                 | Price |
|--------|--------|----------|----------|------|------|------|----------------------------|-------|
| 164007 | 15RLFF | 14,200   | 18,000   | 11.2 | 20.3 | 12.5 | AGU15RLF In, AOU15RLFF Out |       |

**RLFFH Floor-Mounted Mini Split System**

- 208/230V
- Up to 26 SEER
- Compact size
- Energy efficient
- 2-Fan and wide airflow
- High performance heating
- Flexible and easy installation



Indoor Unit: AGU\*RLF  
Outdoor Unit: AOU\*RLFFH

| Part # | Mfg #   | Nom Cool | Nom Heat | HSPF | SEER | EER  | Components                  | Price |
|--------|---------|----------|----------|------|------|------|-----------------------------|-------|
| 163997 | 9RLFFH  | 9,000    | 12,000   | 12.4 | 26.0 | 16.0 | AGU9RLF In, AOU9RLFFH Out   |       |
| 164003 | 12RLFFH | 12,000   | 16,000   | 11.3 | 22.7 | 13.1 | AGU12RLF In, AOU15RLFFH Out |       |
| 164008 | 15RLFFH | 14,200   | 18,000   | 11.0 | 20.3 | 12.5 | AGU15RLF In, AOU15RLFFH Out |       |

**Single Zone Slim Duct Multi-Split Systems**

**RLFCF Slim Duct Mini Split System**

- 208/230V
- Up to 21.5 SEER
- Inverter technology
- 4-Way auto louver for balanced comfort
- Smart system: auto mode
- Humidity control
- Fresh air intake
- Wired remote controller UTY-RNBYU (optional)



Indoor Unit: ARU\*RLF  
Outdoor Unit: AOU\*RLFC

| Part # | Mfg #   | Nom Cool | Nom Heat | HSPF | SEER | EER  | Components                 | Price |
|--------|---------|----------|----------|------|------|------|----------------------------|-------|
| 154772 | 9RLFCF  | 9,000    | 12,000   | 12.2 | 21.5 | 14.5 | ARU9RLF In, AOU9RLFC Out   |       |
| 154773 | 12RLFCF | 12,000   | 16,000   | 11.5 | 20.0 | 12.8 | ARU12RLF In, AOU12RLFC Out |       |
| 154774 | 18RLFCF | 18,000   | 21,600   | 11.3 | 19.7 | 12.0 | ARU18RLF In, AOU18RLFC Out |       |

**Single Zone Mini-Split Systems**

**Single Zone Cassette Multi-Split Systems**

**RLFCC Compact Cassette Mini Split System**

- 208/230V
- Up to 24 SEER
- Inverter technology
- High performance heating
- Cassette model fits into standard ceiling tile
- 2-Stage turbo fan
- Quiet operation
- Wired remote controller
- Smart system: auto mode
- Humidity control
- Fresh air intake



Indoor Unit: AUU\*RLFCC  
Outdoor Unit: AOU\*RLFC

| Part # | Mfg #   | Nom Cool | Nom Heat | HSPF | SEER | EER  | Components                 | Price |
|--------|---------|----------|----------|------|------|------|----------------------------|-------|
| 158386 | 9RLFCC  | 9,000    | 12,000   | 13.0 | 24.0 | 14.5 | AUU9RLF In, AOU9RLFC Out   |       |
| 158384 | 12RLFCC | 12,000   | 16,000   | 12.2 | 21.9 | 12.8 | AUU12RLF In, AOU12RLFC Out |       |
| 158383 | 18RLFCC | 18,000   | 21,600   | 11.5 | 20.1 | 11.2 | AUU18RLF In, AOU18RLFC Out |       |

**RCLX Cassette Mini Split System**

- 208/230V
- Up to 16 SEER
- Inverter technology
- Swing louvers
- 4-Way airflow system
- Simple maintenance
- Wired remote controller
- Energy saver
- Smart system: auto mode
- Humidity control
- Fresh air intake



Indoor Unit: AUU\*RCLX  
Outdoor Unit: AOU\*RCLX

| Part # | Mfg #  | Nom Cool | Nom Heat | HSPF | SEER | EER  | Components                  | Price |
|--------|--------|----------|----------|------|------|------|-----------------------------|-------|
| 103324 | 18RCLX | 17,800   | 21,000   | 8.5  | 16.0 | 11.1 | AUU18RCLX In, AOU18RCLX Out |       |
| 103323 | 24RCLX | 22,200   | 24,200   | 8.5  | 15.0 | 10.6 | AUU24RCLX In, AOU24RCLX Out |       |
| 111989 | 36RCLX | 34,100   | 36,000   | 8.5  | 14.0 | 8.1  | AUU36RCLX In, AOU36RCLX Out |       |
| 106078 | 42RCLX | 42,700   | 45,200   | 8.5  | 15.0 | 9.2  | AUU42RCLX In, AOU42RCLX Out |       |

Cooling - Equipment & Rooftop Units

## Packaged Terminal Air Conditioners

### Packaged Terminal Air Conditioners

- Quiet operation
- High energy efficiency
- Digital control display
- Gold Fin™ anti-corrosion
- Auto restart
- Energy saver mode
- Front desk control
- Freeze room protection
- Dip switch setting for temperature limiting
- Temperature display on unit
- Fresh air ventilation, 70 CFM at 0.3 ESP with open damper door
- Dimensions: 16"H x 42"W x 19-7/8"D
- 5-Year parts and labor warranty on sealed refrigerant system
- 1-Year full system warranty on parts and labor, 5-year parts warranty



#### R-410A Heat/Cool PTAC

| Part # | Mfg #     | Cooling Capacity<br>BTUH | EER  | Electric Heater<br>(kW) | Air Circulation<br>CFM, H/L | Dehumid<br>(Pts/Hr) | Max Overcurrent<br>Protection | Ship Wt   | Price |
|--------|-----------|--------------------------|------|-------------------------|-----------------------------|---------------------|-------------------------------|-----------|-------|
| 141205 | LP093CD3A | 9,000/8,800              | 11.0 | 3.5/3.1                 | 335/300                     | 2.6                 | 20                            | 86.6 lbs  |       |
| 141206 | LP123CD3A | 11,800/11,600            | 10.5 | 3.5/3.1                 | 390/355                     | 3.3                 | 20                            | 97.1 lbs  |       |
| 141207 | LP153CD3A | 14,300/14,100            | 9.2  | 3.5/3.1                 | 390/355                     | 4.4                 | 20                            | 118.1 lbs |       |
| 141208 | LP153CD5A | 14,100/14,300            | 9.2  | 4.6/5.0                 | 388/353                     | 4.4                 | 30                            | 118.1 lbs |       |

#### R-410A Heat Pump PTAC

| Part # | Mfg #     | Cooling Capacity<br>BTUH | EER  | Heating Capacity<br>BTUH | COP | Electric Heater<br>(kW) | Air Circulation<br>CFM, H/L | Dehumid<br>(Pts/Hr) | Max Overcurrent<br>Protection | Ship Wt | Price |
|--------|-----------|--------------------------|------|--------------------------|-----|-------------------------|-----------------------------|---------------------|-------------------------------|---------|-------|
| 141210 | LP093HD3A | 9,000/8,800              | 11.0 | 8,100/7,900              | 3.2 | 3.5/3.1                 | 335/300                     | 2.6                 | 20                            | 101 lbs |       |
| 141212 | LP123HD3A | 11,800/11,600            | 10.6 | 10,800/10,600            | 3.2 | 3.5/3.1                 | 390/355                     | 3.3                 | 20                            | 101 lbs |       |
| 141213 | LP153HD3A | 14,700/14,500            | 9.4  | 12,100/11,900            | 2.6 | 3.5/3.1                 | 390/355                     | 4.4                 | 20                            | 109 lbs |       |

### PTAC Accessories

#### Drain Kit



| Part # | Mfg #   | Description                 | Price |
|--------|---------|-----------------------------|-------|
| 141218 | AYDR101 | Drain Kit Interior/Exterior |       |

Cooling - Equipment & Rooftop Units

## Packaged Terminal Air Conditioners



AYRGALA01

### Grille



AYAGALA01A

| Part # | Mfg #      | Description                       | Price |
|--------|------------|-----------------------------------|-------|
| 141217 | AYRGALA01  | 42" Large Stamp Grille            |       |
| 144096 | AYAGALA01A | 42" Aluminum Architectural Grille |       |

### Sleeve



| Part # | Mfg #    | Description           | Price |
|--------|----------|-----------------------|-------|
| 141216 | AYSVB01A | 42" Large Wall Sleeve |       |

### PTAC Accessory Kit

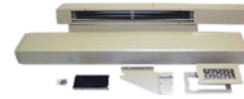

| Part # | Mfg #  | Description      | Price |
|--------|--------|------------------|-------|
| 145162 | AYLD1A | Lateral Duct Kit |       |

**Cooling - Equipment & Rooftop Units**

## Packaged Terminal Air Conditioners

### PTAC Units

- Features:
  - Enhanced dehumidification to lengthen cooling cycles
  - Low temperature protection
  - Continuous fan operation or fan cycling governed by thermostat
  - Condensate dispersion
  - Filtered ventilation
  - Clearly labeled digital controls
  - Electronic temperature limiter with (4) pre-programmed temperature ranges
  - Random restart
- Units come with "Smart Controls" to add optional front desk control and remote thermostats
- 5-Year warranty on compressor, 1-year warranty on parts



### Heat Pump with Electric Heat - R-410A

| Part # | Mfg #        | Voltage  | BTUH   | Heat    | Price |
|--------|--------------|----------|--------|---------|-------|
| 133113 | EKTH09-1G3KW | 208/230V | 9,000  | 3kW     |       |
| 133108 | EKTH12-1G    | 208/230V | 12,000 | No Heat |       |
| 133116 | EKTH12-1G5KW | 208/230V | 12,000 | 5kW     |       |
| 133109 | EKTH15-1G    | 208/230V | 15,000 | No Heat |       |
| 133119 | EKTH15-1G5KW | 208/230V | 15,000 | 5kW     |       |

### PTAC Accessories

| Part # | Mfg #         | Description   | Price |
|--------|---------------|---|-------|
| 133092 | 7602-501      | 42" Stamped Grille  |       |
| 133090 | 7602-530A-230 | 5kW 30A 265V Power Cord for EKTC12-2G, EKTH12-2G, EKTC15-2G & EKTH15-2G |       |





## Roof Top Units

### Commercial Series™ Package Gas/Electric Units

#### R-410A High Efficiency Commercial Series™ Package Gas/Electric 3 to 5 Ton

- Scroll compressors with internal line break overload and high pressure protection
- Single stage compressor
- Convertible airflow
- TXV Refrigerant metering system on each circuit
- High pressure and low pressure/loss of charge protection
- Solid core liquid line filter-drier on each circuit
- Single slab, single pass designed evaporator and condenser coils
- Cooling operation up to 125°F ambient
- Foil faced insulation encapsulated throughout entire unit
- Cabinet features a durable powder-paint finish, steel coated on each side
- One-piece top cover and one-piece base pan with drawn supply and return opening for superior water management
- Externally mounted refrigerant gauge ports
- Forkable base rails
- Single point electrical and gas connections
- 1" Filter standard with slide out design, will accept 2" filter
- 1-Stage gas valve, direct spark ignition, and induced draft
- Tubular heat exchanger
- Solid state furnace control with on-board diagnostics
- Colored and labeled wiring
- Copper tube/aluminum fin indoor coil
- Direct drive or high performance belt drive motor with variable pitch pulleys and quick adjust belt system
- Energy Star® rated
- Drive package:
  - RKNL-XXXXXXK: Direct drive
  - RKNL-XXXXXXL: Belt drive
- 5-Year limited compressor warranty (commercial)
- 10-Year warranty on factory standard heat exchanger (commercial)
- 1-Year limited parts warranty (commercial)
- 20-Year warranty on stainless steel heat exchanger (commercial)



Cooling - Equipment & Rooftop Units

| Part # | Mfg #              | Tons | Gross Cooling BTUH | Heating Input BTUH | Electrical   | Unit Dimensions H x W x D | Ship Wt | Price |
|--------|--------------------|------|--------------------|--------------------|--------------|---------------------------|---------|-------|
| 239336 | RKPN-A036CK12EAJA  | 3.0  | 36,800             | 120,000            | 208/230-1-60 | 35" x 75-17/32" x 46-1/2" | 550 lbs |       |
| 174992 | RKPN-A036JK08E     | 3.0  | 36,200             | 80,000             | 208/230-1-60 | 35" x 75-17/32" x 46-1/2" | 516 lbs |       |
| 174995 | RKPN-A036JK08EAJA  | 3.0  | 36,800             | 80,000             | 208/230-1-60 | 35" x 75-17/32" x 46-1/2" | 550 lbs |       |
| 228850 | RKPN-A036CK08EAJA  | 3.0  | 36,200             | 80,000             | 208/230-3-60 | 35" x 75-17/32" x 46-1/2" | 516 lbs |       |
| 174996 | RKPN-A048JK10EAJA  | 4.0  | 50,500             | 100,000            | 208/230-1-60 | 35" x 75-17/32" x 46-1/2" | 587 lbs |       |
| 228851 | RKPN-A048CK10EAJA  | 4.0  | 48,000             | 100,000            | 208/230-3-60 | 35" x 75-17/32" x 46-1/2" | 545 lbs |       |
| 163392 | RKPN-A060JK13E-AHF | 4.0  | 59,000             | 135,000            | 208/230-3-60 | 35" x 75-17/32" x 46-1/2" | 562 lbs |       |
| 228852 | RKPN-A060CK13EAJA  | 5.0  | 60,000             | 135,000            | 208/230-3-60 | 35" x 75-17/32" x 46-1/2" | 562 lbs |       |
| 174997 | RKPN-A060JK13EAJA  | 5.0  | 61,500             | 135,000            | 208/230-1-60 | 35" x 75-17/32" x 46-1/2" | 604 lbs |       |
| 228853 | RKPN-A060DL13EAJA  | 5.0  | 60,000             | 135,000            | 460-3-60     | 35" x 75-17/32" x 46-1/2" | 576 lbs |       |
| 162121 | RKNN-A036CK08EAJA  | 3.0  | 36,600             | 80,000             | 208/230-3-60 | 35" x 75-17/32" x 46-1/2" | 550 lbs |       |
| 162127 | RKNN-A048CK10EAJA  | 4.0  | 50,500             | 100,000            | 208/230-3-60 | 35" x 75-17/32" x 46-1/2" | 587 lbs |       |

www.plumbsupply.com • Serving our Customers Since 1946 • www.waterconcepts.net



## Roof Top Units

### Commercial Series™ Package Gas/Electric Units (Continued)

#### R-410A High Efficiency Commercial Series™ Package Gas/Electric 3 to 5 Ton

| Part # | Mfg #             | Tons | Gross Cooling BTUH | Heating Input BTUH | Electrical   | Unit Dimensions H x W x D | Ship Wt | Price |
|--------|-------------------|------|--------------------|--------------------|--------------|---------------------------|---------|-------|
| 162131 | RKNN-A060CK10E    | 5.0  | 61,500             | 100,000            | 208/230-3-60 | 35" x 75-17/32" x 46-1/2" | 597 lbs |       |
| 162133 | RKNN-A060CK13EAJA | 5.0  | 61,500             | 135,000            | 208/230-3-60 | 35" x 75-17/32" x 46-1/2" | 604 lbs |       |
| 162136 | RKNN-A060DL13EAJA | 5.0  | 61,500             | 135,000            | 460-3-60     | 35" x 75-17/32" x 46-1/2" | 604 lbs |       |

#### 13 SEER R-410A High Efficiency Commercial Series™ Package Gas/Electric Rooftop - RKNL-B 6 to 12.5 Ton

- Scroll compressors with internal line break overload and high pressure protection
- Single stage compressor on 6 ton models, dual stage compressor on 7.5 to 12.5 models
- Convertible airflow
- TXV Refrigerant metering system on each circuit except 6 ton model
- High pressure and low pressure/loss of charge protection
- Solid core liquid line filter-drier on each circuit
- Single slab, single pass designed evaporator and condenser coils
- Cooling operation up to 125°F ambient
- Foil faced insulation encapsulated throughout entire unit
- Cabinet features a durable powder-paint finish, steel coated on each side
- Slide out indoor fan assembly
- One-piece top cover and one-piece base pan with drawn supply and return opening for superior water management
- Forkable base rails
- Single point electrical and gas connections
- Internally sloped slide out condensate pan conforms to ASHRAE 62 standard
- 2" Filter standard with slide out design
- 2-Stage gas valve, direct spark ignition, and induced draft
- Tubular heat exchanger
- Solid state furnace control with on-board diagnostics
- Colored and labeled wiring
- Copper tube/aluminum fin indoor coil (12-1/2 ton uses Micro-Channel condenser)
- High performance belt drive motor with variable pitch pulleys and quick adjust belt system
- Electronic ignition
- Energy Star® rated
- Drive package:
  - RKNL-XXXXXL: Belt drive
  - RKNL-XXXXXM: Belt drive high static
- 5-Year limited compressor warranty (commercial)
- 10-Year on factory standard heat exchanger (commercial)
- 1-Year limited parts warranty (commercial)
- 1-Year limited on condenser coil and evaporator coil leaks caused by factory defects (commercial)



| Part # | Mfg #          | Tons | Gross Cooling BTUH | Heating Input BTUH | Electrical   | Unit Dimensions H x W x D | Ship Wt | Price |
|--------|----------------|------|--------------------|--------------------|--------------|---------------------------|---------|-------|
| 116742 | RKNL-A048JK13E | 4.0  | 50,500             | 135,000            | 208/230-1-60 | 35" x 75-17/32" x 46-1/2" | 592 lbs |       |



## Roof Top Units

### Commercial Series™ Package Gas/Electric Units (Continued)

**13 SEER R-410A High Efficiency Commercial Series™ Package Gas/Electric Rooftop - RKNL-B 6 to 12.5 Ton**

| Part # | Mfg #             | Tons | Gross Cooling BTUH | Heating Input BTUH | Electrical   | Unit Dimensions H x W x D      | Ship Wt   | Price |
|--------|-------------------|------|--------------------|--------------------|--------------|--------------------------------|-----------|-------|
| 167072 | RKNL-B090CL15E    | 7.5  | 93,000             | 150,000            | 208/230-3-60 | 40-3/16" x 93-11/16" x 58-3/4" | 1,054 lbs |       |
| 158370 | RKNL-B090CM15EAJA | 7.5  | 93,000             | 150,000            | 208/230-3-60 | 40-3/16" x 93-11/16" x 58-3/4" | 1,054 lbs |       |
| 159031 | RKNL-B090DL15EAJA | 7.5  | 93,000             | 150,000            | 460-3-60     | 40-3/16" x 93-11/16" x 58-3/4" | 1,062 lbs |       |
| 158371 | RKNL-B090CM22EAJA | 7.5  | 93,000             | 225,000            | 208/230-3-60 | 40-3/16" x 93-11/16" x 58-3/4" | 1,090 lbs |       |
| 147988 | RKNL-B090CM22EJBA | 7.5  | 93,000             | 225,000            | 208/230-3-60 | 44" x 93-11/16" x 58-3/4"      | 1,090 lbs |       |
| 158372 | RKNL-B120CL22EAJA | 8.5  | 101,000            | 225,000            | 208/230-3-60 | 40-3/16" x 93-11/16" x 58-3/4" | 1,132 lbs |       |
| 159033 | RKNL-B151DL25EAJA | 12.5 | 146,000            | 252,000            | 460-3-60     | 40-3/16" x 93-11/16" x 58-3/4" | 1,267 lbs |       |
| 150303 | RKNL-G090CT22EDPH | 7.5  | 93,000             | 225,000            | 208/230-3-60 | 44" x 93-11/16" x 58-3/4"      | 1,137 lbs |       |

Cooling - Equipment & Rooftop Units



## Roof Top Units

### 11.2 SEER R-410A Standard Efficiency Commercial Series™ Package Gas/Electric Rooftop - RKKL-B 7.5 to 12.5 Ton

- Scroll compressors with internal line break overload and high pressure protection
- 1-Stage compressor on 7.5 and 10 ton models, 2-Stage compressor on 12.5 ton model
- Convertible airflow
- Fixed restriction refrigerant flow control on 7.5 and 10 ton models, TXV on 12.5 ton model
- High pressure and low pressure/loss of charge protection
- Solid core liquid line filter-drier on each circuit
- Single slab, single pass designed evaporator and condenser coils
- Cooling operation up to 125°F ambient
- Foil faced insulation encapsulated throughout entire unit
- Cabinet features a durable powder-paint finish, steel coated on each side
- One-piece top cover indoor section and one-piece base pan
- Forkable base rails
- Single point electrical and gas connections
- 2" Filter standard with slide out design
- 2-Stage gas valve, direct spark ignition, and induced draft
- Tubular heat exchanger
- Solid state furnace control with on-board diagnostics
- Colored and labeled wiring
- Copper tube/aluminum fin indoor coil
- Aluminum Micro-Channel outdoor coil(s)
- High performance belt drive motor with variable pitch pulleys and quick adjust belt system
- Electronic ignition
- Drive package:
  - RKKL-XXXXXL: Belt drive
- 5-Year limited compressor warranty (commercial)
- 10-Year warranty on factory standard heat exchanger (commercial)
- 1-Year limited parts warranty (commercial)
- 1-Year limited warranty on condenser coil and evaporator coil leaks caused by factory defects (commercial)



Cooling - Equipment & Rooftop Units

| Part # | Mfg #          | Tons | Gross Cooling BTUH | Heating Input BTUH | Electrical   | Unit Dimensions H x W x D | Ship Wt   | Price |
|--------|----------------|------|--------------------|--------------------|--------------|---------------------------|-----------|-------|
| 136399 | RKKL-B090CL15E | 7.5  | 87,000             | 150,000            | 208/230-3-60 | 44" x 93-11/16" x 58-3/4" | 919 lbs   |       |
| 142306 | RKKL-B090CL22E | 7.5  | 87,000             | 225,000            | 208/230-3-60 | 44" x 93-11/16" x 58-3/4" | 955 lbs   |       |
| 140163 | RKKL-B120CL22E | 10.0 | 123,000            | 225,000            | 208/230-3-60 | 44" x 93-11/16" x 58-3/4" | 1,057 lbs |       |
| 140164 | RKKL-B151CL25E | 12.5 | 156,000            | 252,000            | 208/230-3-60 | 44" x 93-11/16" x 58-3/4" | 1,303 lbs |       |
| 167075 | RKKL-B151DL25E | 12.5 | 156,000            | 252,000            | 460-3-60     | 44" x 93-11/16" x 58-3/4" | 1,303 lbs |       |



## Roof Top Units

### Commercial Renaissance Line Package Gas Electric Units

- Factory charged with R-410A HFC refrigerant
- Wired and run tested
- Scroll compressors with internal line break overload and high pressure protection
- Model RGEDZR has a single-stage compressor
- Models RGEDZS and RGEDZT have two-stage compressor
- Convertible airflow – vertical down flow or horizontal side flow
- Forkable base rails for easy handling and lifting
- Cooling operation up to 125°F ambient
- Two-stage gas heat input with direct spark ignition system, solid state furnace controls, and optimized induced draft combustion
- MicroChannel evaporator and condenser coil
- PlusOne® ServiceSmart package includes:  
Qwik-Change Flex-Fit Rack™  
Qwik-Slide Blower Assembly™  
Qwik-Clean Drain Pan™
- Over-flow condensate sensor
- PlusOne® Diagnostics with Dual 7-Segment LED Display to meet code compliance
- One-piece top cover and base pan with drawn supply and return opening
- Two-piece control door
- ¼ turn fasteners on filter access door
- Color-coded and labeled wiring
- External lockable gauge ports
- TXV refrigerant metering system
- Solid-core liquid line filter drier
- High pressure and low pressure/loss of charge protection with built-in Smart Logic
- Insulation encapsulated throughout entire unit
- High performance belt drive motor with variable pitch pulleys and quick adjust belt system
- Variable Frequency Drive (VFD) blower is standard on Model RGEDZT and optional on model RGEDZS
- New product footprint with matching connections
- Improved factory lead times



Cooling - Equipment & Rooftop Units

| Part # | Mfg #                | Tons | Gross Cooling BTUH | Heating Input BTUH | Electrical   | Unit Dimensions H x W x D | Ship Wt  | Price |
|--------|----------------------|------|--------------------|--------------------|--------------|---------------------------|----------|-------|
| 245915 | RGEDZS090ACB15BAAAA0 | 7.5  | 80,000             | 150,000            | 208/230-3-60 | 50" x 89" x 57-7/8"       | 878 lbs  |       |
| 245916 | RGEDZS090ACB20BAAAA0 | 7.5  | 80,000             | 205,000            | 208/230-3-60 | 50" x 89" x 57-7/8"       | 878 lbs  |       |
| 249790 | RGEDZS102ACB22BAAAA0 | 8.5  | 99,000             | 225,000            | 208/230-3-60 | 50" x 89" x 57-7/8"       | 907 lbs  |       |
| 245917 | RGEDZS120ACB22BAAAA0 | 10   | 118,000            | 225,000            | 208/230-3-60 | 50" x 89" x 57-7/8"       | 935 lbs  |       |
| 249462 | RGEDZS120ADA152AAAA0 | 10   | 118,000            | 150,000            | 460-3-60     | 50" x 89" x 57-7/8"       | 935 lbs  |       |
| 245918 | RGEDZS150ACA22BAAAA0 | 12.5 | 148,000            | 225,000            | 208/230-3-60 | 60" x 89" x 57-7/8"       | 1133 lbs |       |

### Parts & Accessories

| Part # | Mfg #      | Price             |
|--------|------------|-------------------|
| 245921 | RXKG-DDD14 | 14" Curb          |
| 245922 | RXR-DDCAE  | Roof Curb Adapter |



## Roof Top Units

### Manual Rooftop Fresh Air Damper

- 25% Manual
- Includes parts:
  - Outside air panel (1)
  - Manual hood (2)
  - Base support (3)
  - Relief blade (4)
  - Latch (5)
  - Gasket
  - Hardware bag

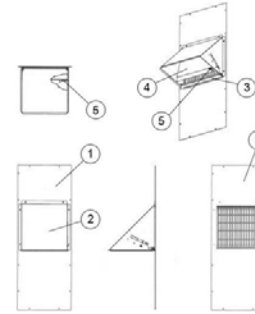

| Part # | Mfg #     | Description                     | Price |
|--------|-----------|---------------------------------|-------|
| 245920 | RXRF-ADA1 | Manual Rooftop Fresh Air Damper |       |

### MicroMetl Modulating Economizer Assembly

- Fully modulating with single enthalpy
- Includes parts:
  - Sensor-Temperature & humidity (2)
  - Actuator (3)
  - Actuator mount (4)
  - Drive pin, 1/2" x 3/8" x 4-1/4"
  - Hood hardware bag
  - Left hood side
  - Right hood side
  - Hood divider
  - Relief damper assembly
  - Front support bracket
  - Two filters
  - Wiring harness

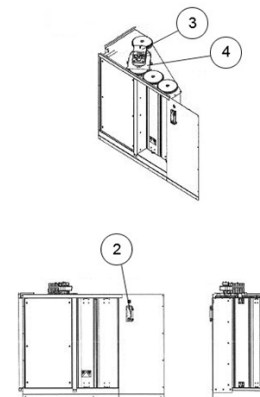

| Part # | Mfg #        | Description                     | Price |
|--------|--------------|---------------------------------|-------|
| 245919 | RXRD-01MDHAM | 7.5-12.5T Modulating Economizer |       |

### Outdoor Coil Louver

- Includes parts:
  - Sixteen screws
  - Granite/steel gray tall cabinet
  - Two Louver panels (43.193W x 55.284H)

| Part # | Mfg #      | Description         | Price |
|--------|------------|---------------------|-------|
| 245923 | RXRX-ADD04 | Outdoor Coil Louver |       |

## Roof Top Units

### Roof Top Unit Accessories

#### RXKG/RXRG/RXRK/RXSG/RXRX - Roof Curb

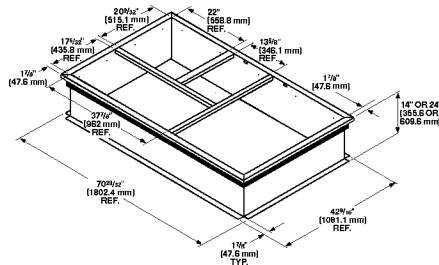

RXKG-CAD14/24

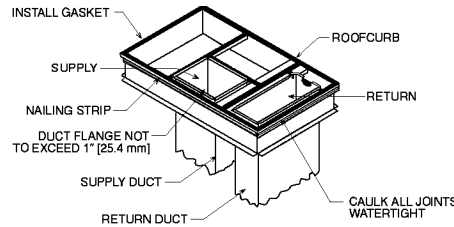

RXKG-CAE14/24

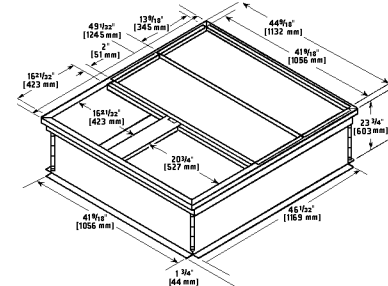

RXSG-AAA2

| Part # | Mfg #      | Description             | Price |
|--------|------------|-------------------------|-------|
| 036937 | RXKG-CAD14 | 14" 3.0-25.0 Ton        |       |
| 039546 | RXKG-CAE14 | 14"                     |       |
| 025599 | RXSG-AAA14 | 14" 1.5-4 Ton Pkg Units |       |

#### RXRD/RXRE/RXRQ/RXRR - Economizer

| Part # | Mfg #      | Description                                 | Price |
|--------|------------|---|-------|
| 036606 | RXRD-CAM10 | Fully Modulating Economizer (Downflow Only) |       |
| 079102 | RXRD-NDCM3 | 7.5 - 15 Ton Horizontal Economizer          |       |
| 127255 | RXRD-PDCM3 | RSI Vertical                                |       |

#### RXRX - Roof Curb Adapter

| Part # | Mfg #        | Description                  | Price |
|--------|--------------|------------------------------|-------|
| 080466 | RXRX-BBCDB21 | For 3-6 Ton Commercial Units |       |
| 035021 | RXRX-BBCDB23 | For 3-6 Ton Commercial Units |       |

#### Economizer

| Part # | Mfg #        | Description   | Price |
|--------|--------------|---|-------|
| 149610 | AXRD-MECM3   | Downflow/Horizontal Economizer with Single Enthalpy         |       |
| 149611 | AXRD-NDCM3   | Economizer with Single Enthalpy                             |       |
| 149613 | AXRD-PDCM3   | Downflow Economizer with Single Enthalpy                    |       |
| 149614 | AXRD-RDCM3   | Horizontal Economizer with Single Enthalpy                  |       |
| 164772 | AXRD-01RECAM | Downflow/Horizontal Economizer with Single Enthalpy         |       |
| 147992 | AXRD-SDCM3   | Downflow Economizer with Single Enthalpy and Smoke Detector |       |
| 177450 | AXRD-01RDDBM | Downflow 6-12.5T Economizer with Eco Smoke Detector, Gray 3 |       |
| 172043 | AXRD-01RDDAM | Downflow Economizer with Single Enthalpy, Gray 3            |       |
| 165873 | AXRF-JDA1    | Fresh Air Damper, Manual                                    |       |
| 149628 | AXRF-FBA1    | Fresh Air Damper, Manual 17"Lx17"Wx21"H                     |       |

#### Louver Panel Kits

| Part # | Mfg #       | Description                        | Price |
|--------|-------------|------------------------------------|-------|
| 147993 | AXRX-AAD01C | For 6-12.5 Ton Package Units, Grey |       |



## Roof Top Units

### Roof Top Unit Accessories (Continued)

#### Louver Panel Kits

| Part # | Mfg #       | Description                         | Price |
|--------|-------------|-------------------------------------|-------|
| 149483 | AXRX-AAD01B | For 6-12.5 Ton Package Units, Green |       |

Cooling - Equipment &  
Roof Top Units



**VRF Equipment**

**Mini-Split VRF Air Conditioner Systems**

- All systems use R-410A refrigerant
- 6-Year compressor warranty
- 2-Year parts warranty



**Airstage™ Outdoor Air Unit**

- Top class lightweight compact design
- Flexible duct design using a DC motor
- Provides air condition and ventilation air at the same time
- Various controllers—individual & central controllers



| Part # | Mfg #      | Nom Cool BTUH | Nom Heating BTUH | Electrical   | Dimensions                    | Price |
|--------|------------|---------------|------------------|--------------|-------------------------------|-------|
| 240707 | AAUA72TLAV | 72,000        | 47,000           | 208/230-1-60 | 16-3/4" x 53-13/16" x 22-1/2" |       |

**21.7 IEER AIRSTAGE® V-II Series Commercial Multi Air Conditioning System**

- Allow control of the air conditioning in each room individually
- Round corner type high density multi-path heat exchanger
- Sine wave DC inverter control
- Centralized remote control system



| Part # | Mfg #       | Nom Cool BTUH | Nom Heating BTUH | Electrical   | Dimensions                  | Price |
|--------|-------------|---------------|------------------|--------------|-----------------------------|-------|
| 147753 | AQUA72RLBV  | 72,000        | 81,000           | 208/230-3-60 | 66.54"H x 36.61"W x 30.12"D |       |
| 147755 | AQUA96RLBV  | 96,000        | 108,000          | 208/230-3-60 | 66.54"H x 36.61"W x 30.12"D |       |
| 167174 | AQUA72TLBV  | 72,000        | 81,000           | 208/230-3-60 | 66.54"H x 36.61"W x 30.12"D |       |
| 167176 | AQUA96TLBV  | 96,000        | 108,000          | 208/230-3-60 | 66.54"H x 36.61"W x 30.12"D |       |
| 173046 | AQUA120TLBV | 120,000       | 135,000          | 208/230-3-60 | 66.54"H x 48.82"W x 30.12"D |       |

**Vertical Air Handler**

- Selectable capacities from 1 to 5 tons
- Broad static pressure range for a wide range of applications
- Durable power-coated thick steel gauge cabinet
- Acoustical and thermal insulation is upgraded from 1/2" to 1" thick to reduce heat loss
- Equipped with standard MERV 3 filter
- Easily retrofitted into existing installations



| Part # | Mfg #      | Nom Cool BTUH | Nom Heating BTUH | Electrical   | Dimensions                 | Price |
|--------|------------|---------------|------------------|--------------|----------------------------|-------|
| 185656 | ARUV12TLAV | 12,000        | 13,500           | 208/230-3-60 | 51"Hx17-11/16"Wx23-13/16"D |       |
| 185658 | ARUV18TLAV | 18,000        | 20,000           | 208/230-3-60 | 51"Hx17-11/16"Wx23-13/16"D |       |
| 185659 | ARUV24TLAV | 24,000        | 27,000           | 208/230-3-60 | 51"Hx17-11/16"Wx23-13/16"D |       |
| 185660 | ARUV30TLAV | 30,000        | 24,000           | 208/230-3-60 | 51"Hx22-3/16"Wx23-13/16"D  |       |

Cooling - Equipment & Rooftop Units

**VRF Equipment**

**Indoor Slim Duct Air Handler Unit**



| Part # | Mfg #      | Nom Cool BTUH | Type                     | Price |
|--------|------------|---------------|--------------------------|-------|
| 147768 | ARUL7RLAV  | 7,000         | Slim Duct, Heat Pump     |       |
| 147769 | ARUL9RLAV  | 9,000         | Slim Duct, Heat Pump     |       |
| 147770 | ARUL12RLAV | 12,000        | Slim Duct, Heat Pump     |       |
| 147772 | ARUL18RLAV | 18,000        | Slim Duct, Heat Pump     |       |
| 147773 | ARUL24RLAV | 24,000        | Slim Duct, Heat Pump     |       |
| 173049 | ARUL18TLAV | 18,000        | Slim Duct, Heat Recovery |       |

**Duct Air Handler Unit**

- Slim and compact design
- Easy maintenance
- Easy installation
- Two-direction drain piping



| Part # | Mfg #      | Nom Cool BTUH | Type                | Price |
|--------|------------|---------------|---------------------|-------|
| 147774 | ARUM30RLAV | 30,000        | Duct, Heat Pump     |       |
| 173071 | ARUM24TLAV | 24,000        | Duct, Heat Recovery |       |
| 173050 | ARUM30TLAV | 30,000        | Duct, Heat Recovery |       |
| 173051 | ARUM36TLAV | 36,000        | Duct, Heat Recovery |       |

**Indoor Wall-Mounted Air Handler Unit**



| Part # | Mfg #      | Nom Cool BTUH | Type                                | Price |
|--------|------------|---------------|-------------------------------------|-------|
| 147785 | ASUA7RLAV  | 7,000         | Compact Wall-Mounted, Heat Pump     |       |
| 147786 | ASUA9RLAV  | 9,000         | Compact Wall-Mounted, Heat Pump     |       |
| 147787 | ASUA12RLAV | 12,000        | Compact Wall-Mounted, Heat Pump     |       |
| 174051 | ASUA9TLAV  | 9,000         | Compact Wall-Mounted, Heat Recovery |       |
| 181051 | ASUA12TLAV | 12,000        | Compact Wall-Mounted, Heat Recovery |       |
| 181053 | ASUA14TLAV | 14,000        | Compact Wall-Mounted, Heat Recovery |       |
| 181054 | ASUB18TLAV | 18,000        | Wall-Mounted, Heat Recovery         |       |
| 181047 | ASUB24TLAV | 24,000        | Wall-Mounted, Heat Recovery         |       |
| 147789 | ASUB18RLAV | 18,000        | Wall-Mounted, Heat Pump             |       |
| 147790 | ASUB24RLAV | 24,000        | Wall-Mounted, Heat Pump             |       |

**Indoor Ceiling Cassette Air Handler Unit**



| Part # | Mfg #     | Nom Cool BTUH | Type                                | Price |
|--------|-----------|---------------|-------------------------------------|-------|
| 147756 | AUUA7RLAV | 7,000         | Compact Ceiling Cassette, Heat Pump |       |
| 147758 | AUUA9RLAV | 9,000         | Compact Ceiling Cassette, Heat Pump |       |

**VRF Equipment**

**Mini-Split VRF Air Conditioner Systems (Continued)**

**Vertical Air Handler**

**Indoor Ceiling Cassette Air Handler Unit**

| Part # | Mfg #      | Nom Cool BTUH | Type                                    | Price |
|--------|------------|---------------|---|-------|
| 147759 | AUUA12RLAV | 12,000        | Compact Ceiling Cassette, Heat Pump     |       |
| 147760 | AUUA14RLAV | 14,000        | Compact Ceiling Cassette, Heat Pump     |       |
| 147761 | AUUA18RLAV | 18,000        | Compact Ceiling Cassette, Heat Pump     |       |
| 147762 | AUUA24RLAV | 24,000        | Compact Ceiling Cassette, Heat Pump     |       |
| 173047 | AUUA7TLAV  | 7,000         | Compact Ceiling Cassette, Heat Recovery |       |
| 173048 | AUUA12TLAV | 12,000        | Compact Ceiling Cassette, Heat Recovery |       |
| 181048 | AUUA24TLAV | 24,000        | Compact Ceiling Cassette, Heat Recovery |       |
| 147766 | AUUB30RLAV | 30,000        | Ceiling Cassette, Heat Pump             |       |

**Indoor High Static Pressure Duct Air Handler Unit**



| Part # | Mfg #      | Nom Cool BTUH | Type                                     | Price |
|--------|------------|---------------|--|-------|
| 173072 | ARUH36TLAV | 36,000        | High Static Pressure Duct, Heat Recovery |       |
| 173052 | ARUH48TLAV | 48,000        | High Static Pressure Duct, Heat Recovery |       |
| 173054 | ARUH60TLAV | 60,000        | High Static Pressure Duct, Heat Recovery |       |
| 181055 | ARUH96TLAV | 96,000        | High Static Pressure Duct, Heat Recovery |       |

**Mini-Split VRF System Remotes**

**UTY-RNKU Wired Remote Control for VRF Units**



| Part # | Mfg #      | Description   | Price |
|--------|------------|---|-------|
| 147803 | UTY-RNKU   | VRF Wired Remote Control                                    |       |
| 166394 | UTY-RNRU   | VRF Individual Touch Panel Controller Wired Remote          |       |
| 147806 | UTY-DCGY   | VRF Central Remote Control                                  |       |
| 147802 | UTY-LNHU   | VRF Wireless Remote Control                                 |       |
| 181050 | UTY-PLGXR1 | VRF Centralized Remote Control option for UTY-ALGX Software |       |
| 147804 | UTY-RSKU   | VRF Simple Remote Control                                   |       |

**Mini-Split VRF System Parts & Accessories**

| Part # | Mfg #       | Description                | Price |
|--------|-------------|----------------------------|-------|
| 147821 | UTB-YWC VRF | IR Receiver for Duct       |       |
| 133356 | UTP-SX248A  | Separation Tube            |       |
| 147827 | UTR-BP090X  | VRF Indoor Separation Tube |       |
| 147826 | UTR-BP180X  | VRF Indoor Separation Tube |       |

## VRF Equipment

### Mini-Split VRF System Parts & Accessories (Continued)

| Part # | Mfg #      | Description   | Price |
|--------|------------|---|-------|
| 147825 | UTR-BP567X | VRF Indoor Separation Tube                          |       |
| 147828 | UTR-CP567X | VRF Outdoor Separation Tube                         |       |
| 133349 | UTG-CCGF   | Compact Cassette Grille for AUU Units               |       |
| 147757 | UTG-CCGV   | Compact Cassette Grille for Airstage V-II Units     |       |
| 147763 | UTG-LCGV   | Cassette Grille for Airstage V-II Units             |       |
| 223399 | UTP-AX180A | WRF Indoor SEP Tub                                  |       |
| 173055 | UTP-BX090A | Ind Separation Tube 90 or less MBU Capacity         |       |
| 173056 | UTP-BX180A | Ind Separation Tube 90-180 MBU Capacity             |       |
| 173057 | UTP-BX567A | Ind Separation Tube 180 or more MBU Capacity        |       |
| 173058 | UTP-DX567A | Outdoor Unit Branch Kit                             |       |
| 173059 | UTP-RU01AH | Refrigeration Branch Unit - Single Type 20k or Less |       |
| 173060 | UTP-RU01BH | Refrigeration Branch Unit - Single Type 60k or Less |       |
| 181056 | UTP-RU01CH | Refrigeration Branch Unit - Single Type 96k or Less |       |
| 173061 | UTP-RU04BH | Refrigeration Branch Unit - Multi Type 191k or less |       |
| 147829 | UTR-H0906L | VRF Header (6) Straight Connects                    |       |
| 147830 | UTR-H1806L | VRF Header (6) "L" Connects                         |       |
| 147831 | UTR-H0908L | VRF Header (8) Straight Connects                    |       |
| 147832 | UTR-H1808L | VRF Header (8) "L" Connects                         |       |
| 181049 | UTY-ALGX   | VRF System Controller Lite Software                 |       |
| 147818 | UTY-ABGX   | VRF BACnet® Gateway Software                        |       |
| 147823 | UTY-ASGX   | VRF Service Tool (Software)                         |       |
| 185661 | UTY-VSGXZ1 | VRF Signal Amplifier                                |       |
| 133361 | UTY-XCBXZ1 | HFI Interface Kit                                   |       |
| 147844 | UTZ-PX1NBA | Drain Pump Unit (Duct Type)                         |       |
| 147847 | UTZ-KXGC   | Insulation Kit for High Humidity                    |       |
| 151930 | UTZ-VXAA   | Fresh Air Intake for Compact Cassette Type          |       |
| 190428 | K00500LW   | 500' Reel VRF Fujitsu Cable                         |       |
| 190429 | K00250LW   | 250' Reel VRF Fujitsu Cable                         |       |

Cooling - Equipment & Rooftop Units



## Brass Sealing Caps

### Sealing Caps

#### Brass Sealing Cap - Hex Head Flare Fitting



| Part # | Mfg #     | Size | Qty | Price |
|--------|-----------|------|-----|-------|
| 140748 | 82-A04544 | 1/4" | 50  |       |
| 140749 | 82-A04545 | 3/8" | 25  |       |

#### Brass Sealing Cap - Serrated Head Flare Fitting

| Part # | Mfg #     | Size | Price |
|--------|-----------|------|-------|
| 140746 | 82-A16447 | 1/4" |       |

#### Protective Cap - Brass w/o Core Removal Tool

| Part # | Mfg #         | Description                                       | Price |
|--------|---------------|---|-------|
| 126195 | 83-CD2245-6PK | Protective Cap - Brass w/o Core Removal Tool 6/PK |       |

**Chemicals**

**Cleaners**

**Evap Foam® Coil Cleaner**

- High performance detergent with special surfactant's and alkaline cleaners, foaming
- "No rinse required" condenser coil cleaner
- Spray right side up or upside down
- For cooling or evaporator coils



| Part # | Mfg #   | Description   | Price |
|--------|---------|---------------|-------|
| 139433 | 4171-75 | 18 oz Aerosol |       |

**Evap Fresh® Coil Cleaner**

- Ready-to-use, non-abrasive, one-step cleaner and disinfectant



| Part # | Mfg #   | Description | Price |
|--------|---------|-------------|-------|
| 199891 | 4166-75 | 18 oz Can   |       |

**Nu-Brite® Coil Cleaner**

- Foaming coil cleaner
- Brightens as it cleans
- Safer than acids
- Biodegradable, USDA approved



4291-18                      4291-08

| Part # | Mfg #   | Description   | Price |
|--------|---------|---------------|-------|
| 139431 | 4291-18 | 18 oz Aerosol |       |
| 139434 | 4291-08 | 1 gal         |       |

**Foam-Brite® Coil Cleaner**

- Non-acidic, alkaline-based cleaner
- Biodegradable ingredients
- High foaming formula



| Part # | Mfg #   | Description | Price |
|--------|---------|-------------|-------|
| 199978 | 4178-08 | 1 gal       |       |

**Green Clean® Coil Cleaner**

- Powerful environmentally friendly formula for all purpose cleaning
- Product can be used direct from bottle or diluted to match duty of the job
- Safe and non-flammable
- Green Clean is biodegradable
- Approved by the EPA Safer Choice Program
- Use it everywhere



| Part # | Mfg #   | Description | Price |
|--------|---------|-------------|-------|
| 215601 | 4186-08 | 1 gal       |       |

**Nu-Solve NR Coil Cleaner**

- Ready-to-use, non-rinse condenser coil cleaner
- Non-foaming, detergent based formula for emulsifying grime
- Formulated where water availability for rinsing the coil is problematic or solvent based aerosols are not desired
- For situations when its desirable to have less diluted cleaner on the roof
- Plastic, metal and rubber safe



| Part # | Mfg #   | Description | Price |
|--------|---------|-------------|-------|
| 189893 | 4295-08 | 1 gal       |       |

**Pan-Treat**

- Condensate tablets control odors can prevent overflows by plugged condensate drain lines
- Non-corrosive, non-toxic, and biodegradable
- Completely soluble in water



| Part # | Mfg #   | Description            | Price |
|--------|---------|------------------------|-------|
| 199892 | 4296-60 | 1 bottle (200 tablets) |       |

**Nu-Blast® Coil Cleaner**

- "No rinse required" condenser coil cleaner
- High pressure blast plus solvent cleaning



| Part # | Mfg #   | Description   | Price |
|--------|---------|---------------|-------|
| 139432 | 4290-75 | 18 oz Aerosol |       |

Cooling - Accessories

**Chemicals**

**BlackHawk Foam Coil Cleaner**

- HVAC/R applications
- Expanding foam
- Heavy-duty formula
- Safe and problem-free in food processing areas



| Part # | Mfg #   | Description | Price |
|--------|---------|-------------|-------|
| 189894 | 4127-75 | 18 oz Can   |       |

**Calci-Solve Cleaner**

- Removes scale and rust from:
  - A/C equipment
  - Air compressor jackets
  - Pasteurizes and tanks
  - Dish washing machines
  - Water sealed blowers
  - Refrigerator drains
  - Calendar machines
  - Blue print drains
  - Boilers
  - Air filters
  - Condensers
  - Siphon pipes
  - Water piping
  - Water pumps



| Part # | Mfg #   | Description    | Price |
|--------|---------|----------------|-------|
| 218244 | 4134-24 | 1 Quart Bottle |       |

**Complete Care Mini-Split Kit**

- Contains one 18 oz can of Evap-Fresh™ No Rinse Evaporator Coil Cleaner & Disinfectant (#4166-75) and one PurCool® Green Mini Strip (#61044)



| Part # | Mfg #   | Description            | Price |
|--------|---------|------------------------|-------|
| 186994 | 4151-08 | Mini-Split Cleaner Kit |       |

**Coil Gun**

- Quick connect feature
- Fix mix ration settings 3:1, 4:1, 6:1, 9:1, & 10:1
- 2-Quart capacity
- Foam wand to enhance foaming
- Deflector tip to fan out spray
- Connects to optional coil gun probe accessory (4774-1) for 90° direction of spray inside the coil



| Part # | Mfg #  | Description      | Price |
|--------|--------|------------------|-------|
| 199887 | 4774-0 | Coil Gun Sprayer |       |

**A/C Drain Sucker**

- Kit Includes:
  - Drain Sucker Pump & Hoses
  - PurCool Green 3 Ton Tablet (#61048)
  - All Fittings for Suction or Pressure Applications



| Part # | Mfg # | Description      | Price |
|--------|-------|------------------|-------|
| 189898 | 61308 | A/C Drain Sucker |       |

**Rx-Acid Scavenger®**

- Neutralizes or "scavenges" acid in refrigeration, air conditioning systems
- Use after burnouts or normal maintenance
- Normal dosage is 2 fl oz/gallon of system oil



| Part # | Mfg #   | Description        | Price |
|--------|---------|--------------------|-------|
| 140754 | 4301-02 | 2 oz Liquid, Boxed |       |

**Rx11-Flush®**

- Ozone-safe solvent for flushing refrigeration and air conditioning systems/line sets
- Rinses away particulate, sludge, carbon residues, acids, oils and water



| Part # | Mfg #   | Description                 | Price |
|--------|---------|-----------------------------|-------|
| 201260 | 4300-08 | 1 lb. can, hose, gun, valve |       |
| 114154 | 4300-09 | 1 lb Canister               |       |
| 114155 | 4300-11 | 2 lb Canister               |       |

Cooling - Accessories

**Chemicals**

**Rx11-Flush® (Continued)**

| Part # | Mfg #   | Description               | Price |
|--------|---------|---------------------------|-------|
| 210232 | 4300-30 | 19.5 fl oz, Unpressurized |       |
| 114158 | 4300-50 | Flushing Tool             |       |
| 199968 | 4300-51 | Rx11 Flush Gun            |       |
| 139863 | 4300-89 | Injection Valve           |       |

**Lubricants**

**A/C Re-New Lubricant**

- Enhances the lubricity and thermal properties of the refrigeration oil when introduced to an a/c or refrigeration system
- Reduces energy consumption
- Improves heat transfer in evaporator and condenser by improving oil return



| Part # | Mfg #   | Description | Price |
|--------|---------|-------------|-------|
| 170384 | 4057-55 | 4 oz liquid |       |

**A/C Re-New Injector Tool**

- Designed to inject A/C Re-New into A/C and refrigeration systems
- 4 fl. oz capacity
- Can be used for other injectable products as well
- Rugged aluminum
- Max working pressure: 600 psi



| Part # | Mfg #   | Description       | Price |
|--------|---------|-------------------|-------|
| 170385 | 4057-99 | 4 fl. oz capacity |       |

**Penetrate HD® Lubricant**

- Super penetrating lubricant
- Loosens rusted and frozen metal parts
- Frees stuck fan blades, blower shafts, pulleys, rusted nuts and bolts, etc.
- Saves time and labor
- Lubricates and protects metals
- Dielectric strength to 40,000 volts,
- Low VOC formula 31,000 volts
- Part numbers 61107 and 61108 meet or exceed California VOC limits
- Can be used with Talon Aerosol Wand (4776-0)



| Part # | Mfg # | Description | Price |
|--------|-------|-------------|-------|
| 189895 | 61105 | 12 oz Can   |       |

Cooling - Accessories



## Leak Detection

### Leak Sealant

#### Cal-Blue Leak Detector

- Freeze-protection 5°F up to 225°F



| Part # | Mfg #   | Description          | Price |
|--------|---------|----------------------|-------|
| 194279 | 4182-24 | 1 Quart Spray Bottle |       |

### Pipe-Dri Pipe Insulation Spray

- Refrigeration Lines
- Air Conditioning Lines
- Cold Water Lines
- Other Cold Surfaces



| Part # | Mfg #   | Description       | Price |
|--------|---------|-------------------|-------|
| 210407 | 4297-75 | 18 oz Aerosol Can |       |

### A/C EasySeal

- Prevents refrigerant leaks and seals existing leaks in air conditioning and refrigeration systems
- Eliminates expensive leak search and repair
- Travels with refrigerant to find leaks fast



| Part # | Mfg #   | Description                            | Price |
|--------|---------|--|-------|
| 133636 | 4050-06 | EasySeal - 2.5 oz. pressurized can     |       |
| 213682 | 4050-01 | EasySeal-SS - 1.23 oz. pressurized can |       |
| 199897 | 4050-02 | EasySeal 2+1 Display Pack              |       |

### Gas Leak Detector

- Fluorescent spray bottle
- Non-corrosive to metal
- Freeze-protected and safe for use on all refrigerants, natural gas, and oxygen



| Part # | Mfg #   | Description          | Price |
|--------|---------|----------------------|-------|
| 167286 | 4184-24 | 1 Quart Spray Bottle |       |

### A/C EasySeal Direct Inject 1.5 to 5 Tons

- Easiest sealant to install
- Permanent seal
- Works with all refrigerants
- Professional use only
- Super concentrate



| Part # | Mfg #   | Description  | Price |
|--------|---------|--|-------|
| 177997 | 4050-08 | Treats Systems 1.5 to 5 Tons 18,000 BTUs or larger |       |

### A/C EasyDry

- Eliminates moisture in residential and commercial systems
- Treats up to 5 ton systems
- Compatible with all oils and refrigerants
- Compliments the system's drier
- Prevents acid from forming



| Part # | Mfg #   | Description          | Price |
|--------|---------|----------------------|-------|
| 204211 | 4051-06 | 3 oz Pressurized Can |       |

**Chemicals**

**Cleaners**  
**Evaporator Coil Cleaner**



| Part # | Mfg #  | Description                     | Price |
|--------|--------|---------------------------------|-------|
| 092115 | 85-C02 | Aerosol Evaporator Coil Cleaner |       |

**Enviro-Coil Cleaner**

- Cleans evaporator and condenser coils
- No foaming action, only attacks dirt buildup
- Environmentally safe
- No rinsing required on evaporator coils
- (4) Containers per case
- USDA Accepted



| Part # | Mfg #     | Description               | Price |
|--------|-----------|---------------------------|-------|
| 141525 | 85-H-EC01 | 1 gal Enviro-Coil Cleaner |       |

**Cal-Brite Coil Cleaner**

- Low pH cleaner for cleaning evaporator coils, air-cooled condensers, and other finned cooling and heating coils
- Based upon glycolic acid and other ingredients, including Mepol®
- Provides moderate foaming and brightening
- Safe for indoor and outdoor use



| Part # | Mfg #   | Description              | Price |
|--------|---------|--------------------------|-------|
| 176312 | 4133-08 | 1 Gal, 3:1 Concentration |       |

**Pro-Treat® 152 King-Size Premium Condensate Drain Pan Treatment**

- Economical, safe, effective king-size tablets last three times longer
- Safe, non-corrosive, odor-free and 100% soluble
- Computer room approved
- Keeps drain pans and condensate lines clean and free flowing
- Dosage: 1 tablet per 3 tons per 3 months



| Part # | Mfg #  | Description          | Price |
|--------|--------|----------------------|-------|
| 149945 | 853002 | (12) Tablets per Jar |       |

**Sta-Clean Condensate Pan Strip**



| Part # | Mfg # | Description     | Price |
|--------|-------|-----------------|-------|
| 142409 | CS100 | Up to 2-1/2 Ton |       |

**Leak Freeze**  
**A/C Leak Freeze**

- Permanently seals leaks in air conditioning and refrigeration systems
- Does not contain polymers
- Not activated by moisture or oxygen
- Non-clogging to A/C compressor and recovery unit



| Part # | Mfg # | Description                           | Price |
|--------|-------|---------------------------------------|-------|
| 149068 | 00284 | 1.5 oz Cartridge, Clamshell w/Adapter |       |

Cooling - Accessories

## Chemicals

### Coil Cleaners

#### Self-Rinsing Evaporator Coil Cleaner

- No foaming action – only attacks dirt build-up, not metal
- Rinsing not required – normal condensation will carry away dirt and contamination
- May irritate eyes and skin – excessive contact should be avoided
- USDA Accepted



| Part # | Mfg #  | Size  | Color | Price |
|--------|--------|-------|-------|-------|
| 041217 | 85-401 | 1 gal | Green |       |

#### Heavy Foaming Acid Condenser Coil Cleaner & Brightener

- Expanding foam action
- Best for brightening – makes condenser coils look new
- Must be thoroughly rinsed with water
- Contains hazardous components hydrofluoric acid and phosphoric acid
- Outdoor use only, protective gloves, and eye/face protection required



| Part # | Mfg #  | Size  | Color | Price |
|--------|--------|-------|-------|-------|
| 041756 | 85-501 | 1 gal | Red   |       |

#### Heavy Foaming Alkaline Condenser Coil Cleaner & Brightener

- Expanding foam action
- Alkaline formulation is excellent on greasy coils
- Must be thoroughly rinsed with water
- Contains hazardous component potassium hydroxide
- Good ventilation, protective gloves, and eye protection required
- USDA Accepted



| Part # | Mfg #   | Size  | Color  | Price |
|--------|---------|-------|--------|-------|
| 041334 | 85-1101 | 1 gal | Orange |       |

**Chemicals**

**Flush Kits**

**Pro-Flush HVAC Flushing Solvent**

- HVAC/R Flushing solvent for R-410A retrofits, refrigerant conversions and retrofits
- Low toxicity
- Non-flammable
- Residue-free



| Part # | Mfg #  | Description     | Price |
|--------|--------|-----------------|-------|
| 213842 | PF-08  | 8 oz. Refill    |       |
| 134797 | PF-16  | 16 oz Refill    |       |
| 134796 | PF KIT | Power Flush Kit |       |

**Super Change™**

- One can treats up to 6 tons
- Eliminates oil change out
- Replaces line set flush
- Boosts oil return
- 20122 Reusable charging hose required —(sold separately)



| Part # | Mfg # | Description               | Price |
|--------|-------|---------------------------|-------|
| 189665 | 981   | Super Change R22 Retrofit |       |

**Coil Cleaners**

**Foam-Plus™ Foaming Coil Cleaner**

- Aerosol can
- Non-flammable and water-based with no chlorinated solvents
- Foaming alkaline detergent quickly liquefies dirt, grease, oil or other residue
- Self rinsing on condensate producing coils



| Part # | Mfg #  | Description       | Price |
|--------|--------|-------------------|-------|
| 114477 | 358-20 | 19 oz Aerosol can |       |

**Saf-N-Kleen™ Aerosol Solvent Coil Cleaner**

- High-solvency formula quickly and easily dissolves dirt, grease, oil or other residue while the blasting nozzle separates the materials from the surface.
- Non-flammable, non-conductive formula is safe to use on live equipment.

| Part # | Mfg #  | Description    | Price |
|--------|--------|----------------|-------|
| 193803 | 357-20 | 18 oz. Aerosol |       |

**Triple D™ Universal Coil Cleaner**

- Triple-D™ is the ultimate universal coil cleaner that can be used on condensers, evaporators, microchannels, roof-top units, and mini-split applications.
- The triple active synergistic highly effective solution is formulated to remove a board range of soils while degreasing and deodorizing. It is ideal for cleaning most metals including aluminum and copper while extending equipment life and diminishing the potential for refrigerant leaks.
- Using 75% less than comparable products, it reduces the amount of solution needed to clean.
- Triple-D is biodegradable, NSF approved and available in seven different packaging configurations.



| Part # | Mfg #    | Description             | Price |
|--------|----------|-------------------------|-------|
| 166062 | TRIPLE-D | 1 quart trigger sprayer |       |
| 166063 | TRIPLE-D | 1 gallon concentrate    |       |

**Pro-Green™ No Rinse Coil Cleaner**

- Mild Alkaline cleaner
- Can be used on air-cooled condensers, evaporators, electronic and permanent filters, fan blades, grilles, mini-split, and microchannel applications
- Cleans deposits on coils and rids condensate pans of slime
- NSF approved



| Part # | Mfg # | Description | Price |
|--------|-------|-------------|-------|
| 193291 | 8-G   | 1 Gallon    |       |

Cooling - Accessories

## Chemicals

### Pro-Red+™ Coil Cleaner

- Brightens, removes condensate "gunk," dirt, grime, and oxide deposits while degreasing
- Ideal for small and large condensers
- A 3 to 1 water to solution ratio for condensers



| Part # | Mfg # | Description | Price |
|--------|-------|-------------|-------|
| 192096 | 8-R   | 1 Gallon    |       |

### Pro-Yellow™ Coil Cleaner

- Cleans and brightens
- Vigorous foaming action
- Non acid formula



| Part # | Mfg # | Description | Price |
|--------|-------|-------------|-------|
| 193292 | 8-Y   | 1 Gallon    |       |

### Leak Detectors

#### Super Seal™ Sealant Total

- Medium systems 1.5-5 tons
- Dries, seals, and includes Flash UV dye for a complete repair solution
- Compatible with all oils and refrigerants
- Ideal for all systems including microchannel, heat pump and geothermal



| Part # | Mfg #  | Description | Price |
|--------|--------|-------------|-------|
| 236353 | 972KIT | 2 oz        |       |

### Pro-Bubble™ Leak Detector

- Easy-to-use, high-bubbling, viscoelastic blue leak detector.
- New improved formula.



| Part # | Mfg #      | Description                  | Price |
|--------|------------|------------------------------|-------|
| 214166 | PRO-BUBBLE | 32 oz. bottle with Spray Top |       |

### Inspection Lights UV Pocket Light

- UV Pocket Light
- Rotating Magnetic Clip
- 3AAA Batteries Included



| Part # | Mfg # | Description          | Price |
|--------|-------|----------------------|-------|
| 248900 | 89DC  | 89DC UV Pocket Light |       |

Cooling - Accessories

**Chemicals**

**Flex Inject Sealant Advanced & Total**

- Flex Inject Sealant Advanced & Total are the fastest, most effective proven way to permanently seal and prevent minor air conditioning and refrigeration (AC/R) leaks.
- With no tools or gauges required, the Flex Inject sealant works by traveling through the system with the oil and refrigerant fixing leaks immediately.
- Flex Inject works with all compressors, heat pumps, condensers, and other system components and it will not plug up manifold gauges, metering devices, thermostatic expansion valves (TXVs), pistons or cause cap tube blockages.
- It meets the ASHRAE ARI 700 refrigerant standard and is compatible with any refrigerant including R-410A with no pump downs or recoveries required.
- Flex Inject is suitable for use in aluminum and copper coils and is microchannel friendly.



**UV Dyes**

- Flash™ UV dye is an advanced class of highly concentrated ultra violet dye that uses DRY R™ instead of POE oil as its carrier.
- This, combined with our patented misting orifice, enables the dye to travel at the speed of the refrigerant while keeping the dye stable.
- One can treats up to 64 oz (1.8L) of oil. Flash UV dye uses the systems refrigerant as the propellant – creating a clean, no-mess injection every time
- Required hose sold separately.



| Part # | Mfg # | Description         | Price |
|--------|-------|---------------------|-------|
| 223617 | 20122 | Clear Charging Hose |       |

| Part # | Mfg # | Description | Price |
|--------|-------|-------------|-------|
|--------|-------|-------------|-------|

**Miscellaneous**

**Pro-Treat® 200 Economy Condensate Drain Pan Treatment**

- Economical with 200 tablets per jar.
- Safe, non-corrosive, odor-free and 100% soluble.
- Approved for computer rooms.
- Convenient, easy-to-use tablet form provides prolonged cleaning action.
- Dosage: 3 tablets per 3 tons per month.



| Part # | Mfg #        | Description     | Price |
|--------|--------------|-----------------|-------|
| 194908 | PROTREAT-200 | 200 Tablets/Jar |       |

Cooling - Accessories

---



---

## Chemicals

---



---

### ParFlush Kits

#### ParFlush Kit for System Conversion & Clean-Up

- *Developed for refrigerant systems up to eight tons*
- *Ideal for R-410A conversions or system clean-up of air conditioning, heat pump or refrigeration systems with 3/8" OK liquid line sets*
- *Non-toxic and non-flammable*



| Part # | Mfg #  | Description | Price |
|--------|--------|-------------|-------|
| 139317 | PFKIT1 | 1 lb Kit    |       |

**Refrigerant & Recovery Cylinders**

**Refrigeration Chemicals**

**Mineral Refrigeration Lubricant**

- Viscosity 150 SUS (ISO VG 32) replaces 3GS
- Viscosity 300 SUS \*(ISO VG 68) replaces 4GS
- For use with CFC and HCFC refrigerants
- Refined from select naphthenic base oils
- Wax free and oem approved
- Highest quality available and long-term, trouble-free service
- Low temperature properties
- (6) Containers per package



H-2301



H-2401

| Part # | Mfg #     | Description          | Price |
|--------|-----------|----------------------|-------|
| 104480 | 85-H-2301 | 1 gal, 150 Viscosity |       |
| 149944 | 85-H-2401 | 1 gal, 300 Viscosity |       |

**Ester 32 POE Refrigeration Oil**

- Synthetic Ester Compressor Lubricant
- Viscosity 32 cSt @ 40°C
- ISO Viscosity Grade 32
- Long lubricant life
- Properly controlled miscibility
- High system efficiency
- Excellent low temperature fluidity
- Excellent high temperature stability
- Excellent hydrolytic stability
- Outstanding protection against compressor wear



| Part # | Mfg #    | Description         | Price |
|--------|----------|---------------------|-------|
| 157479 | 85-32CST | 12 oz, 32 Viscosity |       |

Cooling - Accessories



**Condensate Neutralizers**

**Cooling Tower & Water Treatment Products**

**pH-TREAT™ pH Neutralizer**

- Neutralizes condensate water raising the pH to near neutral
- Includes:
  - (1) C-Clip for mounting
  - (2) 1/2" Barb x 3/8" MPT fittings
  - (2) 3/4" FPT x 3/8" MPT fittings
- Designed for gravity feed
- Product life is expected to have 1-year service life
- Temperature range: 40° to 100°F
- Pressure range: 0 to 125 psi



| Part # | Mfg #   | Description  | Price |
|--------|---------|--|-------|
| 148176 | 4720-06 | 2.5" x 12" Cartridge Housing with 3/8" FPT Connections |       |

## Condensate Drain Guns

### Condensate Drain Cleaners

#### Charles Gallo Drain Gun

- Clears condensate drains with a SWOOSH CO2 cartridge
- Lightweight, portable
- Creates 1,200 psi pressure
- Includes a tapered fitting to fit on 3/8" - 3/4" drain openings
- Cartridges are environmentally safe and recyclable



| Part # | Mfg # | Description                         | Price |
|--------|-------|-------------------------------------|-------|
| 142154 | GG-1  | Gallo Gun with SWOOSH CO2 Cartridge |       |

#### Swoosh CO2 Cartridge



| Part # | Mfg #  | Description                                 | Price |
|--------|--------|---|-------|
| 142156 | GGC-12 | Replacement Cartridge for SWOOSH CO2, 12/PK |       |

#### Drain Kat™ Mini Kit for Nitrogen or CO2

- The Drain Kat™ is an over the shoulder refillable, nitrogen or CO2 mini drain cleaning kit.
- Featuring a small cylinder that holds 9 cubic feet of nitrogen or 2-1/2 pounds of CO2.
- The cylinder includes an integral mounted regulator for quick and easy adjustment of discharge pressure.
- Get exactly the amount of pressure you need with a quick adjustment on the regulator.
- Furnished complete with an 87" hose and drain gun kit, the CW-15 whip hose, and the AP-DK Drain Kat™ Accessory Fitting Kit which contains the DF-75 Drain Dawg™ inflatable tip, the CB-03 3/4"-1" cone fitting, the FA-01 male to male CO2 to nitrogen adapter, the FA-03 CO2 trans-fill adapter, and the QN-S3 needle tip.



| Part # | Mfg # | Description                       | Price |
|--------|-------|-----------------------------------|-------|
| 249061 | MBK-6 | Drain Kat mini drain cleaning kit |       |

## Condensate Drain Pan Switches

### Condensate Overflow Switches

#### Condensate Cop™ Clamp-On Float Switch

- Large over clamping area that fits the edge of all types of drain pans
- Separate float/probe assembly swivels to position switch
- Switch opens when rising water presents a flooding condition
- 2-Wire connection
- 24V/1.5A NC Reed switch
- Includes:
  - 5' Leads
  - Wire nuts
  - Clamping screws



| Part # | Mfg # | Description      | Price |
|--------|-------|------------------|-------|
| 148951 | CC-1  | Drain Pan Switch |       |

#### UA-1 Universal Alarm for Condensate Switches

- Use with the Wet Switch, SOS, Condensate Cop, CP-22 (all types) and all float switches on 24VAC control circuits.



| Part # | Mfg # | Description          | Price |
|--------|-------|----------------------|-------|
| 203939 | UA-1  | UA-1 Universal Alarm |       |

#### Pipe Mounted Switches

- DiversiTech Flood Prevention Switches are simple to install, easy to service and extremely reliable.
- As water level in the auxiliary or main drain pipe rises due to a clogged air conditioning condensate drain, the switch shuts off the system—thus preventing water from overflowing and causing damage to doors, walls and ceilings.
- At the heart of the switch is a durable yet precise magnetic reed switch.
- Constructed of materials that will not rust or stick, the switch operates smoothly every time.



| Part # | Mfg # | Description             | Price |
|--------|-------|-------------------------|-------|
| 224406 | CS1   | Condensate Switch Tee   |       |
| 250287 | CS-2  | Condensate Switch Elbow |       |

### Safety Overflow Switch (SOS)

- Designed for use on 3/4in. PVC condensate drain line.
- Snaps easily over existing drain line tubing and can be glued in place using PVC cement.
- The SOS electronically senses water near the inside wall of the PVC drain tubing
- The LED indicator lights to show that there may be system trouble, and the SOS is doing its job.
- Furnished complete with switch, 5' (1.5 meter) 18 AWG, 2 wire lead, and a 3/4in. PVC male fitting adapter for direct coupling to a primary pan drain line connection



| Part # | Mfg # | Description                  | Price |
|--------|-------|------------------------------|-------|
| 197096 | SOS-1 | SOS-1 Safety Overflow Switch |       |

### CS1200 AC Shutoff Switch

- The CS1200 is a fast installing, reliable, condensate overflow detection switch.
- Featuring a unique universal pan mount design to assure accurate detection in metal or plastic secondary drain pans.

| Part # | Mfg #  | Description              | Price |
|--------|--------|--------------------------|-------|
| 214078 | CS1200 | CS1200 AC Shutoff Switch |       |

### WS-1 Wet Switch® Flood Detector

- A solid state control designed to help prevent flooding, damage to carpets, walls, furniture, ceilings, etc.
- Turns system off when detecting moisture due to condensate or drain leaks.
- A lit LED indicates the Wet Switch is activated and has turned the unit off.
- Connects to 24 VAC.
- More than one unit may be connected to a system.
- 2 amp contact rating.
- Simple 5 wire installation.



| Part # | Mfg # | Description               | Price |
|--------|-------|---------------------------|-------|
| 148945 | WS-1  | Wet Switch Flood Detector |       |

**Condensate Traps**

**Condensate Traps**

**100 Series Plain Clear Condensate Trap**

- Patented "See-Through" technology
- Watertight lower cap opens for easy access to clean drain pan outlet inside unit
- Remove upper cap to completely clean in seconds
- Cap can be replaced with optional float switch to warn owner if blockage is detected
- 3-Year warranty



| Part # | Mfg #    | Description                   | Price |
|--------|----------|-------------------------------|-------|
| 147440 | EZT-113B | 3/4" Blow Molded Trap w/Brush |       |
| 119480 | EZT-119  | 1" Blow Molded Trap w/Brush   |       |



## Condensate Traps

### Condensate Overflows

#### Condensate Overflow Safety Switch



84-SS2

| Part # | Mfg #  | Description  | Price |
|--------|--------|--|-------|
| 114920 | 84-SS2 | Condensate Overflow Safety Switch - Auxiliary Drain Line Mount |       |
| 079708 | 84-SS3 | Condensate Overflow Safety Switch - Pan Mount                  |       |

**Condenser Pads**

**Plastic Equipment Pads**  
**Plastic Equipment Pads**

- Molded with size label and symbol representing content of recycled material
- Rounded edges and concrete gray color
- Limited lifetime warranty

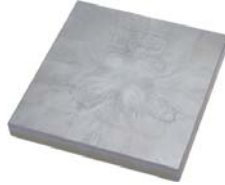

**2" E-Lite™ Equipment Pad**

| Part # | Mfg #    | Size           | Price |
|--------|----------|----------------|-------|
| 023182 | EL2424-2 | 24" x 24" x 2" |       |
| 122773 | EL2430-2 | 24" x 30" x 2" |       |
| 021931 | EL2436-2 | 24" x 36" x 2" |       |
| 023183 | EL3030-2 | 30" x 30" x 2" |       |
| 023229 | EL3036-2 | 30" x 36" x 2" |       |
| 023184 | EL3040-2 | 30" x 40" x 2" |       |
| 039431 | EL3232-2 | 32" x 32" x 2" |       |
| 023185 | EL3636-2 | 36" x 36" x 2" |       |
| 039688 | EL3640-2 | 36" x 40" x 2" |       |
| 021932 | EL3648-2 | 36" x 48" x 2" |       |

**3" E-Lite™ Equipment Pad**

| Part # | Mfg #    | Size           | Price |
|--------|----------|----------------|-------|
| 147199 | EL1838-2 | 18" x 38" x 3" |       |
| 110904 | EL2424-3 | 24" x 24" x 3" |       |
| 156001 | EL2436-3 | 24" x 36" x 3" |       |
| 122936 | EL3030-3 | 30" x 30" x 3" |       |
| 156005 | EL3040-3 | 30" x 40" x 3" |       |
| 156006 | EL3232-3 | 32" x 32" x 3" |       |
| 110907 | EL3636-3 | 36" x 36" x 3" |       |
| 110908 | EL3640-3 | 36" x 40" x 3" |       |
| 151113 | EL3648-3 | 36" x 48" x 3" |       |
| 110910 | EL3842-3 | 38" x 42" x 3" |       |
| 173859 | EL4040-3 | 40" x 40" x 3" |       |

**2" UltraLite™ Equipment Pad**

- Lightweight Concrete Equipment Pads

| Part # | Mfg #    | Description    | Price |
|--------|----------|----------------|-------|
| 135506 | UC2430-2 | 24" x 30" x 2" |       |
| 199877 | UC4040-2 | 40" x 40" x 2" |       |

**3" UltraLite™ Equipment Pad**

- Concrete equipment pad

| Part # | Mfg #    | Size           | Price |
|--------|----------|----------------|-------|
| 156007 | UC1636-3 | 16" x 36" x 3" |       |
| 192089 | UC3030-2 | 30" x 30" x 3" |       |

**Plastic Equipment Pads (Continued)**

**Plastic Equipment Pads**

**3" UltraLite™ Equipment Pad**

| Part # | Mfg #    | Size           | Price |
|--------|----------|----------------|-------|
| 192090 | UC3636-2 | 36" x 36" x 3" |       |

**EcoPad™ Black Plastic Equipment Pad**

- Used where local codes supersede the international code and require a pad thicker than 2"



| Part # | Mfg #    | Description    | Price |
|--------|----------|----------------|-------|
| 215899 | EP3030-3 | 30" x 30" x 3" |       |
| 215900 | EP3232-3 | 32" x 32" x 3" |       |
| 215901 | EP3636-3 | 36" x 36" x 3" |       |

**Heat Pump Pad™**

- Raises the pump a full 8" off the ground
- Precision molded from eco-friendly, recycled polypropylene
- Includes (8) high quality anti-vibration pads
- Base angled to direct melting snow or water from the unit

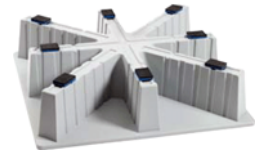

| Part # | Mfg #    | Size           | Price |
|--------|----------|----------------|-------|
| 131414 | HP3636-8 | 36" x 36" x 8" |       |
| 224224 | HP3232-8 | 32" x 32" x 8" |       |

**A/C Condenser Mounting Brackets**

- No hardware included
- Pre-punched holes for fastening unit to bracket
- 7/16" Holes for wall mounting hardware
- Load capacity dependent upon hardware/wall load limitations
- 3" Bracket width, 16" height



| Part # | Mfg #  | Description     | Price |
|--------|--------|-----------------|-------|
| 132370 | ACB-30 | 30" Steel, Pair |       |
| 132372 | ACB-36 | 36" Steel, Pair |       |
| 132373 | ACB-42 | 42" Steel, Pair |       |
| 132374 | ACB-48 | 48" Steel, Pair |       |

Cooling - Accessories

## Condenser Pads

### Vibration Pads

#### Iso-Cube Economy Anti-Vibration Pad

- Circular design offers suction cup effect - no need to bolt down pad
- 50 durometer pad will withstand a load of 180 psi



| Part # | Mfg #  | Size             | Price |
|--------|--------|------------------|-------|
| 193873 | ISO-2  | 2" x 2" x 3/4"   |       |
| 060308 | ISO-18 | 18" x 18" x 3/4" |       |

#### EVA Anti-Vibration Pad

- 3" x 3" x 7/8"
- Composite foam center
- Designed to withstand 50 psi



| Part # | Mfg # | Size           | Price |
|--------|-------|----------------|-------|
| 206858 | MP-3E | 3" x 3" x 7/8" |       |

#### Rubber Anti-Vibration Pad

- Elastomeric oil resistant padding
- Can withstand 50 lbs psi
- Corrugated on both sides

| Part # | Mfg # | Size           | Price |
|--------|-------|----------------|-------|
| 198252 | MP-2  | 2" x 2" x 3/8" |       |

#### Rubber / Cork Anti-Vibration Pad

- Highest quality elastomeric oil resistant padding.
- Designed to withstand 50 psi.
- The rubber pads are corrugated on both sides.
- The cork is laminated between two corrugated pads.
- Ideal for air conditioners, compressors, cooling towers, presses, machines, etc.

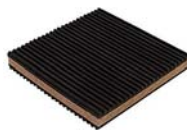

| Part # | Mfg #  | Description      | Price |
|--------|--------|------------------|-------|
| 220263 | MP-18C | 18" x 18" x 7/8" |       |

### Heat Pump Risers

#### One-Piece Heat Pump Riser

- Heavy-duty plastic
- Butyl mastic on top & bottom



| Part # | Mfg #  | Size | Price |
|--------|--------|------|-------|
| 190278 | HPR-3  | 3"   |       |
| 190279 | HPR-6  | 6"   |       |
| 223362 | HPR-12 | 12"  |       |

#### Adjustable Equipment Riser

- Holds up to 300 lbs.
- Barrel twists up 5"-8"
- Includes top cap



| Part # | Mfg # | Size | Price |
|--------|-------|------|-------|
| 190280 | AER-8 | 8"   |       |



---

---

## Condenser Pads

---

---

### A/C Brackets

| Part # | Description      | Price |
|--------|------------------|-------|
| 042910 | 36" Wall Bracket |       |
| 042911 | 42" Wall Bracket |       |



**Condenser Pads**

**Air Conditioning Hanging Brackets**

- 1/8" Thick steel
- Mounts at any height



| Part # | Mfg # | Description     | Price |
|--------|-------|-----------------|-------|
| 066780 | 19881 | 42" A/C Bracket |       |

**Equipment Stands & Mounting Blocks**

**Pump-Up® Equipment Stand**

- Elevate heat pumps and air handling units
- Corrosion-resistant plastic
- Helps prevent corrosion of metal base
- Solid 6" x 6" mounting base
- Top diameter: 4-1/8"

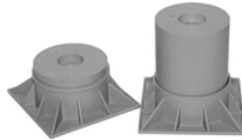

| Part # | Mfg # | Description           | Price |
|--------|-------|-----------------------|-------|
| 064183 | 4004  | 4" Pump-Up® Extension |       |
| 064182 | 4008  | 6" High               |       |
| 056395 | 4012  | 10" High              |       |

Cooling - Accessories

**Defrost Controls**

**Defrost Controls**

**Defrost Control Board**

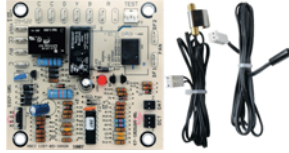

| Part # | Mfg #        | Description                      | Price |
|--------|--------------|----------------------------------|-------|
| 123566 | 47-102684-83 | Defrost Control Board            |       |
| 182513 | 47-102685-87 | Defrost Control Board Kit        |       |
| 032874 | 47-21776-86  | 24V Defrost Control<br>Time/Temp |       |

**Defrost Controls**

**Commercial Refrigeration Defrost Controls**

**8040 Series Defrost Control**

- Time initiated
- Time terminated
- 40 Amp
- Adjusted length of defrost 4 to 110 minutes



| Part # | Mfg #   | Volts @ 60Hz | Contacts 2-4 / 1-3 / 3-N | Price |
|--------|---------|--------------|--------------------------|-------|
| 149813 | 8041-00 | 120V         | Closed/Open/Closed       |       |
| 149808 | 8041-20 | 208/240V     | Closed/Open/Closed       |       |

**Defrost Controls**

**Commercial Refrigeration Controls**

**Single Function Pressure Control**

- NEMA 1 Enclosure with non-conductive cover
- Front-located captive cover screw
- Super Cap® capillary protection system
- Universal mounting & compact design
- Laser-welded bellows for extended life

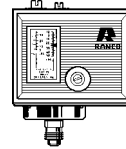

1/4" Male Flare



| Part # | Mfg #    | Description                  | Switch        | Range          | Differential | Price |
|--------|----------|------------------------------|---------------|----------------|--------------|-------|
| 149810 | O10-1483 | 36" Capillary with Flare Nut | SPST Open Low | 10 - 100 psig  | 10 - 40 psi  |       |
| 063790 | O10-2054 | 36" Capillary with Flare Nut | SPST Open Low | 100 - 400 psig | 40 - 150 psi |       |

**Dual Function Pressure Control**

- Exclusive "convertible" reset for manual or automatic high pressure reset on some models
- NEMA 1 Enclosure with non-conductive cover
- Front-located captive cover screw
- Super Cap® capillary protection system
- Universal mounting & compact design
- Laser-welded bellows for extended life
- Heavy-duty plated steel frame

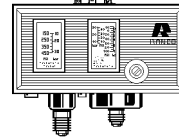

1/4" Male Flare



| Part # | Mfg #    | Cut-In Range PSIG | Diff. PSI | Cut-Out Range PSIG | Diff. PSI | Low Pressure (Opens Low) | High Pressure (Opens High) | Price |
|--------|----------|-------------------|-----------|--------------------|-----------|--------------------------|----------------------------|-------|
| 149809 | O12-4834 | 10 - 100          | 10 - 40   | 150 - 450          | 70 Fixed  | Automatic                | Convertible                |       |

**Temperature Controls**

**ETC Commercial Temperature Control**

- Wide temperature range: -30° to 220°F
- Wide differential adjustment: 1° to 30°F
- LCD Read-out for sensor temperature, control settings and relay status
- High amp output relay
- EEPROM Memory retains control settings during power outages
- Keypad lockout to prevent end-user alteration of settings
- Easy 4-step set up
- Heavy-duty relay 1 hp rated



| Part # | Mfg #      | Number Stages | Enclosure | Input Voltage  | 0 to 10 Volt Output | Price |
|--------|------------|---------------|-----------|----------------|---------------------|-------|
| 066936 | ETC-111000 | 1             | NEMA-1    | 120/208/240VAC | No                  |       |
| 107652 | ETC-112000 | 1             | NEMA 1    | 24VAC          | No                  |       |
| 064236 | ETC-212000 | 2             | NEMA 1    | 24VAC          | No                  |       |

Cooling - Accessories

## Defrost Controls

### General Range Temperature Control

- Maximum adjustment accuracy with 7 revolution range adjustment screws
- NEMA 1 enclosure with non-conductive cover
- Front-located captive cover screw
- Universal mounting & compact design
- Laser-welded bellows for extended life



### General Range Temperature Control - SPST - Opens High or Low

| Part # | Mfg #    | Applications  | Range       | Differential | Description | Price |
|--------|----------|---------------|-------------|--------------|-------------|-------|
| 149812 | O10-1072 | Low (Freezer) | -15° - 40°F | *+3° - 20°F  | Air Coil    |       |
| 149811 | O10-1802 | High          | 25° - 75°F  | *+3° - 20°F  | Air Coil    |       |

\*+Differential at the low end of range is 6 to 25.

Cooling - Accessories

**Electrical**

**Contactors**

**Economy DP-Series Contactor**

- *Electro magnetically-operated definite purpose 2-pole contactors provide switching for across-the-line starting of induction motors*
- *Double 1/4" quick connects*
- *Low profile design allows for more wiring room*
- *Multiple mounting holes and slots for convenient, interchangeable mounting with most competitive devices*
- *Not ARI-780 compliant, use where a "ruggedized" device is NOT required*



| Part # | Mfg #       | Coil Ratings Voltage | Poles  | Electrical Contacts Full Load | Electrical Contacts Resistive | Price |
|--------|-------------|----------------------|--------|-------------------------------|-------------------------------|-------|
| 169827 | DP2030A1004 | 24V                  | 2-Pole | 30A @ 240/277VAC              | 48A @ 240/277,480,600VAC      |       |

\* #10 Combination head screws

**Electrical**

**Protech Contactors**  
**Single Pole Contactor**



| Part # | Mfg #       | Amps | Coil Volts | FLA @230V | LRA @230V | Resistive @230V | Price |
|--------|-------------|------|------------|-----------|-----------|-----------------|-------|
| 018074 | 42-25101-01 | 30A  | 24V        | 25        | 150       | 35              |       |
| 030033 | 42-25101-03 | 40A  | 24V        | 40        | 240       | 50              |       |

**Two Pole Contactor**



| Part # | Mfg #       | Amps | Coil Volts | FLA @230V | LRA @230V | Resistive @230V | Price |
|--------|-------------|------|------------|-----------|-----------|-----------------|-------|
| 022556 | 42-25102-01 | 30A  | 24V        | 32        | 180       | 40              |       |
| 069435 | 42-42139-13 | 40A  | 24V        | 40        | 240       | 50              |       |

**Three Pole Contactor**



| Part # | Mfg #       | Amps | Coil Volts | FLA @230V | LRA @230V | Resistive @230V | Price |
|--------|-------------|------|------------|-----------|-----------|-----------------|-------|
| 017913 | 42-25103-01 | 30A  | 24V        | 32        | 180       | 40              |       |
| 053005 | 42-25103-02 | 30A  | 240V       | 32        | 180       | 40              |       |
| 022561 | 42-25103-05 | 50A  | 24V        | 50        | 300       | 63              |       |

Cooling - Accessories

**Electrical**

**Pressure Controls**

**P70 Series - Single Pole High Pressure Control**

- Full adjustability, minimum differential
- Long life contact structure, no bounce on make
- Manual reset models are "trip-free"
- Includes a universal mounting bracket
- For use with:
  - Air conditioning and refrigeration
  - Controls of air, water, and oil pressure



**Models for High Pressure Non-Corrosive Refrigerants: R-12, R-22, R134A, R-500, R-502 (R)**

| Part # | Mfg #     | Switch Action  | Range PSIG | Diff PSI  | Max Over-Pressure PSIG | Limited Knob Adj | Pressure Connection   | Price |
|--------|-----------|----------------|------------|-----------|------------------------|------------------|-----------------------|-------|
| 143982 | P70AA-400 | SPST Opens Low | 100 to 470 | 35 to 200 | 690                    | None             | 36" Cap, 1/4" Flr Nut |       |



## Spade & Other Electrical Connectors

### LiquidTite Flex Conduit and Fittings

#### Liquid Tite Flexible Conduit

- For electrical applications: outside, inside and industrial uses including transformer connections, air conditioning and heating
- Joins with metallic or non-metallic connectors, easy to cut. Impact resistant, chemical resistant, and will not kink.



| Part # | Mfg #     | Description   | Price |
|--------|-----------|---------------|-------|
| 192061 | 750-34100 | 3/4" x 100 ft |       |
| 194410 | 750-12100 | 1/2" x 100 ft |       |

#### DiversiWhip - Metallic Connectors

- Liquid-tight flexible conduit system
- Three distinct wire colors
- (1) Straight and (1) 90° metallic connectors
- UL & cUL Listed



| Part # | Mfg #  | Description         | Price |
|--------|--------|---------------------|-------|
| 011632 | 6-12-4 | 1/2" x 4', #10 THHN |       |
| 011633 | 6-12-6 | 1/2" x 6', #10 THHN |       |
| 034348 | 6-34-6 | 3/4" x 6', #8 THHN  |       |

### Connectors

#### Liquid Tite Straight Connector

- Type B
- UL & CUL listed
- For use with metallic and Non-metallic liquid conduit



| Part # | Mfg #      | Size | Metallic | Price |
|--------|------------|------|----------|-------|
| 194411 | 750-NMLT50 | 1/2" | No       |       |
| 192063 | 750-NMLT75 | 3/4" | No       |       |

#### Liquid Tite Elbow Connector

- Type B
- UL & CUL listed
- For use with metallic and Non-metallic liquid conduit



| Part # | Mfg #        | Size | Metallic | Degree | Price |
|--------|--------------|------|----------|--------|-------|
| 168189 | 750-NMLT9050 | 1/2" | No       | 90°    |       |
| 192064 | 750-NMLT9075 | 3/4" | No       | 90°    |       |

### Romex Connectors

- Metallic
- Zinc die cast
- For use with Romex wire
- UL listed CSA approved



| Part # | Mfg #     | Description             | Price |
|--------|-----------|-------------------------|-------|
| 192071 | 750-RC841 | 3/8" for 1/2" knockouts |       |
| 211892 | 750-RC842 | 3/4" for 3/4" knockouts |       |

### Screw-On Wire Connectors

- Secures connections for positive continuity
- High-dielectric thermoplastic shell resists chemical action
- Deep skirt design



| Part # | Mfg #   | Description                 | Price |
|--------|---------|-----------------------------|-------|
| 192085 | 623-002 | Blue 72B 22-16 AWG 100/Pk   |       |
| 193784 | 623-003 | Orange 73B 22-14 AWG 100/Pk |       |
| 192084 | 623-004 | Yellow 74B 18-10 AWG 100/Pk |       |
| 192086 | 623-005 | Red 76B 18-10 AWG 100/Pk    |       |
| 208281 | 623-001 | Gray 71B 22-16 AWG 100/Pk   |       |

### Winged Wire Connectors

- Durable thermoplastic material
- Flame retardant, abrasion resistant, non-porous, and non-corrosive
- For use with copper to copper, aluminum to aluminum, and copper to aluminum (dry locations only)



| Part # | Mfg #   | Description    | Price |
|--------|---------|----------------|-------|
| 159373 | 8284    | Yellow 18 Pack |       |
| 159374 | 8286    | Red 14 Pack    |       |
| 192087 | 623-000 | Gray 50 Pack   |       |

### Insulated Butt Connectors

- These insulated terminals crimp to the wires which relieves the need to solder.



| Part # | Mfg # | Description                | Price |
|--------|-------|----------------------------|-------|
| 212222 | 6231  | Red, 16 Pack 12-10 Wire    |       |
| 212223 | 6217  | Yellow, 27 Pack 16-14 Wire |       |

## Spade & Other Electrical Connectors

### Insulated Female Slip-Ons

- These female terminals crimp to the wires which relieves the need to solder.



| Part # | Mfg #  | Description               | Price |
|--------|--------|---------------------------|-------|
| 212224 | 6281   | 22 pack wire range 16-14  |       |
| 212227 | 6282   | 22 pack wire range 22-18  |       |
| 212228 | 6235LX | 50 pack wire range 22-18  |       |
| 212229 | 6235CX | 100 pack wire range 22-18 |       |
| 212230 | 6235   | 22 pack wire range 22-18  |       |
| 212231 | 6218   | 22 pack wire range 16-14  |       |
| 212232 | 6218LX | 50 pack wire range 16-14  |       |
| 212233 | 6218CX | 100 pack wire range 16-14 |       |
| 212234 | 6251   | 17 pack wire range 12-10  |       |
| 212235 | 6251LX | 50 pack wire range 12-10  |       |

### Fully Insulated Female Slip-Ons

- Crimp to the wires which relieves the need to solder
- This terminal features insulation grip
- This terminal is usually supplied vinyl and has an insulation grip



| Part # | Mfg # | Description              | Price |
|--------|-------|--------------------------|-------|
| 212236 | 6233  | 14 pack wire range 16-14 |       |

### Insulated Rings

- These insulated terminals crimp to the wires which relieves the need to solder



| Part # | Mfg #  | Description              | Price |
|--------|--------|--------------------------|-------|
| 212238 | 6216LX | 50 pack wire range 16-14 |       |
| 212240 | 6252   | 17 pack wire range 12-10 |       |

### Insulated Spades

- These insulated terminals crimp to the wires which relieves the need to solder



| Part # | Mfg #   | Description              | Price |
|--------|---------|--------------------------|-------|
| 215569 | 6237LX  | 50 pack wire range 22-18 |       |
| 215570 | 6227LX  | 50 pack wire range 16-14 |       |
| 215571 | 60254LX | 50 pack wire range 12-10 |       |

### Standard Wire Connectors

- Connectors are color coded with spring inserts
- Heat resistant (105°C) thermoplastic
- Connectors are for copper to copper connections
- Parts 6294 and 6296 can connect aluminum to aluminum and copper to aluminum (dry locations only)



| Part # | Mfg # | Description | Price |
|--------|-------|-------------|-------|
| 159370 | 6291  | 29 pack     |       |
| 159371 | 6292  | 25 pack     |       |
| 159372 | 6293  | 20 pack     |       |

### Tab Adapters - Single Female Double Male Tabs

- These insulated terminals crimp to the wires which relieves the need to solder



| Part # | Mfg #  | Description | Price |
|--------|--------|-------------|-------|
| 212243 | 6211   | 27 Pack     |       |
| 212244 | 6211CX | 100 Pack    |       |

### Tab Adapters - Piggy Back Slip-Ons

- These insulated terminals crimp to the wires which relieves the need to solder



| Part # | Mfg #   | Description    | Price |
|--------|---------|----------------|-------|
| 212242 | 60210LX | 50 pack 16-14W |       |

### Contactors

#### Definite Purpose Contactors

- 50 Amp
- 14 Nom VA
- 120 VAC coil
- Current MA 117
- 45.5 res DC ohms
- 135 Max inrush VA
- Quick connect terminals



| Part # | Mfg #    | Poles | Amps | VAC | Price |
|--------|----------|-------|------|-----|-------|
| 239656 | EC503120 | 3     | 50   | 120 |       |
| 198830 | EC40224  | 2     | 40   | 24  |       |
| 209961 | EC30224  | 2     | 30   | 24  |       |

## Spade & Other Electrical Connectors

### Hard Start Kits

#### Torque Plus Hard Start Kit

- 120-288 Volts
- For 1/2-10 h.p. compressors



| Part # | Mfg # | Description            | Price |
|--------|-------|------------------------|-------|
| 198713 | DST-5 | 300% Torque Multiplier |       |
| 198712 | DST-6 | 500% Torque Multiplier |       |

#### Hard Start Kit



| Part # | Mfg # | Description        | Price |
|--------|-------|--------------------|-------|
| 208758 | HSK1  | 3.5-5HP Compressor |       |
| 208759 | HSK5  | 1-3HP Compressor   |       |

### General Accessories

#### EMT Thinwall Fittings

- 1/2" Set screw coupling
- Used to join EMT conduit to boxes on enclosures



| Part # | Mfg #   | Size | Price |
|--------|---------|------|-------|
| 239659 | 625-810 | 1/2" |       |

#### Stranded Copper Wire on Spool

- 100' per spool
- 600V & 90°C
- THHN wire
- 19 Strand copper



| Part # | Mfg #    | Color | Gauge | Price |
|--------|----------|-------|-------|-------|
| 239673 | W121-100 | Black | 12    |       |
| 239674 | W141-100 | Black | 14    |       |

### Hanging Wire

- The 18 gauge galvanized can be used to hang HVAC duct work



| Part # | Mfg #    | Description   | Price |
|--------|----------|---------------|-------|
| 192060 | 710-185G | 18 Gauge 830' |       |

### MAC Line Piercing Valve

- Features uniport: 1 connection for piercing and servicing
- Sealed with refrigerant resistant "O" rings



| Part # | Mfg # | Description       | Price |
|--------|-------|-------------------|-------|
| 192412 | QTM-1 | 1/4", 5/16", 3/8" |       |

### Switch/Plug Combo

- These switches are available in single pole- double pole.
- They are UL listed and furnished with screw terminals. The ratings are A:20A- 125VAC, 20-250 VAC, 1 HP at 120-240 V and B 15A- 125/250 VAC, 3/4 HP at 240 V

| Part # | Mfg #    | Description                | Price |
|--------|----------|----------------------------|-------|
| 207369 | 620-274W | 1P 3W grounding, 15A, 120V |       |

### Compressor Repair Kit

- Fits both non-burned and burned terminals
- Connects to the compressor via precision brass cylinders that fit over the terminals and connect with stainless steel set screws.
- Wires are permanently attached.
- Standard factory 600V, 65 strand machine wire.
- Easy to install and guaranteed for the life of the compressor.



| Part # | Mfg #    | Description          | Price |
|--------|----------|----------------------|-------|
| 192081 | TLC-3-10 | 3 Wire, 10 Gauge Kit |       |

Cooling - Accessories

## Spade & Other Electrical Connectors

### Transparent Plastic Boxes with Terminal Assortment

- Boxes are made of soft, pliable, durable K resin with 18 compartments containing the most popular terminals, including hi-temp and compressor terminals



| Part # | Mfg # | Description                  | Price |
|--------|-------|------------------------------|-------|
| 210238 | PA10  | 180 Terminals (10 Each Kind) |       |

### Adjustable Delay on Make Timer

- Ideal for random starting of multiple units.
- Adjusts from 6 seconds to 8 minutes.
- Spin proof knob.
- Works with 24, 120 or 240 VAC control circuits.
- Supports up to 1.5 Amps.
- Two wire hookup for easy installation.
- Solid state with quick-disconnect terminals.
- Mounts with one self-tapping screw.
- Conformal coated circuitry protects against moisture and shock.



| Part # | Mfg # | Description              | Price |
|--------|-------|--------------------------|-------|
| 192404 | ADM-1 | Adjustable Delay on Make |       |

### Adjustable Delay on Break Timer

- Adjusts from 6 seconds to 8 minutes.
- Spin-proof knob.
- Works with 24, 120 or 240 VAC control circuits.
- Supports up to 1.5 Amps.
- Two wire hookup for easy installation.
- Solid state with quick disconnect terminals.
- Mounts with one self-tapping screw.
- Conformal coated circuitry protects against moisture and shock.



| Part # | Mfg # | Description               | Price |
|--------|-------|---------------------------|-------|
| 192405 | ADB-1 | Adjustable Delay on Break |       |

### Electrical Staples

- We have steel, insulated copper finish, and plastic electrical staples available



| Part # | Mfg # | Description         | Price |
|--------|-------|---------------------|-------|
| 211036 | PI332 | 50 pack 3/8" x 3/4" |       |

### Rayovac Industrial Maximum Alkaline Batteries

- The Shrink Packed Battery has the same battery performance at the Contractor Pack, just at a lower cost.
- This battery is formulated specifically to exceed the everyday demands of the industrial applications and has outstanding dependability for those must work applications.



| Part # | Mfg #      | Description            | Price |
|--------|------------|------------------------|-------|
| 206551 | 7-ALAA-24  | AA Battery, pack of 8  |       |
| 206553 | 7-ALAAA-18 | AAA Battery, pack of 8 |       |
| 206554 | 7-ALC-12   | C Battery, pack of 6   |       |
| 206555 | 7-ALD-12   | D Battery, pack of 6   |       |

### 6180 Series Terminal Blocks

- These terminal blocks are constructed of high barrier thermoplastic are rated 20A-250V
- Terminal block, no. of positions 6, length (in) 2.91, width (in) .88, screw size 6-32, max. wire size 22-14



| Part # | Mfg # | Description       | Price |
|--------|-------|-------------------|-------|
| 249408 | 6183  | Block 6 Position  |       |
| 249409 | 6184  | Block 8 Position  |       |
| 249410 | 6185  | Block 10 Position |       |



## Electrical

### Electrical Parts & Accessories

#### RXAD - Low Ambient Control Kit

| Part # | Mfg #    | Description   | Price |
|--------|----------|---|-------|
| 124470 | RXAD-A08 | Installed in Units to be Operated for Cooling at Outdoor Ambient Temperatures Under 70° F |       |

#### Low Ambient Control

| Part # | Mfg #        | Description     | Price |
|--------|--------------|-----------------|-------|
| 108140 | 47-ICM325HNC | Low Ambient Fan |       |

#### Crankcase Heater

| Part # | Mfg #       | Description      | Price |
|--------|-------------|------------------|-------|
| 043854 | 44-17402-17 | Crankcase Heater |       |
| 033123 | 44-17402-47 | Crankcase Heater |       |

#### Hard Start Kit

| Part # | Mfg #     | Description    | Price |
|--------|-----------|----------------|-------|
| 141497 | 42-ICM860 | Hard Start Kit |       |

#### Kick Start

- For single phase 208V, 230V, 265V A/C refrigeration and heat pump compressors
- 2-Wire pre-assembled starting component utilizes a mechanical potential relay and a start capacitor

| Part # | Mfg #  | Description                              | Price |
|--------|--------|--|-------|
| 104511 | 42-KS1 | 3-1/2 - 5 Ton Condenser Motor Kick Start |       |
| 104510 | 42-TO5 | 1 - 3 Ton Condenser Kick Start           |       |

## Electrical

### Solenoid Valves

#### General Purpose (GP) Type I Two-Way Solenoid Valve

- Minimum operating pressure differential: 1 psi
- Maximum temperature: 225°F
- Normally closed only
- For general application on non-corrosive fluids such as air, water below 180°F, light oils below 300 SSU and low vacuum



| Part # | Mfg # | Description         | Price |
|--------|-------|---------------------|-------|
| 005716 | 70562 | 1/2" Port, 1/2" FPT |       |
| 005717 | 70712 | 3/4" Port, 3/4" FPT |       |

#### Solenoid Coils for GP Valve

| Part # | Mfg # | Description           | Price |
|--------|-------|-----------------------|-------|
| 005722 | 77300 | 9W, 24V, 50/60Hz      |       |
| 005720 | 77310 | 9W, 120V, 56/60Hz     |       |
| 005719 | 77360 | 9W, 120/240V, 50/60Hz |       |

#### Solenoid Valve Repair Kit

| Part # | Mfg # | Description                        | Price |
|--------|-------|------------------------------------|-------|
| 005723 | 76731 | Valve Repair Kit for GP600 (70712) |       |

**Crankcase Heaters**

**Crankcase Heaters**

**Belly Band Type - Scroll Compressor**

- Easy to install; adjustable by screw
- Uses high temperature silicone rubber element
- For optimum heat transfer, mount in lowest position on compressor housing



| Part # | Mfg #        | Volts | Watts | Lead Wire Size (AWG) | Lead Wire Length | Ground Wire Length | Price |
|--------|--------------|-------|-------|----------------------|------------------|--------------------|-------|
| 137561 | 44-101884-05 | 230V  | 40W   | 18                   | 48"              | 48"                |       |
| 091893 | 44-17402-44  | 230V  | 40W   | 18                   | 48"              | 22"                |       |
| 009323 | 44-17402-45  | 230V  | 40W   | 18                   | 48"              | 48"                |       |

**Filter Driers**

**Liquid Line Filter-Driers**

**Liquid Line Filter-Drier (Uni-Directional)**

- Solid core, activated alumina with molecular sieve
- Corrosion resistant epoxy powder paint finish
- Suitable for R-22 and R-410A
- 680 psig Maximum working pressure
- Solid copper fittings



| Part # | Mfg #       | Connection     | OAL     | Body Length | Body Diameter | Price |
|--------|-------------|----------------|---------|-------------|---------------|-------|
| 188932 | 83-25151-40 | 3/8" Sweat ODF | 4-1/2"  | 3"          | 2-5/8"        |       |
| 179891 | 83-25151-41 | 3/8" Sweat ODF | 5-5/16" | 3-7/8"      | 2-5/8"        |       |
| 180298 | 83-25151-42 | 3/8" Sweat ODF | 6-1/8"  | 4-5/8"      | 2-5/8"        |       |

**Liquid Line Filter-Drier (Bi-Directional)**

- Solid core, activated alumina with molecular sieve
- Internal check valve for heat pump applications
- Removes all types of foreign particulate material
- Corrosion resistant epoxy powder paint finish
- For R-22 and R-410A, 680 psig maximum working pressure
- Solid copper fittings



| Part # | Mfg #       | Connection     | OAL    | Body Length | Body Diameter | Price |
|--------|-------------|----------------|--------|-------------|---------------|-------|
| 180774 | 83-25152-10 | 3/8" Sweat ODF | 6-1/8" | 4-5/8"      | 3-1/8"        |       |
| 096137 | 83-EK-163S  | 3/8" Sweat ODF | 6-1/4" | 4-3/4"      | 2-5/8"        |       |

**ADK Core Style Liquid Line Filter-Drier (Uni-Directional)**

- Corrosion resistant epoxy powder paint finish
- High moisture and acid removal capacity
- Solid copper ODF fittings
- Copeland approved for POE oils
- 40 Micron filtration
- UL/cUL File SA3124



| Part # | Mfg #      | Connection     | OAL      | Body Length | Body Diameter | Price |
|--------|------------|----------------|----------|-------------|---------------|-------|
| 149928 | 83-ADK-052 | 1/4" Flare SAE | 4-13/16" | 3"          | 2-5/8"        |       |
| 149929 | 83-ADK-053 | 3/8" Flare SAE | 5-1/8"   | 3"          | 2-5/8"        |       |
| 133408 | 83-ADK-083 | 3/8" Flare SAE | 5-15/16" | 3-3/16"     | 2-5/8"        |       |
| 149930 | 83-ADK-084 | 1/2" Flare SAE | 6-3/16"  | 3-3/16"     | 2-5/8"        |       |
| 094060 | 83-ADK-162 | 1/2" Flare SAE | 6-7/16"  | 4-5/8"      | 2-5/8"        |       |
| 149932 | 83-ADK-163 | 3/8" Flare SAE | 6-3/4"   | 4-5/8"      | 2-5/8"        |       |
| 149933 | 83-ADK-164 | 1/2" Flare SAE | 6-15/16" | 4-5/8"      | 2-5/8"        |       |
| 149934 | 83-ADK-165 | 5/8" Flare SAE | 7-7/16"  | 4-5/8"      | 2-5/8"        |       |
| 149935 | 83-ADK-303 | 3/8" Flare SAE | 9-5/8"   | 7-1/2"      | 3-1/16"       |       |
| 149936 | 83-ADK-304 | 1/2" Flare SAE | 9-7/8"   | 7-1/2"      | 3-1/16"       |       |

Cooling - Accessories



**Filter Driers**

**Sporlan Catch-All Liquid Line Filter-Drier (Uni-Directional)**

- Solid core, activated alumina with molecular sieve
- Corrosion resistant epoxy powder paint finish
- Suitable for R-22, R-410A
- 650 psig Maximum working pressure

| Part # | Mfg #       | Connection     | OAL     | Body Length | Body Diameter | Price |
|--------|-------------|----------------|---------|-------------|---------------|-------|
| 097691 | 83-25208-01 | 1/4" Sweat ODF | 4-3/16" | 3-7/16"     | 2-7/16"       |       |
| 080952 | 83-25208-03 | 3/8" Sweat ODF | 5-1/4"  | 4-3/8"      | 2-5/8"        |       |
| 080950 | 83-25208-04 | 3/8" Sweat ODF | 5-7/8"  | 5"          | 3"            |       |
| 080951 | 83-25208-05 | 1/2" Sweat ODF | 6"      | 5"          | 3"            |       |

**Suction Line Filter-Driers**

**Suction Line Filter Drier (Standard Shell)**

- Solid core; solid copper fittings
- Activated alumina/activated carbon/molecular sieve desiccant
- Suitable for R-22 and R-410A, 500 psig maximum working pressure
- For use after a burnout or when major system work has been performed
- (2) Pressure taps; one each at the inlet and outlet ends
- Corrosion resistant epoxy powder paint finish



83-25153-10

| Part # | Mfg #       | Connection     | OAL     | Body Length | Body Diameter | Price |
|--------|-------------|----------------|---------|-------------|---------------|-------|
| 087301 | 83-25153-10 | 3/4" Sweat ODF | 9-5/8"  | 7-7/16"     | 3"            |       |
| 096158 | 83-25153-11 | 7/8" Sweat ODF | 9-7/16" | 7-7/16"     | 3"            |       |

**Sporlan Catch-All Suction Line Filter-Drier (Standard Shell)**

- Solid core, solid copper fittings
- Premium product with activated alumina/activated carbon/molecular sieve desiccant
- Suitable for R-22, R-410A
- 650 psig Maximum working pressure
- For use after burnout or when major system work has been performed
- One pressure tap at the inlet end
- Corrosion resistant epoxy powder paint finish



| Part # | Mfg #       | Connection       | OAL     | Body Length | Body Diameter | Price |
|--------|-------------|------------------|---------|-------------|---------------|-------|
| 092126 | 83-25209-03 | 7/8" Sweat ODF   | 6-5/16" | 4-9/16"     | 3"            |       |
| 087302 | 83-25209-05 | 7/8" Sweat ODF   | 9-3/4"  | 8"          | 3"            |       |
| 092125 | 83-25209-06 | 1-1/8" Sweat ODF | 9-3/4"  | 8"          | 3"            |       |

Cooling - Accessories

**Filter Driers**

**CSFD Suction Line Filter-Drier (Compact Shell)**

- Solid core; solid copper fittings
- Activated alumina with molecular sieve desiccant
- Suitable for R-22 and R-410A
- Maximum working pressure: 400 psig
- Compact design for short lay-in applications
- Two pressure taps; one each at the inlet and outlet ends
- Corrosion resistant epoxy powder paint finish



| Part # | Mfg #          | Connection     | OAL     | Body Length | Body Diameter | Price |
|--------|----------------|----------------|---------|-------------|---------------|-------|
| 149938 | 83-CSFD-14S4VV | 1/2" Sweat ODF | 4-1/4"  | 2-3/4"      | 4-5/8"        |       |
| 149939 | 83-CSFD-14S5VV | 5/8" Sweat ODF | 4-1/2"  | 2-3/4"      | 4-5/8"        |       |
| 140741 | 83-CSFD-14S6VV | 3/4" Sweat ODF | 4-3/8"  | 2-3/4"      | 4-5/8"        |       |
| 140742 | 83-CSFD-14S7VV | 7/8" Sweat ODF | 4-9/16" | 2-3/4"      | 4-5/8"        |       |

## Filter Driers

### Filter-Driers

#### Liquid Line Filter-Drier

- One valve can be employed for all refrigerants
- Maintains constant evap pressure
- Provides freeze-up protection on A/C
- Compatible with all existing and new refrigerants
- High moisture capacity dessicant



| Part # | Mfg #   | Size | Connection | Price |
|--------|---------|------|------------|-------|
| 008290 | SS-083S | 3/8" | Sweat      |       |

#### Suction Line Filter-Drier

- 500 Hours salt spray protection
- High capacity acid retention desiccants
- Solid copper sweat fittings



| Part # | Mfg #    | Size | Connection | Price |
|--------|----------|------|------------|-------|
| 008255 | SLD135SV | 5/8" | Sweat      |       |
| 008257 | SLD277SV | 7/8" | Sweat      |       |



---

---

## Filter Driers

---

---

### Condenser Accessories

#### Filter Drier

| Part # | Mfg #     | Description                | Price |
|--------|-----------|----------------------------|-------|
| 092127 | 832520902 | Filter-Drier 3/4" C166sthh |       |

**Filter Driers**

**Liquid Line Filter-Driers**

**Liquid Line Filter-Drier**

- Solid copper fittings
- Maximum filtration capacity
- High moisture and acid capacity
- Corrosion resistant powder paint
- Spring loaded, XH-9 molecular sieve desiccant
- Exceptional compatibility with new polyester oils
- Compatible with all existing and new refrigerants and blends including:  
—134a, 401A/B, 402A/B, 404A, 407A/B/C, 410A, 502, 507A



| Part # | Mfg #   | Size | Connection | Cubic Inch | Price |
|--------|---------|------|------------|------------|-------|
| 239677 | DAD164S | 1/2" | Sweat      | 16         |       |
| 239678 | DAD304S | 1/2" | Sweat      | 30         |       |

**Filter Driers**

**Filter Driers**

**ALF Liquid Line Filters**

- The ALF is a liquid line refrigerant filter for recovery, recycle and reclaim usage
- The ALF is also used for protecting solenoid and expansion valve parts from debris
- Filtering media that maximizes removal of finer particles
- Corrosion resistant epoxy powder paint finish



| Part # | Mfg #       | Description | Price |
|--------|-------------|-------------|-------|
| 239676 | EMRALF032MF | 1/4" SAE    |       |

**9Builder Series Filter Drier**

- The Builder Series filter drier provides an economical system protection for air conditioning applications
- ODF - Solid copper connections for easy installation
- Solid core construction
- 40 micron filtration
- Maximum working pressure = 680 psig



| Part # | Mfg #      | Description           | Price |
|--------|------------|-----------------------|-------|
| 218561 | EMRBSS166S | Suction 3/4" ODF 16CU |       |
| 218562 | EMRBSS167S | Suction 7/8" ODF 16CU |       |
| 218564 | EMRBSS306S | Suction 3/4" ODF 30CU |       |
| 218565 | EMRBSS307S | Suction 7/8" ODF 30CU |       |

---



---

**Leak Detection**

---



---

**Leak Detectors**

**Leak-Tech Gold™**

- For use on gas lines, gas cylinders, refrigeration condensers, air lines, air pumps or any other system carrying gas
- Can be used on all types of piping
- Non-toxic and non-corrosive
- Temperature range: 28° to 180°F
- Not for use on oxygen systems

| Part # | Mfg # | Description       | Price |
|--------|-------|-------------------|-------|
| 034246 | LT08  | 8 oz with Dauber  |       |
| 034245 | LS16  | 1 pt Spray Bottle |       |

**Leak Detection**

**Leak Detectors**

**Sure-Chek<sup>®</sup> All-Temperature Leak Detector**

- Ultra-sensitive, long-lasting bubbles
- Fluorescent for improved visibility
- Safe for oxygen
- Non-corrosive, non-toxic



| Part # | Mfg # | Size | Price |
|--------|-------|------|-------|
| 033194 | 32850 | 1 pt |       |

**VISU-GLOW<sup>®</sup> High Visibility Leak Detector**

- Fluorescent color shows brightly even in dimly lit places
- For use on CSST systems
- High viscosity stays on vertical surfaces
- Makes it easy to find leaks
- Non-corrosive, non-toxic
- Safe for oxygen
- Temperature range: 15° to 200°F



| Part # | Mfg # | Size | Price |
|--------|-------|------|-------|
| 005975 | 32898 | 8 oz |       |





## Leak Detection

### Leak Detectors

#### Megabubble® Leak Detector

- Detects gas leaks in pipe lines, tanks, coils, cylinders, valves, etc
- Used to detect leaks of air, natural gas, refrigerants, CO2 and almost all known gases
- Non-toxic and contains only high quality, non-staining ingredients



| Part # | Mfg # | Size               | Price |
|--------|-------|--------------------|-------|
| 132929 | 45801 | 8 oz Dauber Bottle |       |

**Leak Detection**

**All-Purpose Leak Detectors**

- *Detects leaks quickly on all types of tubing valves, cylinders, pressure tanks or other systems under air, gas or oxygen pressure*
- *Temperature range: -55 to +160°F*
- *Slow evaporation rate provides longer inspection time*



| Part # | Mfg # | Size             | Price |
|--------|-------|------------------|-------|
| 018413 | 30209 | 8 oz with Dauber |       |
| 031651 | 30212 | 1 gal            |       |

## Leak Detection

### Leak Detectors

#### Big Blu Micro Leak Detector Solution

- *The only bubble detector capable of identifying gas leakage approaching the sensitivity of electronic sniffers*
- *Non-toxic*
- *Biodegradable*
- *Oxygen safe*



| Part # | Mfg #  | Description | Price |
|--------|--------|-------------|-------|
| 134238 | RT100S | 1 qt Spray  |       |

#### Super Blu Micro Leak Detector Solution

- *50% Glycol solution at the same level of Big Blu detector*



| Part # | Mfg #  | Description | Price |
|--------|--------|-------------|-------|
| 135048 | RT150S | 1 qt Spray  |       |

**Leak Detection**

**Leak Detection Flashlights**

**OPTIMAX Jr™ LED Leak Detection Flashlight**

- Cordless
- Blue light LED for leak detection
- Perfect for tight spaces
- Power comparable to high intensity 75W lamps
- Inspection range up to 6' or more
- 100,000/Hour LED life
- Powered by (3) "AA" batteries (included)
- Includes fluorescence-enhancing glasses (UVS-40)



| Part # | Mfg #     | Description            | Price |
|--------|-----------|------------------------|-------|
| 138625 | OPX-500CS | OPTIMAX Jr™ Flashlight |       |

**Dual-Max™ Multi-Function LED Flashlight**

- Cordless
- Dual-head flashlight features super bright blue light LED for leak detection plus white light LED for general component inspection
- Power comparable to high intensity 75W lamps
- Inspection range up to 6' or more
- Compact design allows easy access into tight spaces
- 100,000/Hour LED life
- Powered by (3) "AAA" batteries (included)
- Includes holster and fluorescence-enhancing glasses (UVS-40)



| Part # | Mfg #     | Description          | Price |
|--------|-----------|----------------------|-------|
| 138626 | OPD-500CS | Dual-Max™ Flashlight |       |

**Leak Detection Kits**

**GLO-STICK® Kit with OPTIMAX Jr™ Flashlight**

- For small to medium size AC&R systems, including high pressure R-410A systems
- Includes:
  - OPTIMAX Jr™ flashlight (OPX-500CS)
  - (1) Bleed valve for attaching GLO-STICK® capsule to service hose (BV-50)
  - (1) Purge capsule (PC-0249)
  - (1) Hose to connect to low side service port (119567)
  - (1) Universal/POE GLO-STICK® dye capsule (GS-1/E)
  - (2) Universal/POE GLO-STICK® dye capsules (GS-2/E)
  - (1) Universal/POE GLO-STICK® dye capsule (GS-3/E)
  - Fluorescence-enhancing glasses (UVS-40)
  - 8 oz Spray bottle of GLO-AWAY™ dye cleaner (CR-800)
  - Plastic carrying case (CC-110)



| Part # | Mfg #      | Description                             | Price |
|--------|------------|---|-------|
| 138623 | OPK-50GS/E | GLO-STICK® Kit w/OPTIMAX Jr™ Flashlight |       |

**Injection Kits**

**ACID-BUSTER™ Injection Kit**

- Acid scavenging solution, eliminates acid buildup in AC&R systems
- Prevents compressor burnout
- Ideal for small to medium sized systems
- Works with all lubricants and systems, including high pressure R-410A systems
- Includes:
  - EZ-Ject™ injector assembly (EZ-50)
  - Hose assembly complete with check valve and 1/4" flare low-loss fitting (EZ-25)
  - (2) 0.5 oz EZ-Ject™ cartridges filled with ACID-BUSTER™ acid scavenging solution (AB-5CS)



| Part # | Mfg #    | Description                | Price |
|--------|----------|----------------------------|-------|
| 138635 | AB-100CS | ACID-BUSTER™ Injection Kit |       |

Cooling - Accessories

## Leak Detection

### Cartridges

#### EZ-Ject™ Universal Dye Cartridge

- (6) 0.5 oz Dye cartridges for mineral oil, polyolester and alkyl benzene



| Part # | Mfg #    | Description   | Price |
|--------|----------|---|-------|
| 138624 | EZ-4/ECS | Treats up to 25 lbs of Refrigerant or 2 gals of Lubricant |       |

#### Replacement ACID-BUSTER™ Universal Cartridge

- Filled with ACID-BUSTER™ acid scavenging solution



| Part # | Mfg #  | Description                   | Price |
|--------|--------|-------------------------------|-------|
| 138636 | AB-5CS | 0.5 oz Cartridge for EZ-Ject™ |       |

#### GLO-STICK® Universal Dye Capsules

- For small to medium size systems
- Prefilled, disposable capsules allow dye to be injected into pressurized systems using refrigerant
- Will withstand pressures of more than 1000 psi
- For mineral oil, polyester and alkyl benzene lubricant systems



| Part # | Mfg #      | Description  | Price |
|--------|------------|--|-------|
| 138629 | GS-101/ECS | Case of (6) 0.03 oz Capsules, Up to 2.9 lbs of Refrigerant or 15 fl oz of Lubricant        |       |
| 138630 | GS-1/ECS   | Case of (6) 0.5 oz Capsules, Up to 4.9 lbs of Refrigerant or 1.6 qts of Lubricant          |       |
| 138632 | GS-2/ECS   | Case of (6) 0.5 oz Capsules, 5 to 9.9 lbs of Refrigerant or 1.7 to 3.2 qts of Lubricant    |       |
| 138634 | GS-3/ECS   | Case of (6) 0.5 oz Capsules, 10 to 25 lbs of Refrigerant or 3.3 qts to 2 gals of Lubricant |       |

## Leak Detection

### Leak Detectors

#### Micro LED UV Leak Detection Kit and Lamp

- *Waterproof*
- *Long life LEDs*
- *Constant ON switch*
- *AA Alkaline battery included*



| Part # | Mfg # | Description                   | Price |
|--------|-------|-------------------------------|-------|
| 182326 | 69789 | Flashlight & Dye Kit for AC/R |       |

#### Universal A/C Disposable Injectors

- *1 oz. Injector*
- *One dye minimizes inventory*
- *80 psi maximum system port pressure*
- *Not for direct injection into R-410A systems due to high pressure*
- *No back-up refrigerant to move dye into system*



| Part # | Mfg # | Injector Qty | Applications | Price |
|--------|-------|--------------|--------------|-------|
| 182321 | 69700 | 6 Pak        | 12 per case  |       |
| 182324 | 69721 | 2 Pak        | 4 Per Pkg    |       |

## SpeediChannel Line Set Cover Systems

### SpeediChannel System

#### SpeediChannel™ Line Set Covers

- SpeediChannel™ 6-1/2' long and can be cut-to-size
- UV-Resistant, UL listed
- White finish, paintable



| Part # | Mfg #     | Size    | Description              | Price |
|--------|-----------|---------|--------------------------|-------|
| 113862 | 230-B2M   | 18"     | Type 2 Wall Bracket(Md)  |       |
| 113863 | 230-B2L   | 21"     | Type 2 Wall Bracket (Lg) |       |
| 113138 | 230-D3    | 3"      | Channel                  |       |
| 113145 | 230-D4    | 4"      | Channel                  |       |
| 118518 | 230-D6    | 6"      | Channel                  |       |
| 113139 | 230-CP3   | 3"      | Union Coupling           |       |
| 113146 | 230-CP4   | 4"      | Union Coupling           |       |
| 143605 | 230-CP6   | 6"      | Union Coupling           |       |
| 117848 | 230-TC34  | 3" x 4" | Reducer Coupling         |       |
| 163115 | 230-TC46  | 4" x 6" | Reducer Coupling         |       |
| 117851 | 230-DC3   | 3"      | Cap                      |       |
| 117852 | 230-DC4   | 4"      | End Cap                  |       |
| 156044 | 230-DC6   | 6"      | End Cap                  |       |
| 113141 | 230-DE3   | 3"      | End Cap                  |       |
| 113148 | 230-DE4   | 4"      | End Cap                  |       |
| 237073 | 230-De6   | 6"      | End Cap                  |       |
| 117841 | 230-EB3   | 3"      | 90° Inside Elbow         |       |
| 117843 | 230-EIN3  | 3"      | 90° Outside Elbow        |       |
| 113140 | 230-FB3   | 3"      | 90° Flat Elbow           |       |
| 179867 | 230-FB6   | 6"      | 90° Flat Elbow           |       |
| 117845 | 230-FB453 | 3"      | 45° Flat Elbow           |       |
| 117846 | 230-FB454 | 4"      | 45° Flat Elbow           |       |
| 224307 | 230-FB456 | 6"      | 45° Flat Elbow           |       |
| 117842 | 230-EB4   | 4"      | 90° Inside Elbow         |       |
| 178071 | 230-EB6   | 6"      | 90° Inside Elbow         |       |
| 117844 | 230-EIN4  | 4"      | 90° Outside Elbow        |       |
| 113147 | 230-FB4   | 4"      | 90° Flat Elbow           |       |
| 117840 | 230-LFB4  | 4"      | 90° Long Radius Flat El  |       |
| 248906 | 230-LFB6  | 6"      | 90° Long Radius Flat El  |       |
| 117839 | 230-LFB3  | 3"      | 90° Long Radius Flat El  |       |
| 113142 | 230-WC3   | 3"      | Wall Penetration Sleeve  |       |
| 113149 | 230-WC4   | 4"      | Wall Penetration Sleeve  |       |
| 124976 | 230-WC6   | 6"      | Wall Penetration Sleeve  |       |

### SpeediChannel System (Continued)

#### SpeediChannel™ Line Set Covers

| Part # | Mfg #      | Size   | Description             | Price |
|--------|------------|--------|-------------------------|-------|
| 117838 | 230-WS2    | 2-1/2" | Wall Penetrating Sleeve |       |
| 117850 | 230-FJ4    | 4"     | Flex Joint              |       |
| 117849 | 230-FJ3    | 3"     | Flex Joint              |       |
| 117847 | 230-TJ4    | 4"     | T-Joint                 |       |
| 213918 | 230-TJ6    | 6"     | T-Joint                 |       |
| 116968 | 230-MB17W  | 17"    | Mounting Block White    |       |
| 116969 | 230-MBCW   |        | Mounting Block End Cap  |       |
| 117853 | 230-FR3    | 3"     | Wall Escutcheon         |       |
| 154312 | 230-DCLIP  |        | SpeediClip 50/PK        |       |
| 202481 | 230DSCREW  |        | Screw 100/PK            |       |
| 117854 | 230-FR4    | 4"     | Flat Wall Escutcheon    |       |
| 117855 | 230-WR3    | 3"     | Wall Escutcheon         |       |
| 117856 | 230-WR4    | 4"     | Wall Escutcheon         |       |
| 179922 | 230-INJ462 | 10"    | Roof Inlet              |       |
| 168414 | 230-SF4    | 4"     | Soffit Fitting          |       |

### Mini-Split Drain Line

- Cut marks every 3.28'



| Part # | Mfg #    | Size           | Price |
|--------|----------|----------------|-------|
| 140145 | 230-DL16 | 5/8" ID x 160' |       |

### Mini-Split Installation Wire and Cabling

- For power supply and control circuits



| Part # | Mfg #    | Description | Price |
|--------|----------|-------------|-------|
| 163873 | 230-14-4 | 50" Roll    |       |



## SpeediChannel Line Set System

### Wall Brackets

#### WBB300 Wall Condenser Bracket

- 300lb capacity
- Heavy duty steel w/ powdercoat finish
- Features a sliding cross bar for exceptional equipment width range
- Level for added convenience



| Part # | Mfg #   | Size                | Price |
|--------|---------|---------------------|-------|
| 185380 | RL87733 | 22" x 33-1/2" x 18" |       |



---



---

**Refrigerant Parts & Accessories**

---



---

**ThermO-Snap Clamps™**

**Universal Mounting Bracket**

- *Pre-mounted brackets provide an easy one-man installation job*
- *Multi-use applications including copper, PVC and ABS pipe*
- *Maintenance free - use indoors or out*
- *Eliminates vibrations and noise call backs*
- *Easy to re-open for an additional or custom adjustment*
- *UV Protected*



| Part # | Mfg # | Description                   | Price |
|--------|-------|-------------------------------|-------|
| 034839 | 41118 | Residential 1-1/2" OD         |       |
| 094315 | 41125 | Commercial Plastic Line 2" OD |       |

## Mounting Systems

### Mounting Brackets and Blocks

#### Quick-Swivel Flush Mount with H Bracket

- The flush mount hanger is slotted to receive a 3/8 lag bolt 16" or 24" on center. It can be attached parallel or perpendicular to the joist
- Our Quick Swivel is made with 14-gauge steel able to hold 200 lbs
- The swivel allows for 360 degree rotation for setting the perfect direction of air flow
- The square steel tubing cuts down on vibration while 3 hitch-pins add to the safety and sturdiness of the Quick Swivel with "H" bracket
- All necessary hardware for installation provided



| Part # | Mfg #      | Description   | Price |
|--------|------------|---|-------|
| 175021 | QSQSWI1000 | "U" Mount 200lbs, H Bracket with Non-Swinging Rotating Platform   |       |
| 175024 | QSQSWI5000 | 400lbs, HD Bracket with Non-Swinging Rotating Platform            |       |
| 175023 | QSWI3000   | Flush Mount 200lbs, H Bracket with Non-Swinging Rotating Platform |       |

#### Mini Split Stand

- 12" High
- The Mini-Split Stands provide a safe, stable platform for mounting a wide variety of HVAC/R equipment
- Keeps unit elevated above lawn mowers, weed trimmers, pets, snow and flooding



| Part # | Mfg #      | Description                              | Price |
|--------|------------|--|-------|
| 175026 | QSMS1201   | Holds up to 400lbs, 12" High - Wide      |       |
| 175025 | QSMS1200   | Holds up to 400lbs, 12" High - Thin      |       |
| 175053 | QSQSMS1202 | Holds up to 400 lbs, 12" High - Dual Fan |       |
| 186115 | QSQSMS1801 | Holds up to 400 lbs, 18" High - Wide     |       |

#### Quick-Sling® Mini Split Super Stand

- Galvanized mounting hardware included
- Include single and double sided U bars to accommodate any multi-unit combination



| Part # | Mfg #      | Description                                      | Price |
|--------|------------|--|-------|
| 238376 | QSSS1003   | VRV IV-18" W/ 36" Crossrails                     |       |
| 188343 | QSQSSS1003 | VRV IV-12" W/ 36" Crossrails                     |       |
| 188353 | QSQSSS1006 | VRV IV-12" W/ 2-pair 36" Crossrails              |       |
| 188354 | QSQSSS1022 | VRV IV-12" W/ 1-pair 36" & 1-pair 48" Crossrails |       |
| 188355 | QSQSSS1008 | VRV IV-12" W/ 2-pair 48" Crossrails              |       |

## Mounting Systems

### Wall Bracket

- *Wall Bracket provides a quick safe, and stable way to mount your unit.*
- *They allow for easy access during installation, service, and maintenance.*
- *Our roof bracket accessory is designed to protect your equipment from snow and freezing rain while maintaining proper air flow around the unit.*



| Part # | Mfg #      | Description            | Price |
|--------|------------|------------------------|-------|
| 224115 | QSQSWB3000 | Holds up to 300 lbs    |       |
| 227295 | QSQSWB2000 | Holds up to to 350 lbs |       |

### Furnace Mounting Blocks

- *Each furnace mounting block can support 40% more weight than competitive products – over 500 pounds!*
- *Easy peel and stick installation.*



| Part # | Mfg # | Description                 | Price |
|--------|-------|-----------------------------|-------|
| 152470 | FB-1  | FB1 Furnace Mounting Blocks |       |

## Novent Locking Caps

### Refrigerant Parts & Accessories

#### Refrigerant Caps and Accessories



R22 Cap



R410 Cap



Multikey



| Part # | Mfg #        | Description                             | Price |
|--------|--------------|---|-------|
| 139299 | NG-R22-2PK   | Tamper-Resistant Green Caps R22 2/Pack  |       |
| 139303 | NG-R22-SDT   | Screwdriver/Key R22 Green/Silver        |       |
| 139300 | NG-R410-10PK | Tamper-Resistant Pink Caps R410 10 Pack |       |
| 139304 | NG-R410-SDT  | Screwdriver/Key R410 Pink               |       |
| 139302 | NV-MULTI-KEY | Locking Refrigerant Cap Key             |       |

**Refrigeration Ball Valves with Press Port**

**Refrigerant Ball Valves  
ABV Refrigeration Ball Valve**

- Forged brass body, hermetic design with access valve



| Part # | Mfg #   | Connection Size | OAL      | Description                         | Price |
|--------|---------|-----------------|----------|-------------------------------------|-------|
| 181357 | BVS-038 | 3/8" ODF        | 5-1/2"   | 1/2" SAE Port with Schrader Core    |       |
| 132261 | BVS-058 | 5/8" ODF        | 5"       | Full Press Port Bi-Directional Flow |       |
| 181358 | BVS-012 | 1/2" ODF        | 6-3/8"   | 1/2" SAE Port with Schrader Core    |       |
| 181130 | BVS-078 | 7/8" ODF        | 7-1/2"   | 3/4" SAE Port with Schrader Core    |       |
| 181359 | BVS-138 | 1-3/8" ODF      | 10"      | 1-1/4" SAE Port with Schrader Core  |       |
| 157803 | BVS-118 | 1-1/8" ODF      | 6-11/16" | Bi-Directional Flow                 |       |

Cooling - Accessories

**Secondary Drain Pans**

**Condensate Drain Pans**

**A/C Secondary Condensate Drain Pan**

- Rolled edges for durability
- Ribbed bottoms for rigidity
- Includes 3/4" PVC fittings



| Part # | Mfg #   | Bottom Dimensions | Drain Line Outlets | Price |
|--------|---------|-------------------|--------------------|-------|
| 040019 | 6-3060L | 30" x 60" x 2"    | Long               |       |
| 192095 | DP3263L | 32" x 63" x 2"    | Long               |       |
| 197538 | 6-2424L | 24" x 24" x 2"    | Long               |       |
| 135390 | 6-3030L | 30" x 30" x 2"    | Long               |       |

**High Rise Pans™**

- Black ABS plastic with 5" rise
- Installation kit includes:
  - (1) CC-1 condensate cap
  - (6) MP-2E 2"x2" EVA™ pads
  - (1) 1-3/4" PVC male adapter



| Part # | Mfg #     | Description | Price |
|--------|-----------|-------------|-------|
| 198580 | 6-HK3060  | 30" x 60"   |       |
| 168273 | 6-HK2748  | 27" x 48"   |       |
| 176050 | 6-HK30501 | 30" x 50"   |       |

**Condensate Drain Pan Fittings**

**A/C Condensate Drain Pan Fittings**

- The Drain Pan Fittings are designed to be used with Condensate Drain Pans.



| Part # | Mfg # | Description | Price |
|--------|-------|-------------|-------|
| 197627 | 6-1   | 3/4"        |       |

Cooling - Accessories

**Site Glasses**

**Sight Glasses**  
**Ruud™ Sight Glass**



| Part # | Mfg #       | Connection     | OAL    | Price |
|--------|-------------|----------------|--------|-------|
| 140739 | 83-25156-02 | 3/8" Sweat ODF | 4-5/8" |       |
| 140740 | 83-25156-04 | 1/2" Sweat ODF | 4-7/8" |       |

**See-All Sight Glass - Sporlan**

- Painted steel body with copper fittings
- Includes protective cap for glass viewing window
- Suitable for R-22 and R-410A, 650 psig maximum working pressure



| Part # | Mfg #       | Connection     | OAL    | Price |
|--------|-------------|----------------|--------|-------|
| 022555 | 83-25211-02 | 3/8" Sweat ODF | 4-5/8" |       |
| 022563 | 83-25211-04 | 1/2" Sweat ODF | 4-7/8" |       |



---

---

## Site Glasses

---

---

### Ruud Sight Glasses RXAG - Sight Glass Kit

| Part # | Mfg #     | Description   | Price |
|--------|-----------|---|-------|
| 094285 | RXAG-A048 | For 125,150,151 Comm Condensing Units & 75,100 Heat Pumps |       |





---



---

## Tap Valves & Piercing Valves

---



---

### Valves Piercing Valve

| Part # | Mfg #   | Description               | Price |
|--------|---------|---------------------------|-------|
| 085911 | 611002  | QTM2 Line Piercing Valve  |       |
| 133637 | 4051-99 | A/C Piercing Valve & Hose |       |

### Valve

| Part # | Mfg #         | Description    | Price |
|--------|---------------|----------------|-------|
| 104504 | 83-CD4338-1PK | Line Tap Valve |       |

## Aluminum Faced Board Panning & Grille Frames

### ThermO-Pan®

#### ThermO-Pan™ with Connectors

- ThermO-Pan® is a high quality, lightweight alternative to sheet metal in constructing return air ducts between joists
- Consists of corrugated insulation faced with aluminum
- Available in light weight sheets in many sizes
- Significantly reduces duct noises and labor
- Requires no shop fabrication
- Molded polypropylene ThermO connectors which easily connect ThermO-Pan® panels
- Kit includes panning, connectors, and (4) headers

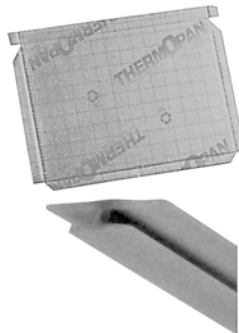

| Part # | Mfg # | Size              | Price |
|--------|-------|-------------------|-------|
| 034604 | 16049 | 16" x 47-1/2" Kit |       |
| 034602 | 19049 | 19-1/2" x 47-1/2" |       |
| 034603 | 24049 | 24" x 47-1/2"     |       |
| 034605 | 32037 | 32" x 35-1/2"     |       |

### ThermO-Headers™

- For tight sealing air block
- ThermO-Headers™ are pre-cut and scored to fit easily between joists
- Specially-sized headers are cut and scored to fit I-joist construction

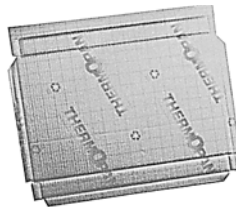

#### ThermO-Header

| Part # | Mfg #  | Size      | Description    | Price |
|--------|--------|-----------|----------------|-------|
| 212281 | 16017R | 16" x 17" | I-Joist Header |       |
| 212282 | 16016R | 16" x 16" | I-Joist Header |       |

#### Fire Rated

| Part # | Mfg # | Size      | Description    | Price |
|--------|-------|-----------|----------------|-------|
| 121097 | 16018 | 16" x 18" | I-Joist Header |       |
| 129601 | 16020 | 16" x 20" | I-Joist Header |       |

### ThermO-Frames™

#### Standard Return Air Grille Dry Wall Frame

- Precision molded polypropylene
- Safety edged
- Frames can be cut for use as a single frame
- Place grille over frame and screw into precision molded frame holes on finished dry wall
- Allows unfiltered air flow



| Part # | Mfg # | Size                      | Price |
|--------|-------|---------------------------|-------|
| 026507 | 14630 | 30" x 6", or 2 @ 14" x 6" |       |
| 168881 | 14632 | 30" x 6" (Bag of 10)      |       |

**Canvas Duct Connectors**

**Flexible Duct Connectors**

**Metal-Fab Connector**

- 3" Metal, 3" fabric, 3" metal
- 24 Gauge galvanized
- Grip Loc seam
- 100' Roll



| Part # | Item # | Item # | Description    | Price |
|--------|--------|--------|----------------|-------|
| 036577 | 10159  | MBX333 | Black Excelon® |       |

**Junior Connector**

- 1-3/4" Metal, 3" fabric, 1-3/4" metal
- 28 Gauge galvanized
- Guard Loc seam
- 100' Roll



| Part # | Item # | Item #  | Description    | Price |
|--------|--------|---------|----------------|-------|
| 005603 | 10169  | JBX-100 | Black Excelon® |       |

## Chimney & Vent

### Type B Round Gas Vent Pipe & Fittings

#### REA45 45 Degree Adjustable Elbow



| Part # | Mfg #  | Size | Price |
|--------|--------|------|-------|
| 184386 | HC1045 | 10"  |       |
| 184234 | HC360  | 3"   |       |

#### REA90 — 90-degree Adjustable Elbow



| Part # | Mfg # | Size | Price |
|--------|-------|------|-------|
| 184245 | HC390 | 3"   |       |
| 184269 | HC490 | 4"   |       |
| 184292 | HC590 | 5"   |       |
| 184323 | HC690 | 6"   |       |
| 184368 | HC890 | 8"   |       |

#### RF Adjustable Roof Flashing (0 - 6/12 pitch)



| Part # | Mfg #     | Size | Price |
|--------|-----------|------|-------|
| 184253 | HC3FLASH  | 3"   |       |
| 184276 | HC4FLASH  | 4"   |       |
| 184299 | HC5FLASH  | 5"   |       |
| 184331 | HC6FLASH  | 6"   |       |
| 184356 | HC7FLASH  | 7"   |       |
| 184376 | HC8FLASH  | 8"   |       |
| 184392 | HC10FLASH | 10"  |       |

### RP Round Pipe (3-12")

- 3" to 12" pipe and fitting couplers overlap 1-3/8" when joined together; therefore, assembled length is 1-3/8" less than listed length.
- The allowable minimum clearance to combustibles is 1"
- Outside Diameter (OD)  
Sizes 3" through 6" is size plus 1/2"  
Sizes 7" through 12" is size plus 1"
- A full set of installation instructions are supplied with caps and supports.



| Part # | Mfg # | Size     | Price |
|--------|-------|----------|-------|
| 184381 | HC103 | 10" x 3' |       |
| 184608 | HC105 | 10" x 5' |       |
| 184395 | HC123 | 12" x 3' |       |
| 184243 | HC312 | 3" x 12" |       |
| 184242 | HC318 | 3" x 18" |       |
| 184241 | HC32  | 3" x 2'  |       |
| 184240 | HC33  | 3" x 3'  |       |
| 184239 | HC34  | 3" x 4'  |       |
| 184238 | HC35  | 3" x 5'  |       |
| 184266 | HC412 | 4" x 12" |       |
| 184265 | HC418 | 4" x 18" |       |
| 184264 | HC42  | 4" x 2'  |       |
| 184263 | HC43  | 4" x 3'  |       |
| 184262 | HC44  | 4" x 4'  |       |
| 184261 | HC45  | 4" x 5'  |       |
| 184289 | HC512 | 5" x 12" |       |
| 184288 | HC518 | 5" x 18" |       |
| 184287 | HC52  | 5" x 2'  |       |
| 184286 | HC53  | 5" x 3'  |       |
| 184285 | HC54  | 5" x 4'  |       |
| 184284 | HC55  | 5" x 5'  |       |
| 184290 | HC56  | 5" x 6"  |       |
| 184315 | HC612 | 6" x 12" |       |
| 184314 | HC618 | 6" x 18" |       |
| 184313 | HC62  | 6" x 2'  |       |
| 184312 | HC63  | 6" x 3'  |       |
| 184311 | HC64  | 6" x 4'  |       |
| 184310 | HC65  | 6" x 5'  |       |
| 184347 | HC718 | 7" x 18" |       |
| 184346 | HC72  | 7" x 2'  |       |
| 184343 | HC75  | 7" x 5'  |       |
| 184366 | HC812 | 8" x 12" |       |
| 184365 | HC818 | 8" x 18" |       |
| 184364 | HC82  | 8" x 2'  |       |
| 184363 | HC83  | 8" x 3'  |       |
| 184362 | HC84  | 8" x 4'  |       |

**Chimney & Vent**

**Type B Round Gas Vent Pipe & Fittings  
(Continued)**

**RP Round Pipe (3-12")**

| Part # | Mfg # | Size    | Price |
|--------|-------|---------|-------|
| 184361 | HC85  | 8" x 5' |       |

**RS Storm Collar**



| Part # | Mfg #  | Size | Price |
|--------|--------|------|-------|
| 184405 | HC12SC | 12"  |       |
| 184255 | HC3SC  | 3"   |       |
| 184278 | HC4SC  | 4"   |       |
| 184301 | HC5SC  | 5"   |       |
| 184333 | HC6SC  | 6"   |       |
| 184358 | HC7SC  | 7"   |       |
| 184378 | HC8SC  | 8"   |       |
| 184394 | HC10SC | 10"  |       |

**RFA Adjustable Roof Flashing (6/12 - 12/12 pitch)**

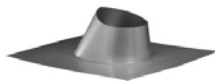

| Part # | Mfg #     | Size | Price |
|--------|-----------|------|-------|
| 184259 | HC36FLASH | 3"   |       |
| 184282 | HC46FLASH | 4"   |       |
| 184309 | HC56FLASH | 5"   |       |
| 184337 | HC66FLASH | 6"   |       |

**RHW Rain Cap (3-8")**

- Prevents rain and debris from entering the vent.
- External screen prevents entry of birds.



| Part # | Mfg #  | Size | Price |
|--------|--------|------|-------|
| 184505 | HC3TOP | 3"   |       |
| 184506 | HC4TOP | 4"   |       |
| 184507 | HC5TOP | 5"   |       |
| 184509 | HC6TOP | 6"   |       |

**RPA/R18A Adjustable Length Pipe**



| Part # | Mfg #  | Size     | Price |
|--------|--------|----------|-------|
| 184244 | HC312A | 3" x 12" |       |
| 184268 | HC412A | 4" x 12" |       |
| 184291 | HC512A | 5" x 12" |       |
| 184316 | HC612A | 6" x 12" |       |
| 184349 | HC718A | 7" x 18" |       |
| 184367 | HC818A | 8" x 18" |       |

**RPC Pipe Collar 3-8"**

- To cover a rough opening.

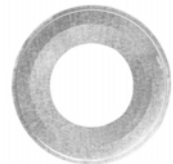

| Part # | Mfg #  | Size | Price |
|--------|--------|------|-------|
| 184257 | HC3COL | 3"   |       |
| 184280 | HC4COL | 4"   |       |
| 184304 | HC5COL | 5"   |       |
| 184335 | HC6COL | 6"   |       |

**RRA Female Adapter**

- Adapts Hart & Cooley vent to other brands of B vent (ours to theirs).



| Part # | Mfg # | Size | Price |
|--------|-------|------|-------|
| 184487 | HC3FA | 3"   |       |
| 184488 | HC4FA | 4"   |       |
| 184489 | HC5FA | 5"   |       |
| 184490 | HC6FA | 6"   |       |

**Chimney & Vent**

**RT Tee**



| Part # | Mfg # | Size | Price |
|--------|-------|------|-------|
| 184246 | HC3T  | 3"   |       |
| 184270 | HC4T  | 4"   |       |
| 184293 | HC5T  | 5"   |       |
| 184324 | HC6T  | 6"   |       |
| 184371 | HC8T  | 8"   |       |

**RTF Tall Cone Roof Flashing**



| Part # | Mfg #   | Size | Price |
|--------|---------|------|-------|
| 184254 | HC3TCFF | 3"   |       |
| 184277 | HC4TCFF | 4"   |       |
| 184332 | HC6TCFF | 6"   |       |
| 184357 | HC7TCFF | 7"   |       |

**RN In increaser**



| Part # | Mfg #   | Size    | Price |
|--------|---------|---------|-------|
| 184272 | HC45INC | 4" x 5" |       |
| 184273 | HC46INC | 4" x 6" |       |
| 184329 | HC68INC | 6" x 8" |       |

**RWT Wall Thimble**

- Provides necessary clearance to combustibles.
- Sleeve is adjustable from 3" to 6"



| Part # | Mfg # | Size | Price |
|--------|-------|------|-------|
| 184279 | HC4WT | 4"   |       |
| 184303 | HC5WT | 5"   |       |

**RAA Male Adapter**

- Adapts thicker wall brands of B vent to Hart&Cooley vent (theirs to ours).



| Part # | Mfg #  | Size | Price |
|--------|--------|------|-------|
| 184283 | HC5RAA | 5"   |       |

**RYF Wye**



| Part # | Mfg #  | Size         | Price |
|--------|--------|--------------|-------|
| 184495 | HC543W | 5" x 4" x 3" |       |
| 184496 | HC544W | 5" x 4" x 4" |       |
| 184494 | HC554W | 5" x 5" x 4" |       |
| 184500 | HC644W | 6" x 4" x 4" |       |

**Type B Vent Oval Gas Pipe & Fittings**

**OC 4" Oval Cap**



| Part # | Mfg # | Size | Price |
|--------|-------|------|-------|
| 184603 | HC4OC | 4"   |       |

**OP Oval Pipe**



| Part # | Mfg #   | Size    | Price |
|--------|---------|---------|-------|
| 184590 | HC4OP24 | 4" x 2' |       |
| 184589 | HC4OP5  | 4" x 5' |       |

**OSC Oval Storm Collar**

- The storm collar serves as a counter flashing and requires mastic to seal to the vent pipe.



| Part # | Mfg #  | Size | Price |
|--------|--------|------|-------|
| 184605 | HC4OSC | 4"   |       |

## Chimney & Vent

### Type B Chimney & Vent Chimney Liner

#### ALK Aluminum Chimney Liner Kits

- Kits include flexible length, round top, flashing, mortar guard
- Standard kit lengths of 15', 25' and 35'
- Available in 3", 4", 5", 6", 7" and 8" diameters in both kits and 10' extensions
- 10' insulated sleeve has tough polyethylene exterior (sold separately)
- Extension kit includes Flexi-Liner with attached connector and fastener package.
- Pull-downs stretch and lead the Flexi-Liner down the chimney
- Liner Material Aluminum 3003, 2-ply (0.005"each)
- Maximum Flue Gas Temperature 470°F
- Stretch Ratio 5:1 (approximate)
- Clearances 0" between liner and chimney interior 0" between combustible materials and chimney exterior
- Liner listed to UL1777 and ULC-S635
- Compatible with Type B gas vent systems
- Lifetime warranty



| Part # | Mfg #    | Size     | Price |
|--------|----------|----------|-------|
| 184653 | HC3ALK35 | 3" x 35' |       |
| 184654 | HC4ALK35 | 4" x 35' |       |
| 184655 | HC5ALK35 | 5" x 35' |       |
| 184656 | HC6ALK35 | 6" x 35' |       |

### Type A Chimney & Vent Chimney Lengths

#### TLC Chimney Lengths

- Slim, advanced design allows for installation between 16" centers and still provides 2" clearance from combustible material
- Secure twist-lock design couples chimney sections together with just a 1/8 turn. Locking bands secure joints
- Includes locking band
- 5"-8" sections overlap by 1 1/8", 10"-14" sections overlap by 1 1/4"
- Chimneys are sized according to the inner diameter and are available in 5" through 14"
- The outside diameter is 2" larger than the inside diameter



| Part # | Mfg #    | Size     | Price |
|--------|----------|----------|-------|
| 184688 | HC6TLC12 | 6" x 1'  |       |
| 184689 | HC6TLC18 | 6" x 18" |       |
| 184690 | HC6TLC24 | 6" x 2'  |       |
| 184692 | HC6TLC36 | 6" x 3'  |       |
| 184694 | HC6TLC48 | 6" x 4'  |       |
| 184713 | HC7TLC48 | 7" x 4'  |       |
| 184719 | HC8TLC24 | 8" x 2'  |       |
| 184720 | HC8TLC36 | 8" x 3'  |       |
| 184721 | HC8TLC48 | 8" x 4'  |       |

### Type A Chimney & Vent Supports

#### TLCAWS Adjustable Wall Support

- Used to support the chimney on a through-the-wall installation.
- 5" – 8" sizes include top plate, side brackets, hardware, non-twist-lock insulated tee cap, and a long L-bracket to hold tee cap in place.
- 10" – 14" sizes do not include the cap. Use tee cap packaged with tee.
- 2" – 6" clearance away from wall.
- 5" – 8" sizes support between 30 feet and 74 feet of chimney, based on size and orientation. See instructions for specific heights.
- 10" – 14" sizes support up to 40 feet of chimney.
- 12" – 14" sizes are nonadjustable supports.



| Part # | Mfg #     | Size | Price |
|--------|-----------|------|-------|
| 184701 | HC6TLCAWS | 6"   |       |
| 184724 | HC8TLCAWS | 8"   |       |

Ducts, Fittings & Accessories

## Chimney & Vent

### TLCCSR Ceiling Supports

- For use in flat ceiling support installations.
- Supports a total of 50 feet of chimney above.
- Chimney pipe cannot pass below support.
- Matte black finish with ceiling ring to cover rough opening.
- Also acts as a firestop.
- Must always use stovepipe adapter.



| Part # | Mfg #     | Size | Price |
|--------|-----------|------|-------|
| 184763 | HC6TLCCSR | 6"   |       |

### Type A Vent Flashings & Storm Collars

#### TLCF6 Adjustable Flashing Assembly 0 - 6/12 pitch

- Used where the chimney passes through a roof with a pitch of Flat to 6/12.
- Comes complete with storm collar.
- All seams are sealed with silicone sealant.
- Galvalume

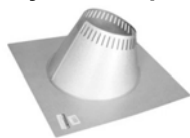

| Part # | Mfg #     | Size | Price |
|--------|-----------|------|-------|
| 184704 | HC6TLCF6  | 6"   |       |
| 184731 | HC8TLCF12 | 8"   |       |

### TLCCS Storm Collar

- Used in conjunction with roof flashing to keep precipitation out.



| Part # | Mfg #    | Size | Price |
|--------|----------|------|-------|
| 184707 | HC6TLCCS | 6"   |       |
| 184748 | HC8TLCCS | 8"   |       |

### TLCRBF Rubber Boot Flashing Kit

- This kit fits 5", 6", 7" and 8" chimneys.
- Used where the chimney passes through a corrugated roof.
- Rubber boot flashing fits roof pitches up to 12/12.
- Kit includes: Special Storm Collar, Rubber Boot, Spacer Kit and Special Boot-Mounting Screws
- UL-listed.



| Part # | Mfg #    | Size  | Price |
|--------|----------|-------|-------|
| 184697 | HCTLCRBF | 5"-8" |       |

### Type A Vent Parts & Accessories

#### TLCSPA Stovepipe Adapter

- For quick and easy transition from black stovepipe to factory-built chimney.
- Twist-lock for easy connection.
- 5" to 8" is black.



| Part # | Mfg #     | Size | Price |
|--------|-----------|------|-------|
| 184709 | HC6TLCSPA | 6"   |       |
| 184749 | HC8TLCSPA | 8"   |       |

#### TLCWB Wall Band

- Stainless steel construction.
- Provides lateral support for the chimney when installed adjacent to a wall.
- Maintains the mandatory 2-inch clearance to combustibles.
- Used above the tee, then every 8 feet thereafter.



| Part # | Mfg #    | Size | Price |
|--------|----------|------|-------|
| 184710 | HC6TLCWB | 6"   |       |

### Type A Chimney & Vent Rain Caps

#### TLCC Rain Caps

- Advanced design, premium quality stainless steel.
- Provides protection against the elements.
- 5" – 8" TLCC with twist lock connection
- 10" – 14" Model TLCC with twist lock connection



| Part # | Mfg #   | Size | Price |
|--------|---------|------|-------|
| 184698 | HC6TLCC | 6"   |       |
| 184714 | HC7TLCC | 7"   |       |
| 184722 | HC8TLCC | 8"   |       |



## Chimney & Vent

### Type A Chimney & Vent Elbows & Tees

#### TLCT Insulated Tee With Tee Cap

- *The insulated chimney tee may be used for through the-wall installation, using a wall support.*
- *A chimney length is required to pass safely through a wall.*
- *Includes the following:*
- *Two locking bands*
- *5" to 8" sizes have an uninsulated (single-wall) twist-lock tee cap for non-wall support applications only.*
- *10" to 14" sizes have an insulated press fit tee cap.*



| Part # | Mfg #   | Size | Price |
|--------|---------|------|-------|
| 184699 | HC6TLCT | 6"   |       |

### Type A Chimney & Vent Shields

#### TLCWT Black Wall Thimble

- *Used in a wall support installation.*
- *Radiation shield is included with spacers, which maintain the mandatory 2-inch clearance to combustibles.*
- *Attractive matte black finishing trim plate is included.*
- *Adjustable wall thickness from 4 1/2" – 8 3/4" for 5" – 8" sizes and from 6" – 11" for 10" – 14" sizes.*



| Part # | Mfg #     | Size | Price |
|--------|-----------|------|-------|
| 184767 | HC8TLCWTB | 8"   |       |

## Duct Boosters

### Duct Boosters®

- Fits round or flat forced air heating/cooling ductwork
- Boosts air flow up to 275 CFM



| Part # | Mfg # | Description                                 | Price |
|--------|-------|---|-------|
| 010372 | DB-2  | Original 120V, 1/20 hp, .51A - 6" & 8" Duct |       |

### Duct Fans

- Fans can be used for exhaust or fresh air intake applications
- Fits metal or flex duct
- Capacities from 180 CFM up to 1,200 CFM



| Part # | Mfg # | Description            | Price |
|--------|-------|------------------------|-------|
| 061571 | EF-6  | For 6" 120V, 30W, .40A |       |
| 023837 | EF-8  | For 8" 120V, 56W, 1.1A |       |

**Duct Boosters**

**Air Boosters**

**Air Booster**

- *Installs in branch duct of any room*
- *Adds up to 1,150 CFM to needy rooms*
- *Can be wired electrically through the main blower, a wall switch, or a line voltage thermostat in the room*



| Part # | Mfg #       | Size | Price |
|--------|-------------|------|-------|
| 116050 | 84-25253-01 | 6"   |       |

## Duct Tape

### Duct Tape

#### 221 Solvent Resistant Duct Tape

- Rubber based adhesive
- Polyethylene coated cloth backing
- Crisp, straight tear and smooth unwind



| Part # | Mfg # | Size        | Color | Price |
|--------|-------|-------------|-------|-------|
| 010344 | 221   | 2" x 60 yds | White |       |

#### 227 Contractor Grade Duct Tape

- Bonds to all types of surfaces
- Will not twist or curl



| Part # | Mfg # | Size        | Color  | Price |
|--------|-------|-------------|--------|-------|
| 010345 | 227   | 2" x 60 yds | Silver |       |

#### 398 Professional Grade Duct Tape

- 011 mil Thickness
- Excellent balance of tearability and tensile strength; 27 lbs/inch
- Conforms well to irregular surfaces
- Superior holding power for hanging applications
- Tears straight, hangs straight, curl resistant
- Easy unwind
- Low VOC content
- PE-coated cloth backing with rubber adhesive



| Part # | Mfg # | Size        | Color | Price |
|--------|-------|-------------|-------|-------|
| 077358 | 398B  | 2" x 60 yds | Black |       |
| 190388 | 398W  | 2" x 60 yds | White |       |

#### 338 FSK Insulation Tape

- Kraft Paper
- Synthetic rubber Adhesive
- Foil/Tri-Directional Fiberglas/Paper
- Aluminum



| Part # | Mfg # | Size        | Color    | Price |
|--------|-------|-------------|----------|-------|
| 176968 | 338   | 3" x 50 yds | Aluminum |       |

Ducts, Fittings & Accessories

## Duct Tape

### Gaffer's Tape

- Premium vinyl coated
- Low gloss, non-reflective cloth backing



| Part # | Mfg # | Size        | Color | Price |
|--------|-------|-------------|-------|-------|
| 010351 | 510   | 2" x 60 yds | Gray  |       |

### Foil Tape

#### 337 Premium Foil Tape

- UL 723 Listed
- 3.7 mil Thickness
- Tensile strength: 14 lb/in
- Exceptional quick stick
- Dead-soft aluminum foil backing for rigid preformed aluminum foil-faced duct systems
- Synthetic rubber adhesive
- Low VOC



| Part # | Mfg # | Size        | Price |
|--------|-------|-------------|-------|
| 010349 | 337   | 2" x 50 yds |       |
| 010350 | 337   | 3" x 50 yds |       |

#### 339 Cold Weather Premium UL 181A and B Printed Foil Tape

- 4.8 mil Thickness
- Tensile strength: 23 lb/in
- High performance in both cold and hot weather
- Instant adhesion, superior quick stick
- Premium performance in joining and sealing rigid fiberglass duct board and Class 1 flex duct
- Tear resistant
- Low VOC



| Part # | Mfg # | Size            | Price |
|--------|-------|-----------------|-------|
| 124231 | 339   | 2-1/2" x 60 yds |       |
| 124230 | 339   | 3" x 60 yds     |       |

### 360-17 Waterproofing Repair Tape

- For indoor or outdoor sealing of medium and high pressure HVAC duct systems including metal duct, fiberglass duct,, flex duct
- Seals cracks and seams in gutters, roof alleys, eaves, hips and ridges
- Seals around chimneys and vent stacks
- Repair gouges, rips, tears in metal panels
- Foilmastic permanent sealant tape - heavy-duty
- Acceptable for use on galvanized materials
- Provides instant water-tight bond
- Paintable - use in place of caulking
- Excellent resistance to cold, heat, water and sunlight



| Part # | Mfg #  | Size      | Price |
|--------|--------|-----------|-------|
| 038561 | 360-17 | 3" x 100' |       |

### 227 Contactor Grad Duct Tape

- 11 mil
- Natural rubber adhesive
- Polyethylene coated cloth
- Single coated



| Part # | Mfg # | Size        | Color | Price |
|--------|-------|-------------|-------|-------|
| 025910 | 227B  | 2" x 60 yds | Black |       |

---

---

**Duct Accessories**

---

---

**PVC Tape**  
**PVC Tape for Fiberglass**

| Part # | Mfg #   | Size      | Price |
|--------|---------|-----------|-------|
| 044361 | 3043033 | 2" x 100' |       |

## Duct Fasteners

### Rivets

#### Stainless Rivet

| Part # | Mfg #     | Rivet Dia | Body Length | Mandrel   | Pk Qty | Price |
|--------|-----------|-----------|-------------|-----------|--------|-------|
| 006487 | SS/SS42DT | 1/8"      | .232        | Stainless | 1,000  |       |
| 006488 | SS/SS44DT | 1/8"      | .357        | Stainless | 1,000  |       |

#### Steel Rivet

| Part # | Mfg #  | Rivet Dia | Body Length | Mandrel | Pk Qty | Price |
|--------|--------|-----------|-------------|---------|--------|-------|
| 006491 | SS42DT | 1/8"      | .232        | Plated  | 1,000  |       |
| 006490 | SS42DX | 1/8"      | .232        | Plated  | 100    |       |
| 006492 | SS44DX | 1/8"      | .357        | Plated  | 100    |       |

### Screws

#### Zip-In® Screw

# Zip-in®

| Part # | Mfg #      | Size       | Pkg Qty | Price |
|--------|------------|------------|---------|-------|
| 006427 | HW7x1/2Z   | 7 x 1/2"   | 15,000  |       |
| 006428 | HW7x1/2ZT  | 7 x 1/2"   | 1,000   |       |
| 006426 | HW7x1/2ZX  | 7 x 1/2"   | 100     |       |
| 006434 | HW8x1/2ZT  | 8 x 1/2"   | 1,000   |       |
| 006433 | HW8x1/2ZX  | 8 x 1/2"   | 100     |       |
| 006436 | HW8x3/4ZT  | 8 x 3/4"   | 1,000   |       |
| 006435 | HW8x3/4ZX  | 8 x 3/4"   | 100     |       |
| 074763 | HW8x3/4Z   | 8" x 3/4"  | 10,000  |       |
| 092077 | HW8x1Z     | 8 x 1"     | 7,000   |       |
| 026305 | HW8x1ZT    | 8 x 1"     | 500     |       |
| 006429 | HW8x1ZX    | 8 x 1"     | 100     |       |
| 006431 | HW8x11/2ZT | 8 x 1-1/2" | 250     |       |
| 006430 | HW8x11/2ZX | 8 x 1-1/2" | 50      |       |
| 046929 | HW8x2ZT    | 8 x 2"     | 250     |       |
| 006419 | HW10x1ZX   | 10 x 1"    | 100     |       |

#### Zip-In® White Screw

# Zip-in®

| Part # | Mfg #    | Size   | Pkg Qty | Price |
|--------|----------|--------|---------|-------|
| 066164 | HW8X2ZWT | 8 x 2" | 250     |       |

### Drill-In Screw

| Part # | Mfg #   | Size    | Pkg Qty | Price |
|--------|---------|---------|---------|-------|
| 084193 | HW10X2T | 10 x 2" | 250     |       |
| 006424 | HW10X2X | 10 x 2" | 50      |       |

### Bit-Tip® #2 Screw - Hex Washer Head

- Taps a matching thread
- Drills it's own hole
- Fastens in steel up to .200 thick

# Bit-Tip®

| Part # | Mfg #  | Screw Size   | Driver Size | Pkg Qty | Price |
|--------|--------|--------------|-------------|---------|-------|
| 037082 | BT131  | 8-18 x 1/2"  | 1/4"        | 100     |       |
| 037085 | BT133T | 8-18 x 3/4"  | 1/4"        | 500     |       |
| 037083 | BT133  | 8-18 x 3/4"  | 1/4"        | 100     |       |
| 058127 | BT143T | 10-16 x 3/4" | 5/16        | 500     |       |

## Duct Fasteners

### Connector Systems

#### Ductmate 35 Rectangular Flange System

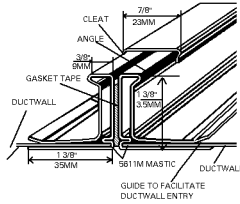

| Part # | Mfg # | Description         | Price |
|--------|-------|---------------------|-------|
| 005621 | DM35  | DM35™ Flange System |       |

#### Ductmate 35 Corner



| Part # | Mfg #  | Description          | Price |
|--------|--------|----------------------|-------|
| 005615 | DC111B | 35 Corner with Clips |       |

Ducts, Fittings & Accessories



**Duct Fasteners**

**Duct Fasteners**

**PN Spotter Pin**

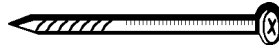

| Part # | Mfg # | Size | Pack | Price |
|--------|-------|------|------|-------|
| 072531 | 26001 | 3/4" | 1000 |       |

**Duct Hangers**

**DDG3W Eye Bolt and Nut**

- 3/8"-16 x 2-1/2"
- 1/2" Thread length
- Zinc plated low carbon steel
- Working load limit: 144 lbs



| Part # | Mfg # | Item # | Description | Price |
|--------|-------|--------|-------------|-------|
| 181619 | 30220 | DDG3W  | 100 per box |       |

**Wire Rope**

- Galvanized carbon steel



| Part # | Mfg #     | Size        | Price |
|--------|-----------|-------------|-------|
| 181611 | 30204-WC4 | 1/8" x 500' |       |

## Duct Fasteners

### Duct Adhesives

#### Iron-Grip™ 601

- For use on metal duct, glass fiber duct board, flex duct, duct fabric and flexible tubing runouts
- Indoor/outdoor use
- Water-based
- All pressure classes
- UL Classified



| Part # | Mfg #  | Size  | Price |
|--------|--------|-------|-------|
| 022827 | 304135 | 1 gal |       |

Ducts, Fittings & Accessories

## Duct Fasteners

### Mastic Duct Sealants

#### Versa-Grip™ 181

- For use on metal duct, glass fiber duct board and flexible duct
- Indoor/outdoor use
- Water-based
- All pressure classes
- UL 181A-M/181B-M Listed



| Part # | Mfg #  | Size  | Color | Price |
|--------|--------|-------|-------|-------|
| 124963 | 304138 | 1 gal | White |       |

#### Duct-Seal™ 321

- Indoor/outdoor use
- Water-based
- All pressure classes
- UL Classified



| Part # | Mfg #  | Size  | Color | Price |
|--------|--------|-------|-------|-------|
| 125162 | 304156 | 1 gal | Gray  |       |

#### Iron-Grip™ 601

- For use on metal duct, glass fiber duct board, flex duct, duct fabric and flexible tubing run outs
- Indoor/outdoor use
- Water-based
- All pressure classes
- UL Classified

1 Gallon



| Part # | Mfg #  | Size  | Color | Price |
|--------|--------|-------|-------|-------|
| 124961 | 304137 | 11 oz |       |       |

### Duct Liner Adhesives

#### Coil-Tack™

- Formerly Glas-Grip 901
- Low tack, nonflammable, water-based insulation adhesive engineered for spray or extruding coil line applications
- Low-viscosity liquid
- Synthetic latex



| Part # | Mfg #  | Size   | Color | Price |
|--------|--------|--------|-------|-------|
| 128234 | 308584 | 50 gal | Black |       |

### Travel-Tack™

- Portable insulation adhesive spray system
- Polymer-based aerosol spray
- Excellent water resistance



| Part # | Mfg #  | Description   | Color     | Price |
|--------|--------|---------------|-----------|-------|
| 125163 | 308599 | 15 oz Aerosol | VOC Clear |       |

### Damper Accessories

#### Kwiki Damper Regulator



| Part # | Mfg #  | Description            | Price |
|--------|--------|------------------------|-------|
| 125160 | 307963 | Kwiki Damper Regulator |       |

**Duct Fasteners**

**Insulation Adhesives & Aerosol Products**

**Aerosol Cylinder Adhesive**

- Industrial grade spray adhesives
- Designed to bond duct liner
- Coverage Approx 100 sq ft / lb
- Free of V. O. C. & C. F. X
- Completely Self Contained & Portable
- Does not require outside support systems

| Part # | Mfg #     | Description | Price |
|--------|-----------|-------------|-------|
| 138959 | CNADACA40 | 40 lbs      |       |

**Duct Sealants & Accessories**

**Buttertack Duct Sealant**

- Buttertack Sealant Applies Easily
- For best results apply over fiberglass membrane tape; allow to cure 48 to 72 hours before pressure check

| Part # | Mfg #         | Description            | Price |
|--------|---------------|------------------------|-------|
| 160360 | CNBT1DUCTSEAL | 1 Gal. Can (4 Per CTN) |       |

**Pins & Clips**

**Pointer Weld Fastener**

- Thru Insulation
- Weld Fastener
- Flat or Cupped Heads
- The Premium Quality Weld Fastener
- 1000 Pack or Bulk CTN
- Sharp Laser Point

| Part # | Mfg #      | Description   | Price |
|--------|------------|---------------|-------|
| 191759 | CNLFCWF50B | 1/2" 5000 CTN |       |

**Pinchers**

**Pincher Impact Fastener**

- The premium quality impact fastener
- 9 Ga.
- Approx 135" Dia
- Thru insulation impact fastener

| Part # | Mfg #      | Description        | Price |
|--------|------------|--------------------|-------|
| 193121 | CNLFCMF50  | 1/2", 1000 Qty/CTN |       |
| 193190 | CNLFCMF100 | 1", 1000 Qty/CTN   |       |
| 193494 | CNLFCMF50B | 1/2", 5000 Qty/CTN |       |

**Vanes & Rails**

**Instant Vane Rail (IVR)**

- Designed for today's pre-formed single blade vanes
- Roll out, cut and use - no tabs, no special tools
- 3-1/2" wide rail or 2" radius vane
- 4-1/2" wide rail for 4-1/2" radius vane

| Part # | Mfg #      | Description             | Price |
|--------|------------|-------------------------|-------|
| 191761 | CAINRAIV4G | 4-1/2" Galv, 100 FT/CTN |       |

**Pre-Formed Single Blade Vane**

- Hemmed Edges 22-24 Ga. Galv
- Packaged 10 Foot Sections
- 300 FT/CTN 2" R Vane
- 150 FT/CTN 4 1/2" R Vane

| Part # | Mfg #   | Description   | Price |
|--------|---------|---------------|-------|
| 191764 | CNRAV2G | 2" x 10' Galv |       |

**Damper Hardware**

**Kwiki Regulator Sets**

**Kwiki Regulator Set K70**

- K70 Includes:
- 2 K708 Bearing
- 1 K704 Washer
- 1 K705 Handle
- 1 K706 Wing Nut

| Part # | Mfg #   | Description         | Price |
|--------|---------|---------------------|-------|
| 191762 | CNDHK70 | 12/Bag, 144 CTN/QTY |       |

**Damper Quadrant Sets**

- 3/8" Quadrant Set includes: Q38, B38 and SB38
- 3/8" Quadrant Set is for dampers up to 20" Dia.
- 1/2" Quadrant Set includes RB12, Q12, and B12
- 1/2" Quadrant Set is for dampers up to 30" Dia.

| Part # | Mfg #    | Description            | Price |
|--------|----------|------------------------|-------|
| 191763 | CNDHQS38 | Reg 3/8", 100 Sets/CTN |       |

**Duct Fasteners**

**Insulation Hangers**

**Stik-Pins**

- Self Adhesive Hanger
- Washers Supplied with Hangers
- 12 GA. Pins (106" - 2.69 MM)
- For Aluminum Nails
- Larger Sizes Available Upon Requests

| Part # | Mfg #       | Description   | Price |
|--------|-------------|---------------|-------|
| 193230 | CNLFSP1250  | 1-1/4" 10/CTN |       |
| 193489 | CNLFSP0750  | 3/4" 10/CTN   |       |
| 196535 | CNLFSP0750B | 3/4" 1000/CTN |       |

**Flexible Duct Connector**

**Duct Connector Heavy Duty Commercial**

- 3" Metal 3" Fabric 3" Metal
- 24 GA. Galv
- "Flex-Loc" Seam
- Priced per 100 ft

| Part # | Mfg #    | Description        | Price |
|--------|----------|--------------------|-------|
| 204543 | CNCNN100 | 100' Neoflex 29 oz |       |

**Duct Connector Light Industrial Duty Residential**

- 1-3/4" Metal 3" Fabric 1-3/4" Metal
- 28 GA. Galv
- "S-LOC" Seam
- Priced Per 100 Ft

| Part # | Mfg #     | Description  | Price |
|--------|-----------|--------------|-------|
| 204546 | CNCNRV100 | 100' Vinylon |       |

**Access Doors**

**Insulated Access Door for Metal Duct**

- 1" Insulated door
- 2" W.C.
- Hinge & cam latches are standard

| Part # | Mfg #    | Description | Price |
|--------|----------|-------------|-------|
| 063441 | DR CAD 8 | 8" x 8"     |       |

Ducts, Fittings & Accessories



## Duct Sealants

### Mastic Duct Sealants

#### #6 Mastic Fiber Seal

- Low to high velocity air duct sealant
- Non-toxic adhesive-sealant for permanently sealing fabricated joints and seams of sheet metal air ducts, UL-181 listed rigid fiberglass air ducts, UL-181 listed flexible air ducts and thermal insulation
- Water-based and non-flammable
- High solid content
- Fiber reinforced
- Weather resistant
- Elastomeric
- City of Los Angeles Approval #RR820



| Part # | Mfg #  | Size  | Price |
|--------|--------|-------|-------|
| 121139 | 106001 | 1 gal |       |

## Duct Hangers

### Basset Brackets - Galvanized Self-Nailing Galvanized Bracket

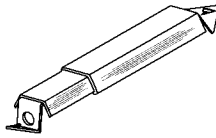

| Part # | Mfg #  | Description        | Ctn Qty | Price |
|--------|--------|--------------------|---------|-------|
| 002244 | A-150  | 12" to 19" Regular | 50      |       |
| 192533 | A-125  | 12" to 19" Regular | 25      |       |
| 034448 | E-125G | 19" to 26" X-Long  | 25      |       |

### "Tab" Galvanized Bracket

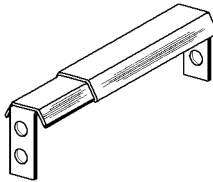

| Part # | Mfg #  | Description        | Ctn Qty | Price |
|--------|--------|--------------------|---------|-------|
| 047447 | AT-150 | 12" to 19" Regular | 50      |       |

### "Tab" Galvanized Bracket with Pre-Loaded Screws

| Part # | Mfg #   | Description        | Ctn Qty | Price |
|--------|---------|--------------------|---------|-------|
| 103953 | AT-S150 | 12" to 19" Regular | 50      |       |

### Pipe Hangers

- Installation of round 5" or 6" heating pipes

| Part # | Mfg # | Carton Qty | Price |
|--------|-------|------------|-------|
| 002245 | BH-2  | 50/Box     |       |

### Square Duct Hangers - Galvanized

- 18 Gauge

| Part # | Mfg # | Size | Price |
|--------|-------|------|-------|
| 035563 | BH-8  | 8"   |       |
| 038070 | BH39  | 9"   |       |
| 125557 | BH-10 | 10"  |       |
| 111709 | BH-11 | 11"  |       |

### Basset Straps Duct Strap



- For all square ducts running below the joists
- 18 Gauge galvanized steel

| Part # | Mfg # | Qty        | Price |
|--------|-------|------------|-------|
| 002246 | DS-3  | 100/Carton |       |

### Wire Duct Strap



| Part # | Mfg #    | Size | Ctn Qty | Price |
|--------|----------|------|---------|-------|
| 038142 | BAGWS412 | 12"  | 100     |       |
| 192534 | BAGWS49  | 9"   | 100     |       |

### Perforated Pipe Strap



| Part # | Mfg #         | Size       | Ctn Qty | Price |
|--------|---------------|------------|---------|-------|
| 190762 | HANG3410GALV  | 3/4"x10"   | 100     |       |
| 190763 | HANG34100GALV | 3/4"x100"  | 1       |       |
| 190764 | HANGPS101024C | 3/4" x 10" | 10      |       |

### Hooks

#### Wire Pipe Hooks

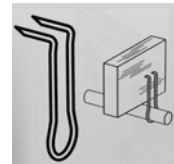

| Part # | Mfg #    | Size      | Ctn Qty | Price |
|--------|----------|-----------|---------|-------|
| 190758 | HANG126P | 1/2" x 6" | 50      |       |
| 190759 | HANG344P | 3/4" x 4" | 50      |       |
| 190760 | HANG346P | 3/4" x 6" | 50      |       |
| 190761 | HANG16P  | 1" x 6"   | 50      |       |

**Flexible Duct**

**Class 1 Air Connectors**

**F090 Commercial Series Uninsulated Duct**

- *UL and CUL listed*
- *25' lengths*
- *Class 1 air connector*
- *High pressure, multi-ply metalized/polyester core, 16" W.C. positive, 1" negative (1/2" W.C. neg for 14" - 20" diameter)*
- *GREENGUARD Level 4 highly microbial resistant*
- *Double-ply, black polyester core, 12" W.C. positive, 1" negative (F010)*



| Part # | Mfg #     | Size      | Price |
|--------|-----------|-----------|-------|
| 222469 | HCF0903   | 3" x 25'  |       |
| 222473 | HCF0904   | 4" x 25'  |       |
| 222475 | HCFF0905  | 5" x 25'  |       |
| 222476 | HCF0906   | 6" x 25'  |       |
| 222474 | HCFF09012 | 12" x 25' |       |

Ducts, Fittings & Accessories



## Flexible Duct

### Insulated Flexible Duct

#### Silver Flex Duct

- Metallized polyester jacket reinforced with fiberglass scrim
- Double-ply, black polyester core 12" W.C. positive, 3/4" W.C. negative
- UL-listed
- R-8.0 (F218)  
R-4.2 (F214)  
R-6.0 (F216)
- Boxed
- 25' Length
- GREENGUARD level 4 highly microbial resistant



| Part#  | Mfg#   | Model | Size      | Price |
|--------|--------|-------|-----------|-------|
| 222557 | 051035 | F214  | 4" x 25'  |       |
| 222558 | 051036 | F214  | 5" x 25'  |       |
| 222559 | 051037 | F214  | 6" x 25'  |       |
| 222560 | 051038 | F214  | 7" x 25'  |       |
| 222561 | 051039 | F214  | 8" x 25'  |       |
| 222562 | 051040 | F214  | 9" x 25'  |       |
| 222563 | 051041 | F214  | 10" x 25' |       |
| 222564 | 051042 | F214  | 12" x 25' |       |
| 222565 | 051043 | F214  | 14" x 25' |       |
| 222566 | 051044 | F214  | 16" x 25' |       |
| 222567 | 051045 | F214  | 18" x 25' |       |
| 222568 | 051046 | F214  | 20" x 25' |       |
| 222553 | 047308 | F214  | 6" x 50'  |       |
| 222555 | 047310 | F214  | 8" x 50'  |       |
| 222556 | 047312 | F214  | 10" x 50' |       |
| 223808 | 051323 | F216  | 4" x 25'  |       |
| 223809 | 051324 | F216  | 5" x 25'  |       |
| 223811 | 051325 | F216  | 6" x 25'  |       |
| 223812 | 051326 | F216  | 7" x 25'  |       |
| 223813 | 051327 | F216  | 8" x 25'  |       |
| 223815 | 051328 | F216  | 9" x 25'  |       |
| 223816 | 051329 | F216  | 10" x 25' |       |
| 223818 | 051330 | F216  | 12" x 25' |       |
| 223819 | 051331 | F216  | 14" x 25' |       |
| 223821 | 051332 | F216  | 16" x 25' |       |
| 223823 | 051333 | F216  | 18" x 25' |       |
| 224487 | 27825  | F218  | 6" x 25'  |       |
| 224482 | 27827  | F218  | 8" x 25'  |       |
| 224484 | 27829  | F218  | 10" x 25' |       |
| 224485 | 27830  | F218  | 12" x 25' |       |

### F114 Black Flex Duct

- Black polyethylene jacket
- R-4.2
- UL-listed
- Boxed or bagged (FB series)
- 25' and 50' lengths
- GREENGUARD Level 4 highly microbial resistant
- Double-ply, black polyester core 12" W.C. positive, 3/4" W.C. negative (1/2" W.C. neg for 14" - 20" diameter)



| Part#  | Mfg#   | Model | Size      | Price |
|--------|--------|-------|-----------|-------|
| 222495 | 051001 | F114  | 4" x 25'  |       |
| 222496 | 051002 | F114  | 5" x 25'  |       |
| 223804 | 051003 | F114  | 6" x 25'  |       |
| 222497 | 051004 | F114  | 7" x 25'  |       |
| 223805 | 051005 | F114  | 8" x 25'  |       |
| 222498 | 051006 | F114  | 9" x 25'  |       |
| 222499 | 051007 | F114  | 10" x 25' |       |
| 222500 | 051008 | F114  | 12" x 25' |       |
| 222501 | 051009 | F114  | 14" x 25' |       |
| 222502 | 051010 | F114  | 16" x 25' |       |
| 222503 | 051011 | F114  | 18" x 25" |       |
| 222504 | 051012 | F114  | 20" x 25' |       |
| 223792 | 047301 | F114  | 6" x 50'  |       |
| 223793 | 047303 | F114  | 8" x 50'  |       |
| 223803 | 047305 | F114  | 10" x 50' |       |

### F116 Black Flex Jacket

- Black polyethylene jacket
- Double-ply, black polyester core 12" W.C. positive, 3/4" W.C. negative
- R-6.0
- UL-listed
- Boxed or bagged (FB series)
- 25' and 50' lengths
- GREENGUARD Level 4 highly microbial resistant



| Part#  | Mfg#   | Model | Size      | Price |
|--------|--------|-------|-----------|-------|
| 222510 | 051313 | F116  | 6" x 25'  |       |
| 222512 | 051315 | F116  | 8" x 25'  |       |
| 222514 | 051317 | F116  | 10" x 25' |       |
| 222519 | 051318 | F116  | 12" x 25' |       |
| 222515 | 051319 | F116  | 14" x 25' |       |

**Flexible Duct**

**F118 Black Flex Duct**

- Black polyethylene jacket
- R-8.0
- UL-listed
- Boxed or bagged (FB series)
- 25' and 50' lengths
- Double-ply, black polyester core  
12" W.C. positive, 3/4" W.C. negative  
(1/2" W.C. neg for 14" - 20" diameter)
- GREENGUARD Level 4 highly microbial resistant



| Part#  | Mfg#   | Model | Size      | Price |
|--------|--------|-------|-----------|-------|
| 222327 | 027814 | F118  | 6" x 25'  |       |
| 222329 | 027815 | F118  | 7" x 25'  |       |
| 222330 | 027816 | F118  | 8" x 25'  |       |
| 222332 | 027818 | F118  | 10" x 25' |       |
| 222334 | 027819 | F118  | 12" x 25' |       |
| 222336 | 027820 | F118  | 14" x 25' |       |

**F104 Sleeve**

- Black polyethylene jacket
- R-4.2
- One starter cone per carton



| Part#  | Mfg#     | Model | Size     | Price |
|--------|----------|-------|----------|-------|
| 222479 | HCF1044  | F104  | 4" x 5'  |       |
| 222480 | HCF1045  | F104  | 5" x 5'  |       |
| 222481 | HCF1046  | F104  | 6" x 5'  |       |
| 222482 | HCF1047  | F104  | 7" x 5'  |       |
| 222483 | HCF1048  | F104  | 8" x 5'  |       |
| 222484 | HCF1049  | F104  | 9" x 5'  |       |
| 222486 | HCF10412 | F104  | 12" x 5' |       |
| 222487 | HCF10414 | F104  | 14" x 5' |       |
| 222488 | HCF10416 | F104  | 16" x 5' |       |
| 184152 | HCF10410 | F104  | 10" x 5' |       |

**F206 Silver Sleeve**

- Metallized polyester jacket
- UL-classified
- R-6.0
- 5' Length
- Starter cone included in each carton



| Part#  | Mfg#    | Model | Size    | Price |
|--------|---------|-------|---------|-------|
| 222545 | HCF2066 | F206  | 6" x 5' |       |
| 222543 | HCF2064 | F206  | 4" x 5' |       |
| 222544 | HCF2065 | F206  | 5" x 5' |       |
| 222546 | HCF2067 | F206  | 7" x 5' |       |

**Insulated Flexible Duct (Continued)**

**F206 Silver Sleeve**

| Part#  | Mfg#     | Model | Size     | Price |
|--------|----------|-------|----------|-------|
| 222547 | HCF2068  | F206  | 8" x 5'  |       |
| 222548 | HCF2069  | F206  | 9" x 5'  |       |
| 222549 | HCF20610 | F206  | 10" x 5' |       |
| 222550 | HCF20612 | F206  | 12" x 5' |       |
| 222551 | HCF20614 | F206  | 14" x 5' |       |
| 222552 | HCF20616 | F206  | 16" x 5' |       |

## Flexible Duct

### Insulated Flexible Duct - 30 Series

- Air-tight inner core - energy efficient, no fiberglass erosion into air stream
- Encapsulated wire helix, no unraveling when cut to length / quick installation
- Smooth inner core for low friction loss
- Thick blanket of fiberglass insulation
- Tough reinforced polyester jacket is tear and puncture resistant
- Lightweight compact carton reduces warehouse and job site handling cost
- Greenguard Indoor Air Quality Certified



### Insulated Flexible Duct - 31 Series

- Air-tight inner core - energy efficient, no fiberglass erosion into air stream
- Encapsulated wire helix, no unraveling when cut to length / quick installation
- Smooth inner core for low friction loss
- Thick blanket of fiberglass insulation
- Tough reinforced polyester jacket is tear and puncture resistant
- Lightweight compact carton reduces warehouse and job site handling cost
- Greenguard Indoor Air Quality Certified



#### R-4.2 Insulated Metallized Jacket - Class 1 Air Duct - UL181

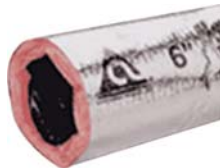

#### R8 Insulated Metallized Jacket - Class 1 Air Duct - UL 181



| Part # | Mfg #     | Size      | Price |
|--------|-----------|-----------|-------|
| 060797 | 425MINFD  | 4" x 25'  |       |
| 060798 | 525MINFD  | 5" x 25'  |       |
| 060799 | 625MINFD  | 6" x 25'  |       |
| 060800 | 725MINFD  | 7" x 25'  |       |
| 060801 | 825MINFD  | 8" x 25'  |       |
| 060803 | 1025MINFD | 10" x 25' |       |
| 060804 | 1225MINFD | 12" x 25' |       |
| 060805 | 1425MINFD | 14" x 25' |       |
| 060807 | 1625MINFD | 16" x 25' |       |
| 060808 | 1825MINFD | 18" x 25' |       |
| 060809 | 2025MINFD | 20" x 25' |       |
| 184167 | 650MINFD  | 6" x 50'  |       |
| 184170 | 850MINFD  | 8" x 50'  |       |
| 184173 | 1050MINFD | 10" x 50' |       |

| Part # | Mfg #       | Size      | Price |
|--------|-------------|-----------|-------|
| 183939 | R8425MINFD  | 4" x 25'  |       |
| 183940 | R8525MINFD  | 5" x 25'  |       |
| 183942 | R8625MINFD  | 6" x 25'  |       |
| 183943 | R8725MINFD  | 7" x 25'  |       |
| 183944 | R8825MINFD  | 8" x 25'  |       |
| 183945 | R8925MINFD  | 9" x 25'  |       |
| 183946 | R81025MINFD | 10" x 25' |       |
| 183947 | R81225MINFD | 12" x 25' |       |
| 184174 | R81425MINFD | 14" x 25' |       |
| 184175 | R81625MINFD | 16" x 25' |       |

## Flexible Duct

### Insulated Flexible Duct - 70 Series

- Grey polyester vapor barrier air-tight inner core - energy efficient, no fiberglass erosion into air stream
- Encapsulated wire helix, no unraveling when cut to length / quick installation
- Smooth inner core for low friction loss
- Thick blanket of fiberglass insulation
- Tough reinforced polyester jacket is tear and puncture resistant
- Lightweight compact carton reduces warehouse and job site handling cost
- Greenguard Indoor Air Quality Certified



#### R-4.2 Insulated Grey Jacket - Class 1 Air Duct - UL181



| Part # | Mfg #    | Size      | Price |
|--------|----------|-----------|-------|
| 015419 | 425INFD  | 4" x 25'  |       |
| 015542 | 525INFD  | 5" x 25'  |       |
| 015713 | 625INFD  | 6" x 25'  |       |
| 068880 | 650INFD  | 6" x 50'  |       |
| 015762 | 725INFD  | 7" x 25'  |       |
| 015843 | 825INFD  | 8" x 25'  |       |
| 089317 | 850INFD  | 8" x 50'  |       |
| 015962 | 925INFD  | 9" x 25'  |       |
| 012325 | 1025INFD | 10" x 25' |       |
| 013302 | 1225INFD | 12" x 25' |       |
| 013585 | 1425INFD | 14" x 25' |       |
| 013645 | 1625INFD | 16" x 25' |       |
| 013698 | 1825INFD | 18" x 25' |       |

#### R-6.0 Insulated Grey Jacket - Class 1 Air Duct - UL181

| Part # | Mfg #      | Size      | Price |
|--------|------------|-----------|-------|
| 091169 | R6425INFD  | 4" x 25'  |       |
| 091171 | R6625INFD  | 6" x 25'  |       |
| 091172 | R6725INFD  | 7" x 25'  |       |
| 091173 | R6825INFD  | 8" x 25'  |       |
| 091175 | R61025INFD | 10" x 25' |       |
| 091176 | R61225INFD | 12" x 25' |       |

### R-8.0 Insulated - Grey Jacket - Class 1 Air Duct - UL181

| Part # | Mfg #      | Size      | Price |
|--------|------------|-----------|-------|
| 097743 | R8425INFD  | 4" x 25'  |       |
| 101787 | R8525INFD  | 5" x 25'  |       |
| 097744 | R8625INFD  | 6" x 25'  |       |
| 097745 | R8725INFD  | 7" x 25'  |       |
| 097746 | R8825INFD  | 8" x 25'  |       |
| 097738 | R81025INFD | 10" x 25' |       |
| 097739 | R81225INFD | 12" x 25' |       |
| 097740 | R81425INFD | 14" x 25' |       |
| 097741 | R81625INFD | 16" x 25' |       |
| 097742 | R81825INFD | 18" x 25' |       |

### Aluminum Flex Duct Uninsulated Flex Duct UL 181 Class 1 Air Duct

- Triple lamination of tough metallized polyester, aluminum foil and polyester
- Wire helix and forms meet requirements of NFPA



| Part # | Mfg #    | Size      | Price |
|--------|----------|-----------|-------|
| 015420 | 425UNFD  | 4" x 25'  |       |
| 015543 | 525UNFD  | 5" x 25'  |       |
| 015714 | 625UNFD  | 6" x 25'  |       |
| 015763 | 725UNFD  | 7" x 25'  |       |
| 015844 | 825UNFD  | 8" x 25'  |       |
| 012326 | 1025UNFD | 10" x 25' |       |

Ducts, Fittings & Accessories

## Flexible Duct

### Insulated Sleeves

#### Foil Sleeve



| Part # | Mfg # | Size<br>R-Value | Price |
|--------|-------|-----------------|-------|
| 059879 | 010   | 4" x 5'         | 4.2   |
| 102025 | 010   | 5" x 5'         | 4.2   |
| 044535 | 010   | 6" x 5'         | 4.2   |
| 044534 | 010   | 7" x 5'         | 4.2   |
| 044533 | 010   | 8" x 5'         | 4.2   |
| 102924 | 010   | 10" x 5'        | 4.2   |
| 184177 | 010   | 4" x 5"         | 6.0   |
| 184179 | 010   | 6" x 5"         | 6.0   |
| 184182 | 010   | 12" x 5"        | 6.0   |
| 097732 | 010   | 4" x 5'         | 8.0   |
| 097733 | 010   | 6" x 5'         | 8.0   |
| 097734 | 010   | 7" x 5'         | 8.0   |
| 097735 | 010   | 8" x 5'         | 8.0   |
| 171990 | 010   | 10" x 5'        | 8.0   |
| 171991 | 010   | 12" x 5'        | 8.0   |
| 172478 | 010   | 14" x 5'        | 8.0   |

---



---

**Galvanized Sheet Metal**

---



---

**Galvanized Sheet Iron**



| Part # | Gauge | Size     | Price |
|--------|-------|----------|-------|
| 010080 | 30ga  | 3' x 8'  |       |
| 076485 | 28ga  | 2' x 8'  |       |
| 010076 | 28ga  | 32" x 8' |       |
| 010077 | 28ga  | 3' x 8'  |       |
| 010078 | 28ga  | 4' x 8'  |       |
| 010074 | 26ga  | 3' x 8'  |       |
| 010075 | 26ga  | 4' x 8'  |       |
| 010072 | 22ga  | 3' x 8'  |       |
| 010073 | 22ga  | 4' x 8'  |       |



## Galvanized Sheet Metal

### Panning Material No. 48 Panning Material



| Part # | Mfg #  | Size             | Price |
|--------|--------|------------------|-------|
| 179149 | 481735 | 16-1/2"(17) x 30 |       |
| 179150 | 483235 | 32" x 35"        |       |

---

---

**Galvanized Sheet Metal**

---

---

**Galvanized Panning**

**Galv Joist Panning**

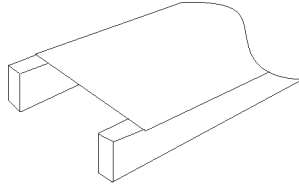

| Part # | Mfg #         | Size          | Price |
|--------|---------------|---------------|-------|
| 011026 | WA323UB161230 | 16-1/2" x 30" |       |
| 011027 | WA323UB3330   | 33" x 30"     |       |



**Oval Fittings**

**Galv Oval Pipe Fittings**

**Galv Oval 4-Piece Flat 90° Elbow**



| Part # | Mfg #    | Size | Price |
|--------|----------|------|-------|
| 011313 | WA502OF6 | 6"   |       |

**Galv Oval 3-Piece Flat 45° Angle**



| Part # | Mfg #      | Size | Price |
|--------|------------|------|-------|
| 022270 | WA503OF645 | 6"   |       |

**Galv Oval 1-Piece Vertical 90° Elbow**

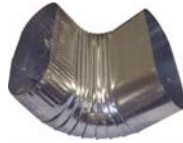

| Part # | Mfg #     | Size | Price |
|--------|-----------|------|-------|
| 011312 | WA502O690 | 6"   |       |

**Galv Oval 1-Piece Vertical 45° Angle**



| Part # | Mfg #     | Size | Price |
|--------|-----------|------|-------|
| 018218 | WA503O645 | 6"   |       |
| 034564 | WA503O745 | 7"   |       |

**Galv Oval Stackhead**



| Part # | Mfg #       | Size          | Price |
|--------|-------------|---------------|-------|
| 011319 | WA507O6106  | 6" x 10" 6"   |       |
| 045254 | WA507O4127  | 4" x 12" x 7" |       |
| 233892 | WA507O76147 | 14" x 6" x 7" |       |
| 171192 | WA507O1266  | 12" x 6" x 6" |       |

**Galv 90° Oval Register Box**

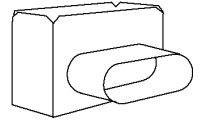

| Part # | Mfg #      | Size          | Price |
|--------|------------|---------------|-------|
| 011321 | WA510O4106 | 4" x 10" - 6" |       |

**Galv 90° Round To Oval Boot**



| Part # | Mfg #     | Size | Price |
|--------|-----------|------|-------|
| 011317 | WA505O690 | 6"   |       |
| 026509 | WA505O790 | 7"   |       |

**Galv Round To Oval Straight Boot**



| Part # | Mfg #   | Size     | Price |
|--------|---------|----------|-------|
| 011314 | WA506O6 | 6" to 6" |       |
| 027404 | WA506O7 | 7" to 7" |       |

**Galv Round To Oval End Boot**



| Part # | Mfg #   | Size | Price |
|--------|---------|------|-------|
| 011318 | WA504O6 | 6"   |       |
| 026511 | WA504O7 | 7"   |       |

**Galv Oval Start Collar**

| Part # | Mfg #    | Size | Price |
|--------|----------|------|-------|
| 022271 | WA513SE6 | 6"   |       |

**Galv Oval Pipe & Fittings**

**Galv 113" Oval Pipe**

| Part # | Mfg #      | Size | Price |
|--------|------------|------|-------|
| 046953 | WA513O6113 | 6"   |       |
| 046954 | WA513O7113 | 7"   |       |

Ducts, Fittings & Accessories

## Oval Pipe & Fittings

### Oval Pipe

#### OVP113 113" Jt Oval Pipe

- 30 Gauge galvanized steel



| Part # | Mfg #   | Size      | Price |
|--------|---------|-----------|-------|
| 179279 | OVP1136 | 6" x 113" |       |
| 179280 | OVP1137 | 7" x 113" |       |

### Oval Fittings

#### 106 Oval to Round Reverse (End) Boot

- 30 Gauge galvanized steel



| Part # | Mfg # | Size | Price |
|--------|-------|------|-------|
| 179290 | 1066  | 6"   |       |
| 179291 | 1067  | 7"   |       |

#### 113 45° Flat Oval Angle (Broadway, Longway)

- 30 Gauge galvanized steel



| Part # | Mfg # | Size | Price |
|--------|-------|------|-------|
| 179282 | 1136  | 6"   |       |

#### 115 45° Vertical Oval Angle (Shortway)

- 30 Gauge galvanized steel



| Part # | Mfg # | Size | Price |
|--------|-------|------|-------|
| 179277 | 1156  | 6"   |       |
| 179278 | 1157  | 7"   |       |

#### 114 90° Flat Oval Elbow (Broadway, Longway)

- 30 Gauge galvanized steel



| Part # | Mfg # | Size | Price |
|--------|-------|------|-------|
| 179281 | 1146  | 6"   |       |

#### 116 90° Vertical Oval Angle (Shortway)

- 30 Gauge galvanized steel



| Part # | Mfg # | Size | Price |
|--------|-------|------|-------|
| 179276 | 1166  | 6"   |       |

#### 124 Oval to Round 90° Boot

- 30 Gauge galvanized steel



| Part # | Mfg # | Size | Price |
|--------|-------|------|-------|
| 179287 | 1246  | 6"   |       |
| 179289 | 1247  | 7"   |       |

#### 124R 90° Oval Register Boot

- 30 Gauge galvanized steel



| Part # | Mfg #    | Size              | Price |
|--------|----------|-------------------|-------|
| 179296 | 124R2126 | 2-1/4" x 12" x 6" |       |



## Oval Pipe & Fittings

### 127 Oval to Round Straight Boot

- 30 Gauge galvanized steel



| Part # | Mfg # | Size | Price |
|--------|-------|------|-------|
| 179283 | 1276  | 6"   |       |
| 179284 | 1277  | 7"   |       |

### 127R Straight Oval Register Boot

- 30 Gauge galvanized steel



| Part # | Mfg #    | Size              | Price |
|--------|----------|-------------------|-------|
| 179293 | 127R2126 | 2-1/4" x 12" x 6" |       |

### 128 Oval to Oval Reverse (End) Boot

- 30 Gauge galvanized steel



| Part # | Mfg # | Size | Price |
|--------|-------|------|-------|
| 179285 | 1286  | 6"   |       |
| 179286 | 1287  | 7"   |       |

### 110 Oval Stackhead



| Part # | Mfg #   | Size          | Price |
|--------|---------|---------------|-------|
| 179292 | 1101066 | 10" x 6" x 6" |       |

Ducts, Fittings & Accessories



## Plenum & Return Air Drops

### Return Air Products

#### Return Air/Cold Air Package

- Package consists of
  - (1) #20 starting collar
  - (2) 30" duct sections
  - (1) return air plenum w/ 1" filter rack
  - (6) 10" drive straps



| Part # | Mfg # | Size      | Price |
|--------|-------|-----------|-------|
| 158632 | 810EC | 20" x 16" |       |
| 158633 | 811EC | 25" x 16" |       |
| 192672 | 811   | 25" x 16" |       |

#### Return Air Support Box with Filter Rack

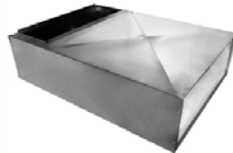

| Part # | Mfg # | Size            | Return Duct Size | Price |
|--------|-------|-----------------|------------------|-------|
| 193763 | SBF36 | 36" x 26" x 15" | 10"x25"          |       |

#### Furnace Box

- 20 x 25 Filter
- 26 Gauge galvanized steel
- Fits most furnace sizes
- Easy access to filter for service
- Raises low profile furnace from ground

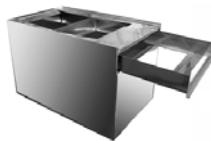

| Part # | Mfg #  | W x H x D                   | Price |
|--------|--------|-----------------------------|-------|
| 193236 | FB2428 | 24-3/4" x 28-1/2" x 18-1/2" |       |

## Plenum & Return Air Drops

### Galvanized Plenum & Return Air Drops

**Galv Low Profile Cold Air Drop - Support Box**  
Complete Package - Return Air Pkg

| Part # | Mfg #  | Size      | Price |
|--------|--------|-----------|-------|
| 012323 | WA1020 | 20" x 10" |       |
| 012324 | WA1225 | 25" x 10" |       |

**Galv Cold Air Drop - Slant Back**  
Complete Package - Return Air Pkg

| Part # | Mfg #         | Size      | Price |
|--------|---------------|-----------|-------|
| 159015 | WA289BRTT1625 | 16" x 25" |       |
| 159014 | WA289BRTT1620 | 16" x 20" |       |

**Galv Cold Air Drop - Slant Back with Filter**  
Complete Package - Return Air Pkg

| Part # | Mfg #           | Size                                 | Price |
|--------|-----------------|--------------------------------------|-------|
| 159023 | WA289KRTT2025   | 20" x 25" with 5" Filter             |       |
| 055507 | WA10251423RASK1 | 20" x 25" with 5" Right Angle Filter |       |

**Galv Cold Air Drop - Slant**  
Complete Package - Return Air Pkg

| Part # | Mfg #         | Size                | Price |
|--------|---------------|---------------------|-------|
| 159019 | WA289KRTT1620 | 20" x 10"-20" x 16" |       |
| 159020 | WA289KRTT1625 | 25" x 10"-25" x 16" |       |
| 159017 | WA289KRTT1425 | 25" x 10"-25" x 14" |       |
| 159016 | WA289KRTT1420 | 20" x 10"-20" x 14" |       |

**Galv Cold Air Boot - Slant Heel**

| Part # | Mfg #         | Size      | Price |
|--------|---------------|-----------|-------|
| 024302 | WA189BRTT1620 | 16" x 20" |       |
| 024303 | WA189BRTT1625 | 16" x 25" |       |

**Galv Cold Air Boot - Slant Heel with Filter**

| Part # | Mfg #       | Size                       | Price |
|--------|-------------|----------------------------|-------|
| 059805 | WA6172025AB | 20" x 25" with 5" Filter   |       |
| 055826 | WA3911      | 20"x25", 5" R Angle Filter |       |

**Galv Cold Air Boot - Square Heel**

| Part # | Mfg #     | Size      | Price |
|--------|-----------|-----------|-------|
| 011254 | WA6172016 | 16" x 20" |       |

### Galv Adjustable Plenum Top

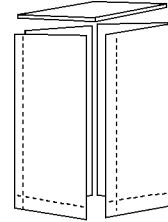

| Part # | Mfg #     | Size      | Price |
|--------|-----------|-----------|-------|
| 008172 | WATOP2323 | 23" x 23" |       |
| 008173 | WATOP2626 | 26" x 26" |       |

### Galv Return Air Support Box

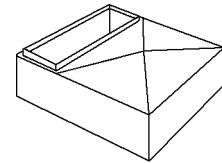

| Part # | Mfg #     | Description              | Price |
|--------|-----------|--------------------------|-------|
| 160421 | WA6388NEW | 32" Wide w/Filter Drawer |       |
| 160422 | WA6402NEW | 39" Wide w/Filter Drawer |       |

### Champion Return Air Drop with Duct Kit

- Side load return with 5" drawer

| Part # | Mfg #          | Size                   | Price |
|--------|----------------|------------------------|-------|
| 158638 | WA3910CHAMPION | Side load w/ 5" Drawer |       |

### Plenums for Ruud Units

| Part # | Mfg #           | Size          | Price |
|--------|-----------------|---------------|-------|
| 179541 | WAPLENUMRUD1736 | 17-1/2" x 36" |       |
| 179542 | WAPLENUMRUD2136 | 21" x 36"     |       |



## Plenum & Return Air Drops

### Plenum

#### Plenum for Nordyne with Filter Drawer

| Part # | Mfg #           | Size                  | Price |
|--------|-----------------|-----------------------|-------|
| 120117 | WAPLENUM1425NOR | 20.25" x 14.25" x 47" |       |
| 122818 | WAPLENUM175NOR  | 20.25" x 17.5" x 47"  |       |
| 122820 | WAPLENUM21NOR   | 20.25" x 21" x 47"    |       |
| 122821 | WAPLENUM245NOR  | 20.25" x 24.5" x 47"  |       |

#### Plenum for Ruud

| Part # | Mfg #          | Size            | Price |
|--------|----------------|-----------------|-------|
| 116829 | WAPLENUM14RUUD | 21" x 14" x 47" |       |
| 116830 | WAPLENUM17RUUD | 21" x 17" x 47" |       |
| 116831 | WAPLENUM21RUUD | 21" x 21" x 47" |       |
| 116832 | WAPLENUM24RUUD | 21" x 24" x 47" |       |

**PVD/PVC Air Duct**

**Heat & Air Duct Pipe**



**Duct Pipe - Bell on One End**

| Part # | Mfg # | Size      | Price |
|--------|-------|-----------|-------|
| 031122 | HA06P | 6" x 10'  |       |
| 031121 | HA08P | 8" x 10'  |       |
| 031120 | HA10P | 10" x 10' |       |
| 031119 | HA12P | 12" x 10' |       |
| 031118 | HA14P | 14" x 10' |       |
| 031117 | HA16P | 16" x 10' |       |

Ducts, Fittings & Accessories

**PVD/PVC Air Duct Fittings**

**Standard PVC Underground Air Duct Fittings**

**PVC Air Duct Tee**



| Part # | Mfg # | Size         | Price |
|--------|-------|--------------|-------|
| 058137 | T888P | 8" x 8" x 8" |       |

**PVC Air Duct Saddle Tee**



| Part # | Mfg # | Size     | Price |
|--------|-------|----------|-------|
| 035155 | S086P | 8" x 6"  |       |
| 035156 | S106P | 10" x 6" |       |

**PVC Air Duct 45° Elbow**



| Part # | Mfg # | Size | Price |
|--------|-------|------|-------|
| 031169 | L645P | 6"   |       |
| 031168 | L845P | 8"   |       |
| 031167 | L105P | 10"  |       |
| 031166 | L125P | 12"  |       |

**PVC Air Duct 90° Elbow**



| Part # | Mfg # | Size | Price |
|--------|-------|------|-------|
| 031163 | L690P | 6"   |       |

**Standard PVC Underground Air Duct Fittings (Continued)**

**PVC Air Duct 90° Elbow**

| Part # | Mfg # | Size | Price |
|--------|-------|------|-------|
| 031162 | L890P | 8"   |       |
| 031161 | L109P | 10"  |       |
| 031160 | L129P | 12"  |       |

**PVC Air Duct Coupling**

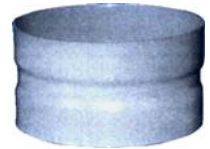

| Part # | Mfg # | Size | Price |
|--------|-------|------|-------|
| 031194 | C600P | 6"   |       |
| 031193 | C800P | 8"   |       |
| 031192 | C100P | 10"  |       |
| 031191 | C120P | 12"  |       |
| 031190 | C140P | 14"  |       |

**PVC Duct Concentric Reducer**



| Part # | Mfg # | Size      | Price |
|--------|-------|-----------|-------|
| 031188 | RC86P | 8" x 6"   |       |
| 031187 | RC10P | 10" x 6"  |       |
| 031186 | RC10P | 10" x 8"  |       |
| 031184 | RC12P | 12" x 10" |       |

**PVC Air Duct End Cap**



| Part # | Mfg # | Size | Price |
|--------|-------|------|-------|
| 031179 | EC60P | 6"   |       |
| 031178 | EC80P | 8"   |       |
| 031177 | EC10P | 10"  |       |
| 031176 | EC12P | 12"  |       |

Ducts, Fittings & Accessories



**PVD/PVC Air Duct Fittings**

**PVC Blackmax Duct Saddle Boot**



| Part # | Mfg #  | Size                       | Price |
|--------|--------|----------------------------|-------|
| 031199 | BM4106 | 4" x 10" on 6" to 16" Pipe |       |
| 031198 | BM4128 | 4" x 12" on 8" Pipe        |       |



**Black Max PVC Underground Duct Fittings**

**PVC 90° Register Boot Box**



| Part # | Mfg # | Size          | Price |
|--------|-------|---------------|-------|
| 031205 | B4106 | 4" x 10" x 6" |       |
| 031204 | B4126 | 4" x 12" x 6" |       |



## Rectangular Collars

### Rectangular Collars

#### 23 Offset Collar

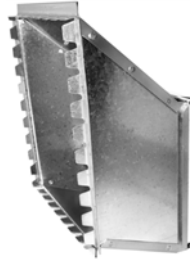

| Part # | Mfg #  | Size      | Price |
|--------|--------|-----------|-------|
| 178788 | 2388   | 8" x 8"   |       |
| 178789 | 23108  | 10" x 8"  |       |
| 178790 | 23128  | 12" x 8"  |       |
| 178791 | 23148  | 14" x 8"  |       |
| 178792 | 23168  | 16" x 8"  |       |
| 178793 | 23188  | 18" x 8"  |       |
| 178794 | 23208  | 20" x 8"  |       |
| 178795 | 23228  | 22" x 8"  |       |
| 178796 | 23248  | 24" x 8"  |       |
| 179231 | 231010 | 10" x 10" |       |
| 179232 | 231210 | 12" x 10" |       |
| 179233 | 231410 | 14" x 10" |       |
| 179234 | 231610 | 16" x 10" |       |
| 179235 | 231810 | 18" x 10" |       |
| 179219 | 232010 | 20" x 10" |       |
| 179230 | 232410 | 24" x 10" |       |
| 179003 | 232412 | 24" x 12" |       |

### Rectangular Collars (Continued)

#### 20 Straight Starting Collar

| Part # | Mfg #  | Size      | Price |
|--------|--------|-----------|-------|
| 178969 | 202510 | 25" x 10" |       |

#### 23AT Transition Collar

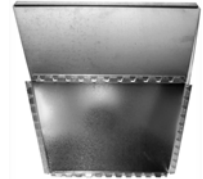

| Part # | Mfg #    | Size      | Price |
|--------|----------|-----------|-------|
| 178878 | 23AT128  | 12" x 8"  |       |
| 178879 | 23AT148  | 14" x 8"  |       |
| 178880 | 23AT168  | 16" x 8"  |       |
| 178881 | 23AT188  | 18" x 8"  |       |
| 179218 | 23AT2010 | 20" x 10" |       |
| 178882 | 23AT208  | 20" x 8"  |       |
| 178883 | 23AT228  | 22" x 8"  |       |
| 179005 | 23AT2410 | 24" x 10" |       |
| 179004 | 23AT2412 | 24" x 12" |       |
| 178884 | 23AT248  | 24" x 8"  |       |
| 178885 | 23AT3010 | 30" x 10" |       |
| 178886 | 23AT308  | 30" x 8"  |       |

#### 20 Straight Starting Collar



| Part # | Mfg #  | Size      | Price |
|--------|--------|-----------|-------|
| 178797 | 2088   | 8" x 8"   |       |
| 178798 | 20108  | 10" x 8"  |       |
| 178799 | 20128  | 12" x 8"  |       |
| 178800 | 20148  | 14" x 8"  |       |
| 178801 | 20168  | 16" x 8"  |       |
| 178802 | 20188  | 18" x 8"  |       |
| 178803 | 20208  | 20" x 8"  |       |
| 178804 | 20228  | 22" x 8"  |       |
| 178805 | 20248  | 24" x 8"  |       |
| 179131 | 201010 | 10" x 10" |       |
| 179132 | 202010 | 20" x 10" |       |

**Rectangular Fittings**

**Galvanized Duct Collars**

**Galv Straight Starting Collar**

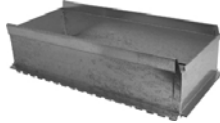

| Part # | Mfg #         | Size      | Price |
|--------|---------------|-----------|-------|
| 010955 | WA141SD2S88   | 8" x 8"   |       |
| 010947 | WA141SD2S108  | 10" x 8"  |       |
| 010948 | WA141SD2S128  | 12" x 8"  |       |
| 010949 | WA141SD2S148  | 14" x 8"  |       |
| 010950 | WA141SD2S168  | 16" x 8"  |       |
| 010951 | WA141SD2S188  | 18" x 8"  |       |
| 010952 | WA141SD2S208  | 20" x 8"  |       |
| 046899 | WA141SD2S2010 | 20" x 10" |       |
| 010953 | WA141SD2S228  | 22" x 8"  |       |
| 010954 | WA141SD2S248  | 24" x 8"  |       |
| 026677 | WA141SD2S2510 | 25" x 10" |       |
| 224763 | WA141SD2S308  | 30" x 8"  |       |

**Galv Transition Takeoff Collar Center**

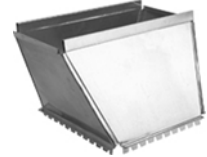

| Part # | Mfg #           | Size      | Price |
|--------|-----------------|-----------|-------|
| 011028 | WA81CSD2R2S128  | 12" x 8"  |       |
| 011029 | WA81CSD2R2S148  | 14" x 8"  |       |
| 011030 | WA81CSD2R2S168  | 16" x 8"  |       |
| 011031 | WA81CSD2R2S188  | 18" x 8"  |       |
| 011032 | WA81CSD2R2S208  | 20" x 8"  |       |
| 035899 | WA81CSD2R2S2010 | 20" x 10" |       |
| 011033 | WA81CSD2R2S228  | 22" x 8"  |       |
| 011034 | WA81CSD2R2S248  | 24" x 8"  |       |
| 033651 | WA81CSD2R2S2410 | 24" x 10" |       |
| 033650 | WA81CSD2R2S2412 | 24" x 12" |       |
| 030893 | WA81CSD2R2S308  | 30" x 8"  |       |

**Galv Offset Takeoff Collar**



| Part # | Mfg #        | Size      | Price |
|--------|--------------|-----------|-------|
| 010946 | WA151SD288   | 8" x 8"   |       |
| 010938 | WA151SD2108  | 10" x 8"  |       |
| 010939 | WA151SD2128  | 12" x 8"  |       |
| 162192 | WA151SD21210 | 12" x 10" |       |
| 010940 | WA151SD2148  | 14" x 8"  |       |
| 116860 | WA151SD21410 | 14" x 10" |       |
| 010941 | WA151SD2168  | 16" x 8"  |       |
| 116861 | WA151SD21610 | 16" x 10" |       |
| 010942 | WA151SD2188  | 18" x 8"  |       |
| 156107 | WA151SD21810 | 18" x 10" |       |
| 010943 | WA151SD2208  | 20" x 8"  |       |
| 035900 | WA151SD22010 | 20" x 10" |       |
| 010944 | WA151SD2228  | 22" x 8"  |       |
| 010945 | WA151SD2248  | 24" x 8"  |       |
| 033649 | WA151SD2410  | 24" x 10" |       |
| 033648 | WA151SD2412  | 24" x 12" |       |



## Rectangular Duct

### Rectangular Duct

#### Trunk Duct

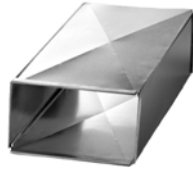

#### 60" Joint Length

| Part # | Mfg #    | Size      | Price |
|--------|----------|-----------|-------|
| 179194 | TD6088   | 8" x 8"   |       |
| 179195 | TD60108  | 10" x 8"  |       |
| 179196 | TD60128  | 12" x 8"  |       |
| 179197 | TD60148  | 14" x 8"  |       |
| 179198 | TD60168  | 16" x 8"  |       |
| 179199 | TD60188  | 18" x 8"  |       |
| 179200 | TD60208  | 20" x 8"  |       |
| 179201 | TD60228  | 22" x 8"  |       |
| 179202 | TD60248  | 24" x 8"  |       |
| 179191 | TD60268  | 26" x 8"  |       |
| 179192 | TD60288  | 28" x 8"  |       |
| 179193 | TD60308  | 30" x 8"  |       |
| 179203 | TD601010 | 10" x 10" |       |
| 179204 | TD601210 | 12" x 10" |       |
| 179205 | TD601410 | 14" x 10" |       |
| 179206 | TD601610 | 16" x 10" |       |
| 179207 | TD601810 | 18" x 10" |       |
| 179208 | TD602010 | 20" x 10" |       |
| 214481 | TD602012 | 20" x 12" |       |
| 194055 | TD602210 | 22" x 10" |       |
| 214475 | TD602212 | 22" x 12" |       |
| 179209 | TD602410 | 24" x 10" |       |
| 179210 | TD602510 | 25" x 10" |       |
| 179211 | TD603010 | 30" x 10" |       |

#### 48" Joint Length

| Part # | Mfg #    | Size      | Price |
|--------|----------|-----------|-------|
| 179188 | TD482010 | 20" x 10" |       |
| 179186 | TD482410 | 24" x 10" |       |
| 179187 | TD482412 | 24" x 12" |       |

#### 30" Joint Length

| Part # | Mfg #    | Size      | Price |
|--------|----------|-----------|-------|
| 179355 | TD302510 | 25" x 10" |       |

**Rectangular Duct**

**Galvanized Duct**

**Galv Duct 32" Button-Lock**

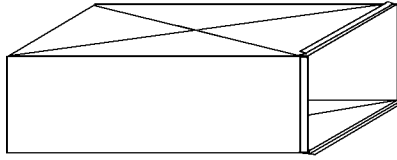

| Part # | Mfg #          | Size      | Price |
|--------|----------------|-----------|-------|
| 019920 | WA125SD5201032 | 20" x 10" |       |
| 011021 | WA125SD5251032 | 25" x 10" |       |

**Galv Duct 4' Button-Lock**

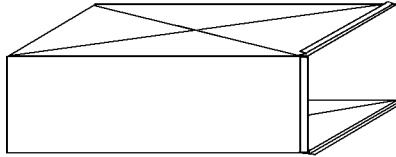

| Part # | Mfg #          | Size      | Price |
|--------|----------------|-----------|-------|
| 035901 | WA125SDR201048 | 20" x 10" |       |
| 033653 | WA125SDR241048 | 24" x 10" |       |
| 033652 | WA125SDR241248 | 24" x 12" |       |

**Galv Duct 5' Button-Lock**

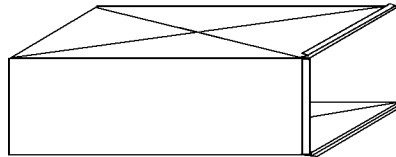

| Part # | Mfg #          | Size      | Price |
|--------|----------------|-----------|-------|
| 011025 | WA125SD58860   | 8" x 8"   |       |
| 011013 | WA125SD510860  | 10" x 8"  |       |
| 011014 | WA125SD512860  | 12" x 8"  |       |
| 011015 | WA125SD514860  | 14" x 8"  |       |
| 011016 | WA125SD516860  | 16" x 8"  |       |
| 011017 | WA125SD518860  | 18" x 8"  |       |
| 011018 | WA125SD520860  | 20" x 8"  |       |
| 011019 | WA125SD522860  | 22" x 8"  |       |
| 091621 | WA125SDR221060 | 22" x 10" |       |
| 011020 | WA125SD524860  | 24" x 8"  |       |
| 062795 | WA125SDR26860  | 26" x 8"  |       |
| 062794 | WA125SDR28860  | 28" x 8"  |       |
| 110667 | WA125SD530860  | 30" x 8"  |       |
| 092658 | WA125SDR121060 | 12" x 10" |       |
| 092657 | WA125SDR141060 | 14" x 10" |       |
| 072107 | WA125SDR161060 | 16" x 10" |       |
| 092627 | WA125SDR181060 | 18" x 10" |       |
| 101661 | WA125SDR201060 | 20" x 10" |       |

**Galvanized Duct (Continued)**

**Galv Duct 5' Button-Lock**

| Part # | Mfg #          | Size      | Price |
|--------|----------------|-----------|-------|
| 101662 | WA125SDR251060 | 25" x 10" |       |
| 101605 | WA125SD5301060 | 30" x 10" |       |

**Trunk Duct**



| Part # | Mfg #          | Size        | Price |
|--------|----------------|-------------|-------|
| 177728 | WA125SD510848  | 10"x8"x48"  |       |
| 177732 | WA125SD512848  | 12"x8"x48"  |       |
| 177729 | WA125SD514848  | 14"x8"x48"  |       |
| 177739 | WA125SD516848  | 16"x8"x48"  |       |
| 177731 | WA125SD518848  | 18"x8"x48"  |       |
| 177734 | WA125SD520848  | 20"x8"x48"  |       |
| 177735 | WA125SD522848  | 22"x8"x48"  |       |
| 177736 | WA125SD524848  | 24"x8"x48"  |       |
| 159471 | WA125SD5101060 | 10"x10"x60" |       |
| 159470 | WA125SD5241060 | 24"x10"x60" |       |
| 152880 | WA125SDR251260 | 25"x12"x60" |       |

Ducts, Fittings & Accessories

## Rectangular Elbows

### Rectangular Fittings

#### 13 45° Flat (Broadway) Angle Radius Throat



| Part # | Mfg #  | Size      | Price |
|--------|--------|-----------|-------|
| 178858 | 1388   | 8" x 8"   |       |
| 178859 | 13108  | 10" x 8"  |       |
| 178860 | 13128  | 12" x 8"  |       |
| 178861 | 13148  | 14" x 8"  |       |
| 178862 | 13168  | 16" x 8"  |       |
| 178863 | 13188  | 18" x 8"  |       |
| 178864 | 13208  | 20" x 8"  |       |
| 178865 | 13228  | 22" x 8"  |       |
| 178866 | 13248  | 24" x 8"  |       |
| 178867 | 13308  | 30" x 8"  |       |
| 179265 | 131010 | 10" x 10" |       |
| 181829 | 131210 | 12" x 10" |       |
| 179266 | 131410 | 14" x 10" |       |
| 179267 | 131610 | 16" x 10" |       |
| 179268 | 131810 | 18" x 10" |       |
| 179269 | 132010 | 20" x 10" |       |
| 179270 | 132210 | 22" x 10" |       |
| 179271 | 132410 | 24" x 10" |       |
| 179272 | 133010 | 30" x 10" |       |

#### 13S 45° Flat (Broadway) Angle Square Throat

| Part # | Mfg #   | Size      | Price |
|--------|---------|-----------|-------|
| 178652 | 13S1210 | 12" x 10" |       |
| 179225 | 13S2510 | 25" x 10" |       |

#### 15 45° Vertical (Shortway) Angle Radius Throat

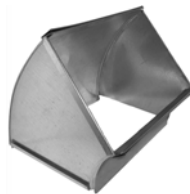

| Part # | Mfg # | Size     | Price |
|--------|-------|----------|-------|
| 178846 | 1588  | 8" x 8"  |       |
| 178847 | 15108 | 10" x 8" |       |
| 178848 | 15128 | 12" x 8" |       |
| 178849 | 15148 | 14" x 8" |       |

### Rectangular Fittings (Continued)

#### 15 45° Vertical (Shortway) Angle Radius Throat

| Part # | Mfg #  | Size      | Price |
|--------|--------|-----------|-------|
| 178850 | 15168  | 16" x 8"  |       |
| 178851 | 15188  | 18" x 8"  |       |
| 178853 | 15208  | 20" x 8"  |       |
| 178855 | 15228  | 22" x 8"  |       |
| 178856 | 15248  | 24" x 8"  |       |
| 178857 | 15308  | 30" x 8"  |       |
| 179255 | 151010 | 10" x 10" |       |
| 179257 | 151210 | 12" x 10" |       |
| 179258 | 151410 | 14" x 10" |       |
| 179259 | 151610 | 16" x 10" |       |
| 179260 | 151810 | 18" x 10" |       |
| 179249 | 152010 | 20" x 10" |       |
| 179261 | 152210 | 22" x 10" |       |
| 179263 | 152410 | 24" x 10" |       |
| 179264 | 153010 | 30" x 10" |       |

#### 15S 45° Vertical (Shortway) Angle Square Throat

| Part # | Mfg #   | Size      | Price |
|--------|---------|-----------|-------|
| 179224 | 15S2510 | 25" x 10" |       |

#### 14 90° Flat (Broadway) Elbow Radius Throat

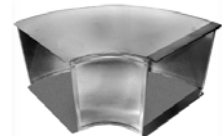

| Part # | Mfg #  | Size      | Price |
|--------|--------|-----------|-------|
| 178868 | 1488   | 8" x 8"   |       |
| 178869 | 14108  | 10" x 8"  |       |
| 178870 | 14128  | 12" x 8"  |       |
| 178871 | 14148  | 14" x 8"  |       |
| 178872 | 14168  | 16" x 8"  |       |
| 178873 | 14188  | 18" x 8"  |       |
| 178874 | 14208  | 20" x 8"  |       |
| 178875 | 14228  | 22" x 8"  |       |
| 178876 | 14248  | 24" x 8"  |       |
| 178877 | 14308  | 30" x 8"  |       |
| 179298 | 141010 | 10" x 10" |       |
| 179236 | 141210 | 12" x 10" |       |
| 179222 | 142510 | 25" x 10" |       |
| 179275 | 143010 | 30" x 10" |       |



## Rectangular Elbows

### 14S 90° Flat (Broadway) Elbow Square Throat

| Part # | Mfg #   | Size      | Price |
|--------|---------|-----------|-------|
| 180277 | 14S148  | 14" x 8"  |       |
| 179243 | 14S1410 | 14" x 10" |       |
| 179244 | 14S1610 | 16" x 10" |       |
| 179245 | 14S1810 | 18" x 10" |       |
| 179246 | 14S2010 | 20" x 10" |       |
| 179247 | 14S2410 | 24" x 10" |       |
| 179248 | 14S2412 | 24" x 12" |       |

### 16 Vertical (Shortway) Elbow Radius Throat

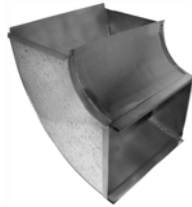

| Part # | Mfg #  | Size      | Price |
|--------|--------|-----------|-------|
| 178835 | 1688   | 8" x 8"   |       |
| 178836 | 16108  | 10" x 8"  |       |
| 178837 | 16128  | 12" x 8"  |       |
| 178838 | 16148  | 14" x 8"  |       |
| 178839 | 16168  | 16" x 8"  |       |
| 178840 | 16188  | 18" x 8"  |       |
| 178841 | 16208  | 20" x 8"  |       |
| 178842 | 16228  | 22" x 8"  |       |
| 178843 | 16248  | 24" x 8"  |       |
| 178845 | 16308  | 30" x 8"  |       |
| 181831 | 161010 | 10" x 10" |       |
| 181830 | 161210 | 12" x 10" |       |
| 179274 | 163010 | 30" x 10" |       |

### 16S Vertical (Shortway) Elbow Square Throat

| Part # | Mfg #   | Size      | Price |
|--------|---------|-----------|-------|
| 179237 | 16S1410 | 14" x 10" |       |
| 179238 | 16S1610 | 16" x 10" |       |
| 179239 | 16S1810 | 18" x 10" |       |
| 179240 | 16S2010 | 20" x 10" |       |
| 179241 | 16S2410 | 24" x 10" |       |
| 179221 | 16S2510 | 25" x 10" |       |
| 179242 | 16S2412 | 24" x 12" |       |

**Rectangular Fittings**

**Galvanized Duct Elbows**

**Galv 45° Vertical Shortway Angle**

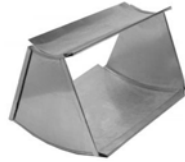

| Part # | Mfg #          | Size      | Price |
|--------|----------------|-----------|-------|
| 010995 | WA121SDR2S88   | 8" x 8"   |       |
| 010988 | WA121SDR2S108  | 10" x 8"  |       |
| 010989 | WA121SDR2S128  | 12" x 8"  |       |
| 150760 | WA121SDR2S1210 | 12" x 10" |       |
| 010990 | WA121SDR2S148  | 14" x 8"  |       |
| 150759 | WA121SDR2S1410 | 14" x 10" |       |
| 010991 | WA121SDR2S168  | 16" x 8"  |       |
| 150758 | WA121SDR2S1610 | 16" x 10" |       |
| 010992 | WA121SDR2S188  | 18" x 8"  |       |
| 150756 | WA121SDR2S1810 | 18" x 10" |       |
| 010993 | WA121SDR2S208  | 20" x 8"  |       |
| 145238 | WA121SDR2S2010 | 20" x 10" |       |
| 048613 | WA121SDR2S228  | 22" x 8"  |       |
| 010994 | WA121SDR2S248  | 24" x 8"  |       |
| 075912 | WA121SDR2S2410 | 24" x 10" |       |
| 133193 | WA121SD2S2510  | 25" x 10" |       |
| 150755 | WA121SDR2S3010 | 30" x 10" |       |

**Galv 45° Horizontal Longway Angle**

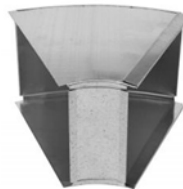

| Part # | Mfg #          | Size      | Price |
|--------|----------------|-----------|-------|
| 046407 | WA123SDR2S88   | 8" x 8"   |       |
| 010996 | WA123SDR2S108  | 10" x 8"  |       |
| 010997 | WA123SDR2S128  | 12" x 8"  |       |
| 150741 | WA123SDR2S1210 | 12" x 10" |       |
| 010998 | WA123SDR2S148  | 14" x 8"  |       |
| 150742 | WA123SDR2S1410 | 14" x 10" |       |
| 010999 | WA123SDR2S168  | 16" x 8"  |       |
| 150743 | WA123SDR2S1610 | 16" x 10" |       |
| 011000 | WA123SDR2S188  | 18" x 8"  |       |
| 150744 | WA123SDR2S1810 | 18" x 10" |       |
| 011001 | WA123SDR2S208  | 20" x 8"  |       |
| 150745 | WA123SDR2S2010 | 20" x 10" |       |
| 011002 | WA123SDR2S228  | 22" x 8"  |       |

**Galvanized Duct Elbows (Continued)**

**Galv 45° Horizontal Longway Angle**

| Part # | Mfg #          | Size      | Price |
|--------|----------------|-----------|-------|
| 011003 | WA123SDR2S248  | 24" x 8"  |       |
| 133195 | WA123SD2S2510  | 25" x 10" |       |
| 108604 | WA123SDR2S308  | 30" x 8"  |       |
| 150747 | WA123SDR2S3010 | 30" x 10" |       |

**Galv 90° Vertical Shortway Elbow with Mitered Throat**



| Part # | Mfg #           | Size      | Price |
|--------|-----------------|-----------|-------|
| 091104 | WA120SD2S8822   | 8" x 8"   |       |
| 091103 | WA120SD2S10822  | 10" x 8"  |       |
| 091105 | WA120SD2S12822  | 12" x 8"  |       |
| 091106 | WA120SD2S14822  | 14" x 8"  |       |
| 091119 | WA120SD2S141022 | 14" x 10" |       |
| 091107 | WA120SD2S16822  | 16" x 8"  |       |
| 091120 | WA120SD2S161022 | 16" x 10" |       |
| 091113 | WA120SD2S18822  | 18" x 8"  |       |
| 091121 | WA120SD2S181022 | 18" x 10" |       |
| 091114 | WA120SD2S20822  | 20" x 8"  |       |
| 091122 | WA120SD2S201022 | 20" x 10" |       |
| 091115 | WA120SD2S22822  | 22" x 8"  |       |
| 091116 | WA120SD2S24822  | 24" x 8"  |       |
| 091123 | WA120SD2S241022 | 24" x 10" |       |
| 091124 | WA120SD2S241222 | 24" x 12" |       |
| 133190 | WA120SD251022   | 25" x 10" |       |
| 010987 | WA120SDR2S88    | 8" x 8"   |       |
| 010979 | WA120SDR2S108   | 10" x 8"  |       |
| 010980 | WA120SDR2S128   | 12" x 8"  |       |
| 164729 | WA120SDR2S1210  | 12" x 10" |       |
| 010981 | WA120SDR2S148   | 14" x 8"  |       |
| 164730 | WA120SDR2S1410  | 14" x 10" |       |
| 010982 | WA120SDR2S168   | 16" x 8"  |       |
| 164731 | WA120SDR2S1610  | 16" x 10" |       |
| 010983 | WA120SDR2S188   | 18" x 8"  |       |
| 164732 | WA120SDR2S1810  | 18" x 10" |       |
| 010984 | WA120SDR2S208   | 20" x 8"  |       |
| 164733 | WA120SDR2S2010  | 20" x 10" |       |
| 010985 | WA120SDR2S228   | 22" x 8"  |       |
| 010986 | WA120SDR2S248   | 24" x 8"  |       |
| 091117 | WA120SDR2S308   | 30" x 8"  |       |



## Rectangular Fittings

### Galv 90° Horizontal Longway Elbow with Mitered Throat

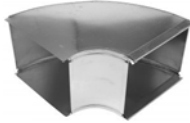

| Part # | Mfg #           | Size      | Price |
|--------|-----------------|-----------|-------|
| 091127 | WA122SD2S8822   | 8" x 8"   |       |
| 091128 | WA122SD2S10822  | 10" x 8"  |       |
| 091129 | WA122SD2S12822  | 12" x 8"  |       |
| 091130 | WA122SD2S14822  | 14" x 8"  |       |
| 091136 | WA122SD2S141022 | 14" x 10" |       |
| 091131 | WA122SD2S16822  | 16" x 8"  |       |
| 091137 | WA122SD2S161022 | 16" x 10" |       |
| 091132 | WA122SD2S18822  | 18" x 8"  |       |
| 091138 | WA122SD2S181022 | 18" x 10" |       |
| 091133 | WA122SD2S20822  | 20" x 8"  |       |
| 091139 | WA122SD2S201022 | 20" x 10" |       |
| 091134 | WA122SD2S22822  | 22" x 8"  |       |
| 091135 | WA122SD2S24822  | 24" x 8"  |       |
| 091141 | WA122SD2S241222 | 24" x 12" |       |
| 011012 | WA122SDR2S88    | 8" x 8"   |       |
| 011004 | WA122SDR2S108   | 10" x 8"  |       |
| 011005 | WA122SDR2S128   | 12" x 8"  |       |
| 164735 | WA122SDR2S1210  | 12" x 10" |       |
| 011006 | WA122SDR2S148   | 14" x 8"  |       |
| 164736 | WA122SDR2S1410  | 14" x 10" |       |
| 011007 | WA122SDR2S168   | 16" x 8"  |       |
| 164737 | WA122SDR2S1610  | 16" x 10" |       |
| 011008 | WA122SDR2S188   | 18" x 8"  |       |
| 164738 | WA122SDR2S1810  | 18" x 10" |       |
| 011009 | WA122SDR2S208   | 20" x 8"  |       |
| 164739 | WA122SDR2S2010  | 20" x 10" |       |
| 011010 | WA122SDR2S228   | 22" x 8"  |       |
| 011011 | WA122SDR2S248   | 24" x 8"  |       |
| 133192 | WA122SDR2S2510  | 25" x 10" |       |
| 108605 | WA122SDR2S308   | 30" x 8"  |       |



## Rectangular Miscellaneous

### Reducers

#### 35 Duct Reducer



| Part # | Mfg # | Size     | Price |
|--------|-------|----------|-------|
| 179608 | 352   | 0-2"     |       |
| 179609 | 354   | 0-4"     |       |
| 181987 | 356   | 0-6"     |       |
| 181988 | 358   | 0-8"     |       |
| 178887 | 35210 | 10"/0-2" |       |
| 178888 | 35410 | 10"/0-4" |       |
| 178889 | 35610 | 10"/0-6" |       |
| 178890 | 35810 | 10"/0-8" |       |

#### 17 Duct Transition



| Part # | Mfg #     | Size      | Price |
|--------|-----------|-----------|-------|
| 179220 | 172010208 | 20" x 10" |       |
| 179007 | 172410248 | 24" x 10" |       |
| 179006 | 172412248 | 24" x 12" |       |

### Caps

#### 21 End Cap



| Part # | Mfg #  | Size      | Price |
|--------|--------|-----------|-------|
| 178891 | 2188   | 8" x 8"   |       |
| 178892 | 21108  | 10" x 8"  |       |
| 197516 | 211010 | 10" x 10" |       |
| 178893 | 21128  | 12" x 8"  |       |
| 178894 | 21148  | 14" x 8"  |       |
| 178895 | 21168  | 16" x 8"  |       |
| 178896 | 21188  | 18" x 8"  |       |
| 197511 | 211810 | 18" x 10" |       |

### Caps (Continued)

#### 21 End Cap

| Part # | Mfg #  | Size      | Price |
|--------|--------|-----------|-------|
| 178897 | 21208  | 20" x 8"  |       |
| 178898 | 21228  | 22" x 8"  |       |
| 178899 | 21248  | 24" x 8"  |       |
| 178900 | 21308  | 30" x 8"  |       |
| 179250 | 211210 | 12" x 10" |       |
| 179251 | 212010 | 20" x 10" |       |
| 194620 | 212210 | 22" x 10" |       |
| 179252 | 212410 | 24" x 10" |       |
| 179148 | 212510 | 25" x 10" |       |

### Register Frames

#### 31 Return Air Frame



| Part # | Mfg # | Size     | Price |
|--------|-------|----------|-------|
| 179102 | 31146 | 14" x 6" |       |
| 179103 | 31246 | 24" x 6" |       |
| 179104 | 31306 | 30" x 6" |       |

#### 31PF Plaster Frame

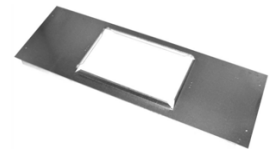

| Part # | Mfg #     | Size            | Price |
|--------|-----------|-----------------|-------|
| 179105 | 31PF16410 | F/16", 4" x 10" |       |
| 179106 | 31PF16412 | F/16", 4" x 12" |       |
| 179107 | 31PF410   | F/24", 4" x 10" |       |
| 179109 | 31PF412   | F/24", 4" x 12" |       |

#### Filter Rack



| Part # | Mfg #    | Size           | Price |
|--------|----------|----------------|-------|
| 178978 | FR1620   | 16" x 20" x 1" |       |
| 178968 | FR1625   | 16" x 25" x 1" |       |
| 243468 | FR411420 | 14" x 20"      |       |
| 243469 | FR411425 | 14" x 25"      |       |
| 243470 | FR411620 | 16" x 20"      |       |



## Rectangular Miscellaneous

### Register Frames (Continued)

#### Filter Rack

| Part # | Mfg #    | Size      | Price |
|--------|----------|-----------|-------|
| 243471 | FR411625 | 16" x 25" |       |
| 243473 | FR412020 | 20" x 20" |       |
| 243474 | FR412025 | 20" x 25" |       |

#### Boots

#### 51FCRD Straight Ext Boot w/Flange & Ceiling Radiation Damper

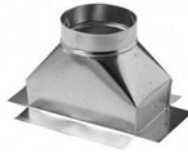

| Part # | Mfg #  | Size          | Price |
|--------|--------|---------------|-------|
| 226531 | 51FCRD | 4" x 12" x 6" |       |

#### 51F Straight Ceiling Box w/ Flange

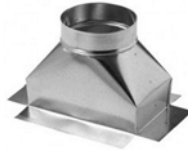

| Part # | Mfg #     | Size          | Price |
|--------|-----------|---------------|-------|
| 194003 | 51F244106 | 4" x 10" x 6" |       |

#### 51P Straight Ceiling Box with Plate

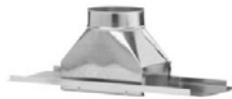

| Part # | Mfg #     | Size            | Price |
|--------|-----------|-----------------|-------|
| 193689 | 51P4106   | 4" x 10" x 6"   |       |
| 243893 | 51P141410 | 14" x 14" x 10" |       |

#### 59P Boot w/ Plate

| Part # | Mfg #   | Size          | Price |
|--------|---------|---------------|-------|
| 193690 | 59P4106 | 4" x 10" x 6" |       |
| 179212 | 59P4126 | 4" x 12" x 6" |       |

### Outlets & Boxes

#### 90° Ceiling Box w/ Flange



| Part # | Mfg #     | Size          | Price |
|--------|-----------|---------------|-------|
| 194006 | 59F244106 | 4" x 10" x 6" |       |
| 194007 | 59F244126 | 4" x 12" x 6" |       |
| 194008 | 59F244127 | 4" x 12" x 7" |       |
| 195620 | 59F4128   | 4" x 12" x 8" |       |

#### 90° Extension Boot w/ Flange & Ceiling Radiation Damper



| Part # | Mfg #      | Size          | Price |
|--------|------------|---------------|-------|
| 196379 | 59FCRD4127 | 4" x 12" x 7" |       |

### 'S' & Drive Cleats

#### S Clip



| Part # | Mfg # | Size              | Price |
|--------|-------|-------------------|-------|
| 179181 | 3760  | 60" with 1/2" Leg |       |
| 179174 | 6S60  | 60"               |       |
| 192605 | 6S120 | 120"              |       |

#### Drive Clips

| Part # | Mfg # | Size | Price |
|--------|-------|------|-------|
| 179175 | 8D8   | 8"   |       |
| 179176 | 8D10  | 10"  |       |
| 179177 | 8D12  | 12"  |       |
| 179178 | 8D60  | 60"  |       |

#### Drive Cleats



| Part # | Mfg #    | Size                         | Price |
|--------|----------|------------------------------|-------|
| 179173 | 37120    | 120" Rigid S-Cleat, 1/2" Leg |       |
| 192604 | 13512026 | 1" x 10'                     |       |



## Rectangular Miscellaneous

### 'S' & Drive Cleats (Continued)

#### Drive Cleats

| Part # | Mfg # | Size | Price |
|--------|-------|------|-------|
| 192606 | 8D    | 120" |       |

#### Mounting Rails



| Part # | Mfg # | Size | Price |
|--------|-------|------|-------|
| 193110 | MR24  | 24"  |       |

**Rectangular Fittings**

**Galvanized Duct Fittings**

**Galv Duct End Cap**



| Part # | Mfg #          | Size      | Price |
|--------|----------------|-----------|-------|
| 011049 | WA187SETSD88   | 8" x 8"   |       |
| 011040 | WA187SETSD108  | 10" x 8"  |       |
| 011041 | WA187SETSD128  | 12" x 8"  |       |
| 145671 | WA187SETSD1210 | 12" x 10" |       |
| 011042 | WA187SETSD148  | 14" x 8"  |       |
| 164414 | WA187SETSD1410 | 14" x 10" |       |
| 011043 | WA187SETSD168  | 16" x 8"  |       |
| 245461 | WA187SETSD1610 | 16" x 10" |       |
| 011044 | WA187SETSD188  | 18" x 8"  |       |
| 246864 | WA187SETSD1810 | 18" x 10" |       |
| 011045 | WA187SETSD208  | 20" x 8"  |       |
| 011046 | WA187SETSD228  | 22" x 8"  |       |
| 011047 | WA187SETSD248  | 24" x 8"  |       |
| 011048 | WA187SETSD308  | 30" x 8"  |       |
| 240217 | WA187SETSD3010 | 30" x 10" |       |
| 111958 | WA187SETSD2010 | 20" x 10" |       |
| 109319 | WA187SETSD2410 | 24" x 10" |       |
| 035597 | WA187SETSD2510 | 25" x 10" |       |

**Galv Drive Cleat**

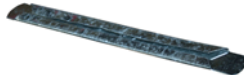

| Part # | Mfg #     | Size | Price |
|--------|-----------|------|-------|
| 011170 | WADRIVE8  | 8"   |       |
| 011168 | WADRIVE10 | 10"  |       |
| 022826 | WADRIVE12 | 12"  |       |
| 011169 | WADRIVE60 | 60"  |       |

**Galv Flat S-Cleat**



| Part # | Mfg #   | Size | Price |
|--------|---------|------|-------|
| 011166 | WA32460 | 60"  |       |

**Galv Standing S-Cleat**

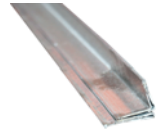

| Part # | Mfg #       | Size | Price |
|--------|-------------|------|-------|
| 011163 | WA32412S60  | 60"  |       |
| 011162 | WA3241S120  | 120" |       |
| 227015 | WA32412S120 | 120" |       |

**Galv Plaster Frame - Rectangular**

| Part # | Mfg #     | Size                     | Price |
|--------|-----------|--------------------------|-------|
| 096773 | WAPF10416 | 4" x 10" - 16" On Center |       |
| 096774 | WAPF41216 | 4" x 12" - 16" On Center |       |
| 096775 | WAPF41024 | 4" x 10" - 24" On Center |       |
| 096776 | WAPF412   | 4" x 12" - 24" On Center |       |
| 011256 | WACAF146  | 6" x 14"                 |       |
| 026392 | WACAF246  | 6" x 24"                 |       |
| 011257 | WACAF306  | 6" x 30"                 |       |

**Galv Plaster Frame - Round**

| Part # | Mfg #   | Size | Price |
|--------|---------|------|-------|
| 102571 | WA61860 | 60"  |       |

**Galv Filter Rack**



| Part # | Mfg #          | Size           | Price |
|--------|----------------|----------------|-------|
| 036258 | WA189FR1620    | 16" x 20" x 1" |       |
| 029512 | WA189FR1625    | 16" x 25" x 1" |       |
| 112204 | WA189FR2025    | 20" x 25" x 1" |       |
| 011124 | WA189FR4WD1620 | 16" x 20" x 6" |       |
| 018112 | WA189FR4WD1625 | 16" x 25" x 6" |       |
| 041202 | WA189FR4WD2025 | 20" x 25" x 6" |       |
| 154847 | WA89FRF1625    | 16" x 25"      |       |

**Galv Trunk Reducer**



| Part # | Mfg #       | Size               | Price |
|--------|-------------|--------------------|-------|
| 035902 | WA190SD2010 | 20" x 10"-20" x 8" |       |

**Rectangular Fittings**

**Galvanized Duct Fittings (Continued)**

**Galv Trunk Reducer**

| Part # | Mfg #          | Size               | Price |
|--------|----------------|--------------------|-------|
| 033647 | WA190SD2410248 | 24" x 10"-24" x 8" |       |
| 033654 | WA190SD2412248 | 24" x 12"-24" x 8" |       |

**Galv Reducer**

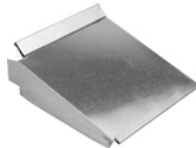

| Part # | Mfg #       | Size       | Price |
|--------|-------------|------------|-------|
| 166231 | WA200SD02   | 0-2"       |       |
| 166233 | WA200SD04   | 0-4"       |       |
| 166234 | WA200SD06   | 0-6"       |       |
| 166235 | WA200SD08   | 0-8"       |       |
| 166236 | WA200SD1002 | 10" / 0-2" |       |
| 166237 | WA200SD1004 | 10" / 0-4" |       |

**Solid Strap**



| Part # | Mfg #         | Size      | Price |
|--------|---------------|-----------|-------|
| 164714 | WASOLID110026 | 1" x 100' |       |
| 243315 | WASOLID110024 | 1" x 100' |       |

**Boot Rail**



| Part # | Mfg #        | Size | Price |
|--------|--------------|------|-------|
| 160238 | WABOOTRAIL26 | 26"  |       |

Ducts, Fittings & Accessories



---

---

## Rectangular Fittings

---

---

### Speedi-Boot™ Boot Hanger

- Telescoping arms
- Dust and debris cover
- Air tight gasket
- Rigid mud-ring and galvanized frame



| Part # | Mfg #   | Size     | Price |
|--------|---------|----------|-------|
| 080008 | SBH-410 | 4" x 10" |       |
| 080009 | SBH-412 | 4" x 12" |       |



## Round Boots

### Round Boots

#### 24R 90° Register Boot



| Part # | Mfg #   | Size              | Price |
|--------|---------|-------------------|-------|
| 187966 | 24R2104 | 2-1/4" x 10" x 4" |       |
| 179047 | 24R2105 | 2-1/4" x 10" x 5" |       |
| 179048 | 24R2106 | 2-1/4" x 10" x 6" |       |
| 179049 | 24R2125 | 2-1/4" x 12" x 5" |       |
| 179046 | 24R2126 | 2-1/4" x 12" x 6" |       |
| 179050 | 24R2127 | 2-1/4" x 12" x 7" |       |
| 179051 | 24R2146 | 2-1/4" x 14" x 6" |       |
| 179052 | 24R2147 | 2-1/4" x 14" x 7" |       |
| 179216 | 24R486  | 4" x 8" x 6"      |       |
| 179053 | 24R4104 | 4" x 10" x 4"     |       |
| 179054 | 24R4105 | 4" x 10" x 5"     |       |
| 179055 | 24R4106 | 4" x 10" x 6"     |       |
| 179056 | 24R4107 | 4" x 10" x 7"     |       |
| 179057 | 24R4125 | 4" x 12" x 5"     |       |
| 179058 | 24R4126 | 4" x 12" x 6"     |       |
| 179059 | 24R4127 | 4" x 12" x 7"     |       |
| 179060 | 24R4128 | 4" x 12" x 8"     |       |
| 179061 | 24R4146 | 4" x 14" x 6"     |       |
| 179062 | 24R4147 | 4" x 14" x 7"     |       |
| 179063 | 24R4148 | 4" x 14" x 8"     |       |
| 179064 | 24R6106 | 6" x 10" x 6"     |       |
| 179065 | 24R6107 | 6" x 10" x 7"     |       |
| 192616 | 24R6108 | 6" x 10" x 8"     |       |
| 192614 | 24R6126 | 6" x 12" x 6"     |       |
| 179066 | 24R6127 | 6" x 12" x 7"     |       |
| 179067 | 24R6128 | 6" x 12" x 8"     |       |
| 192615 | 24R6146 | 6" x 14" x 6"     |       |
| 192617 | 24R6147 | 6" x 14" x 7"     |       |
| 179068 | 24R6148 | 6" x 14" x 8"     |       |

#### 27R Straight Register Boot



| Part # | Mfg #   | Size              | Price |
|--------|---------|-------------------|-------|
| 179024 | 27R2105 | 2-1/4" x 10" x 5" |       |
| 179025 | 27R2106 | 2-1/4" x 10" x 6" |       |

### Round Boots (Continued)

#### 27R Straight Register Boot

| Part # | Mfg #   | Size              | Price |
|--------|---------|-------------------|-------|
| 179026 | 27R2125 | 2-1/4" x 12" x 5" |       |
| 179027 | 27R2126 | 2-1/4" x 12" x 6" |       |
| 179028 | 27R2146 | 2-1/4" x 14" x 6" |       |
| 179029 | 27R2147 | 2-1/4" x 14" x 7" |       |
| 179030 | 27R4104 | 4" x 10" x 4"     |       |
| 179031 | 27R4105 | 4" x 10" x 5"     |       |
| 179032 | 27R4106 | 4" x 10" x 6"     |       |
| 179033 | 27R4107 | 4" x 10" x 7"     |       |
| 179034 | 27R4126 | 4" x 12" x 6"     |       |
| 179035 | 27R4127 | 4" x 12" x 7"     |       |
| 179036 | 27R4128 | 4" x 12" x 8"     |       |
| 179037 | 27R4146 | 4" x 14" x 6"     |       |
| 179039 | 27R4147 | 4" x 14" x 7"     |       |
| 179040 | 27R4148 | 4" x 14" x 8"     |       |
| 179041 | 27R6106 | 6" x 10" x 6"     |       |
| 192609 | 27R6107 | 6" x 10" x 7"     |       |
| 192610 | 27R6108 | 6" x 10" x 8"     |       |
| 179042 | 27R6126 | 6" x 12" x 6"     |       |
| 179043 | 27R6127 | 6" x 12" x 7"     |       |
| 179044 | 27R6128 | 6" x 12" x 8"     |       |
| 192611 | 27R6146 | 6" x 14" x 6"     |       |
| 192612 | 27R6147 | 6" x 14" x 7"     |       |
| 179045 | 27R6148 | 6" x 14" x 8"     |       |

#### 28R Center End Register Boot

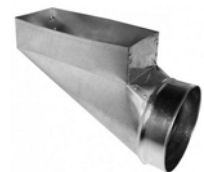

| Part # | Mfg #   | Size              | Price |
|--------|---------|-------------------|-------|
| 187967 | 28R2105 | 2-1/4" x 10" x 4" |       |
| 179069 | 28R2105 | 2-1/4" x 10" x 5" |       |
| 179070 | 28R2106 | 2-1/4" x 10" x 6" |       |
| 179071 | 28R2125 | 2-1/4" x 12" x 5" |       |
| 179072 | 28R2126 | 2-1/4" x 12" x 6" |       |
| 178655 | 28R2127 | 2-1/4" x 12" x 7" |       |
| 179073 | 28R2146 | 2-1/4" x 14" x 6" |       |
| 179130 | 28R4104 | 4" x 10" x 4"     |       |
| 179074 | 28R4105 | 4" x 10" x 5"     |       |
| 179075 | 28R4106 | 4" x 10" x 6"     |       |
| 192618 | 28R4107 | 4" x 10" x 7"     |       |
| 179076 | 28R4126 | 4" x 12" x 6"     |       |





## Round Boots

### Round Boots (Continued)

#### 28R Center End Register Boot

| Part # | Mfg #   | Size          | Price |
|--------|---------|---------------|-------|
| 179077 | 28R4127 | 4" x 12" x 7" |       |
| 179078 | 28R4128 | 4" x 12" x 8" |       |
| 179079 | 28R4146 | 4" x 14" x 6" |       |
| 179080 | 28R4147 | 4" x 14" x 7" |       |
| 179081 | 28R4148 | 4" x 14" x 8" |       |
| 179082 | 28R6106 | 6" x 10" x 6" |       |
| 192627 | 28R6128 | 6" x 12" x 8" |       |
| 192629 | 28R6148 | 6" x 14" x 8" |       |

#### 24RWE 90° Basement Head Boot



| Part # | Mfg #     | Size          | Price |
|--------|-----------|---------------|-------|
| 181406 | 24RWE4106 | 4" x 10" x 6" |       |
| 179126 | 24RWE6106 | 6" x 10" x 6" |       |

#### 28RR Right End Register Boot



| Part # | Mfg #    | Size              | Price |
|--------|----------|-------------------|-------|
| 179092 | 28RR2106 | 2-1/4" x 10" x 6" |       |
| 179093 | 28RR2126 | 2-1/2" x 12" x 6" |       |
| 179094 | 28RR2127 | 2-1/4" x 12" x 7" |       |
| 179095 | 28RR2146 | 2-1/4" x 14" x 6" |       |
| 179096 | 28RR4105 | 4" x 10" x 5"     |       |
| 179097 | 28RR4106 | 4" x 10" x 6"     |       |
| 179098 | 28RR4126 | 4" x 12" x 6"     |       |
| 179099 | 28RR4127 | 4" x 12" x 7"     |       |

#### 28RL Left End Register Boot



| Part # | Mfg #    | Size              | Price |
|--------|----------|-------------------|-------|
| 193525 | 28RL2105 | 2-1/4" x 10" x 5" |       |
| 179083 | 28RL2106 | 2-1/4" x 10" x 6" |       |
| 179084 | 28RL2126 | 2-1/2" x 12" x 6" |       |
| 179085 | 28RL2127 | 2-1/4" x 12" x 7" |       |
| 179087 | 28RL2146 | 2-1/4" x 14" x 6" |       |
| 179088 | 28RL4105 | 4" x 10" x 5"     |       |
| 179089 | 28RL4106 | 4" x 10" x 6"     |       |
| 179090 | 28RL4126 | 4" x 12" x 6"     |       |
| 179091 | 28RL4127 | 4" x 12" x 7"     |       |

**Round Fittings**

**Galvanized Register Boots**

**Galv Straight Back Register Boot**



| Part # | Mfg #        | Size            | Price |
|--------|--------------|-----------------|-------|
| 011187 | WA110R214105 | 2-1/4" x 10"-5" |       |
| 011188 | WA110R214106 | 2-1/4" x 10"-6" |       |
| 011189 | WA110R214125 | 2-1/4" x 12"-5" |       |
| 011190 | WA110R214126 | 2-1/4" x 12"-6" |       |
| 011192 | WA110R214146 | 2-1/4" x 14"-6" |       |
| 101809 | WA110R4104   | 4" x 10"-4"     |       |
| 011194 | WA110R4105   | 4" x 10"-5"     |       |
| 011195 | WA110R4106   | 4" x 10"-6"     |       |
| 011196 | WA110R4107   | 4" x 10"-7"     |       |
| 011197 | WA110R4126   | 4" x 12"-6"     |       |
| 011198 | WA110R4127   | 4" x 12"-7"     |       |
| 019300 | WA110R4128   | 4" x 12"-8"     |       |
| 011199 | WA110R4146   | 4" x 14"-6"     |       |
| 011200 | WA110R4147   | 4" x 14"-7"     |       |
| 011201 | WA110R4148   | 4" x 14"-8"     |       |
| 011202 | WA110R6106   | 6" x 10"-6"     |       |
| 011203 | WA110R6126   | 6" x 12"-6"     |       |
| 011204 | WA110R6127   | 6" x 12"-7"     |       |
| 011205 | WA110R6128   | 6" x 12"-8"     |       |
| 011206 | WA110R6148   | 6" x 14"-8"     |       |

**Galv Register Boot 90° Angle**



| Part # | Mfg #        | Size            | Price |
|--------|--------------|-----------------|-------|
| 011208 | WA113R214105 | 2-1/4" x 10"-5" |       |
| 011209 | WA113R214106 | 2-1/4" x 10"-6" |       |
| 011210 | WA113R214125 | 2-1/4" x 12"-5" |       |
| 011211 | WA113R214126 | 2-1/4" x 12"-6" |       |
| 011212 | WA113R214127 | 2-1/4" x 12"-7" |       |
| 011213 | WA113R214146 | 2-1/4" x 14"-6" |       |
| 101807 | WA113R4104   | 4" x 10"-4"     |       |
| 011215 | WA113R4105   | 4" x 10"-5"     |       |
| 011216 | WA113R4106   | 4" x 10"-6"     |       |
| 011217 | WA113R4107   | 4" x 10"-7"     |       |
| 011218 | WA113R4126   | 4" x 12"-6"     |       |

**Galvanized Register Boots (Continued)**

**Galv Register Boot 90° Angle**

| Part # | Mfg #      | Size        | Price |
|--------|------------|-------------|-------|
| 011219 | WA113R4127 | 4" x 12"-7" |       |
| 011220 | WA113R4128 | 4" x 12"-8" |       |
| 011221 | WA113R4146 | 4" x 14"-6" |       |
| 011222 | WA113R4147 | 4" x 14"-7" |       |
| 011223 | WA113R4148 | 4" x 14"-8" |       |
| 011224 | WA113R6106 | 6" x 10"-6" |       |
| 011226 | WA113R6127 | 6" x 12"-7" |       |
| 011227 | WA113R6128 | 6" x 12"-8" |       |
| 011228 | WA113R6148 | 6" x 14"-8" |       |

**Galv Register End Boot - Center**



| Part # | Mfg #        | Size            | Price |
|--------|--------------|-----------------|-------|
| 011229 | WA112R214105 | 2-1/4" x 10"-5" |       |
| 011230 | WA112R214106 | 2-1/4" x 10"-6" |       |
| 011231 | WA112R214125 | 2-1/4" x 12"-5" |       |
| 011232 | WA112R214126 | 2-1/4" x 12"-6" |       |
| 011233 | WA112R214127 | 2-1/4" x 12"-7" |       |
| 011234 | WA112R214146 | 2-1/4" x 14"-6" |       |
| 101808 | WA112R4104   | 4" x 10"-4"     |       |
| 159446 | WA112R4107   | 4" x 10"-7"     |       |
| 011236 | WA112R4105   | 4" x 10"-5"     |       |
| 011237 | WA112R4106   | 4" x 10"-6"     |       |
| 011238 | WA112R4126   | 4" x 12"-6"     |       |
| 011239 | WA112R4127   | 4" x 12"-7"     |       |
| 056085 | WA112R4128   | 4" x 12"-8"     |       |
| 011240 | WA112R4146   | 4" x 14"-6"     |       |
| 011241 | WA112R4147   | 4" x 14"-7"     |       |
| 011242 | WA112R4148   | 4" x 14"-8"     |       |

**Galv Register End Boot Left**



| Part # | Mfg #         | Size            | Price |
|--------|---------------|-----------------|-------|
| 011243 | WA112RL214106 | 2-1/4" x 10"-6" |       |
| 011245 | WA112RL214126 | 2-1/4" x 12"-6" |       |
| 101886 | WA112RL214127 | 2-1/4" x 12"-7" |       |
| 101888 | WA112RL4105   | 4" x 10"-5"     |       |

**Round Fittings**

**Galvanized Register Boots (Continued)**

**Galv Register End Boot Left**

| Part # | Mfg #       | Size        | Price |
|--------|-------------|-------------|-------|
| 011247 | WA112RL4106 | 4" x 10"-6" |       |
| 011248 | WA112RL4126 | 4" x 12"-6" |       |
| 025227 | WA112RL4127 | 4" x 12"-7" |       |

**Galv Register End Boot Right**



| Part # | Mfg #         | Size            | Price |
|--------|---------------|-----------------|-------|
| 011249 | WA112RR214106 | 2-1/4" x 10"-6" |       |
| 011250 | WA112RR214126 | 2-1/4" x 12"-6" |       |
| 101887 | WA112RR214127 | 2-1/4" x 12"-7" |       |
| 101889 | WA112RR4105   | 4" x 10"-5"     |       |
| 011252 | WA112RR4106   | 4" x 10"-6"     |       |
| 011253 | WA112RR4126   | 4" x 12"-6"     |       |
| 025228 | WA112RR4127   | 4" x 12"-7"     |       |

**Galv Basement Boot with Wings**



| Part # | Mfg #               | Size                      | Price |
|--------|---------------------|---------------------------|-------|
| 125132 | WA113BRB16E410<br>6 | 4" x 10"-6"               |       |
| 058646 | WA113BRB6106        | 6" x 10"-6"-16" On Center |       |

**Galv Register Boot with Frame**



| Part # | Mfg #          | Size                       | Price |
|--------|----------------|----------------------------|-------|
| 225533 | WA113RCF241246 | 4" x 12"-6" w/ 24" Frame   |       |
| 129228 | WA113RCP164106 | 4" x 10"-6" with 16" Frame |       |
| 132359 | WA113RCP4126   | 4" x 12"-6" with 24" Frame |       |
| 166250 | WA113RPF4106   | 4"x10" 6" w/Plaster Frame  |       |
| 035596 | WA113RPF181246 | 4" x 12"-6" w/ 18" Frame   |       |

**Galv Toe Kick Boot**

| Part # | Mfg #     | Size             | Price |
|--------|-----------|------------------|-------|
| 111509 | WATKB2126 | 2-1/4" x 12" -6" |       |

## Round Fittings

### Galvanized Collars

#### 1149CR Long Collar



| Part # | Mfg #    | Size | Price |
|--------|----------|------|-------|
| 061493 | 70506200 | 4"   |       |
| 011273 | 70506600 | 5"   |       |
| 011274 | 70507000 | 6"   |       |
| 011275 | 70507400 | 7"   |       |
| 011276 | 70507800 | 8"   |       |

#### 1149CD Long Collar with Damper



| Part # | Mfg #    | Size | Price |
|--------|----------|------|-------|
| 061488 | 70511000 | 6"   |       |
| 061489 | 70511400 | 7"   |       |
| 061490 | 70511800 | 8"   |       |
| 061491 | 70512600 | 10"  |       |
| 061492 | 70513000 | 12"  |       |



## Round Collars

### Round Collars

#### Air-Tite Flat Takeoff Collar

- Hot dipped galvanized steel
- 4 pre-drilled screw holes
- Pressure rating: +/- 4" w.g.



| Part # | Mfg # | Size | Price |
|--------|-------|------|-------|
| 194039 | ATT7  | 7"   |       |
| 194040 | ATT10 | 10"  |       |
| 194621 | ATT12 | 12"  |       |
| 195240 | ATT14 | 14"  |       |
| 195241 | ATT16 | 16"  |       |

#### AT90 Air-Tite Takeoff Collar

- 90° Bend



| Part # | Mfg # | Size | Price |
|--------|-------|------|-------|
| 195256 | AT908 | 8"   |       |

#### 97LS Long Style Flat Collar



| Part # | Mfg #  | Size | Price |
|--------|--------|------|-------|
| 178996 | 97LS4  | 4"   |       |
| 178997 | 97LS5  | 5"   |       |
| 178998 | 97LS6  | 6"   |       |
| 178999 | 97LS7  | 7"   |       |
| 179000 | 97LS8  | 8"   |       |
| 179001 | 97LS10 | 10"  |       |
| 179002 | 97LS12 | 12"  |       |
| 178975 | 97LS14 | 14"  |       |
| 179128 | 97LS16 | 16"  |       |

### 97LSWD Long Style Flat Collar with Damper



| Part # | Mfg #   | Size | Price |
|--------|---------|------|-------|
| 178994 | 97LSWD4 | 4"   |       |
| 178995 | 97LSWD6 | 6"   |       |
| 181932 | 97LSWD8 | 8"   |       |

### 97 Start Collar

- Crimped



| Part # | Mfg # | Size | Price |
|--------|-------|------|-------|
| 178809 | 973   | 3"   |       |
| 178810 | 974   | 4"   |       |
| 178811 | 975   | 5"   |       |
| 178812 | 976   | 6"   |       |
| 178813 | 977   | 7"   |       |
| 178814 | 978   | 8"   |       |
| 178815 | 979   | 9"   |       |
| 178816 | 9710  | 10"  |       |
| 178817 | 9712  | 12"  |       |
| 178818 | 9714  | 14"  |       |
| 178819 | 9716  | 16"  |       |
| 178820 | 9718  | 18"  |       |
| 178821 | 9720  | 20"  |       |
| 214884 | 9722  | 22"  |       |
| 214747 | 9724  | 24"  |       |

### 97NC Start Collar

- No Crimp

| Part # | Mfg #  | Size | Price |
|--------|--------|------|-------|
| 178822 | 973NC  | 3"   |       |
| 178824 | 974NC  | 4"   |       |
| 178825 | 975NC  | 5"   |       |
| 178826 | 976NC  | 6"   |       |
| 178827 | 977NC  | 7"   |       |
| 178829 | 978NC  | 8"   |       |
| 178830 | 979NC  | 9"   |       |
| 178831 | 9710NC | 10"  |       |
| 178832 | 9712NC | 12"  |       |
| 178833 | 9714NC | 14"  |       |
| 178834 | 9716NC | 16"  |       |



## Round Collars

### 97FG Ductboard Spin Collar



| Part # | Mfg #  | Size | Price |
|--------|--------|------|-------|
| 179142 | 97FG6  | 6"   |       |
| 179144 | 97FG7  | 7"   |       |
| 179145 | 97FG8  | 8"   |       |
| 179146 | 97FG10 | 10"  |       |

### 1051 Short Collar with Hub

| Part # | Mfg #  | Size | Price |
|--------|--------|------|-------|
| 232691 | 10514  | 4"   |       |
| 232692 | 10515  | 5"   |       |
| 219782 | 10516  | 6"   |       |
| 232641 | 10517  | 7"   |       |
| 223039 | 10518  | 8"   |       |
| 232693 | 10519  | 9"   |       |
| 223040 | 105110 | 10"  |       |
| 223041 | 105112 | 12"  |       |
| 232695 | 105114 | 14"  |       |

### 1150 Crimped Long Collar with Hub

| Part # | Mfg #  | Size | Price |
|--------|--------|------|-------|
| 243862 | 11504  | 4"   |       |
| 243863 | 11505  | 5"   |       |
| 204130 | 11506  | 6"   |       |
| 204131 | 11507  | 7"   |       |
| 204132 | 11508  | 8"   |       |
| 243864 | 11509  | 9"   |       |
| 243866 | 115010 | 10"  |       |
| 243867 | 115012 | 12"  |       |
| 243868 | 115014 | 14"  |       |
| 243869 | 115016 | 16"  |       |

### 156 Spin Collar for Metal



| Part # | Mfg # | Size | Price |
|--------|-------|------|-------|
| 179133 | 1566  | 6"   |       |
| 179134 | 1568  | 8"   |       |
| 179135 | 15612 | 12"  |       |

### 156D Spin Collar for Metal w/ Damper



| Part # | Mfg #  | Size | Price |
|--------|--------|------|-------|
| 179136 | 156D6  | 6"   |       |
| 179139 | 156D8  | 8"   |       |
| 179140 | 156D10 | 10"  |       |
| 179141 | 156D12 | 12"  |       |

### 84ST Ductboard Collar 1-1/2" Tabs



| Part # | Mfg # | Size | Price |
|--------|-------|------|-------|
| 188440 | 84ST6 | 6"   |       |
| 188441 | 84ST7 | 7"   |       |
| 188442 | 84ST8 | 8"   |       |

## Round Fittings

### Galvanized Collars

#### Galv Stub Collar - Plain

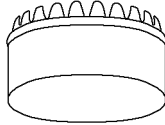

| Part # | Mfg #     | Size | Price |
|--------|-----------|------|-------|
| 010972 | WA313LE3  | 3"   |       |
| 010973 | WA313LE4  | 4"   |       |
| 010974 | WA313LE5  | 5"   |       |
| 010975 | WA313LE6  | 6"   |       |
| 010976 | WA313LE7  | 7"   |       |
| 010977 | WA313LE8  | 8"   |       |
| 010978 | WA313LE9  | 9"   |       |
| 010968 | WA313LE10 | 10"  |       |
| 010969 | WA313LE12 | 12"  |       |
| 010970 | WA313LE14 | 14"  |       |

#### Galv Top Collar - Crimped



| Part # | Mfg #     | Size | Price |
|--------|-----------|------|-------|
| 010961 | WA313SE3  | 3"   |       |
| 010962 | WA313SE4  | 4"   |       |
| 010963 | WA313SE5  | 5"   |       |
| 010964 | WA313SE6  | 6"   |       |
| 010965 | WA313SE7  | 7"   |       |
| 010966 | WA313SE8  | 8"   |       |
| 010967 | WA313SE9  | 9"   |       |
| 010956 | WA313SE10 | 10"  |       |
| 010957 | WA313SE12 | 12"  |       |
| 010958 | WA313SE14 | 14"  |       |
| 010959 | WA313SE16 | 16"  |       |
| 010960 | WA313SE18 | 18"  |       |

#### Start Collar with Ring



| Part # | Mfg #     | Size | Price |
|--------|-----------|------|-------|
| 157735 | WA313SER4 | 4"   |       |
| 157736 | WA313SER5 | 5"   |       |
| 157737 | WA313SER6 | 6"   |       |
| 157738 | WA313SER7 | 7"   |       |
| 157739 | WA313SER8 | 8"   |       |
| 157740 | WA313SER9 | 9"   |       |

### Galvanized Collars (Continued)

#### Start Collar with Ring

| Part # | Mfg #      | Size | Price |
|--------|------------|------|-------|
| 157741 | WA313SER10 | 10"  |       |
| 157742 | WA313SER12 | 12"  |       |
| 157743 | WA313SER14 | 14"  |       |
| 157744 | WA313SER16 | 16"  |       |
| 157745 | WA313SER18 | 18"  |       |

#### Galv Duct Board Collar without Damper



| Part # | Mfg #       | Size | Price |
|--------|-------------|------|-------|
| 061493 | WAFLEXCOL4  | 4"   |       |
| 011273 | WAFLEXCOL5  | 5"   |       |
| 011274 | WAFLEXCOL6  | 6"   |       |
| 011275 | WAFLEXCOL7  | 7"   |       |
| 011276 | WAFLEXCOL8  | 8"   |       |
| 011272 | WAFLEXCOL10 | 10"  |       |
| 020010 | WAFLEXCOL12 | 12"  |       |
| 023906 | WAFLEXCOL14 | 14"  |       |
| 023907 | WAFLEXCOL16 | 16"  |       |

#### 326 Collar with Crimp and Damper



| Part # | Mfg #         | Size | Price |
|--------|---------------|------|-------|
| 061488 | WAFLEXCOLWD6  | 6"   |       |
| 061490 | WAFLEXCOLWD8  | 8"   |       |
| 061491 | WAFLEXCOLWD10 | 10"  |       |
| 061492 | WAFLEXCOLWD12 | 12"  |       |
| 120189 | WAFLEXCOLWD14 | 14"  |       |
| 079002 | WAFLEXCOLWD16 | 16"  |       |

Ducts, Fittings & Accessories

## Round Fittings

### Galv Duct Board Spin-In Collar without Damper

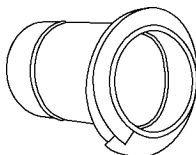

| Part # | Mfg #   | Size | Price |
|--------|---------|------|-------|
| 011283 | WA400D6 | 6"   |       |
| 011284 | WA400D7 | 7"   |       |
| 011285 | WA400D8 | 8"   |       |

### Galv Metal Spin-In Collar with Damper



| Part # | Mfg #    | Size | Price |
|--------|----------|------|-------|
| 028049 | WA401M6  | 6"   |       |
| 028050 | WA401M8  | 8"   |       |
| 028051 | WA401M10 | 10"  |       |

### Galv Round to Round Self-Adhesive Takeoff



| Part # | Mfg #   | Size | Price |
|--------|---------|------|-------|
| 072244 | WA400A6 | 6"   |       |
| 184158 | WA400A7 | 7"   |       |
| 073575 | WA400A8 | 8"   |       |

### Flate Airtite with Damper

- Flat desin allow for installation on trunk lines or starting collars on plenums



| Part # | Mfg #    | Size | Price |
|--------|----------|------|-------|
| 100321 | WA400AD6 | 6"   |       |
| 100322 | WA400AD8 | 8"   |       |

### Round to Round Self-Adhesive Takeoff



| Part # | Mfg #    | Size | Price |
|--------|----------|------|-------|
| 172058 | WA406A5  | 5"   |       |
| 164710 | WA406A6  | 6"   |       |
| 164711 | WA406A7  | 7"   |       |
| 164712 | WA406A8  | 8"   |       |
| 226843 | WA406A10 | 10"  |       |
| 171082 | WA406A12 | 12"  |       |





## Round Elbows

### 90° Round Elbows



#### 90° 24ga Elbow

| Part # | Mfg #  | Size | Price |
|--------|--------|------|-------|
| 192537 | 90424  | 4"   |       |
| 178760 | 90524  | 5"   |       |
| 178761 | 90624  | 6"   |       |
| 178762 | 90724  | 7"   |       |
| 178763 | 90824  | 8"   |       |
| 178764 | 90924  | 9"   |       |
| 178765 | 901024 | 10"  |       |
| 178766 | 901224 | 12"  |       |
| 178767 | 901424 | 14"  |       |
| 178768 | 901624 | 16"  |       |
| 178769 | 901824 | 18"  |       |

#### 90° 26ga Elbow

| Part # | Mfg #  | Size | Price |
|--------|--------|------|-------|
| 178749 | 90326  | 3"   |       |
| 178750 | 90426  | 4"   |       |
| 178751 | 90526  | 5"   |       |
| 178752 | 90626  | 6"   |       |
| 178753 | 90726  | 7"   |       |
| 178754 | 90826  | 8"   |       |
| 178755 | 901026 | 10"  |       |
| 178756 | 901226 | 12"  |       |
| 178757 | 901426 | 14"  |       |
| 178758 | 901626 | 16"  |       |

#### 90° 28ga Elbow

| Part # | Mfg #  | Size | Price |
|--------|--------|------|-------|
| 178746 | 90328  | 3"   |       |
| 178747 | 90428  | 4"   |       |
| 178745 | 901228 | 12"  |       |
| 178748 | 901428 | 14"  |       |

#### 90° 30ga Elbow

| Part # | Mfg # | Size | Price |
|--------|-------|------|-------|
| 178738 | 90330 | 3"   |       |
| 178739 | 90430 | 4"   |       |
| 178740 | 90530 | 5"   |       |
| 178637 | 90630 | 6"   |       |
| 178741 | 90730 | 7"   |       |

### 90° Round Elbows (Continued)

#### 90° 30ga Elbow

| Part # | Mfg #  | Size | Price |
|--------|--------|------|-------|
| 178742 | 90830  | 8"   |       |
| 178743 | 90930  | 9"   |       |
| 178744 | 901030 | 10"  |       |

### 45° Round Elbows



#### 45° 30ga Elbow

| Part # | Mfg # | Size | Price |
|--------|-------|------|-------|
| 178770 | 45530 | 5"   |       |
| 178771 | 45630 | 6"   |       |
| 178772 | 45730 | 7"   |       |

**Round Elbows**

**Galvanized Round Elbows**



**Galv 45° 30ga Elbow**

| Part # | Mfg #   | Size | Price |
|--------|---------|------|-------|
| 021248 | WA45305 | 5"   |       |
| 010936 | WA45306 | 6"   |       |

**Galv 90° 30ga Elbow**

| Part # | Mfg #    | Size | Price |
|--------|----------|------|-------|
| 010899 | WA90303  | 3"   |       |
| 010900 | WA90304  | 4"   |       |
| 010901 | WA90305  | 5"   |       |
| 134912 | WA90306  | 6"   |       |
| 010903 | WA90307  | 7"   |       |
| 010904 | WA90308  | 8"   |       |
| 010906 | WA90309  | 9"   |       |
| 010897 | WA903010 | 10"  |       |

**Galv 90° 28ga Elbow**

| Part # | Mfg #    | Size | Price |
|--------|----------|------|-------|
| 010908 | WA90283  | 3"   |       |
| 010909 | WA90284  | 4"   |       |
| 153110 | WA90289  | 9"   |       |
| 153118 | WA902810 | 10"  |       |
| 021253 | WA902812 | 12"  |       |
| 010907 | WA902814 | 14"  |       |

**Galv 90° 26ga Elbow**

| Part # | Mfg #    | Size | Price |
|--------|----------|------|-------|
| 010911 | WA90263  | 3"   |       |
| 010912 | WA90264  | 4"   |       |
| 028849 | WA90265  | 5"   |       |
| 022328 | WA90266  | 6"   |       |
| 026496 | WA90267  | 7"   |       |
| 043462 | WA90268  | 8"   |       |
| 043463 | WA902610 | 10"  |       |
| 043464 | WA902612 | 12"  |       |
| 021252 | WA902614 | 14"  |       |
| 010910 | WA902616 | 16"  |       |

**Galv 90° 24ga Elbow**

| Part # | Mfg #    | Size | Price |
|--------|----------|------|-------|
| 010916 | WA90245  | 5"   |       |
| 010917 | WA90246  | 6"   |       |
| 010918 | WA90247  | 7"   |       |
| 010919 | WA90248  | 8"   |       |
| 010920 | WA90249  | 9"   |       |
| 010913 | WA902410 | 10"  |       |
| 010914 | WA902412 | 12"  |       |
| 010915 | WA902414 | 14"  |       |
| 030837 | WA902416 | 16"  |       |
| 037283 | WA902418 | 18"  |       |

**Galv Round to Round Self-Adhesive 90° Takeoff**



| Part # | Mfg #   | Size | Price |
|--------|---------|------|-------|
| 116248 | WA201A5 | 5"   |       |
| 098648 | WA201A6 | 6"   |       |
| 116249 | WA201A7 | 7"   |       |
| 116250 | WA201A8 | 8"   |       |

**Galv Round Adjustable 90° Elbow with Adhesive**

- Shipped straight not turned



| Part # | Mfg #   | Size | Price |
|--------|---------|------|-------|
| 154621 | WA302A6 | 6"   |       |



## Round Pipe

### Round Pipe

#### SL12 12" Joint Round Pipe



#### 30 Gauge

| Part # | Mfg #    | Size    | Price |
|--------|----------|---------|-------|
| 178727 | SL120430 | 4" x 1' |       |
| 178630 | SL120530 | 5" x 1' |       |
| 178631 | SL120630 | 6" x 1' |       |
| 178632 | SL120730 | 7" x 1' |       |

#### SL24 24" Joint Round Pipe



#### 24 Gauge

| Part # | Mfg #    | Size     | Price |
|--------|----------|----------|-------|
| 178698 | SL24524  | 5" x 2'  |       |
| 178699 | SL24624  | 6" x 2'  |       |
| 178700 | SL24724  | 7" x 2'  |       |
| 178701 | SL24824  | 8" x 2'  |       |
| 178702 | SL24924  | 9" x 2'  |       |
| 178703 | SL241024 | 10" x 2' |       |
| 178704 | SL241224 | 12" x 2' |       |
| 178705 | SL241424 | 14" x 2' |       |
| 178706 | SL241624 | 16" x 2' |       |
| 178707 | SL241824 | 18" x 2' |       |

#### 26 Gauge

| Part # | Mfg #    | Size     | Price |
|--------|----------|----------|-------|
| 178680 | SL24326  | 3" x 2'  |       |
| 178681 | SL24426  | 4" x 2'  |       |
| 178682 | SL24526  | 5" x 2'  |       |
| 178683 | SL24626  | 6" x 2'  |       |
| 178684 | SL241426 | 14" x 2' |       |
| 178685 | SL241626 | 16" x 2' |       |
| 178687 | SL241826 | 18" x 2' |       |

### 30 Gauge

| Part # | Mfg #    | Size     | Price |
|--------|----------|----------|-------|
| 178671 | SL24330  | 3" x 2'  |       |
| 178672 | SL24430  | 4" x 2'  |       |
| 178673 | SL24530  | 5" x 2'  |       |
| 178674 | SL24630  | 6" x 2'  |       |
| 178675 | SL24730  | 7" x 2'  |       |
| 178676 | SL24830  | 8" x 2'  |       |
| 178677 | SL24930  | 9" x 2'  |       |
| 178678 | SL241030 | 10" x 2' |       |
| 178679 | SL241230 | 12" x 2' |       |

#### SL60 60" Joint Round Pipe



#### 24 Gauge

| Part # | Mfg #   | Size    | Price |
|--------|---------|---------|-------|
| 246023 | SL60424 | 4" x 5' |       |

#### 26 Gauge

| Part # | Mfg #    | Size     | Price |
|--------|----------|----------|-------|
| 178729 | SL60426  | 4" x 5'  |       |
| 178663 | SL60526  | 5" x 5'  |       |
| 178664 | SL60626  | 6" x 5'  |       |
| 178666 | SL60726  | 7" x 5'  |       |
| 178667 | SL60826  | 8" x 5'  |       |
| 178669 | SL60926  | 9" x 5'  |       |
| 178670 | SL601026 | 10" x 5' |       |
| 178728 | SL601226 | 12" x 5' |       |
| 178730 | SL601426 | 14" x 5' |       |
| 178731 | SL601626 | 16" x 5' |       |

#### 30 Gauge

| Part # | Mfg #    | Size     | Price |
|--------|----------|----------|-------|
| 178633 | SL60330  | 3" x 5'  |       |
| 178634 | SL60430  | 4" x 5'  |       |
| 178635 | SL60530  | 5" x 5'  |       |
| 178636 | SL60630  | 6" x 5'  |       |
| 178658 | SL60730  | 7" x 5'  |       |
| 178659 | SL60830  | 8" x 5'  |       |
| 178661 | SL60930  | 9" x 5'  |       |
| 178662 | SL601030 | 10" x 5' |       |



## Round Pipe

### Round Pipe (Continued)

#### SL60 60" Joint Round Pipe

30 Gauge

| Part # | Mfg #    | Size     | Price |
|--------|----------|----------|-------|
| 199472 | SL601230 | 12" x 5' |       |

#### SL120 120" Joint Round Pipe



30 Gauge

| Part # | Mfg #    | Size     | Price |
|--------|----------|----------|-------|
| 192529 | SL120830 | 8" x 10' |       |

**Round Pipe**

**Galvanized Sheet Metal Pipe**



**Galv Sheet Metal 24" 30ga Pipe**

| Part # | Mfg #    | Size | Price |
|--------|----------|------|-------|
| 010786 | WAP3032  | 3"   |       |
| 010788 | WAP3042  | 4"   |       |
| 010791 | WAP3052  | 5"   |       |
| 010794 | WAP3062  | 6"   |       |
| 010797 | WAP3072  | 7"   |       |
| 010799 | WAP3082  | 8"   |       |
| 010801 | WAP3092  | 9"   |       |
| 010783 | WAP30102 | 10"  |       |
| 010785 | WAP30122 | 12"  |       |

**Galv Sheet Metal 24" 26ga Pipe**

| Part # | Mfg #    | Size | Price |
|--------|----------|------|-------|
| 010775 | WAP2632  | 3"   |       |
| 010776 | WAP2642  | 4"   |       |
| 010778 | WAP2652  | 5"   |       |
| 010779 | WAP2662  | 6"   |       |
| 010773 | WAP26142 | 14"  |       |
| 010774 | WAP26162 | 16"  |       |
| 021251 | WAP26182 | 18"  |       |

**Galv Sheet Metal 24" 24ga Pipe**

| Part # | Mfg #    | Size | Price |
|--------|----------|------|-------|
| 010768 | WAP2452  | 5"   |       |
| 010769 | WAP2462  | 6"   |       |
| 010770 | WAP2472  | 7"   |       |
| 010771 | WAP2482  | 8"   |       |
| 010772 | WAP2492  | 9"   |       |
| 010764 | WAP24102 | 10"  |       |
| 010765 | WAP24122 | 12"  |       |
| 010766 | WAP24142 | 14"  |       |
| 010767 | WAP24162 | 16"  |       |

**Galvanized Snap Lock Pipe**

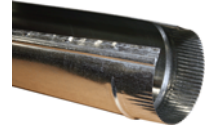

**Galv Snap Lock 60" 30ga Pipe**

| Part # | Mfg #    | Size | Price |
|--------|----------|------|-------|
| 010787 | WAP3035  | 3"   |       |
| 010789 | WAP3045  | 4"   |       |
| 010792 | WAP3055  | 5"   |       |
| 010795 | WAP3065  | 6"   |       |
| 010798 | WAP3075  | 7"   |       |
| 010800 | WAP3085  | 8"   |       |
| 075283 | WAP3095  | 9"   |       |
| 010784 | WAP30105 | 10"  |       |
| 127501 | WAP30125 | 12"  |       |

**Galv Snap Lock 60" 28ga Pipe**

| Part # | Mfg #    | Size | Price |
|--------|----------|------|-------|
| 168507 | WAP2855  | 5"   |       |
| 168508 | WAP2865  | 6"   |       |
| 168509 | WAP2875  | 7"   |       |
| 168510 | WAP2885  | 8"   |       |
| 168513 | WAP28105 | 10"  |       |
| 168514 | WAP28125 | 12"  |       |
| 168521 | WAP28145 | 14"  |       |

**Galv Snap Lock 60" 26ga Pipe**

| Part # | Mfg #    | Size | Price |
|--------|----------|------|-------|
| 010777 | WAP2645  | 4"   |       |
| 028848 | WAP2655  | 5"   |       |
| 026464 | WAP2665  | 6"   |       |
| 025025 | WAP2675  | 7"   |       |
| 043461 | WAP2685  | 8"   |       |
| 033458 | WAP26105 | 10"  |       |
| 020976 | WAP26125 | 12"  |       |
| 105628 | WAP26145 | 14"  |       |
| 137023 | WAP26165 | 16"  |       |

**Galv Snap Lock 120" 30ga Pipe**

| Part # | Mfg #    | Size | Price |
|--------|----------|------|-------|
| 129152 | WAP30410 | 4"   |       |
| 010790 | WAP30510 | 5"   |       |
| 010793 | WAP30610 | 6"   |       |
| 010796 | WAP30710 | 7"   |       |
| 098828 | WAP30810 | 8"   |       |

Ducts, Fittings & Accessories

## Round Takeoffs

### Round Takeoffs 63A Adjustable Takeoff



| Part # | Mfg # | Size | Price |
|--------|-------|------|-------|
| 178773 | 63A5  | 5"   |       |
| 178774 | 63A6  | 6"   |       |
| 178775 | 63A7  | 7"   |       |
| 178776 | 63A8  | 8"   |       |

### 62 Top Takeoff



| Part # | Mfg # | Size | Price |
|--------|-------|------|-------|
| 179013 | 625   | 5"   |       |
| 179014 | 626   | 6"   |       |
| 179015 | 627   | 7"   |       |
| 179016 | 628   | 8"   |       |

### With Slide Lock

| Part # | Mfg # | Size | Price |
|--------|-------|------|-------|
| 204605 | 62SL6 | 6"   |       |

### 63 Side Takeoff



| Part # | Mfg # | Size | Price |
|--------|-------|------|-------|
| 179010 | 636   | 6"   |       |
| 179011 | 637   | 7"   |       |
| 179012 | 638   | 8"   |       |

### 64 Double Top Takeoff



| Part # | Mfg # | Size | Price |
|--------|-------|------|-------|
| 179018 | 646   | 6"   |       |

### 2022 Fiberglass Round to Round Takeoff

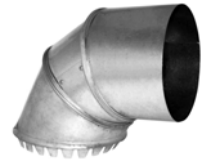

| Part # | Mfg # | Size | Price |
|--------|-------|------|-------|
| 201483 | 20226 | 6"   |       |
| 201484 | 20227 | 7"   |       |

### EP15 Full Tab Round to Round Adjustable Takeoff



| Part # | Mfg #    | Size              | Price |
|--------|----------|-------------------|-------|
| 178779 | EP1565   | 6" x 5"           |       |
| 178780 | EP1576   | 7" x 6"           |       |
| 178781 | EP1587   | 8" x 7"           |       |
| 178782 | EP1598   | 9" x 8"           |       |
| 213470 | EP1598CR | 9" x 8" (Crimped) |       |
| 213468 | EP1576CR | 7" x 6" (Crimped) |       |
| 213469 | EP1587CR | 8" x 7" (Crimped) |       |

### HT15 Half Tab Round to Round Adjustable Takeoff



| Part # | Mfg #  | Size    | Price |
|--------|--------|---------|-------|
| 190191 | HT1564 | 6" x 4" |       |
| 178638 | HT1576 | 7" x 6" |       |
| 178787 | HT1587 | 8" x 7" |       |

### AT63 Air-Tite Side Takeoff (Square to Round)



| Part # | Mfg #  | Size | Price |
|--------|--------|------|-------|
| 179228 | AT638  | 8"   |       |
| 179226 | AT6310 | 10"  |       |



## Round Takeoffs

### ATTRP Air-Tite Saddle Takeoff



| Part # | Mfg #   | Size | Price |
|--------|---------|------|-------|
| 197802 | ATTRP4  | 4"   |       |
| 195321 | ATTRP5  | 5"   |       |
| 195252 | ATTRP6  | 6"   |       |
| 195253 | ATTRP7  | 7"   |       |
| 195254 | ATTRP8  | 8"   |       |
| 195747 | ATTRP9  | 9"   |       |
| 197499 | ATTRP10 | 10"  |       |
| 205840 | ATTRP12 | 12"  |       |
| 232661 | ATTRP14 | 14"  |       |
| 232662 | ATTRP16 | 16"  |       |

### ATT Air-Tite Takeoff



| Part # | Mfg # | Size | Price |
|--------|-------|------|-------|
| 195236 | ATT4  | 4"   |       |
| 195237 | ATT5  | 5"   |       |
| 179253 | ATT6  | 6"   |       |
| 179254 | ATT8  | 8"   |       |
| 195320 | ATT18 | 18"  |       |

### AT90 90° Air-Tite Takeoff

| Part # | Mfg # | Size | Price |
|--------|-------|------|-------|
| 195239 | AT906 | 6"   |       |
| 195255 | AT907 | 7"   |       |
| 195256 | AT908 | 8"   |       |

### ATD Air-Tite Takeoff w/ Damper



| Part # | Mfg # | Size | Price |
|--------|-------|------|-------|
| 195243 | ATD6  | 6"   |       |
| 195244 | ATD7  | 7"   |       |
| 195245 | ATD8  | 8"   |       |

### Round Takeoffs (Continued)

#### ATD Air-Tite Takeoff w/ Damper

| Part # | Mfg # | Size | Price |
|--------|-------|------|-------|
| 195247 | ATD10 | 10"  |       |
| 193597 | ATD12 | 12"  |       |

#### ATTRP45 Air-Tite 45° Saddle Takeoff

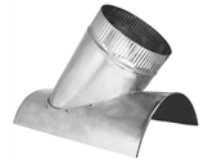

| Part # | Mfg #     | Size | Price |
|--------|-----------|------|-------|
| 189069 | ATTRP4510 | 10"  |       |

#### S5 Pivot Takeoff



| Part # | Mfg # | Size | Price |
|--------|-------|------|-------|
| 244398 | S55   | 5"   |       |
| 244399 | S56   | 6"   |       |

**Round Fittings**

**Galvanized Takeoffs**

**Galv Side Takeoff**



| Part # | Mfg #    | Size | Price |
|--------|----------|------|-------|
| 011142 | WASQ1536 | 6"   |       |
| 011143 | WASQ1537 | 7"   |       |

**Galv Adjustable Top Takeoff  
Sheet Metal**



| Part # | Mfg #     | Size | Price |
|--------|-----------|------|-------|
| 111661 | WA201APL5 | 5"   |       |
| 111662 | WA201APL6 | 6"   |       |
| 111663 | WA201APL7 | 7"   |       |

**Galv Top Takeoff**



| Part # | Mfg #  | Size | Price |
|--------|--------|------|-------|
| 021250 | WA1615 | 5"   |       |
| 011145 | WA1616 | 6"   |       |
| 011147 | WA1618 | 8"   |       |

**Galv Adjustable Takeoffs with 2" Rise**



| Part # | Mfg #  | Size | Price |
|--------|--------|------|-------|
| 011149 | WA1815 | 5"   |       |
| 011150 | WA1816 | 6"   |       |
| 011151 | WA1817 | 7"   |       |
| 011152 | WA1818 | 8"   |       |

**Galv Adjustable Takeoff  
Round To Round Full Tab**



| Part # | Mfg #  | Size | Price |
|--------|--------|------|-------|
| 011155 | WA2015 | 5"   |       |
| 011156 | WA2016 | 6"   |       |
| 011157 | WA2017 | 7"   |       |
| 011158 | WA2018 | 8"   |       |

**Galv Adjustable Takeoff  
Round To Round Half Tab**



| Part # | Mfg #   | Size | Price |
|--------|---------|------|-------|
| 051557 | WA201H6 | 6"   |       |
| 101811 | WA201H7 | 7"   |       |

**Galv Top Takeoff**

• 1" Rise



| Part # | Mfg #  | Size | Price |
|--------|--------|------|-------|
| 011153 | WA1618 | 6"   |       |
| 011146 | WA1617 | 7"   |       |

**Square to Round Transition**



| Part # | Mfg #       | Size            | Price |
|--------|-------------|-----------------|-------|
| 163639 | WA318162016 | 16" x 20" x 16" |       |



## Round Tees & Wyes

### Round Tees

#### Free Flow Tee



#### 24 Gauge Free Flow Tee

| Part # | Mfg #    | Size | Price |
|--------|----------|------|-------|
| 180537 | 1060624  | 6"   |       |
| 180538 | 1060724  | 7"   |       |
| 180539 | 1060824  | 8"   |       |
| 180541 | 10601024 | 10"  |       |
| 180542 | 10601224 | 12"  |       |
| 180543 | 10601424 | 14"  |       |

#### 26 Gauge Free Flow Tee

| Part # | Mfg #    | Size | Price |
|--------|----------|------|-------|
| 180534 | 1060326  | 3"   |       |
| 180535 | 1060426  | 4"   |       |
| 180536 | 1060526  | 5"   |       |
| 180688 | 1060626  | 6"   |       |
| 180689 | 1060726  | 7"   |       |
| 180690 | 1060826  | 8"   |       |
| 180691 | 10601026 | 10"  |       |
| 180692 | 10601226 | 12"  |       |
| 180693 | 10601426 | 14"  |       |

#### 54 Regular Tee



#### 26 Gauge Tee

| Part # | Mfg # | Size | Price |
|--------|-------|------|-------|
| 192650 | 54426 | 4"   |       |
| 192651 | 54526 | 5"   |       |
| 192637 | 54626 | 6"   |       |
| 192646 | 54826 | 8"   |       |
| 192648 | 5410  | 10"  |       |
| 192649 | 5412  | 12"  |       |
| 194009 | 5414  | 14"  |       |
| 192645 | 54726 | 7"   |       |

### 24 Gauge Tee

| Part # | Mfg # | Size | Price |
|--------|-------|------|-------|
| 179114 | 54624 | 6"   |       |
| 179116 | 54824 | 8"   |       |
| 179111 | 544   | 4"   |       |

### Round Wyes

#### Stub Wye



| Part # | Mfg #   | Size         | Price |
|--------|---------|--------------|-------|
| 179214 | 203S444 | 4" x 4" x 4" |       |
| 179122 | 203S543 | 5" x 4" x 3" |       |
| 179125 | 203S544 | 5" x 4" x 4" |       |
| 179123 | 203S553 | 5" x 5" x 3" |       |
| 179124 | 203S663 | 6" x 6" x 3" |       |
| 179120 | 203S866 | 8" x 6" x 6" |       |

#### Wye Branch



| Part # | Mfg # | Size         | Price |
|--------|-------|--------------|-------|
| 179121 | 78866 | 8" x 6" x 6" |       |

#### Flue Wye



| Part # | Mfg # | Size         | Price |
|--------|-------|--------------|-------|
| 192658 | 52433 | 4" x 3" x 3" |       |
| 192657 | 52443 | 4" x 4" x 3" |       |
| 192661 | 52543 | 5" x 4" x 3" |       |
| 193222 | 52544 | 5" x 4" x 4" |       |
| 192659 | 52553 | 5" x 5" x 3" |       |
| 192663 | 52643 | 6" x 4" x 3" |       |
| 192662 | 52653 | 6" x 5" x 3" |       |
| 193253 | 52654 | 6" x 5" x 4" |       |
| 192660 | 52663 | 6" x 6" x 3" |       |



---

---

## Round Tees & Wyes

---

---

### Round Wyes (Continued)

#### Flue Wye

| Part # | Mfg #  | Size          | Price |
|--------|--------|---------------|-------|
| 193244 | 52666  | 6" x 6" x 6"  |       |
| 192654 | 52866  | 8" x 6" x 6"  |       |
| 192656 | 521088 | 10" x 8" x 8" |       |

**Round Fittings**

**Galvanized Tees**  
Galv 90° Tee Joint



| Part # | Mfg #     | Size | Gauge | Price |
|--------|-----------|------|-------|-------|
| 011264 | WA3046EZ  | 6"   | 24ga  |       |
| 011265 | WA3047EZ  | 7"   | 24ga  |       |
| 011266 | WA3048EZ  | 8"   | 24ga  |       |
| 011258 | WA30410EZ | 10"  | 24ga  |       |
| 011259 | WA30412EZ | 12"  | 24ga  |       |
| 011260 | WA30414EZ | 14"  | 24ga  |       |
| 011261 | WA3043EZ  | 3"   | 26ga  |       |
| 011262 | WA3044EZ  | 4"   | 26ga  |       |
| 011263 | WA3045EZ  | 5"   | 26ga  |       |

**Galv Stub Wye**



| Part # | Mfg #       | Size         | Price |
|--------|-------------|--------------|-------|
| 016711 | WA306LBC866 | 8" x 6" x 6" |       |

**Galv Water Heater Tee 45°**

| Part # | Mfg #     | Size         | Price |
|--------|-----------|--------------|-------|
| 011290 | WA306C543 | 5" x 4" x 3" |       |
| 041432 | WA306C544 | 5" x 4" x 4" |       |
| 011291 | WA306C553 | 5" x 5" x 3" |       |
| 011292 | WA306L663 | 6" x 6" x 3" |       |

**Galv Flue Tee - 45°**



| Part # | Mfg #   | Size         | Price |
|--------|---------|--------------|-------|
| 106625 | WA306L4 | 4" x 4" x 4" |       |

**Galvanized Wyes**  
Galv Wye Branch



| Part # | Mfg #    | Size         | Price |
|--------|----------|--------------|-------|
| 017816 | WA307866 | 8" x 6" x 6" |       |

Ducts, Fittings & Accessories



## Round Miscellaneous

### Dampers

#### 44 Damper (Two Quad)

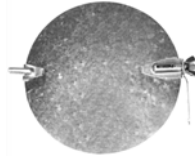

| Part # | Mfg # | Size | Price |
|--------|-------|------|-------|
| 192697 | 446   | 6"   |       |
| 178926 | 448   | 8"   |       |
| 178927 | 4410  | 10"  |       |
| 178928 | 4412  | 12"  |       |

#### 44S Damper (Fixed Hardware)

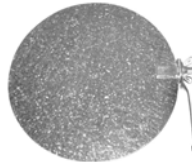

| Part # | Mfg # | Size | Price |
|--------|-------|------|-------|
| 178921 | 44S4  | 4"   |       |
| 178922 | 44S5  | 5"   |       |
| 178923 | 44S6  | 6"   |       |
| 178924 | 44S7  | 7"   |       |
| 178925 | 44S8  | 8"   |       |

#### 40 Damper Section



| Part # | Mfg # | Size | Price |
|--------|-------|------|-------|
| 179008 | 404   | 4"   |       |
| 179009 | 406   | 6"   |       |
| 238609 | 408   | 8"   |       |

### Draw Bands

#### S75 Snap Drawband



| Part # | Mfg # | Size | Price |
|--------|-------|------|-------|
| 180255 | S755  | 5"   |       |
| 180256 | S756  | 6"   |       |

### Draw Bands (Continued)

#### S75 Snap Drawband

| Part # | Mfg # | Size | Price |
|--------|-------|------|-------|
| 180257 | S757  | 7"   |       |
| 180258 | S758  | 8"   |       |

#### 96 Drawband (Gear Clamp)



| Part # | Mfg # | Size | Price |
|--------|-------|------|-------|
| 178783 | 965   | 5"   |       |
| 178784 | 966   | 6"   |       |
| 178785 | 967   | 7"   |       |

### End Caps

#### 55 End Cap

- *Crimped*



| Part # | Mfg # | Size | Price |
|--------|-------|------|-------|
| 178912 | 554   | 4"   |       |
| 178913 | 555   | 5"   |       |
| 178914 | 556   | 6"   |       |
| 178915 | 557   | 7"   |       |
| 178916 | 558   | 8"   |       |
| 178917 | 559   | 9"   |       |
| 178918 | 5510  | 10"  |       |
| 178919 | 5512  | 12"  |       |
| 181322 | 5514  | 14"  |       |
| 178651 | 5516  | 16"  |       |

#### 55NC End Cap

- *No Crimpe*

| Part # | Mfg # | Size | Price |
|--------|-------|------|-------|
| 178902 | 553NC | 3"   |       |
| 178903 | 554NC | 4"   |       |
| 178904 | 555NC | 5"   |       |
| 178905 | 556NC | 6"   |       |
| 178906 | 557NC | 7"   |       |
| 178907 | 558NC | 8"   |       |
| 178908 | 559NC | 9"   |       |



## Round Miscellaneous

### End Caps (Continued)

#### 55NC End Cap

| Part # | Mfg #  | Size | Price |
|--------|--------|------|-------|
| 178909 | 5510NC | 10"  |       |
| 178910 | 5512NC | 12"  |       |
| 178911 | 5514NC | 14"  |       |

### Fresh Air Intakes

#### 36 Fresh Air Intake

- 1/4" Galvanized mesh cover



| Part # | Mfg # | Size | Price |
|--------|-------|------|-------|
| 178653 | 364   | 4"   |       |
| 178970 | 365   | 5"   |       |
| 178971 | 366   | 6"   |       |
| 178974 | 368   | 8"   |       |

### Reducers

#### 58 3-Pc No Crimp Reducer



| Part # | Mfg # | Size    | Price |
|--------|-------|---------|-------|
| 178943 | 5843  | 4" x 3" |       |
| 178944 | 5853  | 5" x 3" |       |
| 178945 | 5854  | 5" x 4" |       |
| 178946 | 5863  | 6" x 3" |       |
| 178947 | 5864  | 6" x 4" |       |
| 178948 | 5865  | 6" x 5" |       |
| 178949 | 5873  | 7" x 3" |       |
| 178950 | 5874  | 7" x 4" |       |
| 178951 | 5875  | 7" x 5" |       |
| 178952 | 5876  | 7" x 6" |       |
| 178953 | 5884  | 8" x 4" |       |
| 178954 | 5885  | 8" x 5" |       |
| 178956 | 5886  | 8" x 6" |       |
| 178957 | 5887  | 8" x 7" |       |
| 178958 | 5896  | 9" x 6" |       |
| 178959 | 5897  | 9" x 7" |       |
| 178960 | 5898  | 9" x 8" |       |

### Reducers (Continued)

#### 58 3-Pc No Crimp Reducer

| Part # | Mfg #  | Size      | Price |
|--------|--------|-----------|-------|
| 178961 | 58106  | 10" x 6"  |       |
| 178962 | 58107  | 10" x 7"  |       |
| 178963 | 58108  | 10" x 8"  |       |
| 178964 | 58109  | 10" x 9"  |       |
| 178965 | 58128  | 12" x 8"  |       |
| 178966 | 581210 | 12" x 10" |       |
| 227738 | 58146  | 14" x 6"  |       |
| 178967 | 581412 | 14" x 12" |       |
| 192703 | 581614 | 16" x 14" |       |

### Saddles

#### 207 90° Vent Saddle



| Part # | Mfg # | Size | Price |
|--------|-------|------|-------|
| 179019 | 2073  | 3"   |       |
| 179020 | 2074  | 4"   |       |

#### 208 45° Vent Saddle



| Part # | Mfg # | Size | Price |
|--------|-------|------|-------|
| 179022 | 2083  | 3"   |       |
| 179023 | 2084  | 4"   |       |

## Round Fittings

### Galvanized Drawbands

#### Galv Drawband

- 316= Screw Style
- 316S= Snap Style



| Part # | Mfg #   | Size | Price |
|--------|---------|------|-------|
| 165725 | WA316S6 | 6"   |       |
| 011160 | WA3166  | 6"   |       |
| 011161 | WA3167  | 7"   |       |

### Galvanized End Caps

#### Galv Round Cleanout End Cap

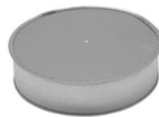

| Part # | Mfg #   | Size | Price |
|--------|---------|------|-------|
| 011053 | WA3103  | 3"   |       |
| 011054 | WA3104  | 4"   |       |
| 011055 | WA3105  | 5"   |       |
| 011056 | WA3106  | 6"   |       |
| 011057 | WA3107  | 7"   |       |
| 011058 | WA3108  | 8"   |       |
| 011059 | WA3109  | 9"   |       |
| 011050 | WA31010 | 10"  |       |
| 011051 | WA31012 | 12"  |       |
| 011052 | WA31014 | 14"  |       |
| 105845 | WA31016 | 16"  |       |

#### Galv Round Cleanout End Cap - Crimped



| Part # | Mfg #   | Size | Price |
|--------|---------|------|-------|
| 011063 | WA3094  | 4"   |       |
| 011064 | WA3095  | 5"   |       |
| 011065 | WA3096  | 6"   |       |
| 011066 | WA3097  | 7"   |       |
| 011067 | WA3098  | 8"   |       |
| 011068 | WA3099  | 9"   |       |
| 011060 | WA30910 | 10"  |       |
| 011061 | WA30912 | 12"  |       |
| 011062 | WA30914 | 14"  |       |

### Galvanized Dampers

#### Galv Round Damper One Quad



| Part # | Mfg #  | Size | Price |
|--------|--------|------|-------|
| 011074 | WA3144 | 4"   |       |
| 011075 | WA3145 | 5"   |       |
| 011076 | WA3146 | 6"   |       |
| 011077 | WA3147 | 7"   |       |
| 011078 | WA3148 | 8"   |       |

#### Galv Round Damper Two Quad



| Part # | Mfg #     | Size | Price |
|--------|-----------|------|-------|
| 011072 | WA314DQ10 | 10"  |       |
| 011073 | WA314DQ12 | 12"  |       |

### Galvanized Reducers

#### Galv Taper Reducer / No Crimp



| Part # | Mfg #  | Size    | Price |
|--------|--------|---------|-------|
| 010809 | WARI43 | 4" x 3" |       |
| 010810 | WARI53 | 5" x 3" |       |
| 010811 | WARI54 | 5" x 4" |       |
| 010812 | WARI63 | 6" x 3" |       |
| 010813 | WARI64 | 6" x 4" |       |
| 010814 | WARI65 | 6" x 5" |       |
| 010815 | WARI73 | 7" x 3" |       |
| 010816 | WARI74 | 7" x 4" |       |
| 010817 | WARI75 | 7" x 5" |       |
| 010818 | WARI76 | 7" x 6" |       |
| 010819 | WARI84 | 8" x 4" |       |
| 010820 | WARI85 | 8" x 5" |       |
| 010821 | WARI86 | 8" x 6" |       |
| 010822 | WARI87 | 8" x 7" |       |

**Round Fittings**

**Galvanized Reducers (Continued)**

**Galv Taper Reducer / No Crimp**

| Part # | Mfg #      | Size      | Price |
|--------|------------|-----------|-------|
| 010823 | WARI96     | 9" x 6"   |       |
| 010824 | WARI97     | 9" x 7"   |       |
| 010825 | WARI98     | 9" x 8"   |       |
| 010803 | WA311P106  | 10" x 6"  |       |
| 010804 | WA311P107  | 10" x 7"  |       |
| 010805 | WA311P108  | 10" x 8"  |       |
| 010806 | WA311P109  | 10" x 9"  |       |
| 055585 | WA311P128  | 12" x 8"  |       |
| 010807 | WA311P1210 | 12" x 10" |       |
| 010808 | WA311P1412 | 14" x 12" |       |

**Galvanized Saddles**

**Galv 45° Saddle**

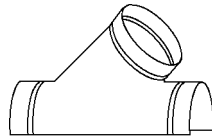

| Part # | Mfg #       | Size | Price |
|--------|-------------|------|-------|
| 011185 | WASADDLE453 | 3"   |       |
| 011186 | WASADDLE454 | 4"   |       |

**Galv 90° Saddle**

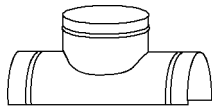

| Part # | Mfg #       | Size | Price |
|--------|-------------|------|-------|
| 011183 | WASADDLE903 | 3"   |       |
| 011184 | WASADDLE904 | 4"   |       |
| 098829 | WASADDLE906 | 6"   |       |
| 162732 | WASADDLE908 | 8"   |       |

**Fresh Air Intakes**

**329 Fresh Air Intake**



| Part # | Mfg #     | Size           | Price |
|--------|-----------|----------------|-------|
| 157685 | WA3294T10 | 4" w/ 10" Tail |       |
| 157687 | WA3296T10 | 6" w/ 10" Tail |       |

## Spiral Pipe & Fittings

### Spiral Pipe

#### 26 Gauge SP10 Spiral Pipe

- 10 Foot lengths
- Galvanized steel
- Riveted connection
- Outside dimensions of each end diameter is approximately 1/8" under nominal size



| Part # | Mfg #    | Size | Price |
|--------|----------|------|-------|
| 179924 | SP10426  | 4"   |       |
| 179923 | SP10526  | 5"   |       |
| 179925 | SP10626  | 6"   |       |
| 179926 | SP10726  | 7"   |       |
| 179927 | SP10826  | 8"   |       |
| 179928 | SP101026 | 10"  |       |
| 179929 | SP101226 | 12"  |       |
| 179930 | SP101426 | 14"  |       |

#### 24 Gauge SP10 Spiral Pipe

- 10 Foot lengths
- Galvanized steel
- Riveted connection
- Outside dimensions of each end diameter is approximately 1/8" under nominal size



| Part # | Mfg #    | Size | Price |
|--------|----------|------|-------|
| 179931 | SP101624 | 16"  |       |
| 179932 | SP101824 | 18"  |       |
| 179933 | SP102024 | 20"  |       |
| 179934 | SP102224 | 22"  |       |
| 179935 | SP102424 | 24"  |       |

### Spiral Elbows

#### 26 Gauge SP45 Spiral Angle

- Galvanized steel
- Riveted connection
- Outside dimensions of each end diameter is approximately 1/8" under nominal size



| Part # | Mfg #    | Size | Price |
|--------|----------|------|-------|
| 180080 | SP45426  | 4"   |       |
| 180081 | SP45526  | 5"   |       |
| 180082 | SP45626  | 6"   |       |
| 180083 | SP45726  | 7"   |       |
| 180084 | SP45826  | 8"   |       |
| 180085 | SP451026 | 10"  |       |

### Spiral Elbows (Continued)

#### 26 Gauge SP45 Spiral Angle

| Part # | Mfg #    | Size | Price |
|--------|----------|------|-------|
| 180086 | SP451226 | 12"  |       |

#### 24 Gauge SP45 Spiral Angle

- Galvanized steel
- Riveted connection
- Outside dimensions of each end diameter is approximately 1/8" under nominal size



| Part # | Mfg #    | Size | Price |
|--------|----------|------|-------|
| 180087 | SP451424 | 14"  |       |
| 180088 | SP451624 | 16"  |       |
| 180089 | SP451824 | 18"  |       |
| 180090 | SP452024 | 20"  |       |
| 180091 | SP452224 | 22"  |       |
| 180092 | SP452424 | 24"  |       |

#### 26 Gauge SP90 Spiral Elbow

- Galvanized steel
- Riveted connection
- Outside dimensions of each end diameter is approximately 1/8" under nominal size



| Part # | Mfg #    | Size | Price |
|--------|----------|------|-------|
| 180053 | SP90426  | 4"   |       |
| 180054 | SP90526  | 5"   |       |
| 180055 | SP90626  | 6"   |       |
| 180056 | SP90726  | 7"   |       |
| 180057 | SP90826  | 8"   |       |
| 180058 | SP901026 | 10"  |       |
| 180059 | SP901226 | 12"  |       |

#### 24 Gauge SP90 Spiral Elbow

- Galvanized steel
- Riveted connection
- Outside dimensions of each end diameter is approximately 1/8" under nominal size



| Part # | Mfg #    | Size | Price |
|--------|----------|------|-------|
| 180060 | SP901424 | 14"  |       |
| 180061 | SP901624 | 16"  |       |



## Spiral Pipe & Fittings

### Spiral Elbows (Continued)

#### 24 Gauge SP90 Spiral Elbow

| Part # | Mfg #    | Size | Price |
|--------|----------|------|-------|
| 180062 | SP901824 | 18"  |       |
| 180063 | SP902024 | 20"  |       |
| 180064 | SP902224 | 22"  |       |
| 180065 | SP902424 | 24"  |       |

#### 26 Gauge SP90LR Long Radius Spiral Elbow

- Galvanized steel
- Riveted connection
- Outside dimensions of each end diameter is approximately 1/8" under nominal size



| Part # | Mfg #      | Size | Price |
|--------|------------|------|-------|
| 180066 | SP90LR426  | 4"   |       |
| 180067 | SP90LR526  | 5"   |       |
| 180068 | SP90LR626  | 6"   |       |
| 180069 | SP90LR726  | 7"   |       |
| 180070 | SP90LR826  | 8"   |       |
| 180071 | SP90LR1026 | 10"  |       |
| 180072 | SP90LR1226 | 12"  |       |

#### 24 Gauge SP90LR Long Radius Spiral Elbow

- Galvanized steel
- Riveted connection
- Outside dimensions of each end diameter is approximately 1/8" under nominal size



| Part # | Mfg #      | Size | Price |
|--------|------------|------|-------|
| 180073 | SP90LR1424 | 14"  |       |
| 180074 | SP90LR1624 | 16"  |       |
| 180075 | SP90LR1824 | 18"  |       |
| 180076 | SP90LR2024 | 20"  |       |
| 180077 | SP90LR2224 | 22"  |       |
| 180078 | SP90LR2424 | 24"  |       |

### Spiral Connectors

#### 26 Gauge SPCON Spiral Connector

- Galvanized steel
- Riveted connection
- Outside dimensions of each end diameter is approximately 1/8" under nominal size



| Part # | Mfg #     | Size | Price |
|--------|-----------|------|-------|
| 180093 | SPCON426  | 4"   |       |
| 180094 | SPCON526  | 5"   |       |
| 180095 | SPCON626  | 6"   |       |
| 180096 | SPCON726  | 7"   |       |
| 180097 | SPCON826  | 8"   |       |
| 180098 | SPCON1026 | 10"  |       |
| 180099 | SPCON1226 | 12"  |       |

#### 24 Gauge SPCON Spiral Connector

- Galvanized steel
- Riveted connection
- Outside dimensions of each end diameter is approximately 1/8" under nominal size



| Part # | Mfg #     | Size | Price |
|--------|-----------|------|-------|
| 180100 | SPCON1424 | 14"  |       |
| 180101 | SPCON1624 | 16"  |       |
| 180102 | SPCON1824 | 18"  |       |
| 180103 | SPCON2024 | 20"  |       |
| 180104 | SPCON2224 | 22"  |       |
| 180105 | SPCON2424 | 24"  |       |

### Spiral Tees

#### 26 Gauge SP54 Spiral Tee

- Galvanized steel
- Riveted connection
- Outside dimensions of each end diameter is approximately 1/8" under nominal size



| Part # | Mfg #   | Size         | Price |
|--------|---------|--------------|-------|
| 180183 | SP54444 | 4" x 4" x 4" |       |
| 180184 | SP54554 | 5" x 5" x 4" |       |
| 180185 | SP54555 | 5" x 5" x 5" |       |
| 180186 | SP54664 | 6" x 6" x 4" |       |
| 180187 | SP54666 | 6" x 6" x 6" |       |

Ducts, Fittings & Accessories



## Spiral Pipe & Fittings

### Spiral Tees (Continued)

#### 26 Gauge SP54 Spiral Tee

| Part # | Mfg #      | Size            | Price |
|--------|------------|-----------------|-------|
| 180188 | SP54774    | 7" x 7" x 4"    |       |
| 180189 | SP54776    | 7" x 7" x 6"    |       |
| 180190 | SP54777    | 7" x 7" x 7"    |       |
| 180201 | SP54884    | 8" x 8" x 4"    |       |
| 180202 | SP54886    | 8" x 8" x 6"    |       |
| 180191 | SP54888    | 8" x 8" x 8"    |       |
| 180203 | SP5410106  | 10" x 10" x 6"  |       |
| 180204 | SP5410108  | 10" x 10" x 8"  |       |
| 180192 | SP54101010 | 10" x 10" x 10" |       |
| 180205 | SP5412126  | 12" x 12" x 6"  |       |
| 180206 | SP5412128  | 12" x 12" x 8"  |       |
| 180207 | SP54121210 | 12" x 12" x 10" |       |
| 180193 | SP54121212 | 12" x 12" x 12" |       |

#### 24 Gauge SP54 Spiral Tee

- Galvanized steel
- Riveted connection
- Outside dimensions of each end diameter is approximately 1/8" under nominal size



| Part # | Mfg #      | Size            | Price |
|--------|------------|-----------------|-------|
| 180208 | SP5414146  | 14" x 14" x 6"  |       |
| 180210 | SP5414148  | 14" x 14" x 8"  |       |
| 180211 | SP54141410 | 14" x 14" x 10" |       |
| 180212 | SP54141412 | 14" x 14" x 12" |       |
| 180194 | SP54141414 | 14" x 14" x 14" |       |
| 180213 | SP5416168  | 16" x 16" x 8"  |       |
| 180214 | SP54161610 | 16" x 16" x 10" |       |
| 180215 | SP54161612 | 16" x 16" x 12" |       |
| 180216 | SP54161614 | 16" x 16" x 14" |       |
| 180195 | SP54161616 | 16" x 16" x 16" |       |
| 180217 | SP54181810 | 18" x 18" x 10" |       |
| 180218 | SP54181812 | 18" x 18" x 12" |       |
| 180219 | SP54181814 | 18" x 18" x 14" |       |
| 180220 | SP54181816 | 18" x 18" x 16" |       |
| 180196 | SP54181818 | 18" x 18" x 18" |       |
| 180221 | SP54202010 | 20" x 20" x 10" |       |
| 180222 | SP54202012 | 20" x 20" x 12" |       |
| 180223 | SP54202014 | 20" x 20" x 14" |       |
| 180224 | SP54202016 | 20" x 20" x 16" |       |
| 180225 | SP54202018 | 20" x 20" x 18" |       |

### Spiral Tees (Continued)

#### 24 Gauge SP54 Spiral Tee

| Part # | Mfg #      | Size            | Price |
|--------|------------|-----------------|-------|
| 180197 | SP54202020 | 20" x 20" x 20" |       |
| 180226 | SP54222218 | 22" x 22" x 18" |       |
| 180227 | SP54222220 | 22" x 22" x 20" |       |
| 180198 | SP54222222 | 22" x 22" x 22" |       |
| 180228 | SP54242418 | 24" x 24" x 18" |       |
| 180230 | SP54242420 | 24" x 24" x 20" |       |
| 180231 | SP54242422 | 24" x 24" x 22" |       |
| 180199 | SP54242424 | 24" x 24" x 24" |       |

### Reducers

#### 26 Gauge SP58 Spiral Tapered Reducer

- Galvanized steel
- Riveted connection
- Outside dimensions of each end diameter is approximately 1/8" under nominal size



| Part # | Mfg #    | Size      | Price |
|--------|----------|-----------|-------|
| 179939 | SP5854   | 5" x 4"   |       |
| 179940 | SP5864   | 6" x 4"   |       |
| 179938 | SP5865   | 6" x 5"   |       |
| 179941 | SP5874   | 7" x 4"   |       |
| 179942 | SP5875   | 7" x 5"   |       |
| 179943 | SP5876   | 7" x 6"   |       |
| 179945 | SP5885   | 8" x 5"   |       |
| 179946 | SP5886   | 8" x 6"   |       |
| 179947 | SP5887   | 8" x 7"   |       |
| 179948 | SP58106  | 10" x 6"  |       |
| 179949 | SP58107  | 10" x 7"  |       |
| 179950 | SP58108  | 10" x 8"  |       |
| 179951 | SP58126  | 12" x 6"  |       |
| 179952 | SP58128  | 12" x 8"  |       |
| 179953 | SP581210 | 12" x 10" |       |

#### 24 Gauge SP58 Spiral Tapered Reducer

- Galvanized steel
- Riveted connection
- Outside dimensions of each end diameter is approximately 1/8" under nominal size



| Part # | Mfg #    | Size      | Price |
|--------|----------|-----------|-------|
| 179955 | SP581410 | 14" x 10" |       |
| 179956 | SP581412 | 14" x 12" |       |
| 179954 | SP58148  | 14" x 8"  |       |



## Spiral Pipe & Fittings

### Reducers (Continued)

#### 24 Gauge SP58 Spiral Tapered Reducer

| Part # | Mfg #    | Size      | Price |
|--------|----------|-----------|-------|
| 179957 | SP581610 | 16" x 10" |       |
| 179958 | SP581612 | 16" x 12" |       |
| 179959 | SP581614 | 16" x 14" |       |
| 179960 | SP581812 | 18" x 12" |       |
| 179961 | SP581814 | 18" x 14" |       |
| 179962 | SP581816 | 18" x 16" |       |
| 179963 | SP582014 | 20" x 14" |       |
| 179964 | SP582016 | 20" x 16" |       |
| 179965 | SP582018 | 20" x 18" |       |
| 179966 | SP582216 | 22" x 16" |       |
| 179967 | SP582218 | 22" x 18" |       |
| 179968 | SP582220 | 22" x 20" |       |
| 179969 | SP582418 | 24" x 18" |       |
| 179970 | SP582420 | 24" x 20" |       |
| 179971 | SP582422 | 24" x 22" |       |

#### 26 Gauge SP58ER Spiral Eccentric Reducer

- Galvanized steel
- Riveted connection
- Outside dimensions of each end diameter is approximately 1/8" under nominal size



| Part # | Mfg #      | Size      | Price |
|--------|------------|-----------|-------|
| 180129 | SP58ER54   | 5" x 4"   |       |
| 180130 | SP58ER64   | 6" x 4"   |       |
| 180131 | SP58ER65   | 6" x 5"   |       |
| 180132 | SP58ER74   | 7" x 4"   |       |
| 180133 | SP58ER75   | 7" x 5"   |       |
| 180134 | SP58ER76   | 7" x 6"   |       |
| 180135 | SP58ER85   | 8" x 5"   |       |
| 180136 | SP58ER86   | 8" x 6"   |       |
| 180137 | SP58ER87   | 8" x 7"   |       |
| 180138 | SP58ER106  | 10" x 6"  |       |
| 180139 | SP58ER107  | 10" x 7"  |       |
| 180140 | SP58ER108  | 10" x 8"  |       |
| 180141 | SP58ER126  | 12" x 6"  |       |
| 180142 | SP58ER128  | 12" x 8"  |       |
| 180143 | SP58ER1210 | 12" x 10" |       |

#### 24 Gauge SP58ER Spiral Eccentric Reducer

- Galvanized steel
- Riveted connection
- Outside dimensions of each end diameter is approximately 1/8" under nominal size



| Part # | Mfg #      | Size      | Price |
|--------|------------|-----------|-------|
| 180145 | SP58ER1410 | 14" x 10" |       |
| 180146 | SP58ER1412 | 14" x 12" |       |
| 180144 | SP58ER148  | 14" x 8"  |       |
| 180147 | SP58ER1610 | 16" x 10" |       |
| 180149 | SP58ER1612 | 16" x 12" |       |
| 180150 | SP58ER1614 | 16" x 14" |       |
| 180152 | SP58ER1812 | 18" x 12" |       |
| 180153 | SP58ER1814 | 18" x 14" |       |
| 180154 | SP58ER1816 | 18" x 16" |       |
| 180155 | SP58ER2014 | 20" x 14" |       |
| 180156 | SP58ER2016 | 20" x 16" |       |
| 180157 | SP58ER2018 | 20" x 18" |       |
| 180158 | SP58ER2216 | 22" x 16" |       |
| 180159 | SP58ER2218 | 22" x 18" |       |
| 180160 | SP58ER2220 | 22" x 20" |       |
| 180161 | SP58ER2418 | 24" x 18" |       |
| 180162 | SP58ER2420 | 24" x 20" |       |
| 180163 | SP58ER2422 | 24" x 22" |       |

### Caps

#### 26 Gauge SP55 Spiral End Cap

- Galvanized steel
- Riveted connection
- Outside dimensions of each end diameter is approximately 1/8" under nominal size



| Part # | Mfg #  | Size | Price |
|--------|--------|------|-------|
| 180106 | SP554  | 4"   |       |
| 180107 | SP555  | 5"   |       |
| 180108 | SP556  | 6"   |       |
| 180109 | SP557  | 7"   |       |
| 180110 | SP558  | 8"   |       |
| 180111 | SP5510 | 10"  |       |
| 180112 | SP5512 | 12"  |       |



## Spiral Pipe & Fittings

### 24 Gauge SP55 Spiral End Cap

- Galvanized steel
- Riveted connection
- Outside dimensions of each end diameter is approximately 1/8" under nominal size



| Part # | Mfg #  | Size | Price |
|--------|--------|------|-------|
| 180113 | SP5514 | 14"  |       |
| 180114 | SP5516 | 16"  |       |
| 180115 | SP5518 | 18"  |       |
| 180116 | SP5520 | 20"  |       |
| 180117 | SP5522 | 22"  |       |
| 180118 | SP5524 | 24"  |       |

### Spiral Saddles

#### SP70 Spiral Register Saddle

- Galvanized steel
- Riveted connection
- Outside dimensions of each end diameter is approximately 1/8" under nominal size



| Part # | Mfg #     | Size             | Price |
|--------|-----------|------------------|-------|
| 180389 | SP702106  | 2-1/4" x 10" 6"  |       |
| 180310 | SP702108  | 2-1/4" x 10" 8"  |       |
| 180311 | SP7021010 | 2-1/4" x 10" 10" |       |
| 180312 | SP7021012 | 2-1/4" x 10" 12" |       |
| 180313 | SP7021014 | 2-1/4" x 10" 14" |       |
| 180314 | SP7021016 | 2-1/4" x 10" 16" |       |
| 180315 | SP7021018 | 2-1/4" x 10" 18" |       |
| 180316 | SP7021020 | 2-1/4" x 10" 20" |       |
| 180391 | SP702126  | 2-1/4" x 12" 6"  |       |
| 180318 | SP702128  | 2-1/4" x 12" 8"  |       |
| 180320 | SP7021210 | 2-1/4" x 12" 10" |       |
| 180321 | SP7021212 | 2-1/4" x 12" 12" |       |
| 180322 | SP7021214 | 2-1/4" x 12" 14" |       |
| 180323 | SP7021216 | 2-1/4" x 12" 16" |       |
| 180325 | SP7021218 | 2-1/4" x 12" 18" |       |
| 180326 | SP7021220 | 2-1/4" x 12" 20" |       |
| 180392 | SP702146  | 2-1/4" x 14" 6"  |       |
| 180327 | SP702148  | 2-1/4" x 14" 8"  |       |
| 180328 | SP7021410 | 2-1/4" x 14" 10" |       |
| 180329 | SP7021412 | 2-1/4" x 14" 12" |       |
| 180330 | SP7021414 | 2-1/4" x 14" 14" |       |
| 180331 | SP7021416 | 2-1/4" x 14" 16" |       |
| 180332 | SP7021418 | 2-1/4" x 14" 18" |       |
| 180333 | SP7021420 | 2-1/4" x 14" 20" |       |

### Spiral Saddles (Continued)

#### SP70 Spiral Register Saddle

| Part # | Mfg #     | Size         | Price |
|--------|-----------|--------------|-------|
| 180393 | SP704106  | 4" x 10" 6"  |       |
| 180336 | SP704108  | 4" x 10" 8"  |       |
| 180337 | SP7041010 | 4" x 10" 10" |       |
| 180338 | SP7041012 | 4" x 10" 12" |       |
| 180339 | SP7041014 | 4" x 10" 14" |       |
| 180340 | SP7041016 | 4" x 10" 16" |       |
| 180342 | SP7041018 | 4" x 10" 18" |       |
| 180343 | SP7041020 | 4" x 10" 20" |       |
| 180395 | SP704126  | 4" x 12" 6"  |       |
| 180344 | SP704128  | 4" x 12" 8"  |       |
| 180345 | SP7041210 | 4" x 12" 10" |       |
| 180346 | SP7041212 | 4" x 12" 12" |       |
| 180347 | SP7041214 | 4" x 12" 14" |       |
| 180348 | SP7041216 | 4" x 12" 16" |       |
| 180349 | SP7041218 | 4" x 12" 18" |       |
| 180350 | SP7041220 | 4" x 12" 20" |       |
| 180396 | SP704146  | 4" x 14" 6"  |       |
| 180352 | SP704148  | 4" x 14" 8"  |       |
| 180353 | SP7041410 | 4" x 14" 10" |       |
| 180354 | SP7041412 | 4" x 14" 12" |       |
| 180355 | SP7041414 | 4" x 14" 14" |       |
| 180356 | SP7041416 | 4" x 14" 16" |       |
| 180357 | SP7041418 | 4" x 14" 18" |       |
| 180358 | SP7041420 | 4" x 14" 20" |       |
| 180397 | SP706106  | 6" x 10" 6"  |       |
| 180359 | SP706108  | 6" x 10" 8"  |       |
| 180360 | SP7061010 | 6" x 10" 10" |       |
| 180361 | SP7061012 | 6" x 10" 12" |       |
| 180362 | SP7061014 | 6" x 10" 14" |       |
| 180363 | SP7061016 | 6" x 10" 16" |       |
| 180364 | SP7061018 | 6" x 10" 18" |       |
| 180365 | SP7061020 | 6" x 10" 20" |       |
| 180399 | SP706126  | 6" x 12" 6"  |       |
| 180366 | SP706128  | 6" x 12" 8"  |       |
| 180367 | SP7061210 | 6" x 12" 10" |       |
| 180368 | SP7061212 | 6" x 12" 12" |       |
| 180369 | SP7061214 | 6" x 12" 14" |       |
| 180370 | SP7061216 | 6" x 12" 16" |       |
| 180371 | SP7061218 | 6" x 12" 18" |       |
| 180372 | SP7061220 | 6" x 12" 20" |       |
| 180381 | SP706146  | 6" x 14" 6"  |       |
| 180373 | SP706148  | 6" x 14" 8"  |       |
| 180374 | SP7061410 | 6" x 14" 10" |       |
| 180375 | SP7061412 | 6" x 14" 12" |       |



## Spiral Pipe & Fittings

### Spiral Saddles (Continued)

#### SP70 Spiral Register Saddle

| Part # | Mfg #     | Size         | Price |
|--------|-----------|--------------|-------|
| 180376 | SP7061414 | 6" x 14" 14" |       |
| 180377 | SP7061416 | 6" x 14" 16" |       |
| 180378 | SP7061418 | 6" x 14" 18" |       |
| 180379 | SP7061420 | 6" x 14" 20" |       |

### Shoe Taps

#### SP 6 Spiral 90° Shoe Tap

- Galvanized steel
- Riveted connection
- Outside dimensions of each end diameter is approximately 1/8" under nominal size



|        |        | Size | Pipe Size |
|--------|--------|------|-----------|
| 180414 | SP606  | 6"   | 6"-10"    |
| 180415 | SP606A | 6"   | 12"-16"   |
| 240062 | SP607  | 7"   | 8"-12"    |
| 180416 | SP608  | 8"   | 8"-12"    |
| 180417 | SP608A | 8"   | 14"-18"   |
| 180418 | SP610  | 10"  | 10"-14"   |
| 180419 | SP610A | 10"  | 16"-20"   |
| 180420 | SP612  | 12"  | 12"-16"   |
| 180421 | SP612A | 12"  | 18"-22"   |



## Wall Stack Duct

### Wallstacks WSJ Wall Stack

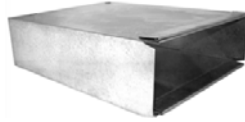

#### 24" Joint

| Part # | Mfg #    | Size         | Price |
|--------|----------|--------------|-------|
| 179167 | WSJ24210 | 2-1/4" x 10" |       |
| 179168 | WSJ24212 | 2-1/4" x 12" |       |
| 179169 | WSJ24214 | 2-1/4" x 14" |       |
| 179170 | WSJ24310 | 3-1/4" x 10" |       |
| 179171 | WSJ24312 | 3-1/4" x 12" |       |
| 179172 | WSJ24314 | 3-1/4" x 14" |       |

#### 60" Joint

| Part # | Mfg #    | Size         | Price |
|--------|----------|--------------|-------|
| 179164 | WSJ60212 | 2-1/4" x 12" |       |
| 179165 | WSJ60310 | 3-1/4" x 10" |       |
| 179166 | WSJ60312 | 3-1/4" x 12" |       |

#### 100" Joint

| Part # | Mfg #     | Size         | Price |
|--------|-----------|--------------|-------|
| 179160 | WSJ100210 | 2-1/4" x 10" |       |
| 179161 | WSJ100212 | 2-1/4" x 12" |       |
| 179162 | WSJ100310 | 3-1/4" x 10" |       |
| 179163 | WSJ100312 | 3-1/4" x 12" |       |
| 234957 | WSJ100314 | 3-1/2" x 14" |       |

**Wall Stack Duct**

**Galvanized Wall Stacks**



**Galv 24" Wall Stack**

| Part # | Mfg #         | Size         | Price |
|--------|---------------|--------------|-------|
| 011113 | WA124BL214102 | 2-1/4" x 10" |       |
| 011115 | WA124BL214122 | 2-1/4" x 12" |       |
| 011119 | WA124BL314102 | 3-1/4" x 10" |       |
| 011121 | WA124BL314122 | 3-1/4" x 12" |       |
| 011123 | WA124BL314142 | 3-1/4" x 14" |       |

**Galv 60" Wall Stack**

| Part # | Mfg #          | Size         | Price |
|--------|----------------|--------------|-------|
| 011116 | WA124BL2141260 | 2-1/4" x 12" |       |
| 011120 | WA124BL3141060 | 3 1/4" x 10" |       |
| 011122 | WA124BL3141260 | 3 1/4" x 12" |       |

**Galv 100" Wall Stack**

| Part # | Mfg #           | Size         | Price |
|--------|-----------------|--------------|-------|
| 011114 | WA124BL21412100 | 2-1/4" x 12" |       |
| 011118 | WA124BL31410100 | 3-1/4" x 10" |       |
| 017815 | WA124BL31412100 | 3-1/4" x 12" |       |



## Wall Stack Fittings

### Elbows

#### WS14 90° Flat Stack Elbow (Broadway, Longway)



| Part # | Mfg #   | Size         | Price |
|--------|---------|--------------|-------|
| 178940 | WS14212 | 2-1/4" x 12" |       |
| 178941 | WS14310 | 3-1/4" x 10" |       |
| 178942 | WS14312 | 3-1/4" x 12" |       |

#### WS15 45° Vertical Stack Angle (Shortway)



| Part # | Mfg #   | Size         | Price |
|--------|---------|--------------|-------|
| 178935 | WS15210 | 2-1/4" x 10" |       |
| 178936 | WS15212 | 2-1/4" x 12" |       |
| 178937 | WS15310 | 3-1/4" x 10" |       |
| 178938 | WS15312 | 3-1/4" x 12" |       |
| 178939 | WS15314 | 3-1/4" x 14" |       |

#### WS16 90° Vertical Stack Elbow (Shortway)



| Part # | Mfg #   | Size         | Price |
|--------|---------|--------------|-------|
| 178929 | WS16210 | 2-1/4" x 10" |       |
| 178931 | WS16212 | 2-1/4" x 12" |       |
| 178932 | WS16310 | 3-1/4" x 10" |       |
| 178933 | WS16312 | 3-1/4" x 12" |       |
| 178934 | WS16314 | 3-1/4" x 14" |       |

### Stack Boots

#### 24 90° Stack Boot



| Part # | Mfg #  | Size              | Price |
|--------|--------|-------------------|-------|
| 178984 | 242106 | 2-1/4" x 10" x 6" |       |
| 178985 | 242126 | 2-1/4" x 12" x 6" |       |
| 178986 | 243106 | 3-1/4" x 10" x 6" |       |
| 178987 | 243126 | 3-1/4" x 12" x 6" |       |
| 178988 | 243127 | 3-1/4" x 12" x 7" |       |
| 178989 | 243148 | 3-1/4" x 14" x 8" |       |

#### 27 Straight Stack Boot



| Part # | Mfg #  | Size              | Price |
|--------|--------|-------------------|-------|
| 179189 | 272106 | 2-1/4" x 10" x 6" |       |
| 178979 | 272126 | 2-1/4" x 12" x 6" |       |
| 178980 | 273106 | 3-1/4" x 10" x 6" |       |
| 178981 | 273107 | 3-1/4" x 10" x 7" |       |
| 178982 | 273126 | 3-1/4" x 12" x 6" |       |
| 178983 | 273127 | 3-1/4" x 12" x 7" |       |
| 227724 | 273147 | 3-1/4" x 14" x 7" |       |

#### 28 End Stack Boot



| Part # | Mfg #  | Size              | Price |
|--------|--------|-------------------|-------|
| 179190 | 282106 | 2-1/4" x 10" x 6" |       |
| 178990 | 282126 | 2-1/4" x 12" x 6" |       |
| 178991 | 283106 | 3-1/4" x 10" x 6" |       |
| 178992 | 283126 | 3-1/4" x 12" x 6" |       |
| 178993 | 283127 | 3-1/4" x 12" x 7" |       |



**Wall Stack Fittings**

**Galvanized Wall Stack Fittings**

**Galv Horizontal 90° Longway Elbow**

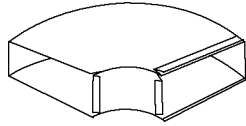

| Part # | Mfg #      | Size         | Price |
|--------|------------|--------------|-------|
| 011092 | WA12221412 | 2-1/4" x 12" |       |
| 011094 | WA12231410 | 3-1/4" x 10" |       |
| 011093 | WA12231412 | 3-1/4" x 12" |       |

**Galv Vertical 45° Shortway Angle**

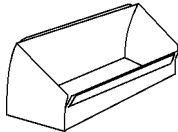

| Part # | Mfg #      | Size         | Price |
|--------|------------|--------------|-------|
| 011087 | WA12121412 | 2-1/4" x 12" |       |
| 011089 | WA12131410 | 3-1/4" x 10" |       |
| 011090 | WA12131412 | 3-1/4" x 12" |       |

**Galv Vertical 90° Shortway Elbow**

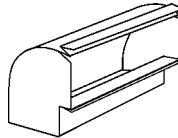

| Part # | Mfg #      | Size         | Price |
|--------|------------|--------------|-------|
| 011081 | WA12021410 | 2-1/4" x 10" |       |
| 011082 | WA12021412 | 2-1/4" x 12" |       |
| 011084 | WA12031410 | 3-1/4" x 10" |       |
| 011085 | WA12031412 | 3-1/4" x 12" |       |
| 011086 | WA12031414 | 3-1/4" x 14" |       |

**Galv Straight Register Stackhead**

| Part # | Mfg #         | Size                  | Price |
|--------|---------------|-----------------------|-------|
| 011105 | WA10421412126 | 2-1/4" x 12"-6" x 12" |       |
| 011107 | WA10431412126 | 3-1/4" x 12"-6" x 12" |       |

**Galvanized Stack Boots**

**Galv Straight Stack Boot**



| Part # | Mfg #        | Size            | Price |
|--------|--------------|-----------------|-------|
| 011126 | WA110S214126 | 2-1/4" x 12"-6" |       |
| 011127 | WA110S314106 | 3-1/4" x 10"-6" |       |
| 011129 | WA110S314126 | 3-1/4" x 12"-6" |       |
| 011128 | WA110S314107 | 3-1/4" x 10"-7" |       |
| 011130 | WA110S314127 | 3-1/4" x 12"-7" |       |
| 173010 | WA110S314147 | 3-1/4" x 14"-7" |       |

**Galv Stack Boot 90° Elbow**



| Part # | Mfg #        | Size            | Price |
|--------|--------------|-----------------|-------|
| 011131 | WA113S214106 | 2-1/4" x 10"-6" |       |
| 011132 | WA113S214126 | 2-1/4" x 12"-6" |       |
| 011134 | WA113S314106 | 3-1/4" x 10"-6" |       |
| 011135 | WA113S314126 | 3-1/4" x 12"-6" |       |
| 011136 | WA113S314127 | 3-1/4" x 12"-7" |       |
| 030889 | WA113S314148 | 3-1/4" x 14"-8" |       |

**Galv Stack Boot Center End**



| Part # | Mfg #        | Size            | Price |
|--------|--------------|-----------------|-------|
| 011139 | WA112S314106 | 3-1/4" x 10"-6" |       |
| 011140 | WA112S314126 | 3-1/4" x 12"-6" |       |

Ducts, Fittings & Accessories

**Fire Safety**

Fire Safety

**AQUASAFE® Looped Fire Safety Systems**

**ProPEX® LF Brass Fire Sprinkler Adapter  
(PEX x PEX x FNPT)**

- Connects residential fire sprinklers to AQUAPEX tubing
- NSF and UL Approved for combining plumbing and fire sprinkler systems



| Part # | Mfg #     | Description                 | Price |
|--------|-----------|-----------------------------|-------|
| 132198 | LF7707575 | Adapter Tee, 3/4"x3/4"x1/2" |       |
| 134020 | LF7701010 | Adapter Tee, 1"x1"x1/2"     |       |

**Parts & Accessories**

**Fire Sprinkler Adapter Mounting Bracket**

| Part # | Mfg #    | Description | Price |
|--------|----------|-------------|-------|
| 132271 | A7750700 | 3/4" and 1" |       |

**Fire Sprinkler Adapter Push-On Nut**

- 25/Pk

| Part # | Mfg #    | Description         | Price |
|--------|----------|---------------------|-------|
| 133923 | F7000005 | Adapter Push-On Nut |       |

**Fire Safety**

**Fire Safety Fittings**

**Viega PEX Press Tee  
(P x P x FPT)**

- Smart connect feature
- Suitable for ViegaPEX Ultra tubing Model V5009.5, V5009.1, V5009.51
- Polymer



| Part # | Mfg # | Size           | Price |
|--------|-------|----------------|-------|
| 233376 | 49140 | 1" x 1" x 1/2" |       |

**Viega PEX Press 90° Elbow  
(P x FPT)**

- Smart connect feature
- Suitable for ViegaPEX Ultra tubing Model V5009.5, V5009.1, V5009.51
- Polymer



| Part # | Mfg # | Size      | Price |
|--------|-------|-----------|-------|
| 233375 | 49145 | 1" x 1/2" |       |

**Fire Safety Accessories**

**J-Clamp Tubing Fasteners**

- For use with ViegaPEX Ultra, Viega FostaPEX, or ViegaPEX Barrier
- Plastic



| Part # | Mfg # | Size | Price |
|--------|-------|------|-------|
| 233377 | 52020 | 1/2" |       |
| 233379 | 52060 | 1"   |       |

Fire Safety

## Screwdrivers & Bits

### Screwdrivers & Bits

#### 9 in 1 Multi-Tool

- Slip-resistant grip
- Thick-walled shaft
- Included:
  - Bits
  - Valve core remover
  - Square #2
  - 1/2" Hex
  - 5/16" Hex
  - 3/8" Hex
  - Phillips #1 & #2
  - 3/16" and 1/4" slotted



| Part # | Mfg #   | Description       | Price |
|--------|---------|-------------------|-------|
| 165766 | 1839053 | 9-in-1 Multi-Tool |       |

#### 3" Shaft Magnetic Nut Drivers

- Secure hold
- Color-coded for quick identification
- Slip-resistant grip
- Hollowed shaft allows for use on long bolts
- Chrome-vanadium steel construction



| Part # | Mfg #   | Description        | Price |
|--------|---------|--------------------|-------|
| 171359 | 1839059 | Red, 1/4" x 3"     |       |
| 171360 | 1839060 | Yellow, 5/16" x 3" |       |

#### 6" Shaft Magnetic Nut Drivers

- Secure hold
- Color-coded for quick identification
- Slip-resistant grip
- Hollowed shaft allows for use on long bolts
- Chrome-vanadium steel construction



| Part # | Mfg #   | Description            | Price |
|--------|---------|------------------------|-------|
| 171362 | 1839068 | Red, 1/4" x 6"         |       |
| 171363 | 1839069 | Yellow, 5/16" x 6"     |       |
| 171364 | 1839074 | Set of 2, 1/4" & 5/16" |       |

### Precision Screwdriver Set

- Comfortable grips
- Maximum precision
  - Rotating head allows for precise adjustments
- Quick identification with easy-to-read tips
- Pouch included for storage
- Includes:
  - #0x3" Phillips, 1/16"x2", 3/32"x3", 1/8"x4", 1/8"x6" Slotted



| Part # | Mfg #   | Description | Price |
|--------|---------|-------------|-------|
| 174627 | 1891089 | 5-Pc Set    |       |

Fire Safety

## Sheet Metal Tools

### Sheet Metal Tools

#### Aviation Snips

- Comfortable grip
- High-carbon steel blades with reinforce chrome silicon spring
- Color-coded handle inserts and splines



| Part # | Mfg #   | Description             | Price |
|--------|---------|-------------------------|-------|
| 177210 | 1891133 | Aviation Snips Left Cut |       |
| 177211 | 1891134 | Aviation Snip Right Cut |       |

#### Hand Seamers

- Comfortable grip
- High-carbon steel blades with reinforced chrome silicon spring
- Quick notification with 1/4" depth marks on blades



| Part # | Mfg #   | Description           | Price |
|--------|---------|-----------------------|-------|
| 174605 | 1891183 | 3" Offset Hand Seamer |       |
| 174604 | 1891185 | 3" Hand Seamer        |       |

#### Folding Tools

- Built for both 3/8" (10mm) and 1" (25mm) folds
- Equipped with sight holes for proper depth alignment



| Part # | Mfg #   | Description      | Price |
|--------|---------|------------------|-------|
| 174607 | 1891146 | 12" Folding Tool |       |
| 174608 | 1890985 | 18" Folding Tool |       |
| 174610 | 1890986 | 24" Folding Tool |       |

#### Hole Cutters

- Lightweight aluminum frame, with a milled bit
- Inch and metric scales
- Fits into any corded or cordless drill with a 1/4" or larger chuck



| Part # | Mfg #   | Description           | Price |
|--------|---------|-----------------------|-------|
| 175060 | 1891191 | 2" to 12" Hole Cutter |       |

### Miscellaneous Tools

| Part # | Mfg #   | Description            | Price |
|--------|---------|------------------------|-------|
| 158489 | 30051SH | Sharpie Black Fine Tip |       |

## Soldering & Brazing

Fire Safety

### Torches

#### Self-Igniting Hand Torch



330544 &  
330545

| Part # | Mfg #    | Description  | Price |
|--------|----------|--|-------|
| 080597 | LX331785 | Self-Igniting w/Adj Swirl Flame                    |       |
| 080624 | 330545   | Self-Igniting Adj Swirl Flame Replacement Assembly |       |
| 080598 | 330546   | Self-Igniting Adj Ultra Swirl Flame                |       |
| 084220 | 330554   | Replacement Tip for LT92                           |       |
| 086360 | 330555   | Replacement Tip for LT90 & LT91                    |       |

#### Mobile Torch System



| Part # | Mfg #  | Description  | Price |
|--------|--------|--|-------|
| 107079 | 10883  | LX300PS Mobile Torch System with LP300 3/8" Tip Included |       |
| 132787 | 330533 | LX400FB Mobile Torch System Kit                          |       |

#### Self-Igniting Swirl Flame



| Part # | Mfg #  | Size | Price |
|--------|--------|------|-------|
| 113302 | 330590 | 1/2" |       |

#### "B" Air Acetylene Kit

- Includes:
  - Air acetylene piston regulator with TANKTOTE handle, GAUGEGUARD and 2" gauge
  - AA Torch handle
  - AA Hose
  - TANKTOTE sleeve
  - "B" Tank key
- Tank sold separately



| Part # | Mfg #       | Description   | Price |
|--------|-------------|---|-------|
| 089164 | 21839LX800B | LX800B Kit with AA800 5/16" Self-Igniting Swirl Flame Tip |       |

#### "MC" Air Acetylene Kit

- Includes:
  - Air acetylene piston regulator with TANKTOTE handle, GAUGEGUARD and 2" gauge
  - AA Torch handle
  - AA Hose
  - TANKTOTE sleeve
  - "MC" Tank key
- Tank sold separately



| Part # | Mfg #        | Description   | Price |
|--------|--------------|---|-------|
| 089165 | 21843LX800MC | LX800MC Kit with AA800 3/8" Self-Igniting Swirl Flame Tip |       |

## Geothermal Accessories

### Geothermal Flow Systems

#### QT Fully Enclosed Non-Pressurized Flow Center

- Removable lid for fast installation easy to fill, check flow rates and add antifreeze
- Air separation chamber continually performs purging function
- Foam insulation eliminates condensation
- Long life check valve
- Hanging handles for ease of handling and installation
- 34"H x 14-3/4"W x 7-1/2"D
- 1" Swivel (FPT) inlet/outlet
- 230/60/1, White cabinet
- Suffix:
  - M = Grundfos 26-116 pump
  - None = without pump
- 5-Year warranty



| Part # | Mfg #      | Description                         | Price |
|--------|------------|-------------------------------------|-------|
| 104061 | 1-230QFC   | (1) 1/6 hp Pump, 230V               |       |
| 228498 | 1-230QFC-L | (1) 1/6 hp Pump, 230V               |       |
| 130846 | 1-230QFC-M | (1) 1/6 hp Pump, 230V               |       |
| 104062 | 2-230QFC   | (2) 1/6 hp Pumps, 230V              |       |
| 130845 | 2-230QFC-M | (2) 1/6 hp Pumps, 230V, 26-116 Pump |       |
| 228500 | 2-230QFC-L | (2) 1/16 hp Pumps, 230V             |       |

#### EA Non-Pressurized Flow Center

- Constructed of stainless steel
- Install (2) heat pumps and connect to the loop field
- Special (2) circuit flow center designed for 6 to 10 ton split coils or total 28 gpm with 2 pumps on each each circuit for one common loop field
- Outlet: 1-1/4" FPT
- Inlet: 1-1/4" MPT
- Field assembly required



| Part # | Mfg #            | Description                           | Price |
|--------|------------------|---------------------------------------|-------|
| 100570 | 2-1E-A-KFC-SS    | (3) 1/6 hp Pumps, 22* gpm. 3.21A/230V | 26-99 |
| 101424 | 2-2E-A-KFC-SS.16 | (4) 1/6 hp Pumps, 28* gpm. 4.28A/230V | 26-99 |

\*Standard: IPT on Inlet Connection. Union can be special ordered. \*For Max Flow Use Grundfos 116F-1.8 AMPS per pump. EXTRA for 116F Pumps EA

### Flow Center Accessories

#### WF-400N Series In-Line Flowmeter

- Acrylic rod stock polished to clear-as-glass finish
- Easy to read scales screen printed on meter body
- Adapters reinforced with aluminum stress rings for added strength
- Viton o-ring seals



| Part # | Mfg #        | Description           | Price |
|--------|--------------|-----------------------|-------|
| 115304 | F-41017LN-16 | 1.0 to 17 gpm, 1" FPT |       |

#### GT Flowmeter Tool

- Provides direct reading of system flow rate



| Part # | Mfg #     | Description      | Price |
|--------|-----------|------------------|-------|
| 055519 | 1-WFT17-A | 17 gal with Case |       |

#### Hose Kit - Complete Installation

- Includes:
  - (2) PEVT666S
  - (2) SPE66
  - (2) RGSE10025
  - (2) RBHE1000
  - (12) WS13053
  - (2) N76-02
  - (1) BRC1PE6
  - 12' WH01-200



| Part # | Mfg #           | Description                    | Price |
|--------|-----------------|--------------------------------|-------|
| 131431 | FC-CHK-KIT1-125 | Complete Installation Hose Kit |       |

#### Hose Kit

- Closed loop



| Part # | Mfg #       | Size              | Price |
|--------|-------------|-------------------|-------|
| 106902 | HK-3/4-1-12 | 3/4" x 1" x 12'   |       |
| 097338 | HK-1-12     | 1" x 12'          |       |
| 099080 | HK-1-114-12 | 1" x 1-1/4" x 12' |       |



## Geothermal Accessories

### Hose

| Part # | Mfg #      | Description                              | Price |
|--------|------------|--|-------|
| 122365 | WH01-200   | 1" x 50' 200 psi Rubber<br>Hose Only     |       |
| 122366 | WH0125-150 | 1-1/4" x 50' 150 psi<br>Rubber Hose Only |       |

### Parts

#### Brass Barb Fitting

| Part # | Mfg #      | Description                               | Price |
|--------|------------|---|-------|
| 098750 | RGSE-10725 | 3/4" MIP x 1" Barb Elbow<br>with PT Port  |       |
| 098749 | RGSE-10025 | 1" MIP x 1" Barb Elbow<br>with PT Port    |       |
| 095402 | BRC1PE6    | 1" Brass Barb x 1-1/4"<br>Fusion Coupling |       |

Geothermal Supplies





## Geothermal Accessories

### Hydron Geothermal Unit Filters

| Part # | Mfg #                   | Size                 | Price |
|--------|-------------------------|----------------------|-------|
| 149446 | ZLPSP23.75x29.75x1EXACT | 23.75" x 29.75" x 1" |       |
| 149387 | ZLPSP27.75x29.75x1EXACT | 27.75" x 29.75" x 1" |       |
| 149447 | ZLPSP27.75x31.75x1EXACT | 27.75" x 31.75" x 1" |       |
| 149386 | ZLPSP27.75x33.75x1EXACT | 27.75" x 33.75" x 1" |       |
| 149448 | ZLPSP27.75x35.75x1EXACT | 27.75" x 35.75" x 1" |       |

Geothermal Supplies

## Ceiling Grilles & Registers

### Residential Ceiling Diffusers

#### 11 Duct Ring for #16 Diffuser

- All-steel construction
- For installation of #16 diffuser when not using a damper
- Golden Sand enamel finish



| Part # | Mfg #  | Size | Price |
|--------|--------|------|-------|
| 005097 | HC1110 | 10"  |       |
| 005098 | HC1112 | 12"  |       |

#### 12 Butterfly Damper for #16 Diffuser

- All-steel construction
- Controls air volume evenly over entire #16 diffuser
- Removable knob operator for adjustment from closed to fully open
- Golden Sand enamel finish



| Part # | Mfg #  | Size | Price |
|--------|--------|------|-------|
| 005105 | HC126  | 6"   |       |
| 005106 | HC128  | 8"   |       |
| 005102 | HC1210 | 10"  |       |
| 005103 | HC1212 | 12"  |       |

#### 16 Steel Round Diffuser

- All-steel construction
- Step-down diffuser rings deflect air stream 360 degrees
- Bright White finish



| Part # | Mfg #  | Size | Price |
|--------|--------|------|-------|
| 005109 | HC166  | 6"   |       |
| 005110 | HC168  | 8"   |       |
| 005107 | HC1610 | 10"  |       |
| 005108 | HC1612 | 12"  |       |
| 017523 | HC1614 | 14"  |       |

### 22 Steel Butterfly Damper for #24 Diffuser

- All-steel construction
- Used with #24 Ceiling Diffuser
- Knob control for quick adjustment (removable)
- Installation flange included
- Golden Sand enamel finish



| Part # | Mfg #  | Size | Price |
|--------|--------|------|-------|
| 005121 | HC226  | 6"   |       |
| 005122 | HC228  | 8"   |       |
| 005119 | HC2210 | 10"  |       |

### 24 Steel, Step Down, Square Diffuser

- All-steel construction
- Step-down face deflects air stream 360 degrees
- Bright White finish



| Part # | Mfg # | Size | Price |
|--------|-------|------|-------|
| 005125 | HC246 | 6"   |       |
| 005126 | HC248 | 8"   |       |

## Ceiling Grilles & Registers

### Ceiling Air Diffusers

#### Airtec™ Classic Air Diffuser - Standard

- 8" x 8" Diffuser assembly



| Part # | Mfg # | Description             | Price |
|--------|-------|-------------------------|-------|
| 043588 | 81911 | Round Grille/Damper/Box |       |
| 038122 | 81914 | 4-Way Grille/Damper/Box |       |

#### Airtec™ Classic Air Diffuser - Small

- 6" x 6" Diffuser assembly



| Part # | Mfg #  | Description             | Price |
|--------|--------|-------------------------|-------|
| 099312 | MV360S | Round Grille/Damper/Box |       |

### Ceiling Support Flanges

#### Rough-In Flange

- Designed for new construction
- RCF Flashing can be fastened to rough framing
- 3/8" Lip that drops below the ceiling



| Part # | Mfg # | Description                        | Price |
|--------|-------|------------------------------------|-------|
| 038125 | 81965 | 16" on Center Framing, 9-1/4" Hole |       |
| 124324 | 81964 | 24" on Center Framing, 9-1/4" Hole |       |

Grilles & Registers

## Ceiling Grilles & Registers

### Ceiling Diffusers

#### 90 Series Step Down Round Diffuser

- Ideal for residential and light commercial applications
- Steel construction
- Attractive concentric ring deflects air stream 360°
- Soft white



| Part # | Mfg # | Size | Price |
|--------|-------|------|-------|
| 122593 | 9006  | 6"   |       |
| 122594 | 9008  | 8"   |       |
| 122646 | 9010  | 10"  |       |
| 122647 | 9012  | 12"  |       |

### Ceiling Dampers

#### 91 Series Round Bowtie Damper

- For use with 90 series diffusers
- Field installable bowtie damper with wound ring
- Mill finish

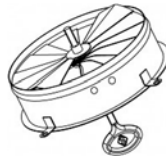

| Part # | Mfg # | Size | Price |
|--------|-------|------|-------|
| 122595 | 9106  | 6"   |       |
| 122597 | 9108  | 8"   |       |
| 122649 | 9110  | 10"  |       |
| 122650 | 9112  | 12"  |       |

#### 92 Series Round Ring

- Use in applications for installing round without damper
- Steel construction

| Part # | Mfg # | Size | Price |
|--------|-------|------|-------|
| 122659 | 9206  | 6"   |       |
| 122660 | 9208  | 8"   |       |
| 123473 | 9210  | 10"  |       |
| 122661 | 9212  | 12"  |       |

**Grilles & Registers**

**Ceiling Air Diffusers**

**Techgrille Diffuser**

- Ceiling-mount
- Fully adjustable 6"



| Part # | Mfg #   | Description                | Price |
|--------|---------|----------------------------|-------|
| 019280 | EAG4CPU | Round, 4" Fully Adjustable |       |
| 019281 | EAG6CPU | Round, 6" Fully Adjustable |       |
| 019282 | EAG8CPU | Round, 8" Fully Adjustable |       |

**CFUSA Ceiling/Wall Fit**

| Part # | Mfg # | Size | Price |
|--------|-------|------|-------|
| 019278 | EACF6 | 6"   |       |

**Accessories**

| Part # | Mfg # | Description            | Price |
|--------|-------|------------------------|-------|
| 049689 | EAQMF | 6" Quick Mount Fitting |       |

Grilles & Registers

## Commercial Grilles & Registers

### Commercial T-Bar Accessories

#### 3800 Round Butterfly Damper for T-bar Diffusers

- Adjustable butterfly damper with removable handle (included)
- For use with 5400 and 6400 Series collars
- Golden Sand finish



| Part # | Mfg #  | Size | Price |
|--------|--------|------|-------|
| 005154 | HC3806 | 6"   |       |
| 005155 | HC3807 | 7"   |       |
| 005156 | HC3808 | 8"   |       |
| 005158 | HC3810 | 10"  |       |
| 005159 | HC3812 | 12"  |       |
| 005160 | HC3814 | 14"  |       |

#### 5400PP Push Pins for 5400 Series Ring Collar

- Attaches 5400 collar to molded fiberglass back for the following products:
- 659TI 1 1/4" long
- PFTI 1 1/4" diameter head
- REN, RENPS/RENPS R6, RE5TI, 96AFBTI, REN4 HVS R6, SRET/SRET R6



| Part#  | Mfg#     | Description     | Price |
|--------|----------|-----------------|-------|
| 051009 | HC5400PP | For 5400 Series |       |

#### 5400 Galvanized Steel Ring Collar

- Unique snap-in design for easy installation
- 2" high collar permits easy flex connections
- Bead on collar improves the strength and provides retention for flexible duct connections
- 14" collar is mounted to diffuser at factory for steel back panels only.



| Part # | Mfg #  | Size | Price |
|--------|--------|------|-------|
| 005200 | HC5406 | 6"   |       |
| 005201 | HC5407 | 7"   |       |
| 005202 | HC5408 | 8"   |       |
| 005204 | HC5410 | 10"  |       |
| 005205 | HC5412 | 12"  |       |
| 005206 | HC5414 | 14"  |       |

### SMF Surface Mount Frame for T-bar Diffusers

- Aluminum construction
- Permits installation of standard T-Bar diffusers in a plaster ceiling
- Accepts standard T-Bar diffusers
- Bright White finish



| Part # | Mfg #     | Size      | Price |
|--------|-----------|-----------|-------|
| 185026 | HCSMF1212 | 12" x 12" |       |

### Commercial T-Bar Surfaire/Renovator Diffusers

#### 444 Aluminum Renovator Series Diffuser

- Unique deflector apertures
- Formed galvanized steel back panel
- Frame includes four seismic safety connections
- Back plate covered with glass fiber insulation to reduce condensation
- Aluminum foil vapor barrier protects insulation from harmful effects of condensation
- Insulation prescored to accommodate collar size desired
- Accepts snap-in collar (5400 Series) (6" to 12")
- 444 - 14" collar is factory-installed
- Utilizes butterfly damper (3800 Series) inserted in collar
- Bright White finish

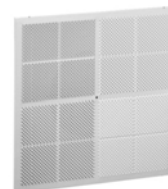

| Part # | Mfg # | Size              | Price |
|--------|-------|-------------------|-------|
| 005194 | HC444 | 23-3/4" x 23-3/4" |       |

### Commercial T-Bar Fixed-pattern Diffusers

#### DPD Steel Plate Diffuser, 6-14" Fixed Collars

- Aesthetically appealing, single-face plate design
- 360 degree air diffusion pattern
- Detachable face plate
- 2" fixed collar
- Optional R6 insulated back (DPD R6)
- White finish



| Part # | Mfg #   | Size | Price |
|--------|---------|------|-------|
| 184998 | HCDPD6  | 6"   |       |
| 185000 | HCDPD8  | 8"   |       |
| 185001 | HCDPD10 | 10"  |       |
| 185003 | HCDPD12 | 12"  |       |

**Commercial Grilles & Registers**

**FPDSteel/Aluminum 4-way Diffuser, 2 Cone Design, 6-14" Fixed Collars**

- Steel construction
- AFPD is Aluminum construction
- Provides high air volume delivery
- 360-degree air diffusion
- Two-cone fixed core
- Fixed collar 6" to 14"
- Unique 2" high collar permits easy flex connections
- Utilizes butterfly damper (3800 Series) inserted in collar; order separately
- Damper adjustable through face
- Formed back panel
- Bright White finish
- FPD R6 features insulated back



| Part # | Mfg #   | Size | Price |
|--------|---------|------|-------|
| 184981 | HCFPD6  | 6"   |       |
| 184982 | HCFPD8  | 8"   |       |
| 184983 | HCFPD10 | 10"  |       |
| 184984 | HCFPD12 | 12"  |       |
| 184986 | HCFPD14 | 14"  |       |

**FPD12 Steel 4-way Diffuser for 1' x 1' T-bar Ceiling, 6-8" Fixed Collars**

- Steel construction
- 360-degree air diffusion
- Two-cone fixed core
- Fixed collar
- Removable plug for damper
- Used with SMF for surface-mount applications
- Bright White finish



| Part # | Mfg #    | Size | Price |
|--------|----------|------|-------|
| 184987 | HCFPD126 | 6"   |       |
| 184988 | HCFPD128 | 8"   |       |

**FPD3 Steel 4-way Diffuser, 3 Cone Design, 6-14" Fixed Collars**

- Steel construction
- Provides high air volume delivery
- 360-degree air diffusion
- Three cone fixed core
- Fixed collar 6" to 14"
- Unique 2" high collar permits easy flex connections
- Utilizes butterfly damper (3800 Series) inserted in collar
- Damper adjustable through face
- Formed steel back panel
- Bright White finish
- FPD3 R6 features insulated back



| Part # | Mfg #    | Size | Price |
|--------|----------|------|-------|
| 029666 | HCFPD308 | 8"   |       |
| 029667 | HCFPD310 | 10"  |       |

**HVS Steel High Volume Supply Diffuser, 4-way, 3 Cone Design, Molded Insulated Back**

- Steel construction
- Provides high air volume delivery
- 360-degree air diffusion
- Formed back panel
- Fixed core
- Fiberglass insulation blanket with foil vapor barrier to minimize condensation on HVS
- Insulation prescored to accommodate collar size desired
- R6 molded fiberglass back on HVS R6; use 5400 with 540PP
- Accepts unique 2' high snap-collar (5400 series) (6" to 12")
- Utilizes butterfly damper (3800 Series) inserted in collar—order separately
- Bright White finish
- HVS14-14" collar factory-installed



| Part # | Mfg #     | Size      | Price |
|--------|-----------|-----------|-------|
| 005080 | HCHVS2424 | 24" x 24" |       |

Grilles & Registers

**Commercial Grilles & Registers**

**Commercial Registers & Grilles**

**821 Steel Register Vertical Fins, MS damper**

- All-steel construction
- Vertical, adjustable face bars
- Horizontal multi-shutter valve
- Bright White finish



| Part # | Mfg #     | Size      | Price |
|--------|-----------|-----------|-------|
| 024742 | HC82166   | 6" x 6"   |       |
| 184729 | HC82188   | 8" x 8"   |       |
| 005317 | HC821104  | 10" x 4"  |       |
| 005318 | HC821106  | 10" x 6"  |       |
| 184730 | HC821108  | 10" x 8"  |       |
| 062220 | HC8211010 | 10" x 10" |       |
| 005319 | HC821124  | 12" x 4"  |       |
| 005320 | HC821126  | 12" x 6"  |       |
| 005321 | HC821128  | 12" x 8"  |       |
| 184732 | HC8211210 | 12" x 10" |       |
| 054931 | HC8211212 | 12" x 12" |       |
| 005323 | HC821144  | 14" x 4"  |       |
| 005324 | HC821146  | 14" x 6"  |       |
| 005325 | HC821148  | 14" x 8"  |       |
| 184734 | HC8211412 | 14" x 12" |       |
| 005322 | HC8211414 | 14" x 14" |       |
| 005327 | HC821166  | 16" x 6"  |       |
| 005328 | HC821168  | 16" x 8"  |       |
| 005326 | HC8211616 | 16" x 16" |       |
| 051585 | HC821186  | 18" x 6"  |       |
| 115183 | HC821188  | 18" x 8"  |       |
| 031309 | HC8211812 | 18" x 12" |       |
| 184740 | HC8211818 | 18" x 18" |       |
| 034182 | HC821206  | 20" x 6"  |       |
| 005329 | HC821208  | 20" x 8"  |       |
| 032180 | HC8212010 | 20" x 10" |       |
| 184742 | HC8212016 | 20" x 16" |       |
| 005331 | HC821248  | 24" x 8"  |       |
| 184743 | HC8212410 | 24" x 10" |       |
| 005330 | HC8212412 | 24" x 12" |       |
| 063703 | HC8213010 | 30" x 10" |       |
| 184746 | HC8213016 | 30" x 16" |       |

**92VHV Steel Double Deflection Register, OBD damper**

- All-steel construction
- Vertical front bars
- Horizontal second bars
- Adjustable face bars may be set to any desired deflection
- Opposed-blade damper
- Larger sizes available in multiple-piece construction
- Bright White finish



| Part # | Mfg #       | Size     | Price |
|--------|-------------|----------|-------|
| 020316 | HC92VHV126W | 12" x 6" |       |

**94A — Steel Return Air Grille, 35-degree Fixed Blade**

- All-steel construction
- 3/4" spaced fins set at 35 degree, horizontal face bars
- Larger sizes available in multiple-piece construction
- Also available as 94AT T-Bar Return Grille
- Bright White finish



| Part # | Mfg #     | Size      | Price |
|--------|-----------|-----------|-------|
| 025524 | HC94A1212 | 12" x 12" |       |
| 026458 | HC94A2020 | 20" x 20" |       |

**RHF45 Aluminum Return Air Filter Grille, 45-degree Fixed Blade**

- Extruded aluminum construction
- Horizontal bars at 45 degrees
- Hinged on the bottom edge
- Accommodates standard 1" thick disposable filter (not included)
- Filter grilles equipped with plastic slide latch
- Bright White or Satin Anodized finish



| Part # | Mfg #        | Size      | Price |
|--------|--------------|-----------|-------|
| 197825 | HCRHF452424W | 24" x 24" |       |

Grilles & Registers



**Commercial Grilles & Registers**

**Commercial T-Bar Perforated Supply/Returns**

**RENPS Steel/Aluminum Perforated Supply**

- Perforated steel face with deflector
- Molded fiberglass back panel available in R4.2 or R6
- Accepts 6" to 14" unique tab collar (6400 series) or 6" to 16" unique snap-in collar (5400 and 5400PP series); also accepts standard spin-in collar
- ARENPS constructed with aluminum face
- Bright White finish

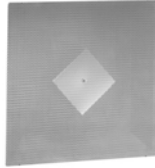

| Part # | Mfg #   | Size      | Price |
|--------|---------|-----------|-------|
| 030255 | HCRENPS | 24" x 24" |       |

**Commercial T-Bar Return Air Filter Grilles**  
**659T Steel Lanced Return Air Filter Grille, 1/3" Fin Spacing**

- Steel construction
- Lanced-face design with 1/3" blade spacing
- Flush, removable face with concealed latches and hinges can be installed in any direction
- Uses standard 1" disposable filters (not furnished)
- Bright White finish
- Available sizes



| Part # | Mfg #      | Size      | Price |
|--------|------------|-----------|-------|
| 005278 | HC659T2020 | 20" x 20" |       |

**Commercial T-Bar Return Air Grilles**  
**RE5T Aluminum Eggcrate Return Air Grille**

- All aluminum construction
- Eggcrate style face
- Mount flush with T-Bar ceilings
- Bright White or Mill Aluminum finish

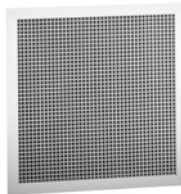

| Part # | Mfg #      | Size      | Price |
|--------|------------|-----------|-------|
| 185005 | HCRE5T4824 | 48" x 24" |       |

**Commercial Ceiling Diffusers**

**SRE Steel Louvered Ceiling Diffuser, Flat Margin**

- Steel construction
- Removable core
- Flat (extended) margin style
- Optional opposed-blade damper available for field installation, SR7
- Bright White enamel finish



| Part # | Mfg #     | Size      | Price |
|--------|-----------|-----------|-------|
| 185030 | HCSRE1212 | 12" x 12" |       |

**RE5TI Eggcrate Return Grille with Insulated Back**

- All aluminum construction
- Eggcrate style face
- R4.2 molded fiberglass back
- Accepts 6" to 14" unique tab collar (6400 series) or 6" to 16" unique snap-in collar (5400 and 5400PP series); also accepts standard spin-in collar
- Bright White or Mill Aluminum finish

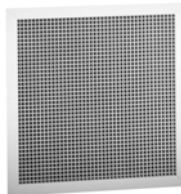

| Part # | Mfg #   | Size              | Price |
|--------|---------|-------------------|-------|
| 005091 | HCRE5TI | 23-3/4" x 23-3/4" |       |

**Molded Fiberglass Plenum-Backed T-Bar Back**

- Deep plenum cavity
- "R" Values Of 4.2, 6.0 and 8.0
- UI 181 erosion and impact test
- 6"-16" Diameter pre-scored back allows neck to be determined at time of installation
- Bonded foil vapor barrier minimizes condensation



| Part # | Mfg #    | Size      | Price |
|--------|----------|-----------|-------|
| 240046 | HC010147 | 24" x 24" |       |

Grilles & Registers

**Commercial Grilles & Registers**

**Commercial Spiral Diffusers**

**SV Aluminum Single Deflection Spiral Diffuser**

- Extruded aluminum construction
- Single row of individually adjustable vertical blades for horizontal air-deflection control
- Available as diffuser only or diffuser with air scoop (SV3)
- Optional face adjustable scoop to direct airflow
- Counter-sunk screw holes
- Bright White and Satin Anodized finishes



| Part # | Mfg #      | Size | Price |
|--------|------------|------|-------|
| 233102 | HCSV11048  | 8"   |       |
| 233105 | HCSV110410 | 10"  |       |
| 233106 | SV110412   | 12"  |       |
| 233107 | HCSV110414 | 14"  |       |
| 233108 | HCSV110418 | 18"  |       |

## Commercial Grilles & Registers

### Commercial Grilles

#### 106 FG Series T-Bar Fiberglass Back Filter Grille

- Return air T-Bar lay-in filter grille
- Removable louvered 20 gauge steel face
- 7/8" Fiberglass back plenum cut holes
- Seismic support holes
- Soft white



| Part # | Mfg # | Size      | Price |
|--------|-------|-----------|-------|
| 123390 | 106FG | 20" x 20" |       |

#### 111 Series T-Bar Fiberglass Back Grille

- Perforated face
- Seismic support hangers
- One size fits 6" - 16"

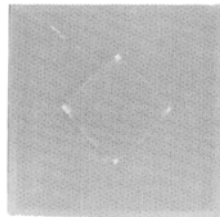

| Part # | Mfg # | Size      | Price |
|--------|-------|-----------|-------|
| 124378 | 111   | 24" x 24" |       |

#### USR34 Universal Spiral Grille

- Double deflection adjustable blade grille
- Front blades are parallel to shortest dimension
- Back blades are parallel to longest dimension
- 4-way airflow adjustment
- Galvanized steel construction
- Nylon bushings on adj. blades prevent metal on metal rattle



| Part # | Mfg #         | Size     | Price |
|--------|---------------|----------|-------|
| 184527 | USR34-FS-12X3 | 12" x 3" |       |
| 158617 | USR34-FS-12X4 | 12" x 4" |       |
| 158618 | USR34-FS-12X6 | 12" x 6" |       |
| 158619 | USR34-FS-14X6 | 14" x 6" |       |
| 158620 | USR34-FS-16X4 | 16" x 4" |       |
| 158622 | USR34-FS-18X6 | 18" x 6" |       |
| 158625 | USR34-FS-20X6 | 20" x 6" |       |
| 158626 | USR34-FS-24X4 | 24" x 4" |       |

### Commercial Diffusers

#### 600T Series Aluminum Lattice T-Bar Diffuser

- 1/2" x 1/2" x 1/2" Aluminum lattice return air T-Bar lay-in grille
- .055 T6 Extruded aluminum frame
- Square collar
- For 22" x 22" duct
- Soft white

| Part # | Mfg #    | Size      | Price |
|--------|----------|-----------|-------|
| 126891 | 600T2424 | 24" x 24" |       |

#### 601T Series Aluminum Lattice T-Bar Diffuser

- 1/2" x 1/2" x 1/2" Aluminum lattice return air T-Bar lay-in grille
- .055 T6 Extruded aluminum frame
- Fiberglass back (2" x 2" only, collar by others)
- For 22" x 22" duct
- Soft white

| Part # | Mfg #    | Size      | Price |
|--------|----------|-----------|-------|
| 123571 | 601T2424 | 24" x 24" |       |

#### FTD Series Fixed T-Bar High Volume Diffuser

- Galvaneal steel face designed for high air volume delivery
- 360° Air diffusion
- No labor collar
- Seismic support hangers
- Soft white



| Part # | Mfg # | Size            | Price |
|--------|-------|-----------------|-------|
| 123411 | FTD6  | 24" x 24" x 6"  |       |
| 123412 | FTD8  | 24" x 24" x 8"  |       |
| 123408 | FTD10 | 24" x 24" x 10" |       |
| 123409 | FTD12 | 24" x 24" x 12" |       |
| 123410 | FTD14 | 24" x 24" x 14" |       |

#### FTD-INS Series Fixed T-Bar High Volume Diffuser

- Includes fiberglass backed plenum insulation
- Galvaneal steel face designed for high air volume delivery
- 360° Air diffusion
- No labor collar
- Seismic support hangers
- Soft white



| Part # | Mfg #    | Size           | Price |
|--------|----------|----------------|-------|
| 123422 | FTD-INS6 | 24" x 24" x 6" |       |

Grilles & Registers

## Commercial Grilles & Registers

### Commercial Diffusers (Continued)

#### FTD-INS Series Fixed T-Bar High Volume Diffuser

| Part # | Mfg #     | Size            | Price |
|--------|-----------|-----------------|-------|
| 123423 | FTD-INS8  | 24" x 24" x 8"  |       |
| 123414 | FTD-INS10 | 24" x 24" x 10" |       |
| 123419 | FTD-INS12 | 24" x 24" x 12" |       |
| 123420 | FTD-INS14 | 24" x 24" x 14" |       |

#### HVD Series 3-Cone T-Bar Diffuser

- Cones are 1-piece stamped construction providing a clean, smooth style
- 360° Air diffusion
- Excellent for variable air volume applications
- Hinged-down core for easy access
- No labor collar
- Seismic support hangers
- Soft white



| Part # | Mfg # | Size           | Price |
|--------|-------|----------------|-------|
| 141067 | HVD6  | 24" x 24" x 6" |       |
| 140762 | HVD8  | 24" x 24" x 8" |       |

### Commercial Dampers

#### BD Series Bowtie Damper

- For use with T-bars
- Field installable butterfly damper
- Mill finish



| Part # | Mfg # | Size | Price |
|--------|-------|------|-------|
| 123406 | BD-6  | 6"   |       |
| 123407 | BD-8  | 8"   |       |
| 123403 | BD-10 | 10"  |       |
| 123404 | BD-12 | 12"  |       |
| 123405 | BD-14 | 14"  |       |

**Commercial Grilles & Registers**

**Ventilation Diffusers**

**Air Return Diffuser**

- Egg crate lay-in louver
- White polystyrene 1/2" open cell grid

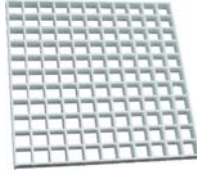

| Part # | Mfg #   | Size           | Price |
|--------|---------|----------------|-------|
| 192724 | 650-100 | 2' x 4' x 1/2" |       |
| 186187 | 650-300 | 2' x 2' x 1/2" |       |

## Deflectors

### Dryer Venting

#### Supurr-Vent® Louvered Vent Hood



| Part # | Mfg # | Size | Color | Price |
|--------|-------|------|-------|-------|
| 108462 | HS6B  | 6"   | Brown |       |

### Specialty Vents/Hoods

#### Fresh Air Intake Vent

- Includes molded 1/4" plastic screen



| Part # | Mfg # | Size | Color | Price |
|--------|-------|------|-------|-------|
| 104250 | HSM6B | 6"   | Brown |       |

### Undereve® Vent

#### For Clothes Dryer or Bathroom Exhaust Venting

- Helps prevent cold air from entering the home
- Helps prevent birds from nesting in the vent and rodents from entering the home
- Designed to vent clothes dryer exhaust, bathroom exhaust and any other venting up to 5" in diameter
- Easy installation: assemble vent, connect duct to opening made in eave, attach Undereve® vent



| Part # | Mfg # | Description         | Price |
|--------|-------|---------------------|-------|
| 045755 | EVE/6 | White Vent - Case/6 |       |

**Floor Grilles & Registers**

**Residential Floor Registers & Grilles**

**210 Heavy Duty Steel Floor Register**

- All-steel construction
- Provides firm, smooth surface
- Extremely rigid
- Free area averages over 75%
- Toe-operated valve control
- Golden Sand enamel finish



| Part # | Mfg #       | Size      | Price |
|--------|-------------|-----------|-------|
| 005117 | HC210810GS  | 8" x 10"  |       |
| 005118 | HC210812GS  | 8" x 12"  |       |
| 005111 | HC2101012GS | 10" x 12" |       |
| 026164 | HC2101214GS | 12" x 14" |       |

**265 Heavy Duty Steel Floor Grille**

- All-steel construction
- Provides firm, smooth surface
- Extremely rigid
- Free area averages over 75%
- Golden Sand enamel finish



| Part # | Mfg #       | Size      | Price |
|--------|-------------|-----------|-------|
| 005136 | HC265410GS  | 4" x 10"  |       |
| 005143 | HC265612GS  | 6" x 12"  |       |
| 005144 | HC265614GS  | 6" x 14"  |       |
| 042407 | HC265616GS  | 6" x 16"  |       |
| 005146 | HC265624GS  | 6" x 24"  |       |
| 005147 | HC265630GS  | 6" x 30"  |       |
| 032870 | HC265810    | 8" x 10"  |       |
| 005148 | HC265812GS  | 8" x 12"  |       |
| 005149 | HC265814GS  | 8" x 14"  |       |
| 088042 | HC265816GS  | 8" x 16"  |       |
| 020905 | HC265820GS  | 8" x 20"  |       |
| 005150 | HC265824GS  | 8" x 24"  |       |
| 005151 | HC265830GS  | 8" x 30"  |       |
| 005129 | HC2651012GS | 10" x 12" |       |
| 037475 | HC2651014GS | 10" x 14" |       |
| 184412 | HC2651018GS | 10" x 18" |       |
| 019796 | HC2651020GS | 10" x 20" |       |
| 005130 | HC2651024GS | 10" x 24" |       |
| 005131 | HC2651030GS | 10" x 30" |       |
| 005127 | HC265GS1212 | 12" x 12" |       |
| 005132 | HC2651214GS | 12" x 14" |       |
| 050049 | HC2651220GS | 12" x 20" |       |
| 005133 | HC2651224GS | 12" x 24" |       |
| 005134 | HC2651230GS | 12" x 30" |       |
| 020973 | HC2651414GS | 14" x 14" |       |

**Residential Floor Registers & Grilles  
(Continued)**

**265 Heavy Duty Steel Floor Grille**

| Part # | Mfg #       | Size      | Price |
|--------|-------------|-----------|-------|
| 184413 | HC2651420GS | 14" x 20" |       |
| 184414 | HC2651424GS | 14" x 24" |       |
| 005135 | HC2651430GS | 14" x 30" |       |
| 184415 | HC2651616GS | 16" x 16" |       |
| 005128 | HC2651620GS | 16" x 20" |       |
| 020987 | HC2651624GS | 16" x 24" |       |
| 184416 | HC2651818GS | 18" x 18" |       |
| 027023 | HC2651824GS | 18" x 24" |       |
| 019134 | HC2651830GS | 18" x 30" |       |
| 053515 | HC2652020GS | 20" x 20" |       |

**420 Steel Toe Kick**

- All-steel construction
- Heavy-gauge, stamped face
- Multi-angle fins
- Golden Sand or Bright White enamel finish



| Part # | Mfg #        | Size         | Price |
|--------|--------------|--------------|-------|
| 005175 | HC42010214   | 10" x 2-1/4" |       |
| 005177 | HC42012214   | 12" x 2-1/4" |       |
| 005180 | HC42014214   | 14" x 2-1/4" |       |
| 184432 | HC420104     | 10" x 4"     |       |
| 005176 | HC420102GS   | 10" x 2"     |       |
| 005178 | HC42012214GS | 12" x 2-1/4" |       |
| 005181 | HC42014214GS | 14" x 2-1/4" |       |
| 184431 | HC420104GS   | 10" x 4"     |       |
| 184434 | HC420124GS   | 12" x 4"     |       |
| 116509 | HC420144GS   | 14" x 4"     |       |

**421 Steel Floor Register**

- All-steel construction
- Multi-angle fin setting
- Rolled fin for strength and safety
- Welded construction
- Foot-operated dial control
- Heavy-gauge, stamped face
- Golden Sand or Bright White enamel finish



| Part # | Mfg #        | Size         | Price |
|--------|--------------|--------------|-------|
| 055429 | HC42148GS    | 4" x 8"      |       |
| 005183 | HC42121410GS | 2-1/4" x 10" |       |
| 005185 | HC42121412GS | 2-1/4" x 12" |       |
| 005187 | HC42121414GS | 2-1/4" x 14" |       |
| 005189 | HC421410GS   | 4" x 10"     |       |

Grilles & Registers

## Floor Grilles & Registers

### Residential Floor Registers & Grilles (Continued)

#### 421 Steel Floor Register

| Part # | Mfg #      | Size         | Price |
|--------|------------|--------------|-------|
| 005191 | HC421412GS | 4" x 12"     |       |
| 005193 | HC421414GS | 4" x 14"     |       |
| 184436 | HC421610GS | 6" x 10"     |       |
| 046343 | HC421612GS | 6" x 12"     |       |
| 184437 | HC421614GS | 6" x 14"     |       |
| 005182 | HC42121410 | 2-1/4" x 10" |       |
| 005184 | HC42121412 | 2-1/4" x 12" |       |
| 005186 | HC42121414 | 2-1/4" x 14" |       |
| 005188 | HC421410   | 4" x 10"     |       |
| 005190 | HC421412   | 4" x 12"     |       |
| 005192 | HC421414   | 4" x 14"     |       |
| 027852 | HC421610   | 6" x 10"     |       |
| 045827 | HC421612   | 6" x 12"     |       |

### Residential Baseboard Registers & Grilles

#### 406 Steel Baseboard Diffuser 4.5" Ht

- All-steel construction
- Blankets wall or window area
- Golden Sand or Bright White enamel finish
- 406 18" Shown



| Part # | Mfg #     | Size | Price |
|--------|-----------|------|-------|
| 074588 | HC40615   | 15"  |       |
| 005162 | HC406     | 18"  |       |
| 005163 | HC406GS   | 18"  |       |
| 196111 | HC406GS15 | 15"  |       |

#### 462 Steel 2 Ft Baseboard Diffuser

- All-steel construction
- Two-foot length
- Airfoil valves reduce resistance
- Equal air distribution over the length of the diffuser
- Face can be easily removed
- Golden Sand or Bright White enamel finish



| Part # | Mfg #   | Size | Price |
|--------|---------|------|-------|
| 048228 | HC462GS | 2'   |       |
| 005195 | HC462   | 2'   |       |

#### 407 Steel Baseboard Return 4.5" Ht

- All-steel construction
- Complementary return air grille for #406 supply
- Golden Sand or Bright White enamel finish



| Part # | Mfg #   | Size | Price |
|--------|---------|------|-------|
| 005165 | HC407GS | 18"  |       |

#### 657 Steel Baseboard Return

- One-piece steel construction
- 1/3" spaced fins set at 20 degrees
- 7/8" margin turnback
- Exceptional free area
- Install with fins upward or downward for best duct concealment
- Complementary return air grille for #654 supply or #664 supply
- Golden Sand or Bright White enamel finish



| Part # | Mfg #      | Size     | Price |
|--------|------------|----------|-------|
| 005265 | HC657146   | 14" x 6" |       |
| 005267 | HC657148   | 14" x 8" |       |
| 005271 | HC657306   | 30" x 6" |       |
| 005272 | HC657306GS | 30" x 6" |       |

#### 658 Steel Baseboard Return, Base Projection

- All-steel construction
- 1/3" spaced fins set at 20 degrees
- Complementary return air grille for #655 supply
- Bright White enamel finish



| Part # | Mfg #     | Size     | Price |
|--------|-----------|----------|-------|
| 035916 | HC658308W | 30" x 8" |       |
| 005276 | HC658306  | 30" x 6" |       |

#### 664 Steel Baseboard Register, Multi-Shutter Damper

- All-steel construction
- 1/3"-spaced fins set at 20 degrees
- 7/8" margin turnback
- 1-5/8" depth when fully opened
- Exceptional free area
- Ideal for shallow duct installations
- Multi-shutter valve
- Bright White enamel finish



| Part # | Mfg #   | Size    | Price |
|--------|---------|---------|-------|
| 184516 | HC66486 | 8" x 6" |       |

Grilles & Registers



## Floor Grilles & Registers

### Floor Grilles

#### 1033 Series Return Air Grille

- 1/3" Spacing dual angular louvers
- 20 and 22 Gauge cold roll steel
- Install with louvers in up or down position for best duct concealment
- Countersunk mounting holes for flush appearance with color matching Phillips posi-drive screws



| Part # | Mfg #     | Size     | Color | Price |
|--------|-----------|----------|-------|-------|
| 123787 | 1033W1406 | 14" x 6" | White |       |
| 123788 | 1033W2406 | 24" x 6" | White |       |
| 123789 | 1033W3006 | 30" x 6" | White |       |
| 123790 | 1033W3008 | 30" x 8" | White |       |

#### 1165 Series Triangular Baseboard Return Air Grille

- 1/2" Spacing dual angular louvers

| Part # | Mfg #     | Size     | Color | Price |
|--------|-----------|----------|-------|-------|
| 123238 | 1165W1406 | 14" x 6" | White |       |
| 123239 | 1165W2406 | 24" x 6" | White |       |
| 123240 | 1165W3006 | 30" x 6" | White |       |

#### 1600 Series Floor Grille

- Steel honeycomb construction
- Flush core and frame provides smooth surface
- Free area equals more than 75% of nominal size
- Driftwood tan



| Part # | Mfg #    | Size      | Price |
|--------|----------|-----------|-------|
| 123675 | 16000424 | 4" x 24"  |       |
| 122662 | 16000612 | 6" x 12"  |       |
| 122663 | 16000614 | 6" x 14"  |       |
| 122664 | 16000624 | 6" x 24"  |       |
| 122665 | 16000630 | 6" x 30"  |       |
| 122666 | 16000814 | 8" x 14"  |       |
| 122667 | 16000824 | 8" x 24"  |       |
| 122668 | 16001012 | 10" x 12" |       |
| 122670 | 16001214 | 12" x 14" |       |
| 123873 | 16001230 | 12" x 30" |       |
| 125839 | 16001420 | 14" x 20" |       |

#### 1075 Series Heavy Duty Return Air Grille

- 1/2" Spacing dual angular louvers
- 20 and 22 Gauge cold roll steel
- Mullions are reinforced with stiffeners for greater strength
- For applications where greater air volume is required
- Install with louvers in up or down position for best duct concealment
- Countersunk mounting holes for flush appearance with color matching Phillips posi-drive screws
- Soft white



| Part # | Mfg #    | Size     | Price |
|--------|----------|----------|-------|
| 149124 | 10751204 | 12" x 4" |       |

#### 1133 Series Baseboard Return Air Grille

- Stamped face
- 1/3" Spacing dual angular louvers

| Part # | Mfg #     | Size     | Color | Price |
|--------|-----------|----------|-------|-------|
| 124305 | 1133B1406 | 14" x 6" | Brown |       |
| 123791 | 1133W1406 | 14" x 6" | White |       |
| 123795 | 1133W3006 | 30" x 6" | White |       |

#### TD Series Toe Space Grille with Damper

- Formed cold roll steel
- Ideal for return air in the toe space areas between kitchen cabinets, stair risers, built-in vanities, etc
- Countersunk mounting holes for flush appearance with color matching Phillips posi-drive screws
- Multi-shutter damper



| Part # | Mfg #    | Size         | Color | Price |
|--------|----------|--------------|-------|-------|
| 123575 | TD21412W | 2-1/4" x 12" | White |       |

### Floor Registers

#### 855 Series Baseboard Register

- Stamped face
- Steel construction
- Fan shaped 1/2" spaced louvers
- Steel multi-shutter damper
- 7/8" Margin turnback
- All component parts, rivets, linkage and handle enclosed in valve to assure trouble-free operation
- Soft white

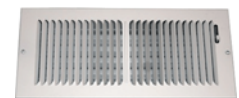

| Part # | Mfg #   | Size     | Price |
|--------|---------|----------|-------|
| 123569 | 8551206 | 12" x 6" |       |

## Floor Grilles & Registers

### 1550 Series Floor Register

- Mounting holes for sidewall and ceiling applications
- Steel honeycomb construction
- Flush core and frame provides smooth surface
- Free area equals more than 75% of nominal size
- Recessed, screwdriver-operated, opposed blade damper to control air volume for positive balance of system
- Positive volume set screw
- Driftwood tan



| Part # | Mfg #    | Size     | Price |
|--------|----------|----------|-------|
| 122636 | 15500612 | 6" x 12" |       |

### Floor Diffusers (Continued)

#### 350 Series Stamped Deluxe Floor Diffuser

| Part # | Mfg #     | Size         | Color | Price |
|--------|-----------|--------------|-------|-------|
| 122943 | 35021412W | 2-1/4" x 12" | White |       |
| 122944 | 35021414B | 2-1/4" x 14" | Brown |       |
| 122945 | 35021414W | 2-1/4" x 14" | White |       |
| 141396 | 3500414B  | 4" x 14"     | Brown |       |
| 122951 | 3500414W  | 4" x 14"     | White |       |

### Floor Diffusers

#### 325 Series Stamped Perimeter Floor Diffuser

- Cold rolled steel construction
- Opposed blade damper standard
- All component parts, rivets, linkage, and handle are enclosed in the valve to assure trouble-free operation
- Locking screw provision concealed beneath the floor for tamper proof settings
- Sold in carton quantity only



| Part # | Mfg #    | Size     | Color | Price |
|--------|----------|----------|-------|-------|
| 123510 | 3250410B | 4" x 10" | Brown |       |
| 123509 | 3250410W | 4" x 10" | White |       |
| 123043 | 3250412B | 4" x 12" | Brown |       |
| 123042 | 3250412W | 4" x 12" | White |       |

#### 350 Series Stamped Deluxe Floor Diffuser

- Heavy-gauge cold-rolled steel
- Louvers designed with rolled rib for maximum strength and rigidity
- Unique fan-shaped air patterns lends to both heating and air conditioning applications
- Opposed blade damper standard on 4" widths
- Parallel blade damper on 6" widths and larger
- All component parts, rivets, linkage, and handle are enclosed in the valve to assure trouble-free operation



| Part # | Mfg #     | Size         | Color | Price |
|--------|-----------|--------------|-------|-------|
| 122941 | 35021410B | 2-1/4" x 10" | Brown |       |
| 122940 | 35021410W | 2-1/4" x 10" | White |       |
| 122942 | 35021412B | 2-1/4" x 12" | Brown |       |



## Grille & Register Accessories

### Accessories

#### Handle

| Part # | Mfg # | Description            | Price |
|--------|-------|------------------------|-------|
| 130875 | 55    | Bow-Tie Plastic Handle |       |

#### Screws and Bits

| Part # | Mfg # | Description                              | Price |
|--------|-------|--|-------|
| 124653 | C     | 8" x 2" Phillips Panhead Baseboard Screw |       |

#### Insulation

| Part # | Mfg # | Description            | Price |
|--------|-------|------------------------|-------|
| 128739 | FBP   | Fiberglass Back Plenum |       |

#### Paint

| Part # | Mfg # | Description                       | Price |
|--------|-------|-----------------------------------|-------|
| 136689 | 45    | Driftwood Tan Spray Paint, 4.5 oz |       |

## Sidewall Grilles & Registers

### Residential Sidewall Registers & Grilles

#### A613MS Aluminum Curved Blade Register 3 Way

- Aluminum face/fin construction
- For sidewall or ceiling application
- Three-way deflection
- Three-way air pattern
- Adjustable curved blades increase deflection control
- Galvanized multi-shutter valve or opposed-blade damper
- Bright White finish



| Part # | Mfg #      | Size    | Price |
|--------|------------|---------|-------|
| 184953 | HCA613MS88 | 8" x 8" |       |

#### A614MS Aluminum Curved Blade Register 4 Way

- Aluminum face/fin construction
- For sidewall or ceiling application
- Four-way deflection
- Four-way air pattern
- Adjustable curved blades increase deflection control
- Galvanized multi-shutter valve or opposed-blade damper
- Bright White finish



| Part # | Mfg #        | Size      | Price |
|--------|--------------|-----------|-------|
| 184956 | HCA614MS1010 | 10" x 10" |       |

#### A618MS Aluminum Straight Blade, Vertical Fin Register

- Aluminum face/fin construction
- Adjustable straight fins provides individual deflection control
- Stamped-face margins eliminate mitered corners and rough edges
- Galvanized multi-shutter valve or opposed-blade damper
- Bright White finish

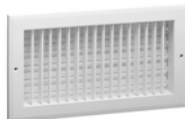

| Part # | Mfg #       | Size     | Price |
|--------|-------------|----------|-------|
| 184957 | HCA618MS104 | 10" x 4" |       |
| 184958 | HCA618MS106 | 10" x 6" |       |
| 184962 | HCA618MS124 | 12" x 4" |       |
| 184963 | HCA618MS146 | 14" x 6" |       |

### 650 Steel Return Air Grille, 1/3" Fin Spacing

- Aluminum construction (A650)
- All-steel construction (650)
- 1/3" spaced fins set at 20 degrees
- Exceptional free area
- 5/16" Margin Turnback
- Bright White finish



| Part # | Mfg #     | Size      | Price |
|--------|-----------|-----------|-------|
| 073815 | HC65064   | 6" x 4"   |       |
| 184444 | HC65066   | 6" x 6"   |       |
| 184445 | HC650614  | 6" x 14"  |       |
| 005262 | HC65088   | 8" x 8"   |       |
| 055788 | HC650814  | 8" x 14"  |       |
| 005212 | HC650104  | 10" x 4"  |       |
| 005213 | HC650106  | 10" x 6"  |       |
| 005211 | HC6501010 | 10" x 10" |       |
| 184446 | HC6501014 | 10" x 14" |       |
| 005217 | HC650124  | 12" x 4"  |       |
| 005218 | HC650126  | 12" x 6"  |       |
| 005219 | HC650128  | 12" x 8"  |       |
| 005215 | HC6501212 | 12" x 12" |       |
| 005223 | HC650144  | 14" x 4"  |       |
| 005224 | HC650146  | 14" x 6"  |       |
| 005225 | HC650148  | 14" x 8"  |       |
| 005220 | HC6501410 | 14" x 10" |       |
| 005221 | HC6501412 | 14" x 12" |       |
| 005222 | HC6501414 | 14" x 14" |       |
| 021112 | HC6501416 | 14" x 16" |       |
| 026359 | HC6501420 | 14" x 20" |       |
| 184448 | HC6501424 | 14" x 24" |       |
| 017157 | HC6501430 | 14" x 30" |       |
| 005229 | HC650166  | 16" x 6"  |       |
| 005230 | HC650168  | 16" x 8"  |       |
| 005226 | HC6501612 | 16" x 12" |       |
| 005228 | HC6501616 | 16" x 16" |       |
| 064671 | HC6501620 | 16" x 20" |       |
| 184449 | HC6501624 | 16" x 24" |       |
| 005235 | HC650188  | 18" x 8"  |       |
| 005232 | HC6501816 | 18" x 16" |       |
| 005233 | HC6501818 | 18" x 18" |       |
| 030938 | HC6501824 | 18" x 24" |       |
| 005242 | HC650206  | 20" x 6"  |       |
| 005243 | HC650208  | 20" x 8"  |       |
| 005236 | HC6502010 | 20" x 10" |       |
| 005237 | HC6502012 | 20" x 12" |       |
| 005238 | HC6502014 | 20" x 14" |       |
| 005239 | HC6502016 | 20" x 16" |       |

Grilles & Registers

**Sidewall Grilles & Registers**

**Residential Sidewall Registers & Grilles  
(Continued)**

**650 Steel Return Air Grille, 1/3" Fin Spacing**

| Part # | Mfg #     | Size      | Price |
|--------|-----------|-----------|-------|
| 005240 | HC6502020 | 20" x 20" |       |
| 027499 | HC6502024 | 20" x 24" |       |
| 016859 | HC6502025 | 20" x 25" |       |
| 184451 | HC6502030 | 20" x 30" |       |
| 005251 | HC650246  | 24" x 6"  |       |
| 005252 | HC650248  | 24" x 8"  |       |
| 005244 | HC6502410 | 24" x 10" |       |
| 005245 | HC6502412 | 24" x 12" |       |
| 005246 | HC6502414 | 24" x 14" |       |
| 005247 | HC6502416 | 24" x 16" |       |
| 051527 | HC6502418 | 24" x 18" |       |
| 005248 | HC6502420 | 24" x 20" |       |
| 005249 | HC6502424 | 24" x 24" |       |
| 184452 | HC6502430 | 24" x 30" |       |
| 005259 | HC650306  | 30" x 6"  |       |
| 005260 | HC650308  | 30" x 8"  |       |
| 005253 | HC6503010 | 30" x 10" |       |
| 005254 | HC6503012 | 30" x 12" |       |
| 005255 | HC6503014 | 30" x 14" |       |
| 033107 | HC6503016 | 30" x 16" |       |
| 005256 | HC6503020 | 30" x 20" |       |
| 005257 | HC6503024 | 30" x 24" |       |
| 031094 | HC6503030 | 30" x 30" |       |
| 057267 | HC6503610 | 36" x 10" |       |
| 192979 | HC650W104 | 10" x 4"  |       |

**651 Steel 1-way Register, Plate Damper, 1/3" Fin Spacing**

- All-steel construction
- 1/3" spaced fins set at 20 degrees
- Volume-control damper
- Bright White finish



| Part # | Mfg #    | Size     | Price |
|--------|----------|----------|-------|
| 028561 | HC651106 | 10" x 6" |       |
| 184461 | HC651146 | 14" x 6" |       |

**659 Steel Return Air Filter Grille, 1/3" Fin Spacing**

- All-steel construction
- 1/3" spaced fins set at 20 degrees
- Effectively conceals filter
- Use standard 1" thick disposable filters (not included)
- Removable face for easy installation and cleaning
- Equipped with adjustable filter retainers
- Bright White finish



| Part # | Mfg #      | Size      | Price |
|--------|------------|-----------|-------|
| 184475 | HC6592024  | 20" x 24" |       |
| 047973 | HC6591616  | 16" x 16" |       |
| 193329 | HC6591424  | 14" x 24" |       |
| 025315 | HC6591212  | 12" x 12" |       |
| 005280 | HC6591414  | 14" x 14" |       |
| 029265 | HC6591420  | 14" x 20" |       |
| 005281 | HC6591425  | 14" x 25" |       |
| 005282 | HC6591620  | 16" x 20" |       |
| 029132 | HC6591625  | 16" x 25" |       |
| 184471 | HC6591818  | 18" x 18" |       |
| 184473 | HC6592010  | 20" x 10" |       |
| 184474 | HC6592012  | 20" x 12" |       |
| 005283 | HC6592014  | 20" x 14" |       |
| 005284 | HC6592016  | 20" x 16" |       |
| 005285 | HC6592020  | 20" x 20" |       |
| 005286 | HC6592025  | 20" x 25" |       |
| 184476 | HC6592030  | 20" x 30" |       |
| 036378 | HC6592412  | 24" x 12" |       |
| 074898 | HC6592414  | 24" x 14" |       |
| 024434 | HC6592418  | 24" x 18" |       |
| 005287 | HC6592424  | 24" x 24" |       |
| 030876 | HC6592514  | 25" x 14" |       |
| 005288 | HC6592516  | 25" x 16" |       |
| 005289 | HC6592520  | 25" x 20" |       |
| 005290 | HC6592525  | 25" x 25" |       |
| 024640 | HC6593012  | 30" x 12" |       |
| 037039 | HC6593014  | 30" x 14" |       |
| 005291 | HC6593020  | 30" x 20" |       |
| 184484 | HC6593024  | 30" x 24" |       |
| 033556 | HC6593030  | 30" x 30" |       |
| 197487 | HC659W1010 | 10" x 10" |       |
| 197886 | HC659W306  | 30" x 6"  |       |

Grilles & Registers

**Sidewall Grilles & Registers**

**661 Steel 2-way Register, MS damper, 1/3" Fin Spacing**

- Stamped aluminum construction (A661)
- All-steel construction (661)
- Used for ceiling or sidewall installations
- For heating or cooling
- Ideal for shallow duct installations
- Two-way deflection
- 1/3" spaced fins set at 20 degrees
- Galvanized multi-shutter valve
- 1-5/8" depth when fully opened
- Interlocking valve louvers for positive shut-off
- Bright White finish



| Part # | Mfg #       | Size     | Price |
|--------|-------------|----------|-------|
| 005308 | HC66184     | 8" x 4"  |       |
| 005309 | HC66186     | 8" x 6"  |       |
| 023966 | HC66188     | 8" x 8"  |       |
| 005295 | HC661104    | 10" x 4" |       |
| 005297 | HC661106    | 10" x 6" |       |
| 005298 | HC661108    | 10" x 8" |       |
| 005299 | HC661124    | 12" x 4" |       |
| 005301 | HC661126    | 12" x 6" |       |
| 005302 | HC661128    | 12" x 8" |       |
| 005303 | HC661144    | 14" x 4" |       |
| 005304 | HC661146    | 14" x 6" |       |
| 005305 | HC661148    | 14" x 8" |       |
| 005306 | HC661168    | 16" x 8" |       |
| 034539 | HC661206    | 20" x 6" |       |
| 197453 | HC661MFL104 | 10" x 4" |       |
| 029170 | HC661WFL124 | 12" x 4" |       |

**672 Steel Return Air Grille, 1/2" Fin Spacing**

- All-steel construction
- 1/2" spaced fins set at 40 degrees
- Exceptional free area
- 5/16" Margin Turnback
- Bright White finish



| Part # | Mfg #      | Size      | Price |
|--------|------------|-----------|-------|
| 196547 | HC672W188  | 18" x 8"  |       |
| 184554 | HC6721625  | 16" x 25" |       |
| 196092 | HC672W3612 | 36" x 12" |       |
| 061628 | HC67288    | 8" x 8"   |       |
| 184530 | HC672104   | 10" x 4"  |       |
| 025481 | HC6721010  | 10" x 10" |       |
| 184533 | HC672124   | 12" x 4"  |       |
| 184535 | HC6721212  | 12" x 12" |       |

**Residential Sidewall Registers & Grilles (Continued)**

**672 Steel Return Air Grille, 1/2" Fin Spacing**

| Part # | Mfg #     | Size      | Price |
|--------|-----------|-----------|-------|
| 184540 | HC672144  | 14" x 4"  |       |
| 109520 | HC672146  | 14" x 6"  |       |
| 021777 | HC672148  | 14" x 8"  |       |
| 184542 | HC6721412 | 14" x 12" |       |
| 061627 | HC6721414 | 14" x 14" |       |
| 184544 | HC6721420 | 14" x 20" |       |
| 184545 | HC6721424 | 14" x 24" |       |
| 184547 | HC672168  | 16" x 8"  |       |
| 184548 | HC6721610 | 16" x 10" |       |
| 184551 | HC6721616 | 16" x 16" |       |
| 184560 | HC6721818 | 18" x 18" |       |
| 184562 | HC6722010 | 20" x 10" |       |
| 184564 | HC6722014 | 20" x 14" |       |
| 184565 | HC6722016 | 20" x 16" |       |
| 184566 | HC6722020 | 20" x 20" |       |
| 051946 | HC672246  | 24" x 6"  |       |
| 027205 | HC6722414 | 24" x 14" |       |
| 005313 | HC6722416 | 24" x 16" |       |
| 184570 | HC6722418 | 24" x 18" |       |
| 184571 | HC6722420 | 24" x 20" |       |
| 184572 | HC6722424 | 24" x 24" |       |
| 109521 | HC672306  | 30" x 6"  |       |
| 184575 | HC672308  | 30" x 8"  |       |
| 184576 | HC6723010 | 30" x 10" |       |
| 021779 | HC6723014 | 30" x 14" |       |
| 184581 | HC6723024 | 30" x 24" |       |
| 184573 | HC6722430 | 24" x 30" |       |
| 184546 | HC6721430 | 14" x 30" |       |
| 060875 | HC6721630 | 16" x 30" |       |
| 184583 | HC6723614 | 36" x 14" |       |

Grilles & Registers

## Sidewall Grilles & Registers

### 673 Steel Return Air Filter Grille, 1/2" Fin Spacing

- All-steel construction
- 1/2" spaced fins set at 40 degrees
- Effectively conceals filter
- Use standard 1" thick disposable filters (not included)
- Removable face for easy installation and cleaning
- Equipped with adjustable filter retainers
- Bright White finish



| Part # | Mfg #     | Size      | Price |
|--------|-----------|-----------|-------|
| 184588 | HC6731010 | 10" x 10" |       |
| 184596 | HC6731212 | 12" x 12" |       |
| 239636 | HC6731218 | 12" x 18" |       |
| 184598 | HC6731220 | 12" x 20" |       |
| 021780 | HC6731224 | 12" x 24" |       |
| 184604 | HC6731414 | 14" x 14" |       |
| 184606 | HC6731420 | 14" x 20" |       |
| 184607 | HC6731424 | 14" x 24" |       |
| 038544 | HC6731425 | 14" x 25" |       |
| 184609 | HC6731430 | 14" x 30" |       |
| 184610 | HC6731616 | 16" x 16" |       |
| 038027 | HC6731620 | 16" x 20" |       |
| 038019 | HC6731625 | 16" x 25" |       |
| 184613 | HC6731818 | 18" x 18" |       |
| 184617 | HC6732014 | 20" x 14" |       |
| 184618 | HC6732016 | 20" x 16" |       |
| 184619 | HC6732020 | 20" x 20" |       |
| 184622 | HC6732025 | 20" x 25" |       |
| 184626 | HC6732412 | 24" x 12" |       |
| 184627 | HC6732414 | 24" x 14" |       |
| 184629 | HC6732418 | 24" x 18" |       |
| 184631 | HC6732420 | 24" x 20" |       |
| 184632 | HC6732424 | 24" x 24" |       |
| 184634 | HC6732514 | 25" x 14" |       |
| 184635 | HC6732516 | 25" x 16" |       |
| 184636 | HC6732520 | 25" x 20" |       |
| 184639 | HC6733012 | 30" x 12" |       |
| 184640 | HC6733014 | 30" x 14" |       |
| 184643 | HC6733020 | 30" x 20" |       |
| 184644 | HC6733024 | 30" x 24" |       |
| 184620 | HC6732024 | 20" x 24" |       |
| 184625 | HC6732410 | 24" x 10" |       |
| 184628 | HC6732416 | 24" x 16" |       |
| 184602 | HC673148  | 14" x 8"  |       |
| 184611 | HC6731624 | 16" x 24" |       |

### 682 Steel 2-way Register, MS damper, 1/2" Fin Spacing

- All-steel construction (682)
- Aluminum construction (A682)
- Used for ceiling or sidewall installations
- Ideal for shallow duct installations
- Two-way deflection
- 1/2" spaced fins set at 40 degrees
- Multi-shutter valve
- 1 5/8" depth when fully opened
- Interlocking valve louvers for positive shut-off
- Bright White finish
- Available with fusible link option, limited sizes (not UL-listed or fire-rated)



| Part # | Mfg #    | Size     | Price |
|--------|----------|----------|-------|
| 184670 | HC68288  | 8" x 8"  |       |
| 184671 | HC682104 | 10" x 4" |       |
| 184672 | HC682106 | 10" x 6" |       |
| 184673 | HC682124 | 12" x 4" |       |
| 184674 | HC682126 | 12" x 6" |       |
| 184676 | HC682144 | 14" x 4" |       |
| 184677 | HC682146 | 14" x 6" |       |
| 184678 | HC682148 | 14" x 8" |       |
| 184679 | HC682168 | 16" x 8" |       |

## Sidewall Grilles & Registers

### Sidewall Grilles

#### 1050 Series Return Air Grille

- 1/2" Spacing dual angular louvers
- 20 and 22 Gauge cold roll steel
- Install with louvers in up or down position for best duct concealment
- Countersunk mounting holes for flush appearance with color matching Phillips posi-drive screws
- Soft white



| Part # | Mfg #    | Size      | Price |
|--------|----------|-----------|-------|
| 127161 | 105084   | 8" x 4"   |       |
| 148603 | 1050104  | 10" x 4"  |       |
| 123194 | 10501006 | 10" x 6"  |       |
| 123195 | 10501008 | 10" x 8"  |       |
| 123196 | 10501010 | 10" x 10" |       |
| 123197 | 10501206 | 12" x 6"  |       |
| 123198 | 10501208 | 12" x 8"  |       |
| 123199 | 10501212 | 12" x 12" |       |
| 123200 | 10501406 | 14" x 6"  |       |
| 123201 | 10501408 | 14" x 8"  |       |
| 123202 | 10501410 | 14" x 10" |       |
| 123203 | 10501412 | 14" x 12" |       |
| 123204 | 10501414 | 14" x 14" |       |
| 137588 | 10501606 | 16" x 6"  |       |
| 127463 | 10501608 | 16" x 8"  |       |
| 123205 | 10501616 | 16" x 16" |       |
| 123206 | 10502006 | 20" x 6"  |       |
| 123207 | 10502008 | 20" x 8"  |       |
| 123208 | 10502010 | 20" x 10" |       |
| 123209 | 10502012 | 20" x 12" |       |
| 123210 | 10502014 | 20" x 14" |       |
| 123211 | 10502016 | 20" x 16" |       |
| 123212 | 10502020 | 20" x 20" |       |
| 129115 | 10502024 | 20" x 24" |       |
| 123213 | 1050244  | 24" x 4"  |       |
| 123214 | 10502406 | 24" x 6"  |       |
| 123215 | 10502408 | 24" x 8"  |       |
| 123216 | 10502410 | 24" x 10" |       |
| 123217 | 10502412 | 24" x 12" |       |
| 123218 | 10502414 | 24" x 14" |       |
| 123219 | 10502416 | 24" x 16" |       |
| 123220 | 10502420 | 24" x 20" |       |
| 123221 | 10502424 | 24" x 24" |       |
| 123222 | 10503006 | 30" x 6"  |       |
| 123223 | 10503008 | 30" x 8"  |       |
| 123224 | 10503010 | 30" x 10" |       |

### Sidewall Grilles (Continued)

#### 1050 Series Return Air Grille

| Part # | Mfg #    | Size      | Price |
|--------|----------|-----------|-------|
| 123225 | 10503012 | 30" x 12" |       |
| 132487 | 10503014 | 30" x 14" |       |

#### 1150 Series Baseboard Return Air Grille

- Stamped face
- 1/2" Spacing dual angular louvers

| Part # | Mfg #     | Size     | Color | Price |
|--------|-----------|----------|-------|-------|
| 123229 | 1150W1206 | 12" x 6" | White |       |
| 123230 | 1150B1406 | 14" x 6" | Brown |       |
| 123232 | 1150W1406 | 14" x 6" | White |       |
| 129392 | 1150W1408 | 14" x 8" | White |       |
| 164097 | 1150B1408 | 14" x 8" | Brown |       |
| 123234 | 1150W2406 | 24" x 6" | White |       |
| 123236 | 1150B3006 | 30" x 6" | Brown |       |
| 123237 | 1150W3006 | 30" x 6" | White |       |
| 132412 | 1150W3008 | 30" x 8" | White |       |

#### TS Series Toe Space Grille

- Formed cold roll steel
- Ideal for return air in the toe space areas between kitchen cabinets, stair risers, built-in vanities, etc
- Countersunk mounting holes for flush appearance with color matching Phillips posi-drive screws



| Part # | Mfg #   | Size     | Color | Price |
|--------|---------|----------|-------|-------|
| 122736 | TS0210B | 2" x 10" | Brown |       |
| 122591 | TS0212B | 2" x 12" | Brown |       |
| 122737 | TS0212W | 2" x 12" | White |       |
| 122740 | TS0214B | 2" x 14" | Brown |       |
| 122738 | TS0214W | 2" x 14" | White |       |
| 122592 | TS0412W | 4" x 12" | White |       |



## Sidewall Grilles & Registers

### FG2 Series Stamped Face 2" Filter Grille

- 1/2" Spacing dual angular louvers
- 20 and 22 Gauge cold roll steel
- Hand operated lever for easy filter access
- Holds up to 2" Filter (not included)
- Removable face for easy cleaning and maintenance
- Filter door hinges parallel to longest side
- 4-Way reversible door on square sizes
- 2-Way reversible door on rectangular sizes
- Filter retention tabs
- Concealed mounting holes
- Soft white



| Part # | Mfg #   | Size      | Price |
|--------|---------|-----------|-------|
| 123382 | FG21420 | 14" x 20" |       |
| 123383 | FG21425 | 14" x 25" |       |
| 123380 | FG21620 | 16" x 20" |       |
| 123384 | FG21625 | 16" x 25" |       |
| 123385 | FG22016 | 20" x 16" |       |
| 123386 | FG22020 | 20" x 20" |       |
| 123387 | FG22025 | 20" x 25" |       |
| 123388 | FG22424 | 24" x 24" |       |
| 123389 | FG22516 | 25" x 16" |       |
| 125075 | FG22520 | 25" x 20" |       |

### Sidewall Diffusers

#### 850 Series Stamped 2-Way Diffuser

- Stamped 1/2" fan-shaped louvers for heating and cooling
- For ceiling or sidewall applications
- All component parts, rivets, linkage and handle are enclosed in the valve to assure trouble-free operation
- Countersunk mounting holes for flush appearance with color matching Phillips posi-drive screws
- Steel multi-shutter damper
- Soft white

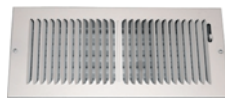

| Part # | Mfg #   | Size     | Price |
|--------|---------|----------|-------|
| 123392 | 8501004 | 10" x 4" |       |
| 123393 | 8501006 | 10" x 6" |       |
| 123394 | 8501204 | 12" x 4" |       |
| 123395 | 8501206 | 12" x 6" |       |
| 123396 | 8501208 | 12" x 8" |       |
| 123397 | 8501404 | 14" x 4" |       |
| 123398 | 8501406 | 14" x 6" |       |
| 123399 | 8501408 | 14" x 8" |       |

### Sidewall Diffusers (Continued)

#### 850 Series Stamped 2-Way Diffuser

| Part # | Mfg #   | Size     | Price |
|--------|---------|----------|-------|
| 123400 | 8501608 | 16" x 8" |       |

#### 875 Series Baseboard Diffuser

- Steel construction
- Generous free area for quiet operation
- Lever operated single-blade damper
- Removable face and damper
- Tension wings to stabilize damper



| Part # | Mfg #  | Size | Color | Price |
|--------|--------|------|-------|-------|
| 122939 | 875B18 | 18"  | Brown |       |
| 122938 | 875W18 | 18"  | White |       |

#### 951 Adjustable Steel Blade Diffuser

- Adjustable steel face blades with steel multi-shutter damper
- For ceiling or sidewall applications
- Vertical air deflectors with nylon bushings for easy adjustment and quiet settings
- Countersunk mounting holes for flush appearance with color matching Phillips posi-drive screws
- All component parts, rivets, linkage and handle are enclosed in the valve to assure trouble-free operation

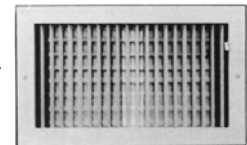

| Part # | Mfg #   | Size     | Price |
|--------|---------|----------|-------|
| 123028 | 9511004 | 10" x 4" |       |
| 123029 | 9511006 | 10" x 6" |       |
| 123030 | 9511204 | 12" x 4" |       |
| 123031 | 9511206 | 12" x 6" |       |
| 129734 | 9511404 | 14" x 4" |       |
| 123032 | 9511406 | 14" x 6" |       |
| 123033 | 9511408 | 14" x 8" |       |
| 141490 | 9511606 | 16" x 6" |       |
| 146924 | 9511608 | 16" x 8" |       |



## Sidewall Grilles & Registers

### Sidewall Air Diffusers

#### Airtec™ Classic Air Diffuser - Small

- 6" x 6" Diffuser assembly



| Part # | Mfg # | Description                      | Price |
|--------|-------|----------------------------------|-------|
| 098602 | MVES  | Return/Exhaust Grille/Damper/Box |       |

## Electric Furnaces

### Electric Furnaces E4EB Electric Furnaces

- Choice of Air Conditioning Options
- Easy Open Door
- Effective Air Filter
- Nichrome Heating Elements
- Appliance Quality Door
- Fully Insulated Cabinet
- Safety and Dependability
- Adaptable
- Versatile
- Heating Relays
- Control Board



| Part # | Mfg #        | Tons      | KW | Dimensions (H x W) | Price |
|--------|--------------|-----------|----|--------------------|-------|
| 182797 | INTE4EB010H  | 2.0 - 4.0 | 10 | 29" x 20"          |       |
| 233678 | INTE4EB012H  | 2.0 - 4.0 | 12 | 29" x 20"          |       |
| 182798 | INTE4EB015H  | 2.0 - 4.0 | 15 | 29" x 20"          |       |
| 227914 | INTE4EB017H  | 2.0 - 4.0 | 17 | 29" x 20"          |       |
| 182836 | INTE4EB020H  | 2.0 - 4.0 | 20 | 29" x 20"          |       |
| 221907 | INTE4EB23H5T | 2.0 - 5.0 | 23 | 29" x 20"          |       |

Heating - Forced Air



## Gas Downflow Furnaces

### 80% AFUE Downflow Gas Furnaces



- 80% Residential Gas Furnace CSA certified
- Downflow Design
- Single Stage Gas Valves
- PSC Blower Motors
- PlusOne™ Diagnostics 7-Segment LED
- Integrated control board
- Insulated blower compartment
- Heat Exchanger is removable
- PlusOne™ Ignition System - DSI for reliability
- Solid Door for Quiet Operation
- QR codes for quick access to product info from smart phone or tablet



#### Warranties

10-Yr Part Warranty

20 Year Heat Exchanger

#### PSC Premium Motor

| Part # | Mfg #           | Tons  | Width | Input   | Output  | AFUE  | Price |
|--------|-----------------|-------|-------|---------|---------|-------|-------|
| 169610 | R801PA050314ZSA | 3 Ton | 14"   | 50,000  | 40,000  | 80.0% |       |
| 169611 | R801PA075317ZSA | 3 Ton | 17"   | 75,000  | 60,000  | 80.0% |       |
| 169613 | R801PA100317ZSA | 3 Ton | 17"   | 100,000 | 80,000  | 80.0% |       |
| 169612 | R801PA075417ZSA | 4 Ton | 17"   | 75,000  | 60,000  | 80.0% |       |
| 169614 | R801PA100521ZSA | 5 Ton | 21"   | 100,000 | 80,000  | 80.0% |       |
| 169615 | R801PA125524ZSA | 5 Ton | 24"   | 125,000 | 100,000 | 80.0% |       |
| 169616 | R801PA150524ZSA | 5 Ton | 24"   | 150,000 | 120,000 | 80.0% |       |

#### PSC Standard Motor

| Part # | Mfg #           | Tons  | Width | Input   | Output  | AFUE  | Price |
|--------|-----------------|-------|-------|---------|---------|-------|-------|
| 169599 | R801SA050314ZSA | 3 Ton | 14"   | 50,000  | 40,000  | 80.0% |       |
| 169600 | R801SA075317ZSA | 3 Ton | 17"   | 75,000  | 60,000  | 80.0% |       |
| 169601 | R801SA075417ZSA | 4 Ton | 17"   | 75,000  | 60,000  | 80.0% |       |
| 169602 | R801SA100421ZSA | 4 Ton | 21"   | 100,000 | 80,000  | 80.0% |       |
| 169603 | R801SA125524ZSA | 5 Ton | 24"   | 125,000 | 100,000 | 80.0% |       |
| 169604 | R801SA150524ZSA | 5 Ton | 24"   | 150,000 | 120,000 | 80.0% |       |

Heating - Forced Air

## Gas Downflow Furnaces

### Gas Downflow Furnaces

#### KG7S (K Series) 80% Gas Downflow Furnace

- Single-stage heat/cool
- 100% fired and tested
- Best packaging in the industry
- Low Boy Height
- Tubular primary heat exchanger
- 30 second blower delay at start-up
- 30 second post purge
- Hot surface ignitor
- Color coded wire harness
- PSC high static blowers
- 90 second cooling cycle blower-off delay (TDR)
- Flexible category I venting system
- Multi-speed direct drive PSC blower
- LP convertible (905028)
- Diagnostic lights for easy troubleshooting without counting flashes
- Integrated control board
- Two piece door design
- Furnace air leakage compliant



| Part # | Mfg #        | Tons | Motor Type | Input BTUH | Heating Capacity BTUH | Dimensions (H x W) | Price |
|--------|--------------|------|------------|------------|-----------------------|--------------------|-------|
| 118722 | KG7SK054C23A | 2-3  | PSC        | 54,000     | 43,200                | 34 1/2" x 14 1/4"  |       |
| 118723 | KG7SK072C24B | 2-4  | PSC        | 72,000     | 57,600                | 34 1/2" x 17 1/2"  |       |
| 118724 | KG7SK090C24B | 2-4  | PSC        | 90,000     | 72,000                | 34 1/2" x 17 1/2"  |       |
| 118725 | KG7SK108C35C | 3-5  | PSC        | 108,000    | 86,400                | 34 1/2" x 21"      |       |
| 118726 | KG7SK126C45D | 4-5  | PSC        | 126,000    | 100,800               | 34 1/2" x 24 1/2"  |       |

Heating - Forced Air

## Gas Downflow Furnaces

### KG7S (L Series) 92% Gas Downflow Furnace

- Single-stage heat/cool
- 100% fired and tested
- Best packaging in the industry
- 30 second blower delay
- 30 second post purge
- Hot surface igniter
- Color coded wire harness
- Flexible category IV venting system
- PSC high static blowers
- Low boy height
- Tubular primary heat exchanger
- 90 second fixed cooling cycle blower-off delay (TDR)
- Multi-speed direct drive PSC blower
- LP convertible (905028)
- Diagnostic lights for easy troubleshooting without counting flashes
- Incorporates integrated control board
- Two piece door design enhances furnace appearance
- Seated vestibule
- Furnace air leakage compliant



| Part # | Mfg #        | Tons | Motor Type | Input BTUH | Heating Capacity BTUH | Dimensions (H x W) | Price |
|--------|--------------|------|------------|------------|-----------------------|--------------------|-------|
| 118732 | KG7SL054D24B | 2-3  | PSC        | 54,000     | 49,700                | 34 1/2" x 17 1/2"  |       |
| 118733 | KG7SL072D24B | 2-4  | PSC        | 72,000     | 66,000                | 34 1/2" x 17 1/2"  |       |
| 118734 | KG7SL090D35C | 3-5  | PSC        | 90,000     | 82,800                | 34 1/2" x 21"      |       |
| 118735 | KG7SL120D45D | 4-5  | PSC        | 120,000    | 110,400               | 34 1/2" x 24 1/2"  |       |

## Gas Downflow Furnaces

### KG7S (M Series) 95% Gas Downflow Furnaces

- Single-stage heat/cool
- 100% fired and tested
- Best packaging in the industry
- 30 second blower delay
- 30 second post purge
- Hot surface igniter
- Color coded wire harness
- Flexible category IV venting system
- PSC high static blower
- Low boy height
- Tubular primary heat exchanger
- 60 second fixed cooling cycle blower-off delay(TDR)
- Multi-speed direct drive PSC blower
- LP convertible (905028)
- Diagnostic lights for easy troubleshooting without counting flashes
- Incorporates integrated control board
- Two piece door design enhances furnace appearance
- Seated vestibule
- Furnace air leakage compliant



| Part # | Mfg #        | Tons | Motor Type | Input BTUH | Heating Capacity BTUH | Dimensions (H x W) | Price |
|--------|--------------|------|------------|------------|-----------------------|--------------------|-------|
| 143088 | KG7SM054D24B | 2-4  | PSC        | 54,000     | 51,300                | 34 1/2" x 17 1/2"  |       |
| 143087 | KG7SM072D35C | 3-5  | PSC        | 72,000     | 68,000                | 34 1/2" x 21"      |       |
| 143086 | KG7SM090D35C | 3-5  | PSC        | 90,000     | 85,500                | 34 1/2" x 21"      |       |
| 143085 | KG7SM118D45D | 4-5  | PSC        | 118,000    | 112,100               | 34 1/2" x 24 1/2"  |       |

## Gas Downflow Furnaces

### KG7T (L Series) 95% Gas Downflow Furnace

- Two-stage heat/cool
- 100% fired and tested
- Best packaging in the industry
- 30 second blower delay
- 30 second post purge
- Hot surface igniter
- Color coded wire harness
- Flexible category IV venting system
- ECM fixed speed high static blowers
- Low boy height
- Tubular primary heat exchanger
- 60 second fixed cooling cycle blower-off delay(TDR)
- ECM fixed speed direct drive blower
- LP convertible (905028)
- Diagnostic lights for easy troubleshooting without counting flashes
- Incorporates integrated control board
- Two piece door design enhances furnace appearance
- Seated vestibule
- Furnace Air Leakage.



| Part # | Mfg #        | Tons | Motor Type | Input BTUH | Heating Capacity BTUH | Dimensions (H x W) | Price |
|--------|--------------|------|------------|------------|-----------------------|--------------------|-------|
| 118736 | KG7TL060D24B | 2-4  | BLDC       | 39,000     | 37,050                | 34 1/2" x 17 1/2"  |       |
| 118737 | KG7TL080D35C | 3-5  | BLDC       | 52,000     | 49,400                | 34 1/2" x 21"      |       |
| 118738 | KG7TL100D35C | 3-5  | BLDC       | 65,000     | 61,750                | 34 1/2" x 21"      |       |
| 118739 | KG7TL120D45D | 4-5  | BLDC       | 78,000     | 74,100                | 34 1/2" x 24 1/2"  |       |



## Gas Downflow Furnaces

### Downflow Gas Furnaces

#### M1 80% Downflow Gas Furnaces

- Sealed Combustion System
- Easy Open Pawl Latch
- Choice of Air Conditioning Options
- Large, Effective Air Filter
- High Efficiency Drum Heat Exchanger
- Appliance Quality Door
- Fully Insulated Cabinet
- Reliable Burner
- LP Convertible (Kit Included)



| Part # | Mfg #         | Motor Type | Input BTUH | Heating Capacity BTUH | A/C Ready    | Dimensions (H x W) | Price |
|--------|---------------|------------|------------|-----------------------|--------------|--------------------|-------|
| 233692 | INTM1MC056ABW | PSC        | 56,000     | 46,000                | -            | 76" x 23 3/4"      |       |
| 233693 | INTM1MC070ABW | PSC        | 70,000     | 57,000                | -            | 76" x 23 3/4"      |       |
| 213927 | INTM1MC077ABW | PSC        | 77,000     | 62,000                | -            | 76" x 23 3/4"      |       |
| 225783 | INTM1MC090ABW | PSC        | 90,000     | 72,000                | -            | 76" x 23 3/4"      |       |
| 178495 | INTM1MB056ABW | PSC        | 56,000     | 46,000                | Up to 3 Tons | 76" x 23 3/4"      |       |
| 177150 | INTM1MB070ABW | PSC        | 70,000     | 57,000                | Up to 3 Tons | 76" x 23 3/4"      |       |
| 177149 | INTM1MB077ABW | PSC        | 77,000     | 62,000                | Up to 3 Tons | 76" x 23 3/4"      |       |
| 177148 | INTM1MB090ABW | PSC        | 90,000     | 72,000                | Up to 3 Tons | 76" x 23 3/4"      |       |

Heating - Forced Air

## Gas Downflow Furnaces

### M7RL 95% Downflow Gas Furnaces

- 100% fired and tested
- Clean and quiet operation
- Fixed 30 second blower delay
- Fixed 30-second post purge
- Dependable, hot surface ignitor
- Tubular primary heat exchanger
- Stainless steel secondary heat exchanger
- 60 second fixed cooling cycle blower-off delay (TDR)
- Sealed combustion approved for direct vent furnace category IV venting system
- LP Convertible (Kit Included)
- 3 amp fuse protection against low voltage shorts
- Low voltage terminal board
- Easy open pawl latch
- Appliance quality door
- Fully insulated cabinet
- Color coded wire harness
- Multi-speed direct drive blower
- Diagnostic lights for easy troubleshooting without counting flashes



| Part # | Mfg #         | Motor Type | Input BTUH | Heating Capacity BTUH | A/C Ready    | Dimensions (H x W) | Price |
|--------|---------------|------------|------------|-----------------------|--------------|--------------------|-------|
| 177151 | INTM7RL060ABW | PSC        | 60,000     | 57,000                | Up to 4 Tons | 56" x 19 7/8"      |       |
| 177152 | INTM7RL072ABW | PSC        | 72,000     | 68,400                | Up to 4 Tons | 56" x 19 7/8"      |       |

## Gas Downflow Furnaces

### M7TL 95% Variable Speed 2 Stage Downflow Gas Furnace

- ECM blower
- 2 Stage gas valve
- 100% fired and tested
- Clean and quiet operation
- Fixed 30 second blower delay
- Fixed 30-second post purge
- Dependable, hot surface ignitor
- Tubular primary heat exchanger
- Stainless steel secondary heat exchanger
- 60 second fixed cooling cycle blower-off delay (TDR)
- Sealed combustion approved for direct vent furnace category IV venting system
- LP convertible
- 3 amp fuse protection against low voltage shorts
- Low voltage terminal board
- Easy open pawl latch
- Appliance quality door
- Fully insulated cabinet
- Color coded wire harness
- 40VA transformer included
- Diagnostic lights for easy troubleshooting without counting flashes



| Part # | Mfg #         | Motor Type | Input BTUH    | Heating Capacity BTUH | A/C Ready | Dimensions (H x W) | Price |
|--------|---------------|------------|---------------|-----------------------|-----------|--------------------|-------|
| 233701 | INTM7TL045ABW | VSB        | 45,000/29,000 | 42,750/27,550         | -         | 55" x 19 7/8"      |       |
| 233704 | INTM7TL060ABW | VSB        | 60,000/39,000 | 57,000/37,050         | -         | 55" x 19 7/8"      |       |
| 233691 | INTM7TL072ABW | VSB        | 72,000/47,000 | 68,400/44,650         | -         | 55" x 19 7/8"      |       |

Heating - Forced Air

**Gas Downflow Furnaces**

**Gas Downflow Furnaces**

**FG7S (K Series) 80% Gas Downflow Furnace**

- 100% fired and tested
- Best packaging in the industry
- Low Boy Height
- Tubular primary heat exchanger
- 30 second blower delay at start-up
- 30 second post purge
- Hot surface igniter
- Color coded wire harness
- High static blowers
- 90 second cooling cycle blower-off delay (TDR)
- Flexible category I venting system
- High efficiency blower kits
- Multi-speed direct drive blower
- LP convertible
- Diagnostic lights for easy troubleshooting without counting flashes
- Integrated control board
- Two piece door design
- Blower Compartment
- Furnace Air Leakage



| Part # | Mfg #           | Tons | Motor Type | Input BTUH | Heating Capacity BTUH | Dimensions (H x W) | Price |
|--------|-----------------|------|------------|------------|-----------------------|--------------------|-------|
| 118838 | FRIFG7SK054C23A | 2-3  | PSC        | 54,000     | 43,200                | 34 1/2" x 14 1/4"  |       |
| 118839 | FRIFG7SK072C24B | 2-4  | PSC        | 72,000     | 57,600                | 34 1/2" x 17 1/2"  |       |
| 118840 | FRIFG7SK090C24B | 2-4  | PSC        | 90,000     | 72,000                | 34 1/2" x 17 1/2"  |       |
| 118841 | FRIFG7SK108C35C | 3-5  | PSC        | 108,000    | 86,400                | 34 1/2" x 21"      |       |
| 118842 | FRIFG7SK126C45D | 4-5  | PSC        | 126,000    | 100,800               | 34 1/2" x 24 1/2"  |       |

Heating - Forced Air

---



---

**Gas Downflow Furnaces**

---



---

**FG7S (L Series) 92% Gas Downflow Furnace**

- 100% fired and tested
- Best packaging in the industry
- 30 second blower delay
- 30 second post purge
- Hot surface igniter
- Color coded wire harness
- Flexible category IV venting system
- High Static Blowers
- Low Boy Height
- Tubular primary heat exchanger
- 90 second fixed cooling cycle blower-off delay (TDR)
- High efficiency blower kits
- Multi-speed direct drive blower
- LP convertible
- Diagnostic lights for easy troubleshooting without counting flashes
- Incorporates integrated control board
- Two piece door design
- Blower Compartment
- Sealed Vestibule
- Furnace Air Leakage



| Part # | Mfg #           | Tons | Motor Type | Input BTUH | Heating Capacity BTUH | Dimensions (H x W) | Price |
|--------|-----------------|------|------------|------------|-----------------------|--------------------|-------|
| 118792 | FRIFG7SL054D24B | 2-4  | PSC        | 54,000     | 49,700                | 34 1/2" x 17 1/2"  |       |
| 118793 | FRIFG7SL072D24B | 2-4  | PSC        | 72,000     | 66,000                | 34 1/2" x 17 1/2"  |       |
| 118794 | FRIFG7SL090D35C | 3-5  | PSC        | 90,000     | 82,800                | 34 1/2" x 21"      |       |
| 118795 | FRIFG7SL120D45D | 4-5  | PSC        | 120,000    | 110,400               | 34 1/2" x 24 1/2"  |       |

---



---

**Gas Downflow Furnaces**

---



---

**FG7S (M Series) 95% Gas Downflow Furnace**

- 100% fired and tested
- Best packaging in the industry
- 30 second blower delay
- 30 second post purge
- Color coded wire harness
- Flexible category IV venting system
- High Static Blowers
- Low Boy Height
- Tubular primary heat exchanger
- 60 second fixed cooling cycle blower-off delay (TDR)
- High efficiency blower kits
- Multi-speed direct drive blower
- LP convertible
- Diagnostic lights for easy troubleshooting without counting flashes
- Incorporates integrated control board
- Two piece door design
- Blower Compartment
- Sealed Vestibule
- Furnace Air Leakage



| Part # | Mfg #           | Tons | Motor Type | Input BTUH | Heating Capacity BTUH | Dimensions (H x W) | Price |
|--------|-----------------|------|------------|------------|-----------------------|--------------------|-------|
| 204434 | FRIFG7SM054D24B | 2-4  | PSC        | 54,000     | 51,300                | 34 1/2" x 17 1/2"  |       |
| 204435 | FRIFG7SM072D35C | 3-5  | PSC        | 72,000     | 68,400                | 34 1/2" x 21"      |       |
| 204436 | FRIFG7SM090D35C | 3-5  | PSC        | 90,000     | 85,500                | 34 1/2" x 21"      |       |
| 204437 | FRIFG7SM118D45D | 4-5  | PSC        | 118,000    | 112,100               | 34 1/2" x 24 1/2"  |       |

---



---

**Gas Downflow Furnaces**

---



---

**FG7T (K Series) 80% Variable Speed Gas Downflow Furnace**

- *iSEER*
- *100% fired and tested*
- *Best packaging in the industry*
- *Low Boy Height*
- *Tubular primary heat exchanger*
- *30 second blower delay at start-up*
- *30 second post purge*
- *Two Stage Inducer*
- *Hot surface igniter*
- *Color coded wire harness*
- *High static blowers*
- *90 second cooling cycle blower-off delay (TDR)*
- *Flexible category I venting system*
- *LP convertible*
- *Diagnostic lights for easy troubleshooting without counting flashes*
- *Integrated control board*
- *Two piece door design*
- *Blower Compartment*
- *Furnace Air Leakage*



| Part # | Mfg #           | Tons | Motor Type | Input BTUH | Heating Capacity BTUH | Dimensions (H x W) | Price |
|--------|-----------------|------|------------|------------|-----------------------|--------------------|-------|
| 202382 | FRIFG7TK060CVA1 |      | Variable   | 39,000     | 31,200                | 34 1/2" x 14 1/4"  |       |
| 202383 | FRIFG7TK080CVB1 |      | Variable   | 52,000     | 41,600                | 34 1/2" x 17 1/2"  |       |
| 232871 | FRIFG7TK100CVC  |      | Variable   | 65,000     | 52,000                | 34 1/2" x 21"      |       |
| 220794 | FRIFG7TK120CVC  |      | Variable   | 78,000     | 62,400                | 34 1/2" x 21"      |       |

---



---

**Gas Downflow Furnaces**

---



---

**FG7T (L Series) 95% Variable Speed Gas Downflow Furnace**

- *iSEER*
- *100% fired and tested*
- *Best packaging in the industry*
- *Low Boy Height*
- *Tubular primary heat exchanger*
- *30 second blower delay at start-up*
- *30 second post purge*
- *Two Stage Inducer*
- *Hot surface igniter*
- *Color coded wire harness*
- *High static blowers*
- *90 second cooling cycle blower-off delay (TDR)*
- *Flexible category I venting system*
- *LP convertible*
- *Diagnostic lights for easy troubleshooting without counting flashes*
- *Integrated control board*
- *Two piece door design*
- *Blower Compartment*
- *Furnace Air Leakage*



| Part # | Mfg #          | Tons | Motor Type | Input BTUH | Heating Capacity BTUH | Dimensions (H x W) | Price |
|--------|----------------|------|------------|------------|-----------------------|--------------------|-------|
| 118800 | FRIFG7TL060DVB |      | Variable   | 39,000     | 37,050                | 34 1/2" x 17 1/2"  |       |
| 118801 | FRIFG7TL080DVC |      | Variable   | 52,000     | 49,400                | 34 1/2" x 21"      |       |
| 118802 | FRIFG7TL100DVC |      | Variable   | 65,000     | 61,750                | 34 1/2" x 21"      |       |
| 118804 | FRIFG7TL120DVD |      | Variable   | 78,000     | 74,100                | 34 1/2" x 24 1/2"  |       |



---



---

**Gas Downflow Furnaces**

---



---

**FG7T ( L Series) 95% Gas Downflow Furnace**

- iSEER
- 100% fired and tested
- Best packaging in the industry
- Low Boy Height
- Tubular primary heat exchanger
- 30 second blower delay at start-up
- 30 second post purge
- Two Stage Inducer
- Hot surface igniter
- Color coded wire harness
- High static blowers
- 90 second cooling cycle blower-off delay (TDR)
- Flexible category I venting system
- LP convertible
- Diagnostic lights for easy troubleshooting without counting flashes
- Integrated control board
- Two piece door design
- Blower Compartment
- Furnace Air Leakage



| Part # | Mfg #           | Tons | Motor Type | Input BTUH | Heating Capacity BTUH | Dimensions (H x W) | Price |
|--------|-----------------|------|------------|------------|-----------------------|--------------------|-------|
| 118796 | FRIFG7TL060D24B | 2-4  | BLDC       | 39,000     | 37,050                | 34 1/2" x 17 1/2"  |       |
| 118797 | FRIFG7TL080D35C | 3-5  | BLDC       | 52,000     | 49,000                | 34 1/2" x 21"      |       |
| 118798 | FRIFG7TL100D35C | 3-5  | BLDC       | 65,000     | 61,750                | 34 1/2" x 21"      |       |
| 118799 | FRIFG7TL120D45D | 4-5  | BLDC       | 78,000     | 74,100                | 34 1/2" x 24 1/2"  |       |

**Gas Downflow Furnaces**

**Gas Downflow Furnaces**

**A802V Two-Stage, Variable Speed Furnace Downflow**

- Rotatable draft inducer for venting flexibility
- Left and right utility connections
- Removable floor base for bottom return air
- "L" designated models comply with California's South Coast Air
- Quality Management district Low NOx requirements
- Zero step horizontal conversion



| Part # | Mfg #          | Tons | Width | Input   | Output | AFUE | Price |
|--------|----------------|------|-------|---------|--------|------|-------|
| 209870 | AA80DS2V070A12 | 3    | 14.5" | 66,000  | 52,000 | 80   |       |
| 209871 | AA80DS2V090B16 | 4    | 17.5" | 88,000  | 69,000 | 80   |       |
| 209872 | AA80DS2V110C20 | 5    | 21"   | 110,000 | 87,000 | 80   |       |

**A962V High-Efficiency, Variable Speed Furnace Downflow**

- Vent materials for Canadian applications must comply with ULC 5636
- Certified for direct vent (2-pipe) and in-direct (1-pipe) applications.
- Left and right utility connections
- Removable floor base for bottom return air
- Zero step horizontal conversion



| Part # | Mfg #           | Tons | Width | Input          | Output         | AFUE | Price |
|--------|-----------------|------|-------|----------------|----------------|------|-------|
| 214469 | AA96DS2V045B12S | 3    | 17.5" | 29,000/44,000  | 28,000/43,000  | 96   |       |
| 214470 | AA96DS2V070B16S | 4    | 17.5" | 43,000/66,000  | 42,000/64,000  | 96   |       |
| 214471 | AA96DS2V090C20S | 5    | 21"   | 57,000/88,000  | 56,000/88,000  | 96   |       |
| 214472 | AA96DS2V110C20S | 5    | 21"   | 72,000/110,000 | 70,000/106,000 | 96   |       |

**A97MV High-Efficiency Modulating Furnace Testing Downflow**

- Communicating control enabled
- Modulating gas valve
- Thermostat flexibility: works with the Comfort Sync T-Stat or a conventional 24V T-Stat
- Self diagnostics saves last 10 fault codes regardless of power interruption
- Category 4 direct vent appliance (2 pipe only)
- Left or right utility connections
- Zero step horizontal conversion
- Removable floor base for bottom return air



| Part # | Mfg #           | Tons | Width | Input  | Output | AFUE | Price |
|--------|-----------------|------|-------|--------|--------|------|-------|
| 209779 | AA97DSMV070B12S | 3    | 17.5" | 66,000 | 64,000 | 97   |       |
| 209780 | AA97DSMV090C16S | 4    | 21"   | 88,000 | 85,000 | 97   |       |
| 209781 | AA97DSMV090C20S | 5    | 21"   | 88,000 | 85,000 | 97   |       |

Heating - Forced Air

**Gas Downflow Furnaces**

**Gas Downflow Furnaces (Continued)**

**A97MV High-Efficiency Modulating Furnace Testing Downflow**

| Part # | Mfg #           | Tons | Width | Input   | Output  | AFUE | Price |
|--------|-----------------|------|-------|---------|---------|------|-------|
| 209782 | AA97DSMV110C20S | 5    | 21"   | 110,000 | 107,000 | 97   |       |

**A952V High-Efficiency, Variable Speed Furnace Downflow**

- Vent materials for Canadian applications must comply with ULC 5636
- Certified for direct vent (2-pipe) and in-direct (1-pipe) applications.
- Left and right utility connections
- Removable floor base for bottom return air
- Zero step horizontal conversion



| Part # | Mfg #           | Tons | Width | Input          | Output         | AFUE | Price |
|--------|-----------------|------|-------|----------------|----------------|------|-------|
| 208673 | AA95DF2V045B12S | 3    | 17.5" | 29,000/44,000  | 28,000/43,000  | 95   |       |
| 208674 | AA95DF2V070B16S | 4    | 17.5" | 43,000/66,000  | 42,000/64,000  | 95   |       |
| 208675 | AA95DF2V090C20S | 5    | 21"   | 57,000/88,000  | 56,000/88,000  | 95   |       |
| 208676 | AA95DF2V110C20S | 5    | 21"   | 72,000/110,000 | 70,000/106,000 | 95   |       |

**A951S 95% Stainless Single-Stage Furnace**

- Single stage gas valve
- Self diagnostics saves last 5 fault codes regardless of power interruption
- Control features electronic air cleaner and humidifer terminals
- Designed certified for direct and non direct applications
- Left or right utility connection
- Design certified for direct and non-direct vent applications
- Zero step horizontal conversion
- Removable floor base for bottom return air



| Part # | Mfg #           | Tons | Width | Input  | Output | AFUE | Price |
|--------|-----------------|------|-------|--------|--------|------|-------|
| 208484 | AA95DF1D045B12S | 3    | 17.5" | 44,000 | 42,000 | 95   |       |

**A951A 95% Efficiency Single Stage Furnace Downflow**

- Up to 95% AFUE
- Single stage heating operation
- Standard PSC blower motor
- Aluminized primary heat exchanger
- Stainless steel secondary heat exchanger



| Part # | Mfg #           | Tons | Width | Input  | Output | AFUE | Price |
|--------|-----------------|------|-------|--------|--------|------|-------|
| 208649 | AA95DF1D045B12A | 3    | 17"   | 44,000 | 42,000 | 95   |       |
| 208650 | AA95DF1D070B12A | 3    | 17"   | 44,000 | 62,500 | 95   |       |
| 208651 | AA95DF1D090C20A | 4    | 21"   | 88,000 | 83,500 | 95   |       |

**Gas Downflow Furnaces**

**Gas Downflow Furnaces (Continued)**

**A951A 95% Efficiency Single Stage Furnace Downflow**

| Part # | Mfg #           | Tons | Width | Input   | Output  | AFUE | Price |
|--------|-----------------|------|-------|---------|---------|------|-------|
| 208652 | AA95DF1D110C20A | 5    | 21"   | 110,000 | 104,500 | 95   |       |

**A951E Single-Stage, Constant Torque Furnace Downflow**

- Single stage gas valve
- Durable silicon nitride ignitor
- Self diagnostics saves last 10 fault codes regardless of power interruption
- Control features electronic air cleaner and humidifier terminals
- Designed certified for direct (2-pipe) and non direct (1-pipe) applications
- Easily vented with PVC pipe
- Left or right utility connection
- Zero step horizontal conversion
- Removable floor base (upflow / horizontal units) for bottom return air



| Part # | Mfg #           | Tons | Width | Input   | Output  | AFUE | Price |
|--------|-----------------|------|-------|---------|---------|------|-------|
| 208660 | AA95DF1E045B12S | 3    | 17.5" | 44,000  | 42,000  | 95   |       |
| 208661 | AA95DF1E070B16S | 4    | 17.5" | 66,000  | 64,000  | 95   |       |
| 208662 | AA95DF1E090C16S | 4    | 21"   | 88,000  | 85,000  | 95   |       |
| 208663 | AA95DF1E110C20S | 5    | 21"   | 110,000 | 106,000 | 95   |       |

**A931A High-Efficiency Single-Stage Furnace Downflow**

- Single stage gas valve
- Durable silicon nitride ignitor
- Self diagnostics saving last 5 fault codes regardless of power interruption
- Control features electronic air cleaner and humidifier terminals
- Certified for direct vent and indirect vent (1 and 2 pipe applications)
- Left or right utility connections
- Removable floor base (upflow / horizontal units) for bottom return air
- Zero step horizontal conversion



| Part # | Mfg #           | Tons | Width | Input   | Output  | AFUE | Price |
|--------|-----------------|------|-------|---------|---------|------|-------|
| 208636 | AA93DF1D045B12A | 3    | 17.5" | 44,000  | 42,000  | 93   |       |
| 208637 | AA93DF1D070B12A | 3    | 17.5" | 66,000  | 62,000  | 93   |       |
| 208638 | AA93DF1D090C16A | 4    | 21"   | 88,000  | 84,000  | 93   |       |
| 208639 | AA93DF1D110C20A | 5    | 21"   | 110,000 | 104,000 | 93   |       |

Heating - Forced Air

**Gas Downflow Furnaces**

**Gas Downflow Furnaces**

**80G1 80% Single Stage Gas Furnace**

- Crimped no-weld aluminized clam shell heat exchanger construction
- Compact 33" height
- Standardized widths for easy coil fit
- Multi-speed PSC blower motor
- Easily removable slide out blower design
- Single stage gas valve
- Self diagnostics saving last 5 fault codes regardless of power interruption
- Rotatable draft inducer for venting flexibility
- Left or right utility connections
- Removable floor base for bottom return air
- Zero step horizontal conversion



| Part # | Mfg #           | Tons | Width | Input   | Output | AFUE | Price |
|--------|-----------------|------|-------|---------|--------|------|-------|
| 208694 | DC80G1DF045AP12 | 3    | 14.5" | 44,000  | 35,200 | 80%  |       |
| 208695 | DC80G1DF070AP12 | 3    | 14.5" | 66,000  | 52,800 | 80%  |       |
| 208696 | DC80G1DF090BP16 | 4    | 17.5" | 88,000  | 70,400 | 80%  |       |
| 208697 | DC80G1DF110CP20 | 5    | 21"   | 110,000 | 88,000 | 80%  |       |

**92G1 92% Single Stage Gas Furnace**

- Aluminized steel design primary heat exchanger with crimped no weld construction
- AL 29-4C Stainless steel secondary heat exchanger
- Aluminized steel inshot burners for smooth ignition
- Compact 33" height
- Standardized widths for easy coil fit
- Multi-speed PSC blower motor
- Easily removable slide-out blower design
- Single Stage Gas Valve
- Self diagnostics saves last 5 fault codes regardless of power interruption
- Control features electronic air cleaner and humidifer terminals
- Designed certified for direct and non direct applications
- Left or right utility connection
- Designed certified for direct and non-direct vent applications
- Zero step horizontal conversion
- Removable floor base for botom return air



| Part # | Mfg #           | Tons | Width | Input  | Output | AFUE | Price |
|--------|-----------------|------|-------|--------|--------|------|-------|
| 208707 | DC92G1DF045BP12 | 3    | 17.5" | 44,000 | 42,000 | 92%  |       |
| 208708 | DC92G1DF070BP12 | 3    | 17.5" | 66,000 | 62,000 | 92%  |       |
| 208709 | DC92G1DF090CP16 | 4    | 21"   | 88,000 | 84,000 | 92%  |       |

Heating - Forced Air

## Gas Downflow Furnaces

### 95G1 95% Single Stage Gas Furnace

- *Aluminized steel design primary heat exchanger with crimped no weld construction*
- *AL 29-4C Stainless steel secondary heat exchanger*
- *Aluminized steel inshop burners for smooth fit*
- *Compact 33" height*
- *Standardized widths for easy coil fit*
- *Multi-speed PSC blower motor*
- *Easily removable slide-out blower design*
- *Single Stage Gas Valve*
- *Self diagnostics saves last 5 fault codes regardless of power interruption*
- *Control features electronic air cleaner and humidifier terminals*
- *Designed certified for direct and non direct applications*
- *Left or right utility connection*
- *Designed certified for direct and non-direct vent applications*
- *Zero step horizontal conversion*
- *Removable floor base for bottom return air*



| Part # | Mfg #           | Tons | Width | Input   | Output  | AFUE | Price |
|--------|-----------------|------|-------|---------|---------|------|-------|
| 208838 | DC95G1DF045BP12 | 3    | 17.5" | 44,000  | 42,000  | 95%  |       |
| 208839 | DC95G1DF070BP12 | 3    | 17.5" | 66,000  | 64,000  | 95%  |       |
| 208840 | DC95G1DF090CP20 | 5    | 21"   | 88,000  | 85,000  | 95%  |       |
| 208841 | DC95G1DF110CP20 | 5    | 21"   | 110,000 | 106,000 | 95%  |       |

**Gas Downflow Furnaces**

**95G1E 95% Single Stage Constant Torque Motor**

- *Designed certified for direct (2-pipe) and non direct (1-pipe) applications*
- *Easily vented with PVC pipe*
- *Left or right utility connection*
- *Design certified for direct and non-direct vent applications*
- *Zero step horizontal conversion*
- *Removable floor base (upflow / horizontal units) for bottom return air*
- *Aluminized steel primary heat exchanger with crimped nonwelded construction*
- *AL 29-4C Stainless steel secondary heat exchanger*
- *Aluminized steel inshot burners for smooth ignition*
- *Compact 33" height*
- *Standardized widths for easy coil fit*
- *Multi-speed high efficiency (constant torque) blower motor*
- *Easily removable slide out blower design*
- *Enhanced cooling SEER ratings when applied with properly matched cooling equipment.*
- *Single stage gas valve*
- *Durable silicon nitride ignitor*
- *Self diagnostics saves last 10 fault codes regardless of power interruption*
- *Control features electronic air cleaner and humidifier terminals*



| Part # | Mfg #           | Tons | Width | Input   | Output  | AFUE | Price |
|--------|-----------------|------|-------|---------|---------|------|-------|
| 208847 | DC95G1DF045BE12 | 3    | 17.5" | 44,000  | 42,000  | 95%  |       |
| 208848 | DC95G1DF070BE16 | 4    | 17.5" | 66,000  | 64,000  | 95%  |       |
| 208849 | DC95G1DF090CE16 | 4    | 21"   | 88,000  | 85,000  | 95%  |       |
| 208850 | DC95G1DF110CE20 | 5    | 21"   | 110,000 | 106,000 | 95%  |       |

Heating - Forced Air

**Gas Downflow Furnaces**

**95G2V 95% Two Stage Variable Speed Gas Furnace**

- Aluminized steel primary heat exchanger with crimped nonwelded construction
- AL29-4C Stainless steel secondary heat exchanger
- Non-welded crimped S-curve primary heat exchanger design for maximum durability
- Aluminized steel in shot burners for smooth ignition
- Isolated burner enclosure for quiet operation
- Compact 33" height
- Standardized widths for easy coil fit
- Unitized construction for cabinet integrity
- Heat exchanger compartment is insulated to increase efficiency and reduce sound levels
- Baked on prepainted steel cabinet finish
- Efficient ECM variable speed blower motor
- Motor features "soft start" and "soft stop" for quiet operation
- Active and passive dehumidification feature
- Easily removable slide-out blower design
- Dynamically balanced blower wheel with resilient motor mounts for smooth and quiet operation
- Two stage gas valve
- Integrated ignition and fan control
- System Sentry™ control retains last five (5) fault codes with push button memory recall, regardless of power interruption
- Hot surface ignition system uses silicon nitride ignitor
- Control features 120 volt electronic air cleaner and humidifier terminals
- Control circuit is fuse protected
- Color coded control wiring
- Compatible with single or two stage thermostats for heating.
- Two stage thermostat is recommended when installed with two stage cooling unit.
- Left or right gas and electric entry
- Zero step horizontal conversion
- Removable floor base (upflow/horizontal units) for bottom return air
- 2-speed induced draft motor with stainless steel shaft, steel ball bearings, and fan cooled for long life
- Vent materials for Canadian applications must comply with ULC S636
- Certified for direct vent (2-pipe) or non-direct (1-pipe) applications
- Direct vent refers to a combustion air supply intake pipe installed in conjunction with flue gas vent pipe.



Heating - Forced Air

| Part # | Mfg #           | Tons | Width | Input           | Output          | AFUE | Price |
|--------|-----------------|------|-------|-----------------|-----------------|------|-------|
| 218356 | DC95G2DF045BV12 | 3    | 17.5" | 29,000, 44,000  | 28,000, 43,000  | 95%  |       |
| 218357 | DC95G2DF070BV16 | 4    | 17.5" | 43,000, 66,000  | 42,000, 64,000  | 95%  |       |
| 218358 | DC95G2DF090CV20 | 5    | 21"   | 57,000, 88,000  | 56,000, 85,000  | 95%  |       |
| 218359 | DC95G2DF110CV20 | 5    | 21"   | 72,000, 110,000 | 70,000, 106,000 | 95%  |       |



**Gas Downflow Furnaces**

**95G2E Two-Stage Constant Torque Gas Furnace**

- Two stage gas valve
- Integrated ignition and fan control
- Control board retains last ten (10) fault codes with push button memory recall and 7 segment LED display, regardless of power interruption
- Hot surface ignition system uses silicon nitride ignitor
- Control features 120 volt electronic air cleaner and humidifier terminals
- Control circuit is fuse protected
- Color coded control wiring
- Compatible with single or two stage thermostats for heating. Two stage thermostat is recommended when installed with two stage cooling unit
- 2-speed induced draft motor with stainless steel shaft, steel ball bearings, and fan cooled for long life
- Vent materials for Canadian applications must comply with ULC S636
- Certified for direct vent and indirect vent (1 and 2 pipe) applications
- Left or right gas and electric entry
- Zero step horizontal conversion
- Removable floor base (upflow/horizontal units) for bottom return air
- Efficient blower motor
- Easily removable slide-out blower design
- Dynamically balanced blower wheel with resilient motor mounts for smooth and quiet operation
- Compact 33" height
- Standardized widths for easy coil fit
- Unitized construction for cabinet integrity
- Heat exchanger compartment is insulated to increase efficiency and reduce sound levels
- Baked on prepainted steel cabinet finish
- Aluminized steel in shot burners for smooth ignition
- Isolated burner enclosure for quiet operation
- Aluminized steel primary heat exchanger with crimped non-welded construction
- AL29-4C Stainless steel secondary heat exchanger
- Non-welded crimped S-curve primary heat exchanger design for maximum durability



| Part # | Mfg #           | Tons | Width | Input           | Output          | AFUE | Price |
|--------|-----------------|------|-------|-----------------|-----------------|------|-------|
| 210868 | DC95G2DF045BE12 | 3    | 17.5" | 29,000, 44,000  | 28,000, 43,000  | 95%  |       |
| 210869 | DC95G2DF070BE16 | 4    | 17.5" | 43,000, 66,000  | 42,000, 64,000  | 95%  |       |
| 210870 | DC95G2DF090CE16 | 4    | 21"   | 57,000, 88,000  | 56,000, 85,000  | 95%  |       |
| 210871 | DC95G2DF110CE20 | 5    | 21"   | 72,000, 110,000 | 70,000, 106,000 | 95%  |       |

Heating - Forced Air



## Gas Multi-Position Furnaces



90+ Gas



- Up to 96% Residential Gas Furnace CSA certified
- 4 Way Multi-Position Design
- Single and Two Stage Gas Valves
- PSC and ECM Blower Motors
- PlusOne™ Diagnostics 7-Segment LED
- PlusOne™ Ignition System - DSI for reliability
- PlusOne™ Water management System

### Warranties

10-Yr Part Warranty

Limited Lifetime Heat Exchanger

### 96% 2-Stage Gas Furnaces w/ Constant Torque Motor

| Part # | Mfg #         | Tons  | Width   | Input   | Output  | AFUE  | Price |
|--------|---------------|-------|---------|---------|---------|-------|-------|
| 234429 | R96TA0402317M | 3 Ton | 17-1/2" | 42,000  | 40,320  | 96.0% |       |
| 234432 | R96TA0602317M | 3 Ton | 17-1/2" | 56,000  | 53,760  | 96.0% |       |
| 234435 | R96TA0702317M | 3 Ton | 17-1/2" | 70,000  | 67,200  | 96.0% |       |
| 234437 | R96TA0852521M | 5 Ton | 21"     | 84,000  | 80,460  | 95.0% |       |
| 234439 | R96TA1002521M | 5 Ton | 21"     | 98,000  | 94,080  | 95.0% |       |
| 234440 | R96TA1152524M | 5 Ton | 24-1/2" | 112,000 | 107,520 | 96.0% |       |

### 96% 2-Stage Gas Furnaces w/ PSC Motor

| Part # | Mfg #           | Tons  | Width   | Input   | Output  | AFUE  | Price |
|--------|-----------------|-------|---------|---------|---------|-------|-------|
| 159994 | R96PA0402317MSA | 3 Ton | 17-1/2" | 42,000  | 41,000  | 96.0% |       |
| 159995 | R96PA0602317MSA | 3 Ton | 17-1/2" | 56,000  | 54,000  | 96.0% |       |
| 159998 | R96PA0702317MSA | 3 Ton | 17-1/2" | 70,000  | 68,000  | 96.0% |       |
| 160001 | R96PA0852521MSA | 5 Ton | 21"     | 84,000  | 81,000  | 95.0% |       |
| 160004 | R96PA1002521MSA | 5 Ton | 21"     | 98,000  | 94,000  | 95.0% |       |
| 160007 | R96PA1152524MSA | 5 Ton | 24"     | 112,000 | 109,000 | 96.0% |       |

### 95% Single Stage Gas Furnaces w/ X-13 Motor

| Part # | Mfg #           | Tons  | Width   | Input   | Output  | AFUE  | Price |
|--------|-----------------|-------|---------|---------|---------|-------|-------|
| 222224 | R95TC0401317MSA | 3 Ton | 17-1/2" | 42,000  | 40,320  | 95.0% |       |
| 222225 | R95TC0601317MSA | 3 Ton | 17-1/2" | 56,000  | 53,760  | 95.0% |       |
| 222226 | R95TC0701317MSA | 3 Ton | 17-1/2" | 70,000  | 67,200  | 95.0% |       |
| 222227 | R95TC0851521MSA | 5 Ton | 21"     | 84,000  | 80,460  | 95.0% |       |
| 222228 | R95TC1001521MSA | 5 Ton | 21"     | 98,000  | 94,080  | 95.0% |       |
| 222229 | R95TC1151524MSA | 5 Ton | 24-1/2" | 112,000 | 107,520 | 95.0% |       |

### 95% Single Stage Gas Furnaces w/ PSC Motor

| Part # | Mfg #           | Tons  | Width   | Input  | Output | AFUE  | Price |
|--------|-----------------|-------|---------|--------|--------|-------|-------|
| 158565 | R95PA0401317MSA | 3 Ton | 17-1/2" | 42,000 | 40,320 | 95.0% |       |
| 158566 | R95PA0601317MSA | 3 Ton | 17-1/2" | 56,000 | 53,760 | 95.0% |       |

Heating - Forced Air



---



---

## Gas Multi-Position Furnaces

---



---

(Continued)

95% Single Stage Gas Furnaces w/ PSC Motor

| Part # | Mfg #           | Tons  | Width   | Input   | Output  | AFUE  | Price |
|--------|-----------------|-------|---------|---------|---------|-------|-------|
| 158567 | R95PA0701317MSA | 3 Ton | 17-1/2" | 70,000  | 67,200  | 95.0% |       |
| 158568 | R95PA0851521MSA | 5 Ton | 21"     | 84,000  | 80,460  | 95.0% |       |
| 158569 | R95PA1001521MSA | 5 Ton | 21"     | 98,000  | 94,080  | 95.0% |       |
| 158570 | R95PA1151524MSA | 5 Ton | 24-1/2" | 112,000 | 107,520 | 95.0% |       |

Heating - Forced Air



## Gas Multi-Position Furnaces

### 92% Single Stage Gas Furnaces w/ PSC Motor

| Part # | Mfg #           | Tons  | Width   | Input   | Output  | AFUE  | Price |
|--------|-----------------|-------|---------|---------|---------|-------|-------|
| 158518 | R92PA0401317MSA | 3 Ton | 17-1/2" | 42,000  | 39,060  | 92.0% |       |
| 158519 | R92PA0601317MSA | 3 Ton | 17-1/2" | 56,000  | 52,080  | 92.0% |       |
| 158520 | R92PA0701317MSA | 3 Ton | 17-1/2" | 70,000  | 65,100  | 92.0% |       |
| 158521 | R92PA0851521MSA | 5 Ton | 21"     | 84,000  | 78,120  | 92.0% |       |
| 158522 | R92PA1001521MSA | 5 Ton | 21"     | 98,000  | 91,140  | 92.0% |       |
| 158523 | R92PA1151524MSA | 5 Ton | 24-1/2" | 112,000 | 104,160 | 92.0% |       |

### Modulating Gas Furnaces

# ULTRA

Series

- EcoNet™ Enabled
- ECM Motor
- Modulating Function: when used with an EcoNet Control
- PlusOne™ Ignition System
- PlusOne™ Water Management System
- PlusOne™ Diagnostics 7- Segment LED
- Blower Shelf design – serviceable in all furnace orientations
- Pre marked hoses – insures proper system drainage
- Vent with 2" or 3" PVC
- Integrated control boards feature dip switches for easy system set up
- Self priming condensate trap
- Solid bottom included



#### Warranties

Parts - 10 Years

Heat Exchanger - Limited Lifetime

Conditional Unit Replacement - Limited Lifetime

### 96% 2-Stage Variable Speed Gas Furnaces

| Part # | Mfg #           | Tons  | Width   | Input   | Output  | AFUE  | Price |
|--------|-----------------|-------|---------|---------|---------|-------|-------|
| 170931 | U96VA0402317MSA | 3 Ton | 17-1/2" | 42,000  | 40,320  | 96.0% |       |
| 160836 | U96VA0602317MSA | 3 Ton | 17-1/2" | 56,000  | 53,760  | 96.0% |       |
| 160837 | U96VA0702317MSA | 3 Ton | 17-1/2" | 70,000  | 67,200  | 96.0% |       |
| 160838 | U96VA0852521MSA | 5 Ton | 21"     | 84,000  | 80,640  | 96.0% |       |
| 160839 | U96VA1002521MSA | 5 Ton | 21"     | 98,000  | 94,080  | 96.0% |       |
| 160840 | U96VA1152524MSA | 5 Ton | 24-1/2" | 112,000 | 107,520 | 96.0% |       |

Heating - Forced Air



## Gas Upflow/Horizontal Furnaces

### 80% Gas Furnaces

- 80% Residential Gas Furnace
- Upflow/Horizontal Design
- Single Stage Gas Valves
- PSC Blower Motors
- PlusOne™ Diagnostics 7-Segment LED
- PlusOne™ Ignition System - DSI for reliability
- Solid Door for Quiet Operation

ACHIEVER  
Series



#### Warranties

10-Yr Part Warranty

20 Year Heat Exchanger

#### 80% Upflow/Horizontal Single Stage Gas Furnaces w/ PSC Motor Includes Insulated Blower Compartment and Solid Bottom

| Part # | Mfg #           | Tons  | Width | Input   | Output  | AFUE  | Price |
|--------|-----------------|-------|-------|---------|---------|-------|-------|
| 169605 | R801PA050314MSA | 3 Ton | 14"   | 50,000  | 40,000  | 80.0% |       |
| 185060 | R801PA075317MSA | 3 Ton | 17"   | 75,000  | 60,000  | 80.0% |       |
| 169606 | R801PA075417MSA | 4 Ton | 17"   | 75,000  | 60,000  | 80.0% |       |
| 180704 | R801PA100417MSA | 4 Ton | 17"   | 100,000 | 80,000  | 80.0% |       |
| 169607 | R801PA100521MSA | 5 Ton | 21"   | 100,000 | 80,000  | 80.0% |       |
| 169608 | R801PA125524MSA | 5 Ton | 24"   | 125,000 | 100,000 | 80.0% |       |
| 169609 | R801PA150524MSA | 5 Ton | 24"   | 150,000 | 120,000 | 80.0% |       |

#### 80% Upflow/Horizontal Single Stage Gas Furnaces w/ PSC Motor Uninsulated Blower Compartment and Open Bottom

| Part # | Mfg #           | Tons  | Width | Input   | Output  | AFUE  | Price |
|--------|-----------------|-------|-------|---------|---------|-------|-------|
| 169592 | R801SA050314MSA | 3 Ton | 14"   | 50,000  | 41,000  | 80.0% |       |
| 185059 | R801SA075317MSA | 3 Ton | 17"   | 75,000  | 61,000  | 80.0% |       |
| 169594 | R801SA075417MSA | 4 Ton | 17"   | 75,000  | 61,000  | 80.0% |       |
| 180705 | R801SA100417MSA | 4 Ton | 17"   | 100,000 | 82,000  | 80.0% |       |
| 169595 | R801SA100521MSA | 5 Ton | 21"   | 100,000 | 81,000  | 80.0% |       |
| 169596 | R801SA125524MSA | 5 Ton | 24"   | 125,000 | 101,000 | 80.0% |       |
| 169597 | R801SA150524MSA | 5 Ton | 24"   | 150,000 | 122,000 | 80.0% |       |

Heating - Forced Air



## Gas Upflow/Horizontal Furnaces

### 97%+ Gas Furnaces

# ULTRA

Series

- EcoNet™ Enabled
- ECM Motor
- Modulating Function: when used with an EcoNet Control
- PlusOne™ Ignition System
- PlusOne™ Water Management System
- PlusOne™ Diagnostics 7-Segment LED
- Blower Shelf design – serviceable in all furnace orientations
- Pre marked hoses – insures proper system drainage
- Vent with 2" or 3" PVC
- Integrated control boards feature dip switches for easy system set up
- Self priming condensate trap
- Solid bottom included



#### Warranties

Parts - 10 Years

Heat Exchanger - Limited Lifetime

Conditional Unit Replacement - Limited Lifetime

### 97% Gas Furnaces

| Part # | Mfg#            | Blower | Width   | Input   | Output  | AFUE  | Price |
|--------|-----------------|--------|---------|---------|---------|-------|-------|
| 185048 | U97VA060M317USA | 3 Ton  | 17-1/2" | 56,000  | 54,320  | 97.0% |       |
| 185049 | U97VA070M317USA | 3 Ton  | 17-1/2" | 70,000  | 67,900  | 97.0% |       |
| 185050 | U97VA085M521USA | 5 Ton  | 21"     | 84,000  | 81,480  | 97.0% |       |
| 185051 | U97VA100M521USA | 5 Ton  | 21"     | 98,000  | 95,060  | 97.0% |       |
| 185052 | U97VA115M524USA | 5 Ton  | 24-1/2" | 112,000 | 408,640 | 97.0% |       |

### 98%+ Gas Furnaces

| Part # | Mfg #           | Tons  | Width   | Input   | Output  | AFUE  | Price |
|--------|-----------------|-------|---------|---------|---------|-------|-------|
| 243342 | U98VB060M317USA | 3 Ton | 17-1/2" | 56,000  | 55,000  | 98.7% |       |
| 243343 | U98VB070M317USA | 3 Ton | 17-1/2" | 70,000  | 69,000  | 98.3% |       |
| 243344 | U98VB085M521USA | 5 Ton | 21"     | 84,000  | 83,000  | 98.1% |       |
| 243345 | U98VB100M521USA | 5 Ton | 21"     | 98,000  | 97,000  | 98.1% |       |
| 243346 | U98VB115M524USA | 5 Ton | 24-1/2" | 112,000 | 110,000 | 98.6% |       |

Heating - Forced Air

## Gas Upflow/Horizontal Furnaces

### Gas Upflow Furnaces

#### 80% KG7SA Series Gas Upflow/Horizontal Furnace

- Single stage heat/cool
- 100% fired and tested
- Best packaging in the industry
- Low Boy Height
- Tubular primary heat exchanger
- 30 second blower delay at start-up
- 30 second post purge
- Hot surface igniter
- Color coded wire harness
- PSC high static blowers
- 90 second cooling cycle blower-off delay (TDR)
- Flexible category I venting system
- Multi-speed direct drive PSC blower
- LP convertible (905028)
- Diagnostic lights for easy troubleshooting without counting flashes
- Integrated control board
- Two piece door design
- Furnace air leakage compliant



| Part # | Mfg #        | Tons | Motor Type | Input BTUH | Heating Capacity BTUH | Dimensions (H x W) | Price |
|--------|--------------|------|------------|------------|-----------------------|--------------------|-------|
| 118713 | KG7SA045C23A | 2-3  | PSC        | 45,000     | 36,000                | 34 1/2" x 14 1/4"  |       |
| 118715 | KG7SA054C23A | 2-3  | PSC        | 54,000     | 43,200                | 34 1/2" x 14 1/4"  |       |
| 118716 | KG7SA072C24B | 2-4  | PSC        | 72,000     | 57,600                | 34 1/2" x 17 1/2"  |       |
| 118717 | KG7SA090C24B | 2-4  | PSC        | 90,000     | 72,000                | 34 1/2" x 17 1/2"  |       |
| 118718 | KG7SA072C35C | 3-5  | PSC        | 72,000     | 57,600                | 34 1/2" x 21"      |       |
| 118719 | KG7SA090C35C | 3-5  | PSC        | 90,000     | 72,000                | 34 1/2" x 21"      |       |
| 118720 | KG7SA108C35C | 3-5  | PSC        | 108,000    | 86,400                | 34 1/2" x 21"      |       |
| 118721 | KG7SA126C45D | 4-5  | PSC        | 126,000    | 100,800               | 34 1/2" x 24 1/2"  |       |

Heating - Forced Air

## Gas Upflow/Horizontal Furnaces

### 92% KG7SC Series Gas Upflow/Horizontal Furnace

- Single stage heat/cool
- 100% fired and tested
- Best packaging in the industry
- Low Boy Height
- Tubular primary heat exchanger
- 30 second blower delay at start-up
- 30 second post purge
- Hot surface igniter
- Color coded wire harness
- PSC high static blowers
- 90 second cooling cycle blower-off delay (TDR)
- Flexible category I venting system
- Multi-speed direct drive PSC blower
- LP convertible (905028)
- Diagnostic lights for easy troubleshooting without counting flashes
- Integrated control board
- Two piece door design
- Furnace air leakage compliant



| Part # | Mfg #        | Tons | Motor Type | Input BTUH | Heating Capacity BTUH | Dimensions (H x W) | Price |
|--------|--------------|------|------------|------------|-----------------------|--------------------|-------|
| 118758 | KG7SC038D23A | 2-3  | PSC        | 38,000     | 35,000                | 34 1/2" x 14 1/4"  |       |
| 118759 | KG7SC054D24B | 2-4  | PSC        | 54,000     | 49,700                | 34 1/2" x 17 1/2"  |       |
| 118760 | KG7SC072D24B | 2-4  | PSC        | 72,000     | 66,000                | 34 1/2" x 17 1/2"  |       |
| 118761 | KG7SC090D35C | 3-5  | PSC        | 90,000     | 82,000                | 34 1/2" x 21"      |       |
| 118762 | KG7SC072D35C | 3-5  | PSC        | 72,000     | 66,800                | 34 1/2" x 21"      |       |
| 118763 | KG7SC108D45D | 4-5  | PSC        | 108,000    | 99,000                | 34 1/2" x 24 1/2"  |       |
| 118764 | KG7SC120D45D | 4-5  | PSC        | 120,000    | 110,400               | 34 1/2" x 24 1/2"  |       |



## Gas Upflow/Horizontal Furnaces

### 95% KG7TC Series Gas Upflow/Horizontal Furnace

- Two-stage heat/cool
- 100% fired and tested
- Best packaging in the industry
- Low Boy Height
- Tubular primary heat exchanger
- 30 second blower delay at start-up
- 30 second post purge
- Hot surface igniter
- Color coded wire harness
- Fixed speed ECM
- High efficiency blower motor
- 90 second cooling cycle blower-off delay (TDR)
- Flexible category I venting system
- Multi-speed direct drive blower (ECM)
- LP convertible (905028)
- Diagnostic lights for easy troubleshooting without counting flashes
- Integrated control board
- Two piece door design
- Furnace Air Leakage



| Part # | Mfg #        | Tons | Motor Type | Input BTUH | Heating Capacity BTUH | Dimensions (H x W) | Price |
|--------|--------------|------|------------|------------|-----------------------|--------------------|-------|
| 118765 | KG7TC060D24B | 2-4  | BLDC       | 60,000     | 57,000                | 34 1/2" x 17 1/2"  |       |
| 118766 | KG7TC080D35C | 3-5  | BLDC       | 80,000     | 76,000                | 34 1/2" x 21"      |       |
| 118767 | KG7TC100D35C | 3-5  | BLDC       | 100,000    | 95,000                | 34 1/2" x 21"      |       |
| 118768 | KG7TC120D45D | 4-5  | BLDC       | 120,000    | 78,000                | 34 1/2" x 24 1/2"  |       |

Heating - Forced Air

## Gas Upflow/Horizontal Furnaces

### 95% KG7SD Series Gas Upflow/Horizontal Furnace

- Single-stage heat/cool
- 100% fired and tested
- Best packaging in the industry
- Low Boy Height
- Tubular primary heat exchanger
- 30 second blower delay at start-up
- 30 second post purge
- Hot surface igniter
- Color coded wire harness
- PSC high static blowers
- 90 second cooling cycle blower-off delay (TDR)
- Flexible category I venting system
- Multi-speed direct drive PSC blower motor
- LP convertible (905028)
- Diagnostic lights for easy troubleshooting without counting flashes
- Integrated control board
- Two piece door design
- Furnace air leakage compliant



| Part # | Mfg #        | Tons | Motor Type      | Input BTUH | Heating Capacity BTUH | Dimensions (H x W) | Price |
|--------|--------------|------|-----------------|------------|-----------------------|--------------------|-------|
| 143089 | KG7SD038D24B | 2-4  | Multi-Speed PSC | 38,000     | 36,100                | 34 1/2" x 17 1/2"  |       |
| 143091 | KG7SD054D24B | 2-4  | Multi-Speed PSC | 54,000     | 51,300                | 34 1/2" x 17 1/2"  |       |
| 143092 | KG7SD072D35C | 3-5  | Multi-Speed PSC | 72,000     | 68,400                | 34 1/2" x 21"      |       |
| 143093 | KG7SD090D35C | 3-5  | Multi-Speed PSC | 90,000     | 85,500                | 34 1/2" x 21"      |       |
| 143094 | KG7SD108D45D | 4-5  | Multi-Speed PSC | 108,000    | 102,600               | 34 1/2" x 24 1/2"  |       |
| 143095 | KG7SD120D45D | 4-5  | Multi-Speed PSC | 120,000    | 114,000               | 34 1/2" x 24 1/2"  |       |

## Gas Upflow/Horizontal Furnaces

### 96% KG7TE Series Gas Upflow Furnace

- Two-stage heat/cool
- Energy efficient brushless DC (ECM) motor - fixed speed
- 100% fired and tested
- Best packaging in the industry
- Low Boy Height
- Aluminized steel primary heat exchanger
- 30 second blower delay at start-up
- 30 second post purge
- 90 second fixed cooling cycle blower-off delay
- Hot surface ignitor
- Color coded wire harness
- Flexible category I venting system
- High static blowers
- Variable speed blower kit available
- LP convertible (905028)
- Diagnostic lights for easy troubleshooting without counting flashes
- Integrated control board
- Two piece door design



| Part # | Mfg #         | Tons | Motor Type | Input BTUH | Heating Capacity BTUH | Dimensions (H x W) | Price |
|--------|---------------|------|------------|------------|-----------------------|--------------------|-------|
| 236802 | KG7TE060D24B1 | 2-4  | ECM        | 60,000     | 57,600                | 34-1/2" x 17-1/2"  |       |
| 236804 | KG7TE080D35C1 | 3-5  | ECM        | 80,000     | 52,000                | 34-1/2" x 21"      |       |
| 236806 | KG7TE100D35C1 | 3-5  | ECM        | 100,000    | 96,000                | 34-1/2" x 21"      |       |

## Gas Upflow/Horizontal Furnaces

### Gas Upflow Furnaces

#### FG7S (A Series) 80% Gas Upflow Furnace

- 100% fired and tested
- Best packaging in the industry
- Low Boy Height
- Tubular primary heat exchanger
- 30 second blower delay at start-up
- 30 second post purge
- Hot surface igniter
- Color coded wire harness
- High static blowers
- 90 second cooling cycle blower-off delay (TDR)
- Flexible category I venting system
- High efficiency blower kits
- Multi-speed direct drive blower
- LP convertible
- Diagnostic lights for easy troubleshooting without counting flashes
- Integrated control board
- Two piece door design
- Blower Compartment
- Furnace Air Leakage



| Part # | Mfg #           | Tons | Motor Type | Input BTUH | Heating Capacity BTUH | Dimensions (H x W) | Price |
|--------|-----------------|------|------------|------------|-----------------------|--------------------|-------|
| 118830 | FRIFG7SA045C23A | 2-3  | PSC        | 45,000     | 36,000                | 34 1/2" x 14 1/4"  |       |
| 118831 | FRIFG7SA054C23A | 2-3  | PSC        | 54,000     | 43,200                | 34 1/2" x 14 1/4"  |       |
| 118832 | FRIFG7SA072C24B | 2-4  | PSC        | 72,000     | 57,600                | 34 1/2" x 17 1/2"  |       |
| 118833 | FRIFG7SA072C35C | 3-5  | PSC        | 72,000     | 57,600                | 34 1/2" x 21"      |       |
| 118834 | FRIFG7SA090C24B | 2-4  | PSC        | 90,000     | 72,000                | 34 1/2" x 17 1/2"  |       |
| 118835 | FRIFG7SA090C35C | 3-5  | PSC        | 90,000     | 72,000                | 34 1/2" x 21"      |       |
| 118836 | FRIFG7SA108C35C | 3-5  | PSC        | 108,000    | 86,400                | 34 1/2" x 21"      |       |
| 118837 | FRIFG7SA126C45D | 4-5  | PSC        | 126,000    | 100,800               | 34 1/2" x 24 1/2"  |       |

## Gas Upflow/Horizontal Furnaces

### FG7S (C Series) 92% Gas Upflow Furnace

- 100% fired and tested
- Best packaging in the industry
- 30 second blower delay
- 30 second post purge
- Hot surface igniter
- Color coded wire harness
- Flexible category IV venting system
- High Static Blowers
- Low Boy Height
- Tubular primary heat exchanger
- 90 second fixed cooling cycle blower-off delay (TDR)
- High efficiency blower kits
- Multi-speed direct drive blower
- LP convertible
- Diagnostic lights for easy troubleshooting without counting flashes
- Incorporates integrated control board
- Two piece door design
- Blower Compartment
- Sealed Vestibule
- Furnace Air Leakage



| Part # | Mfg #           | Tons | Motor Type | Input BTUH | Heating Capacity BTUH | Dimensions (H x W) | Price |
|--------|-----------------|------|------------|------------|-----------------------|--------------------|-------|
| 118843 | FRIFG7SC038D23A | 2-3  | PSC        | 38,000     | 35,000                | 34 1/2" x 14 1/4"  |       |
| 118844 | FRIFG7SC054D24B | 2-4  | PSC        | 54,000     | 49,700                | 34 1/2" x 17 1/2"  |       |
| 118845 | FRIFG7SC072D24B | 2-4  | PSC        | 72,000     | 66,000                | 34 1/2" x 17 1/2"  |       |
| 118847 | FRIFG7SC072D35C | 3-5  | PSC        | 72,000     | 66,000                | 34 1/2" x 21"      |       |
| 118848 | FRIFG7SC090D35C | 3-5  | PSC        | 90,000     | 82,000                | 34 1/2" x 21"      |       |
| 118849 | FRIFG7SC108D45D | 4-5  | PSC        | 108,000    | 99,000                | 34 1/2" x 24 1/2"  |       |
| 118850 | FRIFG7SC120D45D | 4-5  | PSC        | 120,000    | 110,400               | 34 1/2" x 24 1/2"  |       |

**Gas Upflow/Horizontal Furnaces**

**FG7S (D Series) 95% Gas Upflow Furnace**

- 100% fired and tested
- Best packaging in the industry
- 30 second blower delay
- 30 second post purge
- Hot surface igniter
- Color coded wire harness
- Flexible category IV venting system
- High Static Blowers
- Low Boy Height
- Tubular primary heat exchanger
- 60 second fixed cooling cycle blower-off delay (TDR)
- High efficiency blower kits
- Multi-speed direct drive blower
- LP convertible
- Diagnostic lights for easy troubleshooting without counting flashes:
- Incorporates integrated control board
- Two piece door design
- Blower Compartment
- Sealed Vestibule
- Furnace Air Leakage



| Part # | Mfg #           | Tons | Motor Type | Input BTUH | Heating Capacity BTUH | Dimensions (H x W) | Price |
|--------|-----------------|------|------------|------------|-----------------------|--------------------|-------|
| 142960 | FRIFG7SD038D24B | 2-4  | PSC        | 38,000     | 36,100                | 34 1/2" x 17 1/2"  |       |
| 142959 | FRIFG7SD054D24B | 2-4  | PSC        | 54,000     | 51,300                | 34 1/2" x 17 1/2"  |       |
| 142958 | FRIFG7SD072D35C | 3-5  | PSC        | 72,000     | 68,400                | 34 1/2" x 21"      |       |
| 142957 | FRIFG7SD090D35C | 3-5  | PSC        | 90,000     | 85,500                | 34 1/2" x 21"      |       |
| 142956 | FRIFG7SD108D45D | 4-5  | PSC        | 108,000    | 102,600               | 34 1/2" x 24 1/2"  |       |
| 142955 | FRIFG7SD120D45D | 4-5  | PSC        | 120,000    | 114,000               | 34 1/2" x 24 1/2"  |       |

Heating - Forced Air

## Gas Upflow/Horizontal Furnaces

### FG7T (A Series) 80% Gas Upflow Furnace

- *i SEER*
- *100% fired and tested*
- *Best packaging in the industry*
- *Low Boy Height*
- *Tubular primary heat exchanger*
- *30 second blower delay at start-up*
- *30 second post purge*
- *Hot surface igniter*
- *Color coded wire harness*
- *High static blowers*
- *90 second cooling cycle blower-off delay (TDR)*
- *Flexible category I venting system*
- *Variable speed blower kit*
- *LP convertible*
- *Diagnostic lights for easy troubleshooting without counting flashes*
- *Integrated control board*
- *Two piece door design*
- *Blower Compartment*
- *2 Stage Inducer*
- *Furnace Air Leakage*



| Part # | Mfg #           | Tons | Motor Type | Input BTUH | Heating Capacity BTUH | Dimensions (H x W) | Price |
|--------|-----------------|------|------------|------------|-----------------------|--------------------|-------|
| 202365 | FRIFG7TA060C23A | 2-3  | BLDC       | 60,000     | 48,000                | 34 1/2" x 14 1/4"  |       |
| 202366 | FRIFG7TA080C24B | 2-4  | BLDC       | 80,000     | 64,000                | 34 1/2" x 17 1/2"  |       |
| 202367 | FRIFG7TA100C24B | 2-4  | BLDC       | 100,000    | 80,000                | 34 1/2" x 17 1/2"  |       |
| 202369 | FRIFG7TA120C35C | 3-5  | BLDC       | 120,000    | 96,000                | 34 1/2" x 21"      |       |
| 202370 | FRIFG7TA140C45D | 4-5  | BLDC       | 140,000    | 112,000               | 34 1/2" x 24 1/2"  |       |

**Gas Upflow/Horizontal Furnaces**

**FG7T (C Series) 95% Gas Upflow Furnace**

- iSEER
- 100% fired and tested
- Best packaging in the industry
- 30 second blower delay
- 30 second post purge
- Hot surface igniter
- Color coded wire harness
- Flexible category IV venting system
- High Static Blowers
- Low Boy Height
- Tubular primary heat exchanger
- 90 second fixed cooling cycle blower-off delay (TDR)
- Variable speed blower kit
- LP convertible
- Diagnostic lights for easy troubleshooting without counting flashes:
- Incorporates integrated control board
- Two piece door design
- Blower Compartment
- Sealed Vestibule
- 2 Stage Inducer
- Furnace Air Leakage



| Part # | Mfg #           | Tons | Motor Type | Input BTUH | Heating Capacity BTUH | Dimensions (H x W) | Price |
|--------|-----------------|------|------------|------------|-----------------------|--------------------|-------|
| 118851 | FRIFG7TC060D24B | 2-4  | BLDC       | 60,000     | 57,000                | 34 1/2" x 17 1/2"  |       |
| 118852 | FRIFG7TC080D35C | 3-5  | BLDC       | 80,000     | 76,000                | 34 1/2" x 21"      |       |
| 118853 | FRIFG7TC100D35C | 3-5  | BLDC       | 100,000    | 95,000                | 34 1/2" x 21"      |       |
| 118854 | FRIFG7TC120D45D | 4-5  | BLDC       | 120,000    | 114,000               | 34 1/2" x 24 1/2"  |       |

Heating - Forced Air



## Gas Upflow/Horizontal Furnaces

### FG7T (A Series) 80% Variable Speed Gas Upflow Furnace

- *iSEER*
- *100% fired and tested*
- *Best packaging in the industry*
- *Low Boy Height*
- *Tubular primary heat exchanger*
- *30 second blower delay at start-up*
- *30 second post purge*
- *Two Stage Inducer*
- *Hot surface igniter*
- *Color coded wire harness*
- *High static blowers*
- *90 second cooling cycle blower-off delay (TDR)*
- *Flexible category I venting system*
- *LP convertible*
- *Diagnostic lights for easy troubleshooting without counting flashes*
- *Integrated control board*
- *Two piece door design*
- *Blower Compartment*
- *Furnace Air Leakage*



| Part # | Mfg #           | Tons | Motor Type | Input BTUH | Heating Capacity BTUH | Dimensions (H x W) | Price |
|--------|-----------------|------|------------|------------|-----------------------|--------------------|-------|
| 202371 | FRIFG7TA060CVA1 |      | Variable   | 60,000     | 48,000                | 34 1/2" x 14 1/4"  |       |
| 202372 | FRIFG7TA080CVB1 |      | Variable   | 80,000     | 64,000                | 34 1/2" x 17 1/2"  |       |
| 202373 | FRIFG7TA100CVC1 |      | Variable   | 100,000    | 80,000                | 34 1/2" x 21"      |       |
| 202374 | FRIFG7TA120CVC1 |      | Variable   | 120,000    | 96,000                | 34 1/2" x 21"      |       |
| 202375 | FRIFG7TA140CVD1 |      | Variable   | 140,000    | 112,000               | 34 1/2" x 24 1/2"  |       |

## Gas Upflow/Horizontal Furnaces

### FG7T (C Series) 95% Variable Speed Gas Upflow Furnace

- *i SEER*
- *100% fired and tested*
- *Best packaging in the industry*
- *30 second blower delay*
- *30 second post purge*
- *Two Stage Inducer*
- *Hot surface igniter*
- *Color coded wire harness*
- *Flexible category IV venting system*
- *High Static Blowers*
- *Low Boy Height*
- *Tubular primary heat exchanger*
- *90 second fixed cooling cycle blower-off delay (TDR)*
- *LP convertible*
- *Diagnostic lights for easy troubleshooting without counting flashes*
- *Incorporates integrated control board*
- *Two piece door design*
- *Blower Compartment*
- *Sealed Vestibule*
- *Furnace Air Leakage*



| Part # | Mfg #          | Tons | Motor Type | Input BTUH | Heating Capacity BTUH | Dimensions (H x W) | Price |
|--------|----------------|------|------------|------------|-----------------------|--------------------|-------|
| 118855 | FRIFG7TC060DVB |      | Variable   | 60,000     | 57,000                | 34 1/2" x 17 1/2"  |       |
| 118856 | FRIFG7TC080DVC |      | Variable   | 80,000     | 76,000                | 34 1/2" x 21"      |       |
| 118858 | FRIFG7TC100DVC |      | Variable   | 100,000    | 95,000                | 34 1/2" x 21"      |       |
| 118859 | FRIFG7TC120DVD |      | Variable   | 120,000    | 114,000               | 34 1/2" x 24 1/2"  |       |

## Gas Upflow/Horizontal Furnaces

### Gas Upflow/Horizontal Furnaces

#### A951A High-Efficiency Single-Stage Furnace Upflow

- Single stage gas valve
- Self diagnostics saves last 5 fault codes regardless of power interruption
- Control features electronic air cleaner and humidifier terminals
- Designed certified for direct and non direct applications
- Left or right utility connection
- Design certified for direct and non-direct vent applications
- Zero step horizontal conversion
- Removable floor base for bottom return air
- Quality Management district Low NOx requirements



| Part # | Mfg #           | Tons    | Width | Input   | Output  | AFUE | Price |
|--------|-----------------|---------|-------|---------|---------|------|-------|
| 208640 | AA95UH1D045B08A | 1.5-2.5 | 17.5" | 44,000  | 42,000  | 95   |       |
| 208641 | AA95UH1D045B12A | 2-3     | 17.5" | 44,000  | 42,000  | 95   |       |
| 208642 | AA95UH1D070B12A | 2-3     | 17.5" | 66,000  | 64,000  | 95   |       |
| 208644 | AA95UH1D090C12A | 2-3     | 21"   | 88,000  | 85,000  | 95   |       |
| 208645 | AA95UH1D090C16A | 3-4     | 21"   | 88,000  | 85,000  | 95   |       |
| 208646 | AA95UH1D110C16A | 3-4     | 21"   | 110,000 | 106,000 | 95   |       |
| 208647 | AA95UH1D110C20A | 4-5     | 21"   | 110,000 | 106,000 | 95   |       |
| 208648 | AA95UH1D135D20A | 4-5     | 24.5" | 132,000 | 126,000 | 95   |       |

#### A801E Single-Stage, Constant Torque Furnace Upflow

- Self diagnostics saving last 10 fault codes regardless of power interruption
- Control features electronic air cleaner and humidifier terminals
- Rotatable draft inducer for venting flexibility
- Left or right utility connections
- Removable floor base (upflow / horizontal units) for bottom return air
- Zero step horizontal conversion



| Part # | Mfg #          | Tons      | Width | Input   | Output  | AFUE | Price |
|--------|----------------|-----------|-------|---------|---------|------|-------|
| 208510 | AA80UH1E045A12 | 1-1/2 - 3 | 14.5" | 44,000  | 35,200  | 80   |       |
| 208511 | AA80UH1E070B12 | 1-1/2 - 3 | 17.5" | 66,000  | 52,800  | 80   |       |
| 208512 | AA80UH1E090B16 | 2-1/2 - 4 | 17.5" | 88,000  | 70,400  | 80   |       |
| 208513 | AA80UH1E090C20 | 3 - 5     | 21"   | 88,000  | 70,400  | 80   |       |
| 208534 | AA80UH1E110C20 | 4 - 5     | 21"   | 110,000 | 88,000  | 80   |       |
| 208535 | AA80UH1E135D20 | 4 - 5     | 24.5" | 132,000 | 105,600 | 80   |       |

Heating - Forced Air

## Gas Upflow/Horizontal Furnaces

### A802V Two-Stage, Variable Speed Furnace Upflow

- Rotatable draft inducer for venting flexibility
- Left and right utility connections
- Removable floor base for bottom return air
- Quality Management district Low NOx requirements
- Zero step horizontal conversion



| Part # | Mfg #          | Tons | Width | Input   | Output  | AFUE | Price |
|--------|----------------|------|-------|---------|---------|------|-------|
| 209865 | AA80US2V070A12 | 3    | 14.5" | 66,000  | 52,000  | 80   |       |
| 209866 | AA80US2V090B12 | 3    | 17.5" | 88,000  | 70,000  | 80   |       |
| 209867 | AA80US2V090C20 | 5    | 21"   | 88,000  | 70,000  | 80   |       |
| 209868 | AA80US2V110C20 | 5    | 21"   | 110,000 | 87,000  | 80   |       |
| 209869 | AA80US2V135D20 | 5    | 24.5" | 132,000 | 105,000 | 80   |       |

### A951E Single-Stage, Constant Torque Furnace Upflow

- Single stage gas valve
- Durable silicon nitride ignitor
- Self diagnostics saves last 10 fault codes regardless of power interruption
- Control features electronic air cleaner and humidifier terminals
- Designed certified for direct (2-pipe) and non direct (1-pipe) applications
- Easily vented with PVC pipe
- Left or right utility connection
- Zero step horizontal conversion
- Removable floor base (upflow / horizontal units) for bottom return air



| Part # | Mfg #           | Tons | Width | Input   | Output  | AFUE | Price |
|--------|-----------------|------|-------|---------|---------|------|-------|
| 208655 | AA95UH1E045B12S | 3    | 17.5" | 44,000  | 42,000  | 95   |       |
| 208656 | AA95UH1E070B12S | 3    | 17.5" | 66,000  | 64,000  | 95   |       |
| 208657 | AA95UH1E090C16S | 4    | 21"   | 88,000  | 85,000  | 95   |       |
| 208658 | AA95UH1E110C20S | 5    | 21"   | 110,000 | 106,000 | 95   |       |
| 208659 | AA95UH1E135D20S | 5    | 24.5" | 132,000 | 128,000 | 95   |       |

## Gas Upflow/Horizontal Furnaces

### A962V 2 Stage, High-Efficiency, Variable Speed Furnace Upflow

- Vent materials for Canadian applications must comply with ULC 5636
- Certified for direct vent (2-pipe) and in-direct (1-pipe) applications.
- Left and right utility connections
- Removable floor base for bottom return air
- Zero step horizontal conversion



| Part # | Mfg #           | Tons | Width | Input          | Output         | AFUE | Price |
|--------|-----------------|------|-------|----------------|----------------|------|-------|
| 214461 | AA96US2V045B12S | 3    | 17.5" | 29,000/44,000  | 28,000/42,000  | 96   |       |
| 214462 | AA96US2V070B12S | 3    | 17.5" | 43,000/66,000  | 41,000/62,000  | 96   |       |
| 214463 | AA96US2V090C12S | 3    | 21"   | 57,000/88,000  | 55,000/84,000  | 96   |       |
| 214464 | AA96US2V090C16S | 4    | 21"   | 57,000/88,000  | 55,000/85,000  | 96   |       |
| 214465 | AA96US2V090C20S | 5    | 21"   | 57,000/88,000  | 55,000/85,000  | 96   |       |
| 214466 | AA96US2V110C16S | 4    | 21"   | 72,000/110,000 | 70,000/105,000 | 96   |       |
| 214467 | AA96US2V110C20S | 5    | 21"   | 72,000/110,000 | 70,000/106,000 | 96   |       |
| 214468 | AA96US2V135D20S | 5    | 24.5" | 88,000/132,000 | 84,000/126,000 | 96   |       |

### A97MV High-Efficiency Modulating Furnace Testing Upflow

- Communicating control enabled
- Modulating gas valve
- Thermostat flexibility: works with the Comfort Sync T-Stat or a conventional 24V T-Stat
- Self diagnostics saves last 10 fault codes regardless of power interruption
- Category 4 direct vent appliance (2 pipe only)



| Part # | Mfg #           | Tons | Width | Input   | Output  | AFUE | Price |
|--------|-----------------|------|-------|---------|---------|------|-------|
| 209773 | AA97USMV070B12S | 3    | 17.5" | 66,000  | 64,000  | 97   |       |
| 209774 | AA97USMV090C12S | 3    | 21"   | 88,000  | 85,000  | 97   |       |
| 209775 | AA97USMV090C16S | 4    | 21"   | 88,000  | 85,000  | 97   |       |
| 209776 | AA97USMV090C20S | 5    | 21"   | 88,000  | 85,000  | 97   |       |
| 209777 | AA97USMV110C20S | 5    | 21"   | 110,000 | 106,000 | 97   |       |
| 209778 | AA97USMV135D20S | 5    | 24.5" | 132,000 | 127,000 | 97   |       |

Heating - Forced Air

## Gas Upflow/Horizontal Furnaces

### A931A High-Efficiency Single-Stage Furnace Upflow

- Single stage gas valve
- Durable silicon nitride ignitor
- Self diagnostics saving last 5 fault codes regardless of power interruption
- Control features electronic air cleaner and humidifier terminals
- Certified for direct vent and indirect vent (1 and 2 pipe applications)
- Left or right utility connections
- Removable floor base (upflow / horizontal units) for bottom return air
- Zero step horizontal conversion



| Part # | Mfg #           | Tons | Width | Input   | Output  | AFUE | Price |
|--------|-----------------|------|-------|---------|---------|------|-------|
| 208626 | AA93UH1D045B08A | 2    | 17.5" | 44,000  | 41,000  | 93   |       |
| 208627 | AA93UH1D045B12A | 3    | 17.5" | 44,000  | 42,000  | 93   |       |
| 208628 | AA93UH1D070B08A | 2    | 17.5" | 66,000  | 62,000  | 93   |       |
| 208629 | AA93UH1D070B12A | 3    | 21"   | 66,000  | 61,000  | 93   |       |
| 208630 | AA93UH1D090C12A | 3    | 21"   | 88,000  | 83,000  | 93   |       |
| 208631 | AA93UH1D090C16A | 4    | 21"   | 88,000  | 83,000  | 93   |       |
| 208632 | AA93UH1D110C16A | 4    | 21"   | 110,000 | 104,000 | 93   |       |
| 208633 | AA93UH1D110C20A | 5    | 21"   | 110,000 | 104,000 | 93   |       |
| 208635 | AA93UH1D135D20A | 5    | 24.5" | 132,000 | 124,000 | 93   |       |

### A801A Standard-Efficiency Single-Stage Furnace

- Left or right utility connections
- Removable floor base for bottom return air
- Zero step horizontal conversion



| Part # | Mfg #          | Tons | Width | Input   | Output  | AFUE | Price |
|--------|----------------|------|-------|---------|---------|------|-------|
| 208497 | AA80UH1D045A12 | 3    | 14.5" | 44,000  | 35,000  | 80   |       |
| 208498 | AA80UH1D070A08 | 2    | 14.5" | 66,000  | 54,000  | 80   |       |
| 208499 | AA80UH1D070A12 | 3    | 14.5" | 66,000  | 54,000  | 80   |       |
| 208500 | AA80UH1D090B12 | 3    | 17.5" | 88,000  | 71,000  | 80   |       |
| 208501 | AA80UH1D090B16 | 4    | 17.5" | 88,000  | 71,000  | 80   |       |
| 208502 | AA80UH1D110C12 | 3    | 21"   | 110,000 | 89,000  | 80   |       |
| 208503 | AA80UH1D110C16 | 4    | 21"   | 110,000 | 89,000  | 80   |       |
| 208504 | AA80UH1D110C20 | 5    | 21"   | 110,000 | 89,000  | 80   |       |
| 208505 | AA80UH1D135D20 | 5    | 24.5" | 132,000 | 107,000 | 80   |       |

Heating - Forced Air

## Gas Upflow/Horizontal Furnaces

### A952V High-Efficiency, Variable Speed Furnace Upflow

- Vent materials for Canadian applications must comply with ULC 5636
- Certified for direct vent (2-pipe) and in-direct (1-pipe) applications.
- Left and right utility connections
- Removable floor base for bottom return air
- All models comply with California's South Coast Air Quality
- Management district Low NOx requirements
- Zero step horizontal conversion



| Part # | Mfg #           | Tons | Width | Input          | Output         | AFUE | Price |
|--------|-----------------|------|-------|----------------|----------------|------|-------|
| 208664 | AA95UH2V045B12S | 3    | 17.5" | 29,000/44,000  | 28,000/42,000  | 95   |       |
| 208665 | AA95UH2V070B12S | 3    | 17.5" | 43,000/66,000  | 41,000/62,000  | 95   |       |
| 208666 | AA95UH2V090C12S | 3    | 21"   | 57,000/88,000  | 55,000/84,000  | 95   |       |
| 208668 | AA95UH2V090C16S | 4    | 21"   | 57,000/88,000  | 55,000/85,000  | 95   |       |
| 208669 | AA95UH2V090C20S | 5    | 21"   | 57,000/88,000  | 55,000/85,000  | 95   |       |
| 208670 | AA95UH2V110C16S | 4    | 21"   | 72,000/110,000 | 70,000/105,000 | 95   |       |
| 208671 | AA95UH2V110C20S | 5    | 21"   | 72,000/110,000 | 70,000/106,000 | 95   |       |
| 208672 | AA95UH2V135D20S | 5    | 24.5" | 88,000/132,000 | 84,000/126,000 | 95   |       |

**Gas Upflow/Horizontal Furnaces**

**Gas Upflow/Horizontal Furnaces**

**80G1 80% Single Stage Gas Furnace**

- Crimped no-weld aluminized clam shell heat exchanger construction
- Compact 33" height
- Standardized widths for easy coil fit
- Multi-speed PSC blower motor
- Easily removable slide out blower design
- Single stage gas valve
- Self diagnostics saving last 5 fault codes regardless of power interruption
- Rotatable draft inducer for venting flexibility
- Left or right utility connections
- Removable floor base for bottom return air
- Zero step horizontal conversion



| Part # | Mfg #           | Tons | AFUE | Input BTUH | Heating Capacity BTUH | Dimensions (H x W) | Price |
|--------|-----------------|------|------|------------|-----------------------|--------------------|-------|
| 208685 | DC80G1UH045AP12 | 3    | 80%  | 44,000     | 45,000                | 33" x 14-1/2"      |       |
| 208686 | DC80G1UH070AP08 | 2    | 80%  | 66,000     | 70,000                | 33" x 14-1/2"      |       |
| 208687 | DC80G1UH070AP12 | 3    | 80%  | 66,000     | 70,000                | 33" x 14-1/2"      |       |
| 208688 | DC80G1UH090BP12 | 3    | 80%  | 88,000     | 90,000                | 33" x 17-1/2"      |       |
| 208689 | DC80G1UH090BP16 | 4    | 80%  | 88,000     | 90,000                | 33" x 17-1/2"      |       |
| 208690 | DC80G1UH110CP12 | 3    | 80%  | 110,000    | 110,000               | 33" x 21"          |       |
| 208691 | DC80G1UH110CP16 | 4    | 80%  | 110,000    | 110,000               | 33" x 21"          |       |
| 208692 | DC80G1UH110CP20 | 5    | 80%  | 110,000    | 110,000               | 33" x 21"          |       |
| 208693 | DC80G1UH135DP20 | 5    | 80%  | 132,000    | 135,000               | 33" x 24-1/2"      |       |



## Gas Upflow/Horizontal Furnaces

### 92G1 92% Single Stage Gas Furnace

- Aluminized steel design primary heat exchanger with crimped no weld construction
- AL 29-4C Stainless steel secondary heat exchanger
- Aluminized steel inshot burners for smooth ignition
- Compact 33" height
- Standardized widths for easy coil fit
- Multi-speed PSC blower motor
- Easily removable slide-out blower design
- Single Stage Gas Valve
- Self diagnostics saves last 5 fault codes regardless of power interruption
- Control features electronic air cleaner and humidifier terminals
- Designed certified for direct and non direct applications
- Left or right utility connection
- Designed certified for direct and non-direct vent applications
- Zero step horizontal conversion
- Removable floor base for bottom return air



| Part # | Mfg #           | Tons | AFUE | Input BTUH | Heating Capacity BTUH | Dimensions (H x W) | Price |
|--------|-----------------|------|------|------------|-----------------------|--------------------|-------|
| 208698 | DC92G1UH045BP08 | 2    | 92%  | 44,000     | 45,000                | 33" x 17-1/2"      |       |
| 208699 | DC92G1UH045BP12 | 3    | 92%  | 44,000     | 45,000                | 33" x 17-1/2"      |       |
| 208700 | DC92G1UH070BP08 | 2    | 92%  | 66,000     | 70,000                | 33" x 17-1/2"      |       |
| 208701 | DC92G1UH070BP12 | 3    | 92%  | 66,000     | 70,000                | 33" x 17-1/2"      |       |
| 208702 | DC92G1UH090CP12 | 3    | 92%  | 88,000     | 90,000                | 33" x 21"          |       |
| 208703 | DC92G1UH090CP16 | 4    | 92%  | 88,000     | 90,000                | 33" x 21"          |       |
| 208704 | DC92G1UH110CP16 | 4    | 92%  | 110,000    | 110,000               | 33" x 21"          |       |
| 208705 | DC92G1UH110CP20 | 5    | 92%  | 110,000    | 110,000               | 33" x 21"          |       |
| 208706 | DC92G1UH135DP20 | 5    | 92%  | 132,000    | 135,000               | 33" x 24-1/2"      |       |

Heating - Forced Air

## Gas Upflow/Horizontal Furnaces

### 95G1 95% Single Stage Gas Furnace

- Aluminized steel design primary heat exchanger with crimped no weld construction
- AL 29-4C Stainless steel secondary heat exchanger
- Aluminized steel inshop burners for smooth fit
- Compact 33" height
- Standardized widths for easy coil fit
- Multi-speed PSC blower motor
- Easily removable slide-out blower design
- Single Stage Gas Valve
- Self diagnostics saves last 5 fault codes regardless of power interruption
- Control features electronic air cleaner and humidifier terminals
- Designed certified for direct and non direct applications
- Left or right utility connection
- Designed certified for direct and non-direct vent applications
- Zero step horizontal conversion
- Removable floor base for bottom return air



| Part # | Mfg #           | Tons | AFUE | Input BTUH | Heating Capacity BTUH | Dimensions (H x W) | Price |
|--------|-----------------|------|------|------------|-----------------------|--------------------|-------|
| 208830 | DC95G1UH045BP08 | 2    | 95%  | 44,000     | 45,000                | 33" x 17-1/2"      |       |
| 208831 | DC95G1UH045BP12 | 3    | 95%  | 44,000     | 45,000                | 33" x 17-1/2"      |       |
| 208832 | DC95G1UH070BP12 | 3    | 95%  | 66,000     | 70,000                | 33" x 17-1/2"      |       |
| 208833 | DC95G1UH090CP12 | 3    | 95%  | 88,000     | 90,000                | 33" x 21"          |       |
| 208834 | DC95G1UH090CP16 | 4    | 95%  | 88,000     | 90,000                | 33" x 21"          |       |
| 208835 | DC95G1UH110CP16 | 4    | 95%  | 110,000    | 110,000               | 33" x 21"          |       |
| 208836 | DC95G1UH110CP20 | 5    | 95%  | 110,000    | 110,000               | 33" x 21"          |       |
| 208837 | DC95G1UH135DP20 | 5    | 95%  | 132,000    | 135,000               | 33" x 24-1/2"      |       |

## Gas Upflow/Horizontal Furnaces

### 95G1E 95% Single Stage Gas Furnace Constant Torque Motor

- Designed certified for direct (2-pipe) and non direct (1-pipe) applications
- Easily vented with PVC pipe
- Left or right utility connection
- Design certified for direct and non-direct vent applications
- Zero step horizontal conversion
- Removable floor base (upflow / horizontal units) for bottom return air
- Aluminized steel primary heat exchanger with crimped nonwelded construction
- AL 29-4C Stainless steel secondary heat exchanger
- Aluminized steel inshot burners for smooth ignition
- Compact 33" height
- Standardized widths for easy coil fit
- Multi-speed high efficiency (constant torque) blower motor
- Easily removable slide out blower design
- Enhanced cooling SEER ratings when applied with properly matched cooling equipment.
- Single stage gas valve
- Durable silicon nitride ignitor
- Self diagnostics saves last 10 fault codes regardless of power interruption
- Control features electronic air cleaner and humidifier terminals



| Part # | Mfg #           | Tons | AFUE | Input BTUH | Heating Capacity BTUH | Dimensions (H x W) | Price |
|--------|-----------------|------|------|------------|-----------------------|--------------------|-------|
| 208842 | DC95G1UH045BE12 | 3    | 95%  | 44,000     | 45,000                | 33" x 17-1/2"      |       |
| 208843 | DC95G1UH070BE12 | 3    | 95%  | 66,000     | 70,000                | 33" x 17-1/2"      |       |
| 208844 | DC95G1UH090CE16 | 4    | 95%  | 88,000     | 90,000                | 33" x 21"          |       |
| 208845 | DC95G1UH110CE20 | 5    | 95%  | 110,000    | 110,000               | 33" x 21"          |       |
| 208846 | DC95G1UH135DE20 | 5    | 95%  | 132,000    | 135,000               | 33" x 24-1/2"      |       |

## Gas Upflow/Horizontal Furnaces

### 95G2V Two Stage Variable Speed Gas Furnace

- Aluminized steel primary heat exchanger with crimped nonwelded construction
- AL29-4C Stainless steel secondary heat exchanger
- Non-welded crimped S-curve primary heat exchanger design for maximum durability
- Aluminized steel in shot burners for smooth ignition
- Isolated burner enclosure for quiet operation
- Compact 33" height
- Standardized widths for easy coil fit
- Unitized construction for cabinet integrity
- Heat exchanger compartment is insulated to increase efficiency and reduce sound levels
- Baked on prepainted steel cabinet finish
- Efficient ECM variable speed blower motor
- Motor features "soft start" and "soft stop" for quiet operation
- Active and passive dehumidification feature
- Easily removable slide-out blower design
- Dynamically balanced blower wheel with resilient motor mounts for smooth and quiet operation
- Two stage gas valve
- Integrated ignition and fan control
- System Sentry™ control retains last five (5) fault codes with push button memory recall, regardless of power interruption
- Hot surface ignition system uses silicon nitride ignitor
- Control features 120 volt electronic air cleaner and humidifier terminals
- Control circuit is fuse protected
- Color coded control wiring
- Compatible with single or two stage thermostats for heating.
- Two stage thermostat is recommended when installed with two stage cooling unit.
- Left or right gas and electric entry
- Zero step horizontal conversion
- Removable floor base (upflow/horizontal units) for bottom return air



| Part # | Mfg #           | Tons | AFUE | Input BTUH      | Heating Capacity BTUH | Dimensions (H x W) | Price |
|--------|-----------------|------|------|-----------------|-----------------------|--------------------|-------|
| 210864 | DC95G2UH045BV12 | 3    | 95%  | 29,000, 44,000  | 45,000                | 33" x 17-1/2"      |       |
| 210865 | DC95G2UH070BV12 | 3    | 95%  | 43,000, 66,000  | 70,000                | 33" x 17-1/2"      |       |
| 210866 | DC95G2UH090CV12 | 3    | 95%  | 57,000, 88,000  | 90,000                | 33" x 21"          |       |
| 221672 | DC95G2UH090CV20 | 5    | 95%  | 57,000, 88,000  | 90,000                | 33" x 21"          |       |
| 217360 | DC95G2UH110CV20 | 5    | 95%  | 72,000, 110,000 | 110,000               | 33" x 21"          |       |
| 210867 | DC95G2UH135DV20 | 5    | 95%  | 88,000, 132,000 | 135,000               | 33" x 24-1/2"      |       |

**Gas Unit Heaters**

**Unit Heaters**

**UDAP V3® Power Vented, Low Static, Axial Fan Unit Heater**

- All sizes are approved for commercial/industrial installations
- Sizes 30 - 125 are approved for residential application
- Rise range: 50° to 60°F
- Tcore2® Design titanium stabilized aluminized steel heat exchanger and single burner combustion system with 1-piece burner assembly
- 115-1-60 Supply voltage
- Internal overload protection
- Integrated circuit board with diagnostic indicator lights
- Fan relay
- Multi-try direct spark ignition with 100% lockout
- Full fan guard
- 2-Stage natural or propane gas valve on sizes 60 - 400



| Part # | Mfg #     | Gas Type | Input/ Output MBTUH | Efficiency | CFM   | Vent Dia | Blower/ Fan Size | Dimensions H x W x D        | Approx Ship Wt | Price |
|--------|-----------|----------|---------------------|------------|-------|----------|------------------|-----------------------------|----------------|-------|
| 060544 | UDAP30    | NG       | 30/25               | 82%        | 456   | 4"       | 10"              | 12-1/8" x 25-5/8" x 26"     | 61 lbs         |       |
| 060545 | UDAP45    | NG       | 45/37               | 83%        | 629   | 4"       | 10"              | 12-1/8" x 25-5/8" x 26"     | 66 lbs         |       |
| 060546 | UDAP60    | NG       | 60/50               | 83%        | 769   | 4"       | 12"              | 15-1/8" x 25-5/8" x 27"     | 74 lbs         |       |
| 099172 | UDAP60AA2 | LP       | 60/50               | 83%        | 769   | 4"       | 12"              | 15-1/8" x 25-5/8" x 27"     | 67 lbs         |       |
| 060547 | UDAP75    | NG       | 75/62               | 83%        | 961   | 4"       | 12"              | 15-1/8" x 25-5/8" x 27-5/8" | 79 lbs         |       |
| 099171 | UDAP75AA2 | LP       | 75/62               | 83%        | 961   | 4"       | 12"              | 15-1/8" x 25-5/8" x 27-5/8" | 79 lbs         |       |
| 060548 | UDAP100   | NG       | 105/87              | 83%        | 1,345 | 4"       | 16"              | 23-1/8" x 25-5/8" x 28-5/8" | 118 lbs        |       |
| 060549 | UDAP125   | NG       | 120/100             | 83%        | 1,537 | 4"       | 16"              | 23-1/8" x 25-5/8" x 29-3/8" | 123 lbs        |       |
| 063749 | UDAP150   | NG       | 150/125             | 83%        | 1,921 | 5"       | 18"              | 20-1/8" x 38-3/16" x 42"    | 204 lbs        |       |
| 063750 | UDAP175   | NG       | 175/145             | 83%        | 2,242 | 5"       | 18"              | 20-1/8" x 38-3/16" x 42"    | 219 lbs        |       |
| 063751 | UDAP200   | NG       | 200/166             | 83%        | 2,562 | 5"       | 18"              | 20-1/8" x 38-3/16" x 42"    | 219 lbs        |       |
| 063752 | UDAP225   | NG       | 225/187             | 83%        | 2,882 | 5"       | 18"              | 26-1/8" x 38-3/16" x 42"    | 245 lbs        |       |
| 063753 | UDAP250   | NG       | 250/208             | 83%        | 3,202 | 5"       | 20"              | 26-1/8" x 38-3/16" x 42"    | 257 lbs        |       |
| 063754 | UDAP300   | NG       | 300/249             | 83%        | 3,843 | 6"       | 24"              | 34-1/8" x 41 x 42"          | 321 lbs        |       |
| 093423 | UDAP400   | NG       | 400/332             | 83%        | 5,123 | 6"       | 24"              | 34-1/8" x 41 x 42"          | 358 lbs        |       |

Heating - Forced Air

**Gas Unit Heaters**

**UEAS Ultra High Efficiency Unit Heater**

- Up to 93% Thermal efficient
- 50-60 degree F Rise range
- Arranged for use with natural gas (propane conversion kit included with unit)
- Tcore3 409 stainless steel heat exchanger
- Patented Tcore3 single burner combustion system including a one-piece burner assembly
- Extruded aluminum secondary heat exchanger (patent pending)
- 115/1/60 Supply voltage
- 115 Volt open fan motor with internal overload protection
- Transformer for 24-volt controls
- Integrated circuit board with diagnostic indicator lights
- Multi-try direct ignition with 100% lockout
- Fan relay (included on the circuit board)
- Single-stage natural gas valve (field adjustable for operation to 10,000 ft. [3,000 meters] elevation)
- Vibration/noise isolated fan motor
- Sealed control compartment houses all electrical components
- 48 frame, ball bearing, PSC venter motor
- 4-point Suspension
- Built-in disconnect switch (20A @ 115V Rating)
- External terminal strip for 24-volt wiring
- Sealed junction box for supply wiring
- External gas connection
- Fully gasketed door panel with safety
- Full fan guard ~ engineered for safety
- Improved cabinet design with less visible hardware and a NEW Reznor appearance



| Part # | Mfg #   | Gas Type | Input/ Output MBTUH | Efficiency | CFM  | Vent Dia | Blower/ Fan Size | Dimensions H x W x D       | Approx Ship Wt | Price |
|--------|---------|----------|---------------------|------------|------|----------|------------------|----------------------------|----------------|-------|
| 104638 | UEAS130 | NG       | 131/122             | 93%        | 2256 | 4"       | 18"              | 20-1/8"x39-3/16"x50-1/2"   | 255 lbs        |       |
| 104640 | UEAS180 | NG       | 175/159             | 93%        | 2458 | 4"       | 18"              | 20-1/8"x39-3/16"x50-1/2"   | 270 lbs        |       |
| 104641 | UEAS260 | NG       | 260/239             | 93%        | 4430 | 4"       | 24"              | 34-1/8"x40-15/16"x53-5/16" | 385 lbs        |       |
| 104642 | UEAS310 | NG       | 305/277             | 93%        | 4283 | 4"       | 24"              | 34-1/8"x40-15/16"x53-5/16" | 420 lbs        |       |

Heating - Forced Air

## Gas Fireplaces

### Direct Vent Gas Fireplaces

#### Tahoe Deluxe Direct Vent Gas Fireplace

- Millivolt ignition with standing pilot/Piezo



| Part # | Mfg #         | Input BTUH | Gas Type | Ship Wt | Price |
|--------|---------------|------------|----------|---------|-------|
| 094560 | DVD-36-FP30NG | 20,000     | NG       | 102 lbs |       |
| 094568 | DVD-42-FP30NG | 25,000     | NG       | 121 lbs |       |

#### 4" x 6-5/8" Direct Vent Kit

- Includes: cap, wall thimble, collars, gear clamps, vinyl siding shield, and 4' of 4" and 7" flexible vent

| Part # | Mfg #   | Description                | Price |
|--------|---------|----------------------------|-------|
| 086619 | DVVK-4F | DV Horiz Flexible Vent Kit |       |

Heating - Forced Air

## Quiet-One Kickspace Heaters

### Quiet-One 2000

#### Kickspace Heater

- 1-Piece chassis with removable grille manufactured from high grade zinc coated steel
- Headered coil made of copper tubes, tested at 300 psi and sealed for quality
- Integral 2-speed, max-off-min fan switches
- 120-60-1 Power supply is required
- Quiet efficient operation; installer friendly
- Easily fits in tight spaces or hard-to-heat areas



| Part # | Mfg #   | MBTUH | H x W x D                  | Price |
|--------|---------|-------|----------------------------|-------|
| 122268 | KS-2004 | 4.3   | 3-1/2" x 13-7/8" x 10-7/8" |       |
| 122273 | KS-2008 | 8.9   | 3-13/16" x 20" x 10-7/8"   |       |



---

---

## Furnace Accessories

---

---

### LP Conversion Kits

| Part # | Mfg #   | Description            | Price |
|--------|---------|------------------------|-------|
| 150450 | 904404A | LP Kit for G7 Furnaces |       |
| 143717 | 905028  | LP Conversion Kit      |       |
| 243032 | 922311  | R8GE Pkg LP Kit        |       |

**Furnace Accessories**

**Concentric Venting**

**Concentric Vent**

- *Allows both the intake for combustion air and the exhaust vent to pass through a standard roof or sidewall*
- *Kit includes:*
  - *Combustion air inlet cap*
  - *Air inlet pipe*
  - *Vent pipe*
  - *Intake/vent concentric "Y"*
  - *Installation instructions on box*



| Part # | Mfg #   | Description                      | Price |
|--------|---------|----------------------------------|-------|
| 138703 | CVENT-2 | For Use w/2" Intake/Vent Systems |       |
| 138704 | CVENT-3 | For Use w/3" Intake/Vent Systems |       |

## Furnace Accessories

### Accessories

#### Plenum Connectors

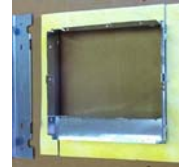

| Part # | Mfg #      | Description                                  | Price |
|--------|------------|--|-------|
| 177147 | INT901988A | 901988A Plenum Connector 11.25 x 13.5 x 2    |       |
| 177146 | INT901989A | 901989A Plenum Connector 11.25 x 13.5 x 4.25 |       |
| 177145 | INT901990A | 901990A Plenum Connector 11.25 x 13.5 x 6.25 |       |
| 177144 | INT901991A | 901991A Plenum Connector 11.25 x 13.5 x 8.25 |       |

#### Flue Transition Kit For M7RL 95%



| Part # | Mfg #     | Description                                   | Price |
|--------|-----------|---|-------|
| 126521 | INT904106 | 904106 PVC Vent Transition Kit for M7RL Units |       |

#### Flat Roof Flue Assembly



| Part # | Mfg #        | Description                        | Price |
|--------|--------------|------------------------------------|-------|
| 177153 | INTFAW15230A | FAW1523-0A Flat Roof Flue Assembly |       |
| 233680 | INTFAW21350A | FAW2135-0A Flat Roof Flue Assembly |       |
| 233682 | INTFAW21350S | FAW2135-0S Flat Roof Flue Assembly |       |
| 177216 | INTFAW27470A | FAW2747-0A Flat Roof Flue Assembly |       |

#### Sloped Roof Flue Assembly



| Part # | Mfg #        | Description                          | Price |
|--------|--------------|--------------------------------------|-------|
| 177141 | INTSAW21352A | SAW2135-2A Sloped Roof Flue Assembly |       |



## Furnace Accessories

### Accessories (Continued) Sloped Roof Flue Assembly

| Part # | Mfg #        | Description                          | Price |
|--------|--------------|--------------------------------------|-------|
| 233683 | INTSAW21352S | SAW2135-2S Sloped Roof Flue Assembly |       |
| 177142 | INTSAW27472A | SAW2747-2A Sloped Roof Flue Assembly |       |
| 233684 | INTSAW27474A | SAW2747-4A Sloped Roof Flue Assembly |       |
| 177143 | INTSAW35632A | SAW3563-2A Sloped Roof Flue Assembly |       |
| 233685 | INTSAW35632S | SAW3563-2S Sloped Roof Flue Assembly |       |
| 233686 | INTSAW35634A | SAW3563-4A Sloped Roof Flue Assembly |       |
| 233687 | INTSAW51952A | SAW5195-2A Sloped Roof Flue Assembly |       |
| 233688 | INTSAW51954A | SAW5195-4A Sloped Roof Flue Assembly |       |
| 233689 | INTSAW51954S | SAW5195-4S Sloped Roof Flue Assembly |       |

## Maxifold Manifolds & Accessories

### Maxifold Manifolds



#### 1-1/2" Stainless Steel Radiant Heating Manifold

- Includes:
  - Inline valves
  - Adjustable flowmeters - up to 2 gpm per loop
  - 1" Swt Manifold transitions
  - Mounting brackets

| Part # | Mfg #  | Description    | Price |
|--------|--------|----------------|-------|
| 144240 | H-4172 | For 2 Branches |       |
| 144241 | H-4173 | For 3 Branches |       |
| 144242 | H-4174 | For 4 Branches |       |
| 144243 | H-4175 | For 5 Branches |       |
| 144244 | H-4176 | For 6 Branches |       |
| 144245 | H-4177 | For 7 Branches |       |
| 144246 | H-4178 | For 8 Branches |       |

#### Stainless Steel Extension Kit with Manifold Coupler

- Total number of loops not to exceed 14

| Part # | Mfg #      | Description               | Price |
|--------|------------|---------------------------|-------|
| 144247 | H-4172 EXT | For 2 Additional Branches |       |
| 144248 | H-4173 EXT | For 3 Additional Branches |       |
| 144249 | H-4174 EXT | For 4 Additional Branches |       |
| 144250 | H-4175 EXT | For 5 Additional Branches |       |
| 144251 | H-4176 EXT | For 6 Additional Branches |       |

### Accessories

| Part # | Mfg #  | Description                    | Price |
|--------|--------|--------------------------------|-------|
| 144253 | H-4700 | 1" Full-Port Ball Valves (Set) |       |
| 144252 | H-4004 | Caps for Unused Loops          |       |
| 144259 | H-4900 | Thermometer                    |       |
| 150018 | H-6815 | Manifold Gasket                |       |

#### Electrothermal Actuator (LH)

- For heating manifolds and zone valves

| Part # | Mfg #  | Description                             | Price |
|--------|--------|---|-------|
| 144239 | H-2496 | Normally Closed with End Switch, 4-Wire |       |

### Compression Fitting (EK20 Size)

- Use with manifolds, panel radiators, and towel warmers

| Part # | Mfg #  | Description | Price |
|--------|--------|-------------|-------|
| 145820 | H-6848 | 5/16" PEX   |       |
| 144254 | H-6849 | 3/8" PEX    |       |
| 144255 | H-6850 | 1/2" PEX    |       |
| 144256 | H-6851 | 5/8" PEX    |       |
| 144257 | H-6852 | 3/4" PEX    |       |

## Boilers

Heating - Hydronic

### Gas Combination Boilers

#### Condensing Gas Combination Boiler (NCB-E)

- Super condensing efficiency
- Dual stainless steel heat exchangers
- SCH40, 2" PVC venting up to 60'
- ½" Gas pipe up to 24'
- Automatic water filling system
- Integrated controls



| Part # | Mfg #    | Gas   | Gas Supply Pressure<br>Min - Max | Heat Capacity<br>Input (MBTUH)<br>Min - Max | Thermal<br>Efficiency | DOE             | Dimensions<br>W x H x D | Approx<br>Ship Wt | Price |
|--------|----------|-------|----------------------------------|---|-----------------------|-----------------|-------------------------|-------------------|-------|
| 181352 | NCB-150E | NG/LP | 3.5" - 10.5"WC                   | 12,000-120,000                              | 95%                   | 28" x 17" x 12" | 66lbs                   |                   |       |
| 181353 | NCB-180E | NG/LP | 3.5" - 10.5"WC                   | 14,000-150,000                              | 95%                   | 28" x 17" x 12" | 74 lbs                  |                   |       |
| 181354 | NCB-210E | NG/LP | 3.5" - 10.5"WC                   | 18,000-180,000                              | 95%                   | 28" x 17" x 12" | 84 lbs                  |                   |       |
| 181356 | NCB-240E | NG/LP | 3.5" - 10.5"WC                   | 18,000-199,000                              | 95%                   | 28" x 17" x 12" | 84 lbs                  |                   |       |

### Gas Heating Boilers

#### Condensing Gas Boiler (NHB)

- Super condensing efficiency
- Dual stainless steel heat exchangers
- SCH40, 2" PVC venting up to 60'
- ½" Gas pipe up to 24'
- TDR 7:1 to 11:1
- integrated controls
- Natural gas supply pressure (from source): 3.5" x 10.5"wc
- Propane gas supply pressure (from source): 8.0"-13.5"wc



| Part # | Mfg #   | Gas   | NG<br>Manifold<br>Pressure | LP<br>Manifold<br>Pressure | Gas<br>Connection<br>Size | Dimensions<br>H x W x D | Ship<br>Wt | Price |
|--------|---------|-------|----------------------------|----------------------------|---------------------------|-------------------------|------------|-------|
| 169617 | NHB-55  | NG/LP | 3.5"-10.5"wc               | 8.0"-13.5"wc               | 3/4" NPT                  | 24" x 17" x 12"         | 73 lbs     |       |
| 169618 | NHB-80  | NG/LP | 3.5"-10.5"wc               | 8.0"-13.5"wc               | 3/4" NPT                  | 24" x 17" x 12"         | 73 lbs     |       |
| 169619 | NHB-110 | NG/LP | 3.5"-10.5"wc               | 8.0"-13.5"wc               | 3/4" NPT                  | 24" x 17" x 13"         | 80 lbs     |       |
| 169620 | NHB-150 | NG/LP | 3.5"-10.5"wc               | 8.0"-13.5"wc               | 3/4" NPT                  | 24" x 17" x 13"         | 80 lbs     |       |

**Boilers**

**Parts & Accessories**

**NHB Series Primary Manifold**

- Pre-assembled
- Designed specifically for use with Navien NHB Series
- 1" FNPT dielectric unions for the boiler supply and return
- 1-1/2" sweat connections for heating supply and return piping
- 1" flange connections
- L-copper piping
- Shut-off valves
- (2) 1" stub-outs
- (2) 1/4" service and drain ports
- 1/2" and 3/4" ports for use with heating system accessories

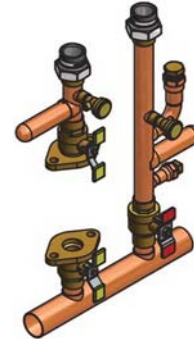

Heating - Hydronic

| Part # | Mfg #           | Description  | Price |
|--------|-----------------|--|-------|
| 172465 | GFFM-MSOZUS-001 | Compatible with NHB-055, NHB-080, NHB-110, and NHB-150 |       |

**NCB Series Primary Manifold**

- Pre-assembled
- Designed specifically for use with Navien NCB Series
- 1" FNPT dielectric unions for the boiler supply and return
- 1-1/4" sweat connections for heating supply and return piping
- L-copper piping
- Shut-off valves
- (2) 1/4" service and drain ports
- (2) 3/4" ports for use with heating system accessories



| Part # | Mfg #           | Description   | Price |
|--------|-----------------|---|-------|
| 172715 | GFFM-MCOZUS-001 | Compatible with NCB-180, NCB-180E, NCB-210, NCB-210E, NCB-240, and NCB-240E |       |

**Thermolec Boilers**

**Electric Stand Alone, Modulating Boilers**

**Standard Features:**

- **Mechanical:**
  - Heavy-duty, fully insulated heat generator
  - Low-watt density Incoloy elements
  - Easy access for installation and maintenance
  - Approved for zero clearance to combustible materials
  - Pressure relief valve
  - Temperature and pressure gauge
- **Electrical:**
  - Convenient plug-in electronic board controls all automatic functions
  - Pre-wired elements electronically controlled for full modulation
  - Quiet magnetic relays for heating elements and pump
  - High-limit thermal protection
  - Adjustable electronic hot water aqua-stat with wide range to suit all applications (80°F to 180°F)
  - Outdoor reset control saves energy and improves comfort
- **FFB Electric Boiler has the above features plus:**
  - Built-in, 2-position, dual fuel control switch allows manual selection of gas/oil or electric
  - Magnetic, diverting valve relay to divert from electric to fossil fuel back-up boiler
- 10-Year warranty on heat generator and Incoloy elements



Heating - Hydronic

| Part # | Mfg #     | kW   | Output BTUH | Total Amps | Breaker Size    | Dimensions H x W x D | Weight | Price |
|--------|-----------|------|-------------|------------|-----------------|----------------------|--------|-------|
| 121876 | B-8U-FFB  | 8kW  | 27,296      | 33.33A     | 1 x 50A         | 18" x 18" x 9-1/2"   | 33 lbs |       |
| 121881 | B-15U-FFB | 15kW | 51,180      | 62.50A     | 1 x 60A/1 x 30A | 18" x 18" x 9-1/2"   | 37 lbs |       |
| 121883 | B-20U-FFB | 20kW | 68,240      | 83.37A     | 2 x 60A         | 18" x 18" x 9-1/2"   | 42 lbs |       |
| 121884 | B-23U-FFB | 23kW | 78,476      | 95.83A     | 2 x 60A         | 18" x 18" x 9-1/2"   | 42 lbs |       |
| 121886 | B-30U-FFB | 30kW | 102,360     | 125.00A    | 3 x 60A         | 28" x 18" x 9-1/2"   | 59 lbs |       |
| 121888 | B-40U-FFB | 40kW | 136,480     | 166.67A    | 4 x 60A         | 28" x 18" x 9-1/2"   | 62 lbs |       |

**High Performance Electric Boilers**

- Single or multiple-zone applications
- Requires no venting
- Sturdy aluminum case
- Stainless steel tank
- Compact and light weight design
- Aquastat control: adjustable supply water temperature range up to 190°F
- Full modulation for precise BTUH demand output
- Thermostat or zone valve end switch connections
- Pump switching relay
- Load management control connections
- Outdoor reset control
- Built-in circuit breaker
- Pressure relief valve: 30 psi
- Temperature and pressure gauge
- CSA Listed



| Part # | Mfg #   | kW   | Output BTUH | Total Amps | Breaker Size | Dimensions H x W x D | Weight | Price |
|--------|---------|------|-------------|------------|--------------|----------------------|--------|-------|
| 135153 | B-6TMB  | 6kW  | 20,472      | 25.00A     | 1 x 40A      | 18" x 13" x 8-7/8"   | 23 lbs |       |
| 135156 | B-11TMB | 11kW | 37,532      | 45.80A     | 1 x 60A      | 18" x 13" x 8-7/8"   | 27 lbs |       |

All boiler specifications @ 240V / 1-phase



## Triangle Tube (Prestige) Boilers

### Prestige Condensing Boilers

#### Prestige Excellence High Efficiency "Tank-in-Tank" Indirect-Fired Condensing Boiler

10-Year Limited Heat Exchanger Warranty

- 96% AFU Efficiency
- Abundant domestic hot water with standard mixing valve
- Highest water content in the industry
- Ideal for small zones without short cycling
- Self cleaning/self descaling
- Quiet operation
- Fully modulating
- Built-in exclusive "Tank-in-Tank"
- Unparalleled resistance to corrosion
- Less sensitive to water flow
- Vertical firetube design
- 439 Grade stainless steel heat exchanger
- Impervious to chloride cracking
- Stable temperature control
- Low pressure drop
- Condensate washes combustion residue away
- Control panel with digital display
- Standard outdoor reset
- Direct vent/sealed combustion



Heating - Hydronic

| Part # | Mfg #   | DOE Heat Capacity | Net IBR | MBH Input Modulation | Dimensions H x W x D  | Water Volume | Gas Type | Ship Wt | Price |
|--------|---------|-------------------|---------|----------------------|-----------------------|--------------|----------|---------|-------|
| 113080 | PE110NG | 99                | 86      | 30 - 110             | 37.2" x 24.7" x 20.8" | 2.5 gal      | NG       | 190 lbs |       |
| 113081 | PE110LP | 87                | 76      | 25 - 97              | 37.2" x 24.7" x 20.8" | 2.5 gal      | LP       | 190 lbs |       |

#### Prestige Solo Stainless Steel Wall Mount Condensing Boiler

Limited 10-Year warranty

- 95% High efficiency
- Quiet operation
- Fully modulating
- 439 Grade stainless steel heat exchanger
- Digital display
- High temperature limit protection
- Low water protection
- Low NOx
- Low pressure drop
- Self cleaning-condensate washes residue away
- Outdoor temperature sensor
- 30 psi Pressure relief valve



| Part # | Mfg #      | DOE Heat Capacity MBH | Net IBR | MBH Input Modulation | Dimensions H x W x D | Water Volume | Gas Type | Ship Wt | Price |
|--------|------------|-----------------------|---------|----------------------|----------------------|--------------|----------|---------|-------|
| 113827 | SOLO-60    | 54                    | 47      | 16 - 60              | 35-1/2" x 20" x 16"  | 2.5 gal      | NG       | 95 lbs  |       |
| 091011 | SOLO-110   | 99                    | 86      | 30 - 110             | 35-1/2" x 20" x 16"  | 2.5 gal      | NG       | 106 lbs |       |
| 091012 | SOLO-110LP | 87                    | 76      | 25 - 97              | 35-1/2" x 20" x 16"  | 2.5 gal      | LP       | 106 lbs |       |

## Triangle Tube (Prestige) Boilers

### Prestige Condensing Boilers (Continued)

#### Prestige Solo Stainless Steel Wall Mount Condensing Boiler

| Part # | Mfg #    | Doe Heat Capacity MBH | Net IBR | MBH Input Modulation | Dimensions H x W x D        | Water Volume | Gas Type | Ship Wt | Price |
|--------|----------|-----------------------|---------|----------------------|-----------------------------|--------------|----------|---------|-------|
| 091013 | SOLO-175 | 154                   | 134     | 50 - 170             | 35-1/2" x 20" x 16"         | 4.6 gal      | NG       | 131 lbs |       |
| 102609 | SOLO-250 | 223                   | 194     | 65 - 245             | 35-1/2" x 20" x 16"         | 4.1 gal      | NG       | 142 lbs |       |
| 107251 | SOLO-399 | 379                   | 330     | 112 - 399            | 37-1/2" x 24-3/4" x 20-3/4" | 7 gal        | NG       | 200 lbs |       |

#### Smart Stainless Steel Indirect Fired Water Heaters

- Exclusive "Tank-in-Tank" Technology
- Abundant domestic hot water at the lowest possible cost
- Limited residential lifetime warranty
- 2" of Polyurethane foam insulation
- Self cleaning/self descaling heat exchanger
- Anti-bacteria growth/maintenance free
- Lowest pressure drop in the industry



| Part # | Mfg #    | Water Capacity | Boiler Output Btu/Hr | First Hour Recovery | Continuous Flow (Gal) | Peak Flow (Gal/10mi) | Price |
|--------|----------|----------------|----------------------|---------------------|-----------------------|----------------------|-------|
| 154764 | SMART100 | 95             | 337,000              | 525                 | 450                   | 150                  |       |

Heating - Hydronic

## Weil McLain Boilers

### Residential Gas Boilers

#### EVG Evergreen Gas Boiler

- Stainless steel fire tube heat exchanger with non-metallic base
- Floor standing boiler with optional wall mount kit
- Sizes 220MBG, 299MBH, 399MBH
- Modulating condensing boiler with 10:1 turndown
- 95% AFUE (220/299); 96.5% combustion (399)
- 4 Pump/auxiliary outputs
- Up to 8 multiple boiler control with lead/lag rotation
- Modbus® to BMS connectivity
- Each input can be assigned to a priority (up to 3)
- Multiple inputs can be assigned on priority (zone base control)
- All lag boiler inputs and output can be used
- 0-10 Volt input (modulation or set point)
- Configurable auxiliary input/output system
- Boiler circulator included



Heating - Hydronic

| Part # | Mfg #       | Boiler Model | CSA Input MBH | AFUE  | DOE Heating Capacity MBH | Net AHRI Rating MBH | Vent Size | Approx Ship Wt | Price |
|--------|-------------|--------------|---------------|-------|--------------------------|---------------------|-----------|----------------|-------|
| 179790 | 383-900-000 | EVG220       | 220           | 95%   | 206                      | 179                 | 3" or 4"  | 215 lbs        |       |
| 179795 | 383-900-001 | EVG299       | 299           | 95%   | 280                      | 243                 | 4"        | 260 lbs        |       |
| 179797 | 383-900-002 | EVG399       | 399           | 96.5% | 383                      | 333                 | 4"        | 260 lbs        |       |

#### WM97+ Wall-Mount Gas Boilers

- Condensing stainless steel fire tube heat exchanger design
- Built in boiler circulator, primary/secondary piping option, low water cutoff and expansion tank
- Pre-wired terminal strip
- Indirect-fired water heater connection
- Capable to vent with PVC, PP and SS up to 100'
- Multi-color LCD display with text
- 3 Zone circulator control with optional domestic hot water priority
- 5 to 1 Turndown ratio capability
- Includes:
  - Propane conversion kit
  - Water treatment kit
  - Vent termination



| Part # | Mfg #       | Boiler Model | AGA Input BTUH | AFUE  | DOE Heating Capacity BTUH | Net I=B=R Rating BTUH | Chimney/Vent Size | Approx Ship Wt | Price |
|--------|-------------|--------------|----------------|-------|---------------------------|-----------------------|-------------------|----------------|-------|
| 144285 | 383-700-003 | WM97+ 70     | 70,000         | 95.2% | 65,000                    | 57,000                | 3"                | 136 lbs        |       |
| 144286 | 383-700-004 | WM97+ 110    | 110,000        | 95%   | 101,000                   | 88,000                | 3"                | 136 lbs        |       |
| 151176 | 383-700-005 | WM97+ 155    | 155,000        | 95.1  | 143,000                   | 124,000               | 3"                | 162 lbs        |       |

## Weil McLain Boilers

### ECO Wall-Mount Gas Boiler

- Class-leading 70,000, 110,000, and 155,000 BTUH models
- Exceeds Energy Star requirements at 95% AFUE efficiency rating
- Durable stainless steel fire tube heat exchanger
- Streamlined design configurable for installation
- Display can be mounted on the boiler or wall (up to 2' away)
- Components positioned for fast and easy service
- Multiple vent configurations and material options
- Optional accessories to match virtually any installation



| Part # | Mfg #       | Boiler Model | AGA Input BTUH | AFUE  | DOE Heating Capacity BTUH | Net I=B=R Rating BTUH | Chimney/Vent Size | Approx Ship Wt | Price |
|--------|-------------|--------------|----------------|-------|---------------------------|-----------------------|-------------------|----------------|-------|
| 170154 | 383-800-003 | ECO70        | 70,000         | 95.2% | 65,000                    | 57,000                | 2" or 3"          | 117 lbs        |       |
| 183864 | 383-800-004 | ECO110       | 110,000        | 95.0% | 101,000                   | 88,000                | 2" or 3"          | 177 lbs        |       |
| 166038 | 383-800-005 | ECO155       | 155,000        | 95.1% | 143,000                   | 124,000               | 3"                | 130 lbs        |       |

### GV90+ Series High Efficiency Cast Iron Gas Boilers

- Insulated extended jacket
- Hot surface ignition system
- Cast iron primary heat exchanger
- Condensing stainless steel secondary heat exchanger
- Unique 7-pass heat exchanger design
- Vents with PVC
- Multiple vent options (direct vent, direct exhaust, concentric)
- Natural gas, easy conversion to propane (kit included)
- 3" Minimum vent size
- Down-fired, counter flow boiler design
- Built-in dual circulator
- Energy Star® rated
- 2-Year warranty on parts; 20-Year warranty on heat exchanger



| Part # | Mfg #       | Boiler Model | AGA Input BTUH | AFUE  | DOE Heating Capacity BTUH | Net I=B=R Rating BTUH | Chimney/Vent Size | Approx Ship Wt | Price |
|--------|-------------|--------------|----------------|-------|---------------------------|-----------------------|-------------------|----------------|-------|
| 143723 | 382-200-601 | GV90+4       | 105,000        | 91.2% | 97,000                    | 84,000                | 3"                | 353 lbs        |       |

Heating - Hydronic

## Weil McLain Boilers

### Ultra Series 3 - Condensing High-Efficiency Gas Boilers

- Factory tested
- Cast aluminum block
- 30 psi ASME Relief valve
- Drain valve
- Stainless steel burner with woven steel fiber mesh
- Direct spark ignition
- Variable speed blower assembly
- Gas/air ratio venturi with air silencer
- Negative pressure regulation gas valve
- 50VA Transformer
- Combination T&P gauge
- Outlet and return water temperature sensor
- Flue gas and outdoor temperature sensors
- Energy Star® rated



Heating - Hydronic

#### Ultra 3 Series - Natural Gas

| Part # | Mfg #       | Boiler Model | CSA Input BTUH | AFUE  | DOE Heating Capacity BTUH | Net I=B=R Rating BTUH | Min Pipe Size | Approx Ship Wt | Price |
|--------|-------------|--------------|----------------|-------|---------------------------|-----------------------|---------------|----------------|-------|
| 237963 | 383-500-732 | Ultra 80     | 80,000         | 95.2% | 71,000                    | 62,000                | 1"            | 199 lbs        |       |

#### Ultra 3 Series - Propane Gas

| Part # | Mfg #       | Boiler Model | CSA Input MBH | AFUE  | DOE Heating Capacity MBH | Net I=B=R Rating MBH | Min Pipe Size | Approx Ship Wt | Price |
|--------|-------------|--------------|---------------|-------|--------------------------|----------------------|---------------|----------------|-------|
| 116487 | 383-500-701 | Ultra 80     | 80,000        | 95.2% | 71,000                   | 62,000               | 1"            | 199 lbs        |       |

#### Ultra Gas S4 Gas Boiler

- Cast aluminum coated heat exchanger
- Up to 94% DOE AFUE efficiency
- Designed to operate in low temperature condensing applications
- Outdoor reset and domestic hot water priority
- Modulates with 5:1 turn-down ratio
- High grade stainless steel burner features quiet operation
- U-Control gives you the power for easy set-up and maintenance:
  - Multiple set-up and zone options
  - System sensing recognizes system and outdoor temperatures
  - Temperature management for up to three different set-points
  - Control multiple boilers from a single control panel
  - Standard screen messages provide service alerts and maintenance reminders



| Part # | Mfg #       | Boiler Model | CSA Input MBH | AFUE  | DOE Heating Capacity MBH | Net I=B=R Rating MBH | Vent Size | Price |
|--------|-------------|--------------|---------------|-------|--------------------------|----------------------|-----------|-------|
| 237964 | 383-500-733 | Ultra 80     | 80,000        | 93.5% | 71,000                   | 62,000               | 2" or 3"  |       |
| 237965 | 383-500-734 | Ultra 105    | 105,000       | 94%   | 94,000                   | 82,000               | 2" or 3"  |       |
| 237966 | 383-500-735 | Ultra 155    | 155,000       | 94%   | 139,000                  | 121,000              | 3"        |       |
| 237967 | 383-500-736 | Ultra 230    | 230,000       | 94.1% | 207,000                  | 180,000              | 3" or 4"  |       |
| 237968 | 383-500-737 | Ultra 299    | 299,000       | 92.5% | 270,000                  | 235,000              | 4"        |       |

## Weil McLain Boilers

### Residential Gas Boilers (Continued)

#### Ultra Gas S4 Gas Boiler

| Part # | Mfg #       | Boiler Model | CSA Input MBH | AFUE  | DOE Heating Capacity MBH | Net I=B=R Rating MBH | Vent Size | Price |
|--------|-------------|--------------|---------------|-------|--------------------------|----------------------|-----------|-------|
| 237969 | 383-500-738 | Ultra 399    | 399,000       | 91.7% | 364,000                  | 317,000              | 4"        |       |

#### CGa Gold Series Gas Boiler

- Compact design saves valuable living space
- Stainless steel burners for quieter ignition, longer life, and improved combustion
- Gas fired water boiler with cast iron sections
- Easily accessible controls, vertical flueways and top cleaning for easy and quick servicing
- Up to 84% AFUE
- C.S.A. design certified for installation on combustible flooring
- "SPD" for boiler with standing pilot  
"PID" for boiler with electronic ignition system  
"N" for natural gas  
"L" for propane gas



| Part # | Mfg #       | Boiler Model | AGA Input BTUH | AFUE  | DOE Heating Capacity BTUH | Net I=B=R Rating BTUH | Chimney/Vent Size | Approx Ship Wt | Price |
|--------|-------------|--------------|----------------|-------|---------------------------|-----------------------|-------------------|----------------|-------|
| 146734 | 381-357-802 | CGA-3-PIDN   | 70,000         | 84.0% | 59,000                    | 51,000                | 4"                | 200 lbs        |       |
| 025732 | 381-357-804 | CGA-4-PIDN   | 105,000        | 84.0% | 88,000                    | 77,000                | 5"                | 240 lbs        |       |
| 113283 | 381-357-806 | CGA-5-PIDN   | 140,000        | 83.5% | 117,000                   | 102,000               | 6"                | 280 lbs        |       |
| 059815 | 381-357-808 | CGA-6-PIDN   | 175,000        | 83.2% | 146,000                   | 127,000               | 6"                | 325 lbs        |       |
| 026674 | 381-357-810 | CGA-7-PIDN   | 210,000        | 83.0% | 175,000                   | 152,000               | 7"                | 370 lbs        |       |

#### CGi Gold Series Gas Boiler

- Gas fired water boiler with cast iron sections
- Natural draft and direct exhaust capability
- Can be used with natural or propane gas
- All units are factory-tested
- Compact design saves valuable living space
- No vertical draft hood and no mechanical vent damper
- Intermittent electronic ignition with standard components for easy servicing
- Up to 85% AFUE
- C.S.A. design certified for installation on combustible flooring
- "PIN" for natural gas  
"PIL" for propane gas



| Part # | Mfg #       | Boiler Model | AGA Input BTUH | AFUE  | DOE Heating Capacity BTUH | Net I=B=R Rating BTUH | Chimney/Vent Size | Approx Ship Wt | Price |
|--------|-------------|--------------|----------------|-------|---------------------------|-----------------------|-------------------|----------------|-------|
| 151641 | 381-357-858 | CGI-3-PIN    | 60,000         | 85.1% | 51,000                    | 45,000                | 4"                | 200 lbs        |       |
| 151642 | 381-357-937 | CGI-4-PIN    | 100,000        | 84.0% | 85,000                    | 74,000                | 5"                | 240 lbs        |       |
| 151643 | 381-357-864 | CGI-5-PIN    | 120,000        | 83.3% | 100,000                   | 87,000                | 5"                | 280 lbs        |       |
| 151644 | 381-357-866 | CGI-6-PIN    | 167,000        | 83.3% | 140,000                   | 122,000               | 5"                | 325 lbs        |       |

## Weil McLain Boilers

### Residential Gas Boilers (Continued)

#### CGi Gold Series Gas Boiler

| Part # | Mfg #       | Boiler Model | AGA Input BTUH | AFUE  | DOE Heating Capacity BTUH | Net I=B=R Rating BTUH | Chimney/Vent Size | Approx Ship Wt | Price |
|--------|-------------|--------------|----------------|-------|---------------------------|-----------------------|-------------------|----------------|-------|
| 151645 | 381-357-868 | CGI-7-PIN    | 200,000        | 83.0% | 167,000                   | 145,000               | 5"                | 370 lbs        |       |
| 151646 | 381-357-870 | CGI-8-PIN    | 233,000        | 82.7% | 194,000                   | 169,000               | 3"                |                |       |

#### EG Gas Boiler

- Comes with automatic vent damper for higher efficiencies and reduced fuel consumption
- Easy access to controls for convenient servicing
- Configured for Natural Gas, intermittent electronic ignition only
- A versatile gas cast iron boiler for water or steam applications
- Cast iron heat exchanger
- Up to 84% AFUE
- "W" for water  
"S" for steam  
"SPD" for boiler with standing pilot  
"PID" for boiler with intermittent electronic ignition system  
"N" for Natural gas  
"L" for Propane gas



| Part # | Mfg #      | Boiler Model | AGA Input BTUH | AFUE  | DOE Heating Capacity BTUH | Net I=B=R Rating BTUH | Chimney/Vent Size | Approx Ship Wt | Price |
|--------|------------|--------------|----------------|-------|---------------------------|-----------------------|-------------------|----------------|-------|
| 151625 | EG-45-PIDN | EG-45-PIDN   | 150,000        | 82.9% | 125,000                   | 94,000                | 6"                | 505 lbs        |       |
| 151628 | EG-55-PIDN | EG-55-PIDN   | 200,000        | 82.8% | 167,000                   | 125,000               | 7"                | 545 lbs        |       |
| 151629 | EG-65-PIDN | EG-65-PIDN   | 250,000        | 83.0% | 209,000                   | 157,000               | 7"                | 630 lbs        |       |
| 151630 | EG-75-PIDN | EG-75-PIDN   | 299,000        | 82.4% | 240,000                   | 180,000               | 8"                | 695 lbs        |       |

Heating - Hydronic

## Weil McLain Boilers

### Commercial Boilers

#### SlimFit Commercial Condensing Gas Boiler

##### SlimFit 550-750

- 93.9% Thermal Efficiency
- 94% Combustion Efficiency
- CSD-1 Compliant is Standard
- Low NOx Certified
- PVC, CPVC, PP or SS (AL29-4C) materials approved for Direct Vent and Direct Exhaust
- 20% - 100% Modulation



##### SlimFit 1000-2000

- Up to 96.1% Combustion Efficiency
- Up to 95.8% Thermal Efficiency
- 1,000,000 TO 2,000,000 BTU/HR
- Low NOx < 20 PPM
- Modulating Burner with 6:1 Turndown Ratio
- CSD-1 Compliant is Standard
- SOLA-Control Flexibility with 7" LCD Touch Screen
- Fully Customizable Outdoor Reset Curve
- Lead/Lag Capability up to 8 Boilers with lead boiler rotation
- Remote modulation through BAS using Modbus or BACnet
- High limit temperature control with manual reset, fixed 200 degree F
- PVC, CPVC, PP or SS (AL29-4C) materials approved for Direct Vent and Direct Exhaust

| Part # | Mfg #       | Boiler Model | CSA Input MBH | CSA Gross Output MBH | Net I=B=R Rating MBH | Vent Air Size | Vent Air Length | Price |
|--------|-------------|--------------|---------------|----------------------|----------------------|---------------|-----------------|-------|
| 176267 | 383-600-330 | SF550        | 550           | 516                  | 449                  | 6"            | 100'            |       |
| 176268 | 383-600-331 | SF750        | 750           | 702                  | 610                  | 6" or 8"      | 30', 100'       |       |
| 160055 | 383-600-013 | SF1500L      | 1500          | 1437                 | 1250                 | 8"            | 100'            |       |
| 160058 | 383-600-016 | SF1500R      | 1500          | 1437                 | 1250                 | 8"            | 100'            |       |
| 160059 | 383-600-017 | SF2000R      | 2000          | 1906                 | 1657                 | 8"            | 100'            |       |



## Weil McLain Boilers

### Ultra Commercial Condensing High-Efficiency Gas Boilers with 20 - 100% Modulation

- Factory test report shipped with boiler
- Cast aluminum block
- CSD-1 Comes standard
- Manual reset low water cut-off
- Adjustable manual reset high limit
- Stainless steel burner with woven steel fiber mesh
- Venting with PVC or CPVC up to 100 feet
- Direct vent or direct exhaust capable
- Venturi mixing system with air silencer
- Variable speed motor
- Negative pressure regulation gas valve
- 50VA Transformer
- Integrated drain in vent adapters
- Outlet and inlet water temperature sensors
- Flue gas and outdoor temperature sensors



Heating - Hydronic

| Part # | Mfg #       | Boiler Model | CSA Input MBH | CSA Gross Output MBH | Net I=B=R Rating MBH | I=B=R Thermal Efficiency | Approx Ship Wt | Price |
|--------|-------------|--------------|---------------|----------------------|----------------------|--------------------------|----------------|-------|
| 127626 | 383-600-010 | 550          | 550,000       | 517,000              | 445,000              | 93.9                     | 505 lbs        |       |
| 127627 | 383-600-011 | 750          | 750,000       | 702,000              | 605,000              | 93.6                     | 550 lbs        |       |

### EGH Atmospheric Gas Boilers

- Factory assembled section block
- Insulated extended jacket
- Horizontal to vertical draft hood
- Non-linting pilot burner
- Combination gas valve and regulator
- Aluminized steel burners
- 40VA Transformer
- Built-in Air separator
- Combination pressure-temperature gauge
- Steam boilers include:
  - 15 psi ASME Relief valve
  - High limit pressure control for PI with damper & PI models
  - Low water cut-off (electrode type)
  - Steam pressure gauge
  - Gauge cocks and glass
  - Siphon



#### EGH Atmospheric Gas Boiler - 24 Volt Intermittent Electronic Ignition Model - Natural Gas - Steam

| Part # | Mfg #       | Boiler Model | CSA Input BTUH | AFUE   | DOE Heating Capacity BTUH | Net I=B=R Rating BTUH | AHRI Chimney/Vent Size | Approx Ship Wt | Price |
|--------|-------------|--------------|----------------|--------|---------------------------|-----------------------|------------------------|----------------|-------|
| 063973 | EGH-85-PIN  | EGH-85-PIN   | 315,000        | 82.34% | 243,000                   | 182,000               | 9" ID                  | 825 lbs        |       |
| 063976 | EGH-105-PIN | EGH-105-PIN  | 405,000        | 82.43% | 312,000                   | 234,000               | 10" ID                 | 1,005 lbs      |       |

**Uponor (Wirsbo) Heating**

Heating - Hydronic

**TruFLOW™ Assembled Stainless Manifolds**

**Stainless Steel Manifold Assembly**

- Features isolation valves, balancing valves w/ flow meters, supply and return ball valves with temperature gauges, and come fully assembled
- For commercial and residential radiant heating and cooling applications
- Available in 1" and 1-1/4" sizes

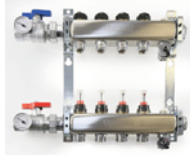

| Part # | Mfg #    | Size   | Loops | Price |
|--------|----------|--------|-------|-------|
| 171998 | A2720302 | 1-1/4" | 3     |       |
| 172123 | A2720402 | 1-1/4" | 4     |       |
| 172476 | A2720502 | 1-1/4" | 5     |       |
| 188930 | A2720602 | 1-1/4" | 6     |       |
| 228374 | A2720802 | 1-1/4" | 8     |       |
| 172475 | A2721002 | 1-1/4" | 10    |       |
| 172504 | A2721202 | 1-1/4" | 12    |       |

**TruFLOW™ Assembled Brass Manifolds**

| Part # | Mfg #    | Description | Price |
|--------|----------|-------------|-------|
| 074022 | A2610200 | 2 Loop      |       |
| 083039 | A2610300 | 3 Loop      |       |
| 074023 | A2610400 | 4 Loop      |       |
| 083429 | A2610500 | 5 Loop      |       |

**TruFLOW™ Assembled Without Flow/Temp Meter**

- Comes fully assembled ready for installation
- The TruFLOW balancing Hex Key is used on the internal balancing valves of the supply manifold to balance the loops
- Manifold is shipped with the appropriate number of actuator adapters (A2630028)
- Maximum recommended flow to the manifold based on manifold body diameter is 21 gpm



| Part # | Mfg #    | Description | Price |
|--------|----------|-------------|-------|
| 079647 | A2610600 | 6 Loop      |       |
| 083428 | A2610700 | 7 Loop      |       |
| 079648 | A2610800 | 8 Loop      |       |
| 086861 | A2611000 | 10 Loop     |       |
| 086863 | A2611200 | 12 Loop     |       |

**TruFLOW™ Brass Manifold Specific Accessories**

**TruFLOW™ Manifold Loop Thermometer**

- Comes with R20 (QS-style) female union on one end and an R20 (QS-style) male on the other
- Thermometer well and removable thermometer are included



Use ONLY with Uponor TruFLOW Jr. and Classic Manifolds

| Part # | Mfg #    | Description                       | Price |
|--------|----------|-----------------------------------|-------|
| 081827 | A2610020 | TruFLOW Manifold Loop Thermometer |       |

**TruFLOW™ Manifold Supply & Return Ball Valves with Thermometer**

- Full-flow 1-1/4" ball valves with R32 male x R32 union nut that fits directly on TruFLOW manifold
- Standard with a thermometer



Use ONLY with Uponor TruFLOW Jr. and Classic Manifolds

| Part # | Mfg #    | Description                 | Price |
|--------|----------|-----------------------------|-------|
| 084177 | A2631250 | Ball Valves Supply & Return |       |

**TruFLOW™ Classic Manifold Extension Kit**

- For easy in-line extension of up to two additional loops for the TruFLOW classic manifold assembly
- Contains (2) 1-1/4" BSP nipples, (1) supply manifold, (1) return manifold and (2) loop end caps



| Part # | Mfg #    | Description                       | Price |
|--------|----------|-----------------------------------|-------|
| 093249 | A2610100 | Classic Manifold Ext Kit, 2 Loops |       |

**Uponor (Wirsbo) Heating**

**Heating Manifolds**

**EP Heating Manifold**

- Includes isolation valve and balancing valve with flow meters
- Made of engineered plastic and fully assembled
- Body ends have R32 unions and loop outlets have R20 male threads
- Mounts on fully assembled bracket (A2670006)



| Part # | Mfg #    | Loops | Price |
|--------|----------|-------|-------|
| 120254 | A2670201 | 2     |       |
| 120255 | A2670301 | 3     |       |
| 120256 | A2670401 | 4     |       |
| 120257 | A2670501 | 5     |       |
| 120258 | A2670601 | 6     |       |
| 120259 | A2670701 | 7     |       |
| 120260 | A2670801 | 8     |       |

**EP Heating Manifold Accessories**



| Part # | Mfg #    | Description      | Price |
|--------|----------|------------------|-------|
| 124454 | A2671300 | Actuator Adapter |       |

**Brass Manifold Accessories**

**End Cap with Vent**

- For 1-1/4" brass manifolds
- Complete with swivel drain valve and manual air vent
- Required gasket included (A2403232)



| Part # | Mfg #    | Description            | Price |
|--------|----------|------------------------|-------|
| 011754 | A2803250 | End Cap with Vent, R32 |       |

**End Cap**

- For 1-1/4" brass manifolds
- Required gasket included

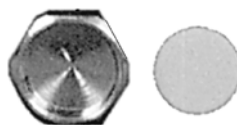

| Part # | Mfg #    | Description        | Price |
|--------|----------|--------------------|-------|
| 011753 | A2080032 | Basic End Cap, R32 |       |

**Brass Manifold Accessories (Continued)**

**End Cap**

| Part # | Mfg #    | Description       | Price |
|--------|----------|-------------------|-------|
| 025646 | A2080020 | Loop End Cap, R20 |       |

**Manifold Accessories for TruFLOW™ and 1-1/4" Brass Manifolds**

**Copper Manifold Adapter**

- Use sweat adapter to transition R32 manifold union nut to 3/4", 1", and 1-1/4" copper pipe, copper fittings and valves



Use with 1-1/4" Brass and TruFLOW Manifolds  
Not compatible with TruFLOW Sr.

| Part # | Mfg #    | Description        | Price |
|--------|----------|--------------------|-------|
| 011764 | A4143210 | R32 x 3/4" or 1"   |       |
| 011763 | A4133210 | R32 x 1" or 1-1/4" |       |

**Manifold Threaded Adapter/Bushing**

- Manifold Adapter for brass manifold transitions the R32 manifold union nut to PEX or MultiCor tubing with QS-style fittings



Use with 1-1/4" Brass and TruFLOW Manifolds  
Not compatible with TruFLOW Sr.

| Part # | Mfg #    | Description                | Price |
|--------|----------|----------------------------|-------|
| 193883 | A2123210 | R32 Male x 1" FNPT Bushing |       |

**ProPEX® Manifold Adapter**

- Use to transition from the R32 manifold union nut to 3/4" and 1" AQUAPEX® and hePEX™plus



Use with 1-1/4" Brass and TruFLOW Manifolds  
Not compatible with TruFLOW Sr.

| Part # | Mfg #    | Description                   | Price |
|--------|----------|-------------------------------|-------|
| 045200 | Q4143275 | R32 x 3/4" Straight Adapter   |       |
| 045201 | Q4143210 | R32 x 1" Straight Adapter     |       |
| 099804 | Q4153275 | R32 x 3/4" Elbow              |       |
| 223377 | Q4143215 | R32 x 1-1/2" Straight Adapter |       |

**Uponor (Wirsbo) Heating**

Heating - Hydronic

**Brass Manifold Pressure Test Kit**

- Includes
  - R32 x 3/4" Manifold bushing
  - R32 Solid brass plug
  - 3/4" Brass nipple and pressure gauge assembly (100 psi)
  - Schraeder valve



Use with 1-1/4" Brass and TruFLOW Manifolds  
Not compatible with TruFLOW Sr.

| Part # | Mfg #    | Description       | Price |
|--------|----------|-------------------|-------|
| 028958 | E6122000 | Pressure Test Kit |       |

**Manifold Gasket**

- Spare part
- For 1-1/4" manifold and manifold parts
- NOTE: Gaskets are not interchangeable between parts except as noted - to seal properly the correct gasket must be used



| Part # | Mfg #    | Description           | Price |
|--------|----------|-----------------------|-------|
| 011755 | A2403232 | End Cap w/Vent Gasket |       |

**TruFLOW Manifold Actuator Adapter**

- M28 brass adapter converts the manifold actuator threads to fit the Uponor Thermal Actuator A3023522
- Use only with the TruFLOW Jr. and Classic Manifolds



| Part # | Mfg #    | Description              | Price |
|--------|----------|--------------------------|-------|
| 110901 | A2630028 | Adapter Replacement Part |       |

**Spacer Ring VA33**

- For White Thermal Actuators

| Part # | Mfg #    | Description                 | Price |
|--------|----------|-----------------------------|-------|
| 185084 | A3019900 | For White Thermal Actuators |       |

**Manifold Wall Cabinet**

- Recessed-style
- 2x4 or 2x6 Stud wall



| Part # | Mfg #    | Description           | Price |
|--------|----------|-----------------------|-------|
| 087014 | A2603539 | 35.5"H x 39"W x 3.5"D |       |

**Replacement and Spare Parts for Manifolds**

| Part # | Mfg #    | Description                                  | Price |
|--------|----------|--|-------|
| 163459 | A2620005 | Replacement Gasket for R32 Union Connections |       |

**Manifold Accessories for TruFLOW™ and 1-1/4" Brass Manifolds (Continued)**

**Replacement and Spare Parts for Manifolds**

| Part # | Mfg #    | Description                                   | Price |
|--------|----------|---|-------|
| 093251 | A2620008 | Replacement O-Ring for 1-1/4" BSP Connections |       |

**Fitting Assemblies**

**QS-Style Fitting Assembly**

- Compression fitting assembly with o-ring (sold separately)
- Connects 5/16", 1/2" and 5/8" Uponor hePEX plus and AQUAPEX tubing to all Uponor manifolds and R20 components PEX tubing to Uponor™ manifold outlets R20 components
- Sold as a 3-piece component



This fitting is not compatible with TruFLOW Sr.

| Part # | Mfg #    | Size  | Type       | Price |
|--------|----------|-------|------------|-------|
| 040687 | A4020313 | 5/16" | R20 Thread |       |
| 022644 | A4020500 | 1/2"  | R20 Thread |       |
| 022645 | A4020625 | 5/8"  | R20 Thread |       |

**ProPEX® Fitting Assembly (PEX to Brass)**

- PEX Tubing to the brass manifolds
- Sold as a 2-piece assembly, it includes a ProPEX® insert and swivel nut
- ProPEX® tool and ProPEX® rings required (sold separately)



This fitting is not compatible with the TruFLOW Sr.

| Part # | Mfg #    | Size | Type       | Price |
|--------|----------|------|------------|-------|
| 045203 | Q4020500 | 1/2" | R20 Thread |       |
| 045204 | Q4020625 | 5/8" | R20 Thread |       |
| 087016 | Q4020750 | 3/4" | R20 Thread |       |
| 112192 | Q4030750 | 3/4" | R25 Thread |       |

**QS Fitting Assembly O-Ring**

| Part # | Mfg #    | Description                       | Price |
|--------|----------|-----------------------------------|-------|
| 025703 | A4021116 | O-Ring Replacement for R20 Thread |       |

**Uponor (Wirsbo) Heating**

**ProPEX Baseboard Elbow and Tee (PEX x CU)**

- Connects 1/2", 5/8", and 3/4" Uponor PEX tubing products to 3/4" copper baseboard
- ProPEX tool is required



| Part # | Mfg #    | Description | Price |
|--------|----------|-------------|-------|
| 043564 | Q4386375 | 5/8" x 3/4" |       |

**Tubing Transition Fittings**

**QS-Style Coupling Nipple (Thread x Thread)**

- Use coupling nipple (brass) and the appropriate fitting assembly to connect 5/16", 3/8", 1/2", 5/8" or 3/4" tubing together



| Part # | Mfg #    | Description      | Price |
|--------|----------|------------------|-------|
| 022651 | A4322020 | R20 x R20 Thread |       |
| 022655 | A4322525 | R25 x R25 Thread |       |

**QS-Style Conversion Nipple (Thread x NPT)**

- The QS-style Conversion Nipple (brass) and the appropriate fitting connect 5/16", 3/8", 1/2", 5/8" or 3/4" Uponor tubing to 1/2", 3/4" and 1" NPT



| Part # | Mfg #    | Description    | Price |
|--------|----------|----------------|-------|
| 022653 | A4322075 | R25 x 3/4" NPT |       |

**QS-Style Copper Adapter (Thread x CU)**

- Use R20 or R25 adapter and appropriate QS-style fitting assembly to transition PEX tubing to 1/2" and 3/4" copper pipe



| Part # | Mfg #    | Description | Price |
|--------|----------|-------------|-------|
| 022657 | A4332050 | R20 x 1/2"  |       |
| 022658 | A4332075 | R20 x 3/4"  |       |

**QS-Style Copper Fitting Adapter (Thread x Copper)**

- Transition Uponor PEX tubing to 1/2" and 3/4" copper fittings



| Part # | Mfg #    | Description | Price |
|--------|----------|-------------|-------|
| 022660 | A4342050 | R20 x 1/2"  |       |
| 022661 | A4342075 | R20 x 3/4"  |       |

**QS-Style Compression Manifold Fitting Assembly**

- Sold as 3-Piece assembly



| Part # | Mfg #    | Description     | Price |
|--------|----------|-----------------|-------|
| 033672 | A4020375 | 3/8" R20 Thread |       |
| 169119 | A4030625 | 5/8" R25 Thread |       |
| 022646 | A4020750 | 3/4" R25 Thread |       |

**Panels and Plates**

**Quik Trak™ Panel**

- The 1/2" plywood panels are attached to an aluminum heat transfer sheet



Use with Uponor 5/16" hePEX plus only

| Part # | Mfg #    | Description | Price |
|--------|----------|-------------|-------|
| 040685 | A5060701 | 7" x 48"    |       |

**Quik Trak™ Return Panel**

- Designed with a "U" groove to complete tubing turns
- The half-moon grooves are attached to the panels
- Each return panel is shipped with a separate aluminum sheet for installation beneath the panel



Use with Uponor 5/16" hePEX plus only

| Part # | Mfg #    | Size     | Price |
|--------|----------|----------|-------|
| 040686 | A5060702 | 7" x 48" |       |

**Quik Trak™ Joist Trak**

- Extruded aluminum heat transfer panels
- Each panel is 4' long x 4" wide
- Comes packaged 20 per box



| Part # | Mfg #    | Size | Price |
|--------|----------|------|-------|
| 066612 | A5080500 | 1/2" |       |

**Fast Trak™ Edge Strip**

- Ideal over pour installation method for remodel and retrofit applications
- Preformed knobbed mats
- 5/16" PEX tubing



| Part # | Mfg #    | Description                              | Price |
|--------|----------|--|-------|
| 145575 | A5090313 | Fast Trak 0.5. 8.3ft <sup>2</sup> /panel |       |
| 145576 | A5091000 | Strip, 65-ft roll                        |       |

Heating - Hydronic

**Uponor (Wirsbo) Heating**

Heating - Hydronic

**ProPEX® Escutcheon's**

- Flared sleeve
- Attractive cover for 1/2" AQUAPEX® tubing and ProPEX connections as they exit the wall



| Part # | Mfg #    | Description   | Price |
|--------|----------|---------------|-------|
| 118898 | F5670500 | White         |       |
| 119669 | F5650500 | Chrome Plated |       |

**Installation Aids**

**PVC Plastic Bend Support**

- Provides rigid 90° bend for 1/2", 5/8", 3/4" and 1" Uponor PEX exiting a concrete slab



| Part # | Mfg #    | Size | Price |
|--------|----------|------|-------|
| 023227 | A5500500 | 1/2" |       |
| 023195 | A5500625 | 5/8" |       |
| 023228 | A5500750 | 3/4" |       |
| 040374 | A5501000 | 1"   |       |

**Metal Bend Support**

- Zinc-plated
- Provides rigid 90° bend for 1/2", 5/8" and 3/4" nominal PEX tubing products



| Part # | Mfg #    | Size | Price |
|--------|----------|------|-------|
| 027955 | A5110500 | 1/2" |       |
| 011777 | A5110625 | 5/8" |       |
| 022596 | A5110750 | 3/4" |       |

**PEX Clip - Plastic**

- Enhanced Uponor PEX clips provide better holding power and can be attached together laterally for tight installations
- PEX Clips are attached under the wood subfloor for joist-heating applications
- Clips prevent tubing from coming in direct contact with subfloor
- Dry wall screws are commonly used to secure the clips to the wood subfloor



| Part # | Mfg #    | Size        | Price |
|--------|----------|-------------|-------|
| 028881 | F7051258 | 1/2" & 5/8" |       |
| 137214 | F7057500 | 3/4"        |       |

**Installation Aids (Continued)**

**PEX Clip - Plastic**

| Part # | Mfg #    | Size          | Price |
|--------|----------|---------------|-------|
| 137215 | F7051001 | 1"            |       |
| 033674 | F7060375 | 3/8" (100/Bx) |       |

**Fixing Wire**

- 6" Galvanized steel tie used to secure PEX tubing products to wire mesh or rebar
- Use with fixing wire twister or auto fixing wire twister (ratchet style)



| Part # | Mfg #    | Description                  | Price |
|--------|----------|------------------------------|-------|
| 011770 | A7031000 | Fixing Wire, 1000 per Bundle |       |

**Ratchet-Style Fixing Wire Twister**

- For use with A7031000 fixing wire



| Part # | Mfg #    | Description         | Price |
|--------|----------|---------------------|-------|
| 019018 | E6091700 | Fixing Wire Twister |       |

**Fixing Wire Twister**

- For use with A7031000



| Part # | Mfg #    | Description         | Price |
|--------|----------|---------------------|-------|
| 011767 | E6090005 | Fixing Wire Twister |       |

**Quik Trak™ Sealant**

- 100% Silicone
- Used to adhere tubing in groove and provide good thermal transfer



| Part # | Mfg #    | Size       | Price |
|--------|----------|------------|-------|
| 040690 | E6050010 | 10.3 fl oz |       |

**Uponor (Wirsbo) Heating**

**PEX Foam Stapler**

- Ideal solution for securing Uponor PEX and (MLC) tubing to foam board insulation in concrete slab radiant heating and cooling applications



| Part # | Mfg #    | Description      | Price |
|--------|----------|------------------|-------|
| 171329 | E6025000 | PEX Foam Stapler |       |

**Foam Staple**

- For use with E6025075 manual stapler
- Plastic foam staple used to secure 1/2", and 5/8" PEX to rigid insulation
- Use part A7015050 for 1" foam and part A7015075 for 1-1/2" or thicker foam



| Part # | Mfg #    | Size   | Price |
|--------|----------|--------|-------|
| 040682 | A7015050 | 1-1/2" |       |
| 033641 | A7015075 | 2-1/2" |       |

**PEX Foam Staple**

- For use with Uponor PEX foam stapler (E6025000) to secure 3/8", 1/2", and 3/4" PEX or 1/2" and 5/8" MLC tubing



| Part # | Mfg #    | Description | Price |
|--------|----------|-------------|-------|
| 171328 | A7012000 | 2"          |       |

**Metal Tubing Staple**

- Use 5/8" staple to secure aluminum plates to furring strips or subfloors
- Use 1-1/4" staples in staple-down installations to secure 1/2" and 5/8" Uponor PEX to wood subfloors

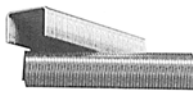

| Part # | Mfg #    | Size   | Pkg Qty    | Price |
|--------|----------|--------|------------|-------|
| 143722 | A7011250 | 1-1/4" | 10,000/Box |       |

**PEX Tubing Cutter**



| Part # | Mfg #    | Description                      | Price |
|--------|----------|----------------------------------|-------|
| 011750 | E6081125 | Metal Tube Cutter Cuts to 1" PEX |       |

**Installation Aids (Continued)**

**PEX Tubing Cutter**

| Part # | Mfg #    | Description                               | Price |
|--------|----------|---|-------|
| 083129 | E6081128 | Plastic Tube Cutter Cuts to 1" PEX (3/4") |       |

**TruFLOW Manifold Balancing Hex Key**

- Use on the supply manifold to adjust the flow rate across the loop for balancing



| Part # | Mfg #    | Description               | Price |
|--------|----------|---------------------------|-------|
| 081829 | A2620002 | Replacement Part, Hex Key |       |

**Tube Uncoiler**

- Facilitates uncoiling of up to 1" PEX tubing
- Simplifies installation and reduces labor
- Weighted arms hold tubing in place while uncoiling
- Eyelet keeps tubing from tangling
- Base is collapsible
- No additional hardware needed to attach arms
- Easy to assemble
- Upon assembly, guide pin must be moved on the swivel guide arm in order to keep it in place



| Part # | Mfg #    | Description   | Price |
|--------|----------|---------------|-------|
| 035147 | E6061000 | Tube Uncoiler |       |

**Zoning Controls - Radiant Heating**

**Zone Control Module**

- 4-Zone control module for 2-wire operation



| Part # | Mfg #    | Description               | Price |
|--------|----------|---------------------------|-------|
| 155032 | A3031003 | 3-Zone 2-Wire Operation   |       |
| 159894 | A3031004 | 4-Zone, 2-Wire Operation  |       |
| 074018 | A3030009 | Replacement Fuse (2 amps) |       |

Heating - Hydronic

**Uponor (Wirsbo) Heating**

Heating - Hydronic

**Uponor Thermal Actuator**

- Slow-opening Thermal Actuator (24VAC) mounts directly onto 1-1/4" brass and TruFLOW valved manifolds
- Provides individual loop flow control on a multi-zoned manifold (manifold serving more than one zone)
- The 4-wire Thermal Actuator includes end switch for activation of relay (pump), heat plant or other auxiliary devices
- Do not mount actuators upside down



| Part # | Mfg #    | Description             | Price |
|--------|----------|-------------------------|-------|
| 171719 | A3023522 | 4-Wire Thermal Actuator |       |

**Uponor Set Point Thermostat**

- Comfort controllers
- Early start features for recovery from setback
- Override feature for periods of extended absence
- Attractive sleek design



| Part # | Mfg #    | Description                    | Price |
|--------|----------|--------------------------------|-------|
| 081433 | A3040079 | Floor Sensor, Replacement Part |       |

**Heat-Only Thermostats**

- Touchscreen
- Designed for radiant floor heating



| Part # | Mfg #    | Description                         | Price |
|--------|----------|-------------------------------------|-------|
| 227368 | A3100101 | Heat-Only Thermostat w/ Touchscreen |       |
| 232157 | A9010599 | Slab Sensor, 10K                    |       |

**Pump Relay**

- Single-zone relay includes secondary low-voltage terminals for boiler operation
- Three-zone relay includes secondary low-voltage terminals for boiler operation and DHW priority options



| Part # | Mfg #    | Description                 | Price |
|--------|----------|-----------------------------|-------|
| 041378 | A3080301 | 24V 3-Zone Multi Pump Relay |       |
| 196539 | A3010100 | 24V Single-Zone             |       |

**Powered Zone Controller**



| Part # | Mfg #    | Description | Price |
|--------|----------|-------------|-------|
| 090979 | A3080404 | 4-Zone      |       |



## Uponor (Wirsbo) Heating

### Radiant Heat Tools

#### Foamboard Stapler

- Operate from standing position
- Ergonomic D-grip handle
- Solid 1-piece magazine
- Leaf spring controlled stop automatically adjusts to set up staple and guide it through the fastening mechanism



| Part # | Mfg # | Description | Price |
|--------|-------|-------------|-------|
| 101994 | FBSN  | 37" Height  |       |

#### Foamboard Staple

- Extra sharp multi-barbed
- 1-1/2" Staples for 1" foamboard
- 2-1/2" Staples for 2" foamboard



| Part # | Mfg # | Description            | Price |
|--------|-------|------------------------|-------|
| 114593 | FBSN1 | 1-1/2" Staples, 200/Pk |       |
| 101995 | FBSN2 | 2-1/2" Staples, 200/Pk |       |

Heating - Hydronic

**Uponor (Wirsbo) Heating**

Heating - Hydronic

**Thermostatic Mixing Valves**

**AM-1 Series 3-Way Thermostatic Mixing Valve  
(Union Sweat)**

- Adjusts, maintains and limits the hot water temperature to a desired setting selected by user
- In domestic use, offers scalding protection and bacteria growth control
- Dual purpose mixing or diverting
- Proportional valve
- Nickel-plated brass construction
- EPDM o-rings



| Part # | Mfg #         | Pipe Size | Operating Temperature | Price |
|--------|---------------|-----------|-----------------------|-------|
| 099800 | AM-101R-US-1  | 3/4"      | 80° - 180°F           |       |
| 099799 | AM-102R-US-1  | 1"        | 80° - 180°F           |       |
| 124499 | AM102C-US-1LF | 1"        | 80° - 120°F           |       |

## Watts Heating

### Stainless Steel Manifolds

- Sold in pairs, mounted to metal bracket
- SS-T20 style fittings are compatible with Stainless Steel manifolds

#### 1" Stainless Steel Flow meter Manifold



D380300SS

| Part # | Mfg #      | Order #  | Size | Price |
|--------|------------|----------|------|-------|
| 114163 | D3803002SS | 81001981 | M-2  |       |
| 114949 | D3803008SS | 81001985 | M-8  |       |
| 139848 | D3803009SS | 81003687 | M-9  |       |
| 139847 | D3803012SS | 81001987 | M-12 |       |

### Manifold Accessories

#### Stainless Steel Manifold ISO BV Accessory Kit

- Includes:
  - (1) Vent and purge assembly
  - (1) Manifold end cap
  - (2) FNPT Trunk isolation ball valves
  - Manifold adapters
  - Neoprene and fiber gaskets
- Order Onix, Crimp or compression fittings separately



| Part # | Mfg #  | Order #  | Size | Price |
|--------|--------|----------|------|-------|
| 114165 | DK1000 | 81003736 | 1"   |       |

#### Stainless Steel Manifold Accessory Kit

| Part # | Mfg #  | Order #  | Size | Price |
|--------|--------|----------|------|-------|
| 125046 | DK3000 | 81005369 | 1"   |       |

### Valve Actuator

- For automatic circuit control
- Optional feature for mounting directly to the balancing manifold
- Incorporates an indicator window that allows you to visually determine whether the valve is fully open or closed
- Provides on/off flow control to individual radiant circuits
- Flow can be balanced prior to installing by turning the adjustment valve under the blue cap
- Actuator is 24VAC with four wires to connect to the thermostat and circulating pump



| Part # | Mfg #    | Order #  | Voltage | Price |
|--------|----------|----------|---------|-------|
| 127878 | PZ656104 | 81001541 | 24V     |       |

### PEX Compression Fittings

#### SST20 PEX Compression Fitting

- PEX Compression x SST20 Swivel BSP
- For connecting:
  - PEX to stainless steel manifolds
  - Custom tubular T20 compression manifolds
  - 3/4" Male BSP x male sweat fittings
- Includes:
  - Insert fitting
  - Compression sleeve
  - BSP threaded nut



| Part # | Mfg #       | Order #  | Size        | Price |
|--------|-------------|----------|-------------|-------|
| 114166 | PX690002-10 | 81005168 | 1/2" x 3/4" |       |
| 117479 | PX690003-10 | 81005170 | 5/8" x 3/4" |       |

### Misc. Accessories

#### Foam Staple Box

| Part # | Mfg #    | Order #              | Size | Price |
|--------|----------|----------------------|------|-------|
| 159249 | 81000825 | Foam 2.25 Staple Box |      |       |

## Air Purgers

### Air Elimination

#### Air Purger

- Cast iron



| Part # | Mfg # | Size   | Dimensions<br>H x W x L | Price |
|--------|-------|--------|-------------------------|-------|
| 002010 | 443-1 | 1"     | 4" x 3" x 6"            |       |
| 002011 | 444-1 | 1-1/4" | 4" x 3" x 6"            |       |
| 002012 | 445-1 | 1-1/2" | 5" x 4" x 8"            |       |
| 002013 | 446-1 | 2"     | 5" x 4" x 8"            |       |

Heating - Hydronic  
Accessories



## Air Vents

### Air Eliminators Automatic Air Vent

- Brass body with non-ferrous internals
- Maximum operating temperature: 240°F



| Part # | Mfg #  | Model | Connection | Max Pressure | Price |
|--------|--------|-------|------------|--------------|-------|
| 002435 | 113001 | 7     | 1/8" FNPT  | 75 psig      |       |
| 002468 | 113020 | 67    | 1/8" MNPT  | 35 psig      |       |

Heating - Hydronic  
Accessories

**Air Vents**

**(Air Eliminators)**

**SuperVent™ Air Eliminator**

- Eliminates air from hydronic heating systems without bleeding
- No clog vent, dirt and debris resistant
- 360° Adjustable collar ring
- Bronze body
- Maximum temperature rating: 240°F
- Maximum operating pressure: 125 psi



NPT

Sweat

| Part # | Mfg #  | Size   | Connection | Price |
|--------|--------|--------|------------|-------|
| 094289 | PV075  | 3/4"   | NPT        |       |
| 094290 | PV075S | 3/4"   | Sweat      |       |
| 094291 | PV100  | 1"     | NPT        |       |
| 094292 | PV100S | 1"     | Sweat      |       |
| 094293 | PV125  | 1-1/4" | NPT        |       |
| 094294 | PV125S | 1-1/4" | Sweat      |       |
| 094295 | PV150  | 1-1/2" | NPT        |       |

**GoldTop Universal Air Vent**

- One-fits-all
- Venting rate 3-4 times that of other products
- Residential or commercial heating and cooling systems

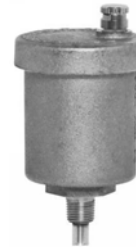

| Part # | Mfg #  | Size | Connection | Price |
|--------|--------|------|------------|-------|
| 200909 | FV180  | 3/4" | Male NPT   |       |
| 200910 | FV180A | 1/4" | Male NPT   |       |

**Parts & Accessories**

| Part # | Mfg #     | Description                       | Price |
|--------|-----------|-----------------------------------|-------|
| 184623 | PV-020-RP | PV SuperVent Vent Top Replacement |       |

**Air Vents**

**Main Steam Vents**

**Model 75/75H Air Valve (Non-Vacuum)**

- For medium and large systems
- Float-type thermostatic vent
- Single non-adjustable port
- 1/2" NPT Female and 3/4" NPT male straight shank
- Maximum pressure: 15 psig



| Part # | Mfg #  | Model | Max Operating Pressure | Price |
|--------|--------|-------|------------------------|-------|
| 005417 | 401434 | 75    | 3 psig                 |       |

**Radiator Steam Vents**

**Model 1A Air Valve (Non-Vacuum)**

- Float-type vent
- Adjustable port for true proportional venting - 6 port settings from slow (1) to fast (6)
- 1/8" NPT Angle connection
- Maximum operating pressure: 1-1/2 psig
- Maximum pressure: 10 psig



| Part # | Mfg #  | Model | Straight Shank | Price |
|--------|--------|-------|----------------|-------|
| 005398 | 401422 | 1A    | 1/8" NPT Angle |       |

**Water Vents**

**Model 79 Water Main Vent Valve**

- For use on hot or cold or glycol water mains and process applications with specific gravity > 0.7
- Tapped at top for 1/8" NPT safety drain connection
- Removable top
- Built-in check valve
- Maximum operating pressure: 75 psig
- Maximum hydrostatic pressure: 200 psig
- Maximum temperature: 250°F



| Part # | Mfg #  | Model | Straight Shank     | Price |
|--------|--------|-------|--------------------|-------|
| 005418 | 401488 | 79    | 1/2" FPT, 3/4" MPT |       |

**Model 790 Water Vent Valve**

- For removing air from convectors, baseboard and wall radiation
- Safety drain connection for discharging moisture
- Fitting and ferrule for 3/16" OD tubing
- Telescopic siphon tube
- Maximum operating pressure: 30 psig
- Maximum pressure: 30 psig



| Part # | Mfg #  | Model | Straight Shank | Price |
|--------|--------|-------|----------------|-------|
| 005419 | 401479 | 790   | 1/8" NPT       |       |

**Model 791 Water Vent Valve**

- For convectors and small frame
- Safety drain connection for discharging moisture
- Fitting and ferrule for 3/16" OD tubing
- Telescopic siphon tube
- Maximum operating pressure: 50 psig
- Maximum pressure: 50 psig



| Part # | Mfg #  | Model | Straight Shank | Price |
|--------|--------|-------|----------------|-------|
| 005420 | 401482 | 791   | 1/4" NPT       |       |

Heating - Hydronic Accessories

---



---

**Air Vents & Gauges**

---



---

**Radiator Coin Key Air Valve & Key**



| Part # | Mfg #   | Description | Price |
|--------|---------|-------------|-------|
| 082258 | R20-002 | Key Only    |       |
| 082257 | R20-003 | Valve Only  |       |

Heating - Hydronic  
Accessories



**Air Vents**

**SPIROTOP®**

**Brass Quick Air Releaser**

- 20-Year limited warranty



| Part # | Mfg #      | Size      | Price |
|--------|------------|-----------|-------|
| 017852 | VTP 050 FT | 1/2" FNPT |       |

**SPIROVENT® JUNIOR**

**Brass Air Eliminators**

- 20-Year limited warranty

**Threaded Design**



| Part # | Mfg #      | Size                       | Price |
|--------|------------|----------------------------|-------|
| 017848 | VJR 075-TM | 3/4" FNPT with 1/2" Tank   |       |
| 017849 | VJR 100-TM | 1" FNPT with 1/2" Tank     |       |
| 017850 | VJR 125-TM | 1-1/4" FNPT with 1/2" Tank |       |
| 017851 | VJR 150-TM | 1-1/2" FNPT with 1/2" Tank |       |
| 087403 | VJR200-TM  | 2" FNPT with 1/2" Tank     |       |

**Sweat Design**

| Part # | Mfg #      | Size                        | Price |
|--------|------------|-----------------------------|-------|
| 089288 | VJS 075-TM | 3/4" Sweat with 1/2" Tank   |       |
| 089289 | VJS 100-TM | 1" Sweat with 1/2" Tank     |       |
| 089290 | VJS 125-TM | 1-1/4" Sweat with 1/2" Tank |       |
| 179832 | VJS 150-TM | 1-1/2" Sweat with 1/2" Tank |       |
| 179833 | VJS 200-TM | 2" Sweat with 1/2" Tank     |       |

**Press Fit Design**

| Part # | Mfg #     | Size         | Price |
|--------|-----------|--------------|-------|
| 233822 | VJP-075TM | 3/4" Press   |       |
| 233823 | VJP-100TM | 1" Press     |       |
| 233824 | VJP-125TM | 1-1/4" Press |       |
| 233825 | VJP-150TM | 1-1/2" Press |       |
| 233826 | VJP-200TM | 2" Press     |       |

**SPIROVENT® SENIOR**

**Steel Air Eliminator**

- MT - Male threads



| Part # | Mfg #      | Size        | Price |
|--------|------------|-------------|-------|
| 020540 | VSR-200-MT | 2" MNPT     |       |
| 024735 | VSR-250-MT | 2-1/2" MNPT |       |
| 030532 | VSR-300-MT | 3" MNPT     |       |

**SPIROVENT® Quad**

**Steel Hydraulic Separator**

- MT - Male threads
- FA - Flanged ASME

| Part # | Mfg #      | Size    | Price |
|--------|------------|---------|-------|
| 138420 | VDX-200-MT | 2" MNPT |       |

**SPIROTRAP® Dirt Separators**

**Brass Dirt Separator**

- Ball valve included
- Patented Spirotube® element



| Part # | Mfg #      | Pipe Size  | Price |
|--------|------------|------------|-------|
| 082005 | TDN-125-FT | 1-1/4" IPS |       |
| 082006 | TDN-150-FT | 1-1/2" IPS |       |

Heating - Hydronic Accessories

## Air Vents

### Boiler Feed Air Vents

#### DuoVent Automatic Air Vent with In-Line Testing Feature

- Maximum temperature: 240°F
- Maximum pressure: 150 psi



| Part # | Mfg #   | Model  | Size | Price |
|--------|---------|--------|------|-------|
| 062989 | 0590719 | WADV18 | 1/8" |       |

#### Automatic Air Vent Valve

- Body and cover are brass construction
- Air vent with silicone rubber seal
- Impurities do not usually affect function as maximum float line of water is always lower than the valve seal
- Float is high temperature resistant polyethylene
- Suitable for use with glycol systems
- Can be disassembled for inspection and cleaning



| Part # | Mfg #   | Model  | Size | Price |
|--------|---------|--------|------|-------|
| 062267 | 0590715 | FV-4M1 | 1/8" |       |

---

---

**Air Vents**

---

---

**Air Vents**  
**Press Air Separator**



| Part # | Mfg # | Size   | Price |
|--------|-------|--------|-------|
| 223028 | 78003 | 3/4"   |       |
| 223029 | 78004 | 1"     |       |
| 223030 | 78005 | 1-1/4" |       |

Heating - Hydronic  
Accessories



## Antifreeze & Other Chemicals

### Harvey Heat Antifreeze



016850



016880



016905

| Part # | Mfg #  | Description                       | Price |
|--------|--------|-----------------------------------|-------|
| 072358 | 16750  | Harvey Heat -100A, 1 gal          |       |
| 072361 | 16760  | Harvey Heat -100A, 5 gal          |       |
| 007733 | 16850  | Harvey Heat -100, 1 gal           |       |
| 019596 | 16860  | Harvey Heat -100, 5 gal           |       |
| 021756 | 16870  | Harvey Heat -100, 55 gal          |       |
| 136190 | 016880 | Harvey Heat RV, 1 gal             |       |
| 108988 | 16900  | Harvey Heat, Arctic Grade, 55 gal |       |
| 069501 | 016905 | Harvey Heat, Arctic Grade, 5 gal  |       |
| 069500 | 016910 | Harvey Heat, Arctic Grade, 1 gal  |       |

Heating - Hydronic  
Accessories

## Antifreeze & Other Chemicals

### Boiler Additives

#### Pro-Tek™ 922 - Hydronic Hot Water Closed-Loop Treatment

- Concentrated corrosion and scale inhibitor treatment specially formulated for hot water, closed-loop heating systems
- Prevents scale and corrosion on aluminum, copper, iron, brass and stainless steel
- Compatible with standard flexible tubing such as PEX and ONIX used in hydronic installations
- Helps control pH & removes oxygen
- Does not contain nitrite
- Non-hazardous



| Part # | Mfg # | Size  | Price |
|--------|-------|-------|-------|
| 137022 | 922-1 | 1 gal |       |

#### Pro-Tek® QT Aerosol Hydronic System Treatment

- Concentrated organic corrosion inhibitor treatment specially formulated for closed loop heating cooling systems
- Helps reduce corrosion on aluminum, brass, copper, iron, and stainless steel
- Non-toxic, environmentally friendly



| Part # | Mfg # | Size | Price |
|--------|-------|------|-------|
| 182853 | 95593 | Kit  |       |

#### RhoGard™ Heat Transfer Fluid

- Aluminum/Stainless Steel safe and multi-metal heat transfer fluid
- Non-toxic, environmentally friendly
- Can be dilute on-site w/ distilled or D.I. water
- Provides freeze protection to < -60°F  
Provides burst protection to -100°F
- Meets and exceeds the corrosion protection requirements of ASTM D1384
- Heating, cooling, and solar system fluid



| Part # | Mfg # | Size   | Price |
|--------|-------|--------|-------|
| 181175 | RG-05 | 5 gal  |       |
| 182834 | RG-55 | 55 gal |       |

#### RhoGard™ RTU Heat Transfer Fluid

- Premixed ready-to-use (RTU) heat transfer fluid
- Blended with virgin propylene glycol and D.I. Water
- Multi-metal corrosion inhibitors and performance additives
- Protects multiple metals, including aluminum & stainless steel
- Requirements of ASTM D1384
- Meets and exceeds the corrosion protection
- Maximizes system efficiency
- Can be custom blended to any glycol % as needed by customer
- Customized freeze or burst protection
- Environmentally friendly
- Non-Toxic



| Part # | Mfg #        | Size  | Price |
|--------|--------------|-------|-------|
| 226215 | RG-RTU-30-05 | 5 gal |       |

#### RhoGard™ Ultra Concentrated Antifreeze

- Aluminum safe and multi-metal antifreeze
- Hydronic and solar system fluid
- Freeze and corrosion protection fluid
- Concentrated Propylene Glycol plus multi-metal corrosion inhibitors
- Protects aluminum, cast iron, copper and steel
- Helps keep heat-exchange surfaces clean
- Helps keep efficiency high
- Non-hazardous
- Burst protection to -100°F
- Environmentally friendly
- Prevents corrosion



| Part # | Mfg #       | Size        | Price |
|--------|-------------|-------------|-------|
| 137009 | RG-ULTRA-5  | 5 gal       |       |
| 184831 | RG-ULTRA-55 | 55 Gal Drum |       |

Heating - Hydronic Accessories

## Antifreeze & Other Chemicals

### Hydro-Solv™ 9100 Hydronic System Cleaner

- Removes bacteria, scale and corrosion
- Cleans aluminum, brass, copper, iron and steel
- Non-hazardous



| Part # | Mfg #           | Size  | Price |
|--------|-----------------|-------|-------|
| 137020 | HYDRO-SOLV 9100 | 1 gal |       |

### EnviroGard™ Ultra Heat HD Transfer Fluid

- All ingredients are listed by the USDA and FDA as (GRAS) "Generally Recognized as Safe".
- Approved by Department of Natural Resources and Department of Health for use in Geothermal Systems
- Concentrated for maximum economy
- Protects cast iron, copper and steel
- Provides freeze, corrosion and scale protection
- Helps keep heat-exchange surfaces clean
- Helps keep efficiency high
- Non-hazardous and non-toxic
- Burst protection to -100°F
- Environmentally friendly

| Part # | Mfg #                   | Size   | Price |
|--------|-------------------------|--------|-------|
| 137478 | ENVIROGARDULTR<br>AHD55 | 55 gal |       |

Heating - Hydronic  
Accessories

---



---

## Antifreeze & Other Chemicals

---



---

### Gunk® Boiler Products

#### Rust Raider®

- Protect entire system
- Turns boiler water blue indicating safe conditions
- Water changes color when additional chemical is need



| Part # | Mfg # | Size  | Price |
|--------|-------|-------|-------|
| 008855 | B5-34 | 1 gal |       |
| 008856 | B5-40 | 5 gal |       |

Heating - Hydronic Accessories

## Antifreeze & Other Chemicals

### Boiler Additives

#### Safe Liquid Boiler Stop Leak

- Forms a water insoluble seal
- Safe to use in all boilers
- Contains no petroleum or hazardous components
- Will not sludge or clog
- Will not surge
- Compatible with propylene glycol and ethylene glycol anti-freeze



| Part # | Mfg #    | Description | Price |
|--------|----------|-------------|-------|
| 010085 | STOPLEAK | 1 qt Can    |       |

#### Squick Boiler Cleaner/Inhibitor with Anti-Foam Silicone SK-24

- Cleans and protects steam boilers by a patented absorption/precipitation process
- Absorbs grease oil, rust, dissolved and suspended solids
- Prevents formation of insulating scale and crystallizing solids
- Prevents corrosion, protects metal surfaces
- Neutralizes free oxygen
- Prevents foaming, surging or priming
- Maximizes heat transfer
- Safe to use in all boilers - contains no petroleum or hazardous components
- No draining, no blow down required



| Part # | Mfg # | Description                | Price |
|--------|-------|----------------------------|-------|
| 010084 | SKSQU | 5 oz Squick Boiler Cleaner |       |

#### #5 Hydronic Formula Cleaner/Inhibitor with Silicon SK-24

- Cleans and protects boilers and hydronic systems
- Prevents formulation of insulating scale on heat transfer surfaces
- Keeps dissolved solids in solution
- Frees and lubricates stuck zone valves
- Dissolves insulating sludge on tankless coils
- Prevents corrosion
- Protects and lubricates pump seals and quiets noisy circulators
- Insures maximum heat transfer
- Safe for all boilers - contains no petroleum or hazardous components
- Compatible with both ethylene glycol and propylene glycol antifreeze



| Part # | Mfg # | Description | Price |
|--------|-------|-------------|-------|
| 010087 | HF-5  | 1 qt        |       |

Heating - Hydronic Accessories





## Antifreeze & Other Chemicals

### Anti-Freeze

#### Cryo-Tek™ Original

- Blend of 45% virgin propylene glycol and the triple protection inhibitor package
- Use in systems fabricated with metal, plastics (except CPVC) and rubber piping, fittings, seals, and other parts



| Part # | Mfg # | Size  | Price |
|--------|-------|-------|-------|
| 161803 | 35260 | 5 gal |       |

#### Cryo-Tek™ 100 Antifreeze

- Contains virgin (not recycled) propylene glycol with triple protection corrosion inhibitor
- Pre-mixed, ready-to-use formulation
- Pink liquid



| Part # | Mfg # | Size  | Price |
|--------|-------|-------|-------|
| 144415 | 35284 | 5 gal |       |

#### Cryo-Tek™ AG

- Concentrated "Arctic Grade" anti-freeze solution
- Blue liquid.
- 100% pure virgin propylene glycol/triple protection inhibitor package
- Cryo-Tek can also be used in radiant tube heating systems, most solar heating systems and geothermal loops



| Part # | Mfg # | Size  | Price |
|--------|-------|-------|-------|
| 176985 | 35285 | 5 gal |       |

### Miscellaneous Chemicals

#### Hercules® Boiler Liquid

- Prevents steam boiler surging
- Will not clog or coat submerged hot water heating coils, controls, vents or valves
- Resists high pressure and is not affected by boiler cleaners
- Will not cause priming or foaming



| Part # | Mfg #  | Size | Price |
|--------|--------|------|-------|
| 192884 | 30-115 | 1 qt |       |

Heating - Hydronic Accessories

**Antifreeze & Other Chemicals**

**Anti-Freeze**

**Alphi-11 Antifreeze Protector**

- Protects against corrosion & lime scale
- Combined antifreeze & protector
- Maintains efficiency so extending system life
- Compatible with all metals and materials commonly used in heating systems
- Non-toxic, environmentally friendly
- Protects heating and chilled water



| Part # | Mfg #    | Description | Price |
|--------|----------|-------------|-------|
| 225281 | Alphi-11 | 5L          |       |

**Protector Test Kit**

- Up to 25 tests per kit



| Part # | Mfg #   | Description            | Price |
|--------|---------|------------------------|-------|
| 177755 | F-57897 | Up to 25 Tests per Kit |       |

**HVAC System Protector F1**

- Central Heating Protector for mixed metal commercial and HVAC heating and cooling systems
- Renders water non-corrosive to steel, cast iron, copper, brass and aluminum
- Prevents lime scale build-up
- Maintains efficiency so extending system life
- Prevents bacterial contamination
- Compatible with all metals and materials commonly used in heating and cooling systems
- Non-toxic, environmentally friendly
- One 2.6 gallon bottle treats 500 gallons of water and one 55 gallon bottle treats 10000 gallons of water



| Part # | Mfg #   | Description | Price |
|--------|---------|-------------|-------|
| 178132 | F-59700 | 2.6 Gallons |       |
| 177750 | F-59900 | Express Can |       |

**HVAC System Cleaner F3**

- Neutral universal cleaner for pre-commissioning new systems in accordance with BS7593:2006
- Removes sludge, limescale and other debris to restore heating efficiency of existing systems
- When used in conjunction with Protector F1 gas savings of up to 15% can be achieved every time you heat your room
- Compatible with all metals and materials commonly used in heating systems
- Easy to use, system can be left running normally during cleaning
- Suitable for use with all known power flushing machines
- pH Neutral, non-hazardous formula (COSHH rated zero)



| Part # | Mfg #   | Description | Price |
|--------|---------|-------------|-------|
| 178131 | F-59701 | 500 ML      |       |

**Cleaner F5**

- Quick, convenient and simple to use – doses in 30 seconds
- Added via a radiator adapter or filling loop supplied
- 100% recyclable can
- Compatible with all metals and materials including aluminum
- Removes sludge and scale and restores heating efficiency
- Removes flux residues and other debris
- pH Neutral, non-hazardous and environmentally formulation



| Part # | Mfg #   | Description        | Price |
|--------|---------|--------------------|-------|
| 177752 | F-59902 | 100 ML Express Can |       |

**Express Boiler Commissioning Kit**

- Treats up to 26 gallons



| Part # | Mfg #   | Description             | Price |
|--------|---------|-------------------------|-------|
| 177754 | F-62089 | Treats up to 26 Gallons |       |

**Aquastats**

**Aquastats®**

**L4006A Immersion Type Aquastat Control**

- Immersion type controllers for limiting or regulating temperatures of liquids in boilers or tanks
- SPST - Breaks circuit on temperature rise
- Visible control point scale and external adjustment screw permit easy setting
- Horizontal or vertical insertion of the sensing element
- Remote bulb model may be used to sense air temperature in ducts and in outside air sensing applications
- Includes: 3" insulation, Stop Factory-Set @240°F, Well Adapter & Heat-Conductive Compound



| Part # | Mfg #      | Temperature Operating Range | Temperature Differential, Mid scale | Price |
|--------|------------|-----------------------------|-------------------------------------|-------|
| 006728 | L4006A1678 | 100°-240°F                  | 5°-30°F Adj                         |       |

**L4006B Immersion Type Aquastat Control**

- Immersion type controllers for limiting or regulating temperatures of liquids in boilers or tanks
- SPST Contacts make on temperature rise
- Includes: 3" Insulation, Stop Factory-Set @240°F, Well Adapter & Heat-Conductive Compound



| Part # | Mfg #      | Temperature Operating Range | Temperature Differential, Mid scale | Price |
|--------|------------|-----------------------------|-------------------------------------|-------|
| 022280 | L4006B1155 | 100° - 240°F                | 5° - 30°F Adj                       |       |

**L4006E Immersion Type Aquastat Control**

- High limit, manual reset
- Contacts break on temp rise
- Immersion type controllers for limiting or regulating temperatures of liquids in boilers or tanks
- Totally enclosed MicroSwitch™ snap-acting switches operate on temperature rise to set point
- Visible control point scale and external adjustment screw permit easy setting
- Horizontal or vertical insertion of the sensing element
- Includes: 3" Insulation, Well Adapter & Heat-Conductive Compound



| Part # | Mfg #      | Temperature Operating Range | Temperature Differential, Mid scale | Price |
|--------|------------|-----------------------------|-------------------------------------|-------|
| 006729 | L4006E1067 | 130° - 270°F                | 250°F                               |       |

Heating - Hydronic Accessories

**Aquastats**

**L6006A Immersion High or Low Limit Aquastat Control, SPDT**

- Remote bulb model may be used to sense air temperature in ducts and outside air sensing applications
- Totally enclosed MicroSwitch<sup>®</sup> snap-acting switch
- Visible control point scale and external adjustment screw permit easy setting
- Horizontal or vertical insertion of the sensing element
- Direct or well immersion of the sensing element
- Select models have wells
- Stop Factory-Set @ 240°F, Heat-Conductive Compound



| Part # | Mfg #      | Temperature Operating Range | Temperature Differential, Mid scale                | Price |
|--------|------------|-----------------------------|--|-------|
| 006740 | L6006A1145 | 100° - 240°F                | Stop Factory-Set @ 240°F, Heat-Conductive Compound |       |

**L6006C Strap-On Mount High or Low Circulator Control, SPDT**

- Remote bulb model may be used to sense air temperature in ducts and outside air sensing applications
- Totally enclosed MicroSwitch<sup>™</sup> snap-acting switch operates on temperature rise
- Visible control point scale and external adjustment screw permit easy setting
- Horizontal or vertical insertion of the sensing element
- Select models have wells



| Part # | Mfg #      | Temperature Operating Range | Includes:                | Price |
|--------|------------|-----------------------------|--------------------------|-------|
| 006741 | L6006C1018 | 65° - 200°F                 | Stop Factory-Set @ 200°F |       |

**Aquastat<sup>®</sup> Relays**

**L8148 Aquastat<sup>®</sup> Relay**

- Immersion-type controllers that combine high limit protection with switching relay control of burner and circulator motors
- High limit opens burner circuit only
- Includes transformer and accessory terminals for adding a remote low limit controller
- Requires 24VAC thermostat with heat anticipator set at 0.2 amps
- Includes well adapter and heat-conductive compound
- Mounts horizontally or vertically
- Maximum Bulb: 40° over selected set point up to 265°F
- Maximum Ambient: 150° including zone valves with low voltage loads up to 1.2 amps



| Part # | Mfg #      | Description  | Price |
|--------|------------|--|-------|
| 093128 | L8148E1265 | Line Voltage, 180° - 240°F High Limit, 4-1/2" Capillary, Vertical Mount                        |       |
| 006743 | L8148J1009 | Millivolt or Low Voltage, 120° - 240°F High Limit, 4-1/2" Capillary, Vertical/Horizontal Mount |       |

**Aquastats**

**Aquastat® Controllers**  
**L8100 Aquastat® Controller**

- Immersion type controller for regulating and limiting tank temperature in water heaters
- Provides energy cutoff (ECO) action on temperature rise past set point
- Includes second sensing element to sense average water temperature to minimize stacking
- Internal adjustment screw
- Operating temperature range: 100° to 180°F



| Part # | Mfg #      | Description   | Price |
|--------|------------|---|-------|
| 150551 | L8100B1037 | SPST, Contacts Break on Temperature Rise, 42" Capillary |       |

**Accessories**  
**Heat Conductive Compound**

| Part # | Mfg #   | Description                   | Price |
|--------|---------|-------------------------------|-------|
| 076507 | 107408  | 4 oz Heat Conductive Compound |       |
| 179645 | 120650U | 1/2 oz Heat Conductive Grease |       |

**Well Assemblies**



| Part # | Mfg #   | Description  | Price |
|--------|---------|--|-------|
| 006831 | 121371A | 3/8" x 3" Bulb Size, Copper 1/2" NPT, 1-1/2" Insulation, 3" Insertion Well with Mounting Clamp |       |
| 006832 | 121371B | 3/8" x 3" Bulb Size, Copper 3/4" NPT, 1-1/2" Insulation, 3" Insertion Well with Mounting Clamp |       |

**Thermometers**

**Thermometer with Thermowell**

- Thermowell included to allow thermometer to be removed without draining the system
- Steel case, brass well



| Part # | Mfg # | Connection | Dial            | Temperature Range | Price |
|--------|-------|------------|-----------------|-------------------|-------|
| 095933 | GT162 | 1/2" NPT   | 2-1/2" Diameter | 32° - 250°F       |       |

Heating - Hydronic Accessories

## Baseboard Radiation

### Therma Trim Hydronic Baseboards Therma Trim Baseboard Enclosure



| Part # | Mfg #       | Description                              | Price |
|--------|-------------|--|-------|
| 135109 | 611-111-005 | 2' Baseboard Enclosure with 3/4" Element |       |
| 135112 | 611-111-010 | 3' Baseboard Enclosure with 3/4" Element |       |
| 135113 | 611-111-015 | 4' Baseboard Enclosure with 3/4" Element |       |
| 135114 | 611-111-020 | 5' Baseboard Enclosure with 3/4" Element |       |
| 135115 | 611-111-025 | 6' Baseboard Enclosure with 3/4" Element |       |
| 135116 | 611-111-030 | 7' Baseboard Enclosure with 3/4" Element |       |
| 135117 | 611-111-035 | 8' Baseboard Enclosure with 3/4" Element |       |
| 135126 | 611-311-075 | 2' Baseboard Enclosure                   |       |
| 135127 | 611-311-080 | 3' Baseboard Enclosure                   |       |
| 135128 | 611-311-085 | 4' Baseboard Enclosure                   |       |
| 135129 | 611-311-090 | 5' Baseboard Enclosure                   |       |
| 135130 | 611-311-095 | 6' Baseboard Enclosure                   |       |
| 135131 | 611-311-100 | 7' Baseboard Enclosure                   |       |
| 135132 | 611-311-105 | 8' Baseboard Enclosure                   |       |

### Therma Trim Baseboard Heating Element

| Part # | Mfg #       | Description                       | Price |
|--------|-------------|-----------------------------------|-------|
| 135118 | 611-211-040 | 2' Baseboard 3/4" Heating Element |       |
| 135119 | 611-211-045 | 3' Baseboard 3/4" Heating Element |       |
| 135120 | 611-211-050 | 4' Baseboard 3/4" Heating Element |       |
| 135122 | 611-211-055 | 5' Baseboard 3/4" Heating Element |       |
| 135123 | 611-211-060 | 6' Baseboard 3/4" Heating Element |       |
| 135124 | 611-211-065 | 7' Baseboard 3/4" Heating Element |       |
| 135125 | 611-211-070 | 8' Baseboard 3/4" Heating Element |       |

### Therma Trim Baseboard Accessories

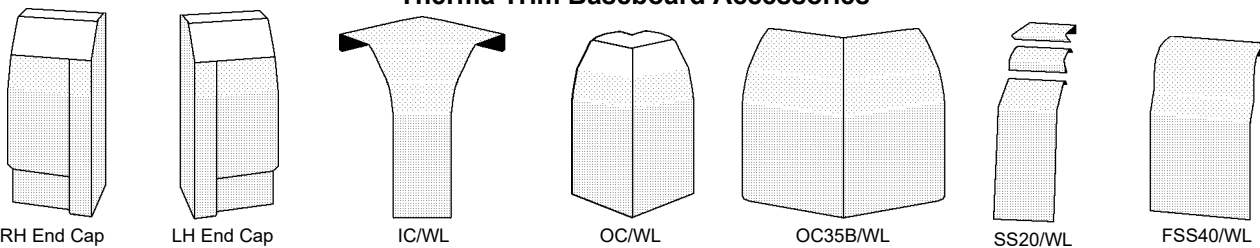

| Part # | Mfg #       | Description                     | Price |
|--------|-------------|---------------------------------|-------|
| 135135 | 611-411-145 | 4" Baseboard LH End Cap w/Hinge |       |
| 135136 | 611-411-150 | 4" Baseboard RH End Cap w/Hinge |       |
| 135137 | 611-411-155 | 2" Baseboard LH End Cap         |       |
| 135138 | 611-411-160 | 2" Baseboard RH End Cap         |       |
| 135139 | 611-411-185 | 2" Baseboard Full Front Splice  |       |
| 135140 | 611-411-190 | 90° Inside Corner               |       |
| 135141 | 611-411-195 | 90° Outside Corner              |       |
| 135142 | 611-411-205 | 135° Outside Bay Corner         |       |
| 135143 | 611-411-210 | 135° Inside Bay Corner          |       |
| 135144 | 611-411-225 | Support Bracket with Pivot      |       |

---

---

## Baseboard Radiation

---

---

### Therma Trim Hydronic Baseboards (Continued) Therma Trim Baseboard Accessories

| Part # | Mfg #       | Description                  | Price |
|--------|-------------|------------------------------|-------|
| 047845 | 611-490-226 | Baseboard Supply Tube Hanger |       |

Heating - Hydronic  
Accessories

**Boiler & Zone Controls**

**Commercial Remote Temperature Controls**

**T775 Electronic Remote Temperature Controller**

- Includes platinum sensor
- Set point range: -40° to 248°F
- Differential temperature: 1° to 150°F
- Heat or cool
- 24/120/240VAC, 50/60Hz



| Part # | Mfg #       | Control Mode | Temp Inputs | Relay Outputs | Notes                    | Price |
|--------|-------------|--------------|-------------|---------------|--------------------------|-------|
| 141882 | T775P2003   | SPDT         | 3           | 4             | 50021579-001 (Three)     |       |
| 190396 | T775L2007/U | SPDT         | 2           | 4             | Stage Sequencer w/ Reset |       |

**Pressuretrol® Pressure Controllers**

**PA404A Pressuretrol® Controller**

- Provides control for steam pressure
- Sensitive pressure-actuated diaphragm expands or contracts with pressure variations moving lever mechanism operating snap-switch
- SPST Snap-acting switch
- Differential: 1 to 5 psi
- Safety control for steam heating boilers, breaks an electrical circuit to shut down burner if steam pressure rises above safe level
- Makes at set point on pressure fall, breaks at set point plus differential on pressure rise



| Part # | Mfg #      | Description          | Price |
|--------|------------|----------------------|-------|
| 006744 | PA404A1033 | SPST, 0.5 to 9.0 psi |       |

**PA404B Pressuretrol® Controller**

- Provides control for steam pressure
- Sensitive pressure-actuated diaphragm expands or contracts with pressure variations moving lever mechanism operating snap-switch
- SPST Snap-acting switch
- Used with suspension-type unit heaters to make the fan circuit when a pressure rise indicates the presence of steam
- Breaks at setpoint on pressure fall, makes at setpoint plus differential on pressure rise



| Part # | Mfg #      | Description  | Price |
|--------|------------|--|-------|
| 042522 | PA404B1023 | Pressuretrol Controller, SPST, 0.5 to 9.0 psi, 1 to 5 psi Differential |       |



**Boiler & Zone Controls**

**Aquatrol® Boiler Controls**

**AQ254 Aquatrol® Add-A-Temperature Expansion Control Panel**

- Used in conjunction with an AQ250, AQ25A, AQ251 or AQ252 control panels
- Provides one additional loop temperature control capability for the AQ2000 control panel it is connected to and expands the total network capacity by up to (16) zones when used with AQ255 and/or AQ257 zoning panels



| Part # | Mfg #    | Description                               | Price |
|--------|----------|---|-------|
| 134582 | AQ25400B | Add-a-Temperature Expansion Control Panel |       |

**AQ255/AQ257 Aquatrol® Expansion Zoning Panel**

- For zoning with pumps or zone valves
- Easily switch from zone valves to pumps with same zoning module - just flip one DIP switch
- Ensures correct voltage is applied to all zone equipment on a panel (120VAC for pumps, 24VAC for valves)
- Works with AQ1000 2-wire communicating thermostats and most digital thermostats and AQ2000 boiler control panels
- Can be combined with additional expansion zoning panels and an AQ2000 control panel for a total of (16) space heating zones



| Part # | Mfg #    | Description  | Price |
|--------|----------|--|-------|
| 134583 | AQ25542B | Aquatrol Zoning Panel for (4) Zones of Pumps less End Switches |       |

Heating - Hydronic Accessories

**Parts & Accessories**  
**Programmable Timers, Clock Type**

- Switching: 1 spdt
- Universal application with 24-hour or 7-day programming
- Battery backup (quartz drive)
- Screw wiring terminals
- Three-way override
- Captive trippers



| Part # | Mfg #       | Description   | Price |
|--------|-------------|---|-------|
| 149677 | ST6008B1005 | Programmable Timers, Clock Type Universal Application 7-Day |       |

## Boiler & Zone Controls

### Zone Controls

#### Zone Circulator Switching Relay

- Universal replaceability and thermostat compatibility
- Indicator lights
- Snap-in PC board to existing enclosure
- Fully enclosed snap-out relay
- UL Approved

1-Zone



| Part # | Mfg #   | Number of Zones | Maximum Voltage (Input) | Maximum Combined Load | Enclosure Dimensions H x W x D | Price |
|--------|---------|-----------------|-------------------------|-----------------------|--------------------------------|-------|
| 088487 | SR501-2 | 1               | 120VAC                  | 5A                    | 5-1/4" x 4-1/4" x 2-3/4"       |       |
| 095583 | SR502   | 2 with Priority | 120VAC                  | 15A                   | 6-3/4" x 10-1/4" x 2-3/4"      |       |
| 068767 | SR503   | 3 with Priority | 120VAC                  | 15A                   | 6-3/4" x 10-1/4" x 2-3/4"      |       |
| 068768 | SR504   | 4 with Priority | 120VAC                  | 20A                   | 6-3/4" x 10-1/4" x 2-3/4"      |       |
| 095584 | SR506   | 6 with Priority | 120VAC                  | 20A                   | 7-1/2" x 11-3/4" x 3"          |       |

#### Zone Valve Control

- All zone valve controls are relay type DPDT and have single phase motor rating per zone of 1/7 hp (SA) @ 120VAC
- (-EXP) expandable power port

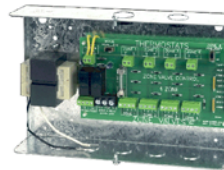

ZVC404



ZVC406

| Part # | Mfg #      | Number of Zones | Transformer Voltage (Input) | Max Output At 24 VAC | Enclosure Dimensions H x W x D | Price |
|--------|------------|-----------------|-----------------------------|----------------------|--------------------------------|-------|
| 095585 | ZVC403-2   | 3 with Priority | 120VAC                      | 40 VA                | 6-3/4" x 10-1/4" x 2-3/4"      |       |
| 095587 | ZVC404-2   | 4 with Priority | 120VAC                      | 40 VA                | 6-3/4" x 10-1/4" x 2-3/4"      |       |
| 166151 | ZVC404-EXP | 4 with Priority | 120VAC                      | 40VA                 | 6-3/4" x 10-1/4" x 2-3/4"      |       |
| 095588 | ZVC405-3   | 5 with Priority | 120VAC                      | 80 VA                | 7-1/2" x 11-3/4" x 3"          |       |
| 095590 | ZVC406-3   | 6 with Priority | 120VAC                      | 80 VA                | 7-1/2" x 11-3/4" x 3"          |       |

**Boiler & Zone Controls**

**Single-Stage Low Voltage Thermostats**

**Universal Single-Stage Mechanical Replacement Thermostat**

- Mercury free
- 24V Replacement for hundreds of White-Rodgers and competitive models installed during the past 50-years
- Same footprint as older models with updated styling
- Enclosed contacts for increased reliability and accuracy
- Heat/cool with heating or cooling 3-wire zone mounting plate included
- Packaging is bilingual (English/Spanish)
- 5-Year warranty



| Part # | Mfg #     | System        | Applications  | Style      | Color | Terminals         | Price |
|--------|-----------|---------------|---------------|------------|-------|-------------------|-------|
| 145434 | 1F56N-444 | 1 Heat/1 Cool | 24V, mV, 3wZn | Horizontal | White | RC,RH,W,Y,G,O,B,A |       |

**Snap Disc Controls**

**3F05 / 3L05 Series Adjustable Snap Disc Fan & Limit Controls**

- 1/4" quick connect terminals are standard.
- Reduces inventory while providing coverage for a wide range of temperature applications.
- Replaces the majority of fixed disc thermostats now on heating equipment and various appliances.
- 2 adjustable fan control models replace 7 fixed snap disc models.
- 5 adjustable limit control models replace 10 fixed snap disc models.



| Part # | Mfg #   | Temperature Range | Differential | Switch Action | Function       | Price |
|--------|---------|-------------------|--------------|---------------|----------------|-------|
| 153005 | WR3F051 | 90 to 130°F       | 20°F         | SPST          | Fan Controls   |       |
| 153003 | WR3L051 | 135 to 175°F      | 40°F         | SPST          | Limit Controls |       |
| 222881 | WR3L052 | 175 to 215°F      | 40°F         | SPST          | Limit Controls |       |

Heating - Hydronic Accessories

**Boiler & Zone Controls**

**Heating Controls**

**356 Mixing Control**

- Microprocessor-based (PID) outdoor reset control
- Designed to operate a permanent capacitor, impedance protected or equivalent pump at varying speeds
- Provides for boiler minimum protection and operation
- 120VAC Rated relay outputs

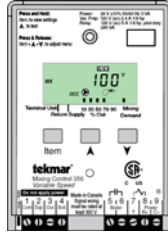

| Part # | Mfg # | Description                               | Price |
|--------|-------|---|-------|
| 047999 | 356   | Variable Speed Reset Controller w/Sensors |       |

**Thermostats**

**Setpoint Controls**

- Microprocessor based control
- Extremely accurate +/- 0.5°F
- Wide temperature ranges
- Remote sensing up to 500 feet
- Large load relay capacity
- Low power consumption

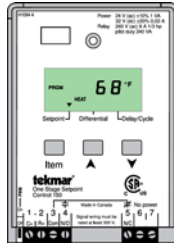

| Part # | Mfg # | Description              | Price |
|--------|-------|--------------------------|-------|
| 030576 | 150   | 1-Stage Setpoint Control |       |

**Boiler/DHW Controls**

**256 Boiler Control**

- Microprocessor-based (PID) control
- Regulates supply water temperature from a single boiler based on outdoor temperature
- Includes:
  - Warm weather shut down (WWSD)
  - Minimum boiler setting
  - Liquid crystal display (LCD)

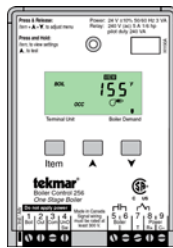

| Part # | Mfg # | Description            | Price |
|--------|-------|------------------------|-------|
| 047998 | 256   | 1-Stage Boiler Control |       |

**274 Boiler Control**

- Microprocessor PID control
- One tN4, four stage boiler & DHW/setpoint control
- Can provide outdoor reset, domestic hot water and setpoint operation with priority
- Not a safety (limit) control
- Indoor use only
- Operates up to four on/off boilers

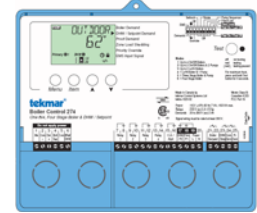

| Part # | Mfg # | Description   | Price |
|--------|-------|---|-------|
| 127773 | 274   | Boiler Control (1) tN4, 4-Stage Boiler & DHW/Setpoint |       |

**Snow Melting Controls**

**Automatic Snow Melting Control**

- Automatic snow/ice detection
- Warm weather cut-off
- Cold weather cut-off
- Accurate slab temperature control
- Slab outdoor reset



090/091

| Part # | Mfg # | Description            | Price |
|--------|-------|------------------------|-------|
| 020296 | 090   | Snow/Ice Sensor        |       |
| 020298 | 091   | Snow/Ice Sensor Socket |       |

**667 Snow Detector & Melting Control**

- Variable speed injection
- When combined with 090 snow/ice sensor provides automatic snow/ice detection
- Operates a variable speed injection pump to provide several protection and control features
- Microprocess PID control
- Not a safety (limit) control

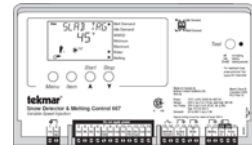

| Part # | Mfg # | Description                     | Price |
|--------|-------|---------------------------------|-------|
| 065840 | 667   | Snow Detector & Melting Control |       |

**Boiler & Zone Controls**

**Sensors**

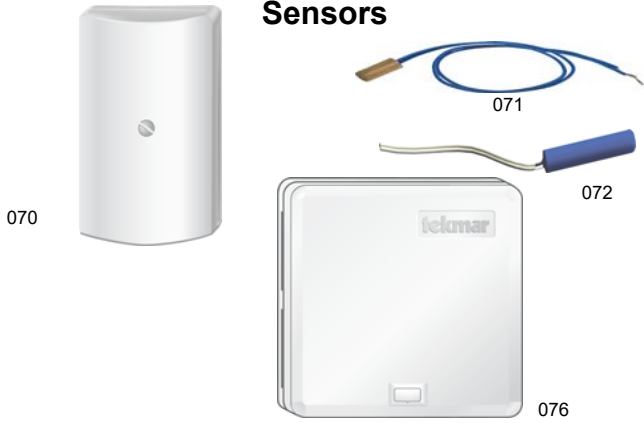

| Part # | Mfg # | Description                                | Price |
|--------|-------|--|-------|
| 065350 | 070   | Outdoor Sensor                             |       |
| 037312 | 071   | Universal Sensor w/12" 2-Cond Wire         |       |
| 044387 | 072   | Slab Sensor w/PVC Sleeve & 20' 2-Cond Wire |       |
| 044864 | 076   | Indoor Sensor, Surface Mount               |       |

*Heating - Hydronic  
Accessories*

---



---

## Boiler Accessories

---



---

### Hose End Valves

#### 74-CL Multi-Turn Boiler Drain

- *Buna-N seat*
- *125 psi to 100°F*
- *Max temp: 180°F*
- *Screw-in bonnet*



| Part # | Mfg #   | Size | Price |
|--------|---------|------|-------|
| 168326 | N64N008 | 1/2" |       |
| 168327 | N64N006 | 3/4" |       |

Heating - Hydronic  
Accessories

## Boiler Drains

### Boiler Drains

#### BD Series Brass Boiler Drain Shut-Off

- 3/4" Hose thread connection on outlet
- Brass body construction
- Cast iron hand wheel
- Maximum pressure: 200 psi
- Maximum temperature: 180°F



| Part # | Mfg #   | Model | Size           | Pattern | Price |
|--------|---------|-------|----------------|---------|-------|
| 013030 | 0820901 | BD1C  | 1/2" Dual Conn | Angle   |       |
| 014608 | 0820902 | BD2C  | 3/4" MNPT      | Angle   |       |

#### BT Series 1/4-Turn Boiler Drain Shut-Off

- 3/4" Hose thread connection on outlet
- Brass body construction
- Tee handle with positive shutoff
- Adjustable Teflon® stem packing
- Maximum pressure: 200 psi



| Part # | Mfg #   | Model | Size                                | Price |
|--------|---------|-------|-------------------------------------|-------|
| 053099 | 0820955 | BD-QT | 1/2" Dual Pattern,<br>MIP or Solder |       |
| 053100 | 0820956 | BD-QT | 3/4" MNPT                           |       |

**Boiler Accessories**

**Boiler Drains**

**Quarter-Turn Boiler Drain**

- CSA certified for Canadian plumbing applications.
- End connections comply with -ANSI / ASME B1.20.1 (MNPT)
- Manufactured in an ISO accredited facility
- Forged brass construction



| Part # | Mfg # | Size | Price |
|--------|-------|------|-------|
| 195163 | R-670 | 1/2" |       |
| 195571 | R-670 | 3/4" |       |

**Lead Free Boiler Drain**

- Certified to ANSI / NSF Standard 61-G
- End connections comply with ANSI / ASME B1.20.1 (FNPT)  
ANSI / ASME B1.20.7 (Male Garden)



| Part # | Mfg # | Size      | Price |
|--------|-------|-----------|-------|
| 191910 | T-522 | 1/2" FNPT |       |
| 191911 | T-522 | 3/4" FNPT |       |

Heating - Hydronic Accessories



## Circulator Pumps

### UP Circulator Pumps - Closed Systems

- Wet rotor, single-stage, direct drive centrifugal pumps designed for domestic and light commercial applications
- Built-in motor protection
- Quiet, maintenance-free performance
- Flushed bearing design
- 60Hz
- Maximum working pressure: 145 psi
- Minimum fluid temperature: 36°F (unless noted)
- 2-Pole motor, single-phase
- 3-Year warranty

#### UP 15-42F Brute II® Cast Iron Circulator Pump

- Cast iron construction
- For residential and light commercial applications
- Flange: (2) 1/2" diameter bolt holes
- Flow range: 0 to 17 gpm
- Head range: 0 to 15'
- 1/2 hp



| Part # | Mfg #   | Amps  | Volts | Capacitor | Price |
|--------|---------|-------|-------|-----------|-------|
| 004957 | UP1542F | 0.74A | 115V  | 10µF/180V |       |

#### UPS 15-58FC/FRC (3-Speed Motor) SuperBrute Cast Iron Circulator Pump

- Fits most standard hydronic applications
- Cast iron construction
- Includes removable check valve
- Flange - (2) 1/2" diameter bolt holes
- Flow range: 0 to 17 gpm
- Head range: 0 to 19.5'
- Minimum liquid temperature: 36°F
- Maximum liquid temperature: 230°F
- 1/25 hp



| Part # | Mfg #      | Amps        | Volts | Capacitor | Price |
|--------|------------|-------------|-------|-----------|-------|
| 076106 | UPS1558FC  | 0.55-0.75A  | 115V  | 10µF/180V |       |
| 118361 | UPS1558FRC | *0.55-.075A | 115V  | 10µF/180V |       |

\* Reversing

### UP 26-64F Cast Iron Circulator Pump

- Cast iron construction
- Flange: (2) 1/2" diameter bolt holes
- Flow range: 0 to 32 gpm
- Head range: 0 to 24.5'
- 1/12 hp



| Part # | Mfg #   | Amps | Volts | Capacitor | Price |
|--------|---------|------|-------|-----------|-------|
| 004960 | UP2664F | 1.7A | 115V  | 8µF/180V  |       |

Less Flanges

### UPS 26-99FC (3-Speed Motor) SuperBrute Cast Iron Circulator Pump

- Cast iron construction
- Includes removable check valve
- Flange: (2) 1/2" diameter bolt holes
- Flow range: 0 to 33 gpm
- Head range: 0 to 29'
- Minimum liquid temperature: 36°F
- Maximum liquid temperature: 230°F
- 1/6 hp



| Part # | Mfg #     | Amps     | Volts | Capacitor | Price |
|--------|-----------|----------|-------|-----------|-------|
| 098645 | UPS2699FC | 1.3-1.8A | 115V  | 20µF/180V |       |
| 106130 | UPS2699FC | 1.3-1.8A | 230V  | 20µF/180V |       |

### UPS Series 3-Speed Motor Circulator Pump with IFC

- Stainless steel construction
- Includes removable check valve
- Includes 2 gaskets (O-rings)
- Whisper-quiet operation
- Flanged: 1/2", 3/4", 1", 1-1/4"
- Flow range: 0 to 33 gpm
- Head range: 0 to 29'
- Minimum liquid temperature: 36°F
- Maximum liquid temperature: 230°F
- 1/6 hp



| Part # | Mfg #      | Amps     | Volts | Capacitor | Price |
|--------|------------|----------|-------|-----------|-------|
| 185595 | UPS2699SFC | 1.3-1.8A | 115V  | 20µF/180V |       |

Heating - Hydronic Accessories

## Circulator Pumps

### UP 26-99F Cast Iron Circulator Pump

- Cast iron construction
- Flange: (2) 1/2" diameter bolt holes
- Flow range: 0 to 34 gpm
- Head range: 0 to 32'
- Minimum liquid temperature: 32°F
- Maximum liquid temperature: 230°F
- 1/6 hp



| Part # | Mfg #   | Amps  | Volts | Capacitor                 | Price |
|--------|---------|-------|-------|---------------------------|-------|
| 004963 | UP2699F | 2.15A | 115V  | 10µF/380V                 |       |
| 004962 | UP2699F | 2.15A | 115V  | 10µF/380V<br>Less Flanges |       |
| 059847 | UP2699F | 1.07A | 230V  | 2.5µF/180V                |       |

### UP 26-116F Cast Iron Circulator Pump

- Cast iron construction
- Flange: (2) 1/2" diameter bolt holes
- Flow range: 0 to 37 gpm
- Head range: 0 to 37'
- Minimum liquid temperature: 32°F
- Maximum liquid temperature: 150°F
- 1/6 hp



| Part # | Mfg #    | Amps  | Volts | Capacitor  | Price |
|--------|----------|-------|-------|------------|-------|
| 079629 | UP26116F | 1.75A | 230V  | 2.5µF/380V |       |

### UPS 43-44FC (3-Speed Motor) SuperBrute Cast Iron Circulator Pump

- Cast iron construction
- For applications requiring higher head
- Includes removable check valve
- 2-Pole, single-phase
- Flange: (2) 1/2" diameter bolt holes
- Flow range: 0 to 63 gpm
- Head range: 0 to 14'
- Minimum liquid temperature: 32°F
- Maximum liquid temperature: 230°F
- Maximum system pressure: 145 psi
- 1/6 hp



| Part # | Mfg #     | Amps     | Volts | Capacitor | Price |
|--------|-----------|----------|-------|-----------|-------|
| 098646 | UPS4344FC | 1.4-1.8A | 115V  | 20µF/180V |       |

### UP 43-75F Cast Iron Circulator Pump

- Cast iron construction
- Flange: (2) 1/2" diameter bolt holes
- Flow range: 0 to 41 gpm
- Head range: 0 to 25'
- 1/6 hp



| Part # | Mfg #   | Amps  | Volts | Capacitor | Price |
|--------|---------|-------|-------|-----------|-------|
| 004964 | UP4375F | 2.15A | 115V  | 10µF/180V |       |

### UPS 26-150F (3-Speed Motor) SuperBrute Cast Iron Circulator Pump

- Cast iron construction
- Flow range: 0 to 53 gpm
- Head range: 0 to 46'
- Flange: (2) 1/2" diameter bolt holes
- 2-Pole, single-phase
- Minimum liquid temperature: 36°F
- Maximum liquid temperature: 230°F
- Maximum system pressure: 145 psi
- 1/6 hp



| Part # | Mfg #     | Amps     | Volts | Capacitor | Price |
|--------|-----------|----------|-------|-----------|-------|
| 130966 | UPS26150F | 2.5-3.5A | 115V  | 40µF/180V |       |

### UPS 43-100F (3-Speed Motor) SuperBrute Cast Iron Circulator Pump

- Flow range: 0 to 65 gpm
- Head range: 0 to 31'
- Flange: (2) 1/2" diameter bolt holes
- 2-Pole, single-phase
- Minimum liquid temperature: 36°F
- Maximum liquid temperature: 230°F
- Maximum system pressure: 145 psi
- 1/6 hp



| Part # | Mfg #     | Amps | Volts | Capacitor | Price |
|--------|-----------|------|-------|-----------|-------|
| 130968 | UPS43100F | 3.5A | 115V  | 40µF/180V |       |

## Circulator Pumps

### Series UP Comfort Recirculation Pump

#### UP 10-16B5 Hot Water Recirculation Pump

- Specifically designed for heating systems
- Flow range: 0 to 3.5 gpm
- Head range: 1 to 5.4'
- Minimum fluid temperature: 36°F
- Maximum fluid temperature: 203°F
- Maximum working pressure: 145 psi
- Features:
  - LC = Line cord
  - TLC - Timer and line cord
  - ATLC = Aquastat, timer, line cord
  - BU ATLC = Aquastat, timer, line cord, check valve and isolation valve



| Part # | Mfg #          | Connection   | Price |
|--------|----------------|--------------|-------|
| 057808 | UP1016BU/AT LC | 1-1/4" Union |       |

#### Comfort PM Auto Hot Water Recirculation Pump

- 115V, Auto, check valve
- 1-1/4" NPSM union
- 6' line cord included
- Easy installation
- Minimize water waste
- Lower energy consumption
- Learns and adapts to homeowner's water temp needs



| Part # | Mfg #           | Connection        | Price |
|--------|-----------------|-------------------|-------|
| 171389 | UP1016APMB U/LC | 1-1/4" NPSM Union |       |

#### UP Comfort Series Recirculation Kit

- Includes:
  - (1) Pump
  - (1) Valve
  - (2) 1/2" FNPS x 1/2" FNPS x 12" Stainless steel flex hoses



| Part # | Mfg #  | Description       | Price |
|--------|--------|-------------------|-------|
| 061116 | 595916 | Recirculation Kit |       |

### UP Circulator Pumps - Open Systems

- Wet rotor, single-stage, direct drive centrifugal pumps designed for domestic & light commercial applications
- For open systems 140°F is maximum recommended fluid temp to avoid precipitation of calcium in water
- Built-in motor protection
- Quiet, maintenance-free performance
- Flushed bearing design
- 60Hz
- 2-Pole, single-phase

#### UP 15-10B5 Circulator Pump

- Brass, lead-free housing
- 115V, 0.22A, 25W, 1/25 hp
- Capacitor: 2µF/400V



| Part # | Mfg #    | Connection | Price |
|--------|----------|------------|-------|
| 039691 | UP1510B5 | 1/2" Sweat |       |
| 040255 | UP1510B7 | 3/4" Sweat |       |

#### UP 15-42B5 Bronze Circulator Pump

- Bronze construction
- 1/2" Sweat connection
- UP15-42B5 Includes line cord
- LC/TLC Models have 6'3" power cord
- 1/25 hp



| Part # | Mfg #    | Amps  | Volts | Capacitor | Price |
|--------|----------|-------|-------|-----------|-------|
| 023051 | UP1542B5 | 0.74A | 115V  | 10µF/180V |       |

#### UPS 15-55SFC (3-Speed Motor) SuperBrute Stainless Circulator Pump

- Stainless construction
- Flange: (2) 1/2" diameter bolt holes
- Includes removable check valve
- Flow rate: 0 to 25 gpm
- Head range: 0 to 18'
- 2-Pole, single-phase
- Minimum liquid temperature: 36°F
- Maximum liquid temperature: 230°F
- Maximum system pressure: 145 psi
- 0.12 hp



| Part # | Mfg #      | Amps     | Volts | Capacitor | Price |
|--------|------------|----------|-------|-----------|-------|
| 110243 | UPS1555SFC | .53-.75A | 115V  | 10µF/180V |       |

Heating - Hydronic Accessories

## Circulator Pumps

### UP 26-96BF Bronze Circulator Pump

- Bronze construction
- Flange: (2) 1/2" diameter bolt holes
- Flow range: 0 to 28 gpm
- Head range: 0 to 30'
- 1/12 hp



| Part # | Mfg #    | Amps | Volts | Capacitor  | Price |
|--------|----------|------|-------|------------|-------|
| 004961 | UP2696BF | 1.7A | 115V  | 110µF/180V |       |

### UPS 43-100F Superbrute Circulator Pump

- Ceramic shaft and radial bearings
- Carbon axial bearing
- Stainless steel rotor can and bearing plate
- Corrosion-resistant impeller, composite, PES
- Cast iron pump housing.



| Part # | Mfg #     | Amps     | Volts | Capacitor   | Price |
|--------|-----------|----------|-------|-------------|-------|
| 130969 | UPS43100F | 1.2-1.7A | 230V  | 10 µF/400 V |       |

### UPS 26-99BFC (3-Speed Motor) SuperBrute Bronze Circulator Pump

- Bronze construction
- Flange: (2) 1/2" diameter bolt holes
- Includes removable check valve
- Flow range: 0 to 33 gpm
- Head range: 0 to 29'
- Minimum liquid temperature: 36°F
- Maximum liquid temperature: 230°F
- Maximum system temperature: 145 psi
- 1/6 hp



| Part # | Mfg #      | Amps     | Volts | Capacitor | Price |
|--------|------------|----------|-------|-----------|-------|
| 109851 | UPS2699BFC | 1.3-1.8A | 115V  | 20µF/180V |       |

### UP 26-116BF Bronze Circulator Pump

- Cast iron construction
- Flange: (2) 1/2" diameter bolt holes
- Flow range: 0 to 37 gpm
- Head range: 0 to 37'
- Minimum liquid temperature: 32°F
- Maximum liquid temperature: 150°F
- 1/6 hp



| Part # | Mfg #     | Amps  | Volts | Capacitor  | Price |
|--------|-----------|-------|-------|------------|-------|
| 099263 | UP26116BF | 1.75A | 115V  | 2.5µF/380V |       |

### UPS 26-150F Superbrute Circulator Pump

- Cast iron construction
- 3-Speed
- Ceramic shaft and radial bearings
- Carbon axial bearing
- Stainless steel rotor can and bearing plate
- Corrosion-resistant impeller, composite, PES
- Cast iron pump housing



| Part # | Mfg #       | Amps | Volts | Capacitor   | Price |
|--------|-------------|------|-------|-------------|-------|
| 130967 | UPS26150F   | 3.5A | 230V  | 40 µF/180 V |       |
| 133525 | UPS26-150SF | 3.5A | 115V  | 40 µF/180 V |       |

### UP 15-29SF Stainless Circulator Pump

- Stainless steel construction
- Flange pipe connection
- Flow range: 0 to 20.5 gpm
- Head range: 0 to 9.7'
- Maximum fluid temperature: 230°F
- 0.12 hp



| Part # | Mfg #    | Amps  | Volts | Capacitor | Price |
|--------|----------|-------|-------|-----------|-------|
| 109850 | UP1529SF | 0.75A | 115V  | 10µF/180V |       |

### UP 15-29SU Stainless Circulator Pump

- Stainless steel construction
- 1/4" Union pipe connection
- Flow range: 0 to 20.5 gpm
- Head range: 0 to 9.7'
- Maximum fluid temperature: 230°F
- T Suffix: timer
- LC Suffix: 6', 3-prong line cord
- 0.12 hp

| Part # | Mfg #             | Amps  | Volts | Capacitor | Price |
|--------|-------------------|-------|-------|-----------|-------|
| 114552 | UP1529<br>SUC/TLC | 0.75A | 115V  | 10µF/180V |       |

Heating - Hydronic Accessories

## Circulator Pumps

### UPS 15-35SFC (3-Speed Motor) Super Brute Stainless Circulator Pump

- Stainless steel construction
- Flange pipe connection
- Capacitor: 10µF/180V
- Flow range: 0 to 21.5 gpm
- Head range: 0 to 12'
- 2-Pole, single-phase
- Minimum liquid temperature: 36°F
- Maximum liquid temperature: 165°F
- Maximum system pressure: 145 psi
- Removable check valve
- 1/3 hp



| Part # | Mfg #      | Amps       | Volts | Price |
|--------|------------|------------|-------|-------|
| 110113 | UPS1535SFC | 0.06-0.95A | 115V  |       |

### UP 43-75BF Bronze Circulator Pump

- Bronze construction
- Flange: (2) 1/2" diameter bolt holes
- Flow range: 0 to 41 gpm
- Head range: 0 to 25'
- 1/6 hp



| Part # | Mfg #    | Amps  | Volts | Capacitor | Price |
|--------|----------|-------|-------|-----------|-------|
| 026604 | UP4375BF | 2.15A | 115V  | 10µF/180V |       |

### Comfort Hot Water Recirculation Solutions - Retrofit

- Stainless steel construction
- No return line required
- Installs in less than one hour
- No electricity needed under sink
- Uses less energy than 25-watt light bulb
- Can save up to 16,000 gallons of water per year
- Flow range: 0 to 6.3 gpm
- Head range: 0 to 5.1'
- Minimum liquid temperature: 36°F
- Maximum liquid temperature: 150°F
- Maximum system pressure: 145 psi



| Part # | Mfg #  | Description   | Price |
|--------|--------|---------------|-------|
| 061115 | 595926 | Comfort Valve |       |

### ALPHA™ Energy-Efficient Circulator Pumps

- AUTOAdapt™ measures system changes automatically and maximizes energy savings
- LED Display shows flow indication and power consumption
- Plugs connections; no wiring required
- Motor: 1X115V
- 115V, 0.65A, 5 to 45W, 1/16 hp
- Flow range: 0 to 21 gpm
- Head range: 0 to 19'
- Maximum working pressure: 150 psi
- Minimum fluid temperature: 36°F
- Maximum fluid temperature: 230°F



ALPHA 15-55F



ALPHA 15-55SF

#### Closed System

- Cast iron construction

| Part # | Mfg #  | Connection  | Price |
|--------|--------|---|-------|
| 233306 | 1555FC | GF 15/26 Flange & Line Cord, (2) 1/2" Diameter Bolt Holes |       |
| 125022 | 1555FC | GF 15/26 Flange & Line Cord, (2) 1/2" Diameter Bolt Holes |       |

### Alpha2 High Efficiency Circulator

- Can be programmed in one of 3-constant speed, 3-constant pressure, or AUTOADAPT control modes
- Large LED display
- For installation, you have the flexibility to use either our unique ALPHA Plug with line cord or the ALPHA2 with terminal box for conduit connections
- ALPHA2 is complete with an integrated check-valve, foam insulation jacket, and nut captures for flanges
- Comes in both cast iron and stainless steel models
- Robust startup enables the ALPHA2 to continuously attempt to restart – indefinitely – in blocked rotor conditions
- Motor: 1 x 115V
- Flow, Q: 21 gpm max
- Head, H: 19 FT max
- Max working pressure: 150 PSI
- Liquid Temp: 36°F to 230°F
- Watts: 5-45W
- Amps: 0.65A
- Approvals: ETL, NSF 61, NSF 372



| Part # | Mfg #      | Amps | Volts | Capacitor                        | Price |
|--------|------------|------|-------|----------------------------------|-------|
| 233298 | GR1555SFC2 |      |       | Stainless Flange w/ Terminal Box |       |

## Circulator Pumps

### VersaFlo® Circulator Pumps

#### VersaFlo® UPS32 - Cast Iron - 3-Speed

- Flanges: 2-Bolt with (2) 1/2" diameter holes
- Flow range: 9 to 78 gpm
- Head range: 1 to 46'
- Maximum working pressure: 145 psi
- Maximum fluid temperature: 140°F



| Part # | Mfg #     | Motor Poles | HP  | Volts | Price |
|--------|-----------|-------------|-----|-------|-------|
| 048821 | UPS3280/2 | 2-Pole      | 1/2 | 115V  |       |

#### VersaFlo® UPS50 - Cast Iron - 3-Speed

- Flanges: 2", 4-bolt with (4) 9/16" diameter holes (non-ANSI)
- Flow range: 20 to 180 gpm
- Head range: 1 to 62'
- Maximum working pressure: 145 psi
- Maximum fluid temperature: 140°F



| Part # | Mfg #     | Motor Poles | HP  | Volts | Price |
|--------|-----------|-------------|-----|-------|-------|
| 031312 | UPS5080/4 | 2-Pole      | 3/4 | 115V  |       |

Heating - Hydronic Accessories

## Circulator Pumps

### Flange Sets

#### Flange Set for Stainless Steel Body Union Mount Pumps

UP15-18SU - UP15-42SU - UP25-64SU

Bronze Half Union Set



| Part # | Mfg #  | Description           | Price |
|--------|--------|-----------------------|-------|
| 058001 | 529913 | 1/2" Sweat Half Union |       |
| 058000 | 529911 | 3/4" Sweat Half Union |       |

#### Flanges for Stainless Steel or Bronze Body Flange Mount Pumps

- For use with UM15-18SF, UP15-42SF, UP25-64SF, UP26-96BF, UP26-99BF, & UP43-75BF pumps

Bronze Threaded Valve Set



| Part # | Mfg #  | Description                   | Price |
|--------|--------|-------------------------------|-------|
| 004999 | 519651 | 3/4" Threaded                 |       |
| 005000 | 519652 | 1" Threaded                   |       |
| 034876 | 539615 | 1-1/2" Threaded for UP43-75BF |       |

#### Flange for Cast Iron Body Flange Mount Pumps

- Includes:
  - (2) Flanges
  - (2) Gaskets
  - (8) Nuts and bolts

Cast Iron Threaded Flange Set



| Part # | Mfg #    | Description                  | Price |
|--------|----------|------------------------------|-------|
| 004995 | 519601   | 3/4" Threaded                |       |
| 004996 | 519602   | 1" Threaded                  |       |
| 004997 | 519603   | 1-1/4" Threaded              |       |
| 004998 | 519604   | 1-1/2" Threaded              |       |
| 005005 | 539605   | 1-1/2" Threaded for UP43-75F |       |
| 084839 | 96409354 | 2" Threaded                  |       |

### Timer Control

- 24-Hour programmable clock/timer
- For use with single speed, series UP circulators



| Part # | Mfg #   | Description        | Price |
|--------|---------|--------------------|-------|
| 091576 | 59-9388 | 115V Timer Control |       |

### Grundfos® Parts

| Part # | Mfg #    | Description   | Price |
|--------|----------|---|-------|
| 051161 | GR510231 | Full Faced Bolt Hole Style Flange/Gasket                                |       |
| 084284 | 510179   | Gasket F/ UP/UPS/TP Flange Donut  |       |
| 090178 | 530244   | Gasket for 1-1/2" Flange  |       |
| 045258 | 595444   | 3/4" Clip-On Aquastat Control   |       |
| 046089 | 595443   | Thermostatic Control, 1/2" Clip-On Mount for 5/8" OD System Piping Size |       |

Heating - Hydronic Accessories



## Circulator Pumps

### Circulating Pumps

#### Bell & Gossett Wet Rotor Circulating Pump

- Cast Iron
- 115V



| Part # | Mfg #  | Description           | Price |
|--------|--------|-----------------------|-------|
| 023992 | NRF-22 | Single Phase, 3 Speed |       |

Heating - Hydronic  
Accessories



## Circulator Pumps

### Grundfos Pumps

- 1/6 hp Recirculator pump with cast iron pump housing
- Built-in motor protection
- Stainless steel construction



| Part # | Mfg #   | Description | Price |
|--------|---------|-------------|-------|
| 139024 | G2-116F | 230V        |       |

Heating - Hydronic Accessories

## Flow Valves

### Flo-Check Valves

- Used in forced hot water heating system to prevent gravity circulation during periods when boiler is hot but space heating zone not wanted
- Maximum operating pressure: 125 psi
- Maximum operating temperature: 277°F
- Media: water or water/glycol



| Part # | Mfg # | Size   | Body      | Type      | Conn Inlet | Conn Outlet | Resistance in Feet of Pipe Equivalent | Price |
|--------|-------|--------|-----------|-----------|------------|-------------|---------------------------------------|-------|
| 103903 | 220   | 1"     | Cast Iron | Universal | NPT        | NPT         | 83.7/6.7                              |       |
| 103904 | 221   | 1-1/4" | Cast Iron | Universal | NPT        | NPT         | 47.8/17                               |       |
| 103905 | 222   | 1-1/2" | Cast Iron | Universal | NPT        | NPT         | 57.9/23.5                             |       |

## Heat Exchangers

### Heat Exchangers ( Brazed Plate Heat Exchanger )

- Single wall copper brazed
- High heat transfer coefficient
- Small size with high heat transfer capacity
- Cost efficient
- Stainless steel 1-1/8" solder
- Easily installed



| Part # | Mfg #    | Size              | Connection | Price |
|--------|----------|-------------------|------------|-------|
| 122451 | LA14-20  | 7.5" x 3" x 2.29" | 3/4"       |       |
| 122452 | LB31-30X | 12" x 5" x 3.19"  | 1"         |       |

Heating - Hydronic Accessories

## Heat Exchangers

### Heat Exchangers

#### Brazed Plate Heat Exchanger

- *Made of high quality acid-resistant stainless steel with 99.9% pure copper brazing*
- *Compact, lightweight, and designed for a variety of applications including radiant heating, snow melt systems and domestic hot water*
- *Counter flow design resulting high turbulence and maximum heat transfer*

| Part # | Mfg #     | Input<br>BTUH | Flow Rate | Boiler Pressure<br>Drop PSI | Water @ 90<br>Temp Rise | Water Pressure<br>Drop PSI | Rated<br>1st Hour | Price |
|--------|-----------|---------------|-----------|-----------------------------|-------------------------|----------------------------|-------------------|-------|
| 041811 | WMBP1-14E | 40,000        | 1.7 gpm   | 0.2 psi                     | 0.8 gpm                 | 0.0 psi                    | 86                |       |

Heating - Hydronic  
Accessories

## Isolation Flanges

### The Isolator® Uni-Flange Ball Valves

#### The Isolator® Uni-Flange Ball Valve (IPS x Flange)

- Full port forged brass ball valve
- Adjustable packing gland
- Bonus wing style T-handle
- Nuts and bolts
- HV Suffix = fits high velocity pumps



| Part # | Mfg #   | Size   | WOG | Price |
|--------|---------|--------|-----|-------|
| 145019 | 40402   | 1/2"   | 600 |       |
| 143756 | 40403   | 3/4"   | 600 |       |
| 143760 | 40404   | 1"     | 600 |       |
| 146935 | 40404HV | 1"     | 600 |       |
| 143761 | 40405   | 1-1/4" | 600 |       |
| 146936 | 40405HV | 1-1/4" | 600 |       |
| 143762 | 40406   | 1-1/2" | 600 |       |
| 146937 | 40406HV | 1-1/2" | 600 |       |
| 143763 | 40407HV | 2"     | 600 |       |

#### The Isolator® Uni-Flange Ball Valve (Swt x Flange)

- Full port forged brass ball valve
- Adjustable packing gland
- Bonus wing style T-handle
- Nuts and bolts
- HV Suffix = fits high velocity pumps



| Part # | Mfg #   | Size   | WOG | Price |
|--------|---------|--------|-----|-------|
| 145020 | 50402   | 1/2"   | 600 |       |
| 143768 | 50403   | 3/4"   | 600 |       |
| 146938 | 50404HV | 1"     | 600 |       |
| 146939 | 50405HV | 1-1/4" | 600 |       |
| 143771 | 50406   | 1-1/2" | 600 |       |
| 146940 | 50406HV | 1-1/2" | 600 |       |
| 143773 | 50407HV | 2"     | 600 |       |

### The Isolator® Uni-Flange Ball Valve with Rotating Flange (IPS x Rotating Flange)

- Full port forged brass ball valve
- Detachable rotating flange
- Adjustable packing gland
- Bonus wing style T-handle
- Nuts and bolts
- HV Suffix = fits high velocity pumps



| Part # | Mfg #    | Size   | WOG | Price |
|--------|----------|--------|-----|-------|
| 143764 | 41403    | 3/4"   | 600 |       |
| 143765 | 41404    | 1"     | 600 |       |
| 146928 | 41404HV  | 1"     | 600 |       |
| 143766 | 41405    | 1-1/4" | 600 |       |
| 146929 | 41405HV  | 1-1/4" | 600 |       |
| 146930 | 41406HV  | 1-1/2" | 600 |       |
| 168543 | 41407WHV | 2"     | 600 |       |

### The Isolator® Uni-Flange Ball Valve with Rotating Flange (Swt x Rotating Flange)

- Full port forged brass ball valve
- Detachable rotating flange
- Adjustable packing gland
- Bonus wing style T-handle
- Nuts and bolts
- HV Suffix = fits high velocity pumps



| Part # | Mfg #   | Size   | WOG | Price |
|--------|---------|--------|-----|-------|
| 143774 | 51403   | 3/4"   | 600 |       |
| 143775 | 51404   | 1"     | 600 |       |
| 146931 | 51404HV | 1"     | 600 |       |
| 143776 | 51405   | 1-1/4" | 600 |       |
| 146932 | 51405HV | 1-1/4" | 600 |       |
| 143777 | 51406   | 1-1/2" | 600 |       |
| 146934 | 51406HV | 1-1/2" | 600 |       |

Heating - Hydronic Accessories

**Isolation Flanges**

**The Isolator® Uni-Flange Ball Valve with Drain and Rotating Flange (IPS x Rotating Flange)**

- Full port forged brass ball valve
- Detachable rotating flange
- Multi-function hi-flow hose drain
- Adjustable packing gland
- Nuts and bolts
- HV Suffix = fits high velocity pumps



| Part # | Mfg #   | Size   | WOG | Price |
|--------|---------|--------|-----|-------|
| 143778 | 41413   | 3/4"   | 600 |       |
| 143779 | 41414   | 1"     | 600 |       |
| 146941 | 41414HV | 1"     | 600 |       |
| 143780 | 41415   | 1-1/4" | 600 |       |
| 146942 | 41415HV | 1-1/4" | 600 |       |
| 143781 | 41416   | 1-1/2" | 600 |       |
| 146943 | 41416HV | 1-1/2" | 600 |       |

**The Isolator® Uni-Flange Ball Valve with Drain and Rotating Flange (Swt x Rotating Flange)**

- Full port forged brass ball valve
- Detachable rotating flange
- Multi-function hi-flow hose drain
- Adjustable packing gland
- Nuts and bolts
- HV Suffix = fits high velocity pumps



| Part # | Mfg #   | Size   | WOG | Price |
|--------|---------|--------|-----|-------|
| 143782 | 51413   | 3/4"   | 600 |       |
| 143783 | 51414   | 1"     | 600 |       |
| 146944 | 51414HV | 1"     | 600 |       |
| 143784 | 51415   | 1-1/4" | 600 |       |
| 146945 | 51415HV | 1-1/4" | 600 |       |
| 143785 | 51416   | 1-1/2" | 600 |       |
| 146946 | 51416HV | 1-1/2" | 600 |       |

**The Isolator® Uni-Flange Ball Valve with Detachable Rotating Flange (Press x Rotating Flange)**

- Full port forged brass ball valve
- Detachable rotating flange
- Adjustable packing gland
- Nuts and bolts
- HV Suffix = fits high velocity pumps



| Part # | Mfg #   | Size   | WOG | Price |
|--------|---------|--------|-----|-------|
| 158127 | 81403HV | 3/4"   |     |       |
| 158128 | 81404HV | 1"     |     |       |
| 158129 | 81405HV | 1-1/4" |     |       |
| 158130 | 81406HV | 1-1/2" |     |       |

**Mini Ball Valves**

**4079M Series Mini Ball Valve**

- Hex body
- 110 WOG non-shock
- Chrome plated extruded brass



| Part # | Mfg # | Size           | WOG | Price |
|--------|-------|----------------|-----|-------|
| 239062 | 40792 | 3/8" MIP x FIP | 110 |       |

Heating - Hydronic Accessories

## Isolation Flanges

### Isolation Pump Flanges

#### IPF Series Isolation Pump Flange

- Isolate circulator pumps to facilitate circulator pump replacement or repairs
- Brass body and flange with bottom loaded blowout proof stem, chrome plated ball and double o-ring stem seal
- Pressure rated at 600 psi WOG



| Part # | Mfg #   | Model   | Size   | Price |
|--------|---------|---------|--------|-------|
| 076650 | 0068090 | IPFM1-T | 3/4"   |       |
| 076651 | 0068091 | IPFM1-T | 1"     |       |
| 076652 | 0068092 | IPFM1-T | 1-1/4" |       |
| 076657 | 0068095 | IPFM1-S | 3/4"   |       |
| 076658 | 0068096 | IPFM1-S | 1"     |       |
| 082649 | 0068097 | IPFM1-S | 1-1/4" |       |
| 120420 | 0068098 | IPFM1-S | 1-1/2" |       |

## Low Water Cut-Offs & Feeders

### Combination Water Feeder/Low Water Cut-Offs

#### 47-2 Combination Mechanical Water Feeder/Low Water Cut-Offs

- For steam and hot water boilers with cold water feed
- Continuous maintenance of minimum safe water level, independent of electrical service
- Proportional feed action
- Quick hook-up fittings provided
- Maximum water supply pressure: 150 psi
- Maximum inlet water temperature: 120°F
- Maximum boiler pressure: 25 psi



| Part # | Mfg #  | Model # | Description | Price |
|--------|--------|---------|-------------|-------|
| 007122 | 132800 | 47-2    | No 2 Switch |       |



## Low Water Cut-Offs & Feeders

### Low Water Cut-Offs

#### Safgard™ LWCO for Steam Boilers

- No moving parts to wear or stick
- Time delay prevents short cycling
- SV Models include the shorter model EL-1214-SV probe suitable for mounting in standard reducing tees



| Part # | Mfg #  | Description                     | Price |
|--------|--------|---------------------------------|-------|
| 097318 | 500-SV | 24V, Manual Reset, Test Button  |       |
| 097319 | 550-SV | 120V, Manual Reset, Test Button |       |

#### Safgard™ Direct Boiler Mounting LWCO with Primary Cut-Offs

- Burner circuit contacts open after 15 second delay in low water condition
- Automatically restarts burner 30 second after water reaches probe
- For residential & commercial boilers to 15 psi
- SV Models include the shorter model EL-1214-SV probe suitable for mounting in standard reducing tees



| Part # | Mfg #  | Description             | Price |
|--------|--------|-------------------------|-------|
| 097320 | 400-SV | 24VAC, 2VA, SPDT 15 psi |       |

### Feeders

#### Automatic Water Feeders for Steam Boilers

- Delay before feed: 2 minutes
- Feed setting: LWCO
- Maximum steam pressure: 15 psi
- Maximum water supply pressure: 150 psi
- Maximum amp draw: 5A (24VAC), 2A (120VAC)



| Part # | Mfg #  | Description | Price |
|--------|--------|-------------|-------|
| 030223 | VXT-24 | 1 gpm, 24V  |       |

Heating - Hydronic Accessories

**Low Water Cut-Offs & Feeders**

**Boiler Feed Water Backflow Preventers**

**Combination Backflow Preventer (9D) and Fill Valve (1156F) for Hot Water Boilers - 1/2"**

- Used on boiler feed lines to provide make up water to the boiler and prevent backflow when supply pressure falls below system pressure
- High capacity fast fill and purge capability
- Maximum pressure: 100 psi
- Maximum temperature: 212°F
- Suffix Options:  
- 911 = NPT x NPT Connections



| Part # | Mfg #   | Model | Description    | Price |
|--------|---------|-------|----------------|-------|
| 041894 | 0386460 | 911M3 | 1156F+9D Combo |       |

Heating - Hydronic  
Accessories

---



---

## Low Water Cut-Offs & Feeders

---



---

### Pigtails

#### Pigtail Syphon

- For use with gauges on steam line
- 1/4" MPT x 1/4" MPT
- Steel construction

G60-000



G60-001



| Part # | Mfg #   | Description    | Price |
|--------|---------|----------------|-------|
| 091486 | G60-000 | 1/4" Straight  |       |
| 091487 | G60-001 | 1/4" 90° Angle |       |



## Pressure Reducing Valves

### Pressure Reducing Valves

- Fast fill feature
- Low inlet pressure check valve
- Convenient cleanable strainer
- Maximum operating temperature: 225°F
- Maximum operating pressure: 125 psig



#### Combination "Dual Units" Pressure Relief and Reducing Valve

- Relief valve pressure setting: 30 psi
- 1/2" NPT Boiler connection
- Brass/iron body construction

| Part # | Mfg #  | Model | Components - Relief Plus | Price |
|--------|--------|-------|--------------------------|-------|
| 002470 | 110199 | 8     | B-38                     |       |

### Pressure Reducing Valve

- Brass body construction
- Pressure factory set to 12 psig
- Adjustable range: 10 - 25 psig

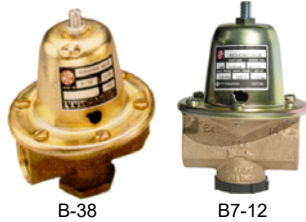

| Part # | Mfg #  | Model | Connection | Price |
|--------|--------|-------|------------|-------|
| 002402 | 110190 | B-38  | 1/2" NPT   |       |
| 002403 | 110196 | B7-12 | 3/4" NPT   |       |

Heating - Hydronic Accessories

## Pressure Reducing Valves

### Boiler Feed Water Pressure Regulators

#### High Capacity Feed Water Pressure Regulator

- Iron and bronze body
- Tight seating check valve
- Purge lever for manual purging
- Stainless steel strainer
- Maximum pressure: 100 psi
- Provides make-up water to the system in the event of system leaks
- For use in commercial and residential hydronic heating systems to fill the boiler and piping system with water, and to maintain water pressure in the system at all times



| Part # | Mfg #   | Model | Inlet Size | Connection | Price |
|--------|---------|-------|------------|------------|-------|
| 036375 | 0386425 | 1156F | 1/2"       | Threaded   |       |

#### BD1156F Feed Water Pressure Regulators

- High capacity
- Dial indicator
- Bronze valve body
- Tight seating check valve
- Push button fast fill with auto-stop
- Stainless steel strainer to protect valve disc from fouling



| Part # | Mfg #   | Model   | Inlet Size | Connection | Price |
|--------|---------|---------|------------|------------|-------|
| 238385 | 0386456 | BD1156F | 3/4"       | Threaded   |       |

#### LFN55BM1-U Water Pressure Regulator

- Double union inlet & outlet connections
- Integral stainless steel strainer
- Thermoplastic seat
- Lead Free\* brass body construction
- Serviceable in line
- Bypass feature controls thermal expansion pressure\*\*\*
- Sealed spring cage on all models for accessible outdoor or pit installations



| Part # | Mfg #   | Model     | Size | Price |
|--------|---------|-----------|------|-------|
| 180454 | 0009589 | LFN55M1-U | 3/4" |       |
| 180453 | 0009639 | LFN55M1-U | 1"   |       |

### LFU5B-Z3 Water Pressure Regulator

- Union inlet connection
- Integral stainless steel strainer
- Replaceable seat module
- Lead Free\* cast copper silicon alloy construction
- Serviceable in line
- Bypass feature controls thermal expansion pressure\*\*\*
- High temperature resistant reinforced diaphragm for hot water
- Standard construction includes Z3 sealed spring cage and stainless steel corrosion resistant adjusting & cage screws for accessible outdoor or pit installations



| Part # | Mfg #   | Model       | Size   | Price |
|--------|---------|-------------|--------|-------|
| 157252 | 0009100 | LFU5B-Z3    | 1/2"   |       |
| 156599 | 0009118 | LFU5B-Z3    | 3/4"   |       |
| 157250 | 0009154 | LFU5B-Z3    | 1"     |       |
| 157253 | 0009180 | LFU5B-Z3    | 1-1/4" |       |
| 158149 | 0009204 | LFU5B-Z3    | 2"     |       |
| 157256 | 0009108 | LFU5B-LP-Z3 | 1/2"   |       |

#### LF25AUB-Z3 Water Pressure Regulator

- Union inlet connection
- Integral stainless steel strainer
- Replaceable seat module
- Lead Free\* cast copper silicon alloy construction
- Serviceable in line
- Bypass feature controls thermal expansion pressure\*\*\*
- High temperature resistant reinforced diaphragm for hot water
- Standard construction includes Z3 sealed spring cage and stainless steel corrosion resistant adjusting & cage screws for accessible outdoor or pit installations
- (Spring -LP model only)



| Part # | Mfg #   | Model         | Size   | Price |
|--------|---------|---------------|--------|-------|
| 158193 | 0009217 | LF25AUB-Z3    | 1/2"   |       |
| 156645 | 0009257 | LF25AUB-Z3    | 3/4"   |       |
| 156601 | 0009128 | LF25AUB-LP-Z3 | 3/4"   |       |
| 163080 | 0009309 | LF25AUB-Z3    | 1"     |       |
| 159642 | 0009431 | LF25AUB-Z3    | 1-1/2" |       |
| 159058 | 0009465 | LF25AUB-Z3    | 2"     |       |

Heating - Hydronic Accessories

## Pressure Reducing Valves

### LF26A Small Pressure Regulator 2-Way

- Rugged forged Lead Free\* Brass body
- Tee handle adjustment
- Oversized orifice



| Part # | Mfg #   | Model | Size | Price |
|--------|---------|-------|------|-------|
| 157268 | 0009811 | LF26A | 1/4" |       |
| 157269 | 0009815 | LF26A | 3/8" |       |
| 157270 | 0009819 | LF26A | 1/2" |       |

**Radiator Traps & Valves**

**Radiator Valves**

**Brass Steam Radiator Globe Valve**

- Angled with ground joint union nut and tailpiece
- 60 psi/15 WSP



| Part # | Mfg # | Size       | Price |
|--------|-------|------------|-------|
| 148415 | 11534 | 1" IPS     |       |
| 148416 | 11535 | 1-1/4" IPS |       |

**Brass Hot Water Radiator Globe Valve**

- Angled with ground joint union nut and tailpiece
- 60 psi



| Part # | Mfg # | Size       | Price |
|--------|-------|------------|-------|
| 143811 | 11553 | 3/4" IPS   |       |
| 143813 | 11554 | 1" IPS     |       |
| 143814 | 11555 | 1-1/4" IPS |       |
| 143816 | 11556 | 1-1/2" IPS |       |

**Water Heater Accessories**

**The Isolator E X P E2 Tankless Water Heater Service Valve Kit**

- Residential pressure relief valve (150 PSI/200,000 BTU)
- IPS Union x Press
- 250 CWP
- ISO 9001
- Hot & Cold set of full port forged brass ball valves with Hi-flow hose drains, pressure relief valve outlet & Adjustable packing gland



| Part # | Mfg #       | Size | Price |
|--------|-------------|------|-------|
| 182466 | 84443WPR-LF | 3/4" |       |

Heating - Hydronic Accessories

**Radiator Traps & Valves**

**PRO-PAL® Series Valves**

**PRO-PAL® Expansion Tank Pro Service Valve™**  
(FIP x MIP x FIP x Hose)

- Full port forged brass ball valve with hi-flow hose drain



| Part # | Mfg # | Size | WOG | Price |
|--------|-------|------|-----|-------|
| 143788 | 41672 | 1/2" | 600 |       |

Heating - Hydronic  
Accessories



---



---

**Radiator Traps & Valves**

---



---

**Radiator Steam Traps**

**Series 17C Balanced Pressure BearTrap®  
Thermostatic Steam Trap**

- For institutional, commercial, and residential heating system applications where low or moderate water hammer may occur
- Subcooling
- Replaceable Dura-Stat® module
- Stainless steel components
- Resistant to moderate water hammer and chemical attack
- Maximum operating pressure: 25 psig
- 3-Year warranty



| Part # | Mfg #  | NPT Size | Description | Price |
|--------|--------|----------|-------------|-------|
| 005399 | 401536 | 1/2"     | Angle       |       |

Heating - Hydronic Accessories

## Radiator Traps & Valves

### Hydronics - Steam Valves

#### RA Series Steam Radiator Valve (FNPT x MNPT Union)

- Teflon® stem packing



RA-1-AP Angle - Bronze Body

| Part # | Mfg #   | Model | Size   | Price |
|--------|---------|-------|--------|-------|
| 036349 | 0067450 | RA1AP | 1/2"   |       |
| 036350 | 0067451 | RA1AP | 3/4"   |       |
| 036353 | 0067453 | RA1AP | 1-1/4" |       |
| 036354 | 0067454 | RA1AP | 1-1/2" |       |

### Bronze Union Radiator Elbows

- For use in steam and hot water systems
- Maximum working pressure: 60 psi (non-shock) for hot water, 15 psi (non-shock) for saturated steam



| Part # | Mfg #   | Model | Size               | Price |
|--------|---------|-------|--------------------|-------|
| 072758 | 0067460 | UL-1  | 1/2" FIP x M Union |       |
| 031791 | 0067461 | UL-1  | 3/4" FIP x M Union |       |

Heating - Hydronic Accessories



---

---

## Spiralink Couplings

---

---

### Spiralink® Couplers

| Part # | Mfg # | Description       | Price |
|--------|-------|-------------------|-------|
| 010269 | 10010 | Spiralink Coupler |       |

Heating - Hydronic  
Accessories

## Thermal Expansion Tanks

### Thermal Expansion Tanks

#### Therm-X-Trol® ASME Diaphragm Thermal Expansion Tank

- For use with potable water heaters only
- Non-ASME
- Pre-pressurized, diaphragm type
- Drawn steel domes, welded steel construction
- Rigid polypropylene liner
- Butyl diaphragm, diaphragm hoop ring mechanically grooved for permanent air-tight seal
- Stainless steel system connection
- Maximum operating system: 200°F
- Maximum working pressure: 150 psig
- Factory pre-charge: 40 psig
- 5-Year limited warranty



#### Therm-X-Trol® ASME Diaphragm In-Line Thermal Expansion Tank

| Part # | Mfg #   | Dia | Height  | Volume  | Price |
|--------|---------|-----|---------|---------|-------|
| 024594 | ST-5-C  | 10" | 10-3/8" | 2.1 gal |       |
| 028941 | ST-12-C | 12" | 13-3/8" | 6.4 gal |       |

#### Therm-X-Trol® ASME Diaphragm Vertical Stand Thermal Expansion Tank

- Stainless steel system connection
- Maximum operating temperature: 200°F
- Factor pre-charge: 55 psig

| Part # | Mfg #    | Dia     | Height | Volume   | Price |
|--------|----------|---------|--------|----------|-------|
| 029837 | ST-20V-C | 12"     | 19"    | 8.0 gal  |       |
| 029838 | ST-30V-C | 16"     | 19"    | 14.0 gal |       |
| 029839 | ST-42V-C | 16"     | 24"    | 18.0 gal |       |
| 029840 | ST-60V-C | 16-1/4" | 34"    | 25.0 gal |       |
| 113382 | ST-70V-C | 16"     | 45"    | 34.0 gal |       |
| 030098 | ST-80V-C | 24"     | 37"    | 53.0 gal |       |

#### Extrol Thermal Expansion Tank

- For use with closed hydronic heating and cooling systems
- Both space and energy saving
- Butyl/EPDM diaphragm
- Air separation design eliminates absorption of system air



| Part # | Mfg # | Dia | Height  | Volume  | Price |
|--------|-------|-----|---------|---------|-------|
| 002008 | 15    | 8"  | 12-5/8" | 2.0 gal |       |

### Thermal Expansion Tanks (Continued)

#### Extrol Thermal Expansion Tank

| Part # | Mfg # | Dia     | Height  | Volume   | Price |
|--------|-------|---------|---------|----------|-------|
| 002009 | 30    | 11"     | 15-1/2" | 4.4 gal  |       |
| 002016 | 60    | 11"     | 23"     | 7.6 gal  |       |
| 021243 | 90    | 15-3/8" | 21"     | 14.0 gal |       |

### Standard Expansion Tanks

#### Extrol® Vertical AX Series Expansion Tank

- Carbon steel shell construction with red oxide primer
- Diaphragm design
- Factory pre-charge: 12 psig
- Operating temperature: 240°F



| Part # | Mfg # | Dia | Length | Volume   | Price |
|--------|-------|-----|--------|----------|-------|
| 052098 | AX15V | 12" | 20"    | 8.0 gal  |       |
| 048739 | AX40V | 16" | 30"    | 21.7 gal |       |

#### SX Extrol® Vertical Boiler System Expansion Tank

- Factory pre-charge: 12 psig
- Maximum working pressure: 100 psig
- Maximum operating temperature: 240°F



| Part # | Mfg #   | Dia | Height | Volume   | Price |
|--------|---------|-----|--------|----------|-------|
| 001999 | SX-30V  | 15" | 25"    | 14.0 gal |       |
| 002000 | SX-40V  | 15" | 32"    | 20.0 gal |       |
| 002001 | SX-60V  | 15" | 48"    | 32.0 gal |       |
| 024728 | SX-90V  | 22" | 36"    | 44.0 gal |       |
| 101641 | SX-160V | 26" | 47"    | 86.0 gal |       |

Heating - Hydronic Accessories

## Thermal Expansion Tanks

### Special Application Expansion Tanks

#### Radiant Extrol® Expansion Tank

- For high-efficiency radiant systems
- Plastic liner is compatible with barrier and non-barrier tubing
- Suitable for use in glycol applications
- Non-ferrous system connection for corrosion resistance
- Factory pre-charged: 12 psig
- Maximum working pressure: 100 psig
- Maximum operating temperature: 200°F

| Part # | Mfg # | Dia | Height | Volume   | Price |
|--------|-------|-----|--------|----------|-------|
| 090481 | RX-15 | 8"  | 13"    | 2.0 gal  |       |
| 090482 | RX-30 | 11" | 16"    | 4.4 gal  |       |
| 090483 | RX-60 | 15" | 19"    | 10.3 gal |       |

#### FT Fill-Trol® System Expansion Tank

- Eliminates the need for a separate, automatic fill valve
- Tank pressure controls system fill
- Factory pre-charged: 12 psig
- Fully adjustable up to a maximum working pressure of 100 psig
- Air purger not included



| Part # | Mfg # | Dia | Height | Volume  | Price |
|--------|-------|-----|--------|---------|-------|
| 002002 | 109   | 8"  | 13"    | 2.0 gal |       |
| 002004 | 110   | 11" | 16"    | 4.4 gal |       |

#### Fill-Trol® Expansion Tank Valve

| Part # | Mfg #  | Air Purger       | Price |
|--------|--------|------------------|-------|
| 002003 | 109-15 | Fill-Trol® Valve |       |

Heating - Hydronic Accessories

## Water Gauges & Sight Glasses

### Water Gauges

#### 20 Series Standard Pattern Bronze Water Gauge - Standard Gauge

- Use for all types of liquid level verification
- EPDM Gauge glass gaskets standard
- Equipped with (2) copper guard rods
- Standard 1/4" needle drain valve in lower arm
- CRN Registered
- Rated: 125 psig @ 350°F, 300 psig @ 100°F



| Part # | Mfg #     | Pipe Size | Glass OD/Length | Wheel Type | Price |
|--------|-----------|-----------|-----------------|------------|-------|
| 003018 | 20-104-00 | 1/2"      | 5/8" x 12"      | Aluminum   |       |

#### 20-200 Series Heavy Pattern Bronze Water Gauge- Standard Gauge

- Heavy valve body pattern for higher service ratings
- Rated 200 psig @ 400°F, 400 psig @ 100°F subject to pressure/temperature ratings of gauge glass



| Part # | Mfg #     | Pipe Size | Glass OD/Length | Wheel Type | Price |
|--------|-----------|-----------|-----------------|------------|-------|
| 003019 | 20-204-00 | 1/2"      | 5/8" x 12"      | Aluminum   |       |

### Water Gauge Components

#### Regular Gauge Glass

| Part # | Mfg #   | Size       | Price |
|--------|---------|------------|-------|
| 004899 | 9858R08 | 5/8" x 8"  |       |
| 004892 | 9858R12 | 5/8" x 12" |       |
| 004897 | 9858R30 | 5/8" x 30" |       |



---

---

## Water Gauges & Sight Glasses

---

---

### Gauge Glasses & Accessories

#### Gray Cut Gauge Glass Gasket

- Synthetic rubber



| Part # | Mfg # | Size                   | Price |
|--------|-------|------------------------|-------|
| 006253 | 881   | 9/16" x 13/16" x 5/16" |       |

## Water Gauges & Sight Glasses

### TruFLOW™ Classic Specific Accessories

- Use Uponor Silicone Oil (A2620007 - sold separately) on male threads to ease installation

#### TruFLOW™ Visual Flow Meter

- Can be used on TruFLOW Jr. and TruFLOW Classic manifolds to accurately measure the flow of hydronic radiant loops



| Part # | Mfg #    | Description     | Price |
|--------|----------|-----------------|-------|
| 113670 | A2640027 | 0.25 To 2.0 gpm |       |

Heating - Hydronic Accessories



**Zone Valves**

**Hydronic Motorized Zone Valves**

**V8043/V8044 Low Voltage Hydronic Zone Valves**

**2-Position Normally Closed Straight-Through Valve with End Switch**

- For controlling flow of hot and cold water, valve closes when de-energized
- Manual opener included
- With 18" wire leads and auxiliary switch
- Voltage: 24V, 50/60Hz

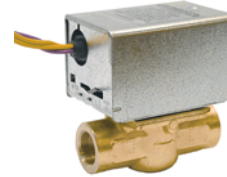

| Part # | Mfg #      | Pipe Size | Capacity | Max Close-Off Pressure | End Switch | Electrical Connections | Price |
|--------|------------|-----------|----------|------------------------|------------|------------------------|-------|
| 006823 | V8043E1012 | 3/4" Swt  | 3.5 Cv   | 20 psi                 | SPST       | 18" Leads              |       |
| 006824 | V8043E1061 | 3/4" Swt  | 8 Cv     | 8 psi                  | SPST       | 18" Leads              |       |
| 006825 | V8043E1079 | 1" Swt    | 8 Cv     | 8 psi                  | SPST       | 18" Leads              |       |
| 081700 | V8043E1145 | 3/4" NPT  | 3.5 Cv   | 20 psi                 | SPST       | 18" Leads              |       |

**2-Position Normally Closed Straight-Through Motorized Valve**

- For controlling flow of hot and cold water
- With end switch, screw terminals and manual opener
- Terminal board with (5) terminals
- Maximum ambient temperature: 125°F
- Electrical connections: screw terminal block
- Voltage: 24V, 50/60Hz



| Part # | Mfg #        | Pipe Size | Capacity | Max Close-Off Pressure | End Switch | Type                | Price |
|--------|--------------|-----------|----------|------------------------|------------|---------------------|-------|
| 006826 | V8043F1036/U | 3/4" Swt  | 3.5 Cv   | 20 psi                 | SPST       | 2-Way Straight Thru |       |

**5000 Series QuickFit® 2-Position Two-Way, Straight-Through Motorized Valve**

- On-off and 2-way low voltage valves consist of an actuator and valve assembly
- For controlling flow of hot water and some models steam
- Includes end switch and manual opener
- Terminal board
- Maximum ambient temperature: 125°F
- Static pressure: 300 psi
- Voltage: 24V @ 60Hz



| Part # | Mfg #      | Pipe Size | Capacity | Max Close-Off Pressure | End Switch | Electrical Connections | Price |
|--------|------------|-----------|----------|------------------------|------------|------------------------|-------|
| 094300 | V8043E5061 | 3/4" Swt  | 8.0 Cv   | 8 psi                  | SPST       | 18" Leads              |       |
| 094301 | V8043E5079 | 1" Swt    | 8.0 Cv   | 8 psi                  | SPST       | 18" Leads              |       |
| 094302 | V8043F5036 | 3/4" Swt  | 3.5 Cv   | 20 psi                 | SPST       | Terminal Block         |       |

Heating - Hydronic Accessories

**Zone Valves**

**V8044A 2-Position Diverting Motorized Valve**

- For controlling flow of hot water
- 1/2" Bottom inlet
- Manual opener
- Maximum ambient temperature: 125°F
- Voltage: 24V, 50/60Hz



| Part # | Mfg #      | Pipe Size | Capacity | Max Close-Off Pressure | End Switch | Electrical Connections | Price |
|--------|------------|-----------|----------|------------------------|------------|------------------------|-------|
| 006827 | V8044E1011 | 3/4" Swt  | 7.0 Cv   | 10 psi                 | SPST       | 18" Leads              |       |

**Miscellaneous Parts & Accessories**

| Part # | Mfg #      | Description                         | Price |
|--------|------------|-------------------------------------|-------|
| 168372 | Q5020A1003 | Globe Valve Linkage with 1/2" Shaft |       |

**2-Way Globe Valve**

- Sizes range from 1/2 to 2 inches
- Direct and reverse acting
- High pressure steam models with stainless steel trim
- Spring-loaded, self-adjusting packing
- Stainless steel stem prevents corrosion
- Valve designs provide equal percentage characteristics of flow for close control of water, and linear characteristic of flow for close control of steam or chilled water
- Valves utilize direct mounting, electric or pneumatic linear valve actuators; Q5001 linkage with Modutrol Motor; or Q5020/Q5022A linkages with direct coupled rotary actuators to operate the valve
- Not suitable for combustible gases



| Part # | Mfg #      | Pipe Size | Capacity | Max Close-Off Pressure | End Switch | Electrical Connections | Price |
|--------|------------|-----------|----------|------------------------|------------|------------------------|-------|
| 170336 | V5011N2097 | 2" FPT    | 46.8 Cv  | 240 psi                | N/A        | N/A                    |       |

Heating - Hydronic Accessories

## Zone Valves

### Zone Valves

#### Whisper Guard Geothermal Valves

- Pump head: 150 feet of water
- Maximum working pressure: 125 psi
- Temperature range: 40-240°F
- Amperage rating: 0.9
- Volt frequency: 24V 60Hz
- 3-Year head, 5-year body warranty



| Part # | Mfg #   | Connection Size | Normal Flow Range | Pressure Drop Thru Valve Equivalent Feet of Pipe | Price |
|--------|---------|-----------------|-------------------|--|-------|
| 101957 | 5101-G2 | 3/4" Threaded   | 2 Way             | 125  |       |

#### Zone Sentry® Zone Valve

- Provides on-off, normally open or normally closed control in both open and closed hot or chilled water systems
- Utilizes microcircuit based logic to control a gear driven electronic actuator which drives a ball valve based body design
- Uses up to 93% less energy than other commonly installed zone valves
- Quiet actuator operation
- Suitable for condensing environments
- Universal installation orientation
- Up to 12 valves on (1) 40VA transformer
- Multi-function LED assists with troubleshooting
- Quick release actuator mounting clips
- Positional indicator shows the ball valve's actual position
- Easy to wire quick connections
- Bi-directional flow (you cannot install the valve backwards)
- The actuator mounts on the valve in either direction
- Shut-off pressure: 125 psi
- Manual override button
- e-smart Energy saving



| Part # | Mfg #  | Description     | Price |
|--------|--------|-----------------|-------|
| 136624 | Z075C2 | 2-Way, 3/4" Swt |       |
| 135892 | Z100C2 | 2-Way, 1" Swt   |       |

#### Zone Valve Power Head

555-050RP



| Part # | Mfg #     | Description                                       | Price |
|--------|-----------|---|-------|
| 010361 | 555-050RP | Power Unit Assembly, Snap Action Switch           |       |
| 010362 | 555-173RP | Replacement Head                                  |       |
| 074288 | ZA024Q4A1 | NO/NC Replacement Motorized Zone Valve Power Head |       |

Heating - Hydronic Accessories

**Zone Valves**

**Zone Valves**  
**Hydronic Zone Control**

- Self aligning barrel-type valve stem uses line pressure to seal off binding on opening and closing
- Valve stem made of stainless steel
- Built-in auxiliary contacts to control burner or circulator relay



**3-Wire, 24V Valve with Screw Terminal Wiring Panel & Auxiliary Switch**

| Part # | Mfg #    | Tubing Size (ID) | 24V AC Thermostat Circuit Rating | Time Cycle Open/Close | Price |
|--------|----------|------------------|----------------------------------|-----------------------|-------|
| 012074 | 1311-102 | 3/4"             | 0.2A                             | 45 Sec/45 Sec         |       |
| 012072 | 1311-103 | 1"               | 0.2A                             | 45 Sec/45 Sec         |       |

**2-Wire, 24V Valve with Screw Terminal Wiring Panel & Auxiliary Switch**

| Part # | Mfg #     | Tubing Size (ID) | 24V AC Thermostat Circuit Rating | Time Cycle Open/Close | Price |
|--------|-----------|------------------|----------------------------------|-----------------------|-------|
| 012075 | 1361-104  | 1-1/4"           | 0.2A                             | 45 Sec/60 Sec         |       |
| 091732 | WR1361102 | 3/4"             | 0.2A                             | 45 Sec/60 Sec         |       |

Heating - Hydronic  
Accessories



JOHN J. MORGAN CO.



JOHN J. MORGAN CO.

## Reznor Infrared Accessories

### Reznor Parts

| Part # | Mfg #   | Description                  | Price |
|--------|---------|------------------------------|-------|
| 066083 | Rezbrkt | Low Ceiling Mounting Bracket |       |

## Schwank Infrared Heating

### Tube Heaters

#### Builder Schwank Tube Heater

- Line voltage thermostat ready
- Simple relay option for 24V thermostat
- Reflector & end caps improve IR heat output
- Swing-down cabinet service access
- Whisper quiet ceramic burner



| Part # | Mfg #        | Capacity | Fuel | Length | Price |
|--------|--------------|----------|------|--------|-------|
| 129084 | S100-45-20   | 45       | NG   | 20'    |       |
| 129085 | S100-60-20   | 60       | NG   | 20'    |       |
| 129087 | S100-60-30   | 60       | NG   | 30'    |       |
| 129088 | S100-80-20   | 80       | NG   | 20'    |       |
| 129089 | S100-80-30   | 80       | NG   | 30'    |       |
| 129090 | S100-80-40   | 80       | NG   | 40'    |       |
| 129092 | S100-100-20  | 100      | NG   | 20'    |       |
| 129093 | S100-110-30  | 110      | NG   | 30'    |       |
| 129094 | S100-110-40  | 110      | NG   | 40'    |       |
| 129095 | S100-110-50  | 110      | NG   | 50'    |       |
| 129096 | S100-130-30  | 130      | NG   | 30'    |       |
| 129098 | S100-130-40  | 130      | NG   | 40'    |       |
| 129099 | S100-130-50  | 130      | NG   | 50'    |       |
| 129101 | S100-155-40  | 155      | NG   | 40'    |       |
| 129102 | S100-155-50  | 155      | NG   | 50'    |       |
| 129103 | S100-155-60  | 155      | NG   | 60'    |       |
| 129104 | S100-175-50  | 175      | NG   | 50'    |       |
| 136923 | S100-175-50L | 175      | LP   | 50'    |       |
| 129106 | S100-175-60  | 175      | NG   | 60'    |       |
| 137376 | S100-175-60L | 175      | LP   | 60'    |       |
| 129107 | S100-175-70  | 175      | NG   | 70'    |       |
| 129109 | S100-200-50  | 200      | NG   | 50'    |       |
| 129111 | S100-200-60  | 200      | NG   | 60'    |       |
| 129112 | S100-200-70  | 200      | NG   | 70'    |       |
| 163390 | S100-200-70  | 200      | LP   | 70'    |       |

#### Set Series WisperJet Two-Stage Tube Heater

- 2-Stage burner operation
- Status indicator lights
- Straight tube or "U" tube configuration
- Swing-down cabinet service access
- Whisper quiet ceramic burner



| Part # | Mfg #     | Capacity | Fuel | Length | Price |
|--------|-----------|----------|------|--------|-------|
| 129932 | SET 80/60 | 80/60    | NG   | 20'    |       |
| 129933 | SET 80/60 | 80/60    | NG   | 30'    |       |

### Tube Heaters (Continued)

#### Set Series WisperJet Two-Stage Tube Heater

| Part # | Mfg #       | Capacity | Fuel | Length | Price |
|--------|-------------|----------|------|--------|-------|
| 129937 | SET 110/75  | 110/75   | NG   | 30'    |       |
| 129940 | SET 110/75  | 110/75   | NG   | 40'    |       |
| 129941 | SET 130/90  | 130/90   | NG   | 30'    |       |
| 129942 | SET 130/90  | 130/90   | NG   | 40'    |       |
| 129943 | SET 155/110 | 155/110  | NG   | 40'    |       |
| 129944 | SET 155/110 | 155/110  | NG   | 50'    |       |
| 129945 | SET 175/125 | 175/125  | NG   | 50'    |       |
| 129947 | SET 200/140 | 200/140  | NG   | 50'    |       |
| 129948 | SET 200/140 | 200/140  | NG   | 60'    |       |

#### PremierSchwank Tube Heater

- Line voltage or 24V thermostat ready
- Status indicator lights
- Power cord with plug
- 4" Bird screened combustion air collar
- Swing-down cabinet service access
- Whisper quiet ceramic burner
- 'Focus shield' reflector and end caps for Premier IR heat output
- Emissive coated radiant tubes



| Part # | Mfg #         | Capacity | Fuel | Length | Price |
|--------|---------------|----------|------|--------|-------|
| 135859 | STS-JZ-45-10  | 45       | NG   | 10'    |       |
| 143905 | STS-JZ-45-20  | 45       | NG   | 20'    |       |
| 151663 | STS-JZ-60-20  | 60       | NG   | 20'    |       |
| 143906 | STS-JZ-60-30  | 60       | NG   | 30'    |       |
| 143907 | STS-JZ-80-20  | 80       | NG   | 20'    |       |
| 143710 | STS-JZ-80-30  | 80       | NG   | 30'    |       |
| 143292 | STS-JZ-80-40  | 80       | NG   | 40'    |       |
| 143911 | STS-JZ-100-20 | 100      | NG   | 20'    |       |
| 129457 | STS-JZ-110-30 | 110      | NG   | 30'    |       |
| 136504 | STS-JZ-110-40 | 110      | NG   | 40'    |       |
| 143912 | STS-JZ-110-50 | 110      | NG   | 50'    |       |
| 143913 | STS-JZ-130-30 | 130      | NG   | 30'    |       |
| 143914 | STS-JZ-130-40 | 130      | NG   | 40'    |       |
| 136509 | STS-JZ-130-50 | 130      | NG   | 50'    |       |
| 143915 | STS-JZ-155-40 | 155      | NG   | 40'    |       |
| 143916 | STS-JZ-155-50 | 155      | NG   | 50'    |       |
| 136967 | STS-JZ-155-60 | 155      | NG   | 60'    |       |
| 143917 | STS-JZ-175-50 | 175      | NG   | 50'    |       |
| 151661 | STS-JZ-175-50 | 175      | LP   | 50'    |       |
| 143918 | STS-JZ-175-60 | 175      | NG   | 60'    |       |

Heating - Infrared

## Schwank Infrared Heating

### Tube Heaters (Continued)

#### PremierSchwank Tube Heater

| Part # | Mfg #         | Capacity | Fuel | Length | Price |
|--------|---------------|----------|------|--------|-------|
| 151662 | STS-JZ-175-60 | 175      | LP   | 60'    |       |
| 143919 | STS-JZ-175-70 | 175      | NG   | 70'    |       |
| 143920 | STS-JZ-200-50 | 200      | NG   | 50'    |       |
| 143921 | STS-JZ-200-60 | 200      | NG   | 60'    |       |
| 143923 | STS-JZ-200-70 | 200      | NG   | 70'    |       |

### Tube Heater Accessories

#### Burner Kit

| Part # | Mfg #      | Description                   | Price |
|--------|------------|-------------------------------|-------|
| 129916 | JS-080T-BN | NG Burner Kit for SET 80/60   |       |
| 129918 | JS-155T-BN | NG Burner Kit for SET 155/110 |       |
| 129920 | JS-200T-BN | NG Burner Kit for SET 200/140 |       |
| 137325 | JS-110P-BN | NG Burner Kit for STW-JZ-110  |       |
| 239848 | JS-110W-BN | NG Burner Kit for SPW-JZ110   |       |
| 144704 | JS-130P-BN | NG Burner Kit for STW-JZ-130  |       |
| 128974 | JS-E045-BN | NG Burner Kit for S100 45     |       |
| 128980 | JS-E060-BN | NG Burner Kit for S100 60     |       |
| 128981 | JS-E080-BN | NG Burner Kit for S100 80     |       |
| 128982 | JS-E100-BN | NG Burner Kit for S100 100    |       |
| 128983 | JS-E110-BN | NG Burner Kit for S100 110    |       |
| 128984 | JS-E130-BN | NG Burner Kit for S100 130    |       |
| 128985 | JS-E155-BN | NG Burner Kit for S100 155    |       |
| 128986 | JS-E175-BN | NG Burner Kit for S100 175    |       |
| 136851 | JS-E175-BL | LP Burner Kit for S100 175    |       |
| 162577 | JS-E200-BL | LP Burner Kit for S100 200    |       |
| 128987 | JS-E200-BN | NG Burner Kit for S100 200    |       |
| 136501 | JS-S110-AN | NG Burner Kit for STS-JZ-110  |       |
| 136505 | JS-S130-AN | NG Burner Kit for STS-JZ-130  |       |
| 136965 | JS-S155-AN | NG Burner Kit for STS-JZ-155  |       |

#### Tube Kit

- Stand-alone tube kits require no additional tube kits
- Primary tube kits require at least one additional secondary tube kit
- Secondary tube kits require a primary tube kit
- Kits include:
  - Tubes
  - Reflectors
  - Hanger
  - Tube couplers

| Part # | Mfg #      | Description                       | Price |
|--------|------------|-----------------------------------|-------|
| 135829 | TS-4510-JZ | 10' Stand-Alone Kit for STR-JZ-45 |       |

### Tube Heater Accessories (Continued)

#### Tube Kit

| Part # | Mfg #      | Description  | Price |
|--------|------------|--|-------|
| 128990 | TM-1020-SX | 20' Stand-Alone Kit for S100-100                     |       |
| 128989 | TM-1420-SX | 20' Stand-Alone Kit for SET80/60                     |       |
| 136172 | TS-1420-JZ | 20' Stand-Alone Kit for STR-JZ-45 & 60               |       |
| 128991 | TM-1430-SX | 30' Stand-Alone Kit for SET80/60, 110/75, & 130/90   |       |
| 128992 | TM-1040-SX | 40' Stand-Alone Kit for SET110/75, 130/90, & 155/110 |       |
| 136502 | TS-1040-JZ | 40' Stand-Alone Kit for STS-JZ-80/110/130/155        |       |
| 128994 | TM-1030-SX | 30' Primary Kit for SET175/125 & 200/140             |       |
| 128993 | TM-F030-SX | 30' Primary Kit for SET155/110                       |       |
| 136506 | TS-F030-JZ | 30' Primary Kit for STS-JZ-110/130/155               |       |
| 137323 | TW-F030-JZ | 30' Primary Kit for SPW/STW-JZ-110/130/155           |       |
| 128999 | TM-1010-SX | 10' Secondary Kit for S100                           |       |
| 128996 | TM-0020-SX | 20' Secondary Kit for SET                            |       |
| 128997 | TM-0030-SX | 30' Secondary Kit for SET                            |       |
| 136507 | TS-0020-JZ | 20' Secondary Kit for STS-JZ                         |       |
| 137324 | TW-0020-JZ | 20' Secondary Kit for SPW-JZ or STW-JZ               |       |
| 136966 | TS-0030-JZ | 30' Secondary Kit for STS-JZ                         |       |
| 128998 | TM-0040-SX | 40' Secondary Kit for S100                           |       |

#### LP Conversion Kit

| Part # | Mfg #      | Description            | Price |
|--------|------------|------------------------|-------|
| 129000 | JS-0556-XE | 45 MBTUH NG to LP      |       |
| 129001 | JS-0557-XX | 60 MBTUH NG to LP      |       |
| 129002 | JS-0559-XX | 80/60 MBTUH NG to LP   |       |
| 129847 | JS-0555-TG | 110/75 MBTUH NG to LP  |       |
| 171260 | JS-0563-XB | 125 MBTUH NG to LP     |       |
| 129929 | JS-0555-TK | 130/90 MBTUH NG to LP  |       |
| 129930 | JS-0555-TO | 155/110 MBTUH NG to LP |       |
| 129129 | JS-0565-XX | 155 MBTUH NG to LP     |       |

Heating - Infrared

**Adjustable Pressure Switches**

**2374 Series Adjustable Air Pressure Sensing Switches**

- Designed to replace a wide variety of air-sensing switches found in residential & light commercial applications including furnaces, electronic air cleaners & humidifiers
- SPDT Switching that can be actuated by positive or negative pressure, or by pressure differential
- Highly accurate, practically insensitive to temperature change
- Operating temperature range: -40° to 190°F
- Electrical connections: 1/4" spade
- Air sample line connectors: will accept 1/8", 1/4" or 3/8" tubing
- UL & CSA Approved
- Includes mounting hardware and adjustment tool



| Part # | Mfg #    | Description                                    | Price |
|--------|----------|--|-------|
| 044313 | 2374-495 | .25" to 1.0"wc Set Point Range, SPDT Switching |       |
| 044314 | 2374-498 | .10" to 4.0"wc Setpoint Range, SPDT Switching  |       |



## Capacitors

### Capacitors

#### Motor Start Capacitor

- Plastic housing
- Variable capacitance
- 1.812" Dia x 3.37" height
- (189-227220) & (233-292220) 2.062" Dia x 3.37" height
- (189-227330) 2.062" Dia x 4.37" height



| Part # | Mfg #      | Description                                    | Price |
|--------|------------|--|-------|
| 205576 | DV88108    | Round Plastic Can, 88-108 $\mu$ F, 110/125 VAC |       |
| 239652 | 108-130220 | Round Plastic Can, 108-130 $\mu$ F, 220/250VAC |       |
| 239653 | 124-156220 | Round Plastic Can, 124-156 $\mu$ F, 220/250VAC |       |
| 239654 | 189-227220 | Round Plastic Can, 189-227 $\mu$ F, 220/250VAC |       |
| 240453 | 189-227330 | Round Plastic Can, 189-227 $\mu$ F, 330VAC     |       |
| 239655 | 233-292220 | Round Plastic Can, 233-292 $\mu$ F, 220/250VAC |       |

#### 370VAC Single Oval Run Capacitors

- Rated Frequency: 50/60 Hz
- Applied Standard: UL-810; CSA22.2 No190, IEC60252
- Meets 10,000AFC safety requirement per UL-810
- Capacitance Tolerance +/-5%
- Permissible Temperature: -40°C to +70°C
- Individually Packaged
- Withstanding Voltage test
- Between Terminals: Rated Voltage X 1.75VAC, 10sec
- Between Terminals and Case: Rated Voltage X 2+1000VAC, 60sec
- Maximum Permissible Voltage: 110% of the rated voltage
- Maximum Permissible Current: 130% of the rated current
- Oil Filled; Non PCB
- 1/4" quick connect terminal



| Part # | Mfg #   | Description              | Price |
|--------|---------|--------------------------|-------|
| 195226 | 37-125H | 370VAC Oval 12.5 $\mu$ F |       |

## Capacitors

### 370VAC Dual Oval Run Capacitor

- Rated Frequency: 50/60 Hz
- Capacitance Tolerance -5% - +5%
- Permissible Temperature: -40°C - +70°C
- Individually Packaged
- Withstanding Voltage test
- Between Terminals: Rated Voltage X 1.75VAC, 10sec
- Between Terminals and Case: Rated Voltage X 2+1000VAC, 60sec
- Maximum Permissible Voltage: 110% of the rated voltage
- Maximum Permissible Current: 130% of the rated current
- Applied Standard: UL-810; CSA22.2 No190, IEC60252
- Meets 10,000AFC safety requirement per UL-810
- Oil Filled; Non PCB
- Quick Connect Terminal - Faston #250 series size



| Part # | Mfg #   | Description          | Price |
|--------|---------|----------------------|-------|
| 195756 | 3GJ7530 | 370VAC Oval 30+7.5μF |       |
| 214443 | 3GJ0515 | 370VAC Oval 15+5μF   |       |

### 370VAC Dual Round Run Capacitor

- Rated Frequency: 50/60 Hz
- Applied Standard: UL-810; CSA22.2 No190, IEC60252
- Meets 10,000 AFC safety requirement per UL-810
- Capacitance Tolerance +/-5%
- Permissible Temperature: -40°C to +70°C
- Individually Packaged
- Withstanding Voltage test
- Between Terminals: Rated Voltage X 1.75VAC, 10sec
- Between Terminals and Case: Rated Voltage X 2+1000VAC, 60sec
- Maximum Permissible Voltage: 110% of the rated voltage
- Maximum Permissible Current: 130% of the rated current
- Oil Filled; Non PCB
- 1/4" quick connect terminal



| Part # | Mfg #   | Description         | Price |
|--------|---------|---------------------|-------|
| 195759 | 3GR0525 | 370VAC Round 25+5μF |       |
| 197632 | 3GR0580 | 370VAC Round 80+5μF |       |

HVAC - General Accessories

## Capacitors

### 440VAC Single Oval Run Capacitors

- Rated Frequency: 50/60 Hz
- Applied Standard: UL-810; CSA22.2 No190, IEC60252
- Meets 10,000AFC safety requirement per UL-810
- Capacitance Tolerance +/-5%
- Permissible Temperature: -40°C to +70°C
- Individually Packaged
- Withstanding Voltage test
- Between Terminals: Rated Voltage X 1.75VAC, 10sec
- Between Terminals and Case: Rated Voltage X 2+1000VAC, 60sec
- Maximum Permissible Voltage: 110% of the rated voltage
- Maximum Permissible Current: 130% of the rated current
- Oil Filled; Non PCB
- 1/4" quick connect terminal



| Part # | Mfg #   | Description            | Price |
|--------|---------|------------------------|-------|
| 202161 | 45030H  | 440VAC Oval 3µF        |       |
| 204347 | 45040H  | 440VAC Oval 4µF        |       |
| 201308 | 45050H  | 440VAC Oval 5µF        |       |
| 211592 | 45050HU | 440VAC Oval 5µF USA    |       |
| 197360 | 45075H  | 440VAC Oval 7.5µF      |       |
| 211593 | 45075HU | 440VAC Oval 7.5µF USA  |       |
| 197361 | 45100H  | 440VAC Oval 10µF       |       |
| 211594 | 45100HU | 440VAC Oval 10µF USA   |       |
| 197362 | 45125H  | 440V Oval 12.5µF       |       |
| 211602 | 45125HU | 440VAC Oval 12.5µF USA |       |
| 197363 | 45150H  | 440VAC Oval 15µF       |       |
| 211595 | 45150HU | 440VAC Oval 15µF USA   |       |
| 239668 | 45175H  | 440VAC Oval 17.5µF     |       |
| 211596 | 45200HU | 440VAC Oval 20µF USA   |       |
| 211597 | 45250HU | 440VAC Oval 25µF USA   |       |
| 211598 | 45300HU | 440VAC Oval 30µF USA   |       |
| 211600 | 45400HU | 440VAC Oval 40µF USA   |       |
| 211601 | 45450HU | 440VAC Oval 45µF USA   |       |
| 211603 | 45500HU | 440VAC Oval 50µF USA   |       |
| 211614 | 45600HU | 440VAC Oval 60µF USA   |       |
| 210278 | 45700H  | 440VAC Oval 70µF USA   |       |

## Capacitors

### 440VAC Single Round Run Capacitor

- Rated Frequency: 50/60 Hz
- Applied Standard: UL-810; CSA22.2 No190, IEC60252
- Meets 10,000AFC safety requirement per UL-810
- Capacitance Tolerance +/-5%
- Permissible Temperature: -40°C to +70°C
- Individually Packaged
- Withstanding Voltage test
- Between Terminals: Rated Voltage X 1.75VAC, 10sec
- Between Terminals and Case: Rated Voltage X 2+1000VAC, 60sec
- Maximum Permissible Voltage: 110% of the rated voltage
- Maximum Permissible Current: 130% of the rated current
- Oil Filled; Non PCB
- 1/4" quick connect terminal



| Part # | Mfg #  | Description       | Price |
|--------|--------|-------------------|-------|
| 198900 | 45150R | 440VAC Round 15µF |       |
| 198901 | 45200R | 440VAC Round 20µF |       |
| 198902 | 45250R | 440VAC Round 25µF |       |
| 198903 | 45300R | 440VAC Round 30µF |       |
| 198904 | 45350R | 440VAC Round 35µF |       |
| 198905 | 45400R | 440VAC Round 40µF |       |
| 198906 | 45450R | 440VAC Round 45µF |       |
| 198907 | 45500R | 440VAC Round 50µF |       |
| 198908 | 45550R | 440VAC Round 55µF |       |
| 198909 | 45600R | 440VAC Round 60µF |       |
| 198910 | 45800R | 440VAC Round 80µF |       |

### 440VAC Dual Oval Run Capacitor

- Rated Frequency: 50/60 Hz
- Applied Standard: UL-810; CSA22.2 No190, IEC60252
- Meets 10,000AFC safety requirement per UL-810
- Capacitance Tolerance +/-5%
- Permissible Temperature: -40°C to +70°C
- Individually Packaged
- Withstanding Voltage test
- Between Terminals: Rated Voltage X 1.75VAC, 10sec
- Between Terminals and Case: Rated Voltage X 2+1000VAC, 60sec
- Maximum Permissible Voltage: 110% of the rated voltage
- Maximum Permissible Current: 130% of the rated current
- Oil Filled; Non PCB
- 1/4" quick connect terminal



| Part # | Mfg #   | Description          | Price |
|--------|---------|----------------------|-------|
| 202163 | 4JJ0530 | 440VAC Oval 5+30µF   |       |
| 202164 | 4JJ0535 | 440VAC Oval 5+35µF   |       |
| 202165 | 4JJ0540 | 440VAC Oval 5+40µF   |       |
| 202166 | 4JJ7535 | 440VAC Oval 7.5+35µF |       |

## Capacitors

### 440VAC Dual Round Run Capacitor

- Rated Frequency: 50/60 Hz
- Applied Standard: UL-810; CSA22.2 No190, IEC60252
- Meets 10,000AFC safety requirement per UL-810
- Capacitance Tolerance +/-5%
- Permissible Temperature: -40°C to +70°C
- Individually Packaged
- Withstanding Voltage test
- Between Terminals: Rated Voltage X 1.75VAC, 10sec
- Between Terminals and Case: Rated Voltage X 2+1000VAC, 60sec
- Maximum Permissible Voltage: 110% of the rated voltage
- Maximum Permissible Current: 130% of the rated current
- Oil Filled; Non PCB
- 1/4" quick connect terminal



| Part # | Mfg #    | Description                | Price |
|--------|----------|----------------------------|-------|
| 197358 | 4JR0525  | 440VAC Round 25+5 µF       |       |
| 211604 | 4JR0525U | 440VAC Round 25+5 µF USA   |       |
| 196431 | 4JR0530  | 440VAC Round 5+30 µF       |       |
| 211605 | 4JR0530U | 440VAC Round 5+30 µF USA   |       |
| 196433 | 4JR0535  | 440VAC Round 5+35 µF       |       |
| 211606 | 4JR0535U | 440VAC Round 5+35 µF USA   |       |
| 196434 | 4JR0540  | 440VAC Round 5+40 µF       |       |
| 211607 | 4JR0540U | 440VAC Round 5+40 µF USA   |       |
| 196435 | 4JR0545  | 440VAC Round 5+45 µF       |       |
| 211609 | 4JR0545U | 440VAC Round 5+45 µF USA   |       |
| 196436 | 4JR0550  | 440VAC Round 5+50 µF       |       |
| 211611 | 4JR0550U | 440VAC Round 5+50 µF USA   |       |
| 196437 | 4JR0555  | 440VAC Round 5+55 µF       |       |
| 211612 | 4JR0555U | 440VAC Round 5+55 µF USA   |       |
| 196438 | 4JR0560  | 440VAC Round 5+60 µF       |       |
| 211613 | 4JR0560U | 440VAC Round 5+60 µF USA   |       |
| 224820 | 4JR0570  | 440VAC Round 5+70 µF       |       |
| 213845 | 4JR1080  | 440VAC Round 10+80 µF      |       |
| 197359 | 4JR7530  | 440VAC Round 7.5+30 µF     |       |
| 196439 | 4JR7535  | 440VAC Round 7.5+35 µF     |       |
| 196440 | 4JR7540  | 440VAC Round 7.5+40 µF     |       |
| 211608 | 4JR7540U | 440VAC Round 7.5+40 µF USA |       |
| 196441 | 4JR7545  | 440VAC Round 7.5+45 µF     |       |
| 211610 | 4JR7545U | 440VAC Round 7.5+45 µF USA |       |
| 201867 | 4JR7550  | 440VAC Round 7.5+50 µF     |       |
| 204184 | 4JR7555  | 440VAC Round 7.5+55 µF     |       |
| 204147 | 4JR7560  | 440VAC Round 7.5+60 µF     |       |
| 224819 | 4JR7570  | 440VAC Round 7.5+70 µF     |       |

**Capacitors**

**Capacitors**

**Dual Round Capacitor**



| Part # | Mfg #        | Microfarad | Volts | Price |
|--------|--------------|------------|-------|-------|
| 103724 | 43-25133-01  | 25/3mfd    | 370V  |       |
| 078956 | 43-25133-02  | 30/3mfd    | 370V  |       |
| 096155 | 43-25133-21  | 30/5mfd    | 370V  |       |
| 096131 | 43-25133-03  | 35/3mfd    | 370V  |       |
| 096156 | 43-25133-35  | 35/5mfd    | 370V  |       |
| 086414 | 43-25133-04  | 40/3mfd    | 370V  |       |
| 096698 | 43-25133-22  | 40/5mfd    | 370V  |       |
| 086403 | 43-25133-05  | 45/3mfd    | 370V  |       |
| 086404 | 43-25133-06  | 45/5mfd    | 370V  |       |
| 113731 | 43-26261-48  | 45/10mfd   | 370V  |       |
| 086405 | 43-25133-07  | 50/3mfd    | 370V  |       |
| 078757 | 43-25133-25  | 50/5mfd    | 370V  |       |
| 142501 | 43-25133-28  | 55/3mfd    | 370V  |       |
| 086406 | 43-25133-08  | 55/5mfd    | 370V  |       |
| 096159 | 43-25133-29  | 55/10mfd   | 370V  |       |
| 086409 | 43-25133-09  | 60/3mfd    | 370V  |       |
| 036187 | 43-25133-10  | 60/5mfd    | 370V  |       |
| 142290 | 43-25133-19  | 25/5mfd    | 370V  |       |
| 103773 | 43-25133-31  | 60/10mfd   | 370V  |       |
| 086411 | 43-25133-32  | 70/5mfd    | 370V  |       |
| 103775 | 43-26271-47  | 70/10mfd   | 370V  |       |
| 080910 | 43-25133-33  | 80/5mfd    | 370V  |       |
| 096161 | 43-25133-34  | 80/10mfd   | 370V  |       |
| 188631 | 43-25133-44  | 40/5mfd    | 370V  |       |
| 175434 | 43-25133-36  | 30/5mfd    | 440V  |       |
| 086340 | 43-25133-11  | 35/3mfd    | 440V  |       |
| 087300 | 43-25133-12  | 35/5mfd    | 440V  |       |
| 072615 | 43-25133-14  | 40/5mfd    | 440V  |       |
| 133921 | 43-25133-16  | 45/5mfd    | 440V  |       |
| 175429 | 43-25133-24  | 45/10mfd   | 440V  |       |
| 133922 | 43-25133-26  | 50/5mfd    | 440V  |       |
| 072616 | 43-25133-17  | 55/5mfd    | 440V  |       |
| 086410 | 43-25133-30  | 60/5mfd    | 440V  |       |
| 161492 | 43-25133-37  | 60/10mfd   | 440V  |       |
| 096160 | 43-26271-45  | 60/10mfd   | 440V  |       |
| 175433 | 43-101665-06 | 35/5mfd    | 440V  |       |
| 103708 | 43-25133-13  | 40/3/mfd   | 440V  |       |

**Dual Oval Capacitor**

- Certified to the highest level of UL 810
- Tested and approved for 5,000 AFC



| Part # | Mfg #       | Microfarad | Volts | Price |
|--------|-------------|------------|-------|-------|
| 063489 | 43-25135-03 | 35/5mfd    | 370V  |       |
| 098888 | 43-25135-19 | 40/3mfd    | 370V  |       |
| 250947 | 43-25135-09 | 25/5mfd    | 440V  |       |

**Single Round Capacitor**



| Part # | Mfg #       | Microfarad | Volts | Price |
|--------|-------------|------------|-------|-------|
| 142502 | 43-25136-01 | 3mfd       | 370V  |       |
| 142503 | 43-25136-02 | 4mfd       | 370V  |       |
| 142505 | 43-25136-03 | 5mfd       | 370V  |       |
| 142506 | 43-25136-04 | 6mfd       | 370V  |       |
| 082669 | 43-25136-05 | 7.5mfd     | 370V  |       |
| 094857 | 43-25136-06 | 10mfd      | 370V  |       |
| 094858 | 43-25136-07 | 12.5mfd    | 370V  |       |
| 074119 | 43-25136-08 | 15mfd      | 370V  |       |
| 094861 | 43-25136-09 | 20mfd      | 370V  |       |
| 142509 | 43-25136-10 | 25mfd      | 370V  |       |
| 125108 | 43-25136-11 | 30mfd      | 370V  |       |
| 095766 | 43-25136-12 | 35mfd      | 370V  |       |
| 105798 | 43-25136-13 | 40mfd      | 370V  |       |
| 142513 | 43-25136-15 | 55mfd      | 370V  |       |
| 142514 | 43-25136-16 | 60mfd      | 370V  |       |
| 113922 | 43-25136-18 | 80mfd      | 370V  |       |
| 142515 | 43-25136-19 | 90mfd      | 370V  |       |
| 234995 | 43-25136-24 | 7.5mfd     | 440V  |       |
| 132363 | 43-25136-32 | 40mfd      | 440V  |       |
| 117432 | 43-25136-33 | 45mfd      | 440V  |       |
| 142512 | 43-25136-34 | 50mfd      | 440V  |       |

**Capacitors**

**Single Oval Capacitor**



| Part # | Mfg #       | Microfarad | Volts | Price |
|--------|-------------|------------|-------|-------|
| 022868 | 43-25134-01 | 3mfd       | 370V  |       |
| 058909 | 43-25134-27 | 4mfd       | 370V  |       |
| 022869 | 43-25134-02 | 5mfd       | 370V  |       |
| 141512 | 43-25134-28 | 6mfd       | 370V  |       |
| 017773 | 43-25134-03 | 7.5mfd     | 370V  |       |
| 020049 | 43-25134-04 | 10mfd      | 370V  |       |
| 020740 | 43-25134-05 | 12.5mfd    | 370V  |       |
| 030139 | 43-25134-06 | 15mfd      | 370V  |       |
| 141513 | 43-25134-07 | 20mfd      | 370V  |       |
| 141515 | 43-25134-09 | 30mfd      | 370V  |       |
| 141516 | 43-25134-10 | 35mfd      | 370V  |       |
| 141518 | 43-25134-17 | 45mfd      | 370V  |       |
| 141519 | 43-25134-18 | 50mfd      | 370V  |       |
| 141520 | 43-25134-19 | 55mfd      | 370V  |       |
| 234980 | 43-25134-22 | 10mfd      | 440V  |       |
| 141521 | 43-25134-29 | 60mfd      | 370V  |       |
| 141522 | 43-25134-30 | 70mfd      | 370V  |       |
| 141523 | 43-25134-31 | 80mfd      | 370V  |       |
| 234988 | 43-25134-23 | 15mfd      | 440V  |       |
| 234978 | 43-25134-33 | 7.5mfd     | 440V  |       |
| 234976 | 43-25134-21 | 5mfd       | 440V  |       |

**Start Capacitor**

- Phenolic case
- 15 Ohm Bleed resistor



| Part # | Mfg #       | Microfarad | Volts | Price |
|--------|-------------|------------|-------|-------|
| 009293 | 43-17075-03 | 135-155mfd | 330V  |       |
| 009294 | 43-17075-04 | 88-106mfd  | 330V  |       |
| 009295 | 43-17075-05 | 189-227mfd | 330V  |       |
| 024251 | 43-17075-07 | 270-324mfd | 330V  |       |

**Parts & Accessories**

| Part # | Mfg #       | Description   | Price |
|--------|-------------|---|-------|
| 180168 | 84-25175-05 | Disconnect Switch - 60A<br>Non-Fused Metal Top Open |       |



## Capacitors

### Capacitors

#### Dual Round Capacitor

- 440 VAC
- Capacitance (1): 30
- Capacitance (2): 3
- 1/4" Quick connects

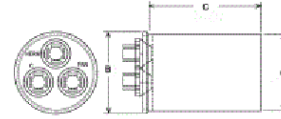

| Part # | Mfg #       | Description       | Price |
|--------|-------------|-------------------|-------|
| 235604 | 43-25133-20 | Control Volts 440 |       |

#### Turbo® 200 MINI Capacitor



| Part # | Mfg #  | Description   | Price |
|--------|--------|---------------|-------|
| 106682 | 439102 | 2.5 - 12.5mfd |       |

#### Turbo® 200 Capacitor



| Part # | Mfg #  | Description           | Price |
|--------|--------|-----------------------|-------|
| 106680 | 439100 | Control Volts 370-440 |       |

#### Turbo® 200X Capacitor



| Part # | Mfg #  | Description   | Price |
|--------|--------|---------------|-------|
| 106681 | 439101 | 2.5 - 97.5mfd |       |





## Chemicals

### Sealants

#### Furnace Cement

- Repairs casting cracks and fills voids
- For use on coal or wood burning furnaces and stoves
- Ready to use, no mixing
- Withstands same temperatures as fire brick



| Part # | Mfg # | Description | Price |
|--------|-------|-------------|-------|
| 005542 | 45050 | 16 oz Can   |       |

## Condensate Pumps

### VCMA Automatic Condensate Pumps

- Suitable for high-efficiency, gas furnace condensate
- Fully automatic
- 1/2 Gallon leak proof, rustproof, high impact ABS tank
- (3) Drain holes
- Removable 3/8" barbed check valve
- 3-Prong plug
- Snap-action switch
- Stainless steel shaft
- Polypropylene impeller
- ABS Plastic motor, tank cover and volute
- Includes check valve
- Optional safety switch
- Thermal overload protection



#### VCMA Series Condensate Pump less Tubing

- S Suffix = safety switch
- 6' Cord

| Part # | Mfg #  | Model      | Description        | Price |
|--------|--------|------------|--------------------|-------|
| 005997 | 554405 | VCMA-15ULS | 115V, 15' Shut-Off |       |
| 005998 | 554425 | VCMA-20ULS | 115V, 20' Shut-Off |       |

### Electronic Condensate Pumps

- Maximum flow: 4 gph
- Compact 2-piece design allows flexible installation for mini-split A/C units
- Self-priming pump can be located up to 3' above reservoir
- Suction tubing: 3" x 5/32" ID  
Vent tubing: 8" x 5/32" ID  
Drain tubing: 3" x 1/2" ID



| Part # | Mfg #  | Model  | Description | Price |
|--------|--------|--------|-------------|-------|
| 053838 | 553455 | EC-400 | 115V 60Hz   |       |
| 106971 | 553458 | EC-400 | 230V 60Hz   |       |

### VCMX NEXTGen™ Automatic Condensate Pumps

- Dimensions: 4.8" x 10.2" x 6.5"
- Oil resistant tank and check valve to eliminate problem of cracked tanks
- 1/4-Turn check valve allows servicing without removal of tubing
- Patent-pending cooling design
- Rubber feet absorb vibration
- Thermal overhead protection
- External overflow safety switch
- External test/run lever
- External tank anti-sweat sleeve
- Multiple brackets: steel mounting bracket for use on either side of tank
- 2-Year warranty



#### VCMX Series Condensate Pump less Tubing

- 20' Shut-off
- 6' Cord

| Part # | Mfg #  | Model      | Description         | Price |
|--------|--------|------------|---------------------|-------|
| 120046 | 554530 | VCMX-20ULS | 115V, Safety Switch |       |

**Condensate Pumps**

**Condensate Pumps**

**LCU Series Condensate Pump**

- High impact ABS tank
- Wall mounts
- (3) Intake holes
- 3/8" OD Outlet
- Barbed and threaded discharge connection
- Removable check valve
- Stainless steel shaft
- 6' Power cord with ground
- Thermally protected
- Quiet operation
- 3-Year warranty

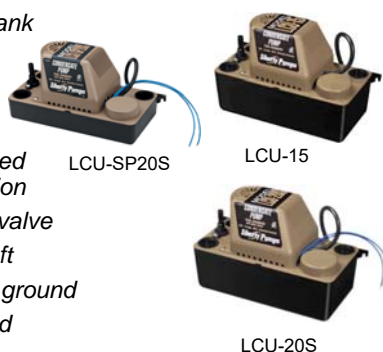

| Part # | Mfg #     | Description  | Price |
|--------|-----------|--|-------|
| 120642 | LCU-15    | 115V, 1/50 hp                                      |       |
| 123251 | LCU-20S   | 115V, 1/30 hp, w/Safety Switch                     |       |
| 124593 | LCU-SP20S | 115V, 1/30 hp, w/Safety Switch, Shallow Pan Design |       |

HVAC - General Accessories

## Condensate Pumps

### Condensate Pumps

#### ClearVue™ Pump - No Float, No Problem

- iQ Technology™ to think and adapt to changing conditions
- Variable lift
- Self-cleaning
- Floatless Sensor™



| Part # | Mfg #     | Description              | Price |
|--------|-----------|--------------------------|-------|
| 143695 | IQP-120   | Clearvue™ Pump 120V      |       |
| 201298 | DVIQP120T | ClearVue™ Pump, CVT 120V |       |

#### CP-22 Condensate Pump with Hose

- 22ft lift with 20ft of 3/8" CVT
- 4-3/8" Height
- Low profile package
- 4 inlet holes
- Motor mounts
- Metal hang tabs
- Clear indicator spray
- Vibration dampening feet
- Float switch and check valve
- 1/4" quick connect terminals (3 terminals)



| Part # | Mfg #      | Description                 | Price |
|--------|------------|-----------------------------|-------|
| 243155 | CP-22-230T | 230V with Tubing            |       |
| 196148 | CP-22T     | 120V with Tubing            |       |
| 198459 | DVCP22LP   | Condensate Pump low profile |       |

#### High Temp Boiler Condensate Removal Pump

- 46' Lift
- Two inlet holes
- 1/4 turn check valve
- Oil resistant tank and impeller
- For hot water applications up to 211°

| Part # | Mfg # | Power | Price |
|--------|-------|-------|-------|
| 238716 | BP-46 | 115V  |       |

#### Mini Split Condensate Pumps

- DiversiTech's Mini Split Condensate Pump is a quiet, super compact, and feature rich pump that fits almost anywhere.
- Available in 115V and 230V versions.
- Pump fits easily in most line sets covers.

| Part # | Mfg #    | Description | Price |
|--------|----------|-------------|-------|
| 187890 | DVCPM230 | 230V        |       |

### Mini-Split Drain Adapters

- Mini-Split fan units — either ceiling cassettes or wall cassettes — typically have a unique (metric) drain line fitting.
- DiversiTech's adapters convert this metric fitting to standard drain line tubing sizes



| Part # | Mfg #     | Description        | Price |
|--------|-----------|--------------------|-------|
| 250737 | 230-DLF25 | 25mm Drain Adapter |       |

HVAC - General Accessories

**Condensate Pumps**

**Condensate Pumps**

**Mini-Split Condensate Pump**

- *Integral Pump-Tank*
- *Piston pump type*
- *120/230V*
- *3.25ft Power cord length*
- *Safety switch included*
- *104°F Max water temp*



| Part # | Mfg #      | Power Supply & Consumption | CTN Weight | Price |
|--------|------------|----------------------------|------------|-------|
| 158107 | ASP-MW-UNI | 120/230V .11A 16W          | 1-3/4 lbs  |       |
| 177095 | ASP-MO-UNI | 120/230V                   | .4 lbs     |       |

HVAC - General Accessories

## Condensate Traps

### Condensate Traps

- Full-flow condensate traps
- Each trap is carefully sized, minimizing bothersome clogged trap service calls
- Manufactured to demanding standards



| Part # | Mfg # | Description            | Price |
|--------|-------|------------------------|-------|
| 116687 | 0357  | 3/4" Sch 40 PVC R-Trap |       |
| 116848 | 16349 | 1" Sch 40 PVC R-Trap   |       |

## Condensate Traps

### Condensate Traps

#### Residential Condensate Trap

- 3/4" Sch. 40 PVC trap saves fittings and job costs when trapping coil condensate lines



| Part # | Mfg #  | Type   | Size        | Price |
|--------|--------|--------|-------------|-------|
| 027598 | 867-30 | P-Trap | 8" x 2-1/2" |       |

#### Condensate Trap

- One piece 3/4" Sch. 40 PVC trap saves fittings and job costs when trapping condensate lines



| Part # | Mfg #  | Type    | Size         | Price |
|--------|--------|---------|--------------|-------|
| 184039 | 867-35 | Running | 10-3/4" x 2" |       |

**Disconnects/Fuses/Electrical Box Covers**

**Electrical Boxes**

**Handy Boxes - Standard Steel Utility Box**

- Dimensions: 4"H x 2-1/8"W



| Part # | Mfg # | Description            | Price |
|--------|-------|------------------------|-------|
| 002313 | 7596  | 2-1/8" Deep, 1/2" KO's |       |

**Steel Electrical Box**

- 1/2" & 3/4" Knockouts



| Part # | Mfg # | Description             | Price |
|--------|-------|-------------------------|-------|
| 143518 | 7588  | 4" Square x 2-1/8" Deep |       |

**Electrical Receptacles**

**Premium Duplex Receptacle**

- Premium specification grade
- 2-Pole, 3-wire grounding receptacles
- Side-wired



| Part # | Mfg # | Description     | Price |
|--------|-------|-----------------|-------|
| 141783 | 16573 | 15A, 125V White |       |

**Electrical Switches**

**Standard Toggle Switch**

- Combination of side wiring & push-in wiring
- Framed toggle
- 15A 1/2 hp 120V



| Part # | Mfg # | Description     | Price |
|--------|-------|-----------------|-------|
| 140155 | 16571 | Grounded, White |       |

HVAC - General  
Accessories





## Disconnects/Fuses/Electrical Box Covers

### Fuses



46-22863-82-5PK



44-ATC3-5PK

| Part # | Mfg #           | Description    | Price |
|--------|-----------------|----------------|-------|
| 056101 | 44-ATC3-5PK     | Fuse 3A 5-Pack |       |
| 064538 | 46-22863-82-5PK | Fuse 2A 5-Pack |       |
| 097898 | 44-ATC5-5PK     | Fuse 5A 5-Pack |       |

**Disconnects/Fuses/Electrical Box Covers**

**Fuses**

**Box Cover Units**

- Maximum 15 Amps
- Maximum 125VAC
- UL Listed and CSA certified
- For use with type T plug fuses



| Part # | Mfg #   | Description            | Price |
|--------|---------|------------------------|-------|
| 002302 | 620-608 | Switch/Fuse Combo/ESSU |       |

**Blade (Auto) Fuses**

- Fast acting low voltage supplementary fuses
- Automotive blade style



| Part # | Mfg #      | Description        | Price |
|--------|------------|--------------------|-------|
| 213723 | 626-AT0003 | 3AMP, Purple, 5/Pk |       |
| 213724 | 626-AT0005 | 5AMP, Tan, 5/Pk    |       |

**In-Line Fuse Holder**

- Controls up to 30 amp
- For use on AC/DC circuits
- Rigid plastic covering for each fuse



| Part # | Mfg # | Amps     | Price |
|--------|-------|----------|-------|
| 239670 | FH-1  | Up to 30 |       |

**Dual Element Fuses**

- Provides time delay for temporary over-current conditions and motor running protection for heating and air conditioning equipment
- Eliminates unnecessary maintenance from harmless overloads. U.L. Class RK-5, Standard for Safety 198E, Current Limiting Fuses, Interrupting Rating 200,000 Amps. rms. A.C.

| Part # | Mfg #    | Description         | Price |
|--------|----------|---------------------|-------|
| 192052 | 7CRNR-15 | Time delay, 15 Amps |       |
| 192053 | 7CRNR-20 | Time delay, 20 Amps |       |
| 192054 | 7CRNR-40 | Time delay, 40 Amps |       |
| 192056 | 7CRNR-50 | Time delay, 50 Amps |       |
| 194412 | 7CRNR-60 | Time delay, 60 Amps |       |
| 200539 | 7CRNR-30 | Time delay, 30 Amps |       |

**Time Delay Plug Fuses, U.L. listed**

- These plugs offer safe protection during momentary overload.
- No adapter necessary. U.L. Listed.



| Part # | Mfg #   | Description               | Price |
|--------|---------|---------------------------|-------|
| 192066 | 626-15T | Type T Plug Fuse – 15 Amp |       |

**Disconnects**

**DiversiTech Pull-Out Disconnect Switch**

- Side opening door
- Line, load, and ground terminals aligned
- Reversible door
- Full dead front



| Part # | Mfg #   | Description    | Price |
|--------|---------|----------------|-------|
| 132308 | DDS-60U | 60A, Non-Fused |       |

**Utility Boxes & Accessories**

**Standard Steel Utility Box**

- 2-1/8" deep
- 1/2" K.O.



| Part # | Mfg #   | Description                     | Price |
|--------|---------|---------------------------------|-------|
| 192062 | 620-202 | 2-1/8" Deep Handy Box           |       |
| 192068 | 620-254 | Flat blank cover                |       |
| 207287 | 620-252 | Flat, 2 duplex receptacle cover |       |

**Steel 1900 Boxes**

- Steel Utility Boxes are used for convenience outlets, switch boxes and small junction boxes.



| Part # | Mfg # | Description | Price |
|--------|-------|-------------|-------|
| 216595 | PI363 | 4"x4"x2"    |       |

**Electrical Tape**

**Tape**

**Scotch 3M Super 33+ Electrical Tape**

- Premium grade, 7 mil all-weather vinyl insulating
- Temperature range: 0° to 220°F



| Part # | Mfg # | Size       | Price |
|--------|-------|------------|-------|
| 132145 | ET33  | 3/4" x 66' |       |

**Economy Electircal Tape**

- Up to 175°F and not more than 600V
- UL listed



| Part # | Mfg #  | Description | Price |
|--------|--------|-------------|-------|
| 196493 | 6-3460 | 3/4" x 60'  |       |

---



---

## Electrical Tape

---



---

### Tape Electrical Tape

- Individually wrapped
- Black vinyl
- UL Listed



| Part # | Mfg #   | Size       | Price |
|--------|---------|------------|-------|
| 106658 | T20-030 | 3/4" x 60' |       |

**Electrical Tape**

**Amazing! Tile Tape**

- *Makes watertight junctions and connections for plastic tubing*
- *Made out of PVC, which provides super stretchability*
- *Properties:*
  - *Tensile strength: 20#/sq inch*
  - *Elongation: 230%*
  - *Dielectric: 8800V*
  - *Thickness: 8 mm*



| Part # | Mfg #   | Description    | Price |
|--------|---------|----------------|-------|
| 127854 | BT02ADC | 2" x 108' Roll |       |

**Gas Valves**

**VR Series Combination Gas Controls**

- Standard features for combination gas valves include:
  - (2) Automatic valves
  - Solenoid-operated first automatic valve opens on thermostat call for heat; closes when call for heat ends.
  - Diaphragm-operated second automatic valve opens under control of regulator; closes if gas or power supply is interrupted
  - Meets codes requiring dual safety shutoff
  - Mounting: 0° to 90°, any direction from upright position of gas control knob, including vertically

**VR8200 Continuous Pilot Dual Automatic Valve Combo Gas Control**

- For 24VAC gas-fired, standing pilot appliances with capacities from 20-200 cfh
- Includes all standard features plus:
  - Controls include manual valve, (2) automatic operators, Servco pressure regulator and pilot adjustment
  - Standard and slow opening natural gas models include natural to LP gas conversion kits; LP to natural gas conversion kits are also available
  - All adjustments, wiring connections and pilot outlets are accessible from the top of control
  - LITE-RITE (Off-Pilot-On) lighting sequence
  - Compatible with ECO connector
  - Capacities based on 1" p.d. 20,000 BTUH minimum, 130,000 BTUH maximum



| Part # | Mfg #       | Inlet/Outlet Size | Capacity cfh | Capacity m3/hr | Pressure Regulator Setting | Type of Gas | Type of Pressure Regulator | Price |
|--------|-------------|-------------------|--------------|----------------|----------------------------|-------------|----------------------------|-------|
| 006813 | VR8200A2132 | 1/2" x 1/2"       | 130          | 3.7            | 3.5"wc/0.9kPa              | NG          | Std (1)                    |       |

(1) Includes 393691 NG to LP conversion kit, 1/2"x 3/8" reducer bushing, 393690-14 bag assembly - 3/4" straight flange with o-ring, screws and wrench

**Universal Standard Opening Direct Ignition Gas Valve**

- Control includes manual valve, two automatic operators, pressure regulator, pilot adjustment, pilot plug and ignition adapter
- Replaces many IP, HSI, or DSI gas control
- For use with natural or manufactured gas or LP gas
- Includes converter kit to adapt from natural to LP gas
- Compact size
- All adjustments and wiring connections accessible from top of control
- 4" Swing radius allows easy rotation into position inside the tightest furnace vestibules
- Clearly marked, keyed terminal block allows quick attachment of wires and IP/DSI/HSI jumper
- Internal inlet screen blocks contaminants in gas line from entering valve



| Part # | Mfg #       | Inlet/Outlet Size | Capacity cfh | Capacity m3/hr | Pressure Regulator Setting | Type of Gas | Type of Pressure Regulator | Price |
|--------|-------------|-------------------|--------------|----------------|----------------------------|-------------|----------------------------|-------|
| 245091 | VR8245M2350 | 1/2" x 1/2"       | 200          | -              | 3.5"wc/0.9kPa              | NG          | Std (1)                    |       |
| 238093 | VR8345Q4563 | 3/4" x 3/4"       | 415          | -              | 3.5"wc/0.87kPa             | NG          | Std                        |       |

(1) Includes 393691 NG to LP conversion kit, 1/2"x 3/8" reducer bushing, 393690-14 bag assembly - 3/4" straight flange with o-ring, screws and wrench

HVAC - General Accessories

**Gas Valves**

**VR8300A Continuous Pilot Dual Automatic Valve Combo Gas Control**

- For 24VAC gas-fired, standing pilot appliances with capacities from 30-300 cfh
- Includes all standard features plus:
  - Controls include 100% safety shutoff, manual valve, magnetic operators, pressure regulator and pilot adjustment
  - Standard and slow opening natural gas models include natural to LP gas conversion kits; LP to natural gas conversion kits are also available
  - All adjustments, wiring connections and pilot outlets are accessible from the top of control
  - LITE-RITE (Off-Pilot-On) lighting sequence
  - Compatible with ECO connector
  - Ambient temperature ratings: 0° to 175°F
  - Capacities based on 1" p.d. 30,000 BTUH minimum, 190,000 BTUH maximum



| Part # | Mfg #       | Inlet/Outlet Size | Capacity cfh | Capacity m3/hr | Pressure Regulator Setting | Type of Gas | Type of Pressure Regulator | Price |
|--------|-------------|-------------------|--------------|----------------|----------------------------|-------------|----------------------------|-------|
| 006815 | VR8300A3500 | 1/2" x 3/4"       | 190          | 5.4            | 3.5"wc/0.87kPa             | NG          | Std (1)                    |       |

(1) Includes (1) 3/4"x 1/2" reducer bushing, 393691 NG to LP conversion kit

**VR8345 Universal Electronic Ignition Combination Gas Control**

- For use with direct spark ignition, hot surface ignition or intermittent pilot ignition in 24VAC, gas-fired appliances, with capacities from 30 to 415 cfh
- Includes all standard features plus:
  - Manual valve, two automatic operators, pressure regulator, pilot adjustment, pilot plug and ignition adapter
  - Replaces virtually any IP, HSI or DSI gas control
  - For use with natural or manufactured gas or LP gas
  - Includes converter kit to adapt from natural gas to LP gas
  - 4" Swing radius allows easy rotation into position inside the tightest furnace vestibules
  - Clearly marked, keyed terminal block allows quick attachment wires and IP/DSI/HSI jumper
  - Internal inlet screen blocks contaminants in gas line from entering valve
  - Capacities based on 1" p.d. 30,000 BTUH minimum, 300,000 BTUH maximum



| Part # | Mfg #       | Inlet/Outlet Size | Capacity cfh | Capacity m3/hr | Pressure Regulator Setting | Type of Gas | Type of Pressure Regulator | Price |
|--------|-------------|-------------------|--------------|----------------|----------------------------|-------------|----------------------------|-------|
| 025055 | VR8345M4302 | 3/4" x 3/4"       | 300          | 8.5            | 3.5"wc/0.87kPa             | NG          | Std (1)                    |       |

(1) Includes two 3/4" x 1/2" NPT reducer bushings and one 1/2" x 1/2" NPT bushing

HVAC - General Accessories

**Gas Valves**

**Combination Gas Controls**

**V800 Low Voltage Standing Pilot Gas Control**

- Auto 24V control for use with 30mV thermocouple, includes integral A and B gas cock, magnetic operator, pressure regulator, auto pilot, 100% shut-off, pressure tap and filter, one 36" thermocouple and LP kit
- Color coded blue to identify 24V operation



| Part # | Mfg #     | Inlet/Outlet Size | Capacity cfh | Capacity m3/hr | Pressure Regulator Setting | Type of Gas | Type of Pressure Regulator | Price |
|--------|-----------|-------------------|--------------|----------------|----------------------------|-------------|----------------------------|-------|
| 006820 | V800A1070 | 1/2" x 3/4"       | 250          | 7.1            | 3.5"wc/0.87kPa             | NG          | Std (1)(2)(3)              |       |
| 006821 | V800A1088 | 3/4" x 3/4"       | 335          | 9.5            | 3.5"wc/0.87kPa             | NG          | Std (1)(2)(3)              |       |

- (1) Includes one 3/4" x 1/2" and one 1/2" x 3/8" reducer bushing/adapter
- (2) Includes Q340 (36") thermocouple with adapters
- (3) NG to LP Conversion Kit

**VS820 Millivoltage Combo**

- Provides complete control of continuous pilot gas-fired central furnaces and boilers
- Self-powered automatic control for use with 750mV thermocouple
- Includes pilot flow adjustment screw
- All adjustments and connections are accessible from top of control
- Add separate energy cutoff (ECO) where codes call for dual safety shutoff
- Complete safety shutoff on pilot flame failure
- LITE-RITE (Off-Pilot-On) lighting sequence
- Adjustable pressure regulator
- Temperature range: 32° to 175°F
- Mounting 0° to 90° in any direction from the upright position of the gas control knob, including vertically



| Part # | Mfg #      | Inlet/Outlet Size              | Capacity cfh | Capacity m3/hr | Pressure Regulator Setting | Type of Gas | Type of Pressure Regulator | Price |
|--------|------------|--------------------------------|--------------|----------------|----------------------------|-------------|----------------------------|-------|
| 006816 | VS820A1047 | 1/2" x 3/4", 1/2" Side Outlets | 250          | 7.1            | 3.5"wc/0.87kPa             | NG          | Std (1)                    |       |

- (1) Includes one 3/4" x 1/2" and one 1/2" x 3/8" reducer bushing/adapter

HVAC - General Accessories



**Gas Valves**

**SmartValve® Hot Surface Pilot Ignition Controls**

**SV9501 SmartValve® System Control**

- Provides easy field replacement of a wide range of SV9500, SV9501, SV9502, SV9601 and SV9602 SmartValve® System models
- Gas appliance manufacturers use these models in many types of gas fired heating appliances including central furnaces, residential boilers, rooftop furnaces, commercial cooking appliances and unit heaters
- Provides intermittent pilot gas ignition sequencing, pilot flame sensing, and both pilot and main gas control functions in a single control
- Ignition sequence includes timed trial for ignition
- Compatible with Q3450 or Q3480 intermittent pilot burners used with the original controls on the appliance



| Part # | Mfg #       | Description   | Price |
|--------|-------------|---|-------|
| 231871 | SV9502H2522 | Intermittent HSI Pilot , 1/2" x 1/2" In/Out, 3.2"wc Standard Opening, Natural Gas |       |
| 098756 | SV9501M2528 | Intermittent HSI Pilot , 1/2" x 1/2" In/Out, 3.5"wc Standard Opening, Natural Gas |       |

**SV9641 SmartValve® System Control**

- Combines gas flow control and electronic intermittent pilot sequencing functions
- Q3450 or Q3480 Pilot hardware supplies the low voltage igniter, flame sensor and pilot burner
- Communicates directly with an electronic fan timer (ST9160 for single-stage applications; ST9162 for 2-stage applications) in typical forced warm air furnace applications
- Provides pre purge, post purge, timed trial for pilot ignition, with 100% shutoff and continuous retry
- Suitable for wide range of fan assisted combustion gas-fired appliances including: furnaces, rooftop furnaces, boilers, unit heaters, infrared heaters, water heaters, and commercial cooking appliances
- Ambient temperature range: -40° to 175°F
- Diagnostic LED



| Part # | Mfg #       | Description  | Price |
|--------|-------------|--|-------|
| 144233 | SV9641M4510 | 2-Rod Flame Sense, 3/4" NPT x 3/4" NPT Intermittent Hot Surface Pilot Ignition SmartValve® |       |

HVAC - General Accessories

**Gas Valves**

**Gas Valves**

**700 24 Volt Combination Valve**

- Electrical rating: 0.18A @ 12VDC  
0.2A @ 24VAC



| Part # | Mfg #   | Inlet Size | Outlet Size | Straight Through | Side Outlet w/Plugs | Pressure Regulator Setting | Capacity | Price |
|--------|---------|------------|-------------|------------------|---------------------|----------------------------|----------|-------|
| 058059 | 700-400 | 1/2" FPT   | 3/4" FPT    | Yes              | None                | Uni-Kit                    | 240,000  |       |

**720 Series Dual Valve Gas Control  
24V Hot Surface - Intermittent Pilot Ignition**



| Part # | Mfg #   | Inlet Size | Outlet Size | Straight Through | Side Outlet w/Plugs | Pressure Regulator Setting | Capacity | Price |
|--------|---------|------------|-------------|------------------|---------------------|----------------------------|----------|-------|
| 042430 | 720-400 | 1/2" FPT   | 3/4" FPT    | Yes              | None                | Uni-Kit                    | 150,000  |       |

**24V Standing Pilot - Step-Opening w/Convertible Pressure Regulator**

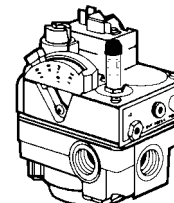

| Part # | Mfg #   | Inlet Size | Outlet Size | Straight Through | Side Outlet w/Plugs | Pressure Regulator Setting | Capacity | Price |
|--------|---------|------------|-------------|------------------|---------------------|----------------------------|----------|-------|
| 044307 | 720-474 | 1/2" FPT   | 1/2" FPT    | Yes              | 1/2" FPT            | Yes                        | 150,000  |       |

**Gas Valves**

**720 Series Gas Valve Uni-Kits®**

- Designed for intermittent pilot ignition applications
- 24V
- Direct spark, electronic ignition
- Valve features:
  - Manual valve
  - Pilot valve
  - (2) Dual automatic valves
  - Main gas pressure regulator



| Part # | Mfg #   | Inlet Size | Outlet Size | Straight Through | Side Outlet w/Plugs | Pressure Regulator Setting | Capacity | Price |
|--------|---------|------------|-------------|------------------|---------------------|----------------------------|----------|-------|
| 044306 | 720-079 | 1/2" FPT   | 3/4" FPT    | Yes              | 1/2" FPT            | Uni-Kit                    | 150,000  |       |

**Temperature Controls**

**Ranco® A22 Series Ice Bin Cold Control**

- SPDT switch
- Dial included
- 6°F differential
- Ice bin level & harvest control
- 48" Capillary sensing element
- Normal off: 35°F, normal on: 51°F
- High-amperage contacts
- Laser-welded stainless steel elbows
- Constant on or off positions available
- Fixed or adjustable temperature settings
- 1/4" Quick-connect terminals with optional screw terminals



| Part # | Mfg #    | Switch | Differential | Connection | Price |
|--------|----------|--------|--------------|------------|-------|
| 239663 | A22-1129 | SPDT   | 6°F          | 1/4"       |       |

**Heat Shrink Tubing**

**Heat Shrink  
Heat Shrink Tubing**



| Part # | Mfg #  | Description   | Price |
|--------|--------|---|-------|
| 140501 | 455062 | Assortment: (5) 1/4", (4) 3/16", & (3) 3/8"         |       |
| 140612 | 455153 | Rainbow Assortment: (5) 1/4", (4) 3/16", & (3) 3/8" |       |

HVAC - General  
Accessories

**Igniters**

**Igniters**

**Glowfly™ Universal Hot Surface Igniter**

- Uses a 120V silicon nitride igniter design with long life and high resistance to damage or burn out in the appliance
- Kit includes specially designed silicon nitride igniter and six different bracket configurations
- Clear instructions and application templates are provided
- Replaces over 110 different models
- 3-Year warranty



| Part # | Mfg #      | Description   | Price |
|--------|------------|---|-------|
| 126476 | Q3200U1004 | Glowfly™ Universal Hot Surface Igniter Kit, Pack of 1 |       |
| 200822 | Q3200U2002 | Glowfly™ Universal Hot Surface Igniter Kit, Pack of 6 |       |

**Q4100 Silicon Carbide Hot Surface Igniter**

- Q4100 igniters work with most configurations of element shapes, brackets, connectors, and lead wire lengths
- Honeywell igniters are made in the USA and backed by a 2-year warranty
- Temperature rating: 392 °F
- 120 Volt
- Natural LP gas



| Part # | Mfg #        | Description   | Price |
|--------|--------------|---|-------|
| 181450 | Q4100C9040/U | 120 Volt, Silicon Carbide Hot Surface Igniter with 5-1/4 in. lead lengths   |       |
| 181451 | Q4100C9042/U | 120 Volt, Silicon Carbide Hot Surface Igniter with 5-1/2 in. lead lengths   |       |
| 181452 | Q4100C9044/U | 120 Volt, Silicon Carbide Hot Surface Igniter with 6 in. lead lengths       |       |
| 181453 | Q4100C9046/U | 120 Volt, Silicon Carbide Hot Surface Igniter with 19-1/8 in. lead lengths  |       |
| 181454 | Q4100C9048/U | 120 Volt, Silicon Carbide Hot Surface Igniter with 5-1/4 in. lead lengths   |       |
| 181455 | Q4100C9050/U | 120 Volt, Silicon Carbide Hot Surface Igniter with 11 in. lead lengths      |       |
| 181456 | Q4100C9052/U | 120 Volt, Silicon Carbide Hot Surface Igniter with 5 in. lead lengths       |       |
| 181457 | Q4100C9054/U | 120 Volt, Silicon Carbide Hot Surface Igniter with 5-1/4 in. lead lengths   |       |
| 181459 | Q4100C9056/U | 120 Volt, Silicon Carbide Hot Surface Igniter with 5-1/4 in. lead lengths   |       |
| 181460 | Q4100C9058/U | 120 Volt, Silicon Carbide Hot Surface Igniter with 4-1/2 in. lead lengths   |       |
| 181461 | Q4100C9060/U | 120 Volt, Silicon Carbide Hot Surface Igniter with 5-1/4 in. lead lengths   |       |
| 181462 | Q4100C9062/U | 120 Volt, Silicon Carbide Hot Surface Igniter with 5-1/4 in. lead lengths   |       |
| 181463 | Q4100C9066/U | 120 Volt, Silicon Carbide Hot Surface Igniter with 5-1/4 in. lead lengths   |       |
| 181464 | Q4100C9068/U | 120 Volt, Silicon Carbide Hot Surface Igniter with 5-1/4 in. lead lengths   |       |
| 181465 | Q4100C9070/U | 120 Volt, Silicon Carbide Hot Surface Igniter with 5-11/16 in. lead lengths |       |
| 181466 | Q4100C9072/U | 120 Volt, Silicon Carbide Hot Surface Igniter with 5-5/16 in. lead lengths  |       |

---



---

**Igniters**

---



---

**Igniter Flame Rod Assembly**

- Use with SV9500, SV9600
- Field replacement for Q3450/Q3480 hot surface pilot burner



| Part # | Mfg #      | Description     | Price |
|--------|------------|-----------------|-------|
| 097708 | Q3400A1024 | 30" Lead Length |       |

HVAC - General Accessories

**Igniters**

**Igniters**

**41 Series Silicon Carbide Hot Surface Igniters**

- Delivers dependable ignition in heating systems of every description
- Engineered for easy handling, simple installation & trouble free operation

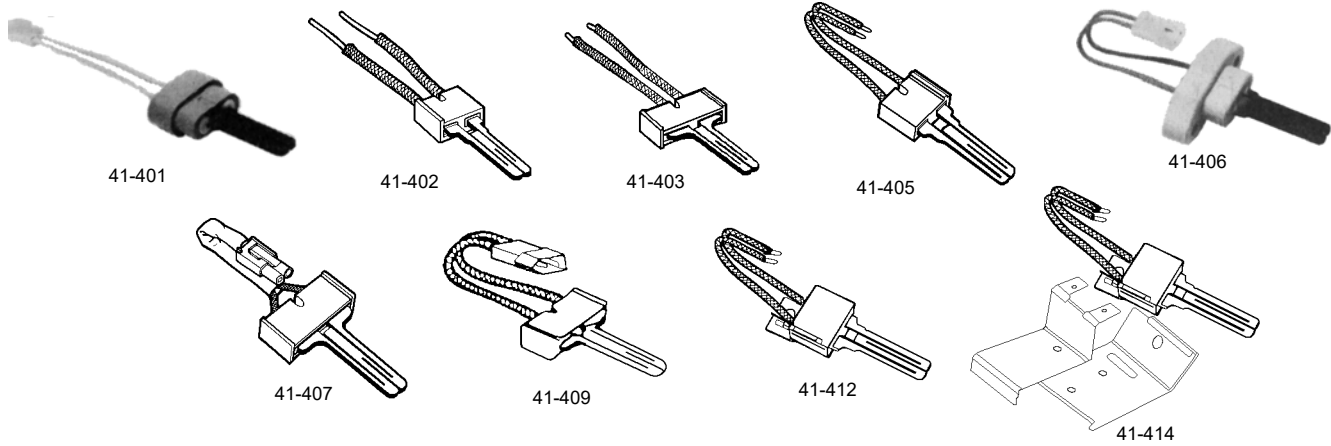

| Part # | Mfg #  | Factory Model# | Ceramic Block Style | Terminal Conn Type | Lead Wire Length | Price |
|--------|--------|----------------|---------------------|--------------------|------------------|-------|
| 044297 | 41-401 | 271A           | A                   | A                  | 4-1/2"           |       |
| 044298 | 41-402 | 217W           | B                   | None               | 19"              |       |
| 044299 | 41-403 | 271            | C                   | None               | 5-1/2"           |       |
| 044300 | 41-405 | 2711D          | D                   | None               | 5-1/2"           |       |
| 044301 | 41-406 | 271Y           | E                   | None               | 10-1/2"          |       |
| 044302 | 41-407 | 271            | C                   | B                  | 4-1/2"           |       |
| 044303 | 41-409 | 271            | C                   | D                  | 4-1/2"           |       |
| 044305 | 41-412 | 271NM          | F                   | None               | 5-1/4"           |       |
| 045277 | 41-414 | 271NM          | F                   | None               | 5-1/4"           |       |

**Series 41-600**



| Part # | Mfg #  | Factory Model              | Housing Length | Comments                                       | Price |
|--------|--------|----------------------------|----------------|--|-------|
| 058084 | 41-605 | 601XBM +Harness & Brackets | 2.5"           | York Replacement Conversion Kit #473-20937-001 |       |

HVAC - General  
Accessories

**Limit Controls**

**Fan & Limit Controls**

**L4064B Combination Fan & Limit Furnace Control**

- For control of high limit and fan motor in forced air heating systems
- (3) Wiring terminal options:
  - Female receptacles for 1/4" male flange connectors
  - Push-in receptacles for stripped wire
  - Field add-on screw terminals
- Helical bimetal sensing element, high limit set @ 200°F
- Manual fan switch
- Includes jumper



| Part # | Mfg #      | Description                      | Price |
|--------|------------|----------------------------------|-------|
| 006734 | L4064B2210 | 11-1/2" Insertion, Surface-Mount |       |
| 006735 | L4064B2228 | 5" Insertion, Surface-Mount      |       |
| 006736 | L4064B2236 | 8" Insertion, Surface-Mount      |       |

HVAC - General Accessories



**Oil Furnace Controls**

**Oil Primary Controls**

**R8184G Protectorelay® Oil Burner Control**

- Provides automatic, non-recycling control of an intermittent ignition oil burner system
- Low volt terminals, line volt lead wire connections and screw
- Intermittent ignition, safety switch
- 120V 60-Cycle or 110V 50-cycle
- Mount on 4" x 4" junction box or direct mount on burner housing
- With LED for lockout indication and manual trip lever on safety switch to assure burner shutdown during servicing
- C554 Cadmium Sulfide Flame Detector and 24VAC thermostat required



| Part # | Mfg #      | Description             | Price |
|--------|------------|-------------------------|-------|
| 006771 | R8184G4009 | 45-Second Safety Switch |       |

**R8184M Protectorelay® Oil Burner Control**

- Operates the oil burner and oil valve (if desired) in response to call for heat from a low voltage control circuit
- Burner mount, low volt terminals, line volt lead wire connections
- Intermittent ignition, 45-second safety switch
- 120V 60-Cycle, intermittent ignition
- 40VA Transformer for heat/cool, 0.2A thermostat current
- Use with C554



| Part # | Mfg #      | Description  | Price |
|--------|------------|--|-------|
| 006773 | R8184M1051 | 45 Second Safety Switch, 0.2A Anticipator Setting, Use with C554 |       |

**R7284B Electric Oil Primary Control**

- Microprocessor oil control
- Mount onto junction box on main burner
- UL and cUL component recognized
- Burner motor, oil valve, ignition, cad cell, limit, thermostat, alarm
- Interrupted ignition type
- LED display
- 15 Second lock out



| Part # | Mfg #        | Description                                | Price |
|--------|--------------|--|-------|
| 189629 | R7284B1024/U | 15 Second Safety Switch, -40° F to +147° F |       |

**RA116/RA117 Protectorelay® Oil Burner Control**

- 1-Piece, stack-mounted oil burner primary controls cycle burner on and shut down burner on flame loss or system malfunction
- 2- or 3-Wire, includes manual trip safety switch lever
- Use with line voltage or 24VAC control circuit
- RA116 - Safety switch heater energizes on flame or power failure lockout occurs if flame is not reestablished by end of safety switch timing



| Part # | Mfg #      | Description                                | Price |
|--------|------------|--|-------|
| 006764 | RA116A1055 | 360VA, Intermittent Ignition Protectorelay |       |

HVAC - General Accessories

---

---

**Oil Furnace Accessories**

---

---

**Flame Sensors**

**C554 Cadmium Sulfide Flame Detector**

- *Photo conductive flame sensing device for sequencing oil burner systems*



| Part # | Mfg #     | Description   | Price |
|--------|-----------|---|-------|
| 006719 | C554A1463 | 60" Lead, A/B/E/J/P Type & Oil Line Mounting Bracket Included |       |

## Oil Furnace Accessories

### Oil Burner Nozzles - Type A Red Vial

- *Hollow cone*
- *Creates stable flame at low flows*

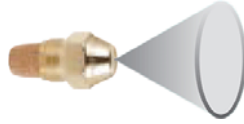

#### 60° Angle Oil Burner Nozzle - Type A

| Part # | Mfg #    | GPH | Price |
|--------|----------|-----|-------|
| 007771 | 0007560A | .75 |       |

#### 70° Angle Oil Burner Nozzle - Type A

| Part # | Mfg #    | GPH  | Price |
|--------|----------|------|-------|
| 007778 | 0008570A | .85  |       |
| 007759 | 0010070A | 1.00 |       |

#### 80° Angle Oil Burner Nozzle - Type A

| Part # | Mfg #    | GPH  | Price |
|--------|----------|------|-------|
| 007779 | 0008580A | .85  |       |
| 007761 | 0010080A | 1.00 |       |
| 007746 | 0011080A | 1.10 |       |
| 007751 | 0012580A | 1.25 |       |
| 007756 | 0015080A | 1.50 |       |

### Oil Burner Nozzles - Type B Blue Vial

- *Solid cone*
- *For larger burners & where air pattern is heavy in the center or for long fires*

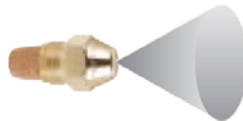

#### 80° Angle Oil Burner Nozzle - Type B

| Part # | Mfg #    | GPH | Price |
|--------|----------|-----|-------|
| 007780 | 0008580B | .85 |       |

### Oil Burner Nozzles - Type W Green Vial

- *Neither truly hollow nor solid*
- *Can be used in place of Type A or B Types in reducing specific problems*

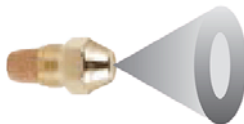

#### 80° Angle Oil Burner Nozzle - Type W

| Part # | Mfg #    | GPH  | Price |
|--------|----------|------|-------|
| 007770 | 0006580W | .65  |       |
| 007781 | 0008580W | .85  |       |
| 007747 | 0011080W | 1.10 |       |

HVAC - General Accessories

---

---

## Oil Furnace Accessories

---

---

### Fuel Filters

#### Replacement Filter Cartridge

- 10 Micron wool felt
- Center core bonded to prevent media migration



| Part # | Mfg # | Description                   | Price |
|--------|-------|-------------------------------|-------|
| 004856 | 1A-30 | Wool Felt - for Filter 1A-25A |       |

**Pilot Assemblies**

**Pilot Burners**

**Q314 Pilot Burner**

- Non-primary aerated, insert orifice-type, for main burner ignition with Q340 or Q390 thermocouple for Pilotstat safety control operation
- Use with Q313 Thermopile generator for 750mV power pile applications
- Includes natural gas and LP orifice
- Compression fitting size: 1/4"
- Special mounting bracket with screws for converting "B" bracket to "A"



| Part # | Mfg #     | Description  | Price |
|--------|-----------|--|-------|
| 006748 | Q314A4586 | B Bracket, BCR-18/BCR-10 Orifice, Single (F) Front Tip |       |
| 037901 | Q314A6094 | B Bracket, BCR-18 Orifice, Single (L) Left Front Tip   |       |
| 037902 | Q314A6102 | B Bracket, BCR-18 Orifice, Single (K) Right Front Tip  |       |

**Q327A Standing Pilot Burner**

- Variety of mounting brackets available
- Variety of tip styles to provide desired flame pattern
- Interchangeable, color-coded orifices can be ordered to convert between natural and LP gas
- Batwing tip style



| Part # | Mfg #      | Description   | Price |
|--------|------------|---|-------|
| 006749 | Q327A-1626 | A26 and K14 Orifices, For Standing Pilot Applications |       |

HVAC - General Accessories

## Pressure Regulators

### Gas Appliance Pressure Regulators

- Gasses: natural, manufactured, mixed, liquefied, petroleum and LP gas-air mixtures
- Corrosion-resistant construction

#### 325-3 Lever Acting Pressure Regulator

- Self-aligning valve with lever action for dead end lockup
- Multi-poise mounting
- Maximum individual load: 100,000 BTUH
- Capacity: 150,000 BTUH
- Vent pipe connection: 1/8" NPT



| Part # | Mfg #       | Description              | Price |
|--------|-------------|--------------------------|-------|
| 124028 | 325-3L12    | 1/2" Line Reg with 12A09 |       |
| 079070 | 325-3L48-44 | 1/2" Line Reg with 12A09 |       |

#### 325-5A Lever Acting Pressure Regulator

- Self-aligning valve with lever action for dead end lockup
- Maximum individual load: 250,000 BTUH
- Capacity: 300,000 BTUH
- Vent pipe connection: 3/8" NPT
- Multi-poise mounting



| Part # | Mfg #     | Description                                  | Price |
|--------|-----------|--|-------|
| 138743 | 325-5L48  | 1/2" Line Reg with 12A39 & OPD 48 Installed  |       |
| 113435 | 325-5L48  | 3/4" Line Reg with 12A39 & OPD 48 Installed  |       |
| 078926 | 325-5L600 | 3/4" Line Reg with 12A39 & OPD 600 Installed |       |
| 118426 | 325-5L34  | 3/4" Line Reg with 12A39 Installed           |       |
| 124030 | 325-5L1   | 1" Line Reg with 12A39 Installed             |       |
| 138744 | 325-5L600 | 1" Line Reg with 12A39 & OPD 600 Installed   |       |

#### 325-5L Lever Acting Pressure Regulator

- High leverage linkage assembly to deliver positive dead-end lockup
- Maximum individual load: 425,000 BTUH
- Capacity: 600,000 BTUH
- Multi-positional mounting



| Part # | Mfg #    | Description                              | Price |
|--------|----------|--|-------|
| 214294 | 325-5L12 | 1/2" w/ Vent Limiter 425 CFH w/v Limiter |       |

### Gas Appliance Pressure Regulators (Continued)

#### 325-5L Lever Acting Pressure Regulator

| Part # | Mfg #    | Description                              | Price |
|--------|----------|--|-------|
| 214291 | 325-5L34 | 3/4" w/ Vent Limiter 425 CFH w/v Limiter |       |
| 214580 | 325-5L1  | 1" w/ Vent Limiter 425 CFH w/v Limiter   |       |

#### 325-7 Lever Acting Pressure Regulator

- Self-aligning valve with lever action for dead end lockup
- Maximum individual load: 1,250,000 BTUH
- Capacity: 1,250,000 BTUH
- Vent pipe connection: 1/2" NPT
- Multi-poise mounting



| Part # | Mfg #         | Description                                      | Price |
|--------|---------------|--|-------|
| 086239 | 325-7AL       | 1-1/4" Line Press Rated Reg with 12A49 Installed |       |
| 075957 | 325-7AL 1-1/2 | 1-1/2" Line Press Reg Cert. to 2PSI Ansi Z21.80  |       |

### Gas Appliance Pressure Regulators Accessories

#### Vent Limiting Means

- Automatic vent limiting device
- When using, regulator must be mounted in horizontal upright position
- 12A04 - IAS Certified for 14" wc and European approval, use on RV48, RV52, RV53, RV61



| Part # | Mfg # | Description                   | Price |
|--------|-------|-------------------------------|-------|
| 134390 | 12A49 | For use with 325-7AL          |       |
| 150323 | 12A09 | For use with 325-3 and 325-3L |       |

#### Vent Protector

- Designed for outdoor applications
- Protect breather hole from outside elements
- Must be mounted in upright position
- 13A15 - Use in 325-3, 325-3L
- 13A15-5 - Use in 325-5A, 325-5AL



| Part # | Mfg #  | Description       | Price |
|--------|--------|-------------------|-------|
| 071088 | 13A15  | For 1/8" NPT Vent |       |
| 152096 | 13A155 | For 3/8" NPT Vent |       |

**Pressure Regulators**

**Gas Appliance Pressure Regulators  
Accessories (Continued)**

**Vent Protector**

| Part # | Mfg # | Description       | Price |
|--------|-------|-------------------|-------|
| 145637 | 13A25 | For 1/2" NPT Vent |       |

**Maxitrol® Maxicap**

- Rain and bug shield for regulators
- Rubber



| Part # | Mfg #      | Description             | Price |
|--------|------------|-------------------------|-------|
| 041419 | MAXICAP-3R | For 325-3 and 3R Series |       |
| 098862 | MAXICAP-5R | For 325-3               |       |

HVAC - General Accessories

## Relays

### Relays

#### General Purpose Relay

- Provides general purpose switching for refrigeration and air conditioning equipment, appliances, vending machines, etc
- 50/60Hz

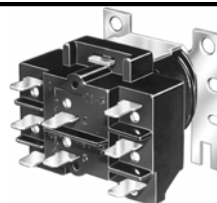

| Part # | Mfg #      | Description   | Price |
|--------|------------|---|-------|
| 006769 | R4222D1013 | DPDT 120V General Purpose, 1 - 6 Power Poles                      |       |
| 006774 | R8222B1067 | SPDT 24V General Purpose, Double Quick Connect, 1 - 3 Power Poles |       |
| 006775 | R8222D1014 | DPDT 24V General Purpose, Double Quick Connect, 1 - 6 Power Poles |       |

### Hydronic Switching Relays

#### R8845 Universal Hydronic Switching Relay

- Enclosed switching relay with internal 24V transformer
- (2) SPST, Plus PowerPile® rated low voltage SPST relay (if normally closed contacts are needed, use RA889A)
- Replaces Honeywell models: R182A,B,C,J; R482A,B,C,J; R845; R882A,B,C,J and RA832



| Part # | Mfg #      | Description  | Price |
|--------|------------|--|-------|
| 135224 | R8845U1003 | Intermediate Switching of Line and Low Voltage Devices from a Line or Low Voltage Controller |       |

#### Hydronic Switching Relay

- Provides intermediate switching of line voltage device from low voltage controller
- Integral transformer provides low voltage power for control circuit
- Provides DPST switching for hot water zone control systems, or SPST control of two separate loads
- Color-coded lead wire for easier wiring
- 50/60Hz



RA89

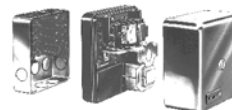

RA832



R845

| Part # | Mfg #      | Description   | Price |
|--------|------------|---|-------|
| 006767 | RA89A1074  | SPST 120V Enclosed 2-Wire for 1-Line Voltage Load                             |       |
| 006766 | RA832A1066 | DPST 120V Enclosed 2-Wire for 2-Line Voltage Loads                            |       |
| 030533 | RA832A1074 | DPST 240V Enclosed 2-Wire for 2-Line Voltage Loads                            |       |
| 033261 | R845A1030  | DPST 120V for Hot Water Zone Control Systems, 2-Wire for 2-Line Voltage Loads |       |

HVAC - General Accessories



**Smoke Bombs**

**Smoke Testers**  
**Smoke Bomb**

- *Emits dense oil-free non-toxic smoke*
- *Easily locates leaks in furnaces and ductwork*
- *Non-explosive, packaged in sealed capsules*



| Part # | Mfg # | Description             | Price |
|--------|-------|-------------------------|-------|
| 135427 | 14340 | 2,500 Cu/Ft, 4 Min Burn |       |

**Spades & Other Electrical Connectors**

**Motor Accessories**

**Wiring Harness**

- Use with Copeland Compressor with Molded Plug Connections



| Part # | Mfg #        | Description         | Price |
|--------|--------------|---------------------|-------|
| 105788 | 45-100834-80 | Bulk Pack (25/Case) |       |

**Terminals & Connectors**

**Ring Flag Terminal**

- 50/Pk



| Part # | Mfg #  | AWG   | Connector Type | Size     | Price |
|--------|--------|-------|----------------|----------|-------|
| 140452 | 455011 | 16-14 | Ring Terminal  | #10 Stud |       |

**Quick Connect Flag Terminal**

- 50/Pk



| Part # | Mfg #  | AWG   | Connector Type | Size     | Price |
|--------|--------|-------|----------------|----------|-------|
| 140454 | 455014 | 16-14 | Quick Connect  | 1/4" FIP |       |

**Quick Connect Compressor Terminal**

- 50/Pk



| Part # | Mfg #  | AWG  | Connector Type      | Size     | Price |
|--------|--------|------|---------------------|----------|-------|
| 140455 | 455015 | 12-8 | Compressor Terminal | 1/4" FIP |       |

**Quick Connect to Stud Adapter**

- 50/Pk
- Uninsulated



| Part # | Mfg #  | Tab Size | Terminal Size | Price |
|--------|--------|----------|---------------|-------|
| 140458 | 455018 | 1/4"     | #10 Stud      |       |

**Quick Connect Spade Adapter**

- Female to double male (Flat Style)
- 50/Pk
- Uninsulated



| Part # | Mfg #  | Tab Size | Tab Type | Price |
|--------|--------|----------|----------|-------|
| 140459 | 455019 | 1/4"     | Female   |       |

**Quick Connect Adapter**

- .296 Chair Gold Double Male/Single Female Adapter
- 50/Pk

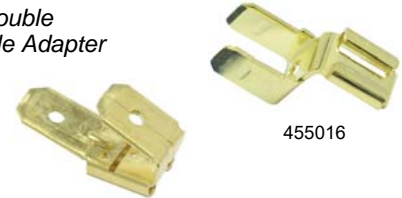

455016

455017

| Part # | Mfg #  | Description     | Price |
|--------|--------|-----------------|-------|
| 140456 | 455016 | Chair Style     |       |
| 140457 | 455017 | Piggyback Style |       |

**Insulated Quick Connect**



455045

| Part # | Mfg #  | AWG   | Color  | Tab Size | Pk  | Price |
|--------|--------|-------|--------|----------|-----|-------|
| 140482 | 455043 | 22-18 | Red    | 1/4"     | 50  |       |
| 140483 | 455045 | 16-14 | Blue   | 1/4"     | 100 |       |
| 140484 | 455046 | 16-14 | Blue   | 1/4"     | 50  |       |
| 140485 | 455047 | 16-14 | Blue   | 1/4"     | 100 |       |
| 140486 | 455048 | 16-14 | Blue   | 1/4"     | 50  |       |
| 140488 | 455049 | 12-10 | Yellow | 1/4"     | 100 |       |
| 140489 | 455050 | 12-10 | Yellow | 1/4"     | 50  |       |
| 140564 | 455091 | 16-14 | Blue   | 3/16"    | 15  |       |
| 140565 | 455092 | 16-14 | Blue   | 1/4"     | 15  |       |
| 140566 | 455093 | 12-10 | Yellow | 1/4"     | 15  |       |
| 140611 | 455152 | 22-18 | Red    | 1/4"     | 50  |       |
| 140562 | 455089 | 12-10 | N/A    | 1/4"     | 25  |       |

**With Piggyback**



| Part # | Mfg #  | AWG   | Color | Tab Size | Pk | Price |
|--------|--------|-------|-------|----------|----|-------|
| 140492 | 455052 | 16-14 | Blue  | 1/4"     | 50 |       |

**Spades & Other Electrical Connectors**

**Fully Insulated Quick Connect**



455145

| Part # | Mfg #  | AWG   | Color  | Tab Size | Pk  | Price |
|--------|--------|-------|--------|----------|-----|-------|
| 140493 | 455053 | 16-14 | Blue   | 1/4"     | 100 |       |
| 140603 | 455144 | 12-10 | Yellow | 1/4"     | 50  |       |
| 140604 | 455145 | 16-14 | Blue   | 1/4"     | 100 |       |
| 140628 | 455170 | 16-14 | Blue   | 1/4"     | 20  |       |

**Twist-On Plastic Wire Connector**



455163

| Part # | Mfg #    | AWG   | Color  | Pk   | Price |
|--------|----------|-------|--------|------|-------|
| 140622 | 455163   | 22-14 | Blue   | 1000 |       |
| 140517 | PD455075 | 22-14 | Blue   | 50   |       |
| 140567 | 455094   | 22-14 | Blue   | 15   |       |
| 140631 | 455173   | 22-14 | Orange | 50   |       |
| 140627 | 455169   | 18-12 | Yellow | 100  |       |
| 179414 | PD455633 | 22-14 | Blue   | 50   |       |
| 179413 | PD455632 | 22-14 | Orange | 50   |       |

**Closed Connector**



| Part # | Mfg #  | AWG   | Color | Pk | Price |
|--------|--------|-------|-------|----|-------|
| 140460 | 455020 | 22-14 | Clear | 50 |       |
| 140461 | 455021 | 12-10 | Clear | 25 |       |

**Uninsulated Butt Connectors**



| Part # | Mfg #  | AWG   | Color | Pk | Price |
|--------|--------|-------|-------|----|-------|
| 140608 | 455149 | 16-14 | SS    | 50 |       |

**Insulated Butt Connectors**



455039

| Part # | Mfg #  | AWG   | Color  | Pk  | Price |
|--------|--------|-------|--------|-----|-------|
| 140478 | 455038 | 22-18 | Red    | 100 |       |
| 140479 | 455039 | 16-14 | Blue   | 100 |       |
| 140480 | 455040 | 16-14 | Blue   | 50  |       |
| 140481 | 455042 | 12-10 | Yellow | 50  |       |
| 140518 | 455076 | 22-18 | Red    | 15  |       |
| 140520 | 455078 | 16-14 | Blue   | 15  |       |
| 140563 | 455090 | 12-10 | Yellow | 15  |       |
| 140630 | 455172 | 12-10 | Yellow | 100 |       |

**Ring Terminal**



455080

| Part # | Mfg #  | AWG   | Size      | Pk | Price |
|--------|--------|-------|-----------|----|-------|
| 140451 | 455010 | 8     | 1/4" Stud | 25 |       |
| 140521 | 455080 | 16-14 | #10 Stud  | 50 |       |

**Insulated Ring Terminal**



455024

| Part # | Mfg #  | AWG   | Color  | Size  | Pk  | Price |
|--------|--------|-------|--------|-------|-----|-------|
| 140463 | 455024 | 16-14 | Blue   | #6    | 100 |       |
| 140464 | 455025 | 16-14 | Blue   | #6    | 50  |       |
| 140465 | 455026 | 16-14 | Blue   | #10   | 100 |       |
| 140466 | 455027 | 16-14 | Blue   | #10   | 50  |       |
| 140469 | 455030 | 12-10 | Yellow | #10   | 100 |       |
| 140470 | 455031 | 12-10 | Yellow | #10   | 50  |       |
| 140471 | 455032 | 12-10 | Yellow | 5/16" | 50  |       |
| 140472 | 455033 | 8     | Red    | #10   | 50  |       |
| 140605 | 455146 | 8     | Red    | 1/4"  | 50  |       |
| 140606 | 455147 | 8     | Red    | 1/4"  | 25  |       |
| 140607 | 455148 | 12-10 | Yellow | 1/4"  | 100 |       |
| 140613 | 455154 | 16-14 | Blue   | #8    | 19  |       |
| 140614 | 455155 | 16-14 | Blue   | 1/4"  | 100 |       |

HVAC - General Accessories

**Spades & Other Electrical Connectors**

**Insulated Spade Terminal**



| Part # | Mfg #    | AWG   | Color  | Size | Pk  | Price |
|--------|----------|-------|--------|------|-----|-------|
| 140516 | 455074   | 16-14 | Blue   | #8   | 50  |       |
| 140474 | 455034   | 16-14 | Blue   | #8   | 15  |       |
| 140475 | 455035   | 16-14 | Blue   | #10  | 100 |       |
| 140476 | 455036   | 12-10 | Yellow | #8   | 25  |       |
| 140477 | PD455037 | 12-10 | Yellow | #10  | 25  |       |

**Compressor Lead Set**



| Part # | Mfg #  | AWG | Ring Size | Butt Size | Price |
|--------|--------|-----|-----------|-----------|-------|
| 140498 | 455059 | 10  | #10       | 10"       |       |

**Strip-Tie**



| Part # | Mfg #  | Length | Width | Max Dia | Pk     | Price |
|--------|--------|--------|-------|---------|--------|-------|
| 140467 | 455028 | 12"    | 3/4"  | 3"      | Black  |       |
| 140468 | 455029 | 12"    | 3/4"  | 3"      | Yellow |       |

**Motor Hook-Up Wire**



| Part # | Mfg #    | AWG | Length | Color | Price |
|--------|----------|-----|--------|-------|-------|
| 140522 | 455081   | 10  | 8'     | Black |       |
| 140600 | 455141   | 10  | 8'     | Blue  |       |
| 179378 | PD455082 | 10  | 8'     | Red   |       |
| 140601 | 455142   | 10  | 8'     | White |       |
| 140556 | 455083   | 12  | 12'    | Black |       |
| 140597 | 455138   | 12  | 12'    | Blue  |       |
| 140557 | 455084   | 12  | 12'    | Red   |       |

**Terminals & Connectors (Continued)**

**Motor Hook-Up Wire**

| Part # | Mfg #  | AWG | Length | Color | Price |
|--------|--------|-----|--------|-------|-------|
| 140598 | 455139 | 12  | 12'    | White |       |
| 140558 | 455085 | 14  | 15'    | Black |       |
| 140595 | 455136 | 14  | 15'    | Blue  |       |
| 140599 | 455140 | 14  | 15'    | Green |       |
| 140559 | 455086 | 14  | 15'    | Red   |       |
| 140596 | 455137 | 14  | 15'    | White |       |
| 140560 | 455087 | 16  | 16'    | Black |       |
| 140561 | 455088 | 16  | 16'    | Red   |       |
| 140594 | 455135 | 16  | 16'    | White |       |

**Metal Box for Electrical Connectors**

- 14"x9-1/4"x2"



| Part # | Mfg #  | Description    | Price |
|--------|--------|----------------|-------|
| 140616 | 455157 | 21 Compartment |       |

**Spades & Other Electrical Connectors**

**Terminal Kits**

**Serviceman's Terminal Kit**

- Consists of 175 assorted insulated and non-insulated items that are often used to service air conditioning, refrigeration and cooling units



| Part # | Mfg #     | Description                    | Price |
|--------|-----------|--------------------------------|-------|
| 111395 | MA02652-2 | Heavy-Duty Molded Plastic Case |       |



## Spades & Other Electrical Connectors

### Terminals & Connectors

#### Connector Kit

| Part # | Mfg #        | Description                               | Price |
|--------|--------------|---|-------|
| 140444 | 86-6966F-1PK | 665-Piece Professional HVAC Connector Kit |       |

#### Terminal

| Part # | Mfg #     | Description                 | Price |
|--------|-----------|-----------------------------|-------|
| 092116 | 86-QT2910 | Qwiklug Terminal Repair Kit |       |

**Temporary Construction Thermostats**

**Thermostats**

**Temporary Construction Thermostat**

- Low cost
- Mercury-free and non-adjustable
- Rugged construction is not effected by heat, moisture, paint and drywall dust



| Part # | Mfg # | Description            | Price |
|--------|-------|------------------------|-------|
| 034003 | 20064 | TS-60, 60°F, Heat Only |       |
| 034004 | 20065 | TS-65, 65°F, Heat Only |       |
| 034005 | 20066 | TS-70, 70°F, Heat Only |       |

**Temporary Construction Thermostats**

**T812 Low Voltage Control Thermostats**

- Snap-acting, bi-metal switch less mercury and requires no leveling
- For low voltage control of single-stage heating, cooling or heating/cooling systems
- Includes dealer logo pocket
- Switch type: snap-acting
- Electrical ratings: 18 to 30VAC
- Setting temperature change: 50° to 90°F
- Dimensions: 3-1/8"H x 3-1/8"W x 7/8"D
- Mounting: square



| Part # | Mfg #     | Application | Switching Action | Terminal Designations | Color | Price |
|--------|-----------|-------------|------------------|-----------------------|-------|-------|
| 101204 | T812A1002 | Heat Only   | SPST             | W,R                   | White |       |

HVAC - General Accessories



**Thermocouples**

**Power Generators**

**Q313 Replacement Thermopile Generator**

- Provides power for a millivoltage, self-powered control system
- Includes spade terminals
- Use with Q314, Q324, Q327, Q377, Q379 and Q382 pilot burners



| Part # | Mfg #     | Description  | Price |
|--------|-----------|--|-------|
| 006746 | Q313A1139 | 600-750mV Replacement Thermopile Generator, 35" Lead, Push-in Clip |       |
| 006747 | Q313A1170 | 600-750mV Replacement Thermopile Generator, 35" Lead, PG9 Adapter  |       |

**Thermocouples**

**Q340 Universal 30 mV Thermocouple**

- Includes push-in clip, split nut and adapter assembly for easy pilot burner installation
- Male nut connector for Pilotstat™ safety control power units



| Part # | Mfg #     | Description | Connection                   | Price |
|--------|-----------|-------------|------------------------------|-------|
| 006750 | Q340A1066 | 18" Lead    | 11/32"-32 Male Connector Nut |       |
| 006751 | Q340A1074 | 24" Lead    | 11/32"-32 Male Connector Nut |       |
| 006752 | Q340A1082 | 30" Lead    | 11/32"-32 Male Connector Nut |       |
| 006753 | Q340A1090 | 36" Lead    | 11/32"-32 Male Connector Nut |       |
| 006754 | Q340A1108 | 48" Lead    | 11/32"-32 Male Connector Nut |       |

HVAC - General Accessories

**Thermocouples**

**Thermocouples & Pilots**

**1951 Thermopile**

- Designed for use on self-powered gas control systems
- Easy burner installation with attached threaded nut
- Stainless steel outer jacket for long life and resistance to heat blistering
- Combination of copper and nickel alloys for good electrical conductivity
- Mica washer to insulate from shorting conditions
- Various lengths available for multiple applications

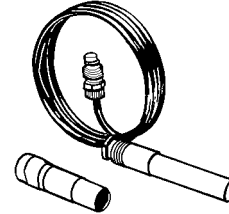

| Part # | Mfg #    | Length | Includes PG 9 Pilot Adapter | Connection Type | Price |
|--------|----------|--------|-----------------------------|-----------------|-------|
| 044312 | 1951-536 | 36"    | Yes                         | Coaxial         |       |

**1980 Snap-Fit™ Thermocouple**

- Offers easy installation into the majority of pilot burners

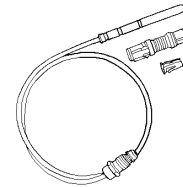

| Part # | Mfg #    | Length | Price |
|--------|----------|--------|-------|
| 044326 | 1980-018 | 18"    |       |
| 044329 | 1980-036 | 36"    |       |

HVAC - General Accessories

**Thermocouples**

**Thermocouples**

**K16 Series - "Husky™" High Performance Thermocouple**

- Heavy-duty
- Millivolt range: 25 - 35 mV
- Replaces BASO 17D, 50, 58D, 87D, 88D, 97D, 107D, & K15DA thermocouples



| Part # | Mfg #    | Length | Carton Quantity | Price |
|--------|----------|--------|-----------------|-------|
| 074880 | K16FA-36 | 36"    | 10              |       |

**Thermostats**

**Non-Programmable Thermostats**

**T87K, T87N Non-Programmable Thermostats - The Round®**

- Mercury free
- Provides electronic control of 24VAC heating and cooling systems
- Separate temperature setting and thermometer
- Classic twist dial
- Manual changeover
- Battery assisted power stealing
- Setting temperature range: 40° to 90°F
- Premier White®



T87K1007



T87N1000



T87N1026

| Part # | Mfg #    | Application                     | Terminal Designations | Dimensions             | Price |
|--------|----------|---------------------------------|-----------------------|------------------------|-------|
| 099889 | T87K1007 | Heat Only                       | R,W,Y                 | 3-11/16" Dia x 1-3/4"D |       |
| 096104 | T87N1000 | 1 Heat/1 Cool Conv & Heat Pump  | R,Rc,W,Y,G,O,B        | 3-11/16" Dia x 1-3/4"D |       |
| 099891 | T87N1026 | 1 Heat/1 Cool Conv & Heat Pump* | R,Rc,W,Y,G,O,B        | 4" Dia x 1-3/4"D       |       |

\* EASY-TO-SEE Model with large raised markings & click at each 2° set point change, includes 6" cover ring & switch position labels

**T822K, T827K Econostat Heat Only Non-Programmable Thermostats**

- Mercury free
- 24VAC Control of single stage low voltage heating systems
- Vented cover for improved temperature sensing
- Coiled bi-metal element operates mercury switch
- Mounts vertically directly on the wall or on vertical outlet box
- Precision snap action switch
- Dimensions: 4-3/4"H x 2-7/8"W x 1-3/8"D
- Premier White®



| Part # | Mfg #     | Application | Switching Action | Setting Temp Range | Terminal Designations | Description | Price |
|--------|-----------|-------------|------------------|--------------------|-----------------------|-------------|-------|
| 124832 | T822K1042 | 1 Heat      | SPST             | 35° - 85°F         | R,W                   | Heat-Off    |       |

HVAC - General Accessories

**Thermostats**

**T8775 The Digital Round™ Electronic Non-Programmable Thermostats**

- Attractive styling complements any decor
- Large easy-to-read display - the temperature reading is easily seen from a distance
- Backlit display
- No batteries required - the set point temperature is held permanently in memory in the event of a power failure.
- Powered through heating-cooling system controls
- 24VAC Gas or oil
- System and fan switches on the T8775C model
- Manual changeover from heat to cool on T8775C model
- Easy installation and set up
- Easily configurable by the use of DIP switches
- Fahrenheit or Celsius temperature
- Selectable heating cycle rates (1, 3, 6, 9 CPH) for a variety of applications
- Cooling cycle rate is fixed at 3 CPH (standard compressor setting)
- Minimum off-time for the compressor in the cooling mode. Protects and extends the life of the equipment
- Decorative cover plate is available to cover marks on the wall or to mount the T8775 Thermostat to an electrical box
- Premier White®



T8775A



T8775C

| Part # | Mfg #      | Application                           | Terminal Designations | Notes:            | Price |
|--------|------------|---------------------------------------|-----------------------|-------------------|-------|
| 099892 | T8775A1009 | 1-Stage Heat Only, Gas or Oil; 2-Wire | R,Rc,W,Y,G,O,B        |                   |       |
| 074622 | T8775C1005 | 1 Heat/1 Cool Heat Pump, No Aux Heat  | R,Rc,W,Y,G,O,B        | Manual Changeover |       |

**FocusPRO® 5000 Non-Programmable Digital Thermostats**

- Electronic control of 24VAC, heating and cooling systems or 750mV heating systems
- Clear back light display available with large (2.98 sq in) or standard (1.95 sq in) screen
- Precise comfort control +/- 1°F of your set temperature
- Temperature control range stops
- Soft-key, simplified controls
- Easy change battery door - flips out without disassembling thermostat
- Automatic/manual selectable changeover
- Dual-powered, battery or hardwired
- Built-in compressor protection: minimum-off timer protects compressor from restarting too early after a shutdown
- Temperature range:
  - Heat: 40° to 90°F
  - Cool: 50° to 99°F
- Dimensions: 3-7/16"H x 4-1/2"W x 1-5/16"D
- Premier White®



Standard Display



Large Display

| Part # | Mfg #       | Application                 | Terminal Designations               | Screen   | Price |
|--------|-------------|-----------------------------|-------------------------------------|----------|-------|
| 079592 | TH5110D1006 | 1 Heat/1 Cool               | R,Rc,C,W(O/B),Y,G                   | Standard |       |
| 079593 | TH5110D1022 | 1 Heat/1Cool                | R, Rc, C, W(O/B), Y, G              | Standard |       |
| 084587 | TH5220D1003 | 2H/2C Conv, 2H/1C Heat Pump | Rc,R,W(O/B),W2(AUX),Y,Y2,(E),G,L,C  | Standard |       |
| 098663 | TH5220D1029 | 2H/2C Conv, 2H/1C Heat Pump | R,Rc,W(O/B),W2 (AUX),Y,Y2,(E),G,L,C | Large    |       |
| 105599 | TH5320U1001 | 2H/2C Conv, 3H/2C Heat Pump | R,Rc,W(O/B),W2(AUX/E),Y,Y2,G,L,C    | Large    |       |

HVAC - General Accessories

**Thermostats**

**PRO® 3000 Basic Non-Programmable Digital Thermostats**

- Electronic control of 24VAC, heating and cooling systems or 750mV heating systems
- Digital back light display - both current and set temperature are easy to read
- Precise comfort control (+/- 1°F)
- Easy slide switches allow selection of heat or cool mode and fan operation
- Manual changeover
- Dual-powered, battery or hardwired
- Temperature range:
  - Heat: 40° to 90°F
  - Cool: 50° to 99°F
- Dimensions: 3-13/16"H x 5-3/8"W x 1-1/4"D
- Premier White®



| Part # | Mfg #       | Application                             | Terminal Designations       | Price |
|--------|-------------|---|-----------------------------|-------|
| 104606 | TH3110D1008 | 1 Heat/ 1 Cool Conventional & Heat Pump | R,Rc,W,Y,G,O,B,C            |       |
| 186398 | TH3210D1004 | Up to 2 Heat/ 1 Cool Heat Pump Systems  | R, Y, AUX, E, G, O, B, L, C |       |

**PRO® 1000 Builder Series Non-Programmable Digital Thermostats**

- Electronic control of 24VAC, heating and cooling systems or 750mV heating systems
- Perfect for multi-family housing developments or apartment complexes
- Clear, back light digital display
- Manual changeover
- Simple-set programming
- Dual-powered, battery or hardwired
- Temperature range:
  - Heat: 40° to 90°F
  - Cool: 50° to 99°F
- Dimensions: 4-11/16"H x 2-7/8"W x 1-1/8"D
- Premier White®



| Part # | Mfg #        | Application | Mount    | Terminal Designations | Price |
|--------|--------------|-------------|----------|-----------------------|-------|
| 162924 | TH1100DV1000 | Heat Only   | Vertical | R, C, W               |       |

**PRO 1000 Vertical Non-Programmable Thermostat**

- Vertical mount
- Switch positions: HEAT-OFF-COOL
- Dual Powered: Battery or Hardware
- Terminal Designations: R, RC, C, W, Y, G, O, B
- Manual changeover



| Part # | Mfg #        | Description   | Price |
|--------|--------------|---|-------|
| 211713 | TH1110DV1009 | 1H/1C Conventional, Heat Pumps with No Auxiliary Heat |       |

HVAC - General Accessories

**Thermostats**

**Low Volt Electric Heating (Ambient and Floor) Non-Programmable Manual Thermostat**

- Three choices of temperature control in a single thermostat (Ambient, Floor, or Ambient with Floor temperature limits)
- 5 mA ground fault circuit interrupter (GFCI) on GA models
- 15 mA equipment ground fault protection devices (EGFPD) on GB models
- GFCI and EGFPD test light verifies safety control is functioning properly and alerts if a leak is detected
- Advanced temperature control ensures total comfort by minimizing temperature swings
- ON/STANDBY switch enables thermostat shutdown at the end of heating season for added security
- On-screen heating power indicator gives at-a-glance verification of power being used
- Backlit display
- Battery-free



| Part # | Mfg #           | Description   | Price |
|--------|-----------------|---|-------|
| 129145 | TH114-AF-024T/U | Easy-to-read backlit display, slim contemporary design and precise temp control |       |

**Programmable Thermostats**

**Lyric Wi-Fi Thermostat**

- Remote Access
- Lyric App allows you to control with your smart phone or tablet
- Geofence control for savings when you're away and comfort when you're home
- Fine Tune temperature control
- Smart Cues for system information and recommendations
- Programmable with Geofencing
- Hardwired, battery back-up, power transformation



| Part # | Mfg #         | Description  | Price |
|--------|---------------|--|-------|
| 223085 | TH8732WFH5002 | 3 Heat/2 Cool Heat Pumps; Up to 2 Heat/2 Cool Conventional Systems |       |

**Lyric™ T6 Pro Wi-Fi Thermostat**

- Stages: up to 3 heat/2 cool heat pumps and 2 heat/2 cool conventional systems
- Includes thermostat, UWP mounting system, installation (j-box) adapter, small decorative plate, screws and anchors, installation guide, and user guide
- Programmability: 7 day, 5-1-1 day, 5-2 day, 1-week or non-programmable
- Geofence technology
- Optional wired indoor/outdoor sensors
- Electrical ratings & supply voltage: 20 to 30 vac
- Integrates with smart home Apple HomeKit and Amazon Alexa
- Dimensions: 4-1/16" long x 4-1/16" wide x 1-3/32" deep



| Part # | Mfg #        | Description  | Price |
|--------|--------------|--|-------|
| 228228 | TH6320WF2003 | 3 Heat/2 Cool Heat Pumps; Up to 2 Heat/2 Cool Conventional Systems |       |

HVAC - General Accessories

**Thermostats**

**FocusPRO® 6000 5+2 or 5+1+1 Day Programmable Digital Thermostats**

- Selectable to 5-1-1 (weekdays, Saturday, Sunday) or 5-2 (weekdays, weekend) programmable thermostat
- Large, clear, back light display - easy to read in various lighting conditions
- Display size options - available in large screen or standard
- Precise comfort control (+/- 1°F) - maintains consistent comfort to the highest level of accuracy
- Simplified programming and operation
- Easy change battery door - flips out without disassembling thermostat
- Built in instructions - simple, pull out instruction manual
- Adaptive Intelligent Recovery™ - ensures programmed temperature is reached by programmed time
- Temperature range stops - prevents user from setting the temperature too high or too low
- Temperature range:
  - Heat: 40° to 90°F
  - Cool: 50° to 99°F
- Dimensions: 3-9/16"H x 5-13/16"W x 1-1/2"D
- Premier White®
- 5-Year warranty



Large Display

| Part # | Mfg #       | Application                 | Terminal Designations                   | Screen   | Price |
|--------|-------------|-----------------------------|---|----------|-------|
| 084585 | TH6110D1005 | 1 Heat/1 Cool               | Rc,R,W(O/B),C,Y,G                       | Standard |       |
| 086938 | TH6110D1021 | 1 Heat/1 Cool               | Rc,R,W(O/B),C,Y,G                       | Large    |       |
| 084586 | TH6220D1002 | 2H/2C Conv, 2H/1C Heat Pump | Rc,R,W(O/B),W2(AUX),Y,Y2(E),G,L,C       | Standard |       |
| 173731 | TH6220D1028 | 2H/2C Conv, 2H/1C Heat Pump | R, RC, C, W(O/B), G, Y, W2(AUX, E, Y2-L | Standard |       |
| 135014 | TH6320U1000 | 2H/2C Conv, 3H/2C Heat Pump | Rc,R,W(O/B),W2(AUX/E),Y,Y2,G,L,C        | Large    |       |

**VisionPRO® 8000 Universal Touchscreen 7-Day Programmable Thermostats**

- Electronic control of 24VAC, heating and cooling systems or 750mV heating systems
- Universal system compatibility, heating only or heating and cooling; conventional or heat pump systems
- Large back light on-screen menu
- Ability to select multiple days
- Real-time clock
- Armchair programming - allows you to remove thermostat from wall to set the schedule
- Multiple HOLD, lockout options
- Adaptive Intelligent Recovery™
- Programmable fan
- Auto or manual changeover
- Dual-powered, battery or hardwired
- Change reminders - reminds you to service or replace the air filter, humidifier pad, ultraviolet lamp or thermostat batteries
- Temperature range:
  - Heat: 40° to 90°F
  - Cool: 50° to 99°F
- Horizontal mounting, dimensions: 4-9/16"H x 6"W x 1-1/4"D
- Premier White®
- 5-Year warranty



| Part # | Mfg #       | Application                 | Terminal Designations                    | Notes:             | Price |
|--------|-------------|-----------------------------|--|--------------------|-------|
| 155766 | TH8321R1001 | 3H/2C Heat Pump, 2H/2C Conv | R,RC,W,(O/B),W2(AUX),Y,Y2,L*,E,G,C,S1,S2 | Dehumidity Control |       |
| 155765 | TH8320R1003 | 3H/2C Heat Pump, 2H/2C Conv | R,RC,C,W-O/B,W2-AUX/E,Y,Y2,G,A-L/A,K,S1  |                    |       |

HVAC - General Accessories



**Thermostats**

**Programmable Thermostats (Continued)**

**VisionPRO® 8000 Universal Touchscreen 7-Day Programmable Thermostats**

| Part # | Mfg #        | Application                 | Terminal Designations                    | Notes: | Price |
|--------|--------------|-----------------------------|--|--------|-------|
| 181757 | TH8321WF1001 | 3H/2C Heat Pump, 2H/2C Conv | R,RC,W,(O/B),W2(AUX),Y,Y2,L*,E,G,C,S1,S2 |        |       |

\* The L terminal is an input or output

**VisionPRO® 8000 with RedLINK™ Technology**

- Thermostat works standalone or with the THM5421R1021 Equipment Interface Module or with the TrueZONE Wireless Adapter
- Smart Schedule - programs in seconds for any lifestyle
- Patented interview based programming and installer setup
- RedLINK™ wireless communication
- Customizable service reminders allow dealers to remind their customers when its time to call for service, when their warranty is expiring and to provide customized alerts.
- MicroSD port for copying the installer setup, customizable reminders, custom events and holidays to multiple thermostats.
- 1 assignable output on the TH8321 model to control humidification, dehumidification, ventilation or a stage of heating/cooling.
- 3 assignable outputs on the Equipment Interface Module to control humidification, dehumidification, ventilation or a stage of heating/cooling  
The TH8110 and TH8320 models require the use of a wireless indoor sensor to control humidification and dehumidification
- 1 assignable input can be used with a wired outdoor, indoor or discharge sensor
- 4 assignable inputs on the Equipment Interface Module can be used with wired outdoor, indoor or discharge sensors, occupancy sensor for remote setback and dry contact devices to trip pre-packaged or custom alerts such as a full drain pan or water leak
- Extend wireless range of the Equipment Interface Module by connecting a THM4000R1000 Wireless Adapter to the ABCD terminals
- Dual powered - battery or hardwired (C wire)
- Precise temperature control (+/- 1° F) for reliable and consistent temperature
- Multiple staging options to provide comfort or energy savings



| Part # | Mfg #       | Application              | Terminal Designations           | Notes: | Price |
|--------|-------------|--------------------------|---------------------------------|--------|-------|
| 155764 | TH8110R1008 | 1H/1C Conv and Heat Pump | R, RC, C, W-O/B, Y, G, K, S1 S1 |        |       |

**VisionPRO® 8000 with RedLINK™ Technology - Kit**

- Includes:
  - RedLINK™ Internet Gateway
  - Portable Comfort Control
  - Wireless Outdoor Sensor
  - Wireless Indoor Sensor
  - Wireless Entry/Exit Remote
  - Wireless Vent
  - Filter Boost Remote



| Part # | Mfg #          | Description   | Price |
|--------|----------------|---|-------|
| 173007 | YTH8321R1002/U | 3H/2C Heat Pump, 2H/2C ConvR,RC,C,W-O/B,W2-AUX/E,Y.Y2,G,A-L/A,K,U1,S1 |       |

HVAC - General  
Accessories

**Thermostats**

**LineVolt™ TH450/U Electric Manual Thermostat**

- Electric heating, baseboard heater, convector or fan-forced heater
- Battery-free, min & max temperature locks
- Minimum Load: 1.25 A (resistive only) 300 W @240 Vac, 150 W @ 120 Vac, Maximum Load: 16.7 A (resistive only), 4000 W @ 240 Vac, 2000 W @ 120 Vac
- Temp range: 40 F to 85



| Part # | Mfg #   | Description                           | Price |
|--------|---------|---------------------------------------|-------|
| 181190 | TH450/U | Line Voltage T-Stat, Non-Programmable |       |

**T6 Pro Series Programmable Thermostat**

- 24 Vac systems; Gas, Oil, Electric Warm Air; Hot water Coil; Gas, Oil, Electric Hydronic; or Steam / Gravity Systems
- Includes:
  - Thermostat
  - UWP mounting system
  - Installation (J-box) adaptor
  - Small decorative cover plate
  - Screws and anchors
  - Installation Guide & User Guides
  - 2 AA Batteries



| Part # | Mfg #         | Description  | Price |
|--------|---------------|--|-------|
| 228229 | TH6320U2008/U | Up to 3 Heat/2 Cool Heat Pumps; Up to 2 Heat/2 Cool Conventional Systems |       |
| 228231 | TH6210U2001/U | Up to 2 Heat/1 Cool Heat Pumps; Up to 1 Heat/1 Cool Conventional Systems |       |
| 228230 | TH6220U2000/U | Up to 2 Heat/1 Cool Heat Pumps; Up to 2 Heat/2 Cool Conventional Systems |       |

**PRO® 4000 5+2 Day Programmable Digital Thermostats**

- Electronic control of 24VAC, heating and cooling systems or 750mV heating systems
- Weekday/weekend programming to fit your lifestyle
- Clear, back light display
- Precise comfort control +/- 1°F of your set temperature
- Easy slide switches allow selection of heat or cool mode, and fan operation
- Dual-powered, battery or hardwired
- Manual changeover
- Built-in instructions - simple, pull out instruction manual
- Adaptive Intelligent Recovery™ - ensures programmed temperature is reached by programmed time
- Temperature range:
  - Heat: 40° to 90°F
  - Cool: 50° to 99°F
- Dimensions: 3-13/16"H x 5-3/8"W x 1-1/4"D
- Premier White®



| Part # | Mfg #       | Application                    | Terminal Designations       | Price |
|--------|-------------|--------------------------------|-----------------------------|-------|
| 096358 | TH4110D1007 | 1 Heat/1 Cool Conv & Heat Pump | Rc,R,W,Y,G,O,B,C            |       |
| 199720 | TH4210D1005 | 2 Heat/1 Cool Heat Pump        | R, Y, AUX, E, G, O, B, L, C |       |

HVAC - General Accessories

**Thermostats**

**LineVoltPro™ 8000 Programmable Electric Heat Only Thermostats**

- Use for electric baseboards, convectors and fan forced heaters (resistive rated loads)
- 7-Day preprogrammed schedule or modify programming to suit your lifestyle
- On-demand back light
- On/off switch and visible heat indicator
- Electrical rating: 15.0A
- 4-Wire/DPST Switching action



| Part # | Mfg #       | Description                                      | Price |
|--------|-------------|--|-------|
| 144533 | TL8230A1003 | 7-Day Programmable Electric Heat, Premier White® |       |

**Thermostat Accessories**

**Cover Plate Assembly For Use With Lyric T6 Pro, T6 Pro, T4 Pro, and T1 Pro Thermostats**

- 6-7/64" x 6-7/64"
- Square mounting with two screw holes
- Includes small & large cover plate, one bracket & mounting hardware
- Use to cover marks on wall or mount thermostat to a 2" x 4" electrical box

| Part # | Mfg #        | Description          | Price |
|--------|--------------|----------------------|-------|
| 232739 | THP2400A1068 | Cover Plate Assembly |       |

**Universal Thermostat Guard**

- Tamper-resistant lock; key cannot be removed unless in locked position
- Vents in guard base allow airflow



TG511A /TG512A

| Part # | Mfg #      | Description  | Price |
|--------|------------|--|-------|
| 006787 | TG511A1000 | Fits Series TH3000, TH4000, TH5000, TH6000, TH8000 & Similar 6-1/2"H x 7-1/2"W x 2-15/16"D   |       |
| 006788 | TG512A1009 | Fits Series TH5000, TH6000, TH8000 & Most Electronic Thermostats 7-1/4"H x 9-3/4"W x 3-3/8"D |       |

**Coverplate Assembly for Prestige® 2-Wire IAQ Thermostat**

- Use to cover marks on the wall or to mount the thermostat to a 2 in. X 4 in. electrical box. Includes a small and large cover plate, one bracket and mounting hardware

| Part # | Mfg #         | Description   | Price |
|--------|---------------|---|-------|
| 209854 | THP2400A1027W | Used with: THX9421R5021WW Prestige® 2-Wire IAQ Thermostat |       |

HVAC - General Accessories

**Thermostats**

**Coverplate Assembly for VisionPRO® Series Thermostats**

- 7-7/8" x 5-1/2"
- Premium White®



| Part # | Mfg #        | Description                                     | Price |
|--------|--------------|---|-------|
| 078078 | 32003796-001 | Used with: TH8000 VisionPRO® Series Thermostats |       |

**Wall Plate for 8000 Series Thermostat**

- Includes bracket and mounting hardware
- Use to cover marks on wall or mount thermostat to a 2" x 4" electrical box



| Part # | Mfg #          | Description                           | Price |
|--------|----------------|---------------------------------------|-------|
| 170430 | THP2400A1019/U | Wall Plate for 8000 Series Thermostat |       |

**Wire Saver C-Wire Adapter**

- For use with Wi-Fi thermostats or RedLINK 8000 Series models
- Acts as a splitter for applications that do not include a 24-volt C wire



| Part # | Mfg #        | Description  | Price |
|--------|--------------|--|-------|
| 246383 | THP9045A1098 | Replaces the need for a C wire (common wire) to power a thermostat |       |

HVAC - General  
Accessories

**Thermostats**

**Wireless Thermostat Systems & Accessories**

**Prestige® IAQ Comfort System**

- 4 Heat/2 cool heat pump or up to 3 heat/2 cool conventional
- Powered by RedLINK™ reliability
- Wireless outdoor sensor
- Large back-lit color display shows current indoor temperature, humidity, temperature setting, date and time on the home screen (also displays outdoor temperature and humidity on home screen if wireless outdoor sensor is installed)
- Automatic daylight savings update
- Auto or manual changeover
- Change reminders for air filter, humidifier pad, ultraviolet bulb or batteries in connected devices
- 7-Day multiple day programming or non-programmable
- Humidity and dehumidity control
- 18 to 30VAC
- Arctic white



| Part # | Mfg #           | Description   | Price |
|--------|-----------------|---|-------|
| 155759 | YTHX9421R5101WW | Prestige HD IAQ Thermostat, Equipment Interface Module                                  |       |
| 155758 | YTHX9421R5085WW | Prestige HD IAQ Thermostat, 2-Wire Comfort System Kit White Front/White Sides           |       |
| 174482 | YTHX9421R5085WG | Prestige HD IAQ Thermostat, 2-Wire Comfort System Kit White Front/Gray Sides            |       |
| 155761 | THX9421R5021WW  | Prestige HD IAQ Kit, w/ 2 Sensor 7-Day Programmable                                     |       |
| 223119 | YTHX9421R5127WW | Prestige HD IAQ Kit, w/ RedLINK, 2-Wire Touchscreen, Interface Module, & Return Sensors |       |

**D6 Pro Wi-Fi Ductless Controller**

- Compatible with most major brands and models
- Wi-Fi communication
- Infrared range to ductless unit in line of sight is 30 ft.
- Programmable (through app) for a time based 7 day, 5-2 day, or 1-week programs, or non-programmable, or GeoFence with sleep periods
- D6 control can sit on the tabletop stand (included) or be mounted to a wall using the adhesive strips (included)
- 5-year warranty
- Powered from USB cable (included) or wall plug (included). Plugs into 120 volt AC wall outlet



| Part # | Mfg #        | Description                      | Price |
|--------|--------------|----------------------------------|-------|
| 246382 | DC6000SF1001 | D6 Pro Wi-Fi Ductless Controller |       |

**Honeywell IAQ Equipment Interface Module**

- 4 Sensor inputs for wired sensors or dry contact devices
- 3 Sets of IAQ contacts to control humidification, dehumidification, and ventilation
- Used with all versions of Prestige IAQ thermostats and RedLINK™ VisionPRO thermostats
- 4 Heat/2 cool heat pump
- 3 Heat/2 cool traditional



| Part # | Mfg #         | Description  | Price |
|--------|---------------|--|-------|
| 163861 | YTHM5421R1010 | Prestige 2-Wire IAQ Equipment Interface Module Kit w/ 2 Duct Sensors                 |       |
| 155767 | THM5421R1021  | 3 Universal IAQ Contacts to control Humidification, Dehumidification, or Ventilation |       |

HVAC - General Accessories

**Thermostats**

**Wifi Heat and Cool Thermostat**

**FocusPRO® Thermostat Kit with RedLINK Internet Gateway**

- Includes:
  - C7735A1000 Return Air Sensor
  - THM5320R1000 Equipment Interface Module
  - THM6000R1002 RedLINK Internet Gateway
  - (YTH6320R1114/U has TH5320R1002 Thermostat)
  - (YTH6320R1122/U has TH6320R1004 Thermostat)
- 3 Heat/2 cool heat pump or up to 2 heat/2 cool conventional



| Part # | Mfg #          | Description   | Price |
|--------|----------------|---|-------|
| 174483 | YTH6320R1114/U | Includes TH5320R1002 Wireless Non-Programmable FocusPRO® Thermostat   |       |
| 174484 | YTH6320R1122/U | Includes TH6320R1004 Wireless 5+1+1 Programmable FocusPRO® Thermostat |       |

**FocusPRO® Wireless Thermostat Kit**

- Powered by RedLINK™ reliability
- Can display outdoor temperature and humidity
- 1-Year battery life, 2-month low battery warning



YTH5320R1000



YTH5320R1017

| Part # | Mfg #        | Description   | Price |
|--------|--------------|---|-------|
| 119159 | YTH5320R1000 | Includes TH5320R1002 Wireless Non-Programmable FocusPRO® Thermostat   |       |
| 119158 | YTH5320R1017 | Includes TH5320R1002 Wireless Non-Programmable FocusPRO® Thermostat   |       |
| 119161 | YTH5320R1025 | Includes TH5320R1002 Wireless Non-Programmable FocusPRO® Thermostat   |       |
| 119090 | YTH6320R1001 | Includes TH6320R1004 Wireless FocusPRO® 5+1+1 Programmable Thermostat |       |
| 119089 | YTH6320R1015 | Includes TH6320R1004 Wireless FocusPRO® 5+1+1 Programmable Thermostat |       |

**Wi-Fi 9000 with Voice Control**

- Change temperature with Voice Control (English only)
- Get Connected – Connect to homes existing Wi-Fi network
- Remote Control – Convenience, comfort and control from anywhere through web, tablet or smartphone access
- App available for tablet and smartphones
- Automatic software updates through Wi-Fi
- Selectable to 7 Day or Non-Programmable
- Program thermostat locally or over the web or app
- Customize the screen color to match any décor



| Part # | Mfg #     | Description  | Price |
|--------|-----------|--|-------|
| 167150 | TH9320WVF | 7-Day Program or Non-Programmable, Up to 2H/2C Conv or 3H/2C Heat Pump |       |

HVAC - General Accessories

**Thermostats**

**Wi-Fi 9000 Color Touchscreen Thermostat**

- *Get Connected – Connect to home’s existing Wi-Fi network*
- *Remote Control – Convenience, comfort and control from anywhere through web, tablet or smartphone access*
- *Apps available for tablet and smartphones*
- *Automatic software updates through Wi-Fi*
- *Selectable to 7 Day or Non-Programmable*
- *Program thermostat locally or over the web or app*
- *Customize the screen color to match any décor*
- *TH9320WF5003 is ENERGY STAR® Certified*



| Part # | Mfg #        | Description  | Price |
|--------|--------------|--|-------|
| 163964 | TH9320WF5003 | 7-Day Program Or Non-Programmable, Up to 2H/2C Conv or 3H/2C Heat Pump |       |

**Wireless FocusPRO® Thermostat**

- *Compatible with gas, oil, electric, heat pump, forced warm air, hot water, steam or gravity*
- *Easily add a zone to a TrueZONE™ system without running new wires*
- *Powered by RedLINK™ reliability*
- *No interference with other wireless devices in the home*
- *Works with compatible RedLINK™ enabled devices*
- *Same great features of the FocusPRO® thermostat now wireless*
- *Installs in minutes*
- *Can display outdoor temperature and humidity (if wireless outdoor sensor is installed)*
- *Battery powered only*
- *1-Year battery life, 2-month low battery warning*
- *Premier White®*



TH5320R1002



TH6320R1004

| Part # | Mfg #        | Description  | Price |
|--------|--------------|--|-------|
| 119160 | TH5320R1002  | Non-Programmable, Up to 3 Heat/2 Cool Heat Pump or Up to 2 Heat/2 Cool Conventional              |       |
| 119091 | TH6320R1004  | 5+1+1 or 5+2 Day Programmable, Up to 3 Heat/2 Cool Heat Pump or Up to 2 Heat/2 Cool Conventional |       |
| 154516 | TH6320WF1005 | 7-Day Program, Up to 3Heat/2 Cool Heat Pump or Up to 2 Heat/2 Cool Conventional                  |       |

**Wireless Outdoor Temperature Sensor**

- *Powered by RedLINK™ reliability*
- *No interference with other wireless devices in the home*
- *Reliable performance in all climates*
- *Installs in minutes*
- *Up to 5-years battery life, 2-month low battery warning*
- *Battery warning displayed on RedLINK™ enabled thermostats*
- *Includes (2) AA Lithium batteries and mounting hardware*



| Part # | Mfg #      | Description  | Price |
|--------|------------|--|-------|
| 120395 | C7089R1013 | Wireless Outdoor Sensor, Senses Outdoor Temperature and Humidity, RedLINK™ |       |

HVAC - General Accessories

**Thermostats**

**Personal Comfort Station™**

- Works in both zoned and non-zoned applications
- Powered by RedLINK™ reliability
- Built in pager with an audible noise helps locate the device in the home
- Battery powered
- Touchscreen interface with back light display
- Can display outdoor temperature and humidity



| Part # | Mfg #        | Description  | Price |
|--------|--------------|--|-------|
| 120396 | REM5000R1001 | Portable Comfort Station Control, RedLINK™ Enabled |       |

**RedLINK™ Equipment Remote Module Kit**

- Wireless RedLink™ communication between condensing unit/compressor or boiler and thermostat
- Eliminates the need to run additional wires to your equipment, for example, during a heat pump upgrade
- Suitable for outdoor use
- Temperature sensor terminals for outdoor temp sensors or indoor freeze protection
- LEDs for easy installation checkout
- May reduce damage to homes since wiring/drilling is eliminated



| Part # | Mfg #          | Description   | Price |
|--------|----------------|---|-------|
| 220491 | YERM5220RVPEIM | Includes: Equipment Remote Module (ERM) (ERM5220R1018), VisionPRO 8000 (TH8321R1001), and Equipment Interface Module (EIM) (THM5421R1021) |       |

**RedLINK™ Equipment Remote Module**

- Wireless RedLink™ communication between condensing unit/compressor or boiler and thermostat
- Eliminates the need to run additional wires to your equipment
- Suitable for outdoor use
- Temperature sensor terminals for outdoor temp sensors or indoor freeze protection
- LEDs for easy installation checkout
- May reduce damage to homes since wiring/drilling is eliminated
- Erm is NOT compatible with RedLink Zone Boards



| Part # | Mfg #                     | Description  | Price |
|--------|---------------------------|--|-------|
| 189864 | Suitable for outdoor use. | Wireless RedLink™ communication between condensing unit/compressor or boiler and thermostat use. |       |

HVAC - General Accessories



**Thermostats**

**RedLINK™ to Internet Gateway and Ethernet Cable and Power Cord**

- 20-30 Vac
- 24 Volt plug in transformer
- 5Vdc, 1000mA power adapter
- 902-928 MHz frequency
- Includes 3' ethernet cable



| Part # | Mfg # | Description                          | Price |
|--------|-------|--------------------------------------|-------|
| 240373 |       | LEDs for easy installation checkout. |       |

**RedLINK™ Internet Gateway**

- Provides remote access to any RedLINK® enabled thermostat through the internet, smart phone or tablet
- Includes 3' Ethernet cable and plug-in power adapter
- Operating temperature: 32° to 120°F



| Part # | Mfg #        | Description                    | Price |
|--------|--------------|--------------------------------|-------|
| 143270 | THM6000R1002 | Up to 4 Heat/2 Cool Heat Pumps |       |

**RedLINK™ Wireless Indoor Air Sensor**

- Used to change the sensing location of the thermostat
- Works with RedLINK™ 2.0 thermostats
- Sense temperature and humidity remotely
- Control temperature and humidity in separate locations
- Humidify and dehumidify in separate locations
- Up to (6) wireless sensors per thermostat
- Dimensions: 2-7/8"H x 1-7/8"W x 15/16"D
- Operating temperature: 0° to 120°F
- Includes:
  - (2) AAA Batteries
  - Mounting hardware



| Part # | Mfg #      | Description                     | Price |
|--------|------------|---------------------------------|-------|
| 143274 | C7189R1004 | RedLINK™ Wireless Indoor Sensor |       |

**TrueIAQ™ Total Home Comfort System**

- Manages humidification, dehumidification, ventilation and bathroom fans from a central point in your home
- Setting changes can be made easily with the touch of a button
- Simultaneously displays both indoor and outdoor temperature and humidit
- y levels on-screen
- Automatically adjusts inside settings based on outdoor conditions
- Include individual air quality enhancements to your system with TrueIAQ™, or integrate them all as part of a total air quality system
- Intuitive digital back light display.



| Part # | Mfg #      | Description  | Price |
|--------|------------|--|-------|
| 111238 | DG115EZIAQ | Steam Type, 120VAC, Duct or Remote Mount with Outdoor Temperature/Humidity Sensor, White |       |

HVAC - General Accessories

**Thermostats**

**Sensors**

**C7089 Remote Outdoor Temperature Sensor**

- Senses outdoor temperature for display; can manage dual-fuel and lock-out auxiliary heat in heat pump applications
- Maximum wire run of 200'
- Includes 60" lead wire, mounting clips and screws
- Dimensions: 2-1/4" x 3/8" with 60" lead wire
- Factory calibrated

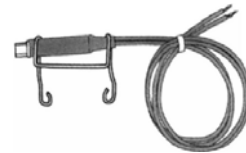

| Part # | Mfg #      | Description                                 | Price |
|--------|------------|---|-------|
| 078072 | C7089U1006 | For VisionPRO® & VisionPRO® IAQ Thermostats |       |

**PT1000 Duct TempSensor**

- Electronic temperature sensors used with DDC systems
- PT1000 TempSensor, 6" insertion
- Use w/ T775, operating range -40-250°F



| Part # | Mfg #        | Description   | Price |
|--------|--------------|---|-------|
| 190400 | C7031B2005/U | For Duct, Use with Excel 10, 50, 80, 100, 500, T775 Series 2000 |       |

**C7041 Immersion Sensor**

- 20K ohm NTC temp sensor, 5 in. insertion
- Immersion sensor for hot or chilled water, purchase well 50001774-001 separately



| Part # | Mfg #        | Description                    | Price |
|--------|--------------|--------------------------------|-------|
| 190399 | C7041D2001/U | For Excel 10, 50, 80, 100, 500 |       |

**Outdoor Air Temperature Sensor**

- Electronic temperature sensors used with DDC systems
- 1715 ohm, for use with W7100 (outdoor reset)
- Outside air temperature



| Part # | Mfg #        | Description   | Price |
|--------|--------------|---|-------|
| 190401 | C7031G2006/U | 1715 ohm Outdoor Air Temperature Sensor, for use with W7100 |       |

HVAC - General Accessories

## Thermostats

### Discharge Temperature Sensor

- Primary and/or secondary sensors in electronic control systems
- No settings or calibration required.
- Solid state components not affected by dust or dirt.
- Fast reacting.
- Rugged aluminum insertion probe.
- Mounts on duct or plenum surface with integral mounting flange, or in a 2 x 4 in. junction box.



| Part # | Mfg #        | Description  | Price |
|--------|--------------|--|-------|
| 190397 | C7046D1008/U | 1097 ohm @ 77 F PTC, Excel 600, Excel 500, Excel 100, Excel 80, and T775 Series 2000 |       |

### Slab/Floor Sensor for use with AQ1000 Series Thermostats

- Sensor-- -58 F to +230 F



| Part # | Mfg #   | Description   | Price |
|--------|---------|---|-------|
| 134580 | AC12C20 | Slab/Floor sensor for use with AQ2000 series control panels & AQ1000 series thermostats |       |

### C7189 Remote Indoor Sensor

- Mounts in living space up to 200' away from W8900 remote module



| Part # | Mfg #      | Description                                 | Price |
|--------|------------|---|-------|
| 078076 | C7189U1005 | For VisionPRO and VisionPRO IAQ Thermostats |       |

### Water Leak Freeze Detectors and Sensor Cables

- 4-Pack
- Place near sinks, washers, water heaters, sump pumps— anywhere leaks could happen
- Battery life lasts up to 3 years without incident
- Notification messages can alert you or your family/ friends, while audible (100 dB alarm) alerts sound when you are at home
- Use to detect temperatures that can freeze pipes, and humidity
- Runs on WiFi - No Extra Hub or hardware purchase required
- Daisy chain extra cable sensors and cover up to 500 feet of space with one leak detector
- Five year warranty for professionally installed devices



| Part # | Mfg #         | Description  | Price |
|--------|---------------|--|-------|
| 234359 | YCHW4000W4004 | Sold in Packs of 4. 3-1/16" Square x 1-1/4" high for each detector |       |

HVAC - General Accessories

**Thermostats**

**Lyric C1 Wi-Fi Security Camera**

- *Allows the user to keep an eye on their home or business while they are away*
- *Intelligent sound detection*
- *High definition wide angle view*
- *Adjustable alert zones*
- *Cloud and SD storage*
- *Night vision*
- *Two-way talk*



| Part # | Mfg #          | Description  | Price |
|--------|----------------|--|-------|
| 236992 | CHC8080W1000/U | Compatible with Lyric App for iPhone, IPad and Android |       |

HVAC - General Accessories

**Commercial Thermostats**

**Programmable Commercial Thermostats**

**TL8100 Hydronic 7-Day Programmable Electronic Thermostat**

- Controls 2- or 3-way zone valves or circulator pumps in both line and low volt
- Special protection modes to prevent system seizures and reduce call backs
- Easy to install
- Millivolt compatible
- Electrical ratings: maximum load: 5A (resistive), 2A (inductive)  
@ 24VDC, 120VAC and 240VAC



| Part # | Mfg #       | Description                               | Price |
|--------|-------------|---|-------|
| 128315 | TL8100A1008 | Programmable Electronic Thermostat, White |       |

**T4 Pro Programmable Thermostat**

- Stages: up to 1 heat/1 cool heat pumps or 1 heat/1 cool conventional systems
- Includes thermostat, UWP mounting system, installation (j-box) adapter
- Programmability: 7 day, 5-1-1 day, 5-2 day, or non-programmable
- Electrical ratings: 20 to 30 vac
- Dimensions: 4-1/16" long x 4-1/16" wide x 1-3/32" deep



| Part # | Mfg #         | Description                               | Price |
|--------|---------------|---|-------|
| 233821 | TH4110U2005/U | Programmable Electronic Thermostat, White |       |

**T6 Pro Programmable Thermostat**

- Stages: up to 2 heat/1 cool heat pumps or 2 heat/2 cool conventional systems
- Includes thermostat, UWP mounting system, installation (j-box) adapter, small decorative cover plate, screws & anchors, installation guide, user guide, and 2 AA batteries
- Programmability: 7 day, 5-1-1 day, 5-2 day, or non-programmable
- Electrical ratings: 20 to 30 vac
- Dimensions: 4-1/16" long x 4-1/16" wide x 1-3/32" deep



| Part # | Mfg #       | Description                             | Price |
|--------|-------------|---|-------|
| 240768 | TH6220U2000 | T-Series Programmable Thermostat, White |       |

**Lyric T6 Pro Wi-Fi Programmable Thermostat**

- Stages: up to 2 heat/1 cool heat pumps or 2 heat/2 cool conventional systems
- Includes thermostat, UWP mounting system, installation (j-box) adapter, small decorative cover plate, screws & anchors, installation guide, user guide, and 2 AA batteries
- Programmability: 7 day, 5-1-1 day, 5-2 day, 1 day, geolocation or non-programmable
- Electrical ratings: 20 to 30 vac
- Dimensions: 4-1/16" long x 4-1/16" wide x 1-3/32" deep



| Part # | Mfg #        | Description                                   | Price |
|--------|--------------|---|-------|
| 228227 | TH6220WF2006 | T-Series Wi-Fi Programmable Thermostat, White |       |

HVAC - General Accessories

**Commercial Thermostats**

**Line Voltage Commercial Thermostats**

**T451 Medium-Duty Line Voltage Commercial Thermostat with Thermometer**

- SPST Switching action, makes on temperature fall, breaks on temperature rise
- Heating application
- Control line voltage on valves, motors, contactors, electric heat elements, duct furnaces and fan coil units
- Mounts on standard vertical or horizontal outlet box
- Includes vertical scale plate with thermometer and high accuracy dual diaphragm sensor
- Dimensions: 4-1/2"H x 2-15/16"W x 1-1/2"D (switches and wiring terminals protrude into outlet box 3/4")
- Champagne gold faceplate with beige cover



| Part # | Mfg #     | Temp Setting | Description                                    | Price |
|--------|-----------|--------------|--|-------|
| 065237 | T451A3005 | 44° - 86°F   | Range Stops, Locking Cover Screws & Wall Plate |       |

**T651A Light-Duty Line Voltage Commercial Thermostat**

- Control line voltage on valves, motors, contactors, electric heat elements, duct furnaces and fan coil units
- SPDT Switching action, breaks heating and makes cooling on temperature rise
- Heating and cooling application
- Mount on standard vertical or horizontal outlet box
- Automatic cooling and heating anticipation
- Includes vertical scale plate with thermometer, horizontal scale plate without thermometer, and high accuracy dual diaphragm sensor
- Dimensions: 4-1/2"H x 2-15/16"W x 1-1/2"D (switches and wiring terminals protrude into outlet box 3/4")
- Champagne gold faceplate with beige cover



| Part # | Mfg #     | Temp Setting | Description                                    | Price |
|--------|-----------|--------------|--|-------|
| 065613 | T651A3018 | 44° - 86°F   | Range Stops, Locking Cover Screws & Wall Plate |       |

**T631A-C Farm Controller**

- Provides line voltage control of heating, cooling and ventilating systems in farm buildings or storage areas
- Light-duty line volt thermostat, 2°F fixed differential
- Treated to resist corrosion



| Part # | Mfg #     | Description                                     | Price |
|--------|-----------|---|-------|
| 006794 | T631A1006 | Farm-O-Stat, 35° - 100°F, SPDT Snap Switch, Red |       |

**Winter Watchman**

- Used as freeze warning device
- Completes circuit to household lamp on temperature fall, indicating inoperative heating equipment



| Part # | Mfg #     | Description   | Price |
|--------|-----------|---|-------|
| 006784 | S483B1002 | Winter Watchman Freeze Warning Device, 30° - 60°F, Adjustable |       |

HVAC - General Accessories

**Commercial Thermostats**

**Thermostat Accessories**

**Thermostat Cover Plate for FocusPRO® & PRO® Series**

- Small cover plate: 4-5/16"H x 5-1/2"W
- Medium cover plate: 5"H x 6-7/8"W
- Large cover plate: 6"H x 8-5/16"W
- Premier White®

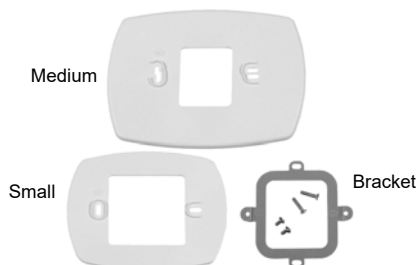

| Part # | Mfg #        | Description                             | Price |
|--------|--------------|---|-------|
| 079594 | 50001137-001 | For TH5110 Thermostat                   |       |
| 079595 | 50002883-001 | For FocusPRO® 6000/5000, PRO® 4000/3000 |       |

**C2 Indoor Wi-Fi Security Camera**

- Intelligent sound detection
- Adjustable alert zones
- Cloud and microSD storage
- Night vision
- Two-way talk
- 5V/2A power adaptor
- High definition wide angle view



| Part # | Mfg #          | Description                     | Price |
|--------|----------------|---------------------------------|-------|
| 240959 | CHC8480W1013/U | C2 Indoor Wi-Fi Security Camera |       |

HVAC - General Accessories

**Thermostats (Private Label)**

**Programmable Thermostats**

**Lyric T6 Pro Wi-Fi Programmable Thermostat - Private Label for Northwest Mechanical**

- Stages: up to 2 heat/1 cool heat pumps or 2 heat/2 cool conventional systems
- Includes thermostat, UWP mounting system, installation (j-box) adapter, small decorative cover plate, screws & anchors, installation guide, user guide, and 2 AA batteries
- Programmability: 7 day, 5-1-1 day, 5-2 day, 1 day, geolocation or non-programmable
- Electrical ratings: 20 to 30 vac
- Dimensions: 4-1/16" long x 4-1/16" wide x 1-3/32" deep



| Part # | Mfg #              | Description  | Price |
|--------|--------------------|--|-------|
| 240770 | TH6220WF2006NWMEC  | Private Label Programmable Thermostat for Northwest Mechanical |       |
| 246108 | TH6220WF2006 NORTH | Private Label Programmable Thermostat for Northwest Mechanical |       |

**T4 Pro Series Programmable Thermostat - For Private Label Colony**

- 20-30 Vac systems; Gas, Oil, Electric Warm Air; Hot water Coil; Gas, Oil, Electric Hydronic; or Steam / Gravity Systems
- Includes:
  - Thermostat
  - UWP mounting system
  - Installation (J-box) adaptor



| Part # | Mfg #          | Description  | Price |
|--------|----------------|--|-------|
| 239306 | TH4210U2002-14 | Up to 2 Heat/1 Cool Heat Pumps; Up to 1 Heat/1 Cool Conventional Systems |       |

**T4 Pro Programmable Thermostat—For Private Label Northwest Mechanical**

- Stages: up to 1 heat/1 cool heat pumps or 1 heat/1 cool conventional systems
- Includes thermostat, UWP mounting system, installation (j-box) adapter
- Programmability: 7 day, 5-1-1 day, 5-2 day, or non-programmable
- Electrical ratings: 20 to 30 vac
- Dimensions: 4-1/16" long x 4-1/16" wide x 1-3/32" deep



| Part # | Mfg #              | Description  | Price |
|--------|--------------------|--|-------|
| 240772 | TH4110U2005-NWMECH | Private Label Programmable Thermostat for Northwest Mechanical |       |
| 246109 | TH4110U2005-NORTH  | Private Label Programmable Thermostat for Northwest Mechanical |       |

**T4 Pro Programmable Thermostat—For Private Label Reece Heating and Cooling**

- Stages: up to 1 heat/1 cool heat pumps or 1 heat/1 cool conventional systems
- Includes thermostat, UWP mounting system, installation (j-box) adapter
- Programmability: 7 day, 5-1-1 day, 5-2 day, or non-programmable
- Electrical ratings: 20 to 30 vac
- Dimensions: 4-1/16" long x 4-1/16" wide x 1-3/32" deep



| Part # | Mfg #            | Description   | Price |
|--------|------------------|---|-------|
| 242263 | TH4110U2005-3586 | Private Label Programmable Electronic Thermostat for Reece Heating and Cooling, White |       |



**Thermostats (Private Label)**

**T6 Pro Programmable Thermostat - For Private Label Reece**

- TH6220U Up to 2H/1C heat pump and 2H/2C conventional
- 7-day, 5-2, 5-1-1 or non-programmable
- Uses the UWP mounting system that's standard across all T Series thermostats
- Easy upsell to a connected Lyric T6 Pro Wi-Fi when your customer is ready for Wi-Fi (C-wire required)
- Optional dual fuel (TH6320U & TH6220U only)
- Optional wired indoor/outdoor sensors (TH6320U & TH6220U only)
- Simple push-button functionality
- Filter change reminders
- 5-year warranty



| Part # | Mfg #               | Description                                     | Price |
|--------|---------------------|---|-------|
| 242262 | TH6220U2000/U-REECE | Private Label Programmable Thermostat for Reece |       |

**T4 Pro Programmable Thermostat—For Private Label Precision Plumbing, Heating, and Air**

- Stages: up to 1 heat/1 cool heat pumps or 1 heat/1 cool conventional systems
- Includes thermostat, UWP mounting system, installation (j-box) adapter
- Programmability: 7 day, 5-1-1 day, 5-2 day, or non-programmable
- Electrical ratings: 20 to 30 vac
- Dimensions: 4-1/16" long x 4-1/16" wide x 1-3/32" deep



| Part # | Mfg #            | Description  | Price |
|--------|------------------|--|-------|
| 245297 | TH4110U2005-4471 | Private Label Programmable Electronic Thermostat for Precision Plumbing, Htg & AC, White |       |

**T4 Pro Programmable Thermostat—For Private Label Colony**

- Stages: up to 1 heat/1 cool heat pumps or 1 heat/1 cool conventional systems
- Includes thermostat, UWP mounting system, installation (j-box) adapter
- Programmability: 7 day, 5-1-1 day, 5-2 day, or non-programmable
- Electrical ratings: 20 to 30 vac
- Dimensions: 4-1/16" long x 4-1/16" wide x 1-3/32" deep



| Part # | Mfg #            | Description                                | Price |
|--------|------------------|--|-------|
| 248508 | TH4110U2005-4782 | Private Label T4 Pro Thermostat for Colony |       |

HVAC - General Accessories

**Thermostats (Private Label)**

**T6 Pro Programmable Thermostat - For Private Label Colony**

- TH6220U Up to 2H/1C heat pump and 2H/2C conventional
- 7-day, 5-2, 5-1-1 or non-programmable
- Uses the UWP mounting system that's standard across all T Series thermostats
- Easy upsell to a connected Lyric T6 Pro Wi-Fi when your customer is ready for Wi-Fi (C-wire required)
- Optional dual fuel (TH6320U & TH6220U only)
- Optional wired indoor/outdoor sensors (TH6320U & TH6220U only)
- Simple push-button functionality
- Filter change reminders
- 5-year warranty



| Part # | Mfg #            | Description                                   | Price |
|--------|------------------|---|-------|
| 248506 | TH6220U2000-2318 | Private Label T6 Pro for Private Label Colony |       |

**T4 Pro Programmable Thermostat—For Private Label Scharnweber Water Conditioning, Inc**

- Stages: up to 1 heat/1 cool heat pumps or 1 heat/1 cool conventional systems
- Includes thermostat, UWP mounting system, installation (j-box) adapter
- Programmability: 7 day, 5-1-1 day, 5-2 day, or non-programmable
- Electrical ratings: 20 to 30 vac
- Dimensions: 4-1/16" long x 4-1/16" wide x 1-3/32" deep



| Part # | Mfg #             | Description   | Price |
|--------|-------------------|---|-------|
| 246723 | TH4110U2005U-4646 | Private Label T4 Pro Thermostat for Scharnweber Water Conditioning, Inc |       |

**FocusPRO® 6000 Programmable Digital Thermostats—For Private Label Colony**

- **TH6110D1021** Stages: 1 Heat/1 Cool or heat pump without auxiliary heat
- **TH6220D1028** Stages: 2 Heat/2 Cool conventional; 2 Heat/1 Cool heat pump with auxiliary heat
- Selectable to 5-1-1 (weekdays, Saturday, Sunday) or 5-2 (weekdays, weekend) programmable thermostat
- Large, clear, back light display - easy to read in various lighting conditions
- Display size options - available in large screen or standard
- Precise comfort control (+/- 1°F) - maintains consistent comfort to the highest level of accuracy
- Easy change battery door - flips out without disassembling thermostat
- Built in instructions - simple, pull out instruction manual
- Adaptive Intelligent Recovery™ - ensures programmed temperature is reached by programmed time
- Temperature range stops - prevents user from setting the temperature too high or too low
- Temperature range:
  - Heat: 40° to 90°F
  - Cool: 50° to 99°F
- Dimensions: 3-9/16"H x 5-13/16"W x 1-1/2"D
- Premier White®
- 5-Year warranty



Large Display

| Part # | Mfg #           | Description                                       | Price |
|--------|-----------------|---|-------|
| 095462 | TH6110D1021-68  | Private Label FocusPRO 6000 Thermostat for Colony |       |
| 095463 | TH6220D1028-131 | Private Label FocusPRO 6000 Thermostat for Colony |       |

**Thermostats (Private Label)**

**Lyric™ T6 Pro Wi-Fi Thermostat—For Private Label Colony**

- Stages: up to 3 heat/2 cool heat pumps and 2 heat/2 cool conventional systems
- Includes thermostat, UWP mounting system, installation (j-box) adapter, small decorative plate, screws and anchors, installation guide, and user guide
- Programmability: 7 day, 5-1-1 day, 5-2 day, 1-week or non-programmable
- Geofence technology
- Optional wired indoor/outdoor sensors
- Electrical ratings & supply voltage: 20 to 30 vac
- Integrates with smart home Apple HomeKit and Amazon Alexa
- Dimensions: 4-1/16" long x 4-1/16" wide x 1-3/32" deep



| Part # | Mfg #            | Description                                      | Price |
|--------|------------------|--|-------|
| 239303 | TH6320WF2003-386 | Private Label T6 Pro Wi-Fi Thermostat for Colony |       |

**VisionPRO® 8000 with RedLINK™ Technology—For Private Label Colony**

- **TH8110R1008** Stages: 1 heat/1 cool conventional systems and heat pumps
- **TH8321R1001** Stages: 2 heat/2 cool conventional systems and 3 heat/2 cool heat pumps
- Similar stages: 4 heat/2 cool heat pump or 3 heat/2 cool conventional when used with interface module
- Residential or commercial use
- Thermostat works standalone or with the THM5421R1021 Equipment Interface Module or with the TrueZONE Wireless Adapter
- Smart Schedule - programs in seconds for any lifestyle
- Patented interview based programming and installer setup
- RedLINK™ wireless communication
- Customizable service reminders allow dealers to remind their customers when its time to call for service, when their warranty is expiring and to provide customized alerts.
- MicroSD port for copying the installer setup, customizable reminders, custom events and holidays to multiple thermostats.
- 1 assignable output on the TH8321 model to control humidification, dehumidification, ventilation or a stage of heating/cooling.
- 3 assignable outputs on the Equipment Interface Module to control humidification, dehumidification, ventilation or a stage of heating/cooling  
The TH8110 and TH8320 models require the use of a wireless indoor sensor to control humidification and dehumidification
- 1 assignable input can be used with a wired outdoor, indoor or discharge sensor
- 4 assignable inputs on the Equipment Interface Module can be used with wired outdoor, indoor or discharge sensors, occupancy sensor for remote setback and dry contact devices to trip pre-packaged or custom alerts such as a full drain pan or water leak
- Extend wireless range of the Equipment Interface Module by connecting a THM4000R1000 Wireless Adapter to the ABCD terminals
- Dual powered - battery or hardwired (C wire)
- Precise temperature control (+/- 1° F) for reliable and consistent temperature
- Multiple staging options to provide comfort or energy savings



| Part # | Mfg #           | Application   | Terminal Designations | Notes: | Price |
|--------|-----------------|---|-----------------------|--------|-------|
| 168623 | TH8110R1008-95  | Private Label VisionPRO 8000 for Private Label Colony |                       |        |       |
| 168626 | TH8321R1001-361 | Private Label VisionPRO 8000 for Private Label Colony |                       |        |       |

HVAC - General Accessories

**Thermostats (Private Label)**

**PRO® 4000 5+2 Day Programmable Digital Thermostats Private Label Chown Appliance**

- Electronic control of 24VAC, heating and cooling systems or 750mV heating systems
- Weekday/weekend programming to fit your lifestyle
- Clear, back light display
- Precise comfort control +/- 1°F of your set temperature
- Easy slide switches allow selection of heat or cool mode, and fan operation
- Dual-powered, battery or hardwired
- Manual changeover
- Built-in instructions - simple, pull out instruction manual
- Adaptive Intelligent Recovery™ - ensures programmed temperature is reached by programmed time
- Temperature range:
  - Heat: 40° to 90°F
  - Cool: 50° to 99°F
- Dimensions: 3-13/16"H x 5-3/8"W x 1-1/4"D
- Premier White®



| Part # | Mfg #           | Application   | Terminal Designations | Price |
|--------|-----------------|---|-----------------------|-------|
| 119999 | TH4110D1007-544 | Private Label Programmable Digital Thermostat for Chown Appliance |                       |       |

**T6 Pro Series Programmable Thermostat - Private Label for Reece Heating & Cooling**

- 24 Vac systems; Gas, Oil, Electric Warm Air; Hot water Coil; Gas, Oil, Electric Hydronic; or Steam / Gravity Systems
- Includes:
  - Thermostat
  - UWP mounting system
  - Installation (J-box) adaptor
  - Small decorative cover plate
  - Screws and anchors
  - Installation Guide & User Guides
  - 2 AA Batteries



| Part # | Mfg #            | Description   | Price |
|--------|------------------|---|-------|
| 242259 | TH6210U2001-1623 | Private Label Programmable Digital Thermostat for Reece Heating & Cooling |       |

**T4 Pro Programmable Thermostat—For Private Label Kraus**

- Stages: up to 1 heat/1 cool heat pumps or 1 heat/1 cool conventional systems
- Includes thermostat, UWP mounting system, installation (j-box) adapter
- Programmability: 7 day, 5-1-1 day, 5-2 day, or non-programmable
- Electrical ratings: 20 to 30 vac
- Dimensions: 4-1/16" long x 4-1/16" wide x 1-3/32" deep



| Part # | Mfg #            | Description                               | Price |
|--------|------------------|---|-------|
| 249037 | TH4110U2005-4817 | Private Label T4 Pro Thermostat for Kraus |       |

HVAC - General Accessories

**Thermostats (Private Label)**

**T6 Pro Series Programmable Thermostat - Private Label for Northwest Mechanical**

- 24 Vac systems; Gas, Oil, Electric Warm Air; Hot water Coil; Gas, Oil, Electric Hydronic; or Steam / Gravity Systems
- Includes:
  - Thermostat
  - UWP mounting system
  - Installation (J-box) adaptor
  - Small decorative cover plate
  - Screws and anchors
  - Installation Guide & User Guides
  - 2 AA Batteries



| Part # | Mfg #            | Description  | Price |
|--------|------------------|--|-------|
| 246107 | TH6220U2000NORTH | Private Label Programmable Thermostat for Northwest Mechanical |       |

**T6 Pro Programmable Thermostat - For Private Label Soper Plumbing Heating & Electric**

- TH6220U Up to 2H/1C heat pump and 2H/2C conventional
- 7-day, 5-2, 5-1-1 or non-programmable
- Uses the UWP mounting system that's standard across all T Series thermostats
- Easy upsell to a connected Lyric T6 Pro Wi-Fi when your customer is ready for Wi-Fi (C-wire required)
- Optional dual fuel (TH6320U & TH6220U only)
- Optional wired indoor/outdoor sensors (TH6320U & TH6220U only)
- Simple push-button functionality
- Filter change reminders
- 5-year warranty



| Part # | Mfg #            | Description   | Price |
|--------|------------------|---|-------|
| 249508 | TH6220U2000-2377 | Private Label Programmable Thermostat for Soper Plumbing Heating & Electric |       |

**Non-Programmable Thermostats**

**FocusPRO® 5000 Non-Programmable Digital Thermostats—For Private Label Colony**

- **TH5110D1022** Stages: 1 Heat/1 cool conventional systems and heat pumps with no auxiliary heat
- **TH5220D1029** Stages: 2 Heat/2 cool conventional systems and 2 heat/1 cool heat pumps
- Electronic control of 24VAC, heating and cooling systems or 750mV heating systems
- Precise comfort control +/- 1°F of your set temperature
- Easy change battery door - flips out without disassembling thermostat
- Automatic/manual selectable changeover
- Dual-powered, battery or hardwired
- Built-in compressor protection: minimum-off timer protects compressor from restarting too early after a shutdown
- Temperature range:
  - Heat: 40° to 90°F
  - Cool: 50° to 99°F
- Dimensions: 3-7/16"H x 4-1/2"W x 1-5/16"D
- Premier White®



Large Display

| Part # | Mfg #           | Description   | Price |
|--------|-----------------|---|-------|
| 095457 | TH5110D1022-157 | Private Label Non-Programmable Digital Thermostat for Colony, White |       |
| 095461 | TH5220D1029-183 | Private Label Non-Programmable Digital Thermostat for Colony, White |       |

HVAC - General Accessories

**Thermostats (Private Label)**

**Pro Non-Programmable Digital Thermostat—For Private Label Kraus**

- Manual changeover
- Battery or Hardwired
- Frequency: 50 Hz; 60 Hz
- Electrical ratings: 20-30 vac or 750 mV
- 1 Heat/1 cool conventional systems and heat pumps with no auxiliary heat
- Dimensions: 3-13/16" high x 5-3/8" wide x 1-1/4" deep



| Part # | Mfg #           | Description  | Price |
|--------|-----------------|--|-------|
| 136069 | TH3110D1008-197 | Private Label Non-Programmable Digital Thermostat for Kraus, White |       |

**Pro Non-Programmable Digital Thermostat—For Private Label Hollond**

- Manual changeover
- Battery or Hardwired
- Frequency: 50 Hz; 60 Hz
- Electrical ratings: 20-30 vac or 750 mV
- 1 Heat/1 cool conventional systems and heat pumps with no auxiliary heat
- Dimensions: 3-13/16" high x 5-3/8" wide x 1-1/4" deep



| Part # | Mfg #            | Description  | Price |
|--------|------------------|--|-------|
| 168438 | TH3110D1008-1571 | Private Label Non-Programmable Digital Thermostat for Holland, White |       |

**FocusPRO® 5000 Non-Programmable Digital Thermostat - Private Label Scharnweber Water Conditioning Inc**

- Electronic control of 24VAC, heating and cooling systems or 750mV heating systems
- Clear back light display available with large (2.98 sq in) or standard (1.95 sq in) screen
- Precise comfort control +/- 1°F of your set temperature
- Temperature control range stops
- Soft-key, simplified controls
- Easy change battery door - flips out without disassembling thermostat
- Automatic/manual selectable changeover
- Dual-powered, battery or hardwired
- Built-in compressor protection: minimum-off timer protects compressor from restarting too early after a shutdown
- Temperature range:
  - Heat: 40° to 90°F
  - Cool: 50° to 99°F
- Dimensions: 3-7/16"H x 4-1/2"W x 1-5/16"D
- Premier White®



| Part # | Mfg #           | Application  | Terminal Designations | Screen | Price |
|--------|-----------------|--|-----------------------|--------|-------|
| 079893 | TH5110D1006-157 | Private Label Non-Programmable Digital Thermostat for Scharnweber Water Conditioning |                       |        |       |

HVAC - General Accessories

**Thermostats (Private Label)**

**FocusPRO® 5000 Non-Programmable Digital Thermostat -  
Private Label for Soper Plumbing Heating & Electric**

- Electronic control of 24VAC, heating and cooling systems or 750mV heating systems
- Clear back light display available with large (2.98 sq in) or standard (1.95 sq in) screen
- Precise comfort control +/- 1°F of your set temperature
- Temperature control range stops
- Soft-key, simplified controls
- Easy change battery door - flips out without disassembling thermostat
- Automatic/manual selectable changeover
- Dual-powered, battery or hardwired
- Built-in compressor protection: minimum-off timer protects compressor from restarting too early after a shutdown
- Temperature range:
  - Heat: 40° to 90°F
  - Cool: 50° to 99°F
- Dimensions: 3-7/16"H x 4-1/2"W x 1-5/16"D
- Premier White®



| Part # | Mfg #           | Application   | Terminal Designations | Screen | Price |
|--------|-----------------|---|-----------------------|--------|-------|
| 122149 | TH5220D1003-625 | Private Label Non-Programmable Digital Thermostat for Soper Plumbing Heating & Electric |                       |        |       |

HVAC - General Accessories

## Pro1 Thermostats

### Pro1 Thermostats

- Separate heating and cooling swing adjustments
- Battery or 24V power
- 5-Year warranty

#### T700 Thermostat

- Blue back light with glow-in-the-dark light button
- Easy access battery compartment
- Electric or gas configurable
- Simple private label badge system
- Separate B & O terminals
- Easy wire color-coded terminal blocks
- Room temperature calibration adjustment
- 5-Minute compressor delay protection
- Universal sub-base
- Mounts on wall or junction box



T701/T771/T721



T705/T715



T755/ T755H

| Part # | Mfg # | Stages        | Programs                  | Description  | Price |
|--------|-------|---------------|---------------------------|--------------|-------|
| 138686 | T701  | 1 Heat/1 Cool | Non-Programmable          | Single-Stage |       |
| 138687 | T705  | 1 Heat/1 Cool | 5+1+1                     | Single-Stage |       |
| 138688 | T715  | 2 Heat/2 Cool | 5+1+1                     | Multi-Stage  |       |
| 148128 | T755S | 2 Heat/2 Cool | 5+1+1                     | Multi-Stage  |       |
| 138690 | T755  | 3 Heat/2 Cool | 5+1+1 or Non-Programmable | Heat Pump    |       |
| 140228 | T755H | 3 Heat/2 Cool | 5+1+1 or Non-Programmable | Universal    |       |
| 138691 | T771  | 1 Heat/1 Cool | Non-Programmable          | Single-Stage |       |

#### T800 Thermostat

- Blue back light with glow-in-the-dark light button
- Easy access battery compartment
- Extra large, easy-to-read temperature display
- Electric or gas configurable
- Simple private label badge system
- Separate B & O terminals
- Easy wire color-coded terminal blocks
- Room temperature calibration adjustment
- 5-Minute compressor delay protection
- Universal sub-base
- Mounts on wall or junction box



| Part # | Mfg # | Stages        | Programs             | Description  | Price |
|--------|-------|---------------|----------------------|--------------|-------|
| 138693 | T805  | 1 Heat/1 Cool | 5+1+1                | Single-Stage |       |
| 138694 | T855  | 2 Heat/2 Cool | 7-Day or 5+1+1       | Universal    |       |
| 240777 | T855S | 3 Heat/2 Cool | 7-Day or 5+1+1 or NP | Universal    |       |
| 172146 | T855I | 2 Heat/2 Cool | 7-Day or 5+1+1       | Multi-Stage  |       |



## Pro1 Thermostats

### T801 Thermostat

- Extra large, easy-to-read temperature display
- Auto Changeover
- 8 sq. inch display
- Blue Back-light
- Glow in the dark light button
- Separate B & O terminals
- Room temperature calibration adjustment
- 5 minute compressor delay protection (selectable on or off)
- Filter change indicator(selectable on or off)
- Simple private label badge system
- Easy wire color coded terminal blocks
- Universal sub-base
- Mounts on wall or junction box
- Battery or 24v power
- 5 year warranty



| Part # | Mfg # | Stages        | Programs         | Description  | Price |
|--------|-------|---------------|------------------|--------------|-------|
| 169127 | T801  | 1 Heat/1 Cool | Non-Programmable | Single Stage |       |

### T900 Thermostat

- Touchscreen with blue back light and glow-in-the-dark light button
- Auto changeover
- Easy access battery compartment
- Electric or gas configurable
- Filter change indicator
- Simple private label badge system
- Keypad lockout
- Separate B & O terminals
- Easy wire color-coded-terminal blocks
- Room temperature calibration adjustment
- 5-Minute compressor delay protection
- Universal sub-base
- Mounts on wall or junction box



| Part # | Mfg # | Stages        | Programs       | Description | Price |
|--------|-------|---------------|----------------|-------------|-------|
| 138905 | T925  | 3 Heat/2 Cool | 7-Day or 5+1+1 | Heat Pump   |       |

## Pro1 Thermostats

### T955W Wireless Thermostat

- 13" Touchscreen display with blue back light and glow in the dark light button
- Set dual fuel balance points
- Connects up to 4 indoor remotes (R251W)
- Connects to outdoor remotes (R250W)
- Auto changeover
- Programmable fan
- Electric or gas configurable
- Heating and cooling setpoint limit
- Room temperature calibration adjustment
- 5 Minute compressor delay protection
- Mounts on junction box



| Part # | Mfg #    | Stages        | Programs                         | Description                     | Price |
|--------|----------|---------------|----------------------------------|---------------------------------|-------|
| 159881 | PD411093 | 3 Heat/2 cool | 7-Day, 5+1+1 or Non-Programmable | Universal with Humidity Control |       |

### Thermostat Accessories

#### Wireless Wire® Base Module

- Replaces 25V wire
- Input module: 7 terminal inputs and 2 terminal outputs
- Output module: 7 terminal outputs and 2 terminal inputs



| Part # | Mfg #  | Description  | Price |
|--------|--------|--|-------|
| 138696 | WW160W | Includes Both Input Base Module and Output Base Module |       |

#### Remote Temperature Sensor



Indoor



Outdoor

| Part # | Mfg #    | Description           | Price |
|--------|----------|-----------------------|-------|
| 138685 | PD411070 | Remote Indoor Sensor  |       |
| 138683 | PD411071 | Remote Outdoor Sensor |       |
| 146724 | PD411098 | Remote Outdoor Sensor |       |

#### T119 Wall Plate

- 5-1/2" x 7-1/2"
- White
- Fits all Pro1 IAQ models



| Part # | Mfg #    | Stages     | Programs | Description | Price |
|--------|----------|------------|----------|-------------|-------|
| 142069 | PD411073 | Wall Plate |          |             |       |

**Protech Thermostats**

**Thermostats**

**500 Series High Definition Communicating Thermostat**

- Universal choice of 7-day, 5/2 day programmable or non-programmable
- Dehumidification and humidification control
- Outdoor temperature display
- Intelligent scheduling ramp-up/program anticipation
- USB connection for uploading of programming and configuration
- Maintenance reminders
- Compressor short cycle protection
- 5-Year limited warranty



RHC-TST550CMMS

| Part # | Mfg #          | Description   | System    | Type                              | Price |
|--------|----------------|---------------|-----------|-----------------------------------|-------|
| 126929 | UHC-TST550CMMS | 2 Heat/2 Cool | Dual Fuel | Dehumidification & Humidification |       |

**T701i WiFi Single Stage Thermostat**

- 1 Heat 1 cool
- 4" sq. inch display
- Glow in the dark light button
- Universal sub-base
- Electric or gas configurable
- Easy wire color coded terminal blocks
- Programming optional through app
- Separate heating and cooling swing (cycle rate) adjustments
- 5-Minute compressor delay protection (selectable on or off)



| Part # | Mfg # | Description                                | Price |
|--------|-------|--|-------|
| 177242 | T701i | 1 Heat/1 Cool Single Stage WiFi Thermostat |       |

**EcoNET™ Smart Thermostat**

- Built-In WiFi
- 4.3" LCD Touch Screen
- Amazon Alexa Compatible – Enables the use of voice commands to control the HVAC system with Amazon Echo or Echo Dot devices 1
- Local Weather – Current conditions plus 6-day forecast
- 5 Operating Modes – Heat, Cool, Auto, Emergency Heat and Fan Only
- 7-Day Programmable Schedule – Offers comfort without thought
- One-Touch Away – Quickly switch to your energy-saving away preferences
- Vacation Scheduling – Allows you to save while you're away and come home to comfort
- Motion Sensor – Automatically wakes the screen as you approach
- Standby Screen – Displays indoor temperature and current weather



| Part # | Mfg #       | Description   | Price |
|--------|-------------|---|-------|
| 250408 | UETST700SYS | Compatible w/ select HVAC and Water Heating Products, and the new R96V Furnaces |       |

HVAC - General Accessories

**Protech Thermostats**

**EcoNet WiFi Kit**

- *Enables remote operation*
- *WiFi Kit Components:*
  - EcoNet WiFi Module
  - Installation Instructions
  - V Power Adapter
  - Junction Box
  - 24" Port to Port Connection Cable
  - 1" x 2" Double Adhesive Mounting Tape
  - RJ12 Y Splitter (for use with communicating electric water heaters)



| Part # | Mfg #       | Description  | Price |
|--------|-------------|--|-------|
| 174498 | REWRA630SYS | Works with any HVAC system which includes an EcoNet Enabled Furnace or Air Handler |       |

HVAC - General Accessories



## Ruud Thermostats

### Thermostats

#### 200 Series Universal Programmable Thermostat

- Universal choice of 7-day, 5+1+1 or 5+2 programmable or non-programmable
- 4 Time and 4 temperature settings per program (heat & cool)
- 4" Lighted blue display
- Permanent program retention
- Battery/hardwired



| Part # | Mfg #          | Description   | System               | Type        | Price |
|--------|----------------|---------------|----------------------|-------------|-------|
| 131301 | UHC-TST213UNMS | 2 Heat/2 Cool | Universal (AC/HP/GE) | Multi-Stage |       |

#### 300 Series Deluxe Programmable Thermostat

- Universal programming, choice of 7-day, 5+2 or non-programmable
- 12 Sq inch touchscreen display
- Larger, easy-to-read character size
- Keypad lockout option
- Dual power - hardwired or battery
- Easy, menu-drive programming
- Audio prompting to ensure program change confirmation
- Intuitive red/blue temperature keys
- 5-Year warranty from date of purchase



| Part # | Mfg #          | Description  | Price |
|--------|----------------|--|-------|
| 123952 | UHC-TST305UNMS | 4 Heat / 2 Cool Gas, Oil, Electric, Heat Pump, Dual Fuel |       |

#### 400 Series Special Deluxe Programmable Thermostat

- Hardwired power source
- Lighted display



| Part # | Mfg #          | Description   | System    | Type        | Price |
|--------|----------------|---------------|-----------|-------------|-------|
| 124272 | UHC-TST412MDMS | 1 Heat/2 Cool | Dual Fuel | Multi-Stage |       |

#### 500 Series Touchscreen Communicating Thermostat

- Scrolling system status
- Dehumidification control
- Armchair programming allows users to remove thermostat from wall to set the schedule
- Outdoor temperature display
- Intelligent scheduling ramp-up/program anticipation
- Maintenance reminders
- Compressor short cycle protection
- 5-Year limited warranty



| Part # | Mfg #          | Description   | System    | Type             | Price |
|--------|----------------|---------------|-----------|------------------|-------|
| 131449 | UHC-TST501CMMS | 4 Heat/2 Cool | Dual Fuel | Dehumidification |       |

HVAC - General Accessories

**White-Rodgers Thermostats**

**Thermostats**

**80 Series® Blue 2" Thermostat**

- 2" Wide LCD lighted screen
- Fossil fuel or electric heat compatible
- Dual powered, choice of battery or hardwired for all applications
- Easy push-connect color coded terminals
- Cool Savings™
- Dimensions: 3.8"H x 4.8"W x 1.5"D
- Classic white color
- 5-Year warranty



| Part # | Mfg #     | Stages        | Program  | Control Range | Terminals              | Price |
|--------|-----------|---------------|----------|---------------|------------------------|-------|
| 127608 | 1F86-0244 | 1 Heat/1 Cool | Non-Prog | 45 to 90°F    | R,C,W,Y,G,O/B          |       |
| 200234 | 1F89-0211 | 2 Heat/1 Cool | Non-Prog | 45 to 90°F    | R, C, W2, Y, O/B, G, L |       |

**80 Series® Universal Thermostat**

- Attractive Sensi thermostat styling for non-wi-fi applications
- Universal (single stage, multi-stage, heat pump), conventional and heat pump models
- Bright, high contrast backlight
- Automatic heat/cool changeover option
- Keypad lockout and adjustable heat/cool temperature limits
- Built in dual fuel logic program eliminates the need for an outdoor sensor



| Part # | Mfg #      | Stages        | Program     | Control Range | Terminals                              | Price |
|--------|------------|---------------|-------------|---------------|--|-------|
| 227366 | 1F85U-42PR | 2 Heat/2 Cool | 7, 5+1+1, ∅ | 45 to 99°F    | RC, RH, C, W/E, W2, Y, Y2, O/B/6, G, L |       |
| 221337 | 1F85U-22PR | 2 Heat/2 Cool | 7, 5+1+1    | 45 to 99°F    | RC, RH, C, W/E, W2, Y, Y2, O/B/6, G, L |       |
| 227365 | 1F85U-22NP | 2 Heat/2 Cool | Non-Prog    | 45 to 99°F    | RC, RH, C, W/E, W2, Y, Y2, O/B/6, G, L |       |
| 227363 | 1F83C-11NP | 1 Heat/1 Cool | Non-Prog    | 45 to 99°F    | RC, RH, C, W, Y, O/B, G                |       |

**80 Series® Classic Thermostat**

- Conventional system 1H/1C



| Part # | Mfg #    | Stages        | Program  | Control Range | Terminals                | Price |
|--------|----------|---------------|----------|---------------|--------------------------|-------|
| 062261 | 1F86-344 | 1 Heat/1 Cool | Non-Prog | 32 to 105°F   | RC, RH, C, W, Y, O, B, G |       |

## White-Rodgers Thermostats

### 70 Series™ Digital Thermostat

- (-E) Economy series



| Part # | Mfg #    | Stages        | Program  | Control Range | Terminals           | Price |
|--------|----------|---------------|----------|---------------|---------------------|-------|
| 195654 | 1E78-144 | 1 Heat/1 Cool | Non-Prog | 45 to 90°F    | RC,RH, W, Y,O, B, G |       |
| 194271 | 1F78-144 | 1Heat/1Cool   | Non-Prog | 45 to 90°F    | RC,RH, W, Y,O, B, G |       |
| 195653 | 1E78151  | 1Heat/1Cool   | 5+2      | 45 to 90°F    | RC,RH, W, Y,O, B, G |       |
| 194272 | 1F78151  | 1Heat/1Cool   | 5+2      | 45 to 90°F    | RC,RH, W, Y,O, B, G |       |

### Line Voltage Thermostat

- For Direct Control of Fan Coils, Fans, Motor Starters, Circulator Motors, Contactors, Valves for Heating, Cooling and SPDT Applications
- Two dial stops for setting a maximum or minimum temperature. Minimum between 66 to 87°F. Maximum between 60 to 81°F.
- Thermostat mounts on 2" x 4" electrical box.
- Includes set point locking feature at 66°, 69°, 72°, 75°, 78° or 81°F
- Optional heating and cooling subbase S29-21 available



| Part # | Mfg #   | Description  |  |
|--------|---------|--|--|
| 191149 | 1A10651 | 36 to 90°F, SPDT Switch Action, 1.5°F Differential |  |

### Light Duty Fan Coil Thermostat

- For Direct Control of Line Voltage Valves and/or Blower Motors on Fan Coil Units Featuring Manual Changeover from Heat to Cool and a 3-Speed Fan Switch, Subbase Included
- Mounts to a standard vertical outlet box or on a two-gang outlet box. May also be mounted on a 4"x 4" junction box with an adapter (not provided).
- Wiring color coded for ease of installation.
- 3-speed manual fan switch: High – Medium – Low.
- System Switch: Heat – OFF – Cool. "OFF" breaks both valve and fan circuits.



| Part # | Mfg # | Description  |  |
|--------|-------|--|--|
| 210672 | 1A112 | 36 to 90°F, SPDT Switch Action, 1.5°F Differential |  |

## White-Rodgers Thermostats

### Line Voltage Baseboard Thermostat

- 1A66 types are a double-pole disconnect model with "OFF" position which mechanically breaks both sides of line.
- Electric Heat Thermostats Used for Controlling Baseboards, Cable Heat, Glass Panels, etc.



| Part # | Mfg #   | Description                                   |
|--------|---------|---|
| 191145 | 1A65641 | 40 to 85°F, Open on Rise, 1.0°F Switch Action |
| 191146 | 1A66641 | 40 to 85°F, Open on Rise, 1.0°F Switch Action |

### Economy Mechanical Thermostat

- Rugged snap-action contacts.
- Adjustable heat anticipator.
- Bi-Metal thermometer.
- Heat / Cool model includes switching subbase.
- Heat / Cool model compatible with Electric Heat systems.



| Part # | Mfg #   | Stages        | Program  | Control Range | Terminals                | Price |
|--------|---------|---------------|----------|---------------|--------------------------|-------|
| 194088 | 1C20101 | 1 Heat        | Non-Prog | 50-90°F       | R, W                     |       |
| 191147 | 1C26101 | 1 Heat/1 Cool | Non-Prog | 50-90°F       | RC, RH, W, Y, O, B, G, A |       |

### Mechanical Thermostat

- Mercury free snap-action contacts with dust cover.
- Resistant to vibration.
- Mounts to wall or junction box.
- Built in bimetal thermometer.
- Horizontal and Vertical models.
- 24 Volt, 750 mV and 3 - wire zone options.



| Part # | Mfg #    | Stages    | Program  | Control Range | Terminals                | Price |
|--------|----------|-----------|----------|---------------|--------------------------|-------|
| 198249 | 1E30N910 | Heat Only | Non-Prog | 50 to 90°F    | R, W                     |       |
| 198248 | 1E56N444 | Heat-Cool | Non-Prog | 50 to 90°F    | RC, RH, W, Y, O, B, G, A |       |



## White-Rodgers Thermostats

### Line Voltage Digital Thermostat

- Line Voltage Digital Thermostats for Applications Covering 150W
- Up to 4000W. Choice of Programmable or Non-programmable
- Models. For Electric Baseboard, Convector and Fan-Forced Heater
- Applications. 1E65-144 will Also Cover Radiant Floor and Ceiling
- Large LCD with great contrast for greater viewing.
- 100% silent operation with optional proportional control feature.
- Selectable anticipation for ultimate performance.
- Celsius of Fahrenheit compatible.



| Part # | Mfg #   | Description                                  |
|--------|---------|--|
| 205606 | 1E65144 | 45 to 90°F, Open On Rise, 0.5°C Differential |

### Blue 12" Touchscreen Thermostat

- Universal models quickly configure for single stage, multi-stage or heat pump and heat pump dual fuel systems - programmable or non-programmable.
- Humidity control offers humidification/dehumidification.
- Commercial offers occupied damper or economizer control.
- Staging control for nearly all conventional and heat pump systems.
- Single stage model compatible with all single stage systems low voltage, 750 mV and 3-wire zone systems.
- Heat Pump dual fuel option eliminates the need for a fossil fuel kit.
- Automatic changeover option.
- Program fan options.
- Keypad lockout and setpoint temperature limit options.
- Indoor remote sensor for averaging option.
- Outdoor remote sensor option. Add to Universal models for outdoor temp reading or, on select models, dual fuel balance point and outdoor thermostat functions.
- Dual power - hardwire and/or battery or Tripower—hardwire and/or battery with system assist.



| Part # | Mfg #     | Stages    | Program     | Control Range | Terminals  | Price |
|--------|-----------|-----------|-------------|---------------|--|-------|
| 198569 | 1F95-1291 | Universal | 7, 5+1+1, Ø | 45 to 99 F    | RC, RH, C, W/E, W2, Y, Y2, O/B, G, L, 6, +, S, - |       |
| 196546 | 1F95-1277 | Universal | 7, 5+1+1, Ø | 45 to 99 F    | RC, RH, C, W/E, W2, Y, Y2, O/B, G, L, 6, +, S, - |       |

### Thermostat Accessories

#### 90 Series Wired Indoor Remote Sensor

- Indoor Remote Sensor
- Compatible With ALL White-Rodgers Thermostats With Wired Indoor Remote Sensor Option



| Part # | Mfg #    | Description                           |
|--------|----------|---------------------------------------|
| 094177 | F1451328 | 40 to 99°F Wired Indoor Remote Sensor |

**Thermostat Wire**

**Genesis Cable  
Mini Split Cable**

- For mini-split systems
- Sunlight resistant
- RoHS Compliant PVC jacket
- 600V Direct burial
- Operating temperature: -4° to 194°F
- UL Listed



| Part # | Mfg #       | Description                  | Price |
|--------|-------------|------------------------------|-------|
| 120933 | MINIWIRE4   | 14 AWG 4/C Solid, 250' Spool |       |
| 177516 | MINIWIRE4EZ | 14 AWG 4/C Solid, 250' Spool |       |
| 209840 | MSW14450    | 14 AWG 4Stranded, 50' Spool  |       |

**Jacketed Cables Shielded (Overall Shield) - CL2 Rated**

- For wiring of thermostat controls, heating & air conditioning equipment, doorbells, and other low voltage applications
- Sunlight resistant
- Copper conductors, polypropylene insulation & polyvinyl-chloride jacket



| Part # | Mfg #           | Description                   | Price |
|--------|-----------------|-------------------------------|-------|
| 131441 | THERMWIRE6SHIEL | 18 AWG 6/C Stranded OAS, 250' |       |

**Jacketed Cables Overall Shield - CL2P Rated**

- For wiring of burglar alarms, public address systems, intercoms, telephone stations, speakers, instrumentation, control and other low voltage circuits that are power-limited
- Sequential footage markings
- Twisted copper conductors, low smoke PVC insulation, aluminum/mylar shield, low smoke PVC jacket



| Part # | Mfg #       | Description                   | Price |
|--------|-------------|-------------------------------|-------|
| 224240 | THERMWIRE2W | 18 AWG 2/C Solid, 500' Spool  |       |
| 010365 | THERMWIRE2  | 18 AWG 2/C Solid, 500' Spool  |       |
| 010366 | THERMWIRE3  | 18 AWG 3/C Solid, 500' Spool  |       |
| 222664 | THERMWIRE3W | 18 AWG 3/C Solid, 500' Spool  |       |
| 110368 | THERMWIRE5  | 18 AWG 5/C Solid, 250' Spool  |       |
| 29999  | THERMWIRE6  | 18 AWG 6/C Solid, 250' Spool  |       |
| 22666  | THERMWIRE8W | 18 AWG 8/C Solid, 250' Spool  |       |
| 30000  | THERMWIRE8  | 18 AWG 8/C Solid, 250' Spool  |       |
| 17899  | THERMWIRE10 | 18 AWG 10/C Solid, 250' Spool |       |

**Jacketed Stranded Shielded (OAS) CM/CL2 (PVC) Cable**

- 1000ft - 22/1pr
- Grey Jacket
- HVAC applications
- AWG: 22



| Part # | Mfg #    | Description          | Price |
|--------|----------|----------------------|-------|
| 155918 | VRFCABLE | 22 AWG CM/CL2, 1000' |       |

## Thermostat Wire

### Stranded CL2P Rated Plenum Control Cable

- For wiring of burglar alarms, public address systems, intercoms, telephone stations, speakers, instrumentation, control and other low voltage circuits that are power-limited
- Available in 500 ft or 1,000 ft tangle-free boxes or spools



| Part # | Mfg #         | Description                    | Price |
|--------|---------------|--------------------------------|-------|
| 201661 | THERMW184PLNM | 18/4 Stranded Plenum 500' Roll |       |

### Solid CL2P Plenum Thermostat Cabl

- Braided ripcord
- Sunlight resistant except CL2P
- For use with all power-limited circuits
- For wiring of thermostat controls, heating and air conditioning equipment, doorbells, as well as other low voltage applications



| Part # | Mfg #        | Description                 | Price |
|--------|--------------|-----------------------------|-------|
| 094125 | THERMWIRE8PL | 18/8 Solid Plenum 250' Roll |       |

### Solid Thermostat CL2

- UL Standard 13; NEC Article 725
- Tubed jacket over untwisted insulated conductors
- Temperature Rating: -20 to 60 oC
- Operating Voltage: 300 Volts max.
- Capacitance: 25 pf/ft nom.
- Characteristic Impedance: 100 Ohms nom.
- DC Resistance: 6.5 Ohms/M' at 20oC
- Flame Rating: UL 1685 Vertical Tray



| Part # | Mfg #      | Description                  | Price |
|--------|------------|------------------------------|-------|
| 010367 | THERMWIRE4 | 18 AWG 4/C Solid, 250' Spool |       |

### Tracer Wire

- For water pipes, fiber optics, gas pipes, and dog containment systems
- Polyethylene insulation
- 600V Direct burial
- UL Listed

| Part # | Mfg #           | Description                 | Price |
|--------|-----------------|-----------------------------|-------|
| 104923 | TRACERWIREBLUE  | 12 AWG 1/C Solid, 500' Blue |       |
| 159042 | TRACERWIREYELLO | 500' Yellow                 |       |

HVAC - General Accessories

**Transformers**

**Transformers**

**AT72 NEMA Standard Transformer**

- 24V Control circuit step-down transformer designed to power any 24V control system, including thermostats, gas valves and relays
- NEMA Type D, meets NEC Class 2 Not Wet, Class 3 Wet and UL 1585 requirements
- Color-coded lead wire for primary connections
- 9" Lead wire (primary)
- Combination mount can be foot-mounted, plate-mounted on 4 x 4", 4" octagon or 2" x 4" electrical boxes (transformer all above or 3/4 above plate) or clamp-mounted via a junction box knockout



| Part # | Mfg #     | Output (100 % Factor) | Primary Voltage @ 50/60 Hz | Secondary Voltage (Open Circuit) | Mounting    | Electrical Connections Secondary | Price |
|--------|-----------|-----------------------|----------------------------|----------------------------------|-------------|----------------------------------|-------|
| 006714 | AT72D1683 | 40VA                  | 120V                       | 26.5                             | Combination | (2) Screw Terminals              |       |
| 006715 | AT72D1691 | 40VA                  | 208/240V                   | 26.5                             | Combination | (2) Screw Terminals              |       |

**AT87 NEMA Standard Transformer**

- Used primarily for powering 24V air conditioning circuits
- NEMA Type E, meets NEC Class 2 Not Wet, Class 3 Wet and UL 1585 requirements
- Overload protection provided
- Color-coded lead wire for primary connections
- 13" Lead wire, built-in protection, primary winding burnout

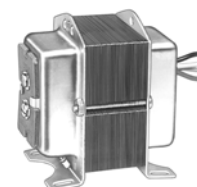

| Part # | Mfg #     | Output (100 % Factor) | Primary Voltage @ 50/60 Hz | Secondary Voltage (Open Circuit) | Mounting              | Electrical Connections Secondary | Price |
|--------|-----------|-----------------------|----------------------------|----------------------------------|-----------------------|----------------------------------|-------|
| 006717 | AT87A1106 | 50VA                  | 120/208/240V               | 26.5                             | Foot or 4" x 4" Plate | (2) Screw Terminals              |       |

**AT175A Class 2 General Purpose Transformer**

- Color-coded lead wire for primary connections
- 9" Leads (primary)
- Screw terminal secondary
- UL Listed, CSA certified



AT140A



AT175A

| Part # | Mfg #      | Output (100 % Factor) | Primary Voltage @ 60 Hz | Mounting                            | Price |
|--------|------------|-----------------------|-------------------------|-------------------------------------|-------|
| 006713 | AT140A1000 | 40VA                  | 120V                    | Universal-Mount (Plate, Foot & K/O) |       |
| 098836 | AT140A1018 | 40VA                  | 120/208/240V            | Universal-Mount (Plate, Foot & K/O) |       |
| 098838 | AT175A1008 | 75VA                  | 120/208/240V            | Universal-Mount (Plate, Foot & K/O) |       |

**Transformers**

**AT150F/AT175F Circuit Breaker Transformer**

- 9" Leads on primary and secondary
- Includes circuit breaker button
- UL Listed, CSA certified

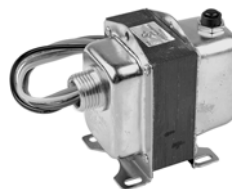

| Part # | Mfg #      | Output (100 % Factor) | Primary Voltage @ 60 Hz | Mounting             | Price |
|--------|------------|-----------------------|-------------------------|----------------------|-------|
| 120399 | AT150F1022 | 50VA                  | 120/208/240V            | Conduit & Foot-Mount |       |

HVAC - General Accessories



## Transformers

### Parts & Accessories

#### Transformer

| Part # | Mfg #        | Description  | Price |
|--------|--------------|--|-------|
| 107986 | 46-101496-01 | 120V-24V 40VA Fused Control Transformer (OEM Mount), Leads with 1/4" Insulated Female Quick Connects |       |
| 094838 | 46-101905-01 | 208/230V Primary 24V Secondary 40VA Transformer  |       |
| 094839 | 46-101944-02 | 120V Transformer   |       |
| 145468 | 46-102856-01 | Transformer  |       |
| 037653 | 46-22863-04  | Transformer  |       |
| 055227 | 46-23115-02  | 208/230V-24V 40VA Transformer (OEM Mount), Leads with Stripped Ends                                  |       |
| 020764 | 46-25107-02  | Transformer  |       |
| 030177 | 46-25107-03  | Transformer  |       |
| 141189 | 46-25107-04  | 120/208/240V-24V 40VA Transformer (Channel Mount - 2-Hole), Leads with Stripped Ends                 |       |
| 141509 | 46-25107-12  | 120/208/230/460V-24V 75VA Transformer (Channel Mount - 2-Hole), Leads with Stripped Ends             |       |
| 172658 | 46-102856-02 | 120V Primary 24V Secondary 50VA Transformer  |       |

**Universal Ignition Modules**

**Ignition Pilot Modules**

**Y8610U Universal Retrofit Intermittent Pilot Gas Burner Ignition System**

- Complete kit for converting conventional standing pilot systems to intermittent pilot systems
- For use with 24VAC gas-fired atmospheric furnaces, boiler and heating appliances
- Includes:
  - S8610U Intermittent pilot module
  - VR8304M Dual valve combination gas control or VR8204A dual valve combination gas control
  - 392431 Igniter sensor
  - 394800-30 Ignition cable
  - 393691 Natural to LP gas conversion kit
  - Wiring harness
  - 393690-14 3/4" Straight flange kit
  - Reducer adapters for gas control with VR8304M
  - Installation hardware

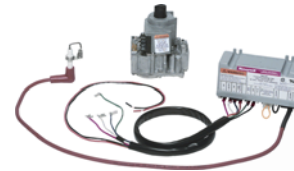

| Part # | Mfg #      | Description  | Price |
|--------|------------|--|-------|
| 021614 | Y8610U6006 | Y-Pack Containing S8610U3009 & VR8304M w/1/2" x 3/4" Inlet/Outlet, Flange Kit, LP Conversion Kit |       |

**S8610U Universal Intermittent Pilot Module**

- Field service replacement for most Honeywell, Robert Shaw, Johnson and UTEC (HSC) intermittent pilot ignition modules
- Provides electronic control of most intermittent pilot ignition systems used on gas-fired furnaces, boilers and other heating appliances
- For use in systems with combination igniter-sensor (single rod or dual rod sense)
- 100% Pilot gas shut-off and lockout on loss of pilot flame
- Includes relay contacts for use with any intermittent pilot gas control string with max 1.0A pilot or 2.0A main valve rating
- Honeywell VR8204, VR8304 or VR8345M combination gas control recommended
- Functional equivalent of S86, S8600, S8610 and S90 modules
- Includes spark cable adapters to allow field replacement of both Honeywell and competitive controls without replacing existing spark cable
- Includes damper connection and automatic vent damper plug



| Part # | Mfg #      | Description   | Price |
|--------|------------|---|-------|
| 102849 | S8610U3009 | NG or LP Gas, 90 Second Trial for Ignition, 6-Minute Wait, Continuous Retry (Replaces S8610U1003) |       |

HVAC - General Accessories

**Universal Ignition Modules**

**S8910U Universal Hot Surface Ignition Module**

- Provides operating control of a direct ignition system using 120VAC hot surface igniter
- Replaces most hot surface ignition modules manufactured by Honeywell, Robert Shaw and White-Rodgers
- Flame failure response time: 1.5 seconds
- For local (single rod) or remote (dual rod) rectification type flame sensing
- Provides (1) or (3) ignition trials (4-second or 7-second trials) per call for heat; pre purge of 32-seconds or less; up to 96-seconds between purge trial times
- Number of trials for ignition and trial time is determined by the selection tab. If a selection tab is not installed, the module will operate at 4-seconds trial time and (1) ignition trial
- Temperature range: -40° to 175°F

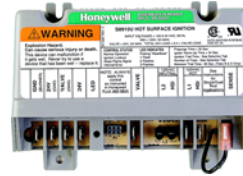

| Part # | Mfg #      | Description            | Price |
|--------|------------|------------------------|-------|
| 016077 | S8910U1000 | 60 Hz Frequency        |       |
| 229139 | S89103000  | 50 Hz; 60 Hz Frequency |       |

**S9200U Hot Surface Ignition Control**

- Universal hot surface ignition integrated furnace control
- Controls a standard induction-type circulating fan motor
- Can be used with conventional thermostats as well as the EnviraCOM™ enable VisionPRO IAQ and FocusPRO
- Main burner ignition using a 120V hot surface igniter
- Flame rectification circuit to monitor flame presence
- Monitors system pressure switch, high temperature limit, and Rollout functions



| Part # | Mfg #      | Description                          | Price |
|--------|------------|--------------------------------------|-------|
| 110086 | S9200U1000 | Universal Integrated Furnace Control |       |

HVAC - General Accessories



**Universal Ignition Modules**

**Pilot Ignition  
Automatic Pilot Relight Kit**



| Part # | Mfg #   | Description  | Price |
|--------|---------|--|-------|
| 044310 | 785-001 | 24/120V Includes Igniter Assembly & Mounting Bracket |       |

**780-910 Universal Hot Surface Ignition Module Uni-Kit®**

- Local or remote flame sensors
- 1 or 3 Ignition attempts
- 17 or 34 Second igniter warm-up time
- 34 seconds or less prepurge
- Natural or LP gas controls
- 120VAC



| Part # | Mfg #   | Description   | Price |
|--------|---------|---|-------|
| 044309 | 780-910 | 100% Lockout/Complete Gas Shutoff if Main Burner Does Not Light After the Selected Trial f/Ignition Sequence Has Been Completed |       |

**Wire Nuts & Leads**

**Wire Connectors**

**Screw-On Wire Connector**

- Color-coded connector shells
- Heat resistant up to 221°F
- Resists practically all chemical action
- Unaffected by gasoline, oils, diluted acids and alkaline solutions



| Part # | Mfg # | Description   | Price |
|--------|-------|---|-------|
| 139015 | 8651  | Blue, #22 - #14 AWG, Min 3 #22, Max 2 #16, 300V                   |       |
| 139016 | 8652  | Orange, #22 - #14 AWG, Min 3 #22, Max 3 #16 & 1 #18, 600V         |       |
| 139017 | 8653  | Yellow, #18 - #12 AWG, Min 1 #14 & 1 #18, Max 2 #14 & 3 #16, 600V |       |

HVAC - General Accessories

**Wire Ties & Connectors**

**Wire Ties**  
**Stainless Steel Wire Tie**

| Part # | Mfg #  | Description                           | Price |
|--------|--------|---------------------------------------|-------|
| 140499 | 455060 | 7.5", 250 lb Tensile Strength, 50/Pk  |       |
| 140500 | 455061 | 14.5", 250 lb Tensile Strength, 50/Pk |       |

**Nylon Wire Tie**

| Part # | Mfg #    | Description                             | Price |
|--------|----------|---|-------|
| 140502 | 455063   | 4" Natural, 100/Pk                      |       |
| 140503 | 455064   | 4" UV Black, 100/Pk                     |       |
| 140504 | 455065   | 5.5" Natural, 100/Pk                    |       |
| 140506 | 455066   | 5.5" UV Black, 100/Pk                   |       |
| 140507 | 455067   | 7.5" Natural, 100/Pk                    |       |
| 140508 | 455068   | 7.5" UV Black, 100/Pk                   |       |
| 140509 | 455069   | 11.5" Natural, 100/Pk                   |       |
| 140510 | 455070   | 11.5" UV Black, 100/Pk                  |       |
| 140513 | 455071   | 14.5" Natural, 100/Pk                   |       |
| 140514 | 455072   | 14.5" UV Black, 100/Pk                  |       |
| 140515 | 455073   | 7.5" UV Black, Screw Mount-Heat, 100/Pk |       |
| 179377 | PD455068 | 7.5" UV Black, 100/Pk                   |       |

HVAC - General Accessories

**Vibration Pads**

**Anti-Vibration Pads**

- Reduces vibration and noise from air-conditioning and refrigeration equipment
- Compounded for excellent resistance to aging, compression set and oil

**Cork/Rubber Anti-Vibration Pad**

- Solid cross-ribbed design (3/8" thick)
- Ribbed design with cork center (7/8" thick)

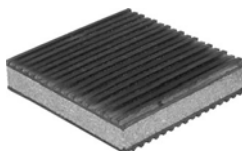

| Part # | Mfg # | Size           | Price |
|--------|-------|----------------|-------|
| 095859 | 6132  | 2" x 2" x 7/8" |       |
| 120264 | 6133  | 3" x 3" x 7/8" |       |
| 027603 | 6134  | 4" x 4" x 7/8" |       |

**All Rubber Anti-Vibration Pad**

- Has a solid cross-ribbed design (3/8" thick)
- High quality Elastomeric materials
- 50 lbs per square inch maximum loading capacity

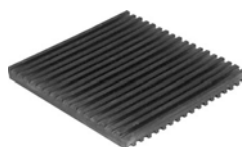

| Part # | Mfg # | Size      | Price |
|--------|-------|-----------|-------|
| 058036 | 6434  | 4" x 4"   |       |
| 002304 | 6438  | 18" x 18" |       |

HVAC - General Accessories

**Zone Dampers & Accessories**

**Wifi Heat and Cool Accessories**

**TrueZONE™ Wireless Zoning Kit**

- Includes TrueZONE panel, transformer and discharge air temperature sensor



| Part # | Mfg #  | Description   | Price |
|--------|--------|---|-------|
| 111211 | HZ311K | For Conventional, Single-Stage Applications up to (3) Zones                           |       |
| 111209 | HZ322K | For Conventional & Heat Pump Applications up to (3) Zones (2 Heat/2 Cool)             |       |
| 111207 | HZ432K | For Conventional, Heat Pump or Dual Fuel Applications up to (3) Zones (3 Heat/2 Cool) |       |
| 202880 | HZ221K | For Single Stage Heat Pumps w/ Auxiliary Heat Applications up to 2 Zones              |       |

**Wireless RedLINK™ Adapter**

- Allows you to easily add RedLINK™ enabled thermostats to a TrueZONE™ system without running new wires



| Part # | Mfg.#        | Description  | Price |
|--------|--------------|--|-------|
| 129308 | THM4000R1000 | Add RedLINK™ Enabled Thermostats to a TrueZONE™ System |       |

**TrueZONE™ Panel**

- Universal application
- Robust push terminals
- Common-sense LED's
- Clean, professional installation
- Smaller footprint
- Auto changeover
- Variable-speed fan control
- Discharge air temperature compatible
- Resettable fuse
- Individual zone fan control



| Part # | Mfg # | Description  | Price |
|--------|-------|--|-------|
| 111206 | HZ432 | 3 Heat/2 Cool Conv, Heat Pump or Dual Fuel, 4-Zone Expandable, Standard Checkout Procedure |       |

HVAC - General Accessories

**Zone Dampers & Accessories**

**Communicating Programmable Thermostats**

**VisionPRO® IAQ Communicating Touchscreen Digital 7-Day Programmable Thermostat**

- Electronic control of 24VAC heating and cooling systems in addition to humidification, dehumidification and ventilation control with just 3 wires to the thermostat in conventional and heat pump systems
- 7-Day multiple day programming or non-programmable
- For use with W8835A Envirazone Panel and THM5421C1008 equipment interface module
- Eliminate the need for fossil fuel kit
- Clear back light display available in large or standard screen
- Precise Comfort control +/- 1°F of your set temperature
- Temperature range:
  - Heat: 40° to 90°F
  - Cool: 60° to 99°F
- Automatic/manual selectable changeover
- Premier White®
- 5-Year warranty



| Part # | Mfg #       | Description   | Price |
|--------|-------------|---|-------|
| 103348 | TH9421C1004 | Up to 3 Heat/2 Cool Conventional, up to 4 Heat/2 Cool in Heat Pump Mode |       |

**Wifi Temperature Sensors**

**C7735A1000 Discharge Air Temperature Sensor**

- Use with THM5320R1000 Equipment Interface Module; TH6320R1004 or TH5320R1002 Wireless FocusPRO® Thermostat
- Mount on return duct for backup control of non-zoned systems RedLINK™ enabled wireless systems
- Works with EIM to maintain safe indoor temperatures if power is lost at the wireless thermostat
- Operating temperature range: 0° to 200°F
- Dimensions: 3-7/8"H x 4-1/8"W x 1-1/4"D
- Gray



| Part # | Mfg #      | Description  | Price |
|--------|------------|--|-------|
| 068726 | C7735A1000 | Discharge Air Temperature Sensor, Includes Mounting Hardware |       |

**Zone Control Dampers**

**Automatic Round Damper**

- Galvanized steel, single-blade damper
- Side or top motor mount
- Used with Honeywell zoning systems
- 24V, 60Hz, 2-Position motor type, (2) wires to motor



| Part # | Mfg #     | Size | Price |
|--------|-----------|------|-------|
| 179708 | ARD6TZ/U  | 6"   |       |
| 179709 | ARD8TZ/U  | 8"   |       |
| 179704 | ARD10TZ/U | 10"  |       |
| 179705 | ARD12TZ/U | 12"  |       |

**Zone Dampers & Accessories**

**Zone Control Dampers (Continued)**  
**Automatic Round Damper**

| Part # | Mfg #     | Size | Price |
|--------|-----------|------|-------|
| 179707 | ARD14TZ/U | 14"  |       |

**Retrofit Round Damper**

- Inserts into rigid round ducts for retrofit zoning in forced air heating and cooling
- Power open, power closed actuator draws 2.5 VA allowing multiple dampers per zone



| Part # | Mfg # | Size | Price |
|--------|-------|------|-------|
| 104578 | RRD6  | 6"   |       |

**TrueZONE® Bypass Pressure Regulating Damper**

- Quick installation and setup
- No weight to adjust
- Can be installed in any orientation
- Engineered to provide constant system pressure regardless of changes in zones ceiling or blower speed



| Part # | Mfg #   | Size | Shape | Price |
|--------|---------|------|-------|-------|
| 155823 | CPRD8U  | 8"   | Round |       |
| 155822 | CPRD10U | 10"  | Round |       |
| 155824 | CPRD12U | 12"  | Round |       |
| 155885 | CPRD14U | 14"  | Round |       |

**ZD Series Damper**

- Power close, spring open
- 24V Spring-return motor used to control circulating air in HVAC systems
- Used when a normally open damper is required, typically used with the TrueZONE™ systems and other electronic zoning damper systems
- Kevlar gearing reduces wear, more than doubling damper life
- Adjustable range stops
- Mechanical visual position indicator for damper status
- Solid construction using extruded aluminum frame and blades
- Parallel blade design for low leakage performance
- Quieter operation with fewer blades
- Simple, easy-to-wire, 2-wire installation
- Compatible with conventional and networked zoning
- Ordering Instructions: Order ZD + dimension 1 x dimension 2; note: motor is always mounted on dimension 2 side
- Damper can be installed in any orientation (mounting side can be on either the bottom or the side of the duct)



| Part # | Mfg #    | Size    | Shape  | Motor Mount | Price |
|--------|----------|---------|--------|-------------|-------|
| 179655 | ZD8X8TZU | 8" x 8" | Square | Side        |       |

**Zone Dampers & Accessories**

**Zone Control Dampers (Continued)**

**ZD Series Damper**

| Part # | Mfg #      | Size      | Shape       | Motor Mount | Price |
|--------|------------|-----------|-------------|-------------|-------|
| 179656 | ZD8X10TZU  | 8" x 10"  | Rectangular | Bottom      |       |
| 179657 | ZD8X12TZU  | 8" x 12"  | Rectangular | Bottom      |       |
| 179658 | ZD8X14TZU  | 8" x 14"  | Rectangular | Bottom      |       |
| 179659 | ZD8X16TZU  | 8" x 16"  | Rectangular | Bottom      |       |
| 179660 | ZD8X18TZU  | 8" x 18"  | Rectangular | Bottom      |       |
| 179661 | ZD8X20TZU  | 8" x 20"  | Rectangular | Bottom      |       |
| 179662 | ZD8X22TZU  | 8" x 22"  | Rectangular | Bottom      |       |
| 179663 | ZD8X24TZU  | 8" x 24"  | Rectangular | Bottom      |       |
| 179703 | ZD8X24TZU  | 8" x 28"  | Rectangular | Bottom      |       |
| 179664 | ZD10X8TZU  | 10" x 8"  | Rectangular | Side        |       |
| 179697 | ZD10X10TZU | 10" x 10" | Square      | Side        |       |
| 179698 | ZD10X12RZU | 10" x 12" | Rectangular | Bottom      |       |
| 179694 | ZD10X14TZU | 10" x 14" | Rectangular | Bottom      |       |
| 179695 | ZD10X16TZU | 10" x 16" | Rectangular | Bottom      |       |
| 179696 | ZD10X18TZU | 10" x 18" | Rectangular | Bottom      |       |
| 179699 | ZD10X20TZU | 10" x 20" | Rectangular | Bottom      |       |
| 179700 | ZD10X24TZU | 10" x 24" | Rectangular | Bottom      |       |
| 179665 | ZD12X8TZU  | 12" x 8"  | Rectangular | Side        |       |
| 204141 | ZD12X10TZU | 12" x 10" | Rectangular | Side        |       |
| 113931 | ZD12X12TZU | 12" x 12" | Rectangular | Side        |       |
| 205075 | ZD12X14TZU | 12" x 14" | Rectangular | Side        |       |
| 208374 | ZD12X16TZU | 12" x 16" | Rectangular | Side        |       |
| 179666 | ZD14X8TZU  | 14" x 8"  | Rectangular | Side        |       |
| 204142 | ZD14X10TZU | 14" x 10" | Rectangular | Side        |       |
| 179667 | ZD16X8TZU  | 16" x 8"  | Rectangular | Side        |       |
| 207829 | ZD16X10TZU | 16" x 10" | Rectangular | Side        |       |
| 206764 | ZD16X12TZU | 16" x 12" | Rectangular | Side        |       |
| 206512 | ZD16X16TZU | 16" x 16" | Square      | Side        |       |
| 179668 | ZD18X8TZU  | 18" x 8"  | Rectangular | Side        |       |
| 179669 | ZD20X8TZU  | 20" x 8"  | Rectangular | Side        |       |
| 179701 | ZD20X10TZU | 20" x 10" | Rectangular | Side        |       |
| 205792 | ZD20X12TZU | 20" x 12" | Rectangular | Side        |       |
| 179670 | ZD22X8TZU  | 22" x 8"  | Rectangular | Side        |       |
| 207321 | ZD22X10TZU | 22" x 10" | Rectangular | Side        |       |
| 179671 | ZD24X8TZU  | 24" x 8"  | Rectangular | Side        |       |
| 213765 | ZD24X10TZU | 24" x 10" | Rectangular | Side        |       |

HVAC - General Accessories



**Zone Dampers & Accessories**

**Damper Actuators**

**M847D 24VAC Spring Return Damper Actuator**

- 2-Position, 24 VAC spring return actuator for ARD, EARD, and ZD dampers
- Low voltage, spring-return damper actuator.
- Equipped with anti-rotation and drive shaft extensions for direct mounting to 7/16 inch diameter coupling style dampers.
- Adjustable range stops.
- Direct replacement for M847D1004



| Part # | Mfg #      | Description                              | Price |
|--------|------------|--|-------|
| 185746 | M847D-ZONE | Replacement Motor for ARD and ZD Dampers |       |

**MSTN Damper Actuator**

- Power open/power close damper motor
- Use with MVRV; MVRH; SRTD; IOBD; AOBD-BM; AOBD; ASCD; ARCD



| Part # | Mfg # | Description               | Price |
|--------|-------|---------------------------|-------|
| 023257 | MSTN  | 3-Wire 24V Actuator Motor |       |

**Zone Control Accessories**

**Freeze Protection Control**

- Breaks Y circuit to compress below 36°F and remakes it at 46°F
- For use with minizone panels



| Part # | Mfg # | Description   | Price |
|--------|-------|---|-------|
| 023258 | FPC   | Protects A/C Coil From Freezing Due to Low Air Flow or Excessive Bypass Air |       |

**Fresh Air Ventilators**

**Y8150 Fresh Air Ventilation System**

- "Set it and forget it" program calculates needs based on square feet and number of rooms, etc.
- Operates a fresh air intake damper and when necessary activates the main HVAC blower to efficiently meet ASHRAE ventilation rates
- Includes W8150A fresh air ventilation control, EARD6 normally closed 6" damper, AT120B 120VAC/24VAC 20VA transformer, mounting hardware, homeowner information label
- 5-Year warranty



| Part # | Mfg #      | Description                                | Price |
|--------|------------|--|-------|
| 179801 | Y8150A1017 | 50 to 160 CFM Fresh Air Ventilation System |       |

HVAC - General Accessories

## Duct Insulation & Adhesives

### Duct Liner Insulation Adhesives

#### Insta-Tack™ Insulation Adhesive

- Instant-tacking, solvent-based spray booth application
- UL Classified



Insulation

| Part # | Mfg #  | Size  | Color | Price |
|--------|--------|-------|-------|-------|
| 124942 | 308591 | 1 gal | Red   |       |

**Duct Liner**

**Duct Liner**

| Part # | Mfg #      | Size              | Price |
|--------|------------|-------------------|-------|
| 058537 | INS1259100 | 1/2" x 59" x 100' |       |

**Black Duct Liner**

| Part # | Mfg #   | Size                  | Price |
|--------|---------|-----------------------|-------|
| 005629 | 3010031 | 1/2" x 47" x 100'     |       |
| 141887 | 3010033 | 1/2" x 59" x 100'     |       |
| 005631 | 3010005 | 1" x 47" x 100'       |       |
| 190433 | SOIT-01 | 1/2" x 47-1/2" x 100' |       |

**Duct Board**

| Part # | Mfg #   | Size    | Price |
|--------|---------|---------|-------|
| 222851 | 3004001 | 4 x 10' |       |

Insulation

Duct Wrap

Insulation

Foil Duct Wrap

Foil Duct Wrap - R4.2

| Part # | Size                | Price |
|--------|---------------------|-------|
| 005622 | 1-1/2" x 48" x 100' |       |

Foil Duct Wrap - R6

| Part # | Size               | Price |
|--------|--------------------|-------|
| 131777 | 2" x 48" x 75'     |       |
| 190435 | 2-1/8" x 48" x 75' |       |

Foil Duct Wrap - R8

| Part # | Size           | Price |
|--------|----------------|-------|
| 094791 | 3" x 48" x 50' |       |

**Duct Liner**

**Duct Liner**

**rFOIL Big8™ Reflective Bubble with Spacer**

- 97% reflectivity.
- Inhibits condensation, mold and fungi growth
- Helps reduce heat loss through your duct surfaces
- Raises your cooling and heating efficiency
- Performance Tested UL723 Test Standard
- Class 1 / Class A fire rating approved
- Only 1" Thick for minimal space requirements

| Part # | Mfg #       | Size      | Price |
|--------|-------------|-----------|-------|
| 237000 | 2280-48-050 | 48" x 50' |       |
| 237030 | 2280-48-075 | 48" x 75' |       |

**Thermo Reflect Reflective Double Bubble**

- 97% reflectivity
- Easy to install
- Fiber free and environmentally friendly
- Inhibits condensation, mold and fungi
- NFPA 286 Full Room Burn Test Approved
- Helps reduce heat loss through your duct surfaces
- Raises your cooling and heating efficiency
- Helps ensure better climate control and comfort
- R-6 with air-space, R-4.3 without air-space
- ASTM E84-Class 1/Class A fire rating approved also
- ASTM C411-Passed

| Part # | Mfg #         | Size       | Price |
|--------|---------------|------------|-------|
| 189839 | T12290-36-050 | 36" x 50'  |       |
| 195275 | T12290-48-125 | 48" x 125' |       |
| 197219 | T12290-60-125 | 60" x 125' |       |

Insulation

**Duct Liner**

Insulation

**Mastic Duct Sealants**

**Duct-Seal™ 321**

- Indoor/outdoor use
- Water-based
- All pressure classes
- UL Classified



| Part # | Mfg #  | Size  | Color | Price |
|--------|--------|-------|-------|-------|
| 094151 | DS-321 | 1 gal | Gray  |       |

## Foam Board

### In-Floor Heating Systems

#### Thermo-Snap™ Foam Board

- Quick, easy PEX tube installation
- Panels hold PEX in place during concrete pour - no float or displacement
- Retains strong bond with concrete
- Panels are easily trimmed to accommodate custom shapes



| Part # | Mfg#       | Size             | PSI | Price |
|--------|------------|------------------|-----|-------|
| 158110 | 24416PSI   | 2" x 4' x 4'     | 16  |       |
| 159066 | 24425PSI   | 2" x 4' x 4'     | 25  |       |
| 177240 | 2124416PSI | 2-1/2" x 4' x 4' | 16  |       |
| 177241 | 2124425PSI | 2-1/2" x 4' x 4' | 25  |       |

Insulation

---



---

**Fiberglass Pipe Insulation**

---



---

**Fiberglass Pipe Covering**

| Part # | Mfg #   | Size          | Price |
|--------|---------|---------------|-------|
| 005607 | 3001000 | 1/2" x 1/2"   |       |
| 076280 | 3001100 | 1/2" x 1"     |       |
| 189766 | 3001000 | 7/8" x 1/2"   |       |
| 005613 | 3001001 | 5/8" x 1/2"   |       |
| 005611 | 3001002 | 3/4" x 1/2"   |       |
| 005604 | 3001003 | 1" x 1/2"     |       |
| 005606 | 3001004 | 1-1/4" x 1/2" |       |
| 005605 | 3001005 | 1-1/2" x 1/2" |       |
| 005608 | 3001006 | 2" x 1/2"     |       |
| 005640 | 3001110 | 3" x 1"       |       |

Insulation



**Insulation Tape**

**Insulation Tape  
Cork Insulation Tape**

- Adheres firmly to all metals
- Can be used on hot and cold pipes
- Won't dry or crack
- Stops condensation and drips



| Part # | Mfg # | Description          | Price |
|--------|-------|----------------------|-------|
| 002287 | 1006  | 1/8" x 2" x 30' Roll |       |

**Foam Insulation Tape**

- Self-adhesive tape
- Easily cut and molded
- Works on both hot and cold pipes, valves and fittings



| Part # | Mfg # | Description          | Price |
|--------|-------|----------------------|-------|
| 002288 | 1007  | 1/8" x 2" x 30' Roll |       |

Insulation

---



---

**Insulation Tape**

---



---

Insulation

**Insulation Accessories**  
**ASJ White Tape for Fiberglass**

| Part # | Mfg #   | Size        | Price |
|--------|---------|-------------|-------|
| 087593 | 3043052 | 3" x 50 yds |       |

**FSK Tape for Foil Wrap**

| Part # | Mfg #   | Size        | Price |
|--------|---------|-------------|-------|
| 010342 | 3043040 | 3" x 50 yds |       |

**Insulation Tape**

**Polyken Pipeline Accessory Products**

**Polyken 826 Joint and Pipe Wrap Tape**

- 12 mil Thickness
- Tensile strength: 25 lb/in
- Polyethylene joint and pipe wrap
- Use Polyken primer for surface prep
- Corrosion protection for use interior, exterior and in-ground of small diameter pipe



| Part # | Mfg # | Size      | Color | Price |
|--------|-------|-----------|-------|-------|
| 010352 | 826   | 2" x 100' | Black |       |

Insulation

**Mechanical Fasteners**

**Insulation Fasteners**

**Weld-Ons™**



| Part # | Mfg #  | Size           | Qty       | Price |
|--------|--------|----------------|-----------|-------|
| 132418 | 308119 | 1/2" Flat Head | 5,000/Box |       |
| 132419 | 308120 | 3/4" Flat Head | 5,000/Box |       |

Insulation

**Duct Fasteners**

**Insulation Fasteners**

**DynaStick Self-Adhesive Hanger  
with Steel Washer**



| Part # | Mfg # | Size | Pack | Price |
|--------|-------|------|------|-------|
| 005633 | 26071 | 2"   | 100  |       |
| 157583 | SAH34 | 3/4" | 100  |       |

**Standard Bangers™**



| Part # | Mfg #  | Size         | Pack  | Price |
|--------|--------|--------------|-------|-------|
| 005637 | BGT-12 | 1/2" - 2 lbs | 1,000 |       |

*Insulation*

## R-Foil Insulation

Insulation

### Reflective Insulation Reflective Duct Insulation

- Double layer of polyethylene bubbles sandwiched between two highly reflective surfaces
- Three methods of installation that will yield thermal resistances of R-4.3, R-5.5 and R-6.0
- Class 1/Class A in accordance with ASTM E84 fire test standard
- Vapor barrier
- Inhibits condensation, mold and fungi growth
- Non-toxic and non-carcinogenic
- Reflects 94% of radiant heat

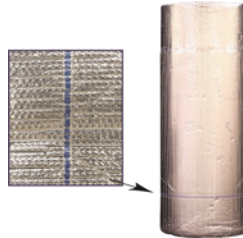

| Part # | Mfg #       | Description           | Price |
|--------|-------------|-----------------------|-------|
| 098392 | 2290-48-100 | 48" x 100' Insulation |       |

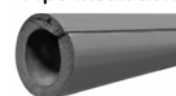
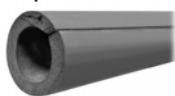

## Rubber Pipe Insulation

### Pipe Insulation

#### Double Stick Rubber Pipe Insulation

- 318' (I80) or 24' (I81) per carton
- Environmentally friendly
- Split with adhesive on both sides
- CFC-free
- Color – Black with blue ink
- Easy installation, flexible

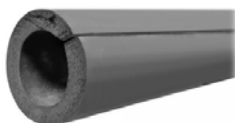

| Part#  | Mfg#    | Size     | Wall | Price |
|--------|---------|----------|------|-------|
| 229189 | I80-034 | 3/4" OD  | 3/8" |       |
| 242308 | I81-418 | 4-1/8 OD | 1/2" |       |

#### Seamless Rubber Pipe Insulation

- Environmentally friendly
- Tough skin withstands tearing, rough handling and severe environmental conditions
- CFC-Free
- Color: black with blue ink
- Flexible



| Part # | Mfg #   | Copper (IPS/PVC)   | Wall | Price |
|--------|---------|--------------------|------|-------|
| 015045 | I60-038 | 3/8" OD            | 3/8" |       |
| 013153 | I60-050 | 1/2" OD (1/4")     | 3/8" |       |
| 015580 | I60-058 | 5/8" OD (3/8")     | 3/8" |       |
| 014724 | I60-075 | 3/4" OD            | 3/8" |       |
| 015774 | I60-078 | 7/8" OD (1/2")     | 3/8" |       |
| 013018 | I60-118 | 1-1/8" OD          | 3/8" |       |
| 013450 | I60-138 | 1-3/8" OD          | 3/8" |       |
| 013631 | I60-158 | 1-5/8" OD (1-1/4") | 3/8" |       |
| 012476 | I60-200 | 2" OD (1-1/2")     | 3/8" |       |
| 014204 | I60-218 | 2-1/8" OD          | 3/8" |       |
| 013841 | I60-250 | 2-1/2" OD (2")     | 3/8" |       |
| 014278 | I60-258 | 2-5/8" OD          | 3/8" |       |
| 014511 | I60-318 | 3-1/8" OD          | 3/8" |       |
| 014366 | I60-350 | 3-1/2" OD (3")     | 3/8" |       |
| 092086 | I61-058 | 5/8" OD (3/8")     | 1/2" |       |
| 092087 | I61-075 | 3/4" OD            | 1/2" |       |
| 092578 | I61-078 | 7/8" OD            | 1/2" |       |
| 092579 | I61-118 | 1-1/8" OD          | 1/2" |       |
| 140961 | I61-138 | 1-3/8" OD          | 1/2" |       |
| 126912 | I61-158 | 1-5/8" OD (1-1/4") | 1/2" |       |
| 126911 | I61-200 | 1-1/2" IPS         | 1/2" |       |
| 143431 | I61-218 | 2-1/8" OD          | 1/2" |       |
| 126909 | I61-250 | 2-1/2" OD (2")     | 1/2" |       |
| 074497 | I61-358 | 3-5/8" OD          | 1/2" |       |
| 122310 | I61-450 | 4-1/2" OD (4")     | 1/2" |       |
| 237573 | I62-038 | 3/8" OD            | 3/4" |       |

### Pipe Insulation (Continued)

#### Seamless Rubber Pipe Insulation

| Part # | Mfg #   | Copper (IPS/PVC)  | Wall | Price |
|--------|---------|-------------------|------|-------|
| 173788 | I62-058 | 5/8" OD           | 3/4" |       |
| 237572 | I62-050 | 1/2" OD (1/4"IPS) | 3/4" |       |
| 173789 | I62-075 | 3/4" OD           | 3/4" |       |
| 173790 | I62-078 | 7/8" OD           | 3/4" |       |
| 173791 | I62-118 | 1-1/8" OD         | 3/4" |       |
| 173792 | I62-138 | 1-3/8" OD         | 3/4" |       |
| 173793 | I62-158 | 1-5/8" OD         | 3/4" |       |
| 173795 | I62-200 | 1-1/2" OD         | 3/4" |       |
| 173796 | I62-218 | 2-1/8" OD         | 3/4" |       |
| 173797 | I62-250 | 2" OD             | 3/4" |       |
| 173798 | I62-258 | 2-5/8" OD         | 3/4" |       |
| 173911 | I62-350 | 3" OD             | 3/4" |       |
| 227362 | I63-058 | 5/8" OD           | 1"   |       |

#### Double Stick Pipe Insulation

- Complete seal assured on hot or cold water pipes
- (2) Strips of self-adhesive mylar seal easily at any length
- 100% Closed cell polyethylene
- Temperature range: -160° to 200°F



| Part # | Mfg #   | Size          | Wall | Price |
|--------|---------|---------------|------|-------|
| 014723 | I52-034 | 3/4" Nom ID   | 3/8" |       |
| 015579 | I52-058 | 5/8" Nom ID   | 3/8" |       |
| 015773 | I52-078 | 7/8" Nom ID   | 3/8" |       |
| 013017 | I52-118 | 1-1/8" Nom ID | 3/8" |       |
| 013449 | I52-138 | 1-3/8" Nom ID | 3/8" |       |
| 055569 | I52-158 | 1-5/8" Nom ID | 3/8" |       |
| 101687 | I52-178 | 2" Nom ID     | 3/8" |       |
| 045207 | I52-218 | 2-1/8" Nom ID | 3/8" |       |
| 142337 | I52-238 | 2-3/8" Nom ID | 3/8" |       |
| 086331 | I52-258 | 2-5/8" Nom ID | 3/8" |       |
| 072530 | I52-318 | 3-1/8" Nom ID | 3/8" |       |
| 191221 | I53-038 | 3/8" Nom ID   | 1/2" |       |
| 191220 | I53-058 | 5/8" Nom ID   | 1/2" |       |
| 191223 | I53-075 | 3/4" Nom ID   | 1/2" |       |
| 191224 | I53-078 | 7/8" Nom ID   | 1/2" |       |
| 191234 | I53-218 | 2-1/8" Nom ID | 1/2" |       |
| 191225 | I53-118 | 1-1/8" Nom ID | 1/2" |       |
| 191231 | I53-138 | 1-3/8" Nom ID | 1/2" |       |
| 191226 | I53-158 | 1-5/8" Nom ID | 1/2" |       |
| 191233 | I53-178 | 2" Nom ID     | 1/2" |       |
| 191241 | I53-238 | 2-3/8" Nom ID | 1/2" |       |
| 191243 | I53-258 | 2-5/8" Nom ID | 1/2" |       |

Insulation

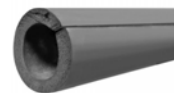
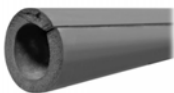

## Rubber Pipe Insulation

### Pipe Insulation (Continued)

#### Double Stick Pipe Insulation

| Part # | Mfg #   | Size          | Wall | Price |
|--------|---------|---------------|------|-------|
| 191240 | I53-312 | 3-1/2" Nom ID | 1/2" |       |
| 140583 | I53-418 | 4-1/8" Nom ID | 1/2" |       |
| 032093 | I53-412 | 4-1/2" Nom ID | 1/2" |       |
| 129849 | I57-078 | 7/8" Nom ID   | 1"   |       |

#### Insulation Contact Adhesives

- Fast tack
- Brush top cans
- For use with rubber insulation only



| Part # | Mfg #  | Size | Price |
|--------|--------|------|-------|
| 005643 | IA1100 | 1 Pt |       |

Insulation



**Cleaners**

**Hand Cleaners**

**Klein Kleaners® Hand Cleaning Towels**

- Pre-moistened towels
- Powerful, gentle, pumice like cleansing action
- No rinsing, no drying, no residue
- 10-1/2" x 12-1/4"



| Part # | Mfg # | Description    | Price |
|--------|-------|----------------|-------|
| 125643 | 51425 | (72) Count Tub |       |

Cleaners & Lubricants



## Cleaners

### (Hand Cleaners)



38156

| Part # | Mfg # | Description             | Price |
|--------|-------|-------------------------|-------|
| 017668 | 38156 | Plumb Label Power Scrub |       |

### Cit-Grit Hand Cleaner

- Natural citrus formula, biodegradable
- Contains aloe, lanolin and jojoba oil
- Flip-top spout plastic bottle



| Part # | Mfg # | Description | Price |
|--------|-------|-------------|-------|
| 005539 | 38125 | 15 fl oz    |       |

Cleaners & Lubricants

## Cleaners

### Ice Machine Maintenance

#### IMS-III Sanitizing Concentrate

- EPA Registered
- Registered in all 50 states
- Controls slime build-up on all hard surface areas
- Bacteria will not grow or multiply
- Controls mold and mildew formation
- Eliminates odor



| Part # | Mfg #   | Description | Price |
|--------|---------|-------------|-------|
| 202563 | 4211-34 | 16 fl oz    |       |

### De-Greasing Solvents

#### Degreasing Solvent EF

- Dries at a controlled rate, leaving no residue
- Dissolves grease and oil in seconds
- Has a dielectric strength greater than 26,000 volts
- Non-corrosive
- Environmentally & Ozone safe



| Part # | Mfg #   | Description  | Price |
|--------|---------|--------------|-------|
| 221598 | 4083-75 | EF- 14oz Can |       |

### Nickel-Safe IMC

- Specially formulated citric/phosphoric food-grade product for removing scale deposits from ice makers having nickel-plated or tin-plated evaporators



| Part # | Mfg #   | Description | Price |
|--------|---------|-------------|-------|
| 208988 | 4287-08 | 1 Gallon    |       |
| 208987 | 4287-34 | 16 fl oz    |       |

### Hand Cleaners

#### Great Wipes

- Industrial strength hand towels
- Waterless wipes made specifically for the A/C, and Plumbing services
- Absorbent, non-scratching abrasive hand towels



| Part # | Mfg #   | Description | Price |
|--------|---------|-------------|-------|
| 189899 | 4185-75 | 75/Pk       |       |

### Urinal Cleaners

#### UrinaKleen Urinal Cleaner

- Acid-based bowl cleaner removes scale deposits and odors
- Ideal for dissolving rust, urinary salts and mineral scale from flush tanks, urinal drains and bowls



| Part # | Mfg #   | Description | Price |
|--------|---------|-------------|-------|
| 159421 | 4590-24 | 1 Quart     |       |
| 159422 | 4590-08 | 1 Gallon    |       |

Cleaners & Lubricants



---



---

## Cleaners

---



---

### Cleaners

#### Gel-Gloss® Cleaner

- *Contains non-harmful abrasive cleaning agents that remove surface oxidation and light scratches while leaving behind a protective carnauba wax coating*
- *Cleans, protects and restores luster while providing a long lasting protective finish*

| Part # | Mfg # | Description    | Price |
|--------|-------|----------------|-------|
| 120346 | GA-12 | 12 oz, Aerosol |       |

#### Gel-Gloss® No-Streak Glass & Silver Polish Cleaner

- *Contains silicone and protects like a wax*
- *Wipe it on, allow it to dry to a haze and polish it off*
- *Cleaner works aggressively on hard water spots and tough residue*
- *Beads water and leaves behind a protective coating*

| Part # | Mfg # | Description | Price |
|--------|-------|-------------|-------|
| 141442 | NS-8  | 1/2 pt      |       |

Cleaners & Lubricants



## Lubricants

### Pipe Joint Lubricant Plumber's Faucet & Valve Grease

- *Waterproof*
- *Resists high temperature*
- *Frees sticky faucets, prevents rust*
- *Use on hot water or steam up to 350°F*



| Part # | Mfg #    | Description | Price |
|--------|----------|-------------|-------|
| 029140 | 05005012 | 1 oz Tube   |       |

Cleaners & Lubricants

**Lubricants**

**Lubricants**

**Pull-A-Spout Oiler**

- All purpose oiler
- 14" Telescoping spout



| Part # | Mfg # | Size | Price |
|--------|-------|------|-------|
| 002300 | CO-1  | 4 oz |       |

**Rust Breaker**

- Loosens rusted bolts, screws, shafts, piping etc
- Telescoping spout applicator



| Part # | Mfg # | Size | Price |
|--------|-------|------|-------|
| 002299 | CR-1  | 4 oz |       |

Cleaners & Lubricants



## Lubricants

### Lubricants

#### Dow 111 Silicone Lubricant

- For o-rings and valve stems



| Part # | Mfg #  | Tub Size  | Price |
|--------|--------|-----------|-------|
| 060945 | 963-01 | 1/4 Ounce |       |

Cleaners & Lubricants

---



---

## Lubricants

---

### WD-40® Lubricants

- Cleans, lubricates, displaces moisture
- Penetrates stuck metal parts
- Protects against rust and corrosion



| Part # | Mfg #   | Size | Price |
|--------|---------|------|-------|
| 045103 | S95-700 | 8 oz |       |



**Radon Fans**

**Fans for Radon Applications**

- 4-1/2" Pipe diameter, 115V
- Improved UV-resistant housings approved for commercial applications
- Sealed housings and wiring boxes to prevent Radon leakage or water penetration
- Energy efficient permanent split capacitor motors
- External wiring box
- UL Approved for wet locations (outdoors)
- Full 5-year factory warranty



**HP Series Radon Fans**

| Part # | Mfg #  | Wattage Range | Max Amps | CFM @ 0.75" | Price |
|--------|--------|---------------|----------|-------------|-------|
| 113123 | HP2133 | 14 - 20W      | 0.17A    | 19          |       |
| 113124 | HP2190 | 60 - 85W      | 0.78A    | 104         |       |

Radon Equipment & Supplies

## Radon Pits and Lids

### Radon Sewage Basins

- *Constructed of durable, corrosion-resistant polyethylene resin*

#### Economy Basin - 18" x 22"

- *Designed for new construction or retrofit applications*
- *Rotationally molded*
- *22 Gallon capacity*



| Part # | Mfg #     | Description      | Price |
|--------|-----------|------------------|-------|
| 180279 | E222001UD | 4" Inlet Grommet |       |

#### Radon Economy Basin - 18" x 22"

- *Includes: gas-tight Ringer grommets*
- *22 Gallon capacity*



| Part # | Mfg #  | Description                   | Price |
|--------|--------|-------------------------------|-------|
| 013695 | B22SSR | Gas-Tight Simplex Steel Cover |       |

Radon Equipment & Supplies

## Radon Pits and Lids

### Radon Sump Pump Basins

#### Corrugated Pit and Radon Lid

- Includes:
  - (1) 18" x 24" Pit
  - (1) 18" Radon pit lid (SLR1)



| Part # | Mfg #       | Description     | Price |
|--------|-------------|-----------------|-------|
| 133074 | COMBO RADON | Radon Pit & Lid |       |

### Accessories

#### GOLDLINE® Radon Safety Locking Lid

- For radon abatement systems
- Child-proof, rugged self-locking lid is drilled for gasketed piping and venting
- Includes gaskets



| Part # | Mfg # | Description              | Price |
|--------|-------|--------------------------|-------|
| 133071 | SLR1  | Radon Safety Locking Lid |       |

**Airease Repair Parts & Accessories**

**Parts & Accessories**

| Part # | Mfg #        | Description              | Price |
|--------|--------------|--------------------------|-------|
| 208935 | H4TXV01-HP   | 1.5-3T HP/AC TXV         |       |
| 208936 | H4TXV02-HP   | 3-5/T HP/AC TXV          |       |
| 208937 | H4TXV03-HP   | 4-5/T HP/AC TXV          |       |
| 209605 | AEHBCC05CSA1 | 1.821056 5KW Heat Kit    |       |
| 209606 | AEHBCC07CSA1 | 1.821057 7.5KW Heat Kit  |       |
| 209607 | AEHBCC10CSA1 | 1.821058 10KW Heat Kit   |       |
| 209608 | AEHBCC15CSA1 | 1.821046 15KW Heat Kit   |       |
| 209609 | AEHBCC20CSA1 | 1.821048 20KW Heat Kit   |       |
| 208677 | ECB255CBP    | 12R60 5KW H/K *SER 2     |       |
| 208678 | ECB2575CBP   | 12S08 7.5KW HK *SER 2    |       |
| 208679 | ECB2510CBP   | 12S60 10KW H/K *SER 2    |       |
| 209590 | ECB25125CBP  | 12S77 12.5KW *SER 2      |       |
| 208680 | ECB2515CBP   | 12S87 15KW H/K *SER2     |       |
| 210243 | R40403-003   | Duct Circuit Board       |       |
| 209368 | 11K50        | NAT to LP Conversion Kit |       |

## American Standard Repair Parts

### Faucet Repair/Replacement Parts

#### Diaphragm Kit

| Part # | Mfg #      | Description                           | Price |
|--------|------------|---------------------------------------|-------|
| 001906 | 72940-0700 | Aquaseal Diaphragm<br>f/Heritage (Pr) |       |

### Toilet Repair/Replacement Parts

#### Flapper

| Part # | Mfg #       | Description            | Price |
|--------|-------------|------------------------|-------|
| 026083 | 47146-0070A | Am Std, Rubber Flapper |       |

#### Tank-to-Bowl Kit

| Part # | Mfg #    | Description              | Price |
|--------|----------|--------------------------|-------|
| 001760 | 47060-07 | Am Std, Tank-to-Bowl Kit |       |

#### Toilet Flush Actuator

| Part # | Mfg #      | Description   | Price |
|--------|------------|---|-------|
| 001662 | 33642-0700 | Am Std, Toilet Actuating<br>Valve for #5 w/Disc, Chain,<br>Clip & Grommet |       |

#### Toilet Installation

| Part # | Mfg #      | Description  | Price |
|--------|------------|--|-------|
| 001663 | 33643-0700 | Am Std, Snap-on Seat Disc<br>for 2031.016 Heritage<br>Toilet |       |

#### Trip Lever

| Part # | Mfg #       | Description               | Price |
|--------|-------------|---------------------------|-------|
| 001778 | 47242-0020A | Am Std, Chrome f/Cadet II |       |
| 001779 | 47242-0200A | Am Std, White f/Cadet II  |       |

Repair Parts



## Basco Repair Parts

### Tub & Shower Accessories Self-Adhesive Tape

| Part # | Mfg #  | Description        | Price |
|--------|--------|--------------------|-------|
| 048292 | SC4248 | Self Adhesive Tape |       |

### Vinyl

| Part # | Mfg #  | Description             | Price |
|--------|--------|-------------------------|-------|
| 048294 | SCV284 | Tapered Drip Vinyl, 37" |       |



## Bell & Gossett Repair Parts

### Check-Trol™ Isolation Flow Control Flange Sets

- Packaged with an isolation flange of the same size as a pair
- For circulator installations, gives you features of flow control valve, isolation valve and companion flange
- Cap screws and nuts included
- Maximum working pressure: 150 psi
- Maximum operating temperature: 200°F



**Flange for NRF/NBF/SSF Wet Rotors (Except NRF-45 & NBF-45),  
Series PL-30, PL-36, PL-55, Series 100, PR & LR**

| Part # | Mfg #  | Model | Size            | Price |
|--------|--------|-------|-----------------|-------|
| 079000 | 101232 | CTF-1 | 1" NPT x Flange |       |

**Flange for 4JA87, 4JA88, 4PD08, 4PD11, 4P976, 4P977, 4RC92, 4RD05, 4RD10, 4RD17, 5P428, 5P433, All Taco  
Bronze Pumps Except 4PC79**

| Part # | Mfg #    | Model | Size              | Price |
|--------|----------|-------|-------------------|-------|
| 002423 | 101208LF |       | 3/4" NPT x Flange |       |

### Pump Motors and Accessories

#### Power Pack Motor

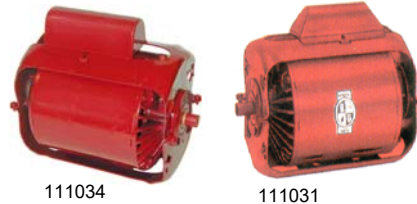

| Part # | Mfg #  | Phase  | Voltage | HP   | Price |
|--------|--------|--------|---------|------|-------|
| 002433 | 111034 | Single | 115V    | 1/12 |       |
| 002432 | 111031 | Single | 115V    | 1/6  |       |

#### Motor Coupler



| Part # | Mfg #  | Description  | Price |
|--------|--------|--|-------|
| 002446 | 118473 | For PD-35, PD-37, 60 "AA", 1522 (1/2" Shaft Frame) |       |
| 002452 | 118705 | Pump Coupler for Series 100, HV, 2", PR            |       |

#### Seal Kit

| Part # | Mfg #  | Description                      | Price |
|--------|--------|----------------------------------|-------|
| 002457 | 186862 | Seal Kit #1 1-1/4" ID Bronze Fit |       |

Repair Parts



## Bell & Gossett Repair Parts

### Bearing Assembly



| Part # | Mfg #  | Description                               | Price |
|--------|--------|---|-------|
| 002455 | 118844 | For 100 Series NFI & BI                   |       |
| 048806 | 185332 | For PD-35, PD-37, 60 "AA"; IB, BF or AB   |       |
| 002462 | 189105 | For Series PR, 2-1/2", LD-3, HD-3         |       |
| 002465 | 189134 | Series 100                                |       |
| 044637 | 189163 | Obsolete 1-1/2", Obsolete 2", Obsolete HV |       |
| 044778 | 189165 | For HV, 2", 1-1/2" Obsolete IB or BI      |       |

### Flange Gasket Set



| Part # | Mfg #  | Description  | Price |
|--------|--------|--|-------|
| 002442 | 118373 | For 1-1/2", HV and All 1-1/2AA or 1-1/2A Models  |       |
| 002441 | 118368 | For LR, PL-30, PL-36, Series 100, PR, 60 1AA, 60 11/4AA, PL-55 and All 1AA or 1-1/4AA Models |       |

### Parts & Accessories



| Part # | Mfg #  | Description     | Price |
|--------|--------|-----------------|-------|
| 002407 | L23401 | 1.5 oz Oil Tube |       |
| 002454 | 118723 | Coupler         |       |



**Bradley Washfountain Repair Parts**

**Classic Washfountain Parts**

**Foot Valve Repair Kit**

• *Includes:*

- S21-027 Needle assembly
- S64-006 Valve plunger assembly
- 125-001BW Gasket
- 117-016 Valve seat
- 125-001Y Diaphragm
- 124-001V Fibre washer
- 110-095 Body-needle valve
- 135-001P Spring
- 130-033 Key-valve seat

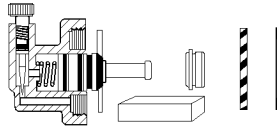

| Part # | Mfg #    | Description           | Price |
|--------|----------|-----------------------|-------|
| 002730 | S65-001A | Foot Valve Repair Kit |       |

Repair Parts

## Chicago Faucet Repair Parts

### Handles & Handle Parts



| Part # | Mfg #      | Description                                       | Finish | Price |
|--------|------------|---|--------|-------|
| 002876 | 369-PRJKCP | (2) 2-3/8" ADA Levers with Hot/Cold Index Buttons | CP     |       |

### Faucet Stem & Cartridge



1-099XTJKNF/1-100XTJKNF      377-XTRHJKNF/377-XTLHJK

| Part # | Mfg #           | Description   | Finish | Price |
|--------|-----------------|---|--------|-------|
| 016112 | 1-099XTJKNF     | New Style RH Quatum™ Short Stem Unit for Exposed Valve (12/Box Only)        | NF     |       |
| 056563 | 1-099XKJKNF     | RH Ceramic Short Stem Unit for Exposed Valve (12/Box Only)                  | NF     |       |
| 016112 | 1-099XTJK(AB)NF | New Style RH Quatum™ Short Stem Unit for Exposed Valve (12/Box Only)        | NF     |       |
| 016111 | 1-100XTJKNF     | New Style LH Quatum™ Short Stem Unit for Exposed Valve (12/Box Only)        | NF     |       |
| 056562 | 1-100XKJKNF     | LH Ceramic 1/4-Turn Short Stem Unit for Exposed Valve                       | NF     |       |
| 099706 | 377-XKLHJKNF    | LH Ceramic 1/4-Turn Long Stem Unit for Concealed Valve (Sold by box 12/Lot) | NF     |       |
| 099700 | 377-XKRHJKNF    | RH Ceramic 1/4-Turn Long Stem Unit for Concealed Valve (Sold by box 12/Lot) | NF     |       |
| 002877 | 377-XTLHJKNF    | LH Quatum™ Long Stem Cartridge for Concealed Valve (Sold by box 12/Lot)     | NF     |       |
| 002878 | 377-XTRHJKNF    | RH Quatum™ Long Stem Cartridge for Concealed Valve                          | NF     |       |
| 020910 | 386-XSLOJKNF    | Urinal Push-Button Cartridge  | NF     |       |

### Pre-Rinse Faucet Components Stainless Steel Hose/Handle Assembly

- Insulated handle
- 3/4"-14 UNS Female outlet, 3/8" MNPT inlet
- T&S & Fisher adapters supplied



| Part # | Mfg #   | Description                              | Finish | Price |
|--------|---------|--|--------|-------|
| 068698 | 83-44NF | 44" Stainless Steel Hose/Handle Assembly | NF     |       |

### Single Water Inlet Fittings Deck-Mount Fitting

- Solid brass body construction
- 5-1/4" Rigid/swing gooseneck spout
- 1/2" NPSM Coupling nut for 3/8" or 1/2" flexible riser
- Mounting hardware included



| Part # | Mfg #    | Description                                      | Finish | Price |
|--------|----------|--|--------|-------|
| 002897 | 626-E3CP | 1-Hole, E3 Softflo Pressure Compensating Aerator | CP     |       |

Repair Parts

## Chicago Faucet Repair Parts

### Spouts

- Fits 1-1/16"-18 UNEF male body outlet



DJ13JKCP



L8JKCP

| Part # | Mfg #    | Description   | Finish | Price |
|--------|----------|---|--------|-------|
| 002797 | DJ13JKCP | Double Jointed Swing Spout, 3-7/8"H, 13" Reach, E3 Softflo® Aerator     | CP     |       |
| 002798 | DJ18JKCP | Double Jointed Swing Spout, 3-7/8"H, 17-3/4" Reach, E3 Softflo® Aerator | CP     |       |
| 002811 | L8JKCP   | L-Type Swing Spout, 4-3/8"H, 8" Reach, E3 Softflo® Aerator              | CP     |       |
| 020853 | L9JKCP   | L-Type Swing Spout, 6-1/2"H, 9-1/2" Reach, E3 Softflo® Aerator          | CP     |       |
| 002810 | L12JKCP  | L-Type Swing Spout, 4-5/8"H, 12" Reach, E3 Softflo® Aerator             | CP     |       |
| 002812 | S6JKCP   | Swing Spout, 1-3/4"H, 6" Reach, E3 Softflo® Aerator                     | CP     |       |

### Gooseneck Spouts

- Available in numerous standard dimensions
- Heavy 1 1/16" OD chrome-plated brass tubing
- Inlet union nut for quick change out
- Allows for field conversion of gooseneck spouts from rigid to swing AND vice-versa

#### Type A Gooseneck Spout

- Designed to accept Group A spout ends
- Fits 1-1/16"-18 UNEF male body outlet



| Part # | Mfg #      | Description  | Finish | Price |
|--------|------------|--|--------|-------|
| 002804 | GN1AE3JK   | Rigid/Swing GN Spout w/13/16"-24 Male Outlet 8-3/8"H, 3-1/2" Reach                           | CP     |       |
| 002805 | GN2AE3JKCP | Rigid/Swing GN Spout, 9-3/4"H, 5-1/4" Reach, E3 Softflo® Aerator                             | CP     |       |
| 002806 | GN8AE3JKCP | Rigid/Swing Spout w/E3 Pressure Compensating Softflo® Aerator<br>2.2 gpm, 11-1/4"H, 8" Reach | CP     |       |

### Outlets & Adapters

- All flow rates up to 80 psi

#### E3 Pressure Compensating Softflo® Aerator

- Maximum flow rate: 2.2 gpm @ 60 psi
- 13/16"-24 Female inlet



| Part # | Mfg #  | Description                   | Finish | Price |
|--------|--------|-------------------------------|--------|-------|
| 002802 | E3JKCP | Fits Spouts w/Group A Outlets | CP     |       |

#### E12 Pressure Compensating Softflo® Aerator

- Maximum flow rate: 2.2 gpm @ 60 psi
- 13/16"-27 Male inlet



| Part # | Mfg #   | Description                                | Finish | Price |
|--------|---------|--|--------|-------|
| 002799 | E12JKCP | For Widespread & Centerset Lavatory Faucet | CP     |       |

## Chicago Faucet Repair Parts

### Supply & Shank Connections/Inlets Shanks

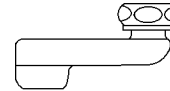

| Part # | Mfg # | Description                    | Finish | Price |
|--------|-------|--------------------------------|--------|-------|
| 020958 | HJKCP | 2-1/2" Offset Inlet Supply Arm | CP     |       |

### Renewing Kits

#### Quatern™ & Slow Compression Unit Kit - New Style

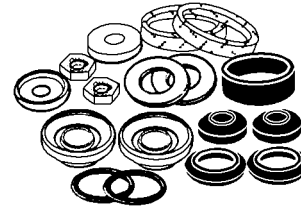

| Part # | Mfg # | Description           | Price |
|--------|-------|-----------------------|-------|
| 002833 | 1277D | Jiffy Kit - Box of 12 |       |

### Replacement Parts



671-XJKNF

| Part # | Mfg #           | Description  | Finish | Price |
|--------|-----------------|--|--------|-------|
| 002818 | 1-006JKNF       | Packing (50/Box Only)  | NF     |       |
| 002819 | 1-011JKNF       | Rubber Washer (50/Box Only)  |        |       |
| 002822 | 1-021JKNF       | Rubber Seat Washer for X or XT   | NF     |       |
| 002823 | 1-022JKNF       | Retainer for X or XT (100/Box Only)  |        |       |
| 002825 | 1-027JKNF       | Seat for X Style (100/Box Only)  |        |       |
| 002826 | 1-031JKNF       | Stem Washer for X Style (100/Box Only)   |        |       |
| 002827 | 1-043JKNF       | Cap Gasket for X Style (100/Box Only)  |        |       |
| 134195 | 1-104JKNF       | Spout Gland  |        |       |
| 100595 | 1104-007JKNF    | O-Ring   |        |       |
| 028379 | 50-035JK(AB)NF  | Spout O-Ring   |        |       |
| 144383 | 122-NF          | Thermostatic Mixing Valve  | NF     |       |
| 139530 | 131-NF          | Thermostatic Mixing Valve  | NF     |       |
| 026523 | 217-XTLHJKNF    | LH Slo-Comp (12/Box)   | NF     |       |
| 002847 | 217-XTRHJK      | RH Slo-Comp (12/Box)   |        |       |
| 002848 | 244-006JKNF     | Rubber Seat Washer for NAIAD Cartridges  | NF     |       |
| 133595 | 305-SVBJKCP     | Rigid Atmospheric Vacuum Breaker Spout w/3/4" Hose Thread                                    | CP     |       |
| 028864 | 333-XSLOPSHJKNF | Pushbutton Unit with Slow-Closing Push Button Cartridge, Push Index & Adj Cycle Time Closure |        |       |
| 138699 | 420-XJKNF       | Ceramic Volume & Temperature Control Cartridge   | NF     |       |
| 033135 | 671-XJKNF       | Metering Valve Unit  |        |       |
| 135738 | 734-CP          | Vacuum Breaker Kit   |        |       |
| 029908 | 734-005JKNF     | Body Gasket  |        |       |
| 134779 | 892-254KJKCP    | Vacuum Breaker Cover & Screw Kit   | CP     |       |

Repair Parts

## Chicago Faucet Repair Parts

### Replacement Parts (Continued)

| Part # | Mfg #        | Description                           | Finish | Price |
|--------|--------------|---------------------------------------|--------|-------|
| 130310 | 892-302KJKAB | Atmospheric Vacuum Breaker Repair Kit | NA     |       |
| 173077 | 892-402KJKAB | Vacuum Breaker                        | NA     |       |

#### Ceramic Operating Cartridge for Single Lever Faucets

- ECAST™ construction
- Lift on
- Replaceable
- Manual shut off
- Left or right hand
- Short stem for exposed caps



| Part # | Mfg #        | Description                 | Finish | Price |
|--------|--------------|-----------------------------|--------|-------|
| 227046 | 2300-XJKABNF | Ceramic Operating Cartridge |        |       |

### Parts & Accessories

#### Angle Stop Ball Valve with Loose Key Handle

- Stop with 5/8" Inlet
- 2" Tee Handle, Tapered Square Broach
- 5/8" O.D. (1/2" Nominal) Female Compression Inlet
- 3/8" O.D. Female Compression Outlet
- Chrome Plate Finish
- Weight: 0.506lbs
- ECAST® construction with equal to or less than 0.25% lead content by weighted average



| Part # | Mfg #        | Description             | Finish | Price |
|--------|--------------|-------------------------|--------|-------|
| 186612 | STB-31-00-AB | 5/8" O.D. x 3/8" F Comp |        |       |

#### HyTronic Cover Plate

- Locating pin and mounting hardware included



| Part # | Mfg #        | Size | Price |
|--------|--------------|------|-------|
| 103250 | 240.627.21.1 | 4"   |       |

## Chicago Faucet Repair Parts

### Check Valve

- 3/8" Compression male thread outlet
- Includes 3/8" Compression nut and ring
- 3/8" Compression female nut thread
- Inlet rubber sealing washer
- Spring loaded check
- ECAST® construction with equal to or less than 0.25% lead content
- Weight: 0.045lbs



| Part # | Mfg #        | Description                                  | Finish | Price |
|--------|--------------|--|--------|-------|
| 188846 | 243.315.AB.1 | Package Dimensions: 7.00"L x 6.00"W x 2.00"H |        |       |

**Dearborn Brass Repair Parts**

**Waste Repair Parts**

**Repair Part for Bath Waste**

- -1 Polished chrome

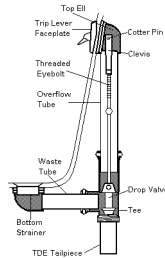

| Part # | Mfg #  | Description   | Price |
|--------|--------|---|-------|
| 003327 | 4503-1 | Faceplate, Trip Lever   |       |
| 026678 | 4538-3 | Pop-Up Waste Drain Seat & Plug includes a fulcrum linkage and nut and plug seat |       |

**Cast Brass Fittings**

**90° Slip Joint Elbow**

- Cast Brass



| Part # | Mfg #  | Size   | Gauge | Price |
|--------|--------|--------|-------|-------|
| 175072 | 1675-2 | 1-1/2" |       |       |

**Showerheads**

| Part # | Mfg # | Size   | Gauge | Price |
|--------|-------|--|-------|-------|
| 176822 | 122WS | Chrome Plated Brass Water Saving Shower Head |       |       |

Repair Parts

## Delta Faucet Repair Parts

### Single-Handle Repair Parts Kit

| Part # | Mfg #     | Description                                      | Price |
|--------|-----------|--|-------|
| 243409 | RP46748   | Metal Lever Handle Kit, Chrome                   |       |
| 168961 | RP46748SS | Metal Lever Handle Kit, Stainless*               |       |
| 157966 | RP47270SS | Single Lever Handle Kit                          |       |
| 157967 | RP47271   | Button and Set Screw                             |       |
| 152794 | RP52833   | Single Metal Lever Handle Kit                    |       |
| 143022 | RP53409   | Dryden™ Metal Lever Roman Tub Handle Kit, Chrome |       |
| 153001 | RP60965   | Single Lever Handle Kit w/ Button and Set Screw  |       |
| 131775 | RP63138   | Single-Handle Repair Parts Kit                   |       |
| 245340 | RP70640RB | Linden™ Volume Control Hdl, Venetian Bronze      |       |
| 240471 | RP72749   | Cassidy™ Metal Lever Handle Kit, Chrome          |       |

### Ara® 17 Series Temperature Knob and Cover



| Part # | Mfg #     | Description | Price |
|--------|-----------|-------------|-------|
| 240123 | RP75441SS | Stainless*  |       |

### Classic Roman Tub Handle Base & Gasket



| Part # | Mfg #     | Description | Price |
|--------|-----------|-------------|-------|
| 248389 | RP62094   | Chrome      |       |
| 155272 | RP62094SS | Stainless*  |       |

### Dryden™ Roman Tub Handle Base

- Nut & gasket



| Part # | Mfg #   | Description | Price |
|--------|---------|-------------|-------|
| 144013 | RP53410 | Chrome      |       |

### Trinsic® Roman Tub Handle Base

- Gasket included

| Part # | Mfg #     | Description | Price |
|--------|-----------|-------------|-------|
| 243415 | RP73161SS | Stainless*  |       |

\* Brilliance® Anti-Tarnish Lifetime Finishes

### Installation Aids

#### Quick-Connect Vegetable Spray Nipple Cap

- Converts "with spray" to "less spray"

| Part # | Mfg #   | Description                                 | Price |
|--------|---------|---|-------|
| 074978 | RP40301 | Quick Connect Coupling, Vegetable Spray Cap |       |
| 181058 | RP70613 | Set Screw & Wrench                          |       |

#### Quick-Connect Hose

- For installing handle and spout farther apart

| Part # | Mfg #   | Description          | Price |
|--------|---------|----------------------|-------|
| 144185 | RP50390 | Hose Assembly & Clip |       |

#### Hose Assembly



| Part # | Mfg #   | Description   | Price |
|--------|---------|---------------|-------|
| 055924 | RP32527 | Hose Assembly |       |

### Lavatory Drains

#### Metal Lavatory Drain Assembly

- Metal pop-up drain
- Metal lift-rod



| Part # | Mfg #    | Description      | Price |
|--------|----------|------------------|-------|
| 003641 | RP5651   | Chrome           |       |
| 003643 | RP5651PB | Polished Brass*  |       |
| 093335 | RP5651RB | Venetian Bronze® |       |
| 103471 | RP5651SS | Stainless*       |       |

#### Lavatory Drain Stopper



| Part # | Mfg #    | Description       | Price |
|--------|----------|-------------------|-------|
| 003637 | RP5648   | Chrome            |       |
| 168193 | RP5648CZ | Champagne Bronze™ |       |
| 168478 | RP5648NK | Luxe Nickel*      |       |
| 159075 | RP5648RB | Venetian Bronze®  |       |
| 158887 | RP5648SS | Stainless*        |       |



## Delta Faucet Repair Parts

### RP51732 Lift Rod Assembly



| Part # | Mfg #     | Description | Price |
|--------|-----------|-------------|-------|
| 167091 | RP51732SS | Stainless*  |       |

### RP41588 Lift Rod



| Part # | Mfg #   | Description | Price |
|--------|---------|-------------|-------|
| 164015 | RP41588 | Chrome      |       |

### Ara® Lift Rod and Slider

- Metal pop-up

| Part # | Mfg #   | Description    | Price |
|--------|---------|----------------|-------|
| 248925 | RP90058 | 1-Hole, Chrome |       |

### RP40267 Lift Rod

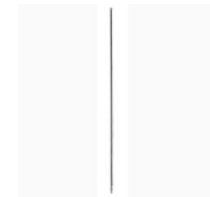

| Part # | Mfg #     | Description | Price |
|--------|-----------|-------------|-------|
| 171467 | RP40267   | Chrome      |       |
| 249496 | RP40267SS | Stainless   |       |

### Peerless Double Bend Lift Rod

- For B2596LF



| Part # | Mfg #     | Description | Price |
|--------|-----------|-------------|-------|
| 245524 | RP42092SS | Stainless*  |       |

### RP52597 Lift Rod



| Part # | Mfg #     | Description     | Price |
|--------|-----------|-----------------|-------|
| 230772 | RP52597RB | Venetian Bronze |       |

### Dryden™ Roman Tub Diverter Lift Rod & Finial

- SpotShield®



| Part # | Mfg #   | Description | Price |
|--------|---------|-------------|-------|
| 249640 | RP53411 | Chrome      |       |

### RP54095 Lift Rod and Finial

| Part # | Mfg #     | Description      | Price |
|--------|-----------|------------------|-------|
| 168032 | RP26151   | Chrome           |       |
| 187287 | RP51291   | Chrome           |       |
| 157901 | RP54095RB | Venetian Bronze® |       |

### Lahara® Lift Rod and Finial

- Flextech

| Part # | Mfg #   | Description | Price |
|--------|---------|-------------|-------|
| 242268 | RP64165 | Chrome      |       |

### Lift Rod and Finial

- For diverter roman tub



| Part # | Mfg #   | Description | Price |
|--------|---------|-------------|-------|
| 238742 | RP41586 | Chrome      |       |

### Trinsic® Lift Rod & Finial

- 1H lavatory



| Part # | Mfg #     | Description | Price |
|--------|-----------|-------------|-------|
| 244866 | RP74666BL | Matte Black |       |

\* Brilliance® Anti-Tarnish Lifetime Finishes

[www.plumbsupply.com](http://www.plumbsupply.com) • Serving our Customers Since 1946 • [www.waterconcepts.net](http://www.waterconcepts.net)

## Delta Faucet Repair Parts

### Final - Lavatory Lift Rod Top



| Part # | Mfg #     | Description | Price |
|--------|-----------|-------------|-------|
| 171468 | RP41574   | Chrome      |       |
| 173135 | RP41574SS | Stainless*  |       |

### Lavatory Drain Flange

- RP5651 & RP26533



| Part # | Mfg #     | Description       | Price |
|--------|-----------|-------------------|-------|
| 027896 | RP23060   | Chrome            |       |
| 168192 | RP23060CZ | Champagne Bronze™ |       |
| 149920 | RP23060SS | Stainless*        |       |

### Bath Installation Aids

#### Delta® Extension Kits

- Adds 1" to shanks
- For 3530/3540/3543/3544/3555/3665/3567/3569/3577/3578/3583



| Part # | Mfg #   | Description  | Price |
|--------|---------|--|-------|
| 051857 | RP10612 | For 3530/3540/3543/3544/3555/3665/3567/3569/3577/3578/3583 |       |

### RP31845 Extension Kit



| Part # | Mfg #   | Description   | Price |
|--------|---------|---------------|-------|
| 046440 | RP31845 | Extension Kit |       |

### TempAssure® 17T Series Extension Kit

- Additional 1-3/4" installation



| Part # | Mfg #   | Description                | Price |
|--------|---------|----------------------------|-------|
| 183263 | RP75136 | Extension Kit - 17T Series |       |

### Monitor 14 Series MultiChoice Extension Kit



| Part # | Mfg #   | Description               | Price |
|--------|---------|---------------------------|-------|
| 231280 | RP77991 | Extension Kit - 14 Series |       |

### 3 And 6-Setting Diverter Extension Kit



| Part # | Mfg #   | Description              | Price |
|--------|---------|--------------------------|-------|
| 157035 | RP75137 | Extension Kit - Diverter |       |

### Delta® Horizontal Rod



| Part # | Mfg #   | Description | Price |
|--------|---------|-------------|-------|
| 003436 | RP12517 | Chrome      |       |

### Conversion Ball

- Converts knob to lever handle
- Makes faucet ADA compliant



| Part # | Mfg #   | Description     | Price |
|--------|---------|-----------------|-------|
| 003587 | RP20111 | Conversion Ball |       |

### Cartridges and Valves

#### Diverter Cartridge



| Part # | Mfg #   | Description                   | Price |
|--------|---------|-------------------------------|-------|
| 135236 | RP51919 | 6-Setting, Diverter Cartridge |       |
| 135235 | RP51918 | 3-Setting, Diverter Cartridge |       |

\* Brilliance® Anti-Tarnish Lifetime Finishes

[www.waterconcepts.net](http://www.waterconcepts.net) • Serving our Customers Since 1946 • [www.plumbsupply.com](http://www.plumbsupply.com)

## Delta Faucet Repair Parts

### 3-Setting Non-Shared Diverter Cartridge



| Part # | Mfg #   | Description        | Price |
|--------|---------|--------------------|-------|
| 163268 | RP71718 | Diverter Cartridge |       |

### 2-Hdi DIAMOND™ Valve Assembly



| Part # | Mfg #   | Description | Price |
|--------|---------|-------------|-------|
| 148058 | RP60400 | Valve Assy  |       |

### Euro-Motion™ Valve Assembly



| Part # | Mfg #   | Description | Price |
|--------|---------|-------------|-------|
| 153040 | RP60114 | Valve Assy  |       |

### Euro-Motion™ Ceramic Valve



| Part # | Mfg #   | Description   | Price |
|--------|---------|---------------|-------|
| 187321 | RP75402 | Ceramic Valve |       |

### Tesla® Lavatory Cartridge

- DIAMOND™ seal valve

| Part # | Mfg #   | Description               | Price |
|--------|---------|---------------------------|-------|
| 247066 | RP78715 | Cartridge with Seal Valve |       |

### Trinsic® DIAMOND™ Euro-Motion Valve

- Short stem



| Part # | Mfg #   | Description | Price |
|--------|---------|-------------|-------|
| 242251 | RP73000 | Short Stem  |       |

### Multi-Choice® Universal Cartridge Assembly -13/14 Series

- Monitor® single-function pressure-balance cartridge
- Rotational limit stop easily adjusts via lift and turn
- For MultiChoice® universal 13/14 series tub and showers



| Part # | Mfg #   | Description    | Price |
|--------|---------|----------------|-------|
| 095758 | RP46074 | Cartridge Assy |       |

### Multi-Choice® Universal Cartridge Assembly -17 Series

- Monitor® dual-function pressure- balance control
- For MultiChoice® 17 series tub and showers
- Allows for separate volume and temperature control



| Part # | Mfg #   | Description    | Price |
|--------|---------|----------------|-------|
| 102530 | RP46463 | Cartridge Assy |       |

### Multi-Choice® Universal Cartridge Assembly -17T Series

- TempAssure® dual-function thermostatic cartridge
- For Multi-Choice® 17T series trim
- Allows for separate volume and temperature control



| Part # | Mfg #   | Description    | Price |
|--------|---------|----------------|-------|
| 115704 | RP47201 | Cartridge Assy |       |

\* Brilliance® Anti-Tarnish Lifetime Finishes

[www.plumbsupply.com](http://www.plumbsupply.com) • Serving our Customers Since 1946 • [www.waterconcepts.net](http://www.waterconcepts.net)

## Delta Faucet Repair Parts

### Diverter Assembly



| Part # | Mfg #   | Description       | Price |
|--------|---------|-------------------|-------|
| 003529 | RP17730 | Diverter Assembly |       |
| 035054 | RP19653 | Diverter Assembly |       |

### Transfer Valve



| Part # | Mfg #   | Description    | Price |
|--------|---------|----------------|-------|
| 025321 | RP18632 | Transfer Valve |       |

### Stem Cartridge Kit - (2)



| Part # | Mfg #   | Description        | Price |
|--------|---------|--------------------|-------|
| 170775 | RP41701 | Stem Cartridge Kit |       |

### Two Handle Ceramic Stem Cartridge - (Pair)



| Part # | Mfg #   | Description           | Price |
|--------|---------|-----------------------|-------|
| 167855 | RP47422 | Stem Cartridge - Pair |       |

### Stem Unit Assembly

- Includes:
- Seat
- Spring
- Bonnet Nut
- Washer



| Part # | Mfg #   | Description    | Price |
|--------|---------|----------------|-------|
| 171576 | RP54801 | Stem Unit Assy |       |

### Metering Valve



| Part # | Mfg #   | Description    | Price |
|--------|---------|----------------|-------|
| 166640 | RP72773 | Metering Valve |       |

### Valve Cartridge



| Part # | Mfg #   | Description     | Price |
|--------|---------|-----------------|-------|
| 164727 | RP50265 | Valve Cartridge |       |

### Non-Shared Diverter Cartridge



| Part # | Mfg #   | Description                              | Price |
|--------|---------|--|-------|
| 166480 | RP71717 | 2-Function Non-Shared Diverter Cartridge |       |

### Cartridge Fluehs



| Part # | Mfg #   | Description             | Price |
|--------|---------|-------------------------|-------|
| 155280 | RP61824 | Cartridge Fluehs - Cold |       |
| 154243 | RP61825 | Cartridge Fluehs - Hot  |       |

### RP42410 Cartridge Assembly



| Part # | Mfg #   | Description        | Price |
|--------|---------|--------------------|-------|
| 125499 | RP42410 | Diverter Cartridge |       |

\* Brilliance® Anti-Tarnish Lifetime Finishes

[www.waterconcepts.net](http://www.waterconcepts.net) • Serving our Customers Since 1946 • [www.plumbsupply.com](http://www.plumbsupply.com)

## Delta Faucet Repair Parts

### Cer-Tek Cartridge

- RH

| Part # | Mfg #   | Description          | Price |
|--------|---------|----------------------|-------|
| 130298 | 063000A | RH Cer-Tek Cartridge |       |
| 130299 | 063001A | LH Cer-Tek Cartridge |       |

### Thin Wall Installation Aid

- For MultiChoice® universal thin mount installation aid



| Part # | Mfg #   | Description    | Price |
|--------|---------|----------------|-------|
| 094435 | RP47202 | Thin Mount Aid |       |

### Shower Renovation Cover Plate

- Covers up 8" center holes



| Part # | Mfg #     | Finish           | Price |
|--------|-----------|------------------|-------|
| 040814 | RP29827   | Chrome           |       |
| 130864 | RP29827RB | Venetian Bronze® |       |
| 134118 | RP29827SS | Stainless*       |       |

### Ara® Escutcheon and Gasket

- 1- or 3-Hole

| Part # | Mfg #   | Description | Price |
|--------|---------|-------------|-------|
| 247643 | RP90057 | Chrome      |       |

### Deep Escutcheon



| Part # | Mfg #     | Description | Price |
|--------|-----------|-------------|-------|
| 222353 | RP21633SS | Stainless*  |       |

### 600 Series Escutcheon - Shallow



| Part # | Mfg #  | Description | Price |
|--------|--------|-------------|-------|
| 040905 | RP6083 | Chrome      |       |

### 600 Series Tub and Shower Renovation Kit

- Includes:
  - RP17443RB - Lever handle
  - RP5883RB - Escutcheon
  - RP1050RB - Cap
  - RP5893RB - Sleeve
  - RP196RB - Escutcheon screws
  - RP20111 - Conversion ball
  - RP4993 - Seats and springs
  - RP188 = Cam and packing
- Order RP2865 plug for push button diverter
- Diverter tub spout may be required



| Part # | Mfg #     | Finish           | Price |
|--------|-----------|------------------|-------|
| 132394 | RP54870   | Chrome           |       |
| 132395 | RP54870RB | Venetian Bronze® |       |
| 129199 | RP54870SS | Stainless*       |       |

### 1900 Conversion Trim Kit



| Part # | Mfg #     | Description      | Price |
|--------|-----------|------------------|-------|
| 164080 | RP54316   | Chrome           |       |
| 171340 | RP54318   | Chrome           |       |
| 167369 | RP54318RB | Venetian Bronze* |       |

### 3-Setting Diverter Escutcheon

| Part # | Mfg #      | Description     | Price |
|--------|------------|-----------------|-------|
| 233908 | RP51924-RB | Venetian Bronze |       |

### 6-Setting Diverter Escutcheon

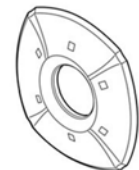

| Part # | Mfg #     | Description | Price |
|--------|-----------|-------------|-------|
| 154615 | RP61658SS | Stainless*  |       |

\* Brilliance® Anti-Tarnish Lifetime Finishes

[www.plumbsupply.com](http://www.plumbsupply.com) • Serving our Customers Since 1946 • [www.waterconcepts.net](http://www.waterconcepts.net)

## Delta Faucet Repair Parts

### Deep Escutcheon with Push Button Diverter



| Part # | Mfg #   | Description        | Price |
|--------|---------|--------------------|-------|
| 162814 | RP21634 | Escutcheon, Chrome |       |

### Tub & Shower Escutcheon

• Square



| Part # | Mfg #     | Description      | Price |
|--------|-----------|------------------|-------|
| 154796 | RP52583RB | Venetian Bronze® |       |

### Escutcheon

• Diagonal escape screw holes



| Part # | Mfg #     | Description | Price |
|--------|-----------|-------------|-------|
| 032826 | RP19809   | Chrome      |       |
| 157469 | RP19809SS | Stainless*  |       |

### Dryden™ 6-Setting Diverter Escutcheon

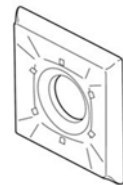

| Part # | Mfg #     | Description      | Price |
|--------|-----------|------------------|-------|
| 154795 | RP52594RB | Venetian Bronze® |       |

### Escutcheon - Shallow



| Part # | Mfg #  | Description | Price |
|--------|--------|-------------|-------|
| 043944 | RP7577 | Chrome      |       |

### 6-Setting Diverter Escutcheon



| Part # | Mfg #     | Description      | Price |
|--------|-----------|------------------|-------|
| 179525 | RP42413RB | Venetian Bronze® |       |

### Escutcheon - Deep

• 1-13/16" Inside diameter



| Part # | Mfg #  | Description | Price |
|--------|--------|-------------|-------|
| 018419 | RP6019 | Chrome      |       |

### Escutcheon - 14 Series



| Part # | Mfg #   | Description | Price |
|--------|---------|-------------|-------|
| 154524 | RP48716 | Chrome      |       |

### Escutcheon and Gasket

• 3-Hole



| Part # | Mfg #   | Description | Price |
|--------|---------|-------------|-------|
| 247521 | RP78358 | Chrome      |       |

### Escutcheon Trim Screws

• Set of 2



| Part # | Mfg #   | Description | Price |
|--------|---------|-------------|-------|
| 087663 | RP196SS | Stainless*  |       |

\* Brilliance® Anti-Tarnish Lifetime Finishes

[www.waterconcepts.net](http://www.waterconcepts.net) • Serving our Customers Since 1946 • [www.plumbsupply.com](http://www.plumbsupply.com)

## Delta Faucet Repair Parts

### Jetted Shower XO® Stem Extender

| Part # | Mfg #   | Description   | Price |
|--------|---------|---------------|-------|
| 135242 | RP37902 | Stem Extender |       |
| 100606 | RP37903 | Stem Extender |       |

### Handshower Assembly



| Part # | Mfg #     | Description | Price |
|--------|-----------|-------------|-------|
| 159519 | RP52589SS | Stainless*  |       |

### Kitchen Spray Assemblies

#### Victorian® Spray and Hose Assembly

- To be used for DIAMOND™ seal technology models



| Part # | Mfg #     | Description | Price |
|--------|-----------|-------------|-------|
| 244160 | RP37489   | Chrome      |       |
| 164086 | RP37489SS | Stainless*  |       |

#### Classic Spray & Hose Assembly

- To be used for non-DIAMOND™ seal technology models



| Part # | Mfg #   | Description | Price |
|--------|---------|-------------|-------|
| 074675 | RP39360 | White       |       |

#### Signature® Waterfall® Spray & Hose Assembly

- To be used for non-DIAMOND™ seal technology models
- Includes nest



| Part # | Mfg #     | Finish     | Price |
|--------|-----------|------------|-------|
| 098546 | RP39345   | Chrome     |       |
| 091323 | RP39345SS | Stainless* |       |

### Pilar® Linden™ Spray, Hose and Diverter Assembly

- To be used for DIAMOND™ seal technology models
- Touch-Clean® spray holes
- Front trigger control
- Finished spray face



| Part # | Mfg #     | Description      | Price |
|--------|-----------|------------------|-------|
| 185590 | RP53880   | Chrome           |       |
| 165648 | RP53880AR | Arctic Stainless |       |
| 156781 | RP53880RB | Venetian Bronze® |       |

### Victorian® Spray, Hose, and Diverter Assembly

- To be used for DIAMOND™ seal technology models



| Part # | Mfg #     | Description      | Price |
|--------|-----------|------------------|-------|
| 170824 | RP53881RB | Venetian Bronze® |       |
| 244811 | RP53881SS | Stainless*       |       |

### Collins™ Spray, Hose and Diverter Assembly

- To be used for DIAMOND™ seal technology models
- Touch-Clean® spray holes
- Finished spray face



| Part # | Mfg #     | Description | Price |
|--------|-----------|-------------|-------|
| 130164 | RP54235   | Chrome      |       |
| 144787 | RP54235SS | Stainless*  |       |

### Cassidy™ Spray and Hose Assembly

- Touch-Clean® spray holes
- Front trigger control
- Finished spray face



| Part # | Mfg #   | Description | Price |
|--------|---------|-------------|-------|
| 167693 | RP72751 | Chrome      |       |

\* Brilliance® Anti-Tarnish Lifetime Finishes

[www.plumbsupply.com](http://www.plumbsupply.com) • Serving our Customers Since 1946 • [www.waterconcepts.net](http://www.waterconcepts.net)

## Delta Faucet Repair Parts

### Spray and Hose Assembly



| Part # | Mfg #     | Description      | Price |
|--------|-----------|------------------|-------|
| 179527 | RP61013RB | Venetian Bronze* |       |

### Classic and Signature® Spray & Hose Assembly

- To be used for single handle non-DIAMOND™ seal technology models
- Finished sprayer



| Part # | Mfg #   | Finish | Price |
|--------|---------|--------|-------|
| 044116 | RP31612 | Chrome |       |

### Spray & Hose Assembly



| Part # | Mfg #     | Finish          | Price |
|--------|-----------|-----------------|-------|
| 058833 | RP28900   | Chrome          |       |
| 059165 | RP28900SS | Stainless*      |       |
| 168533 | RP32250BN | Brushed Nickel* |       |

### Kitchen Spray Assembly



| Part # | Mfg #     | Description | Price |
|--------|-----------|-------------|-------|
| 224779 | RP43524SS | Stainless*  |       |

### Classic Spray, Hose and Diverter Assembly

- To be used for DIAMOND™ seal technology models



| Part # | Mfg #   | Finish | Price |
|--------|---------|--------|-------|
| 134487 | RP60097 | Chrome |       |

### Kitchen Spray Assemblies (Continued)

#### Classic Spray, Hose and Diverter Assembly

| Part # | Mfg #     | Finish     | Price |
|--------|-----------|------------|-------|
| 180881 | RP60097SS | Stainless* |       |

#### Foundations® Spray, Hose Assembly and Spray Support

- Lead free
- For single handle kitchen models



| Part # | Mfg #     | Description | Price |
|--------|-----------|-------------|-------|
| 145981 | RP54807   | Chrome      |       |
| 187325 | RP54807SS | Stainless*  |       |

#### Spray Support Assembly



| Part # | Mfg #  | Description | Price |
|--------|--------|-------------|-------|
| 003664 | RP6015 | Chrome      |       |

#### Quick-Connect Vegetable Spray Hose



| Part # | Mfg #     | Description | Price |
|--------|-----------|-------------|-------|
| 103219 | RP37034GR | White       |       |

#### 2-Hdl Kitchen or Lavatory 16" Hose



| Part # | Mfg #  | Description | Price |
|--------|--------|-------------|-------|
| 003676 | RP6050 | White       |       |

#### Pilar® Pull-Down Spray Assembly



| Part # | Mfg #     | Description      | Price |
|--------|-----------|------------------|-------|
| 244885 | RP53210AR | Arctic Stainless |       |

\* Brilliance® Anti-Tarnish Lifetime Finishes

[www.waterconcepts.net](http://www.waterconcepts.net) • Serving our Customers Since 1946 • [www.plumbsupply.com](http://www.plumbsupply.com)



## Delta Faucet Repair Parts

### Pull-Out Wand Assembly



| Part # | Mfg #     | Description       | Price |
|--------|-----------|-------------------|-------|
| 154289 | RP53102AR | Arctic Stainless™ |       |
| 147391 | RP53102SS | Stainless*        |       |

### Pull-Down Spray Assembly

- Includes aerator



| Part # | Mfg #     | Description | Price |
|--------|-----------|-------------|-------|
| 159024 | RP47269SS | Stainless*  |       |

### Pull-Down Wand Assembly



| Part # | Mfg #     | Description             | Price |
|--------|-----------|-------------------------|-------|
| 160975 | RP72680AR | Pull-Down Wand Assembly |       |

### Fuse Pull-Down Wand Assembly

| Part # | Mfg #     | Description               | Price |
|--------|-----------|---------------------------|-------|
| 175890 | RP70703SB | Stainless*/Cracked Pepper |       |

### Sprayer Wand Assembly

- Pull-out faucets



| Part # | Mfg #     | Description | Price |
|--------|-----------|-------------|-------|
| 152076 | RP53438SS | Stainless*  |       |

### Wand Assembly



| Part # | Mfg #     | Description      | Price |
|--------|-----------|------------------|-------|
| 182191 | RP51480   | Chrome           |       |
| 156754 | RP51480RB | Venetian Bronze® |       |
| 152052 | RP51480SS | Stainless*       |       |
| 237802 | RP51480AR | Arctic Stainless |       |

### Wand Assembly with Hose

- Pull-out faucets



| Part # | Mfg #     | Description       | Price |
|--------|-----------|-------------------|-------|
| 063196 | RP32542   | Chrome            |       |
| 161322 | RP32542AR | Arctic Stainless™ |       |
| 162140 | RP32542BL | Matte Black       |       |
| 081006 | RP32542SS | Stainless*        |       |

### Spray Assembly



| Part # | Mfg #     | Description | Price |
|--------|-----------|-------------|-------|
| 181927 | RP46751SS | Stainless*  |       |

### Palo Wand Assembly



| Part # | Mfg #   | Description | Price |
|--------|---------|-------------|-------|
| 117444 | RP44643 | Chrome      |       |

\* Brilliance® Anti-Tarnish Lifetime Finishes

[www.plumbsupply.com](http://www.plumbsupply.com) • Serving our Customers Since 1946 • [www.waterconcepts.net](http://www.waterconcepts.net)

## Delta Faucet Repair Parts

### Kitchen Spray Assemblies (Continued)

#### Palo Wand Assembly

| Part # | Mfg #     | Description | Price |
|--------|-----------|-------------|-------|
| 168840 | RP44643SS | Stainless*  |       |

#### RP44477 Pull-Out Wand Assembly



| Part # | Mfg #     | Description | Price |
|--------|-----------|-------------|-------|
| 168481 | RP44477SS | Stainless*  |       |

### Soap/Lotion Dispenser Accessories

#### Soap/Lotion Dispenser Nut

| Part # | Mfg #   | Description   | Price |
|--------|---------|---------------|-------|
| 037864 | RP21945 | Dispenser Nut |       |

#### Soap/Lotion Dispenser Body Assembly



| Part # | Mfg #     | Description | Price |
|--------|-----------|-------------|-------|
| 187739 | RP21906SS | Stainless*  |       |

#### Soap/Lotion Dispenser Pump Head



| Part # | Mfg #     | Description | Price |
|--------|-----------|-------------|-------|
| 160946 | RP21905SS | Stainless*  |       |

### Kitchen Accessories

#### Sliding Weight

- For use with Pull-Down/Out kitchen faucets

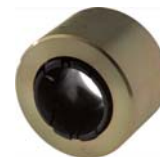

| Part # | Mfg #   | Description | Price |
|--------|---------|-------------|-------|
| 188349 | RP49149 | N/A         |       |

#### Kitchen Diverter Assembly

- Diverter assembly kit 1-handle Delta® replacement

| Part # | Mfg #      | Description                      | Price |
|--------|------------|----------------------------------|-------|
| 133121 | RP63135    | Kitchen Faucet Diverter Assembly |       |
| 136138 | RP63135MBS | Diverter Assembly                |       |
| 132777 | RP63136    | 1-Handle Diverter Assembly       |       |
| 133157 | RP63136MBS | Kitchen Diverter Assembly        |       |

#### Brizo Lavatory Escutcheon

- 3/8" Height
- Can be used with (65005LF)



| Part # | Mfg #     | Description         | Price |
|--------|-----------|---------------------|-------|
| 243611 | RP61619BZ | 4", Brushed Bronze* |       |

#### 8" Escutcheon



| Part # | Mfg #     | Description       | Price |
|--------|-----------|-------------------|-------|
| 149596 | RP64070   | Chrome            |       |
| 146679 | RP64070AR | Arctic Stainless™ |       |
| 162388 | RP64070CZ | Champagne Bronze™ |       |

#### Cassidy™ Escutcheon

- 10-1/4" Length
- 1 or 3-hole installation
- 8" centers on 3-hole installation
- 2-1/2" Maximum deck thickness



| Part # | Mfg #     | Description      | Price |
|--------|-----------|------------------|-------|
| 244648 | RP71545PN | Polished Nickel* |       |

\* Brilliance® Anti-Tarnish Lifetime Finishes

[www.waterconcepts.net](http://www.waterconcepts.net) • Serving our Customers Since 1946 • [www.plumbsupply.com](http://www.plumbsupply.com)

## Delta Faucet Repair Parts

### Escutcheon

- 8" Length
- 1-1/2" connection



| Part # | Mfg #   | Description | Price |
|--------|---------|-------------|-------|
| 249251 | 061270A | Chrome      |       |

### Escutcheon

- 4" Length
- 1-1/2" connection



| Part # | Mfg #   | Description | Price |
|--------|---------|-------------|-------|
| 250327 | 061269A | Chrome      |       |

### Escutcheon and Gasket

- Transitional/contemporary bar



| Part # | Mfg #     | Description       | Price |
|--------|-----------|-------------------|-------|
| 189018 | RP77702   | Chrome            |       |
| 217804 | RP77702AR | Arctic Stainless™ |       |

### Escutcheon, Base, and Gasket



| Part # | Mfg #     | Description      | Price |
|--------|-----------|------------------|-------|
| 252777 | RP70714   | Chrome           |       |
| 236796 | RP70714AR | Arctic Stainless |       |
| 249466 | RP70714BL | Matte Black      |       |

### Escutcheon, Base, and Gasket



| Part # | Mfg #     | Description       | Price |
|--------|-----------|-------------------|-------|
| 148562 | RP64472AR | Arctic Stainless™ |       |
| 168129 | RP64472SS | Stainless*        |       |

### Square Escutcheon



| Part # | Mfg #     | Description      | Price |
|--------|-----------|------------------|-------|
| 153685 | RP63970RB | Venetian Bronze® |       |
| 143753 | RP63970SS | Stainless*       |       |

### Escutcheon - 3 Hole



| Part # | Mfg #     | Description | Price |
|--------|-----------|-------------|-------|
| 170028 | RP44645SS | Stainless*  |       |

### 10" Escutcheon



| Part # | Mfg #     | Description       | Price |
|--------|-----------|-------------------|-------|
| 158527 | RP47274AR | Arctic Stainless™ |       |
| 158533 | RP47274RB | Venetian Bronze®  |       |

### Escutcheon, Gasket (3-Hole)



| Part # | Mfg #     | Description | Price |
|--------|-----------|-------------|-------|
| 225247 | RP72991SS | Stainless*  |       |

### Decorative Escutcheon

- 10" Long



| Part # | Mfg #     | Description       | Price |
|--------|-----------|-------------------|-------|
| 158526 | RP71545   | Chrome            |       |
| 154412 | RP71545AR | Arctic Stainless™ |       |
| 158563 | RP71545CZ | Champagne Bronze™ |       |

\* Brilliance® Anti-Tarnish Lifetime Finishes

[www.plumbsupply.com](http://www.plumbsupply.com) • Serving our Customers Since 1946 • [www.waterconcepts.net](http://www.waterconcepts.net)

## Delta Faucet Repair Parts

### Kitchen Accessories (Continued)

#### Decorative Escutcheon

| Part # | Mfg #     | Description      | Price |
|--------|-----------|------------------|-------|
| 153577 | RP71545RB | Venetian Bronze® |       |

#### Shallow Escutcheon

- Pressure balance diverter off indicator

| Part # | Mfg #  | Description | Price |
|--------|--------|-------------|-------|
| 076614 | RP6107 | Chrome      |       |

#### Handle Base

- Square handle bases
- Sold in pairs
- Includes flange support, gasket and set screw



| Part # | Mfg #     | Description | Price |
|--------|-----------|-------------|-------|
| 157758 | RP52659SS | Stainless*  |       |

#### Mounting Hardware



| Part # | Mfg #   | Description       | Price |
|--------|---------|-------------------|-------|
| 186978 | RP52609 | Mounting Hardware |       |

#### Pilar® Check Valves



| Part # | Mfg #   | Description         | Price |
|--------|---------|---------------------|-------|
| 138069 | RP53468 | Pilar® Check Valves |       |

### Shower Parts

#### Single Lever Handle Kit - 17T Series



| Part # | Mfg #     | Description | Price |
|--------|-----------|-------------|-------|
| 153179 | RP51309SS | Stainless*  |       |

#### Linden™ 17 Series Handle Assembly

- Temperature knob and cover



| Part # | Mfg #     | Description     | Price |
|--------|-----------|-----------------|-------|
| 184230 | RP70641   | Chrome          |       |
| 245341 | RP70641RB | Venetian Bronze |       |

#### 13/14 Series Handle Assembly



| Part # | Mfg #     | Description | Price |
|--------|-----------|-------------|-------|
| 132336 | RP48717   | Chrome      |       |
| 143667 | RP48717SS | Stainless*  |       |

#### Gasket Insert for Showerhead

- Plastic



| Part # | Mfg #   | Description | Price |
|--------|---------|-------------|-------|
| 243850 | RP43621 | Grey        |       |

#### Handle Assembly



| Part # | Mfg #   | Description | Price |
|--------|---------|-------------|-------|
| 164895 | RP73643 | Chrome      |       |

\* Brilliance® Anti-Tarnish Lifetime Finishes

[www.waterconcepts.net](http://www.waterconcepts.net) • Serving our Customers Since 1946 • [www.plumbsupply.com](http://www.plumbsupply.com)

## Delta Faucet Repair Parts

### Shower Parts (Continued)

#### Handle Assembly

| Part # | Mfg #     | Description      | Price |
|--------|-----------|------------------|-------|
| 186959 | RP72685RB | Venetian Bronze® |       |

#### Temperature Dial



| Part # | Mfg #   | Description | Price |
|--------|---------|-------------|-------|
| 163903 | RP73642 | Chrome      |       |

#### Single Lever Handle Kit - 17 Series



| Part # | Mfg #   | Description | Price |
|--------|---------|-------------|-------|
| 067929 | RP32103 | Chrome      |       |

#### Universal Jet Sleeve Assembly

- Jetted shower™



| Part # | Mfg #   | Description     | Price |
|--------|---------|-----------------|-------|
| 243184 | RP37891 | Jet Sleeve Assy |       |

#### Trim Sleeve - Tub & Shower



| Part # | Mfg #     | Description      | Price |
|--------|-----------|------------------|-------|
| 157460 | RP50879RB | Venetian Bronze® |       |
| 166988 | RP50879SS | Stainless*       |       |

#### Trim Sleeve - 17 and 18 Series



| Part # | Mfg #     | Description      | Price |
|--------|-----------|------------------|-------|
| 249255 | RP50880   | Chrome           |       |
| 151398 | RP50880RB | Venetian Bronze® |       |
| 151435 | RP50880SS | Stainless*       |       |

#### Trim Sleeve - Tub & Shower



| Part # | Mfg #  | Description | Price |
|--------|--------|-------------|-------|
| 031006 | RP5893 | Chrome      |       |

#### Trim Sleeve - 13 and 14 Series



| Part # | Mfg #     | Description            | Price |
|--------|-----------|------------------------|-------|
| 172685 | RP22735SS | Stainless*             |       |
| 096706 | RP39407   | 14 Series Only, Chrome |       |

#### Copper Plug - Shower Only



| Part # | Mfg #   | Description | Price |
|--------|---------|-------------|-------|
| 021656 | RP20032 | Copper      |       |

#### Hose Clip

- Clip only
- Quick-connect



| Part # | Mfg #   | Description | Price |
|--------|---------|-------------|-------|
| 144186 | RP60911 | Hose Clip   |       |

\* Brilliance® Anti-Tarnish Lifetime Finishes

[www.plumbsupply.com](http://www.plumbsupply.com) • Serving our Customers Since 1946 • [www.waterconcepts.net](http://www.waterconcepts.net)

## Delta Faucet Repair Parts

### Valve Sleeve Assembly



| Part # | Mfg #     | Description      | Price |
|--------|-----------|------------------|-------|
| 172344 | RP51481RB | Venetian Bronze® |       |

### Bar Slide Knob



| Part # | Mfg #  | Description                     | Price |
|--------|--------|---------------------------------|-------|
| 175920 | 4116BX | For Models 55024 & 55030, Clear |       |

### Bath Waste Parts

#### Bath Waste Assembly

- Toe-operated
- 13-1/2" Max vertical adjustment
- 7-3/4" max horizontal adjustment
- Brass construction



| Part # | Mfg #   | Description       | Price |
|--------|---------|-------------------|-------|
| 177578 | RP293   | Chrome            |       |
| 143839 | RP693CZ | Champagne Bronze™ |       |

### Tub Drain

- Toe-operated
- Stopper and waste plug
- Stopper screw threads are 5/16"-18



| Part # | Mfg #     | Description       | Price |
|--------|-----------|-------------------|-------|
| 159165 | RP31558CZ | Champagne Bronze™ |       |

### Waste Plug

- Toe operated
- 1-1/2"-11-1/2" NPSM



| Part # | Mfg #   | Description | Price |
|--------|---------|-------------|-------|
| 166059 | RP16687 | Chrome      |       |

### Bonnet Cap

- With adjusting ring



| Part # | Mfg # | Finish | Price |
|--------|-------|--------|-------|
| 003631 | RP50  | Chrome |       |

### Stopper Assembly

- Toe operated
- 5/16" - 18" thread size



| Part # | Mfg #     | Description      | Price |
|--------|-----------|------------------|-------|
| 177577 | RP16686PN | Polished Nickel* |       |

### Mini-Bulk Parts

#### Aerator

- 15/16" - 27 Male thread
- For most kitchen and lavatory faucets
- 2.2 gpm @ 60 psi



| Part # | Mfg #    | Description         | Price |
|--------|----------|---------------------|-------|
| 022154 | RP330MBS | Chrome, 60 Per Case |       |

### Cam and Packing-Knob

- For single knob handle faucets



| Part # | Mfg #    | Description            | Price |
|--------|----------|------------------------|-------|
| 003552 | RP188    | For Single Knob Handle |       |
| 017861 | RP188MBS | 64 Per Case            |       |

### Cam & Packing - Lever

- For single lever handle faucets



| Part # | Mfg #   | Description | Price |
|--------|---------|-------------|-------|
| 017522 | RP61MBS | 64 Per Case |       |

\* Brilliance® Anti-Tarnish Lifetime Finishes

[www.waterconcepts.net](http://www.waterconcepts.net) • Serving our Customers Since 1946 • [www.plumbsupply.com](http://www.plumbsupply.com)

## Delta Faucet Repair Parts

### Seat

- For all 1-handle and 2-handle faucets



| Part # | Mfg #     | Description  | Price |
|--------|-----------|--------------|-------|
| 022156 | RP1806MBS | 240 Per Case |       |

### Spring

- For all 1-handle and 2-handle faucets



| Part # | Mfg #     | Description  | Price |
|--------|-----------|--------------|-------|
| 022158 | RP3427MBS | 240 Per Case |       |

### Seats, Springs, Quad Rings

- Qty. 2



| Part # | Mfg #   | Description                | Price |
|--------|---------|----------------------------|-------|
| 063896 | RP28603 | Seats, Springs, Quad Rings |       |

### Seats & Springs Boxed Assortment Kit

- RP4993 (24)



| Part # | Mfg #  | Description               | Price |
|--------|--------|---------------------------|-------|
| 003740 | RP4039 | Seats & Springs 24-RP4993 |       |

### Ceramic Seats and Seals

- Qty. 2



| Part # | Mfg #   | Description             | Price |
|--------|---------|-------------------------|-------|
| 020357 | RP10700 | Ceramic Seats and Seals |       |

### Stainless Steel Ball - Knob

- For single knob handle faucets except 1300, 1400 & 1600 tub/shower series and pull-out spray models



| Part # | Mfg #    | Description | Price |
|--------|----------|-------------|-------|
| 022152 | RP212MBS | 60 Per Case |       |

### Stainless Steel Ball - Lever

- For single lever handle faucets except 1300, 1400, 1500, 1600, 1700 & 1800 T/S series and pull-out spray models



| Part # | Mfg #   | Description | Price |
|--------|---------|-------------|-------|
| 022151 | RP70MBS | 60 Per Case |       |

### Stem Unit & Seat

- For 1600 tub/shower series

| Part # | Mfg #     | Description                   | Price |
|--------|-----------|-------------------------------|-------|
| 003582 | RP1991    | Stem Unit & Seat              |       |
| 022157 | RP1991MBS | Stem Unit & Seat, 12 Per Case |       |

### Stem Unit with Stainless Steel Plate

- For 2-handle and basin faucets



| Part # | Mfg #     | Description                 | Price |
|--------|-----------|-----------------------------|-------|
| 003515 | RP1740    | Stem Unit Assy              |       |
| 022155 | RP1740MBS | Stem Unit Assy, 60 Per Case |       |

### Delta® Plumber's Box of Parts



| Part # | Mfg #   | Description            | Price |
|--------|---------|------------------------|-------|
| 134141 | RP63139 | Plumber's Box of Parts |       |

### Ball Assemblies

| Part # | Mfg # | Description   | Price |
|--------|-------|---------------|-------|
| 003724 | RP70  | For 1-H Lever |       |
| 003592 | RP212 | For 1-H Knob  |       |

### O-Rings

| Part # | Mfg #   | Description         | Price |
|--------|---------|---------------------|-------|
| 114466 | RP13938 | O-Ring              |       |
| 071330 | RP14414 | 13/14 Series Qty. 2 |       |
| 154097 | RP18362 | O-Ring              |       |

\* Brilliance® Anti-Tarnish Lifetime Finishes

[www.plumbsupply.com](http://www.plumbsupply.com) • Serving our Customers Since 1946 • [www.waterconcepts.net](http://www.waterconcepts.net)

## Delta Faucet Repair Parts

### Mini-Bulk Parts (Continued)

#### O-Rings

| Part # | Mfg #   | Description                     | Price |
|--------|---------|---------------------------------|-------|
| 043131 | RP23336 | O-Ring F/1400                   |       |
| 003605 | RP25    | 1-Hdl Kit Spout                 |       |
| 003589 | RP2055  | For 2-H Kitchen Spout           |       |
| 040285 | RP22934 | For 2-H Waterfall® Kitchen Deck |       |
| 061918 | RP32520 | Spout O-Rings for 470 & 472     |       |
| 178227 | RP50388 | O-Ring                          |       |
| 170777 | RP73984 | Clip and O-Ring                 |       |
| 247379 | RP83781 | O-Ring & Limit Stop             |       |
| 249032 | RP90771 | Cartridge Assy and O-Ring       |       |

#### O-Ring

- For 100/200/300/400 single-handle kitchen deck faucets manufactured since 1969 models



| Part # | Mfg #   | Description  | Price |
|--------|---------|--------------|-------|
| 022150 | RP25MBS | 120 Per Case |       |

#### Screws

| Part # | Mfg #     | Description                                      | Price |
|--------|-----------|--|-------|
| 003437 | RP12630   | Escutcheon Trim Screws, Extra Long               |       |
| 155211 | RP12630RB | Escutcheon Trim Screws, Extra Long - Ven Bronze® |       |
| 003496 | RP152     | For Single Lever Handle                          |       |
| 003564 | RP196     | Chrome   |       |
| 033496 | RP25620   | Set Screws for Small Handle Bases                |       |
| 032801 | RP26865   | Set Screws for Large Handle Bases                |       |
| 168960 | RP40650   | Set Screw  |       |
| 157647 | RP5417OB  | Escutcheon Screws (2)                            |       |
| 158261 | RP61819   | On Wall Screws 4 Lengths                         |       |

### Delta® Repair Parts

| Part # | Mfg #   | Description                                       | Price |
|--------|---------|---|-------|
| 217207 | 4124CBG | Cap - GL Rail BG                                  |       |
| 028507 | 4959BG  | Rubber Gaskets - Bag of 5                         |       |
| 144039 | 060602A | Sngl Blade Hdl w/ Screw                           |       |
| 111465 | 060683A | Hard Wire Converter                               |       |
| 247208 | 060791A | Comm Garden Hose Thread Adapter w/ Vacuum Breaker |       |
| 207016 | 060949A | Comm 4" Hooded Lvr Hdl                            |       |

### Delta® Repair Parts (Continued)

| Part # | Mfg #      | Description                               | Price |
|--------|------------|---|-------|
| 248502 | 061128A    | 2 H&C Ceramic Cartridges                  |       |
| 238143 | 061131A    | Extension Kit for 060852A Diverter Valve  |       |
| 162306 | 063044A    | 8" Swing Spout Assembly                   |       |
| 023673 | 060864A    | 4" Blade Handle Pair                      |       |
| 098175 | 060302A    | Vacuum Breaker Repair                     |       |
| 126956 | 060638A    | 1.5 GPM Vandal Resistant Aerator          |       |
| 252220 | 060757A    | 3/8 IP Angle Vac Breaker                  |       |
| 237119 | 061203A    | 0.5 gpm VR Laminar Outlet                 |       |
| 243261 | 061297A    | Commercial Driver Board                   |       |
| 225244 | 061252A    | Driver Board, H2Optics and Proximity      |       |
| 188507 | 063093A    | R3 Spout for 54T2402                      |       |
| 243260 | 063230A    | Commercial Spout Assy                     |       |
| 247528 | 063257A    | Commercial Brass Solenoid                 |       |
| 246656 | 063258A    | Commercial Battery Box                    |       |
| 162728 | 063128A    | CAM Surface Box Assembly                  |       |
| 247639 | 33W576-BL  | Commercial Push Button, Matte Black       |       |
| 177587 | EP73954    | AP Power Supply                           |       |
| 183919 | EP74854    | Solenoid Assembly                         |       |
| 109632 | RP1050     | Bonnet Nut, Chrome                        |       |
| 240775 | RP1050RB   | Bonnet Nut, Venetian Bronze               |       |
| 188994 | RP11768HDF | Commercial Lever Handles, Brass w/ Screws |       |
| 026356 | RP12629    | Screw Set                                 |       |
| 099577 | RP16213    | Screwdriver Stop Assembly                 |       |
| 003512 | RP16423    | Reverse Ball                              |       |
| 019240 | RP18090    | Escutcheon                                |       |
| 025093 | RP18276    | Chrome Escutcheon                         |       |
| 025092 | RP18136    | Sleeve, Chrome                            |       |
| 029096 | RP21463    | Retainer - Spout                          |       |
| 033619 | RP21469    | 1Hdl Lever Kit with Screw                 |       |
| 154634 | RP21469SS  | 1Hdl Lever Kit with Screw                 |       |
| 086213 | RP23094SS  | Handle Base w/ Gasket                     |       |
| 243320 | RP52658    | Set Screw & Button Set, Polished Nickel*  |       |
| 237393 | RP53410SS  | Roman Tub Handle Base                     |       |
| 003597 | RP2389     | Clear 1-Handle Lavatory w/Button & Screw  |       |
| 003599 | RP2391     | Clear Knob w/Button & Screw               |       |
| 003601 | RP2393     | 1 Kitchen Lever Handle w/Set Screw        |       |
| 003603 | RP2411     | Button, Clear                             |       |
| 003608 | RP250      | Adjusting Ring                            |       |
| 031329 | RP250MBS   | Adjusting Ring                            |       |

\* Brilliance® Anti-Tarnish Lifetime Finishes

[www.waterconcepts.net](http://www.waterconcepts.net) • Serving our Customers Since 1946 • [www.plumbsupply.com](http://www.plumbsupply.com)





## Delta Faucet Repair Parts

### Delta® Repair Parts (Continued)

| Part # | Mfg #     | Description                                | Price |
|--------|-----------|--|-------|
| 044850 | RP28595   | Temp Knob and Cover                        |       |
| 054794 | RP29569   | Spacer                                     |       |
| 059633 | RP33805   | 10-1/8" Horizontal Rod                     |       |
| 003623 | RP3614    | Lever Repair Kit                           |       |
| 155976 | RP37022SS | Bonnet, Washer and Clip                    |       |
| 237857 | RP38674   | Nut and Washer                             |       |
| 244140 | RP40664SS | Roman Tub Hose & Gaskets R4700, Stainless* |       |
| 171342 | RP42208   | Wrench                                     |       |
| 243216 | RP42407   | 3-Port 6 Func Diverter Trim Bonnet         |       |
| 164132 | RP47030   | Lavatory Wrench                            |       |
| 003630 | RP4993    | Deluxe Seats & Springs (2)                 |       |
| 122686 | RP50366   | Stem Assembly w/ O-Rings and Nuts          |       |
| 249098 | RP50786SS | Button Indicator, Stainless                |       |
| 238441 | RP50790SS | Single Lvr Handle Kit, Stnlss*             |       |
| 144187 | RP51503   | Bonnet Nut                                 |       |
| 239500 | RP51019   | Set Screw & Button, Chrome                 |       |
| 132784 | RP52834   | Single Metal Lever Handle Kit              |       |
| 252844 | RP53210SS | Pilar Pull-Down Spray Assy, Stainless*     |       |
| 131263 | RP53997   | Diverter Clip                              |       |
| 237661 | RP5417    | Screw                                      |       |
| 003639 | RP5649    | Diverter Assembly, Chrome                  |       |
| 003649 | RP574     | Balance Spool Assembly                     |       |
| 003657 | RP5861    | Coupling Nuts                              |       |
| 003662 | RP6011    | Hose & Spray, Black/CP                     |       |
| 003678 | RP6060    | Nut  |       |
| 003681 | RP6068    | Plug Button                                |       |
| 037831 | RP6079    | Bonnet, Chrome                             |       |
| 040904 | RP6081    | Sleeve, Chrome                             |       |
| 003687 | RP6092    | Nuts & Washers                             |       |
| 252044 | RP60976RB | Addison Wand Assy & Hose, Venetian Bronze  |       |
| 237655 | RP61184   | Escutcheon, Chrome                         |       |
| 003695 | RP6130    | Pivot Seat & Gasket                        |       |
| 153121 | RP61820   | Stem Assembly                              |       |
| 003705 | RP6183    | Locknuts                                   |       |
| 238406 | RP62381SS | 6-Setting Escutcheon, Stnlss               |       |
| 243523 | RP63505   | Nut/Tee Kit                                |       |
| 224647 | RP64240   | Mounting Bracket                           |       |
| 227492 | RP64288   | Gasket for 400DST                          |       |
| 238763 | RP64364SS | Metal Lvr Hndl Set, *Stainless             |       |
| 144951 | RP64364   | Classic Handle Set, Chrome                 |       |
| 240958 | RP64449   | Hot&Cold Blade Hdl Set, Chr                |       |

### Delta® Repair Parts (Continued)

| Part # | Mfg #     | Description   | Price |
|--------|-----------|---|-------|
| 151297 | RP64696   | Spout Assembly - Locked                                 |       |
| 242851 | RP70607   | Screw, Adapter, & Insert Parts                          |       |
| 243590 | RP71447PC | Spout Assy with Magnet                                  |       |
| 252051 | RP72564SS | Cassidy Set Screw & Button, Stainless*                  |       |
| 249519 | RP72752AR | Cassidy Spray Nest, Arctic Stainless                    |       |
| 245502 | RP73391   | Cassidy 2-Hole Kitchen Spout Retainer & Ring            |       |
| 250641 | RP73640   | Comm Spout Assy & Tee                                   |       |
| 171629 | RP74456   | Odin Extension Kit                                      |       |
| 239499 | RP75438SS | Ara 17 Series Escutcheon & Gasket, Stainless*           |       |
| 244719 | RP78360   | Lift Rod Hole Button, Chrome                            |       |
| 244994 | RP78739PN | Tesla 2H Lav Flange & Gasket, *Pol Nickel               |       |
| 251251 | RP78943   | Spout Body Diverter                                     |       |
| 239093 | RP80523   | Hose Weight Assy  |       |
| 249154 | RP80528   | Kitchen Faucet Gasket                                   |       |
| 003734 | RP8230    | Ceramic Stem, Seat, O-Ring, Spring                      |       |
| 237520 | RP84704SS | Volume Hndl Assy, Stainless*                            |       |
| 239968 | RP90056   | Ara® Stem & Valve                                       |       |
| 003434 | RP12491   | (2) HDF Wrist Blade Handles w/Set Screw                 |       |
| 024497 | RP12490   | Screws - Red and Blue                                   |       |
| 003520 | RP17449   | Clear Handle w/Button & Screw, for Single Handle Faucet |       |
| 023197 | RP17451   | Clear Handle w/Button & Screw, for Tub & Shower         |       |
| 024762 | RP18627   | Extender less Screws                                    |       |
| 003572 | RP19804   | Cartridge Assembly                                      |       |
| 022311 | RP19807   | Limit Stop  |       |
| 049620 | RP22734   | Plated Bonnet   |       |
| 187688 | RP23094CZ | Handle Base & Gasket                                    |       |
| 030260 | RP23498   | Clear Knob Handle w/Screws                              |       |
| 185875 | RP23611RB | Base with Gasket  |       |
| 024314 | RP24096   | Brass Stem Assy   |       |
| 003604 | RP2412    | Two Handle Blade (2)                                    |       |
| 050183 | RP25513   | Stem Unit w/Brass Stem                                  |       |
| 137175 | RP2865    | Plug Push Button Diverter                               |       |
| 071395 | RP28906   | Red/Blue Indicator                                      |       |
| 179884 | RP30532   | Battery Holder  |       |
| 045840 | RP32104   | 1700 Cartridge  |       |
| 067930 | RP32105   | 1700 Handle Screw                                       |       |
| 048950 | RP32522   | Quick-Connect Clip                                      |       |
| 120382 | RP34359RB | Trim Ring - 14 Series                                   |       |

\* Brilliance® Anti-Tarnish Lifetime Finishes

[www.plumbsupply.com](http://www.plumbsupply.com) • Serving our Customers Since 1946 • [www.waterconcepts.net](http://www.waterconcepts.net)

## Delta Faucet Repair Parts

### Delta® Repair Parts (Continued)

| Part # | Mfg #     | Description                                   | Price |
|--------|-----------|---|-------|
| 151759 | RP36203   | Ext Nut and Washer for Electronic Fct         |       |
| 187883 | RP38367   | End Valve Assembly                            |       |
| 184164 | RP41702   | 2Hdl Kitchen Diverter                         |       |
| 140695 | RP40668   | R4700 Diverter Valve Assembly                 |       |
| 101730 | RP41478   | Nut and Adapter                               |       |
| 241265 | RP41896   | Small Glide Ring                              |       |
| 241266 | RP41898   | Large Glide Ring                              |       |
| 174179 | RP44118BN | Handle Kit, Brushed Nickel                    |       |
| 172682 | RP44123   | Repair Kit                                    |       |
| 184827 | RP44493   | Hose Assembly                                 |       |
| 107694 | RP44647   | Pull-Out Hose Assembly                        |       |
| 241504 | RP40505   | Roman Tub Top Washer & Body for R2700/RP40505 |       |
| 144594 | RP46079   | Pressure Test Hot/Cold Plug                   |       |
| 186204 | RP47029   | Lavatory Mounting Bracket                     |       |
| 157015 | RP48592   | Single Lever Handle Kit                       |       |
| 169900 | RP49835   | Mounting Nut                                  |       |
| 169899 | RP50391   | Gasket and Baseplate                          |       |
| 241137 | RP50786RB | Hot/Cold Button, Venetian Brz                 |       |
| 107655 | RP51099   | 7' Leader Hose for Roman Tub                  |       |
| 160483 | RP51290SS | Roman Tub Hand Shower Base Escutcheon         |       |
| 223508 | RP51306RB | 17 Series Handle Kit                          |       |
| 187868 | RP51306SS | 17 Series Handle Kit                          |       |
| 151859 | RP51307   | 1-Hdl Lever Handle Kit                        |       |
| 230767 | RP51307CZ | 17 Series Handle Kit                          |       |
| 223509 | RP51307RB | 17 Series Handle Kit                          |       |
| 187869 | RP51307SS | 17 Series Handle Kit                          |       |
| 161418 | RP51345   | Aerator - 1.5 GPM                             |       |
| 187690 | RP51424   | Temperature Knob and Cover                    |       |
| 160738 | RP51479RB | Valve Sleeve Assembly                         |       |
| 222638 | RP51502AR | Bonnet Cap, Arctic Stainless                  |       |
| 241278 | RP51502RB | Bonnet Cap, Venetian Bronze                   |       |
| 173807 | RP51514SS | Sleeve Assembly                               |       |
| 157876 | RP51628RB | Escutcheon & Gasket                           |       |
| 154211 | RP51685   | Mounting Bracket and Nut                      |       |
| 179559 | RP52147SS | Temp Knob and Cover                           |       |
| 164030 | RP53879   | Handle Button                                 |       |
| 166762 | RP53879SS | Handle Button, Stainless*                     |       |
| 131262 | RP54269   | Spray Cap                                     |       |
| 157044 | RP54974   | Hot/Cold Indicator                            |       |
| 137154 | RP60923   | Kitchen Repair Part                           |       |
| 135054 | RP43233   | D-Spacer 14 Series                            |       |

### Delta® Repair Parts (Continued)

| Part # | Mfg #     | Description  | Price |
|--------|-----------|--|-------|
| 122117 | RP50587   | Single Handle Valve Cartridge                      |       |
| 161889 | RP51490   | Escutcheon - Single Handle Kitchen Faucet          |       |
| 154210 | RP52610   | Trim Ring, Base & Gasket                           |       |
| 164131 | RP53217   | Mounting Hardware - Valve                          |       |
| 176568 | RP53531   | Mounting Nuts                                      |       |
| 173987 | RP54232   | Handle Kit, Chrome                                 |       |
| 181486 | RP54232SS | Handle Kit, Stainless                              |       |
| 166331 | RP54687   | Single Lever Elbow Handle                          |       |
| 153810 | RP60962   | Escutcheon and Gasket                              |       |
| 177033 | RP60979   | Trim Ring, Base and Gasket                         |       |
| 236968 | RP61122   | Addison Anchor Kit                                 |       |
| 158729 | RP6148    | Escutcheon   |       |
| 177305 | RP61839RB | Escutcheon - Single Hole                           |       |
| 151718 | RP6185    | Stop Stem Assembly                                 |       |
| 177217 | RP62150SS | Handle Kit   |       |
| 251901 | RP62601RB | Brizo Slide Bar Assy, Venetian Bronze              |       |
| 251736 | RP62778AR | Linden Trim Ring, Base, & Gasket, Arctic Stainless |       |
| 171385 | RP62961   | Bidet Base, Chrome                                 |       |
| 164948 | RP62961SS | Bidet Base, Stainless                              |       |
| 154459 | RP63131   | Spout Assembly                                     |       |
| 175400 | RP63265   | 1/2" Slip Joint Adapter                            |       |
| 187192 | RP64150SS | Mounting Post                                      |       |
| 187191 | RP64152SS | Slide Mechanism                                    |       |
| 158670 | RP64706   | Handle Kit - 2-Hdl                                 |       |
| 158671 | RP64760   | Stem Unit Assembly                                 |       |
| 173247 | RP64851   | Diverter Bonnet Nut                                |       |
| 181639 | RP70635RB | Roman Tub 2-Hdl Handle Kit                         |       |
| 181640 | RP70637RB | Handle Flange, Ven Brz                             |       |
| 185771 | RP70638RB | Diverter Lift Rod                                  |       |
| 168736 | RP70639RB | Shower Handle Assembly, Ven Bronze                 |       |
| 178178 | RP72289   | Lift Rod Plug                                      |       |
| 185650 | RP72721SS | Handshower Base                                    |       |
| 180482 | RP73054   | Gaskets  |       |
| 155687 | RP73192   | Red/Blue Button                                    |       |
| 168272 | RP73837   | Low Flow Regulator                                 |       |
| 177576 | RP7424PN  | Overflow Plate                                     |       |
| 156883 | RP7424RB  | Overflow Plate                                     |       |
| 181717 | RP74608   | 54" PO Hose (Small OD)                             |       |
| 181034 | RP74812   | O-Rings  |       |
| 252444 | RP74836   | Cartridge  |       |
| 173787 | RP75408   | Rectangular Aerator, Set Screw                     |       |

\* Brilliance® Anti-Tarnish Lifetime Finishes

[www.waterconcepts.net](http://www.waterconcepts.net) • Serving our Customers Since 1946 • [www.plumbsupply.com](http://www.plumbsupply.com)



---



---

## Delta Faucet Repair Parts

---



---

### Delta® Repair Parts (Continued)

| Part # | Mfg #     | Description                            | Price |
|--------|-----------|--|-------|
| 187322 | RP75409   | Flow Regulator                         |       |
| 237173 | RP75497   | Handshower Base - Roman Tub            |       |
| 170776 | RP76691   | Centerset Extension Kit                |       |
| 185305 | RP77162   | Escutcheon                             |       |
| 186205 | RP77263SS | Escutcheon - 3 Hole                    |       |
| 186203 | RP77457SS | Button - Lift Rod Hole Cover           |       |
| 166060 | RP7900    | Gasket                                 |       |
| 252441 | RP80619   | Dominic Bonnet Nut                     |       |
| 189416 | RP81914AR | Mateo® Escutcheon                      |       |
| 225577 | RP81914   | Mateo® Escutcheon                      |       |
| 186097 | RP83888   | Valve Bracket                          |       |
| 239225 | RP84986SS | Diverter Temp Knob & Cover, *Stainless |       |
| 252706 | RP90838   | Addison Wand Assy                      |       |
| 252613 | RP91788PC | Litze Handle Kit, Chrome               |       |
| 245563 | 0611159A  | 4" Deck Plate & Holdown Pkg            |       |

Repair Parts

\* Brilliance® Anti-Tarnish Lifetime Finishes

[www.plumbsupply.com](http://www.plumbsupply.com) • Serving our Customers Since 1946 • [www.waterconcepts.net](http://www.waterconcepts.net)

**Elkay Repair Parts**

**Elkay Sink Parts & Accessories**  
**Mounting Clip**



| Part # | Mfg #        | Description                                  | Price |
|--------|--------------|--|-------|
| 238525 | LK-000000222 | Black/Grey Slot Clips, 8 Per Package         |       |
| 006122 | LK-363       | Long Sink Clips                              |       |
| 104709 | LK-463       | Sink Clips for 1-5/8", 2", 2-1/2" Thick Tops |       |
| 162112 | LKUCLIP8     | Mounting Clip for Undermount Sinks           |       |

**Parts**

| Part # | Mfg #        | Description                                 | Price |
|--------|--------------|---|-------|
| 006120 | LK-350       | Socket Screwdriver                          |       |
| 197181 | LKMK462      |   |       |
| 251855 | P29248       | Cartridge                                   |       |
| 240190 | 1000001877   | Drain Replacement Kit for EZ/EZTL           |       |
| 238906 | 1000002436   | Kitchen LED Board                           |       |
| 237642 | 100023340560 | Waste Tube Gasket                           |       |
| 237637 | 101570540560 | Drain Gasket                                |       |
| 237640 | 101637451550 | Friction Ring                               |       |
| 237639 | 110346220550 | Drain Nut                                   |       |
| 237636 | 160270508640 | Strainer Plate                              |       |
| 237641 | 161637308640 | Drain Plug                                  |       |
| 250822 | 45660C       | Bubbler                                     |       |
| 249178 | 45833C       | Cover Bottom                                |       |
| 250124 | 45932C       | Tail Piece                                  |       |
| 237638 | 51575C       | Packing Ring                                |       |
| 249745 | 75507C       | Quick Connect For Solenoid 1/4 NPT x 1/4 OD |       |
| 244931 | 98753C       | Overload Relay Kit                          |       |
| 244475 | 98999C       | Drain Pad Kit for VRC8WS                    |       |

**Elkay Repair Parts**

**Water Cooler Parts**



35981-C



50986-C



55996-C



61313-C



61314-C

| Part # | Mfg #  | Description                  | Price |
|--------|--------|------------------------------|-------|
| 241890 | 21222C | Elkay Basin EHF/WC with DIMP |       |
| 023576 | 31513C | Elkay Cold Control           |       |
| 086622 | 35981C | Elkay 1/4 Solenoid Valve     |       |
| 045589 | 55996C | Cooler Y-Strainer            |       |
| 006168 | 61313C | Cartridge for Water Cooler   |       |
| 024551 | 61314C | Green Cartridge              |       |

**EZH2O™ Parts**

**WaterSentry® Filters**

- CTO Filters
- Features:
  - Quick-disconnect
  - 1/4 Turn installation
  - Hand never touch the actual filter media
  - Outer protective wrap
- NSF/ANSI 42 and 53 certified

| Part # | Mfg #       | Flow Rate | Rated | Full Load | Ship Wt | Description                                 | Price |
|--------|-------------|-----------|-------|-----------|---------|---|-------|
| 162211 | EWF3000     |           |       |           |         | Complete Kit, 3000 Gallon Filtration System |       |
| 189544 | WSF6000R2PK |           |       |           |         | 6000 Gallon, 2-pack                         |       |
| 132220 | 51300C      |           |       |           |         | 3000 Gallon, 1-Pack                         |       |
| 164978 | 51300C12PK  |           |       |           |         | 3000 Gallon, 12-Pack                        |       |
| 132222 | 51300C3PK   |           |       |           |         | 3000 Gallon, 3-Pack                         |       |

Repair Parts



---

---

## Empire Comfort Repair Parts

---

---

### Replacement Parts

#### Blower

| Part # | Mfg # | Description           | Price |
|--------|-------|-----------------------|-------|
| 127041 | FBB-4 | Variable-Speed Blower |       |

---



---

## Fenner Drives Repair Parts

---



---

### Belts

#### PowerTwist Plus® V-Belt

- *No tools required, assembles in minutes*
- *High strength and low elongation under load*
- *High performance polyurethane elastomer reinforced with multiple plies of polyester fabric*



| Part # | Mfg #     | Type | Length | Pack | Price |
|--------|-----------|------|--------|------|-------|
| 143772 | 0418010SL | 3L   | 5'     | Slv  |       |
| 143792 | 0418030SL | A/4L | 5'     | Slv  |       |
| 143793 | 0405030   | A/4L | 25'    | Box  |       |
| 143795 | 0418050SL | B/5L | 6'     | Slv  |       |
| 143796 | 0405050   | B/5L | 25'    | Box  |       |

## Franklin Electric Repair Parts

### Capacitor Kits

| Part # | Mfg #       | HP  | Volts | Price |
|--------|-------------|-----|-------|-------|
| 098889 | 305-207-905 | 1/2 | 230V  |       |
| 098890 | 305-207-918 | 3/4 | 230V  |       |
| 118594 | 305-207-913 | 1   | 230V  |       |
| 097608 | 305-218-976 | 1/2 | 230V  |       |
| 096114 | 305-218-978 | 3/4 | 230V  |       |

### Relays Relay Kit

| Part # | Mfg #       | Volts | Price |
|--------|-------------|-------|-------|
| 096115 | 305-102-902 | 230V  |       |



## General Filter Repair Parts

### Manual Control Humidistats

- Senses variation in relative humidity levels
- Humidity range: 10% - 85%
- Duct cut-out dimensions: 2-1/4" x 1-3/4"
- Duct plate dimensions: 4" x 5-1/2"
- Mounting screws included



### Wall-Mount Housing

- Allows for both wall and duct mount

| Part # | Mfg # | Description                                 | Price |
|--------|-------|---|-------|
| 146561 | WMH3  | Wall-Mount Housing for MHX3, MHX3C, or DHX3 |       |

### GeneralAire Replacement Parts 1042 Series Humidifier Replacement Parts



| Part # | Mfg #  | Description   | Price |
|--------|--------|---|-------|
| 004874 | 990-53 | Solenoid Valve Assembly - 24V for 1042/1137 (Includes Fittings) |       |
| 206827 | GA4231 | Yellow Orifice  |       |

### Replacement Evaporator Pad

- Aluminum evaporator material enclosed in heavy wire frame and channeling
- Pad has super absorbent coating



| Part # | Mfg #   | Description   | Price |
|--------|---------|---|-------|
| 004870 | 990-13  | 11-3/4"H x 9-3/4"W Evaporator Pad for Model SL-16, 1042, 1040, 1137 |       |
| 125681 | 1099-20 | 12"H x 14-1/4"W Evaporator Pad for Model 1099, 950                  |       |

Repair Parts



## Gerber Repair Parts

### Gerber Replacement Parts Cartridge Assembly



92-298

| Part # | Mfg #  | Description   | Price |
|--------|--------|---|-------|
| 023522 | 97-013 | Complete Hardwater® Assembly, Less Control Cartridge              |       |
| 023523 | 97-014 | Complete Safetemp Assembly, Less Control Cartridge                |       |
| 028493 | 92-298 | Hardwater® Ceramic Cartridge with Limit Stop, Chrome              |       |
| 088008 | 95-152 | Hardwater® II & Safetemp II Washerless Pressure Balance Cartridge |       |
| 088009 | 95-154 | Replacement Cartridge for GS103/GS105                             |       |
| 029460 | 97-022 | Safetemp™ Control Cartridge, Chrome                               |       |
| 004822 | 97-510 | Ceramic Disc Cartridge  |       |
| 087758 | 98-674 | Compression Cartridge - Cold                                      |       |
| 004830 | 98-688 | Compression Cartridge for Deck Faucet - Hot                       |       |
| 004831 | 98-689 | Compression Cartridge for Deck Faucet - Cold                      |       |
| 020941 | 98-705 | Long Ceramic Cartridge  |       |
| 047463 | 98-709 | T&S Ceramic Disc Cartridge-Cold                                   |       |

### Faceplate

| Part # | Mfg #     | Description                | Price |
|--------|-----------|----------------------------|-------|
| 004816 | 97-130    | Faceplate Assembly, Chrome |       |
| 026255 | 97-171-KT | Faceplate Assembly, Chrome |       |

### Handle

| Part # | Mfg #  | Description                                      | Price |
|--------|--------|--|-------|
| 031332 | 86-986 | Ceramaflow™ Disc Cartridge, Handle, Cold, Chrome |       |
| 031331 | 86-987 | Ceramaflow™ Disc Cartridge, Handle, Hot, Chrome  |       |
| 082641 | 97-020 | Replacement Shower Handle                        |       |
| 004840 | 98-879 | Wrist Blade Handles, Pair                        |       |

### Shower Arm



| Part # | Mfg #  | Description   | Price |
|--------|--------|---|-------|
| 004716 | 49-205 | Lock Shower Arm Ell, Thin Wall Install, Less Spray Plate, Rough Brass |       |

### Stem and Bonnet Assembly



| Part # | Mfg #  | Description                 | Price |
|--------|--------|-----------------------------|-------|
| 004827 | 98-673 | Stem & Bonnet Assembly, Hot |       |
| 004836 | 98-726 | Diverter Stem & Bonnet Assy |       |

### Unit Bag

| Part # | Mfg #  | Description                                 | Price |
|--------|--------|---|-------|
| 004849 | 99-537 | Unit Bag 298-290/590/790/794/795/796, White |       |
| 063774 | 99-538 | UltraFlush Unit Bag, White                  |       |
| 105006 | 99-660 | Gerber Unit Bag for Avalanche               |       |

### O-Ring



| Part # | Mfg #  | Description                               | Price |
|--------|--------|---|-------|
| 093297 | 92-257 | O-Ring                                    |       |
| 004802 | 92-660 | Spout O-Ring                              |       |
| 004803 | 92-730 | O-Ring                                    |       |
| 004837 | 98-727 | Bonnet O-Ring Stem Cage for 40-700 Series |       |

### Parts

| Part # | Mfg #  | Description                      | Price |
|--------|--------|----------------------------------|-------|
| 178553 | 43-971 | Offset Grid Strainer             |       |
| 076038 | 90-067 | Nipple 5/8" - 24 x 2.687"        |       |
| 004776 | 90-161 | Brass Seat 5/8"-20 NS-2 Thread   |       |
| 026022 | 90-390 | Fibre Follower                   |       |
| 091688 | 90-230 | Screw                            |       |
| 004792 | 91-132 | Middle Wire                      |       |
| 004799 | 91-280 | Strainer Screw                   |       |
| 246168 | 91-565 | 0.5 gpm Aerator                  |       |
| 091418 | 92-294 | Limit Stop for Safetemp          |       |
| 241782 | 93-059 | 1Hdl Escutcheon Sleeve, Chrome   |       |
| 248228 | 94-040 | Spray Diverter w/ Vacuum Breaker |       |
| 237303 | 95-163 | Safetemp Loop Handle, Chrome     |       |
| 136096 | 95-166 | Safetemp Escutcheon, Chrome      |       |
| 004812 | 96-121 | Shoe Plug for Trip Lever         |       |

\*Physical Vapor Deposition (PVD) Limited Lifetime Finish

www.waterconcepts.net • Serving our Customers Since 1946 • www.plumbsupply.com



## Gerber Repair Parts

### Gerber Replacement Parts (Continued)

#### Parts

| Part # | Mfg #     | Description   | Price |
|--------|-----------|---|-------|
| 095128 | 97-164    | Wire/Plunger Assy for Roman Trip Lever Drain            |       |
| 212516 | 97-232    | Pressure Balance Mixing Valve, Cartridge, & Check Valve |       |
| 085928 | 97-305    | Pop-Up Extension Assembly                               |       |
| 237124 | 97-820    | T&S Coupling Nuts (2)                                   |       |
| 039568 | 98-412    | Handle, Button, & Screw                                 |       |
| 204001 | 98-736    | S/H Bath Body Stem Assy & Bottom Seal Kit               |       |
| 227955 | 99-031    | Maxwell Dual Flush Valve<br>1.1/1.6gpf, White           |       |
| 004843 | 99-161    | Lav Hanger  |       |
| 027906 | 99-290    | Urinal Wall Hanger (2 QTY)                              |       |
| 004850 | 99-539    | Tank to Bowl Assy Kit (Unit Bag)                        |       |
| 101710 | 99-579    | Channel Pad   |       |
| 028454 | 99-605    | Lid Locking Assy  |       |
| 126879 | 99-685-09 | Avalanche LH Trip Lever, Biscuit                        |       |
| 112220 | 99-685-WH | Avalanche LH Trip Lever, White                          |       |
| 137907 | 99-788    | Flapper   |       |
| 180235 | 99-791    | Maxwell Flush Valve Kit,<br>1.1/1.6gpf (DF-28-190/195)  |       |

\*Physical Vapor Deposition (PVD) Limited Lifetime Finish

[www.plumbsupply.com](http://www.plumbsupply.com) • Serving our Customers Since 1946 • [www.waterconcepts.net](http://www.waterconcepts.net)

---

---

**Gibson Repair Parts & Accessories**

---

---

**Parts & Accessories**

**Heater Kits**

| Part # | Mfg #      | KW   | Volts | Price |
|--------|------------|------|-------|-------|
| 176339 | H8HK010H11 | 11.9 | 240   |       |
| 176338 | H8HK015H21 | 14.4 | 240   |       |
| 176337 | H8HK020H21 | 19.2 | 240   |       |

**Hi-Velocity (Energy Savings Products) Repair Parts**

**Electrical Components**



EPC Control Board

| Part # | Mfg #       | Part Name         | Description   | Price |
|--------|-------------|-------------------|---|-------|
| 107815 | 20120100111 | EPC Control Board | Control Board for All HE/LV-E Fan Coils with EPC Motors |       |
| 127481 | 20120100001 | EPC Circuit Board | Circuit Board for all HE/LV-E Fan Coils with EPC Motors |       |
| 127483 | 20120100030 | EPC Transformer   | Transformer for all HE/LV-E Fan Coils with EPC Motors   |       |

**Refrigerant Components**



| Part # | Mfg #       | Part Name              | Description  | Price |
|--------|-------------|------------------------|--|-------|
| 097149 | 10040500010 | Fixed Temp Freeze Stat | Fixed Temp Freeze Stat For use with RCM/RM/RPM Units |       |

Repair Parts

**Honeywell Repair Parts**

**Fan Centers**

**R8239 Control Center**

- Provides low voltage control of line voltage fan motors and auxiliary circuits in heating, cooling or heat-cooling circuits
- Includes NEMA D Transformer, relay enclosures
- Convenient connections for thermostat and heating-cooling equipment wiring
- Mounts on standard 4" x 4" junction box in any indoor location without additional enclosures
- Relay is easily replaced without disturbing wiring



| Part # | Mfg #      | Description   | Price |
|--------|------------|---|-------|
| 112616 | R8239B1076 | 120/208/240V, DPDT Switching, 50VA Transformer, Includes R8222D |       |

**R8285 Control Center**

- Transformer powers low voltage control systems and provides overload protection
- Low voltage terminal board provides convenient connections for thermostat and heating/cooling equipment wiring
- Mounts on standard 4" x 4" junction box
- Relay is easily replaced without disturbing wiring



| Part # | Mfg #      | Description  | Price |
|--------|------------|--|-------|
| 006780 | R8285A1048 | 120V, SPDT Switching, 40VA Transformer, 24V Secondary, Includes R8222B Plug-In Relay for 1 or 2 Speed Fans |       |

**Fan Timers**

**Universal Electronic Fan Timer**

- Diagnostic LED
- Replaceable fuse
- DIP switch selectable heat and cool delay on and off times
- Includes EAC and HUM terminal connections & continuous low speed indoor air circulation
- Integrates control of all combustion blower & circulating fan operations in a gas warm-air appliance



| Part # | Mfg #       | Description          | Price |
|--------|-------------|----------------------|-------|
| 134225 | ST9120U1011 | Electronic Fan Timer |       |

**Parts & Accessories**

| Part # | Mfg #        | Description                | Price |
|--------|--------------|----------------------------|-------|
| 138257 | 50041883-002 | TrueEase AC Solenoid Valve |       |

---



---

**Humidifier Parts & Accessories**

---



---

**Humidifier Parts & Accessories**

**Humidifier Parts**

| Part # | Mfg #        | Description  | Price |
|--------|--------------|--|-------|
| 037355 | 32001615-001 | Drain Fitting for HE220 and HE260 Humidifiers  |       |
| 037357 | 32001639-002 | Solenoid Valve Assembly for Honeywell Humidifiers, Includes Water Feed Tube & Nozzle |       |

**Honeywell Repair Parts**

**Honeywell Accessories**  
**Motors**

| Part # | Mfg #     | Description                                      | Price |
|--------|-----------|--|-------|
| 006844 | 802360JA  | 24V Sealed Replacement Motor for V8043/V8044     |       |
| 163574 | 802360LA  | 120V, 60 Hz Replacement Motor for V4043, V4044   |       |
| 099342 | MZV520-RP | 24V 60 Hz Motor for MZV524E/25E/26E/27E w/switch |       |

**Replacement Head for V Series Zone Valves**

| Part # | Mfg #        | Description   | Price |
|--------|--------------|---|-------|
| 006841 | 40003916-026 | 24VAC, 50/60 Hz Replacement Head with End Switch for V8044E |       |
| 031407 | 40003916-048 | 24VAC, 50/60 Hz Replacement Head with End Switch for V8043F |       |

**Checkout Kit for Economizer Logic Modules**

- Includes resistor and jumpers
- Used with W7459, W7210, W7212, and W7215



| Part # | Mfg #   | Description  | Price |
|--------|---------|--|-------|
| 223324 | 4074EJM | Economizer Checkout Kit for W7459, W7210, W7212, and W7215 |       |

**Honeywell Parts**

| Part # | Mfg #          | Description   | Price |
|--------|----------------|---|-------|
| 074665 | 32001754-001   | Current Sensing Relay for Whole-House Humidification Units  |       |
| 006842 | 40003918-006   | Adapter Kit for V4043, V8043, 2-Way Hydronic Valves   |       |
| 127196 | 50027997-001   | Solenoid Valve for TrueSTEAM  |       |
| 163982 | 50041883-001   | DC Solenoid Valve   |       |
| 143930 | 50027998-002   | True Steam Water Level Sensor   |       |
| 152377 | Y8427U9045     | Universal Service Kit, Carton Consists of: (1) S8610U3009/U. (1) ST9120U1011/U. (1) Q3200U2002/U. (1) S9200U1000/U. (1) Multi tool. |       |
| 137379 | 50033181-001   | TrueSTEAM Water Tank - Large  |       |
| 129898 | 50028044-001   | Humidifier Filter, In-Line Scale/Sediment   |       |
| 200692 | C7232A1008     | Wall Mount CO2 Sensor with display, 0/2-10Vdc or 0/4-20mA output  |       |
| 166027 | GROW2          | Honeywell Kit   |       |
| 209920 | VCZAL1100U     | 3/4" Valve Body   |       |
| 171083 | THP9045A1023/U | WireSaver for THX9000 Series Thermostats  |       |

Repair Parts



## Jones Stephens Repair Parts

### Nuts and Washers

#### Basin Nut



| Part # | Mfg #   | Description                  | Price |
|--------|---------|------------------------------|-------|
| 044429 | B10-102 | 1/2"-14 x 1/2" Regular Zamak |       |

### Basket Strainer Locknut

- Die cast zinc



| Part # | Mfg #   | Description                   | Price |
|--------|---------|-------------------------------|-------|
| 093968 | B10-094 | Basket Strainer Rubber Washer |       |

### Flat Bibb Washer

- Trade size



| Part # | Mfg #  | Description | Price |
|--------|--------|-------------|-------|
| 191520 | O25202 | 1/4"        |       |

### Carrier Nut & Washer Set

- 5/8-11 Threads



| Part # | Mfg #   | Description         | Price |
|--------|---------|---------------------|-------|
| 125755 | C56-100 | 4-Pk Nuts & Washers |       |

### Hex Nut



| Part # | Mfg #   | Description | Price |
|--------|---------|-------------|-------|
| 191511 | F33-082 | 3/8" - 16   |       |
| 191512 | F33-083 | 1/2" - 13   |       |

### Zinc Plated Flat Washer

- 3/8" (1" OD)



| Part # | Mfg #   | Description      | Price |
|--------|---------|------------------|-------|
| 191507 | F33-094 | 3/8" (1" OD)     |       |
| 191509 | F33-096 | 3/8" (1-1/2" OD) |       |
| 191508 | F33-097 | 1/2" (2" OD)     |       |
| 191506 | F33-098 | 1/4" (1" O.D.)   |       |

### O-Ring Kit

- Packed in re sealable plastic case with fitting chart on lid



| Part # | Mfg #   | Description                  | Price |
|--------|---------|------------------------------|-------|
| 093646 | O25-200 | 200-Pc O-Ring Plumber's Pack |       |

### Tail Pieces

#### Flanged Tailpiece

- 17 Gauge rough brass



| Part # | Mfg #  | Size        | Price |
|--------|--------|-------------|-------|
| 240051 | P38459 | 1-1/2" x 8" |       |

### Parts & Accessories

#### Stem for Heavy Kitchen & Bath Faucet

- Carded
- Cap gaskets or seals included
- Screws, washers, & packings included



| Part # | Mfg #  | Description | Price |
|--------|--------|-------------|-------|
| 241190 | C1756C | Cold        |       |
| 241191 | C1756H | Hot         |       |

## Kohler Repair Parts

### Kitchen Side Sprays Standard Kitchen Side Spray & Hose



| Part # | Mfg #       | Description                   | Price |
|--------|-------------|-------------------------------|-------|
| 187506 | 1011130-VS  | Sidespray Assy, *Stainless    |       |
| 156774 | 1021724-VF  | Sidespray w/Hose, Brass       |       |
| 122911 | GP1021724-7 | Sidespray w/Hose, Black Black |       |

### Spray & Hose



| Part # | Mfg #        | Description                | Price |
|--------|--------------|----------------------------|-------|
| 171513 | 1013838-BV   | Spray Assy, *Br Brz        |       |
| 153883 | 1014048-CP   | Hose Secondary, Chrome     |       |
| 155335 | 1036940-0    | White Spray Head Kit       |       |
| 153433 | 1037518-CP   | Hose Kit, Polished Chrome  |       |
| 244327 | K-1032256-BN | Brushed Nickel*            |       |
| 098050 | 1041319-CP   | Pull-Out Spry Head Chrome  |       |
| 173755 | 1041319-G    | Pull-Out Spry Head Chrome  |       |
| 152453 | 1041320-CP   | Hose Kit, Polished Chrome  |       |
| 152453 | 1041320-CP   | Hose Kit, Chrome           |       |
| 101298 | 1056336-CP   | Hose Kit, Chrome           |       |
| 153955 | 1109445-BN   | Spray w/ Screen *Br Nickel |       |
| 134128 | 1114379-BC   | Hose Kit, Bright Chrome    |       |
| 164835 | 1148629-BC   | Hose Kit, Bright Chrome    |       |
| 166252 | 1155250-CP   | Bellera Spray Head Chrome  |       |
| 182429 | 1141915      | Hose Kit                   |       |
| 183339 | 1153208      | Hose Guide                 |       |
| 156335 | 1155250-VS   | Spray Head, *Stainless     |       |
| 172261 | 1155250-2BZ  | Spray head, Oil-Rbd Bronze |       |
| 165112 | 1155355-CP   | Spray Head, Pol Chrome     |       |
| 155345 | 1155355-VS   | Spray Head, *Stainless     |       |
| 162203 | 1179931      | Sprayhead Adapter          |       |
| 222878 | 1218822-CP   | Spray Assy, Chrome         |       |
| 181715 | 1218823-CP   | Spray Assy, Chrome         |       |
| 170388 | 1218824-CP   | Spray Assy, Chrome         |       |
| 173920 | 1218824-VS   | Spray Assy, *Stainless     |       |
| 167009 | 1219935-BC   | Hose Kit, Bright Chrome    |       |
| 244611 | 1296842-CP   | Hand spray Assy, Chrome    |       |

### Kitchen Side Sprays (Continued) Spray & Hose

| Part # | Mfg #      | Description     | Price |
|--------|------------|-----------------|-------|
| 157802 | GP1092201  | Hose Kit        |       |
| 055348 | GP78825-CP | Hose Kit Chrome |       |

### Side Spray Assembly

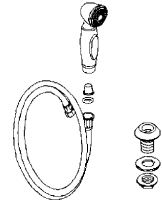

| Part # | Mfg #      | Description                             | Price |
|--------|------------|---|-------|
| 175894 | 1005010-CP | Hose Service Kit, Chrome                |       |
| 153716 | 1005010-VF | Hose Service Kit, * Brass               |       |
| 135248 | 1011130-G  | Side Spray Assy Br Chrome               |       |
| 155090 | 1085211-CP | Side Spray Assy, Chrome                 |       |
| 166253 | 1088395-VS | Side Spray Kit, *Stainless              |       |
| 244405 | 1304674-BC | Pullout Hose Service Kit, Bright Chrome |       |

### Shower Installation Pressure Balancing Kit

| Part # | Mfg #     | Description                  | Price |
|--------|-----------|------------------------------|-------|
| 134263 | K-1144925 | PBU for K-306-KS & K-2971-KS |       |

### Urinal Installation

| Part # | Mfg # | Description          | Price |
|--------|-------|----------------------|-------|
| 056119 | 21403 | Urinal Cleanout Plug |       |

### Urinal Spud Assembly



| Part # | Mfg # | Size   | Price |
|--------|-------|--------|-------|
| 145344 | 18759 | 1-1/4" |       |

### Toilet/Urinal Installation & Accessories

| Part # | Mfg #   | Description              | Price |
|--------|---------|--------------------------|-------|
| 246241 | 1261108 | Urinal Piston, 0.125 GPF |       |
| 246242 | 1261109 | Urinal Piston, 0.5 GPF   |       |
| 246243 | 1261110 | Urinal Piston, 1.0 GPF   |       |

\* Vibrant Limited Lifetime Warranty

[www.waterconcepts.net](http://www.waterconcepts.net) • Serving our Customers Since 1946 • [www.plumbsupply.com](http://www.plumbsupply.com)

## Kohler Repair Parts

### Toilet/Urinal Installation & Accessories (Continued)

| Part # | Mfg #   | Description             | Price |
|--------|---------|-------------------------|-------|
| 246244 | 1261111 | Toilet Piston, 1.1 GPF  |       |
| 246247 | 1261113 | Toilet Piston, 1.6 GPF  |       |
| 246249 | 1261112 | Toilet Piston, 1.28 GPF |       |

#### Urinal Strainer



| Part # | Mfg #     | Description                    | Price |
|--------|-----------|--------------------------------|-------|
| 183714 | 53147-S   | Urinal Strainer, Pol Stainless |       |
| 169956 | GP1211759 | Urinal Strainer                |       |
| 173481 | GP1217811 | Urinal Strainer                |       |
| 057460 | 9161-NA   | Behive Urinal Strainer         |       |

#### Ballcock Retro Fit Valve

- For Rialto/  
San Raphael 3.5 toilets



| Part # | Mfg #   | Description | Price |
|--------|---------|-------------|-------|
| 055292 | K-84499 | Plastic     |       |

#### Cap Assembly



| Part # | Mfg #        | Description                 | Price |
|--------|--------------|-----------------------------|-------|
| 072213 | 1013092-0    | Bolt Cap Accy Pack, White   |       |
| 153559 | 1013092-G9   | Bolt Cap Accy Pack, Sndbr   |       |
| 186397 | 1013092-NY   | Bolt Cap Accy Pack, Dune    |       |
| 108130 | GP1013092-96 | Bolt Cap Accy Pack, Biscuit |       |
| 223630 | 5420-0       | Low-Profile, White          |       |
| 223631 | 5420-96      | Low-Profile, Biscuit        |       |
| 226816 | 5420-K4      | Low-Profile, Cashmere       |       |

### Faucet Valves

#### Complete Valve Assembly for Retrofitting Faucet

- 1/2" Valve

| Part # | Mfg #   | Description           | Price |
|--------|---------|-----------------------|-------|
| 137033 | 1131481 | Valve Body w/Hot Stem |       |
| 172151 | 1170273 | Valve Replacement     |       |

#### Valve Repair Seat

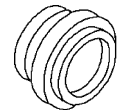

| Part # | Mfg #    | Description    | Price |
|--------|----------|----------------|-------|
| 055320 | 20774-RP | Renewable Seat |       |

#### Vacuum Breaker

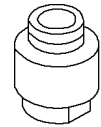

| Part # | Mfg #   | Description    | Price |
|--------|---------|----------------|-------|
| 055422 | GP49114 | Vacuum Breaker |       |

#### Valve Repair Kit

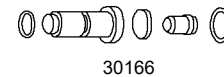

30166



1000187

| Part # | Mfg #     | Description               | Price |
|--------|-----------|---------------------------|-------|
| 182594 | 30147     | Valve Service Kit         |       |
| 182596 | 30372     | Valve Service Kit         |       |
| 182627 | 40409     | End Valve Assy            |       |
| 182681 | 58076     | Valve Assy                |       |
| 171801 | 76567     | Valve Assy                |       |
| 056161 | 1000187   | Valve Repair Kit          |       |
| 162934 | 1178733   | Valve Assy                |       |
| 165027 | 1021121   | Valve, Volume Control     |       |
| 246767 | 1235756   | Valve, 35 MM Short        |       |
| 132759 | GP1017426 | Valve, Kitchen            |       |
| 160355 | GP1093674 | Valve, Kitchen            |       |
| 222832 | GP1152350 | Valve, Centerset Faucet   |       |
| 222831 | GP1192521 | Valve, 25 MM White        |       |
| 055381 | GP78579   | Valve Repair Kit          |       |
| 055308 | GP30166   | Valve Service Kit         |       |
| 055317 | GP30119   | Valve, Trend Shower (Hot) |       |

\* Vibrant Limited Lifetime Warranty

[www.plumbsupply.com](http://www.plumbsupply.com) • Serving our Customers Since 1946 • [www.waterconcepts.net](http://www.waterconcepts.net)

## Kohler Repair Parts

### Washers, Nuts & Gaskets



| Part # | Mfg #    | Description             | Price |
|--------|----------|-------------------------|-------|
| 182530 | 20496-BC | Lock Nut, Bright Chrome |       |
| 182532 | 20564    | Washer                  |       |
| 182533 | 20565    | Washer                  |       |
| 182536 | 20644    | Gasket                  |       |
| 247267 | 21600    | Washer F/STR-PLU        |       |
| 182569 | 21766    | Nut                     |       |
| 182572 | 21779    | Gasket                  |       |
| 182574 | 21844    | Nut                     |       |
| 153386 | 23094    | Nut                     |       |
| 182584 | 24003-CP | Nut, Polished Chrome    |       |
| 153819 | 32008    | Nut                     |       |
| 182601 | 32060    | Washer                  |       |
| 163448 | 32313    | Nut                     |       |
| 182603 | 32841    | Gasket                  |       |
| 182604 | 33331    | Washer                  |       |
| 182606 | 33504    | Washer                  |       |
| 182607 | 33772    | Washer                  |       |
| 182608 | 34037    | Gasket                  |       |
| 182610 | 34074-CP | Nut, Polished Chrome    |       |
| 154416 | 34274    | Washer                  |       |
| 182618 | 36262    | Washer                  |       |
| 182626 | 40295    | Washer                  |       |
| 170645 | 41376    | Gasket                  |       |
| 154513 | 50751    | Nut                     |       |
| 112456 | 50752    | Washer                  |       |
| 182646 | 50843    | Washer                  |       |
| 182647 | 51250    | Gasket                  |       |
| 113702 | 51531    | Gasket                  |       |
| 169200 | 52705-CP | Nut, Polished Chrome    |       |
| 055325 | 53410    | Washer                  |       |
| 159433 | 55164    | Nut                     |       |
| 182656 | 55413    | Washer                  |       |
| 182687 | 59606    | Gasket                  |       |
| 181864 | 65157    | Nut                     |       |
| 165926 | 65885    | Gasket                  |       |
| 178854 | 71108    | Nut                     |       |
| 177272 | 71813    | Gasket                  |       |
| 250568 | 71975    | Gasket, Alignment       |       |
| 166860 | 78058    | Washer                  |       |
| 166861 | 78057    | Washer                  |       |
| 166859 | 78087    | Gasket                  |       |
| 182733 | 78913    | FacePlate Gasket        |       |
| 182745 | 1007995  | Washer                  |       |
| 182740 | 1000949  | Washer, Plastic         |       |

### Valve Repair (Continued)

#### Washers, Nuts & Gaskets

| Part # | Mfg #      | Description          | Price |
|--------|------------|----------------------|-------|
| 154945 | 1009882    | Gasket, Molded       |       |
| 165460 | 1015190    | Washer               |       |
| 183181 | 1018336-RP | Nut, Rough Plate     |       |
| 181866 | 1020677    | Gasket               |       |
| 183184 | 1025642    | Washer               |       |
| 166877 | 1037307    | Gasket               |       |
| 152641 | 1050048-B  | Nut                  |       |
| 183214 | 1051504-RP | Nut, Rough Plate     |       |
| 178035 | 1070291    | Gasket Kit           |       |
| 155661 | 1106733    | Washer               |       |
| 154740 | 1113583    | Locknut & Gasket Kit |       |
| 183328 | 1128531    | Washer               |       |
| 180292 | 1222738    | Gasket               |       |
| 187471 | 1181517-RP | Nut, Rough Plate     |       |

### Rough-In Valves Parts and Assemblies

#### Rite-Temp® Test Cap for K-8300 Series Valve Bodies

- Includes test cap assembly with seals
- Rated for pressure-testing up to 150 psi maximum (air or water)
- Supplied as standard with K-8300 series valve body rough-ins
- Available as an optional extra for K-8304 series valve body and cartridge kits
- Allows installed valve rough-in to be flushed and pressure-tested without installing cartridge



| Part # | Mfg #      | Description                             | Price |
|--------|------------|---|-------|
| 226714 | K-10351-NA | Test Cap for K-8300 Series Valve Bodies |       |

#### 10" Rough-In Full Skirt Trap and Attachment System

- 10" (254 mm) rough-in
- Converts standard 12" rough-in products to 10" configuration
- Plastic trapway



For use with the K-3981 Tresham one-piece toilet, K-6428 Memoirs Stately skirted one-piece toilet and K-6424 Memoirs Classic skirted one-piece toilet

| Part # | Mfg #     | Description      | Price |
|--------|-----------|------------------|-------|
| 230307 | K-5383-NA | 10" Rough-In Kit |       |

\* Vibrant Limited Lifetime Warranty

[www.waterconcepts.net](http://www.waterconcepts.net) • Serving our Customers Since 1946 • [www.plumbsupply.com](http://www.plumbsupply.com)

**Kohler Repair Parts**

**Sink Service Parts**

**Rough-In Kit**



GP1030932

| Part # | Mfg #        | Description              | Price |
|--------|--------------|--------------------------|-------|
| 166957 | 1066498      | Rough-In Kit             |       |
| 170792 | 1139260-CP   | Rough-In Kit, Pol Chrome |       |
| 158598 | 1131486      | Rough-In Kit             |       |
| 168420 | 1187917      | Rough-In Kit             |       |
| 169472 | 1194630      | Rough-In Kit             |       |
| 127033 | 56373-CP     | Rough-In Kit, Pol Chrome |       |
| 182707 | 73418-CP     | Rough-In Kit, Pol Chrome |       |
| 098493 | GP1007937-CP | Rough-In Kit Pol Chrome  |       |
| 090369 | GP1025388    | Rough-In Kit Pol Chrome  |       |
| 087416 | GP1030932    | Rough-In Kit Pol Chrome  |       |

**Parts**

| Part # | Mfg #      | Description               | Price |
|--------|------------|---------------------------|-------|
| 154944 | 1000193-BV | Escutcheon, *Br Bronze    |       |
| 166994 | 1000282-CP | Handle Kit, Pol Chrome    |       |
| 189946 | 1001384-47 | Service Kit, Almond       |       |
| 153127 | 1001384-96 | Service Kit, Biscuit      |       |
| 155078 | 1001384-89 | Service Kit, Desert Bloom |       |
| 166039 | 1001726-G  | Handle Service Kit        |       |
| 185783 | 1001795-BN | Handle Kit, * Br Nickel   |       |
| 190273 | 1001795-47 | Handle Kit                |       |
| 177854 | 1001978-CP | Escutcheon, Pol Chrome    |       |
| 153385 | 1002856    | Bracket-Hold Down         |       |
| 182739 | 100315     | Clicker-Drain Assy        |       |
| 182018 | 1003594    | Spout Seal                |       |
| 151709 | 1005129    | O-Ring                    |       |
| 166832 | 1006008    | Lift Rod Kit              |       |
| 103651 | 1006026    | Retainer                  |       |
| 182741 | 1006057-CP | Door Hinge, Pol Chrome    |       |
| 182742 | 1006134-CP | Door Hinge, Pol Chrome    |       |
| 177856 | 1006262    | Stem Adapter Assy         |       |
| 180497 | 1006269-CP | Escutcheon, Pol Chrome    |       |
| 182744 | 1006396    | Pin                       |       |
| 245107 | 1006397-CP | Hinge Cover, Pol Chrome   |       |
| 167396 | 1006784-CP | Escutcheon Assy, Chrome   |       |
| 180037 | 1007376-CP | Handle Kit, Pol Chrome    |       |
| 162642 | 1007718-CP | Handle, Pol Chrome        |       |
| 156197 | 1007999    | Stem Driver               |       |
| 177857 | 1008205    | Screw                     |       |

**Parts (Continued)**

| Part # | Mfg #       | Description                 | Price |
|--------|-------------|-----------------------------|-------|
| 187098 | 1009781-CP  | Faceplate, Pol Chrome       |       |
| 189790 | 1009814-CP  | Escutcheon, Pol Chrome      |       |
| 183175 | 1009872-AF  | Bonnet, *French Gold        |       |
| 154055 | 1009888-CP  | Base Handle, Chrome         |       |
| 165459 | 1010161-BN  | Trim Ring, *Br Nickel       |       |
| 188789 | 1010315-CP  | Escutcheon, Pol Chrome      |       |
| 181490 | 1010672     | Air Pressure Switch         |       |
| 182875 | 1011032-0   | Whirlpool Trim Kit, White   |       |
| 182874 | 1011031-96  | Whirlpool Trim Kit, Biscuit |       |
| 165984 | 1012391-BN  | Handle, *Br Nickel          |       |
| 166803 | 1012916     | Split Coupling              |       |
| 170229 | 1012977     | Adapter                     |       |
| 167478 | 1013452-0   | Dial Trim Assy, White       |       |
| 167477 | 1013453     | Detent Spring               |       |
| 181867 | 1013469-0   | Trim Ring, White            |       |
| 164795 | 1013489     | Stem                        |       |
| 165835 | 1014065     | Tank Plate                  |       |
| 182876 | 1014072-7   | Toilet Seat, Black Black    |       |
| 178298 | 1014086-08  | Seal                        |       |
| 165458 | 1014087-BN  | Bonnet, *Br Nickel          |       |
| 183178 | 1014554-SN  | Spout & Hardware, *Nickel   |       |
| 160891 | 1014555-CP  | Spout & Hardware, Chrome    |       |
| 182877 | 1014556-CP  | Spout & Hardware, Chrome    |       |
| 167744 | 1014917-G   | Lift Rod Assy, Br Chrome    |       |
| 175018 | 1015084-BN  | Button, *Brushed Nickel     |       |
| 167746 | 1015084-G   | Button, Brushed Chrome      |       |
| 136712 | 1015345     | Graphics, Red & Blue        |       |
| 172143 | 1015467-2BZ | Handle Assy Oil-Rbd Bronze  |       |
| 165456 | 1015782     | Screw                       |       |
| 153165 | 1016455-CP  | Escutcheon Assy, Chrome     |       |
| 183180 | 1017273     | Screw                       |       |
| 181863 | 1018662     | Control Assy                |       |
| 182879 | 1020006-G   | Shower Arm, Br Chrome       |       |
| 182880 | 1020007-VF  | Shower Arm, *Pol Brass      |       |
| 182881 | 1020609     | Tube                        |       |
| 167479 | 1023381     | Service Tool                |       |
| 190293 | 1022562-VF  | Trip Lever Kit, Pol Brass   |       |
| 173541 | 1024303-0   | Button, White               |       |
| 162318 | 1024303-2BZ | Button, Oil Rubbed Bronze   |       |
| 162335 | 1024303-BN  | Button, *Brushed Nickel     |       |
| 183183 | 1024303-VF  | Button, Polished Brass      |       |
| 183167 | 1025637-AF  | Trim Ring, *French Gold     |       |
| 154765 | 1025637-BN  | Trim Ring, *Brushed Nickel  |       |
| 153164 | 1030689-CP  | Escutcheon, Pol Chrome      |       |

Repair Parts

\* Vibrant Limited Lifetime Warranty

[www.plumbsupply.com](http://www.plumbsupply.com) • Serving our Customers Since 1946 • [www.waterconcepts.net](http://www.waterconcepts.net)

## Kohler Repair Parts

### Parts (Continued)

| Part # | Mfg #       | Description                  | Price |
|--------|-------------|------------------------------|-------|
| 183185 | 1031444     | Soap Dish                    |       |
| 176758 | 1031869-CP  | Escutcheon, Pol Chrome       |       |
| 183186 | 1031962     | Bearing                      |       |
| 183187 | 1032126-VF  | Drain Handle Assy, Brass     |       |
| 175899 | 1032250     | Seal                         |       |
| 187628 | 1032253-BC  | Body Assy, Bright Chrome     |       |
| 183188 | 1032267     | Replacement Screw            |       |
| 186677 | 1032493-0   | Bubble bath Interface, White |       |
| 177257 | 1032546     | Valve Stops                  |       |
| 223376 | 1032872-BC  | Valve Stem Adapter           |       |
| 190205 | 1033209     | Tube, 10.50                  |       |
| 171281 | 1033743-BN  | Escutcheon, *Br Nickel       |       |
| 153729 | 1034578     | Retainer                     |       |
| 184322 | 1035359-BN  | Escutcheon, *Br Nickel       |       |
| 166029 | 1035359-CP  | Escutcheon, Chrome           |       |
| 183191 | 1035359-VS  | Escutcheon, *Stainless       |       |
| 183192 | 1035564     | Drain Link                   |       |
| 168072 | 1035605     | Screw Set                    |       |
| 170434 | 1035796-CP  | Handle, Pol Chrome           |       |
| 246749 | 1036041-CP  | Body Spray Face, Chrome      |       |
| 163159 | 1036044     | Clamp                        |       |
| 182830 | 1036210     | Blower Kit                   |       |
| 183193 | 1036218     | Check Valve Assy Kit         |       |
| 183194 | 1036221     | Cover/CB Assy                |       |
| 172555 | 1036453-CP  | Handle Assembly, Chrome      |       |
| 171280 | 1036906     | Putty Plate                  |       |
| 187935 | 1036932-BN  | TrimRing, *Brushed Nickel    |       |
| 183195 | 1036994-AF  | Plunger Assy, *French Gold   |       |
| 159708 | 1036994-VF  | Plunger Assy, Pol Brass      |       |
| 175689 | 1037021-BN  | Plunger Assy *Br Nickel      |       |
| 183197 | 1037021-G   | Plunger Assy Br Chrome       |       |
| 172528 | 1037022-BKB | Plunger Assembly, Br Black   |       |
| 161237 | 1037023-BN  | Drain Assy, *Br Nickel       |       |
| 183198 | 1037023-G   | Drain Assy, Br Chrome        |       |
| 175333 | 1037334     | Plunger Arm Assy             |       |
| 245304 | 1037431-BN  | Spray Holder Assy, *Br Nkl   |       |
| 170632 | 1037431-BV  | Spray Holder Assy, *Br Brz   |       |
| 225585 | 1037431-G   | Spray Holder Assy, Br Chr    |       |
| 153316 | 1039475     | Mounting Kit                 |       |
| 184794 | 1039714-BN  | Lever Handle, *Br Nickel     |       |
| 163161 | 1039745     | Set Screw                    |       |
| 166289 | 1040484-CP  | Spout Kit, Pol Chrome        |       |
| 183200 | 1041109-G   | Escutcheon, Br Chrome        |       |
| 174324 | 1041180-BN  | Lift Rod, *Brushed Nickel    |       |

### Parts (Continued)

| Part # | Mfg #         | Description                              | Price |
|--------|---------------|--|-------|
| 185607 | 1041321-CP    | Handle Kit, Br Chrome                    |       |
| 165318 | 1041573-G     | Spray Face, Br Chrome                    |       |
| 177167 | 1041840       | Drain Rod                                |       |
| 183201 | 1042007       | Check Valve Kit                          |       |
| 177074 | 1042634       | Wall Sleeve Assy                         |       |
| 163145 | 1044060       | O-Ring                                   |       |
| 168711 | 1044616       | Retainer                                 |       |
| 163427 | 1045251       | Cable Assembly                           |       |
| 248081 | 1043340-CP    | LH Trip Lever Assembly                   |       |
| 163158 | 1045768       | Sprayhead Kit                            |       |
| 165316 | 1045769       | Sprayhead Kit                            |       |
| 177258 | 1046101       | Seal Kit                                 |       |
| 183203 | 1046153       | Weight                                   |       |
| 183204 | 1048208-B     | Screw                                    |       |
| 183205 | 1048208-C     | Screw                                    |       |
| 183206 | 1048656-P     | Sealing Liquid                           |       |
| 183695 | 1049146       | Floor Mounted Fixing Pack                |       |
| 163160 | 1051487       | Membrane                                 |       |
| 183207 | 1051503-BN    | Bonnet, *Brushed Nickel                  |       |
| 165317 | 1051682       | Membrane                                 |       |
| 185403 | 1052086       | Power Supply Kit                         |       |
| 183215 | 1052857       | Reduce Bushing                           |       |
| 183216 | 1054165-SN    | Lift Rod Assy, *Pol Nickel               |       |
| 183218 | 1055628       | Solenoid Assembly                        |       |
| 135539 | 1055666       | Solenoid                                 |       |
| 187554 | 1055800-BN    | Handle Kit, *Br Nickel                   |       |
| 169720 | 1060438-CP    | Escutcheon, Pol Chrome                   |       |
| 120956 | 1060514       | Insert - Square Stem for Coralais Handle |       |
| 176650 | 1060800       | Spacer Kit                               |       |
| 169793 | 1067372-96    | Toilet Seat, Biscuit                     |       |
| 183220 | 1068202-BN    | Stopper, *Brushed Nickel                 |       |
| 163642 | 1068202-BV    | Stopper, *Brushed Bronze                 |       |
| 177685 | 1068525-BN    | Assembly Cover, *Br Nickel               |       |
| 163641 | 1068525-BV    | Assembly Cover, *Br Brz                  |       |
| 187234 | 1068945       | Retainer                                 |       |
| 183221 | 1069315       | Spring                                   |       |
| 183222 | 1069723-0     | Trip Lever, White                        |       |
| 245108 | 1070676-01-58 | Strike Jamb Seal, Thunder Grey           |       |
| 183223 | 1070844       | Hardware Bag                             |       |
| 183224 | 1071000       | Storage Locker Parts Kit                 |       |
| 169116 | 1071652       | Hex Bit                                  |       |
| 171261 | 1074034       | Tool Assy                                |       |
| 183225 | 1074721-BN    | Bonnet, *Br Nickel                       |       |
| 183226 | 1074724-BN    | Adapter, *Brushed Nickel                 |       |

\* Vibrant Limited Lifetime Warranty

[www.waterconcepts.net](http://www.waterconcepts.net) • Serving our Customers Since 1946 • [www.plumbsupply.com](http://www.plumbsupply.com)

**Kohler Repair Parts**

**Parts (Continued)**

| Part # | Mfg #        | Description                 | Price |
|--------|--------------|-----------------------------|-------|
| 183227 | 1075614      | O-Ring                      |       |
| 183228 | 1075615      | O-Ring                      |       |
| 178585 | 1077791-96   | Plug Buttons, Biscuit       |       |
| 245303 | 1077792-96   | Plug Buttons, Biscuit       |       |
| 171786 | 1077792-BN   | Plug Buttons, *Br Nickel    |       |
| 183229 | 1077813      | Solenoid Valve Kit          |       |
| 183230 | 1077815      | Valve Cover Kit             |       |
| 183231 | 1077816      | Diaphragm Kit               |       |
| 128818 | 1078578      | Flush Valve Assembly Kit    |       |
| 155319 | 10813650-0   | Floor Mounting Kit Assy     |       |
| 183232 | 1081873-BN   | Handle, *Brushed Nickel     |       |
| 222456 | 1081873-CP   | Handle, Chrome              |       |
| 114111 | 1083980      | Canister Valve Assy Kit     |       |
| 156362 | 1086408-CP   | Handle, Pol Chrome          |       |
| 156410 | 1086409-58   | Ring, Thunder Grey          |       |
| 222940 | 1085211-VS   | Side Spray Assembly         |       |
| 155113 | 1086972      | Hinge Mount                 |       |
| 163815 | 1088996      | Valve Kit                   |       |
| 181309 | 1090621-2BZ  | Lift Rod Assy, ORB          |       |
| 183235 | 1093029      | Assembly Body               |       |
| 161131 | 1093053-BV   | Spout & Diverter *Br Bronze |       |
| 160252 | 1094550-CP   | Straight Stop, Pol Chrome   |       |
| 183236 | 1094562      | Bonnet                      |       |
| 170190 | 1094612-CP   | Valve, Polished Chrome      |       |
| 154678 | 1094633      | Seat & Sleeve Assembly      |       |
| 166611 | 1094724      | Side Body                   |       |
| 148639 | 1095910      | Diaphragm Assembly          |       |
| 183240 | 1098124      | O-Ring                      |       |
| 183176 | 1010343-CP   | Handle, Polished Chrome     |       |
| 182747 | 1010376      | Flapper                     |       |
| 155669 | 1011059-58   | Ring, Thunder Grey          |       |
| 165461 | 1011530-BN   | Handle, *Brushed Nickel     |       |
| 246158 | 1012692      | Pressure Switch             |       |
| 157984 | 1013457-E-96 | Flagship Assy, Biscuit      |       |
| 159535 | 1013970      | Screw                       |       |
| 152457 | 1013975      | Adapter                     |       |
| 154533 | 1014049      | Steam Adapter               |       |
| 157985 | 1015009      | Plug Assy                   |       |
| 169377 | 1016310      | Plate                       |       |
| 156133 | 1016953      | Pump Assy                   |       |
| 156195 | 1018651-CP   | Handle Polished Chrome      |       |
| 159106 | 1018651-BN   | Handle *Brushed Nickel      |       |
| 157818 | 1018651-BRZ  | Handle, Oil Rubbed Bronze   |       |
| 165985 | 1019021-BN   | Waste Plug, *Br Nickel      |       |
| 151743 | 1020678-E-96 | Cover/CB Assy, Biscuit      |       |

**Parts (Continued)**

| Part # | Mfg #         | Description                   | Price |
|--------|---------------|-------------------------------|-------|
| 156951 | 1020679-A     | Cover/CB Assembly             |       |
| 251115 | 1021961-BV    | Lift Rod Assy, *Br Bronze     |       |
| 159540 | 1024303-47    | Plug Button, Almond           |       |
| 160135 | 1024303-96    | Plug Button, Biscuit          |       |
| 157926 | 1024303-CP    | Plug Button, Pol Chrome       |       |
| 111678 | 1024419       | Hub                           |       |
| 159622 | 1025210-BN    | Escutcheon Assy, *Br Nkl      |       |
| 154531 | 1025639-BC    | Drain, Bright Chrome          |       |
| 159534 | 1032871-BC    | Adapter, Bright Chrome        |       |
| 151597 | 1033731       | Plug Assembly                 |       |
| 151598 | 1033732       | Mixer Valve                   |       |
| 158221 | 1034484       | Clip                          |       |
| 154831 | 1035023-CP    | Handle Assy, Pol Chrome       |       |
| 152485 | 1035783       | Seal Assy                     |       |
| 152917 | 1036160       | Push Rod Kit                  |       |
| 152344 | 1036212       | Kit, Blower-International     |       |
| 172556 | 1036452-CP    | Handle Assy, Pol Chrome       |       |
| 153655 | 1036994-CP    | Plunger Assy, Pol Chrome      |       |
| 183196 | 1036994-G     | Plunger Assy, Br Chrome       |       |
| 152915 | 1037044-CP    | Handle Assembly, Chrome       |       |
| 183199 | 1038690       | Vent Assembly                 |       |
| 159505 | 1039095-CP    | Assy, Polished Chrome         |       |
| 173128 | 1041321-BN    | Handle Kit, *Brushed Nickel   |       |
| 155666 | 1041321-G     | Handle Kit, Br Chrome         |       |
| 248045 | 1042629-CP    | Control Ring Assy, Chrome     |       |
| 190209 | 1042831       | Flush Valve Kit               |       |
| 153884 | 1043004       | Screw Set                     |       |
| 152643 | 1044585       | Roller                        |       |
| 223269 | 1045770       | Adapter Kit                   |       |
| 120496 | 1046987-CP    | Handle Kit, Pol Chrome        |       |
| 223375 | 1048476       | Screw, M4 x 60MM Long         |       |
| 152637 | 1051142-A     | Screw                         |       |
| 152456 | 1051609-BN    | Lift Rod, *Br Nickel          |       |
| 152435 | 1054623-BN    | Diverter Assy, *Br Nickel     |       |
| 162256 | 1055650-CP    | Push Button Assy, Chrome      |       |
| 153605 | 1055715       | Service Kit                   |       |
| 152639 | 1059792       | Bushing                       |       |
| 135541 | 1060056       | Kit, Piston Cover             |       |
| 186964 | 1062356-33    | Drain Cover, Mexican Sand     |       |
| 157607 | 1065219       | Electronic Unit Assy          |       |
| 248941 | 1068202-2BL   | Stopper, Black                |       |
| 155414 | 1068204       | Cartridge Assy                |       |
| 171397 | 1068380-0     | Access Panel                  |       |
| 246111 | 1070675-01-58 | Strike Jamb Cap, Thunder Grey |       |

Repair Parts

\* Vibrant Limited Lifetime Warranty

[www.plumbsupply.com](http://www.plumbsupply.com) • Serving our Customers Since 1946 • [www.waterconcepts.net](http://www.waterconcepts.net)

## Kohler Repair Parts

### Parts (Continued)

| Part # | Mfg #      | Description                 | Price |
|--------|------------|-----------------------------|-------|
| 152838 | 1072961-CP | Button Assy, Pol Chrome     |       |
| 152644 | 1077763-A  | Bolt                        |       |
| 165893 | 1077792-BV | Plug Buttons, *Br Bronze    |       |
| 159625 | 1077792-47 | Plug Buttons, Almond        |       |
| 152717 | 1080774    | Union Assy                  |       |
| 157870 | 1081349    | Adapter Assy                |       |
| 152040 | 1093052-VF | Kit, Polished Brass         |       |
| 183173 | 1100507-0  | Hinge Cover, White          |       |
| 155987 | 1100590    | Hose                        |       |
| 148638 | 1102542    | Solenoid Assy               |       |
| 157194 | 1104111-BV | Nozzle Assy, *Br Bronze     |       |
| 185157 | 1104111-CP | Nozzle Assy, Chrome         |       |
| 164048 | 1104111-VF | Nozzle Assy, Pol Brass      |       |
| 164773 | 1104235    | Solenoid Kit                |       |
| 168064 | 1104270    | Assy                        |       |
| 170369 | 1104271    | Electronic Unit Assy        |       |
| 168063 | 1104272    | Piston Cover Kit            |       |
| 154930 | 1104617    | Crank Assy                  |       |
| 172129 | 1104957    | Laminar Insert              |       |
| 125323 | 1105656    | O-Ring                      |       |
| 189739 | 1105685-BN | Overflow Cover, *Br Nickel  |       |
| 247385 | 1105685-CP | Overflow Cover, Chrome      |       |
| 183243 | 1105706    | Tool Kit                    |       |
| 188100 | 1105900    | Spout Extension Assy        |       |
| 165033 | 1106015    | Sensor Assy                 |       |
| 155660 | 1106729-BN | Handle, *Brushed Nickel     |       |
| 248480 | 1109254-CP | Loure Escutcheon, Chrome    |       |
| 248402 | 1125009-CP | Cover Assy, Chrome          |       |
| 168062 | 1111139    | Solenoid Kit                |       |
| 244187 | 1112258    | Tank Plate                  |       |
| 183324 | 1115286    | Ring                        |       |
| 246840 | 1115841-CP | Flange, Chrome              |       |
| 160683 | 1119112    | Slip-Fit Clamp Kit          |       |
| 183325 | 1120992-BN | Handle, *Brushed Nickel     |       |
| 248023 | 1123790-CP | Handle Assy, Chrome         |       |
| 137034 | 1131482    | Vlv Assy for WS Fcts (Cold) |       |
| 140785 | 1131496    | Seal, Canister Dual Flush   |       |
| 183329 | 1131838-58 | Bumper, Thunder Grey        |       |
| 152557 | 1133024    | Hardware Pack               |       |
| 177252 | 1133070    | Service Kit                 |       |
| 155662 | 1138476-BN | Escutcheon Assy *Br Nickel  |       |
| 158967 | 1139558    | Collect-Push-In             |       |
| 183696 | 1139526-CP | Elbow Assy, Pol Chrome      |       |
| 168212 | 1139600    | Trapway Service Kit         |       |
| 155640 | 1140164-BN | Flange, *Brushed Nickel     |       |

### Parts (Continued)

| Part # | Mfg #       | Description                  | Price |
|--------|-------------|------------------------------|-------|
| 141416 | 1140858-CP  | Slidebar Assy, Chrome        |       |
| 183331 | 1140867-BN  | Cover, *Brushed Nickel       |       |
| 183697 | 1141213-B   | Cartridge, Transfer Valve    |       |
| 222069 | 1142457-BN  | Spout Assembly               |       |
| 177423 | 1142538     | Filter Block                 |       |
| 183336 | 1145563     | Kit, SPR Valve Assembly      |       |
| 172730 | 1145638-HW1 | Toe Tap Assy                 |       |
| 169192 | 1146417     | Pump                         |       |
| 183337 | 1146802-0   | Air Jet Service Assy, White  |       |
| 152316 | 1147742-0   | Air Switch Kit, White        |       |
| 157788 | 1147742-47  | Air Switch Kit, Almond       |       |
| 166779 | 114847-VS   | Spray, *Stainless            |       |
| 183338 | 1150464-0   | EB Hinge Kit, White          |       |
| 249067 | 1150464-96  | EB Hinge Kit, Biscuit        |       |
| 160674 | 1151429-CP  | Collar, Polished Chrome      |       |
| 180822 | 1151441-CP  | Shower Arm, Pol Chrome       |       |
| 163200 | 1151968-BN  | Service Kit, *Brushed Nickel |       |
| 163170 | 1151968-CP  | Service Kit, Pol Chrome      |       |
| 171450 | 1152299-BN  | Spray/Screen Kit, *Br Nickel |       |
| 166599 | 1153944-BN  | Handle Kit, *Br Nickel       |       |
| 164798 | 1153944-CP  | Handle Kit, Pol Chrome       |       |
| 187838 | 1153944-G   | Handle Kit, Br Chrome        |       |
| 167699 | 1154757-58  | Screw Cover Service Kit      |       |
| 188368 | 1154836     | Hose Assy                    |       |
| 249368 | 1155515     | Flush Valve Fixing           |       |
| 170194 | 1155520     | Pipe System                  |       |
| 177056 | 1156410-BN  | Plug Button, *Br Nickel      |       |
| 183698 | 1156410-CP  | Plug Button, Pol Chrome      |       |
| 183555 | 1161770     | Rotary Assy                  |       |
| 183702 | 1160753     | Adapter                      |       |
| 190321 | 1166635     | 3/4" Volume Control Insert   |       |
| 166308 | 1166879-BN  | Tube, *Brushed Nickel        |       |
| 223932 | 1166879-CP  | Tube, Pol Chrome             |       |
| 176945 | 1173678     | Cartridge Assy               |       |
| 180261 | 1175870-BN  | Lift Rod, *Br Nickel         |       |
| 181980 | 1177160     | Sink Clips                   |       |
| 183704 | 1177161     | Installation Clip Kit        |       |
| 173008 | 1178736     | PCB Board & Cover Assy       |       |
| 248940 | 1179957-BL  | Strainer, Matte Black        |       |
| 183706 | 1179957-BN  | Strainer, *Brushed Nickel    |       |
| 248943 | 1179957-2BL | Strainer, Black              |       |
| 069038 | 1179-NA     | Tiling-In Bead, 180" Length  |       |
| 167166 | 1180445-VF  | Escutcheon, Polished Brass   |       |
| 056792 | 1181-NA     | Tiling-In Bead, 132" Length  |       |
| 161065 | 1185540-BN  | Assy Slider, *Br Nickel      |       |

\* Vibrant Limited Lifetime Warranty

[www.waterconcepts.net](http://www.waterconcepts.net) • Serving our Customers Since 1946 • [www.plumbsupply.com](http://www.plumbsupply.com)



## Kohler Repair Parts

### Parts (Continued)

| Part # | Mfg #        | Description                        | Price |
|--------|--------------|------------------------------------|-------|
| 188413 | 1187796-SH   | Handle Kit, Bright Silver          |       |
| 172092 | 1187796-SHP  | Handle Kit, Bright Pol Silver      |       |
| 158906 | 1190050-K-CP | Assy, Polished Chrome              |       |
| 188463 | 1191575-CP   | Shower Arm, Pol Chrome             |       |
| 171043 | 1194302-CP   | Large Escutcheon, Pol Chr          |       |
| 182831 | 1194940      | Cable                              |       |
| 183710 | 1200948      | Chain Kit                          |       |
| 172093 | 1201773-BN   | Spout Assy, *Br Nickel             |       |
| 188554 | 1202708      | Mirrored Door Assy                 |       |
| 169231 | 1202077      | Supply Hose SS                     |       |
| 224199 | 1202709      | Mirrored Door Assembly             |       |
| 186691 | 1204788-2BZ  | Cold Handle Assy, ORB              |       |
| 186251 | 1207169      | Supply Hose                        |       |
| 183711 | 1207943      | Diverter Spout Cap                 |       |
| 165035 | 1209172-VS   | Escutcheon,* Stainless             |       |
| 222939 | 1209172-CP   | Escutcheon, Oil-Rubbed Brz         |       |
| 251085 | 1211811-0    | Tank Cover, White                  |       |
| 224985 | 1218071      | Supply Adapter                     |       |
| 186669 | 1218822-VS   | Spray Assy, *Stainless             |       |
| 176606 | 1218922-CP   | Button, Polished Chrome            |       |
| 181868 | 1219654      | Heater                             |       |
| 179983 | 1219693      | Pipe Plug                          |       |
| 180294 | 1222736      | Adapter                            |       |
| 188461 | 1224550-CP   | Escutcheon, Pol Chrome             |       |
| 187872 | 1229031      | Supply Adapter                     |       |
| 171581 | 1229524      | Basin Rack Wheels                  |       |
| 244980 | 1222873      | Quick Connector Kit                |       |
| 183712 | 1232221-BN   | Handle Assy, *Br Nickel            |       |
| 177253 | 1239016      | Hardware Pack                      |       |
| 178416 | 1240529      | Overflow Shell                     |       |
| 185308 | 1256315      | OEM Touchless Assy                 |       |
| 251116 | 1261116-CP   | Handle Assy Kit, Chrome            |       |
| 189976 | 1262603-CP   | Steam Head Kit, Pol Chr            |       |
| 250700 | 1276184      | Cover Assy Detail                  |       |
| 250654 | 1345879      | Touchless 1.5 Flush Kit RetroFit   |       |
| 158897 | 13602-NA     | Cable Assy                         |       |
| 247220 | 13603-NA     | 8' Cable Assy                      |       |
| 155785 | 14511-CP     | Escutcheon Plate, Chrome           |       |
| 124369 | 18376        | 3/4" Urinal Spud Assembly          |       |
| 182526 | 20345-BN     | Flange & Set Screw Assy,*Br Nickel |       |
| 156847 | 20345-CP     | Flange & Set Screw Assy, Chrome    |       |

### Parts (Continued)

| Part # | Mfg #     | Description                            | Price |
|--------|-----------|--|-------|
| 165097 | 20345-VF  | Flange & Set Screw Assy, Pol Brass     |       |
| 162187 | 20363-VF  | Flange Assy, Pol Brass                 |       |
| 182529 | 20413-CP  | Valve Stem, Pol Chrome                 |       |
| 182527 | 20401     | Post                                   |       |
| 222959 | 70442     | Stem Extension Kit                     |       |
| 182531 | 20536-CP  | Lift Rod, Pol Chrome                   |       |
| 182534 | 20615-BN  | Screw, *Brushed Nickel                 |       |
| 182535 | 20617-CP  | Overflow Hood, Chrome                  |       |
| 182537 | 20650-CP  | Stopper Assy, Chrome                   |       |
| 182538 | 20652-CP  | Screw, Chrome                          |       |
| 182539 | 20654-RP  | Valvet, Rough Plate                    |       |
| 182540 | 20851-CP  | Escutcheon, Pol Chrome                 |       |
| 055337 | 20961     | Seat Washer                            |       |
| 182558 | 21072-BN  | Stopper Assy, * Br Nickel              |       |
| 182560 | 21098-CP  | Escutcheon, Chrome                     |       |
| 223383 | 21694     | Lift Toggle Assembly                   |       |
| 182570 | 21775     | Screw                                  |       |
| 182571 | 21777     | Niedecken Detail                       |       |
| 182573 | 21843-BC  | Screw, Bright Chrome                   |       |
| 182575 | 21845     | Packing                                |       |
| 164410 | 21152     | Screw                                  |       |
| 164411 | 21153     | Adjusting Block                        |       |
| 164409 | 21155     | Lift Rod                               |       |
| 158316 | 21166-BKB | Strainer Body, Br Black                |       |
| 173074 | 21166-CP  | Strainer Body, Chrome                  |       |
| 182561 | 21166-VF  | Strainer Body, Pol Brass               |       |
| 182562 | 21281-CP  | Shroud Cover, Chrome                   |       |
| 182882 | 21318-AF  | Stopper Assy, * Fr Gold                |       |
| 158315 | 21318-BKB | Stopper Assy, Br Black                 |       |
| 182563 | 21318-VF  | Stopper Assy, Pol Brass                |       |
| 182564 | 21354     | Lift Rod                               |       |
| 182565 | 21496     | O-Ring Assy                            |       |
| 247266 | 21603-VF  | Screw, Oval Countersunk .250-20 x 1.50 |       |
| 182567 | 21712-BC  | Stem, Bright Chrome                    |       |
| 182568 | 21745-CP  | Cover, Pol Chrome                      |       |
| 172647 | 22125     | Plunger                                |       |
| 172649 | 22126     | Plunger                                |       |
| 172650 | 22211     | Disc Holder                            |       |
| 172651 | 22212     | Disc Holder                            |       |
| 182576 | 22325     | Spline Insert                          |       |
| 182577 | 22511     | Valve                                  |       |
| 182578 | 22692     | Diverter Seat                          |       |
| 182579 | 22859     | Screw                                  |       |
| 182580 | 22862-BC  | Diverter Stem, Bright Chr              |       |

\* Vibrant Limited Lifetime Warranty

[www.plumbsupply.com](http://www.plumbsupply.com) • Serving our Customers Since 1946 • [www.waterconcepts.net](http://www.waterconcepts.net)

## Kohler Repair Parts

### Parts (Continued)

| Part # | Mfg #    | Description                 | Price |
|--------|----------|-----------------------------|-------|
| 162949 | 22910-CP | Sleeve, Polished Chrome     |       |
| 182581 | 22916-BN | Overflow Plate, * Br Nickel |       |
| 182582 | 22916-CP | Overflow Plate, Chrome      |       |
| 182583 | 22942    | Seat                        |       |
| 153611 | 23023-BC | Valve Stem, Bright Chrome   |       |
| 153119 | 23058-BC | Valve Stem, Bright Chrome   |       |
| 182585 | 24015    | Union Joint                 |       |
| 174497 | 28518    | Pin                         |       |
| 182586 | 29037-BC | Drain Crank, Bright Chrome  |       |
| 182587 | 29039-BC | Drain Crank, Bright Chrome  |       |
| 182588 | 29060-BN | Lever Lift, * Br Nickel     |       |
| 182589 | 29077-BN | Screw, *Br Nickel           |       |
| 182590 | 29643    | Lift Toggle                 |       |
| 182591 | 30040    | Valve Stem Ledge            |       |
| 182592 | 30042    | Valve Stem                  |       |
| 182593 | 30139    | Sleeve & Diverter Kit       |       |
| 175179 | 30152    | Plunger Assy                |       |
| 182595 | 30154    | Lift Rod Assy               |       |
| 151344 | 30253-RP | Rebuilding Kit, Rough Plate |       |
| 154165 | 30297-CP | Rebuilding Kit, Chrome      |       |
| 166211 | 30299    | Rebuilding Kit              |       |
| 177747 | 30332-RP | Hardware Kit, Rough Plate   |       |
| 167058 | 30394-RP | Valve, Rough Plate          |       |
| 182597 | 30419    | Tank Accessory Pack         |       |
| 182598 | 30467    | Diverter                    |       |
| 165924 | 30739    | Removal Tool                |       |
| 160203 | 30775    | WP Control Kit              |       |
| 163455 | 31537    | Ball & Frame Assy           |       |
| 182600 | 31584-BC | Valve Stem Assy, Brgt Chr   |       |
| 182599 | 31439-BC | Diverter Assy, Chrome       |       |
| 153818 | 32005    | Packing                     |       |
| 056023 | 32462    | Renew Unit Assembly, RH     |       |
| 182602 | 32657    | O-Ring                      |       |
| 182605 | 33357-BN | Screw, *Brushed Nickel      |       |
| 189795 | 33625    | Screw                       |       |
| 173081 | 33681-CP | Strainer, Chrome            |       |
| 182609 | 34064-BN | Lever Handle, * Br Nickel   |       |
| 182611 | 34117    | O-Ring                      |       |
| 153817 | 34190    | Valve Spacer                |       |
| 154166 | 34230    | Spring                      |       |
| 168123 | 34294    | Packing                     |       |
| 182612 | 34532    | Post For Soap Dish          |       |
| 182613 | 34533-CP | Nut, Pol Chrome             |       |
| 160251 | 34777    | Pressure Regulator Assy     |       |
| 170189 | 34902-G  | Condensate Plate, Chrome    |       |

### Parts (Continued)

| Part # | Mfg #         | Description                   | Price |
|--------|---------------|-------------------------------|-------|
| 182614 | 35103         | Angle Stop Assy               |       |
| 182615 | 35285         | Screw                         |       |
| 161208 | 35296-CP      | Bubbler Shank, Chrome         |       |
| 159530 | 35311-CP      | Lever Handle Assy, Chrome     |       |
| 170191 | 35314-CP      | Fountain Trap, Pol Chrome     |       |
| 175962 | 35594         | Union Conn                    |       |
| 182616 | 36258         | Push Button                   |       |
| 182617 | 36261         | Valve Stem                    |       |
| 182619 | 36263         | Spring                        |       |
| 182620 | 36415         | Spout Bearing                 |       |
| 182621 | 36417-RP      | Swing Spout Post, RP          |       |
| 182622 | 39881         | Valve Stem Packing            |       |
| 182623 | 40004         | End Valve Body Assy           |       |
| 182624 | 40235         | Ball Lever Seat               |       |
| 136388 | 40236         | Ball-Rod Assembly             |       |
| 182625 | 40282         | Diverter Bushing              |       |
| 170179 | 40343-CP      | Handle Assy, Pol Chrome       |       |
| 182883 | 40479-BN      | Bonnet, *Br Nickel            |       |
| 182628 | 40966         | Packing                       |       |
| 169521 | 41240-VF      | Insert, Pol Brass             |       |
| 182629 | 41489         | Stand Pipe                    |       |
| 182630 | 42036         | Hot Plunger                   |       |
| 182631 | 42038         | Cold Plunger                  |       |
| 182632 | 42052-CP      | Mixer Sleeve, Chrome          |       |
| 182633 | 42160         | O-Ring                        |       |
| 182634 | 42258         | Sleeve                        |       |
| 182635 | 42271         | Bonnet                        |       |
| 171282 | 42414         | Screw                         |       |
| 182636 | 42451         | O-Ring                        |       |
| 182637 | 42675         | Plug, Handle, Shower          |       |
| 251197 | 427280-0      | Small Ceramic Insert, White   |       |
| 179506 | 43040         | Trap                          |       |
| 153582 | 43070BV       | Strainer Plate, *Br Bronze    |       |
| 172119 | 48096-CP      | Strainer SA, Chrome           |       |
| 189793 | 48250-CP      | Wall Saddle, Pol Chrome       |       |
| 189796 | 48251-CP      | Rod, Pol Chrome               |       |
| 165964 | 48609-BGD     | Bidet Spray, *Moderne Br Gold |       |
| 182639 | 48686         | O-Ring                        |       |
| 182640 | 500180        | Bumper Kit                    |       |
| 168997 | 500306-G3-B11 | Paint Kit, Ice                |       |
| 179745 | 500452        | Rebuild Kit, Diverter         |       |
| 182641 | 500455-CP     | Stem Extension Kit, Pol Chr   |       |
| 182642 | 50338         | Detent                        |       |
| 177748 | 50340-VF      | Escutcheon, Pol brass         |       |

\* Vibrant Limited Lifetime Warranty

[www.waterconcepts.net](http://www.waterconcepts.net) • Serving our Customers Since 1946 • [www.plumbsupply.com](http://www.plumbsupply.com)

**Kohler Repair Parts**

**Parts (Continued)**

| Part # | Mfg #    | Description               | Price |
|--------|----------|---------------------------|-------|
| 182643 | 50344-CP | Bonnet, Chrome            |       |
| 182644 | 50588-BN | Diverter, *Br Nickel      |       |
| 182648 | 51261    | Clip                      |       |
| 182649 | 51419    | Seat                      |       |
| 189794 | 51967-CP | Screw, Pol Chrome         |       |
| 170192 | 52054    | Wall Screw                |       |
| 182650 | 52156    | Tube                      |       |
| 154844 | 52478    | O-Ring                    |       |
| 164797 | 52588    | Screw                     |       |
| 182651 | 52703    | Overflow Tube             |       |
| 182888 | 52865-BN | Screw, * Br Nickel        |       |
| 182652 | 52936-CP | Hndl & Btn Assy, Pol Chr  |       |
| 182653 | 53448-CP | Screw, Chrome             |       |
| 159108 | 534-NA   | Install Kit               |       |
| 173257 | 550-NA   | Install Kit               |       |
| 182655 | 55108    | O-Ring                    |       |
| 182659 | 56318-RP | Seat Replacement Kit, RP  |       |
| 165965 | 56702    | Shank                     |       |
| 225354 | 57081-CP | Centerpiece®, Handle      |       |
| 247502 | 57411-CP | Lift Rod, Chrome          |       |
| 183342 | 57411-G  | Lift Rod, Br Chrome       |       |
| 182677 | 57711    | O-Ring                    |       |
| 161416 | 577-NA   | Install Kit               |       |
| 182679 | 57745-CP | Blade Handle, Chrome      |       |
| 056004 | 57746-CP | Tend Handle, Chrome       |       |
| 182680 | 57751    | Spray Diverter            |       |
| 173294 | 57930-VF | Escutcheon, Pol Brass     |       |
| 162186 | 58015-VF | Sleeve, Pol Brass         |       |
| 168631 | 58180-CP | Escutcheon, Chrome        |       |
| 182682 | 58249    | Pipe Cap                  |       |
| 182683 | 58307-VF | Shower Head, Pol Brass    |       |
| 182685 | 58895-CP | Handle Kit, Chrome        |       |
| 162749 | 591-NA   | Install Kit               |       |
| 156756 | 592-NA   | Install Kit               |       |
| 161743 | 593-NA   | Install Kit               |       |
| 111732 | 59425    | Nut Escutcheon            |       |
| 182689 | 59636-G  | Sleeve, Br Chrome         |       |
| 182690 | 59637-G  | Handle Base, Br Chrome    |       |
| 182691 | 59637-VF | Handle Base, Pol Brass    |       |
| 182686 | 59418    | Lower Bushing             |       |
| 182692 | 60380    | Screw                     |       |
| 182693 | 64503    | Hanger                    |       |
| 182694 | 65054-S  | Screw, Pol Stainless      |       |
| 182889 | 65061-BV | Suction Cover, *Br Bronze |       |
| 182695 | 65156-0  | Switch Flange, White      |       |

**Parts (Continued)**

| Part # | Mfg #     | Description                        | Price |
|--------|-----------|------------------------------------|-------|
| 182522 | 65156-47  | Switch Flange, Almond              |       |
| 182696 | 65226-96  | Suction Cover Plug, Biscuit        |       |
| 182697 | 65879     | Retaining Ring                     |       |
| 165925 | 67429     | Flange                             |       |
| 165927 | 67889     | Housing Assy                       |       |
| 182699 | 70504     | Plug Button                        |       |
| 182700 | 70505     | Plug Button                        |       |
| 182701 | 70539     | Threaded Sleeve                    |       |
| 250567 | 70591-CW  | SA Ceramic Insert, Chrome w/ White |       |
| 180038 | 70593-CP  | Brass Inserts, Pol Chrome          |       |
| 156915 | 71015     | O-Ring                             |       |
| 182702 | 71016     | O-Ring                             |       |
| 181966 | 7117-NA   | Test Seal Kit                      |       |
| 055352 | 71906     | Stem Adapter                       |       |
| 182703 | 71911     | Mixer Face Plate                   |       |
| 166030 | 71940     | O-Ring                             |       |
| 190311 | 71973-CP  | Handle Lever                       |       |
| 250570 | 71974-CP  | Cover, Chrome                      |       |
| 182704 | 73065     | Stem Adapter                       |       |
| 182705 | 73066     | Stem Adapter                       |       |
| 153331 | 73094     | Adapter                            |       |
| 158723 | 73175     | Flexible Shaft                     |       |
| 158720 | 73179     | Sleeve                             |       |
| 164075 | 73203-G   | Bezel IR Sensor, Chrome            |       |
| 172152 | 73330     | Spacer                             |       |
| 158722 | 73404-CP  | Tube Assy, Pol Chrome              |       |
| 158718 | 73439-CP  | Lift Rod, Chrome                   |       |
| 172755 | 73455-CP  | Escutcheon, Chrome                 |       |
| 182198 | 73703     | Side Valve                         |       |
| 182708 | 73719-BC  | Stem Extension, Chrome             |       |
| 244764 | 73744-AU  | Diverter Spout Kit, Pol Gold       |       |
| 165687 | 73744-BN  | Spout Kit, *Br Nickel              |       |
| 182709 | 73860     | Tee Assy                           |       |
| 172068 | 74385-G   | Escutcheon, Br Chrome              |       |
| 158314 | 74675-2BZ | Overflow Hood Assy, ORB            |       |
| 182716 | 75059     | Diaphragm Assy                     |       |
| 182717 | 7511-58   | Shank, Thunder Grey                |       |
| 182718 | 75462     | Graphic Cover                      |       |
| 162495 | 75564     | Retaining Ring                     |       |
| 177491 | 75601-BN  | Bonnet, *Br Nickel                 |       |
| 153434 | 75610-CP  | Bonnet, Pol Chrome                 |       |
| 182719 | 75740     | Adjustment Collar Assy             |       |
| 158239 | 75771-CP  | Cap, Polished Chrome               |       |
| 225355 | 42669-CP  | Stem/Skirt Handle                  |       |

\* Vibrant Limited Lifetime Warranty

[www.plumbsupply.com](http://www.plumbsupply.com) • Serving our Customers Since 1946 • [www.waterconcepts.net](http://www.waterconcepts.net)

## Kohler Repair Parts

### Parts (Continued)

| Part # | Mfg #     | Description                 | Price |
|--------|-----------|-----------------------------|-------|
| 168741 | 76602-CP  | Escutcheon Assy, Chrome     |       |
| 182720 | 76704-0   | Bonnet Cap, White           |       |
| 250024 | 76704-BN  | Bonnet Cap, *Br Nickel      |       |
| 073775 | 76704-CP  | Bonnet Cap, Pol Chrome      |       |
| 152934 | 76713     | Screw                       |       |
| 244250 | 76725-BL  | Cap, Matte Black            |       |
| 250652 | 76728-0   | Mounting Plate              |       |
| 182722 | 76755-VF  | Handle Skirt, Pol Brass     |       |
| 182724 | 77012-VF  | Handle Skirt, Pol Brass     |       |
| 182727 | 77099     | Bearing                     |       |
| 182932 | 77172-BN  | Escutcheon, *Br Nickel      |       |
| 245980 | 77172-VF  | Escutcheon, *Pol Brass      |       |
| 164796 | 77642     | O-Ring                      |       |
| 244704 | 77887-BV  | Lever Handle Assy, *Br. Brz |       |
| 157465 | 77887-VF  | Lever Handle Assy, Brass    |       |
| 248992 | 77948     | O-Ring                      |       |
| 159624 | 77971-47  | Graphic Cover, Almond       |       |
| 162319 | 78042-2BZ | Plug Button, ORB            |       |
| 161850 | 78042-96  | Plug Button, Biscuit        |       |
| 182933 | 78050-BN  | Escutcheon, *Br Nickel      |       |
| 181411 | 78139-BV  | Handle Assy, *Br Bronze     |       |
| 159432 | 78139-2BZ | Handle Assy, ORB            |       |
| 182934 | 78139-CP  | Handle Assy, Chrome         |       |
| 182730 | 78148-CP  | Handle Assy, Chrome         |       |
| 182731 | 78155     | Screw                       |       |
| 182935 | 78172-BN  | Stopper Assy, *Br Nickel    |       |
| 160987 | 78205-47  | Plug Button, Almond         |       |
| 156226 | 78205-96  | Plug Button, Biscuit        |       |
| 163179 | 78205-BV  | Plug Button, *Br Bronze     |       |
| 156120 | 78205-2bz | Plug Button, ORB            |       |
| 183343 | 78205-G   | Plug Button, Br Chrome      |       |
| 182732 | 78205-VF  | Plug Button, Pol Brass      |       |
| 158237 | 78562-58  | Grip Ring, Thunder Grey     |       |
| 131130 | 78797     | Rubber Seal                 |       |
| 184161 | 78923-BN  | Collar, *Brushed Nickel     |       |
| 153015 | 78925     | Hose Guide Assy             |       |
| 152208 | 78969-58  | Adapter, Thunder Grey       |       |
| 165028 | 79150-58  | Adapter Kit, Thunder Grey   |       |
| 182734 | 800065-CP | Lever Handle, Chrome        |       |
| 157839 | 83143     | Seal Diaphragm              |       |
| 183344 | 834404    | Screw                       |       |
| 185858 | 83451     | Cap Assy                    |       |
| 183345 | 836664    | Mounting Hardware           |       |
| 152205 | 84100     | O-Ring                      |       |
| 249429 | 84305     | Flush Valve Kit             |       |

### Parts (Continued)

| Part # | Mfg #          | Description                   | Price |
|--------|----------------|-------------------------------|-------|
| 182737 | 84786          | Hardware Pack Seat            |       |
| 081376 | 85500          | Mixer Cap Kit                 |       |
| 167088 | 85516          | Set Screw Spout Assy          |       |
| 182940 | 85698-CP       | Escutcheon, Chrome            |       |
| 167086 | 86036          | O-Ring/Bearing Kit            |       |
| 166292 | 86633          | Bath Stem                     |       |
| 166482 | 86861-CP       | Lift Rod, Polished Chrome     |       |
| 182944 | 87117          | Backing Plate                 |       |
| 164794 | 87118-CP       | Collar, Chrome                |       |
| 181643 | 87390          | Filter Head                   |       |
| 187099 | 87448-CP       | Sleeve, Pol Chrome            |       |
| 166995 | 87536          | Screw                         |       |
| 176620 | 88057-BN       | Plug Button, *Br Nickel       |       |
| 182945 | 88093-G        | Screw, Br Chrome              |       |
| 175356 | 88532-96       | Trim Ring Kit, Biscuit        |       |
| 248993 | 89098          | Base Seal                     |       |
| 182948 | 89279          | Hold Down Plate               |       |
| 158886 | 91915          | Hardware Kit                  |       |
| 186467 | 93766-0        | Cover, White                  |       |
| 166427 | 93838          | PVC Tube                      |       |
| 182950 | 94497          | Flat Pillow Kit               |       |
| 180291 | 94853          | Service Kit                   |       |
| 182738 | 95045          | Screw                         |       |
| 186466 | 97740          | Switch Assy                   |       |
| 176680 | 99272-CP       | Escutcheon, Chrome            |       |
| 186260 | 99272-SN       | Escutcheon, *Pol Nickel       |       |
| 238025 | 99272-VS       | Escutcheon, *Stainless        |       |
| 056035 | B2100          | Rod Parts                     |       |
| 170699 | CB-DXCLC10F S  | Mirrored Cabinet Door         |       |
| 188928 | CB-DXCLC20B AN | Mirrored Cabinet Door         |       |
| 183171 | CB-DXCLC20F S  | Mirrored Cabinet Door         |       |
| 183347 | CB-SHLFCLC20   | Inner Shelf                   |       |
| 183348 | CB-SHLFCLC30   | Inner Shelf                   |       |
| 087887 | GP1003736-0    | Sprayhead, White              |       |
| 105414 | GP1016515      | Valve for Kitchen Faucets     |       |
| 120573 | GP1035350-CP   | Premier Drain Chrome          |       |
| 086238 | GP1036940-CP   | Spray Head Kit Pol Chrome     |       |
| 122914 | GP1037021-CP   | Standard Plunger Assy, Chrome |       |
| 122915 | GP1037022-CP   | Plunger Brass Assy, Chr       |       |
| 151936 | GP1043211-VS   | Sprayhead, *Stainless         |       |
| 135542 | GP1056873      | Piston Assy                   |       |
| 117018 | GP1074231      | Spline Adapters               |       |

\* Vibrant Limited Lifetime Warranty

[www.waterconcepts.net](http://www.waterconcepts.net) • Serving our Customers Since 1946 • [www.plumbsupply.com](http://www.plumbsupply.com)

## Kohler Repair Parts

### Parts (Continued)

| Part # | Mfg #       | Description                            | Price |
|--------|-------------|--|-------|
| 122905 | GP1077791-0 | Plug Buttons, White                    |       |
| 122906 | GP1077792-0 | Plug Buttons, White                    |       |
| 121407 | GP1083167   | Fill Valve Kit                         |       |
| 152038 | GP1092203   | Cold Valve Cartridge Assy              |       |
| 152039 | GP1092204   | Hot Valve Cartridge Assy               |       |
| 183237 | GP1095915   | Handle for Elec Faucets                |       |
| 183172 | GP1105825   | Flapper w/ Float Kit                   |       |
| 055318 | GP21087-CP  | Trend Handle - Large                   |       |
| 055368 | GP30000     | Plug Button Kit                        |       |
| 005943 | GP30002     | Valvet                                 |       |
| 005944 | GP30004     | Valvet                                 |       |
| 055346 | GP30082     | Centura Repair Kit                     |       |
| 055128 | GP30090     | Repair Kit                             |       |
| 055316 | GP30100     | Plunger Service Kit                    |       |
| 056078 | GP30320     | Pressure Balance Adapter Kit - Plastic |       |
| 055311 | GP30413     | Valve                                  |       |
| 055353 | GP30416     | Knob Handle Kit                        |       |
| 072769 | GP30420     | O-Ring Seal Kit                        |       |
| 228375 | GP330002    | 1/4 Turn Valvet, HOT                   |       |
| 228376 | GP330004    | 1/4 Turn Valvet, COLD                  |       |
| 101598 | GP41398-CP  | Strainer Cup Assy, Chrome              |       |
| 055340 | GP43146     | Acrylic Handle                         |       |
| 055302 | GP500520    | Pressure Balancing Unit                |       |
| 055305 | GP51487     | Tank Gasket w/Bolts                    |       |
| 055344 | GP52050     | Tank Bolt Accessory Pack               |       |
| 055338 | GP71969     | Valve Mixer Kit                        |       |
| 056122 | GP75878     | Diverter Assembly                      |       |
| 055332 | GP76671     | Coralais Valve, CCW Close              |       |
| 055339 | GP76672     | Coralais Valve, CW Close               |       |
| 055319 | GP76851     | Mixer Pressure Balance Kit             |       |
| 055293 | GP77005-RP  | Ceramic Valve                          |       |
| 055294 | GP77006-RP  | Ceramic Valve                          |       |
| 055301 | GP77548     | Ceramic Valve                          |       |
| 121052 | GP77759     | Mixer Cap Kit                          |       |
| 055351 | GP77886     | Mixer Cap Kit                          |       |
| 056127 | GP78205-0   | Plug Button White                      |       |
| 070270 | GP78500     | Plunger Kit                            |       |
| 230421 | GP800881    | Repair Cartridge, 8304                 |       |
| 180982 | GP83996     | Gasket for Select Flush Vlv            |       |
| 055367 | GP85061     | Beehive Strainer                       |       |
| 055303 | GP88921     | Flush Ball Kit                         |       |
| 190060 | RGP64512    | Hanger (2)                             |       |
| 236510 | 1052070     | Solenoid Manifold Kit                  |       |
| 249428 | 1068033     | Fill Valve Assembly                    |       |

### Parts (Continued)

| Part # | Mfg #      | Description                              | Price |
|--------|------------|--|-------|
| 145967 | 1145688    | Cartridge, Transfer Valve                |       |
| 124370 | 18766      | Urinal Outlet Kit                        |       |
| 055355 | 30006      | Valve Repair - Right Hand                |       |
| 157034 | 1103464-SR | Aerator Kit, Bright Nickel               |       |
| 236984 | 1105050-CP | Aerator Kit-1.5gpm, Chrome               |       |
| 120651 | 84544-0    | Service Kit - Feet                       |       |
| 144324 | 1073881    | Deep Rough-In Kit                        |       |
| 087885 | 86101-CP   | Body Spray, Zero Leakage                 |       |
| 055980 | 34842      | Sleeve                                   |       |
| 120986 | GP1067183  | Flapper - Class 5                        |       |
| 055981 | 30008      | Valve Repair - Left Hand                 |       |
| 005942 | 23004-RP   | Valve Seat & Washer Assembly             |       |
| 067062 | 30249      | Bearing Kit                              |       |
| 136029 | 1056934    | Sensor Clip                              |       |
| 065793 | 50729      | O-Ring                                   |       |
| 080954 | 20242-BC   | Valve Stem Assembly, RH                  |       |
| 132172 | 84999      | Toilet Seat Anchor Kit                   |       |
| 094480 | 1000739    | Valve Restrictor Kit                     |       |
| 142908 | 1157032    | Piston Assembly                          |       |
| 145765 | 73858-RP   | Tee Assembly                             |       |
| 129338 | 1097686    | Seal, Flat                               |       |
| 237586 | 1016154-CP | Deep Rough-In, Rite-Temp                 |       |
| 103305 | 64839      | Lavatory Hanger                          |       |
| 146199 | 590-NA     | Underscore 5' UM Installation Kit        |       |
| 229514 | 1123617    | Hybrid Power Cell Potted                 |       |
| 137090 | 1172936-CP | Master Shower/Water Haven SH Service Kit |       |
| 071014 | 30126      | Valve Repair Kit                         |       |
| 238418 | 1068034    | Fill Valve Assembly                      |       |
| 113728 | 1007937-G  | Deep Rough-In Kit                        |       |
| 120179 | 1034693-BN | Trip Lever, Cimarron *Brushed Nickel     |       |
| 080960 | 20241      | Bonnet SA                                |       |
| 102083 | 32002      | Valve Bonnet                             |       |
| 121450 | 40372      | Adjustable Linkage                       |       |
| 120889 | 1108711    | Spacer Kit                               |       |
| 055366 | 51291      | Plunger                                  |       |
| 164079 | 1014086-05 | Seal, Threshold 28.125"                  |       |
| 238804 | 1102432    | Kit, Hardware                            |       |
| 055342 | 22947      | Plunger SA - Clockwise Close - Plastic   |       |
| 056007 | 22948      | Plunger SA, CCW Close Plastic            |       |
| 240444 | 1207327    | Emblem, Tank Cover                       |       |

\* Vibrant Limited Lifetime Warranty

[www.plumbsupply.com](http://www.plumbsupply.com) • Serving our Customers Since 1946 • [www.waterconcepts.net](http://www.waterconcepts.net)

---

---

**Kohler Repair Parts**

---

---

**Parts (Continued)**

| Part # | Mfg #      | Description                   | Price |
|--------|------------|-------------------------------|-------|
| 249194 | 1017282-BN | Lever Handle Assembly<br>Bath |       |

## Malco Repair Parts

### Hole Cutter Parts

#### Hole Cutter Replacement Part

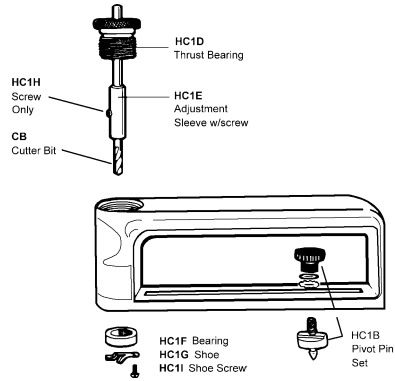

| Part # | Mfg # | Description               | Price |
|--------|-------|---------------------------|-------|
| 006379 | CB    | Malco Bit for HC1 and HC2 |       |
| 006409 | HC1B  | Pivot Pinset for HC1      |       |
| 034909 | HC1D  | Thrust Bearing w/Adapter  |       |
| 006410 | HC1E  | Adjustable Sleeve for HC1 |       |
| 006411 | HC1F  | Ball Bearing for HC1      |       |
| 006412 | HC1G  | Guide for HC1             |       |
| 054345 | HC1I  | Shoe Screw                |       |

## McDonnell & Miller Repair Parts

### Replacement Parts

#### Gasket



| Part # | Mfg #  | Model # | Used With:             | Price |
|--------|--------|---------|------------------------|-------|
| 007100 | 302600 | CO-12   | 42,61,63,64,<br>65,42S |       |

#### Strainer Basket Assembly

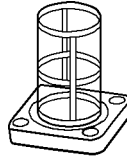

| Part # | Mfg #  | Model #  | Used With:  | Price |
|--------|--------|----------|-------------|-------|
| 007104 | 347100 | SA101-38 | 47, 51, 101 |       |



## Moen Repair Parts

### Handle Adapters



100429

| Part # | Mfg #  | Description        | Price |
|--------|--------|--------------------|-------|
| 058893 | 100429 | Handle Adapter Kit |       |
| 244987 | 174329 | Handle Adapter Kit |       |

### Chateau Knob Handle Kit

- 1-Hdl Tub/Shower



| Part # | Mfg # | Description                    | Price |
|--------|-------|--------------------------------|-------|
| 007370 | 96797 | Clear w/ White & Chrome Insert |       |

### Traditional Handle Kit



| Part # | Mfg # | Description   | Price |
|--------|-------|---------------|-------|
| 016904 | 94514 | Single-Handle |       |

### Handle Hub



| Part # | Mfg #    | Description  | Price |
|--------|----------|--------------|-------|
| 244555 | 114344WR | Wrought Iron |       |

### Handle Kit



| Part # | Mfg #  | Description | Price |
|--------|--------|-------------|-------|
| 243526 | 128866 | Chrome      |       |

### Faucet Cartridges

#### 1255 Duralast™ Cartridge



| Part # | Mfg # | Description | Price |
|--------|-------|-------------|-------|
| 140023 | 1255  | Duralast™   |       |

#### 1-Hdl Faucet Cartridge

- Brass
- Hot/cold operation
- Includes:
  - Cartridge
  - Retainer Clips
  - Installation tool
  - Installation instructions



| Part # | Mfg # | Description                             | Price |
|--------|-------|---|-------|
| 007169 | 1200B | For 1200 Faucet, Bulk (12/Pk)           |       |
| 007173 | 1225B | For All Moen 1-Hdl Faucets Bulk (12/Pk) |       |

#### Duralast™ 2-Hdl Faucet Cartridge



| Part # | Mfg # | Description      | Price |
|--------|-------|------------------|-------|
| 189508 | 1234  | 2-Hdl, Duralast™ |       |

#### Duralast™ 2-Hdl Roman Tub Faucet Cartridge

- Hot or cold



| Part # | Mfg # | Description        | Price |
|--------|-------|--------------------|-------|
| 249073 | 1258  | 2-Hdl, Hot or Cold |       |

\*Lifeshine® Anti-Tarnish Lifetime Finish

[www.plumbsupply.com](http://www.plumbsupply.com) • Serving our Customers Since 1946 • [www.waterconcepts.net](http://www.waterconcepts.net)

## Moen Repair Parts

### 2-Hdl Faucet Cartridge

- Brass
- Hot/cold operation



| Part # | Mfg # | Description                           | Price |
|--------|-------|---------------------------------------|-------|
| 007172 | 1224B | For 2-Hdl Moen® Faucets, Bulk (12/Pk) |       |

### Posi-Temp 1-Hdl Faucet Cartridge

- Brass
- Hot/cold operation



| Part # | Mfg # | Description                               | Price |
|--------|-------|---|-------|
| 007171 | 1222B | For 1-Hdl Posi-Temp Faucets, Bulk (12/Pk) |       |

### Commercial Heavy-Duty Posi-Temp Cartridge



| Part # | Mfg #  | Description | Price |
|--------|--------|-------------|-------|
| 226819 | 1222HD | Brass Shell |       |

### Commercial 2-Hdl Ceramic Disc Cartridge



| Part # | Mfg # | Description | Price |
|--------|-------|-------------|-------|
| 147672 | 52001 | Cold        |       |
| 147671 | 52000 | Hot         |       |

### Cartridge



| Part # | Mfg # | Description | Price |
|--------|-------|-------------|-------|
| 209555 | 4000  | Replacement |       |

### Replacement Cartridge

- For 4999 Roman Tub Valve



| Part # | Mfg #  | Description              | Price |
|--------|--------|--------------------------|-------|
| 007174 | 1248   | For 4999 Roman Tub Valve |       |
| 103661 | 116719 | Replacement Cartridge    |       |

### Commercial Cartridge



| Part # | Mfg # | Description        | Price |
|--------|-------|--------------------|-------|
| 218673 | 52100 | Metering Cartridge |       |

### Commercial 2-Hdl Cartridge



| Part # | Mfg #  | Description | Price |
|--------|--------|-------------|-------|
| 198775 | 121550 | Hot         |       |
| 198776 | 121551 | Cold        |       |

## Moen Repair Parts

### Commercial 1-Hdl Cartridge

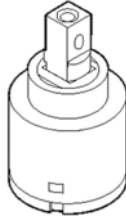

| Part # | Mfg #  | Description    | Price |
|--------|--------|----------------|-------|
| 174468 | 121620 | For Model 8701 |       |

### Cartridge Removal Tool

- For 1200, 1225, or 1222 cartridges



| Part # | Mfg #  | Description            | Price |
|--------|--------|------------------------|-------|
| 046820 | 104421 | Cartridge Removal Tool |       |

### Cartridge Removal Tool



| Part # | Mfg # | Description                     | Price |
|--------|-------|---------------------------------|-------|
| 020117 | 14272 | Cartridge Retainer Removal Tool |       |

### Service Parts

| Part # | Mfg #     | Description  | Price |
|--------|-----------|--|-------|
| 090524 | A1616BN   | Kingsley Extension Kit, Br Nickel                  |       |
| 236533 | A780      | 80" Commercial Metal Hose                          |       |
| 239505 | 123245    | Escutcheon & Gasket Kit, Chrome                    |       |
| 096538 | 104021    | Solenoid Repair Kit                                |       |
| 246689 | 104570    | Commercial Service Kit, Chrome                     |       |
| 230761 | 147208    | Cartridge Repair Kit                               |       |
| 230762 | 147209    | Check Stop   |       |
| 250132 | 3806SRN   | Diverter Spout, Spot Resist Br Nkl                 |       |
| 036804 | 93980     | Handle Mechanism Kit<br>f/7400/7600 Kitchen Faucet |       |
| 212816 | 179104    | Handle Adapter Kit                                 |       |
| 226712 | 116711    | Flow Restrictor Kit                                |       |
| 243252 | 116712    | Flow Restrictor Kit                                |       |
| 018319 | 11985     | 50/50 Drain Assembly                               |       |
| 019922 | 12689     | Pivot Rod & Clip                                   |       |
| 237959 | 124738CSL | Pull-Out Wand, Stainless                           |       |
| 241464 | 130142    | Spline Adapter & Screw Kit                         |       |
| 243432 | 130143    | Extension Kit                                      |       |
| 243431 | 130158    | Check Stop   |       |
| 163701 | 131381    | Hose Kit   |       |

### Service Parts (Continued)

| Part # | Mfg #     | Description  | Price |
|--------|-----------|--|-------|
| 020119 | 96365     | Retainer Clips                                     |       |
| 007353 | 883       | Retainer Clip                                      |       |
| 021710 | 96914     | Posi-Temp Retainer Clip                            |       |
| 244557 | 114343WR  | Handle Cap & Screw, Wrought Iron                   |       |
| 113430 | 140780    | Metal Pop-Up Lav Drain, Chrome                     |       |
| 103739 | 140780BN  | Metal Pop-Up Lav Drain, Brushed Nickel             |       |
| 103122 | 140780ORB | Metal Pop-Up Lav Drain, Oil Rubbed Bronze          |       |
| 226575 | 131553BN  | Pop-Up Lav Drain, Brushed Nickel                   |       |
| 021437 | 96497     | Waste Assembly, Chrome                             |       |
| 023012 | 12314     | Plug & Cap   |       |
| 007200 | 1920      | Valve Cover Plate, Chrome                          |       |
| 131700 | 1920BN    | Valve Cover Plate, Brushed Nickel                  |       |
| 078637 | 101663BN  | Drain Cover, Brushed Nickel                        |       |
| 101250 | 101663ORB | Drain Cover, Oil Rubbed Bronze                     |       |
| 238566 | 101663WR  | 4-1/4" Drain Cover, Wrought Iron                   |       |
| 236868 | 101664BN  | Drain Cover, Brushed Nickel                        |       |
| 202661 | 102763BN  | 4" Drain Cover, Brushed Nickel                     |       |
| 035758 | 1423      | Balancing Spool                                    |       |
| 201600 | 52012     | Commercial Vacuum Breaker                          |       |
| 244429 | 52007     | Cartridge Nut                                      |       |
| 140881 | 588       | Donner Commercial C-Clamp                          |       |
| 007391 | 97557     | Monticello Handle Inserts, Chrome                  |       |
| 007382 | 97462     | Monticello Handle Insert, Chrome                   |       |
| 007362 | 91751     | Knob Insert Kit, Chateau                           |       |
| 044029 | 96782     | Chateau Handle Kit                                 |       |
| 007369 | 96791     | Chateau Handle Kit                                 |       |
| 007360 | 91192     | Diverter Kit for 1Hdl Kit Fct                      |       |
| 007368 | 96790     | Handle Kit, Chrome                                 |       |
| 091499 | 116653    | Handle Adapter Kit                                 |       |
| 020189 | 98039     | Handle Kit, Acrylic                                |       |
| 118478 | 136103C   | Kitchen Spray and Hose                             |       |
| 144317 | 106378    | Asceri Stem Extension Kit                          |       |
| 007386 | 97466     | Monticello Handle Knob Insert,<br>Porcelain/Chrome |       |
| 019330 | 97556     | Monticello Handle Adapter Kit                      |       |
| 020032 | 95606     | Monticello Handle Hub Kit                          |       |
| 032729 | 95602     | Monticello Handle Hub Kit                          |       |
| 007389 | 97479     | Monticello Stem Extension Kit                      |       |
| 007372 | 97344     | Monticello Stem Extension Kit                      |       |
| 124051 | 145058    | Adapter Kit  |       |
| 026035 | 14732     | Handle Kit, Chrome                                 |       |
| 236993 | 147556    | Extension Kit, Vessel                              |       |
| 103271 | 100818    | Extension Kit                                      |       |
| 238428 | 113173    | Mounting Kit                                       |       |

\*Lifeshine® Anti-Tarnish Lifetime Finish

[www.plumbsupply.com](http://www.plumbsupply.com) • Serving our Customers Since 1946 • [www.waterconcepts.net](http://www.waterconcepts.net)

## Moen Repair Parts

### Service Parts (Continued)

| Part # | Mfg #    | Description  | Price |
|--------|----------|--|-------|
| 097867 | 114299   | Hose Kit   |       |
| 045742 | 12318    | Check Stop   |       |
| 196066 | 94770    | Plug Button & Set Screw  |       |
| 179477 | 150259   | Hose Kit   |       |
| 114856 | A750     | Slide Bars   |       |
| 238174 | 52711    | Slide/Grab Bar Shower Connector, Gray Plastic                  |       |
| 162734 | 104524   | Manual Override Button - Flush Valve                           |       |
| 031502 | 101099   | Handle Connector, Spacer, Screw & Washer for Loop Hdl Kitchens |       |
| 043598 | 101310   | Chateau Lever Handle Kit                                       |       |
| 165290 | 104401   | Multi-Unit AC Power Adapter                                    |       |
| 109518 | 9601     | Choiceflo Replacement Filter 9600/9602/9500/9502               |       |
| 071412 | 100021   | Chateau Handle Cap, Chrome                                     |       |
| 071756 | 100710   | Posi-Temp T&S Acrylic Handle                                   |       |
| 017776 | 14699    | Retainer Pivot Nut, 1Hdl Kit Fct                               |       |
| 022554 | 15528    | Escutcheon Screws  |       |
| 007163 | 10089    | Legend & Chateau 1Hd T&S Knob Handle Stop Tube                 |       |
| 031100 | 96987    | Stop Tube, PosiTemp 1-Hdl TS Trim                              |       |
| 089374 | 100657   | Handle Kit, Chrome   |       |
| 186665 | 221672   | Weymouth Hot & Cold Handle Caps, Chrome                        |       |
| 225625 | 221672BN | Weymouth Hot & Cold Handle Caps, Brushed Nickel                |       |
| 017751 | 13463    | Chateau Tub Fct Stem Extension                                 |       |
| 007371 | 96884    | Handle Insert Kit  |       |
| 215829 | 155655   | Screen Filter  |       |
| 224150 | 155658   | Hardware Kit   |       |
| 146281 | 10116    | Plug Button Kit, Chrome  |       |
| 216901 | 104444   | Commercial Supply Line   |       |
| 247571 | 114324   | Handle Cap Kit, Chrome   |       |
| 245748 | 114324W  | Hot & Cold Handle Cap Kit, White                               |       |
| 247885 | 116731   | Bearing Washer Kit   |       |
| 007168 | 1198     | Push Button Diverter   |       |
| 032769 | 13462    | Handle Adapter Kit   |       |
| 224151 | 155651   | Hardware Kit   |       |
| 025797 | 13769    | Chateau Escutcheon, Chrome                                     |       |
| 017752 | 13774    | Wall Tube, Chrome  |       |
| 248620 | 155656   | Extension Kit  |       |
| 121811 | 163WR    | Escutcheon Screws, Wrought Iron                                |       |
| 105725 | 128284   | Twin Elbow   |       |
| 216105 | 131109   | Handle Kit, Chrome   |       |
| 240320 | 137396BN | Handle Kit, Brushed Nickel                                     |       |
| 240286 | 147556BN | 90° Vessel Extension Kit                                       |       |
| 249984 | 176415   | Vacuum Breaker for MO8124/8232                                 |       |

### Service Parts (Continued)

| Part # | Mfg #     | Description                                     | Price |
|--------|-----------|---|-------|
| 249405 | 178755    | Remodel Cover Plate for Posi-Temp Valve, Chrome |       |
| 212814 | 179103    | Handle Adapter Kit                              |       |
| 249842 | 179108    | Universal Kitchen Spray Kit, Chrome             |       |
| 185665 | AT2099ORB | T/S Accent Kit, Oil Rubbed Bronze               |       |
| 201230 | 143530    | Diverter Plug                                   |       |
| 195900 | A714      | Vacuum Breaker, Chrome                          |       |
| 121669 | 96945     | Handle Extension Kit                            |       |
| 211430 | 140710    | Cartridge Nut                                   |       |
| 221963 | 130153BN  | Handle Escutcheon, Brushed Nickel               |       |
| 244985 | 135152    | Spacer Kit                                      |       |
| 124535 | 129102BN  | Trim Ring, Brushed Nickel                       |       |
| 244548 | 97577WR   | Escutcheon, Wrought Iron                        |       |

#### Spout O-Ring Kit



| Part # | Mfg #  | Description | Price |
|--------|--------|-------------|-------|
| 007167 | 117    | Bulk        |       |
| 215830 | 155654 | O-Ring Kit  |       |
| 201190 | 146789 | O-Ring Kit  |       |
| 020120 | 96778  | O-Ring Kit  |       |

\*Lifeshine® Anti-Tarnish Lifetime Finish

---

---

## EL Mustee Repair Parts

---

---

### Shower Stall Parts

| Part # | Mfg #  | Description             | Price |
|--------|--------|-------------------------|-------|
| 169874 | 68.600 | 4" Plastic Shower Valve |       |
| 034312 | 80.451 | Cold Index Plug         |       |
| 007569 | 82.400 | 1-1/2" PVC Shower Drain |       |
| 007546 | 65.700 | Hose Holder             |       |

**Navien Repair Parts**

**Parts & Accessories**



O-Ring



Packing O-Ring

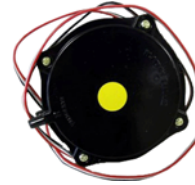

Pressure Flow Sensor

| Part # | Mfg #        | Description                             | Price |
|--------|--------------|---|-------|
| 149791 | 2505401A     | CPVC Vent Collar                        |       |
| 234582 | 30000456B    | 7M Gas 120V/60HZ Circulation Pump       |       |
| 127478 | 30000663A    | Air Pressure Sensor, NASS9EX00009       |       |
| 135435 | 30000669A    | Air Pressure Sensor, NASS9EXOS001       |       |
| 126626 | 30004802C    | Water Flow Sensor, AASS9EXFS003C        |       |
| 188868 | 30014451A    | Circulation Pump Air Vent               |       |
| 231214 | 30014367A    | Common Vent Backflow Damper Kit         |       |
| 172073 | 30012226A    | Igniter NPE                             |       |
| 162623 | 30010537A    | Water Sensor                            |       |
| 136813 | BH0914002B   | Motorized 2-Way Valve                   |       |
| 126593 | BH2507399A   | 3-Way Valve, A-Type Copper              |       |
| 136814 | BH1201041D   | Ignition Transformer with Wire          |       |
| 126589 | BH1205008A   | Transformer                             |       |
| 126623 | BH1303013A   | Inlet Filter                            |       |
| 126630 | BH1403081A   | Thermostat (Black Wire)                 |       |
| 134822 | BH2101273B   | Remote Wire                             |       |
| 126587 | BH2124012A   | Fuse, 125V, 5A                          |       |
| 126599 | BH2421008A   | O-Ring, Gas Black, 19.8"Dia x 2.4"T     |       |
| 126653 | BH2421997A   | Black O-Ring                            |       |
| 126602 | BH2423052A   | O-Ring, White or Blue, 15.8"Dia x 2.4"T |       |
| 126600 | BH2423053A   | O-Ring, Red, 17.8"Dia x 2.4"T           |       |
| 126654 | BH2423055A   | O-Ring, Black, 17.5"Dia x 2.7"T         |       |
| 126603 | BH2423064A   | O-Ring, Red Water, 15.8"Dia x 2.7"T     |       |
| 126597 | PH1062017A   | Back-Up O-Ring                          |       |
| 126588 | BH2501679A   | NG Flame Rod                            |       |
| 136815 | BH2507507A   | Water Pipe Adapter, Black               |       |
| 127841 | BCRA1129     | Ready-Link Connection Cable             |       |
| 245209 | GXXX001727   | Magnetic Boiler Filter                  |       |
| 136820 | NAPU9GLPCT01 | NP Series Circulation Pump              |       |
| 136821 | NARC1GSNR007 | Remote Control                          |       |
| 126591 | NASS9EXGPS01 | Gas Pressure Flow Sensor                |       |
| 126625 | NCVM9EX00005 | Flow Adjustment Valve                   |       |
| 126595 | PAPCT1W0725  | 058 Pump                                |       |
| 126632 | PH1799013A   | Pipe Adapter                            |       |
| 241658 | 30004825A    | Motorized 2-Way Valve                   |       |
| 241659 | 30002491A    | Transformer 120V CR/CC                  |       |
| 241661 | 30003311A    | Syphon CR/CC, NR/NP                     |       |
| 241663 | 30010238A    | Air Press Sensor NPE                    |       |
| 245316 | 30018661A    | NPE Parts Kit                           |       |
| 241664 | 30008834A    | Inducer Fan NCB, NPE                    |       |

Repair Parts

## Navien Repair Parts

### Parts & Accessories (Continued)

| Part # | Mfg #       | Description                      | Price |
|--------|-------------|----------------------------------|-------|
| 241665 | 30011534A   | Flow Sensor NPE-S                |       |
| 241667 | 30011532A   | Water Adj Valve NPE-S            |       |
| 241668 | 30009756B   | Syphon & Hose NPE A/S            |       |
| 241669 | 30008366A   | Thermistor NPE/NHB               |       |
| 241670 | 30015421A   | Inducer Fan NPE-150S             |       |
| 241671 | 30014183A   | Igniter Flame Rod Assembly       |       |
| 241673 | 30012241A   | Auto Feed Assembly NCB-ALL       |       |
| 241674 | 30011586A   | Gas Valve NHB All                |       |
| 241675 | 30014216A   | Syphon & Hose NHB 055/080        |       |
| 241676 | 30014024A   | Syphon & Hose NHB 110/150        |       |
| 241677 | 30014189A   | Igniter Flame Rod Assembly       |       |
| 241678 | 30012907A   | Thermistor NHB                   |       |
| 241680 | 30013984A   | Inducer Fan NHB 055/80           |       |
| 241681 | 30013985A   | Inducer Fan NHB 150              |       |
| 223331 | 30008429A   | Gas Valve NPE-A/S, NCB           |       |
| 227942 | 30009478A   | Exhaust Thermister NPE           |       |
| 238359 | 30008245A   | Water Adjustment Valve           |       |
| 230697 | 30004819C   | 3-Way Valve CR/CC, NR/NP         |       |
| 230698 | 30002282E   | Check Valve CR/CC, NR/NP         |       |
| 233400 | 30002475A   | Ignition Transformer             |       |
| 241465 | 30000466A   | Circ Pump CR/CC, NR/NP           |       |
| 226737 | 30013685A   | Flow Sensor Assembly Dom         |       |
| 222447 | 30002493A   | Transformer 120V 60 Hz           |       |
| 233740 | 30000181A   | PCB Control Board CH             |       |
| 171172 | GXXX001322  | Residential Neutralizer          |       |
| 167004 | 30012950A   | Outdoor Sensor & Wire            |       |
| 188054 | 20017210A   | O-Ring                           |       |
| 167481 | 30004684A   | LP Flame Rod                     |       |
| 171169 | PFMZ-02P-01 | Smartzone 2-Zone Pump Controller |       |
| 186505 | GXXX001417  | Supply/Return Sensor             |       |
| 175139 | 20018013A   | O-Ring                           |       |
| 174167 | 30004680A   | NG Flame Rod Kit                 |       |
| 167480 | 30004834B   | Flow Adjustable Valve            |       |
| 181936 | GXXX001324  | Neutralization Kit               |       |
| 165953 | 30000666A   | Gas Pressure Flow Sensor         |       |
| 165466 | 30010455A   | Ign. Transfer NPE                |       |
| 184906 | 30004837B   | Mixing Valve                     |       |
| 173551 | 30010780B   | Circulation Pump                 |       |
| 177980 | 30000182A   | Board F/Cr-180                   |       |
| 239003 | 30008360A   | Check Valve NPE                  |       |
| 222617 | PBCM-AS-01  | Wifi Control                     |       |
| 224573 | 30009323A   | Easy Valve Kit                   |       |
| 183273 | 30008571A   | NPE Flow Sensor                  |       |
| 186308 | 30014699A   | LWCO Water Sensor                |       |
| 171171 | PFMZ-04P-01 | Smartzone 4-Zone Pump Controller |       |

Repair Parts

**Navien Repair Parts**

**Parts & Accessories (Continued)**

| Part # | Mfg #        | Description                      | Price |
|--------|--------------|----------------------------------|-------|
| 171170 | PFMZ-03P-01  | Smartzone 3-Zone Pump Controller |       |
| 168655 | 30009757A    | Remote for NPE                   |       |
| 165951 | 30009875A    | Thermistoer                      |       |
| 143846 | 30011330A    | NPE Parts Kit                    |       |
| 176969 | PFMZ-06P-001 | Smartzone 6-Zone Pump Controller |       |
| 223557 | 30011690D    | PCB Control Board NPE All        |       |
| 224914 | 30013687A    | Siphon                           |       |
| 165833 | 30012685A    | NCB Parts Kit                    |       |
| 223559 | 30013044A    | FP Front Panel F/NHB             |       |
| 154387 | GXXX001178   | CH Quik-Install Manifold Kit     |       |
| 223558 | 30012262B    | PCB Control Board F/NCB          |       |
| 228187 | 30011450A    | CH Parts Kit                     |       |
| 177075 | 30014307A    | NHB Parts Kit                    |       |
| 163395 | UA0900002A   | 3/4 Plumb Easy LF Valve          |       |
| 227667 | 30012768A    | Circulation Pump                 |       |
| 224572 | GXXX001323   | Replacement Media                |       |
| 231992 | GXXX001328   | Anti-Scale Refill                |       |
| 188650 | 30012033B    | NCB/NCB-E Flow Sensor            |       |
| 242432 | 30004831C    | 3-Way Valve                      |       |



**Reznor Repair Parts**

**Limit Controls**

| Part # | Mfg #  | Description  | Price |
|--------|--------|--|-------|
| 008477 | 45602  | (180°F) White Auto Limit Control                             |       |
| 008480 | 50417  | (125°F) White Auto Limit Control                             |       |
| 008481 | 50418  | (145°F) Blue Auto Limit Control                              |       |
| 008497 | 82091  | (160°F) Red Auto Limit Control                               |       |
| 008498 | 82414  | (306°F) ECO Energy Cut-Out Limit Control                     |       |
| 008500 | 85449  | (200°F) Yellow Auto Limit Control                            |       |
| 008524 | 96512  | (220°F) High Temperature Limit Control                       |       |
| 027171 | 131449 | (228°F) ECO Energy Cut-Out Limit Control                     |       |
| 008458 | 123974 | (135°F) Fan Control  |       |
| 008459 | 123976 | (135°F) Fan Control  |       |
| 030936 | 147676 | (150°F) Fan Control w/Bracket for XL/CXL/EEXL/CEEXL 30 - 400 |       |
| 083879 | 209184 | Fan Control Replacement Kit                                  |       |

**Gas Conversion Kits**



| Part # | Mfg #  | Description   | Price |
|--------|--------|---|-------|
| 008536 | 99244  | LP Conversion Kit for F/FE-50                       |       |
| 153551 | 269835 | LP Conversion Kit for Model UDAP/UDAS Size 30, 45   |       |
| 153552 | 269836 | LP Conversion Kit for Model UDAP/UDAS Size 60, 75   |       |
| 154397 | 269837 | LP Conversion Kit for Model UDAP/UDAS Size 100, 125 |       |
| 153554 | 269838 | LP Conversion Kit for Model UDAP/UDAS Size 150, 175 |       |
| 153553 | 269839 | LP Conversion Kit for Model UDAP/UDAS Size 200, 250 |       |
| 066004 | 201732 | LP Conversion Kit for Model UDAP/UDAS Size 300, 400 |       |
| 073497 | 205515 | LP Conversion Kit                                   |       |
| 073498 | 205516 | LP Conversion Kit                                   |       |
| 127038 | 257472 | Ignition Conversion Kit (Replaces 97782)            |       |
| 127637 | 257473 | LP Conversion Kit, Old #G77                         |       |

**Gas Valves**

| Part # | Mfg #  | Description  | Price |
|--------|--------|--|-------|
| 008518 | 96300  | 1/2" Natural Gas Valve (W/R #36C03-211) Replacement                |       |
| 008519 | 96307  | 1/2" Natural Gas Valve Replacement                                 |       |
| 022074 | 121599 | 1/2" Single Stage Valve (VR8304M2816)                              |       |
| 027313 | 147830 | 1/2" Single Stage Natural Gas Valve (VR8205M1130)                  |       |
| 082010 | 204301 | 1/2" Single Stage Natural Gas Valve (VR8205M2955)                  |       |
| 091161 | 208920 | 1/2" Single Stage Natural Gas Valve w/Standing Pilot (VR8200M7005) |       |

## Reznor Repair Parts

### Motors

| Part # | Mfg #  | Description  | Price |
|--------|--------|--|-------|
| 008476 | 45331  | 1/40 hp Motor                                      |       |
| 027821 | 102380 | 1/8 hp Motor                                       |       |
| 008485 | 61069  | 1/20 hp Motor                                      |       |
| 008508 | 95547  | 1/20 hp Motor for Model F 130 & 200                |       |
| 008509 | 95548  | 1/30 hp Motor                                      |       |
| 008502 | 88781  | 1/6 hp Motor                                       |       |
| 066238 | 196241 | Fan Motor for UDAP 45 - 60                         |       |
| 066252 | 196242 | Fan Motor for UDAP 75                              |       |
| 066267 | 196243 | Fan Motor for UDAP 100                             |       |
| 066314 | 196247 | 115V Fan Motor for UDAP and UDAS 300 - 400         |       |
| 008507 | 95546  | Fan Motor  |       |
| 008515 | 96287  | Fan Motor  |       |
| 008516 | 96288  | 1/15 hp Fan Motor                                  |       |
| 102121 | 147571 | Fan Motor  |       |
| 008514 | 96018  | Venter Motor Assembly                              |       |
| 027692 | 97727  | Venter Motor and Wheel Assembly                    |       |
| 100298 | 131410 | 115V Venter Motor with Capacitor                   |       |
| 170634 | 214067 | 115V Venter Motor less Capacitor                   |       |
| 033127 | 148055 | 115V Venter Blower Motor                           |       |
| 066281 | 196036 | 115V Venter Motor for UDAP and UDAS 150 - 175      |       |
| 109924 | 214066 | 115V Venter Motor for VR 175/200 with Capacitor    |       |
| 144784 | 217032 | 120V, 60Hz Venter Motor for UDAP (Replaces 175273) |       |
| 139008 | 260422 | 115V Venter Motor                                  |       |

### Pilots & Components

| Part # | Mfg #  | Description  | Price |
|--------|--------|--|-------|
| 008486 | 61145  | Natural Gas Pilot Assy w/ Orifice, High Tension Lead & Flame Probe; less Pilot Tubing & Flame Sensor |       |
| 008523 | 96360  | Natural Gas Pilot Assembly with Orifice, Pilot Tubing, & Thermocouple; (for All F Models)            |       |
| 020439 | 110853 | Natural Gas Spark Pilot Assembly   |       |
| 066224 | 175272 | DSI Electrode Assembly   |       |

### Pressure Switches

| Part # | Mfg #  | Description   | Price |
|--------|--------|---|-------|
| 066242 | 196388 | High Altitude Pressure Switch for UDAP-CV, UDAS 100 |       |
| 062419 | 196653 | Pressure Switch                                     |       |
| 091540 | 205442 | 0.20"wc Low Speed White Label Pressure Switch       |       |
| 091216 | 205443 | Low Speed Yellow Label Pressure Switch              |       |
| 066288 | 201158 | 1.10"wc Pressure Switch                             |       |
| 020765 | 121275 | Block Vent Switch                                   |       |

### Transformers

| Part # | Mfg #  | Description         | Price |
|--------|--------|---------------------|-------|
| 008461 | 131988 | 120/24V Transformer |       |

Repair Parts

**Reznor Repair Parts**

**Transformers (Continued)**

| Part # | Mfg #  | Description                    | Price |
|--------|--------|--------------------------------|-------|
| 008462 | 132204 | 120/24V, 20VA Transformer      |       |
| 091211 | 175265 | 115V, 30VA Control Transformer |       |
| 066225 | 194808 | Transformer, 40VA              |       |

**Vent Caps**



| Part # | Mfg #  | Description                    | Price |
|--------|--------|--------------------------------|-------|
| 067827 | 111849 | 5" Vent Cap for UDAP 150 - 250 |       |
| 107774 | 111848 | 4" Vent Cap for UDAP 30-125    |       |

**Parts**

| Part # | Mfg #  | Description  | Price |
|--------|--------|--|-------|
| 022890 | 43425  | Inducer Blower Wheel (AD326-215-101-2)   |       |
| 008527 | 97534  | Natural Gas Pilot Assembly   |       |
| 020436 | 97535  | LP Pilot Assembly with Flame Sensor  |       |
| 020437 | 97572  | Compression Nut  |       |
| 020449 | 97724  | Venter Wheel FE130-400   |       |
| 021456 | 97725  | Venter Wheel FE25-100  |       |
| 021538 | 18549  | RBM Relay All FE Models  |       |
| 008534 | 98697  | Flame Rod  |       |
| 021502 | 116019 | 37-1/8" Tubular Section for TR & TR-H Models                                     |       |
| 060039 | 116045 | Burner On Light  |       |
| 091538 | 120545 | Venter Wheel   |       |
| 026634 | 132007 | Venter Wheel   |       |
| 061819 | 135979 | Venter Wheel   |       |
| 027310 | 147165 | Flame Sensor   |       |
| 027317 | 148085 | 18" Ignition Cable   |       |
| 066231 | 195036 | Venter Wheel Assembly  |       |
| 090713 | 195046 | Compression Spring for Louvers   |       |
| 066222 | 195265 | Control Board  |       |
| 066223 | 195292 | Flame Sensor   |       |
| 066237 | 196949 | Flame Rollout  |       |
| 084139 | 197205 | High Altitude Conversion Kit   |       |
| 067749 | 201685 | 3 amp Fuse   |       |
| 086607 | 204611 | DSI Electrode Assembly for Model VR  |       |
| 073531 | 204955 | DSI Ignition Control   |       |
| 123105 | 257531 | UDAP Circuit Board   |       |
| 133894 | 259521 | Time Delay Relay Kit   |       |
| 139262 | 262971 | Time Delay Relay Kit   |       |
| 036781 | CC2    | Vertical Vent Terminal/Combustion Air Inlet Assembly through Roof for UEAS Model |       |

Repair Parts



## Ruud Water Heater Repair Parts

### Water Heater Parts & Accessories

| Part # | Mfg #     | Description  | Price |
|--------|-----------|--|-------|
| 109636 | RTG-20040 | Ez-Link Cable Connects (2) Tankless Gas Water Heaters to Operate As One Unit |       |
| 074314 | AP12938   | 42" Aluminum Anode Rod   |       |
| 063009 | SP11309C  | 44" Resistor Magnesium Anode Rod   |       |
| 091619 | SP8371B   | 52" Anode Rod w/Resistor Flex  |       |
| 164493 | SP11526C  | Anode Rod - 0.900" x 44-3/8"   |       |
| 165325 | SP20717   | GHE Flame Sensor   |       |
| 063007 | SP11248R  | Dip Tube   |       |
| 113598 | SP6830    | Adapt-O-Flange   |       |
| 216119 | SP20260K  | GHE Display & Control Board  |       |
| 219461 | SP20364   | Advantage Plus Service Kit - 160,000 BTU/HR                                  |       |
| 213463 | SP20365   | Advantage Plus Service Kit - 199,000 BTU/HR                                  |       |
| 190943 | AP13044   | 21"x21"x16" Water Heater Stand   |       |
| 190942 | AP67089   | Gasket - Element   |       |
| 096635 | SP20003   | Nipples - Heat Trap  |       |

### Blower Assembly

| Part # | Mfg #    | Description  | Price |
|--------|----------|--|-------|
| 100247 | AP13416  | Blower Assembly for 40/50 gal PowerVent Units      |       |
| 133976 | SP13605  | Blower Assembly for 40/50 gal PowerVent Units      |       |
| 137367 | AP151091 | Blower Assembly for 40/50 gal Tall PowerVent Units |       |

### Control

| Part # | Mfg #    | Description  | Price |
|--------|----------|--|-------|
| 159000 | SP20231  | Gas Control (Thermostat) - NG                                  |       |
| 164454 | SP20233  | Gas Control(Thermostat) - LP                                   |       |
| 113853 | SP20161A | Natural Gas Wiper Control & Gas Valve Assembly for PowerVent 2 |       |
| 113854 | SP20162A | LP Gas Wiper Control & Gas Valve Assembly for PowerVent 2      |       |
| 120504 | SP20170A | Natural Gas FV Wiper Control & Gas Valve Assembly              |       |
| 120505 | SP20170B | Natural Gas FV Wiper Control & Gas Valve Assembly              |       |
| 101157 | SP20123B | FV Wiper Electronics   |       |

### OEM Screw-In Elements - 1-1/2" Copper

- Specifically designed for Marathon and Eclipse Water Heaters
- Includes gasket
- Low Watt Density



| Part # | Mfg #     | Description               | Price |
|--------|-----------|---------------------------|-------|
| 116994 | SP10698MH | 240V/4500W, 12.33" Length |       |
| 095422 | SP610160  | 240V/4500W, 13.38" Length |       |

### OEM Screw-In Elements - 1-1/2" Titanium

- Specifically designed for Marathon and Eclipse Water Heaters
- Includes gasket
- Low Watt Density



| Part # | Mfg #    | Description               | Price |
|--------|----------|---------------------------|-------|
| 141163 | SP213790 | 240V/4500W, 14" Length    |       |
| 238106 | SP213820 | 240V/3800W, 14" Length    |       |
| 132919 | SP213670 | 240V/4500W, 16.5" Length  |       |
| 111268 | SP210198 | 240V/3800W, 16.46" Length |       |

### OEM Screw-In Elements - 1" Stainless Steel



| Part # | Mfg #     | Description               | Price |
|--------|-----------|---------------------------|-------|
| 063478 | SP10867JL | 208V/3000W, 12.38" Length |       |

### Electric Water Heater Tune-Up Kit

- Includes:
  - (2) Screw-in elements (AP10552MH-4)
  - Electric thermostat (AP11695-4)
  - Electric thermostat (AP11698-5)
  - (2) Element gaskets (AP6708-9)
  - Tune-up kit back card (PD991176)
  - Tune-up kit blister (PD991231)
  - Front card (PD991234)
- For use with PD137981 and SP13266



| Part # | Mfg #   | Description | Price |
|--------|---------|-------------|-------|
| 140554 | SP20060 | 240V/4500W  |       |

Repair Parts



## Ruud Water Heater Repair Parts

### Electric Water Heater Elements Copper - R-Tech

- Screw-in elements - 1 Inch  
-Fits most water heaters with 1" NPSM threads
- R-Tech - Features a patented restored design that increased the life of both the element and water heater tank
- Watt Density Guide - lower watt density means the element stays cooler and will last longer  
-LWD: low watt density (100 watts/in<sup>2</sup> or less)  
-MWD: medium watt density (101-150 watts/in<sup>2</sup>)  
-HWD: high watt density (over 150 watts/in<sup>2</sup>)



| Part # | Mfg #     | Description              | Price |
|--------|-----------|--------------------------|-------|
| 126122 | SP10552JH | 240V/3000W, 10-5/8" HWD  |       |
| 063001 | SP10552KL | 240V/3500W, 13-3/8" LWD  |       |
| 078390 | SP10552ML | 240V/4500W, 13-3/4" LWD  |       |
| 063002 | SP10552MH | 240V/4500W, 13-5/8" HWD  |       |
| 063000 | SP10552PH | 240V/5500W, 13-1/2" HWD  |       |
| 076289 | SP10552QH | 240V/6000W, 11-3/4" HWD  |       |
| 062998 | SP10874FH | 120V/1500W, 7-11/16" HWD |       |
| 062997 | SP10874GH | 120V/2000W, 7-11/16" HWD |       |
| 062996 | SP10874HH | 120V/2500W, 9-7/16" HWD  |       |

### Electric Water Heater Elements Stainless Steel - R-Tech

- Screw-in elements - 1 Inch  
-Fits most water heaters with 1" NPSM threads
- R-Tech - Features a patented restored design that increased the life of both the element and water heater tank
- Watt Density Guide - lower watt density means the element stays cooler and will last longer  
-LWD: low watt density (100 watts/in<sup>2</sup> or less)  
-MWD: medium watt density (101-150 watts/in<sup>2</sup>)  
-HWD: high watt density (over 150 watts/in<sup>2</sup>)



| Part # | Mfg #     | Description             | Price |
|--------|-----------|-------------------------|-------|
| 063479 | SP10867LL | 208V/4000W, 10.08", LWD |       |
| 063481 | SP10867NL | 208V/5000W, 19.25", LWD |       |
| 063486 | SP10869ML | 240V/4500W, 15-1/2" LWD |       |
| 190941 | SP10869KL | 240V/3500W, 13-1/2" LWD |       |
| 073434 | SP10869MM | 240V/4500W, 13-1/2" MWD |       |
| 063480 | SP10867ML | 208V/4500W, 17.58" LWD  |       |
| 063482 | SP10867QL | 208V/6000W, 19-1/4" LWD |       |
| 073434 | SP10869MM | 240V/4500W, 13-1/2" LWD |       |
| 063488 | SP10869QL | 240V/6000W, 19-1/8" LWD |       |
| 063494 | SP10870NL | 480V/5000W 19.28", LWD  |       |
| 063493 | SP10870ML | 480V/4500W 17.63" LWD   |       |
| 063495 | SP10870QL | 480V/6000W 19.21" LWD   |       |

### Heating Element Wrench

- Allows use of screwdriver for additional leverage



| Part # | Mfg #     | Description              | Price |
|--------|-----------|--------------------------|-------|
| 063006 | SP35871AB | Fits 1-1/2" Hex          |       |
| 169225 | PT49057   | Fits 1-1/2" & 1-7/8" Hex |       |

### Igniter

| Part # | Mfg #    | Description   | Price |
|--------|----------|---|-------|
| 063860 | SP10972  | Hot Surface Igniter                                 |       |
| 108321 | SP12143  | Igniter for Advantage Plus Comm Water Heaters       |       |
| 064395 | SP12560B | Spark Igniter & Pilot Assembly (LP) for PowerVent 2 |       |
| 064396 | SP12560C | Spark Igniter & Pilot Assembly (LP) for PowerVent 2 |       |
| 064393 | SP12562  | High Performance Blower Assembly for PowerVent 2    |       |
| 100162 | SP13447B | Flammable Vapor Sensor/FV Wiper Replacement Kit     |       |
| 129324 | SP14218A | Igniter for PowerVent Units                         |       |
| 109619 | SP14218B | Igniter for PowerVent Units                         |       |
| 146883 | SP20307  | Piezo Igniter                                       |       |

### Pilot Assembly

| Part # | Mfg #    | Description                  | Price |
|--------|----------|------------------------------|-------|
| 104045 | SP13418  | Pilot Assembly - Natural Gas |       |
| 117788 | SP13422  | Pilot Assembly - Natural Gas |       |
| 177859 | SP13884A | Pilot Tube Assembly Kit      |       |
| 190075 | SP13884H | Pilot Assembly Kit - NG 12"  |       |
| 170382 | SP20305A | Pilot Assembly - Natural Gas |       |

### Switch

| Part # | Mfg #   | Description                     | Price |
|--------|---------|---------------------------------|-------|
| 128923 | AP12767 | On/Off Switch                   |       |
| 063577 | SP11875 | Vacuum Switch                   |       |
| 065175 | SP12766 | Pressure Switch for PowerVent 2 |       |
| 101155 | SP20116 | Vacuum Switch for PowerVent     |       |

## Ruud Water Heater Repair Parts

### Thermostat

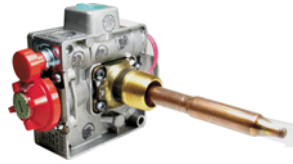

| Part # | Mfg #   | Description  | Price |
|--------|---------|--|-------|
| 131662 | SP20164 | Gas Control Thermostat, Natural Gas for Use with 2LAC9 |       |

### Gas Control (Thermostat) - LP



| Part # | Mfg #    | Description    | Price |
|--------|----------|----------------|-------|
| 156423 | SP20304B | LP Gas Control |       |

### Gas Control Assembly

- Rheem/Ruud replacement gas control thermostat
- For PowerVent Models only



| Part # | Mfg #   | Description   | Price |
|--------|---------|---|-------|
| 159000 | SP20231 | 6"x6"x4" Replacement Gas Control for PowerVent Models |       |

### Gas Control (Thermostat) - NG



| Part # | Mfg #    | Description         | Price |
|--------|----------|---------------------|-------|
| 180874 | AP14270C | Natural Gas Control |       |

### 2-Pole High Limit - Normally closed Thermostat Contacts (TOD)

- Upper Thermostat in residential electric water heaters
- With Simultaneous design:  
-Both elements are on at the same time



| Part # | Mfg #   | Description                    | Price |
|--------|---------|--------------------------------|-------|
| 063011 | SP11699 | 240V Single Element Thermostat |       |

### 2-Pole High Limit - Normally Open & Normally Closed Thermostat Contacts (TOD)

- Upper thermostat for residential electric water heaters
- Non-Simultaneous element operation
- 59T/66T Series



| Part # | Mfg #    | Description                                    | Price |
|--------|----------|--|-------|
| 063013 | SP11698  | Upper Thermostat, 90° to 150° Adjustment Range |       |
| 135205 | SP210245 | Upper Thermostat, 80° to 140° Adjustment Range |       |

### 1-Pole High Limit - Normally Closed Thermostat Contacts (TOD)

- Commonly used for 120V residential water heaters with only one element
- 59T/66T Series



| Part # | Mfg #   | Description                                    | Price |
|--------|---------|--|-------|
| 063004 | SP11700 | Upper Thermostat, 90° to 150° Adjustment Range |       |

### Electric Thermostats w/o High Limit Control (TOD)

- Used as the lower Thermostat in residential electric water heaters
- 59T Series



| Part # | Mfg #    | Description                                     | Price |
|--------|----------|---|-------|
| 063012 | SP11695  | Lower Thermostat, 90° to 150° Adjustment Range  |       |
| 141066 | SP210239 | Lower Thermostat, 90° to 150° Adjustment Range  |       |
| 111142 | SP310020 | Lower Thermostat, 110° to 170° Adjustment Range |       |



## Ruud Water Heater Repair Parts

### Robertshaw Thermostat

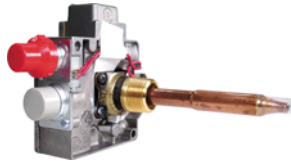

| Part # | Mfg #    | Description  | Price |
|--------|----------|--|-------|
| 063016 | SP12258B | LP Gas, 57° - 160° Control Valve with LH Main Burner |       |

### Thermostat Shank



| Part # | Mfg #    | Description                 | Price |
|--------|----------|-----------------------------|-------|
| 147598 | AP14696A | Thermostat Shank - 1.926    |       |
| 139027 | AP14696B | Thermostat Shank - 2.870 PV |       |

### Thermocouple



| Part # | Mfg #   | Description      | Price |
|--------|---------|------------------|-------|
| 063005 | SP6379R | 24" Thermocouple |       |

### Valve

| Part # | Mfg #      | Description   | Price |
|--------|------------|---|-------|
| 076815 | AP12575B-1 | 3/4" T&P Valve for FVIR Long Shaft                      |       |
| 171596 | AP14838G   | T&P Valve   |       |
| 063423 | SP11652B   | Natural Gas Valve                                       |       |
| 109615 | SP13845A   | Natural Gas Intelli-Vent Valve for PowerVent Units      |       |
| 109616 | SP13845B   | Natural Gas Intelli-Vent Valve for PowerVent Units      |       |
| 109617 | SP13846A   | LP Gas Intelli-Vent Valve for PowerVent Units           |       |
| 109618 | SP13846B   | LP Gas Intelli-Vent Valve for PowerVent Units           |       |
| 127436 | SP20167C   | LP Gas Valve and Thermostat                             |       |
| 129691 | SP623336   | Vacuum Relief Valve Assembly for Marathon Water Heaters |       |
| 133902 | SP20171A   | Gas Control Thermostat Kit                              |       |
| 159270 | SP20303A   | Nat Gas Control Thermostat Kit                          |       |

### Vent Damper

| Part # | Mfg #    | Description               | Price |
|--------|----------|---------------------------|-------|
| 108929 | AP13142  | Vent Hood Damper Assembly |       |
| 250648 | AP131432 | Vent Hood Damper Assembly |       |

### Warranty Upgrade

| Part # | Mfg #   | Description                            | Price |
|--------|---------|--|-------|
| 078740 | SP20079 | Protection Plus 4-Year Kit             |       |
| 234916 | SP20866 | Protection Plus Warranty Extension Kit |       |

### Flammable Vapor Ignition Resistant (FVIR) Parts

#### Robertshaw Part



SP20064

| Part # | Mfg #   | Description                  | Price |
|--------|---------|------------------------------|-------|
| 073470 | SP20065 | Pilot Assembly - Natural Gas |       |
| 082616 | SP20075 | Pilot Assembly - Natural Gas |       |
| 097155 | SP20055 | Piezo & Pilot Assembly Kit   |       |

#### White-Rodgers Part

| Part # | Mfg #    | Description                      | Price |
|--------|----------|----------------------------------|-------|
| 109602 | SP14270G | Gas Valve - Natural Gas          |       |
| 109603 | SP14270H | Gas Valve - Natural Gas          |       |
| 109607 | SP14269A | Gas Valve - LP Gas               |       |
| 109609 | SP14269E | Gas Valve - LP Gas               |       |
| 109611 | SP20127  | Pilot Assembly Kit - Natural Gas |       |
| 109612 | SP20128  | Pilot Assembly Kit - LP Gas      |       |

#### Common Service Part

| Part # | Mfg #    | Description   | Price |
|--------|----------|---|-------|
| 073471 | SP20064  | Thermocouple Kit  |       |
| 082082 | SP12112G | Electric Drain Valve  |       |
| 073962 | SP12112S | Brass Drain Valve   |       |
| 082825 | SP8346   | Watts 100XL, 3/4", 150 psi, 100,000 BTU Temperature & Pressure Relief Valve |       |
| 073469 | SP20063  | Gasket Kit  |       |



## Ruud Water Heater Repair Parts

### Commercial Water Heater Parts

| Part # | Mfg #      | Description  | Price |
|--------|------------|--|-------|
| 069329 | AP12231B-1 | 3/4" NPT Brass Drain Valve                         |       |
| 144116 | AP9013D    | 130 to 199K Temperature and Pressure Relief Valve  |       |
| 144117 | AP9012B    | 250 to 400K Temperature and Pressure Relief Valve  |       |
| 065179 | SP10963D   | Natural Gas Valve                                  |       |
| 073418 | AP12015-1  | Thermostat and High Limit                          |       |
| 082771 | AP12841    | 3-Pole Contractor                                  |       |
| 144111 | AP14074-3  | Temperature Sensor                                 |       |
| 144120 | AP14157-3  | GHE Blower Control Harness                         |       |
| 145841 | AP14159-5  | GHE Gas Valve Harness                              |       |
| 144112 | AP14280-1  | Exhaust Temperature Flue Sensor                    |       |
| 209545 | AP14720    | FV Sensor Harness                                  |       |
| 144118 | AP14758    | Display Jumper Harness                             |       |
| 144128 | AP14859    | Diffuser Nipple                                    |       |
| 144124 | AP15261    | Ground Wire Harness                                |       |
| 143193 | RTG20224A  | Commercial Upgrade Chip for RTGH-95DVN Natural Gas |       |
| 075285 | SP12142    | ECO/Temperature Probe                              |       |
| 073486 | SP12144    | Flame Rectification Probe                          |       |
| 073495 | SP12189    | Combustion Blower                                  |       |
| 148468 | SP15138    | Burner Mounting Flange Gasket                      |       |
| 073485 | SP12140    | Pressure Switch                                    |       |
| 065181 | SP10764B   | Pilot Assembly for Natural Gas Units               |       |
| 065180 | SP11798B   | High Limit Thermostat                              |       |
| 065178 | SP12234B   | Commercial Light Duty Gas Thermostat               |       |
| 063119 | SP5886     | Hand Hole Gasket                                   |       |
| 084096 | SP8293     | Therm-O-Disc Upper Thermostat                      |       |
| 073160 | SP8295     | Therm-O-Disc Lower Thermostat                      |       |
| 065182 | SP10763C   | Ignition Control                                   |       |
| 093329 | SP8828D    | Ignition Cable                                     |       |
| 131606 | RTG20210   | Horizontal Vent Termination Kit                    |       |

Repair Parts



**Schwank Repair Parts**

**Tube Heater Parts**

| Part # | Mfg #      | Description  | Price |
|--------|------------|--|-------|
| 129015 | JA-0528-XX | 4" Horizontal Flue Vent Terminal                     |       |
| 130962 | JA-0568-XX | 24VAC DSI Control                                    |       |
| 134135 | JA-0571-KT | DSI Tube Heater Igniter & Gasket                     |       |
| 129442 | JA-0775-XX | 120/24V, 20VA Transformer                            |       |
| 129441 | JL-0703-AA | LP Gas Valve   |       |
| 147558 | JL-0771-XX | 1/2" x 24" SS Flexible Gas Connector                 |       |
| 147560 | JL-0771-YY | 3/4" x 36" SS Flexible Gas Connector                 |       |
| 129016 | JL-0772-XX | Dual Scale Line Voltage Thermostat                   |       |
| 129010 | JL-0798-SH | 1-7/8" 'S' Hook - 25/Pk                              |       |
| 136512 | JL-0800-SH | 2" Safety Snap Hook - 24/Pk                          |       |
| 129009 | JL-0798-JC | 50' Box of #8 Jack Chain                             |       |
| 136510 | JL-0800-XX | 200' Roll of #2 Lion Chain                           |       |
| 130761 | JM-0303-KT | 24V Transformer/Relay Kit                            |       |
| 129018 | JS-0508-SM | 90° Aluminum Steel Elbow Kit                         |       |
| 129962 | JS-0532-SE | 4" Fresh Air Intake Adapter                          |       |
| 129012 | JS-0532-VC | 4" Outside Air Intake Wall Vent Hood with Birdscreen |       |
| 129452 | JS-0568-KT | 24V Thermostat Control Relay Kit                     |       |
| 129447 | JS-0576-AA | Air Proving Switch - .85" WC                         |       |
| 129444 | JS-0576-XX | Air Proving Switch - .48" WC                         |       |
| 129445 | JS-0576-YY | Air Proving Switch - .30" WC                         |       |
| 129450 | JS-0577-SS | Blocked Flue Switch - .58" WC                        |       |
| 129448 | JS-0577-ZZ | Blocked Flue Switch - 1.41" WC                       |       |
| 129449 | JS-0577-YY | Blocked Flue Switch - .90" WC                        |       |
| 134136 | JS-0518-XX | 24" High Voltage Ignition Cable                      |       |

**Sloan Repair Parts**

**Manual Flushometer Parts  
Royal Flushometer Parts**

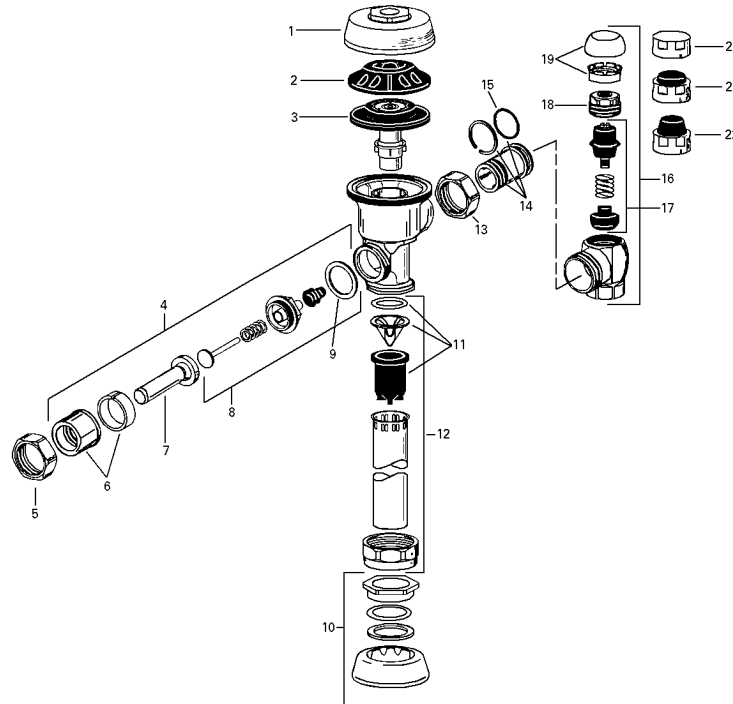

| Part # | Mfg #   | Model     | Ref  | Description   | Price |
|--------|---------|-----------|------|---|-------|
| 083761 | 3301503 | A-1042-A  |      | Repair Kit Royal 1.0 gpf Dual Filter Diaphragm Kit          |       |
| 036284 | 3301070 | A-1101-A  | 3-5  | Rebuild Kit 1.6 gpf - Closet Exposed                        |       |
| 036283 | 3301071 | A-1102-A  | 3-6  | Rebuild Kit 3.5 gpf - Closet Exposed                        |       |
| 036282 | 3301074 | A-1107-A  | 3-9  | Rebuild Kit 1.0 gpf - Urinal Exposed                        |       |
| 036291 | 3301075 | A-1108-A  | 3-10 | Rebuild Kit 1.5 gpf - Urinal Exposed                        |       |
| 010092 | 5301188 | A-156-A   | 5    | Diaphragm   |       |
| 010097 | 5301139 | A-31      | 9    | Handle Gasket   |       |
| 021329 | 0301082 | A-6       | 5    | Handle Coupling, CP   |       |
| 010107 | 0301168 | A-71      | 2    | Inside Cover  |       |
| 010108 | 0301172 | A-72      | 1    | Outside Cover, CP   |       |
| 010112 | 5302279 | B-32-A    | 4-2  | Handle Assembly   |       |
| 036285 | 3302306 | B-51-A    | 8    | Handle Repair Kit   |       |
| 010119 | 0302390 | B-73-A    | 4-1  | Handle Assembly   |       |
| 010137 | 0306146 | F-5-AT    | 10-3 | 1-1/2" Spud Coupling, CP                                    |       |
| 010138 | 0306140 | F-5-AU    | 10-2 | 1-1/4" Spud Coupling, CP                                    |       |
| 010136 | 0306125 | F-5-AW    | 10-1 | 3/4" Spud Coupling, CP                                      |       |
| 020801 | 3308790 | H-1009-A  | 19-2 | 3/4" Vandal Resistant Stop Cap For H-700-A                  |       |
| 010148 | 3308853 | H-541-ASD | 17-1 | 1" Screwdriver Stop Repair Kit                              |       |
| 010149 | 3308856 | H-543-ASD | 17-2 | 3/4" Screwdriver Stop Repair Kit                            |       |
| 010150 | 0308801 | H-551-A   | 14   | 2-1/16" Tail Assembly, CP                                   |       |
| 010152 | 5308696 | H-553     | 15   | O-Ring  |       |
| 010154 | 0308848 | H-582     | 20-2 | 3/4" Cap, CP  |       |
| 028922 | 3308386 | H-700-A   | 16-2 | 1" Adjustable Screwdriver Stop w/Vandal Resistant Cap #19-2 |       |

Repair Parts

**Sloan Repair Parts**

**Manual Flushometer Parts (Continued)**

**Royal Flushometer Parts**

| Part # | Mfg #   | Model    | Ref  | Description                    | Price |
|--------|---------|----------|------|--------------------------------|-------|
| 036290 | 3393004 | V-600-AA | 12-1 | 3/4" x 9" Vacuum Breaker, CP   |       |
| 036288 | 3393006 | V-600-AA | 12-1 | 1-1/4" x 9" Vacuum Breaker, CP |       |
| 036287 | 3393007 | V-600-AA | 12-3 | 1-1/2" x 9" Vacuum Breaker, CP |       |
| 036286 | 3323182 | V-651-A  | 11   | Vacuum Breaker Repair Kit      |       |

**Regal Flushometer Parts**

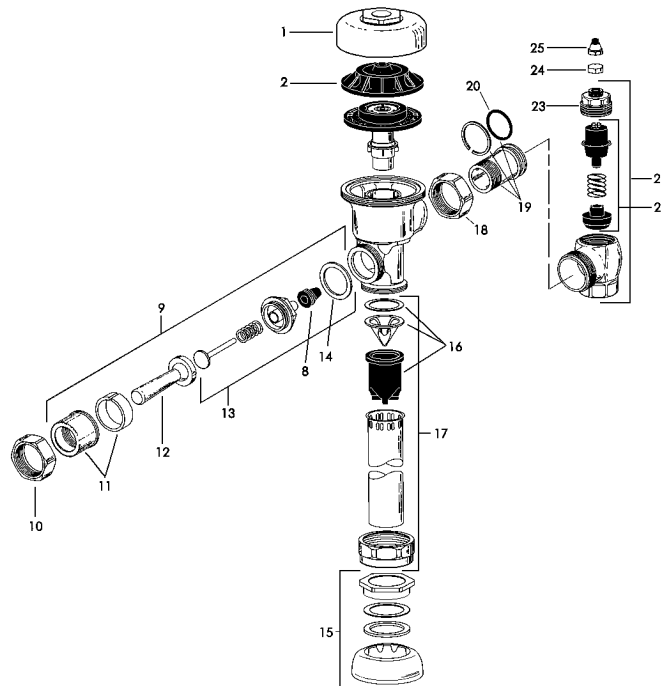

**7. INSIDE PARTS KITS**

|  |   |  |   |   |   |   |
|--|---|--|---|---|---|---|
|  |   |  |   |   |   |   |
| <b>A-36-A</b><br>3301036<br>4.5 gpf/17.0 Lpf<br>CLOSET | <b>A-37-A</b><br>3301037<br>1.5 gpf/5.7 Lpf<br>URINAL | <b>A-38-A</b><br>3301038<br>3.5 gpf/13.2 Lpf<br>CLOSET | <b>A-41-A</b><br>3301041<br>1.5 gpf/6.0 Lpf<br>CLOSET | <b>A-42-A</b><br>3301044<br>1.0 gpf/3.8 Lpf<br>URINAL | <b>A-43-A</b><br>3301081<br>0.5 gpf/1.9 Lpf<br>URINAL | <b>A-44-A</b><br>3301024<br>2.4 gpf/9.0 Lpf<br>CLOSET |

| Part # | Mfg #   | Model    | Ref      | Description  | Price |
|--------|---------|----------|----------|--|-------|
| 010091 | 5301111 | A-15-A   | 4        | Molded Disc  |       |
| 010093 | 5301189 | A-156-AA | 4,5,8,14 | Diaphragm Repair                                   |       |
| 010094 | 5301236 | A-163-A  | 6A       | Guide Assembly for 4.5 gpf Closet & 1.5 gpf Urinal |       |
| 010095 | 5301058 | A-19-AC  | 3A       | Relief Valve Closet                                |       |

**Sloan Repair Parts**

**Manual Flushometer Parts (Continued)**

**Regal Flushometer Parts**

| Part # | Mfg #   | Model    | Ref  | Description                    | Price |
|--------|---------|----------|------|--------------------------------|-------|
| 010096 | 5301059 | A-19-AU  | 3B   | Relief Valve Urinal            |       |
| 010098 | 3301036 | A-36-A   | 7A   | 4.5 gpf Closet Repair Kit      |       |
| 010099 | 3301037 | A-37-A   | 7B   | 1.5 gpf Urinal Repair Kit      |       |
| 010100 | 3301038 | A-38-A   | 7C   | 3.5 gpf Water Saver Repair Kit |       |
| 010101 | 3301041 | A-41-A   | 7D   | 1.6 gpf Closet Repair Kit LC   |       |
| 010102 | 3301044 | A-42-A   | 7E   | 1.0 gpf Urinal Kit LC          |       |
| 010113 | 5302297 | B-39     | 8    | Seal                           |       |
| 010115 | 5302305 | B-50-A   | 13   | Handle Repair Kit              |       |
| 010141 | 5308156 | H-37     | 24   | Cap CP                         |       |
| 010176 | 5323005 | V-500-AA | 17-1 | 3/4" x 9" Vacuum Breaker CP    |       |
| 010182 | 5323006 | V-500-AA | 17-2 | 1-1/4" x 9" Vacuum Breaker CP  |       |
| 010178 | 5323007 | V-500-AA | 17-3 | 1-1/2" x 9" Vacuum Breaker CP  |       |

**Piston Operated Flushometers**

**GEM 2® Piston Operated Flushometers**

- Fixed volume piston with filtered O-ring by-pass
- ADA Compliant metal oscillating handle
- Vandal-resistant stop cap
- Adjustable tailpiece
- Vacuum breaker flush connection
- High copper, low zinc brass castings for dezincification resistance
- Non-hold-open handle and no external volume adjustment to ensure water conservation
- Handle packing, stop seat and vacuum breaker molded from PERMEX™ rubber compound for chloramine resistance



**GEM 2 Repair Kit**

| Part # | Mfg #   | Model  | Description             | Price |
|--------|---------|--------|-------------------------|-------|
| 112656 | 5307074 | G-50-A | Handle Repair Kit, 6/Pk |       |

**Sloan Repair Parts**

**Sensor Operated Flushometer Parts**  
**OptimaPlus® Flushometer Parts**

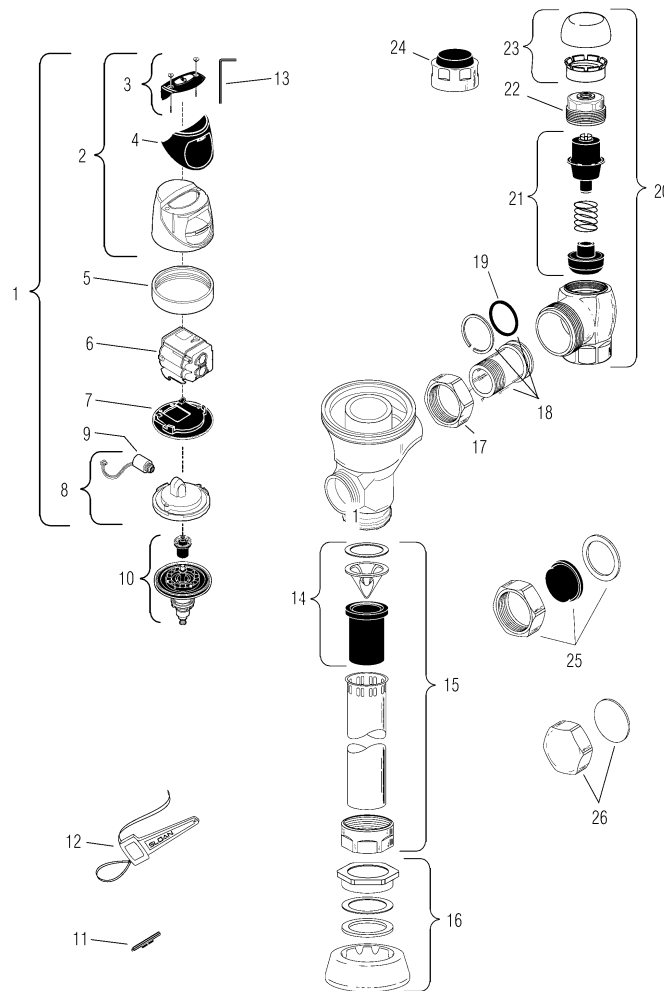

| Part # | Mfg #   | Model       | Ref | Description  | Price |
|--------|---------|-------------|-----|--|-------|
| 057970 | 3301500 | EBV-12      |     | Diaphragm Only Kit                                       |       |
| 066898 | 3325001 | EBV-1020-A  | 10  | 1.6 Flex Tube Diaphragm Inside Part Kit                  |       |
| 066899 | 3325000 | EBV-1022-A  | 10  | OptimaPlus Repair Kit, 1.0, 1.5 Urinal                   |       |
| 093722 | 3325450 | EBV-129-A-C | 6   | G2 Electronic Module - Water Closet                      |       |
| 084024 | 3325451 | EBV-129-A-U | 6   | G2 Electronic Module - Urinal                            |       |
| 100551 | 0325172 | EBV-130-A   | 3   | G2 Override Button Assembly                              |       |
| 080085 | 3325453 | EBV-136-A   | 9   | Isolated Solenoid  |       |
| 130178 | 0325160 | EBV-138-A   | 1   | G2 Cover/Ring/Sensor Assembly - Water Closet             |       |
| 085884 | 3325462 | EBV-144-A   | 9   | Isolated Solenoid Operator                               |       |
| 071385 | 0325176 | EBV-146-A-C |     | G2 Electronic Module Optima 1.6 - Closet                 |       |
| 071242 | 0325177 | EBV-146-A-U |     | G2 Sensor Module Urinal                                  |       |
| 028637 | 5325813 | EBV-18      |     | Quad Ring  |       |
| 022200 | 3325013 | EBV-60-A    |     | Metal Cover Assembly with Override Button - Water Closet |       |

Repair Parts

**Sloan Repair Parts**

**Sensor Operated Flushometer Parts (Continued)**

**OptimaPlus® Flushometer Parts**

| Part # | Mfg #   | Model    | Ref | Description                          | Price |
|--------|---------|----------|-----|--------------------------------------|-------|
| 057264 | 0305118 | EL-165-2 |     | Solenoid Coil, 24VAC                 |       |
| 049083 | 0305165 | EL-163-A |     | Sloan Solenoid Assembly              |       |
| 010216 | 3308855 | H-541-AA | 21  | 1" Screwdriver Angle Stop Repair Kit |       |

**Flush Valve Transformer**



| Part # | Mfg #   | Model  | Description                             | Price |
|--------|---------|--------|---|-------|
| 010126 | 0345154 | EL-154 | 120VAC/24VAC, 50/60Hz (50VA), Box-Mount |       |

**Optima® Flushometer Parts**

**110/111/115/116/140/152/153 ES-S**

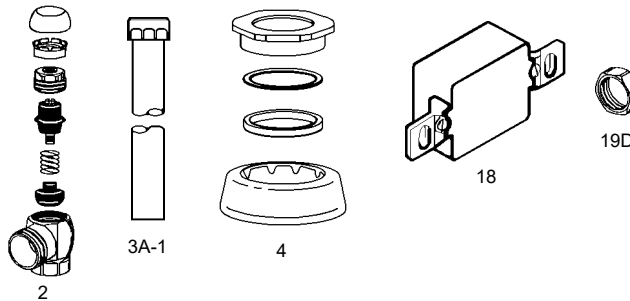

| Part # | Mfg #   | Model     | Ref | Description                | Price |
|--------|---------|-----------|-----|----------------------------|-------|
| 010125 | 3305621 | EL-1500-L | 18  | Sensor Repair Kit - Closet |       |

**Optima® Systems Solenoid/Sensor Parts and Assemblies List**

| Part # | Mfg #   | Model | Description | Price |
|--------|---------|-------|-------------|-------|
| 010123 | 0337086 | DO-22 | O-Ring      |       |

**Showerheads**

**Act-O-Matic**



| Part # | Mfg #   | Model | Description                              | Price |
|--------|---------|-------|--|-------|
| 010088 | 4020100 | AC-11 | 2.5 gpm Std Self-Cleaning Showerhead, CP |       |

Repair Parts

**Sloan Repair Parts**

**Needle Spray Showerhead Repair Kit**

- Kit includes:
  - Gasket
  - Spacer
  - Ball joint coupling
  - Flow control assembly



| Part # | Mfg #   | Model     | Description                      | GPF | Spud | Price |
|--------|---------|-----------|----------------------------------|-----|------|-------|
| 245242 | 4328466 | SH-1002-A | Needle Spray Showerhead Assembly |     |      |       |

**Replacement Parts and Accessories**

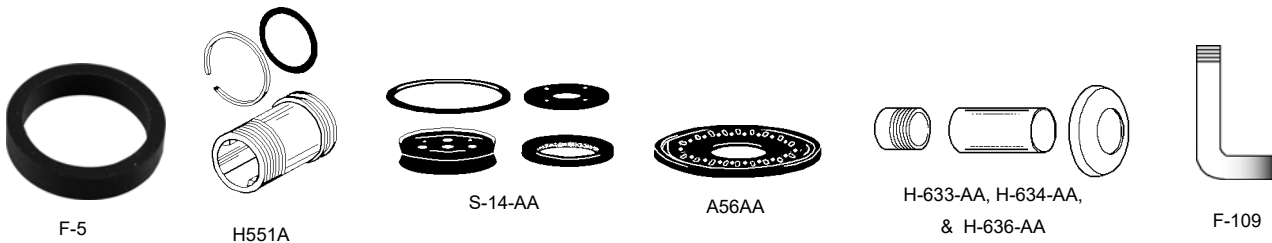

| Part # | Mfg #   | Model      | Description  | Price |
|--------|---------|------------|--|-------|
| 023238 | 3301077 | A-1008-A   | 3/4" Spud Coupling Kit   |       |
| 029505 | 3301079 | A-1010-A   | 1-1/2" Spud Coupling Kit   |       |
| 057971 | 3301501 | A-1038-A   | Closet Repair Kit  |       |
| 032380 | 0301104 | A-175-A    | Low Pressure Guide Repair Kit (P-600-EGL)                                  |       |
| 045723 | 0301178 | A-19-ALCM  | Closet Relief Valve, Brass LC  |       |
| 010103 | 0301255 | A-50       | Super Wrench   |       |
| 010104 | 5301170 | A-56-A     | Segment Diaphragm w/A-29 Copper Gasket                                     |       |
| 010105 | 5301176 | A-56-AA    | Diaphragm Repair   |       |
| 010122 | 3303398 | C-70-A     | Push Button For Concealed Royal & Crown - Contains #7-11                   |       |
| 032633 | 3305043 | EL-128-A   | Actuator Cartridge   |       |
| 019381 | 3305620 | EL-1500    | Urinal Sensor Repair Kit   |       |
| 103862 | 3365092 | ETF-1023-A | Repair Kit .5gpm Male LF CP  |       |
| 028928 | 0396322 | F-109      | 1-1/2" x 21" x 5" Tubular Bend, CP   |       |
| 010134 | 5306055 | F-3        | 3/4" Red Friction Ring   |       |
| 010133 | 5306058 | F-3        | 1-1/2" Red Friction Ring   |       |
| 010135 | 5306113 | F-5        | 3/4" Slip Joint Gasket   |       |
| 020802 | 3308772 | H-1010-A   | 1" Vandal Resistant Stop Cap   |       |
| 010143 | 3308277 | H-47-AA    | Stop Repair Kit  |       |
| 010146 | 3308780 | H-533-AS   | Sweat Solder Kit For 1" Supply Closet & Urinal                             |       |
| 010147 | 3308786 | H-536-A    | 3/4" Sweat Adapter Kit   |       |
| 010151 | 0308803 | H-551-A    | 3-1/16" Long Adjustable Tailpiece, CP                                      |       |
| 034119 | 0308805 | H-551-A    | 4-1/16" Long Adjustable Tailpiece, CP                                      |       |
| 016687 | 5308850 | H-584      | Screwdriver Control Stop Seat Only For 1" H-540, H-600 & H-700 Series Stop |       |
| 043117 | 3308782 | H-633-AA   | Sweat Solder Kit 1" w/Cast Set Screw Flange (YBYC)                         |       |
| 111258 | 3308785 | H-634-AA   | Sweat Solder Kit 1", CP  |       |
| 084384 | 3308788 | H-636-AA   | Sweat Solder Kit 3/4" w/Cast Set Screw Flange (YBYC)                       |       |
| 010186 | 3323192 | V-551-A    | Vacuum Repair Kit  |       |
| 010159 | 0310083 | J-212-A    | 1-1/2" Solid Ring Pipe Support - 5 C/E Complete, CP                        |       |

Repair Parts

**Sloan Repair Parts**

**Replacement Parts and Accessories (Continued)**

| Part # | Mfg #   | Model   | Description               | Price |
|--------|---------|---------|---------------------------|-------|
| 010170 | 5319086 | S-30    | 1-1/2" Gasket             |       |
| 010175 | 3322079 | V-101-A | Vacuum Breaker Repair Kit |       |
| 010174 | 5322001 | VBF-5   | 1-1/2" Gasket             |       |
| 126485 | 345125  | EL-451  | Transformer 6V 25VA       |       |

**Vacuum Breaker**



| Part # | Mfg #   | Model    | Description                                | Price |
|--------|---------|----------|--|-------|
| 010179 | 0323014 | V-500-AA | 1-1/2" x 13-1/2", CP                       |       |
| 010180 | 0323015 | V-500-AA | 1-1/2" x 21-1/2", CP                       |       |
| 010181 | 0323016 | V-500-AA | 1-1/2" x 24-1/2"                           |       |
| 010183 | 0323020 | V-500-AA | 1-1/4" x 21-1/2"                           |       |
| 021735 | 0323057 | V-500-AA | 1-1/2" x 32-1/2"                           |       |
| 010184 | 0323210 | V-500-AA | 3/4" x 15", CP                             |       |
| 010185 | 5323010 | V-500-A  | 1-1/2" x 11-1/2", RB (140 ES-S & 152 ES-S) |       |



**Sloan Repair Parts**

**FLUSHMATE® Replacement Parts**



BU100505-K



C-100500-K

| Part # | Mfg #        | Description   | Price |
|--------|--------------|---|-------|
| 080376 | B-108288     | Duckbill Valve (Air Inducer) Allows Air Into Tank but Not Out                 |       |
| 046465 | BL100504-3-K | Lower Supply Kit for 503 & 504 Series   |       |
| 046464 | BU100505-K   | Upper Supply Kit for Flushmate Pressurized Tank                               |       |
| 010120 | C-100500-K   | Flush Cartridge for All Flushmate Series                                      |       |
| 120907 | M-101526-F31 | Pressure-Assist Flush 1.6 gpf System for 503 Series Tanks Except Kohler K4404 |       |
| 046467 | RK100100     | Replacement Supply System for All Series Except 503 & 504                     |       |

Repair Parts

---

---

**Speakman Repair Parts**

---

---

**Speakman® Parts**

| Part # | Mfg #        | Description                   | Price |
|--------|--------------|-------------------------------|-------|
| 068748 | RPG05-0520   | Vacuum Breaker Hub Repair Kit |       |
| 164331 | RPG05-0532CA | Hot side ceramic cartridge    |       |

## T & S Brass Repair Parts

### Handles



- Chrome-plated zinc handle
- B-WH models come with screw, all others, screw is sold separately

| Part # | Mfg #     | Description             | Price |
|--------|-----------|-------------------------|-------|
| 010415 | 001636-45 | Lever Handle Cold Index |       |
| 010416 | 001637-45 | Lever Handle Hot Index  |       |

### Bonnet Assembly



| Part # | Mfg #     | Description          | Price |
|--------|-----------|----------------------|-------|
| 030182 | 002856-40 | B502 Bonnet Assembly |       |

### Swing Nozzles



| Part # | Mfg # | Description      | Price |
|--------|-------|------------------|-------|
| 044168 | 062X  | 12" Swing Nozzle |       |

### Spindle



002711-40



002712-40

| Part # | Mfg #     | Description                   | Price |
|--------|-----------|-------------------------------|-------|
| 010419 | 002711-40 | Cold Spindle 174A             |       |
| 010420 | 002712-40 | Hot Spindle 175A              |       |
| 028123 | 002713-40 | Eterna LH Spindle Assembly    |       |
| 028124 | 002714-40 | Eterna RH Spindle Assembly    |       |
| 085560 | 005960-40 | Eterna Spindle Assembly, Hot  |       |
| 110659 | 005959-40 | Eterna Spindle Assembly, Cold |       |

### Repair Kits



B-9K



B-10K

| Part # | Mfg #       | Description                        | Price |
|--------|-------------|------------------------------------|-------|
| 061402 | B-9K        | Lever Handle Kit                   |       |
| 010405 | B-10K       | Repair Kit for B-0107              |       |
| 046499 | B-21K       | Eterna Cartridge Replacement       |       |
| 107843 | B-39K       | Brass Rotary Waste Valve Parts Kit |       |
| 130038 | B-0969-RK01 | Vacuum Breaker Repair Kit          |       |
| 010409 | 001121-45   | Spray Face #1                      |       |

### Supply Nipple

- Brass

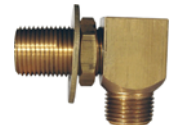

| Part # | Mfg #    | Description         | Price |
|--------|----------|---------------------|-------|
| 110214 | B-0230-K | Angle Supply Nipple |       |

### Waste Valve with Drain Adapter - Twist



| Part # | Mfg #  | Description                                  | Price |
|--------|--------|--|-------|
| 107844 | B-3940 | 3.0" Sink Opening, 1.5" or 2.0" Drain Outlet |       |
| 119775 | B-3950 | 3-1/2" x 2" & 1-1/2" Adapter                 |       |

### T&S Brass Parts

#### Flexible Stainless Steel Hose

- Heat resistant gray handle
- Polyurethane inner tubing
- 3/4-14 UN female outlet
- 3/4-14 UN female inlet
- Hose washers included
- Material: Polished chrome plated brass end fittings, thermoplastic handle and stainless steel hose



| Part # | Mfg #    | Description                  | Price |
|--------|----------|------------------------------|-------|
| 010404 | B-0044-H | 44" Flexible Stainless Steel |       |

### Washer



| Part # | Mfg #     | Description     | Price |
|--------|-----------|-----------------|-------|
| 010411 | 001041-45 | Spreader Washer |       |

Repair Parts

## T & S Brass Repair Parts

### T&S Brass Parts (Continued)

#### Washer

| Part # | Mfg #     | Description     | Price |
|--------|-----------|-----------------|-------|
| 022191 | 001092-45 | T&S Seat Washer |       |

### Wall Brackets

#### Wall Bracket

- Fits 3/8" pipe
- 2-1/4" Wall flange
- Polished chrome plated brass
- Chrome-plated mounting screws included



| Part # | Mfg #     | Size | Price |
|--------|-----------|------|-------|
| 033142 | B-0109-01 | 6"   |       |

### Parts & Accessories

| Part # | Mfg #     | Description                             | Price |
|--------|-----------|---|-------|
| 010417 | 018L      | Stem                                    |       |
| 010427 | 067L      | Stem                                    |       |
| 010426 | 066L      | Removable Insert                        |       |
| 010425 | 064L      | Removable Insert                        |       |
| 019815 | 003164-45 | Spring Check Seat Washer with Seat Disc |       |
| 208371 | 011355-45 | Overflow Tube                           |       |
| 208370 | 011356-45 | Waste Overflow Head                     |       |

## Taco Repair Parts

### Pro-Fit™ Replacement Parts

- For Bell & Gossett and Armstrong pumps

#### Coupler

- Rugged, cast zinc w/steel reinforced eyelets
- Heavy-duty spring
- Fits all 1/2" motor shafts
- Std Woods 3-J for all 5/8" motor shafts (opt 1/2" inserts included)



| Part # | Mfg #       | B&G Part #                  | Armstrong Part #                     | Price |
|--------|-------------|-----------------------------|--------------------------------------|-------|
| 079914 | COU-ABC-100 | 118705,189110,118712,118723 | 806026-001                           |       |
| 079915 | COU-D100    | 118473,118709               | 810120-003/006,806137-000,807436-000 |       |

**Thermolec Repair Parts**

**Parts & Accessories**

| Part # | Mfg #     | Description   | Price |
|--------|-----------|---|-------|
| 130137 | 10-02-005 | Magnetic B/U, 50A Spade Style Contactor               |       |
| 130139 | 10-02-006 | CCT-140 SPDT Diverting Valve Pump Relay               |       |
| 241766 | 16-04-250 | TH22 Conversion Kit                                   |       |
| 241767 | 16-04-300 | TH22 Controller                                       |       |
| 128230 | 17-02-102 | CBLR055 Incoloy Element 5kW, 240V                     |       |
| 121185 | 17-02-103 | CBLR060 Incoloy Element 5.75kW 240V                   |       |
| 130133 | 17-02-107 | CBLR130 Electronic Temperature. Sensor - Supply Water |       |
| 110489 | 17-02-110 | CBLR025 Mono Energy Control Board TH-600-M            |       |
| 130131 | 17-02-115 | CSR113 Solid State Relay SSR-20-DC                    |       |
| 130130 | 17-02-116 | CTR040 Control Transformer 30VA 240/24V               |       |

## Triangle Tube Repair Parts

### Prestige Parts

| Part # | Mfg #    | Description   | For:                | Price |
|--------|----------|---|---------------------|-------|
| 115737 | PSENS01  | Outdoor Sensor Kit  |                     |       |
| 093308 | PSSTND01 | Floor Stand   | PS110, PS175, PS250 |       |
| 107252 | PSSTND02 | Wall Kit, Recommended f/Hanging on Anything Other Than a Masonry Wall |                     |       |
| 107253 | PSSTND03 | Floor Stand Kit Use w/PSSTND02 Wall Kit                               | PE110 & PS399       |       |

### Electronic Components

| Part # | Mfg #    | Description                         | For:                 | Price |
|--------|----------|-------------------------------------|----------------------|-------|
| 091015 | PSRKIT04 | NTC Sensor                          | PS110, PS175 & PS250 |       |
| 091016 | PSRKIT13 | Blower Kit w/Gasket                 | PS110 & PS175        |       |
| 091019 | PSRKIT19 | Transformer with Surge Protection   | SOLO 110             |       |
| 114363 | PSRKIT20 | Control Module Display              | SOLO 110             |       |
| 118949 | PSRKIT50 | Control Module                      | SOLO 110             |       |
| 120439 | PSRKIT55 | Blower Kit w/Gasket                 | PS110                |       |
| 117640 | PSRKIT58 | MCBA Control Module Replacement Kit | PE110                |       |
| 138226 | PSRKIT63 | NTC3 Domestic Hot Water Sensor      | PE110                |       |

### Burner Components

| Part # | Mfg #    | Description      | For:     | Price |
|--------|----------|------------------|----------|-------|
| 091021 | PGRKIT01 | Gas Valve Kit    | PS110    |       |
| 091017 | PSRKIT15 | Igniter w/Gasket | SOLO 110 |       |
| 120440 | PSRKIT41 | Gas Valve        | SOLO 399 |       |

### Internal Components

| Part # | Mfg #    | Description            | For:     | Price |
|--------|----------|------------------------|----------|-------|
| 091020 | PGRKIT20 | Lwco Pressure Device   | SOLO 110 |       |
| 118581 | PSRKIT40 | 399 Blower with Gasket | SOLO 399 |       |

**Union Brass Repair Parts**

**Parts**  
**Valve Assemblies**

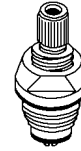

80038



80080

| Part # | Mfg # | Description                 | Price |
|--------|-------|-----------------------------|-------|
| 010503 | 80038 | 1837AC Cold Valve Assembly  |       |
| 051376 | 80080 | 1839A-C Cold Valve Assembly |       |



**Ruud Heating & AC Repair Parts**

**Blower Wheels**

**Blower Wheel**

- CW Rotating



| Part # | Mfg #       | Rotation   | Nom Size  | Overall Dia x Overall W | Hub  | Disc Shape (Hub Side) | # of Blades | Price |
|--------|-------------|------------|-----------|-------------------------|------|-----------------------|-------------|-------|
| 009619 | 70-18631-01 | CW         | 9" x 7"   | 9-1/2" x 7-1/8"         | 1/2" | Convex                | 43          |       |
| 024572 | 70-20218-02 | CW         | 10" x 7"  | 10-5/8" x 7-3/16"       | 1/2" | Convex                | 48          |       |
| 016858 | 70-18629-01 | CW         | 10" x 10" | 10-5/8" x 10-5/8"       | 1/2" | Concave               | 48          |       |
| 051174 | 70-23110-30 | CCW        | 10" x 10" | 10-5/8" x 10-3/4"       | 1/2" | Concave               | 48          |       |
| 030369 | 70-23111-05 | CW         | 11" x 7"  | 11-15/16" x 7-1/8"      | 1/2" | Concave               | 54          |       |
| 074404 | 70-23111-43 | CW         | 11" x 7"  | 11-15/16" x 7-1/8"      | 1/2" | Concave               | 54          |       |
| 049454 | 70-24254-02 | CW         | 11" x 7"  | 11-15/16" x 7-1/8"      | 1/2" | Convex                | 54          |       |
| 009622 | 70-20602-01 | CW         | 11" x 10" | 11-7/8" x 10-11/16"     | 1/2" | Concave               | 54          |       |
| 050595 | 70-24119-01 | CW         | 12" x 7"  | 12-3/4" x 7"            | 1/2" | Concave               | 43          |       |
| 086470 | 70-24179-01 | CW         | 12" x 11" | 12-25/32" x 11-1/8"     | 1/2" | Convex                | 43          |       |
| 019546 | 70-24041-01 | CW         | 12" x 11" | 12-3/4" x 11-1/8"       | 1/2" | Concave               | 43          |       |
| 051179 | 70-42540-02 | Reversible | 15" x 15" | 15" x 15"               | 1"   | Double Convex         | 51          |       |

**Compressors**

**R-410 Scroll Compressor**

**Copeland R-410A Air Conditioning Scroll Compressor - 208/230**

- Crankcase heater not included



| Part # | Mfg #           | Vendor #        | Capacity MBTUH | Run Capacitor | Start Capacitor | Start Kit | Kick Start | Crankcase Heater | Price |
|--------|-----------------|-----------------|----------------|---------------|-----------------|-----------|------------|------------------|-------|
| 113737 | 55-102045-14S   | ZP16K5E-PFV     | 15.5           | 30/370        | 88-106/330      | SK-A1     | 42-TO5     | 44-17402-44      |       |
| 113736 | 55-102045-01S   | ZP21K5E-PFV     | 21.3           | 40/370        | 88-106/330      | SK-A1     | 42-TO5     | 44-17402-44      |       |
| 113735 | 55-102045-02S   | ZP21K5E-PFV     | 21.3           | 40/370        | 88-106/330      | SK-A1     | 42-TO5     | 44-17402-44      |       |
| 113903 | 55-102045-31S   | ZP24K5E-PFV     | 24.0           | 40/370        | 88-106/330      | SK-A1     | 42-TO5     | 44-17402-44      |       |
| 113901 | 55-102045-03S   | ZP31K5E-PFV     | 31.0           | 45/370        | 88-106/330      | SK-A1     | 42-TO5     | 44-17402-44      |       |
| 131585 | 55-102045-17S   | ZP38K5E-PFV     | 37.5           | 45/370        | 175-216/330     | SK-A3     | 42-KS1     | 44-17402-45      |       |
| 113730 | 55-102045-09S   | ZP42K5E-PFV     | 42.0           | 70/370        | 88-106/330      | SK-A1     | 42-KS1     | 44-17402-45      |       |
| 113734 | 55-102045-15S   | ZP34K5E-PFV     | 34.0           | 45/370        | 88-106/330      | SK-A1     | 42-TO5     | 44-17402-45      |       |
| 113900 | 55-102045-26S   | ZP51K5E-PFV     | 51.0           | 70/370        | 175-216/330     | SK-A3     | 42-KS1     | 44-17402-45      |       |
| 175440 | 55-102045-27S   | ZP51K5E-TF5-830 | 51.0           | -             | -               | -         | -          | 44-17402-45      |       |
| 113729 | 55-102045-13S   | ZP54K5E-PFV     | 54.0           | 80/370        | 175-216/330     | SK-A3     | 42-KS1     | 44-17402-45      |       |
| 250959 | ZP49K5E-PFV-800 | ZP49K5E-PFV-800 | 49.400         | 70/370        | 88-106/330      | SK-A1     | 42-KS1     | 44-101884-08     |       |

Repair Parts

**Ruud Heating & AC Repair Parts**

**R-22 Scroll Compressor**

Copeland R-22 Air Conditioning Scroll Compressor - 208/230-1

**Copeland**  
good products



| Part # | Mfg #           | MBTUH* | Electrical   | RLA  | Max Dimensions<br>H x W x L | Stub Tube<br>Conn(ID")<br>Dischg, Suc | Mnt Dim<br>W x L | Price |
|--------|-----------------|--------|--------------|------|-----------------------------|---------------------------------------|------------------|-------|
| 133280 | ZR16K5E-PFV-800 | 20.3   | 208/230-1-60 | 9.3  | 15.86" x 9.50" x 9.50"      | 1/2", 3/4"                            | 7.5" x 7.5"      |       |
| 222707 | ZR21K5E-PFV-800 | 27.5   | 208/230-1-60 | 32.9 | 18.75" x 11.23" x 10.38"    | 22/25", 1-1/8"                        | 7.5" x 7.5"      |       |
| 133217 | ZR25K5E-PFV-800 | 32.8   | 208/230-1-60 | 15   | 15.86" x 9.50" x 9.50"      | 1/2", 3/4"                            | 7.5" x 7.5"      |       |
| 133806 | ZR28K5E-PFV-800 | 36.9   | 208/230-1-60 | 15.7 | 15.86" x 9.50" x 9.50"      | 1/2", 3/4"                            | 7.5" x 7.5"      |       |
| 222708 | ZR32K5E-PFV-800 | 42.6   | 208/230-1-60 | 17.1 | 15.86" x 9.50" x 9.50"      | 1/2", 3/4"                            | 7.5" x 7.5"      |       |
| 164723 | ZR34K5E-PFV-800 |        | 208/230-1-60 | 18.6 | 15-5/16"H                   | 1/2", 3/4"                            | 7.5" x 7.5"      |       |
| 180171 | ZR42K5E-PFV-800 | 54.8   | 208/230-1-60 | 22.1 | 16.94" x 9.56" x 9.59"      | 1/2", 7/8"                            | 7.5" x 7.5"      |       |
| 141164 | ZR54K5E-PFV-800 | 69.7   | 208/230-1-60 | 28.2 | 16.94" x 9.56" x 9.59"      | 1/2", 7/8"                            | 7.5" x 7.5"      |       |
| 139752 | ZR48K5E-PFV-800 | 48.2   | 208/230/1-60 | 24.3 | 16-7/16"H                   | 1/2", 7/8"                            | 7.5" x 7.5"      |       |
| 176782 | ZR61K3E-TF5-950 | 62     | 208/230-3-60 | 19.3 | 17-3/4"H                    | 1/2", 7/8"                            | 7.5" x 7.5"      |       |
| 168710 | ZR61K3E-PFV-950 | 62     | 208/230/1-60 | 32.1 | 17-3/8"H                    | 1/2", 7/8"                            | 7.5" x 7.5"      |       |

**Expansion Valves**

Thermal Expansion Valve

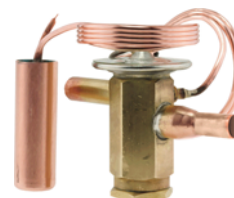

| Part # | Mfg #        | Description   | Price |
|--------|--------------|---|-------|
| 140730 | 611006       | 2T R-22 Expansion Valve                               |       |
| 140731 | 611007       | 3T R-22 Expansion Valve                               |       |
| 140732 | 611008       | 4T R-22 Expansion Valve                               |       |
| 140733 | 611009       | 5TR-22 Expansion Valve                                |       |
| 140734 | 611011       | 2T R-410A Expansion Valve                             |       |
| 140735 | 611012       | 3T R-410A Expansion Valve                             |       |
| 140736 | 611013       | 4T R-410A Expansion Valve                             |       |
| 134296 | 611064       | 3T R-410A To R-22 Conversion, Thermal Expansion Valve |       |
| 141976 | 61-103652-05 | 2T R-410A TX Expansion Valve                          |       |
| 236790 | 61-106238-37 | 5T TXV Expansion Valve                                |       |
| 131854 | 61-21922-46  | 1.5T R-22 TXV Expansion Valve                         |       |
| 105705 | 61-21922-47  | 2T R-22 TXV Expansion Valve                           |       |
| 249495 | 61-106238-34 | 2.5T TXV Expansion Valve                              |       |
| 131857 | 61-21922-50  | 4T R-22 TXV Expansion Valve                           |       |
| 105707 | 61-21922-82  | 2.5T R-22 TXV Expansion Valve                         |       |

Repair Parts

**Ruud Heating & AC Repair Parts**

**Expansion Valves (Continued)**

**Thermal Expansion Valve**

| Part # | Mfg #       | Description                 | Price |
|--------|-------------|-----------------------------|-------|
| 105708 | 61-21922-83 | 3T R-22 TXV Expansion Valve |       |
| 105709 | 61-21922-84 | 4T R-22 TXV Expansion Valve |       |
| 105710 | 61-21922-85 | 5T R-22 TXV Expansion Valve |       |

**Fan Blades**

**Fan Blade with Integral Hub**

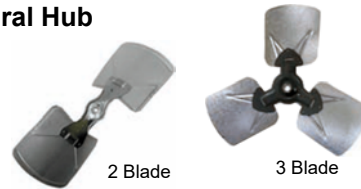

| Part # | Mfg #        | Diameter | Pitch | Rotation | # of Blades | Price |
|--------|--------------|----------|-------|----------|-------------|-------|
| 079832 | 70-21859-05  | 18"      | 28°   | CCW      | 2           |       |
| 123681 | 70-102033-05 | 18"      | 30°   | CCW      | 3           |       |
| 071438 | 70-20607-04  | 20"      | 27°   | CCW      | 2           |       |
| 107473 | 70-102011-06 | 20"      | 29°   | CCW      | 3           |       |
| 084834 | 70-21858-06  | 22"      | 21°   | CCW      | 2           |       |
| 009623 | 70-20608-01  | 22"      | 27°   | CCW      | 2           |       |
| 105796 | 70-102011-07 | 22"      | 35°   | CCW      | 2           |       |
| 107476 | 70-102011-09 | 24"      | 22°   | CCW      | 2           |       |
| 024245 | 70-19897-01  | 24"      | 22°   | CCW      | 3           |       |
| 103769 | 70-100580-03 | 24"      | 22°   | CCW      | 3           |       |
| 123680 | 70-102011-03 | 24"      | 24°   | CCW      | 2           |       |
| 084787 | 70-26166-01  | 24"      | 24°   | CCW      | 2           |       |
| 096139 | 70-100580-04 | 24"      | 28°   | CCW      | 3           |       |
| 086771 | 70-23137-01  | 24"      | 19°   | CCW      | 2           |       |
| 117441 | 70-21858-17  | 24"      | 22°   | CCW      | 3           |       |
| 106241 | 70-21858-12  | 18"      | 27°   | CCW      | 2           |       |

**Fan Center**

- Terminals: W, G, Y, R, C
- 120V Primary voltage
- 24V Secondary voltage
- Transformer frequency: 50,60Hz
- Relay not included, SPDT configuration
- Relay coil voltage: 24V



| Part # | Mfg #       | Description                 | Price |
|--------|-------------|-----------------------------|-------|
| 009344 | 47-19807-04 | Fan Center, 4-1/4" x 4-1/4" |       |

Repair Parts

**Ruud Heating & AC Repair Parts**

**Gas Valves**



| Part # | Mfg #       | Description   | Price |
|--------|-------------|---|-------|
| 009499 | 60-22174-02 | Natural Gas Valve, 150,000 BTU/HR @ 1" WC Pressure Drop |       |
| 009501 | 60-22447-01 | Natural Gas Valve, 150,000 BTU/HR @ 1" WC Pressure Drop |       |
| 067321 | 60-24215-03 | Modulating Natural Gas Valve                            |       |
| 127859 | 60-24394-01 | Natural Gas Valve, 150,000 BTU/HR @ 1" WC Pressure Drop |       |

**Gas Control**



| Part # | Mfg #    | Description                   | Price |
|--------|----------|-------------------------------|-------|
| 132343 | SP20166A | Gas Valve - Natural Gas       |       |
| 129359 | SP20166B | Gas Valve - Natural Gas       |       |
| 128611 | SP20166C | Gas Valve - Natural Gas       |       |
| 180874 | AP14270C | Gas Control (Thermostat) - NG |       |

**White-Rodgers 36G Gas Valve**

- 140,000 BTUH Capacity @ 1"wc pressure drop
- Slow opening
- Hot Surface/ Direct Spark

60-24180-81



| Part # | Mfg #        | Description  | Price |
|--------|--------------|--|-------|
| 125567 | 60-24180-81  | 36G23-202E91 1/2" NG Hot Surface/Direct Spark 1-Stg 140,000            |       |
| 143224 | 60-101921-81 | 36G55-521 1/2" NG Hot Surface/Direct Spark 2-Stg 140,000 BTUH Capacity |       |

**White-Rodgers 36J Gas Valve**

- Natural gas
- 140,000 BTUH Capacity @ 1"wc pressure drop
- 4-3/4"L x 2-3/8"W x 4-1/4"H



| Part # | Mfg #        | Description  | Price |
|--------|--------------|--|-------|
| 179394 | 60-103901-01 | 36J23-502 1/2" NG Hot Surface/Direct Spark 1-Stg 140,000 BTUH Capacity |       |

Repair Parts

**Ruud Heating & AC Repair Parts**

**Honeywell VR8215S1313 Gas Valve**

- Natural gas
- 150,000 BTU/HR Capacity @ 1"wc pressure drop
- 4-7/16"L x 2-3/4"W x 4-1/8"H
- Hot Surface/Direct Spark



| Part # | Mfg #        | Description  | Price |
|--------|--------------|--|-------|
| 172007 | 60-105055-01 | VR8215S1313 1/2" NG Hot Surface/Direct Spark 1-Stg 150,000 BTU/HR Capacity |       |

**Honeywell VR8304 Intermittent Pilot Dual Automatic Valve Combo Gas Control**

- For use in 24VAC gas-fired, intermittent pilot with capacities from 30-415 cfh
- Includes all standard features plus:
  - Controls include 100% safety shut-off, manual valve, two automatic operators, pressure regulator & pilot adjustment
  - Standard & slow opening natural gas models include natural to LP gas conversion kits; LP to natural gas conversion kits are also available
  - All adjustments, wiring connections & pilot outlets are accessible from the top of control
  - Adjustable servo regulator
  - Compatible with ECO connector
  - On-Off lighting sequence
  - Use with S86F,H; S860D; S8600F,H; S8610 & S90A,B Control Modules
  - Single stage unless otherwise noted
  - Capacities based on 1" p.d. 30,000 BTUH minimum, 300,000 BTUH maximum

**Honeywell**

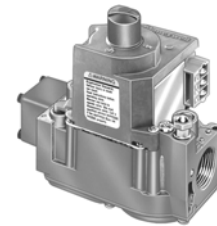

| Part # | Mfg #       | Description   | Price |
|--------|-------------|---|-------|
| 009498 | 60-21621-81 | VR8304M3101 3/4" NG Pilot 1-Stg 270,000 BTUH Capacity |       |

**Gas Valve Spring Kit**

| Part # | Mfg #       | Description          | Price |
|--------|-------------|----------------------|-------|
| 009490 | 60-18759-07 | Gas Valve Spring Kit |       |

**Heat Cell**

| Part # | Mfg #       | Description          | Price |
|--------|-------------|----------------------|-------|
| 008940 | AS-61164-83 | Heat Cell - Aluminum |       |

**Inducer Motors**

**Induced Draft Blower with Gasket**



| Part # | Mfg #        | Description   | Price |
|--------|--------------|---|-------|
| 090631 | 70-101087-81 | 120V 1-Stg Sheet Metal Inducer Housing Right Side Discharge |       |
| 160013 | 70-104157-82 | Induced Draft Blower Assembly with Gasket                   |       |
| 009627 | 70-21496-83  | 120V 1-Stg Polymeric Inducer Housing Left Side Discharge    |       |
| 009632 | 70-22436-02  | 120V Induced Draft Blower w/ Gasket                         |       |

**Ruud Heating & AC Repair Parts**

**Inducer Motors (Continued)**  
**Induced Draft Blower with Gasket**

| Part # | Mfg #       | Description   | Price |
|--------|-------------|---|-------|
| 024248 | 70-23641-81 | 208-230V 1-Stg Sheet Metal Inducer Housing Right Side Discharge |       |
| 072199 | 70-23641-82 | 380-415V, 460V, 50-60Hz 1-Stg Induced Draft Blower w/Gasket     |       |
| 009635 | 70-24033-01 | 120V 1-Stg Polymeric Inducer Housing Right Side Discharge       |       |
| 041979 | 70-24157-03 | 120V 1-Stg Cast Metal Inducer Housing Right Side Discharge      |       |
| 027297 | 70-24206-01 | 120V 2-Stg Polymeric Inducer Housing Right Side Discharge       |       |

**1-Stage Draft Inducer Blower**

- 115V 1-Speed
- For use with Rheem/Ruud gas furnaces models RGRK-07EMAES and UGRK-07EAMES



| Part # | Mfg #       | Description          | Price |
|--------|-------------|----------------------|-------|
| 120707 | 703020      | Draft Inducer Blower |       |
| 131722 | 70-24071-94 | Draft Inducer Blower |       |

**2-Stage Draft Inducer Blower**

- 115V 2-Speed
- For use with Rheem/Ruud gas furnaces models RGRK-07EMAES and UGRK-07EAMES



| Part # | Mfg #        | Description          | Price |
|--------|--------------|----------------------|-------|
| 136280 | 70-100612-03 | Draft Inducer Blower |       |
| 139895 | 70-100612-81 | Draft Inducer Blower |       |
| 139892 | 70-102691-81 | Draft Inducer Blower |       |
| 139896 | 70-102814-81 | Draft Inducer Blower |       |
| 139894 | 70-103086-01 | Draft Inducer Blower |       |
| 145465 | 70-103597-01 | Draft Inducer Blower |       |

**Blower Assembly**



| Part # | Mfg #       | Description     | Price |
|--------|-------------|-----------------|-------|
| 015970 | 70-22165-81 | Blower Assembly |       |
| 009631 | 70-22436-01 | Blower Assembly |       |
| 137367 | AP15109-1   | Blower Assembly |       |

**Ruud Heating & AC Repair Parts**

**Vent Motor with Blades**

- 208/230V, Nominal 3,000 rpm
- Includes centrifugal proving switch
- Mounting bolt pattern 4-1/4" x 4-1/4"
- Includes (3) fan blades (3", 3-1/2" and 4" diameter)



| Part # | Mfg #       | Description                                       | Price |
|--------|-------------|---|-------|
| 009414 | 51-21964-11 | Vent Motor with Blades, 208/230V Nominal 3000 rpm |       |

**Motor Mount**



| Part # | Mfg #       | Description   | Price |
|--------|-------------|---|-------|
| 022307 | 562300109   | Blower Motor Mount Kit For 48 Frame   |       |
| 093274 | AE-58384-81 | Screw Mounting Kit, 5-5/8" 48 Frame Motors, 16" Nom Blower Mounting Bolt Circle Dia, (4) Arms |       |
| 041165 | AE-61698-82 | Screw Mntg Kit, 5-5/8" 48 Frame Motors, 14-13/16" Nom Blower Mntg Bolt Circle Dia, (4) Arms   |       |
| 008936 | AS-55306-02 | Condenser Motor Plate Mount Kit   |       |
| 223191 | AS-55306-82 | Condenser Motor Plate Kit   |       |

**Limit Controls**

**Therm-O-Disc Temperature Limit Control Switch**

**36T Small Flanged Airstream - Manual Reset**

- 120/230V maximum rating, 15/10A maximum current rating
- Enclosed disc face
- SPST Switching
- Normally closed
- 300° Open temperature



| Part # | Mfg #       | Temp Open | Tolerance Open | Color Code | Mounting Tube | Price |
|--------|-------------|-----------|----------------|------------|---------------|-------|
| 009391 | 47-22861-02 | 300°F     | +/-14°F        | Blue       | 5/32"         |       |
| 160018 | 47-22861-04 | 250°F     | +/-12°F        | Red        | 5/32"         |       |

**36T Special Small Flanged Airstream - Manual Reset**

- 120/230V Max rating, 15/10A Max current rating
- Enclosed disc face
- SPST Switching
- Normally closed
- 250° Open temperature



| Part # | Mfg #       | Temp Open | Tolerance Open | Color Code | Mounting Tube | Price |
|--------|-------------|-----------|----------------|------------|---------------|-------|
| 103688 | 47-22861-03 | 250°F     | +/-12°F        | --         | 3/16"         |       |

Repair Parts

**Ruud Heating & AC Repair Parts**

**74T Large Flanged Airstream - Auto Reset**

- 230V Max rating, 25A Max current rating
- Enclosed disc face
- SPST Switching
- 3/8" Maximum mounting insertion depth



| Part # | Mfg #       | Description   | Price |
|--------|-------------|---|-------|
| 141499 | 47-25115-02 | Open Temp: 135°F - 175°F; Close Temp: Open Temp Minus 40°F, 40° Nom Temp Difference |       |
| 141500 | 47-25115-03 | Open Temp: 175°F - 215°F; Close Temp: Open Temp Minus 40°F, 40° Nom Temp Difference |       |

**Limit Control Switch - Auto Reset - 69T Heat Assisted**

- Normally closed
- Exposed disc face
- SPST Switch type



| Part # | Mfg #       | Description                  | Price |
|--------|-------------|------------------------------|-------|
| 009388 | 47-22860-01 | 95°F Close Temperature Red   |       |
| 009389 | 47-22860-02 | 100°F Close Temperature Blue |       |

**Limit Switch - Auto Reset 60T Series**

- Normally closed
- Flanged airstream
- 1-Pole
- SPST Switch type
- Normally closed



| Part # | Mfg #        | Description                   | Price |
|--------|--------------|-------------------------------|-------|
| 160015 | 47-104465-01 | 95°F Close Temperature Yellow |       |

**Limit Control Switch - Manual Reset - 36T**

- Flanged Airstream



| Part # | Mfg #       | Description                                    | Price |
|--------|-------------|--|-------|
| 009375 | 47-22453-01 | Normally Closed Enclosed Disc Face SPST        |       |
| 009376 | 47-22453-02 | Normally Closed Enclosed Disc Face SPST        |       |
| 009390 | 47-22861-01 | Normally Closed Exposed Disc Face SPST         |       |
| 009393 | 47-22862-02 | Normally Closed Blue Exposed Disc Face SPST    |       |
| 009395 | 47-22862-04 | Normally Closed Orange Enclosed Disc Face SPST |       |

Repair Parts



**Ruud Heating & AC Repair Parts**

**Limit Switch/Defrost Sensor - Auto Reset**

- Tube mount
- Moisture resistant
- SPST switch type
- 120/230



| Part # | Mfg #       | Description                                | Price |
|--------|-------------|--|-------|
| 085224 | 47-23683-04 | Close on Rise Wire Leads - 98" Wire Length |       |

**Limit Control/Switch**



| Part # | Mfg #       | Description   | Price |
|--------|-------------|---------------|-------|
| 009351 | 47-21663-01 | Limit Switch  |       |
| 009367 | 47-21900-05 | Limit Control |       |
| 009368 | 47-21900-06 | Limit Control |       |
| 009371 | 47-22383-13 | Limit Switch  |       |
| 026839 | 47-22383-33 | Limit Control |       |

**Limit Control Switch - Auto Reset - 36T**

- Enclosed disc face
- SPST Switch type
- Normally closed
- Board mount 90° strap angle



| Part # | Mfg #       | Description                           | Price |
|--------|-------------|---------------------------------------|-------|
| 009356 | 47-21711-06 | 150°F Close Temperature               |       |
| 009360 | 47-21711-10 | 150°F Close Temperature               |       |
| 034226 | 47-25349-02 | 150°F Close Temperature Blue/Blue     |       |
| 036843 | 47-25349-03 | 150°F Close Temperature Yellow/Yellow |       |
| 009361 | 47-21711-11 | 160°F Close Temperature               |       |
| 038081 | 47-25349-01 | 160°F Close Temperature Red/Red       |       |
| 038093 | 47-25349-05 | 180°F Close Temperature Orange/Orange |       |
| 038095 | 47-25350-07 | 180°F Close Temperature Green/Green   |       |
| 034120 | 47-25350-01 | 190°F Close Temperature Red/Red       |       |
| 009354 | 47-21711-04 | 200°F Close Temperature               |       |
| 036657 | 47-25350-09 | 200°F Close Temperature Tan/Tan       |       |
| 040953 | 47-25350-06 | 150°F Close Temperature Brown/Brown   |       |
| 009403 | 47-24006-08 | Limit Switch                          |       |
| 059560 | 47-25350-02 | Limit Control                         |       |
| 050264 | 47-25350-04 | Limit Control                         |       |
| 085327 | 47-25350-05 | Limit Control                         |       |
| 145464 | 47-25350-12 | Limit Control, 195°F Open             |       |

Repair Parts

**Ruud Heating & AC Repair Parts**

**Motors**  
**ECM Motor**



| Part # | Mfg #        | Description                                   | Price |
|--------|--------------|---|-------|
| 142897 | 51-102728-05 | ECM Outdoor CA330R Motor                      |       |
| 169001 | 51-104304-28 | 1/2 hp Variable Speed ECM Motor               |       |
| 166659 | 51-104306-01 | Variable-Speed 1 hp Direct Drive ECM 48 Frame |       |
| 166319 | 51-104306-03 | Variable Speed 1 hp Direct Drive ECM Motor    |       |
| 166281 | 51-104306-24 | 1 hp ECM Motor                                |       |
| 166321 | 51-104306-25 | 1 hp ECM Motor                                |       |
| 137902 | 51-42534-24  | 1/3 hp Fan Motor                              |       |
| 145469 | 51-102602-01 | 1/2 hp Communicating Motor                    |       |
| 168216 | 51-104304-01 | 1/2 hp ECM Motor                              |       |
| 235420 | 51-102870-08 | ECM (Outdoor) - Not Programmable              |       |
| 249815 | 51-102870-07 | ECM (Outdoor) - Not Programmable              |       |
| 249817 | 51-105035-05 | 1/2 hp ECM (Outdoor) - Variable-Speed         |       |

**OEM Condenser Motor (208/230V)**

- These motors are OEM replacements for Rheem, Ruud, and WeatherKing models; additionally they may be suitable for after market retrofit in many other applications
- Single speed, single phase



| Part # | Mfg #        | Description   | Price |
|--------|--------------|---|-------|
| 086497 | 51-100999-02 | 1/10 hp 825 rpm 208/230V Condenser Motor                                |       |
| 085274 | 51-100999-03 | 1/6 hp 1075 rpm 208/230V Condenser Motor                                |       |
| 086548 | 51-100999-04 | 1/5 hp 1075 rpm 208/230V Condenser Motor                                |       |
| 086549 | 51-100998-05 | 1/3 hp Condenser Motor  |       |
| 113859 | 51-100998-13 | 1/3 hp 1075 rpm 208/230V Condenser Motor                                |       |
| 249816 | 51-101774-40 | 1/5 hp 825 rpm 208/230V Condenser Motor                                 |       |
| 123683 | 51-102500-02 | Sgl Speed, 1/6 hp 1075 rpm 208/230V CCW 3/370 Capacitor                 |       |
| 105406 | 51-102500-04 | 1/5 hp 825 rpm 208/230V Condenser Motor                                 |       |
| 113905 | 51-102500-05 | 1/10 hp 825 rpm 208/230V Condenser Motor                                |       |
| 099184 | 51-42179-01  | Sgl Speed, 1/3 hp 1075 rpm 208/230-1-60 CCW 10/370 Run Capacitor        |       |
| 052997 | 51-42534-01  | Sgl Speed, 1/3 hp 1075 rpm 208/220/230-1-50/60 CCW 10/370 Run Capacitor |       |

Repair Parts

**Ruud Heating & AC Repair Parts**

**Condenser Fan Motor**

- 60 Hz
- Single stage
- Sleeve bearing
- 825 rpm/ 1 speed
- Input voltage: 208-230
- Counter clockwise rotation

| Part # | Mfg #        | Description | Price |
|--------|--------------|-------------|-------|
| 237994 | 51-101774-52 | 1/6 HP      |       |

**Ruud Wholesale Condenser Motor (208/230V)**



| Part # | Mfg #       | Description                       | Price |
|--------|-------------|-----------------------------------|-------|
| 009426 | 51-23055-12 | 1/5 hp Direct Drive 230V 825 rpm  |       |
| 009425 | 51-23055-11 | 1/5 hp Direct Drive 230V 1075 rpm |       |
| 133785 | 51-21853-11 | 1/2 hp 1075 rpm/1 speed           |       |

**Ruud Wholesale Condenser Motor (460V)**



| Part # | Mfg #       | Description  | Price |
|--------|-------------|--|-------|
| 086789 | 51-23063-11 | Sgl Speed, 1/3 hp 1075 rpm 460-1-60 Reversible 7.5/370 Capacitor |       |

**Condenser Motor**



| Part # | Mfg #        | Description             | Price |
|--------|--------------|-------------------------|-------|
| 132537 | 51-100998-08 | 1/8 hp Condenser Motor  |       |
| 125111 | 51-102728-11 | ECM Condenser           |       |
| 125103 | 51-102728-12 | ECM Condenser Fan Motor |       |
| 125112 | 51-102728-13 | ECM Condenser           |       |
| 236933 | 51-102728-24 | ECM Condenser Motor     |       |
| 125432 | 51-102870-01 | ECM Condenser (Outdoor) |       |
| 125110 | 51-102870-03 | Condenser Fan Motor     |       |
| 236636 | 51-102870-09 | Condenser Fan Motor     |       |

**Ruud Heating & AC Repair Parts**

**Motors (Continued)**  
**Condenser Motor**

| Part # | Mfg #       | Description  | Price |
|--------|-------------|--|-------|
| 140687 | 5464        | 1/6 - 1/3 hp 825 rpm 208/230V Emerson RESCUE Condenser Motor |       |
| 061734 | 51-21853-15 | Condenser Motor - 1/3 hp 460/1/60                            |       |
| 140686 | 5462        | 1/3 to 1/6 hp 1075 rpm 208/230V RESCUE Condenser Motor       |       |

**TripSaver Condenser Motor**



| Part # | Mfg #        | Description                              | Price |
|--------|--------------|--|-------|
| 009424 | 51-23053-21  | 1/3 / 1/5 hp Direct Drive 230V 1,075 rpm |       |
| 143484 | 51-103823-01 | 1 hp 230V X13 Motor                      |       |

**OEM Indoor Blower Motor**



| Part # | Mfg #        | Capacitor  | HP     | Volts    | Amps  | RPM/Speed | Rotation | Price |
|--------|--------------|------------|--------|----------|-------|-----------|----------|-------|
| 128889 | 51-103243-01 | 15mfd/370V | 1/2 hp | 120-1-60 | 8.00A | 1,075/4   | CCW      |       |
| 042374 | 51-23679-01  | 10mfd/370V | 1/2 hp | 208/230  | 2.70A | 1,075/3   | CW       |       |

**Trip Saver Indoor Blower Motor**



| Part # | Mfg #       | Description  | Price |
|--------|-------------|--|-------|
| 009422 | 51-23022-41 | 4-Speed 1/6-1/2 hp 1,075 rpm 208/230-1-60 REV 5/370, 7.5/370 or 10.370 Capacitor |       |

**SelecTech Blower Motor**

- Variable # of speeds
- One phase
- Direct drive
- Ball bearings
- Shell-band mounting

| Part # | Mfg #        | Description         | Price |
|--------|--------------|---------------------|-------|
| 241742 | 51-104355-11 | 1/2 hp 120V 1 Phase |       |

**Ruud Heating & AC Repair Parts**

**Motors (Continued)**  
**SelecTech Blower Motor**

| Part # | Mfg #        | Description             | Price |
|--------|--------------|-------------------------|-------|
| 241743 | 51-104355-12 | 1/2 hp 120V 1 Phase     |       |
| 241744 | 51-104355-13 | 1/2 hp 120V 1 Phase     |       |
| 241745 | 51-104357-04 | 1 hp 120V 1 Phase       |       |
| 241746 | 51-104357-05 | 1 hp 120V 1 Phase       |       |
| 241747 | 51-104357-06 | 1 hp 120V 1 Phase       |       |
| 248652 | 51-104358-09 | 1/3 hp 208/230V 1 Phase |       |
| 248651 | 51-104359-01 | 1/2 hp 208/230V 1 Phase |       |

**Blower Motor**



| Part # | Mfg #        | Description   | Price |
|--------|--------------|---|-------|
| 100478 | 51-101879-01 | 1/3 hp 240V X-13 Blower Motor   |       |
| 094848 | 51-101880-01 | 1/2 hp 208/230V 1-Phase X-13 Blower Motor                                       |       |
| 113814 | 51-102497-01 | 3/4 hp 230V Variable Speed X-13 Blower Motor with Resilient Rotor               |       |
| 113813 | 51-102497-02 | 3/4 hp 230V Variable Speed X-13 Blower Motor                                    |       |
| 009418 | 51-23012-41  | 1/6 - 1/2 hp 1,075 rpm 120V 4-Speed Reversible Rotation Tripsaver™ Blower Motor |       |
| 028318 | 51-23017-42  | 1/4 - 3/4 hp 1,075 rpm 120V Indoor Blower Motor                                 |       |
| 016108 | 51-24070-02  | 1/2 hp Indoor Blower Motor 120V 1,075 rpm                                       |       |
| 024237 | 51-23555-02  | Blower Motor - 3/4 hp 208/230/1/60  |       |
| 124801 | 51-21898-01  | 3/4 hp 208-230/1 V 1075 rpm   |       |
| 038103 | 51-23102-08  | 1/2hp Dir Dr 208-230V 825 rpm   |       |
| 160026 | 51-104342-01 | 3/4 hp 120/1/60 (1075 rpm/4 Speed)  |       |

**Motor**

| Part # | Mfg #        | Description                             | Price |
|--------|--------------|---|-------|
| 009420 | 51-23015-91  | 1/5 hp 120/1/60 1075 rpm 3-Speed        |       |
| 141494 | 51-23027-31  | Blower Motor 3-Speed 230V 3/4 hp        |       |
| 145470 | 51-102605-01 | 1 hp 120/230V ECM Motor                 |       |
| 127336 | 51-24374-27  | 1/2 hp ECM Blower Motor                 |       |
| 125741 | 51-24374-28  | 1/2 hp ECM Blower Motor                 |       |
| 052874 | 51-24376-03  | Motor w/ICM Module (Modulating Furnace) |       |
| 078007 | 51-24382-81  | 1/2 hp ECM Module                       |       |
| 134008 | 51-102008-08 | Condenser Fan Motor                     |       |

**Motor Mounting Kit**

| Part # | Mfg #       | Description        | Price |
|--------|-------------|--------------------|-------|
| 125546 | 70-24104-82 | Motor Mounting Kit |       |

**Ruud Heating & AC Repair Parts**

**Relay's**

**Control Relay**

**Sealed Case (SPDT) Control Relay**



| Part # | Mfg #       | Contact Bias | Coil Volts | FLA @120V | FLA @230V | LRA @120V | LRA @230V | Price |
|--------|-------------|--------------|------------|-----------|-----------|-----------|-----------|-------|
| 009290 | 42-25104-06 | NO/NC        | 24V        | 14        | 8         | 84        | 48        |       |

**Relay - DPTD**



| Part # | Mfg #       | Contact Bias | Coil Volts | FLA @120V | FLA @230V | LRA @120V | LRA @230V | Price |
|--------|-------------|--------------|------------|-----------|-----------|-----------|-----------|-------|
| 009222 | 42-18287-12 | NO/NC (2)    | 24V        | 12        | 6         | 60        | 35        |       |

**Open Coil (DPDT) Control Relay**

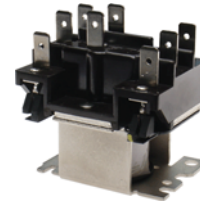

| Part # | Mfg #       | Contact Bias | Coil Volts | FLA @120V | FLA @230V | LRA @120V | LRA @230V | Price |
|--------|-------------|--------------|------------|-----------|-----------|-----------|-----------|-------|
| 027431 | 42-25106-01 | NO/NC (2)    | 24V        | 13.8      | 6.9       | 82.8      | 41.4      |       |

**Control Relay - Small Sealed Case (SPDT)**



| Part # | Mfg #       | Contact Bias | Coil Volts | FLA @277V  | LRA @230V  | LRA @277V  | Price |
|--------|-------------|--------------|------------|------------|------------|------------|-------|
| 117427 | 42-23114-06 | NO/NC        | 24V        | 20NO, 10NC | 60NO, 33NC | 60NO, 33NC |       |

Repair Parts

**Ruud Heating & AC Repair Parts**

**Start Relays - Potential Type**



| Part # | Mfg #       | Hot Pickup (V) | Cold Pickup (V) | Dropout (V) | Max Cont Coil Volt (V) | Start Kit Relay Code | Price |
|--------|-------------|----------------|-----------------|-------------|------------------------|----------------------|-------|
| 041054 | 42-25105-01 | 170-180V       | 162-175V        | 40-90V      | 336V                   | A                    |       |

**Time Delay Relay**



| Part # | Mfg #     | Time Delay Adj. | Make Time Delay | Voltage Rating | Current Rating Steady State | Current Rating Inrush | Price |
|--------|-----------|-----------------|-----------------|----------------|-----------------------------|-----------------------|-------|
| 042350 | 42-ICM102 | Variable        | .03 - 10 Min    | 18-230 VAC     | 1.5                         | 15                    |       |

**Time Delay Relay**



| Part # | Mfg #       | Time Delay Adj. | Break Time Delay | Voltage Rating | Current Rating Steady State | Current Rating Inrush | Price |
|--------|-------------|-----------------|------------------|----------------|-----------------------------|-----------------------|-------|
| 121707 | 47-23433-93 | Fixed           | .17 Min          | 18-30 VAC      | 1                           | 10                    |       |

**Timer Delay**



| Part # | Mfg #     | Time Delay Adj. | Break Time Delay | Voltage Rating | Current Rating Steady State | Current Rating Inrush | Price |
|--------|-----------|-----------------|------------------|----------------|-----------------------------|-----------------------|-------|
| 092118 | 42-ICM    | Variable        | .17 -16.6 Min    | 18-230 VAC     | 1                           | 10                    |       |
| 042351 | 42-ICM203 | Variable        | .03 - 10 Min     | 18-230 VAC     | 1.5                         | 15                    |       |

**Time Delay Relay - On Delay On Break (Anti-Short Cycle)**



42-22655-02

| Part # | Mfg #       | Time Delay Adj. | Break Time Delay | Voltage Rating | Current Rating Steady State | Current Rating Inrush | Price |
|--------|-------------|-----------------|------------------|----------------|-----------------------------|-----------------------|-------|
| 044912 | 42-22655-02 | Fixed           | 5 Min            | 18-30 VAC      | 1.5                         | -                     |       |
| 047231 | 42-22655-03 | Fixed           | .5 Min           | 18-30 VAC      | 1.5                         | -                     |       |

Repair Parts

**Ruud Heating & AC Repair Parts**

**Sequencers**

**Sequencer**

**24V Angle Bracket with (2) Mounting Holes Sequencer**

- DPST-NO

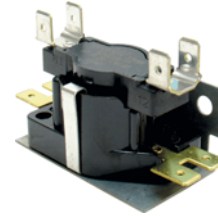

| Part # | Mfg #       | Poles | Sequencing Off   | Sequencing On    | Switching | Price |
|--------|-------------|-------|------------------|------------------|-----------|-------|
| 050196 | 42-23116-08 | 2     | 10 - 30          | 30 - 60          | DPST NO   |       |
| 034057 | 42-23116-06 | 2     | 10 - 40/30 - 160 | 90 - 160/30 - 60 | DPST-NO   |       |
| 052164 | 42-23116-09 | 3     | 10 - 30          | 90 - 150/30 - 60 | TPST NO   |       |

**Sequencing Relay**

- Flush mount plate w/ mounting hole & tab
- 1/4" Quick connects
- Heater Wattage/ Power Consumption:  
24 VAC/.10A-.18A steady state/.35 - 1.0 amps peak for 0.8 sec



| Part # | Mfg #       | Poles | Sequencing Off | Sequencing On | Switching | Price |
|--------|-------------|-------|----------------|---------------|-----------|-------|
| 137087 | PD425078    | 2     | 30 - 60        | 1 - 30        | DPST-NO   |       |
| 185861 | 425079      | 2     | 1 - 30         | 30 - 60       | DPST-NO   |       |
| 020492 | 42-23116-07 | 3     | 30-60          | 10-30         | TPST - NO |       |

**Service Valves**

**Service Valve**

- Front seating valves, isolate sections of a system for servicing and provide a means for refrigerant charging
- All brass corrosion resistant body and solid copper fittings
- Includes 1/4 Flare SAE charge port; communicates with lower fitting when in closed position
- Suitable for R-22 and R-410A, 600 psig maximum working pressure



| Part # | Mfg #       | Connect        | OPP Connect    | OAL    | Charge Port Location | Price |
|--------|-------------|----------------|----------------|--------|----------------------|-------|
| 085196 | 61-21368-13 | 3/8" Sweat ODF | 3/8" Sweat ODF | 4-5/8" | Side                 |       |
| 101321 | 61-21368-07 | 3/4" Sweat ODF | 3/4" Sweat ODF | 5"     | Bottom               |       |
| 096123 | 61-21368-15 | 7/8" Sweat ODF | 7/8" Sweat ODF | 5"     | Side                 |       |
| 083261 | 61-21368-16 | 7/8" Sweat ODF | 3/4" Sweat ODF | 5-1/8" | Side                 |       |

**Service Valve**



| Part # | Mfg #         | Description            | Price |
|--------|---------------|------------------------|-------|
| 092122 | 803003        | 1/4" OD Service Valve  |       |
| 143354 | 83-CD8403-6PK | 3/16" OD Service Valve |       |

Repair Parts



**Ruud Heating & AC Repair Parts**

**Miscellaneous**

**Remote Sensor for 90 Series®**

- Digital signal output provides superior temperature control, even over long wire runs
- No temperature variance caused by wire resistance
- Choice of styling, indoor models are interchangeable
- Perfect for securing the thermostat in one area or room while sensing temperature in the conditioned space



| Part # | Mfg #     | Color         | Dimensions             | Model   | Range                         | Price |
|--------|-----------|---------------|------------------------|---------|-------------------------------|-------|
| 102316 | F145-1328 | Classic White | 2-1/8" x 3-1/2" x 3/4" | Indoor  | 40° to 99°F All Indoor Remote |       |
| 101726 | F145-1378 | Classic White | 2-1/8" x 3-1/2" x 3/4" | Outdoor | -40° to 140°F                 |       |

**Mixed Air Sensor**

| Part # | Mfg #  | Description      | Price |
|--------|--------|------------------|-------|
| 076571 | 470010 | Mixed Air Sensor |       |

**Logic Module**

| Part # | Mfg #    | Description   | Price |
|--------|----------|---|-------|
| 143968 | PD470009 | Demand Control Ventilation Economizer Logic Module with Heat Pump Input |       |

**Start Kit**

- 330 VAC
- 60Hz



| Part # | Mfg # | Description  | Price |
|--------|-------|--|-------|
| 173840 | SK-A1 | Compatible with RA13, RA14, RA16, RP14, RP15, UA17, & RJMA Units |       |

**ECM Motor Repair Kit**



| Part # | Mfg # | Description          | Price |
|--------|-------|----------------------|-------|
| 176875 | VZREP | ECM Motor Repair Kit |       |

Repair Parts

**Ruud Heating & AC Repair Parts**

**Pressure Switches**

**Pressure Control**

**Low Pressure Control - Auto Reset**



| Part # | Mfg #        | Description   | Price |
|--------|--------------|---|-------|
| 150872 | 47-101529-09 | 50 psig Open Pressure 5/16" Sweat Connection, 90° Elbow End |       |
| 249818 | 47-103670-02 | 50 psig Open Pressure                                       |       |
| 249819 | 47-103670-04 | 50 psig Open Pressure                                       |       |

**High Pressure Control - Auto Reset (Sweat w/o Cap Tube)**



| Part # | Mfg #        | Description  | Price |
|--------|--------------|--|-------|
| 113929 | 47-26184-01  | 610 psig Open Pressure 420 psig Close, 1/4" Swt Connection, Straight Fitting |       |
| 177684 | 47-102431-03 | 655 psig Open Pressure   |       |

**Low Pressure Limit - Auto Reset**



| Part # | Mfg #        | Description           | Price |
|--------|--------------|-----------------------|-------|
| 178391 | 47-102240-03 | 50 psig Open Pressure |       |

**Pressure Control Switch**



| Part # | Mfg #        | Description                | Price |
|--------|--------------|----------------------------|-------|
| 161588 | 42-101225-81 | Pressure Switch            |       |
| 091197 | 42-101233-81 | Pressure Control           |       |
| 091198 | 42-101443-89 | Pressure Control, 0.45" WC |       |
| 091200 | 42-101443-91 | Pressure Control, 0.60" WC |       |
| 091311 | 42-101444-83 | Pressure Control, 1.00" WC |       |
| 091438 | 42-101445-83 | Pressure Control, 0.40" WC |       |
| 083509 | 42-101447-07 | Pressure Control           |       |
| 098938 | 42-101447-86 | Pressure Control, 1.80" WC |       |
| 107479 | 42-101447-89 | Pressure Control, 1.95" WC |       |
| 091542 | 42-101511-84 | Pressure Control           |       |

**Pressure Switches (Continued)**

**Low Pressure Limit - Auto Reset**

**Pressure Control Switch**

| Part # | Mfg #         | Description                               | Price |
|--------|---------------|---|-------|
| 128891 | 42-101955-02  | Pressure Switch for RGRC034T 074T 105T    |       |
| 137097 | 42-101955-08  | Pressure Switch for RGRC Drain            |       |
| 109677 | 42-101956-09  | Pressure Switch for RGRC RGTC Vent        |       |
| 109679 | 42-101956-10  | Pressure Control, 1.20" WC                |       |
| 128890 | 42-101956-12  | Pressure Switch for RGRC Vent             |       |
| 107812 | 42-102056-01  | Dual Pressure Control, -0.80" & -1.30" WC |       |
| 112161 | 42-102056-02  | Dual Pressure Control, -0.60" & -1.08" WC |       |
| 107814 | 42-102056-03  | Dual Pressure Control, -0.86" & -1.20" WC |       |
| 125747 | 42-102056-05  | Dual Pressure Control, -0.40" & -0.60" WC |       |
| 107813 | 42-102056-06  | Dual Pressure Control, -0.66" & -1.30" WC |       |
| 123676 | 42-102056-13  | Dual Pressure Control, -0.30" & -0.50" WC |       |
| 136527 | 42-102056-22  | Dual Pressure Control, -0.40" & -0.30" WC |       |
| 145463 | 42-102056-25  | Dual Pressure Control                     |       |
| 145462 | 42-102056-26  | Dual Pressure Control                     |       |
| 145461 | 42-102056-27  | Dual Pressure Control                     |       |
| 145460 | 42-102056-28  | Dual Pressure Control                     |       |
| 160008 | 42-102069-01  | Pressure Switch Assembly                  |       |
| 162412 | 42-102069-06  | Pressure Switch Assembly                  |       |
| 162413 | 42-102070-14  | Pressure Switch Assembly                  |       |
| 162414 | 42-102070-18  | Pressure Switch Assembly                  |       |
| 127334 | 42-103193-01  | Dual Pressure Control                     |       |
| 186615 | 42-105601-105 | Pressure Switch Assembly                  |       |
| 089690 | 42-24194-01   | Pressure Switch                           |       |
| 091194 | 42-24194-82   | Pressure Control                          |       |
| 080580 | 42-24195-03   | Pressure Control, for UGRA UGFD 90RS 90RT |       |
| 135420 | 42-24195-81   | Pressure Control, 0.50" WC                |       |
| 080915 | 42-24196-81   | Pressure Control, For UGRA UGFD 90RS      |       |
| 083251 | 42-24196-82   | Pressure Control                          |       |
| 083259 | 42-24196-83   | Pressure Control                          |       |
| 081061 | 42-24196-84   | Pressure Control                          |       |
| 082670 | 42-24197-01   | Dual Pressure Control, -0.80" & -1.30" WC |       |
| 141506 | 47-103670-06  | Low Pressure Control                      |       |
| 031417 | 47-21604-03   | Pressure Switch                           |       |

**Ruud Heating & AC Repair Parts**

**Pressure Switches (Continued)**

**Low Pressure Limit - Auto Reset  
Pressure Control Switch**

| Part # | Mfg #        | Description     | Price |
|--------|--------------|-----------------|-------|
| 138441 | SP20313      | Pressure Switch |       |
| 162415 | 42-102070-05 | Pressure Switch |       |

**Ignition Controls & Other Boards**

**Control Boards**

| Part # | Mfg #        | Description  | Price |
|--------|--------------|--|-------|
| 247921 | 47-105221-01 | Power Inverter - 3.7 kW                            |       |
| 249670 | 47-105369-02 | Control Board - EEV                                |       |
| 249814 | 47-105395-02 | Control Board - EcoNet                             |       |
| 129524 | 47-100436-02 | Control Board for X-13 Motor                       |       |
| 115784 | 47-102090-82 | Control Board for UARL                             |       |
| 163875 | 47-102090-93 | Control Board Kit - Communicating                  |       |
| 186557 | 47-102077-03 | Control Board - ECM                                |       |
| 129219 | 62-102635-81 | Control Board                                      |       |
| 110554 | 62-102636-01 | Integrated Furnace Control Board                   |       |
| 133313 | 62-102860-01 | Integrated Control Board                           |       |
| 127527 | 62-103189-01 | Integrated Furnace Control Board                   |       |
| 145473 | 62-103565-01 | Integrated Furnace Control Board                   |       |
| 145475 | 62-103578-01 | Inducer Control Board                              |       |
| 160036 | 62-104058-02 | Integrated Furnace Control Board                   |       |
| 162408 | 62-104059-01 | Integrated Furnace Control Board                   |       |
| 241754 | 62-104061-04 | Integrated Furnace Control Board                   |       |
| 222724 | 62-105217-01 | Integrated Furnace Control Board                   |       |
| 241741 | 62-106321-01 | Integrated Furnace Control Board                   |       |
| 150560 | 62-23599-05  | Integrated Furnace Control Board                   |       |
| 081759 | 62-24140-04  | Integrated Furnace Control Board Direct Spark      |       |
| 093116 | 62-24174-02  | Modulating Control Board                           |       |
| 082900 | 62-24268-03  | Hot Surface Igniter and Integrated Furnace Control |       |
| 115091 | 62-25338-01  | Control Board                                      |       |
| 071437 | 62-42506-02  | Integrated Furnace Control Board                   |       |
| 033177 | 62-25341-81  | Integrated Furnace Control Board                   |       |

**Fan Control Board**



47-22827-83

| Part # | Mfg #       | Description       | Price |
|--------|-------------|-------------------|-------|
| 009374 | 47-22445-01 | Fan Control Board |       |
| 009386 | 47-22827-83 | Fan Control Board |       |
| 009378 | 47-22481-81 | Fan Control Board |       |

**Ignition Module**



| Part # | Mfg #  | Description  | Price |
|--------|--------|--|-------|
| 127446 | 620044 | 5059-134 Ignition Module White-Rodgers 24V Intermittent Pilot Ignition |       |

**Ignition Control**



| Part # | Mfg #       | Description                            | Price |
|--------|-------------|--|-------|
| 086472 | 62-24181-01 | Ignition Control/Direct Spark Ignition |       |
| 053123 | 62-25078-02 | Ignition Control                       |       |
| 009561 | 62-22578-01 | Ignition Control Module - HSI          |       |

**Igniters & Flame Sensors**

**Igniters**



| Part # | Mfg #        | Description                 | Price |
|--------|--------------|-----------------------------|-------|
| 145476 | 62-103541-01 | Hot Surface Igniter         |       |
| 009550 | 62-21747-02  | Igniter                     |       |
| 009563 | 62-22669-92  | Igniter                     |       |
| 009574 | 62-22868-93  | Igniter                     |       |
| 051183 | 62-23556-03  | Igniter                     |       |
| 137901 | 62-23556-08  | Direct Spark Igniter        |       |
| 137712 | 62-23556-10  | Igniter                     |       |
| 119752 | 62-23556-82  | Igniter                     |       |
| 051711 | 62-24141-04  | Direct Spark Ignition (DSI) |       |

Repair Parts

**Ruud Heating & AC Repair Parts**

**Igniters & Flame Sensors (Continued)**

**Igniters**

| Part # | Mfg #       | Description                                | Price |
|--------|-------------|--|-------|
| 160039 | 62-24141-05 | Direct Spark Ignition (DSI)                |       |
| 042260 | 62-24164-01 | Direct Spark Ignition (DSI)                |       |
| 166512 | SP20794     | NG Igniter with Gasket and Mounting Screws |       |

**Transformer**



| Part # | Mfg #       | Description      | Price |
|--------|-------------|------------------|-------|
| 160017 | 46-24124-06 | Transformer 120V |       |

**Discharge Air Sensor**



| Part # | Mfg #  | Description          | Price |
|--------|--------|----------------------|-------|
| 154552 | 470023 | Discharge Air Sensor |       |

**Flame Sensor**



| Part # | Mfg #       | Description  | Price |
|--------|-------------|--|-------|
| 009582 | 62-23543-01 | Flame Sensor Rod, 2-1/2"L Mnt Flg to Sensor Tip 1-9/16"L Sensor Offset 90° Angle Sensor Offset |       |
| 051177 | 62-23543-02 | Flame Sensor Rod, 2-1/16"L Mnt Flg to Sensor Tip 1-13/16"L Sensor Offset 90° Angle Sensor      |       |
| 128886 | 62-23543-06 | Flame Sensor   |       |
| 036437 | 62-24044-71 | Non-Integrated w/ Mnt Brackets for Ribbon & Inshot Style Burners & 62-23543-01 Igniter         |       |
| 141681 | SP15129     | Flame Sensor with Gasket and Mounting Screw  |       |
| 144183 | SP20172     | Flammable Vapor Sensor Kit with Cap Plug   |       |

**Heat Exchangers**

**Heat Exchanger**



Primary

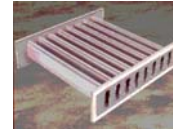

Secondary



Turbulex

| Part # | Mfg #       | Description             | Price |
|--------|-------------|-------------------------|-------|
| 142996 | AS-59066-89 | Heat Exchanger          |       |
| 092267 | AS-61805-16 | Heat Exchanger Assembly |       |
| 083242 | AS-61805-17 | Heat Exchanger Assembly |       |
| 110398 | AS-61805-20 | Heat Exchanger Assembly |       |
| 093422 | AS-61849-16 | Heat Exchanger          |       |

**Traps & Connectors**

**Vent Transition**

| Part # | Mfg #       | Description     | Price |
|--------|-------------|-----------------|-------|
| 080464 | 68-24047-10 | Vent Transition |       |

**Condensate Trap Assembly**



| Part # | Mfg #        | Description              | Price |
|--------|--------------|--------------------------|-------|
| 009615 | 68-24048-01  | Condensate Trap Assembly |       |
| 080873 | 68-100651-01 | Trap Assembly for UGRK   |       |
| 021617 | 68-24021-01  | Pipe-Outlet Air          |       |
| 160002 | 68-104346-01 | Condensate Drain         |       |

**Vent Termination Kit**

• For gas furnace



| Part # | Mfg #   | Description                                | Price |
|--------|---------|--|-------|
| 135776 | SP20245 | Concentric Vent Termination Kit for 3" PVC |       |

**Connection/Transition**

| Part # | Mfg #        | Description                | Price |
|--------|--------------|----------------------------|-------|
| 025662 | 68-24047-08  | Connection/Transition      |       |
| 125740 | 68-103061-01 | Connection/Transition Assy |       |

Repair Parts

**Ruud Heating & AC Repair Parts**

**Trap**



| Part # | Mfg #       | Description     | Price |
|--------|-------------|-----------------|-------|
| 020322 | 68-24120-01 | Horizontal Trap |       |

**Trap Assembly Connector**

| Part # | Mfg #       | Description             | Price |
|--------|-------------|-------------------------|-------|
| 022339 | 68-24047-07 | Trap Assembly Connector |       |
| 022340 | 68-24047-09 | Trap Assembly Connector |       |

**Furnace Accessories  
Gas Valve Conversion Kit**

| Part # | Mfg #       | Description                                    | Price |
|--------|-------------|--|-------|
| 031644 | 60-21193-02 | White Rodgers 36E Series LP to Natural Gas Kit |       |
| 166053 | 60-22513-04 | Honeywell VR8205 Series Natural Gas to LP      |       |
| 031639 | 60-23430-03 | Robertshaw 7200 Series LP to Natural Gas Kit   |       |
| 243423 | EP-94D      | LP Conversion Kit                              |       |
| 058453 | FP-15       | Conversion Kit NAT/LPG                         |       |
| 151024 | FP-31       | HK LP Conversion Kit                           |       |
| 158962 | FP-33       | JC LP Conversion Kit for 1-Stage               |       |
| 158963 | FP-34       | LP Conversion Kit for 2-Stage                  |       |
| 235100 | FP-38       | LP Conversion Kit for 1-Stage                  |       |
| 185112 | FP-37       | LP Conversion Kit                              |       |
| 158961 | RXGY-ZK     | Zero Clearance Downflow Conversion Kit         |       |

**Filter Cores**

**Filter Core**

| Part # | Mfg #  | Description | Price |
|--------|--------|-------------|-------|
| 149940 | 83-F48 | Filter Core |       |
| 149943 | 83-H48 | Filter Core |       |

**Drier Core**

| Part # | Mfg #   | Description | Price |
|--------|---------|-------------|-------|
| 149941 | 83-W48  | Drier Core  |       |
| 149942 | 83-W100 | Drier Core  |       |

**Solid Furnace Bottoms**



| Part # | Mfg #       | Description                  | Price |
|--------|-------------|------------------------------|-------|
| 073627 | AE-61874-01 | AE-61874-01 Solid Bottom 14" |       |
| 022627 | AE-61874-02 | AE-61874-02 Solid Bottom 17" |       |
| 022628 | AE-61874-03 | AE-61874-03 Solid Bottom 21" |       |
| 073628 | AE-61874-04 | AE-61874-04 Solid Bottom 24" |       |

**Pilots & Orifices**

**Orifice**



| Part # | Mfg #       | Description | Price |
|--------|-------------|-------------|-------|
| 049438 | 62-22175-50 | Orifice     |       |

**Pilot**



| Part # | Mfg #       | Description | Price |
|--------|-------------|-------------|-------|
| 009572 | 62-22864-82 | Pilot       |       |

**Pilot Burner**



| Part # | Mfg #       | Description  | Price |
|--------|-------------|--------------|-------|
| 038148 | 62-21609-01 | Pilot Burner |       |

**Pilot Orifice**



| Part # | Mfg #       | Description   | Price |
|--------|-------------|---------------|-------|
| 009543 | 62-21489-01 | Pilot Orifice |       |
| 009545 | 62-21612-02 | Pilot Orifice |       |
| 009548 | 62-21743-05 | Pilot Orifice |       |
| 009552 | 62-21883-01 | Pilot Orifice |       |

Repair Parts

**Ruud Heating & AC Repair Parts**

**Pilot Safety**



| Part # | Mfg #       | Description  | Price |
|--------|-------------|--------------|-------|
| 009540 | 62-21426-02 | Pilot Safety |       |

**Pilot Sensor**



| Part # | Mfg #       | Description  | Price |
|--------|-------------|--------------|-------|
| 009549 | 62-21744-01 | Pilot Sensor |       |
| 160037 | 62-23543-08 | Flame Sensor |       |

**Drain Pans**

**Drain Pan**

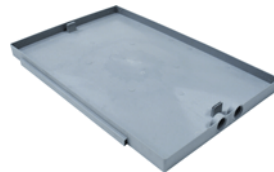

| Part # | Mfg #        | Description                  | Price |
|--------|--------------|------------------------------|-------|
| 229624 | 68-101805-81 | 14" 4-Row Drain Pan          |       |
| 159621 | 68-101805-82 | 17" Drain Pan Vertical 6 Row |       |

**Door Switches**

**Door Switch**



42-21268-04

| Part # | Mfg #       | Description             | Price |
|--------|-------------|-------------------------|-------|
| 050499 | 42-21268-04 | Door Switch             |       |
| 123748 | 42-22692-06 | Push Button Door Switch |       |
| 125543 | 42-22692-09 | Door Switch             |       |
| 160012 | 42-22692-10 | Door Switch             |       |

**Burners**

| Part # | Mfg #       | Description            | Price |
|--------|-------------|------------------------|-------|
| 035443 | 75-22840-02 | Burner Tube - Inshot   |       |
| 028110 | 75-24001-01 | Burner Head Kit        |       |
| 061420 | AS-60993-03 | Burner Halves Assembly |       |
| 103698 | AS-60993-06 | Burner                 |       |
| 043357 | AS-61984-04 | UGRA 1-Pc Burner       |       |
| 043358 | AS-61984-05 | UGRA 1-Pc Burner       |       |
| 043359 | AS-61984-06 | UGRA 1-Pc Burner       |       |
| 043360 | AS-61984-07 | UGRA 1-Pc Burner       |       |
| 043361 | AS-61984-08 | UGRA 1-Pc Burner       |       |

**Burner Support**

| Part # | Mfg #       | Description    | Price |
|--------|-------------|----------------|-------|
| 111992 | AE-61809-15 | Burner Support |       |
| 109627 | AE-61809-12 | Burner Support |       |

**Anti-Vibration Pads**

**EVA Anti-Vibration Pad**

• 2"x2"x7/8"



| Part # | Mfg #  | Description              | Price |
|--------|--------|--------------------------|-------|
| 156821 | 864011 | 2"x2" Anti-Vibration Pad |       |
| 156822 | 864013 | 4"x4" Anti-Vibration Pad |       |

**Miscellaneous**

**Blower Parts**

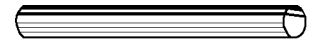

| Part # | Mfg #       | Description | Price |
|--------|-------------|-------------|-------|
| 102437 | 70-42540-04 | 1" Shaft    |       |

**Choke**



| Part # | Mfg #       | Description        | Price |
|--------|-------------|--------------------|-------|
| 052335 | 46-24256-02 | Power Factor Choke |       |

**Ruud Heating & AC Repair Parts**

**Tubing**



| Part # | Mfg #       | Description                                | Price |
|--------|-------------|--|-------|
| 020713 | 79-21491-83 | Silicone Tubing                            |       |
| 162989 | 79-24182-83 | Santoprene Tubing, 31-1/2"L, 2 Hose Clamps |       |
| 173578 | 79-21491-93 | Silicone Tubing, 120"                      |       |

**Sheath Heater Kit**

| Part # | Mfg #       | Description             | Price |
|--------|-------------|-------------------------|-------|
| 037996 | AS-58386-92 | Sheath Heater Kit 3.5kW |       |

**Solenoid Assembly**

| Part # | Mfg #       | Description           | Price |
|--------|-------------|-----------------------|-------|
| 044160 | 61-25055-08 | 24V Solenoid Assembly |       |

**Bearing**



| Part # | Mfg #       | Description            | Price |
|--------|-------------|------------------------|-------|
| 097430 | 70-41854-02 | Ball Bearing With Lock |       |

**OEM Neoprene Gasket**

- Suitable for temperature range of -70° to 250°F
- Meets UL94HFI and UL94HBF flammability tests



| Part # | Mfg #       | Description              | Price |
|--------|-------------|--------------------------|-------|
| 059148 | 68-22079-81 | 1-1/8"W 25'L 5/16" Thick |       |

**ShuBee Shoe Covers**

- Waterproof
- Box of 40 pairs



| Part # | Mfg #  | Color     | Price |
|--------|--------|-----------|-------|
| 166026 | 849120 | Dark Blue |       |

**Replacement Parts and Accessories**

| Part # | Mfg #        | Description   | Price |
|--------|--------------|---|-------|
| 111991 | AE-61913-02  | Overtemperature Switch Bracket                      |       |
| 145536 | SP14410      | Piezo Igniter with Bracket                          |       |
| 160006 | 68-104446-01 | Parts Bag   |       |
| 162200 | 45-22980-05  | Button Plug   |       |
| 107681 | 1000         | FAST-STAT Wire Extender                             |       |
| 161388 | AS-58922-01  | Turbulator  |       |
| 168203 | 6231         | Cold Weather Kit - GEN15ADC-E, GEN16AD-E, GEN20AD-E |       |
| 180506 | 630500       | SMART Flow Elbow                                    |       |
| 230606 | RXGY-J02     | Sensor Kit - Outdoor                                |       |
| 047567 | 68-24022-02  | Gasket - Outlet Air                                 |       |

Repair Parts

## Ruud Heating & AC Repair Parts

### Ruud Accessories

#### RXCT - Expansion Valve Conversion Kit

- Use to convert RCBA indoor coils to RCGA/RCGJ/RCHA and RCHJ coils



| Part # | Mfg #    | Description                 | Price |
|--------|----------|-----------------------------|-------|
| 132107 | RXCT-FBA | R410 Universal TXV Repl Kit |       |
| 133834 | RXCT-EBA | TXV R22 Universal 2 Ton     |       |
| 132108 | RXCT-FBB | R410 Univ TXV Repl Kit      |       |
| 132109 | RXCT-FBC | Expansion Valve Kit         |       |
| 132110 | RXCT-FBD | TXV Universal Kit           |       |

#### Controls

| Part # | Mfg #    | Description           | Price |
|--------|----------|-----------------------|-------|
| 173851 | RXAB-A07 | High Pressure Control |       |
| 173850 | RXAC-A07 | Low Pressure Control  |       |
| 130488 | RXRZ-C02 | Low Ambient Control   |       |

#### RXGF - Media Air Cleaner



RXGF-CB

RXGF-CC

RXGF-CD

| Part # | Mfg #   | Outside Dimensions                         | Price |
|--------|---------|--|-------|
| 132422 | RXGF-CB | Bottom Mount 24-1/4"W x 28-1/4"L x 3-1/2"H |       |
| 020727 | RXGF-CC | Top Mount Filter Rack - Gas Downflow       |       |
| 158964 | RXGF-CD | Side Return Filter Rack - Gas Upflow       |       |

#### External Filter Rack

- Upflow - Electric
- Duct configuration: Through
- Air opening inlet/outlet: 15-3/4" x 19-1/2"
- Housing overall: 17-1/2" x 21" x 3-5/8"
- Hinged door - opening on 17-1/2" side
- Replacement media dimensions: 16" x 20"



| Part # | Mfg #   | Description                            | Price |
|--------|---------|--|-------|
| 147301 | RXHF-17 | External Filter Rack - Electric Upflow |       |

### Ruud Accessories (Continued)

#### External Filter Rack

| Part # | Mfg #   | Description                            | Price |
|--------|---------|--|-------|
| 158306 | RXHF-21 | External Filter Rack - Electric Upflow |       |

#### RXMG - Label Kit

| Part # | Mfg #   | Description           | Price |
|--------|---------|-----------------------|-------|
| 105390 | RXMG-AU | Ruud Label Kit        |       |
| 127216 | RXMG-AY | WeatherKing Label Kit |       |

#### RXBH - Heater Kit



| Part # | Mfg #         | Description       | Price |
|--------|---------------|-------------------|-------|
| 133645 | RXBH-1724A18J | 18kW 208-230/1/60 |       |
| 133870 | RXBH-1724A13J | 12kW 208-230/1/60 |       |

### Repair & Replacement Parts

| Part # | Mfg #       | Description               | Price |
|--------|-------------|---------------------------|-------|
| 236864 | 43-25136-21 | 4/440 Sngle Rnd Capacitor |       |

#### Drain Trap

| Part # | Mfg #  | Description       | Price |
|--------|--------|-------------------|-------|
| 125544 | 791000 | Tubing Drain Trap |       |
| 125548 | 791001 | Tubing Drain Trap |       |

#### Gas Valve



| Part # | Mfg #        | Description | Price |
|--------|--------------|-------------|-------|
| 009506 | 60-22525-03  | Gas Valve   |       |
| 009507 | 60-22525-04  | Gas Valve   |       |
| 236634 | 60-102787-85 | Gas Valve   |       |
| 009508 | 60-22525-05  | Gas Valve   |       |





## Ruud Heating & AC Repair Parts

### 36J Series Gas Valve

- Natural gas
- 1/2" NPT
- Hot surface/direct spark



| Part # | Mfg #        | Description              | Price |
|--------|--------------|--------------------------|-------|
| 175965 | 60-103901-02 | 36J Series White Rodgers |       |

### Vent Damper



| Part # | Mfg #   | Description | Price |
|--------|---------|-------------|-------|
| 145411 | AP15561 | Vent Damper |       |

### Induced Draft Blower with Gasket

- Polymeric
- 460V
- 60Hz



| Part # | Mfg #       | Side of Discharge | Price |
|--------|-------------|-------------------|-------|
| 241412 | 70-42242-01 | Left              |       |

### Ignition Control



| Part # | Mfg #       | Description            | Price |
|--------|-------------|------------------------|-------|
| 034342 | 62-24084-82 | Ignition Control Board |       |

### Igniter



| Part # | Mfg #    | Description         | Price |
|--------|----------|---------------------|-------|
| 137361 | AP14698B | NG Igniter Assembly |       |
| 137360 | AP14700B | LP Igniter Assembly |       |

### Pressure Switches

| Part # | Mfg #        | Description     | Price |
|--------|--------------|-----------------|-------|
| 240688 | 42-105499-07 | Pressure Switch |       |
| 240687 | 42-105499-09 | Pressure Switch |       |
| 239326 | 42-105583-04 | Pressure Switch |       |
| 239320 | 42-105583-08 | Pressure Switch |       |
| 240691 | 42-105583-10 | Pressure Switch |       |
| 240689 | 42-105583-11 | Pressure Switch |       |
| 240690 | 42-105583-12 | Pressure Switch |       |



## Furnace Accessories

### Ruud Furnace Accessories Integrated Furnace Control Board

- IFC

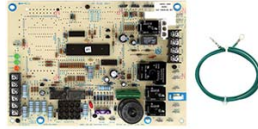

| Part # | Mfg #        | Description              | Price |
|--------|--------------|--------------------------|-------|
| 155291 | 62-102636-81 | Integrated Control Board |       |
| 246259 | 62-105563-02 | Integrated Control Board |       |

### Low Ambient Control

- Auto reset
- Low pressure limit
- Open pressure: 150 psig
- Close pressure: 275 psig
- Includes 36" capillary tube
- 1/4" Flare (Female SAE) connection size



| Part # | Mfg #       | Description         | Price |
|--------|-------------|---------------------|-------|
| 090119 | 47-25343-82 | Low Ambient Control |       |

### RXGP - Twinning Kit

| Part # | Mfg #    | Description                                    | Price |
|--------|----------|--|-------|
| 138545 | RXGP-F03 | For Use w/Gas Furnaces for Parallel Operations |       |

### ERV/HRV - Vent Termination Kit

| Part # | Mfg #     | Description           | Price |
|--------|-----------|-----------------------|-------|
| 155994 | 84-ERVHRV | HEPA Vent Termination |       |

### RXGY - Vent Termination Kit

- For gas furnace

| Part # | Mfg #    | Description                            | Price |
|--------|----------|--|-------|
| 087666 | RXGY-G01 | Horizontal Vent Termination for 3" PVC |       |
| 097398 | RXGY-G02 | Horizontal Vent Termination for 2" PVC |       |

### Conversion Kits

| Part # | Mfg #   | Description                        | Price |
|--------|---------|------------------------------------|-------|
| 158960 | RXGY-CK | Downflow/Horizontal Conversion Kit |       |

### RXPF - Fossil Fuel Kit

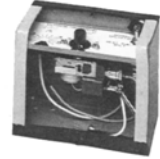

| Part # | Mfg #    | Description                | Price |
|--------|----------|----------------------------|-------|
| 032692 | RXPF-F01 | Fossil Fuel Kit - Standard |       |

### RXRY - Filter Kit

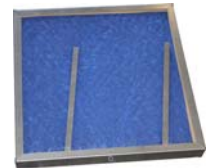

| Part # | Mfg #    | Description   | Price |
|--------|----------|---|-------|
| 085898 | RXRY-B01 | For Vertical or Horizontal Discharge in RQKA & RQMA |       |

### Furnace Repair & Replacement Parts

| Part # | Mfg #       | Description                                 | Price |
|--------|-------------|---|-------|
| 074120 | 60-21193-01 | Gas Valve Spring Kit White-Rodgers F92-0659 |       |
| 083260 | 60-22513-03 | Gas Valve Spring Kit Honeywell 396221-2     |       |
| 031641 | 60-23430-01 | Gas Valve Spring Kit Honeywell 394588       |       |

### Conversion Kit - NG - LP

| Part # | Mfg # | Description           | Price |
|--------|-------|-----------------------|-------|
| 025489 | FP-02 | Nat-LP Conversion Kit |       |
| 058453 | FP-15 | Nat-LP Conversion Kit |       |
| 100705 | FP-21 | Nat-LP Conversion Kit |       |
| 121685 | FP-26 | Nat-LP Conversion Kit |       |
| 129578 | FP-27 | Nat-LP Conversion Kit |       |

### Enthalpy Sensor

- Direct replacement for 470008



| Part # | Mfg #  | Description     | Price |
|--------|--------|-----------------|-------|
| 124299 | 470011 | Enthalpy Sensor |       |

Repair Parts

## Ruud Heating & AC Repair Parts

### Motors

#### Motor Mount - Flex Bracket

- Torsion flex bracket



| Part # | Mfg # | Description                 | Price |
|--------|-------|-----------------------------|-------|
| 198041 | DMB-1 | Fits 5-1/2" Diameter Motors |       |
| 139342 | DMB-3 | Fits 5-1/2" Diameter Motors |       |

#### Multiple Horsepower Blower Motor

- Reversing plugs
- Extended thru bolts
- 36 inch leads
- Designed for 370 volt capacitors.
- Installs with all 48 mounting brackets.



| Part # | Mfg #    | Description                          | Price |
|--------|----------|--------------------------------------|-------|
| 198034 | WG840463 | 1/6-1/2 HP-FLA 115V Blower Motor     |       |
| 198035 | WG840464 | 1/6-1/2 HP-FLA 208-230V Blower Motor |       |
| 198036 | WG840466 | 1/5-3/4 HP-FLA 115V Blower Motor     |       |
| 198037 | WG840467 | 1/5-3/4 HP-FLA 208-230V Blower Motor |       |

#### Multiple Horsepower Condenser Fan Motors

- Reversing plugs
- Extended thru bolts
- 36 inch leads
- Designed for 370 volt capacitors
- Installs with all 48 frame mounting brackets.



| Part # | Mfg #    | Description                                 | Price |
|--------|----------|---|-------|
| 198038 | WG840465 | 1/6-1/3 HP-FLA 208-230V Condenser Fan Motor |       |
| 198039 | WG840468 | 1/5-1/2 HP-FLA 208-230V Condenser Fan Motor |       |
| 198040 | WG840469 | 1/6-1/2 HP-FLA 208-230V Condenser Fan Motor |       |

### Direct Drive Furnace Blower Motors

- Installed with standard 48 frame mounting brackets
- Quiet operator and electrically reversible
- Automatic Thermal Overload Protector
- Class B insulation
- 30in. leads and 60 HZ with low power consumption
- Standard 48 frame motor casing size
- Drain holes with plugs on both end plates
- Continuous air over
- 60 C Ambient Design with Extended Studs.



| Part # | Mfg #    | Description                          | Price |
|--------|----------|--------------------------------------|-------|
| 198021 | WG840583 | 1/4 HP 4.6 FLA 115V Blower Motor     |       |
| 198022 | WG840584 | 1/4 HP 2.2FLA 208/230V Blower Motor  |       |
| 198023 | WG840585 | 1/3 HP 6.7 FLA 115V Blower Motor     |       |
| 198024 | WG840586 | 1/3 HP 2.9 FLA 208/230V Blower Motor |       |
| 198025 | WG840587 | 1/2 HP 10.2 FLA 115V Blower Motor    |       |
| 198026 | WG840588 | 1/2 HP 5.0 FLA 208/230V Blower Motor |       |
| 198027 | WG840589 | 3/4 HP 11.3 FLA 115V Blower Motor    |       |
| 198028 | WG840590 | 3/4 HP 5.4 FLA 208/230V Blower Motor |       |
| 206600 | WG840595 | 1HP 12.6 FLA 115V Blower Motor       |       |

### Single Speed Condenser Fan Motors

- Installs with all standard 48 frame mounting brackets
- Quiet operator and electrically reversible
- Includes Automatic Thermal Overload Protector
- Class B insulation
- 370V Capacitor
- Standard 48 frame motor casing size
- 2.5in. diameter hub rings included.



| Part # | Mfg #    | Description                                 | Price |
|--------|----------|---|-------|
| 198029 | WG840727 | 1/6 HP 1.3 FLA 208/230V Condenser Fan Motor |       |

Repair Parts



---



---

## Ruud Heating & AC Repair Parts

---



---

### Motors (Continued)

#### Single Speed Condenser Fan Motors

| Part # | Mfg #    | Description                                    | Price |
|--------|----------|--|-------|
| 198030 | WG840728 | 1/4 HP 2.2 FLA 208/230V<br>Condenser Fan Motor |       |
| 198031 | WG840729 | 1/3 HP 2.8 FLA 208/230V<br>Condenser Fan Motor |       |
| 198032 | WG840730 | 1/2 HP 4.2 FLA 208/230V<br>Condenser Fan Motor |       |
| 198033 | WG840731 | 3/4 HP 4.5 FLA 208/230V<br>Condenser Fan Motor |       |

## Water Right Repair Parts

### Installation Fittings

| Part # | Mfg #      | Description                  | Price |
|--------|------------|------------------------------|-------|
| 126558 | CV-3007    | 1" PVC Male NPT 90° Assembly |       |
| 066030 | CV-3007-02 | 1" Brass Sweat Assembly      |       |
| 066031 | CV-3007-03 | 3/4" Brass Sweat Assembly    |       |
| 134871 | CV-3007-12 | 3/4" Shark Bite Assembly     |       |
| 129386 | CV-3150    | Split Ring                   |       |
| 121817 | CV-3005-2  | Spacer Stack Assembly        |       |

### Replacement Parts

| Part # | Mfg #      | Description                            | Price |
|--------|------------|--|-------|
| 075129 | CH1072-01  | 18" dia Salt Grid with 4" Hole         |       |
| 073577 | FP-60049   | Plastic Bypass Assembly                |       |
| 074255 | CS-1448-RS | 35 gal Replacement Membrane for WRO035 |       |

### Accessories

| Part # | Mfg #   | Description              | Price |
|--------|---------|--------------------------|-------|
| 101608 | HT-5B   | Water-Right Hardness Kit |       |
| 113671 | FP60066 | Brine Valve Water-Right  |       |
| 148693 | CU7002  | Water Sample Bottle      |       |
| 150670 | RO12N   | 1.5# Softener Rust Out   |       |
| 099934 | VA-2    | Better Air Gap           |       |
| 192000 | M-G20   | W-R Gravel Per 1# Bag    |       |



## Watts Regulator Repair Parts

### Dielectric Union Kits

#### 3000 Series Dielectric Union Gasket Kit

| Part # | Mfg #   | Model   | Size   | Price |
|--------|---------|---------|--------|-------|
| 030973 | 0881401 | GAB KIT | 3/4"   |       |
| 030972 | 0881402 | GAC KIT | 1"     |       |
| 030971 | 0881403 | GAD KIT | 1-1/4" |       |
| 030970 | 0881404 | GAE KIT | 1-1/2" |       |
| 030969 | 0881405 | GAF KIT | 2"     |       |

## Weil McLain Repair Parts

### Weil-McLain Boiler Parts & Components

| Part # | Mfg.#       | Description   | For                          | Price |
|--------|-------------|---|------------------------------|-------|
| 241885 | 381-330-027 | Ignition Board  |                              |       |
| 110792 | 382-200-449 | Conversion Kit, NG, from Cycle Pilot System to Gold control HSI |                              |       |
| 011885 | 382-930-216 | 10C523 Igniter Kit  | VHE, HE II                   |       |
| 076751 | 383-500-345 | Repair Plug Kit   |                              |       |
| 128037 | 383-500-603 | (5) Ultra U-Control Module Fuses, 3A, Fast-Blow AG              | F1                           |       |
| 145731 | 383-500-604 | (5) Ultra U-Control Module Fuses, 12A, Slow-Blow AG             | F2                           |       |
| 066016 | 383-500-190 | Control Module for All 1 and 2 Ultra Boilers                    |                              |       |
| 237635 | 383-500-665 | Control Module - Ultra Series 1 & 2 Boilers                     |                              |       |
| 129778 | 383-500-622 | Heat Exchanger Replacement Kit                                  | 230                          |       |
| 129779 | 383-500-623 | Heat Exchanger Replacement Kit                                  | 310                          |       |
| 128030 | 383-600-069 | Low Water Cut-Off   |                              |       |
| 239617 | 383-900-064 | Evergreen 220 LP Kit  |                              |       |
| 076395 | 389-900-203 | WMCR-3 3 Zone Circulator Control                                |                              |       |
| 045038 | 389-900-205 | 6 Zone Circulator Control                                       |                              |       |
| 138955 | 389-900-206 | WMZV-4 4 Zone Valve Control                                     |                              |       |
| 136985 | 389-900-220 | BCP-3 Hydronic Multi-Stage Boiler Control Panel                 |                              |       |
| 011893 | 510-218-099 | 10C034 Tridicator Gauge, 2-1/2" Short Shank                     | GV, GO, CG Prior to Jan 2000 |       |
| 101982 | 510-300-014 | 210°C Spill Switch with Reset                                   | CG Sect/Base Series 1-12     |       |
| 127719 | 510-312-015 | High Limit Temperature Control                                  | HE II, HE, VHE               |       |
| 011899 | 510-312-166 | 10C053 Combination 120/24V Transformer-Relay Receptacle         | CG, AHE, EGH, HE II, HE, PFG |       |
| 116334 | 510-312-218 | Outdoor Temp Sensor   |                              |       |
| 038133 | 510-312-250 | 10C055 Limit Control & 1/2" Well                                | CG, CGm, EGH, PFG            |       |
| 021051 | 510-312-312 | 10C567 Blower Motor Assembly                                    | HE II, HE                    |       |
| 011904 | 510-312-317 | 10C579 Motor Repl Kit   | VHE                          |       |
| 239431 | 510-312-361 | 399 MBH Blower Motor Assembly                                   | 7050-0118                    |       |
| 011909 | 510-350-223 | 10C072 Control Relay, DPST 24V                                  | AHE, CG, EG, EGH, HEII, PFG  |       |
| 032886 | 510-811-221 | Pilot Assembly NG   |                              |       |
| 032887 | 510-811-222 | Pilot Assembly Propane  |                              |       |
| 011913 | 510-811-362 | NG-LP Conversion Kit  | CG 25 - 6                    |       |
| 107651 | 510-811-502 | 24V Combination Ignition-Sensing Control Module                 |                              |       |
| 022497 | 510-811-644 | Pilot Assembly Kit  |                              |       |
| 011922 | 510-811-655 | 10C528 NG Valve   | HE, HEII, VHE                |       |
| 011923 | 510-811-656 | 10C529 Step Open LP Gas Valve                                   | HE, HEII, VHE                |       |
| 044138 | 511-044-382 | Gas Valve 3/4" x 3/4" NG 10C489                                 |                              |       |
| 078890 | 511-114-479 | 63m Low Water Cut-off   |                              |       |
| 078891 | 511-114-526 | w/McLain LWCO 150smd M&M 17180 672619142831                     |                              |       |
| 059929 | 511-330-081 | LP Pilot Burner Assembly  |                              |       |
| 011934 | 511-330-095 | Ignition Module 10C486  | CG, EG, EGH, PFG             |       |
| 019926 | 511-330-184 | Igniter Only 10C455   | HE/VHE                       |       |
| 011943 | 511-330-186 | Pilot Burner Assembly   |                              |       |
| 011944 | 511-330-192 | Flame Sensor 10C188   | HE, VHE                      |       |
| 011945 | 511-330-197 | Pilot Burner  | E38-2 24V                    |       |
| 073640 | 511-330-218 | Pin Pilot Burner 10C481   | CG                           |       |
| 064739 | 511-330-221 | Pilot Burner Assembly with Ignition Lead and Orifice PSE-NA16   |                              |       |
| 011947 | 511-624-510 | Switch .95 Pressure Switch 3-5 2, 000'-4, 000' 10C213           | HE                           |       |

## Weil McLain Repair Parts

### Weil-McLain Boiler Parts & Components (Continued)

| Part # | Mfg.#       | Description   | For                  | Price |
|--------|-------------|---|----------------------|-------|
| 011948 | 511-624-514 | Pressure Switch 51.2 Pressure Switch VHE 2000'-4000' 10C215 |                      |       |
| 074480 | 511-724-259 | Thermopile for EG-75  |                      |       |
| 038426 | 511-724-274 | Main Flame Sensor   |                      |       |
| 011956 | 512-050-230 | Thermal Fuse 10C257   | CG, EG, HE, PFG, VHE |       |
| 056344 | 512-200-000 | Steel Burner Tube   |                      |       |
| 056346 | 512-200-001 | Steel Burner Tube with Bracket                              |                      |       |
| 118676 | 512-200-035 | Burner  | HE VHE CGi           |       |
| 011958 | 512-200-045 | Pilot Burner 10B867   |                      |       |
| 127431 | 540-131-052 | X100 Sentinel Corrosion Inhibitor Kit                       |                      |       |
| 127432 | 540-131-053 | X100 Sentinel Corrosion Inhibitor Kit                       |                      |       |
| 127433 | 540-131-054 | X100 Sentinel Corrosion Inhibitor Kit                       |                      |       |
| 011968 | 560-742-860 | Pilot Tubing  |                      |       |
| 020911 | 590-317-610 | Blower Gasket   |                      |       |
| 015274 | 590-735-140 | 1/2" x 100" Glass Rope 10B985                               |                      |       |
| 086820 | 591-200-000 | Cover Plate Gasket/Insulation                               |                      |       |
| 239521 | 591-222-025 | Front Base Insulation                                       |                      |       |
| 114285 | 591-706-200 | Heat Exchanger Cleaning Tool                                |                      |       |
| 011981 | 591-706-214 | Flue Brush 11B146   |                      |       |
| 011985 | 592-800-011 | 2" Square Cut Seal  |                      |       |
| 127434 | 592-900-002 | Sentinel X-100 Corrosion Inhibitor Concentrate              |                      |       |
| 127632 | 592-900-003 | X400 Cleaner  |                      |       |
| 239853 | 633-600-012 | AcuTemp Thermostat Repair Kit                               | Series 2             |       |
| 059875 | 633-900-102 | Thermostat with Cover Plate Kit for Plus Water Heaters      |                      |       |
| 094665 | 633-900-130 | Gold Plus Thermostat Kit                                    |                      |       |
| 011986 | 635-100-010 | Kit Thermostat Plus   |                      |       |

### Vent Damper

| Part # | Mfg.#       | Description                       | Price |
|--------|-------------|-----------------------------------|-------|
| 019945 | 381-800-474 | 4" Vent Damper                    |       |
| 019946 | 381-800-475 | 10C081 5" Vent Damper for EG30/35 |       |
| 019944 | 381-800-476 | 6" Damper Assembly CGM,EG         |       |
| 019947 | 381-800-477 | 7" Damper Assembly CGM,EG,PFG     |       |
| 030770 | 381-800-478 | 10C478 8" Vent Damper for EG65/75 |       |

### CGa Series Accessories

| Part # | Mfg.#       | Description                                      | For            | Price |
|--------|-------------|--|----------------|-------|
| 146736 | 381-357-313 | Pilot less Ignition for Natural Gas Boilers      | CGa-8          |       |
| 049683 | 450-021-245 | CGa-7 Draft Hood Vertical                        |                |       |
| 032392 | 450-021-246 | CGa-8 Draft Hood Vertical                        |                |       |
| 242387 | 510-811-946 | NG-LP Conversion Kit                             | CGa 25 - CGa 7 |       |
| 242388 | 510-811-947 | LP Kit   | CGa-8          |       |
| 050610 | 512-200-077 | CGa Main Stainless Steel Burner Tube             |                |       |
| 065995 | 512-200-079 | CGa Stainless Steel Burner with Pilot Bracket LP |                |       |



## Weil McLain Repair Parts

### CGi Series Accessories

| Part # | Mfg.#       | Description                             | For | Price |
|--------|-------------|---|-----|-------|
| 058742 | 511-330-090 | Control Module with 10 Second Pre-purge |     |       |
| 064887 | 510-312-167 | Transformer                             |     |       |
| 059928 | 511-330-080 | Pilot Assembly Kit NG                   |     |       |

### CGm Series Accessories

| Part # | Mfg.#       | Description | For     | Price |
|--------|-------------|-------------|---------|-------|
| 041152 | 511-044-256 | NG Valve    | CGm 7-8 |       |

### CGs Series Accessories

| Part # | Mfg.#       | Description                   | For | Price |
|--------|-------------|-------------------------------|-----|-------|
| 017582 | 311-103-818 | Intermediate Section Assembly |     |       |

### CGt Series Accessories

| Part # | Mfg.#       | Description   | For        | Price |
|--------|-------------|---|------------|-------|
| 112055 | 380-000-000 | Combination Pressure-Temperature Gauge Kit, 60° - 360°F | CGt Series |       |

### PFG Series Accessories

| Part # | Mfg.#       | Description                   | For | Price |
|--------|-------------|-------------------------------|-----|-------|
| 011912 | 510-512-337 | Vent Damper Motor Operator    |     |       |
| 024710 | 511-044-287 | NG Control Valve, 1" x 1" NPT | PFG |       |

### Ultra Series Accessories

| Part # | Mfg.#       | Description  | For                     | Price |
|--------|-------------|--|-------------------------|-------|
| 109058 | 383-500-021 | Time Delay/Relay Box                                 |                         |       |
| 066027 | 383-500-025 | Gas Valve Kit  | Ultra 155               |       |
| 066028 | 383-500-030 | Gas Valve/Venturi Kit                                | Ultra 230               |       |
| 066022 | 383-500-035 | Blower Assembly                                      | Ultra 155               |       |
| 066024 | 383-500-040 | Blower Assembly                                      | Ultra 230               |       |
| 066039 | 383-500-045 | Ignition Electrode Kit                               | Ultra 80 & 105          |       |
| 066042 | 383-500-055 | Flue Temperature Sensor Replacement Kit              |                         |       |
| 066040 | 383-500-085 | Burner Replacement Kit                               | Ultra 155               |       |
| 130501 | 383-500-095 | Watts #330 300 psi Pressure Relief Valve, ASME       |                         |       |
| 120566 | 383-500-105 | 3" Vent Termination Bird Screen                      | Ultra 80, 105, & 155    |       |
| 105545 | 383-500-110 | 4" Vent Termination Bird Screen                      | Ultra 230 & 310         |       |
| 066021 | 383-500-125 | Outdoor Temperature Sensor                           |                         |       |
| 066017 | 383-500-195 | 115VAC / 24VAC, 50-60Hz, 50 VA Honeywell Transformer |                         |       |
| 093857 | 383-500-210 | Pressure/Temperature Gauge Assembly                  |                         |       |
| 143606 | 383-500-235 | 5 Amp Fast-Blow Fuses                                | Circulator Circuit 5/Pk |       |
| 143607 | 383-500-240 | 4 Amp Slow-Blow Fuses                                | 24-Volt Circuit 5/Pk    |       |
| 086818 | 383-500-250 | Cover Plate Gasket/Insulation                        | Ultra 155, 230, & 310   |       |
| 086819 | 383-500-255 | Cover Plate Gasket                                   | Ultra 155, 230, & 310   |       |
| 074417 | 383-500-360 | Blower Assembly Kit                                  | Ultra 310               |       |
| 074418 | 383-500-390 | Gas Valve/Venturi Kit                                | Ultra 310               |       |

## Weil McLain Repair Parts

### Weil-McLain Boiler Parts & Components (Continued) Ultra Series Accessories

| Part # | Mfg.#       | Description                               | For                        | Price |
|--------|-------------|---|----------------------------|-------|
| 133205 | 383-500-395 | Cover Plate Replacement Kit               | Ultra 155 & 230            |       |
| 116337 | 383-500-408 | Display Board/Bracket Assembly            | Ultra 155/230              |       |
| 121565 | 383-500-600 | Flue Temperature Sensor Replacement Kit   |                            |       |
| 116333 | 383-500-601 | System Temperature Sensors                |                            |       |
| 116331 | 383-500-602 | Return/Supply Sensor Kit, (1) Sensor      |                            |       |
| 120435 | 383-500-605 | Maintenance Kit                           | Ultra 80 and 105           |       |
| 120436 | 383-500-620 | Maintenance Kit                           | Ultra 155, 230, 299, & 399 |       |
| 129776 | 383-500-621 | Heat Exchanger Kit                        | Ultra 155                  |       |
| 120152 | 383-500-628 | 120V/24V Transformer                      |                            |       |
| 133206 | 383-500-630 | Pressure/Temperature Gauge Assembly       |                            |       |
| 130577 | 383-500-649 | Ultra Easy-Up Manifold Kit, 1-1/4" Piping | UG 80 & 105                |       |
| 133204 | 383-500-650 | Blower Assembly Kit                       | Ultra 399                  |       |
| 133203 | 383-500-652 | Gas Valve Kit                             | Ultra 399                  |       |
| 127630 | 383-500-658 | Control Module                            |                            |       |
| 127885 | 383-500-659 | Display Board Assembly                    |                            |       |
| 074410 | 383-501-027 | Blower Assembly Kit                       | Ultra 80 & 105             |       |
| 074411 | 383-501-029 | Gas Valve/Venturi Kit                     | Ultra 80                   |       |
| 074413 | 383-501-030 | Gas Valve/Venturi Kit                     | Ultra 105                  |       |
| 125176 | 511-100-005 | LWCO with Harness & Test Button           |                            |       |
| 090744 | 511-405-133 | Taco 0014 Boiler Circulator, less Flanges | Ultra 155, 230, & 310      |       |
| 107709 | 590-317-310 | Gasket Cork                               |                            |       |

### Ultra Commercial Series Accessories

| Part # | Mfg.#       | Description   | For | Price |
|--------|-------------|---|-----|-------|
| 127629 | 383-600-065 | Watts 174A 80 psi Relief Valve, 3/4" x 3/4", 1,400 mbh Capacity |     |       |
| 143176 | 383-600-079 | Maintenance Kit   |     |       |

### WM97+ Series Accessories

| Part # | Mfg.#       | Description                   | For            | Price |
|--------|-------------|-------------------------------|----------------|-------|
| 146863 | 383-700-113 | Igniter, Gasket and Screw     | WM97+ 70 & 110 |       |
| 146859 | 383-700-139 | Ignition Control              | WM97+ 70 & 110 |       |
| 146870 | 383-700-157 | Piping Assembly Blower & Clip | WM97+ 70 & 110 |       |
| 146871 | 383-700-159 | Piping Assembly Gas Valve     | WM97+ 70       |       |
| 146872 | 383-700-160 | Piping Assembly Gas Valve     | WM97+ 110      |       |
| 146860 | 511-724-292 | Flue Sensor                   | WM97+ 70 & 110 |       |
| 146861 | 511-724-296 | Water Temperature Sensor      | WM97+ 70 & 110 |       |
| 146864 | 511-802-015 | 50VA Transformer              | WM97+ 70 & 110 |       |

### GV Series Accessories

| Part # | Mfg.#       | Description            | For          | Price |
|--------|-------------|------------------------|--------------|-------|
| 011874 | 382-200-325 | Burner Replacement Kit | GV4 & GV90+4 |       |
| 011875 | 382-200-330 | Burner Replacement Kit | GV5 & GV90+5 |       |
| 011877 | 382-200-340 | Blower Assembly        |              |       |

## Weil McLain Repair Parts

### Weil-McLain Boiler Parts & Components (Continued) GV Series Accessories

| Part # | Mfg.#       | Description                                      | For                      | Price |
|--------|-------------|--|--------------------------|-------|
| 011878 | 382-200-345 | Blower Motor Kit 10C380                          |                          |       |
| 011879 | 382-200-350 | Vent 90 10C387                                   |                          |       |
| 011881 | 382-200-375 | Switch Kit 10C403                                | GV90                     |       |
| 011882 | 382-200-385 | Hose Trap Kit                                    |                          |       |
| 030451 | 382-200-410 | Boiler Gas Valve 10C399                          |                          |       |
| 065429 | 382-200-411 | Gas Valve Kit GV Series 4                        |                          |       |
| 043582 | 382-200-448 | Ignition Control Module (GV Series 1,2&3) 10C400 |                          |       |
| 011896 | 510-312-019 | 10C411 Limit Control                             |                          |       |
| 050453 | 510-312-021 | Limit Control w/1/2" Well                        | GV Ser 1, 2, 3 Sect Assy |       |
| 011941 | 511-330-148 | Ignition Kit 10C402                              |                          |       |
| 011949 | 511-624-520 | Pressure Switch 10C382                           | GV                       |       |
| 011955 | 511-842-370 | Transformer 10C401                               | GV                       |       |

### EG/EGH Series Accessories

| Part # | Mfg.#       | Description                                    | For                             | Price |
|--------|-------------|--|---------------------------------|-------|
| 239732 | 321-711-115 | Section Assy for EGH 95 Boiler                 |                                 |       |
| 239733 | 381-700-246 | 42-1/2" Base Panel for EGH 95 Boiler           |                                 |       |
| 239734 | 381-700-506 | Base Assy for EGH 95 Boilers                   |                                 |       |
| 035079 | 381-800-677 | EG75 SPDN Boiler Water Trim No Tankless Option |                                 |       |
| 035078 | 381-800-675 | EGH-30 to 65 Water Trim                        |                                 |       |
| 239736 | 411-800-271 | Jacket Assy Carton for EGH-95 Boilers          |                                 |       |
| 239738 | 450-014-751 | Collector Hood for EGH-95 Boilers              |                                 |       |
| 239737 | 450-206-241 | Draft Hood for EGH Series Boiler               |                                 |       |
| 011892 | 510-218-097 | 10C526 Tridicator, 2-1/2" Long Shank           | EG Series 1-4 Section Base Assy |       |
| 074482 | 511-724-255 | 36" Thermocouple with Spade Terminal Block     | EG 75, EGH 85 & 95              |       |
| 011966 | 560-528-985 | LP Gas Pilot Orifice                           |                                 |       |
| 074479 | 590-850-561 | 5" Lead Wire                                   | EG 75                           |       |
| 151620 | 381-800-837 | Trim Steam EG30-75                             |                                 |       |

### Sentinel Series Accessories

| Part # | Mfg #       | Description                 | Price |
|--------|-------------|-----------------------------|-------|
| 127435 | 592-900-005 | Sentinel X100 Quik Test Kit |       |

### Ultra Oil Accessories

| Part # | Mfg #       | Description                  | Price |
|--------|-------------|------------------------------|-------|
| 066035 | 383-500-300 | Water Temperature Sensor Kit |       |
| 066012 | 389-900-180 | Wall Mount Kit               |       |

## Westinghouse/Philco Repair Parts

### Blower Wheels

| Part # | Mfg #   | Description                | Price |
|--------|---------|----------------------------|-------|
| 241795 | 622683  | 1/2" HP, CCWLE             |       |
| 245085 | 667187R | Draft Inducer Blower Wheel |       |
| 119974 | 667207  | 10-3/4" x 10", CW          |       |
| 119975 | 667251  | 10" x 6", CW               |       |
| 245205 | 667252R | 10" x 7", CW               |       |
| 119976 | 667258R | 11" x 8", CCWLE            |       |
| 119977 | 667280  | 11" x 10", CCW             |       |
| 119979 | 667374  | 11" x 8", CW               |       |

### Burners

| Part # | Mfg #     | Description                                  | Price |
|--------|-----------|--|-------|
| 134174 | 660921    | Burner L1                                    |       |
| 134173 | 661128    | Inshot Burner G7T                            |       |
| 242549 | M0062414R | Burner Box Kit for Use with Ignitor 10177435 |       |

### Capacitors

| Part # | Mfg #   | Description                 | Price |
|--------|---------|-----------------------------|-------|
| 146433 | 01-0024 | 10mfd, 370V Round Capacitor |       |
| 119928 | 622135  | 15mfd, 370V Round Capacitor |       |
| 136994 | 622545  | 10mfd, 370V Round Capacitor |       |

### Contactors

| Part # | Mfg #    | Description           | Price |
|--------|----------|-----------------------|-------|
| 139778 | 621661   | 25A, 1-Pole           |       |
| 139779 | 621662   | 35A, 1-Pole           |       |
| 246424 | 1014866R | 24VAC, 2-Pole, 25 FLA |       |

### Control Boards

| Part # | Mfg #   | Description         | Price |
|--------|---------|---------------------|-------|
| 242566 | 624689R | Interface Module    |       |
| 133371 | 904531  | Board All Units     |       |
| 129223 | 920915  | Control Board G7    |       |
| 130336 | 920916  | Control Board G7    |       |
| 128774 | 920920  | Board Direct Torque |       |

### Control Modules

| Part # | Mfg #  | Description                        | Price |
|--------|--------|------------------------------------|-------|
| 139792 | 624651 | Comfort Alert Module New           |       |
| 120743 | 903106 | Control Module for G4 G5 G6 Models |       |

### Defrost Boards

| Part # | Mfg #   | Description            | Price |
|--------|---------|------------------------|-------|
| 147380 | 920338  | Defrost Board Adaptive |       |
| 127634 | 917178A | Defrost Board          |       |

### Door Switches

| Part # | Mfg #  | Description | Price |
|--------|--------|-------------|-------|
| 119950 | 632125 | Door Switch |       |

### Fan Blades

| Part # | Mfg #   | Description                             | Price |
|--------|---------|---|-------|
| 139796 | 667261  | Fan Blade                               |       |
| 139797 | 667318  | Fan Blade f/S3QC Series 3 Ton Only      |       |
| 139784 | 667319  | Fan Blade 2 Blade 24 OD 27p CW 1/2 1200 |       |
| 139783 | 667351  | Fan Blade 2 Blade 24 OD 25p CW 1/2      |       |
| 240945 | 667357R | Fan 3-Blade, 24 OD, 18P, CW 1/2, 1200   |       |
| 139798 | 667383  | 24" CW 3W 20° Fan Blade                 |       |

### Flame Sensors

| Part # | Mfg #  | Description                | Price |
|--------|--------|----------------------------|-------|
| 120728 | 903600 | Flame Sensor (old #632396) |       |

### Igniters

| Part # | Mfg #    | Description                              | Price |
|--------|----------|--|-------|
| 120726 | 903758   | Replacement Igniter Kit                  |       |
| 134164 | 921074   | Igniter Replacement Kit G7/GC2           |       |
| 119987 | 904839   | Igniter Assembly for G7 (New# Is 921074) |       |
| 241821 | 1017743S | Replacement Igniter SI NI G7             |       |

### Limit Controls

| Part # | Mfg #  | Description       | Price |
|--------|--------|-------------------|-------|
| 120741 | 626350 | Vent Limit 260°F  |       |
| 120733 | 626418 | Limit 150/20°F    |       |
| 120735 | 626419 | Limit 195/20°F    |       |
| 120736 | 626425 | Limit 210/20°F    |       |
| 120734 | 626434 | 3" Limit 180/20°F |       |
| 120749 | 626435 | Limit 220/20°F    |       |
| 120737 | 626449 | 3" Limit 250/20°F |       |
| 120744 | 626461 | Vent Limit 160°F  |       |
| 136184 | 626522 | Main Limit Switch |       |

## Westinghouse/Philco Repair Parts

### Limit Controls (Continued)

| Part # | Mfg #  | Description                 | Price |
|--------|--------|-----------------------------|-------|
| 119934 | 626541 | Switch Blower Limit G7      |       |
| 119941 | 626561 | Main Air Limit G7           |       |
| 119945 | 626563 | Main Air Limit G7           |       |
| 145504 | 626598 | Main Air Limit SD054, 072   |       |
| 144772 | 626599 | Limit Switch 1/2d,1s, or 16 |       |
| 145498 | 626611 | Blower Limit KG7SD          |       |

### Lineset Fittings

| Part # | Mfg #  | Description            | Price |
|--------|--------|------------------------|-------|
| 131551 | 664378 | Liquid Lineset Fitting |       |

### Motors

| Part # | Mfg #   | Description                           | Price |
|--------|---------|---------------------------------------|-------|
| 139793 | 621952  | A/C Fan Motor                         |       |
| 139795 | 621917  | Fan Motor for FS3BA048                |       |
| 139794 | 621919  | PSC K 1/10 6p 1-Spd CWLE Fan Motor    |       |
| 139788 | 622018  | PSC 1/4 hp CWLE Fan Motor for 15 SEER |       |
| 139782 | 622066  | PSC K 1/4 hp CWLE 6p 1-Spd Fan Motor  |       |
| 139781 | 622080  | 1/4 hp CWLE Fan Motor                 |       |
| 139780 | 622171  | .05 hp CWLE 2 Ton Motor               |       |
| 130637 | 622264  | Blower Motor 1/2hp 3-Spd              |       |
| 246090 | 634632R | Repl, Harness, B3VM, Motor            |       |
| 245861 | 634826  | Fan Motor Power Wire HRN              |       |
| 245863 | 634827  | Fan Motor Control Wirehar             |       |
| 143885 | 904502  | Motor 1/3 3-Spd 115V                  |       |
| 206946 | 902042  | Blower Motor 1/8 HP/115V              |       |
| 120723 | 903111  | Venter Motor 80% With Gasket          |       |
| 134163 | 903962  | Venter Motor w/Gasket                 |       |
| 134161 | 904085  | Venter Motor GL1RC                    |       |
| 135437 | 903404  | Inducer Motor                         |       |
| 119983 | 904796  | Inducer Motor G7                      |       |
| 119985 | 904798  | Inducer Motor G7                      |       |
| 119991 | 904857  | Blower Motor G7                       |       |
| 119992 | 904858  | Blower Motor G7                       |       |
| 119993 | 904859  | Blower Motor G7                       |       |
| 119994 | 904860  | Blower Motor G7                       |       |
| 241599 | 1007729 | Condenser Fan Motor                   |       |

### Orifices

| Part # | Mfg #  | Description | Price |
|--------|--------|-------------|-------|
| 149071 | 664067 | Orifice #67 |       |

### Orifices (Continued)

| Part # | Mfg #   | Description        | Price |
|--------|---------|--------------------|-------|
| 149073 | 664071  | Orifice #71        |       |
| 245346 | 151885R | 1" Inducer Orifice |       |

### Pressure Switches

| Part # | Mfg #    | Description   | Price |
|--------|----------|---|-------|
| 120746 | 632302   | Pressure Switch Vent for G6D                              |       |
| 139791 | 632393   | Low Pressure Switch 39" (5CO-20CI) 632393                 |       |
| 120780 | 632444   | Pressure Switch NO 1.75 Close 1.55 Open                   |       |
| 139785 | 632473   | High Pressure Switch                                      |       |
| 119953 | 632484   | Sensor Flame G7   |       |
| 119954 | 632487   | Pressure Switch   |       |
| 119955 | 632489   | Pressure Switch G7  |       |
| 119956 | 632491   | Pressure Switch Condensate G7                             |       |
| 119958 | 632493   | Pressure Switch Inducer G7                                |       |
| 119960 | 632499   | Pressure Switch G7  |       |
| 119961 | 632514   | Pressure Switch G7 Variable Speed Downflow                |       |
| 119962 | 632515   | Pressure Switch G7 Variable Speed Downflow                |       |
| 119963 | 632516   | Pressure Switch   |       |
| 119966 | 632521   | Pressure Switch G7  |       |
| 134165 | 632546   | Pressure Switch Inducer 1.0 for FG7TC                     |       |
| 134168 | 632547   | Pressure Switch G7 Fixed Condensate                       |       |
| 134166 | 632548   | Pressure Switch   |       |
| 134167 | 632550   | Pressure Switch G7  |       |
| 134169 | 632554   | Pressure Switch   |       |
| 130948 | 632561   | Pressure Switch for Fg7                                   |       |
| 130950 | 632563   | Pressure Switch for Fg7                                   |       |
| 130951 | 632565   | Pressure Switch for Fg7                                   |       |
| 130952 | 632567   | Pressure Switch for Fg7                                   |       |
| 130953 | 632594   | Pressure Switch 40 Close .20 Open Long Run for iQ Furnace |       |
| 122723 | 632571   | Pressure Switch G7  |       |
| 134010 | 632585   | Pressure Switch   |       |
| 145499 | 632622   | Pressure Switch for M7                                    |       |
| 145500 | 632624   | Pressure Switch for M7                                    |       |
| 240803 | 1016291R | Pressure Switch No. 0.85                                  |       |
| 240804 | 1016292  | Pressure Switch No. 0.85                                  |       |
| 240802 | 1016293R | Pressure Switch No. 0.85                                  |       |

## Westinghouse/Philco Repair Parts

### Plugs

| Part # | Mfg #   | Description           | Price |
|--------|---------|-----------------------|-------|
| 240979 | 631756R | 12 Pin Male Plug      |       |
| 239631 | 634715R | Molded Plug 56" Leads |       |

### Relays

| Part # | Mfg #   | Description  | Price |
|--------|---------|--------------|-------|
| 139790 | 621931  | Relay Blower |       |
| 242942 | 1017206 | AC Relay Kit |       |
| 243133 | 1017207 | DC Relay Kit |       |

### Restrictors

| Part # | Mfg #  | Description          | Price |
|--------|--------|----------------------|-------|
| 149069 | 664048 | 1.5T Restrictor .048 |       |
| 149070 | 664056 | 2T Restrictor .056   |       |
| 149072 | 664061 | 2.5T Restrictor .061 |       |
| 149074 | 664076 | 4T Restrictor .076   |       |

### Roll-out Switches

| Part # | Mfg #  | Description               | Price |
|--------|--------|---------------------------|-------|
| 120731 | 626343 | Switch Roll-out 300f      |       |
| 119938 | 626558 | Roll-out Switch G7        |       |
| 119939 | 626559 | Roll-out Switch G7        |       |
| 119940 | 626560 | Roll-out Switch G7        |       |
| 145497 | 626609 | Roll-out Switch SD038     |       |
| 145505 | 626610 | Roll-out Switch SD054,072 |       |

### Transformers

| Part # | Mfg #  | Description                        | Price |
|--------|--------|------------------------------------|-------|
| 134170 | 622341 | Transformer 40VA/120/24            |       |
| 134175 | 622396 | Transformer 60 VA for 23 SEER Coil |       |

### Tubing

| Part # | Mfg #  | Description                           | Price |
|--------|--------|---------------------------------------|-------|
| 119925 | 263967 | High Temperature Tubing 3/16 36" Long |       |

### Valves

#### Gas Valve

| Part # | Mfg #  | Description                    | Price |
|--------|--------|--------------------------------|-------|
| 119930 | 624652 | Gas Valve 2-Stage for TC TI G7 |       |
| 130954 | 624703 | Gas Valve for iQ Furnace       |       |
| 143845 | 624787 | Gas Valve 2-Stage for Fg7      |       |

### Valves (Continued)

#### Gas Valve

| Part # | Mfg #  | Description                | Price |
|--------|--------|----------------------------|-------|
| 143844 | 904081 | Gas Valve                  |       |
| 144173 | 921691 | Gas Valve Kit with Harness |       |

#### Service Valves

| Part # | Mfg #  | Description                              | Price |
|--------|--------|--|-------|
| 139777 | 663862 | Valve Liquid 3/8"                        |       |
| 139786 | 663864 | Valve Suction 3/4" for FS5BD18-36        |       |
| 133428 | 663963 | Valve Ball 7/8" for FS4BD48-60, FT4B42-6 |       |

#### TXV Valves

| Part # | Mfg #  | Description            | Price |
|--------|--------|------------------------|-------|
| 134244 | 669681 | TXV for C6BAX24        |       |
| 134245 | 669682 | TXV for C6BAX30        |       |
| 134246 | 669683 | TXV for C6BAX35 And 36 |       |
| 134247 | 669684 | TXV for C6BAX42        |       |
| 134250 | 669686 | TXV for C6BAX60        |       |
| 134249 | 669852 | TXV R-410A 4.0 Ton     |       |

### Parts & Repair

| Part # | Mfg #   | Description                           | Price |
|--------|---------|---------------------------------------|-------|
| 243108 | 2B6462R | Coil Guard 24" Lgtng Bolt             |       |
| 239223 | 276921  | Cover, Control, Panel, AC&HP          |       |
| 245674 | 286802R | FRU, SOW, AH, VS                      |       |
| 241050 | 294941R | 12" Duct Collar Kit                   |       |
| 241051 | 294942R | 14" Duct Collar Kit                   |       |
| 240668 | 297217R | Blower Housing                        |       |
| 244460 | 624811R | Repl. Coresense Module                |       |
| 119951 | 632261  | 3 Amp Fuse                            |       |
| 119952 | 632269  | 5 Amp Fuse                            |       |
| 119981 | 664435  | Drain Assy Upflow/Inline              |       |
| 145506 | 664659  | PVC Trap KG7SD                        |       |
| 242155 | 902809  | Nordyne Blower                        |       |
| 134162 | 904573  | Inducer for 95% With Gasket           |       |
| 119986 | 904799  | Blower Kit Inducer G7 Var Sp Downflow |       |
| 143415 | 904986  | Replacement Parts Kit                 |       |
| 130955 | 904800  | Induced Draft Blower FG7MQ            |       |
| 245613 | 904804  | Header Box with Gasket                |       |
| 240920 | 919707D | Coil Assy, 030, B5BW, FRU             |       |
| 131416 | 920994  | Blower Control, Cons CFM, Vs Downflow |       |

Repair Parts

---

---

**Westinghouse/Philco Repair Parts**

---

---

**Parts & Repair (Continued)**

| Part # | Mfg #    | Description                    | Price |
|--------|----------|--------------------------------|-------|
| 239078 | 921852   | Blwer, B6BM, 1/8, 10X6, 1.5-2T |       |
| 243685 | 922178   | Comp-Cope, ZR48K5E-TF5-800     |       |
| 243666 | 1010439R | Pressure 2X No. .7/- .2B       |       |
| 213290 | 921952   | Replacement Coil               |       |

**Repair Parts: White Rodgers**

**Surface (Strap-On) Type Hydrionic Control**

- Sensing element has twice the contact area of competitive models.
- Hydraulic action element can be mounted in any position – no leveling required.
- Dustproof steel case.
- Special screw terminals with “ears” securely hold solid and stranded wires.
- Includes pipe strap and mounting screws.



| Part # | Mfg #   | Description        | Price |
|--------|---------|--------------------|-------|
| 191159 | WR11272 | 100 to 240°F Range |       |

**Hydrionic Zone Valves**

- Two Types of Valves, 2-Wire or 3-Wire, for Zoning Hydrionic Systems Up to 50 PSI
- Quiet operation.
- Valve stem made of stainless steel.
- Automatic recycling manual operator shows valve position at all times.
- Built-in auxiliary contacts to control burner or circulator relay.
- Motor can be removed from valve assembly without draining system.



**2-Wire, 24V Valves With Screw Terminal Wiring Panel and Auxiliary Switch**

| Part # | Mfg #     | Description         | Price |
|--------|-----------|---------------------|-------|
| 191161 | WR1361103 | 1" I.D.2-Wire Valve |       |

**Repair Parts**

**Well Immersion Single Control**

- Types for Use as High Limit, Reverse Action or SPDT Switching
- Action: May be Mounted Either Horizontal or Vertical
- Extra capillary length for extended shank wells.
- Special screw terminals with “ears” securely hold solid and stranded wires.
- Screwdriver-adjustable differential with direct-read indicator.
- Knockouts on top and bottom and plenty of wiring room.
- Hydraulic action element – fast acting.



| Part # | Mfg #     | Description                | Price |
|--------|-----------|----------------------------|-------|
| 191160 | WR1131102 | Tapered Bulbs, SPDT Action |       |
| 193675 | WR11D181  | Open on Rise Action        |       |

**Refrigeration Temperature Control**

- Provide Positive Control of Refrigeration Applications where Remote Control is Desired
- Hydraulic action element.
- Dustproof steel case with top and bottom knockouts.
- Temperature dial graduated in °F and °C and can be adjusted through cover.
- High electrical ratings allow operation of most equipment without use of relays or motor starters.



| Part # | Mfg #     | Description                | Price |
|--------|-----------|----------------------------|-------|
| 211476 | WR1609101 | -30 to +90°F Close on Rise |       |
| 191148 | WR16879   | -30 to +90°F SPDT          |       |

**Electronic Temperature Control**

- Universal
- Refrigeration or Heating Applications
- Alarm Output with Selectable Delay
- No Common Wire Required



| Part # | Mfg #      | Description         | Price |
|--------|------------|---------------------|-------|
| 203630 | WR16E09101 | -40°F to 220°F SPDT |       |



**Repair Parts: White Rodgers**

**HotRod Universal Nitride Ignitor Upgrade Kit**

- 120V Nitride Upgrade Kit for Conversion of Silicon Carbide (Flat or Spiral)
- Robust Ignitor Design – for longer life and fewer callbacks – 5 year warranty
- Nitride Ignitor with 15.5" leads
- Universal mounting bracket and screw and ceramic wire nuts



| Part # | Mfg #      | Description         | Price |
|--------|------------|---------------------|-------|
| 210669 | WR21D645PK | HotRod 5-Pack 15.5" |       |

**24A34 Series Electric Heat Sequencers**

- Replaces Honeywell, MARS, TOD, GEMLINE, Klixon (Texas Instruments).
- Any contacts (except M1 & M2) can be used as auxiliary contacts.
- 24V input control.
- Multi-poise mounting.
- Double quick-connect terminals for combination loads.



| Part # | Mfg #     | Description                | Price |
|--------|-----------|----------------------------|-------|
| 191180 | WR24A341  | 24A34-1 Sequencer          |       |
| 194547 | WR24A3415 | 24A34-15 Heat Pump Control |       |
| 201195 | WR24A342  | 24A34-2 Sequencer          |       |

**36C Series Snap Open, Single Function, Standing Pilot Gas Valves**

- Electrical Rating: 0.23 amps
- Ambient Operating Range: -40 to +175°F (-40 to 79°C)
- Maximum Pressure Rating: 1/2 PSI (14.0" W.C.)
- Pilot Gas Connection: 1/4" compression fitting
- Pressure Tap: 1/8" N.P.T.



| Part # | Mfg #       | Description                  | Price |
|--------|-------------|------------------------------|-------|
| 191162 | WR36C03A410 | 120VAC 3/4" x 3/4" Gas Valve |       |
| 191175 | WR36C03U333 | 750mV 1/2" x 3/4" Gas Valve  |       |

**36H Series Gas Valves**

- Combination Multi-function Controls for a Wide Range of Applications.
- The 36H Combination Gas Control Valve is a Versatile Multifunction Control Designed to Meet the Requirements for Use with Intermittent Ignition Systems (Direct Ignition, Proven Pilot, HSI).
- Adjustable regulator.
- Quiet operation redundant design.
- Inlet/outlet screens.
- Tamper resistant screws.



| Part # | Mfg #      | Description                 | Price |
|--------|------------|-----------------------------|-------|
| 202850 | WR36H33412 | 24VAC 3/4" x 3/4" Gas Valve |       |

**36G, 36J Series Gas Valves**

- The 36G, 36J is a Combination Gas Control Valve Designed for Use with Non-Piloted Intermittent Ignition Systems.
- The Control is Designed to Meet Today's Maximum Capacity, Smaller Size and High Efficiency Gas Systems
- Inlet and outlet screens.
- Quiet redundant.
- Built-in pressure tap.
- Quick-connect terminals (1/4")



| Part # | Mfg #      | Description                  | Price |
|--------|------------|------------------------------|-------|
| 208011 | WR36J22214 | 1/2" 1 Stage, Fast Opening   |       |
| 203362 | WR36J24214 | 1/2" 1 Stage, Slow Opening   |       |
| 204950 | WR36J54214 | 1/2" Two-Stage, Fast Opening |       |

Repair Parts

**Repair Parts: White Rodgers**

**3F05 / 3L05 Series Adjustable Snap Disc Fan & Limit Controls**

- Adjustable Snap Disc Thermostat Allows You to Set the Temperature Set Point to Match Your Specific Needs which Simplifies Inventory
- ¼" quick connect terminals are standard.
- Reduces inventory while providing coverage for a wide range of temperature applications.
- Replaces the majority of fixed disc thermostats now on heating equipment and various appliances.
- 2 adjustable fan control models replace 7 fixed snap disc models.
- 5 adjustable limit control models replace 10 fixed snap disc models.



| Part # | Mfg #   | Description                    | Price |
|--------|---------|--------------------------------|-------|
| 191150 | WR3F052 | 140 - 180°F SPST Fan Control   |       |
| 242995 | WR3L053 | 210 - 250°F SPST Limit Control |       |

**Snap Disc Fan or Limit Controls**

- For Regulation of Fan, Blower or High Limit Safety Control



| Part # | Mfg #     | Description                 | Price |
|--------|-----------|-----------------------------|-------|
| 191152 | WR3L01140 | 100°F Cut-in, 140°F Cut-out |       |

**Universal Heat Pump Defrost Control**

- Universal upgrade for single stage heat pump systems with a PSC fan Motor.
- Select from: pre-congured demand timed defrost routines or congure to replicate virtually any set up.
- Universal Replacement: Selectable demand or timed defrost. O or B reversing valve. Congures to any system.
- Easy Installation & Set Up: Universal mounting with rotating display. Pre-congured for major OEM brands. Integrated outdoor thermostat.
- Versitile Matrix Display: Access set up and diagnostic menus from any orientation.
- Compressor Protection: Brown out and short cycle protection plus. Hi/Low pressure inputs.
- Replacement Kit Contents: Defrost control board. Wiring harnesses. New coil and ambient temp thermistors. Mounting accessories and labels
- Timing Specifications: All timing is accurate to +/- 5% of nominal over the full temperature and voltage range at 60Hz. All timings are 20% longer when operated with 50Hz power supply.



| Part # | Mfg #       | Description                 | Price |
|--------|-------------|-----------------------------|-------|
| 218970 | WR47D01U843 | Universal Heat Pump Defrost |       |

**49P11-843 SURESWITCH™**

- Universal Electronic Upgrade for Mechanical Compressor Contactors.
- 5x Contactor Life, Sealed to Keep Out Ants and Debris
- Microprocessor controlled sealed compressor switching.
- Line voltage brownout protection, short cycle protection, tricolor LED displays.
- Heavy-duty lug connectors, zero chatter latching relay.
- Four-hole mounting matches mechanical contactors.
- Random start delay on power up and brownout recovery.
- Compressor test and cycle count by push-button.



| Part # | Mfg #      | Description           | Price |
|--------|------------|-----------------------|-------|
| 209189 | WR49P11843 | Universal SURESWITCH™ |       |

**Repair Parts: White Rodgers**

**Pilot Relite Controls**

- Generates spark pulse until flame is sensed through spark electrode.
- Begins sparking immediately if flame extinguishes.
- Rugged solid state module design.
- Spark plug or spike output configurations available.



| Part # | Mfg #    | Description                    | Price |
|--------|----------|--------------------------------|-------|
| 208562 | WR505923 | Spark plug and 1/4" connectors |       |

**50A55-743 Goodman Single Stage Integrated HSI Furnace Control**

- Controls Gas Valve, Ignitor, Blower, Inducer, Humidifier(Both 120V & 24V Input), and Air Cleaner Replaces OEM Goodman and White-Rodgers Models
- Includes flash code diagnostics.
- Twinning connection.
- Fused to protect low voltage system transformer



| Part # | Mfg #      | Description                 | Price |
|--------|------------|-----------------------------|-------|
| 211409 | WR50A55743 | 1 Stage HSI Furnace Control |       |

**50D50-842 Universal Direct Spark Ignition Control Kit**

- Microprocessor Based Gas Ignition Control for Heating Appliance Using Either Natural or LP Gas. Proof of Flames is Accomplished. The Unit is Designed as a Direct Spark Ignition Source
- Color LED indicator for diagnostics.
- Program keys.
- 1/4" and 3/16" quick connect terminals.
- Damper interface.



| Part # | Mfg #      | Description                      | Price |
|--------|------------|----------------------------------|-------|
| 196695 | WR50D50842 | Universal Spark Ignition Control |       |

**50D50-843 Universal Proven Pilot Spark Control Kit**

- Microprocessor Based Gas Ignition and Primary Safety Control.
- Designed for Interrupted Spark and Burner Supervision of All Gases.
- Used in Gas Fired Appliance Applications
- Field service replacement for most Honeywell, Robertshaw, Johnson Controls and UTEC Intermittent Pilot Ignition Controls.
- Provides ignition, proof of ignition and precise timing.
- Works with single rod or dual rod remote sensor.
- Color LED indicator for diagnostics.



| Part # | Mfg #      | Description                       | Price |
|--------|------------|-----------------------------------|-------|
| 196696 | WR50D50843 | Universal Pilot Spark Control Kit |       |

**50T35-743 Goodman Silicon Carbide Integrated HSI Furnace Control**

- Controls Gas Valve, Ignitor, Two-Speed Blower Motor, Inducer, Humidifier (Both 120v & 24v Input), and Air Cleaner. Replaces OEM Goodman, UTEC and TI Models
- Includes flash code diagnostics.
- Twinning.
- Includes mounting hole template.
- Fused to protect low voltage system transformers.
- Adjustable blower relay.
- 90+ furnace option



| Part # | Mfg #      | Description                    | Price |
|--------|------------|--------------------------------|-------|
| 199654 | WR50T35743 | Integrated HSI Furnace Control |       |

**57T01-843 Blower Time Delay Relay**

- The 57T01-843 Time Delay Relay is for Use in Air Handlers Installed in Compressor-Run Air Conditioning and Heat Pump Systems to Delay the Blower Shut-Off After the Compressor has Shut Off.
- Allows residual cooled air to be blown into the controlled space, increasing the efficiency of the system in cooling.
- Depending on electrical hookup in a heat pump system, delay of blower shut-off could also occur in heating.



| Part # | Mfg #      | Description             | Price |
|--------|------------|-------------------------|-------|
| 214640 | WR57T01843 | Blower Time Delay Relay |       |

Repair Parts

**Repair Parts: White Rodgers**

**767A Series Silicon Carbide Hot Surface Ignitors**

- Multiple mounting styles.
- Works with 15, 17 or 45 second HSI systems.



| Part # | Mfg #     | Description | Price |
|--------|-----------|-------------|-------|
| 195527 | WR767A369 | 5.5"        |       |
| 195523 | WR767A370 | 5.25"       |       |

**Fan Control Center**

- Transformer and Relay Combination for Easy Installation on a 4"x 4" Junction Box
- Line voltage connections pre-wired.
- Energy limiting class II transformer design.
- Color coded pre-stripped leads.
- Low voltage connections on terminal board.



| Part # | Mfg #   | Description     | Price |
|--------|---------|-----------------|-------|
| 191188 | WR90113 | SPDT 60 Hz 120V |       |

**WR/RBM Type 154 Contractors**

- Any position mounting.
- Interchangeable mounting plate.
- Low wattage coil.
- Double break contacts ensure positive make and break



| Part # | Mfg #   | Description               | Price |
|--------|---------|---------------------------|-------|
| 239669 | WR90165 | 30 Amp 208/240 Voltage AC |       |
| 211287 | WR90171 | 40 Amp 120 Voltage AC     |       |
| 206003 | WR90172 | 40 Amp 208/240 Voltage AC |       |

**WR/RBM Type 122 Contractors**

- Low VA coil for cooler operation and increased life.
- Quiet operation.
- Universal style mounting bracket fits existing mounting holes.
- Double break contacts ensure positive make and break.
- Screw terminals or pressure connectors and double 1/4" quick connects provided on all models for easy installation.



| Part # | Mfg #   | Description           | Price |
|--------|---------|-----------------------|-------|
| 191194 | WR90245 | 30 Amp 120 Voltage AC |       |

**WR/RBM Type 84 Relays**

- Used for Switching Single or Two Speed Fan Motors, Solenoids, Relays, Resistive Loads and General Purpose Switching
- Compact, totally enclosed design.
- For heating and cooling applications and general switching.
- Quiet, reliable and economical.



| Part # | Mfg #    | Description             | Price |
|--------|----------|-------------------------|-------|
| 194682 | WR90293Q | SPDT 24 Coil Voltage AC |       |

**WR/RBM Type 91 Relays**

- A Two Pole Double Throw Semi-Enclosed Relay
- 90-340 Fits Fan Control Centers 90-112, 90-113, 90-118E and 90-119
- Easy to install.
- Suited for use in vending machines, appliances, heating and air conditioning applications and general purpose switching.



| Part # | Mfg #   | Description          | Price |
|--------|---------|----------------------|-------|
| 191192 | WR90341 | 115/120 Coil Voltage |       |
| 191193 | WR90342 | 208/240 Coil Voltage |       |

**WR/RBM Type 184 Relays**

- Heavy-Duty General Purpose Relay Operates in Any Position
- Compact, totally enclosed design.
- For heating and cooling applications and general switching.
- Quiet, reliable and economical



| Part # | Mfg #   | Description             | Price |
|--------|---------|-------------------------|-------|
| 191190 | WR90370 | SPDT 24 Coil Voltage AC |       |

**Repair Parts: White Rodgers**

**24 Volt Secondary Class 2 Transformers Energy Limiting**

- For Industrial, Heating and Air Conditioning Controls Applications
- Color coded primary leads.
- Multi-mount styles available.



| Part # | Mfg #     | Description                  | Price |
|--------|-----------|------------------------------|-------|
| 191173 | WR90T40F1 | 120V Foot-Mount              |       |
| 191177 | WR90T40M1 | 120V Universal Multi-Mount   |       |
| 193285 | WR90T40M3 | 120/208/240V Uni Multi-Mount |       |
| 191189 | WR90T75C3 | 120/208/240V Foot-Mount      |       |

**24A34 Series Electric Heat Sequencer**



| Part # | Mfg #    | Description                | Price |
|--------|----------|----------------------------|-------|
| 191182 | WR24A344 | Sequenced Time Delay Relay |       |
| 191181 | WR24A343 | Sequenced Time Delay Relay |       |

**Thermostat Guards - Metal**

- These Durable Metal Guards are Designed for Government, Military, Industrial and Educational Applications to Prevent Adjustment of the Temperature by Unauthorized Personnel
- Model F29-0220 fits ALL Emerson / White-Rodgers Thermostats.
- Each model furnished with one key and can be mounted vertically or horizontally.
- Tamper-resistant design. 18 gauge cover, 22 gauge frame.
- Beige enamel finish over heavy-duty steel enclosure.
- Models available in a ring or solid base.



| Part # | Mfg #     | Description      | Price |
|--------|-----------|------------------|-------|
| 201357 | WRF290192 | Solid Base Metal |       |
| 193243 | WRF290222 | Ring Base Metal  |       |

**Thermostat Guards - Plastic**

- These Durable Thermostat Guards are Designed for use in Offices, Churches, Restaurants and Other Public Areas to Prevent Adjustment of the Temperature by Unauthorized Personnel
- F29-0198 will accept ALL Emerson / White-Rodgers thermostat types.
- Each model furnished with one key and can be mounted vertically or horizontally.
- Clear plastic models for applications that need the thermostat visible.
- Opaque plastic models for applications that require the thermostat be kept hidden from view.
- Each model furnished with a ring and/or solid wall mounting plate.



| Part # | Mfg #     | Description   | Price |
|--------|-----------|---------------|-------|
| 191172 | WRF290198 | Clear Plastic |       |

**Wallplate for 90 series Blue Touchscreen thermostats**

- 8-1/8"W x 5-3/8"H
- Classic White color
- For use with or without horizontal junction box.



| Part # | Mfg #     | Description         | Price |
|--------|-----------|---------------------|-------|
| 197520 | WRF612600 | 8-1/8" W x 5-3/8" H |       |

**Zone Valves - 1300 Series**

- Valve Assemblies
- Water Seal Replacement Kit (Quad ring, "O" ring, Tru-arc ring and cotter pin)
- Motor Assemblies



| Part # | Mfg #     | Description                 | Price |
|--------|-----------|-----------------------------|-------|
| 012057 | WRF840434 | 1" Valve Assemblies         |       |
| 087789 | WRF840435 | 1-1/4" Valve Assemblies     |       |
| 202671 | WRF920227 | 3/4" Water Seal Replacement |       |

Repair Parts

**Repair Parts: White Rodgers**

**Universal Media Filter Replacements**

- FR- Filter Replacements



| Part # | Mfg #    | Description    | Price |
|--------|----------|----------------|-------|
| 194955 | WRFR1400 | 16" x 26" x 5" |       |
| 194956 | WRFR2000 | 20" x 26" x 5" |       |

**H06E / F Series Universal Replacement Thermocouples**

- Specially Designed for Universal Replacement. Thermocouples are Priced Individually, Order Only in Multiples of 10
- Stainless steel element construction for prolonged thermocouple life.
- Each kit individually enclosed in plastic.
- Universal adapter fittings included with each kit for replacing thermocouple in most types of pilot burners.
- Visible instructions for quick, easy installation.
- Available in a variety of 10-packs in desired thermocouple lengths.
- Standard thermocouple 11/32" double lead thread.
- Replaces Honeywell Q34A, Johnson K19, Robershaw 1980 and White-Rodgers H06E.



| Part # | Mfg #    | Description      | Price |
|--------|----------|------------------|-------|
| 191167 | WRH06E18 | 18" thermocouple |       |
| 191169 | WRH06E30 | 30" thermocouple |       |
| 191170 | WRH06E36 | 36" thermocouple |       |
| 191171 | WRH06E48 | 48" thermocouple |       |

**Universal Two-Stage HSI Integrated Variable Speed (ECM) Furnace Control Kit**

- Kit Includes:
- Ignition Control Module
- Wiring Harnesses for Amana/Goodman
- Universal 120V Nitride Ignitor Kit - 21D64-2
- Installation Instructions and OEM Cross-Reference



| Part # | Mfg #       | Description | Price |
|--------|-------------|-------------|-------|
| 202875 | WR21V51U843 | 2 Stage HSI |       |

**36H Series Gas Valves**

- Combination Multi-function Controls for a Wide Range of Applications.
- The 36H Combination Gas Control Valve is a Versatile Multifunction
- Control Designed to Meet the Requirements for Use with Intermittent
- Ignition Systems (Direct Ignition, Proven Pilot, HSI). 36H is Our
- Highest Capacity Combination Gas Valve
- Adjustable regulator.
- Quiet operation redundant design.
- Inlet/outlet screens.
- Tamper resistant screws.



| Part # | Mfg #      | Description  | Price |
|--------|------------|--------------|-------|
| 202851 | WR36H32423 | 24 Volt 3/4" |       |

**Humidifier Timer**

- The White-Rodgers A02-0815-017 installation package includes:
- Flushing timer
- Power cord with AC adapter (plugs in to a 120v outlet)
- 15 feet of 3/8" ID tubing
- Mounting hardware
- Installation instructions
- Fittings and tubing clamps for installation on White-Rodgers units, as well as on other manufacturers humidifiers.



| Part # | Mfg #        | Description      | Price |
|--------|--------------|------------------|-------|
| 203019 | WRA020815017 | Humidifier Timer |       |

**Key For F29 Thermostat Guards**

- Key For F29 Thermostat Guards (Bag of 2)



| Part # | Mfg #      | Description | Price |
|--------|------------|-------------|-------|
| 198999 | WRF1450999 | 2 Keys      |       |

Repair Parts

**Repair Parts: White Rodgers**

**Compact Zone Valves 13A00 Series - Power Head**

- Includes Seal Ring
- For 2-way Zone Valves
- Includes auxillary switch
- 24 VAC Power Head for 2 Way 13A00 Zone Valve with Conduit Hub for 13A02-101 & 13A02-102



| Part # | Mfg #    | Description       | Price |
|--------|----------|-------------------|-------|
| 242757 | F19-0187 | 24 VAC Power Head |       |

**Board Mount Limit Controls**

- 1/2" Bimetal Disc with Ranges for Your System Needs
- Proven reliability in a compact, versatile, cost-effective design.
- Provides high-speed contact separation.
- OEM replacement for competitive models.



| Part # | Mfg #    | Description             | Price |
|--------|----------|-------------------------|-------|
| 242999 | WR3L098  | 180 Opens/160 Closes °F |       |
| 243000 | WR3L0910 | 200 Opens/160 Closes °F |       |

**1/2" Disc Manual Reset Flame Rollout Limit Switches**

- This new line of limit switches complements our existing line of 1/2" automatic (3F11) fan controls & (3L11) limit controls and are offered in a broad range of temperature limit cut-outs to cover most heating applications.



| Part # | Mfg #     | Description               | Price |
|--------|-----------|---------------------------|-------|
| 243005 | WR3L12250 | 250°F Cut-Out Temperature |       |
| 243007 | WR3L12300 | 300°F Cut-Out Temperature |       |
| 243008 | WR3L12350 | 350°F Cut-Out Temperature |       |

Repair Parts



## Woodford Repair Parts

### Yard Hydrant Repair Parts

| Part # | Mfg # | Description                              | Price |
|--------|-------|--|-------|
| 011648 | 10009 | Upper Link for Y34/Y1/Y2                 |       |
| 011649 | 10011 | Reducing Coupling for Y1/Y2/Y34/W34      |       |
| 011658 | 10100 | Packing Nut for Y1/Y2/Y34/W34            |       |
| 011659 | 10101 | Packing for Y1/Y2/Y34/W34                |       |
| 011660 | 10102 | Packing Support Washer for Y1/Y2/Y34/W34 |       |
| 011662 | 10104 | Brass Rod Stem for Y1/Y2/Y34/W34         |       |
| 011678 | 15003 | 3/4 Head Assembly                        |       |

### Nozzle

| Part # | Mfg # | Description                                   | Price |
|--------|-------|---|-------|
| 011646 | 10004 | 3/4" Brass Hose Nozzle for Y34/Y1/W34/X34/R34 |       |
| 098547 | 55437 | Nozzle for 70/71/B71/81                       |       |

### Plunger

| Part # | Mfg # | Description                     | Price |
|--------|-------|---------------------------------|-------|
| 011663 | 10105 | Plunger for Y30/Y34/Y70/Y95/W34 |       |
| 011664 | 10106 | Plunger for Y1/Y2               |       |

### Thermaline® Repair Parts

#### Thermaline® Parts

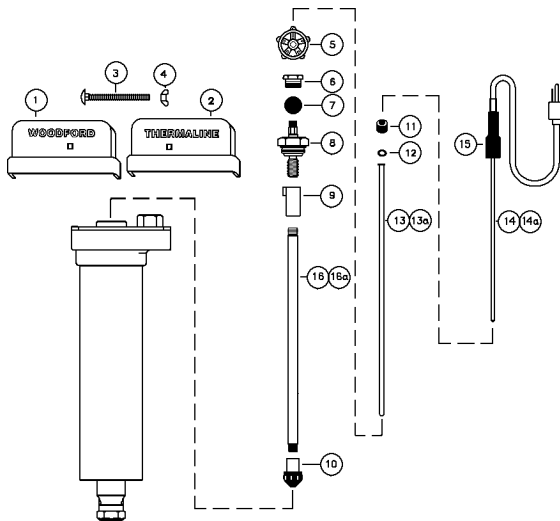

| Part # | Mfg # | Description                  | Price |
|--------|-------|------------------------------|-------|
| 011747 | 85015 | 10 - Combination Valve Ass'y |       |

### Thermaline® Repair Parts (Continued)

#### Thermaline® Parts

| Part # | Mfg # | Description                                | Price |
|--------|-------|--|-------|
| 011748 | 85062 | 14 - 2' Heater Assembly (Includes Item 15) |       |

### Repair Kits

#### Repair Kit for 14/18 Wall Faucet

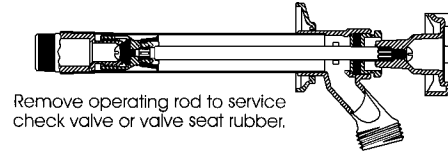

Remove operating rod to service check valve or valve seat rubber.

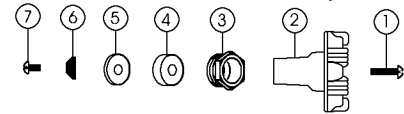

| Part # | Mfg #   | Description                                  | Price |
|--------|---------|--|-------|
| 034143 | RK14-MH | Repair Kit for 14/18 Includes 1-7, Metal Hdl |       |

#### Repair Kit for 17 Wall Faucet

- 35301 VB Float Kit
- 30002 Handle Screw
- 30099 Handle
- 30059 Packing Nut
- 30005 Packing
- 30421 Packing Washer
- 30418 Check Valve
- 30008 Valve Seat Rubber
- 30009 Retainer Screw
- 30459 Bevel Check Valve

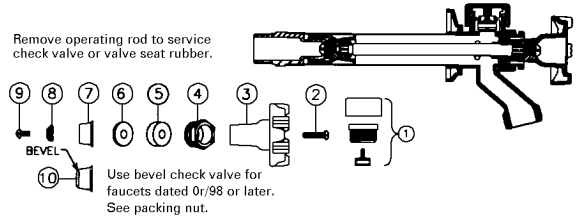

Remove operating rod to service check valve or valve seat rubber.

Use bevel check valve for faucets dated 0r/98 or later. See packing nut.

| Part # | Mfg # | Description   | Price |
|--------|-------|---|-------|
| 039455 | RK-17 | Repair Kit for 17 Includes 1-2, 4-10, 30099 Metal Hdl |       |



## Woodford Repair Parts

### Repair Kit for 22 Wall Faucet

1. 30566 Hot Plug Button
2. 30002 Handle Screw (2)
3. 30096 Round, Die Cast Alum. Wheel Handle (2)
4. 30497 Deep Packing Nut
5. 30560 EPDM Packing (2)
6. 30006 Packing Washer (2)
7. 30565 Cold Plug Button
8. 30059 Packing Nut
9. 30459 Check Valve (2)
10. 30008 Valve Seat Rubber (2)
11. 30009 Retainer Screw (2)

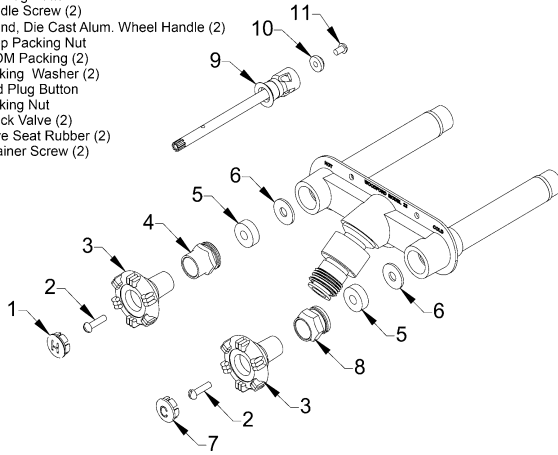

| Part # | Mfg #   | Description                      | Price |
|--------|---------|----------------------------------|-------|
| 100876 | RK-22MH | Repair Kit for 22 w/Metal Handle |       |

### Repair Kit for 25/27H Wall Faucet

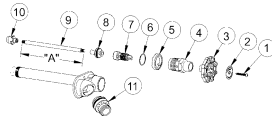

| Part # | Mfg # | Description                            | Price |
|--------|-------|--|-------|
| 032340 | RK-25 | Wheel Handle Repair 5/16" Square Shank |       |

### Repair Kit for 65 Wall Hydrant

- |                      |                     |
|----------------------|---------------------|
| 1. 50009 Tee Key     | 5. 50251 "C" Washer |
| 2. 50264 Head Nut    | 6. 51014 Yoke Nut   |
| 3. 50252 Stem Washer | 7. 50250 Plunger    |
| 4. 55062 Stem Screw  |                     |

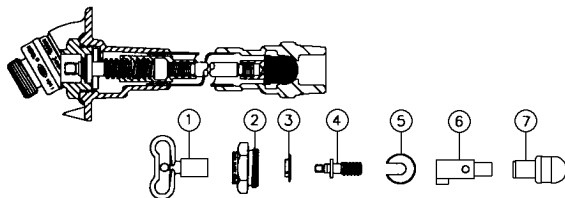

| Part # | Mfg # | Description                                 | Price |
|--------|-------|---|-------|
| 043118 | RK-65 | Chrome Repair Kit for 60/65/67 Includes 1-7 |       |

### Repair Kit for 70 Wall Hydrant

- |                         |                            |
|-------------------------|----------------------------|
| 1. 50009 Tee key        | 6. 50027 Support Washer    |
| 2. 30109 Packing Nut    | 7. 51013 Ball Valve Rubber |
| 3. 30247 Packing        | 8. 50028 Round Brass Nut   |
| 4. 55177 Head Nut Assy. |                            |
| 5. 51014 Yoke Nut       |                            |

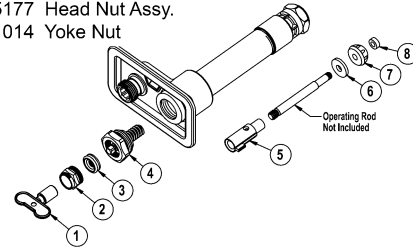

| Part # | Mfg # | Description   | Price |
|--------|-------|---|-------|
| 055079 | RK-70 | Repair Kit for 70 & Obsolete Models 7/8/80/85/90/95 |       |

### Repair Kit for Y34 Yard Hydrant

- |                      |                         |
|----------------------|-------------------------|
| 1. 10104 Rod Stem    | 4. 10102 Support Washer |
| 2. 10100 Packing Nut | 5. 10105 Plunger        |
| 3. 10101 Packing     |                         |

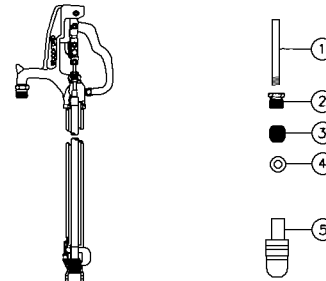

| Part # | Mfg #  | Description  | Price |
|--------|--------|--------------|-------|
| 046472 | RK-Y34 | Includes 1-5 |       |

### Individual Parts



| Part # | Mfg # | Description                               | Price |
|--------|-------|---|-------|
| 025782 | 30008 | Rubber Valve Seat                         |       |
| 025786 | 30109 | Chrome Packing Nut                        |       |
| 011710 | 30230 | Plunger Assembly for 25                   |       |
| 011712 | 30238 | Stem Screw Delrin for 25                  |       |
| 011716 | 35280 | Drain Valve Assembly for 20/25/27         |       |
| 011723 | 50250 | Plunger for All Auto Drain Hydrants       |       |
| 019019 | 50251 | "C" Washer All Auto Drain Hydrants        |       |
| 024447 | 50252 | Stem Washer for All Auto Drain Hydrants   |       |
| 011726 | 51014 | Yoke Nut for All Freezeless Wall Hydrants |       |

Repair Parts



## Woodford Repair Parts

### Individual Parts (Continued)

| Part # | Mfg # | Description                                 | Price |
|--------|-------|---|-------|
| 011725 | 51013 | Ball Valve Rubber                           |       |
| 112487 | RH-MS | Roof Hydrant Mounting System                |       |
| 116915 | WF-MS | Mounting Sleeve for Models: 14, 16, 17 & 19 |       |

### Handle



30096

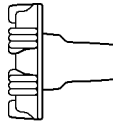

30099

| Part # | Mfg # | Description                 | Price |
|--------|-------|-----------------------------|-------|
| 054339 | 30096 | 14/17 Metal Wheel Handle    |       |
| 011708 | 30099 | 14/17/22 Metal Wheel Handle |       |
| 095886 | 30106 | 24 Unplated Metal Handle    |       |
| 011711 | 30233 | 24 Brown Lexan Wheel Handle |       |
| 022301 | 30239 | 25 2" Metal Wheel Handle    |       |

### Operating Rod Assembly

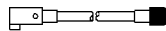

| Part # | Mfg # | Description  | Price |
|--------|-------|--|-------|
| 019023 | 55412 | 12" Operating Rod Assembly for Auto Drain (14-5/16" OAL) |       |

### Packing



| Part # | Mfg # | Description                        | Price |
|--------|-------|------------------------------------|-------|
| 072390 | 30512 | Packing Nut with Stem Gd for 14/17 |       |
| 080502 | 30560 | EPDM Packing for 14/17/22          |       |

### Rod Assembly

| Part # | Mfg #   | Description                            | Price |
|--------|---------|--|-------|
| 043133 | 35722   | 8" Wall Rod Assembly for 14/ 17/22/V22 |       |
| 043888 | WH35724 | 12" Wall Rod Assembly for 14/17/22/V22 |       |

### Tee Key



RK-STK

| Part # | Mfg #  | Description   | Price |
|--------|--------|---|-------|
| 011719 | RK-STK | Tee Key, 1-3/4" Short for 5/16" Square Stem (50009) |       |
| 011720 | RK-LTK | 3-1/4" Long Tee Key for Square Stem (50010)         |       |



---



---

## Yellow Jacket Repair Parts

---



---

### Parts

| Part # | Mfg # | Description                                    | Price |
|--------|-------|--|-------|
| 181738 | 41042 | Titan Blue Handle w/ Screw                     |       |
| 181739 | 41044 | Titan Red Handle w/ Screw                      |       |
| 181745 | 41080 | Series 41 Rebuild Kit                          |       |
| 181746 | 41083 | Brute II Rebuild Kit                           |       |
| 181797 | 41103 | Brute II 3/8" Piston Assy                      |       |
| 181800 | 41123 | 1/4" Liquid Charging Adapter                   |       |
| 181801 | 41131 | O-Rings, 10 Pak                                |       |
| 181802 | 41133 | Complete Valve Piston                          |       |
| 181874 | 49010 | 2-1/2" Replacement Crystal<br>for 49011, 49012 |       |
| 181884 | 49100 | 3-1/8" Replacement Crystal                     |       |
| 204202 | 60349 | Tension Spring                                 |       |

Repair Parts

## Zoeller Repair Parts

### Parts & Accessories

#### Simplex Electrical Control Panel

- Alarm horn
- Terminal strip
- Alarm float only
- NEMA 4X enclosure with hinged cover
- Horn silence switch to turn alarm on or off
- Receptacle for use with piggyback pump switch



| Part # | Mfg #   | Phase | Panel   | Price |
|--------|---------|-------|---------|-------|
| 207659 | 10-1019 | 1     | Plug-In |       |

#### Gasket



| Part # | Mfg #  | Description         | Price |
|--------|--------|---------------------|-------|
| 052983 | 267007 | Gasket - Case/Cover |       |

#### Switch Assembly



| Part # | Mfg #  | Description                    | Price |
|--------|--------|--------------------------------|-------|
| 028971 | 004705 | M53/98/72 Switch Assembly "50" |       |
| 052675 | 004892 | ASM Rack Pk "50/90"AH          |       |

## Drill Bits

### Shockwave® Driver Bit Sets

#### SHOCKWAVE™ 9PC 1/2" Deep Well Socket Set

**Includes:**

- (1) 3/8" SHOCKWAVE impact socket
- (1) 7/16" SHOCKWAVE impact socket
- (1) 1/2" SHOCKWAVE impact socket
- (1) 9/16" SHOCKWAVE impact socket
- (1) 5/8" SHOCKWAVE impact socket
- (1) 11/16" SHOCKWAVE impact socket
- (1) 3/4" SHOCKWAVE impact socket
- (1) 7/8" SHOCKWAVE impact socket
- (1) 1/4" Hex to 1/2" square adapter



| Part # | Mfg #      | Description                                 | Price |
|--------|------------|---|-------|
| 160302 | 49-66-4484 | SHOCKWAVE™ 1/2" Deep Well Socket Set (9 PC) |       |

#### Shockwave™ 12PC Impact Drive Guide Set

**Includes:**

- (1) ECX™ Bit 1" #1
- (1) ECX™ Bit 1" #2
- (2) Phillips Bit 1" P2
- (1) Phillips Bit 1" P3
- (1) Slotted Bit 1" SL 1/4"
- (1) Slotted Bit 1" SL 3/16"
- (1) Square Bit 1" SQ2
- (1) TORX® Bit 1" T15
- (1) TORX® Bit 1" T20
- (1) TORX® Bit 1" T25
- (1) SHOCKWAVE™ 3 Magnetic bit tip holder



| Part # | Mfg #      | Description                 | Price |
|--------|------------|-----------------------------|-------|
| 164158 | 48-32-4507 | 12PC Impact Drive Guide Set |       |

#### 18PC Shockwave™ Driver Bit Set

**Includes:**

- (1) Phillips bit 1" P1
- (1) Phillips bit 1" P2
- (1) Phillips bit 1" P3
- (1) Slotted bit 1" SL 1/4"
- (1) Slotted bit 1" SL 3/16"
- (1) Square bit 1" SQ1
- (1) Square bit 1" SQ2
- (2) Phillips bit 2" P2
- (1) Phillips bit 2" P3
- (2) Square bit 2" SQ2
- (1) Square bit 2" SQ3
- (1) TORX® 2" T15
- (1) TORX® bit 2" T20
- (1) 3 1/2" Phillips #2
- (1) 3 1/2" Square drive #2
- (1) Case with bulk storage container
- (1) SHOCKWAVE™ magnetic bit holder



| Part # | Mfg #      | Description          | Price |
|--------|------------|----------------------|-------|
| 161626 | 48-32-4403 | 18-Pc Driver Bit Set |       |

### 29-Piece Shockwave® Impact Duty™ Driver Bit Set

**Includes:**

- Phillips bits:  
1" - (1) P1, (7) P2, (2) P3;  
2" Power - (2) P2, (1) P3
- Square bits:  
1" - (1) SQ1, (4) SQ2, (1) SQ3  
2" Power - (2) SQ2
- Torx® bits:  
1" - (1) T15, (1) T20, (1) T25
- Magnetic nut drivers: (1) 1/4" red, (1) 5/16" amber,  
(1) 3/8" blue
- (1) Magnetic bit holder
- (1) Case with bulk storage container



| Part # | Mfg #      | Description          | Price |
|--------|------------|----------------------|-------|
| 137578 | 48-32-4401 | 29-Pc Driver Bit Set |       |

### 26-Piece Shockwave™ Drive and Fasten Set

**Includes:**

- Phillips bits:  
1" - (1) P1, (1) P2, (3) P3  
2" - (1) P2
- Square bits:  
1" - (1) SQ1, (2) SQ2,  
(1) SQ3  
2" - (1) SQ2
- Torx® bits:  
1" - (2) T20, (2) T25, (1) T30  
2" - (1) T20, (1) T25
- 1/4" Hex to 3/8" square adapter (1)
- 1/4" Magnetic nut driver (1)
- Slotted bit 1" SL 3/16" (1)
- Drive Sockets:  
(1) 3/8" Drive: 1/2" Socket,  
(1) 3/8" Drive: 9/16" Socket
- Magnetic nut drivers:  
(1) 3/8" Magnetic nut driver,  
(1) 5/16" Magnetic nut driver  
(1) Shockwave™ compact magnetic bit holder



| Part # | Mfg #      | Description                | Price |
|--------|------------|----------------------------|-------|
| 173708 | 48-32-4408 | 26-Pc Drive and Fasten Set |       |

Tools

## Drill Bits

Tools

### 32-Piece Shockwave™ Driver Bit Set

- Includes:
- Magnetic nut driver:  
(1) 1/4", (1) 5/16"
- Phillips bits:  
1" (1) P1, (4) P2, (1) P3  
2" (2) P2
- Phillips reduced 1" PR2 bit
- Slotted:  
1" (1) #8, (1) #10  
2" (1) #10
- Square bits:  
1" (1) SQ1, (3) SQ2, (1) SQ3  
2" (1) SQ2
- Torx® bits:  
1" (1) T15, (2) T20, (2) T25, (1) T30  
2" (1) T20, (1) T25



| Part # | Mfg #      | Description          | Price |
|--------|------------|----------------------|-------|
| 173709 | 48-32-4004 | 32-Pc Driver Bit Set |       |

### 35-Piece Shockwave® Impact Duty™ Driver Bit Set

- Includes:
- ECX™: 1" - (1) ECX1, (1) ECX2
- Phillips bits:  
1" (1) P1, (2) P2, (1) P3;  
2" Power: (1) P1, (1) P2  
3-1/2" Power: (1) P2
- Square bits:  
1" (1) SQ1, (2) SQ2, (1) SQ3  
2" Power: (1) SQ1, (1) SQ2, (1) SQ3  
3-1/2" Power: (1) SQ2
- Torx® bits:  
2" Power: (1) T15, (1) T20, (1) T25, (1) T30
- Slotted bits:  
2" Power: (1) SL1/8", (1) SL3/16", (1) SL1/4"
- Magnetic nut drivers: (1) 1/4" red, (1) 5/16" amber,  
(1) 3/8" blue
- Hex Shank Drill Bits:  
1/4" (1) 1/8", (1) 5/32", (1) 3/16", (1) 7/32", (1) 1/4"
- Socket adapters: (1) 1/4" hex shank to 3/8" square  
(1) 1/4" hex shank to 1/2" square
- (1) Magnetic bit holder
- (1) Case with bulk storage container



| Part # | Mfg #      | Description                 | Price |
|--------|------------|-----------------------------|-------|
| 140584 | 48-32-4402 | 35-Pc M/E Drill & Drive Set |       |

### 40-PC Shockwave™ Drill & Drive Set

- Includes:
- (1) 1/2" Socket adapter
- (1) 1/4" Magnetic nut driver
- (1) 1/4" Shockwave Hex drive bit
- (1) 1/8" Drill bit
- (1) 3/16" Shockwave Hex drive bit
- (1) 3/8" Magnetic nut driver
- (1) 3/8" Socket adapter
- (1) 5/16" Magnetic nut driver
- (1) Shockwave™ Compact magnetic bit holder
- Hex bits:  
1" (1) 1/4", (1) 1/8", (1) 3/16", (1) 5/32"
- Phillips bits:  
1" (1) P1, (2) P2, (1) P3  
2" (4) P2, (1) P3
- (1) Phillips reduced 1" PR2 bit
- Slotted bits:  
1" (1) #10, (1) #8  
2" (1) #10
- Square bits:  
1" (1) SQ1, (2) SQ2, (1) SQ3  
2" (1) SQ2, (1) SQ3
- TORX® BITS:  
1" (1) T15, (1) T20, (2) T25  
2" (1) T20, (2) T25



| Part # | Mfg #      | Description          | Price |
|--------|------------|----------------------|-------|
| 173711 | 48-32-4006 | 40-Pc Driver Bit Set |       |

### 10-PC SHOCKWAVE™ Torx® Security Insert Bit Set

- Includes:
- (1) T7 Security Insert Bit
- (1) T8 Security Insert Bit
- (1) T9 Security Insert Bit
- (1) T10 Security Insert Bit
- (1) T15 Security Insert Bit
- (1) T20 Security Insert Bit
- (1) T25 Security Insert Bit
- (1) T30 Security Insert Bit
- (1) T40 Security Insert Bit



| Part # | Mfg #      | Description          | Price |
|--------|------------|----------------------|-------|
| 237356 | 48-32-4618 | 10-Pc Insert Bit Set |       |

## Drill Bits

### 36-Piece Shockwave™ Driver Bit Set

- Includes:
  - (1) 1/4" Insert magnetic nut driver
  - (1) 3/8" Socket adapter
  - (1) 5/16" Insert magnetic nut driver
  - (1) Shockwave™ 6" Magnetic bit tip holder
  - (1) Shockwave™ Compact magnetic bit holder
  - Hex bits:
    - 1" (1) 1/4", (1) 1/8", (1) 3/16", (1) 3/32", (1) 5/32", (1) 5/64", (1) 7/64", (1) 9/64"
  - Phillips bits:
    - 1" (1) P1, (3) P2, (1) P3
    - (1) Phillips reduced 1" PR2 bit
  - Slotted bits:
    - 1" (2) #10, (1) #12, (1) #8
  - Square bits:
    - 1" (1) SQ1, (1) SQ3
  - Torx® bits:
    - 1" (1) T10, (1) T15, (2) T20, (2) T25, (1) T27, (1) T30, (1) T40



| Part # | Mfg #      | Description          | Price |
|--------|------------|----------------------|-------|
| 173710 | 48-32-4005 | 36-Pc Driver Bit Set |       |

### 10-Piece SHOCKWAVE™ Hex Bit Set



| Part # | Mfg #      | Description       | Price |
|--------|------------|-------------------|-------|
| 164160 | 48-89-4445 | 10-Pc Hex Bit Set |       |

### 10-Piece SHOCKWAVE™ RED HELIX™ Titanium Drill Bit Set

- Includes:
  - (1) 1/8" Titanium SHOCKWAVE™ (48-89-4605)
  - (1) 9/64" Titanium SHOCKWAVE™ (48-89-4606)
  - (1) 5/32" Titanium SHOCKWAVE™ (48-89-4607)
  - (1) 11/64" Titanium SHOCKWAVE™ (48-89-4608)
  - (1) 3/16" Titanium SHOCKWAVE™ (48-89-4609)
  - (1) 7/32" Titanium SHOCKWAVE™ (48-89-4611)
  - (1) 1/4" Titanium SHOCKWAVE™ (48-89-4613)
  - (1) 5/16" Titanium SHOCKWAVE™ (48-89-4617)
  - (1) 3/8" Titanium SHOCKWAVE™ (48-89-4621)

| Part # | Mfg #      | Description     | Price |
|--------|------------|-----------------|-------|
| 242614 | 48-89-4633 | 10Pc RED HELIX™ |       |

### SHOCKWAVE™ Impact Hex Drill Bit

- Extreme durability
- Fast, accurate drilling
- Corrosion resistant
- 1/4" Hex power groove shank offers quick bit changes



| Part#  | Mfg#       | Length | Diameter | Price |
|--------|------------|--------|----------|-------|
| 164179 | 48-89-4405 | 2.62"  | 1/8"     |       |
| 164180 | 48-89-4407 | 2.72"  | 5/32"    |       |
| 164181 | 48-89-4409 | 2.80"  | 3/16"    |       |
| 164182 | 48-89-4411 | 2.90"  | 7/32"    |       |
| 164183 | 48-89-4413 | 3.00"  | 1/4"     |       |
| 164184 | 48-89-4414 |        | 5/16"    |       |

### SHOCKWAVE™ Magnetic Bit Tip Holder



| Part # | Mfg #      | Size                        | Price |
|--------|------------|-----------------------------|-------|
| 141230 | 48-32-4503 | 3"                          |       |
| 169681 | 48-32-4508 | 3" (Guide Sleeve w/ C-Ring) |       |
| 188311 | 48-32-4511 | 6"                          |       |

### Titanium SHOCKWAVE™ Drill Bit

- RED HELIX™
- Titanium coating
- 135° Split point
- 1/4" Hex



| Part#  | Mfg#       | Length | Diameter | Price |
|--------|------------|--------|----------|-------|
| 237346 | 48-89-4601 | 2-1/4" | 1/16"    |       |
| 237348 | 48-89-4606 | 2.63"  | 9/64"    |       |
| 237347 | 48-89-4603 | 2.38"  | 3/32"    |       |
| 237349 | 48-89-4621 | 4.65"  | 3/8"     |       |
| 237350 | 48-89-4629 | 5.12"  | 1/2"     |       |

## Drill Bits

Tools

### 15-Pc Titanium SHOCKWAVE™ Drill Bit Kit

- (1) 1/16" Titanium SHOCKWAVE™ (48-89-4601)
- (1) 5/64" Titanium SHOCKWAVE™ (48-89-4602)
- (1) 3/32" Titanium SHOCKWAVE™ (48-89-4603)
- (1) 7/64" Titanium SHOCKWAVE™ (48-89-4604)
- (2) 1/8" Titanium SHOCKWAVE™ (48-89-4605)
- (1) 9/64" Titanium SHOCKWAVE™ (48-89-4606)
- (1) 5/32" Titanium SHOCKWAVE™ (48-89-4607)
- (2) 3/16" Titanium SHOCKWAVE™ (48-89-4609)
- (1) 7/32" Titanium SHOCKWAVE™ (48-89-4611)
- (1) 1/4" Titanium SHOCKWAVE™ (48-89-4613)
- (1) 5/16" Titanium SHOCKWAVE™ (48-89-4617)
- (1) 3/8" Titanium SHOCKWAVE™ (48-89-4621)
- (1) 1/2" Titanium SHOCKWAVE™ (48-89-4629)



| Part # | Mfg #      | Description  | Price |
|--------|------------|--------------|-------|
| 219060 | 48-89-4630 | 15-Piece Kit |       |

### Thunderbolt® Bits

#### Thunderbolt® Drill Bit Set



| Part # | Mfg #      | Description               | Price |
|--------|------------|---------------------------|-------|
| 137838 | 48-89-2803 | 15-Pc Black Oxide Bit Set |       |
| 154239 | 48-89-2801 | 21-Pc Black Oxide Bit Set |       |

### 20-Pc Thunderbolt® Titanium Drill Bit Set

- Includes:
- (2) 1/16" Titanium Coated Drill Bit (48-89-2201)
- (2) 5/64" Titanium Coated Drill Bit (48-89-2202)
- (2) 3/32" Titanium Coated Drill Bit (48-89-2203)
- (2) 7/64" Titanium Coated Drill Bit (48-89-2204)
- (2) 1/8" Titanium Coated Drill Bit (48-89-2205)
- (1) 9/64" Titanium Coated Drill Bit (48-89-2206)
- (1) 5/32" Titanium Coated Drill Bit (48-89-2207)
- (1) 11/64" Titanium Coated Drill Bit (48-89-2208)
- (1) 3/16" Titanium Coated Drill Bit (48-89-2209)
- (1) 13/64" Titanium Coated Drill Bit (48-89-2210)
- (1) 7/32" Titanium Coated Drill Bit (48-89-2211)
- (1) 1/4" Titanium Coated Drill Bit (48-89-2213)
- (1) 5/16" Titanium Coated Drill Bit (48-89-2217)
- (1) 3/8" Titanium Coated Drill Bit (48-89-2221)
- (1) 1/2" Titanium Coated Drill Bit (48-89-2229)



| Part # | Mfg #      | Description            | Price |
|--------|------------|------------------------|-------|
| 185383 | 48-89-1105 | 20-Pc Titanium Bit Set |       |

### 14-Pc Thunderbolt® Titanium Drill Bit Set

- Includes:
- (1) 1/16" Thunderbolt® Titanium Drill Bit (48-89-2201)
- (1) 5/64" Thunderbolt® Titanium Drill Bit (48-89-2202)
- (1) 3/32" Thunderbolt® Titanium Drill Bit (48-89-2203)
- (1) 7/64" Thunderbolt® Titanium Drill Bit (48-89-2204)
- (2) 1/8" Thunderbolt® Titanium Drill Bit (48-89-2205)
- (1) 9/64" Thunderbolt® Titanium Drill Bit (48-89-2206)
- (1) 5/32" Thunderbolt® Titanium Drill Bit (48-89-2207)
- (1) 3/16" Thunderbolt® Titanium Drill Bit (48-89-2209)
- (1) 7/32" Thunderbolt® Titanium Drill Bit (48-89-2211)
- (1) 1/4" Thunderbolt® Titanium Drill Bit (48-89-2213)
- (1) 5/16" Thunderbolt® Titanium Drill Bit (48-89-2217)
- (1) 3/8" Thunderbolt® Titanium Drill Bit (48-89-2221)
- (1) 1/2" Thunderbolt® Titanium Drill Bit (48-89-2229)



| Part # | Mfg #      | Description            | Price |
|--------|------------|------------------------|-------|
| 146916 | 48-89-0011 | 14-Pc Titanium Bit Set |       |



## Drill Bits

### 29-Pc Thunderbolt® Titanium Drill Bit Set

- (1) 1/16" Thunderbolt® Titanium Drill Bit (48-89-2201)
- (1) 5/64" Thunderbolt® Titanium Drill Bit (48-89-2202)
- (1) 3/32" Thunderbolt® Titanium Drill Bit (48-89-2203)
- (1) 7/64" Thunderbolt® Titanium Drill Bit (48-89-2204)
- (1) 1/8" Thunderbolt® Titanium Drill Bit (48-89-2205)
- (1) 9/64" Thunderbolt® Titanium Drill Bit (48-89-2206)
- (1) 5/32" Thunderbolt® Titanium Drill Bit (48-89-2207)
- (1) 11/64" Thunderbolt® Titanium Drill Bit (48-89-2208)
- (1) 3/16" Thunderbolt® Titanium Drill Bit (48-89-2209)
- (1) 13/64" Thunderbolt® Titanium Drill Bit (48-89-2210)
- (1) 7/32" Thunderbolt® Titanium Drill Bit (48-89-2211)
- (1) 15/64" Thunderbolt® Titanium Drill Bit (48-89-2212)
- (1) 1/4" Thunderbolt® Titanium Drill Bit (48-89-2213)
- (1) 17/64" Thunderbolt® Titanium Drill Bit (48-89-2214)
- (1) 9/32" Thunderbolt® Titanium Drill Bit (48-89-2215)
- (1) 19/64" Thunderbolt® Titanium Drill Bit (48-89-2216)
- (1) 5/16" Thunderbolt® Titanium Drill Bit (48-89-2217)
- (1) 21/64" Thunderbolt® Titanium Drill Bit (48-89-2218)
- (1) 11/32" Thunderbolt® Titanium Drill Bit (48-89-2219)
- (1) 23/64" Thunderbolt® Titanium Drill Bit (48-89-2220)
- (1) 3/8" Thunderbolt® Titanium Drill Bit (48-89-2221)
- (1) 25/64" Thunderbolt® Titanium Drill Bit (48-89-2222)
- (1) 13/32" Thunderbolt® Titanium Drill Bit (48-89-2223)
- (1) 27/64" Thunderbolt® Titanium Drill Bit (48-89-2224)
- (1) 7/16" Thunderbolt® Titanium Drill Bit (48-89-2225)
- (1) 29/64" Thunderbolt® Titanium Drill Bit (48-89-2226)
- (1) 15/32" Thunderbolt® Titanium Drill Bit (48-89-2227)
- (1) 31/64" Thunderbolt® Titanium Drill Bit (48-89-2228)
- (1) 1/2" Thunderbolt® Titanium Drill Bit (48-89-2229)



| Part # | Mfg #      | Description            | Price |
|--------|------------|------------------------|-------|
| 161240 | 48-89-0012 | 29-Pc Titanium Bit Set |       |

### Thunderbolt® Black Oxide Drill Bit

- Provides longer life and faster drill times
- Parabolic flute clears chips faster
- 135° Split point, precision start no walking



| Part # | Mfg #      | Diameter | Price |
|--------|------------|----------|-------|
| 137807 | 48-89-2710 | 1/16"    |       |
| 137808 | 48-89-2711 | 5/64"    |       |
| 137809 | 48-89-2712 | 3/32"    |       |
| 137810 | 48-89-2713 | 7/64"    |       |
| 137812 | 48-89-2714 | 1/8"     |       |
| 137813 | 48-89-2715 | 9/64"    |       |
| 137815 | 48-89-2716 | 5/32"    |       |
| 137816 | 48-89-2717 | 11/64"   |       |
| 137817 | 48-89-2718 | 3/16"    |       |
| 137818 | 48-89-2719 | 13/64"   |       |

### Thunderbolt® Bits (Continued)

#### Thunderbolt® Black Oxide Drill Bit

| Part # | Mfg #      | Diameter | Price |
|--------|------------|----------|-------|
| 137819 | 48-89-2720 | 7/32"    |       |
| 137820 | 48-89-2721 | 15/64"   |       |
| 137821 | 48-89-2722 | 1/4"     |       |
| 137822 | 48-89-2723 | 17/64"   |       |
| 137823 | 48-89-2724 | 9/32"    |       |
| 137824 | 48-89-2725 | 19/64"   |       |
| 137825 | 48-89-2726 | 5/16"    |       |
| 137826 | 48-89-2727 | 21/64"   |       |
| 137827 | 48-89-2728 | 11/32"   |       |
| 137828 | 48-89-2729 | 23/64"   |       |
| 137829 | 48-89-2730 | 3/8"     |       |
| 137830 | 48-89-2731 | 25/64"   |       |
| 137831 | 48-89-2732 | 13/32"   |       |
| 137832 | 48-89-2733 | 27/64"   |       |
| 137833 | 48-89-2734 | 7/16"    |       |
| 137834 | 48-89-2735 | 29/64"   |       |
| 137835 | 48-89-2736 | 15/32"   |       |
| 137836 | 48-89-2737 | 31/64"   |       |
| 137837 | 48-89-2738 | 1/2"     |       |

#### Thunderbolt® Aircraft Length Black Oxide Drill Bit

- Provides longer life and faster drill times
- Parabolic flute clears chips faster
- 135° Split point, precision start no walking



| Part # | Mfg #      | Diameter   | Price |
|--------|------------|------------|-------|
| 138278 | 48-89-2772 | 1/4" x 12" |       |

### Bits & Accessories

#### Flat Boring Bit

- Fluted bit clears chips
- Bores cleaner and faster
- Furnished with hole for use in wire pulling
- Flats for secure chuck grip
- Precision made of high carbon steel



| Part # | Mfg #      | Shank Dia  | Overall Length  | Price |
|--------|------------|------------|-----------------|-------|
| 006921 | 48-27-0561 | 9/16" x 6" | Flat Boring Bit |       |
| 006918 | 48-27-0371 | 3/8" x 6"  | Flat Boring Bit |       |
| 170327 | 48-27-0621 | 5/8" x 6"  | Flat Boring Bit |       |
| 006924 | 48-27-0871 | 7/8" x 6"  | Flat Boring Bit |       |
| 006920 | 48-27-0501 | 1/2" x 6"  | Flat Boring Bit |       |
| 006922 | 48-27-0751 | 3/4" x 6"  | Flat Boring Bit |       |

Tools

## Drill Bits

Tools

### Bits & Accessories (Continued)

#### Flat Boring Bit

| Part # | Mfg #      | Shank Dia   | Overall Length  | Price |
|--------|------------|-------------|-----------------|-------|
| 006925 | 48-27-1001 | 1" x 6"     | Flat Boring Bit |       |
| 170328 | 48-27-1121 | 1-1/8" x 6" | Flat Boring Bit |       |
| 170329 | 48-27-1251 | 1-1/4" x 6" | Flat Boring Bit |       |
| 170330 | 48-27-1371 | 1-3/8" x 6" | Flat Boring Bit |       |
| 170331 | 48-27-1501 | 1-1/2" x 6" | Flat Boring Bit |       |
| 243046 | 48-27-0170 | 3/8" x 16"  | Flat Boring Bit |       |

#### Bull Point SDS Plus Demolition Steel

- Carbide bits/masonry drill bits
- Bull point
- SDS-PLUS shank
- Made from forged high grade steel



| Part # | Mfg #      | Description | Price |
|--------|------------|-------------|-------|
| 178594 | 48-62-6010 | 10"         |       |

#### Speed Feed Wood Bit

- Up to 10x faster drilling than flat boring bits
- Fast chip removal
- Clean holes
- 1/4" power groove shank fits all 1/4" extensions



| Part # | Mfg #      | Description                   | Price |
|--------|------------|-------------------------------|-------|
| 170321 | 48-13-0048 | 1/2" x 6" Speed Feed Wood Bit |       |
| 170322 | 48-13-0058 | 5/8" x 6" Speed Feed Wood Bit |       |
| 170323 | 48-13-0068 | 3/4" x 6" Speed Feed Wood Bit |       |
| 170324 | 48-13-0078 | 7/8" x 6" Speed Feed Wood Bit |       |
| 170325 | 48-13-0088 | 1" x 6" Speed Feed Wood Bit   |       |
| 170326 | 48-13-0108 | 1-1/4x6" Speed Feed Wood Bit  |       |
| 146745 | 48-13-0400 | 6-1/2" (4 Pc)                 |       |

#### SHOCKWAVE™ Impact Torx Bits



| Part # | Mfg #      | Description    | Price |
|--------|------------|----------------|-------|
| 247233 | 48-32-4846 | 6" T25 (10/Pk) |       |
| 219271 | 48-32-4414 | 1" T20 (2/Pk)  |       |

### Ship Auger Bit

- Hardened, one-face 20° rake angle design
- Nonstick, polished and coated flutes
- Impact-rated shank: Strong enough to use with an impact wrench
- One line of Milwaukee® auger bits covers all applications and tools



| Part#  | Mfg#       | Size         | Price |
|--------|------------|--------------|-------|
| 169686 | 48-13-0753 | 3/4" x 6"    |       |
| 144979 | 48-13-0873 | 7/8" x 6"    |       |
| 169687 | 48-13-1003 | 1" x 6"      |       |
| 144980 | 48-13-1123 | 1-1/8" x 6"  |       |
| 221628 | 48-13-1503 | 1-1/2" x 6"  |       |
| 169688 | 48-13-1253 | 1-1/4" x 6"  |       |
| 169693 | 48-13-6250 | 1-1/4" x 18" |       |
| 144861 | 48-13-1373 | 1-3/8" x 6"  |       |

### Spur Auger Bit

- Double wing spurs: Allow for fast, clean hole cutting
- Fast chip removal: Nonstick, polished and coated flutes eliminate costly cleaning time
- Impact-rated shank: Strong enough to use with an impact wrench
- One line of auger bits covers all applications and tools



| Part#  | Mfg#       | Size            | Price |
|--------|------------|-----------------|-------|
| 145684 | 48-13-1250 | 1-1/4" x 6-1/2" |       |
| 232417 | 48-13-1500 | 1-1/2"X6-1/2"   |       |

### Boring Bit Sets

#### 8-Piece Universal Quik-Lok™ Flat Boring Bit Set

- Includes the Universal Quik-Lok™
- Double wing spurs
- 1/4" Quick change hex shank



| Part # | Mfg #      | Description            | Price |
|--------|------------|------------------------|-------|
| 137800 | 49-22-0175 | 8-Pc with 6" Extension |       |

## Drill Bits

### Flat Boring Bit Kit

- Contains (6) popular size flat boring bits in heavy protective plastic
- In pockets for orderly storage and easy size selection



| Part # | Mfg #      | Sizes Include:                    | Price |
|--------|------------|-----------------------------------|-------|
| 006980 | 49-22-0071 | 3/8", 1/2", 5/8", 3/4", 7/8" & 1" |       |

### Plumbers' Bit Kit

- Includes 5-1/2" 1-piece shank and coupling extension and carrying case
- Includes:
  - Self-feed bits: 1-3/4", 2-1/8" & 2-9/16"
  - Auger bits: 7/8", 1-1/8", 1-1/4" & 1-1/2"



| Part # | Mfg #      | Sizes Include:              | Price |
|--------|------------|-----------------------------|-------|
| 140832 | 49-22-0065 | Auger Bits & Self-feed Bits |       |

### 6-Piece SPEED FEED Wood Bit Set



| Part # | Mfg #      | Description | Price |
|--------|------------|-------------|-------|
| 170791 | 48-13-0600 | 6-1/2"      |       |

### 42-PC Driver Bit Set

- TORX® Bit  
(1) 2" T25, (1) 2" T20, (1) 1" T30, (1) 1" T25, (1) 1" T20  
(1) 1" T15, (1) 1" T10, (1) 2" T15
- Square Bit  
(1) 3-1/2" SQ2, (1) 2" SQ3, (1) 2" SQ2, (1) 1" SQ3  
(6) 1" SQ2, (2) 1" SQ1
- Slotted Bit  
(1) SL 2" 1/4", (1) 2" SL 3/16", (1) 1" SL 3/16",  
(1) 1" SL 1/8", (1) 1" SL 1/4"
- Phillips Bit  
(1) 3-1/2" P2, (1) 2" P3, (1) 2" P2,  
(1) 1" P3, (6) 1" P2, (2) 1" PR2
- HEX Bit  
(1) 1" 3/16", (1) 1" 1/4"
- Magnetic drive guide



| Part # | Mfg #      | Description          | Price |
|--------|------------|----------------------|-------|
| 219316 | 48-32-1551 | 42-Pc Driver Bit Set |       |

## Bit Kits

### Contractor's Selffeed Bit Kit

- Includes:
  - (1) Extension
  - (1) 1" Selffeed Bit
  - (1) 1-1/8" Selffeed Bit
  - (1) 1-1/4" Selffeed Bit
  - (1) 1-1/2" Selffeed Bit
  - (1) 1-3/4" Selffeed Bit
  - (1) 2-1/8" Selffeed Bit
  - (1) 2-9/16" Selffeed Bit
  - (1) 5-1/2" One-Piece Shank and Coupling
  - (1) Carrying Case



| Part # | Mfg #      | Description | Price |
|--------|------------|-------------|-------|
| 006981 | 49-22-0130 | 7-Pc Kit    |       |

### Contractors' Bit Kit

- Assortment of self-feed bits for big hole drilling
- Includes impact resistant carrying case



| Part # | Mfg #      | Description                     | Price |
|--------|------------|---------------------------------|-------|
| 006982 | 49-22-0135 | 1-3/8", 1-1/2", 2-1/8", 2-9/16" |       |

## Drill Bits

Tools

### 95-PC Drill & Drive Set

• Includes:

- (1) 1/16" Thunderbolt Black Oxide Drill Bit
- (1) 1/4" Magnetic Nut Driver
- (1) 1/4" Thunderbolt Black Oxide Drill Bit
- (1) 1/8" Thunderbolt Black Oxide Drill Bit
- (1) 3/16" Thunderbolt Black Oxide Drill Bit
- (1) 3/32" Thunderbolt Black Oxide Drill Bit
- (1) 5/16" Magnetic Nut Driver
- (1) 5/32" Thunderbolt Black Oxide Drill Bit
- (1) 5/64" Thunderbolt® Black Oxide Drill Bit
- (1) 7/64" Thunderbolt Black Oxide Drill Bit
- (2) Hex Bit 1" 1/16"
- (2) Hex Bit 1" 1/4"
- (2) Hex Bit 1" 3/16"
- (1) Hex Bit 1" 5/32"
- (1) Hex Bit 1" 9/64"
- (2) Hex Bit 1" 1/8"
- (2) Hex Bit 1" 3/32"
- (2) Hex Bit 1" 5/64"
- (2) Hex Bit 1" 7/64"
- (1) Magnetic Drive Guide
- (3) Phillips Bit 1" P1
- (10) Phillips Bit 1" P2
- (4) Phillips Bit 1" P3
- (3) Phillips Bit 1" PR2
- (1) Phillips Bit 2" P2
- (1) Pozidrive Bit 1"
- P2(1) Pozidrive Bit 1"
- P3(2) Slotted Bit 1" SL 1/4"
- (2) Slotted Bit 1" SL 1/8"
- (2) Slotted Bit 1" SL 3/16"
- (2) Slotted Bit 1" SL 7/64"
- (1) Slotted Bit 1" SL 9/32"
- (1) Slotted Bit 2" SL 3/16"
- (3) Square Bit 1" SQ1
- (8) Square Bit 1" SQ2
- (3) Square Bit 1" SQ3
- (1) Square Bit 2" SQ2
- (2) TORX® Bit 1"
- x10(2) TORX® Bit 1" T15
- (3) TORX® Bit 1" T20
- (3) TORX® Bit 1" T25
- (2) TORX® Bit 1" T27
- (2) TORX® Bit 1" T30
- (2) TORX® Bit 1" T40
- (2) TORX® Bit 1" T9
- (1) TORX® Bit 2" T20
- (1) TORX® Bit 2" T25



| Part # | Mfg #      | Description               | Price |
|--------|------------|---------------------------|-------|
| 219317 | 48-89-1561 | 95-Pc Drill and Drive Set |       |

### Drill Accessories

#### Bellhanger Bit

- Aggressive tip geometry for faster drilling
- Coated flutes for fast chip removal
- Wire pulling hole
- 3-Flat shank



| Part # | Mfg #      | Dia   | OAL | Price |
|--------|------------|-------|-----|-------|
| 138408 | 48-13-7125 | 1/4"  | 12" |       |
| 140014 | 48-13-7225 | 1/4"  | 18" |       |
| 169696 | 48-13-7237 | 3/8"  | 18" |       |
| 169821 | 48-13-7231 | 5/16" | 18" |       |
| 138666 | 48-13-7325 | 1/4"  | 24" |       |
| 153612 | 48-13-7337 | 3/8"  | 24" |       |

#### Centering Bit

- Use with SDS-MAX and spline 1-Pc core bits to start drilling
- Centering tip to reduce bit walking and create exact spot drilling



| Part # | Mfg #      | Description       | Price |
|--------|------------|-------------------|-------|
| 189747 | 48-20-5495 | For 1Pc Core Bits |       |

### Hole Saw Accessories

#### Rotary Hammer Bit

- SDS Shank



| Part # | Mfg #      | Size            | Price |
|--------|------------|-----------------|-------|
| 137647 | 48-20-7410 | 3/16" x 2" x 4" |       |
| 137648 | 48-20-7411 | 3/16" x 4" x 6" |       |
| 137649 | 48-20-7430 | 1/4" x 2" x 4"  |       |
| 137650 | 48-20-7431 | 1/4" x 4" x 6"  |       |
| 137651 | 48-20-7441 | 5/16" x 4" x 6" |       |
| 137652 | 48-20-7451 | 3/8" x 4" x 6"  |       |
| 137653 | 48-20-7471 | 1/2" x 4" x 6"  |       |

#### Switchblade™ Selffeed Bit



| Part # | Mfg #      | Description | Price |
|--------|------------|-------------|-------|
| 235679 | 48-25-5125 | 1-1/2"      |       |

## Drill Bits

### Selffeed Bit

- Faster, more accurate drilling
- Clean holes
- Long-lasting performance



| Part # | Mfg #      | Description          | Price |
|--------|------------|----------------------|-------|
| 169683 | 48-25-1502 | Selffeed Bit 1-1/2"  |       |
| 169684 | 48-25-2122 | Selffeed Bit 2-1/8"  |       |
| 006904 | 48-25-1002 | Selffeed Bit, 1"     |       |
| 006905 | 48-25-1122 | Selffeed Bit 1-1/8"  |       |
| 006906 | 48-25-1252 | Selffeed Bit 1-1/4"  |       |
| 181958 | 48-25-1752 | Selffeed Bit 1-3/4"  |       |
| 006910 | 48-25-2002 | Selffeed Bit 2"      |       |
| 144970 | 48-25-2252 | Selffeed Bit 2-1/4"  |       |
| 006913 | 48-25-2562 | Selffeed Bit 2-9/16" |       |
| 144171 | 48-25-5120 | Selffeed Bit 1-3/8"  |       |
| 144172 | 48-25-5140 | Selffeed Bit 2-1/8"  |       |
| 144174 | 48-25-5150 | Selffeed Bit 2-9/16" |       |
| 006914 | 48-25-3621 | Selffeed Bit 3-5/8"  |       |
| 006915 | 48-25-4621 | Selffeed Bit, 4-5/8" |       |

### For 1/2" D-Handle & Larger Model Drill



| Part # | Mfg #      | Dia    | Shank Type | Price |
|--------|------------|--------|------------|-------|
| 006907 | 48-25-1371 | 1-3/8" | 7/16" Hex  |       |
| 006911 | 48-25-2121 | 2-1/8" | 7/16" Hex  |       |

### For 1/2" D-Handle & Larger Model Drill Except 1001-1 & 1007-1

| Part # | Mfg #      | Dia     | Shank Type | Price |
|--------|------------|---------|------------|-------|
| 006912 | 48-25-2561 | 2-9/16" | 7/16" Hex  |       |

### Diamond Core Bit Pre-Stress

- Maximum speed
- High quality
- Versatile



| Part # | Mfg #      | Description                 | Price |
|--------|------------|-----------------------------|-------|
| 159936 | 48-17-1060 | 6" Diamond Core Bit         |       |
| 246058 | 48-17-2025 | 2-1/2" Diamond Wet Core Bit |       |
| 246059 | 48-17-2040 | 4" Diamond Wet Core Bit     |       |

### Switchblade™ 5-Piece Plumbers' Kit

- Includes:
  - (4) Switchblade™ self-feed bit blades - 1-3/8", 1-1/2", 2-1/8" and 2-9/16"
  - (1) Universal Quik-Lok® extension - 5-1/2" x 7/16"
  - (1) Each replacement blades - 1-3/8", 1-1/2", 2-1/8", and 2-9/16"
  - (4) Feed screws
  - (4) Set screws
  - (1) Hex wrench
  - Removable storage case
  - Compact carrying case with handle



| Part # | Mfg #      | Description                   | Price |
|--------|------------|-------------------------------|-------|
| 149390 | 49-22-5100 | 5-Pc Switchblade Plumbers Kit |       |

### Replacement Switchblades



| Part # | Mfg #      | Description                    | Price |
|--------|------------|--------------------------------|-------|
| 170832 | 48-25-5225 | 3-Pk, 1-1/2" Diameter          |       |
| 144551 | 48-25-5420 | Single Blade, 1-3/8" Diameter  |       |
| 179631 | 48-25-5220 | 3-Pk, 1-3/8" Diameter          |       |
| 169678 | 48-25-5320 | 10-Pk, 1-3/8" Diameter         |       |
| 144552 | 48-25-5440 | Single Blade, 2-1/8" Diameter  |       |
| 146743 | 48-25-5240 | 3-Pk, 2-1/8" Diameter          |       |
| 169549 | 48-25-5540 | 3-Pk, 2-1/8" Diameter          |       |
| 169679 | 48-25-5340 | 10-Pk, 2-1/8" Diameter         |       |
| 245442 | 48-25-5543 | 3-Pk, 2-1/4" Diameter          |       |
| 169680 | 48-25-5350 | 10-Pk, 2-9/16" Diameter        |       |
| 146744 | 48-25-5250 | 3-Pk, 2-9/16" Diameter         |       |
| 169548 | 48-25-5550 | 3-Pk, 2-9/16" Diameter         |       |
| 147445 | 48-25-5450 | Single Blade, 2-9/16" Diameter |       |

### Replacement Feed Screw Kit

- For Switchblade™ selffeed bits
- Up to 2-9/16"
- Faster, more accurate drilling



| Part # | Mfg #      | Description                | Price |
|--------|------------|----------------------------|-------|
| 150897 | 48-25-5275 | Replacement Feed Screw Kit |       |

## Drill Bits

Tools

### Step Drill Bits

#### High Speed Steel Step Drill Bit

- Jam-Free performance
- Rapid Strike™ Tip
- Up to 4X longer bit life
- Up to 50% more holes per battery charge
- Laser-engraved reference marks
- 3-Flat Secure-Grip™ shanks



| Part # | Mfg #      | Size                  | # of Steps | Price |
|--------|------------|-----------------------|------------|-------|
| 169382 | 48-89-9207 | 7/8" x 3/8"           | 1          |       |
| 169191 | 48-89-9201 | 1/8"-1/2" x 1/32"     | 13         |       |
| 169381 | 48-89-9202 | 3/16" - 1/2" x 1/16"  | 6          |       |
| 169186 | 48-89-9203 | 1/4" - 3/4" x 1/16"   | 9          |       |
| 169187 | 48-89-9204 | 3/16" - 7/8" x 1/16"  | 12         |       |
| 169351 | 48-89-9205 | 1/4" - 1-3/8"         | 10         |       |
| 169188 | 48-89-9206 | 3/8" - 1/2" x 1/16"   | 2          |       |
| 169189 | 48-89-9208 | 7/8" - 1-1/8" x 3/8"  | 9          |       |
| 169190 | 48-89-9209 | 7/8" - 1-1/8"         | 2          |       |
| 169383 | 48-89-9211 | 7/8" - 1-7/32" x 3/8" | 13         |       |
| 169384 | 48-89-9212 | 7/8" - 1-3/8" x 3/8"  | 5          |       |

#### 2-Piece Step Drill Bit Set

- Includes:
  - (1) 13-Hole bit (48-89-9100)
  - (1) 9-Hole bit (48-89-9105)



| Part # | Mfg #      | Description             | Price |
|--------|------------|-------------------------|-------|
| 145131 | 48-89-9050 | 2-Pc Step Drill Bit Set |       |

#### 2-Piece #4 Step Drill Bit Set

- (2) #4 Step Drill Bit, 3/16" - 7/8" by 1/16" (48-89-9204)



| Part # | Mfg #      | Description             | Price |
|--------|------------|-------------------------|-------|
| 178317 | 48-89-9234 | 2-Pc Step Drill Bit Set |       |

#### 2-Piece #9 Step Drill Bit Set

- (2) #9 Step Drill Bit, 7/8" & 1-1/8" (48-89-9209)



| Part # | Mfg #      | Description             | Price |
|--------|------------|-------------------------|-------|
| 178318 | 48-89-9239 | 2-Pc Step Drill Bit Set |       |

#### 3-Piece Step Drill Bit Set

- Includes:
  - (1) 6-Hole bit (48-89-8955)
  - (1) 9-Hole bit (48-89-9105)
  - (1) 13-Hole bit (48-89-9100)



| Part # | Mfg #      | Description             | Price |
|--------|------------|-------------------------|-------|
| 145130 | 48-89-8990 | 3-Pc Step Drill Bit Set |       |

### SDS Bits and Accessories

#### One Piece SDS-MAX Core Bit



| Part # | Mfg #      | Description      | Price |
|--------|------------|------------------|-------|
| 242436 | 48-20-5412 | 2-5/8" x 11-3/8" |       |
| 243816 | 48-20-5470 | 3-1/8" x 11-3/8" |       |
| 243817 | 48-20-5482 | 4" x 11-3/8"     |       |
| 243819 | 48-20-5490 | 6" x 22"         |       |

#### One Piece SDS-MAX Tunnel Bit

- Centering tip
- Chisel and raker teeth
- Land and core thickness



| Part # | Mfg #      | Description  | Price |
|--------|------------|--------------|-------|
| 244755 | 48-20-5312 | 2-1/8" x 22" |       |
| 244756 | 48-20-5318 | 2-1/2" x 22" |       |

## Drill Bits

### Core Bit With Center Bit

- Abrasion-resistant carbide teeth
- Centering bit eliminates slipping
- Use with 11" extension for extra-deep drilling
- Multipurpose SDS-MAX or spline shank: Interchangeable with a variety of drilling heads from 1-1/2" to 5"



| Part # | Mfg #      | Description                     | Price |
|--------|------------|---------------------------------|-------|
| 166215 | 48-20-5092 | 2-1/8" Core Bit With Center Bit |       |

### SDS-PLUS Thin Wall Carbide Tipped Core Bit

- Thin wall design
- 2" Diameter
- Usable cutting depth 2-13/16"
- Use with 8" or 12" SDS PLUS adapter shanks (48-03-3555, 48-03-3561)
- Use with 7-1/2" extensions 48-95-6075
- Includes core body with guide plate & centering pin



| Part # | Mfg #      | Description                                       | Price |
|--------|------------|---|-------|
| 163505 | 48-20-5035 | SDS-PLUS Thin Wall Carbide Tipped Core Bit 2"     |       |
| 163506 | 48-20-5050 | SDS-PLUS Thin Wall Carbide Tipped Core Bit 3-1/2" |       |

### SDS-Max and SPLINE Thick Wall Carbide Tipped Core Bit

- Thick Wall Design
- Use with 12" or 18" SPLINE adapter shanks (48-00-3564, 48-03-3565) and 12" or 18" SDS-Max adapter shanks (48-03-3572, 48-03-3573)
- Use with 7-1/2" extension 48-95-6085
- Includes core body with guide plate & centering pin



| Part # | Mfg #      | Description | Price |
|--------|------------|-------------|-------|
| 164477 | 48-20-5130 | 1-3/4"      |       |
| 159714 | 48-20-5140 | 2-1/2"      |       |
| 155357 | 48-20-5150 | 3-1/2"      |       |
| 162578 | 48-20-5155 | 4"          |       |

### SDS-MAX to Spline Adapter

- Allows the use of SPLINE shank accessories in a SDS-Max shank rotary hammer



| Part # | Mfg #      | Description               | Price |
|--------|------------|---------------------------|-------|
| 238466 | 48-03-3012 | SDS-MAX to Spline Adapter |       |

### SDS-Max Bit

- SDS-Max shank
- 4-Cutter head
- Highest quality carbide
- Optimized flutes provide fastest debris extraction for faster drilling



| Part # | Mfg #      | Description              | Price |
|--------|------------|--------------------------|-------|
| 154017 | 48-20-3918 | SDS-Max Bit 5/8" x 21"   |       |
| 236941 | 48-20-3992 | SDS-Max Bit 1-3/4" x 23" |       |

### SDS-Plus 2CT Bit

- Enhanced rebar guards
- Breaker points lead to faster drilling speeds
- Variable flute for 20% more holes per charge
- Centering tip for exact spot drilling
- Wear mark indicators
- Reinforced flutes for minimized vibration & max durability



| Part # | Mfg #      | Description                   | Price |
|--------|------------|-------------------------------|-------|
| 170315 | 48-20-7432 | SDS-Plus 2CT 1/4" x 6" x 8"   |       |
| 170316 | 48-20-7452 | SDS-Plus 2CT 3/8" x 6" x 8"   |       |
| 167611 | 48-20-7459 | SDS-Plus 2CT 3/8" x 22" x 24" |       |
| 179485 | 48-20-7473 | SDS-Plus 2CT 1/2" x 8" x 10"  |       |
| 170317 | 48-20-7474 | SDS-Plus 2CT 1/2" x 10" x 12" |       |
| 170318 | 48-20-7481 | SDS-Plus 2CT 9/16" x 4" x 6"  |       |
| 170319 | 48-20-7601 | SDS-Plus 2CT 5/8" x 4" x 6"   |       |
| 170320 | 48-20-7604 | SDS-Plus 2CT 5/8" x 10" x 12" |       |
| 170314 | 48-20-7065 | SDS-Plus 2CT 3/4" x 10" x 12" |       |
| 142705 | 48-20-7454 | SDS-Plus 2CT 3/8" x 10" x 12" |       |
| 153951 | 48-20-7061 | SDS-Plus 2CT 3/4" x 6" x 8"   |       |

### SDS-Plus 4CT MX4™ Bit

- Enhanced rebar guards provide increased durability
- Breaker points lead to faster drilling speeds
- Variable flute for up to 20% more holes per charge in rotary hammers
- Centering tip for exact spot drilling
- Wear mark indicators to show end of life and when bit no longer meets the ANSI requirement
- Reinforced flutes for minimized vibration and maximum durability



| Part # | Mfg #      | Description      | Price |
|--------|------------|------------------|-------|
| 152697 | 48-20-7206 | 5/8" x 16" x 18" |       |

## Drill Bits

Tools

### SDS Bit Assortment

- Includes:
  - 3/16" x 4-1/2"
  - 1/4" x 6"
  - 5/16" x 6"
  - 3/8" x 6"
  - 1/2" x 6"
- SDS Shank
- Carbide



| Part # | Mfg #      | Description      | Price |
|--------|------------|------------------|-------|
| 137655 | 48-20-7490 | 5-Pc SDS Bit Set |       |

### SDS Bit - 44 Magnum™ Series

- 4-Fluted spiral shaft



| Part # | Mfg #      | Bit Dia | Overall Length | Drilling Depth | Price |
|--------|------------|---------|----------------|----------------|-------|
| 137646 | 48-20-7401 | 5/32"   | 4"             | 6"             |       |
| 137657 | 48-20-7602 | 5/8"    | 6"             | 8"             |       |

### SDS Bit with 1/4" Hex

- 2-Cutter head
- SDS Shank w/ hex shoulder for Tap-Con screw system



| Part # | Mfg #      | Bit Dia | Overall Length | Drilling Depth | Price |
|--------|------------|---------|----------------|----------------|-------|
| 137644 | 48-20-7091 | 5/32"   | 7"             | 4"             |       |
| 137645 | 48-20-7092 | 3/16"   | 7"             | 4"             |       |

### Spline Bit 4-Cutter

- 17" Drilling depth



| Part # | Mfg #      | Bit Dia | Overall Length | Drilling Depth | Price |
|--------|------------|---------|----------------|----------------|-------|
| 236911 | 48-20-4400 | 1-1/4"  | 22"            | 17"            |       |

### Stop Bit SDS-PLUS

- For use with drop-in anchors
- Stopping shoulder to drill accurate depths repeatedly
- Patented flute geometry to remove debris rapidly and maximize impact energy
- Centering tip to reduce bit walking and create exact spot drilling



| Part # | Mfg #      | Description              | Price |
|--------|------------|--------------------------|-------|
| 171096 | 48-20-7651 | 3/8" x 1-1/16" Stop Bit  |       |
| 171101 | 48-20-7653 | 1/2" x 1-11/16" Stop Bit |       |
| 171103 | 48-20-7655 | 5/8" x 2-1/16" Stop Bit  |       |
| 242646 | 48-20-7652 | 1/2" x 13/16" Stop Bit   |       |

### Spline to SDS-Plus Adapter

- Allows the use of SDS-Max shank accessories in a spline shank rotary hammer



| Part # | Mfg #      | Description | Price |
|--------|------------|-------------|-------|
| 193588 | 48-03-3015 | Adapter     |       |

### Hammer Drill Bits

#### Carbide-Tip Hammer Drill Bit

| Part # | Mfg #      | Description                   | Price |
|--------|------------|-------------------------------|-------|
| 137662 | 48-20-8810 | 1/4" x 2" x 4" with Hex Shank |       |

#### Three-Flat Secure-Grip™ Hammer Drill Bit

- Fast drilling, long life
- 3-Flat Secure-Grip™ prevents bit from slipping in the chuck



| Part # | Mfg #      | Size               | Price |
|--------|------------|--------------------|-------|
| 137665 | 48-20-8821 | 3/8" x 4" x 6"     |       |
| 137658 | 48-20-8800 | 1/8" x 1-1/2" x 3" |       |
| 137663 | 48-20-8811 | 1/4" x 4" x 6"     |       |
| 137659 | 48-20-8801 | 5/32" x 4" x 6"    |       |
| 137660 | 48-20-8805 | 3/16" x 2" x 4"    |       |
| 137661 | 48-20-8806 | 3/16" x 4" x 6"    |       |
| 137664 | 48-20-8816 | 5/16" x 4" x 6"    |       |
| 137666 | 48-20-8830 | 1/2" x 4" x 6"     |       |
| 235675 | 48-20-8840 | 5/8" x 4" x 6"     |       |
| 184757 | 48-20-8812 | 1/4" x 10" x 12"   |       |

#### 5-Piece, 3-Flat Secure-Grip™ Hammer-Drill Bit Set

- Comprehensive offering with diameters from 1/8" to 1" with lengths up to 18"



| Part # | Mfg #      | Description          | Price |
|--------|------------|----------------------|-------|
| 137667 | 48-20-8851 | Bit Hammer-Drill Kit |       |



## Drill Bits

### Miscellaneous

#### Diamond Premium Segmented Wheel

- Extended Life
- Fast Cutting
- Designed to be used Wet or Dry

| Part # | Mfg #      | Description                     | Price |
|--------|------------|---------------------------------|-------|
| 186478 | 49-93-7005 | 4-1/2", Arbor: 7/8", 20mm, 5/8" |       |

#### Scraping Chisel

- Made from forged high grade steel



| Part # | Mfg #      | Description        | Price |
|--------|------------|--------------------|-------|
| 172488 | 48-62-2065 | 2" Scraping Chisel |       |

#### SDS Demo Flat Chisel



| Part # | Mfg #      | Description                 | Price |
|--------|------------|-----------------------------|-------|
| 151866 | 48-62-6015 | SDSPlus 3/4" x 10"          |       |
| 167377 | 48-62-4079 | SDSMAX Demo 12" Flat Chisel |       |
| 186711 | 48-62-6020 | 1/2" x 10" Scaling Chisel   |       |
| 186712 | 48-62-6030 | 9-1/2" Tile Chisel          |       |
| 186713 | 48-62-6035 | 9/16"x7" Mortar Scraper     |       |

#### SPL/RDHEX Demo Flat Chisel

- Cold Chisel
- Carbide Bits/Masonry Drill Bits



| Part # | Mfg #      | Description | Price |
|--------|------------|-------------|-------|
| 226835 | 48-62-2130 | 1" x 18"    |       |

### Feed and Set Screw Accessory Set

- Includes:
- (5) Feed Screws
- (1) Hex Key
- (3) Set Screws



| Part # | Mfg #      | Description | Price |
|--------|------------|-------------|-------|
| 169682 | 48-25-6000 | 8 Pc Set    |       |

### 12-Piece 3/8" Drive SAE Socket Set

- Includes:
- (1) 3/8" Drive Roto Ratchet
- (1) 3/8" Deep Well Socket
- (1) 7/16" Deep Well Socket
- (1) 1/2" Deep Well Socket
- (1) 9/16" Deep Well Socket
- (1) 5/8" Deep Well Socket
- (1) 11/16" Deep Well Socket
- (1) 3/4" Deep Well Socket
- (1) 6" Extension
- (1) 3/8" to 1/4" Drive Adaptor
- (1) 3/8" to Hex Adaptor
- (1) Carrying Case



| Part # | Mfg #      | Description | Price |
|--------|------------|-------------|-------|
| 232445 | 48-22-9000 | 12Pc, 3/8"  |       |

### 12-Piece 3/8" Drive Metric Socket Set

- Includes:
- (1) 3/8" Drive Roto Ratchet
- (1) 10mm Deep Well Socket
- (1) 12mm Deep Well Socket
- (1) 13mm Deep Well Socket
- (1) 14mm Deep Well Socket
- (1) 15mm Deep Well Socket
- (1) 17mm Deep Well Socket
- (1) 18mm Deep Well Socket
- (1) 19mm Deep Well Socket
- (1) 6" Extension
- (1) 3/8" to 1/4" Drive Adaptor
- (1) 3/8" to Hex Adaptor
- (1) Carrying Case



| Part # | Mfg #      | Description | Price |
|--------|------------|-------------|-------|
| 232446 | 48-22-9001 | 12Pc, 3/8"  |       |

## Drill Bits

Tools

### Drill Bits

#### Polished Double Enders Drill Bit

- Punch style length
- Bit at each end
- 135° Split point
- For use on sheet metal



| Part # | Mfg # | Bit Dia | O/A Length | Price |
|--------|-------|---------|------------|-------|
| 006385 | DE1/8 | 1/8"    | 2"         |       |
| 006384 | DE1/4 | 1/4"    | 2-1/2"     |       |

**Flaring Tools**

**Flaring Tools**

**Pro-Set® Flaring Tool**



- For use on the following tube materials:
  - Copper
  - Aluminum
  - Brass
  - Thin-Wall Steel

| Part # | Mfg #      | Description   | Price |
|--------|------------|---|-------|
| 134798 | 87-FT800FN | R-410A Imperial Block 3/16", 1/4", 5/16", 3/8", 1/2", 5/8", 3/4" with Ratchet |       |

Tools

**Flaring Tools**

**Flaring Tools**

**Ratchet Flaring Tool**

- Ratcheting feed screw handle
- Hardened steel flaring cone, eccentrically mounted in needle bearings



| Part # | Mfg # | Model | Type           | Sizes  | Price |
|--------|-------|-------|----------------|--|-------|
| 045766 | 83037 | 458R  | 45° SAE Flares | 1/8", 3/16", 1/4", 5/16", 3/8", 1/2", 5/8", 3/4" |       |

**Flaring Tool**

- Precision designed tool for producing 45° flares in soft copper, brass, aluminum, and mild steel (JIC and Bundy) tubing
- A hardened, smooth cone provides fast, 45° flares either single or double lap
- A single clamp screw provides for easy clamping and removal of tubing



| Part # | Mfg # | Model | Type           | Sizes                                       | Price |
|--------|-------|-------|----------------|---|-------|
| 008721 | 23332 | 345   | 45° SAE Flares | 3/16", 1/4", 5/16", 3/8", 7/16", 1/2", 5/8" |       |

**Hammer-Type Flaring Tool**

- Made of high-grade hardened steel
- Long nose guide that centers tools for smooth, 45° uniform flares



| Part # | Mfg # | Model | Water Tube Size | Price |
|--------|-------|-------|-----------------|-------|
| 067998 | 41320 | E-45  | 1/2"            |       |
| 008618 | 41330 | E-47  | 3/4"            |       |
| 008625 | 41335 | E-52  | 1"              |       |
| 025807 | 41345 | E-63  | 1-1/2"          |       |
| 022441 | 41350 | E-64  | 2"              |       |

Tools

## Flaring Tools

### Flaring Tools

#### Flaring Tool

- Makes smooth flare
- For OD sizes 3/16", 1/4", 5/16", 3/8", 1/2" and 5/8"



| Part # | Mfg #   | Description      | Price |
|--------|---------|------------------|-------|
| 041946 | J40-080 | Bar Flaring Tool |       |

### Copper Swedge Tools

- Heat-treated carbon steel
- Can be used on copper tube, oft copper, aluminum or any other thin-walled tubing



| Part # | Mfg #   | Description                  | Price |
|--------|---------|------------------------------|-------|
| 064624 | J40-369 | 5/8" to 1-1/8" Copper Swedge |       |

## Flaring Tools

Tools

### Flaring Tools

#### Deluxe 45° Flaring Tool

- Easy-to-use with four basic steps
- Designed with the new R-410A system
- Automatic tube height gauge
- Multi-faceted burnishing cone produces a burnished flare seat for a positive seal
- Self-centering yoke grips without marring or constricting tube



| Part # | Mfg # | For:           | Price |
|--------|-------|----------------|-------|
| 182105 | 60278 | 1/8"-3/4" O.D. |       |

#### Eccentric Cone Flaring Tool

- Large feed screw handle
- Black oxide-finished steel flaring bars are heat-treated
- Recommended for soft materials such as copper and aluminum
- Built-in clutch release to prevent over-torquing



| Part # | Mfg # | For:            | Price |
|--------|-------|-----------------|-------|
| 182107 | 60295 | 3/16"-3/4" O.D. |       |

#### 45° Small Flaring Tool

- Chrome finish
- Forged steel yoke
- Hardened steel flaring bar
- Threaded feed screw and long handle



| Part # | Mfg # | For:           | Price |
|--------|-------|----------------|-------|
| 238075 | 60230 | 1/2"-3/4" O.D. |       |

#### Punch-Type Swaging Tool

- Expands one end of copper tubing for connecting same size tubes
- Heat-treated and plated alloy steel
- Made in the USA



| Part # | Mfg # | Size      | Price |
|--------|-------|-----------|-------|
| 182156 | 60466 | 3/8" O.D. |       |
| 182158 | 60469 | 3/4" O.D. |       |
| 182159 | 60470 | 7/8" O.D. |       |

### Complete Tubing Expander/Swager Kit

- Heat treated handles and expanding pin
- Use on 0.063" wall soft copper and aluminum to 1-5/8" O.D.
- Use on 0.047" wall soft steel to 7/8" O.D.
- Kit includes six expander heads; three optional sizes sold separately



| Part # | Mfg # | Heads For:                                | Price |
|--------|-------|---|-------|
| 182147 | 60407 | 3/8", 1/2", 5/8", 3/4", 7/8", 1-1/8" O.D. |       |

### Complete Swage and 45° Flare Kit

- Kit includes:
  - Yoke
  - Deluxe case
  - 6 Swage adapters
  - Flaring cone
  - 2 Flaring bars
- Deeply knurled adapters
- Six hardened and plated alloy steel adapters are interchangeable
- Slip-on self-centering steel yoke has a feed screw with extra long handle
- Flaring bars are hardened and chrome plated



| Part # | Mfg # | Description     | Price |
|--------|-------|-----------------|-------|
| 182152 | 60440 | 3/16"-3/4" O.D. |       |

## Work Lights

### M12™ Work Lights

#### M12™ Work Light

- REDLITHIUM™ battery technology
- Compact design
- 90° rotating head
- Integrated magnet



| Part # | Mfg #      | Length | Voltage | Price |
|--------|------------|--------|---------|-------|
| 164019 | 49-24-0145 | 7"     | 12V     |       |

#### M12™ LED Work Light

- REDLITHIUM™ Battery technology
- Sealed aluminum head
- 90° Rotating head
- Magnetic back



| Part # | Mfg #      | Length | Voltage | Price |
|--------|------------|--------|---------|-------|
| 137576 | 49-24-0146 | 7"     | 12V     |       |

#### M12™ TRUEVIEW™ LED Spotlight

- Up to 700 yard beam distance
- 3 Light output modes for distance, clarity, and safety
- High: 750 lumens
- Low: 400 lumens
- Strobe: 800 lumens
- Impact and moisture resistant



| Part # | Mfg #   | Length | Voltage | Price |
|--------|---------|--------|---------|-------|
| 181689 | 2353-20 | 6.5"   | 12V     |       |

#### M12™ LED Lantern/Flood Light

- TRUEVIEW™: High definition lighting technology
- 180° - 360° Adjustable beam
- 2.1A USB Charger
- Rugged design
- Four light settings: High, medium, low, strobe
- Two stainless steel hooks



| Part # | Mfg #   | Length | Voltage | Price |
|--------|---------|--------|---------|-------|
| 171826 | 2362-20 | 10.6"  | 12V     |       |

### M12™ LED Stick Light (Bare Tool)

- TRUEVIEW™ High definition lighting technology
- Powerful 3-LED design
- Multi-position stainless steel hook
- Over 4+ hours of run-time
- Bright, smooth, even beam pattern
- Impact resistant/replaceable lens



| Part # | Mfg #      | Length | Voltage | Price |
|--------|------------|--------|---------|-------|
| 158985 | 2351-20    | 9-1/4" | 12V     |       |
| 158986 | 49-24-2351 | 1-3/4" | N/A     |       |

### M12™ Compact Flood Light

- High mode: 1,000 Lumens 3.5hrs
- Low mode: 200 Lumens 15hrs



| Part # | Mfg #   | Length | Voltage | Price |
|--------|---------|--------|---------|-------|
| 225830 | 2364-20 | 7.5"   | 12V     |       |

### M12™ LED Underhood Light

- 1,350 Lumens of TRUEVIEW™ High Definition Output
- FINISHGUARD™ hooks provide lasting protection against scratches to a vehicle's finish
- 2x more gripping surface for maximum hold
- Rotate, slide, remove and hang light bar for added flexibility and versatility
- Mounting Hooks Extend up to 78" to cover wide cars and trucks
- Light bar with SS hook
- Sturdy aircraft aluminum frame
- Impact and chemical resistant lens
- 5 Year Tool Warranty



| Part # | Mfg #   | Description | Price |
|--------|---------|-------------|-------|
| 234818 | 2125-20 | Bare Tool   |       |

## Work Lights

Tools

### M12™ LED Metal Flashlight

- High mode: 800 Lumens, 5 Hrs
- Low mode: 325 Lumens, 7 Hrs



| Part # | Mfg #   | Description | Price |
|--------|---------|-------------|-------|
| 222067 | 2355-20 | Bare Tool   |       |
| 222068 | 2355-21 | Kit         |       |

### M18™ ROVER™ LED Flood Light

- Trueview: High definition lighting technology
- Up to 30% brighter than corded 250 halogen lights
- Up to 8 hours of run-time
- Innovative roll cage design
- Multiple hanging features: emt hanger, key hole hanger, cross bar hanger, handle hanger



| Part # | Mfg #   | Length | Voltage | Price |
|--------|---------|--------|---------|-------|
| 161982 | 2361-20 | 8-3/4" | 18V     |       |

### M18™ Work Lights

#### M18™ Search Light

- 1250 Lumens with 700 yard beam distance
- 198° Head rotation
- Modes: Spot, Flood, Spot/Flood, & Strobe



| Part # | Mfg #   | Length    | Voltage | Price |
|--------|---------|-----------|---------|-------|
| 226122 | 2354-20 | Bare Tool |         |       |
| 226123 | 2354-21 | Kit       |         |       |

### M18™ ROVER™ Mounting Flood Light

- 1500 lumens up to 20 hours of runtime
- Magnets, 2" spring loaded clamp, & folding rotating light head design
- 3 output modes for optimal brightness and runtime



| Part # | Mfg #   | Description | Price |
|--------|---------|-------------|-------|
| 240424 | 2365-20 | Bare Tool   |       |

### M18™ RADIUS™ Compact Site Light

- Flood mode
- 4-1/4" Hanging hook
- AC inlet for all day runtime
- 3 Area and task output modes
- Dual function: 360° area lighting, 90° flood lighting



| Part # | Mfg #   | Length | Voltage | Price |
|--------|---------|--------|---------|-------|
| 244930 | 2144-20 | 8"     | 18V     |       |

### M18™ Cordless LED Work Light

- Sealed, aluminum head
- 160 Lumen LED
- Lasts up to 12 hours on one charge
- Integrated hook
- 135° Rotating head



| Part # | Mfg #   | Length | Voltage | Price |
|--------|---------|--------|---------|-------|
| 137577 | 2735-20 | 8.5"   | 18V     |       |

### M18™ RADIUS™ Site Light with ONE-KEY™

- Low battery indicator
- Plug-in and daisy chain
- Program automatic schedules
- Optimize brightness and runtime
- Set light remotely from up to 100ft
- Integrated two-bay sequential charger
- Integrated tool tracking and security
- 180° and 360° electronic light control



| Part # | Mfg #   | Description | Price |
|--------|---------|-------------|-------|
| 239064 | 2150-20 | 18V         |       |



## Work Lights

### M18™ ROCKET™ LED Tower Light

- 7ft Max extension
- Rotating and pivoting head is extendable from 4-7ft
- Compact 26" footprint w/ low center of gravity
- Three light output modes
  - High: 2,000 lumens
  - Medium: 1,300 lumens
  - Low: 850 lumens
- Impact resistant, reinforced legs



| Part # | Mfg #   | Height | Voltage | Price |
|--------|---------|--------|---------|-------|
| 181687 | 2130-20 | 4-7 Ft | 18V     |       |

### M18 ROCKET™ LED Tower Light/Charger

- 5 Second setup, 7 foot extension
- 3,000 Lumens of multidirectional light
- Impact resistant, reinforced legs
- Built in M18™ charger
- Covered AC Plug-in
- 3 Independently pivoting light heads
- Protective guard to secure head and lens during transport and storage
- Compact footprint, low center of gravity
- Low battery indicator



| Part # | Mfg #     | Height | Voltage | Price |
|--------|-----------|--------|---------|-------|
| 226119 | 2135-20   | 4-7 Ft | 18V     |       |
| 226121 | 2135-21HD | 4-7 Ft | 18V     |       |

### M18™ ROCKET™ Dual Pack Tower Light w/ One Key

- 5400 Lumens up to 26 hrs runtime
- 5'5" Extension, collapses to 22"
- Waterproof and dustproof
- Dual batter design: use one or two batteries
- 3 Leg positions
- One key capable
- 3 Output modes
  - High: 5400 Lumens
  - Medium: 3100 Lumens
  - Low: 1600 Lumens
- -HD model includes: 9.0 battery w/ rapid charger



| Part # | Mfg #     | Height  | Voltage | Price |
|--------|-----------|---------|---------|-------|
| 238902 | 2120-20   | 22"-65" | 18V     |       |
| 238905 | 2120-22HD | 22"-65" | 18V     |       |

### M18™ Rover™ LED Dual Power Flood Light

- Three light output modes
- Medium Mode: 1,500 lumens for up to 4 hours with M18™ XC 5.0 Pack
- High Mode: 3,000 lumens for up to 2 hours with M18™ XC 5.0 Pack
- Low Mode: 650 lumens for up to 8 hours with M18™ XC 5.0 Pack
- High Definition Output with true color, even beam, and natural light
- Dual Power Source: M18™ or Corded
- Light Head rotates 240° with positive stops
- (3) integrated keyholes for hanging horizontally or vertically
- Durable Roll Cage protects light head



| Part # | Mfg #   | Length | Voltage | Price |
|--------|---------|--------|---------|-------|
| 181688 | 2360-20 |        | 18V     |       |

### M18™ LED Stick Light

- TRUEVIEW: High definition lighting technology
- Forward and backward pivoting head
- Rugged design: replaceable lens plate and chemical resistant body
- Two adjustable metal hooks
- Compact design



| Part # | Mfg #   | Length | Voltage | Price |
|--------|---------|--------|---------|-------|
| 172034 | 2352-20 | 11.6"  | 18V     |       |

### M18™ LED Lantern/Flood Light

- TRUEVIEW: High definition lighting technology
- 180° - 360° Adjustable beam
- 2.1A USB Charger
- Rugged design
- Four light settings: High, medium, low, strobe
- Two stainless steel hooks



| Part # | Mfg #   | Length | Voltage | Price |
|--------|---------|--------|---------|-------|
| 171827 | 2363-20 | 11.5"  | 18V     |       |

## Work Lights

Tools

### M18™ RADIUS™ LED Compact Site Light w/ ONE-KEY™

- Set light remotely from 50ft
- Optimize brightness and runtime
- Program automatic schedule
- Lighting for task, area, and overhead
- High impact polycarbonate lens
- 4,400 Lumens for maximum coverage
- AC in and out: string up to 10 together
- Protected AC plugs self-centering hang hook
- Reinforced hang hole
- 180 and 360 electronic: light control
- Low battery indicator



| Part # | Mfg #   | Length | Voltage | Price |
|--------|---------|--------|---------|-------|
| 222799 | 2146-20 |        | 18V     |       |

### M18™ RADIUS™ LED Compact Site Light



| Part # | Mfg #   | Length | Voltage | Price |
|--------|---------|--------|---------|-------|
| 222798 | 2145-20 |        | 18V     |       |

### Complete Flashlights Headlamp

- Wide flood beam pattern
- High, medium, and low mode
- 7-Position tilting light head
- Includes (3) AAA batteries
- 3 Light output modes for optimal brightness & runtime



| Part # | Mfg # | Description | Price |
|--------|-------|-------------|-------|
| 238980 | 2106  | Headlamp    |       |

### Penlight

- 6000 Series aircraft aluminum body
- Over 3 hours continuous runtime
- Removable metal clip on/off
- Momentary-on button
- 43 Meter beam distance
- Includes (2) AAA batteries



| Part # | Mfg # | Description | Price |
|--------|-------|-------------|-------|
| 238979 | 2105  | Penlight    |       |

### USB Rechargeable Hard Hat Headlamp

- REDLITHIUM™
- LED fuel gauge
- 2FT Micro-USB braided cord
- 7-Position tilting light head
- Flood, spot, & spot/flood beam patterns —Low, medium, and high modes
- 475 Lumens of TRUEVIEW™ high definition output
- 5 Light output modes for optimal brightness & runtime
- Clips & rubber grips included for hard hat attachment



| Part # | Mfg #   | Description       | Price |
|--------|---------|-------------------|-------|
| 238968 | 2111-21 | Hard Hat Headlamp |       |

### USB Rechargeable Flashlight

- REDLITHIUM™
- LED fuel gauge
- 2' heavy duty USB cord
- Removable metal cord
- 155 Meter beam distance
- Spot-flood sliding beam adjustment
- 6,000 Series aircraft aluminum body
- 3 Light output modes: high, low, & strobe
- 700 Lumens of TRUEVIEW™ high definition output



| Part # | Mfg #   | Description                 | Price |
|--------|---------|-----------------------------|-------|
| 238967 | 2110-21 | USB Rechargeable 700L Light |       |

## Work Lights

### USB Rechargeable ROVER™ Pocket Flood Light

- REDLITHIUM™
- LED fuel gauge
- Dual magnet clip
- 2FT Micro-USB braided cord
- 2 Light output modes for max brightness or run time
- Lumens of TRUEVIEW™ high definition output  
—High (445) and Low (100) modes



| Part # | Mfg #   | Description        | Price |
|--------|---------|--------------------|-------|
| 238969 | 2112-21 | Pocket Flood Light |       |

### Replacement Bulbs



49-81-0030



49-81-0090

| Part # | Mfg #      | Description                    | Price |
|--------|------------|--------------------------------|-------|
| 141993 | 49-81-0030 | Bulbs for 18V Work Light, 2/Pk |       |
| 138845 | 49-81-0090 | LED Upgrade Work Lights        |       |

---

---

## Flashlights

---

---

### LED Flashlights

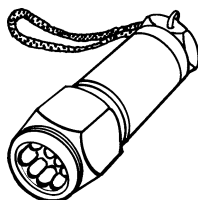

| Part # | Mfg #   | Description           | Price |
|--------|---------|-----------------------|-------|
| 136007 | R319350 | Pocket LED Lightstick |       |

Tools

## Flashlights

Tools

### **RAYOVAC**® Industrial Flashlights

- Yellow flashlight with ring hangers



| Part # | Mfg #   | Description | Price |
|--------|---------|-------------|-------|
| 052370 | F20-001 | (2) D Cell  |       |

### Batteries

#### Rayovac Heavy-Duty Alkaline Batteries



F20008



F20010



F20009



F20011



F20012

| Part # | Mfg #   | Description         | Price |
|--------|---------|---------------------|-------|
| 045080 | F20-008 | (8) AA Alkaline     |       |
| 052368 | F20-009 | (6) 9 Volt Alkaline |       |
| 052369 | F20-010 | (6) C Alkaline      |       |
| 045082 | F20-011 | (6) D Alkaline      |       |
| 045081 | F20-012 | (8) AAA Alkaline    |       |

**Flashlights**

Tools

**Flashlights**

**LED Mini Pocket Flashlight**

- 5mm Nichia white LED light
- 50,000 Hours of lamp life
- 9-Lumen tested light-output generates a strong concentrated beam
- Battery life: 130 hours
- Pushbutton on/off switch provides constant or momentary modes
- Polycarbonate body with o-ring sealed Xenoy® shroud
- Includes a breakaway lanyard and pocket clip
- Interchangeable clear, red and green colored discs



| Part # | Mfg # | Description        | Price |
|--------|-------|--------------------|-------|
| 120393 | X5    | (4) LR44 Batteries |       |



Sensible Products



Sensible Products

## Flashlights

### Flashlights

#### Extendable Magnetic Flashlight

- Magnet on grip and at light
- Telescopes from 6.5" to 21"
- Flexible shaft
- (3) Super-bright LEDS with on/off button



EMF-1

| Part # | Mfg # | Description               | Price |
|--------|-------|---------------------------|-------|
| 134816 | EMF-1 | LED Telescopic Flashlight |       |

#### Batteries

| Part # | Mfg # | Description             | Price |
|--------|-------|-------------------------|-------|
| 134817 | FB-1  | (4) Batteries for EMF-1 |       |

#### Magnetic Stick Light

- Pocket-sized floodlight
- Magnet in handle
- Molded clip keeps in pocket
- Rugged, water resistant
- (6) Super-bright LEDS
- 36 Lumen output
- Runs more than 10 hours



| Part # | Mfg # | Description          | Price |
|--------|-------|----------------------|-------|
| 145098 | MSL-1 | Magnetic Stick Light |       |

#### Pocket Area LED Light

- Ratcheting hinge angles light as needed
- Hanging hook swivels 360°
- Powerful magnet attaches securely to a horizontal or vertical surface
- (18) Super-bright LEDS
- Runs more than 6 hours
- Easy on/off - open/close

| Part # | Mfg # | Description       | Price |
|--------|-------|-------------------|-------|
| 145267 | PAL-1 | Pocket Area Light |       |

Tools

## Hammers

Tools

### Hammers

#### Smooth Face Framing Hammer

- Shockshield™ Handle
- Most Durable Grip Construction
- Magnetic Nail Set
- I-Beam Handle Construction
- Anti-Ring Claw
- Smooth Face
- Straight Claw



| Part # | Mfg #      | Description        | Price |
|--------|------------|--------------------|-------|
| 232892 | 48-22-9017 | 16-1/8"L x 5-3/4"W |       |
| 232894 | 48-22-9023 | 15"L x 6-1/8"W     |       |

#### Smooth Face Poly/Fiberglass Handle Hammer

- Most Durable Fiberglass Handle
- Magnetic Nail Set
- Asymmetrical Anti-Ring Claw
- Smooth Face
- Straight Claw



| Part # | Mfg #      | Description       | Price |
|--------|------------|-------------------|-------|
| 232895 | 48-22-9316 | 15-1/4"L x 5-5/8" |       |

#### Milled Face Framing Hammer

- Shockshield™ Handle
- Most Durable Grip Construction
- Magnetic Nail Set
- I-Beam Handle Construction
- Asymmetrical Anti-Ring Claw
- Milled Face
- Straight Claw



| Part # | Mfg #      | Description | Price |
|--------|------------|-------------|-------|
| 232893 | 48-22-9022 | 22oz        |       |
| 232891 | 48-22-9016 | 17oz        |       |



## Hammers

### Hammers

#### Sheet Metal Hammer - Riveting

- Polished finish



| Part # | Mfg # | Size   | Handle  | Head Weight | Price |
|--------|-------|--------|---------|-------------|-------|
| 006477 | RH4   | 4-7/8" | Leather | 12 oz       |       |

#### Sheet Metal Hammer - Setting

- Polished finish



| Part # | Mfg # | Size   | Handle  | Head Weight | Price |
|--------|-------|--------|---------|-------------|-------|
| 006482 | SH3   | 5-1/2" | Leather | 18 oz       |       |

**Hammers**

**Hammers**

**Hammer**



Ball Pein



Ripping Claw



Tools

| Part # | Mfg # | Model | Description  | Head Weight | Overall Length | Price |
|--------|-------|-------|--------------|-------------|----------------|-------|
| 008654 | 52455 | 016   | Ball Pein    | 16 oz       | 14"            |       |
| 008705 | 52485 | 216   | Ripping Claw | 16 oz       | 13-1/4"        |       |

## Hole Saws

### Hole Cutter Kits

#### Big Hawg® Hole Cutter Kit

- 50X Life in nail embedded wood & abrasive material applications
- 5X Faster cuts
- Thicker backer for extreme life in demanding applications
- Enlarged braze surface for stronger bond to the carbide teeth
- (3) Tooth design for fast aggressive cuts
- Cuts 1000+ more nails
- 10X Larger carbide teeth
- Carbide tipped multi-material pilot bit for increased material versatility
- Cuts wood, nails, shingles, cement board, plaster and more
- Includes:
  - 2-1/8" BIG HAWG™ with Carbide Teeth
  - (1) 2-9/16" BIG HAWG™ with Carbide Teeth
  - (1) 3-5/8" BIG HAWG™ with Carbide Teeth
  - (2) BIG HAWG™ with Carbide Teeth Pilot Bit (49-56-9300)
  - (1) BIG HAWG™ with Carbide Teeth Arbor (49-56-9305)
  - (1) BIG HAWG™ with Carbide Teeth Diamond File (48-09-5055)



| Part # | Mfg #      | Description | Price |
|--------|------------|-------------|-------|
| 249929 | 49-56-9280 | 7-Piece     |       |

#### Big Hawg® Hole Cutter Kit

- Includes:
  - (1) 2-1/8" BIG HAWG™ with Carbide Teeth
  - (1) 2-9/16" BIG HAWG™ with Carbide Teeth
  - (1) 3-5/8" BIG HAWG™ with Carbide Teeth
  - (1) 4-5/8" BIG HAWG™ with Carbide Teeth
  - (2) BIG HAWG™ with Carbide Teeth Pilot Bit (49-56-9300)
  - (1) BIG HAWG™ with Carbide Teeth Arbor (49-56-9305)
  - (1) BIG HAWG™ with Carbide Teeth Diamond File (48-09-5055)



| Part # | Mfg #      | Description | Price |
|--------|------------|-------------|-------|
| 248848 | 49-56-9285 | 8-Piece     |       |

### Big Hawg® Hole Cutter Kit

- Kit Includes:
  - (1) 2-1/8" BIG HAWG™ with Carbide Teeth
  - (1) 2-1/4" BIG HAWG™ with Carbide Teeth
  - (1) 2-9/16" BIG HAWG™ with Carbide Teeth
  - (1) 3" BIG HAWG™ with Carbide Teeth
  - (1) 3-5/8" BIG HAWG™ with Carbide Teeth
  - (1) 4-1/4" BIG HAWG™ with Carbide Teeth
  - (2) BIG HAWG™ with Carbide Teeth Pilot Bit (49-56-9300)
  - (1) BIG HAWG™ with Carbide Teeth Arbor (49-56-9305)
  - (1) BIG HAWG™ with Carbide Teeth Diamond File (48-09-5055)



| Part # | Mfg #      | Description | Price |
|--------|------------|-------------|-------|
| 249930 | 49-56-9290 | 10-Piece    |       |

### Hole Saw Kits

#### Ice Hardened™ Hole Saw Kit

- Ice Hardened™ for up to 50% longer life
- Includes:
  - (5) Hole saws: 3/4", 7/8", 1", 1-1/8", 1-1/2"
  - Twist-Release™ arbor with pilot bit: 49-56-7210
  - Additional pilot bit: 49-56-8010
  - 1/8" Hex Key
  - Adapter: 49-56-6560



| Part # | Mfg #      | Description | Price |
|--------|------------|-------------|-------|
| 150075 | 49-22-4005 | 8-Piece     |       |

#### Plumber's Ice Hardened™ Hole Saw Kit

- Includes:
  - (6) Hole saws: 3/4", 7/8", 1-1/8", 1-1/2", 1-3/4", 2-1/4"
  - (2) Arbors with pilot bits (49-56-7010 and 49-56-9100)
  - (2) Additional pilot bits (49-56-8010)
  - (1) Adapter (49-56-6560)
  - (1) Spacer (49-67-0120)



| Part # | Mfg #      | Description | Price |
|--------|------------|-------------|-------|
| 139022 | 49-22-4145 | 10-Piece    |       |

## Hole Saws

Tools

### 18-Piece Master Plumbers Ice Hardened™ Hole Saw Kit

- Cryogenically treated
- Optimized tooth form for up to 2 times faster cutting
- Wide, angled and offset slots
- Includes:
  - (13) Hole saws - 3/4", 7/8", 1-1/8", 1-3/8", 1-1/2", 1-3/4", 2-1/4", 2-5/8", 3", 3-1/2", 4", 4-1/4", and 4-1/2"
  - (2) Arbors with pilot bits (49-56-7010 and 49-56-9100)
  - (3) Additional pilot bits (49-56-6560)
  - (1) Spacer (49-67-0120)



| Part # | Mfg #      | Description | Price |
|--------|------------|-------------|-------|
| 139021 | 49-22-4155 | 18-Piece    |       |

### All Purpose Professional Hole Dozer™ Hole Saw Kit

- Rip Guard™, the strongest tooth form in the industry
- Rip Guard™ limited lifetime tooth break warranty
- Plug Jack™, an all access slot design for fast plug removal
- Bi-metal construction with 8% cobalt for increased wear resistance



49-22-4185

| Part # | Mfg #      | Description | Price |
|--------|------------|-------------|-------|
| 154644 | 49-22-4185 | 28-Piece    |       |
| 227494 | 49-22-4175 | 15-Piece    |       |
| 173237 | 49-22-4142 | 12-Piece    |       |

### 8 Pc Refrigeration Hole Dozer™ Hole Saw Kit

- Rip Guard™, strongest tooth form
- Rip Guard™ limited lifetime tooth break warranty
- Plug Jack™ all access slot design for fast plug removal
- Bi-metal construction with 8% cobalt for increased wear resistance



| Part # | Mfg #      | Description | Price |
|--------|------------|-------------|-------|
| 246026 | 49-22-4079 | 8-Piece     |       |

### Hole Cutters

#### Big Hawg® Hole Cutter with Carbide Teeth

- 5X Faster cuts
- 3 Tooth design for aggressive cuts
- Thicker backer for extreme life
- Enlarged braze surface for stronger bond to the carbide teeth
- Cuts 1000+ nails
- 10X Larger carbide teeth
- Cuts wood, nails, shingles, cement board, plaster and more



| Part # | Mfg #      | Diameter | Price |
|--------|------------|----------|-------|
| 249926 | 49-56-9200 | 1-3/8"   |       |
| 246974 | 49-56-9210 | 2-1/8"   |       |
| 249927 | 49-56-9215 | 2-1/4"   |       |
| 246976 | 49-56-9220 | 2-9/16"  |       |
| 246978 | 49-56-9230 | 3"       |       |
| 246979 | 49-56-9240 | 3-5/8"   |       |
| 246980 | 49-56-9255 | 4-1/4"   |       |
| 249861 | 49-56-9265 | 4-5/8"   |       |
| 249928 | 49-56-9270 | 5-1/4"   |       |
| 249862 | 49-56-9275 | 6-1/4"   |       |

### Hole Saws

#### Carbide Tipped Hole Saws

- Tungsten carbide tipped for long life
- Aggressive tooth form for fast cutting
- Wide, angled & offset slots for easy plug access



| Part # | Mfg #      | Description | Price |
|--------|------------|-------------|-------|
| 165184 | 49-56-0873 | 7/8"        |       |
| 165186 | 49-56-1123 | 1-1/8"      |       |
| 165189 | 49-56-1503 | 1-1/2"      |       |
| 141827 | 49-56-1873 | 1-7/8"      |       |
| 165196 | 49-56-2503 | 2-1/2"      |       |
| 165202 | 49-56-2623 | 2-5/8"      |       |
| 165205 | 49-56-3003 | 3"          |       |
| 165207 | 49-56-3503 | 3-1/2"      |       |
| 144973 | 49-56-3623 | 3-5/8"      |       |
| 154873 | 49-56-4003 | 4"          |       |

## Hole Saws

### Hold Dozer™ with Carbide Teeth



| Part # | Mfg #      | Hole Dia | Price |
|--------|------------|----------|-------|
| 165182 | 49-56-0623 | 5/8"     |       |
| 246983 | 49-56-0702 | 3/4"     |       |
| 246984 | 49-56-0704 | 7/8"     |       |
| 249969 | 49-56-0707 | 1"       |       |
| 246985 | 49-56-0708 | 1-1/8"   |       |
| 249970 | 49-56-0710 | 1-1/4"   |       |
| 249971 | 49-56-0712 | 1-3/8"   |       |
| 246986 | 49-56-0713 | 1-1/2"   |       |
| 165190 | 49-56-0720 | 1-5/8"   |       |
| 246987 | 49-56-0717 | 1-3/4"   |       |
| 249973 | 49-56-0720 | 2"       |       |
| 165193 | 49-56-2123 | 2-1/8"   |       |
| 246988 | 49-56-0724 | 2-1/4"   |       |
| 249975 | 49-56-0727 | 2-1/2"   |       |
| 246989 | 49-56-0729 | 2-5/8"   |       |
| 165203 | 49-56-2753 | 2-3/4"   |       |
| 165204 | 49-56-2873 | 2-7/8"   |       |
| 246990 | 49-56-0734 | 3"       |       |
| 165206 | 49-56-3253 | 3-1/4"   |       |
| 249976 | 49-56-0738 | 3-1/2"   |       |
| 249977 | 49-56-0739 | 3-5/8"   |       |
| 165208 | 49-56-3753 | 3-3/4"   |       |
| 249978 | 49-56-0742 | 4"       |       |
| 246991 | 49-56-0744 | 4-1/4"   |       |
| 249979 | 49-56-0746 | 4-1/2"   |       |
| 165210 | 49-56-5003 | 5"       |       |
| 165211 | 49-56-6003 | 6"       |       |

### Hole Dozer™ Hole Saw

- Rip Guard™, the strongest tooth form in the industry
- Plug Jack™, an all access slot design for fast plug removal
- Bi-metal construction for increased wear resistance



| Part # | Mfg #      | Description | Price |
|--------|------------|-------------|-------|
| 165164 | 49-56-0012 | 5/8"        |       |
| 152110 | 49-56-0023 | 3/4"        |       |
| 152111 | 49-56-0032 | 7/8"        |       |

### Hole Saws (Continued)

#### Hole Dozer™ Hole Saw

| Part # | Mfg #      | Description | Price |
|--------|------------|-------------|-------|
| 165165 | 49-56-0017 | 1 1/16"     |       |
| 152112 | 49-56-0043 | 1"          |       |
| 165166 | 49-56-0047 | 1-1/16"     |       |
| 152113 | 49-56-0052 | 1-1/8"      |       |
| 152114 | 49-56-0062 | 1-1/4"      |       |
| 152115 | 49-56-0072 | 1-3/8"      |       |
| 152116 | 49-56-0082 | 1-1/2"      |       |
| 165167 | 49-56-0092 | 1-5/8"      |       |
| 165178 | 49-56-0112 | 1-7/8"      |       |
| 152119 | 49-56-0132 | 2-1/4"      |       |
| 152117 | 49-56-0127 | 2-1/8"      |       |
| 163909 | 49-56-0142 | 2-3/8"      |       |
| 165168 | 49-56-0153 | 2-9/16"     |       |
| 153383 | 49-56-0163 | 2-3/4"      |       |
| 165170 | 49-56-0167 | 2-7/8"      |       |
| 165171 | 49-56-0177 | 3-18"       |       |
| 165172 | 49-56-0183 | 3-1/4"      |       |
| 165173 | 49-56-0203 | 3-3/4"      |       |
| 152120 | 49-56-0213 | 4"          |       |
| 165174 | 49-56-0217 | 4-1/8"      |       |
| 165175 | 49-56-0223 | 4-1/4"      |       |
| 165176 | 49-56-0237 | 4-3/4"      |       |
| 165177 | 49-56-0253 | 6"          |       |
| 219363 | 49-56-9656 | 6"          |       |

### Ice Hardened™ Hole Saw

- Ice Hardened™ for up to 50% longer life



| Part # | Mfg #      | Size   | Price |
|--------|------------|--------|-------|
| 143992 | 49-56-0102 | 1-3/4" |       |
| 144015 | 49-56-0117 | 2"     |       |
| 144016 | 49-56-0147 | 2-1/2" |       |
| 150074 | 49-56-0158 | 2-5/8" |       |
| 144017 | 49-56-0173 | 3"     |       |
| 148183 | 49-56-0193 | 3-1/2" |       |
| 144018 | 49-56-0197 | 3-5/8" |       |
| 144019 | 49-56-0233 | 4-1/2" |       |
| 142700 | 49-56-0243 | 5"     |       |

## Hole Saws

Tools

### Diamond Plus™ Hole Saw

- Diamond Plus™ greater durability and toughness delivers up to 10X longer life
- Higher grade diamonds and improved braze: Provides best-in class performance
- Large slug ejection slot
- Versatile: Ideal for cutting anchoring and clearance holes in all tile, stone and glass



| Part # | Mfg #      | Description | Price |
|--------|------------|-------------|-------|
| 173242 | 49-56-0505 | 1/4"        |       |
| 173243 | 49-56-0507 | 5/16"       |       |
| 233568 | 49-56-0509 | 3/8"        |       |
| 234018 | 49-56-0511 | 1/2"        |       |
| 173244 | 49-56-0515 | 3/4"        |       |
| 170733 | 49-56-0503 | 3/16"       |       |
| 173245 | 49-56-0426 | 1-3/8"      |       |

### Thin Wall Hole Saw

- 1/4" Quick change hex shank for use with impact drivers
- Thin wall 8 TPI design for 40% faster cuts than standard bi-metal hole saws
- Stop shoulder design prevents over drilling and damaging components
- Ejection spring automatically removes slugs



| Part # | Mfg #      | Description | Price |
|--------|------------|-------------|-------|
| 169268 | 49-56-9805 | 3/4"        |       |
| 169269 | 49-56-9810 | 7/8"        |       |
| 169270 | 49-56-9815 | 1"          |       |
| 169271 | 49-56-9820 | 1-1/8"      |       |
| 169272 | 49-56-9825 | 1-1/4"      |       |
| 169273 | 49-56-9830 | 1-3/8"      |       |
| 169274 | 49-56-9835 | 1-1/2"      |       |

### Adjustable Hole Cutter

- Quik-Lok™ Arbor
- 2" through 7" Diameters with 1/4" Increments
- Black Oxide Coated with Laser Etched Size Indicators
- Durable debris shield



| Part # | Mfg #      | Description      | Price |
|--------|------------|------------------|-------|
| 173825 | 49-56-0320 | Depth of cut: 1" |       |

### Arbors

#### Small Arbor

- Durable hardened steel construction



| Part # | Mfg #      | Size Range    | Shank Size | Price |
|--------|------------|---------------|------------|-------|
| 007021 | 49-56-7000 | Up to 1-3/16" | 7/16"      |       |
| 144976 | 49-56-7010 | Up to 1-3/16" | 3/8"       |       |

#### Big Hawg® Arbor

- Standard 5/8"-18 thread fits all hole saws or hole cutters 1-1/4" through 6-1/4"
- Includes:
  - (1) Flat boring pilot bit
  - (1) Big Hawg® Arbor
  - (1) 7/16" Quick change shank



| Part # | Mfg #      | Description     | Price |
|--------|------------|-----------------|-------|
| 137895 | 49-56-9105 | Big Hawg® Arbor |       |

#### Large Quick Change Arbor

- Tool-free operation
- Universal, quick change with all brands of hole saws
- No adapters required
- Hardened steel construction
- Fits all hole saws 1-1/4" and larger
- Fits all drill chucks 3/8" and larger



| Part # | Mfg #      | Size Range | Shank Size      | Price |
|--------|------------|------------|-----------------|-------|
| 144975 | 49-56-7250 | 1-1/4"+    | 3/8"            |       |
| 149219 | 49-56-9100 | 1-1/4"+    | 7/16" No Wobble |       |
| 007022 | 49-56-7055 | 1-1/4" +   | 7/16"           |       |

### Pilot Drill Bits

#### Big Hawg® Hole Cutter Pilot Bit

- Machined cutting edge for increased cutting speed
- Exclusive bit geometry aids plug removal



| Part # | Mfg #      | Description                | Price |
|--------|------------|----------------------------|-------|
| 137898 | 48-27-1401 | Big Hawg® Center Spade Bit |       |

## Hole Saws

### Big Hawg® with Carbide Teeth Pilot Bit

- 50X Life in nail embedded wood & abrasive material applications
- Cuts 1000+ more nails
- 5x Faster cuts
- 5/16" Multi material pilot bit
- Carbide tipped for fast drilling in nail embedded wood and abrasive materials
- Exclusive bit geometry aids in plug removal



| Part # | Mfg #      | Description          | Price |
|--------|------------|----------------------|-------|
| 246981 | 49-56-9300 | 5/16" Multi-Material |       |

### High Speed Steel Pilot Bit

- Thunderbolt® tapered web for added durability
- 135° split point provides accurate hole placement
- 3-Flat shank won't slip in arbor or chuck
- Parabolic flute clears chips faster
- 12/Pk



| Part # | Mfg #      | Size          | Price |
|--------|------------|---------------|-------|
| 007024 | 49-56-8000 | 1/4" x 4"     |       |
| 152121 | 49-56-8010 | 1/4" X 3-1/2" |       |

### Carbide Tipped Pilot Bit

- Tungsten carbide tipped for long life
- Fits all hole saw sizes



| Part # | Mfg #      | Size      | Price |
|--------|------------|-----------|-------|
| 007025 | 49-56-8005 | 1/4" x 4" |       |

### Hole Saw Accessories

#### Big Hawg® Arbor with Carbide Teeth

- Exclusive bit geometry aids in plug removal
- Cuts 1000+ more nails
- Carbide tipped for fast drilling in nail embedded wood and abrasive materials
- 50X Life in nail embedded wood and abrasive material applications
- 5X faster cuts



| Part # | Mfg #      | Description        | Price |
|--------|------------|--------------------|-------|
| 246982 | 49-56-9305 | 7/16" Quick Change |       |

### Universal Quik-Lok™ Extension

- Accepts all 7/16" shanks
- No tools required for bit change
- Impact rated



| Part # | Mfg #      | Size           | Price |
|--------|------------|----------------|-------|
| 144978 | 48-28-1000 | 3" x 1/4"      |       |
| 152998 | 48-28-1030 | 5-1/2" x 7/16" |       |
| 147701 | 48-28-1040 | 12" x 7/16"    |       |
| 170804 | 48-28-1050 | 18" x 7/16"    |       |

### Hex-Wrench Bit Extension

- Accepts all 7/16" hex shanks
- For selfeed bits, auger bits and hole saw 1" diameter and larger



| Part # | Mfg #      | Description   | Price |
|--------|------------|---------------|-------|
| 238663 | 48-28-4016 | 24" Length    |       |
| 006928 | 48-28-4006 | 12" Length    |       |
| 177316 | 48-28-4001 | 5-1/2" Length |       |

### Hex Extension

| Part # | Mfg #      | Description       | Price |
|--------|------------|-------------------|-------|
| 138372 | 48-28-1010 | 6" Hex Extension  |       |
| 138373 | 48-28-1020 | 12" Hex Extension |       |

### Right Angle Attachment

- Rated up to 235 in/lbs torque
- Accepts standard 1/4" hex shank bits



| Part # | Mfg #      | Description            | Price |
|--------|------------|------------------------|-------|
| 149497 | 49-22-8510 | Right Angle Attachment |       |

### Files

#### Big Hawg® Diamond File

- Easy re-sharpening on job site



| Part # | Mfg #      | Description            | Price |
|--------|------------|------------------------|-------|
| 137897 | 48-95-5055 | Big Hawg® Diamond File |       |

**HVAC Testing Tools**

Tools

**Motor Testers**

**TECMate Pro ECM Motor Tester**

- Analyze ECM motors independent of the HVAC system
- Operates in the basic HVAC settings of fan-only, heating, cooling and de-humidification
- Designed to detect and isolate motor failures from other HVAC system failures



| Part # | Mfg #    | Description              | Price |
|--------|----------|--------------------------|-------|
| 153548 | PD510009 | TECMate Pro Motor Tester |       |

**Test Connector**

| Part # | Mfg #       | Description    | Price |
|--------|-------------|----------------|-------|
| 031520 | 45-24318-01 | Test Connector |       |

**Circuit Protection Products**

**ZBreaker Circuit Breaker Set**



| Part # | Mfg # | Description | Price |
|--------|-------|-------------|-------|
| 141508 | ZK005 | 5 Amp       |       |

**Short-Pro Tool™**

- Finds 24 volt system shorts
- Automatically resets the breaker
- (2) 18" Leads



| Part # | Mfg # | Description  | Price |
|--------|-------|--------------|-------|
| 140758 | ZSPRT | Short-Finder |       |

**Safety Power Adapters**

**Zebra'Dapter Fused Power Tap Cord**

- Lighted to show voltage level of plug
- Safe way to obtain 120V power to vacuum pumps, charging scales, drop lights, etc.



| Part # | Mfg # | Description                    | Price |
|--------|-------|--------------------------------|-------|
| 140729 | ZD002 | 2' Lighted Female Cordset Blue |       |
| 140728 | ZD001 | 2' Lighted Male Cordset Yellow |       |

**Smoke Detector & Accessories**

**SL-2000 Duct Smoke Detector**

- Hi-Temp
- Low-Flow
- No Tools



**MEA**  
approved



| Part # | Mfg #     | Description       | Price |
|--------|-----------|-------------------|-------|
| 118470 | SL-2000-N | 4-Wire Ionization |       |

**Sampling Tube for SL-2000 & RT-3000 Series**



| Part # | Mfg #   | Description | Price |
|--------|---------|-------------|-------|
| 118471 | STN-2.5 | 12" to 3.0' |       |

**Meters**

**Thermo-Psychrometer**

- Large storage area for probes
- TM350 Includes:
  - (1) TMX2A 15' Air probe
  - (1) TMX2G 15' General purpose
  - (1) TMX2S 15' Surface probe



| Part # | Mfg #    | Description          | Price |
|--------|----------|----------------------|-------|
| 143080 | 87-TM350 | Four Remote Stations |       |



**HVAC Testing Tools**

**Probe for TM350 Thermo-Psychrometer**



TMX2S

| Part # | Mfg #    | Description | Price |
|--------|----------|-------------|-------|
| 143081 | 87-TMX2C | Clamp-On    |       |
| 143082 | 87-TMX2P | Puncture    |       |
| 143083 | 87-TMX2S | Surface     |       |

**Hardware**

**Alligator Clip**

| Part # | Mfg #  | Description                                  | Price |
|--------|--------|--|-------|
| 140494 | 455055 | 1" Black, 6/Pk                               |       |
| 140495 | 455056 | 1" Red, 6/Pk                                 |       |
| 140496 | 455057 | Alligator Clips with 18 AWG - 36" Test Leads |       |

**Test Lead**

| Part # | Mfg #  | Description               | Price |
|--------|--------|---------------------------|-------|
| 140609 | 455150 | 10 AWG, 36" with 10A Clip |       |

**Combustion Analyzer Kits**

**Testo Residential Combustion Analyzer Kit**

- Fast 30-second startup
- Sensor technology
- Integrated probe hose
- Use for:
  - Boiler tuning
  - Checking furnace efficiency
  - Water heater checks
- Measures:
  - Ambient CO
  - Undiluted CO (CO air free)
  - O<sub>2</sub>, CO (with built-in NO<sub>x</sub> filter), CO<sub>2</sub>
  - Draft & pressure temperature
  - Combustion/flue gas efficiency & excess air



| Part # | Mfg #    | # of Fuels | Price |
|--------|----------|------------|-------|
| 181036 | PD875492 | 5          |       |

Tools

## HVAC Testing Tools

Tools

### Voltage Detectors

#### Voltage Detector with LED

- Safety rating: CAT IV 1,000V
- Green power on indicator light
- Pocket clip
- Requires (2) AA batteries (included)



| Part # | Mfg #   | Voltage Range  | Price |
|--------|---------|----------------|-------|
| 137565 | 2202-20 | 50 to 1,000 AC |       |

#### Dual Range Voltage Detector

- Different colors identify voltage range
- Built-in LED work light
- Auto-off
- Pocket clip
- Blade-tip for checking outlets
- Constant power ON LED indicator



| Part # | Mfg #   | Voltage Range | Price |
|--------|---------|---------------|-------|
| 168492 | 2203-20 | 10-1,000 V    |       |

### Test & Measurement Tools

#### Fork Meter for HVAC/R

- Heavy-duty True-RMS electrical tester for professional residential, commercial and industrial applications
- High contrast white-on-black display
- Five tools in one:
  - Current measurement
  - Temperature measurement
  - Voltage measurement
  - Voltage detection
  - Task lighting - LED work light
- Includes:
  - Fork clamp
  - Test leads
  - Dual banana thermocouple
  - (2) AA Batteries
  - Manual
- 5-Year warranty



| Part # | Mfg #   | Description                | Price |
|--------|---------|----------------------------|-------|
| 137566 | 2206-20 | 8" Length, 200A Current AC |       |

### Tru RMS Digital Multimeter

- Wide voltage range to 600VAC/DC
- Auto range to millivolts
- True-RMS for accurate measurement in all applications
- Lo-Z measurement to eliminate ghost voltage
- Frequency measurements from 10Hz to 50kHz
- Contact temperature measurement: -40° to 752°F
- Current measurement to 10AAC/DC
- High contrast white on black display with back light
- Rugged over-molding increases durability and user grip
- 5-Year warranty
- Includes:
  - Multimeter
  - Test leads
  - Dual banana thermocouple
  - (2) AA Batteries
  - Manual



| Part # | Mfg #   | Description                    | Price |
|--------|---------|--------------------------------|-------|
| 136067 | 2217-20 | 6-1/2" L, 10.00A Current AC/DC |       |

#### Clamp Meter for HVAC/R

- Electrical current tester for professional residential, commercial and industrial applications
- 1.3" Jaw opening to easily handle large conductors
- White-on-black display
- LED Work light
- Includes:
  - Clamp
  - Test leads
  - Dual banana thermocouple
  - (2) AA Batteries
  - Manual
- 5-Year warranty



| Part # | Mfg #   | Description                    | Price |
|--------|---------|--------------------------------|-------|
| 137567 | 2236-20 | 9-1/2" Length, 600A Current AC |       |

## HVAC Testing Tools

### Detectors

#### Dust Smoke Detector

- Ionization



| Part # | Mfg #  | Description         | Price |
|--------|--------|---------------------|-------|
| 118470 | 849046 | Dust Smoke Detector |       |

#### Air Products Sampling Tube

- For SL-2000

| Part # | Mfg #  | Model # | Size      | Price |
|--------|--------|---------|-----------|-------|
| 118471 | 849051 | STN-2.5 | 2-1/2" ft |       |

### Meters & Testers

#### Vane Anemometer

- Air humidity meter with temperature measurement
- Integrated measurement with 1.5 in. vane
- Timed mean value calculation
- Hold function and max./min. values
- Wind chill calculation for outside areas (perceived temperature)
- Back lit display
- Air humidity measurement with long-term stable Testo humidity sensor
- Incl. dewpoint calculation and wet bulb
- Includes:
  - Integrated humidity measurement and NTC air thermometer
  - Protective cap for safe storage
  - Wrist strap and belt clip
  - (2) Type AAA batteries, 60 hour life
  - Calibration certificate



| Part # | Mfg #  | Description  | Price |
|--------|--------|--|-------|
| 143078 | 875043 | Vane Anemometer with Integrated Humidity & NTC Air Thermometer |       |

#### Carbon Monoxide Stick Meter

- Detects presence of carbon monoxide in ambient air from gas furnaces, water heaters, and other appliances or equipment
- Visual and audio warnings, adjustable alarm threshold
- No zero phase, instrument can be used immediately
- CO Zeroing on-site
- Self test function



| Part # | Mfg #  | Description  | Price |
|--------|--------|--|-------|
| 143084 | 875036 | Includes Leather Holster w/Belt Strap, Earphone, Wrist Strap |       |

#### Humidity and Temperature Meter

- Long-term, stable Testo humidity sensor
- +/-2.5 %RH Accuracy
- Hold function and max/min values
- Includes:
  - Protective cap for safe storage
  - Batteries
  - Calibration certificate



| Part # | Mfg #  | Description               | Price |
|--------|--------|---------------------------|-------|
| 143079 | 875042 | Dewpoint & Wet Bulb Meter |       |

#### Electrical

| Part # | Mfg #    | Description | Price |
|--------|----------|-------------|-------|
| 141560 | 86-22510 | Test Leads  |       |

**HVAC Testing Tools**

Tools

**Clamp-On Digital Multimeters**

**DL389 G2 Phoenix Pro+ Clamp-On Multimeter**

- Dual display and low battery display lock
- Test lead storage and holder on clamp head
- Auto off
- Input jack lock
- Detachable clamp head
- Worklight
- Magnetic mount
- User temperature calibration
- EasyView high contrast backlight display
- Compatible with common industry accessories heads
- Safety compliance CAT III 600V, CAT II 1000V
- Includes:
  - Test leads
  - K-Type probe (no adapter required)
  - Zippered case
  - (2) AAA Batteries
- 3-Year limited warranty



| Part # | Mfg # | Description                                       | Price |
|--------|-------|---|-------|
| 128764 | DL389 | 12 Functions Including TRUE-RMS (AC Volts & Amps) |       |

**Thermometers**

**550B Digital Pocket Thermometer**

- Water resistant
- Records minimum & maximum temperatures
- Protective boot
- Magnetic mount
- HOLD freezes the current temp reading
- Auto power off
- Ergonomic designed head
- 3-Year limited warranty



| Part # | Mfg # | Description         | Price |
|--------|-------|---------------------|-------|
| 069651 | 550B  | -58° to 572°F Range |       |

**Digital Thermometer**

- Waterproof
- Built-in magnetic mount
- Records minimum & maximum temperatures
- Data hold
- Auto power off
- Easy access battery compartment
- Enhanced accuracy of digital circuitry
- Includes battery & multipurpose probe
- -58° to 572°F Range
- 3-Year limited warranty

PDT550



PDT650



| Part # | Mfg #  | Description  | Price |
|--------|--------|--------------|-------|
| 082376 | PDT550 | Pen Type     |       |
| 153228 | PDT650 | Folding Type |       |

**CO Detectors**

**CO71 "The CO Detective" Carbon Monoxide Monitor**

- Tri-color LED indicates concentrations at 3 levels complying with residential and work place standards
- Audible alert triggers at 35 ppm indicating the threshold of dangerous concentration
- Backlight display
- Operating temperature: 32° to 104°F
- MAX Continually updates to provide recall of highest CO reading
- Auto zero activates upon turn on
- 9V Battery operated
- 3-Year limited warranty



| Part # | Mfg # | Description                                   | Price |
|--------|-------|---|-------|
| 051760 | CO71  | Displays 0 to 999 ppm CO Level in Ambient Air |       |

**Leak Detectors**

**CD100A Combustible Gas Leak Detector**

- Long 18" gooseneck for hard to reach areas
- Tip light in sensor cap illuminates search area
- Probe cage protects sensor
- Audio and visual tic rate fully adjustable
- Headphone jack
- Includes:
  - Sensor and cap
  - 9V Battery
- 1-Year limited warranty



| Part # | Mfg #  | Description              | Price |
|--------|--------|--------------------------|-------|
| 038331 | CD100A | 50 ppm Minimum Detection |       |

**HVAC Testing Tools**

**Manometers**

**EM151 Digital Electronic Manometer**

- Single input measurement to ±20" wg
- Integral protective boot w/magnet
- Simple two-button operation
- Measures in inches water gauge and Mbar
- Automatic after 5 minutes of inactivity and manual power-off
- Includes:
  - (1) Pressure tubes with brass fitting connector
  - (1) Std 9V battery
  - Manual
- 1-Year limited warranty



| Part # | Mfg # | Description                       | Price |
|--------|-------|-----------------------------------|-------|
| 126553 | EM151 | Single Input Electronic Manometer |       |

**SSM1 Super Heat/Sub Cool Meter**

- Measures:
  - Pressure from 0 - 500 psia
  - Temperature from -40° to 400°F
- Calculates:
  - Superheat for low side
  - Subcool for high side (TXV systems)
- Refrigerants included for calculations: R-22, R-134a, R-404A, and R-410A
- 1-Year limited warranty



| Part # | Mfg # | Description               | Price |
|--------|-------|---------------------------|-------|
| 133479 | SSM1  | Super Heat/Sub Cool Meter |       |

**Static Pressure Kit**

- Dynamic Min/Max value capture
- Data hold
- Backlit display
- Ruggedized, including rubber boot with integral magnet
- Auto power off
- 3-Year limited warranty



| Part # | Mfg #      | Description                                       | Price |
|--------|------------|---|-------|
| 161833 | EM201SPKIT | Dual input differential measurement to +/-60 InWC |       |

**Electrical Testers**

**PET1 Pocket Electrical Tester**

The PET1 features:

- Worklight
- Non-contact AC voltage test from 12-600VAC (with adjustable sensitivity)
- Detects high and low AC voltage
- Continuity check: 0-80 megohms
- Audible/visual indicators
- 3-Year limited warranty



| Part # | Mfg # | Description         | Price |
|--------|-------|---------------------|-------|
| 083035 | PET1  | Volt Tester w/Light |       |

**Probes**

**ATL5 Modular Test Lead Tip**

- Back probe



| Part # | Mfg # | Description           | Price |
|--------|-------|-----------------------|-------|
| 237035 | ATL-5 | Modular Test Lead Tip |       |

Tools

**HVAC Testing Tools**

Tools

**Electrical Testers**

**Non-Contact Voltage Tester**

- High intensity, bright green LED indicator when on
- High intensity, bright red LED indicator when voltage is detected
- Package contains insert card with integrated owner's manual and (2) AAA 1.5V batteries



| Part # | Mfg #  | Description  | Price |
|--------|--------|--------------|-------|
| 125141 | NCVT-1 | 50 - 1000VAC |       |

**Dual Range Non-Contact Voltage Tester**

- Automatically detects and indicates:
  - Low voltage (12-48VAC)
  - Standard voltage (48-1000VAC)
- High intensity, bright green LED indicates the tester is operational and aids in illuminating the workspace
- Digitally controlled ON/OFF power button
- Auto power-off feature conserves and extends battery life
- Microprocessor controlled low-battery indicator
- CAT IV 1000V Rating
- Lightweight, durable polycarbonate plastic resin construction; convenient pocket clip



| Part # | Mfg #  | Description | Price |
|--------|--------|-------------|-------|
| 137459 | NCVT-2 | 50 - 500Hz  |       |

**Clamp Meters**

**CL200 Professional Series Clamp Meter**

- Worklights illuminate dark work spaces
- Backlit display
- Data hold captures measurements in any situation
- Diode and continuity tests
- Includes test leads, batteries, case and thermocouple
- Measures temperature, frequency and capacitance
- 8.2"H x 3"W x 1.4"D



| Part # | Mfg # | Description                    | Price |
|--------|-------|--------------------------------|-------|
| 140679 | CL200 | 1" Jaw, 600A AC w/Thermocouple |       |

## HVAC Testing Tools

### Meters

#### TurboMeter™

| Part # | Mfg #  | Description        | Price |
|--------|--------|--------------------|-------|
| 106684 | 439103 | Air Velocity Meter |       |

#### Differential Pressure Meter

- Includes protective cap, batteries and calibration certificate
- Display in Pascal optional over entire measurement range
- Temperature compensation
- Magnetic back permits free-hand work
- Accuracy:  $\pm 0.01$  "H<sub>2</sub>O (0 to 0.12 "H<sub>2</sub>O) /  $\pm 0.02$  "H<sub>2</sub>O (0.13 to 0.4 "H<sub>2</sub>O)
- Flow velocity measurement with Pilot tube (Pilot tube not included in delivery)
- Air density compensation
- Includes:
  - Protective cap for safe storage
  - (2) Type AAA Batteries, 50 hour life
  - Including wrist strap and belt clip



| Part # | Mfg #  | Description                         | Price |
|--------|--------|-------------------------------------|-------|
| 142784 | 875044 | Digital Differential Pressure Meter |       |

#### Smartphone Static Pressure Meter

- Automatically imports local weather data based on GPS location
- Easily emails professional, detailed reports
- Rugged, weather resistant housing with hands-free magnetic holder



| Part # | Mfg #   | Description                   | Price |
|--------|---------|-------------------------------|-------|
| 180508 | SPM-100 | Dual Port Manometer Accessory |       |

Tools

## HVAC Testing Tools

Tools

### Meters

#### Economy Auto-Ranging Clamp-On Meter

- Reads volts, amps and ohms
- Data hold and continuity buzzer
- CAT II
- Includes carrying case



| Part # | Mfg #    | Description                 | Price |
|--------|----------|-----------------------------|-------|
| 111388 | MA-600CF | Temp Range: -38° to 1,750°F |       |

#### Oil & Glycol Refractometer



| Part # | Mfg #      | Description                 | Price |
|--------|------------|-----------------------------|-------|
| 111392 | MA-REF401F | Glycol Fahrenheit Refractor |       |

#### Torsion Mounting Bracket

- 5.5"

| Part # | Mfg #   | Description            | Price |
|--------|---------|------------------------|-------|
| 197937 | MA-FM55 | Mounting Bracket Motor |       |



## HVAC Testing Tools

### Meters & Testers

#### Digital Psychrometer

- Data hold
- Auto power off
- °F/°C switchable
- Power: 2 AAA batteries
- Dimensions: 7" x 1-7/8" x 1"
- Operating temperature range: 4° to 122°F
- Response time of 60 seconds to changes in humidity
- Display relative humidity & temperature simultaneously



| Part # | Mfg # | Description          | Price |
|--------|-------|----------------------|-------|
| 182260 | 69008 | Digital Psychrometer |       |

#### Gas Pressure Test Kit

- Helps to accurately set manifold pressure natural or L.P. gas
- Two gauge ranges available
- single bellows on brass plate design
- Sensitive diaphragm gauge calibrated in inches of water column and ounces per square inch
- Tube nipple for easy connection to system manifold



| Part # | Mfg # | Description           | Price |
|--------|-------|-----------------------|-------|
| 182330 | 78060 | Gas Pressure Test Kit |       |

### Manometers

#### Dual Port Manometer

- Auto power-off
- 9V Battery required
- Single button operation
- Measures gas pressure, static pressure, & pressure differential
- Measures pressure between -19.95 and 19.95inWC (inches of water column)
- Includes a easy to use zero function
- Designed for HVACR field service technicians
- Measures pressure drop directly across two points such as filter pressure drop or flow volumes
- Positive and negative pressures can be read directly if measured on the appropriate input
- Kit includes: 30" tubing, clear hose, tube splice and 1/8" NPT brass fitting.



| Part # | Mfg # | Description         | Price |
|--------|-------|---------------------|-------|
| 240354 | 78052 | Dual Port Manometer |       |

### Water-Type Manometer

- Plastic tubing with fitting
- Set manifold pressure for natural gas or L.P. gas
- Strong magnet holds manometer in upright position



| Part # | Mfg # | Description                | Price |
|--------|-------|----------------------------|-------|
| 182335 | 78075 | 0-15" Water-Type Manometer |       |

### Detectors

#### AccuProbe™ UV Leak Detector

- Low battery indicator
- True mechanical pump
- 17" Probe length
- Instantaneous response time
- Power: 4 AA alkaline batteries
- SmartAlarm™ leak size indicator
- 3 selectable sensitivity level settings
- Long life, stable electrolyte sensor
- Humidity: 0 to 95% RH non-condensing
- Operating temperature range: 24° to 125°F
- Automatic calibration and reset to environment
- Clears in 12 seconds or less after exposure to a 1.75 oz (50 g)/year leak
- Sensitivity: HFC – 0.06 oz.(1.7 g)/year; HCFC – 0.03 oz.(0.9 g)/year; HFO – 0.15 oz. (4.3 g)/year



| Part # | Mfg # | Description             | Price |
|--------|-------|-------------------------|-------|
| 182305 | 69336 | AccuProbe Leak Detector |       |

#### AccuProbe™ II Leak Detector

- Low battery indicator
- True mechanical pump
- 17" Probe length
- Instantaneous response time
- Power: 4 AA alkaline batteries
- SmartAlarm™ leak size indicator
- 3 selectable sensitivity level settings
- Long life, stable electrolyte sensor
- Humidity: 0 to 95% RH non-condensing
- Operating temperature range: 24° to 125°F
- Automatic calibration and reset to environment
- Clears in 12 seconds or less after exposure to a 1.75 oz (50 g)/year leak
- Sensitivity: HFC – 0.06 oz.(1.7 g)/year; HCFC – 0.03 oz.(0.9 g)/year; HFO – 0.15 oz. (4.3 g)/year



| Part # | Mfg # | Description                | Price |
|--------|-------|----------------------------|-------|
| 182306 | 69354 | AccuProbe II Leak Detector |       |

---



---

## HVAC Testing Tools

---



---

Tools

### Combustible Gas Detector

- Probe length: 17"
- Sensor life: 500 hours
- Automatic calibration
- 25 second warm up time
- Instantaneous response time
- Power battery: 4 AA alkaline batteries
- Operating temperature range: 32° to 110°F
- Sensitivity: 5 ppm methane or better 2 ppm propane



| Part # | Mfg # | Description              | Price |
|--------|-------|--------------------------|-------|
| 182308 | 69373 | Combustible Gas Detector |       |

### Parts & Accessories

| Part # | Mfg # | Description                           | Price |
|--------|-------|---------------------------------------|-------|
| 182311 | 69384 | AccuProbe Replacement Sensor & Filter |       |
| 182312 | 69385 | AccuProbe Sensor Filters-5Pk          |       |
| 182331 | 78062 | Hose w/ Nipple for 78055/60           |       |
| 182332 | 78064 | Brass Barb Ftg For 78055/60           |       |
| 182333 | 78065 | Rubber Nipple for 78055/60            |       |

## Knives & Replacement Blades

### Utility Knives and Knife Blades

#### Quick Open Utility Knife

- Retractable blade
- Integrated hinge



| Part # | Mfg # | Description | Price |
|--------|-------|-------------|-------|
| 048168 | 9PK   | 3-Position  |       |

#### Top Button Action Utility Knife

- Safe, easy to operate thumb action mechanism on top



| Part # | Mfg # | Description | Price |
|--------|-------|-------------|-------|
| 006528 | 4PK   | 3-Position  |       |

## Knives & Replacement Blades

Tools

### Utility Knives

#### Fastback Compact Flip Utility Knife

- Press and flip opening
- Compact size
- Quick blade change
- Belt clip
- Lanyard hole



| Part # | Mfg #      | Length | Price |
|--------|------------|--------|-------|
| 188651 | 48-22-1906 | 6.2"   |       |

#### Sliding Utility Knife

- Side slide activated blade
- Rubber over mold hand grip
- On board blade storage
- Tool-free blade change
- Integrated gut hook and wire stripper



| Part # | Mfg #      | Length | Price |
|--------|------------|--------|-------|
| 137585 | 48-22-1910 | 7-1/4" |       |

#### 18mm Snap Off Knife

- Durable lock- up to 2x longer life
- Speed thread- 2x faster blade adjustment
- Microcarbide blade- up to 2x longer blade life
- Acetone resistant
- 8 Point blade



| Part # | Mfg #      | Length | Price |
|--------|------------|--------|-------|
| 163299 | 48-22-1964 | 6"     |       |

#### Fastback™ Utility Knife

- One-handed blade opening
- Tool-free blade change
- Wire stripper
- Integrated gut hook
- Thin body design



| Part # | Mfg #      | Length | Price |
|--------|------------|--------|-------|
| 137584 | 48-22-1901 | 7-1/4" |       |
| 225380 | 48-22-1903 | 6-3/4" |       |

### HARDLINE™ Smooth Blade Pocket Knife

- Drop point smooth blade
- Flipper with bearing system
- Opening steel frame lock
- Glass filled nylon handle with stainless steel back
- Stone washed black oxide finish
- Reversible tip up belt clip
- Lanyard hole



| Part # | Mfg #      | Length | Price |
|--------|------------|--------|-------|
| 243683 | 48-22-1928 | 10.3"  |       |
| 222817 | 48-22-1994 | 6.9"   |       |
| 222819 | 48-22-1999 | 8.2"   |       |

### Multi-Purpose Knives

#### FASTBACK™ Smooth Folding Pocket Knife

- Press and flip operation: Permits one-handed opening
- Stainless steel drop-point blade: resharpenable edge for long lasting use
- Liner lock
- Slim, compact body: stores easily yet withstands job site abuse
- Piercing tip: allows controlled piercing and smooth cutting
- Lanyard hole
- Reversible wire-form belt clip



| Part # | Mfg #      | Length | Price |
|--------|------------|--------|-------|
| 163301 | 48-22-1990 | 7-3/4" |       |

#### FASTBACK™ Spring Assisted Serrated Knife

- Spring-assisted opening: Permits one-handed operation
- Black oxide-coated stainless steel serrated blade: Maintains long-lasting sharp edge
- Liner lock
- Serrated blade: Ideal for tearing through material, Tanto tip: Ideal for piercing material
- Slim, compact body: Stores easily yet withstands job site abuse
- Reversible wire-form belt clip



| Part # | Mfg #      | Length | Price |
|--------|------------|--------|-------|
| 162813 | 48-22-1995 | 8-1/4" |       |

## Knives & Replacement Blades

### FASTBACK™ Hawk Bill Folding Knife

- Press-and-flip operation: permits one handed opening
- Stainless steel curved blade
- Liner lock
- Slim, compact body
- Piercing tip: allows controlled piercing and smooth cutting
- Lanyard hole
- Reversible wire-form belt clip



| Part # | Mfg #      | Length | Price |
|--------|------------|--------|-------|
| 170008 | 48-22-1985 | 7-1/4" |       |

### FASTBACK™ Spring Assisted Knife

- Spring Assisted Open for fast one-handed opening
- Black Oxide Stainless Steel Blade
- Liner Lock
- Reversible Wire Form Belt Clip



| Part # | Mfg #      | Length              | Price |
|--------|------------|---------------------|-------|
| 180512 | 48-22-1996 | Realtree Xtra® Camo |       |

### Tradesman Fixed Blade Knife

- Stays sharper longer
- Full tang
- 4" Drop point blade
- 9-1/2" Overall length
- Lanyard hole
- Stainless steel blade



| Part # | Mfg #      | Description | Price |
|--------|------------|-------------|-------|
| 240552 | 48-22-1926 | 9-1/2"      |       |

### HARDLINE™ Pocket Knife

- Drop Point Smooth Blade
- Flipper with Bearing System
- Opening Steel Frame Lock
- Glass Filled Nylon Handle with SS Back
- Stone Washed Black Oxide Finish
- Reversible Tip Up Belt Clip
- Lanyard Hole



| Part # | Mfg #      | Description        | Price |
|--------|------------|--------------------|-------|
| 222816 | 48-22-1997 | 2.5", Smooth Blade |       |
| 222818 | 48-22-1998 | 3", Serrated Blade |       |

### Duct Knife

- Stainless steel blade
- Full tang for tough cuts
- Double edged blade
- Durable sheath with belt clip
- Lanyard hole



| Part # | Mfg #      | Description     | Price |
|--------|------------|-----------------|-------|
| 181527 | 48-22-1920 | Includes Sheath |       |

### Insulation Knife

- Stainless steel blade
- Full tang for tough cuts
- Rounded handle for smoothing applications
- Durable blade cover for storage
- Lanyard hole



| Part # | Mfg #      | Description    | Price |
|--------|------------|----------------|-------|
| 181528 | 48-22-1921 | Smooth Blade   |       |
| 181529 | 48-22-1922 | Serrated Blade |       |

### Replacement Blades

#### 50 PC General Purpose Utility Blades w/ Dispenser

- Micro carbide deposited metal delivers up to 3X longer life than standard carbon blades
- Precision grind process removes the burr from cutting edge for cleaner cuts
- Optimized grind angles deliver improved sharpness for less repeat cuts
- Made in the USA



| Part # | Mfg #      | Description                                       | Price |
|--------|------------|---|-------|
| 163303 | 48-22-1950 | 50 PC General Purpose Utility Blades w/ Dispenser |       |

#### General Purpose Utility Blades

- Micro carbide dispersed metal
- Precision grind process removes the burr from cutting edge for cleaner cuts
- Optimized grind angles deliver improved sharpness for less repeat cuts



| Part # | Mfg #      | Description       | Price |
|--------|------------|-------------------|-------|
| 233562 | 48-22-1905 | 5 Pc              |       |
| 219300 | 48-22-1934 | 5 Pc, Round Point |       |

**Knives & Replacement Blades**

**Putty Knives**



| Part # | Mfg #   | Size   | Price |
|--------|---------|--------|-------|
| 096245 | K50-015 | 1-1/4" |       |

Tools

## Knives & Replacement Blades

### Knives

#### Lightweight Lockback Knife - Drop-Point Blade with Pocket/Belt Clip

- Blade is AUS8 stainless hardened to 58-59 Rc
- Anodized aluminum finish on handle is silver with stainless steel blade or black with black-chrome blade
- Reversible thumb stud



| Part # | Mfg #     | Blade Length | Color | Price |
|--------|-----------|--------------|-------|-------|
| 117588 | 44001-BLK | 2-1/2"       | Black |       |

### Utility Knives

#### Utility Blades

- Heavy-duty razor edged reversible



| Part # | Mfg # | Description | Price |
|--------|-------|-------------|-------|
| 125646 | 44101 | (5) Blades  |       |

#### Double-Locking Folding Utility Knife

- Blade locks in both open and closed position
- Pocket/belt clip



| Part # | Mfg # | Closed Length | Overall Length | Price |
|--------|-------|---------------|----------------|-------|
| 125645 | 44108 | 3"            | 6-1/8"         |       |

### Pocket Knives

#### 2-Blade Lockback Pocket Knife - Drop Point & Screwdriver Tip Blades

- Anodized aluminum handle
- Thumb stud
- Includes removable pocket/belt clip

| Part # | Mfg # | Description     | Price |
|--------|-------|-----------------|-------|
| 117581 | 44008 | Stainless Steel |       |

Tools



## Knives & Replacement Blades

### Utility Knives and Blades

#### #82 Safety Nose Retractable Blade Knife

| Part # | Mfg # | Description    | Price |
|--------|-------|----------------|-------|
| 036760 | 38205 | Heavy-Duty Red |       |

Tools



**Levels**

**Levels**  
**Torpedo Level**

- Ideal for general use and work in tight places
- Three vials for plumb, level and 45° miter
- Full length strong magnetic edge
- V-Grooved edge for pipe and conduit work
- Large top read level vial



| Part # | Mfg # | Model | Description         | Price |
|--------|-------|-------|---------------------|-------|
| 051918 | 20233 | 395   | 9" Nightshade Level |       |

## Levels

### Empire Levels

#### TRUE BLUE® Magnetic DUAL-PITCH™ Torpedo Level

- Powerful rare earth magnets provide superior holding strength
- All aluminum frame with top read window
- V-Groove working edge for accurate alignment on pipe or conduit
- Ruler Groove compatible with most straight edges for extended measuring and marking
- Surface grip surrounds level vial for increased stability



| Part # | Mfg #   | Size | Price |
|--------|---------|------|-------|
| 232260 | EM75.10 | 10"  |       |

#### TRUE BLUE® Magnetic Billet Torpedo Level

- Powerful rare earth magnets provide superior holding strength
- High contrast e-BAND™ vials highlight the edge of the bubble
- VARI-PITCH™ vial reads slope at 1/8", 1/4", 3/8", or 1/2" per foot of horizontal run
- V-Groove working edge for accurate alignment on pipe or conduit
- Top read window provides clear overhead viewing
- Laser etched ruled edge allows for quick measurements on working material
- Tapered design for easy in and out of pocket
- Billet aluminum frame for superior durability



| Part # | Mfg #  | Size | Price |
|--------|--------|------|-------|
| 187324 | EM71.8 | 8"   |       |

#### Magnetic Torpedo Level

- High contrast e-BAND™ vials highlight the edge of the bubble
- High contrast vial surrounds improve vial visibility
- 3 vials - plumb, level and 45°
- V-Groove working edge for accurate alignment on pipe or conduit
- Aluminum frame with top read window
- Strong magnetic edge



| Part # | Mfg #   | Size | Price |
|--------|---------|------|-------|
| 218536 | EM81.9  | 9"   |       |
| 218537 | EM81.12 | 12"  |       |
| 173520 | EM81.24 | 24"  |       |
| 174326 | EM81.48 | 48"  |       |

#### TRUE BLUE® ULTRAVIEW™ LED Magnetic Box Level

- Surface grippers
- e-BAND™ vials made in the USA
- 2 minute auto shut-off or press and hold to turn off
- Hang hole for ease of storage
- Limited lifetime warranty on frame and vials. 1 year warranty on electronics
- 2 (AA) batteries included



| Part # | Mfg #   | Size | Price |
|--------|---------|------|-------|
| 224519 | EM95.24 | 24"  |       |
| 237855 | EM95.10 | 10"  |       |

### Levels

#### Die Cast Torpedo Level w/ 360° Locking Vial



| Part # | Mfg #      | Size | Price |
|--------|------------|------|-------|
| 240706 | 48-22-5210 | 10"  |       |

#### Compact Billet Torpedo Level

- Amplified rare earth magnets
- Maximized viewing area



| Part # | Mfg #      | Size           | Price |
|--------|------------|----------------|-------|
| 226658 | 48-22-5107 | Billet Torpedo |       |

#### Torpedo Level Starter Kit

- Includes: (1) 24" Milwaukee Box
- Tough, water resistant nylon
- All metal hardware
- Durable zipper closure
- Two Integrated carrying or hanging handles
- Integrated external tool loops for additional tool storage
- Two debris vent to prevent dust, dirt and/or water build up



| Part # | Mfg #   | Size                               | Price |
|--------|---------|------------------------------------|-------|
| 243836 | MLBXC48 | Includes Bag, 48" Level, 24" Level |       |

## Levels

### 24" / 48" REDSTICK™ Box Level Set



- ALL-METAL BACKBONE™
- SHARPSITE™ Vial Technology
- High Density, Removable End-Caps protect frame and provide access in tight spaces
- Wide, durable handles for comfort and portability
- Precision milled measuring surface guarantees accuracy in all working positions
- Overmolded, Non-Slip Grips stick to the wall and prevent sliding
- Durable, All-Metal Hang Hole for storage

| Part # | Mfg #   | Size      | Price |
|--------|---------|-----------|-------|
| 234217 | MLBXS48 | 24" & 48" |       |

### 48" REDSTICK™ Box Level



- ALL-METAL BACKBONE™
- SHARPSITE™ Vial technology
- Guaranteed lifetime accuracy: accurate to .029°
- High contrast vial system is easy to clean and optimizes visibility
- High density, removable end-caps protect frame and provide access in tight spaces
- Wide, durable handles for comfort and portability

| Part # | Mfg #   | Size                 | Price |
|--------|---------|----------------------|-------|
| 245215 | MLBX48  | 48"                  |       |
| 245217 | MLCM48  | 48" Compact          |       |
| 245218 | MLCMM48 | 48" Magnetic Compact |       |

Tools

---



---

## Levels

---

### Levels

#### Torpedo Level

- Aluminum construction
- Professional quality



| Part # | Mfg #   | Description                   | Price |
|--------|---------|-------------------------------|-------|
| 110080 | J40-100 | 7-1/2" Length, Magnetic Sides |       |

Tools

---

---

## Levels

---

---

### Levels Pocket Level



- Strong molded plastic frame with pocket clip
- Multi view vial reads top, bottom or side
- Ideal for leveling thermostats

| Part # | Mfg # | Length | # of Vials | Price |
|--------|-------|--------|------------|-------|
| 006443 | L5    | 5"     | 1          |       |

---

---

**Levels**

---

---

**Levels**



| Part # | Mfg #   | Description | Price |
|--------|---------|-------------|-------|
| 008910 | R148700 | ML-24       |       |

Tools

## Levels

### Torpedo Levels

#### Aluminum Level

- Lightweight, precision made
- Acrylic plastic yellow vials



| Part # | Mfg # | Description           | Price |
|--------|-------|-----------------------|-------|
| 110504 | 930-9 | 9" Level, Plumb & 45° |       |

#### Heavy-Duty Level with Magnet

- Allows hands-free measurements on iron or steel surfaces
- Features Rare Earth magnets and vial frames with E-Z-See™ glow-in-the-dark-material



| Part # | Mfg #   | Description           | Price |
|--------|---------|-----------------------|-------|
| 111224 | 931-9RE | 9" Level, Plumb & 45° |       |

#### Torpedo Level

- Large, high visibility vials are easy-to-read
- Rare Earth magnet
- Vials set for measurements at 0°, 30°, 45° and 90°
- Machined billet aluminum design
- High contrast laser etched markings



| Part # | Mfg #   | Description                 | Price |
|--------|---------|-----------------------------|-------|
| 125146 | 932-9RE | 9" Level, Plumb, 30°, & 45° |       |

Tools

**Miscellaneous Tools**

Tools

**Maxstraps**

**The Original 1" Polypropylene Cam Tiedown**

- Ideal for lumber, pipe, ladders, and outdoor gear
- Weather and sunlight resistant
- 750 lb Test
- Rustproof cam buckle
- Easy thumb release



| Part # | Mfg # | Description | Price |
|--------|-------|-------------|-------|
| 053091 | 00216 | 2' Black    |       |
| 053093 | 00411 | 4' Red      |       |
| 053094 | 00612 | 6' Yellow   |       |
| 053095 | 00813 | 8' Green    |       |
| 053096 | 01014 | 10' Blue    |       |



**Miscellaneous Tools**

**Utility Strap**

**Rubber Tie Down Strap**

- Stretches to double it length
- Extra heavy steel S-hooks on each end



| Part # | Mfg #  | Description      | Price |
|--------|--------|------------------|-------|
| 002270 | 540-31 | 31" Rubber Strap |       |

**Strapping Hanger Iron**

- Galvanized 3/4in. vent strapping, hanger iron, plumber's tape, pipe hanger tape and many other uses
- 1/4in. centers for bolts or nails.



| Part # | Mfg #      | Description | Price |
|--------|------------|-------------|-------|
| 194311 | 710-A16100 | 3/4" x 100' |       |

**Hanging Strap**

- Strong, versatile, easy way to secure loose gear safely. Tie down ladders, tubing, cylinders or almost anything in seconds.
- Cannot snap back. Strong, durable 1 in. polypropylene webbing.
- Reinforced grommet lets you hang it up, tie it up, hook it up or attach it permanently.
- Spring loaded adjustable buckle. Easy to get firm tension with no slipping.
- Make an endless length by connecting 2 or more together.



| Part # | Mfg # | Description | Price |
|--------|-------|-------------|-------|
| 046209 | HS-30 | 30"         |       |
| 049072 | HS-60 | 60"         |       |

**Ratchet Strap**

- Easy ratcheting permits tie-down of appliances securely.
- An innovative latch and a fast release cam reduces socket wear.
- Cadmium-plated steel buckle has a positive lock that eliminates release due to vibration.
- When closed, the handle locks the latch into the sprocket to prevent inadvertent release. 16 foot nylon webbing rated at 3000 PSI tensile.
- Vinyl coated end hooks rated at 1200 PSI tensile.



| Part # | Mfg #  | Description | Price |
|--------|--------|-------------|-------|
| 192407 | HS-192 | 16 ft       |       |

**Woven Polypropylene Duct Strap**

- Webbed duct strap processing high tensile and abrasion resistance.
- This can be used for flex duct as it is easy to cut and staple to joists.
- The product is chemical resistant and tested to meet UL Standard 2043.



| Part # | Mfg #   | Description        | Price |
|--------|---------|--------------------|-------|
| 192065 | 710-100 | 1-3/4" x 100 Yards |       |
| 137962 | 710-102 | 3" x 100 Yards     |       |

**Metallic Duct Strap**

- Galvanized duct strap in a convenient cardboard dispenser is not only easy to drill or nail, but also solid strapping.
- Plenum rated.



| Part # | Mfg #   | Description            | Price |
|--------|---------|------------------------|-------|
| 192070 | 710-001 | 26 Gauge, 1" x 100'    |       |
| 194518 | 710-003 | 30 Gauge 1-1/2" x 100' |       |

**Miscellaneous Tools**

**Fin Whisk**

- Plastic handled whisk for cleaning condenser and evaporator fins



| Part # | Mfg # | Description     | Price |
|--------|-------|-----------------|-------|
| 141528 | B-26  | Fin Whisk Brush |       |

Tools

## Miscellaneous Tools

Tools

### Chip Brush

- 100% pure bristle
- Wood handle
- Poly sleeve over bristles
- Use once and throw away



| Part # | Mfg # | Description       | Price |
|--------|-------|-------------------|-------|
| 195230 | B-504 | 2-1/2" Chip Brush |       |

### SuperComb

- Easier to grip, easier to use tool for straightening condenser and evaporator fins.
- Straightens 50% more fins in one stroke.
- Keeps hands a safe distance from fins.
- Easy to grip, strong, durable, heavy duty nylon.
- Color coded for easy identification.
- 6 per set.



| Part # | Mfg # | Description | Price |
|--------|-------|-------------|-------|
| 143979 | T-400 | 6 Pack      |       |

### Multi-Head Fin-Tool

- Conveniently straightens and cleans condenser and evaporator fins.
- Each nylon head slides into the master handle and tightens in place.
- Heads are designed to fit units with fin spacing of 4–24 fins per inch.
- Each head is engraved with its own size and is color coded for fast identification.
- Heads are angled so that when inserted in the handle, the hand is a safe distance from the sharp fins.
- Heads may also be reversed in the handle so that combing with an upward stroke (recommended method) may be done easily with proper leverage.
- The master handle rests comfortably in a man-size grip, is rigid and long lasting.



| Part # | Mfg # | Description       | Price |
|--------|-------|-------------------|-------|
| 192409 | T-100 | 6 Heads, 1 Handle |       |

## Miscellaneous Tools

### Telescoping Tools

#### Telescopic Inspection Mirror

- American made
- Double ball joint links swivel mirrors for viewing to 360°



| Part # | Mfg # | Description                    | Price |
|--------|-------|--------------------------------|-------|
| 192406 | M-2   | 2-1/4" Circular Extends 10-14" |       |
| 002322 | M-5   | 1" x 2" Oval Extends 8-1/2"    |       |

### Refrigeration Tools

#### Nitrogen Purge Tool

- Adjustable dial
- Quickly switch between braze, purge or off
- Accurately regulates flow and volume for purging or brazing



| Part # | Mfg # | Description     | Price |
|--------|-------|-----------------|-------|
| 234800 | DP-1  | Adjustable Dial |       |

#### Access Fittings

- May be installed in any position on either high or low side for charging, purging, quick testing, or pressure checking



| Part # | Mfg #  | Description              | Price |
|--------|--------|--------------------------|-------|
| 192402 | VC-4   | Flare Cap, 1/4" SAE Male |       |
| 193548 | VVC-1  | Valve Core               |       |
| 195766 | VST-44 | Swivel Tee               |       |
| 195768 | VTS-68 | Solder Tee 3/8"          |       |
| 195769 | VTS-12 | Solder Tee 3/4"          |       |
| 206641 | VS-4   | Swivel Female Nut        |       |

#### Extended Copper Tube

- For refrigeration servicing
- May be installed in any position
- 1/4" SAE male flare access ports
- Includes
  - Quick seal cap
  - Stainless and brass special refrigerant valve core



| Part # | Mfg # | Description                     | Price |
|--------|-------|---------------------------------|-------|
| 192416 | VAX-2 | Extended Copper Tube, 1/8"O     |       |
| 192415 | VAX-3 | 3/16" O.D. x 1/8" I.D.          |       |
| 224361 | VAX-4 | Ext Copper Tube, 1/4"ODx3/16"ID |       |

### Cop Cap™ Locking Valve Cover

- Includes 2 caps, 1 wrench



| Part # | Mfg # | Description         | Price |
|--------|-------|---------------------|-------|
| 204182 | VVC-4 | 2 Caps and 1 Wrench |       |

### Copper Saddle Valve

- For copper-to-copper brazing.
- Penetrates line in one easy operation with no holes to drill.
- Steel pin with valve core pierces line and is locked into valve body by tightening cap.
- Teflon ring assures positive seal.
- Available in sizes from 1/4in. to 1-1/8in..



| Part # | Mfg # | Description                      | Price |
|--------|-------|----------------------------------|-------|
| 192413 | VLC10 | 5/8in. O.D. Tube Size, Pack of 3 |       |
| 192414 | VLC12 | 3/4in. O.D. Tube Size, Pack of 2 |       |
| 194230 | VLC-6 | 3/8in. O.D. Tube Size, Pack of 6 |       |
| 196482 | VLC-8 | 1/2in. O.D. Tube Size, Pack of 4 |       |
| 196181 | VLC-4 | 1/4in. O.D. Tube Size, Pack of 6 |       |

### Core Storer

- All steel valve core remover and storage container.
- Completely knurled for easier grip, eliminating slippage when using with oily or greasy hands.
- Core Storer features a compartment for storing extra valve cores.
- Four replacement cores are included with each tool.



| Part # | Mfg # | Description            | Price |
|--------|-------|------------------------|-------|
| 192398 | VCR-1 | Core Remover and Store |       |

## Miscellaneous Tools

Tools

### Staple Guns

#### T-50 Series Staples

- Used extensively by building contractors, home do-it-yourselfers and specialty trade applications for tacking insulation, ceiling tile, window screening, cornerite, and 1001 other jobs ranging from light to heavy duty work.
- The T-50 Outward Clinch Staple Gun is ideal for fiberglass ductwork.



| Part # | Mfg #   | Description                       | Price |
|--------|---------|-----------------------------------|-------|
| 196495 | 540-509 | 9/16" Staples for T50 Staple Guns |       |

### Miscellaneous

#### Surge Trap® STXH Series

- TPMOV® technology
- 1/2"-14 threaded hub
- LED status indicator
- Frequency: 50-60 Hz
- Pre-wired 18" 10AWG
- -40°C to +85°C Temperature
- Volts: 120/240VAC split phase
- Surge capacity: 50kA
- Nominal discharge current rating: 20kA
- Short-circuit current rating: 200kA
- Includes sealing locking washer
- Compact footprint designed to mate with AC disconnect switches
- 3 Modes of protection (L-N, L-L)
- Fits 1/2" knockouts with 18" leads
- NEMA 4X enclosure for outdoor or indoor use
- For use in ANSI/UL Type 1 or 2 SPD installations



| Part # | Mfg #     | Description            | Price |
|--------|-----------|------------------------|-------|
| 245751 | STXH240S0 | 120/240VAC Split Phase |       |
|        | 5         |                        |       |

**Miscellaneous Tools**

**Tools**

**Pro-Set® Inspection Mirror**



| Part # | Mfg #     | Description                                 | Price |
|--------|-----------|---|-------|
| 098914 | 87-TLMIR3 | 3.5" x 2.12" Rectangular Telescoping Mirror |       |

**Batteries**

**Batteries - Alkaline**

- Batteries all alkaline
- Attractive retail-type packaging



| Part # | Mfg #    | Description | Price |
|--------|----------|-------------|-------|
| 180520 | BV900243 | AA - 18 PK  |       |
| 180522 | BV900244 | AAA - 18 PK |       |
| 180521 | BV900245 | 9V - 4PK    |       |
| 180523 | BV900269 | C - 2PK     |       |

Tools

## Miscellaneous Tools

Tools

### Flue and Boiler Tube Brushes

#### Fine-Wire Single Spiral Brush

- For small boilers, burners, nozzles and fans
- 3" Brush lengths

| Part # | Mfg # | Description                             | Price |
|--------|-------|---|-------|
| 007444 | 01216 | 3/4" Dia, 24" OAL 4" Loop, Carbon Steel |       |

### Tool Cases

#### Stackable Utility Case

- Tough, durable, double-lock catch, 12" x 6" x 6"
- Lifetime guarantee

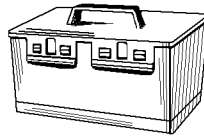

| Part # | Mfg # | Description       | Price |
|--------|-------|-------------------|-------|
| 007462 | 75600 | Tote Box - Carton |       |

### Lock 'N Load Heavy-Duty Drybox

- Locks out moisture as well as dirt and grime
- (3) Compartments store and organize tools and accessories
- Easy access top compartment is ideal for small tools and parts
- Dimensions: 15" x 8" x 10"



| Part # | Mfg # | Description                 | Price |
|--------|-------|-----------------------------|-------|
| 061933 | 75605 | Lock 'N Load Drybox, Carton |       |

### Tube Cleaning Brushes

#### #6200 Series Power Tube Cleaning Brush

- Use for solder or brazed fittings
- Carded 1/4" hex-shank tube cleaning brushes
- Point-of-purchase display

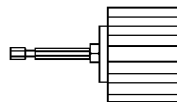

| Part # | Mfg # | Description | Price |
|--------|-------|-------------|-------|
| 007454 | 62350 | 1/2" Bagged |       |
| 007455 | 62370 | 3/4" Bagged |       |

### Toilet Bolts



| Part # | Mfg # | Description    | Price |
|--------|-------|----------------|-------|
| 169958 | 73065 | 5/16" x 2-1/4" |       |
| 235895 | 73070 | 5/16" x 3-1/2" |       |



---

---

## Miscellaneous Tools

---

---

### Chemicals Insecticide

| Part # | Mfg #   | Description               | Price |
|--------|---------|---------------------------|-------|
| 140752 | 85-200  | Bee/Wasp Spray            |       |
| 189900 | 4292-75 | Nu-Kill II Aerosol - 14oz |       |

Tools

---

---

**Miscellaneous Tools**

---

---

Tools

**Cases & Carriers**

**Nipple Box**

- Holds 1/2" CL through 6" nipples
- Fold away handle
- Epoxy coated steel

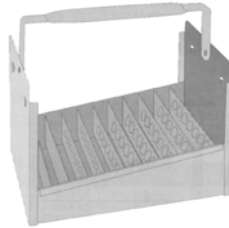

| Part # | Mfg # | Size | Holds | Price |
|--------|-------|------|-------|-------|
| 013210 | 3080  | 1/2" | 77    |       |



**Miscellaneous Tools**

**Nipple Boxes**

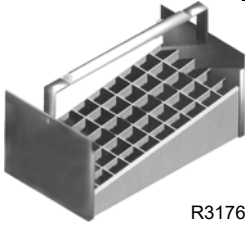

R317600

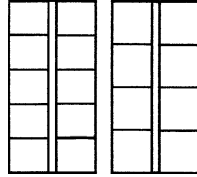

R318410

| Part # | Mfg #   | Description             | Price |
|--------|---------|-------------------------|-------|
| 014776 | R317600 | E-51-R 3/4"             |       |
| 080438 | R318410 | Galvanized Fitting Tray |       |

**Plumb Bob Red Bucket**

| Part # | Mfg #          | Description             | Price |
|--------|----------------|-------------------------|-------|
| 226028 | PLUMBBOBBUCKET | 5 Gallon Bucket         |       |
| 226029 | PLUMBBOBLID    | Lid for 5 Gallon Bucket |       |

Tools

## Miscellaneous Tools

Tools

### Nipple Caddies

#### Steel Nipple Caddy Tray

- Steel construction
- Push away handles
- Baked epoxy finish
- Nipple storage range (close - 6")



| Part # | Mfg #   | Description | Capacity | Price |
|--------|---------|-------------|----------|-------|
| 109306 | N70-050 | 1/2" Nipple | 77-Pc    |       |
| 109307 | N70-075 | 3/4" Nipple | 66-Pc    |       |
| 109308 | N70-016 | 1" Nipple   | 50-Pc    |       |

### Internal Pipe Nipple & Screw Extractors

#### Internal Pipe Nipple Extractors

- Heat treated and cad plated

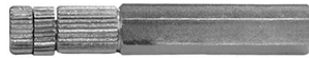

| Part # | Mfg #   | Size | Price |
|--------|---------|------|-------|
| 056472 | J40-050 | 3/8" |       |
| 041956 | J40-051 | 1/2" |       |
| 041957 | J40-052 | 3/4" |       |

#### Nipple and Screw Extractor

- Left hand spiral
- Removes nipples, bolts, and screws w/o thread damage
- Sizes:
  - J41104: 1/4" Pipe , 19/64" Drill , 3/8"-5/8" Bolt
  - J41106: 1/2" Pipe , 17/32" Drill , 7/8"-1-1/8" Bolt
  - J41107: 3/4" Pipe , 13/16" Drill , 1-1/8"-5/8" Bolt
  - J41108: 1" Pipe , 1-1/16" Drill , 1-3/8" - 2" Bolt



| Part # | Mfg #  | Description | Price |
|--------|--------|-------------|-------|
| 186259 | J41104 | 1/4" Pipe   |       |
| 186926 | J41106 | 1/2" Pipe   |       |
| 186927 | J41107 | 3/4" Pipe   |       |
| 186929 | J41108 | 1" Pipe     |       |

### PlumbBest Handi-Plug

- Combination test plug and stub-out for drop eared elbow
- No thread seal required
- Re-usable - long lasting
- Time and labor savings
- Smooth at thread end for easy plastering



| Part # | Mfg #   | Description         | Price |
|--------|---------|---------------------|-------|
| 073271 | H54-050 | 1/2" MIP Handi-Plug |       |

### Packing

#### Graphite Packing

- Non-asbestos material in resalable spools



| Part # | Mfg #   | Description               | Price |
|--------|---------|---------------------------|-------|
| 045477 | T60-005 | 1/8" Diameter x 12' Spool |       |

### Utility Pry Bar



| Part # | Mfg #   | Description         | Price |
|--------|---------|---------------------|-------|
| 041929 | S49-489 | 13" Utility Pry Bar |       |

### Probing Rod

#### Steel Probing Rod

- Welded steel construction
- Stainless steel replaceable tip



| Part # | Mfg #   | Description          | Price |
|--------|---------|----------------------|-------|
| 043178 | P27-004 | 4' Steel Probing Rod |       |

### Caulk Guns

#### Drop-In Half-Barrel Type Caulk Gun

- Painted steel



| Part # | Mfg #   | Description         | Price |
|--------|---------|---------------------|-------|
| 021059 | C35-090 | 9" Barrel Caulk Gun |       |

### Caulking Tools

#### Inside Caulking Tool

- For finishing lead joint



| Part # | Mfg #   | Size        | Price |
|--------|---------|-------------|-------|
| 053532 | J41-009 | 5/8"W x 7"L |       |

## Miscellaneous Tools

### Outside Caulking Tool

- For finishing lead joint



| Part # | Mfg #   | Size        | Price |
|--------|---------|-------------|-------|
| 053533 | J41-010 | 5/8"W x 7"L |       |

### Caution Tape

- Black print on safety yellow
- 3 mil Thickness



| Part # | Mfg #   | Size      | Price |
|--------|---------|-----------|-------|
| 041971 | J43-300 | 3" x 300' |       |

### Knee Pads

#### Heavy Duty Foam Economy Knee Pads

- Lightweight and water-resistant
- Comfortable while kneeling, standing or walking
- Won't pinch or bind behind knee
- Soft, breathable inner lining for coolness and comfort
- Velcro closures on straps



| Part # | Mfg #  | Description | Price |
|--------|--------|-------------|-------|
| 224085 | K01120 | 1 Per Pack  |       |

### Shop Towels

#### Wypall® Teri® Towel

- Strong and durable, wet or dry
- Reusable
- Equivalent to 18 lbs of rags
- Reinforced HYDROKNIT® provides extra scrubbing power



| Part # | Mfg #   | Description          | Price |
|--------|---------|----------------------|-------|
| 107287 | B05-003 | (125) Sheets per Box |       |

### Box of Rags

- Colored cotton sweatshirt material
- 100% Recycled
- Pull-out dispensing



| Part # | Mfg #   | Description      | Price |
|--------|---------|------------------|-------|
| 041975 | B05-001 | 5 lb Box of Rags |       |

### Heavy Duty Big Wipes

- 80 Count
- 8" x 12" wipes
- Removes paint, glue, oil, sealants, grease, and grime
- Dermatologically tested, plus Vitamin E and Aloe Vera added
- Dual sided, scrubs and cleans



| Part # | Mfg #  | Description | Price |
|--------|--------|-------------|-------|
| 186715 | B05050 | 80 Count    |       |

### Trash Bags

- 2'8"x 4'2"
- 20 bags per box
- 42 gal
- 3 mil



| Part # | Mfg #  | Description          | Price |
|--------|--------|----------------------|-------|
| 181931 | G02042 | 42 Gallon Trash Bags |       |

### Marking Paints

- Inverted tip
- Water base formula
- Fast-drying and non-clogging
- Color-coded paint:
  - White for general purposes
  - Red for electric and fire protection systems
  - Blue for water and irrigation
  - Orange for telephone, telegraph and cable TV systems



| Part # | Mfg #   | Color  | Price |
|--------|---------|--------|-------|
| 043622 | J40-380 | White  |       |
| 041973 | J40-381 | Yellow |       |
| 041974 | J40-382 | Red    |       |
| 043621 | J40-383 | Blue   |       |
| 095800 | J40-385 | Orange |       |

### Sponges and Brushes

#### Commercial Grade Cellulose Sponge

- 8" x 4-1/2" x 3/4"
- Deeply textures
- Made in USA



| Part # | Mfg #   | Description               | Price |
|--------|---------|---------------------------|-------|
| 093645 | S50-002 | Large, 8" x 4-1/2" x 3/4" |       |

## Miscellaneous Tools

### Bucket Caddies



T60-102

| Part # | Mfg #   | Description                                  | Price |
|--------|---------|--|-------|
| 084476 | T60-102 | 5 Gallon Bucket, (1) Large & (4) Small Trays |       |
| 126414 | T60-105 | Lid for 5 Gal Bucket                         |       |
| 129190 | T60-106 | 5 Gallon Bucket                              |       |
| 229436 | T60-111 | 5 Gallon Bucket, (3) Large Trays             |       |

### Washers

#### Assorted Flat Washer Kit

- Contains:
  - 40-00, 40-0, 40-1/4, 30-1/4 large,
  - 20-3/8 & 20-3/8 medium,
  - 10-3/8 large & 10-1/2 large
- Available with flat or beveled washers



| Part # | Mfg #   | Description | Price |
|--------|---------|-------------|-------|
| 118020 | J40-151 | 210 Pieces  |       |

**Miscellaneous Tools**

**Tool Holders**

**Tape Measure Holder - Powerline™ Series**

- Holds most tape measures with belt clips
- Rust-resistant metal clip riveted for strength
- Tunnel belt connection up to 2-1/4" belt width
- 1000 Denier DuPont Cordura® nylon
- Washable

**PowerLine™ Series**



| Part # | Mfg # | Overall Size    | Price |
|--------|-------|-----------------|-------|
| 110786 | 5707  | 4-1/8" x 3-3/4" |       |

**Zipper Canvas Bag**

- Constructed of No. 8 canvas



| Part # | Mfg # | Description   | Price |
|--------|-------|---|-------|
| 107648 | 5140  | Set of 4, 7" x 12-1/2", Olive, Orange, Royal Blue, and Yellow |       |

**Tool Bags**

**Tool Organizer**

- Constructed of double-layered 600 x 300 denier polyester
- Water-resistant
- Interior pockets include:
  - (3) Tool sleeves
  - (1) Power tool/cord sleeve
  - (6) Universal pockets
- Exterior pockets include:
  - (9) Screwdriver/nut driver pockets
  - (11) Plier pockets
  - (11) Utility pockets
  - (2) Wire stripper pockets
  - (2) Velcro® closable pockets
- Heavy-duty webbing keeps pockets open for easy access to supplies and tools
- Tools are sold separately



| Part # | Mfg # | Description               | Price |
|--------|-------|---------------------------|-------|
| 106843 | 5777  | Tool Organizer 45 Pockets |       |

Tools

## Miscellaneous Tools

Tools

### Radios/Speakers

#### M18™/M12™ Wireless Jobsite Speaker

- AC adapter
- Impact resistant roll cage
- Stream high definition music from over 100ft.



| Part # | Mfg #   | Description | Price |
|--------|---------|-------------|-------|
| 229138 | 2891-20 | 12V and 18V |       |

#### M18™ Jobsite Radio

- Customizable EQ
- 2.1A USB charger
- 10 station presets
- 3.5mm Aux In Port
- Powered by all M18™ Batteries or A/C outlet —(battery not included)
- Weather sealed auxiliary compartment
- Up to 12hrs run time with an M18™ 5.0Ah battery



| Part # | Mfg #   | Description         | Price |
|--------|---------|---------------------|-------|
| 185219 | 2890-20 | M18™ Job Site Radio |       |

#### M18™ Job site Radio/Charger

- Built-in charger
- Digital Bluetooth® receiver
- USB power port
- 40-watt amplifier
- Customizable equalizer
- 10-station preset
- Reinforced roll cage and metal handles
- Weather-sealed compartment
- On-board bottle opener
- Includes:
  - (1) M18™ Job site radio/charger (2792-20)
  - (1) 16" Auxiliary input cord
  - (2) AAA batteries



| Part # | Mfg #   | Description                 | Price |
|--------|---------|-----------------------------|-------|
| 163377 | 2792-20 | M18™ Job Site Radio/Charger |       |

#### M12™ Job site Radio

- Digital reception with signal processor
- 1/8" Stereo jack auxiliary input



| Part # | Mfg #   | Description | Price |
|--------|---------|-------------|-------|
| 139355 | 2590-20 | Bare Tool   |       |

#### M12™ Wireless Jobsite Radio

- Bluetooth® Connectivity with portable electronic devices up to 30ft away
- Premium Speaker with integrated Bass Port delivers loud, clear sound at all volumes
- Jobsite Durability
- 2.1A USB Charger electronic devices
- 3.5mm Aux In Port for wired playback (cable not included)
- Integrated Loop for easy hanging and transport



| Part # | Mfg #   | Description | Price |
|--------|---------|-------------|-------|
| 172937 | 2592-20 | Bare Tool   |       |
| 181843 | 2592-21 | Kit         |       |

### Carrying Cases and Bags

#### Zipper Pouch

- Hang loop
- Rugged metal zipper
- Heavy duty No. 10 canvas
- Water resistant stand-up base



| Part # | Mfg #      | Description  | Price |
|--------|------------|--------------|-------|
| 170552 | 48-22-8180 | Zipper Pouch |       |

#### 3 PK Zipper Pouches

- Hang loop
- Rugged metal zipper
- Water resistant stand-up base
- Heavy duty No. 10 canvas



| Part # | Mfg #      | Description         | Price |
|--------|------------|---------------------|-------|
| 170554 | 48-22-8193 | 3 Pk Zipper Pouches |       |

#### Meter Case

- Rugged nylon
- Three sided zipper closure
- One inside pocket, one compartment
- Strong nylon strap with snap closure
- The following Milwaukee meters fit this case:
  - 2205-20 Fork meter
  - 2206-20 Fork meter for HVAC/R
  - 2216-20 Digital multimeter
  - 2217-20 Digital multimeter
  - 2235-20 400amp clamp meter
  - 2265-20 Laser temp-gun
  - 2266-20 Laser temp-gun



| Part # | Mfg #      | Description | Price |
|--------|------------|-------------|-------|
| 164509 | 48-55-0175 | Meter Case  |       |

## Miscellaneous Tools

### Carrying Cases and Bags (Continued)

#### Meter Case

| Part # | Mfg #      | Description      | Price |
|--------|------------|------------------|-------|
| 164510 | 48-55-0180 | Large Meter Case |       |

#### Job Site Organizer

- Mountable bins
- Full access when stacked
- 20% More capacity
- Weather seal
- No-travel bins seals



| Part # | Mfg #      | Size           | Price |
|--------|------------|----------------|-------|
| 176587 | 48-22-8030 | 14" x 18" x 5" |       |

#### Jobsite Cooler

- 2X the insulation
- Food grade leak proof liner
- 1680D ballistic material
- Holds ice for 24 hours
- Heavy duty metal zippers
- Padded shoulder strap
- Tape measure clip w/ bottle opener
- Tech Pocket for storing tablets and electronic devices
- Dry storage compartment
- No sweat exterior
- 3 Total pockets inside and 5 pockets outside
- Holds 21.65 liquid quarts



| Part # | Mfg #      | Description                | Price |
|--------|------------|----------------------------|-------|
| 239938 | 48-22-8250 | 11.1"L x 13.77"W x 14.96"H |       |

#### Organizer Bag



| Part # | Mfg #      | Use with:                  | Price |
|--------|------------|----------------------------|-------|
| 145691 | 49-17-0110 | Contractor Parts Organizer |       |

### Job Site Backpack

- 35 Pockets for organizing tools
- Bulk pocket
- Impact resistant molded base
- 1680 Ballistic material
- Load-bearing harness
- 15.6" Laptop sleeve
- Attachment strap



| Part # | Mfg #      | Description       | Price |
|--------|------------|-------------------|-------|
| 170551 | 48-22-8200 | Job Site Backpack |       |

### Ultimate Jobsite Backpack

- 48 Pockets, 2 external
- 1680D Ballistic material
- Impact resistant base
- Sternum strap
- Tape measure clip
- Rugged metal zippers
- Attachment strap for dolly's
- Loaded-bearing harness
- Hardshell protected electronic & equipment pockets



| Part # | Mfg #      | Description                | Price |
|--------|------------|----------------------------|-------|
| 238907 | 48-22-8201 | Ultimate Job Site Backpack |       |

### Low-Profile Job Site Backpack

- 22 Pockets, 4 external
- 1680D Ballistic material
- Reinforced base
- Sternum strap
- Tape measure clip
- Rugged metal zippers
- Attachment strap for dolly's
- Padded electronics sleeve



| Part # | Mfg #      | Description                  | Price |
|--------|------------|------------------------------|-------|
| 238908 | 48-22-8202 | Low-Profile Jobsite Backpack |       |

### Jobsite Tech Bag

- Impact resistant molded base
- 1680D ballistic material construction
- Integrated rain fly
- Protected tech pocket
- 53 Total pockets



| Part # | Mfg #      | Description      | Price |
|--------|------------|------------------|-------|
| 188643 | 48-22-8210 | Tech Jobsite Bag |       |

## Miscellaneous Tools

Tools

### Contractor Bag

- Tough, water resistant 600 denier material
- Shoulder strap or dual handle straps for easy carrying
- Durable zipper closure
- Ideal for tool and accessory storage



| Part # | Mfg #      | Description            | Price |
|--------|------------|------------------------|-------|
| 140379 | 48-55-3500 | 20-1/2"L x 9"W x 8"H   |       |
| 140378 | 48-55-3510 | 18"L x 11"W x 10"H     |       |
| 225575 | 48-55-3490 | 17"L x 9"W x 10"H      |       |
| 140377 | 48-55-3530 | 26-1/2"L x 13"W x 14"H |       |

### Contractor Work Belt w/ Suspension Rig

- 24 Pockets
- 1680D Nylon construction
- Riveted seams
- All metal hardware
- Integrated carry handles
- Puncture resistant pocket
- Padded work belt- Fits 30" to 53" waists



| Part # | Mfg #      | Description              | Price |
|--------|------------|--------------------------|-------|
| 170550 | 48-22-8120 | Includes Suspension Ring |       |

### Electricians Work Pouch w/ Quick Adjust Belt

- 15 Pockets
- 1680D Nylon construction
- Riveted seams
- All metal hardware
- Integrated carry handle
- Stable base
- Puncture resistant pocket
- Tape measure clip
- Belt slot- fits up to a 3" work belt
- Quick adjust belt



| Part # | Mfg #      | Description                   | Price |
|--------|------------|-------------------------------|-------|
| 170548 | 48-22-8100 | Work Pouch w/ Adjustable Belt |       |

### Electricians Work Belt

- 29 Pockets
- 1680D nylon construction
- Riveted seams
- All metal hardware
- Integrated carry handles
- Stable base
- Puncture resistant pocket
- Tape measure clip
- Belt slot- Fits up to a 3" work belt



| Part # | Mfg #      | Description            | Price |
|--------|------------|------------------------|-------|
| 170549 | 48-22-8110 | Electricians Work Belt |       |

### Packout™ Tote

- All metal hardware
- Padded shoulder strap
- Durable overmolded handle
- Impact resistant molded base
- 1680 Ballistic material construction
- Part of the PACKOUT™ modular storage system



| Part # | Mfg #      | Tote Size | Pockets | Price |
|--------|------------|-----------|---------|-------|
| 237607 | 48-22-8310 | 10"       | 28      |       |
| 237606 | 48-22-8315 | 15"       | 31      |       |
| 237605 | 48-22-8320 | 20"       | 32      |       |

### Parachute Organizer Bag

- Stand up, stay open design
- Stackable
- Reinforced water resistant base
- External zipper pocket storage



| Part # | Mfg #      | Tote Size         | Pockets | Price |
|--------|------------|-------------------|---------|-------|
| 221399 | 48-22-8170 | 11.81"L x 11.02"H |         |       |

### Bucket-Less Tool Organizer

- Padded handles
- 50 total pockets
- Heavy-duty water resistant 600 Denier Ripstop Polyester Material
- Internal hammer loop keeps hammer easily accessible



| Part # | Mfg #      | Tote Size  | Pockets | Price |
|--------|------------|------------|---------|-------|
| 138843 | 49-17-0180 | 50 Pockets |         |       |



## Miscellaneous Tools

### Bucket Organizer Bag

- Open Bucket Design - Allows full access and use of the interior of the bucket
- 2 Exterior Zipper Pockets
- 1680D Ballistic Material Construction
- 32 Exterior Pockets



| Part # | Mfg #      | Tote Size                  | Pockets | Price |
|--------|------------|----------------------------|---------|-------|
| 221400 | 48-22-8175 | 10.04"L x 2.17"W x 13.39"H |         |       |

### 18" Jobsite Rolling Bag

- 6" All-Terrain Metal Rim Wheels
- Industry's Strongest Extendable Handle
- All Metal Skid Plates
- Full Length Metal Axle
- 200 lbs Weight Capacity
- Wide Grip Handle
- Fold Down Front Panel
- 1680D Ballistic Material Construction
- Integrated Tablet Sleeve
- 66 Total Pockets



| Part # | Mfg #      | Description            | Price |
|--------|------------|------------------------|-------|
| 233580 | 48-22-8221 | 19-1/2"W x 16"L x 21"H |       |

### 24" Hardtop Rolling Bag

- Designed for stacking
- 6" All-terrain metal rim wheels
- Strongest extendable handle
- 250 lbs Weight capacity
- Wide grip handle
- Fold down front panel
- 1680D Ballistic material
- Integrated tablet sleeve
- 53 Total pockets



| Part # | Mfg #      | Description        | Price |
|--------|------------|--------------------|-------|
| 230510 | 48-22-8220 | 25"W x 16"L x 21"H |       |

### Packout™ Rolling Tool Box

- 9" All-terrain wheels
- Interior organizer tray
- 250lbs weight capacity
- IP65 Rated weather seal
- Industrial grade extension handle
- Metal reinforced corners & locking point
- Constructed with impact resistant polymers
- Mounting Location for the ONE-KEY™ TICK™
- Part of the PACKOUT™ modular storage system



| Part # | Mfg #      | Description              | Price |
|--------|------------|--------------------------|-------|
| 237609 | 48-22-8426 | Packout Rolling Tool Box |       |

### Packout™ Tool Box

- Interior organizer tray
- IP65 Rated weather seal
- Impact resistant polymers
- Metal reinforced corners, locking point, & top handle
- Mounting Location for the ONE-KEY™ TICK™
- Part of the PACKOUT™ modular storage system



| Part # | Mfg #      | Description                | Price |
|--------|------------|----------------------------|-------|
| 237611 | 48-22-8424 | 75lbs Capacity, W/O Handle |       |
| 237610 | 48-22-8425 | Large Box, 100lbs Capacity |       |

### Packout™ Compact Organizer

- IP65 Rated weather seal
- 5 Removable & mountable bins
- Impact resistant polymers
- No-travel bins seal prevent small part migration between Bins
- Part of the PACKOUT™ modular storage system



| Part # | Mfg #      | Description       | Price |
|--------|------------|-------------------|-------|
| 237613 | 48-22-8435 | Compact Organizer |       |

### Packout™ Organizer

- IP65 Rated weather seal
- 10 Removable & mountable bins
- Impact resistant polymers
- No-travel bins seal prevent small part migration between Bins
- Part of the PACKOUT™ modular storage system



| Part # | Mfg #      | Description       | Price |
|--------|------------|-------------------|-------|
| 237612 | 48-22-8430 | Packout Organizer |       |

## Miscellaneous Tools

Tools

### 48" Level Bag

- Tough, water resistant nylon construction
- All metal hardware to ensure ultimate durability
- Durable zipper closure
- Two integrated carrying or hanging handles
- Integrated external tool loops for additional tool storage
- Two debris vent to prevent dust, dirt and/or water build up



| Part # | Mfg #  | Description   | Price |
|--------|--------|---------------|-------|
| 243112 | MLSB48 | 48" Level Bag |       |

### M12™ Tool Holster

- Heavy duty nylon material
- Easy snap-on
- On board bit storage
- Compatible with most M12™ drilling & fastening tools



| Part # | Mfg #   | Description  | Price |
|--------|---------|--------------|-------|
| 151175 | 2335-20 | Tool Holster |       |

### 13" Job Site Work Box

- Impact resistant construction
- Vertical tool storage tray
- 16" Seat height
- Cut groove
- Wide grip locking handle
- Drip ledge lid
- Indexing square
- Made in USA



| Part # | Mfg #      | Description           | Price |
|--------|------------|-----------------------|-------|
| 170620 | 48-22-8010 | 13" Job Site Work Box |       |

### 26" Job Site Work Box

- Impact resistant construction
- Buttressed hinges
- Protected recessed latches
- Reinforced corners
- Integrated weather seal
- Clamping cut groove
- Over molded wide grip handle
- Pass through side grips
- Integrated screw mounting bosses
- Corner pocket storage
- Space for long and bulky tools
- Indexing square
- Made in USA



| Part # | Mfg #      | Description           | Price |
|--------|------------|-----------------------|-------|
| 170622 | 48-22-8020 | 26" Job Site Work Box |       |

### Belt Clip

| Part # | Mfg #      | Description | Price |
|--------|------------|-------------|-------|
| 164935 | 42-70-2653 | Assembly    |       |

### Milwaukee® Markers

#### INKZALL® Marker

- Clog resistant marker tip
- Writes through dusty, wet and oily surfaces
- Write on concrete, OSB and rough surfaces
- Built-In hard hat storage clip
- Fine point
- Ink dries in seconds
- Lanyard hole
- Anti-roll body design
- Non-toxic ink



| Part#  | Mfg#       | Color       | Point  | Pk |
|--------|------------|-------------|--------|----|
| 165641 | 48-22-3100 | Black       | Fine   | 1  |
| 171184 | 48-22-3105 | Black       | Fine   | 2  |
| 166905 | 48-22-3104 | Black       | Fine   | 4  |
| 175754 | 48-22-3102 | Black       | Medium | 2  |
| 186547 | 48-22-3170 | Red         | Fine   | 1  |
| 186548 | 48-22-3180 | Blue        | Fine   | 1  |
| 186549 | 48-22-3190 | Green       | Fine   | 1  |
| 189841 | 48-22-3121 | Silver      | Fine   | 2  |
| 189843 | 48-22-3123 | Silver/Gold | Fine   | 2  |
| 226974 | 48-22-3107 | Multi       | Fine   | 8  |

## Miscellaneous Tools

### INKZALL® Paint Marker

- Writes on dirtiest, hottest, roughest surfaces
- Durable acrylic nib
- Water & UV resistant markings
- 10 second dry time
- Marks on surfaces up to 300F
- Valve action marker



| Part#  | Mfg#       | Color  | Point | Pk |
|--------|------------|--------|-------|----|
| 189845 | 48-22-3711 | White  | Paint | 1  |
| 189844 | 48-22-3712 | White  | Paint | 1  |
| 189848 | 48-22-3721 | Yellow | Paint | 1  |
| 189567 | 48-22-3722 | Yellow | Paint | 1  |
| 189854 | 48-22-3771 | Orange | Paint | 1  |
| 189851 | 48-22-3741 | Red    | Paint | 1  |
| 189849 | 48-22-3731 | Black  | Paint | 1  |
| 189852 | 48-22-3751 | Green  | Paint | 1  |
| 189853 | 48-22-3761 | Blue   | Paint | 1  |

### 1PK Medium Chisel Black Marker

- Clog resistant chisel tip marker
- Built-in hard hat storage clip
- Writes through dusty, wet, and oily surfaces
- Writes on concrete, OSB, and rough surfaces



| Part#  | Mfg#       | Color | Point      |
|--------|------------|-------|------------|
| 171183 | 48-22-3103 | Black | Med Chisel |

### INKZALL® Stylus & Fine Point Black Marker

- Conductive stylus tip
- Clog resistant marker tip
- Writes through dusty, wet and oily surfaces
- Writes on concrete, OSB and rough surfaces
- Built-In hard hat storage clip
- Ink dries in seconds
- Lanyard hole
- Anti-roll body design
- Non-toxic ink



| Part # | Mfg #      | Description           | Price |
|--------|------------|-----------------------|-------|
| 165228 | 48-22-3101 | Stylus & Black Marker |       |

### 4-PK Fine Point Colored Markers

- Clog resistant marker tip
- Built-in hard hat storage clip
- Writes through dusty, wet, and oily surfaces
- Writing on concrete, OSB, and rough surfaces



| Part # | Mfg #      | Description          | Price |
|--------|------------|----------------------|-------|
| 171185 | 48-22-3106 | 4-PK Colored Markers |       |

### Reaming Pen

- Pen provides easy deburring of copper tubing and PVC
- all-metal design for durability
- The blade is heat treated and black oxide coated for extended life
- A slide resistant clip allows easy storage



| Part # | Mfg #      | Description | Price |
|--------|------------|-------------|-------|
| 186221 | 48-22-4255 | 5.5" Length |       |

## Measuring Tools

### Closed Reel Long Tape Measure

- Grime Guard™
- Heavy duty metal frame
- Nylon coated steel blade
- 100ft Folding hook



| Part # | Mfg #      | Blade Length | Price |
|--------|------------|--------------|-------|
| 238210 | 48-22-5101 | 100 Foot     |       |

### Tape Measure

- Nylon bond blade protection
- 5-Point reinforced frame
- Finger stop
- Wire form belt clip
- 2-Sided printing
- Up to 9' stand out
- 360° hook attachment
- Blueprint scale- Calculated 1/4" and 1/8" drawings



| Part # | Mfg #      | Size | Price |
|--------|------------|------|-------|
| 168290 | 48-22-5117 | 16'  |       |
| 168291 | 48-22-5126 | 25'  |       |
| 168292 | 48-22-5131 | 30'  |       |
| 169837 | 48-22-5136 | 35'  |       |
| 173931 | 48-22-5525 | 25'  |       |

## Miscellaneous Tools

Tools

### Magnetic Tape Measure

- Nylon bond blade protection
- 5-point reinforced frame
- Finger stop
- Dual magnets
- Wire form belt clip
- 2 Sided printing
- 360° hook attachment
- Blueprint scales- calculates 1/4" and 1/8" drawings



| Part # | Mfg #       | Size      | Price |
|--------|-------------|-----------|-------|
| 159975 | 48-22-5116  | 16'       |       |
| 159976 | 48-22-5125  | 25'       |       |
| 224243 | 48-22-7125  | 25'       |       |
| 226323 | 48-22-7125G | 25' (2Pk) |       |
| 227233 | 48-22-7130  | 30'       |       |
| 224242 | 48-22-7116  | 16'       |       |

### Compact Tape Measure

- Nylon bond blade protection
- 5-point reinforced frame
- Stamped steel belt clip
- Lanyard read
- Optimized hook designed for scoring



| Part # | Mfg #      | Size | Price |
|--------|------------|------|-------|
| 236370 | 48-22-6616 | 16'  |       |
| 230575 | 48-22-6625 | 25'  |       |

### Auto Lock Tape Measure

- Auto Lock brake
- Nylon bond blade protection
- 5-Point reinforced frame
- Fractional ccale
- Optimized hook designed for scoring
- Stamped steel belt clip
- Lanyard ready



| Part # | Mfg #      | Description | Price |
|--------|------------|-------------|-------|
| 248194 | 48-22-6825 | 25'         |       |

### Key chain Tape Measure

- 6'2m



| Part # | Mfg #      | Size | Price |
|--------|------------|------|-------|
| 186517 | 48-22-5506 | 6'   |       |

### Composite Folding Rule

- Most durable markings and blades
- Heat stamped markings
- Wear and scratch resistant laminate
- Corrosion-free embedded joints



| Part # | Mfg #      | Description     | Price |
|--------|------------|-----------------|-------|
| 183684 | 48-22-3801 | 9-1/4" x 1-3/8" |       |

### Laser Distance Meter

- +/- 1/16" Accuracy
- Side-shot button
- Digital auto-level
- Backlit color screen
- Simplified user interface



| Part # | Mfg #      | Size | Price |
|--------|------------|------|-------|
| 233153 | 48-22-9802 | 150' |       |
| 241057 | 48-22-9803 | 330' |       |

### 100' Precision Line Chalk Reel

- StripGuard™ Clutch
- Planetary Gear System
- 6:1 Gear Retraction Ratio
- Low spillage line
- All metal body



| Part # | Mfg #      | Description        | Price |
|--------|------------|--------------------|-------|
| 188278 | 48-22-3992 | Kit with Red Chalk |       |

### 100' Bold Line Chalk Reel

- StripGuard™ Clutch
- Planetary Gear System
- 6:1 Gear Retraction Ratio
- Flush Handle Storage
- Rubber Overmold



| Part # | Mfg #      | Description         | Price |
|--------|------------|---------------------|-------|
| 188283 | 48-22-3980 | Reel Only           |       |
| 188280 | 48-22-3982 | Kit with Blue Chalk |       |
| 188281 | 48-22-3986 | Kit with Red Chalk  |       |

## Miscellaneous Tools

### Replacement Line

- 1.5mm Replacement Line
- High Strength Braided Line
- 100ft



| Part # | Mfg #      | Description | Price |
|--------|------------|-------------|-------|
| 188285 | 48-22-3989 | Bold Line   |       |

### Miscellaneous

#### TICK™ Tool and Equipment Tracker

- Allows you to track the location of any item in your inventory
- The app will automatically store the last time any ONE-KEY™ app was within the 100 ft Bluetooth® range of your TICK™. Check your app to easily pinpoint the last seen date, time and location to find leave-behinds, view equipment deployment, and help find missing equipment



| Part # | Mfg #      | Description              | Price |
|--------|------------|--------------------------|-------|
| 232950 | 48-21-2000 | 3V Lithium-Ion Coin Cell |       |

#### +Stop Lock Hand Clamp

- +STOP LOCK™ Mechanism
- Optimized pad geometry for more secure clamping
- Hex Release Mechanism
- Riveted Pivoting Clamp Pads
- High Grade Resin
- Rust protection



| Part#  | Mfg#       | Size | Price |
|--------|------------|------|-------|
| 221198 | 48-22-3002 | 2"   |       |
| 221199 | 48-22-3004 | 4"   |       |

### Staple & Nail Gun

- Up to 75% More Driving Power
- Hi/Low power switch for driving control
- Tilt & Fire Mechanism  
-Fully drive staples at an angle
- Integrated Stapler Puller
- All Metal Jam Free Magazine
- Stapler Flush Drive Surface
- Belt Clip
- Compatible with Arrow t50® staples sizes - 9/16", 1/2", 3/8", 5/16", 1/4"
- Compatible with 5/8" & 1/2" 18ga brad nails



| Part # | Mfg #      | Description | Price |
|--------|------------|-------------|-------|
| 181710 | 48-22-1010 | 7-1/2"      |       |

### Bottle Opener

- Wire Stripper - Up to 12ga
- Chrome Plated Rust Protection
- Hardened Steel for Durability
- Cushion Grip Handle
- Rear Cap ID Marking



| Part # | Mfg #      | Description   | Price |
|--------|------------|---------------|-------|
| 165227 | 48-22-2000 | 6-3/5" Length |       |

### Hook and Pick Set

- All-metal core
- Comfort grip handle
- Knurling
- Includes:  
—Hook  
—90° Hook  
—Offset hook  
—Straight pick



| Part # | Mfg #      | Description               | Price |
|--------|------------|---------------------------|-------|
| 239632 | 48-22-9215 | 4-Piece Hook and Pick Set |       |

### Inner Core Bulb Head Cable

- RUST GUARD™



| Part # | Mfg #      | Size       | Price |
|--------|------------|------------|-------|
| 238927 | 48-53-2563 | 1/4" x 25' |       |

## Miscellaneous Tools

Tools

### Inner Core Drop Head Cable

- RUST GUARD™



| Part # | Mfg #      | Size        | Price |
|--------|------------|-------------|-------|
| 238929 | 48-53-2561 | 5/16" x 25' |       |
| 238930 | 48-53-2562 | 5/16" x 25' |       |
| 238928 | 48-53-2564 | 1/4" x 25'  |       |

### Inner Core Coupling Cable

- RUST GUARD™



| Part # | Mfg #      | Size       | Price |
|--------|------------|------------|-------|
| 238932 | 48-53-2675 | 3/8" x 35' |       |
| 238937 | 48-53-2773 | 3/8" x 50' |       |
| 238936 | 48-53-2774 | 1/2" x 50' |       |
| 242542 | 48-53-2775 | 5/8" x 50' |       |

### Inner Core Bulb Head Cable

- Solid polymer core
- Carries power through end of cable
- Maneuvers the tightest bends
- Corrosion resistant core
- End of cable indicator: approximately 3' from back end of cable



| Part # | Mfg #      | Size                | Price |
|--------|------------|---------------------|-------|
| 188683 | 48-53-2571 | 5/16" x 25'         |       |
| 242348 | 48-53-2673 | 5/16" x 35'         |       |
| 188687 | 48-53-2581 | 5/16" x 25' w/ Drum |       |

### Inner Core Drop Head Cable w/ Drum



| Part # | Mfg #      | Size                | Price |
|--------|------------|---------------------|-------|
| 188688 | 48-53-2582 | 5/16" x 25' w/ Drum |       |

### Small Drop Head Attachment

- RUST GUARD™ Plating



| Part # | Mfg #      | Description                | Price |
|--------|------------|----------------------------|-------|
| 250038 | 48-53-2682 | Small Drop Head Attachment |       |

### 5-Piece Drain Line Kit

- RUST GUARD™



| Part # | Mfg #      | Size   | Price |
|--------|------------|--------|-------|
| 238933 | 48-53-2685 | Small  |       |
| 238934 | 48-53-2790 | Medium |       |

### TRAPSNAKE™ Manual Toilet Auger

- Powers through tough clogs and retrieve with control
- Integrated locking mechanism which holds the cable in place for easy telescoping extension and retraction
- Fixed Rubber Boot: Prevents porcelain scratches throughout the life of the tool
- Industry's first replaceable cables



| Part # | Mfg #      | Description          | Price |
|--------|------------|----------------------|-------|
| 230884 | 49-16-2576 | 6' x 1/2" Cable Size |       |
| 230886 | 49-16-2574 | 4' x 3/8" Cable Size |       |

---



---

## Miscellaneous Tools

---

### Miscellaneous Tools

#### Fin Straightener

- Long comfort-grip handle
- Adjustable straightening wire tension
- Accommodates various fin types
- Wires held by a sturdy metal body



| Part # | Mfg # | Description      | Price |
|--------|-------|------------------|-------|
| 182251 | 61170 | Fin Straightener |       |

#### Tube Deburring Tool



| Part # | Mfg # | Description    | Price |
|--------|-------|----------------|-------|
| 237074 | 60163 | Deburring Tool |       |

Tools

**Miscellaneous Tools**

Tools

**Bucket Organizers**

- High-impact plastic pail
- Storage trays fit snugly inside
- Easy on/off lid



| Part # | Mfg # | Bucket | Trays:            | Price |
|--------|-------|--------|-------------------|-------|
| 008175 | 502   | 5 gal  | 2 Large & 2 Small |       |

**Bucket Organizer Pail Lid**

- Fits both 3.5 and 5 gallon pails

| Part # | Mfg # | Description | Price |
|--------|-------|-------------|-------|
| 059482 | 001   | Lid Only    |       |



**Miscellaneous Tools**

**Tie Downs**

**EPDM Tie-Down Strap**

- Super-strong 100% EPDM material with 2-1/2" galvanized S hooks



| Part # | Mfg #  | Max Length | Length | Price |
|--------|--------|------------|--------|-------|
| 183405 | 319-15 | 22"        | 15"    |       |
| 183406 | 319-20 | 30"        | 20"    |       |
| 183407 | 319-31 | 45"        | 31"    |       |

**Extendable Inspection Mirror with Angle Ball Joint**

- Pocket clasp included
- Powerful long life magnetic tip



| Part # | Mfg #     | Size    | Extension      | Price |
|--------|-----------|---------|----------------|-------|
| 156742 | 390-50115 | 1" x 2" | 5-5/8"-18-3/4" |       |

Tools

## Miscellaneous Tools

Tools

### PowerPEX® F1807 Tools & Miscellaneous

#### PowerPEX® F1807 Stainless Compression Tool

- Steel handle
- Exclusively for installing Sioux-Chief's **305-83TX** V-Sleeve™ stainless steel PEX compression system
- PowerPEX® tools by Tomahawk™



| Part # | Mfg #    | Size | Price |
|--------|----------|------|-------|
| 165320 | 305-82TX | 1/2" |       |
| 165321 | 305-83TX | 3/4" |       |
| 165322 | 305-84TX | 1"   |       |

#### PowerPEX® F1807 PEX Crimp Ring Removal Tool

- Allows fitting recovery without damaging the sealing surfaces of the fitting
- Do not use on Copper F1807 PEX or AccuCrimp™ fittings
- Two cuts on copper ring allows user to reclaim fitting
- Cutting blade only penetrates the copper ring and pipe
- Suitable for use on 1/2" through 1" PEX pipe sizes
- PowerPEX™ tools by Tomahawk™



| Part # | Mfg #  | Description             | Price |
|--------|--------|-------------------------|-------|
| 165518 | 305-99 | Crimp Ring Removal Tool |       |

## Pipe Cutters - Copper

### Tubing Cutters

#### Close Quarters Tubing Cutter

- Use in restricted spaces on small diameter, hard and soft copper, aluminum, brass and plastic tubing
- Large knurled feed screw knob



| Part # | Mfg # | Model | Capacity       | Description       | Std Wheel | Price |
|--------|-------|-------|----------------|-------------------|-----------|-------|
| 008656 | 40617 | 101   | 1/4" - 1-1/8"  | Cutter            | E-3469    |       |
| 008659 | 32975 | 103   | 1/8" - 5/8"    | Cutter            | E-3469    |       |
| 008660 | 32985 | 104   | 3/16" - 15/16" | Cutter            | E-3469    |       |
| 067702 | 97787 | 117   | 3/16" - 15/16" | Quick-Feed Cutter | E-3469    |       |
| 051432 | 86127 | 118   | 1/4" - 1-1/8"  | Quick-Feed Cutter | E-3469    |       |

#### Constant Swing Cutter with X-CEL

- Features an enclosed feed screw to eliminate clogging and jamming, grooved rolls for close-to-flare cuts, and a fold-away reamer
- Made from high-strength aluminum alloy



| Part # | Mfg # | Model | Capacity      | Description                  | Std Wheel | Price |
|--------|-------|-------|---------------|------------------------------|-----------|-------|
| 008687 | 31622 | 150   | 1/8" - 1-1/8" | Feed Cutter                  | E-3469    |       |
| 008688 | 31627 | 150   | 1/8" - 1-1/8" | Feed Cutter with HD Wheel(s) | E-4546    |       |

#### Tubing and Conduit Cutter with X-CEL

- Clean, square cuts on copper, brass, aluminum, and thin-wall conduit



| Part # | Mfg # | Model | Capacity       | Description                                | Std Wheel | Price |
|--------|-------|-------|----------------|--|-----------|-------|
| 008655 | 32910 | 10    | 1/8" - 1"      | Screw Feed Cutter                          | F-158     |       |
| 008648 | 32920 | 15    | 3/16" - 1-1/8" | Screw Feed Cutter, Fold-Away Reamer        | F-158     |       |
| 008703 | 32930 | 20    | 5/8" - 2-1/8"  | Screw Feed Cutter, Fold-Away Reamer        | F-158     |       |
| 008713 | 32940 | 30    | 1" - 3-1/8"    | Screw Feed Cutter f/Lg Dia Steel & SS Tube | F-158     |       |

#### Quick-Acting Tubing Cutter with X-CEL

- I-Beam construction, hardened wear surfaces and bearing side assemblies for smooth operation
- Plastic cutters include spare cutting wheel for cutting copper



| Part # | Mfg # | Model | Capacity        | Description                    | Std Wheel | Price |
|--------|-------|-------|-----------------|--------------------------------|-----------|-------|
| 008689 | 31632 | 151   | 1/4" - 1-5/8"   | Quick-Acting, Fold-Away Reamer | E-3469    |       |
| 008690 | 31642 | 152   | 1/4" - 2-5/8"   | Quick-Acting, Fold-Away Reamer | E-3469    |       |
| 008691 | 31652 | 154   | 1-7/8" - 4-1/2" | Quick-Acting Tubing Cutter     | E-2558    |       |

**Pipe Cutters - Copper**

**Internal Tubing Cutter**

- For trimming tubing below floor level for shower and floor drain installations, or above the ceiling for sprinkler head installations



| Part # | Mfg # | Model | Capacity Nom / Depth    | Description                     | Std Wheel | Price |
|--------|-------|-------|-------------------------|---------------------------------|-----------|-------|
| 018338 | 33005 | 106   | 2" - 3" / 1/4" - 2-5/8" | Internal, Steel & Aluminum Body | E-2558    |       |

**Tubing Cutter Wheel**



| Part # | Mfg # | Model  | Blade Exp | Application                       | For Model                               | Price |
|--------|-------|--------|-----------|-----------------------------------|---|-------|
| 008575 | 33165 | E-1240 | .162      | Steel - SS                        | 10, 15, 15-SI                           |       |
| 008596 | 33175 | E-2191 | .292      | HD Steel Tubing                   | 30, 40, 122, 122XL, 133, 154, 156       |       |
| 008599 | 33170 | E-2558 | .220      | Aluminum & Copper                 | 30, 40, 108, 109P, 133, 154, 156        |       |
| 023461 | 34695 | E-3495 | .290      | Aluminum                          | 151, 152, 153, 205                      |       |
| 008617 | 33190 | E-4546 | .162      | Steel - SS                        | 151, 152, 153, 205                      |       |
| 008606 | 33185 | E-3469 | .149      | Copper, Aluminum, Brass & Plastic | 101,103,104,117,118,150,151,152,153,205 |       |
| 008636 | 33160 | F-158  | .149      | Aluminum & Copper                 | 10,15, 20                               |       |

**Tubing Cutter Parts**

| Part # | Mfg # | Description        | For Model                | Price |
|--------|-------|--------------------|--------------------------|-------|
| 129719 | 34620 | Roll Housing Screw | 20                       |       |
| 024438 | 42327 | Retaining Ring     | 101, 103, 104, 117 & 118 |       |

**Tubing Tools**

**456 Tri-Bender**

- Ideal for plumbing and HVAC applications
- 90° Start angle minimizes effort required to form a bend
- Handy reference marks indicate the angle for quick bends through 90°



| Part # | Mfg # | Model | Capacity          | Price |
|--------|-------|-------|-------------------|-------|
| 008738 | 44852 | 456   | 1/4", 5/16", 3/8" |       |

**Spring-Type Tube Bender**

- Fast, free-form bending of soft copper and aluminum tube



| Part # | Mfg # | Model  | Length | Tube OD | Price |
|--------|-------|--------|--------|---------|-------|
| 008563 | 35255 | D-1377 | 10"    | 3/8"    |       |

## Pipe Cutters - Copper

### Copper Tubing Cutters Close Quarters Tubing Cutter

- Most compact
- Longest life
- Chrome rollers
- Weep holes
- Directional grip
- Replaceable blade



| Part # | Mfg #      | Size | Price |
|--------|------------|------|-------|
| 225206 | 48-22-4260 | 1/2" |       |
| 225207 | 48-22-4261 | 3/4" |       |
| 225208 | 48-22-4262 | 1"   |       |

### Mini Copper Tubing Cutter

- Proprietary adjustment mechanism
- Chrome Rollers
- Easy Grip Knob



| Part # | Mfg #      | Size | Price |
|--------|------------|------|-------|
| 188005 | 48-22-4250 | 1/2" |       |
| 229533 | 48-22-4258 | 3/4" |       |
| 188006 | 48-22-4251 | 1"   |       |

### Constant Swing Copper Tubing Cutter

- 4 Roller design
- Chrome rollers
- Smooth adjustment mechanism
- On-Board reamer



| Part # | Mfg #      | Size   | Price |
|--------|------------|--------|-------|
| 234876 | 48-22-4259 | 1"     |       |
| 188007 | 48-22-4252 | 1-1/2" |       |

### Quick Adjust Copper Tubing Cutter

- 4 Roller design
- Chrome rollers
- Quick adjustment mechanism
- Tool-free blade change
- Extra blade included



| Part # | Mfg #      | Size   | Price |
|--------|------------|--------|-------|
| 234288 | 48-22-4253 | 2-1/2" |       |
| 234872 | 48-22-4254 | 3-1/2" |       |

### 3 Piece Close Quarters Tubing Cutter Set

- Most compact
- Longest life
- Chrome rollers
- Weep holes
- Directional grip
- Replaceable blade
- Includes:
  - (1) 1/2" Close quarters tubing cutter (48-22-4260)
  - (1) 3/4" Close quarters tubing cutter (48-22-4261)
  - (1) 1" Close quarters tubing cutter (48-22-4262)



| Part # | Mfg #      | Size            | Price |
|--------|------------|-----------------|-------|
| 225209 | 48-22-4263 | 1/2", 3/4" & 1" |       |

### 2 Piece Close Quarters Cutter Replacement Blades

- Replacement cutter wheels
- Designed for use with Milwaukee® close quarters tubing cutters
- Two pack
- High carbon steel blades
- Precision machined
- Optimized for copper



| Part # | Mfg #      | Description | Price |
|--------|------------|-------------|-------|
| 225210 | 48-22-4266 | 2/Pk        |       |

### Copper Cutter Wheels

- Hardened steel with black oxide
- Convex blade design
- For use with Milwaukee® 12V copper cutter (2471)



| Part # | Mfg #      | Description | Price |
|--------|------------|-------------|-------|
| 138792 | 48-38-0010 | 2/Pk        |       |

### 2Pc Replacement Cutter Wheels

- Designed for use with Milwaukee Mini and Constant Swing Copper Tubing Cutters
- Two Pack
- High Carbon Steel Blades
- Optimized for Copper



| Part # | Mfg #      | Description | Price |
|--------|------------|-------------|-------|
| 188008 | 48-22-4256 | 2/Pk        |       |

## Pipe Cutters - Copper

Tools

### 3 Pc Replacement Reaming Blades

- Designed for use with Milwaukee Constant Swing Copper Tubing Cutters
- Heat Treated
- Black Oxide Blade



| Part # | Mfg #      | Description | Price |
|--------|------------|-------------|-------|
| 188009 | 48-22-4257 | 3 Pack      |       |

### M12™ Cordless Copper Tubing Cutter

- Close quarter rotating cutting head
- Automatic adjustment from 3/8" to 1" tubing
- Auto locking mechanism
- Water resistant sealed metal cutter head
- Battery fuel gauge displays remaining run time
- Built-in LED light illuminates line of cut
- No load speed: 500 rpm
- Capacity: 1/2" to 1-1/8" OD
- Kit includes:
  - Tubing cutter (2471-20)
  - (2) 12V Lithium-Ion battery (2471-21 is single battery kit)
  - 30-Minute charger
  - Carrying case
- 5-Year warranty



| Part # | Mfg #   | Size                 | Price |
|--------|---------|----------------------|-------|
| 148546 | 2471-20 | 3/8"-1" 1/2"-1-1/8OD |       |
| 137554 | 2471-21 | 3/8"-1"              |       |



## Pipe Cutters - Copper

### Autocut™ Copper Tubing Cutters



ATC



RH

| Part # | Mfg #  | Description               | Price |
|--------|--------|---------------------------|-------|
| 031428 | ATC12  | For 1/2" Tubing           |       |
| 031429 | ATC34  | For 3/4" Tubing           |       |
| 073599 | ATC100 | For 1" Tubing             |       |
| 031674 | RH12   | Ratchet Handle for ATC12  |       |
| 031675 | RH34   | Ratchet Handle for ATC34  |       |
| 031430 | ATCW   | Replacement Cutter Wheels |       |

Tools

## Pipe Cutters - Copper

Tools

### Tube Benders

#### Tri-Tube Bender

- Indicators on handle help identify tube sizes
- Color-coded to help spot the right tube size
- Indicators on side help measure the bend radius, up to 180°



| Part # | Mfg #   | Description       | Price |
|--------|---------|-------------------|-------|
| 167766 | 1839026 | 1/4", 5/16", 3/8" |       |
| 171454 | 1839027 | 1/4", 3/8", 1/2"  |       |



## Pipe Cutters - Copper

### Copper Tubing Cutters

#### Heavy Duty Mini Cutter

- Large rollers
- Flare cut-off groove



| Part # | Mfg # | Cuts From:     | Price |
|--------|-------|----------------|-------|
| 182094 | 60121 | 1/4"-7/8" O.D. |       |

#### Premium Tube Cutter

- Textured finish
- Wide rollers with flare cut-off groove
- Wheel retracts into cutter body to save 1" in cutting radius
- Fold away steel reamer with turned cutting edge for deburring
- Textured corrosion-resistant finish on lightweight aluminum frame
- Wheels are pinned to rotate in either direction without the screw backing out



| Part # | Mfg # | Size  | For:             | Price |
|--------|-------|-------|------------------|-------|
| 182092 | 60101 | Small | 1/8"-1-1/8" O.D. |       |
| 182093 | 60102 | Large | 1/4"-1-5/8" O.D. |       |

#### Ratchet Hand Bender Kit

- Index marks to locate bends
- Trouble free ratchet mechanism
- Without reverse bending mandrel
- Kit includes all items required to bend; 1/4", 5/16", 3/8", 1/2", 5/8", 3/4" and 7/8" tubing
- Hard copper must be annealed before bending



| Part # | Mfg # | Description             | Price |
|--------|-------|-------------------------|-------|
| 182133 | 60331 | Ratchet Hand Bender Kit |       |

#### Spring Tube Bender

| Part # | Mfg # | Description                        | Price |
|--------|-------|------------------------------------|-------|
| 251479 | 60353 | Set-1/2", 5/8", 3/4" and 7/8" O.D. |       |
| 246907 | 60358 | 1/2" O.D.                          |       |

#### Parts & Accessories

| Part # | Mfg # | Description         | Price |
|--------|-------|---------------------|-------|
| 238178 | 60094 | Pin Clips, 5 Pack   |       |
| 182091 | 60100 | Copper Cutter Wheel |       |

#### Replacement Parts for 60331 and 60325

- 60331 Basic ratchet hand bender kit
- 60325 Deluxe ratchet hand bender kit

| Part # | Mfg # | Description               | Price |
|--------|-------|---------------------------|-------|
| 182132 | 60329 | 3/4"-7/8" Crossbar Assy   |       |
| 182136 | 60336 | 7/8" O.D. Bending Mandrel |       |
| 236600 | 60340 | Ratchet Bar 9' for Bender |       |
| 182138 | 60342 | Reverse Bending Mandrel   |       |
| 182140 | 60348 | Wing Nut Screw (8, 11)    |       |

## Pipe Cutters - PEX

Tools

### Tubing Cutters

#### ProPEX®/Tubing Cutter

- Replaceable blades
- Double ground steel V-shaped blade
- Metal core - indestructible frame
- Rework groove
- One-handed locking mechanism
- Rust protection



48-22-4200



48-22-4202

| Part # | Mfg #      | Jaw Capacity |
|--------|------------|--------------|
| 143343 | 48-22-4200 | 1"           |
| 184107 | 48-22-4202 | 1"           |

### Cutter Wheel for PVC and PEX

- Cuts PVC, CPVC, ABS, and PEX
- For use with Milwaukee® quick adjust tubing cutters
- Cuts up to 2 in. plastic pipe with the 48-22-4253 quick adjust cutter
- Cuts up to 3 in. pipe with the 48-22-4254 quick adjust cutter
- High carbon steel
- .4" Max wall thickness
- 1.3" Diameter



| Part # | Mfg #      | Description      | Price |
|--------|------------|------------------|-------|
| 234878 | 48-22-4206 | PEX Cutter Wheel |       |

### Ratcheting Pipe Cutter

- Pierce Point Blade Durable Stainless Steel Blade
- Ergonomic Handle Design
- Integrated Lanyard Hole
- Limited Lifetime Warranty



| Part # | Mfg #      | Jaw Capacity |
|--------|------------|--------------|
| 236683 | 48-22-4210 | 1-5/8"       |
| 236684 | 48-22-4215 | 2-3/8"       |

### Replacement Blades and Accessories

#### ProPEX®/Tubing Cutter Replacement Blade

- Double-Ground V-Shaped Blade - Cleaner Cuts on 1" rubber and plastic tubing/PEX-a tubing
- Rust protection - stainless design for increased tool life and corrosion resistance



Fits 48-22-4200 and 48-22-4202 Milwaukee® Tubing Cutters

| Part # | Mfg #      | Description | Price |
|--------|------------|-------------|-------|
| 170838 | 48-22-4203 | Blades Only |       |

#### Ratcheting Pipe Cutter Replacement Blade

- For use with 48-22-4210 pipe cutter
- 1-5/8" max capacity
- Heat treated
- Precision ground edge
- Pierce point blade durable stainless steel



| Part # | Mfg #      | Description        | Price |
|--------|------------|--------------------|-------|
| 236685 | 48-22-4211 | Blade Only, 1-5/8" |       |
| 236686 | 48-22-4216 | Blade Only, 2-3/8" |       |

## Pipe Cutters - Plastic

### Plastic Tubing Cutters Quick-Acting CSST Cutter

- I-Beam frame
- Cuts corrugated gas tubing 3/8" - 1"
- Two sets of split-floating guide wheels
- Ergonomic knob
- Full lifetime warranty



| Part # | Mfg # | Model    | Capacity  | Description              | Std Wheel | Price |
|--------|-------|----------|-----------|--------------------------|-----------|-------|
| 122158 | 32078 | 151 CSST | 3/8" - 1" | Quick-Acting CSST Cutter | 33190     |       |

### Plastic Pipe Tubing Cutter

- Designed for quick, clean cuts through plastic pipe and tube



PC-1375



RC-1625



| Part # | Mfg # | Model   | Capacity      | Description   | Std Wheel       | Price |
|--------|-------|---------|---------------|---|-----------------|-------|
| 104549 | 23493 | PC-1375 | 1/8" - 1"     | Single Stroke Plastic Pipe & Tubing Cutter            | X-CEL™ PCB-1375 |       |
| 108391 | 23498 | RC-1625 | 1/2" - 1-5/8" | Ratchet Action Plastic Pipe & Tubing Cutter, Erg Grip | 27858           |       |
| 119754 | 30088 | RC-2375 | 1/2" - 2-3/8" | Ratchet Action Plastic Pipe & Tubing Cutter, Erg Grip | 30093           |       |

### Cutter Replacement Blade

| Part # | Mfg # | Model    | Description                   | Price |
|--------|-------|----------|-------------------------------|-------|
| 008706 | 22086 | 1493     | Replacement Blade with Clip   |       |
| 104550 | 25588 | PCB-1375 | X-CEL™ Replacement Blade      |       |
| 132081 | 27858 | RCB-1625 | Replacement Blade for RC-1625 |       |
| 123436 | 30093 | RCB-2375 | Replacement Blade for RC-2375 |       |
| 008565 | 92170 | 138      | Replacement Blade for 91125   |       |

### Plastic Tubing Cutter Wheel



| Part # | Mfg # | Model  | Blade Exp | Application             | For Model                                | Price |
|--------|-------|--------|-----------|-------------------------|--|-------|
| 008626 | 33195 | E-5272 | .290      | PVC, ABS, Standard Wall | 151-P, 152-P                             |       |
| 008627 | 33180 | E-5299 | .412      | PVC, ABS, Standard Wall | 30P - 133P, 106, 108, 109P, 154-P, 156-P |       |

**Pipe Cutters - Plastic**

Tools

**Big Nipper™**

- Cuts hose and tubing up to 2-1/2" ID, polyethylene up to 1-1/2" ID, and PVC up to 1-1/2" ID



- Excellent for cutting tubing insulation
- Replaceable stainless steel blade
- Clean cut - no burrs or sawdust replaceable blades

| Part # | Mfg # | Description       | Price |
|--------|-------|-------------------|-------|
| 112016 | 16368 | Big Nipper Cutter |       |

**Li'l Nipper™**

- Cuts up to 1-1/4" polyethylene, PVC, ABS, and rubber hose
- Cutters are light and can be handily carried in back pocket or tool pouch
- Strong nylon handle with replaceable blades
- Cutters do not distort pipe



| Part # | Mfg # | Description          | Price |
|--------|-------|----------------------|-------|
| 002266 | 0125  | Li'l Nipper™ Cutter  |       |
| 026128 | 0127  | 2 Replacement Blades |       |

**Pipe Cutters - Plastic**

**PVC Cutters**

**PVC Cutter**

- *Makes clean burr-free cuts*
- *Reversible blade*
- *Handle latch keeps tool closed*



| Part # | Mfg # | PVC Capacity | Flex Pipe Capacity | Price |
|--------|-------|--------------|--------------------|-------|
| 125142 | 50506 | 3/4" Sch 40  | 1-3/8"             |       |

**PVC Cutter Replacement Blade**



| Part # | Mfg # | Description     | Price |
|--------|-------|-----------------|-------|
| 141615 | 50549 | Blade for 50506 |       |

Tools

## Pipe Cutters - Plastic

Tools

### Pipe/Tubing Cutters

#### Professional PVC Pipe Cutter

- Rustproof
- Non-electro nickel-plated blade
- Locking hook can be used to debur pipe
- Carded



| Part # | Mfg #   | Description            | Price |
|--------|---------|------------------------|-------|
| 054586 | P70-018 | 1-1/4" PVC Pipe Cutter |       |

#### PVC Pipe Cutter

- High carbon steel blades
- Aluminum alloy handles
- Ratchet action



| Part # | Mfg #   | Description                | Price |
|--------|---------|----------------------------|-------|
| 040773 | P70-001 | 1" Pipe Cutter             |       |
| 071043 | P70-002 | 2" Pipe Cutter, Heavy-Duty |       |

#### PlumbBest E-Z Shear Inside Pipe Cutter

- Cuts PVC and ABS pipe
- High speed steel blade with zinc-plated shaft



| Part # | Mfg #   | Description            | Price |
|--------|---------|------------------------|-------|
| 026324 | J40-830 | E-Z Shear Pipe Cutter  |       |
| 026325 | J40-831 | (2) Replacement Blades |       |

#### Socket Saver

- Removes Sch 40 plastic pipe from plastic fittings
- Cuts ABS or PVC DWV pipe below slab
- Fits 1/2" variable speed power drill



| Part # | Mfg #   | Description         | Price |
|--------|---------|---------------------|-------|
| 082721 | J44-075 | 3/4" Socket Saver   |       |
| 054591 | J44-150 | 1-1/2" Socket Saver |       |
| 054592 | J44-200 | 2" Socket Saver     |       |
| 054593 | J44-300 | 3" Socket Saver     |       |
| 054594 | J44-400 | 4" Socket Saver     |       |

## Pipe Cutters - Plastic

### Tube and Pipe Cutters

#### Inside Pipe Cutter

- Steel blade for plastic pipe
- Abrasive disc for plastic or steel pipe



390-50163

| Part # | Mfg #     | Steel Blade Size | Price |
|--------|-----------|------------------|-------|
| 035402 | 390-50163 | 1-1/4"           |       |
| 035403 | 390-50164 | 1-1/4" Hardened  |       |

#### PowerPEX Crimp Tools (Complete Line of ASTM F1807 Options)

- Complete line of F1807 crimp tool options below:
- Steel or composite handles
- Composite handles are strong and durable, yet lightweight
- Compact tools allow one-hand crimping
- Combo tool for the most common crimp connections and added cost savings
- Free Go/No-Go gauge provided with every model
- Also work on PB 1380 tube and fittings



305-23CPK

#### Composite Handle

| Part # | Mfg #     | Description         | Length | Price |
|--------|-----------|---------------------|--------|-------|
| 183403 | 305-23CPK | 1/2"Over-3/4" Combo | 14"    |       |

#### Plactic Tube and Hose Cutter

- Quickly cut PEX, PVC, CPVC and other poly pipe or non-metallic hose
- For 1 1/8" O.D. tube or smaller



304-08

| Part # | Mfg #  | Blade Length | Price |
|--------|--------|--------------|-------|
| 160228 | 304-08 | 2-1/4"       |       |

Tools

**Pipe Cutters - Soil Pipe**

**Soil Pipe Cutters**

- Provides 1-stroke cutting of 1-1/2" to 6" service weight, No-Hub® soil pipe, clay, asbestos and cement pipe



Tools

| Part # | Mfg # | Model | Pipe Capacity | Description   | Price |
|--------|-------|-------|---------------|---|-------|
| 008709 | 32900 | 246   | 1-1/2" - 6"   | Cuts Clay, Cast Iron, Cement Pipe, 4" Class 22 Water Main |       |



## Pipe Cutters - Steel

### Pipe Cutters

#### Heavy-Duty Pipe Cutter

- Fast, clean pipe cutting by hand or power
- Extra-long shank protects adjustment threads, while an extra-large handle is provided for quick, easy adjustment
- Can be converted to 3-wheel cutter by replacing rollers with cutter wheel



| Part # | Mfg # | Model | Pipe Capacity | Description            | Price |
|--------|-------|-------|---------------|------------------------|-------|
| 008701 | 32820 | 2-A   | 1/8" - 2"     | Heavy-Duty Pipe Cutter |       |

#### Pipe Cutter Replacement Wheel



| Part # | Mfg # | Model  | Blade Exp | Application          | For Model  | Price |
|--------|-------|--------|-----------|----------------------|--|-------|
| 008732 | 44185 | E-1032 | .450      | Steel & Ductile Iron | 202, 360, 732, 820/364                               |       |
| 008641 | 33105 | F-3    | .312      | Steel & Ductile Iron | 1A, 2A, 42A, 202, 360, 732, 820/364                  |       |
| 008637 | 33125 | F-229  | .411      | Steel & Ductile Iron | 3S, 4S, 44S, 466C/S/HWS, 468C/S/HWS, 472C/S/HWS, 764 |       |
| 008643 | 33100 | F-514  | .312      | Steel & Ductile Iron | 1A, 2A, 42A, 202, 360, 732, 820/364                  |       |

#### Pipe Cutter Parts

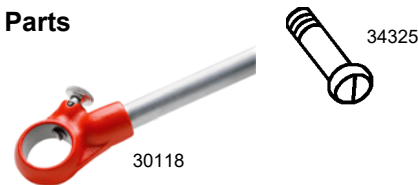

| Part # | Mfg # | Model   | Description                | For Model                              | Price |
|--------|-------|---------|----------------------------|--|-------|
| 008664 | 30118 | E-3055X | Ratchet with Handle        | 12-R                                   |       |
| 008720 | 32142 |         | Wheel Pins with Clip, 5/Pk | 151-P, 152, 152-P, 152-PVC, 153, 153-P |       |
| 008574 | 33970 | E-1189X | Rings with Pin, 5/Pk       | 101, 103, 104                          |       |
| 008590 | 34325 | E-1948  | Screws, 10/Pk              | 10, 15, 15-SI                          |       |
| 008638 | 34805 | F-255   | Roller, 5/Pk               | 15                                     |       |
| 129720 | 34825 | F-266   | Roller, 5/Pk               | 20                                     |       |

## Pipe Cutters - Plastic

### Pipe Cutters

#### Inside Pipe Cutter Replacement Blades

- For P70023 pipe cutter
- Cuts 2" and larger plastic pipe
- Fits electric drill



| Part # | Mfg #   | Description            | Price |
|--------|---------|------------------------|-------|
| 053717 | P70-029 | (3) Replacement Blades |       |

---

---

## Pipe Taps

---

---

### Machine Screw Tap - Plug Style



| Part # | Mfg #   | Description      | Price |
|--------|---------|------------------|-------|
| 141468 | R305100 | WC10 1/4-20 N.C. |       |

**Pipe Taps**

**Pipe Taps**  
Pipe Tap



Tools

| Part # | Mfg #   | Size | Price |
|--------|---------|------|-------|
| 056686 | T41-001 | 1/8" |       |
| 056687 | T41-002 | 1/4" |       |
| 041961 | T41-004 | 1/2" |       |
| 041962 | T41-005 | 3/4" |       |
| 050029 | T41-006 | 1"   |       |
| 056690 | T41-008 | 2"   |       |

## Pipe Threaders

### Pipe Tools Pipe Reamer

- All reamers include handles



| Part # | Mfg # | Model | Capacity  | Description    | Price |
|--------|-------|-------|-----------|----------------|-------|
| 008702 | 34955 | 2-S   | 1/4" - 2" | Spiral Ratchet |       |

### Inner-Outer Reamer

- Plastic construction with long-wearing alloy steel blades



| Part # | Mfg # | Model | Description                      | Construction | Price |
|--------|-------|-------|----------------------------------|--------------|-------|
| 017583 | 34965 | 127   | 1/4" - 1-1/2" Nominal Water Tube | Plastic      |       |

### Hardened Steel Inner-Outer Reamer

- Hardened steel construction
- 46 Cutting edges on interior cone
- For fast, clean, inner reaming and outer deburring/beveling of 1/2"-2" copper and stainless steel tubing



| Part # | Mfg # | Model | Description                  | Construction   | Price |
|--------|-------|-------|------------------------------|----------------|-------|
| 111700 | 29993 | 227S  | 1/2" - 2" Copper & SS Tubing | Hardened Steel |       |

### Deburring Tool

- For plastic pipe and tubing
- Made of high-grade steel with long-lasting cutting edges
- Ideal for removing outside ridges and inside burrs on plastic pipe and tubing



| Part # | Mfg # | Model | Capacity | Plastic Cap ID | Price |
|--------|-------|-------|----------|----------------|-------|
| 033796 | 64967 | 74    | 4"       | --             |       |

### Individual Pipe Extractor

- Easily removes broken threaded ends of pipe, pipe plugs and fittings
- Each is plainly marked showing drill size used when solid ends of plugs and fittings must be drilled to receive extractor



| Part # | Mfg # | Model | Pipe Size | Length Overall | Use Drill | Price |
|--------|-------|-------|-----------|----------------|-----------|-------|
| 120553 | 35610 | 83    | 1/2"      | 3"             | 5/8"      |       |

## Pipe Threaders

### Manual Threaders

#### Manual Threader Die Head

- North American standards



| Part # | Mfg # | Model | Description | Nominal Pipe Capacity | Price |
|--------|-------|-------|-------------|-----------------------|-------|
| 008661 | 37040 | 11-R  | Alloy RH    | 1/2"                  |       |
| 008672 | 37390 | 12-R  | Alloy RH    | 1/2"                  |       |
| 008679 | 37395 | 12-R  | Alloy RH    | 3/4"                  |       |
| 008666 | 37400 | 12-R  | Alloy RH    | 1"                    |       |
| 008668 | 37410 | 12-R  | Alloy RH    | 1-1/2"                |       |
| 008677 | 37415 | 12-R  | Alloy RH    | 2"                    |       |

#### Pipe Die - National Pipe Taper NPT



| Part # | Mfg # | Model | Description      | Nominal Pipe Capacity | Price |
|--------|-------|-------|------------------|-----------------------|-------|
| 008671 | 37825 | 12-R  | Alloy RH         | 1/2" - 14             |       |
| 008678 | 37830 | 12-R  | Alloy RH         | 3/4" - 14             |       |
| 008665 | 37835 | 12-R  | Alloy RH         | 1" - 11-1/2           |       |
| 008669 | 37840 | 12-R  | Alloy RH         | 1-1/4" - 11-1/2       |       |
| 008667 | 37845 | 12-R  | Alloy RH         | 1-1/2" - 11-1/2       |       |
| 008676 | 37850 | 12-R  | Alloy RH         | 2" - 11-1/2           |       |
| 008724 | 37920 | 12-R  | High Speed SS RH | 3/4" - 14             |       |
| 008725 | 37925 | 12-R  | High Speed SS RH | 1" - 11-1/2           |       |

### Power Threading Equipment

#### Model 300 Power Drive Complete

- RIDGID® speed chuck
- Reversible 1/2 HP universal motor
- Ideal for use with RIDGID roll groovers
- Heavy-duty forward/off/reverse and integral foot switch
- Speed chuck with replaceable rocker-action jaws
- Cam-action turns with chuck
- Heavy-duty support bar



| Part # | Mfg # | Model        | Description          | Price |
|--------|-------|--------------|----------------------|-------|
| 022267 | 15682 | 300 Complete | 115V, 25-60 Hz (NPT) |       |

**Pipe Threaders**

Pipe Die for Machine Die Heads



Pipe Die for 504A, 711, 731, 811A, 815A and 842

| Part # | Mfg # | Die Material or Type | (NPT) Nominal Pipe Size<br>Threads Per Inch | Price |
|--------|-------|----------------------|---|-------|
| 008747 | 47745 | Alloy RH NPT         | 1/2"-3/4" - 14                              |       |
| 008748 | 47750 | Alloy RH NPT         | 1"-2" - 11-1/2                              |       |

Tools



## Pipe Threaders

### Golden Tool™ Pipe Threaders Golden Pipe Shredder™ Kit

- 4 Shredder tools: 1-1/2", 2", 3", 4"
- 1/2" Arbor size



Tools

| Part # | Mfg # | Size   | Qty | Price |
|--------|-------|--------|-----|-------|
| 143396 | 98040 | 1-1/2" | 4   |       |
| 143394 | 98041 | 2"     | 4   |       |



## Pliers & Wire Strippers

### Pliers

#### 6-in-1 Long Nose Pliers

- Integrated reaming head to smooth-out rough edges of metal pipe
- High-leverage design
- (6) Applications:
  - Reaming
  - Wire stripping
  - Nail/wire cutting
  - Nail pulling
  - Pliers
  - Loop maker



| Part # | Mfg #      | Overall Length | Price |
|--------|------------|----------------|-------|
| 150218 | 48-22-3068 | 8"             |       |

#### Long Nose Pliers

- 2" Gripping nose reaming head design - Up to 1"
- On-Board fish tape puller
- Comfort grips will not peel
- Forged design for added strength
- Rust resistance



| Part # | Mfg #      | Overall Length | Price |
|--------|------------|----------------|-------|
| 175004 | 48-22-6101 | 8"             |       |

#### 6-in-1 Combination Pliers

- Integrated reaming head
- High-leverage design
- (6) Applications:
  - Reaming
  - Wire stripping
  - Bolt cutter
  - Wire cutting
  - Pliers
  - Loop maker



| Part # | Mfg #      | Overall Length | Price |
|--------|------------|----------------|-------|
| 149136 | 48-22-3069 | 7-1/2"         |       |

### Cable Cutting Pliers

- Rust resistant
- Comfort grips
- Beveled jaw head
- Optimized blade angle
- Forged strength design
- Ergonomic handle design
- 2/0 Copper max capacity
- 4/0 Aluminum max capacity



| Part # | Mfg #      | Jaw Length | Price |
|--------|------------|------------|-------|
| 241143 | 48-22-6104 | 2.13"      |       |

### PVC/Oil Filter Pliers

- Comfort grips will not peel or dig into hands during extended use
- Rust resistant
- Forged strength design



| Part # | Mfg #      | Jaw Length | Price |
|--------|------------|------------|-------|
| 185825 | 48-22-6321 | 3.5"       |       |

### Combination Wire Pliers

- Reaming head design
- Bolt cutter - thread and cut #6 and #8 bolts
- Wire stripper
- One-handed swing lock
- Curved cutting blade
- Ruse protection
- Tether-ready handle loops



| Part # | Mfg #      | Overall Length | Price |
|--------|------------|----------------|-------|
| 190123 | 48-22-3079 | 7.75"          |       |

### High Leverage Lineman's Pliers w/ Crimper

- Iron carbide edge cutting edge hardened blades
- Reaming head design - up to 1 1/2" (patent pending)
- Integrated crimper for INS and NON INS terminals
- On-Board fish tape puller
- Comfort grips will not peel
- Forged design for added strength
- Rust resistance



| Part # | Mfg #      | Overall Length | Price |
|--------|------------|----------------|-------|
| 175003 | 48-22-6100 | 9"             |       |

## Pliers & Wire Strippers

Tools

### 6-in-1 Lineman's Pliers

- Integrated reaming head
- High-leverage design
- (6) Applications:
  - Reaming
  - Bolt cutter
  - Wire cutter
  - Nail pulling
  - Pliers
  - Fish tape puller



| Part # | Mfg #      | Overall Length | Price |
|--------|------------|----------------|-------|
| 149137 | 48-22-3309 | 9"             |       |

### 6-In-1 Diagonal Pliers

- Reaming head design
- Bolt cutter
- High-leverage design
- Laser hardened cutting edges
- Offset head design - 15 degree offset head for easier and quicker prying and pulling (Patent Pending)
- Rust protection



| Part # | Mfg #      | Overall Length | Price |
|--------|------------|----------------|-------|
| 175105 | 48-22-6107 | 7"             |       |

### Diagonal Cutting Pliers

- Reaming head design
- Flush cutting blades
- On-board fish tape puller
- Comfort grips
- Forged design for added strength
- Rust resistance



| Part # | Mfg #      | Overall Length | Price |
|--------|------------|----------------|-------|
| 175106 | 48-22-6106 | 6"             |       |
| 175005 | 48-22-6108 | 8"             |       |

### Tongue & Groove Pliers

- Reaming head design
- Forged alloy steel for maximum tool strength
- Induction hardened jaws
- Smooth transition grips minimize wear tear and improve punchability
- Rust protection increases tool life by reducing corrosion



| Part # | Mfg #      | Overall Length | Price |
|--------|------------|----------------|-------|
| 143342 | 48-22-3210 | 10"            |       |
| 150217 | 48-22-3212 | 12"            |       |

### Straight-Jaw Pliers

- REAM & PUNCH™ handles
- Hardened teeth for long gripping life
- Comfort grips
- Rust resistant
- Forged design for added strength



| Part # | Mfg #      | Overall Length | Price |
|--------|------------|----------------|-------|
| 175007 | 48-22-6306 | 6"             |       |
| 175008 | 48-22-6310 | 10"            |       |
| 175009 | 48-22-6312 | 12"            |       |
| 175010 | 48-22-6316 | 16"            |       |
| 175006 | 48-22-6330 | 6" & 10" (2Pk) |       |

### Hex-Jaw Pliers

- Hex-Jaw design for hex bolts
- All-Metal quick adjustment mechanism
- REAM & PUNCH™ Handles
- Slim head design comfort grips
- Rust resistant



| Part # | Mfg #      | Overall Length | Price |
|--------|------------|----------------|-------|
| 175109 | 48-22-6208 | 8"             |       |
| 175108 | 48-22-6210 | 10"            |       |
| 175107 | 48-22-6212 | 12"            |       |

### 3 Pc Pliers Kit

- Includes:
  - (1) 8" Long Nose Pliers (48-22-6101)
  - (1) 7" Diagonal Cutting Pliers (48-22-6107)
  - (1) 10" Straight-Jaw Pliers (48-22-6310)



| Part # | Mfg #      | Description | Price |
|--------|------------|-------------|-------|
| 189817 | 48-22-6331 | Multi-Use   |       |

### 2 Pc Locking Pliers Set

- Includes:
  - (1) 10" Torque Lock™ Curved Jaw Locking Pliers (48-22-3420)
  - (1) 6" Long Nose (48-22-3506)



| Part # | Mfg #      | Overall Length | Price |
|--------|------------|----------------|-------|
| 226918 | 48-22-3602 | 6" & 10"       |       |

## Pliers & Wire Strippers

### Maxbite Curved Jaw Locking Pliers

- **MAXBITE JAW DESIGN**  
3X GRIPPING FORCE
- Torque lock faster setup and more force for locking tools
- MAXBITE jaw maximizes pressure points for round pipe, hex bolts, and many other locking tool applications
- Control release fast, easy, one-handed release
- Hardened jaws better grip force on jobsite material
- Forged alloy steel for maximum tool strength and durability



| Part # | Mfg #      | Overall Length | Price |
|--------|------------|----------------|-------|
| 221689 | 48-22-3610 | 10"            |       |

### TORQUE LOCK™ Straight Jaw Locking Pliers

- TORQUE LOCK™: Faster setup and easy release
- Straight Jaw: Maximizes contact points on job site work surfaces
- Hardened Jaws: Better grip force on job site material
- Forged Alloy Steel: For maximum tool strength and durability
- Rust Protection: Increases tool life by reducing corrosion



| Part # | Mfg #      | Overall Length | Price |
|--------|------------|----------------|-------|
| 168826 | 48-22-3507 | 7"             |       |
| 168825 | 48-22-3510 | 10"            |       |

### TORQUE LOCK Pliers

#### TORQUE LOCK™ Curved Jaw Locking Pliers with Durable Grip

- TORQUE LOCK™ Faster setup and easy release
- Curved Jaw: Maximizes pressure points for any bolt, nut or locking tool application
- Hardened Jaws: Better grip force on job site material
- Rust Protection: Increases tool life by reducing corrosion
- Overmold Grips: Durable and comfortable



| Part # | Mfg #      | Overall Length | Price |
|--------|------------|----------------|-------|
| 168835 | 48-22-3405 | 5"             |       |
| 168834 | 48-22-3407 | 7"             |       |
| 168827 | 48-22-3410 | 10"            |       |

#### TORQUE LOCK™ Curved Jaw Locking Pliers

- TORQUE LOCK™: Faster setup and easy release
- Curved Jaw: Maximizes pressure points for any bolt, nut or locking tool application
- Hardened Jaws: Better grip force on job site material
- Forged Alloy Steel: For maximum tool strength and durability
- Rust Protection: Increases tool life by reducing corrosion



| Part # | Mfg #      | Overall Length | Price |
|--------|------------|----------------|-------|
| 221690 | 48-22-3607 | 7"             |       |
| 168824 | 48-22-3420 | 10"            |       |

#### TORQUE LOCK™ Long Nose Locking Pliers With Durable Grip

- TORQUE LOCK™ Faster setup and easy release
- Curved Jaw: Maximizes pressure points for any bolt, nut or locking tool application
- Hardened Jaws: Better grip force on job site material
- Rust Protection: Increases tool life by reducing corrosion
- Overmold Grips: Durable and comfortable



| Part # | Mfg #      | Overall Length | Price |
|--------|------------|----------------|-------|
| 168838 | 48-22-3406 | 6"             |       |
| 168837 | 48-22-3409 | 9"             |       |

#### TORQUE LOCK™ Curved Jaw Locking Pliers Set

- Includes:  
(1) 7" TORQUE LOCK Curved Jaw Locking Pliers (48-22-3407)  
(1) 10" TORQUE LOCK™ Curved Jaw Locking Pliers (48-22-3410)



| Part # | Mfg #      | Overall Length | Price |
|--------|------------|----------------|-------|
| 168839 | 48-22-3402 | 7" & 10"       |       |

**Pliers & Wire Strippers**

Tools

**Pliers**  
**Water Pump Pliers**



- *Hardened and tempered for durability*



| Part # | Mfg # | Model | Description | Length | Price |
|--------|-------|-------|-------------|--------|-------|
| 008764 | 80475 | 734   | 2" Capacity | 10"    |       |

**Pliers & Wire Strippers**

**Milled Jaw Slip-Joint Pliers**

- Nickel-plated finish with plastic grips
- Angle-nose pliers have grip tight clip



306-10

| Part # | Mfg #  | Type | Size       | Max Opening | Price |
|--------|--------|------|------------|-------------|-------|
| 113964 | 306-10 | 10"  | Angle Nose | 1-1/2"      |       |

Tools

## Pliers & Wire Strippers

Tools

### Pliers

- Undercut tongue and groove design won't slip
- Patented reinforcing edge minimizes stress breakage
- CHANNELLOCK BLUE® grips for comfort

#### Smooth Jaw Tongue & Groove Pliers

- Smooth jaws for non-marring surfaces (PVC pipe, chromes, etc)
- Smooth jaw for use on plated fixtures
- PermaLock® fastener eliminates nut and bolt failure



| Part # | Mfg #   | Length | Capacity | Price |
|--------|---------|--------|----------|-------|
| 026715 | R116800 | 10"    | 2"       |       |

#### Straight Jaw Tongue & Groove Pliers

- High-carbon C1080 steel for superior performance on the job and electronic coating for ultimate rust prevention
- Right-angle, laser-heat treated teeth grip better and last longer
- PermaLock® fastener eliminates nut and bolt failure



R117200



R117400



R117600



R117800



R117900

| Part # | Mfg #   | Length  | Capacity | Price |
|--------|---------|---------|----------|-------|
| 076358 | R117200 | 6-1/2"  | 7/8"     |       |
| 008905 | R117400 | 9-1/2"  | 1-1/2"   |       |
| 008907 | R117600 | 10"     | 2"       |       |
| 008908 | R117800 | 12"     | 2-1/4"   |       |
| 109928 | R117900 | 16-1/2" | 4-1/4"   |       |

### V-Jaw Tongue & Groove Pliers

- High-carbon C1080 steel for superior performance on the job and electronic coating for ultimate rust prevention
- Right-angle, laser heat-treated teeth grip better and last longer
- V-Jaws give you more points of contact on round stock and tubing
- PermaLock® fastener eliminates nut and bolt failure



R118300



R118400

| Part # | Mfg #   | Length | Capacity | Price |
|--------|---------|--------|----------|-------|
| 008906 | R118300 | 9-1/2" | 1-1/2"   |       |

## Pliers & Wire Strippers

### Standard Side-Cutting Pliers

#### NE-Type Side-Cutting Pliers

- Plastic dipped handles
- Sure-gripping, cross-hatched knurled jaws



| Part # | Mfg #    | Overall Length | Jaw Length | Jaw Width | Price |
|--------|----------|----------------|------------|-----------|-------|
| 106804 | D201-7NE | 7-7/16"        | 1-9/32"    | 1-1/16"   |       |

### High Leverage Side-Cutting Pliers

#### NE-Type Side-Cutting Pliers - Streamlined Design

- Plastic dipped handles
- Streamlined design with sure-gripping, cross-hatched knurled jaws
- High leverage



| Part # | Mfg #    | Overall Length | Jaw Length | Jaw Width | Price |
|--------|----------|----------------|------------|-----------|-------|
| 106803 | D213-9NE | 9-1/4"         | 1-19/32"   | 1-1/4"    |       |

### High Leverage Diagonal-Cutting Pliers

#### Diagonal Cutter Pliers

- Plastic dipped handles
- High leverage



| Part # | Mfg #  | Overall Length | Jaw Length | Jaw Width | Price |
|--------|--------|----------------|------------|-----------|-------|
| 106806 | D228-7 | 7-1/8"         | 13/16"     | 1-3/16"   |       |

### Diagonal Angled Head Cutter Pliers

- Plastic dipped handles
- High leverage



| Part # | Mfg #    | Overall Length | Jaw Length | Jaw Width | Price |
|--------|----------|----------------|------------|-----------|-------|
| 106805 | D248-8 * | 8-1/16"        | 13/16"     | 1-3/16"   |       |

\* Semi-flush cuts Cherry Barrel rivets - for use on non-ferrous wire only

### Journeyman™ Diagonal Angled Head Cutter Pliers

- Dual material handles
- High leverage

**JOURNEYMAN**



| Part # | Mfg #  | Overall Length | Jaw Length | Jaw Width | Price |
|--------|--------|----------------|------------|-----------|-------|
| 112637 | J248-8 | 8-1/8"         | 13/16"     | 1-3/16"   |       |

### Needle-Nose Pliers

#### Standard Long-Nose Side-Cutting Pliers

- Plastic dipped handles
- Induction hardened, long-lasting cutting knives
- Knurled jaws for sure wrapping and looping



| Part # | Mfg #  | Overall Length | Jaw Length | Jaw Width | Price |
|--------|--------|----------------|------------|-----------|-------|
| 106807 | D203-6 | 6-5/8"         | 1-7/8"     | 11/16"    |       |

### Heavy-Duty Side-Cutting Long-Nose Pliers - Wire Stripping & Crimping

- Plastic dipped extended handles
- Cleanly strips 12 AWG wire
- Crimps connectors, lugs, and terminals
- Induction hardened cutting knives



| Part # | Mfg #     | Overall Length | Jaw Length | Jaw Width | Price |
|--------|-----------|----------------|------------|-----------|-------|
| 106808 | D203-8NCR | 8-5/8"         | 2-5/16"    | 1"        |       |

### Slip-Joint Pliers

#### Slip-Joint Pliers - Plastic Dipped Handles

- (2) Versatile jaw positions
- Serrated jaws
- Nickel-chrome plated



| Part # | Mfg #  | Overall Length | Jaw Length | Jaw Width | Price |
|--------|--------|----------------|------------|-----------|-------|
| 112647 | D511-6 | 6-1/2"         | 1-3/16"    | 1-3/16"   |       |

### Pump Pliers

#### Pump Pliers - Plastic Dipped Handles

- Secure tongue and groove design for non-slip grip
- Wide range of versatile jaw positions



| Part # | Mfg #   | Length  | Max    | Price |
|--------|---------|---------|--------|-------|
| 111629 | D502-6  | 6-1/2"  | 7/8"   |       |
| 106809 | D502-10 | 10"     | 1-3/4" |       |
| 106810 | D502-12 | 12-1/4" | 2-3/8" |       |

**Pliers & Wire Strippers**

Tools

**Wire Stripping & Cutting Tools**

**TripSaver® Combination Multi-Tool**

- High-carbon, rust-resistant stainless steel
- Lightweight, compact, sturdy
- Locking "L" handle snaps into "L" channel
- Includes:
  - Needle-nose pliers
  - Beveled wire cutter
  - Toothed pipe grippers
  - Files (coarse and fine)
  - 5-Slot wire stripper (10-18 AWG)
  - Wire-looping hole
  - Scraper
  - Awl/reamer
  - Serrated sheepfoot knife
  - Clip-point knife
  - Standard/metric ruler
  - Drywall saw
  - Locking "L" handle
  - #1 and #2 Phillips hex bits
  - (1) Small- and (2) large-slotted hex bits
  - 1/4" Socket adapter
  - Lanyard hole and nylon pouch



| Part # | Mfg # | Description                       | Price |
|--------|-------|-----------------------------------|-------|
| 111226 | 1016  | 5-3/4" Long, TripSaver Multi-Tool |       |

**Long-Nose Multi-Purpose Tool**

- Crimps insulated and non-insulated terminals and 7 to 8mm ignition terminals
- Long, curved cutting blade
- Cleanly shears bolts
- Plastic covered cushioned handles



| Part # | Mfg # | Strips & Cuts | Price |
|--------|-------|---------------|-------|
| 107642 | 1010  | 10 - 22 AWG   |       |

**Klein-Kurve™ Wire Stripper/Cutter**

- Precision shear-type blades
- Clean cuts on solid and stranded copper wire
- Markings on both sides
- Curved handles
- Wire looping and bending holes
- Coil spring provides fast self-opening action
- Precision-ground stripping holes
- Strong-gripping serrated nose
- Screw-shearing holes
- Handy closure lock for convenient storage
- Double dipped comfort grips



**KLEIN-KURVE**®

| Part # | Mfg # | Strips & Cuts               | Price |
|--------|-------|-----------------------------|-------|
| 106811 | 11055 | 10-18 Solid, 12-20 Stranded |       |



## Pliers & Wire Strippers

### Pliers

#### Tongue and Groove Pliers

- Right angle teeth
- Comfort grips
- Undercut tongue and groove - won't slip



**CHANNEL LOCK**

| Part # | Mfg #   | Description                  | Price |
|--------|---------|------------------------------|-------|
| 187740 | J40-401 | 6-1/2" Long, 7/8" Capacity   |       |
| 187741 | J40-402 | 9-1/2" Long, 1-1/2" Capacity |       |
| 041942 | J40-403 | 10" Long, 2" Capacity        |       |
| 041943 | J40-404 | 12" Long, 2-1/4" Capacity    |       |

#### Tongue and Groove Pliers with Smooth Jaw

- Channel lock no. 415
- Smooth jaws for non-marring surfaces (PVC, chromes, etc)
- Undercut tongue and groove  
Comfort grips



| Part # | Mfg #   | Description                   | Price |
|--------|---------|-------------------------------|-------|
| 187742 | J40-406 | 10" Channel Lock. 2" Capacity |       |

## Pliers & Wire Strippers

Tools

### Wire Strippers

#### 7" Wire Stripper

- *Comfortable grip*
- *Quick ID with easy-to-read size markings*



| Part # | Mfg #   | Description       | Price |
|--------|---------|-------------------|-------|
| 174618 | 1885426 | 7" Wire Strippers |       |

### Pliers

#### Quick-Adjusting Tongue & Groove Pliers

- *Comfortable grip*
- *Push button allows for quick adjustments while multiple grooves guarantee precise positioning*
- *Machined jaws increase grip on the material*



| Part # | Mfg #   | Description | Price |
|--------|---------|-------------|-------|
| 174615 | 1890996 | 8" Pliers   |       |
| 174616 | 1890997 | 10" Pliers  |       |

## Power Tools - M12 and Misc

### M12™ Cordless Tools

#### M12™ Cordless 3/8" Right Angle Drill Driver

- No load speed: 0 to 800 rpm
- Clutch settings: 11+ Drill
- Chuck type: 3/8" single sleeve
- Head length/weight: 3-3/4"/2.4 lbs
- Kit Includes:
  - M12™ 3/8" Right angle drill driver
  - M12™ Lithium-Ion battery
  - 30-Minute charger
  - Soft carrying case



| Part # | Mfg #   | Description | Price |
|--------|---------|-------------|-------|
| 160481 | 2415-20 | Bare Tool   |       |
| 137547 | 2415-21 | Tool Kit    |       |

#### M12™ Cordless Lithium-Ion No-Hub Driver

- Kit Includes:
  - (1) M12™ Cordless No-Hub Driver (2455-20)
  - (2) M12™ REDLITHIUM™ Battery (48-11-2401)
  - (1) M12™ Lithium-ion Battery Charger (48-59-2401)
  - (1) SHOCKWAVE™ 1-7/8" MAG NUTDRIVER 1/4" (49-66-4502)
  - (1) SHOCKWAVE™ 1-7/8" MAG NUTDRIVER 5/16" (49-66-4503)
  - (1) SHOCKWAVE™ 1-7/8" MAG NUTDRIVER 3/8" (49-66-4505)
  - (1) Carrying Case
  - (3) SHOCKWAVE™ Sockets



| Part # | Mfg #   | Description | Price |
|--------|---------|-------------|-------|
| 137555 | 2455-22 | Kit         |       |

#### SDS Demolition Hammer

- 14 Amp motor
- Heavy-duty construction
- Variable-speed dial
- AVS Anti-Vibration system
- Service reminder light
- Lock-on trigger
- Kit includes:
  - (1) 2" SDS Max Demo Hammer
  - (2) Auxiliary handle
  - (1) Carrying case



| Part # | Mfg #   | Description | Price |
|--------|---------|-------------|-------|
| 237268 | 5339-21 | Kit         |       |

#### M12™ 3/8" Hammer Drill/Driver Kit

- Delivers up to 275 in lbs of Torque
- On-board battery fuel gauge displays remaining run time
- New ergonomic handle design for increased comfort
- Metal ratcheting chuck for maximum durability
- Includes:
  - (1) M12™ 3/8" Hammer drill/driver (Bare Tool) (2408-20)
  - (2) M12™ REDLITHIUM™ battery (48-11-2401)
  - (1) M12™ Lithium-ion battery charger (48-59-2401)
  - (1) Belt clip
  - (1) Carrying case



| Part # | Mfg #   | Description | Price |
|--------|---------|-------------|-------|
| 162002 | 2408-20 | Bare Tool   |       |
| 161649 | 2408-22 | Kit         |       |

#### M12™ 3/8" Drill/Driver

- Delivers up to 275 in-lbs of torque
- On-board battery fuel gauge displays remaining run time
- Metal ratcheting chuck for maximum durability
- Kit Includes:
  - (1) M12™ 3/8" Drill/Driver (bare tool) (2407-20)
  - (1) M12™ REDLITHIUM Battery (48-11-2401)
  - (1) M12™ Lithium-ion battery charger (48-59-2401)
  - (1) Belt clip
  - (1) Carrying case



| Part # | Mfg #   | Description | Price |
|--------|---------|-------------|-------|
| 162001 | 2407-20 | Bare Tool   |       |
| 162000 | 2407-22 | Kit         |       |

## Power Tools - M12 and Misc

Tools

### M12 FUEL™ 1/2" Drill/Driver

- POWERSTATE™ Brushless motor
- REDLITHIUM™ Battery technology
- REDLINK Plus™ Intelligence
- Kit Includes:
  - (1) M12 FUEL™ 1/2" Drill/Driver (2403-20)
  - (1) M12 REDLITHIUM™ 2.0 Compact battery pack (48-11-2420)
  - (1) M12™ REDLITHIUM™ XC 4.0 extended capacity battery pack (48-11-2440)
  - (1) M12™ Lithium-ion battery charger (48-59-2401)
  - (1) Belt clip
  - (1) Carrying case



| Part # | Mfg #   | Description | Price |
|--------|---------|-------------|-------|
| 172508 | 2403-20 | Bare Tool   |       |
| 165720 | 2403-22 | Kit         |       |

### M12™ Cordless Rotary Tool

- Kit Includes:
  - M12™ Rotary tool (2460-20)
  - (1) REDLITHIUM™ Battery (48-11-2401)
  - (5) Cutting wheels, mandrel
  - Wrench
  - 30-Minute charger



| Part # | Mfg #   | Description | Price |
|--------|---------|-------------|-------|
| 162782 | 2460-20 | Bare Tool   |       |
| 144497 | 2460-21 | Kit         |       |

### M12™ 1/4" Hex 2-Speed Screwdriver

- Delivers up to 275 in-lbs of torque
- On-board battery fuel gauge displays remaining run time
- New ergonomic handle design for increased comfort
- 1/4" Hex quick change chuck for one-handed bit changes
- Kit Includes:
  - (1) M12™ 1/4" Hex 2-speed screwdriver (2406-20)
  - (2) M12™ REDLITHIUM™ battery (48-11-2401)
  - (1) M12™ Lithium-ion battery charger (48-59-2401)
  - (1) Belt clip
  - (1) Carrying case



| Part # | Mfg #   | Description | Price |
|--------|---------|-------------|-------|
| 162004 | 2406-20 | Bare Tool   |       |
| 162003 | 2406-22 | Kit         |       |

### M12 FUEL™ 1/4" Hex 2-Speed Screwdriver

- POWERSTATE™ Brushless motor
- REDLITHIUM™ Battery technology
- REDLINK Plus™ Intelligence



| Part # | Mfg #   | Description | Price |
|--------|---------|-------------|-------|
| 165722 | 2402-22 | Kit         |       |

### M12™ 1/4" Hex Screwdriver

- Quick one-handed bit-loading
- Variable speed trigger
- No load speed: 0 to 500 rpm
- Kit Includes:
  - M12™ Screwdriver (2401-20)
  - (2) 12V Lithium-ion batteries
  - 12V Charger
  - Compact driver storage bag
  - 5-Year warranty



| Part # | Mfg #   | Description | Price |
|--------|---------|-------------|-------|
| 137546 | 2401-22 | Kit         |       |

### M12™ 1/4" Hex Impact Driver Kit

- 1,000 in-lbs of torque
- 0-2,500 RPM
- On-board battery fuel gauge
- Kit Includes:
  - (1) M12™ 1/4" Hex impact driver (2462-20)
  - (1) M12™ REDLITHIUM™ battery (48-11-2401)
  - (1) M12™ Lithium-ion battery charger (48-59-2401)
  - (1) Belt clip
  - (1) Carrying case



| Part # | Mfg #   | Description | Price |
|--------|---------|-------------|-------|
| 160215 | 2462-20 | Bare Tool   |       |
| 160216 | 2462-22 | Kit         |       |

## Power Tools - M12 and Misc

### M12™ 1/4" Hex Right Angle Impact Driver

- Offers users maximum access for hard-to-reach fastener
- Provides the most power and highest RPM in its class
- Part of the M12 System, featuring over 70 tools
- Best-in-class power and speed with 600 in. lbs. of torque and 0 - 2,150 RPM
- Variable speeds provides maximum control for any job
- Extended paddle switch for multiple grip positions



| Part # | Mfg #   | Description | Price |
|--------|---------|-------------|-------|
| 188323 | 2467-20 | Bare Tool   |       |
| 219059 | 2467-21 | Kit         |       |

### M12™ 1/4" Impact Wrench Kit

- Lightweight, compact design
- On-board battery fuel gauge
- 1/4" anvil with friction ring
- Kit Includes:
  - (1) M12™ 1/4" Impact wrench (2461-20)
  - (2) M12™ REDLITHIUM™ battery (48-11-2401)
  - (1) M12™ Lithium-ion battery charger (48-59-2401)
  - (1) Belt clip
  - (1) Carrying case



| Part # | Mfg #   | Description | Price |
|--------|---------|-------------|-------|
| 162010 | 2461-20 | Bare Tool   |       |
| 162009 | 2461-22 | Kit         |       |

### M12 FUEL™ 1/4" Impact Wrench

- POWERSTATE™ Brushless motor
- REDLITHIUM™ 2.0 Battery REDLINK Plus™ Intelligence
- DRIVE CONTROL™
- Kit Includes:
  - (1) M12 FUEL™ 1/4" Impact wrench (2452-20)
  - (2) M12 REDLITHIUM™ 2.0 Compact battery pack (48-11-2420)
  - (1) M12™ Lithium-ion battery charger (48-59-2401)
  - (1) Belt clip
  - (1) Carrying case



| Part # | Mfg #   | Description | Price |
|--------|---------|-------------|-------|
| 165719 | 2452-22 | Kit         |       |

### M12 FUEL™ 3/8" Impact Wrench

- POWERSTATE™ Brushless motor
- REDLITHIUM™ 2.0 Battery REDLINK Plus™ Intelligence
- DRIVE CONTROL™



| Part # | Mfg #   | Description | Price |
|--------|---------|-------------|-------|
| 238273 | 2454-20 | Bare Tool   |       |
| 165718 | 2454-22 | Kit         |       |

### M12™ 3/8" Impact Wrench Kit

- 1,200 in-lbs of torque
- On-board battery fuel gauge
- 3/8" anvil with friction ring
- Kit Includes:
  - (1) M12™ 3/8" Impact wrench (2463-20)
  - (2) M12™ REDLITHIUM™ battery (48-11-2401)
  - (1) M12™ Lithium-ion battery charger (48-59-2401)
  - (1) Belt clip
  - (1) Carrying case



| Part # | Mfg #   | Description | Price |
|--------|---------|-------------|-------|
| 162008 | 2463-20 | Bare Tool   |       |
| 162006 | 2463-22 | Kit         |       |

### M12 FUEL™ 5/8" SDS Plus Rotary Hammer Kit

- REDLINK™ Intelligence
- REDLITHIUM™ Battery technology
- Electro pneumatic mechanism
- Delivers 0-900 RPM and 0-6,200 BPM for superior performance
- Compact, lightweight design
- 2-Mode operation
- LED light: Illuminates the work surface



| Part # | Mfg #     | Description | Price |
|--------|-----------|-------------|-------|
| 228736 | 2416-20   | Bare Tool   |       |
| 165721 | 2416-22XC | Kit         |       |

## Power Tools - M12 and Misc

Tools

### M12™ Cordless Ratchet

- Torque: 30 ft-lbs
- Speed: 250 rpm
- Anvil: 1/4" ball detent
- Kit includes:
  - M12™ Ratchet
  - (1) M12™ REDLITHIUM™ battery
  - 30-Minute charger
  - Carrying case



| Part # | Mfg #   | Description | Size | Price |
|--------|---------|-------------|------|-------|
| 143704 | 2456-20 | Bare Tool   | 1/4" |       |
| 143703 | 2456-21 | Kit         | 1/4" |       |
| 143706 | 2457-20 | Bare Tool   | 3/8" |       |
| 143705 | 2457-21 | Kit         | 3/8" |       |

### M12™ Hackzall™ Cordless Reciprocating Saw

- 11" Long and 2.6 lbs for cutting in tight spaces
- 1/2" Stroke, 0 to 3,000 strokes per minute
- All-metal gear case
- Variable speed trigger
- Battery fuel gauge
- QUIK-LOK™ blade clamp
- Built-in LED light illuminates work surface
- Accepts both Hackzall™ and Sawzall® style blades
- Kit includes:
  - Hackzall™ (2420-20)
  - 30-Minute charger
  - (2) Hackzall™ blades
  - Carrying case



| Part # | Mfg #   | Description | Price |
|--------|---------|-------------|-------|
| 146874 | 2420-20 | Bare Tool   |       |
| 137550 | 2420-21 | Kit         |       |

### M12™ Cordless PVC Shear Kit

- Ultra sharp blade with pierce point
- Offset blade cuts PVC/PEX in-wall, in-ground, or close to wall
- Quick return blade
- All metal planetary drive
- Stainless steel blade and aluminum jaw
- Variable speed trigger
- Impact, water and rust resistant
- On board fuel gauge - displays remaining run-time
- Torque: 1,900 in-lbs
- Kit Includes:
  - M12™ Cordless PVC shear (2470-20)
  - (1) Lithium-Ion battery
  - 30-Minute charger
  - Carrying case



| Part # | Mfg #   | Description | Price |
|--------|---------|-------------|-------|
| 152547 | 2470-20 | Bare Tool   |       |
| 137552 | 2470-21 | Kit         |       |

### M12™ Cordless Grease Gun

- Maximum operating pressure: 8,000 psi
- Grease capacity: 14 oz cartridge/16 oz bulk
- Kit Includes:
  - M12™ Grease gun (2446-20)
  - M12™ XC REDLITHIUM™ battery
  - 60-Minute charger
  - 36" High pressure flex hose with spring guard
  - Grease coupler
  - Carrying case



| Part # | Mfg #     | Description | Price |
|--------|-----------|-------------|-------|
| 224896 | 2446-20   | Bare Tool   |       |
| 141426 | 2446-21XC | Kit         |       |

### M12™ 600 MCM Cable Cutter Kit

- Powerful open jaws: Cut effortlessly through 600 MCM copper and 750 MCM aluminum
- REDLITHIUM™ Battery technology:
- Auto release lever: Cut, reload and quickly repeat for maximum productivity
- 2-Speed gear box:
- Built-in LED light: Illuminates the line of cut



| Part # | Mfg #     | Description | Price |
|--------|-----------|-------------|-------|
| 177727 | 2472-21XC | Kit         |       |

## Power Tools - M12 and Misc

### M12™ Cordless LITHIUM-ION Multi-Tool

- Cuts, grinds, sands and scrapes
- Variable speed dial
- On board fuel gauge displays run time
- Runs 5,000 to 20,000 OPM
- Kit includes:
  - Cordless multi-tool
  - Accessory adapter
  - Wood cutting blade
  - (1) REDLITHIUM™ battery
  - 30-Minute charger
  - Contractor bag



| Part # | Mfg #   | Description | Price |
|--------|---------|-------------|-------|
| 150059 | 2426-20 | Bare Tool   |       |
| 143165 | 2426-21 | Kit         |       |

### M12™ Cordless Multi-Tool

- Cuts, grinds, sands and scrapes
- Variable speed dial
- On board fuel gauge displays run time
- Runs 5,000 to 20,000 OPM
- Kit Includes:
  - Cordless multi-tool
  - Accessory adapter
  - Wood cutting blade
  - Sanding pad
  - (5) Assorted sanding sheets
  - (2) REDLITHIUM™ batteries
  - 30-Minute charger
  - Contractor bag



| Part # | Mfg #   | Description | Price |
|--------|---------|-------------|-------|
| 139011 | 2426-22 | Kit         |       |

### M12™ Soldering Iron Kit

- 18 Second heat up time
- LED work light
- 3-Stop pivoting head
- 750° Max temperature
- 90W heater
- Kit includes
  - Pointed tip
  - Chisel tip
  - M12™ Soldering iron (2488-20)
  - M12 Charger and carrying case
  - M12™ REDLITHIUM compact battery pack



| Part # | Mfg #   | Description | Price |
|--------|---------|-------------|-------|
| 241854 | 2488-21 | Kit         |       |
| 244358 | 2488-20 | Bare Tool   |       |

### M12™ Cordless 2-Tool Combo Kit

- 1/4" Hex screwdriver delivers 150 in-lbs of torque, 15 position clutch, and 0 to 500 rpm
- Hackzall™ reciprocating saw delivers 0 to 3000 spm
- Kit includes:
  - Screwdriver (2401-20)
  - Hackzall™ Reciprocating saw (2420-20)
  - (2) M12™ Lithium-Ion batteries
  - 30-Minute charger
  - (2) Hackzall™ blades
  - Contractor bag



| Part # | Mfg #   | Description | Price |
|--------|---------|-------------|-------|
| 137556 | 2490-22 | Combo Kit   |       |

### M12 FUEL™ 2-Tool Combo Kit

- Kit includes:
  - (1) M12 FUEL™ 1/2" Drill/Driver (2403-20)
  - (1) M12 FUEL™ 1/4" Hex Impact Driver (2453-20)
  - (1) M12 REDLITHIUM™ 2.0 Battery (48-11-2420)
  - (1) M12™ REDLITHIUM™ XC 4.0 Extended Capacity Battery Pack (48-11-2440)
  - (1) M12™ Lithium-ion Battery Charger (48-59-2401)
  - (2) Belt Clip
  - (1) Carrying Case



| Part # | Mfg #   | Description | Price |
|--------|---------|-------------|-------|
| 186086 | 2594-22 | Combo Kit   |       |

### M12 FUEL™ 2-Tool Combo Kit (1/2" Hammer Drill, 1/4" Hex Impact Driver)

- Kit includes:
  - (1) M12 FUEL™ 1/2" Drill/Driver (2503-20)
  - (1) M12 FUEL™ 1/4" Hex Impact Driver
  - (1) M12 REDLITHIUM™ Battery
  - (2) Belt Clip
  - (1) Contractor Bag



| Part # | Mfg #   | Description | Price |
|--------|---------|-------------|-------|
| 244456 | 2598-22 | Combo Kit   |       |

## Power Tools - M12 and Misc

Tools

### M12™ Cordless LITHIUM-ION 2-Tool Combo Kit

- Kit Includes:
  - M12™ 3/8" Hammer Drill/Driver
  - M12™ 1/4" Hex Impact Driver
  - REDLITHIUM Battery



| Part # | Mfg #   | Description | Price |
|--------|---------|-------------|-------|
| 163696 | 2497-22 | Kit         |       |

### M12™ Cordless 2-Tool Combo Kit

- Kit Includes:
  - 3/8" Drill driver (2410-20)
  - 1/4" Hex impact driver (2450-20)
  - (2) M12™ REDLITHIUM™ Batteries (48-11-2401)
  - 30-Minute charger (48-59-2401)
  - Contractor bag



| Part # | Mfg #   | Description | Price |
|--------|---------|-------------|-------|
| 137558 | 2494-22 | Combo Kit   |       |

### M12™ Cordless 4-Tool Combo Kit

- Hackzall™ reciprocating saw delivers 0 to 3000 spm
- Copper tubing cutter adjusts to cut 3/8" to 1" copper
- Work light illuminates large work area with 90° rotating head and integrated magnet



- Kit Includes:
  - Screwdriver (2401-20)
  - Hackzall™ reciprocating saw (2420-20)
  - Copper tubing cutter (2471-20)
  - Work light (49-24-0145)
  - (2) 12V Lithium-Ion battery packs
  - 30-Minute charger
  - (2) Hackzall™ blades
  - Contractor bag

| Part # | Mfg #   | Description | Price |
|--------|---------|-------------|-------|
| 138377 | 2490-24 | Combo Kit   |       |

### M12™ Cordless 2-Tool Combo Kit (1)

- Kit Includes:
  - 1/4" Hex Impact driver (2450-20)
  - Hackzall™ Reciprocating saw (2420-20)
  - (2) Lithium-Ion batteries
  - 30-Minute charger
  - Contractor bag



| Part # | Mfg #   | Description | Price |
|--------|---------|-------------|-------|
| 139268 | 2491-22 | Combo Kit   |       |

### M12 Fuel™ Cordless Tools

#### M12™ FUEL 1/2" Drill/Driver

- Most capable, lightest weight, most compact
- 1/2" All metal chuck for maximum grip and bit retention
- E-Clutch for consistent repeatability
- 1700 RPMs for faster drilling speeds
- 350 in lbs of peak torque



| Part # | Mfg #   | Description | Price |
|--------|---------|-------------|-------|
| 244564 | 2503-20 | Bare Tool   |       |
| 244562 | 2503-22 | Kit         |       |

#### M12 FUEL™ 1/2" Hammer Drill Kit

- Most capable, lightest weight, most compact
- 1/2" All metal chuck for maximum grip and bit retention
- E-Clutch for consistent repeatability
- 1700 RPMS for faster drilling speeds
- 350 in lbs of peak torque



| Part # | Mfg #   | Description | Price |
|--------|---------|-------------|-------|
| 244567 | 2504-20 | Bare Tool   |       |
| 244566 | 2504-22 | Kit         |       |



## Power Tools - M12 and Misc

### M12 FUEL™ 1/2" Hammer Drill/Driver Kit

- POWERSTATE™ Brushless motor
- REDLINK Plus™ Intelligence
- REDLITHIUM™ Battery technology
- Kit Includes:
  - (1) M12 FUEL™ 1/2" hammer drill/driver (2404-20)
  - (1) M12 REDLITHIUM™ 2.0 compact battery pack (48-11-2420)
  - (1) M12™ REDLITHIUM™ XC 4.0 extended capacity battery pack (48-11-2440)
  - (1) M12™ Lithium-ion battery charger (48-59-2401)
  - (1) Belt clip
  - (1) Carrying case



| Part # | Mfg #   | Description | Price |
|--------|---------|-------------|-------|
| 154724 | 2404-22 | Kit         |       |

### M12 FUEL™ 1/4" Hex Impact Driver Kit

- Most Compact
- 4-Mode Drive Control
- POWERSTATE brushless motor
- REDLINK PLUS intelligence
- REDLITHIUM batteries
- 4-mode drive control provides greater control over output speed and power



| Part # | Mfg #   | Description | Price |
|--------|---------|-------------|-------|
| 244569 | 2553-20 | Bare Tool   |       |
| 244568 | 2553-22 | Kit         |       |

### M12 FUEL™ 1/4" Hex Impact Driver

- POWERSTATE™ Brushless motor
- REDLITHIUM™ 2.0 Battery technology
- REDLINK Plus™ Intelligence
- DRIVE CONTROL™
- Kit Includes:
  - (1) M12 FUEL™ 1/4" hex impact driver (2453-20)
  - (2) M12 REDLITHIUM™ 2.0 compact battery pack (48-11-2420)
  - (1) M12™ Lithium-ion battery charger (48-59-2401)
  - (1) Belt clip
  - (1) Carrying case



| Part # | Mfg #   | Description | Price |
|--------|---------|-------------|-------|
| 159974 | 2453-20 | Bare Tool   |       |
| 154725 | 2453-22 | Kit         |       |

### M12 FUEL™ 2-Tool Combo Kit: 1/2" Drill Driver and 1/4" Hex Impact Driver

- Most Capable 12V Drill
- Lightest Weight in its class
- Most Compact in its class
- 1/2" All Metal chuck for maximum grip and bit retention
- E-Clutch for consistent repeatability in driving applications
- 1700 RPMs for faster drilling speeds
- 350 in.lbs of peak torque



| Part # | Mfg #   | Description | Price |
|--------|---------|-------------|-------|
| 244570 | 2596-22 | Kit         |       |

### M12 FUEL™ HACKZALL® Recip Saw Kit

- One-handed design
- Compact size
- POWERSTATE™ brushless motor
- REDLINK PLUS™ Intelligence
- REDLITHIUM™ XC 4.0 Battery pack



| Part # | Mfg #     | Description | Price |
|--------|-----------|-------------|-------|
| 166203 | 2520-20   | Bare Tool   |       |
| 166202 | 2520-21XC | Kit         |       |

### M12 FUEL™ Circular Saw



| Part # | Mfg #     | Description       | Price |
|--------|-----------|-------------------|-------|
| 220202 | 2530-20   | Bare Tool, 5-3/8" |       |
| 185807 | 2530-21XC | Kit, 5-3/8"       |       |

### M12™ Cordless LITHIUM-ION 4-Tool Combo Kit

- Kit Includes:
  - (1) M12™ 3/8" Drill/Driver (bare tool) (2407-20)
  - (1) M12™ HACKZALL® Recip saw (bare tool) (2420-20)
  - (1) M12™ 1/4" Hex impact driver (bare tool) (2462-20)
  - (2) M12™ REDLITHIUM™ Battery (48-11-2401)
  - (1) M12™ Lithium-ion battery charger (48-59-2401)
  - (1) M12™ Work light (49-24-0145)
  - (1) Contractor bag



| Part # | Mfg #   | Description | Price |
|--------|---------|-------------|-------|
| 159666 | 2498-24 | Combo Kit   |       |

## Power Tools - M12 and Misc

Tools

### M12 FUEL™ 1/4" Ratchet Tool

- Torque: 40ft-lbs
- Recessed head profile
- Pneumatic ratchet performance
- Delivers 250 RPM
- REDLINK PLUS™
- REDLITHIUM™ Battery
- Variable speed metal trigger
- LED light illuminates the work area



| Part # | Mfg #   | Description    | Price |
|--------|---------|----------------|-------|
| 240413 | 2556-20 | Bare Tool 1/4" |       |
| 240414 | 2556-22 | Kit 1/4"       |       |

### M12™ Fuel Cordless Ratchet

- Torque: 55ft-lbs
- Speed: 250 rpm
- LED light
- REDLINK PLUS™
- REDLITHIUM™ batteries
- POWERSTATE™ brushless motor



| Part # | Mfg #   | Description | Size | Price |
|--------|---------|-------------|------|-------|
| 241820 | 2557-20 | Bare Tool   | 3/8" |       |
| 240746 | 2557-22 | Kit         | 3/8" |       |

### M12™ Rivet Tool

- Pull Up to 3/16" Stainless Steel Rivets
- 450 1/8" Steel Rivets per charge
- Aluminum, Steel, Stainless Steel - Capacity
- Part of 90+ Solutions on the M12 Platform
- 450 1/8" Steel Rivets per charge
- Pull 3/32", 1/8", 5/32", 3/16" Rivet
- 0.8" Stroke Length
- 2,000 lbs. pulls force
- Tool holds rivet in any orientation



| Part # | Mfg #   | Description | Price |
|--------|---------|-------------|-------|
| 247116 | 2550-20 | Bare Tool   |       |
| 247118 | 2550-22 | Kit         |       |

### M12™ Miscellaneous Tools

#### M12™ Caulk and Adhesive Gun

- 30 Minutes charge time
- Kit includes:
  - (1) M12™ 10oz. Caulk and Adhesive Gun (Bare Tool) (2441-20)
  - (1) 3/8" Hollow Shaft Nut Driver (48-22-2424)
  - (1) 3/8" Hollow Shaft Nut Driver (48-22-2424)



| Part # | Mfg #   | Description | Price |
|--------|---------|-------------|-------|
| 158760 | 2441-20 | Bare Tool   |       |
| 232433 | 2441-21 | Kit         |       |

#### M12™ Sausage Style Caulk and Adhesive Gun

- 20 oz Aluminum barrel
- Kit Includes:
  - 12V 20oz Sausage conversion kit (48-08-0905)
  - M12 Lithium-ion battery charger (48-59-2401)
  - M12 REDLITHIUM Battery (48-11-2401)



| Part # | Mfg #   | Description | Price |
|--------|---------|-------------|-------|
| 243478 | 2442-21 | Kit         |       |

#### M12™ Cordless Palm Nailer

- 12V
- REDLITHIUM™ technology
- REDLINK™ Intelligence
- On-board fuel gauge
- Build-in LED light
- Industrial-duty collet: 6D-16D magnetic collet provides secure hold for one-handed tool use



| Part # | Mfg #   | Description | Price |
|--------|---------|-------------|-------|
| 242609 | 2458-20 | Bare Tool   |       |

#### M12™ Compact Inflator

- Includes: Ball inflation needle, Presta chuck, Schrader chuck, Inflator nozzle
- TrueFill™ auto shut-off technology increases accuracy, protects from over-temp and over-fill
- Illuminated digital gauge with target and current pressure reading
- Inflates car, LT truck, and compact equipment tires
- High efficiency pump & motor for true 120PSI capability



| Part # | Mfg #   | Description | Price |
|--------|---------|-------------|-------|
| 245947 | 2475-20 | Bare Tool   |       |

## Power Tools - M12 and Misc

### M12™ Miscellaneous Tools (Continued)

#### M12™ Compact Inflator

| Part # | Mfg #     | Description | Price |
|--------|-----------|-------------|-------|
| 246162 | 2475-21XC | Kit         |       |

#### M12™ Crown Stapler

- Kit includes:
  - (1) M12 3/8" Crown Stapler (2447-20)
  - (1) M12™ REDLITHIUM™ Battery (48-11-2401)
  - (1) M12™ Lithium-ion Battery Charger (48-59-2401)



| Part # | Mfg #   | Description | Price |
|--------|---------|-------------|-------|
| 238190 | 2447-20 | Bare Tool   |       |
| 238191 | 2447-21 | Kit         |       |

#### M12™ 160 x 120 Thermal Imager Kit

- 30-Minute charge time
- 4-Hour battery life
- Knurled focus ring
- 3.5" High resolution LCD
- 4" Minimum focus distance
- Hinged camera style lens
- Raised corners protect the LCD and thermal engine if dropped
- Complete report software
- Broader temperature range —14 to 662°F
- REDLITHIUM™ batteries
- Built-in visual camera & flashlight
- Auto and manual ranging
- Iron, rainbow, and gray color pallets
- Data storage: 2GB SD card
- All thermal and visual images use standard JPEG format for use in any program



| Part # | Mfg #   | Display Resolution | Price |
|--------|---------|--------------------|-------|
| 144777 | 2260-21 | 160 x 120 Pixels   |       |

### M-Spector™ Inspection Scope Kit

- 2.7" LCD display
- Four surround LED lights
- 3 ft enhanced cable
- Kit Includes:
  - (1) M-Spector™ Scope Kit
  - (1) Pipe guide attachment
  - (1) 9V Battery
  - (1) Carrying case



| Part # | Mfg #   | Description | Price |
|--------|---------|-------------|-------|
| 229565 | 2309-20 | Kit         |       |

### M12™ M-Spector Flex™ 9FT Inspection Camera Cable Kit

- Kit Includes:
  - (1) M12™ M-SPECTOR FLEX™ 9' FT Inspection Camera
  - (1) M12™ REDLITHIUM™ CP1.5 Battery Pack (48-11-2401)
  - (1) M12™ Lithium-ion Battery Charger (48-59-2401)
  - (1) USB Cable
  - (1) SD Card
  - (1) Carrying Case



| Part # | Mfg #   | Description | Price |
|--------|---------|-------------|-------|
| 228027 | 2316-21 | Kit         |       |

### M12™ M-Spector 360™ Rotating Inspection Scope

- Rotating display allows user to orient the image without having to fight the cable
- 640 x 480 Digital image sensor
- (4) LED lights
- Display: 2.7" LCD
- 9mm Aluminum head
- 3' Cable
- Kit Includes:
  - M-Spector 360™ console
  - M12™ REDLITHIUM™ battery
  - 30 Minute charger
  - Hook, magnet and mirror attachments
  - Carrying case



| Part # | Mfg #   | Description    | Price |
|--------|---------|----------------|-------|
| 148602 | 2313-21 | Kit            |       |
| 155645 | 2314-21 | Kit, 9Ft Cable |       |

## Power Tools - M12 and Misc

Tools

### SUB-SCANNER™ M12™ Detection Tool

- Measures depth and location of Rebar up to 6" through concrete
- Detects location of wood and metal studs
- Differentiates between steel and copper or aluminum metals
- Intuitive user interface displays stud centers and edges
- High contrast white on black display and back light for easy reading
- Rugged over-molding improves durability and user grip
- One button calibration for all surfaces



| Part # | Mfg #   | Description | Price |
|--------|---------|-------------|-------|
| 153058 | 2291-20 | Bare Tool   |       |

### Drills

#### 3/8" Pistol Drill

- 8 Amp motor
- 120VAC Only
- Keyless, metal chuck type
- All metal gear case
- Soft grip handle and 2-finger trigger
- 8' Cord
- Kit Includes:
  - 3/8" Drill
  - Side handle



| Part # | Mfg #   | No Load RPM | Price |
|--------|---------|-------------|-------|
| 139060 | 0240-20 | 0 - 2,800   |       |

#### SDS Plus Rotary Hammer Kit



| Part#  | Mfg#    | Description | Size   | Price |
|--------|---------|-------------|--------|-------|
| 164855 | 5263-21 | Kit         | 5/8"   |       |
| 219770 | 5268-21 | Kit         | 1-1/8" |       |

### 1-9/16" Spline Rotary Hammer

- Powerful 10.5 amp motor: Delivers 450RPM and 3,000 BPM
- Powerful hammer mechanism
- CPT™- Constant power technology Mechanical clutch
- 2-Mode operation: Rotary hammer and hammer only
- 12-Position chipping adjustment



| Part # | Mfg #   | Description | Price |
|--------|---------|-------------|-------|
| 153749 | 5316-21 | Kit         |       |

### 1-9/16" SDS Max Rotary Hammer

- Powerful 10.5 Amp motor: Delivers 450 RPM and 3,000BPM
- Powerful hammer mechanism
- CPT™- Constant power technology
- Mechanical clutch
- 2-mode operation: Rotary hammer and hammer only
- 12-Position chipping adjustment: Allows the user to maintain the desired hammer position while chipping in any orientation



| Part # | Mfg #   | Description | Price |
|--------|---------|-------------|-------|
| 159786 | 5317-21 | Kit         |       |

### 1/2" D-Handle Drill

- 0-500 RPM
- 7.0 Amp motor
- Torque: Offers 1/2" capacity in steel
- Heavy-Duty keyed chuck w/ holder
- QUIK-LOK® Cord: 8ft, 3-wire ground rubber cord



| Part # | Mfg #  | No Load RPM | Price |
|--------|--------|-------------|-------|
| 242791 | 1107-6 | 0-500       |       |

## Power Tools - M12 and Misc

### 2" SDS Max Rotary Hammer

- 15-Amp motor, 120V AC
- 19.9 ft-lbs of blow energy
- D-handle style
- Variable-speed dial
- Service reminder light
- Double insulated cord type
- Vibration isolation system
- No load speed: 125-250
- No load BPM: 975-1,950
- 6" Thick wall core bit capacity
- Drilling mode: Rotary hammer & hammer only



| Part # | Mfg #   | No Load RPM | Price |
|--------|---------|-------------|-------|
| 221333 | 5342-21 | 125-250     |       |

### 1/2" Hole Hawg® Drill 900 RPM

- Powerful 7.5-amp motor: Delivers 900 RPM with reverse
- Selffeed bit capacity: Handles up to a 2-9/16"
- Reinforced nylon resin casing
- Kit Includes:
  - (1) 1/2" Hole Hawg® Drill 900RPM (1670-1)
  - (1) Pipe handle



| Part # | Mfg #  | Description | Price |
|--------|--------|-------------|-------|
| 224919 | 1670-1 | Kit         |       |

### 3/4" Large Drill, 350 RPM

- Powerful 10.0-amp motor. Delivers up to 350RPM with reverse
- Torque: Offers 3/4" capacity in steel
- Heat-treated gears: Helical-cut for quiet performance
- 8-ft fixed rubber cord
- Includes:
  - (1) 3/4" Large Drill (1854-1)
  - (1) Pipe Handle



| Part # | Mfg #  | Description                  | Price |
|--------|--------|------------------------------|-------|
| 151479 | 1854-1 | 1854-1 3/4" 120V 350RP Drill |       |

### 1/2" Magnum® Drill

- Motor: 120VAC 8A
- 360° Locking side handle
- Chuck key with holder
- 8' Cord



| Part # | Mfg #   | No Load RPM | Price |
|--------|---------|-------------|-------|
| 139067 | 0299-20 | 0 - 850     |       |
| 184121 | 0300-20 | 0-850       |       |

### Right Angle Drill Kits

#### 1/2" Reversing Right Angle Drill Kit

- 120VAC, 7.0A R.A.D.
- 1/2" Trigger speed control reversing
- Use with up to 4-5/8" self-feed bits
- Head and handle swivel 360°
- Allow 5-1/2" for right angle drill head and chuck
- Kit Includes:
  - Chuck key and rubber flex key holder
  - Right angle drive
  - 9/16" Open end wrench
  - 3/16" Socket wrench
  - Chuck remover bar
  - Side handle
  - Steel carrying case
  - 8' 3-Wire Quik-Lok® cord set



| Part # | Mfg #  | Kit Type | Drill RPM | Amps | Price |
|--------|--------|----------|-----------|------|-------|
| 137799 | 3107-6 | Variable | 0-500     | 7.0  |       |

### Super Hawg™ Drills

#### Super Hawg™ 1/2" Drill

- Clutch in low speed
- High operating speeds for maximum productivity
- 90° Left-right, Roto-Lok® handle
- Comfort grip switch handle and gear case with front T-bar handle
- Includes side handle
- 1680-21 Includes carrying case
- 5-Year warranty



| Part # | Mfg #   | No Load RPM | Steel Capacity | Price |
|--------|---------|-------------|----------------|-------|
| 148643 | 1680-20 | 450/1,750   | 1/2"           |       |
| 137572 | 1680-21 | 450/1,750   | 1/2"           |       |

## Power Tools - M12 and Misc

Tools

### Hole-Hawg®

#### Hole-Hawg® Drill

- 120VAC, 7.5A
- Compact design
- Triple reduction gearing
- 2-Position pipe handle
- 3-Position spade handle
- 2-Speed gear shift
- External brush caps
- Includes steel carrying case



| Part # | Mfg #  | No Load RPM | Price |
|--------|--------|-------------|-------|
| 144516 | 1676-6 | 300/1,200   |       |

### Miter Saws

#### Dual-Bevel Sliding Compound Miter Saw

- Angle digital readout
- Angle fine adjust w/ detent override
- Dual integral jobsite lights
- Powerful 15.0 amp, 3.3 Max HP direct drive motor
- Constant Power Technology with Soft Start
- Integral dust channel
- Dual horizontal steel railers
- Oversized single lever bevel adjustment



| Part # | Mfg #   | Description    | Price |
|--------|---------|----------------|-------|
| 242515 | 6955-20 | 12", Bare Tool |       |

### Circular Saws

#### TILT-LOK™ 7-1/4" Circular Saw with Case

- New exclusive TILT-LOK™ main handle adjusts to the work or most comfortable work position
- 10.4 pounds net weight
- 15 amp, 3.25 peak horsepower
- Wide, clear sight line
- Kit Includes:
  - (1) TILT-LOK™ 7-1/4" Circular Saw with case (6390-21)
  - (1) Blade wrench
  - (1) Carrying case
  - (1) Circular saw blade



| Part # | Mfg #   | Description | Price |
|--------|---------|-------------|-------|
| 154578 | 6390-21 | Kit         |       |

### 8" Metal Cutting Saw Kit

- Dry-cut technology
- Durable blade shields with integral chiptank deflects/collects hot chips and sparks
- Plunge lever for fast, effective plunge cuts
- Exclusive quick-release shield latch
- 2-9/16 in cut depth for one-pass cuts through most common materials
- Powerful 13.0 amp, 3,700 rpm motor
- Premium cement-tipped blades cut faster, cleaner, and longer than other carbide-tipped or friction blades



| Part # | Mfg #   | Description | Price |
|--------|---------|-------------|-------|
| 243054 | 6370-20 | Bare Tool   |       |
| 161013 | 6370-21 | Kit         |       |

### Sawzall® Reciprocating Saws

#### 15 Amp Super Sawzall® Reciprocating Saw

- Constant Power Technology™
- Gear Protecting Clutch
- Counter Balanced Mechanism
- Variable Speed trigger and drill speed control
- Quick-Lok™ blade clamp system
- Includes carrying case



| Part # | Mfg #   | Length of Stroke | Strokes Per Minute | Price |
|--------|---------|------------------|--------------------|-------|
| 227013 | 6538-21 | 1-1/4"           | 0-2,800            |       |

#### 13 Amp Orbital Super Sawzall® with Case

- Orbital cutting action
- Variable speed trigger
- Quik-Lok™ blade clamp
- 8' Cord
- 5-Year warranty



| Part # | Mfg #   | Length of Stroke | Strokes Per Minute | Price |
|--------|---------|------------------|--------------------|-------|
| 148168 | 6536-21 | 1-1/4"           | 0 - 3,000          |       |

## Power Tools - M12 and Misc

### 12 Amp Sawzall® Reciprocating Saw

- Quik-Lok™ blade clamp
- Gear protecting clutch
- Counter weighted mechanism
- Includes:
  - (1) Sawzall® Recip Saw
  - Carrying case



| Part # | Mfg #   | Length of Stroke | Strokes Per Minute | Price |
|--------|---------|------------------|--------------------|-------|
| 137571 | 6509-31 | 3/4"             | 0 - 3,000          |       |
| 219154 | 6519-31 | 1-1/8"           | 0-3,000            |       |

### 360° Rotating Handle Orbital Super Sawzall® Reciprocating Saw

- 360° Rotating handle
- 13 Amp Milwaukee built motor
- Orbital cutting action
- Variable speed trigger, 0-3000 SPM
- 1-1/4in stroke
- Counter balanced/gear protection systems
- Speed dial
- QUIK-LOK™ blade clamp
- QUIK-LOK® cord
- Includes:
  - (1) 360° Rotating handle orbital super Sawzall® recip saw (6523-21)
  - (1) Carrying case



| Part # | Mfg #   | Description | Price |
|--------|---------|-------------|-------|
| 154278 | 6523-21 | Kit         |       |

### Band Saws

#### M12™ Sub-Compact Band Saw

- One-Handed Cuts
- Cuts 3/4" EMT in 3 seconds  
1-5/8" Cut Capacity
- LED Light
- Blade tension adjustment
- Kit Includes:
  - (1) 18 TPI Sub-Compact Band Saw Blade
  - (1) M12™ Sub-Compact Band Saw (Bare Tool) (2429-20)
  - (1) M12™ XC High Capacity REDLITHIUM™ Battery (48-11-2402)
  - (1) M12™ Lithium-ion Battery Charger (48-59-2401)
  - (1) Carrying Case



| Part # | Mfg #     | Description | Price |
|--------|-----------|-------------|-------|
| 172509 | 2429-20   | Bare Tool   |       |
| 150209 | 2429-21XC | Kit         |       |

### Compact Band Saw

- 120VAC
- 7.0A Motor, 3-wire, 8' cord
- LED Work light
- Blade ejection system
- Drop-resistant pulley guard
- Cast aluminum gear case
- Adjustable material guide
- Maximum rectangular capacity: 3-1/4" x 3-1/4"
- Maximum round capacity: 3-1/4"
- Kit Includes:
  - Band saw
  - Case



| Part # | Mfg #  | No Load SFPM | Price |
|--------|--------|--------------|-------|
| 142295 | 6242-6 | 200 - 300    |       |

### Abrasive Cut-Off Machines

#### 14" Abrasive Cut-Off Machine

- Cuts up to 5" pipe
- Oversized wheel guards
- Miter capacity: 45° with adjustable fence
- Large spindle lock button
- Kit Includes:
  - Vise
  - Abrasive wheel
  - Hex wrench



| Part # | Mfg #   | Description        | Price |
|--------|---------|--------------------|-------|
| 142284 | 6177-20 | 120VAC/DC, 15 Amps |       |

#### 14" Hand Held Cut-Off Machine

- Powerful 15-amp, 4.8 maximum horsepower motor
- 20-amp overload protection switch
- Downward cutting rotation
- Externally accessible brushes | and brush cutoff feature
- Kit Includes:
  - (1) 14" Abrasive Cut-Off Machine (6177-20)
  - (1) Abrasive Wheel
  - (1) Hex Wrench
  - (1) Vise



| Part # | Mfg #   | Description | Price |
|--------|---------|-------------|-------|
| 161844 | 6185-20 | Kit         |       |

## Power Tools - M12 and Misc

Tools

### Sanders

#### 5" Random Orbit Palm Sander

- 3 Amp permanent magnet motor
- Variable speed dial
- Kit Includes:
  - (1) 5" Random Orbit Palm Sander (6034-21)
  - (2) 80 Grit Sandpaper
  - (1) Plastic Dust Canister
  - (1) Universal Vac Hose Adapter
  - (1) Contractor Bag



| Part # | Mfg #   | Description | Price |
|--------|---------|-------------|-------|
| 231354 | 6034-21 | Kit         |       |

#### 3.5 Max HP Sander

- 7"/9"
- 6000 RPM



| Part # | Mfg #  | Speed RPM | Disc Dia | Price |
|--------|--------|-----------|----------|-------|
| 237737 | 6066-6 | 6,000     | 7"/9"    |       |

#### M12™ Variable Speed Polisher/Sander

- Variable speed trigger
- 5-Pc Accessory pack
  - 3" Polishing backing pad
  - 2" Sanding backing pad
  - Wool pad
  - Yellow foam pad
  - White foam pad



2438-22X

| Part # | Mfg #    | Description | Price |
|--------|----------|-------------|-------|
| 229843 | 2438-22X | Kit         |       |

### Grinders

#### 11 AMP 4-1/2" Small Angle Grinder Paddle, Lock-On

- Powerful 11 AMP, 11,000 RPM motor
- Overload Protection
- Electronic Clutch
- Tool-Free accessory change
- Tool-Free adjustable guard
- Advanced airflow system
- Debris baffles
- Includes:
  - (1) 11 Amp 4-1/2" small angle grinder paddle, lock-on (6146-30)
  - (1) Contractor bag
  - (1) Flange
  - (1) Grinding wheel
  - (1) Side handle
  - (1) Spanner wrench
  - (1) Type 27 guard



| Part # | Mfg #   | Description | Price |
|--------|---------|-------------|-------|
| 240167 | 6141-30 | Kit         |       |
| 158930 | 6146-30 | Kit         |       |

#### 7 AMP 4-1/2" Small Angle Grinder

- Compact, Lightweight Design: At 10.2" long and 3.5 lbs
- Debris Baffles- protect internal components by deflecting damaging debris out of the airflow at the intake vents
- Multi-Port Exhaust-reduces motor burn-up
- Tool Free, Burst Resistant Guard



| Part # | Mfg #   | Description         | Price |
|--------|---------|---------------------|-------|
| 150013 | 6130-33 | 7 AMP 750 MWO Motor |       |



## Power Tools - M12 and Misc

### Misc. Tools

#### M12™ HAMMervac Universal Dust Extractor

- Auto-on mode allows extractor to turn it on and off
- Provides filtration up to 160 holes on a single charge
- Part of the M12 System, featuring over 70 tools
- Universal handle system- compatible with most SDS plus rotary hammers and some AC and DC hammer drills
- Self-powered by M12 red lithium battery pack
- Replaceable HEPA filter-highest quality debris filtration and lowest cost of ownership



| Part # | Mfg #   | Description | Price |
|--------|---------|-------------|-------|
| 186658 | 2306-22 | Kit         |       |

#### 8 Gallon Dust Extractor

- 2 Step filtration system
- On-board tool activated plug
- Quiet operation: 69dB
- Suction control dial
- 13 Ft Anti-static hose
- Large wheels, locking swivel casters for jobsite durability
- Water level float valve shuts off suction when tank is full



| Part # | Mfg #   | Description | Price |
|--------|---------|-------------|-------|
| 242452 | 8960-20 | Bare Tool   |       |

#### Diamond Coring Rig w/ Large Base Stand, Vac-U-Rig® Kit, Meter Box and Diamond Coring Motor

- Kit Includes:
  - Diamond coring large base stand
  - Diamond coring motor
  - Large base stand
  - Vac-U-Rig® kit
  - Diamond coring rig
  - Meter box



| Part # | Mfg #   | Description | Price |
|--------|---------|-------------|-------|
| 244274 | 4120-22 | Kit         |       |

### Fixed-Base Production Router

- 15 Amps
- 8' Fixed cord
- 120V AC
- Double insulated
- 36-Position speed dial
- 10,000-22,000 No load rpm
- Kit includes:
  - 1/2" Collet
  - 2-1/2" Sub-base
  - 1-1/8" Collet wrenches
  - T-handle wrench



| Part # | Mfg #   | Description   | Price |
|--------|---------|---------------|-------|
| 241914 | 5625-20 | 3-1/2" MAX HP |       |

### Milner Saw Stand

- Material supports with steel rollers extend to 9.5' for maximum work piece support
- 550 lbs table area weight capacity
- Rubber wheels for max portability
- Adjustable leg provides stability on uneven surfaces
- Collapsible legs for compact storage



| Part # | Mfg #      | Description                         | Price |
|--------|------------|-------------------------------------|-------|
| 227452 | 48-08-0550 | 55"(119" Fully Extended) x 39-1/2"H |       |

### Folding Miter Saw Stand

- Mounting brackets work with all brands of miter saws
- Light weight aluminum construction for easy portability
- Compact folding design for easy storage
- Supports up to 500 lbs off main beam
- Adjustable foot for leveling on uneven surfaces
- Extends to a maximum of 100" to support large work pieces
- Quick and easy adjustments for fast setup and tear down



| Part # | Mfg #      | Description                 | Price |
|--------|------------|-----------------------------|-------|
| 239095 | 48-08-0551 | 43-1/2"-100"L x 27"W x 32"H |       |

## Power Tools - M12 and Misc

Tools

### Folding Table Saw Stand

- Adjustable foot for cutting on uneven surfaces
- Compact design for easy storage
- Quick attach latching system
- Only 15 lbs
- All steel construction



| Part # | Mfg #      | Description                | Price |
|--------|------------|----------------------------|-------|
| 248729 | 48-08-0561 | 17-3/4"L x 23"W x 20-1/2"H |       |

### 14 Gauge Shear

- 5 amps, 4,000 SPM
- Clear unobstructed visibility
- Cuts close curves either left or right
- Blade design eliminates jamming



| Part # | Mfg # | Description    | Price |
|--------|-------|----------------|-------|
| 176044 | 6815  | 14 Gauge Shear |       |

### 10 Gauge Nibbler

- 4.0 amp, 1,000 SPM
- Cuts up to 8.75ft per minute
- 1.65 in. starting hole required
- AC-DC toggle switch allows for two-handed operation



| Part # | Mfg # | Description      | Price |
|--------|-------|------------------|-------|
| 176046 | 6880  | 10 Gauge Nibbler |       |

### M12™ TRAPSAKE™ Toilet Auger

- 6'
- Kit includes:
  - (1) M12™ TRAPSAKE™ 6' Toilet Auger (Tool Only) (2576-20)
  - (1) M12™ REDLITHIUM™ Battery (48-11-2401)
  - (1) M12™ Lithium-ion Battery Charger (48-59-2401)



| Part # | Mfg #   | Description | Price |
|--------|---------|-------------|-------|
| 230879 | 2576-20 | Bare Tool   |       |
| 230877 | 2576-21 | Kit         |       |

### M12™ TRAPSAKE™ 2-Tool Combo Kit

- Kit includes:
  - (1) M12™ TRAPSAKE™ 4' Urinal Auger (Tool Only) (2574-20)
  - (1) M12™ TRAPSAKE™ 6' Toilet Auger (Tool Only) (2576-20)
  - (1) M12™ REDLITHIUM™ Battery (48-11-2401)
  - (1) M12™ Lithium-ion Battery Charger (48-59-2401)



| Part # | Mfg #   | Description | Price |
|--------|---------|-------------|-------|
| 230883 | 2577-21 | Kit         |       |

### M12™ TRAPSAKE™ Urinal Auger

- Maneuvers traps faster and protects porcelain, compatible with all TRAPSAKE™ Augers
- Fixed rubber boot: Prevents porcelain scratches throughout the life of the tool
- Integrated locking mechanism which holds the cable in place for easy telescoping extension and retraction



| Part # | Mfg #   | Description | Price |
|--------|---------|-------------|-------|
| 230882 | 2574-20 | Bare Tool   |       |
| 230881 | 2574-21 | Kit         |       |

### M12 AIRSNAKE™ Drain Cleaning Air Gun Kit

- Up to 50 PSI
- 25+ pressure cycles
- Includes:
  - (3) Drain plug attachments
  - Straight connector
  - 15° offset connector
  - Carrying case
  - Drain shroud attachment
  - M12 Lithium-ion battery charger
  - M12 REDLITHIUM™ battery pack



| Part # | Mfg #    | Description | Price |
|--------|----------|-------------|-------|
| 238926 | 2572A-21 | 12V         |       |
| 240438 | 2572B-21 | 12V         |       |

### Airsnake™ Accessories

| Part # | Mfg #      | Description   | Price |
|--------|------------|---------------|-------|
| 242106 | 48-53-2570 | 10" Extension |       |

## Power Tools - M12 and Misc

### M12™ Drain Snake Kit

- 1) M12™ Drain Snake (2571-20)
- (1) 5/16"X25' BULB CABLE W/DRUM (48-53-2581)
- (1) 5 Gallon Storage Bucket
- (1) M12™ REDLITHIUM™ Battery (48-11-2401)
- (1) M12™ Lithium-ion Battery Charger (48-59-2401)



| Part # | Mfg #   | Description                           | Price |
|--------|---------|---------------------------------------|-------|
| 188681 | 2571-20 | Bare Tool                             |       |
| 188682 | 2571-21 | 25' of 1/4" or 5/16" Inner Core Cable |       |

### 1-Stage Wet/Dry Vacuum Cleaner

- 10 gal, 1-1/8 bu. recovery capacity, 8.0 amp motor
- Positive water shut-off
- Can be used as a blower
- One-stage bypass motor for wet/dry operation



| Part # | Mfg #      | Description                        | Price |
|--------|------------|------------------------------------|-------|
| 176821 | 8955       | 1-Stage Wet/Dry Vacuum Cleaner     |       |
| 142565 | 49-90-1900 | Filter, 8950,8955,8936-20, 8938-20 |       |

### M12™ Compact Vacuum

- 33CFM for use on wide range of materials
- Up to 29 minutes\* on a single charge using REDLITHIUM™ XC4.0 batteries
- Versatile attachments
- Clear viewing window
- Reusable 42 pleat filter
- Lock-on switch reduces



| Part # | Mfg #      | Description   | Price |
|--------|------------|---------------|-------|
| 173344 | 0850-20    | Bare Tool     |       |
| 178389 | 49-90-1950 | Vacuum Filter |       |

### SHOCKWAVE™ Lineman's Impact Socket Adapter

- Pin detent design
- Optimized shock zone
- Custom alloy 76 steel
- Fits all 1/2" drive accessories
- Use with Shockwave™ Lineman's 3 in 1 utility sockets



| Part # | Mfg #      | Size                             | Price |
|--------|------------|----------------------------------|-------|
| 241167 | 48-32-5100 | 7/16" Hex to 1/2" Square Adapter |       |

### Temperature Guns

#### Infrared Laser TEMP-GUN™ Thermometer Kit

- Basic accuracy: 1.50%
- Distance to spot: 12 to 1
- Includes:
  - Laser TEMP-GUN™ thermometer
  - (3) AA Alkaline batteries
  - K-Type thermocouple
  - Slide rail system
- 5-Year warranty



| Part # | Mfg #   | Temperature Range | Price |
|--------|---------|-------------------|-------|
| 137568 | 2266-20 | -20° to 932°F     |       |
| 228847 | 2268-20 | -22°F to 1022°F   |       |

#### Laser TEMP-GUN™ M12™ Cordless Lithium-Ion Thermometer for HVAC/R

- Infrared surface temperature measurement from -22 to 1472° F (-30 to 800° C)
- Contact surface temperature measurement from -40 to 1022° F (-40 to 550° C)
- 40:1 Distance to spot ratio
- Measure ambient humidity and dew point
- Adjustable emissivity from 0.10 to 1.00 for increased accuracy
- Unit memory stores up to 20 temperature values



| Part # | Mfg #   | Temperature Range | Price |
|--------|---------|-------------------|-------|
| 180839 | 2277-20 | -22 to 1472° F    |       |

#### M12™ Infrared Temp-Gun™

- 12:1 distance-to-spot ratio
- 6' Drop test
- Trigger lock
- Laser on/off
- 0.95 Fixed emissivity
- Premium LCD display
- Fully bumpered nose
- High/Low temperature alert
- Hold, max, min, avg, diff modes
- M12™ 12V Lithium-ion battery
- Clear button functions with rubber overmolded grip



| Part # | Mfg #   | Surface Temperature | Price |
|--------|---------|---------------------|-------|
| 223515 | 2278-20 | -22°F to 1022°F     |       |

## Power Tools - M12 and Misc

Tools

### Spot Infrared Imager

- Measurements from long range or up close with 56:1 distance-to-spot performance
- Powered by standard 9V Alkaline battery
- DUAL SENSE™ pixels are ultra-responsive
- Ironbow color palette allows easy differentiation between hot and cold areas
- Toggle between °F and °C measurements with switch in the battery compartment



| Part # | Mfg #   | Surface Temperature | Price |
|--------|---------|---------------------|-------|
| 240565 | 2257-20 | 14°F - 626°F        |       |

### M12™ 102 X77 Infrared Camera

- 7,854 (102 x 77) pixel resolution captures highest resolution image in it's class
- DUAL SENSE™ pixels are ultra-responsive, adjusting individually to eliminate blurring of hot and cold details
- Measure surface temperatures 14°F to 626°F degrees for images spanning wide ranges
- 2-Stage trigger activates lasers for easy scanning or quickly captures images
- Dual lasers frame on-screen temperature area
- Multiple color palettes available: rainbow, grayscale and ironbow
- Automatically locates highest and lowest temperatures
- Fully compatible with Milwaukee® thermal imager reporting software available at Milwaukeeetool.com
- Compatible with over 70+ M12™ tools



| Part # | Mfg #   | Description              | Price |
|--------|---------|--------------------------|-------|
| 185579 | 2258-21 | 102 X 77 Infrared Camera |       |

### Heat Guns

#### Dual Temperature Heat Gun

- Dual temperature 570 and 1000 degrees F, 11.6 amp motor
- Unique impact resistant heating element
- Three position rock switch - off, high and low



| Part # | Mfg #  | Description               | Price |
|--------|--------|---------------------------|-------|
| 161906 | 8975-6 | Dual Temperature Heat Gun |       |

#### M18™ Compact Heat Gun

- LED light
- Ladder hook
- Guarded nozzle
- REDLINK PLUS™ intelligence
- High performance heating coil
- M18™ REDLITHIUM battery included with -21 Kit



| Part # | Mfg #   | Description | Price |
|--------|---------|-------------|-------|
| 238367 | 2688-21 | Kit         |       |
| 240763 | 2688-20 | Tool Only   |       |

## Power Tools

### M18™ Cordless Drills

#### M18™ Cordless Right Angle Drill

- No load speed: 0 to 1550 rpm
- Torque: 125 in-lbs
- Chuck type: 3/8" single sleeve ratcheting
- Includes:
  - M18™ Right angle drill (2615-20)
  - M18™ REDLITHIUM™ XC High capacity battery
  - 1-Hour charger
  - Carrying case



| Part # | Mfg #   | Description | Price |
|--------|---------|-------------|-------|
| 162304 | 2615-20 | Bare Tool   |       |
| 142940 | 2615-21 | Kit         |       |

### M18™ Compact Drill Driver

- Built-in LED light
- 18V DC
- No load speed: 350 to 1,400 rpm
- Torque: 425 in-lbs
- Kit includes:
  - M18™ Compact drill driver (2601-20)
  - (2) 18V Lithium-Ion batteries
  - 18V Lithium-Ion charger
  - 1/2" 3-Jaw keyless chuck
- 5-Year warranty



| Part # | Mfg #   | Description | Price |
|--------|---------|-------------|-------|
| 137559 | 2601-22 | Kit         |       |

Tools

### M18™ Cordless 2-Speed 1/4" Right Angle Impact Driver

- No Load RPM: 0-1,500 (mode 1) 0-2,250 (mode 2)
- 2-Speed Drive-Control™
- 1/4" hex drive with 1" bit acceptance
- Extended paddle switch for multiple grip options



| Part # | Mfg #   | Description | Price |
|--------|---------|-------------|-------|
| 180431 | 2667-20 | Bare Tool   |       |

### M18™ 1/2" High Performance Hammer/Drill Driver

- 4-Pole frameless motor
- 1/2" Single-sleeve ratcheting metal chuck with carbide jaws
- Battery fuel gauge displays remaining run-time
- Built-in LED light illuminates work surface
- Variable speed trigger
- No load speed: 0 to 1,800 rpm
- No load BPM: 0 to 28,000 BPM
- Includes:
  - (2) M18™ 18V XC Lithium-Ion batteries
  - 18V Charger
  - Side handle
  - Carrying case
- 5-Year warranty



| Part # | Mfg #   | Description       | Price |
|--------|---------|-------------------|-------|
| 139122 | 2611-24 | 650 in-lbs Torque |       |

### M18™ FUEL™ 1/2" Drill/Driver Kit

- POWERSTATE™ Brushless motor
- REDLINK PLUS™ Intelligence
- Kit Includes:
  - (1) M18 FUEL™ 1/2" Drill/Driver (Bare Tool) (2703-20)
  - (2) M18™ REDLITHIUM™ XC5.0 Extended Capacity Battery Pack (48-11-1850)
  - (1) M18™ & M12™ Multi-Voltage Charger (48-59-1812)
  - (1) Belt Clip
  - (1) Bit Holder
  - (1) Side Handle
  - (1) Carrying Case



| Part # | Mfg #   | Description | Price |
|--------|---------|-------------|-------|
| 179571 | 2703-20 | Bare Tool   |       |
| 179572 | 2703-22 | Kit         |       |

### M18 FUEL™ 1/2" Drill Driver

- Up To 60% More Power: 1,200 in-lbs of torque
- LED on foot of tool for better lighting in dark spaces
- POWERSTATE™ Brushless Motor
- REDLINK PLUS™ Intelligence



| Part # | Mfg #   | Description | Price |
|--------|---------|-------------|-------|
| 248755 | 2803-20 | Bare Tool   |       |

## Power Tools

Tools

### Kit Includes

- (1) M18 FUEL™ 1/2" Drill Driver (Tool Only) (2803-20)
- (2) M18™ REDLITHIUM™ XC5.0 Battery Pack (48-11-1850)
- (1) M18™ & M12™ Multi-Voltage Charger (48-59-1812)
- (1) Carrying Case, (1) Side Handle, (1) Belt Clip
- (1) Bit Holder

| Part # | Mfg #   | Description | Price |
|--------|---------|-------------|-------|
| 248756 | 2803-22 | Kit         |       |

### M18 FUEL™ 1/2" Hammer Drill/Driver

- Up To 60% More Power: 1,200 in-lbs of torque
- LED on foot of tool for better lighting in dark spaces
- POWERSTATE™ Brushless Motor
- REDLINK PLUS™ Intelligence



| Part # | Mfg #   | Description | Price |
|--------|---------|-------------|-------|
| 248757 | 2804-20 | Bare Tool   |       |

### Kit Includes

- (1) M18 FUEL™ 1/2" Hammer Drill/Driver (2804-20)
- (2) M18™ REDLITHIUM™ XC5.0 Battery Pack (48-11-1850)
- (1) M18™ & M12™ Multi-Voltage Charger (48-59-1812)
- (1) Belt Clip, (1) Bit Holder, (1) Carrying Case, (1) Side Handle

| Part # | Mfg #   | Description | Price |
|--------|---------|-------------|-------|
| 248759 | 2804-22 | Kit         |       |

### M18 FUEL™ HOLE HAWG® 1/2" Right Angle Drill Kit

- Kit Includes:
  - (1) M18 FUEL™ HOLE HAWG® 1/2" Right Angle Drill (Tool Only) (2707-20)
- (1) Contractor Bag
- (1) Chuck Key
- (2) M18™ REDLITHIUM™ XC5.0 Extended Capacity Battery Pack (48-11-1850)
- (-22 Model) - (1) Multi-Voltage Charger (48-59-1812)
- (-22HD Model)- (1) Rapid Charger (48-59-1808)

| Part # | Mfg #     | Description | Price |
|--------|-----------|-------------|-------|
| 170227 | 2707-22   | Kit         |       |
| 234423 | 2707-22HD | Kit         |       |

### M18™ FUEL™ Hole Hawg™ Right Angle Drill with QUIK-LOK™

- POWERSTATE™ brushless motor
- REDLINK™ PLUS
- Kit Includes:
  - M18™ FUEL™ 1/2" Right angle drill
  - M18™ REDLITHIUM™ battery pack
  - M18™&M12™ multi-voltage charger
  - Contractor bag



| Part # | Mfg #   | Description | Price |
|--------|---------|-------------|-------|
| 171055 | 2708-20 | Bare Tool   |       |
| 171056 | 2708-22 | Kit         |       |

### High Demand

| Part # | Mfg #     | Description | Price |
|--------|-----------|-------------|-------|
| 227455 | 2708-22HD | Kit         |       |

### M18™ FUEL™ Super Hawg™ 1/2" Right Angle Drill Kit

- POWERSTATE™ brushless motor
- REDLINK™ PLUS intelligence ensures optimal performance and overload protection
- Kit Includes:
  - M18™ FUEL™ 1/2" Right Angle Drill
  - M18™ REDLITHIUM™ battery pack (-HD models: REDLITHIUM™ HIGH DEMAND™ battery)
  - M18™&M12™ rapid charger
  - Chuck key
  - Side handle
  - Contractor bag



| Part # | Mfg #     | Description     | Price |
|--------|-----------|-----------------|-------|
| 181107 | 2709-22   | Kit             |       |
| 230567 | 2709-22HD | High Demand Kit |       |

### M18™ FUEL™ Super Hawg™ Right Angle Drill with Quick-Lok™ Kit

- Includes:
  - (1) (Bare Tool) (2711-20)
  - (2) 9.0 Battery Pack (48-11-1890)
  - (1) Rapid Charger (48-59-1808)
  - (1) Side Handle
  - (1) Contractor Bag



| Part # | Mfg #     | Description     | Price |
|--------|-----------|-----------------|-------|
| 181108 | 2711-20   | Bare Tool       |       |
| 226174 | 2711-22HD | Kit, Heavy Duty |       |
| 181109 | 2711-22   | Kit             |       |

## Power Tools

### M18™ Compact 1/2" Hammer Drill/Driver

- 4-Pole Frameless Motor:  
Features a robust design combined with rare-earth magnets for longer life, best-in-class 500 in-lbs of torque and 0-400/0-
- All-Metal gear case and chuck
- REDLINK™ Intelligence



| Part # | Mfg #   | Description | Price |
|--------|---------|-------------|-------|
| 170819 | 2607-20 | Bare Tool   |       |
| 166993 | 2607-22 | Kit         |       |

### M18™ Compact Hammer Drill Driver

- 4-Pole frameless motor
- 1/2" Single-sleeve ratcheting metal chuck
- Variable speed trigger
- No load speed: 0 to 1,700 rpm
- No load BPM: 0 to 29,000 BPM
- Torque: 550 in-lbs
- Kit includes:
  - M18™ Hammer-drill driver (2602-22)
  - (2) 18V XC Lithium-Ion batteries
  - 1-Hour 18V charger
  - Carrying case
- 5-Year warranty



| Part # | Mfg #   | Description | Price |
|--------|---------|-------------|-------|
| 143056 | 2602-20 | Bare Tool   |       |
| 137560 | 2602-22 | Kit         |       |

### M18™ FUEL™ 1/2" Hammer Drill/Driver Kit

- 2-Speed Powerstate™ brushless motor
- Redlink PLUS™ Intelligence system communications with overload protection
- No load speed: 0 to 500/0 to 1850 rpm
- Kit Includes:
  - 1/2" Drill/driver
  - (2) 18V Compact REDLITHIUM™ batteries
  - Multi-voltage charger
  - Locking chuck
  - LED Light
- 5-Year warranty



| Part # | Mfg #   | Description | Price |
|--------|---------|-------------|-------|
| 179573 | 2704-20 | Bare Tool   |       |
| 179574 | 2704-22 | Kit         |       |

### M18 FUEL™ 1-9/16" SDS Max Hammer Drill

- POWERSTATE™ brushless motor
- REDLITHIUM™ battery pack
- REDLINK PLUS™ intelligence



| Part # | Mfg #     | Description | Price |
|--------|-----------|-------------|-------|
| 226125 | 2717-21HD | Kit         |       |
| 226126 | 2717-22HD | Kit         |       |

### M18™ FUEL™ with ONE-KEY™ 1/2" Hammer Drill/Driver Kit

- Kit includes:
  - (1) M18 FUEL™ with ONE-KEY™ 1/2" Hammer Drill/Driver (Tool Only) (2706-20)
  - (2) M18™ REDLITHIUM™ XC5.0 Extended Capacity Battery Pack (48-11-1850)
  - (1) M18™ & M12™ Multi-Voltage Charger (48-59-1812)
  - (1) Belt Clip
  - (1) Bit Holder
  - (1) Side Handle
  - (1) Carrying Case



| Part # | Mfg #   | Description | Price |
|--------|---------|-------------|-------|
| 223514 | 2706-20 | Bare Tool   |       |
| 230428 | 2706-22 | Kit         |       |

### M18™ 1/4" Hex Compact Impact Driver

- 1/4" Hex quick change chuck
- 4-Pole frameless motor
- Battery fuel gauge displays remaining run-time
- No load speed: 0 to 2,200 rpm
- No load IPM: 0 to 3,200 IPM
- Variable speed trigger
- Built-in LED light illuminates work surface
- 18V
- Includes:
  - M18™ Impact driver (2650-20)
  - (2) M18™ REDLITHIUM™ XC high capacity batteries
  - Battery charger
  - Belt clip
  - Carrying case
- 5-Year warranty



| Part # | Mfg #   | Description | Price |
|--------|---------|-------------|-------|
| 144367 | 2650-20 | Bare Tool   |       |

## Power Tools

Tools

### M18™ Cordless Drills (Continued)

#### M18™ 1/4" Hex Compact Impact Driver

| Part # | Mfg #   | Description | Price |
|--------|---------|-------------|-------|
| 137562 | 2650-22 | Kit         |       |

#### M18™ 1/4" Hex Impact Driver

- Milwaukee® 4-Pole frameless motor
- Delivers maximum power and application speed for greater efficiency on the job
- REDLINK™ Intelligence
- 2-Mode DRIVE CONTROL™
- 1/4" Hex quick-connect chuck
- REDLITHIUM™ Battery
- Kit Includes:
  - (1) M18 2-Speed 1/4" hex impact driver (Bare tool)
  - (2) M18™ Compact REDLITHIUM™ battery (48-11-1815)
  - (1) M18™ & M12™ Multi-voltage charger (48-59-1812)
  - (1) Belt clip
  - (1) Carrying case



| Part # | Mfg #   | Description         | Price |
|--------|---------|---------------------|-------|
| 164016 | 2657-20 | Bare Tool (2-Speed) |       |
| 179431 | 2656-20 | Bare Tool           |       |

#### M18 FUEL™ 1/4" Hex Impact Driver

- POWERSTATE™ Brushless motor
- Torque: 2,000in-lbs
- 4-Mode drive control
- Self-Tapping screw mode
- Single handed bit insertion
- LED light to illuminate work area



| Part # | Mfg #   | Description | Price |
|--------|---------|-------------|-------|
| 248760 | 2853-20 | Bare Tool   |       |

#### Kit Includes

- (1) M18 FUEL™ 1/4" Hex Impact Driver (2853-20)
- (2) M18™ REDLITHIUM™ XC5.0 Battery Pack (48-11-1850)
- (1) M18™ & M12™ Multi-Voltage Charger (48-59-1812)
- (1) Belt Clip, (1) Bit Holder, (1) Carrying Case

| Part # | Mfg #   | Description | Price |
|--------|---------|-------------|-------|
| 248762 | 2853-22 | Kit         |       |

#### M18™ 1/4" Hex Brushless Impact Driver

- Compact Design
- REDLINK™ Intelligence
- REDLITHIUM™ Battery

#### Kit Includes:

- (1) M18™ 1/4" Hex Brushless Impact Driver (2750-20)
- (1) M18™ & M12™ Multi-Voltage Charger (48-59-1812)
- (2) M18™ REDLITHIUM™ CP2.0 Battery Pack (48-11-1820)
- (1) Carrying Case

| Part # | Mfg #     | Description | Price |
|--------|-----------|-------------|-------|
| 173942 | 2750-22CT | Kit         |       |

#### M18™ FUEL™ SURGE™ 1/4" Hex Hydraulic Driver

- Kit includes:
  - (1) 1/4" Hex Hydraulic Driver (Tool Only) (2760-20)
  - (2) M18™ REDLITHIUM™ XC5.0 (48-11-1850)
  - (1) M18™ & M12™ Multi-Voltage Charger (48-59-1812)
  - (1) Belt Clip
  - (1) Bit Holder
  - (1) Carrying Case



| Part # | Mfg #   | Description | Price |
|--------|---------|-------------|-------|
| 231122 | 2760-20 | Bare Tool   |       |
| 231123 | 2760-22 | Kit         |       |

#### M18 FUEL™ High Torque 1/2" Impact Wrench w/ Pin Detent

- 8.1" in length
- Bolt removal mode
- REDLINK PLUS™ intelligence
- REDLITHIUM™ batteries
- Features a pin detent design for maximum socket retention
- Premium rubber overmold
- Reduced user fatigue at only 7.1lbs w/ battery
- LED light to illuminate the work area



| Part # | Mfg #   | Description | Price |
|--------|---------|-------------|-------|
| 245924 | 2766-22 | Kit         |       |



## Power Tools

### M18 FUEL™ 3/8" Compact Impact Wrench with Friction Ring Kit

- Kit Includes:
  - (1) M18 FUEL™ 3/8" Compact Impact Wrench w/ Friction Ring (Bare Tool) (2754-20)
  - (2) M18™ REDLITHIUM™ XC5.0 Ext Capacity Batteries(48-11-1850)
  - (1) M18™ & M12™ Multi-Voltage charger (48-59-1812)
  - (1) Belt Clip
  - (1) Carrying Case



| Part # | Mfg #   | Description | Price |
|--------|---------|-------------|-------|
| 222174 | 2754-20 | Bare Tool   |       |
| 181171 | 2754-20 | Kit         |       |

With ONE-KEY™

| Part # | Mfg #   | Description | Price |
|--------|---------|-------------|-------|
| 245791 | 2758-22 | Kit         |       |

### M18™ 3/8" Impact Wrench Kit with Friction Ring

- 3/8" Anvil with friction ring
- Kit Includes:
  - (1) M18™ 3/8" Impact wrench with friction ring (bare tool) (2658-20)
  - (2) M18™ REDLITHIUM™ XC battery (48-11-1828)
  - (1) M18™ & M12™ Multi-voltage charger (48-59-1812)
  - (1) Belt clip
  - (1) Carrying case



| Part # | Mfg #   | Description | Price |
|--------|---------|-------------|-------|
| 166198 | 2658-22 | Kit         |       |

### M18 FUEL™ 1/2" Compact Impact Wrench with Friction Ring Kit

- Kit Includes:
  - (1) M18 FUEL™ 1/2" Compact Impact Wrench w/ Friction Ring (Bare Tool) (2755B-20)
  - (2) M18™ REDLITHIUM™ XC5.0 Extended Capacity Battery Pack (48-11-1850)
  - (1) M18™ & M12™ Multi-Voltage Charger (48-59-1812)
  - (1) Belt Clip
  - (1) Carrying Case



| Part # | Mfg #    | Description | Price |
|--------|----------|-------------|-------|
| 228402 | 2755B-20 | Bare Tool   |       |
| 226462 | 2755B-22 | Kit         |       |

### M18 FUEL™ 1/2" High Torque Impact Wrench with Pin Detent

- Kit includes:
  - (1) M18 FUEL™ 1/2" High Torque Impact Wrench (2762-20)
  - (1) M18™ & M12™ Multi-Voltage Charger (48-59-1812)
  - (2) M18™ REDLITHIUM™ XC5.0 Ext Capacity Battery (48-11-1850)
  - (1) Carrying Case



| Part # | Mfg #   | Description | Price |
|--------|---------|-------------|-------|
| 221607 | 2762-20 | Bare Tool   |       |
| 166737 | 2762-22 | Kit         |       |

### M18 FUEL™ 1/2" High Torque Impact Wrench with Friction Ring Kit

- Delivers up to 700 ft-lbs of maximum fastening torque, up to 1,100 ft-lbs of nut-busting torque and up to 2X more runtime
- POWERSTATE™ Brushless Motor
- REDLINK PLUS™ Intelligence



Kit Includes

- (1) M18 FUEL™ 1/2" High Torque Impact Wrench with Friction Ring (Bare Tool) (2763-20)
- (2) M18™ REDLITHIUM™ XC5.0 Extended Capacity Battery Pack (48-11-1850)
- (1) M18™ & M12™ Rapid Charger (48-59-1808)

| Part # | Mfg #   | Description | Price |
|--------|---------|-------------|-------|
| 165987 | 2763-22 | Kit         |       |

## Power Tools

Tools

### M18 FUEL™ 3/4" High Torque Impact Wrench with Friction Ring Kit

- Delivers up to 700 ft-lbs of maximum fastening torque, up to 1,100 ft-lbs of nut-busting torque and up to 2X more runtime
- POWERSTATE™ Brushless Motor
- REDLINK PLUS™ Intelligence



#### Kit Includes

- (1) M18 FUEL™ 3/4" High-Torque Impact Wrench with Friction Ring (Bare Tool) (2764-20)
- (2) M18™ REDLITHIUM™ XC5.0 Extended Capacity Battery Pack (48-11-1850)
- (1) M18™ & M12™ Multi-Voltage Charger (48-59-1812)
- (1) Carrying Case

| Part # | Mfg #   | Description | Price |
|--------|---------|-------------|-------|
| 167328 | 2764-22 | Kit         |       |

### M18 FUEL™ 1/2" High Torque Impact Wrench with Friction Ring

- LED light
- Bolt removal mode
- Rubber overmold
- REDLINK PLUS™
- REDLITHIUM™ batteries
- POWERSTATE™ brushless motor



| Part # | Mfg #   | Description | Price |
|--------|---------|-------------|-------|
| 239311 | 2767-20 | Bare Tool   |       |
| 238946 | 2767-22 | Kit         |       |

### M18 FUEL™ 1/2" Mid-Torque Impact Wrench with Friction Ring

- LED light
- Delivers up to 450 ft-lbs of fastening torque
- Delivers up to 600 ft-lbs of nut-busting torque
- REDLINK PLUS™
- REDLITHIUM™ batteries
- POWERSTATE™ brushless motor
- Utilizes a friction ring design to ensure quick & easy socket changes



| Part # | Mfg #   | Description | Price |
|--------|---------|-------------|-------|
| 243289 | 2861-20 | Bare Tool   |       |

### M18™ 1/2" Impact Wrench with Pin Detent

- Kit includes:
  - (1) M18™ 1/2" Impact Wrench w/ Pin Detent (2659-20)
  - (2) M18™ REDLITHIUM™ XC Extended Capacity Battery (48-11-1828)
  - (1) M18™ & M12™ Multi-Voltage Charger (48-59-1812)
  - (1) Belt Clip
  - (1) Carrying Case



| Part # | Mfg #   | Description | Price |
|--------|---------|-------------|-------|
| 167795 | 2659-20 | Bare Tool   |       |
| 228550 | 2659-22 | Kit         |       |

### M18™ FUEL 1/2" Compact Impact Wrench with Pin Detent

- Kit Includes:
  - (1) M18 FUEL™ 1/2" Compact Impact Wrench w/ Pin Detent (2755-20)
  - (2) M18™ REDLITHIUM™ XC5.0 Battery Pack (48-11-1850)
  - (1) M18™ & M12™ Multi-Voltage Charger (48-59-1812)
  - (1) Belt Clip
  - (1) Carrying Case



| Part # | Mfg #   | Description | Price |
|--------|---------|-------------|-------|
| 179580 | 2755-22 | Kit         |       |

### M18™ 1/2" High-Torque Impact Wrench with Friction Ring Kit

- Milwaukee® 4-pole frameless motor
- REDLITHIUM™ battery technology
- REDLINK™ intelligence
- Includes:
  - (1) M18™ 1/2" high-torque impact wrench with friction ring (2663-20)
  - (2) M18™ REDLITHIUM™ XC extended capacity battery (48-11-1828)
  - (1) M18™ & M12™ Multi-voltage charger (48-59-1812)
  - (1) Carrying case



| Part # | Mfg #   | Description | Price |
|--------|---------|-------------|-------|
| 152298 | 2663-22 | Kit         |       |

## Power Tools

### M18™ Cordless 2-Speed 3/8" Right Angle Impact Wrench

- 2-Speed Drive-Control™ offers greater control over applications
- 3/8" Anvil with friction ring for fast, easy socket change
- 1.4" Head



| Part # | Mfg #   | Description | Price |
|--------|---------|-------------|-------|
| 223133 | 2668-20 | Bare Tool   |       |

### M18™ Cordless 5/8" SDS Plus Rotary Hammer Kit

- REDLITHIUM™ battery technology: superior pack construction, electronics, and performance deliver more work per charge and more work over pack life than any battery on the market
- Powerful 18-volt motor: delivers 0-1,300 RPM and 0-7,000 BPM
- 2-Mode operation: choose rotary hammer or rotation only for added versatility
- LED light: illuminates dark work spaces



| Part # | Mfg #   | Description | Price |
|--------|---------|-------------|-------|
| 244697 | 2612-20 | Bare Tool   |       |
| 166128 | 2612-21 | Kit         |       |

### M18™ FUEL™ SDS Plus Rotary Hammer

- POWERSTATE™ brushless motor
- REDLINK PLUS™
- REDLITHIUM™ battery
- AVS system



| Part # | Mfg #     | Description                    | Price |
|--------|-----------|--------------------------------|-------|
| 227454 | 2712-22HD | High Demand Kit, 1"            |       |
| 173340 | 2712-22   | Kit, 1"                        |       |
| 182779 | 2712-20   | Bare Tool, 1"                  |       |
| 221606 | 2715-20   | Bare Tool, 1-1/8"              |       |
| 171580 | 2715-22   | Kit, 1-1/8"                    |       |
| 178540 | 2715-22DE | DE(Dust Extractor) Kit, 1-1/8" |       |
| 189902 | 2713-20   | Bare Tool, 1" w/ D-Handle      |       |
| 188836 | 2713-22   | Kit, 1" w/ D-Handle            |       |
| 234424 | 2713-22HD | High Demand Kit, 1" D-Handle   |       |

### M18 FUEL™ 1" SDS Plus Rotary Hammer with Dedicated Dust Extractor

- POWERSTATE™ brushless motor
- REDLINK PLUS™
- REDLITHIUM™ battery
- AVS system
- Kit includes:
  - (1) M18 FUEL™ 1" SDS Plus Rotary Hammer(2712-20)
  - (1) HAMMERVAC™ Dedicated Dust Extractor (2712-DE)
  - (2) M18™ REDLITHIUM™ XC5.0 Extended Capacity Battery Pack (48-11-1850)
  - (1) M18™ & M12™ Multi-Voltage Charger (48-59-1812)
  - (1) Depth Rod
  - (1) HEPA Filter
  - (1) Side Handle
  - (1) Carrying Case



| Part # | Mfg #     | Description | Price |
|--------|-----------|-------------|-------|
| 185835 | 2712-22DE | Kit         |       |

### M18 FUEL™ 1" SDS Plus Rotary Hammer with Dedicated Dust Extractor

- POWERSTATE™ brushless motor
- REDLINK PLUS™
- REDLITHIUM™ battery
- AVS system
- Kit includes:
  - (1) M18 FUEL™ 1" SDS Plus Rotary Hammer(2712-20)
  - (1) HAMMERVAC™ Dedicated Dust Extractor (2712-DE)
  - (2) M18™ REDLITHIUM™ XC5.0 Extended Capacity Battery Pack (48-11-1850)
  - (1) M18™ & M12™ Multi-Voltage Charger (48-59-1812)
  - (1) Depth Rod
  - (1) HEPA Filter
  - (1) Side Handle
  - (1) Carrying Case



| Part # | Mfg #   | Description          | Price |
|--------|---------|----------------------|-------|
| 228970 | 2712-DE | Hammervac™ Dedicated |       |

### HAMMERVAC™ Dedicated Dust Extractor

- Engineered to connect directly to and be powered by the M18 FUEL 1" SDS Plus Rotary Hammer



| Part # | Mfg #   | Description | Price |
|--------|---------|-------------|-------|
| 159511 | 2605-22 | Kit         |       |

## Power Tools

Tools

### HAMMERVAC™ Filter

- Use with HAMMERVAC™ 2306-20 and 2306-22 and 2712-22DE & 2715-22DE
- HEPA Certified Filters



| Part # | Mfg #      | Description | Price |
|--------|------------|-------------|-------|
| 186622 | 49-90-2306 | 3 Pack      |       |

### M18 Fuel™ Cordless Drills

#### M18™ FUEL™ 1/2" Hammer Drill/Driver

- POWERSTATE™ brushless motor
- REDLINK PLUS™ Intelligence prevents damage
- No load RPM: 0-550/0-2,000  
BPM: 32,000
- Includes:
  - 1/2" 18V Hammer Drill/Driver
  - Side handle
  - Belt clip
- 5-Year warranty



| Part # | Mfg #   | Description | Price |
|--------|---------|-------------|-------|
| 179573 | 2704-20 | Bare Tool   |       |

#### M18 FUEL™ 3/8" Impac Wrench Kit with Friction Ring

- 200 ft-lbs and 2,400 in-lbs of torque in a compact design
- POWERSTATE™ brushless motor
- REDLINK PLUS™
- REDLITHIUM™ battery pack
- Utilizes a friction ring design for fast, easy socket changes
- Includes:
  - (1) M18 FUEL™ 3/8" Impact wrench with friction ring (2654-20)
  - (2) M18™ REDLITHIUM™ XC 4.0 Extended capacity battery pack (48-11-1840)
  - (1) M18 & M12™ multi-voltage charger (48-59-1812)
  - (1) Belt clip
  - (1) Carrying case



| Part # | Mfg #   | Description | Price |
|--------|---------|-------------|-------|
| 158102 | 2654-22 | Kit         |       |

### M18 FUEL™ 1/2" Impact Wrench Kit with Pin Detent

- 210 ft-lbs and 2,520 in-lbs of torque in a compact design
- POWERSTATE™ Brushless Motor
- REDLITHIUM™ XC 4.0 Battery REDLINK PLUS™
- Utilizes a pin detent design for maximum socket retention
- Includes:
  - (1) M18 FUEL™ 1/2" Impact wrench with pin detent(bare tool) (2655-20)
  - (2) M18™ REDLITHIUM™ XC 4.0 extended capacity battery pack (48-11-1840)
  - (1) M18™ & M12™ multi-voltage charger (48-59-1812)
  - (1) Belt clip
  - (1) Carrying case



| Part # | Mfg #   | Description | Price |
|--------|---------|-------------|-------|
| 158103 | 2655-22 | Kit         |       |

### M18 FUEL™ Mud Mixer with 180° Handle Kit

- Includes:
  - LED light
  - Church key
  - Contractor's bag
  - M18 REDLITHIUM™ XC5.0
  - M18™ & M12™ Multi-voltage charger
- Up to 15 buckets per charge
- 16 Adjustable handle settings



| Part # | Mfg #   | Voltage   | Price |
|--------|---------|-----------|-------|
| 239069 | 2810-20 | Bare Tool |       |
| 239068 | 2810-22 | Kit       |       |

### M18™ Cordless Saws

#### M18™ Sawzall® Reciprocating Saw Kit

- Gear-protecting clutch
- Lever action Quik-Lok™ blade clamp
- Battery fuel gauge displays remaining run-time
- Variable speed trigger
- Kit Includes:
  - (1) Sawzall® Reciprocating saw (2621-20)
  - (2) M18™ REDLITHIUM™ XC Battery (48-11-1828)
  - (1) Multi-Voltage Charger (48-59-1812)
  - (1) Blade
  - (1) Carrying Case



| Part # | Mfg #   | Description | Price |
|--------|---------|-------------|-------|
| 173952 | 2621-20 | Bare Tool   |       |
| 173953 | 2621-21 | Kit         |       |
| 173954 | 2621-22 | Kit         |       |

## Power Tools

### M18™ HACKZALL® Cordless One-Handed Reciprocating Saw

- Speed: 0 to 3,000 spm
- Stroke length: 3/4"
- Blade clamp: QUIK-LOK™ universal
- Kit includes:
  - M18™ HACKZALL® Reciprocating saw (2625-20)
  - M18™ REDLITHIUM™ XC High capacity battery
  - 10-Hour charger
  - SAWZALL® Blade
  - Contractor bag



| Part # | Mfg #   | Description | Price |
|--------|---------|-------------|-------|
| 144657 | 2625-20 | Bare Tool   |       |
| 138662 | 2625-21 | Kit         |       |

### M18™ HACKZALL® Recip Saw Kit

- One-handed design provides superior control & versatility
- Compact size allows for cutting in tight spaces, and light weight makes overhead work easier
- Built-in LED light
- Includes:
  - (1) M18™ HACKZALL® Recip Saw (2625-20)
  - (1)M18™ Compact REDLITHIUM Battery (48-11-1815)
  - (1) M18™ & M12™ Multi-Voltage Charger (48-59-1812)
  - (1) Contractor Bag



| Part # | Mfg #     | Description | Price |
|--------|-----------|-------------|-------|
| 150993 | 2625-21CT | Kit         |       |

### M18™ Cordless Band Saw

- 3-1/4" Cut capacity
- Tool-free adjustable material shoe
- LED Work light
- Blade ejection system
- Drop resistant pulley guard
- Cast aluminum gear case
- Kit includes:
  - M18™ Band saw
  - (2) M18™ REDLITHIUM™ XC High capacity batteries
  - 1-Hour charger
  - Blade
  - Case
- 5-Year warranty



| Part # | Mfg #   | Description | Price |
|--------|---------|-------------|-------|
| 139287 | 2629-20 | Bare Tool   |       |
| 143146 | 2629-22 | Kit         |       |

### M18™ Cordless 6-1/2" Circular Saw

- Speed: 3,500 rpm
- Capacity: 2-1/8" @90° and 1-9/16" @45°
- Arbor: 5/8"
- Blade: 6-1/2" 24T carbide tipped
- Kit includes:
  - M18™ Circular saw (2630-20)
  - (2) M18™ REDLITHIUM™ XC High capacity batteries
  - 1-Hour charger
  - Contractor bag



| Part # | Mfg #   | Description | Price |
|--------|---------|-------------|-------|
| 143400 | 2630-20 | Bare Tool   |       |
| 138753 | 2630-22 | Kit         |       |

### M18™ Cordless Jig Saw

- Speed: 0 to 2,700 SPM
- Stroke length: 1"
- Bevel capacity: 45°
- Kit includes:
  - M18™ Jig saw (2645-20)
  - (2) M18™ REDLITHIUM™ XC High capacity batteries
  - 1-Hour charger
  - Jig saw blade
  - Non-marring shoe
  - Carrying case



| Part # | Mfg #   | Description | Price |
|--------|---------|-------------|-------|
| 142858 | 2645-20 | Bare Tool   |       |

## Power Tools

Tools

### M18™ Cordless Saws (Continued)

#### M18™ Cordless Jig Saw

| Part # | Mfg #   | Description | Price |
|--------|---------|-------------|-------|
| 138656 | 2645-22 | Kit         |       |

#### M18™ Cordless 5-3/8" Metal Saw

- 4-Pole frameless motor
- Speed: 3,600 rpm
- Cut capacity: 1/8" to 2"
- Blade: 5-3/8" 30T carbide-tipped
- Includes:
  - M18™ 5-3/8" Metal saw
  - (2) M18™ REDLITHIUM™ XC High capacity batteries
  - 1-Hour charger
  - 30T Metal Tech™ carbide-tipped blade
  - Blade wrench
  - Contractor bag



| Part # | Mfg #   | Description | Price |
|--------|---------|-------------|-------|
| 141828 | 2682-22 | Kit         |       |

### M18™ FUEL™ Cordless Saws

#### M18 FUEL™ 6-1/2" Circular Saw

- POWERSTATE™ Brushless motor
- REDLINK PLUS™ Intelligence
- REDLITHIUM™ XC 4.0 Battery
- Kit Includes:
  - (1) M18 FUEL™ 6-1/2" Circular saw (bare tool) (2730-20)
  - (1) M18™ REDLITHIUM™ XC Extended capacity battery pack
  - (1) M18™ & M12™ Multi-voltage charger (48-59-1812)
  - (1) Blade
  - (1) Blade wrench
  - (1) Contractor bag



| Part # | Mfg #   | Description | Price |
|--------|---------|-------------|-------|
| 162303 | 2730-20 | Bare Tool   |       |
| 166409 | 2730-21 | Kit         |       |
| 161702 | 2730-22 | Kit         |       |

#### M18 FUEL™ 7-1/4" Circular Saw

- POWERSTATE™ Brushless motor
- REDLINK PLUS™ Intelligence
- REDLITHIUM™ XC 4.0 Battery
- Kit Includes:
  - (1) M18 FUEL™ 7-1/4" Circular Saw (Bare Tool) (2731-20)
  - (2) M18™ REDLITHIUM™ XC5.0 Extended Capacity Battery Pack (48-11-1850)
  - (1) M18™ & M12™ Multi-Voltage Charger (48-59-1812)
  - (1) Blade
  - (1) Blade Wrench
  - (1) Contractor Bag



| Part # | Mfg #   | Description | Price |
|--------|---------|-------------|-------|
| 174393 | 2731-20 | Bare Tool   |       |
| 172223 | 2731-21 | Kit         |       |
| 172201 | 2731-22 | Kit         |       |

#### M18 FUEL™ 7-1/4" Circular Saw

- POWERSTATE™ Brushless Motor
- REDLINK PLUS™ Intelligence
- REDLITHIUM™ HIGH OUTPUT™ HD12.0 Battery
- Magnesium shoe and guards for maximum durability
- Integrated rafter hook
- LED light
- Integrated dust port on guard and included vac adaptor
- Electric brake to stop blade after tripper is released



| Part # | Mfg #     | Description | Price |
|--------|-----------|-------------|-------|
| 248727 | 2732-21HD | Kit         |       |

#### M18 FUEL™ Metal Cutting Circular Saw

- POWERSTATE™ Brushless motor
- REDLITHIUM™ battery
- REDLINK PLUS™ intelligence
- 5-3/8" - 5-7/8"



| Part # | Mfg #   | Description | Price |
|--------|---------|-------------|-------|
| 233188 | 2782-20 | Bare Tool   |       |
| 234480 | 2782-22 | Kit         |       |

## Power Tools

### M18 FUEL™ Hackzall Reciprocating Saw

- One-handed design
- 7/8" Stroke length
- Pivoting shoe
- POWERSTATE™
- REDLINK PLUS™
- REDLITHIUM™
- Includes SAWZALL® blade
- Kit includes:
  - Contractor's bag
  - SAWZALL® blade
  - M18 XC5.0 Battery pack
  - M18 FUEL Hackzall (2719-20)
  - M18/M12 Multi-voltage charger



| Part # | Mfg #   | Description | Price |
|--------|---------|-------------|-------|
| 239589 | 2719-20 | Bare Tool   |       |
| 239591 | 2719-21 | Kit         |       |

### M18 FUEL™ Sawzall® Reciprocating Saw Kit

- Delivers faster than corded cutting speed and the durability of a corded saw
- POWERSTATE™ Brushless motor
- REDLINK PLUS™ Intelligence
- REDLITHIUM™ XC 4.0 Battery
- 2720-22, 2720-21 Kit Includes:
  - (1) M18 FUEL™ SAWZALL® reciprocating saw (2720-20)
  - (1) M18™ REDLITHIUM™ extended capacity battery pack
  - (1) M18™ & M12™ Multi-voltage charger
  - (1) Blade
  - (1) Carrying case



| Part # | Mfg #     | Description      | Price |
|--------|-----------|------------------|-------|
| 161655 | 2720-20   | Bare Tool        |       |
| 161658 | 2720-21   | Kit              |       |
| 161581 | 2720-22   | Kit              |       |
| 235946 | 2720-22HD | Kit, High Demand |       |

### M18 FUEL™ SUPER SAWZALL® Reciprocating Saw

- POWERSTATE™ brushless motor
- REDLINK PLUS™ Intelligence
- REDLITHIUM™ HIGH OUTPUT™ HD12.0 Battery
- 1-1/4" Stroke length removes more material
- Variable speed trigger and 5-speed dial
- Integrated rafter hook
- LED light
- Adjustable shoe
- QUIK-LOK® blade clamp
- Compatible with all M18™ batteries



| Part # | Mfg #     | Description | Price |
|--------|-----------|-------------|-------|
| 248733 | 2722-21HD | Kit         |       |

### M18 FUEL™ Deep Cut Band Saw

- POWERSTATE™ brushless motor
- REDLITHIUM™
- REDLINK PLUS™
- Kit Includes:
  - (1) Deep Cut Band Saw (Bare Tool) (2729-20)
  - (1) M18™ REDLITHIUM™ XC5.0 Extended Capacity Battery Pack (48-11-1850)
  - (1) M18™ & M12™ Multi-Voltage Charger (48-59-1812)
  - (1) Blade
  - (1) Carrying Case



| Part # | Mfg #   | Description | Price |
|--------|---------|-------------|-------|
| 167156 | 2729-20 | Bare Tool   |       |
| 167158 | 2729-21 | Kit         |       |
| 167159 | 2729-22 | Kit         |       |

### M18 FUEL™ High Demand Deep Cut Band Saw

- POWERSTATE™ brushless motor
- REDLITHIUM™
- REDLINK PLUS™
- Kit Includes:
  - (1) M18 FUEL™ Deep Cut Band Saw (Bare Tool) (2729-20)
  - (1) M18™ & M12™ Rapid Charger (48-59-1808)
  - (2) M18™ REDLITHIUM™ HIGH DEMAND™ 9.0 Battery Pack (48-11-1890)
  - (1) Blade
  - (1) Carrying Case



| Part # | Mfg #     | Description | Price |
|--------|-----------|-------------|-------|
| 230566 | 2729-22HD | Kit         |       |

## Power Tools

Tools

### M18 FUEL™ 7-1/4" Dual Bevel Sliding Compound Miter Saw

- Only 28 lbs with battery
- Dual bevel with stops at 45° and 48°
- Over 600 cuts per charge
- 3-1/2" Vertical capacity
- 2x8 Horizontal capacity
- 3-5/8" Nested crown capacity
- Cam locking miter detent system
- Shadow cut line indicator for quickly lining up cuts
- Integrated top and side carry handles for easy transportation



| Part # | Mfg #   | Description | Price |
|--------|---------|-------------|-------|
| 240500 | 2733-20 | Bare Tool   |       |

### M18 FUEL™ Sliding Compound Miter Saw

- REDLINK PLUS™
- POWERSTATE™ brushless motor
- REDLITHIUM™ battery pack
- Up to 400 cuts per charge
- Shadow cut line indicator
- Top & side carrying handles
- Tall sliding/removable fences
- Cam locking miter system with adjustable miter detent plate and 11 detent locations
- Dual bevel with 9 detents & easy access bevel level
- Kit includes:
  - (1) M18 FUEL™ Dual Bevel Sliding Compound Miter Saw (2734-20)
  - (1) M18™ REDLITHIUM™ HIGH DEMAND™ 9.0 Battery Pack (48-11-1890)
  - (1) M18™ & M12™ Rapid Charger (48-59-1808)
  - (1) Blade Wrench
  - (1) Carbide Tipped Blade
  - (1) Clamp
  - (1) Dust Bag



| Part # | Mfg #     | Description | Price |
|--------|-----------|-------------|-------|
| 239066 | 2734-20   | Bare Tool   |       |
| 225667 | 2734-21HD | Kit         |       |

### M18 FUEL™ 18" Chain saw Kit

- KIT INCLUDES:
- (1) M18 FUEL™ 16" Chain saw(1) 16" Oregon Bar and
- (1) M18 REDLITHIUM™ HIGH OUTPUT™ HD12.0 Battery Pack (48-11-1812)
- (1) M18™ & M12™ Rapid Charger (48-59-1808)
- (1) Scrench



| Part # | Mfg #     | Description | Price |
|--------|-----------|-------------|-------|
| 248734 | 2727-21HD | Kit         |       |

### M18 FUEL™ 8-1/4" Table Saw w/ One-Key™

- POWERSTATE™ Brushless motor
- REDLINK PLUS™ Intelligence
- REDLITHIUM™ HIH OUTPUT™ HD12.0 battery pack
- 24.5" Rip capacity to rip 4x8 sheets of plywood or OSB
- On board storage for guard, riving knife, push stick, fence and miter gauge
- Rack and pinion fence system
- All metal frame
- Single wrench blade change



| Part # | Mfg #     | Description | Price |
|--------|-----------|-------------|-------|
| 248728 | 2736-21HD | Kit         |       |

### M18™ Knockout Tools

#### M18™ FORCELOGIC™ 6T Knockout Tool

- Includes:
  - 7/16" Draw stud
  - 3/4" Draw stud
  - 1-1/8" Draw stud
  - EXACT™ 2-1/2" die
  - EXACT™ 2-1/2" punch
  - EXACT™ 3" die
  - EXACT™ 3" punch
  - EXACT™ 3-1/2" die
  - EXACT™ 3-1/2" punch
  - EXACT™ 4" die
  - EXACT™ 4" punch
  - M18™ REDLITHIUM™ battery
  - M18™ & M12™ Multi-voltage charger
  - EXACT™ rapid reset 3/4" draw stud set
  - EXACT™ 1/2"-2" conduit punches and dies
  - Quick-connect alignment system
  - Carrying case



| Part # | Mfg #   | Description | Price |
|--------|---------|-------------|-------|
| 239293 | 2677-23 | Kit         |       |



## Power Tools

### FORCELOGIC™ M18™ 10 Ton Knockout Tool Kit

- Includes:
- (2) M18™ REDLITHIUM™ XC Extended Capacity Battery (48-11-1828)
- (1) M18™ & M12™ Multi-voltage charger (48-59-1812)
- (1) Exact™ 1/2" Stainless steel die (49-16-2660S)
- (1) Exact™ 1/2" Stainless steel punch (49-16-2661S)
- (1) Exact™ 3/4" Die (49-16-2662)
- (1) Exact™ 3/4" Punch (49-16-2663)
- (1) Exact™ 1" Die (49-16-2664)
- (1) Exact™ 1" Punch (49-16-2665)
- (1) Exact™ 1-1/4" Die (49-16-2666)
- (1) Exact™ 1-1/4" Punch (49-16-2667)
- (1) Exact™ 1-1/2" Die (49-16-2668)
- (1) Exact™ 1-1/2" Punch (49-16-2669)
- (1) Exact™ 2" Die (49-16-2670)
- (1) Exact™ 2" Punch (49-16-2671)
- (1) 7/16" Draw Stud (49-16-2680)
- (1) 3/4" Draw Stud (49-16-2681)
- (1) Ball Stud
- (1) Coupler
- (1) Quick connect collar
- (1) Carrying case



| Part # | Mfg #   | Description | Price |
|--------|---------|-------------|-------|
| 167335 | 2676-22 | Kit         |       |

### FORCELOGIC™ M18™ 10 Ton Knockout Tool

- Includes:
- (1) 1-1/8" Draw Stud
- (2) M18™ REDLITHIUM™ XC extended capacity battery (48-11-1828)
- (1) M18™ & M12™ Multi-voltage charger (48-59-1812)
- (1) EXACT™ 1/2" Stainless steel die (49-16-2660S)
- (1) EXACT™ 1/2" Stainless steel punch (49-16-2661S)
- (1) EXACT™ 3/4" Die (49-16-2662)
- (1) EXACT™ 3/4" Punch (49-16-2663)
- (1) EXACT™ 1" Die (49-16-2664)
- (1) EXACT™ 1" Punch (49-16-2665)
- (1) EXACT™ 1-1/4" Die (49-16-2666)
- (1) EXACT™ 1-1/4" Punch (49-16-2667)
- (1) EXACT™ 1-1/2" Die (49-16-2668)
- (1) EXACT™ 1-1/2" Punch (49-16-2669)
- (1) EXACT™ 2" Die (49-16-2670)
- (1) EXACT™ 2" Punch (49-16-2671)
- (1) EXACT™ 2-1/2" Die (49-16-2672)
- (1) EXACT™ 2-1/2" Punch (49-16-2673)
- (1) EXACT™ 3" Die (49-16-2674)
- (1) EXACT™ 3" Punch (49-16-2675)
- (1) EXACT™ 3-1/2" Die (49-16-2676)
- (1) EXACT™ 3-1/2" Punch (49-16-2677)
- (1) EXACT™ 4" Die (49-16-2678)
- (1) EXACT™ 4" Punch (49-16-2679)
- (1) 7/16" Draw stud (49-16-2680)
- (1) 3/4" Draw stud (49-16-2681)
- (1) Ball stud
- (1) Coupler
- (1) Quick connect collar
- (2) Carrying case



| Part # | Mfg #   | Description | Price |
|--------|---------|-------------|-------|
| 167336 | 2676-23 | Kit         |       |

### M18™ Miscellaneous Tools

#### M18™ 3-1/4" Planer Tool

- Kit Includes:
- (1) M18™ 3-1/4" Planer (Tool Only) (2623-20)
- (1) M18™ REDLITHIUM™ XC Extended Capacity Battery (48-11-1828)
- (1) M18™ & M12™ Multi-Voltage Charger (48-59-1812)
- (2) Double Edge Carbide Blade
- (1) Contractor's Bag
- (1) Bevel/Edge Guide



| Part # | Mfg #   | Description | Price |
|--------|---------|-------------|-------|
| 225421 | 2623-20 | Bare Tool   |       |
| 225234 | 2623-21 | Kit         |       |

## Power Tools

Tools

### M18™ Cordless 10oz Caulk and Adhesive Gun

- All metal gears
- Variable-speed trigger
- CFT™ Constant Flow Technology
- Anti-drip mechanism
- Rotating quick-change collar
- 6-Setting max speed dial



| Part # | Mfg #   | Description | Price |
|--------|---------|-------------|-------|
| 173334 | 2641-20 | Bare Tool   |       |

#### Kit Includes

- (1) M18™ Cordless 10oz. Caulk and Adhesive Gun (Tool Only) (2641-20)
- (1) 10oz Carriage Conversion Kit (48-08-1076)
- (1) M18™ Compact REDLITHIUM™ Battery (48-11-1815)
- (1) M18™ & M12™ Multi-Voltage Charger (48-59-1812)
- Where To Buy

| Part # | Mfg #     | Description | Price |
|--------|-----------|-------------|-------|
| 173333 | 2641-21CT | Kit         |       |

### M18™ Cordless 20oz Aluminum Barrel Caulk and Adhesive Gun

- All metal gears
- Variable-speed trigger
- CFT™ Constant Flow Technology
- Anti-drip mechanism
- Rotating quick-change collar
- 6-Setting max speed dial



- Kit Includes:
  - (1) M18™ Cordless Caulk and Adhesive Gun
- (1) 20oz Aluminum Barrel Sausage Conversion Kit (48-08-1093)
- (1) M18™ Compact REDLITHIUM™ Battery (48-11-1815)
- (1) M18™ & M12™ Multi-Voltage Charger (48-59-1812)

| Part # | Mfg #     | Description | Price |
|--------|-----------|-------------|-------|
| 141557 | 2642-21CT | Kit         |       |

### M18 FUEL™ Drywall Screw Gun Kit

- Kit includes:
  - (1) M18 FUEL™ Drywall Screw Gun (2866-20)
  - (2) M18™ REDLITHIUM™ XC5.0 Extended Capacity Battery (48-11-1850)
  - (1) M18™ & M12™ Multi-Voltage Charger (48-59-1812)
  - (1) Belt Clip
  - (1) PR2 Bit
  - (1) Contractor Bag



| Part # | Mfg #   | Description | Price |
|--------|---------|-------------|-------|
| 227453 | 2866-20 | Bare Tool   |       |
| 231942 | 2866-22 | Kit         |       |

### M18 FUEL™ 7" Variable Speed Polisher



| Part # | Mfg #   | Description | Price |
|--------|---------|-------------|-------|
| 24296  | 2738-20 | Bare Tool   |       |

### M18™ Random Orbit Sander

- 12,000 OPM max
- More material removed per charge
- Variable speed control
- 5" Sanding pad
- 7,000-12,000 OPM Variable speed
- 3/32" Orbit diameter
- Dust canister with filter
- Universal hose adapter included



#### Kit Includes

- (1) M18™ Random Orbit Sander Kit (2648-21)
- (1) Dust Canister
- (1) Universal Hose Adapter
- (1) Extension Adapter
- (2) 80 Grit Sandpaper
- (1) M18™ REDLITHIUM™ XC Ext Capacity Battery
- (1) Multi-Voltage Charger
- (1) Contractor Bag

| Part # | Mfg #   | Description | Price |
|--------|---------|-------------|-------|
| 248147 | 2648-21 | Kit         |       |

## Power Tools

### M18 FUEL™ 18ga Brad Nailer

- POWERSTATE™ Brushless motor
- REDLINK PLUS™ intelligence
- Zero ramp-up time
- No gas cartridges



| Part # | Mfg #   | Description | Price |
|--------|---------|-------------|-------|
| 223482 | 2740-20 | Bare Tool   |       |

### M18 FUEL™ 15ga Finish Nailer

- POWERSTATE™ Brushless motor
- REDLINK PLUS™ Intelligence
- Sink 2-1/2" finish nails in solid oak
- Zero ramp-up time
- No gas cartridges



| Part # | Mfg #   | Description | Price |
|--------|---------|-------------|-------|
| 189724 | 2743-20 | Bare Tool   |       |

### M18 FUEL™ 16ga Straight Finish Nailer

- POWERSTATE™ Brushless Motor
- REDLINK PLUS™
- Sinks 2-1/2" finish nails in solid oak
- No gas cartridges
- Zero ramp-up time



| Part # | Mfg #   | Description | Price |
|--------|---------|-------------|-------|
| 228977 | 2741-20 | Bare Tool   |       |

### M18 FUEL™ 16ga Angled Finish Nailer

- POWERSTATE™ Brushless motor
- REDLINK PLUS™ Electronic Intelligence
- Sink 2-1/2" finish nails in solid oak
- Zero ramp-up time
- No gas cartridges



| Part # | Mfg #   | Description | Price |
|--------|---------|-------------|-------|
| 190524 | 2742-20 | Bare Tool   |       |

#### Kit Includes

- (1) M18 FUEL™ 16ga Angled Finish Nailer (2742-20)
- (1) M18™ & M12™ Multi-Voltage Charger (48-59-1812)
- (1) M18™ REDLITHIUM™ CP2.0 Battery Pack (48-11-1820)
- (1) Contractor Bag
- (1) Belt Clip

| Part # | Mfg #     | Description | Price |
|--------|-----------|-------------|-------|
| 190525 | 2742-21CT | Kit         |       |

### M18™ Transfer Pump

- Self-priming pump
- Flexible impeller moves water up to 480 gph
- Generates up to 18' of lift and produces up to 75' of head height
- REDLINK™ intelligence
- Kit Includes:
  - (1) M18™ Transfer Pump (2771-20)
  - (1) M18™ REDLITHIUM™ XC Extended Capacity Battery (48-11-1828)
  - (1) M18™ & M12™ Multi-Voltage Charger (48-59-1812)



| Part # | Mfg #   | Description | Price |
|--------|---------|-------------|-------|
| 226698 | 2771-20 | Bare Tool   |       |
| 226699 | 2771-21 | Kit         |       |

### M18™ Cordless Multi Tool

- Kit Includes:
  - (1) M18™ Cordless Multi-Tool (Bare Tool) (2626-20)
  - (1) M18™ REDLITHIUM™ XC Extended Capacity Battery (48-11-1828)
  - (1) M18™ & M12™ Multi-Voltage Charger (48-59-1812)
  - (1) Adapter
  - (5) Assorted Sanding Sheets
  - (1) Contractor Bag
  - (1) Sanding Pad
  - (1) Wood Cutting Blade



| Part # | Mfg #   | Description | Price |
|--------|---------|-------------|-------|
| 166675 | 2626-20 | Bare Tool   |       |
| 166678 | 2626-22 | Kit         |       |

## Power Tools

Tools

### M18™ Force Logic™ 12 Ton Crimper

- (1) Carbineer
- (1) Overhead utility bag
- (1) M18 Lithium-Ion AC/DC charger
- (1) M18 REDLITHIUM™ XC5.0 extended capacity battery pack
- (1) M18 REDLITHIUM™ 2.0 compact battery pack
- 350° Head rotation
- Pre-Crimp battery check
- Ergonomic grip design
- ONE-KEY™ technology
- POWERSTATE® brushless motor
- Predictive force monitoring (PFM™)
- REDLINK PLUS™ electronic intelligence



| Part # | Mfg #   | Description | Price |
|--------|---------|-------------|-------|
| 237770 | 2778-22 | Kit         |       |

### M18™ Force Logic™ 750 MCM Crimper

- (1) Carrying case
- (1) M18 & M12 multi-voltage charger
- (1) M18 REDLITHIUM™ XC5.0 extended capacity battery pack
- (1) M18 REDLITHIUM™ 2.0 compact battery pack
- 350° Head rotation
- Pre-Crimp battery check
- Ergonomic grip design
- ONE-KEY™ technology
- POWERSTATE® brushless motor
- Predictive force monitoring (PFM™)
- REDLINK PLUS™ electronic intelligence



| Part # | Mfg #   | Description | Price |
|--------|---------|-------------|-------|
| 237771 | 2779-22 | Kit         |       |

### M18 FUEL™ 4-1/2" / 5" Grinder, Slide Switch Lock-On

- Kit includes:
  - (1) M18 FUEL™ 4-1/2" / 5" Grinder, Slide Switch Lock-On (Bare Tool) (2781-20)
  - (1) M18™ REDLITHIUM™ XC5.0 Extended Capacity Battery Pack (48-11-1850)
  - (1) M18™ & M12™ Multi-Voltage Charger (48-59-1812)
  - (1) Carrying Case
  - (1) Flange Nuts
  - (1) Wheel Guard
  - (1) Spanner Wrench



| Part # | Mfg #   | Description | Price |
|--------|---------|-------------|-------|
| 166871 | 2781-20 | Bare Tool   |       |

### M18™ Miscellaneous Tools (Continued)

#### M18 FUEL™ 4-1/2" / 5" Grinder, Slide Switch Lock-On

| Part # | Mfg #   | Description | Price |
|--------|---------|-------------|-------|
| 166872 | 2781-21 | Kit         |       |

#### M18 FUEL™ 4-1/2"/5" Grinder, Paddle Switch No-Lock Kit

- POWERSTATE™ Brushless motor
- REDLINK PLUS™ Intelligence
- REDLITHIUM™ XC 4.0 Battery
- Power TO GRIND
- DURABILITY
- 100% tool free productivity
- Paddle-switch design: provides increased comfort and ease-of-use when operating in various positions
- Kit Includes:
  - (1) M18 FUEL™ 4-1/2"/5" Grinder, paddle switch no-lock (bare tool) (2780-20)
  - (2) M18™ REDLITHIUM™ XCEXtended capacity battery pack
  - (1) M18™ & M12™ Multi-voltage charger
  - (1) Carrying case
  - (1) Flange nut
  - (1) Spanner wrench
  - (1) Wheel guard



| Part # | Mfg #     | Description      | Price |
|--------|-----------|------------------|-------|
| 162116 | 2780-20   | Bare Tool        |       |
| 171444 | 2780-21   | Kit              |       |
| 164099 | 2780-22   | Kit              |       |
| 236384 | 2780-22HD | Kit, High Demand |       |

#### M18™ FUEL™ 4-1/2" / 5" Braking Grinder

- 100% tool free: Make all accessory changes and guard adjustments without a wrench for increased productivity
- POWERSTATE™ Brushless Motor
- REDLINK PLUS™ Intelligence



| Part # | Mfg #   | Description | Price |
|--------|---------|-------------|-------|
| 180423 | 2783-20 | Bare Tool   |       |

## Power Tools

### Kit Includes

- (1) M18 FUEL™ 4-1/2" / 5" Braking Grinder (2783-20)
- (2) M18™ REDLITHIUM™ XC5.0 Extended Capacity Battery Pack (48-11-1850)
- (1) M18™ & M12™ Multi-Voltage Charger (48-59-1812)
- (1) T27 Guard, (1) Flange Nut, (1) FIXTEC Nut

| Part # | Mfg #   | Description | Price |
|--------|---------|-------------|-------|
| 179534 | 2783-22 | Kit         |       |

### M18 FUEL™ 7" / 9" Large Angle Grinder

- 100% Tool Free: Make all accessory changes and guard adjustments without a wrench for increased productivity
- Dual action trigger: eliminating accidental trigger actuation
- POWERSTATE™ Brushless Motor
- REDLINK PLUS™ Intelligence



### Kit Includes

- (1) M18 FUEL™ 7" / 9" Large Angle Grinder Kit
- (2) M18 REDLITHIUM™ HIGH OUTPUT™ HD12.0 Battery Pack (48-11-1812)
- (1) M18™ & M12™ Rapid Charger (48-59-1808)
- (1) 9 inch T27 Guard, (1) Anti-Vibration Side Handle
- (1) Back Flange, (1) Dust Vent Clip, (1) FIXTEC Nut
- (1) Spanner Wrench

| Part # | Mfg #     | Description | Price |
|--------|-----------|-------------|-------|
| 248730 | 2785-21HD | Kit         |       |

### M18 FUEL™ 1/4" Die Grinder

- Kit Includes:
  - (1) M18 FUEL™ 1/4" Die Grinder (2784-20)
  - (2) M18™ REDLITHIUM™ XC5.0 Extended Capacity Battery Pack (48-11-1850)
  - (1) M18™ & M12™ Multi-Voltage Charger (48-59-1812)
  - (1) 1/4" Collet
  - (2) Wrench



| Part # | Mfg #   | Description | Price |
|--------|---------|-------------|-------|
| 235256 | 2784-20 | Bare Tool   |       |
| 231944 | 2784-22 | Kit         |       |

### M18™ Cordless 4-1/2" Cut-Off / Grinder



| Part # | Mfg #   | Description | Price |
|--------|---------|-------------|-------|
| 141679 | 2680-20 | Bare Tool   |       |

### M18™ Cut Out Tool



| Part # | Mfg #   | Description | Price |
|--------|---------|-------------|-------|
| 232311 | 2627-20 | Bare Tool   |       |

### M18 FUEL™ Drain Snake with Cable-Drive Kit

- LED light
- Fully enclosed drum
- REDLINK PLUS™
- POWERSTATE™ brushless motor
- CABLE-DRIVE™ locking feed system
- Capacity: 1/4" x 50', 5/16" x 35' inner core cable
- Includes:
  - Storage bucket
  - M18 REDLITHIUM™ battery
  - M18 & M12™ multi-voltage charger



| Part # | Mfg #    | Description | Price |
|--------|----------|-------------|-------|
| 238924 | 2772A-21 | 18V         |       |

### M18™ Job Site Fan

- Circulates air over 40 feet
- 120° adjustable head
- 9 stopping positions,
- AC adaptor included
- Four keyhole hangers and two hanging holes
- Compatible with all M18™ REDLITHIUM™ batteries
  - 17 Hours runtime on XC5.0 battery



| Part # | Mfg #   | Description       | Price |
|--------|---------|-------------------|-------|
| 176814 | 0886-20 | M18™ Job Site Fan |       |

## Power Tools

Tools

### M18™ Compact Blower

- Extension nozzle
- Lock-on switch
- Universal inflator/deflator
- 3-Speed electronic switch and variable speed trigger
- Shock-absorbing polymer and reinforced handle
- Soft plastic nozzle to resist crushing or cracking



| Part # | Mfg #   | Description | Price |
|--------|---------|-------------|-------|
| 163737 | 0884-20 | (Bare Tool) |       |

### M18 FUEL™ Blower Kit

- Cruise control
- 100 MPH maximum air speed
- POWERSTATE™ brushless motor
- Kit Includes:  
M18 FUEL™ Blower (Tool Only) (2728-20)
- (1) M18™ REDLITHIUM™ HIGH DEMAND™ 9.0 Battery Pack (48-11-1890)
- (1) M18™ & M12™ Rapid Charger (48-59-1808)



| Part # | Mfg #     | Description | Price |
|--------|-----------|-------------|-------|
| 229242 | 2728-20   | Bare Tool   |       |
| 229241 | 2728-21HD | Kit         |       |

### M18 FUEL™ Blower Kit

- Power to clear from 15'
- Full throttle in under 1 second
- up to 4lbs lighter
- POWERSTATE™ brushless motor
- REDLINK PLUS™ intelligence
- REDLITHIUM™ HIGH DEMAND™ 9.0 battery (Kit Only)
- Max air volume: 450 CFM  
Max air speed: 120 MPH



| Part # | Mfg #   | Description | Price |
|--------|---------|-------------|-------|
| 244533 | 2724-20 | Bare Tool   |       |

**Kit Includes**  
**(1) M18 FUEL™ Blower**

**(1) M18™ REDLITHIUM™ HIGH DEMAND™ 9.0 Battery**  
**(1) Rapid Charger**

| Part # | Mfg #     | Description | Price |
|--------|-----------|-------------|-------|
| 247196 | 2724-21HD | Kit         |       |

### M18 FUEL™ String Trimmer

- Kit includes:  
M18 FUEL™ String Trimmer (Tool Only) (2725-20)
- (1) M18™ REDLITHIUM™ 9.0 Battery (48-11-1890)
- (1) M18™ & M12™ Rapid Charger (48-59-1808)



| Part # | Mfg #     | Description | Price |
|--------|-----------|-------------|-------|
| 229238 | 2725-20   | Bare Tool   |       |
| 229237 | 2725-21HD | Kit         |       |

### Accessories

| Part # | Mfg #      | Description               | Price |
|--------|------------|---------------------------|-------|
| 229245 | 49-16-2710 | Trimmer Head              |       |
| 244532 | 49-16-2714 | Easy Load Trimmer Head    |       |
| 229246 | 49-16-2711 | Loaded Trimmer Head Spool |       |

### M18 FUEL™ Hedge Trimmer

- POWERSTATE™ brushless motor
- REDLINK PLUS™
- Slider crank mechanism
- 24" Blade with tip guard
- Kit Includes:  
(1) M18 FUEL™ Hedge Trimmer (Tool Only) (2726-20)  
(1) M18™ REDLITHIUM™ HIGH DEMAND™ 9.0 Battery Pack (48-11-1890)  
(1) M18™ & M12™ Rapid Charger (48-59-1808)



| Part # | Mfg #     | Description | Price |
|--------|-----------|-------------|-------|
| 229240 | 2726-20   | Bare Tool   |       |
| 229239 | 2726-21HD | Kit         |       |

### M18™ Tool Box Style Wet/Dry Vacuum

- On-board accessory and hose storage
- HEPA Rated high efficiency filter
- Includes:  
- Wet/dry vacuum  
- Filter assembly  
- Crevice tool  
- Wide utility nozzle  
- Wireless vinyl hose
- Battery and charger not included



| Part # | Mfg #   | Description | Price |
|--------|---------|-------------|-------|
| 136036 | 0880-20 | 2 gal, 18V  |       |

## Power Tools

### 18" Hose Adapter



| Part # | Mfg #      | Description | Price |
|--------|------------|-------------|-------|
| 139837 | 14-37-0160 | 1 Pack      |       |

### M18™ Compact Vacuum

- High performance motor
- Adapts from handheld to stationary
- 40 CFM
- Removable HEPA filter
- Clear view and easy to empty canister
- Canister volume: 36oz
- Inlet diameter: 1 1/4"
- Includes:
  - (1) M18™ Compact vacuum (0882-20)
  - (1) Crevice tool
  - (2) Extension
  - (1) HEPA filter



| Part # | Mfg #   | Description         | Price |
|--------|---------|---------------------|-------|
| 228972 | 0882-20 | M18™ Compact Vacuum |       |

### HEPA Dry Filter Kit

- For (0882-20) M18™ Compact Vacuum
- 2/Pk



| Part # | Mfg #      | Description | Price |
|--------|------------|-------------|-------|
| 228971 | 49-90-1951 | 2 Pack      |       |

### M18™ Cordless 2-Speed Grease Gun Kit

- 0,000 PSI max operating pressure
- max flow of up to 10oz / minute
- Pre-set grease counter dial
- 48" flexible hose
- Air bleeder valve for quick priming
- M18™ REDLITHIUM™ System
- Lock-on/ Lock-off trigger
- Includes:
  - (1) M18™ Cordless 2-speed grease gun (2646-20)
  - (1) 48" Flex hose w/spring guard
  - (2) M18™ Compact REDLITHIUM™ battery (48-11-1815)
  - (1) M18™ & M12™ Multi-voltage charger (48-59-1812)
  - (1) High pressure grease coupler
  - (1) Hard carrying case
  - (1) Shoulder strap



| Part # | Mfg #     | Description | Price |
|--------|-----------|-------------|-------|
| 160459 | 2646-20   | Bare Tool   |       |
| 160923 | 2646-22CT | Kit         |       |
| 181713 | 2646-21CT | Kit         |       |

### M18™ Cordless 18g Double Cut Shear

- 360° Tool-free rotating head
- Ergonomic body design
- Variable speed trigger
- Kit Includes:
  - (1) M18™ Cordless 18 Gauge Double Cut Shear (Bare Tool) (2635-20)
  - (2) M18™ REDLITHIUM™ XC Extended Capacity Battery (48-11-1828)
  - (1) M18™ & M12™ Multi-Voltage Charger (48-59-1812)
  - (1) Contractor Bag



| Part # | Mfg #   | Description | Price |
|--------|---------|-------------|-------|
| 180620 | 2635-20 | Bare Tool   |       |
| 171803 | 2635-22 | Kit         |       |

### M18™ 18g Single Cut Shear

- 360° Tool-Free Rotating Head
- Ergonomic Body Design
- Variable Speed Trigger
- Belt Clip



| Part # | Mfg #   | Description | Price |
|--------|---------|-------------|-------|
| 228271 | 2637-20 | Bare Tool   |       |
| 176736 | 2637-22 | Kit         |       |

## Power Tools

Tools

### M18™ Cordless 14g Double Cut Shear

- 360° Tool-free rotating head
- Ergonomic body design
- Variable speed tripper
- Kit Includes:
  - M18™ 14G Double Cut Shear (2636-20)
  - M18™&M12™ Multi-Voltage Charger (48-59-1812)
  - M18™ REDLITHIUM™ XC Extended Capacity Battery
  - Contractor Bag



| Part # | Mfg #   | Description | Price |
|--------|---------|-------------|-------|
| 243336 | 2636-22 | Kit         |       |

### M18 FUEL™ SWITCH PACK™ Sectional Drum System Kit

- Fully enclosed drum
- Spin speed: 250 RPM
- Accepts other brand cables
- Includes:
  - Integrated drum brake
  - Built-in backpack straps
  - SWITCH PACK™ powered base
  - SWITCH PACK™ drum w/ anchor cable
  - 3/8" x 50' Inner core coupling cable
  - 5-Piece medium drain line kit
  - M18™ REDLITHIUM™ XC5.0 battery
  - M18™ & M12™ multi-voltage charger
  - REDLINK PLUS
  - POWERSTATE™ brushless motor
  - Electronic foot pedal with non-slip grip



| Part # | Mfg #     | Voltage | Price |
|--------|-----------|---------|-------|
| 238925 | 2775B-211 | 18V     |       |

### SWITCH PACK™ Drum with Anchor Cable

- Tool-free drum latch
- Full enclosed drum
- Accepts other brand cables
- 1/2" x 50' Inner core cables
- 5/8" x 50' Open wind cable
- Drum capacity: 5/16" x 75' & 3/8" x 50'
- On-board storage for cable head attachments
- Part of the SWITCHPACK™ sectional drum system



| Part # | Mfg #      | Description            | Price |
|--------|------------|------------------------|-------|
| 238935 | 47-53-2775 | Drum with Anchor Cable |       |

### M18™ Tool Combo Kits

#### M18™ 2-Tool Combo Kit (Compact Brushless Hammer Drill and Brushless Impact)



##### Kit Includes

- (1) M18™ 1/2" Compact Brushless Hammer Drill/Driver (2702-20)
- (1) M18™ 1/4" Hex Brushless Impact Driver (2750-20)
- (1) M18™ Compact REDLITHIUM™ Battery (48-11-1815)
- (1) M18™ REDLITHIUM™ XC Ext Cap Battery (48-11-1828)
- (1) Belt Clip, (1) Contractor Bag

| Part # | Mfg #     | Description | Price |
|--------|-----------|-------------|-------|
| 173946 | 2799-22CX | Kit         |       |

#### M18™ FUEL 2-Tool Combo Kit (Hammer Drill/Driver and Hex Impact Driver)

- (1) M18 FUEL™ 1/2" Hammer Drill/Driver (2704-20)
- (1) M18 FUEL™ 1/4" Hex Impact Driver (2753-20)
- (2) M18™ REDLITHIUM™ XC5.0 Extended Capacity Battery Pack (48-11-1850)
- (1) M18™ & M12™ Multi-Voltage Charger (48-59-1812)
- (2) Belt Clip
- (2) Bit Holder
- (1) Side Handle
- (1) Carrying Case



| Part # | Mfg #   | Description      | Price |
|--------|---------|------------------|-------|
| 179577 | 2897-22 | 2-Tool Combo Kit |       |



## Power Tools

### M18™ FUEL 2-Tool Combo Kit with ONE-KEY™ (Hammer Drill/Driver and Hex Impact Driver)

- M18 FUEL™ 1/2" hammer drill/driver (2706-20)
- M18 FUEL™ 1/4" hex impact driver (2757-20)
- M18™ REDLITHIUM™ (48-11-1850)
- M18™ & M12™ multi-voltage
- (2) Belt Clip
- (2) Bit Holder
- (1) Side Handle
- (1) Carrying Case



| Part # | Mfg #   | Description      | Price |
|--------|---------|------------------|-------|
| 187613 | 2796-22 | 2-Tool Combo Kit |       |

### M18 FUEL™ 2 Tool Combo Kit Hammer Drill/Driver and SAWZALL Reciprocating)

- Includes:
- (1) M18 FUEL™ 1/2" Hammer drill/driver (bare tool) (2604-20)
- (1) M18 FUEL™ SAWZALL® reciprocating saw (bare tool) (2720-20)
- (2) M18™ REDLITHIUM™ XC 4.0 Extended capacity battery pack (48-11-1840)
- (1) M18™ & M12™ Multi-voltage charger (48-59-1812)
- (1) Contractor bag
- (1) 6" 10 TPI thin kerf SAWZALL® blade



| Part # | Mfg #   | Description      | Price |
|--------|---------|------------------|-------|
| 166501 | 2794-22 | 2-Tool Combo Kit |       |

### M18™ FUEL™ 2-Tool Combo Kit (Hammer Drill/Driver and Hex Hydraulic Driver)

- Kit Includes:
- (1) M18 FUEL™ 1/2" Hammer Drill/Driver (2704-20)
- (1) M18 FUEL™ SURGE™ 1/4" Hex Hydraulic Driver (2760-20)
- (2) M18™ REDLITHIUM™ XC5.0 Battery Pack (48-11-1850)
- (1) M18™ & M12™ Multi-Voltage Charger (48-59-1812)
- (2) Belt Clip
- (2) Bit Holder
- (1) Carrying Case



| Part # | Mfg #   | Description | Price |
|--------|---------|-------------|-------|
| 231124 | 2899-22 | Kit         |       |

### M18™ Cordless 2-Tool Combo Kit with DPM™ (Hammer/Drill Driver and Hex Impact Driver)

- Digital power management protection prevents damage to the tool and battery in abusive situations
- Includes:
- 1/2" Hammer-Drill driver (2602-20)
- 1/4" Hex impact driver (2650-20)
- (2) REDLITHIUM™ batteries
- 1-Hour charger
- Contractor bag
- 5-Year warranty



| Part # | Mfg #   | Description      | Price |
|--------|---------|------------------|-------|
| 139154 | 2697-22 | 2-Tool Combo Kit |       |

### M18 FUEL™ 2-Tool Combo Kit (Hammer Drill/Driver and SAWZALL Saw)

- (1) M18 FUEL™ 1/2" Hammer Drill/Driver (2704-20)
- (1) M18 FUEL™ SAWZALL® Saw (2720-20)
- (2) M18™ REDLITHIUM™ XC5.0 Extended Capacity Battery Pack (48-11-1850)
- (1) M18™ & M12™ Multi-Voltage Charger (48-59-1812)
- (1) Belt Clip
- (1) Bit Holder
- (1) Contractor Bag
- (1) SAWZALL® Blade
- (1) Side Handle



| Part # | Mfg #   | Description      | Price |
|--------|---------|------------------|-------|
| 179583 | 2894-22 | 2-Tool Combo Kit |       |

## Power Tools

Tools

### M18™ Cordless LITHIUM-ION 2-Tool Combo Kit (Compact Drill/Driver and Hex Impact Driver)

- Includes:
- (1) M18™ Compact 1/2" drill driver (bare tool) (2606-20)
- (1) M18™ 1/4" Hex impact driver (bare tool) (2656-20)
- (2) M18™ Compact REDLITHIUM™ battery (48-11-1815)
- (1) M18™ & M12™ Multi-voltage charger (48-59-1812)
- (1) Contractor bag



| Part # | Mfg #   | Description      | Price |
|--------|---------|------------------|-------|
| 153676 | 2691-22 | 2-Tool Combo Kit |       |

### M18™ Cordless LITHIUM-ION 2-Tool Combo Kit (Compact Hammer Drill/Driver and SAWZALL)

- Includes:
- (1) M18™ Compact 1/2" Hammer drill/driver (bare tool) (2607-20)
- (1) M18™ SAWZALL® Recip saw (bare tool) (2620-20)
- (1) M18™ REDLITHIUM™ XC Extended capacity battery (48-11-1828)
- (1) M18™ & M12™ Multi-Voltage charger (48-59-1812)
- (1) Contractor bag



| Part # | Mfg #   | Description      | Price |
|--------|---------|------------------|-------|
| 155644 | 2694-22 | 2-Tool Combo Kit |       |

### M18 FUEL™ 2-Tool Combo Kit

- Includes:
- (1) M18 FUEL™ 1/2" Hammer Drill/Driver (2804-20)
- (1) M18 FUEL™ 1/4" Hex Impact Driver (2853-20)
- (2) M18™ REDLITHIUM™ XC5.0 Extended Capacity Battery Pack (48-11-1850)
- (1) M18™ & M12™ Multi-Voltage Charger (48-59-1812)
- (1) Carrying Case
- (1) Side Handle
- (2) Belt Clip
- (2) Bit Holder



| Part # | Mfg #   | Description      | Price |
|--------|---------|------------------|-------|
| 248763 | 2997-22 | 2-Tool Combo Kit |       |

### M18™ Cordless 4-Tool Combo Kit

- Includes:
- 1/2" Hammer drill driver (2602-20)
- Sawzall® reciprocating saw (2620-20)
- 6-1/2" Circular saw (2630-20)
- Work light (49-24-0171)
- (2) REDLITHIUM™ XC High capacity batteries
- 1-Hour charger
- (1) Sawzall® blade
- Contractor bag



| Part # | Mfg #   | Description      | Price |
|--------|---------|------------------|-------|
| 137564 | 2694-24 | 4-Tool Combo Kit |       |

### M18™ Cordless 4-Tool Combo Kit (2)

- Includes:
- M18™ 1/2" Hammer drill driver (2602-20)
- M18™ HACKZALL® Reciprocating saw (2625-20)
- M18™ 1/4" Hex Impact driver (2650-20)
- M18™ Work light (49-24-0171)
- (2) M18™ REDLITHIUM™ XC High capacity batteries (48-11-1828)
- 1-Hour charger (48-59-1801)
- General purpose Sawzall® blade
- Contractor bag



| Part # | Mfg #   | Description      | Price |
|--------|---------|------------------|-------|
| 138971 | 2695-24 | 4-Tool Combo Kit |       |

### M18™ Cordless LITHIUM-ION 2-Tool Combo Kit

- Kit Includes:
- (1) M18™ 1/2" Hammer Drill Driver (2602-20)
- (1) M18™ HACKZALL® One-Handed Recip Saw (2625-20)



| Part # | Mfg #   | Description      | Price |
|--------|---------|------------------|-------|
| 138928 | 2695-22 | 2-Tool Combo Kit |       |

## Power Tools

### M18™ Cordless 4-Tool Combo Kit (3)

• Includes:

- 1/2" Hammer drill driver (2602-20)
- 1/4" Hex impact driver (2650-20)
- Sawzall® M18™ reciprocating saw (2620-20)
- Work light (49-24-0171)
- (2) REDLITHIUM™ XC High capacity batteries
- 1-Hour charger
- General purpose Sawzall® blade
- Contractor bag



| Part # | Mfg #   | Description      | Price |
|--------|---------|------------------|-------|
| 138527 | 2696-24 | 4-Tool Combo Kit |       |

### M18 FUEL™ LITHIUM-ION 4-Tool Combo Kit

• Includes:

- (1) M18 FUEL™ 1/2" Hammer Drill/Driver (bare tool) (2604-20)
- (1) M18 FUEL™ 1/4" Hex impact driver (bare tool) (2653-20)
- (1) M18 FUEL™ SAWZALL® Reciprocating saw (bare tool) (2720-20)
- (1) M18™ LED Work light (2735-20)
- (1) M18™ REDLITHIUM™ XC 4.0 Extended capacity battery pack (48-11-1840)
- (1) M18™ & M12™ Multi-voltage charger (48-59-1812)
- (1) Belt clip
- (1) Contractor bag
- (1) Reciprocating blade



| Part # | Mfg #   | Description      | Price |
|--------|---------|------------------|-------|
| 164933 | 2796-24 | 4-Tool Combo Kit |       |

### M18™ FUEL™ 4-Tool Combo Kit

• Includes:

- (1) M18 FUEL™ 1/2" Hammer Drill/Driver (Tool Only) (2704-20)
- (1) M18 FUEL™ SAWZALL® Reciprocating Saw (Bare Tool) (2720-20)
- (1) M18™ LED Work Light (2735-20)
- (1) M18 FUEL™ 1/4" Hex Impact Driver (Bare Tool) (2753-20)
- (2) M18™ REDLITHIUM™ XC5.0 Extended Capacity Battery Pack (48-11-1850)
- (1) M18™ & M12™ Multi-Voltage Charger (48-59-1812)
- (2) Belt Clip
- (2) Bit Holder
- (1) Contractor Bag
- (1) SAWZALL® Blade
- (1) Side Handle



| Part # | Mfg #   | Description      | Price |
|--------|---------|------------------|-------|
| 179584 | 2896-24 | 4-Tool Combo Kit |       |

### M18 FUEL™ LITHIUM-ION 6-Tool Combo Kit

• Includes:

- (1) M18 FUEL™ 1/2" Hammer Drill/Driver (bare tool) (2604-20)
- (1) M18 FUEL™ 1/4" Hex impact driver (bare tool) (2653-20)
- (1) M18 FUEL™ SAWZALL® Reciprocating saw (bare tool) (2720-20)
- (1) M18 FUEL™ 6-1/2" Circular saw (bare tool) (2730-20)
- (1) M18™ LED work light (2735-20)
- (1) M18 FUEL™ 4-1/2"/5" Grinder, paddle switch no-lock (bare tool) (2780-20)
- (2) M18™ REDLITHIUM™ XC 4.0 Extended capacity battery pack (48-11-1840)
- (1) M18™ & M12™ Multi-voltage charger (48-59-1812)
- (1) Belt clip
- (1) Circular saw blade
- (2) Contractor bag
- (1) Reciprocating blade
- (1) Spanner wrench



| Part # | Mfg #   | Description      | Price |
|--------|---------|------------------|-------|
| 164934 | 2796-26 | 6-Tool Combo Kit |       |

### M18 FUEL™ 6-Tool Combo Kit

• Kit Includes:

- (1) M18 FUEL™ 1/2" Hammer Drill/Driver (2704-20)
- (1) M18 FUEL™ SAWZALL® Reciprocating Saw (2720-20)
- (1) M18 FUEL™ 6-1/2" Circular Saw (2730-20)
- (1) M18™ LED Work Light (2735-20)
- (1) M18 FUEL™ 1/4" Hex Impact Driver (2753-20)
- (1) M18 FUEL™ 4-1/2" / 5" Grinder, Paddle Switch No-Lock (2780-20)
- (2) M18™ REDLITHIUM™ XC5.0 Extended Capacity Battery Pack (48-11-1850)
- (1) M18™ & M12™ Multi-Voltage Charger (48-59-1812)
- (2) Belt Clip
- (2) Bit Holder
- (1) Circular Saw Blade
- (2) Contractor Bag
- (1) SAWZALL® Blade
- (1) Side Handle
- (1) Spanner Wrench



| Part # | Mfg #   | Description      | Price |
|--------|---------|------------------|-------|
| 179585 | 2896-26 | 6-Tool Combo Kit |       |

## Power Tools

Tools

### M18™ Cordless 6-Tool Combo Kit

- (1) Compact 1/2" Hammer Drill/Driver (2607-20)
- (1) SAWZALL® Reciprocating Saw (2621-20)
- (1) 6 1/2" Circular Saw (2630-20)
- (1) 1/4" Hex Impact Driver (2656-20)
- (1) Cordless 4-1/2" Cut-off / Grinder (2680-20)
- (1) LED Work Light (2735-20)
- (2) REDLITHIUM™ XC Extended Capacity Battery (48-11-1828)
- (1) Multi-Voltage Charger (48-59-1812)
- (1) Contractor Bag



| Part # | Mfg #   | Description      | Price |
|--------|---------|------------------|-------|
| 148165 | 2696-26 | 6-Tool Combo Kit |       |

### M18 FUEL™ 7-Tool Combo Kit

- Includes:
- (1) M18 FUEL™ 1/2" Hammer Drill/Driver (2804-20)
- (1) M18 FUEL™ 1/4" Hex Impact Driver (2853-20)
- (1) M18 FUEL™ SAWZALL® Reciprocating (2720-20)
- (1) M18 FUEL™ 6-1/2" Circular Saw (2730-20)
- (1) M18 FUEL™ 1/2" Mid-Torque Impact Wrench with Friction Ring (2861-20)
- (1) M18 FUEL™ 4-1/2" / 5" Grinder, Paddle Switch No-Lock (2780-20)
- (1) M18™ Work Light (2735-20)
- (2) M18™ REDLITHIUM XC5.0 Batteries (48-11-1850)
- (1) M18™ & M12™ Multi-Voltage Charger (48-59-1812)
- (1) 6" 18T Thin Kerf Ice Hardened SAWZALL® Blade
- (1) Circular Saw Blade, (1) Grinding Disc, (3) Belt Clips
- (2) Bit Holder, (2) Contractor Bag, (1) Side Handle

| Part # | Mfg #   | Description      | Price |
|--------|---------|------------------|-------|
| 248769 | 2997-27 | 7-Tool Combo Kit |       |

### M18™ Cordless LITHIUM-ION 9-Tool Combo Kit

- Includes:
- (1) M18™ Cordless 1/2" hammer drill/driver (2602-20)
- (1) M18™ Cordless right angle drill (2615-20)
- (1) M18™ SAWZALL® Recip saw (2620-20)
- (1) M18™ Cordless LITHIUM-ION 6-1/2" circular saw (2630-20)
- (1) M18™ Cordless LITHIUM-ION jig saw (2645-20)
- (1) M18™ 1/4" Hex compact impact driver (2650-20)
- (1) M18™ 1/2" High-torque impact wrench with friction ring (2663-20)
- (1) M18™ Cordless LITHIUM-ION 4-1/2" cut-off/grinder (2680-20)
- (2) M18™ REDLITHIUM™ XC Extended capacity battery (48-11-1828)
- (1) M18™ & M12™ Multi-voltage charger (48-59-1812)
- (1) M18™ Work light (49-24-0171)



| Part # | Mfg #   | Description      | Price |
|--------|---------|------------------|-------|
| 156090 | 2696-29 | 9-Tool Combo Kit |       |

## Power Tool Accessories

### Cordless Batteries and Accessories

#### 12V Lithium-Ion Battery

- Over 65% lighter than "compact" NiCd batteries
- For use with Milwaukee® 12V cordless tools
- 2-Year warranty



| Part # | Mfg #      | Description | Price |
|--------|------------|-------------|-------|
| 137574 | 48-11-2401 | Lithium-Ion |       |

#### M12™ REDLITHIUM™ Compact Battery

- 3.0 Amp hour
- REDLINK™ Intelligence
- Best-in-Class Construction
- Delivers fade-free power in extreme job site conditions
- Powers 70+ Milwaukee M12™ cordless solutions



| Part#  | Mfg#       | Amp Hour | Pack   | Price |
|--------|------------|----------|--------|-------|
| 231116 | 48-11-2460 | 6.0      | Single |       |
| 231115 | 48-11-2430 | 3.0      | Single |       |
| 165350 | 48-11-2420 | 1.5      | Single |       |
| 154721 | 48-11-2411 | 1.5      | 2      |       |

#### M12 REDLITHIUM™ XC Battery

- 3.0 Amp hour
- High current discharge
- Sturdy base- Allows M12™ tools to easily stand
- LITHIUM-ION battery delivers long life and run time with fade-free power
- Battery fuel gauge displays charge status on tools
- M12™ Compatibility



| Part # | Mfg #      | Description | Price |
|--------|------------|-------------|-------|
| 146046 | 48-11-2402 | Single Pack |       |
| 171802 | 48-11-2412 | 2 Pack      |       |

#### M12™ REDLITHIUM™ XC 4.0 Extended Capacity Battery Pack

- REDLINK™ Intelligence
- All-weather performance
- Powers most M12™ cordless power tools



| Part # | Mfg #      | Description | Price |
|--------|------------|-------------|-------|
| 166387 | 48-11-2440 | Single Pack |       |

#### M18™ REDLITHIUM™ HIGH OUTPUT™ HD12.0 Battery Pack

- REDLINK™ Intelligence
- Fuel gauge onboard
- Best-in-class construction
- Powers more than 150 M18™ cordless solutions



| Part # | Mfg #      | Description | Price |
|--------|------------|-------------|-------|
| 248737 | 48-11-1812 | Single Pack |       |

#### M18™ REDLITHIUM™ 2.0 Compact Battery Pack

- REDLINK™ Intelligence
- Best-in-class construction
- Fuel gauge onboard
- All-weather performance



| Part # | Mfg #      | Description          | Price |
|--------|------------|----------------------|-------|
| 154722 | 48-11-1820 | Compact Battery Pack |       |

#### M18™ REDLITHIUM™ XC Extended Capacity Battery

- REDLINK™ Intelligence
- Fuel gauge onboard
- All-weather performance
- Powers more than 40 Milwaukee M18™ cordless power tools



| Part # | Mfg #      | Description | Price |
|--------|------------|-------------|-------|
| 136039 | 48-11-1828 | Single Pack |       |

#### M18™ REDLITHIUM™ XC 4.0 Extended Capacity Battery Pack

- REDLINK™ Intelligence
- Best-in-class construction
- Fuel gauge onboard
- All-weather performance
- Versatility: Powers more than 40 Milwaukee M18™ cordless power tools



| Part # | Mfg #      | Description                    | Price |
|--------|------------|--------------------------------|-------|
| 158199 | 48-11-1840 | Extended Capacity Battery Pack |       |

## Power Tool Accessories

Tools

### M18™ REDLITHIUM™ XC 5.0 Extended Capacity Battery Pack

- REDLINK™ Intelligence: Provides optimized performance and overload protection using total system communication between tool, battery and charger
- Best-in-class construction
- Fuel gauge onboard
- All-weather performance
- Versatility- Powers more than 60 Milwaukee® M18™ cordless power tools



| Part # | Mfg #      | Description               | Price |
|--------|------------|---------------------------|-------|
| 173430 | 48-11-1850 | Extended Capacity Battery |       |
| 237660 | 48-11-1851 | Pack of 10                |       |
| 174426 | 48-11-1852 | Pack of 2                 |       |

### M18™ REDLITHIUM™ XC6.0 Battery Pack

- REDLINK™ Intelligence
- Fuel gauge onboard
- All-Weather Performance
- Powers more than 100 M18™ cordless power tools



| Part # | Mfg #      | Description               | Price |
|--------|------------|---------------------------|-------|
| 225396 | 48-11-1860 | Extended Capacity Battery |       |

### M18 REDLITHIUM™ HIGH OUTPUT™ XC6.0 Battery Pack



| Part # | Mfg #      | Description | Price |
|--------|------------|-------------|-------|
| 248741 | 48-11-1865 | High Output |       |

### M18™ REDLITHIUM™ HIGH DEMAND™ 9.0 Battery Pack

- REDLINK™ Intelligence
- Best-in-Class Construction
- Fuel gauge onboard
- Delivers fade free power in extreme job site conditions
- Powers more than 100 Milwaukee® M18™ cordless power tools



| Part # | Mfg #      | Description | Price |
|--------|------------|-------------|-------|
| 224567 | 48-11-1890 | Single Pack |       |

### M18 REDLITHIUM™ High Capacity Battery Two Pack

- 3.0 Amp hour
- LITHIUM-ION battery delivers long life and run time with fade-free
- Battery fuel gauge
- Overload protection
- Temperature management system
- Individual cell monitoring
- Discharge protection
- Best in class construction
- Integrated weld frame
- Cell separator
- Impact and vibration protective rubber



| Part # | Mfg #      | Description | Price |
|--------|------------|-------------|-------|
| 154296 | 48-11-1822 | Two Pack    |       |

### 18V Ni-Cd Battery

- Works with all 18V NiCd and V18 tools excluding:
  - 1108
  - 3108
  - 5364
  - 6516



| Part # | Mfg #      | Description        | Price |
|--------|------------|--------------------|-------|
| 139148 | 48-11-2230 | Easy Release Latch |       |

### 28V Lithium-Ion Battery

- Overload protection
- Temperature management system
- Individual cell voltage monitoring
- Discharge protection
- Battery fuel gauge
- 3-Year warranty



| Part # | Mfg #      | Description         | Price |
|--------|------------|---------------------|-------|
| 142696 | 48-11-2830 | Lithium-Ion Battery |       |

## Power Tool Accessories

### M12™ Power Source

- 2.1 amp powered USB port charges all portable electronic devices, including tablets
- On-board fuel gauge
- Compatible with all M12™ battery packs
- Compatible with all M12™ heated gear



| Part # | Mfg #      | Description  | Price |
|--------|------------|--------------|-------|
| 161648 | 49-24-2310 | Power Source |       |

### M18™ Power Source

- Compatible with M18™ compact and XC™ batteries
- Powered USB port charges portable electronic devices
- Compatible with M12™ heated jackets with the expandable battery pocket



| Part # | Mfg #      | Description  | Price |
|--------|------------|--------------|-------|
| 151840 | 49-24-2371 | Power Source |       |

### M18™ REDLITHIUM™ HIGH DEMAND™ 9.0 Starter Kit

- REDLINK™ Intelligence
- Best-in-Class Construction
- Fuel gauge onboard
- All-Weather Performance



| Part # | Mfg #      | Description     | Price |
|--------|------------|-----------------|-------|
| 234175 | 48-59-1890 | 18V Lithium-Ion |       |

### M18™ REDLITHIUM™ XC5.0 System Starter Kit

- REDLINK™ Intelligence
- Best-in-Class Construction
- Fuel gauge onboard
- All-Weather Performance
- Includes:
  - (1) M18™ REDLITHIUM™ XC5.0 Battery (48-11-1850)
  - (1) M18™ & M12™ Multi-Voltage Charger (48-59-1812)



| Part # | Mfg #      | Description | Price |
|--------|------------|-------------|-------|
| 179457 | 48-59-1850 | 18V         |       |

### M12™ AC/DC Wall Vehicle Charger

- 2-In-1 Design
- Charge time: 40 minutes
- Lithium-Ion battery (not included)
- 5-Year warranty



| Part # | Mfg #   | Description                       | Price |
|--------|---------|-----------------------------------|-------|
| 138274 | 2510-20 | M12™ AC/DC Wall & Vehicle Charger |       |

### M12™ Lithium-Ion Battery Charger

- 30-Minute charge time
- 5-Year warranty



| Part # | Mfg #      | Description             | Price |
|--------|------------|-------------------------|-------|
| 137575 | 48-59-2401 | 12V Lithium-Ion Charger |       |

### M12™ Four Bay Sequential Charger

- Accepts up to 4 M12™ Battery Packs
- Sequentially charges batteries
- Compact design with wall mount
- REDLINK™ Intelligence: charger communication with the battery pack to ensure optimum performance and extend life



| Part # | Mfg #      | Description           | Price |
|--------|------------|-----------------------|-------|
| 173929 | 48-59-1204 | M12™ Four Bay Charger |       |

### M18™ Six Pack Sequential Charger

- Charges up to six batteries sequentially
- Convenient carrying handle
- Pass through plug
- Compact size



| Part # | Mfg #      | Description           | Price |
|--------|------------|-----------------------|-------|
| 154534 | 48-59-1806 | M18™ Six Pack Charger |       |

Tools

## Power Tool Accessories

Tools

### M18™ and M12™ Rapid Battery Charger

- Charges batteries up to 40% faster
- Charges all M12™ and M18™ batteries
- Sequential charging: automatically charges the second inserted pack once the first pack is fully charged
- REDLINK™ Intelligence



| Part # | Mfg #      | Description           | Price |
|--------|------------|-----------------------|-------|
| 180814 | 48-59-1808 | M18™ and M12™ Charger |       |

### M18™ and M12™ Multi-Voltage Battery Charger

- 12V and 18V
- 5-Year warranty



| Part # | Mfg #      | Description           | Price |
|--------|------------|-----------------------|-------|
| 148692 | 48-59-1812 | M18™ and M12™ Charger |       |

### M18™ & M12™ Rapid Charge Station

- REDLINK™
- Pass through plug
- Charges three batteries simultaneously
- Accepts (3) M18™ and (3) M12™ battery packs



| Part # | Mfg #      | Description | Price |
|--------|------------|-------------|-------|
| 173750 | 48-59-1807 | 18V & 12V   |       |

### M18™ Lithium-Ion AC/DC Wall & Vehicle Charger

- AC Wall charger and DC vehicle charger
- Charges all M18™ batteries
- Charge times:
  - 48-11-1815: 30-Minute
  - 48-11-1828: 1-Hour
  - 48-11-1820: 45-Minute
  - 48-11-1840: 90-Minute



| Part # | Mfg #   | Description | Price |
|--------|---------|-------------|-------|
| 138273 | 2710-20 | 18V         |       |

### M18™ and M12™ Vehicle Charger

- Plugs into vehicle 12V or 24V DC Outlet
- Charges all M18 & M12 batteries
- Automatically shuts down charger to prevent excessive discharge of vehicle battery



| Part # | Mfg #      | Description           | Price |
|--------|------------|-----------------------|-------|
| 236978 | 48-59-1810 | Vehicle for M18 & M12 |       |

### REDLITHIUM™ USB Battery & Charger Kit

- Charges the Milwaukee® REDLITHIUM™ USB Batteries via Micro USB Cord
- 2X More Capacity than (3) AAA Alkaline Batteries
- LED Fuel Gauge Allows Fast Checking of REDLITHIUM™ USB Battery Charge
- 2ft Heavy Duty Micro-USB Braided Cord w/ Metal Ends



| Part # | Mfg #      | Description           | Price |
|--------|------------|-----------------------|-------|
| 238974 | 48-59-2003 | Kit                   |       |
| 238972 | 48-59-2002 | Charger and Cord Only |       |

### M28™ 3-Bay Universal Charger

- Single-unit simplicity: Milwaukee M28™ lithium-ion, V18 Lithium-ion and NiCd batteries
- Durable construction: Withstands tough job site conditions
- 9-ft. Pass-through plug
- High-visibility LED light: Displays charge status from across the room



| Part # | Mfg #      | Description                  | Price |
|--------|------------|------------------------------|-------|
| 164783 | 48-59-0280 | M28™ 3-Bay Universal Charger |       |

### Miscellaneous Batteries

#### REDLITHIUM™ USB Battery

- Over 2,000 charges
- Charge inside USB rechargeable products or with 48-59-2002 REDLITHIUM™ charger



| Part # | Mfg #      | Description             | Price |
|--------|------------|-------------------------|-------|
| 238970 | 48-11-2130 | REDLITHIUM™ USB Battery |       |



## Power Tool Accessories

### REDLITHIUM™ USB Charger

- LED fuel gauge
- 2FT Micro-USB braided cord
- Stores battery when not in use



| Part # | Mfg #      | Description             | Price |
|--------|------------|-------------------------|-------|
| 238972 | 48-59-2002 | REDLITHIUM™ USB Charger |       |

### Milwaukee® Parts & Accessories

#### SDS+ Dust Trap™ Drilling Shroud

- Industry's first OSHA® compliance solution without a vacuum, ideal for overhead drilling applications
- universal fit allows the DUST TRAP™ to work with all SDS Plus rotary hammers and SDS Plus drill bits up to an 8" length, including stop bits and other anchor installations tools



| Part # | Mfg #      | Description                              | Price |
|--------|------------|--|-------|
| 244316 | 48-03-3035 | Clear Sleeve, Compact Collapsible Design |       |

#### Chuck Key

- This chuck key tightens the jaws of the 1/2 inch capacity chuck 48-66-1360, 48-66-1370, and 48-66-1381
- Key holder 48-66-4040 should be used to attach this chuck key to the corset



| Part # | Mfg #      | Description | Price |
|--------|------------|-------------|-------|
| 140524 | 48-66-3280 | Chuck Key   |       |

#### Bit Holder

| Part # | Mfg #      | Description | Price |
|--------|------------|-------------|-------|
| 150713 | 43-72-0550 | Bit Holder  |       |

#### Screws, Nuts & Bolts

| Part # | Mfg #      | Description                   | Price |
|--------|------------|-------------------------------|-------|
| 150710 | 06-82-5275 | 6-32" x 5/16" Torx Head Screw |       |

#### Spline/Round Hex 2Pc Floor Scraper

| Part # | Mfg #      | Description | Price |
|--------|------------|-------------|-------|
| 236691 | 48-62-2016 | 6" x 25"    |       |

### Tamper Shank

- Used to mount tamper plate



| Part # | Mfg #      | Description | Price |
|--------|------------|-------------|-------|
| 243757 | 48-62-4060 | 15-1/2"     |       |

### Tent Stake Driver - Head Only

- Drives in large tent stakes (Use with 48-62-4060)



| Part # | Mfg #      | Description | Price |
|--------|------------|-------------|-------|
| 243756 | 48-62-4061 | 5-1/2"      |       |

### Universal Surface Grinding Dust Shroud



| Part # | Mfg #      | Description | Price |
|--------|------------|-------------|-------|
| 242453 | 49-40-6105 | 7"          |       |

### SDS Max Dust Extraction Attachment

| Part # | Mfg #   | Description       | Price |
|--------|---------|-------------------|-------|
| 242451 | 5317-DE | 8.75" x 4.6" x 2" |       |

### Cut-Off Machine Accessories

#### Cut-Off Wheel

- For general purpose to specialized high performance applications
- Consistent performance from wheel to wheel
- Tested for balance, resulting in smooth, vibration free grinding and cutting



| Part # | Mfg #      | Size   | Type | Price |
|--------|------------|--------|------|-------|
| 138407 | 49-94-4500 | 4-1/2" | 1    |       |
| 186774 | 49-94-5000 | 5"     | 1    |       |
| 242287 | 49-94-5020 | 5"     | 7/8" |       |
| 162159 | 49-94-4520 | 4-1/2" | 1/4" |       |
| 171104 | 49-94-4505 | 4-1/2" | 7/8" |       |
| 140073 | 49-94-1405 | 14"    | 1    |       |
| 180939 | 49-94-6305 | 6"     | 1    |       |

**Power Tools**

Tools

**Pipe Inspecting and Locating**

**SeeSnake® micro™ Inspection Camera**

- Allows you to easily perform visual inspections in hard to reach areas
- Lightweight, hand-held design can be carried anywhere
- 3' Cable reach expandable to 30' with optional extensions
- Includes batteries, mirror, hook and magnet



| Part # | Mfg # | Display        | Diameter | Lighting     | Power Source     | Price |
|--------|-------|----------------|----------|--------------|------------------|-------|
| 141173 | 36738 | 3.5" Color LCD | 17mm     | (4) Adj LEDs | (4) AA Batteries |       |

**SeeSnake® Sewer Camera Locator**

- Flexible transmitters
- 768 x 494 Video resolution
- 6 rugged, high-intensity LED lights built in camera
- Hardened stainless steel snake camera head with spring assembly
- For use with 2-1/2" diameter plumbing line with a max run of 200'



| Part # | Mfg # | Size | Color    | Price |
|--------|-------|------|----------|-------|
| 206936 | 13998 | 325' | Red/Gray |       |

**Refrigeration Tools**

Tools

**Refrigerant Piping and Components**

**Rotary Vane Deep Vacuum Pump**

- Internal check valve stops oil blowout in case of accidental power loss
- Gas ballast valve helps prevent oil contamination caused by high moisture
- Manifold valve isolates pump from system when testing for leaks
- Center oil fill port is accessible from front & sides
- Durable light weight die cast aluminum housing
- Delrin vanes for quieter, longer-lasting performance
- 2-Stage for lower pumping pressure
- Oil drain valve at bottom of oil reservoir
- 25 Microns ultimate vacuum
- Electrical Specs: 120V/60Hz (2-Stage\_



| Part # | Mfg #        | Free Air Displace | Motor  | Nom Pump Speed | Price |
|--------|--------------|-------------------|--------|----------------|-------|
| 150637 | 90066-2V-110 | 6 CFM             | 1/3 hp | 3440 rpm       |       |

**ACCU-Charge II Electronic Refrigerant Scale**

- Functions:
  - Charge programming
  - Pause/charge
  - Tank capacity programming (empty/full)
  - Repeat
- Capacity: 240 lbs
- Auto off: 3 hours
- Operating temperature: 32° to 120°F
- Battery life approximately 40 hours (9 VDC)



| Part # | Mfg #   | Description      | Price |
|--------|---------|------------------|-------|
| 140934 | 98210-A | 9" x 9" Platform |       |

**Pro-Set® Cyclone Refrigerant Recovery Machine**

- Fastest overall ARI certified recovery rates in its class in all temperature environments
- Automatic low pressure shut-off feature turns unit off when recovery is completed
- Rugged high density double walled plastic housing with easy view top mounted controls
- R-410A Ready with 550 psi high pressure shut-off switch
- Ergonomic well balanced design for easy transport including shoulder strap, weighs 36 lbs
- Built-in suction filter located under suction port



| Part # | Mfg #    | Description           | Price |
|--------|----------|-----------------------|-------|
| 112428 | 87-CR700 | 1 hp Oil-Less Cyclone |       |

**Refrigeration Tools**

Tools

**Electronic Digital Vacuum Gauge**

- Large 5 digit LCD display
- Measurement units are selectable for microns, in/hg, mBar, Torr. Advanced field
- Cleanable sensor can withstand 400 psi positive pressure
- Operates 30 hours on standard 9V alkaline battery



| Part # | Mfg #    | Description                                       | Price |
|--------|----------|---|-------|
| 113610 | 87-VG200 | Digital Gauge, Carry Hook, Tee, 9V Battery & Case |       |

**Brass Access Tee - Sweat**

- One valve core included for each tee
- All male flare fittings are internally threaded to accept installation of valve core
- Includes brass cap for use with core wrench



| Part # | Mfg #         | Fitting 1      | Fitting 2      | Branch Fitting | Body   | Price |
|--------|---------------|----------------|----------------|----------------|--------|-------|
| 092124 | 83-CC8414-2Pk | 1/4" Sweat ODF | 1/4" Sweat ODF | 1/4" SAE Flare | Copper |       |
| 080959 | 83-CC8438-2Pk | 3/8" Sweat ODF | 3/8" Sweat ODF | 1/4" SAE Flare | Copper |       |
| 080956 | 83-CC8412-2Pk | 1/2" Sweat ODF | 1/2" Sweat ODF | 1/4" SAE Flare | Copper |       |

**Brass Access Tee - Threaded**

- One valve core included for each tee
- All male flare fittings are internally threaded to accept installation of valve core



| Part # | Mfg #         | Fitting 1          | Fitting 2          | Branch Fitting     | Body   | Price |
|--------|---------------|--------------------|--------------------|--------------------|--------|-------|
| 103852 | 83-CD9601-2PK | 1/4" SAE Flare (F) | 1/4" SAE Flare (M) | 1/4" SAE Flare (M) | Copper |       |

**Valves**

**Pro-Set® Ball Valve**

- Add existing hose to eliminate refrigerant loss to comply with EPA regulations
- 1/4-Turn operation, color-coded handles



| Part # | Mfg #      | Description                       | Price |
|--------|------------|-----------------------------------|-------|
| 119736 | 87-BV3-3PK | 1/4" Female, 1/4" Male, SAE, 3/Pk |       |

**Microseal™ Anti-Blowback Valve**

- Automated sealing eliminates refrigerant loss and blowback
- Non-restrictive porting for maximum refrigerant flow
- SAE Male x SAE Female



| Part # | Mfg #      | Description                       | Price |
|--------|------------|-----------------------------------|-------|
| 098447 | 87-AB3-3PK | 1/4" Female, 1/4" Male, SAE, 3/Pk |       |

**Refrigeration Tools**

**Valve Core**



| Part # | Mfg #         | Description      | Price |
|--------|---------------|------------------|-------|
| 140745 | 83-CD4460-6PK | Valve Core, 6/Pk |       |

**Refrigerant Wrenches**  
**6-in-1 Metric Torque Wrench**

- Ideal for installing mini-split systems
- Includes (6) interchangeable heads: 12, 22, 24, 26, 27 & 29mm jaw sizes



| Part # | Mfg #  | Description                        | Price |
|--------|--------|------------------------------------|-------|
| 150265 | TLTWSM | Metric 6-in-1 Metric Torque Wrench |       |

**BLACKMAX Digital Torque Wrench**



| Part # | Mfg #  | Description           | Price |
|--------|--------|-----------------------|-------|
| 232482 | BTLDTW | Digital Torque Wrench |       |

**Chemicals**

**Acid Test Kit**

- Use to determine the acid level in mineral and alkybenzene lubricants typically used with HCFC refrigerants such as R-22 and R-401A (not for use with POE oil)
- One test per kit
- Easy to use, no complicated charts, results in seconds
- Simply add oil, shake, and observe color change (turns yellow if acidic)



| Part # | Mfg #       | Description           | Price |
|--------|-------------|-----------------------|-------|
| 031600 | 85-25140-01 | Ref Oil Acid Test Kit |       |

**QwikCheck Acid Test Kit**

- Color Change Indicates Pass/Fail
- Tests for Inorganic Acids to the ARI-700 limit of 1ppm
- Works with All Refrigerants & Oils
- Meets EPA Venting Regulations
- Unique Patented Disposable Design
- U.S. Patents #6,514,765 & #6,825,040



| Part # | Mfg #  | Description  | Price |
|--------|--------|--|-------|
| 158735 | QT2000 | Detects inorganic acid in 2-seconds down to 1 part per million |       |

Tools

**Refrigeration Tools**

Tools

**Refrigeration Oil Test Kits**

**Phase III® Refrigeration Oil Test Kit**

- For use on POE's, minerals oils, and alkylbenzene
- Tests acid level in refrigeration oil



| Part # | Mfg #   | Description            | Price |
|--------|---------|------------------------|-------|
| 140753 | 4320-W8 | Phase III Oil Test Kit |       |



## Refrigeration Tools

### Refrigerant Parts

#### Gasket

| Part # | Mfg #  | Description  | Price |
|--------|--------|--|-------|
| 144859 | 87-HXG | Hose Gasket, 10/Pack, Fits<br>1/4"SAE, 1/2" Acme or 1/2"<br>20 UNF |       |

#### Hose - Refrigerant

| Part # | Mfg #    | Description   | Price |
|--------|----------|---|-------|
| 140755 | 40360    | 5' Blue, Red, Yellow<br>Refrigerant Hose Set                                  |       |
| 140756 | 41601    | 5' Blue Refrigerant Hose  |       |
| 140757 | 41602    | 5' Yellow Refrigerant Hose  |       |
| 126840 | 41603    | 5' Red Refrigerant Hose   |       |
| 096037 | 45360    | 5' Blue, Red, & Yellow<br>Refrigerant Hose Set with<br>Anti-Blowback Fittings |       |
| 148224 | 87-HP5BA | 5' Blue Refrigerant Hose<br>with Anti-Blowback Fittings                       |       |
| 148223 | 87-HP5RA | 5' Red Refrigerant Hose<br>with Anti-Blowback Fittings                        |       |
| 148222 | 87-HP5YA | 5' Yellow Refrigerant Hose<br>with Anti-Blowback Fittings                     |       |
| 148221 | 87-HS3A  | 3' Refrigerant Hose Set with<br>Anti-Blowback Fittings                        |       |

#### Manifold

| Part # | Mfg #    | Description  | Price |
|--------|----------|--|-------|
| 132142 | 57161    | Aluminum 2-Way Manifold<br>Gauge Set with 5' Hoses |       |
| 105054 | 87-MBHP5 | Manifold with<br>Hose(R-410A-R22)                  |       |

#### Vacuum Pump Oil

| Part # | Mfg #   | Description | Price |
|--------|---------|-------------|-------|
| 148101 | 85-2600 | 1 qt        |       |
| 092114 | 85-2601 | 1 gal       |       |

### Tools, Gauges & Solder

#### Valve Core Tool

| Part # | Mfg #         | Description                          | Price |
|--------|---------------|--------------------------------------|-------|
| 104588 | 91490         | Protech Universal Valve<br>Core Tool |       |
| 140984 | 91496         | Valve Core Remover                   |       |
| 140743 | 83-CD3813-1PK | Valve Core<br>Container/Wrench       |       |
| 104515 | 83-CD3800-1PK | Valve Core Wrench                    |       |

## Refrigeration Tools

Tools

### Manifolds

#### 4-Valve Aluminum Manifold

- Forged aluminum body
- Replaceable ss valve seats
- SAE styl o-ring
- Large sight glass
- 3/8" bore throughout
- Comfort grip
- Glows in the dark
- R22-404A-410A



| Part # | Mfg #   | Description                             | Price |
|--------|---------|---|-------|
| 167725 | 1839130 | 60" Hoses, Low Loss Ball-Valve Adapters |       |

#### 4-Valve Aluminum Manifold Set

- Forged aluminum body
- Replaceable ss valve seats
- SAE styl o-ring
- Large sight glass
- 3/8" bore throughout
- Comfort grip
- Includes:
  - Valve
  - Dual Readout Thermometer
  - 60" Refrigeration hoses w/ ball valve adapters
- R22-404A-410A



| Part # | Mfg #   | Description                    | Price |
|--------|---------|--------------------------------|-------|
| 168342 | 1839131 | 60" Hoses, Ball-Valve Adapters |       |

#### 2-Valve Aluminum Manifold

- Forged aluminum body
- Replaceable ss valve seats
- SAE style o-ring
- Large sight glass
- Comfort grip
- Glows in the dark
- Built-in pressure reminder



| Part # | Mfg #   | Description              | Price |
|--------|---------|--------------------------|-------|
| 166823 | 1839134 | -30" Hg to 300 - 500 psi |       |

### Flaring Tools

#### Orbital Flare

- Off-center mounted cone spins on an axis to effectively produce quality flares
- Clutch mechanism stops the flaring when the job is done
- Spring-loaded block grips tube securely
- A tube-stop arrow slides to set correct height and positioning, while ball detents allow for easy flaring cone alignment
- Tube Sizes (O.D.) - 3/16", 1/4", 5/16", 3/8", 1/2", 5/8", 3/4"



| Part # | Mfg #   | Description    | Price |
|--------|---------|----------------|-------|
| 167767 | 1838952 | 45° Flare Type |       |

### Swaging Tools

#### Compact Swage Tool

- The power to swage 1-5/8" tubing and the control to swage 5/16" without splitting the tube
- Compact design
- One-handed operation



**Kit Includes:** 3/8", 1/2", 5/8", 3/4", 7/8", expander heads, body, deburrer, kit box

| Part # | Mfg #   | Description                                    | Price |
|--------|---------|--|-------|
| 165773 | 1839015 | Tube sizes (O.D.) 3/8", 1/2", 5/8", 3/4", 7/8" |       |

### Pumps

#### Vacuum Pump

- Hands-free carry
- Drains oil quickly
- Quick, easy access
- Easy to check oil
- Extra confidence
- Prolong oil life



| Part # | Mfg #   | Description     | Price |
|--------|---------|-----------------|-------|
| 231489 | 1948121 | VP5 5 CFM 1/2HP |       |



## Refrigeration Tools

### Electronic Tools

#### Dual Readout Thermometer

- Manifold-compatible compact thermometer
- Use it on any gauge set, or remove it and use it independently
- Two easy-to-use, K-style tube clamp thermocouples



| Part # | Mfg #   | Description   | Price |
|--------|---------|---------------|-------|
| 167727 | 1839106 | 0° C to +50°C |       |

### Service Tools

#### Deburrers

- Steel blades



| Part # | Mfg #   | Description    | Price |
|--------|---------|----------------|-------|
| 168257 | 1891258 | 1/4" to 1-5/8" |       |

#### Valve Core Removal Tool

- Max working pressure: 800 psi
- Burst pressure: 4000 psi
- Operating Temp: -20°F to +180°F



| Part # | Mfg #   | Description | Price |
|--------|---------|-------------|-------|
| 237080 | 194796  | 1/4"        |       |
| 244572 | 1947968 | 5/16"       |       |

### Hoses

#### Refrigeration Hoses

- Extra abrasion-resistant layer
- Rated for 800 PSI working pressure
- 60" Length



| Part # | Mfg #   | Description                  | Price |
|--------|---------|------------------------------|-------|
| 168252 | 1839153 | Set of 3 (Red, Blue, Yellow) |       |

Tools

**Refrigeration Tools**

**Vacuum Gauges**

**Gas Test Pressure Gauge Assembly  
(with Clamshell)**

- 2" diameter steel case



Tools

| Part # | Mfg #     | Gas Test Fitting | Conn.    | Price |
|--------|-----------|------------------|----------|-------|
| 183408 | 355-05PK2 | Air Valve Only   | 3/4" FIP |       |

---

---

## Rulers & Tape Measures

---

---

### Power Return Tapes

- Ultraviolet curing extends blade life
- Impact-resistant cases

### Magnetic Tip Tape Measure

- Reinforced end hook
- Nylon coated blade
- Yellow blade



| Part # | Mfg # | Size     | Price |
|--------|-------|----------|-------|
| 080609 | T425M | 1" x 25' |       |

**Rulers & Tape Measures**

Tools

**Steel Tapes**

**Power Return Tape - Double-Sided**

- Baked-on epoxy coating to resist scratches, rust, and abrasions
- Thick rubber grip; blue case
- Oversized bold black number on first 11" 16" & 19" Red stud marks



| Part # | Mfg #  | Length | Width | Price |
|--------|--------|--------|-------|-------|
| 135034 | 908-25 | 25'    | 1"    |       |

**Folding Wood Rules**

**Standard Rule**

- 6' Long hardwood rules with clear abrasion resistant coating
- Black markings on yellow, with red stud center markings every 16 inches
- Measurements are marked on both sides and both edges, graduated to 1/16th inch
- Engraved graduations on both sides



| Part # | Mfg # | Reading | Length | Price |
|--------|-------|---------|--------|-------|
| 112668 | 900-6 | Inside  | 6'     |       |

**Rulers & Tape Measures**

**Rulers**

**Fiberglass Folding Ruler**

- Precision made of flexible heavy-duty fiberglass
- With embedded easy-to-read boldface figures and graduations with red 16" stud marks and positive locking joints
- 6" Inside flat reading



| Part # | Mfg # | Model | Width | Length | Price |
|--------|-------|-------|-------|--------|-------|
| 008692 | 73370 | 1619F | 5/8"  | 6'     |       |

## Saws & Blades

### Abrasive Saw

- Heavy-duty cast iron base with non-slip rubber feet
- D-Handle grip ergonomic handle
- Die cast aluminum motor housing with externally accessible brushes
- Tool-less fence adjustment
- Arbor lock and arbor wrench included
- Miter cut to 45°



### Replacement Saw Blade

| Part # | Mfg # | Description                         | Price |
|--------|-------|-------------------------------------|-------|
| 067703 | 46956 | 14" Abrasive Disks for Steel, 10/Pk |       |

Tools

## Saws & Blades

### Hand Saws

#### High Tension Hacksaw

- Reinforced metal frame
- High-leverage tension knob
- Internal blade storage
- 45° Angle blade position
- Overmolded handle



| Part # | Mfg #      | Description | Price |
|--------|------------|-------------|-------|
| 186596 | 48-22-0050 | 12"         |       |

#### Compact Hack Saw

- Tool-free blade change
- Adjustable blade length
- Rubber over mold grip



| Part # | Mfg #      | Description            | Price |
|--------|------------|------------------------|-------|
| 137579 | 48-22-0012 | Includes (1) 10" Blade |       |

#### Rasping Jab Saw

- Rasping holes along the side of the blade to rapidly expand holes or smooth rough edges of sheet rock
- Rubber over mold grip
- 6" Plaster/dry wall blade



| Part # | Mfg #      | Description        | Price |
|--------|------------|--------------------|-------|
| 137581 | 48-22-0304 | 6" Rasping Jab Saw |       |

#### Folding Jab Saw

- Folds for easy storage
- Uses standard Sawzall® blades
- Includes:
  - (1) Folding jab saw
  - (3) Reciprocating blades (metal, wood, multi-purpose)



| Part # | Mfg #      | Description        | Price |
|--------|------------|--------------------|-------|
| 137583 | 48-22-0305 | 6" Folding Jab Saw |       |

#### 18" PVC/ABS Saw

- Tool free blade change
- Metal core body
- Clamshell design
- Rubber over mold grip



| Part # | Mfg #      | Description | Price |
|--------|------------|-------------|-------|
| 137580 | 48-22-0223 | 18" Blade   |       |
| 226368 | 48-22-0218 | 18" Blade   |       |

### Sawzall® Blades

- Matrix II high speed steel teeth with 8% cobalt, tough bi-metal design; 1/2" universal tang

#### Mega SAWZALL® Blade Kit



| Part # | Mfg #      | Pack Qty | Price |
|--------|------------|----------|-------|
| 222915 | 49-22-1132 | 32       |       |

### SAWZALL® Blades

- NAIL GUARD™ Ordinary teeth
  - FANG TIP™
  - Matrix II bi-metal teeth for greater durability
- (5 Pk)



| Part # | Mfg #      | Blade Size | TPI       | Pkg Qty | Price |
|--------|------------|------------|-----------|---------|-------|
| 164267 | 48-00-5091 | 6"         | 8/12 TPI  | 5 Pk    |       |
| 233564 | 48-00-5041 | 6"         | 4/6 TPI   | 5 Pk    |       |
| 164213 | 48-00-5035 | 6"         | 5 TPI     | 5 Pk    |       |
| 164207 | 48-00-5092 | 6"         | 10 TPI    | 5 Pk    |       |
| 164210 | 48-00-5182 | 6"         | 14 TPI    | 5 Pk    |       |
| 164211 | 48-00-5184 | 6"         | 18 TPI    | 5 Pk    |       |
| 233566 | 48-00-5185 | 4"         | 24 TPI    | 5 Pk    |       |
| 164212 | 48-00-5186 | 6"         | 24 TPI    | 5 Pk    |       |
| 164279 | 48-00-5093 | 8"         | 8/12 TPI  | 5 Pk    |       |
| 164202 | 48-00-5036 | 9"         | 5 TPI     | 5 Pk    |       |
| 164203 | 48-00-5016 | 9"         | 6 TPI     | 5 Pk    |       |
| 164273 | 48-00-5187 | 9"         | 14 TPI    | 5 Pk    |       |
| 164274 | 48-00-5188 | 9"         | 18 TPI    | 5 Pk    |       |
| 164288 | 48-00-5189 | 12"        | 18 TPI    | 5 Pk    |       |
| 233561 | 48-00-5193 | 8"         | 10/14 TPI | 5 Pk    |       |
| 164200 | 48-00-5037 | 12"        | 5 TPI     | 5 Pk    |       |
| 169673 | 48-00-5094 | 12"        | 8/12 TPI  | 5 Pk    |       |
| 167949 | 48-00-5194 | 12"        | 10/14 TPI | 5 Pk    |       |

#### (25 Pk)

| Part # | Mfg #      | Blade Size | TPI      | Pkg Qty | Price |
|--------|------------|------------|----------|---------|-------|
| 168482 | 48-01-2035 | 6"         | 5 TPI    | 25 Pk   |       |
| 242767 | 48-01-2093 | 8"         | 8/12 TPI | 25 Pk   |       |
| 168483 | 48-01-2036 | 9"         | 5 TPI    | 25 Pk   |       |

## Saws & Blades

Tools

(50 Pk)

| Part # | Mfg #      | Blade Size | TPI   | Pkg Qty | Price |
|--------|------------|------------|-------|---------|-------|
| 152610 | 48-01-6035 | 6"         | 5 TPI | 50 Pk   |       |

### Thin Kerf SAWZALL® Blades

- Optimized tooth design providing 2X more life than our previous generation SAWZALL® blades
- Tough Neck™ ribs strengthen the blade tang and minimize breakage
- Grid Iron™ honeycomb pattern increases blade rigidity to resist blade buckling



(5 Pk)

| Part # | Mfg #      | Blade Size | TPI    | Pkg Qty | Price |
|--------|------------|------------|--------|---------|-------|
| 167946 | 48-00-5181 | 4"         | 14 TPI | 5 Pk    |       |
| 233565 | 48-00-5183 | 4"         | 18 TPI | 5 Pk    |       |

(25 Pk)

| Part # | Mfg #      | Blade Size | TPI    | Pkg Qty | Price |
|--------|------------|------------|--------|---------|-------|
| 168363 | 48-01-2184 | 6"         | 18 TPI | 25 Pk   |       |
| 168364 | 48-01-2188 | 9"         | 18 TPI | 25 Pk   |       |
| 233563 | 48-00-8184 | 6"         | 18 TPI | 25 Pk   |       |

(50 Pk)

| Part # | Mfg #      | Blade Size | TPI    | Pkg Qty | Price |
|--------|------------|------------|--------|---------|-------|
| 240138 | 48-01-6186 | 6"         | 24 TPI | 50 Pk   |       |
| 242750 | 48-00-4188 | 9"         | 18 TPI | 50 Pk   |       |

(100 Pk)

| Part # | Mfg #      | Blade Size | TPI    | Pkg Qty | Price |
|--------|------------|------------|--------|---------|-------|
| 242766 | 48-01-7092 | 6"         | 10 TPI | 100 Pk  |       |
| 175719 | 48-01-7035 | 6"         | 5 TPI  | 100 Pk  |       |
| 167948 | 48-01-7184 | 6"         | 18 TPI | 100 Pk  |       |
| 175717 | 48-01-7188 | 9"         | 18 TPI | 100 Pk  |       |

### Thin Kerf Ice Hardened™ SAWZALL® Blades

- Optimized tooth design providing 2X more life than our previous generation SAWZALL® blades
- Tough Neck™ ribs strengthen the blade tang and minimize breakage
- Grid Iron™ honeycomb pattern increases blade rigidity to resist blade buckling



(5 Pk)

| Part # | Mfg #      | Blade Size | TPI    | Pkg Qty | Price |
|--------|------------|------------|--------|---------|-------|
| 169667 | 48-00-4182 | 6"         | 14 TPI | 5 Pk    |       |
| 167951 | 48-00-4189 | 12"        | 18 TPI | 5 Pk    |       |

(50 Pk)

| Part # | Mfg #      | Blade Size | TPI    | Pkg Qty | Price |
|--------|------------|------------|--------|---------|-------|
| 152609 | 48-01-8184 | 6"         | 18 TPI | 50 Pk   |       |

### The Torch™ SAWZALL® Blades

- Optimized tooth design providing 2X more life than our previous generation
- SAWZALL® blades Tough Neck™ ribs strengthen the blade tang and minimize breakage
- Grid Iron™ honeycomb pattern increases blade rigidity to resist blade buckling



(5 Pk)

| Part # | Mfg #      | Blade Size | TPI    | Pkg Qty | Price |
|--------|------------|------------|--------|---------|-------|
| 152136 | 48-00-5712 | 6"         | 10 TPI | 5 Pk    |       |
| 152137 | 48-00-5782 | 6"         | 14 TPI | 5 Pk    |       |
| 152139 | 48-00-5784 | 6"         | 18 TPI | 5 Pk    |       |
| 164297 | 48-00-5786 | 6"         | 24 TPI | 5 Pk    |       |
| 152129 | 48-00-5713 | 9"         | 10 TPI | 5 Pk    |       |
| 152130 | 48-00-5787 | 9"         | 14 TPI | 5 Pk    |       |
| 152131 | 48-00-5788 | 9"         | 18 TPI | 5 Pk    |       |
| 164298 | 48-00-5790 | 9"         | 24 TPI | 5 Pk    |       |
| 152132 | 48-00-5714 | 12"        | 10 TPI | 5 Pk    |       |
| 152133 | 48-00-5794 | 12"        | 14 TPI | 5 Pk    |       |
| 152134 | 48-00-5789 | 12"        | 18 TPI | 5 Pk    |       |
| 169669 | 48-00-5791 | 12"        | 24 TPI | 5 Pk    |       |



## Saws & Blades

(25 Pk)

| Part # | Mfg #      | Blade Size | TPI    | Pkg Qty | Price |
|--------|------------|------------|--------|---------|-------|
| 161705 | 48-01-2713 | 9"         | 10 TPI | 25 Pk   |       |
| 177451 | 48-00-8782 | 6"         | 14 TPI | 25 Pk   |       |
| 168987 | 48-00-8787 | 9"         | 14 TPI | 25 Pk   |       |
| 234323 | 48-00-8788 | 9"         | 18 TPI | 25 Pk   |       |
| 226631 | 48-01-2788 | 9"         | 18 TPI | 25 Pk   |       |

(100 Pk)

| Part # | Mfg #      | Blade Size | TPI    | Pkg Qty | Price |
|--------|------------|------------|--------|---------|-------|
| 244875 | 48-01-7782 | 6"         | 14 TPI | 100 Pk  |       |

### The Torch™ with Carbide Teeth SAWZALL® Blades

- 50X Life in thick metal
- 7 TPI for fast efficient cutting in thick and extreme metals
- Carbide teeth for longer life and greater versatility
- Cuts cast iron, stainless steel, & high strength alloys
- 25% more carbide per tooth for longest life
- 1" Tall for demolition
- Fast in cast iron



| Part # | Mfg #      | Blade Size | TPI   | Pkg Qty | Price |
|--------|------------|------------|-------|---------|-------|
| 238621 | 48-00-5201 | 6"         | 7 TPI | 1       |       |
| 238623 | 48-00-5202 | 9"         | 7 TPI | 1       |       |
| 246971 | 48-00-5301 | 6"         | 7 TPI | 3       |       |
| 246972 | 48-00-5302 | 9"         | 7 TPI | 3       |       |
| 238622 | 48-00-5501 | 6"         | 7 TPI | 5       |       |
| 238624 | 48-00-5502 | 9"         | 7 TPI | 5       |       |

### The Torch™ Ice Hardened™ SAWZALL® Blades

- Optimized tooth design providing 2X more life than our previous generation SAWZALL® blades
- Tough Neck™ ribs
- Grid Iron™ honeycomb pattern



(5 Pk)

| Part # | Mfg #      | Blade Size | TPI    | Pkg Qty | Price |
|--------|------------|------------|--------|---------|-------|
| 229537 | 48-00-4712 | 6"         | 10 TPI | 5 Pk    |       |
| 229538 | 48-00-4782 | 6"         | 14 TPI | 5 Pk    |       |
| 169668 | 48-00-4784 | 6"         | 18 TPI | 5 Pk    |       |
| 229539 | 48-00-4713 | 9"         | 10 TPI | 5 Pk    |       |
| 187923 | 48-00-4787 | 9"         | 14 TPI | 5 Pk    |       |

### Sawzall® Blades (Continued)

#### The Torch™ Ice Hardened™ SAWZALL® Blades (5 Pk)

| Part # | Mfg #      | Blade Size | TPI    | Pkg Qty | Price |
|--------|------------|------------|--------|---------|-------|
| 229540 | 48-00-4788 | 9"         | 18 TPI | 5 Pk    |       |

#### The Ax™ SAWZALL® Blades

- NAIL GUARD™ Ordinary teeth
- FANG TIP™
- The 1" tall blade body reduces blade twisting for straighter cuts
- Matrix II bi-metal teeth for greater durability



(5 Pk)

| Part # | Mfg #      | Blade Size | TPI   | Pkg Qty | Price |
|--------|------------|------------|-------|---------|-------|
| 152529 | 48-00-5021 | 6"         | 5 TPI | 5 Pk    |       |
| 152530 | 48-00-5026 | 9"         | 5 TPI | 5 Pk    |       |
| 152531 | 48-00-5027 | 12"        | 5 TPI | 5 Pk    |       |
| 233567 | 48-00-5052 | 9"         | 5 TPI | 5 Pk    |       |

(25 Pk)

| Part # | Mfg #      | Blade Size | TPI   | Pkg Qty | Price |
|--------|------------|------------|-------|---------|-------|
| 167955 | 48-00-8021 | 6"         | 5 TPI | 25 Pk   |       |
| 226632 | 48-01-2021 | 6"         | 5 TPI | 25 Pk   |       |

(100 Pk)

| Part # | Mfg #      | Blade Size | TPI   | Pkg Qty | Price |
|--------|------------|------------|-------|---------|-------|
| 167947 | 48-01-7021 | 6"         | 5 TPI | 100 Pk  |       |

#### The Ax™ with Carbide Teeth SAWZALL® Blades

- Best tooth design
- NAIL GUARD™
- FANG TIP™
- Optimized for cordless: 25% more cuts per charge



| Part # | Mfg #      | Blade Size | TPI | Pkg Qty | Price |
|--------|------------|------------|-----|---------|-------|
| 225843 | 48-00-5221 | 6"         | 5   | 1       |       |
| 225845 | 48-00-5226 | 9"         | 5   | 1       |       |
| 225847 | 48-00-5227 | 12"        | 5   | 1       |       |

## Saws & Blades

Tools

### The Wrecker™ SAWZALL® Blades

- A precise manufacturing process creates a sharper cutting edge on each tooth for a faster cutting blade
- A complete, unset raker tooth on the blade tip allows for easier, faster plunging by minimizing walking and bouncing
- A thicker, more rigid blade body resists fracturing and bending for maximum durability
- The 1" tall blade body reduces blade twisting for straighter, more accurate cuts



(5 Pk)

| Part # | Mfg #      | Blade Size | TPI      | Pkg Qty | Price |
|--------|------------|------------|----------|---------|-------|
| 152135 | 48-00-5701 | 6"         | 8 TPI    | 5 Pk    |       |
| 152128 | 48-00-5706 | 9"         | 8 TPI    | 5 Pk    |       |
| 242781 | 48-00-8706 | 9"         | 7/11 TPI | 25 Pk   |       |
| 152127 | 48-00-5711 | 12"        | 8 TPI    | 5 Pk    |       |
| 242752 | 48-00-8711 | 12"        | 7/11 TPI | 25 Pk   |       |

(100 Pk)

| Part # | Mfg #      | Blade Size | TPI  | Pkg Qty | Price |
|--------|------------|------------|------|---------|-------|
| 172982 | 48-01-7701 | 6"         | 7/11 | 100 Pk  |       |

### Fleam Ground SAWZALL® Blades

- Deep gullet design cuts up to 25% faster than standard wood blades
- Fleam ground process creates super sharp teeth for clean cuts
- Matrix II bi-metal teeth for greater durability



(5 Pk)

| Part # | Mfg #      | Blade Size | TPI   | Pkg Qty | Price |
|--------|------------|------------|-------|---------|-------|
| 169671 | 48-00-5015 | 6"         | 6 TPI | 5 Pk    |       |

### Carbide Grit SAWZALL® Blade

- Tungsten carbide for long life
- Coarse grit for fast cutting



| Part # | Mfg #      | Blade Size | Pkg Qty | Price |
|--------|------------|------------|---------|-------|
| 169674 | 48-00-1420 | 6"         | 3 Pk    |       |
| 159451 | 48-00-1430 | 9"         | 3 Pk    |       |

### Diamond Grit THE TORCH™ SAWZALL® Blade

- Diamond Grit delivers up to 30x longer life than standard carbide grit blades
- The precisely controlled size and placement of the diamond grit allow these blades to cut up to 2x faster than standard carbide grit blades
- The 1" tall blade body reduces blade twisting for straighter, more accurate cuts



| Part#  | Mfg#       | Size | Price |
|--------|------------|------|-------|
| 152141 | 48-00-1440 | 6"   |       |
| 151654 | 48-00-1450 | 9"   |       |

### Wood Cutting Sawzall® Blade

- For cutting stock 3/8" and above
- Recommended for very fast cutting, nail-embedded wood, general roughing-in



| Part # | Mfg #      | TPI | Blade Size | Pkg Qty | Price |
|--------|------------|-----|------------|---------|-------|
| 141058 | 48-00-8036 | 6   | 9" x 3/4"  | 25 Pk   |       |

### Sawzall® Flush Cut Blade

- Floor guard shields teeth from floor contact during bottom plate cut-outs
- Double truss design guides blade for straight window cut-outs
- Nail Guard™ unique design protects against tooth fracture when cutting nails between studs and joists
- Fang Tip™ delivers fast plunge cutting for window cut-outs



| Part # | Mfg #      | TPI | Blade Size   | Pkg Qty | Price |
|--------|------------|-----|--------------|---------|-------|
| 140976 | 48-00-1600 | 5   | 12" x 2-1/8" | 1 Pk    |       |

### Sawzall® Rough-In Blade

- Low blade profile cuts 2-1/8" diameter holes for 1-1/2" PVC pipe
- Can cut holes through double top plates
- NAIL GUARD™ Unique design protects against tooth fracture when cutting through holes in nail embedded wood
- FANG TIP™ fast plunge cutting through bottom plates and subfloors



| Part # | Mfg #      | TPI | Blade Size    | Pkg Qty | Price |
|--------|------------|-----|---------------|---------|-------|
| 140978 | 48-00-1610 | 5   | 7-3/8" x 1/2" | 5 Pk    |       |

## Saws & Blades

### SUPER SAWZALL® Blade

- Double relief angle reduces tooth stress for long life
- Precision forming process creates sharper teeth for fast cutting
- Matrix II bi-metal teeth for greater durability



| Part # | Mfg #      | TPI    | Blade Size | Pkg Qty | Price |
|--------|------------|--------|------------|---------|-------|
| 170458 | 48-00-5161 | 3-5/8" | 10 TPI     | 5 Pk    |       |

### Ductwork SAWZALL® Blade

- Pierce point tip geometry for quick plunging in ductwork with on tool
- Low blade profile for tight radius cuts
- Optimized tooth form designed specifically for cutting ductwork



| Part # | Mfg #      | Description                    | Price |
|--------|------------|--------------------------------|-------|
| 169675 | 48-00-1630 | Ductwork SAWZALL® Blade (5 Pk) |       |

### Drywall Access SAWZALL® Blade

- Ideal for servicing plumbing and electrical
- Optimized length to minimize damage to pipe and wire
- Cut all directions
- Fast plunge



| Part # | Mfg #      | Description          | Price |
|--------|------------|----------------------|-------|
| 156089 | 48-00-1640 | Drywall Access Blade |       |

### Pruning Sawzall® Blade



| Part # | Mfg #      | TPI | Blade Size | Pkg Qty | Price |
|--------|------------|-----|------------|---------|-------|
| 142581 | 48-00-1303 | 5   | 12" x 3/4" | 5 Pk    |       |
| 186164 | 48-00-1301 | 5   | 9"         | 5 Pk    |       |

### High-Carbon Steel Jig Saw Blade

- Heavy duty: Advanced construction for long life in tough professional applications
- Fast cuts; Tooth shape and sharpness permit clean scroll cutting in wood
- Versatile: Fits any jig saw that accepts a T-shank blade



| Part # | Mfg #      | TPI    | Blade Size | Pkg Qty | Price |
|--------|------------|--------|------------|---------|-------|
| 162387 | 48-42-5640 | 12 TPI | 3"         | 5 Pk    |       |
| 245521 | 48-42-5200 | 6 TPI  | 4"         | 5 Pk    |       |

### Sawzall® Blades (Continued)

#### High-Carbon Steel Jig Saw Blade

| Part # | Mfg #      | TPI    | Blade Size | Pkg Qty | Price |
|--------|------------|--------|------------|---------|-------|
| 245520 | 48-22-5220 | 8 TPI  | 4"         | 5 Pk    |       |
| 245522 | 48-42-5240 | 10 TPI | 4"         | 5 Pk    |       |

#### B-Metal Jig Saw Blade

- Longer life
- Fast cuts
- Versatile: features a universal tang



| Part # | Mfg #      | TPI    | Blade Size | Pkg Qty | Price |
|--------|------------|--------|------------|---------|-------|
| 242753 | 48-42-2120 | 18 TPI | 2-3/4"     | 5 Pk    |       |
| 242754 | 48-42-2190 | 14 TPI | 3-5/8"     | 5 Pk    |       |
| 242739 | 48-42-2310 | 10 TPI | 4-1/8"     | 5 Pk    |       |

### Sawzall® Blade Sets

#### 12-Piece Assortment General Purpose Sawzall® Blade Kit

- Includes:
  - (4) 6" 18 TPI The Torch blades
  - (2) 6" 8 TPI The Wrecker blades
  - (2) 6" 5 TPI The Ax blades
  - (2) 9" 5 TPI The Ax blades
  - (2) 9" 14 TPI The Torch blades
  - (1) Storage container



| Part # | Mfg #      | Description     | Price |
|--------|------------|-----------------|-------|
| 143952 | 49-22-1129 | 12-Pc Blade Kit |       |

#### 9-Piece Sawzall® Blade Set

- Includes:
  - (2) 6" Wood cutting blades
  - (1) 9" Wood cutting blade
  - (3) 6" 14TPI Blades
  - (3) 6" 24TPI Blades



| Part # | Mfg #      | Description    | Price |
|--------|------------|----------------|-------|
| 152473 | 49-22-1145 | 9-Pc Blade Set |       |

## Saws & Blades

Tools

### 5-Piece Assortment General Purpose Sawzall® Blade Kit

- Includes:
  - The Ax™ wood cutting
  - The Torch™ metal cutting blades
  - Demolition blades
  - 1" tall profile for TOUGH, STRAIGHT CUTS



| Part # | Mfg #      | Description              | Price |
|--------|------------|--------------------------|-------|
| 237166 | 49-22-1105 | 5-Pc Demolition SAWZALL® |       |

### Hackzall™ Blades

#### M12 Hackzall™ Blade



| Part # | Mfg #      | TPI | Length | For         | Pkg  | Price |
|--------|------------|-----|--------|-------------|------|-------|
| 144141 | 49-00-5310 | 10  | 3-1/2" | Wood        | 5/Pk |       |
| 144142 | 49-00-5324 | 24  | 3-1/2" | Metal       | 5/Pk |       |
| 144143 | 49-00-5461 | 6   | 4"     | Plaster     | 5/Pk |       |
| 244543 | 49-00-5410 |     | 4"     | Multi       | 5/Pk |       |
| 244544 | 49-00-5614 |     | 6"     | PVC/Plastic | 5/Pk |       |
| 176363 | 49-00-5460 |     | 4"     | Wood        | 5/Pk |       |

#### M12 Hackzall™ Blade 10-Pc Set

- Includes:
  - (2) Wood blades
  - (3) EMT Blades
  - (2) Duct Blades
  - (3) PVC Blades
  - Storage pouch



| Part # | Mfg #      | Description              | Price |
|--------|------------|--------------------------|-------|
| 143951 | 49-22-0220 | M12™ Hackzall™ 10-Pc Set |       |

### Hackzall™ Blades

- Longer life: Bi-metal construction lasts longer than high-speed steel and carbon blades
- Cuts common materials 1/4" - 1/2" thick
- Convenient: Fits most 12" hack saw frames



| Part # | Mfg #      | TPI | Length | Pkg Qty | Price |
|--------|------------|-----|--------|---------|-------|
| 006937 | 48-43-0610 | 18  | 12"    | 10      |       |
| 186598 | 48-43-0620 | 24  | 12"    | 10      |       |
| 006938 | 48-43-0630 | 32  | 12"    | 10      |       |

### Sawzall® & Hackzall® Accessories

#### Scraper Blade

- Fits all Sawzall® and Hackzall® reciprocating saws
- Induction hardened blade edge
- Corrosion resistant coating
- Chambered corners prevent digging into work material
- Resharpenable blade



| Part # | Mfg #      | Description          | Price |
|--------|------------|----------------------|-------|
| 148390 | 49-00-5463 | 1-1/2" Scraper Blade |       |
| 148391 | 49-00-5456 | 3" Scraper Blade     |       |
| 159007 | 49-00-5455 | 5" Scraper Blade     |       |

#### Grout Removal Tool

- Fits all SAWZALL® and HACKZALL™ recip saws
- Curved cutting edge for maximum accuracy
- Coarse carbide grit for fast grout removal
- Corrosion resistant coating for longer life



| Part # | Mfg #      | Description        | Price |
|--------|------------|--------------------|-------|
| 159006 | 49-00-5450 | Grout Removal Tool |       |

## Saws & Blades

### 3Pc Material Removal Blade

- Fits all Sawzall® and Hackzall™ Recip Saws
- Induction hardened blade edge for maximum durability
- Corrosion resistant coating
- Chamfered corners prevent digging into work material
- Resharpenable blade



| Part # | Mfg #      | Description                                 | Price |
|--------|------------|---|-------|
| 145865 | 49-22-5403 | Scraper, Grout Removal, Coarse Carbide Grit |       |

### Accessories

#### 18 Gauge Shear Head Assembly



| Part # | Mfg #      | Description | Price |
|--------|------------|-------------|-------|
| 244205 | 48-08-0500 | 18 Gauge    |       |

#### PVC Shear Blade

- Compatible only with the M12™ PVC Shear Tool
- Reinforced cutting edge
- Designed to cut PVC, CPVC, PEX, non-metallic conduit and rubber hose
- Bowtie connection



| Part # | Mfg #      | Description        | Price |
|--------|------------|--------------------|-------|
| 177853 | 48-44-0405 | 4" x 2.5" x 0.149" |       |

#### Bit Extension for Hex Shank Hole Saw Arbors

- Hex-wrench



| Part#  | Mfg#       | Shank | Length | Price |
|--------|------------|-------|--------|-------|
| 170805 | 48-28-4008 | 3/8"  | 12"    |       |
| 229946 | 48-28-4011 | 7/16" | 18"    |       |

### Band Saw Blades

#### Bi-Metal Band Saw Blade

- Matrix II high speed steel teeth
- For the fastest cutting, longest life blade life available

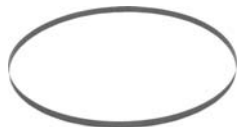

| Part # | Mfg #      | Description              | Price |
|--------|------------|--------------------------|-------|
| 169677 | 48-39-0500 | 10 TPI Standard Deep Cut |       |
| 138593 | 48-39-0511 | 14 TPI Standard Deep Cut |       |

### Band Saw Blades (Continued)

#### Bi-Metal Band Saw Blade

| Part # | Mfg #      | Description              | Price |
|--------|------------|--------------------------|-------|
| 169676 | 48-39-0520 | 18 TPI Standard Deep Cut |       |
| 174043 | 48-39-0521 | 18 TPI Standard Deep Cut |       |
| 160569 | 48-39-0531 | 24 TPI Standard Deep Cut |       |

#### Compact Portable Band Saw Blade

- Matrix II high speed steel teeth
- Alloy backing steel
- Precision formed teeth



| Part # | Mfg #      | Description                 | Price |
|--------|------------|-----------------------------|-------|
| 235684 | 48-39-0509 | 10 TPI Band Saw Blade, 3 Pk |       |
| 163508 | 48-39-0518 | 14 TPI Band Saw Blade       |       |
| 149985 | 48-39-0519 | 14 TPI Band Saw Blade       |       |
| 152649 | 48-39-0529 | 18 TPI Band Saw Blade       |       |
| 163509 | 48-39-0538 | 24 TPI Band Saw Blade       |       |
| 160570 | 48-39-0539 | 24 TPI Band Saw Blade       |       |
| 150495 | 48-39-0572 | 18 TPI Band Saw Blade       |       |

#### Standard Deep Cut Band Saw Blade

| Part # | Mfg #      | Description        | Price |
|--------|------------|--------------------|-------|
| 006935 | 48-39-0510 | 14 TPI Portable    |       |
| 006936 | 48-39-0530 | 24 TPI Portable    |       |
| 233570 | 48-39-0550 | 10/14 TPI Portable |       |
| 235683 | 48-39-0501 | 10 TPI, 3/Pk       |       |

### Circular Saw Blade

#### Circular Saw Blade 6-1/2"

- 5/8 in. arbor
- Thin kerf for faster cutting
- Framing and ripping blade
- Anti-kickback shoulder
- Precision ground carbide
- Expansion slots for truer cuts under heavy use



| Part#  | Mfg#       | Size   | Teeth | Pk Qty | Price |
|--------|------------|--------|-------|--------|-------|
| 151837 | 48-40-4108 | 6-1/2" | 24    | 1      |       |
| 151836 | 48-40-4015 | 6-1/2" | 48    | 1      |       |
| 221315 | 48-40-4112 | 6-1/2" | 40    | 1      |       |

## Saws & Blades

Tools

### 7-1/4" Circular Saw Blade

- 5/8 in. arbor with diamond knockout
- Thin kerf for faster cutting
- Framing and ripping blade
- Anti-kickback shoulder
- Precision ground carbide
- Expansion slots for truer cuts under heavy use



| Part#  | Mfg#       | Size   | Teeth | Pk Qty |
|--------|------------|--------|-------|--------|
| 155049 | 48-40-4116 | 7-1/4" | 16    | 1      |
| 154493 | 48-40-4126 | 7-1/4" | 40    | 1      |
| 220097 | 48-40-4123 | 7-1/4" | 24    | 25     |
| 224590 | 48-40-4120 | 7-1/4" | 24    | 1      |

### Ferrous Metal Circular Saw Blade

- Dry - No lubricant required
- Cool - No extreme heat buildup
- Clean - No burrs



| Part # | Mfg #      | Description     | Price |
|--------|------------|-----------------|-------|
| 148958 | 48-40-4070 | 5-3/8" 30 Teeth |       |
| 167389 | 48-40-4515 | 8" 42 Teeth     |       |

### Sanding Disc

- Ceramic resin
- Duct pick up not available



| Part # | Mfg #      | Grit | Size | Qty/Pk | Price |
|--------|------------|------|------|--------|-------|
| 237738 | 48-80-0838 | 80   | 9"   | 5/Pk   |       |

### Finish Wood Blades

- A High-ATB tooth pattern provides a superior finish with minimal tearout in the cut material
- Milwaukee's anti-friction coating keeps the blade cool while cutting and resists corrosion & gumming
- Laser cutting technology from 100% sheet steel increase cutting accuracy
- High alternate tooth bevel pattern
- Cobalt infused tungsten carbide
- Thin kerf blade
- Blade tensioning ring
- 100 Tooth; 1" arbor hole
- Great for use with: Softwoods, Hardwoods, Malamine, MDF, Veneered Plywoods, Paneling and Moldings



| Part # | Mfg #      | Description        | Price |
|--------|------------|--------------------|-------|
| 247798 | 48-40-0622 | 6-1/2" Fine Finish |       |

### Circular Saw Blade (Continued)

#### Finish Wood Blades

| Part # | Mfg #      | Description        | Price |
|--------|------------|--------------------|-------|
| 247799 | 48-40-0726 | 7-1/4" Fine Finish |       |
| 247800 | 48-40-1028 | 10" Fine Finish    |       |

#### Framing Wood Blade

- Laser cut vibration slots minimize wobble and warping
- Thin kerf blade
- 18 Tooth; 10mm arbor hole
- Laser cutting technology from 100% sheet steel increase cutting accuracy
- Cobalt infused tungsten carbide
- Optimized for both cordless & corded tools



| Part # | Mfg #      | Description | Price |
|--------|------------|-------------|-------|
| 247804 | 48-41-0710 | 7-1/4" 24T  |       |
| 247802 | 48-41-0720 | 7-1/4" 24T  |       |
| 247801 | 48-41-0620 | 6-1/2" 24T  |       |

#### General Purpose Circular Saw Blade



| Part # | Mfg #      | Description | Price |
|--------|------------|-------------|-------|
| 247803 | 48-40-1024 | 10", 40T    |       |

### Segment Tool Blades

#### Titanium Segment Multi-Tool Blade



| Part # | Mfg #      | Description | Price |
|--------|------------|-------------|-------|
| 178189 | 48-90-0035 | 3-1/8"      |       |

## Saws & Blades

### Segment Multi-Tool Blade

- Ideal for Cutting Wood, Drywall & Plaster, Fiberglass and Non-Ferrous Metals



| Part # | Mfg #      | Description | Price |
|--------|------------|-------------|-------|
| 178191 | 48-90-0045 | 3-1/8"      |       |

### Carbide Grit Segment Multi-Tool Blade

- Carbide Grit for Grout Removal and Cutting into Brick, Cement, Drywall & Plaster, and other Abrasive Materials



| Part # | Mfg #      | Description | Price |
|--------|------------|-------------|-------|
| 178194 | 48-90-0100 | 2-1/2"      |       |
| 178195 | 48-90-0110 | 1-1/4"      |       |

### Miscellaneous Blades

#### 25mm Precision Snap Blades

- Optimized grind angles
- Micro carbide dispersed metal
- Includes Snap-Off knife blade storage case



| Part # | Mfg #      | Length | Pack Qty | Price |
|--------|------------|--------|----------|-------|
| 239735 | 48-22-9125 | 7"     | 10 Pack  |       |

### Multi-Tool Accessory Blades

- Assortment of Multi-Tool Blades for a variety of applications
- Ideal for Cutting Wood with Nails, non-ferrous metals, and PVC



| Part # | Mfg #      | Description           | Price |
|--------|------------|-----------------------|-------|
| 178197 | 48-90-1050 | 3-Piece               |       |
| 178196 | 48-90-1000 | 3-Piece               |       |
| 227885 | 48-90-1009 | 9-Piece               |       |
| 178186 | 48-90-0020 | 1-3/4" Titanium       |       |
| 178187 | 48-90-0025 | 1-1/8" Titanium       |       |
| 178188 | 48-90-0030 | 1-1/4" Hard Point     |       |
| 178190 | 48-90-0040 | 1-1/4" Bi-Metal       |       |
| 178192 | 48-90-0050 | 2-1/2" Bi-Metal       |       |
| 178193 | 48-90-0055 | 1-1/4" Japanese Tooth |       |

### Miscellaneous Blades (Continued)

#### Multi-Tool Accessory Blades

| Part # | Mfg #      | Description                | Price |
|--------|------------|----------------------------|-------|
| 178184 | 48-90-0010 | 1-1/4" Extended Multi-Tool |       |
| 178185 | 48-90-0015 | 3/4" Multi-Tool            |       |

#### Scraper Blade

- Rigid design for heavy duty scraping applications
- Adaptor (48-90-0000) available for Porter Cable®, Black & Decker®, and DeWalt® Multi-Tools



| Part # | Mfg #      | Description  | Price |
|--------|------------|--------------|-------|
| 178198 | 48-90-0060 | 2.75" x 2.5" |       |

#### Multi-Tool Sanding Pad

- Universal Shank\* connects to most professional grade multi-tools.
- Designed connection for use with Dust Extractor Kit (49-90-2400)
- Velcro backing for secure connection to sanding paper



| Part # | Mfg #      | Description     | Price |
|--------|------------|-----------------|-------|
| 178199 | 48-90-2000 | 3-1/2" x 3-1/2" |       |

#### 80 Grit Sand Paper for Multi-Tool

- Velcro backing for secure connection to sanding pad.
- For use with M18™ Sanding Pad (48-90-2000)
- Designed holes for additional use of Dust Extractor Kit (49-90-2400)



| Part # | Mfg #      | Description | Price |
|--------|------------|-------------|-------|
| 178201 | 48-90-2080 | 8-Pk        |       |

#### Universal Multi-Tool Blade Adapter

- Allows for all Milwaukee Multi-Tool Blades to be used with Porter Cable, Black & Decker, and DeWalt brand multi-tools



| Part # | Mfg #      | Description          | Price |
|--------|------------|----------------------|-------|
| 178183 | 48-90-0000 | Universal Multi-Tool |       |

## Saws & Blades

Tools

### Hand Saws

#### Mini Hacksaw—Pistol Grip & Standard

- Separate screw sets the 6" blade tension
- Good for fine work in small areas.
- Six inch steel blade cuts copper and brass tube, bolts, steel, wood and plaster
- Pistol Grip is easier to hold and grasp



301-062

| Part # | Mfg #   | Type               | Blade | Price |
|--------|---------|--------------------|-------|-------|
| 031884 | 301-062 | Deluxe Pistol Grip | 6"    |       |
| 183402 | 301-065 | Standard D-Type    | 6"    |       |

#### SawHorse™ Multi-Purpose Saw

- High-quality, hardened-steel blade remains sharp through thousands of cuts
- Teeth are on the nose for notching in tight areas and starting cuts in the middle of floor or wall
- Perfect for plastic pipe, wood and many other materials
- 20" model has 10 teeth/inch for faster cutting
- 12" model has 13 teeth/inch for fine cutting.
- Both include plastic teeth protector



300-20

| Part # | Mfg #  | Blade Size | Price |
|--------|--------|------------|-------|
| 049442 | 300-12 | 20"        |       |
| 183400 | 300-20 | 12"        |       |

### Replacement Blades

#### For: SawHorse™ Multi-Purpose Saws

| Part # | Mfg #   | For Model: | Price |
|--------|---------|------------|-------|
| 051535 | 300-12B | 300-12     |       |

#### For: Mini Hacksaw—Pistol Grip & Standard

- 32 Teeth/Inch
- Pin ends

| Part # | Mfg #   | Material     | Blade | Price |
|--------|---------|--------------|-------|-------|
| 031885 | 301-061 | Carbon Steel | 6"    |       |



## Saws & Blades

### Saws

#### PlumBest Plastic Pipe Saw

- Die cast aluminum handle
- Large comfortable grip
- Flame hardened blade
- Quickly cuts PVC, ABS, wood, sheet rock, etc.
- 18" Blade has 10 TPI



| Part # | Mfg #   | Description        | Price |
|--------|---------|--------------------|-------|
| 054589 | S49-001 | 18" Blade & Handle |       |

#### E-Z Stroke Pipe Saw

- Tri-edge teeth are borazon wheel ground
- For smooth, fast, accurate cutting
- Pull-stroke cutting action
- Cuts plastic pipe and wood
- Replaceable blade



| Part # | Mfg #   | Description             | Price |
|--------|---------|-------------------------|-------|
| 044951 | S49-005 | 8" E-Z Stroke Pipe Saw  |       |
| 045193 | S49-006 | 8" Replacement Blade    |       |
| 044963 | S49-008 | 12" E-Z Stroke Pipe Saw |       |
| 045192 | S49-007 | 12" Replacement Blade   |       |

#### Drywall Saw

- High quality carbon steel blade
- Great for sheet rock, wallboard, gypsum, plywood, wood and plastic pipe
- 6" to 8 TPI Aggressive tooth design ensures super sharp, fast and easy cut
- Comfortable grip with thumb stop for greater leverage
- Handy wrist strap



| Part # | Mfg #   | Description | Price |
|--------|---------|-------------|-------|
| 055539 | S49-012 | Drywall Saw |       |

#### Close Quarters Hacksaw

- Nickel-plated steel frame
- Cuts wood, plastic, brass, aluminum and steel



| Part # | Mfg #   | Description           | Price |
|--------|---------|-----------------------|-------|
| 005881 | S50-060 | 6" Hacksaw            |       |
| 111480 | S50-062 | 6" Adjustable Hacksaw |       |
| 005882 | S50-061 | Blades for S50-061    |       |

### Saws (Continued)

#### Close Quarters Hacksaw

| Part # | Mfg #   | Description        | Price |
|--------|---------|--------------------|-------|
| 111479 | S50-063 | Blades for S50-062 |       |

**Saws & Blades**

Tools

**Jab Saw**

- Cuts drywall, wallboard, plywood, and plastic
- Triple ground teeth for a fast cut
- Blade cuts in both directions (push and pull)
- Hardened, carbon steel blade for durability
- Hardened, beveled blade point for scoring and plunge cuts
- Comfort cushion grip with thumb groove
- Handle structure designed for strength and durability
- Flat end grip for palming or punching through drywall



| Part # | Mfg # | Blade Length | Overall Length | Price |
|--------|-------|--------------|----------------|-------|
| 106821 | 725   | 6"           | 12"            |       |



---

---

## Saws & Blades

---

---

### Hole Saws Replacement Blade

| Part # | Mfg # | Diameter | Price |
|--------|-------|----------|-------|
| 072037 | RBW68 | 4-1/4"   |       |

Tools

---



---

## Saws & Blades

---

### Saws

#### PVC Cable Saw

- *Cuts plumbing or electrical PVC faster than hacksaw*
- *Ideal for tight spots and in-ground repairs*

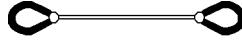

| Part # | Mfg # | Description         | Price |
|--------|-------|---------------------|-------|
| 002737 | 70390 | 26" Cable Saw - Std |       |

Tools

## Screwdrivers & Bits

### Screwdrivers

#### #1 Phillips - 3" Screwdriver

- Wrench ready HEX shanks
- Forged tool shanks
- Wire bending hole- bend up to 12 gauge wire
- Wire stripper (Patent Pending)- strip up to 12G wire
- Visible ID markings



| Part # | Mfg #      | Description      | Price |
|--------|------------|------------------|-------|
| 169658 | 48-22-2011 | #1 Phillips - 3" |       |
| 245658 | 48-22-2811 | #1 Phillips - 3" |       |

#### #2 Phillips- 4" Screwdriver

- Wrench ready HEX shanks
- Forged tool shanks
- Wire bending hole - bend up to 12 gauge wire
- Wire stripper (Patent Pending) - strip up to 12G wire
- Visible ID markings



| Part # | Mfg #      | Description      | Price |
|--------|------------|------------------|-------|
| 169659 | 48-22-2012 | #2 Phillips - 4" |       |
| 245659 | 48-22-2812 | #2 Phillips - 3" |       |

#### #3 Phillips - 6" Screwdriver

- Wrench ready HEX shanks
- Forged tool shanks
- Wire bending hole - bend up to 12 gauge wire
- Wire stripper (Patent Pending) - strip up to 12G wire
- Visible ID markings



| Part # | Mfg #      | Description      | Price |
|--------|------------|------------------|-------|
| 169660 | 48-22-2013 | #3 Phillips - 6" |       |
| 245660 | 48-22-2813 | #3 Phillips - 6" |       |

#### Demolition Screwdriver

- Wrench ready HEX shanks
- High impact steel cap
- Forged tool shanks
- Visible ID markings



| Part # | Mfg #      | Description                  | Price |
|--------|------------|------------------------------|-------|
| 169661 | 48-22-2021 | 1/4" Slotted- 4" Demolition  |       |
| 162649 | 48-22-2022 | 5/16" Slotted- 6" Demolition |       |
| 162625 | 48-22-2023 | 3/8" Slotted- 8" Demolition  |       |
| 245662 | 48-22-2821 | 1/4" Slotted- 4" Demolition  |       |
| 245663 | 48-22-2823 | 5/16" Slotted- 6" Demolition |       |
| 245664 | 48-22-2825 | 3/8" Slotted- 8" Demolition  |       |

#### 3/16" Cabinet - 6" Screwdriver

- Forged tool shanks
- Visible ID Markings



| Part # | Mfg #      | Description          | Price |
|--------|------------|----------------------|-------|
| 169662 | 48-22-2032 | CAB 3/16", 6" Length |       |
| 245665 | 48-22-2832 | 3/16" - 6"           |       |
| 245666 | 48-22-2833 | 3/16" - 8"           |       |

#### #1 Square Screwdriver

- Forged tool shanks
- Visible ID Markings



| Part # | Mfg #      | Description    | Price |
|--------|------------|----------------|-------|
| 245667 | 48-22-2851 | #1 Square - 3" |       |

#### Compact 8-in-1 Multi Bit Driver

- Power groove bits for power tool compatibility and jobsite versatility
- Precision machined bit tips: durable tips for secure figment
- Wrench ready: Hex shanks for additional leverage
- Chrome plated bits



| Part # | Mfg #      | Description | Price |
|--------|------------|-------------|-------|
| 174829 | 48-22-2120 | 3.5" Length |       |

#### 10-in-1 SAE HEX Key Driver

- 3-1/2" Power groove bits for power tool compatibility
- Revolver style bit storage and selection
- Up to 10ga wire stripper and loop maker
- Includes:
  - (1) 10IN1 Handle
  - (1) 3 1/2" HEX x 1/4"
  - (1) 3 1/2" HEX x 1/8"
  - (1) 3 1/2" HEX x 3/16"
  - (1) 3 1/2" HEX x 5/32"
  - (1) 3 1/2" HEX x 7/32"
  - (1) 3 1/2" HEX x 7/64"
  - (1) 3 1/2" HEX x 9/64"



| Part # | Mfg #      | Description                | Price |
|--------|------------|----------------------------|-------|
| 163154 | 48-22-2104 | 10-in-1 SAE HEX Key Driver |       |

Tools

## Screwdrivers & Bits

Tools

### 10-in-1 Metric HEX Key Driver

- 3-1/2" Power groove bits for power tool compatibility
- Revolver style bit storage and selection
- Up to 10ga wire stripper and loop maker
- Includes:
  - (1) 10IN1 Handle
  - (1) 3 1/2" HEX x 1.5mm
  - (1) 3 1/2" HEX x 2mm
  - (1) 3 1/2" HEX x 2.5mm
  - (1) 3 1/2" HEX x 3mm
  - (1) 3 1/2" HEX x 4mm
  - (1) 3 1/2" HEX x 5mm
  - (1) 3 1/2" HEX x 6mm



| Part # | Mfg #      | Description                  | Price |
|--------|------------|------------------------------|-------|
| 163155 | 48-22-2106 | 10-in1 Metric HEX Key Driver |       |

### 10-in-1 ECX™ Multi Bit Driver

- 3-1/2" Power groove bits for power tool compatibility
- Revolver style bit storage and selection
- Up to 10ga wire stripper and loop maker
- Includes:
  - (1) 10IN1 Handle
  - (1) 3-1/2" ECX™ #1
  - (1) 3-1/2" ECX™ #2
  - (1) 3-1/2" Phillips #1
  - (1) 3-1/2" Phillips #2
  - (1) 3-1/2" Slotted 1/4"
  - (1) 3-1/2" Slotted 3/16"
  - (1) 3-1/2" Square Drive #2



| Part # | Mfg #      | Description                  | Price |
|--------|------------|------------------------------|-------|
| 161629 | 48-22-2101 | 10-in-1 ECX Multi Bit Driver |       |

### 10-in-1 TORX® Key Driver

- 3-1/2" Power groove bits for power tool compatibility
- Revolver style bit storage and selection
- Up to 10ga wire stripper and loop maker
- Includes:
  - (1) 10IN1 Handle
  - (1) 3 1/2" TORX® T8
  - (1) 3 1/2" TORX® T10
  - (1) 3 1/2" TORX® T15
  - (1) 3 1/2" TORX® T20
  - (1) 3 1/2" TORX® T25
  - (1) 3 1/2" TORX® T27
  - (1) 3 1/2" TORX® T30



| Part # | Mfg #      | Description              | Price |
|--------|------------|--------------------------|-------|
| 162804 | 48-22-2103 | 10-in-1 TORX® Key Driver |       |

### Compact 8-in-1 Ratchet Multi Bit Driver

- All metal ratchet
- Power groove bits for power tool compatibility
- Precision machined bit tips
- Includes:
  - (1) Compact 8IN1 Ratchet handle
  - (1) 1-1/2" Phillips #1 power groove bit
  - (1) 1-1/2" Phillips #2 power groove bit
  - (1) 1-1/2" Slotted 1/16" power groove bit
  - (1) 1-1/2" Slotted 3/32" power groove bit
  - (1) 1-1/2" Square recess #1 power groove bit
  - (1) 1-1/2" Square recess #2 power groove bit
  - (1) 1-1/2" TORX® 15 power groove bit



| Part # | Mfg #      | Description                     | Price |
|--------|------------|---------------------------------|-------|
| 171804 | 48-22-2320 | 8-in-1 Ratchet Multi Bit Driver |       |

### 10-in-1 Square Drive Multi Bit Driver

- 3-1/2" Power groove bits for power tool compatibility
- Revolver style bit storage and selection
- Up to 10ga wire stripper and loop maker
- Includes:
  - (1) 10IN1 Handle
  - (1) 3-1/2" Phillips #1
  - (1) 3-1/2" Phillips #2
  - (1) 3-1/2" Slotted 1/4"
  - (1) 3-1/2" Slotted 3/16"
  - (1) 3-1/2" Square drive #1
  - (1) 3-1/2" Square drive #2
  - (1) 3-1/2" Square drive #3



| Part # | Mfg #      | Description             | Price |
|--------|------------|-------------------------|-------|
| 170691 | 48-22-2102 | 10-in1 Multi Bit Driver |       |

### 10-in1 Square Drive Ratcheting Multi Bit Driver

- All metal high torque ratchet
- 3 1/2" Power groove bits for power tool compatibility
- Revolver style bit storage and selection
- Up to 10ga wire stripper and loop maker
- Includes:
  - (1) 10in1 Ratchet handle
  - (1) 3 1/2" Phillips #1
  - (1) 3 1/2" Phillips #2
  - (1) 3 1/2" Slotted 1/4"
  - (1) 3 1/2" Slotted 3/16"
  - (1) 3 1/2" Square drive #1
  - (1) 3 1/2" Square drive #2
  - (1) 3 1/2" Square drive #3



| Part # | Mfg #      | Description                  | Price |
|--------|------------|------------------------------|-------|
| 169218 | 48-22-2302 | 10-in-1 Ratcheting Multi Bit |       |

## Screwdrivers & Bits

### 10-in-1 ECX™ Ratcheting Multi Bit Driver

- All metal high torque ratchet
- 3 1/2" Power groove bits for power tool compatibility
- Revolver style bit storage and selection
- Up to 10ga wire stripper and loop maker
- Includes:
  - (1) 10IN1 Ratchet handle
  - (1) 3 1/2" ECX™ #1
  - (1) 3 1/2" ECX™ #2
  - (1) 3 1/2" Phillips #1
  - (1) 3 1/2" Phillips #2
  - (1) 3 1/2" Slotted 1/4"
  - (1) 3 1/2" Slotted 3/16"
  - (1) 3 1/2" Square Drive #2



| Part # | Mfg #      | Description              | Price |
|--------|------------|--------------------------|-------|
| 162815 | 48-22-2301 | 10-in-1 Multi Bit Driver |       |

### 11-in-1 ECX™ Screwdriver

- Includes:
  - (1) Phillips #1
  - (1) Phillips #2
  - (1) Slotted 3/16"
  - (1) Slotted 1/4"
  - (1) Square #1
  - (1) Square #2
  - (1) ECX (TM) #1
  - (1) ECX (TM) #2
  - (1) 1/4" Nut Driver
  - (1) 3/8" Nut Driver
  - (1) Loop Maker



| Part # | Mfg #      | Description           | Price |
|--------|------------|-----------------------|-------|
| 239242 | 48-22-2760 | Multi-Use Screwdriver |       |

### 13-in-1 Cushion Grip Screwdriver with Schrader Bit

- 8 unique driver bits - P1, P2, SL 3/16, SL 1/4, SQ1, SQ2, Std. Schrader, Lrg. Schrader
- 4 Unique nut drivers - 1/4", 5/16", 3/8", 1/2"
- 13 Unique functions
- Tri-material cushion grip handle
- Loop maker



| Part # | Mfg #      | Description             | Price |
|--------|------------|-------------------------|-------|
| 248988 | 48-22-2881 | 13-in-1 Screwdriver Set |       |

### Demo Driver

- All metal core
- Multiple strike surfaces
- Aggressive duct piercing tip



| Part # | Mfg #      | Description | Price |
|--------|------------|-------------|-------|
| 243684 | 48-22-2860 | Demo Driver |       |

### 2-Pc Demo Screwdriver Set

- Includes:
  - (1) Phillips #6 x 6"
  - (1) Slotted 5/16" x 6"



| Part # | Mfg #      | Description     | Price |
|--------|------------|-----------------|-------|
| 239236 | 48-22-2702 | Demo Driver Set |       |

### 4 PC Precision Screwdriver Set

- All metal cores: up to 4x stronger
- Precision machined driving tips
- Longer shanks
- 360° rotating back caps
- Includes:
  - (1) Phillip #1 -4"
  - (1) Slotted 1/16" - 2 1/2"
  - (1) Slotted 3/32" - 2 1/2"
  - (1) Slotted 1/8" 3 1/2" Slotted



| Part # | Mfg #      | Description                    | Price |
|--------|------------|--------------------------------|-------|
| 171805 | 48-22-2604 | 4 PC Precision Screwdriver Set |       |

### 6 PC Precision Screwdriver Set

- All metal cores: up to 4x stronger
- Precision machined driving tips
- Longer shanks
- 360° rotating back caps



| Part # | Mfg #      | Description                    | Price |
|--------|------------|--------------------------------|-------|
| 172872 | 48-22-2606 | 6 PC Precision Screwdriver Set |       |

## Screwdrivers & Bits

Tools

### 6 PC TORX® Precision Screwdriver Set

- All metal cores: Up to 4X Stronger
- Precision machined driving tips
- Longer shanks for improved visibility and extended reach
- 360-degree rotating back caps
- Color coded markings
- Chrome plated shanks
- Durable case with robust zipper



| Part # | Mfg #      | Description          | Price |
|--------|------------|----------------------|-------|
| 174831 | 48-22-2610 | 6 PC TORX® Precision |       |

### 6 Pc Screwdriver Set

- Heat treated steel cap
- Wrench ready HEX shanks
- Forged tool shanks
- Wire bending hole
- Wire Stripper
- Visible ID Markings



| Part # | Mfg #      | Description             | Price |
|--------|------------|-------------------------|-------|
| 175841 | 48-22-2006 | 6 Piece Screwdriver Set |       |

### 8 PC Screwdriver Kit with ECX

- Includes:
  - (1) ECX (TM) #1
  - (1) ECX (TM) #2
  - (1) Phillips #1 x 3"
  - (1) Phillips #2 x 4"
  - (1) Phillips #2 x 6"
  - (1) Slotted 1/4" x 4"
  - (1) Slotted 3/16" x 6"
  - (1) Slotted 5/16" x 6"



| Part # | Mfg #      | Description     | Price |
|--------|------------|-----------------|-------|
| 239239 | 48-22-2708 | 8 PC Kit w/ ECX |       |

### 8 PC Screwdriver Kit with Square Recess



| Part # | Mfg #      | Description               | Price |
|--------|------------|---------------------------|-------|
| 239240 | 48-22-2718 | 8 PC kit w/ Square Recess |       |

### 3-Pc 1000V Insulated Screwdriver Set

- Flame retardant & impact resistant handle and shank
- UL® Classified
- Meets OSHA Insulated Tool Standard
- VDE & GS Certified
- Visible ID Markings
- Dual Layer Insulation
- Includes:
  - (1) #2 Phillips - 4" 1000V Insulated Screwdriver (48-22-2212)
  - (1) 1/4" Slotted - 6" 1000V Insulated Screwdriver (48-22-2221)
  - (1) #1 ECX™ - 4" 1000V Insulated Screwdriver (48-22-2241)



| Part # | Mfg #      | Description   | Price |
|--------|------------|---------------|-------|
| 231074 | 48-22-2202 | 3Pc Insulated |       |

### 7 Pc Hollow Shaft SAE Nut Driver Set

- Includes:
  - (1) 1/4" Hollow Shaft Nut Driver (48-22-2421)
  - (1) 5/16" Hollow Shaft Nut Driver (48-22-2422)
  - (1) 11/32" Hollow Shaft Nut Driver (48-22-2423)
  - (1) 3/8" Hollow Shaft Nut Driver (48-22-2424)
  - (1) 7/16" Hollow Shaft Nut Driver (48-22-2425)
  - (1) 1/2" Hollow Shaft Nut Driver (48-22-2426)
  - (1) 9/16" Hollow Shaft Nut Driver (48-22-2427)



| Part # | Mfg #      | Description | Price |
|--------|------------|-------------|-------|
| 221061 | 48-22-2407 | 7Pc Set     |       |



## Screwdrivers & Bits

### 4Pc Pry Bar Set

- I-Beam design: up to 40% stronger
- All-metal core
- Hammer-ready strike cap
- Comfortable tri-lobe handles
- Chrome finish
- Easy-access storage tray
- Lifetime guarantee



| Part # | Mfg #      | Description       | Price |
|--------|------------|-------------------|-------|
| 243159 | 48-22-9214 | 8", 12", 18", 24" |       |

### Nut Drivers

#### Hollow Shaft Nut Driver

- Universal driver head fits 4X more fasteners
- Removes rusted and stripped bolts
- 3" Hollow shaft depth
- Wrench ready HEX shanks
- Chrome plated
- Forged steel shanks
- Deep well sockets
- Multiple ID markings



| Part#  | Mfg#       | Size  | Price |
|--------|------------|-------|-------|
| 163305 | 48-22-2421 | 1/4"  |       |
| 163306 | 48-22-2422 | 5/16" |       |

#### HollowCore™ Magnetic Nut Driver

- HollowCore™ unlimited depth
- Magnetic drivers
- Universal driver head fits 4X more fasteners
- Removes rusted and stripped bolts
- Color coded ID markings
- Wrench ready HEX shanks
- Chrome plated
- Forged steel shanks
- Deep well sockets



| Part#  | Mfg#       | Size   | Price |
|--------|------------|--------|-------|
| 162644 | 48-22-2521 | 1/4"   |       |
| 162645 | 48-22-2522 | 5/16"  |       |
| 162646 | 48-22-2524 | 3/8"   |       |
| 162817 | 48-22-2525 | 7/16"  |       |
| 162818 | 48-22-2526 | 1/2"   |       |
| 162819 | 48-22-2527 | 9/16"  |       |
| 162816 | 48-22-2523 | 11/32" |       |

### 2PC SAE Hollow Shaft Nut Driver Set

- Universal driver head fits 4X more fasteners
- Removes rusted and stripped bolts
- 3" Hollow shaft depth
- Wrench ready HEX shanks
- Chrome Plated
- Multiple ID markings



| Part # | Mfg #      | Description            | Price |
|--------|------------|------------------------|-------|
| 163307 | 48-22-2402 | 2-Pc HollowCore Driver |       |

### 2 PC SAE HollowCore™ Magnetic Nut Driver Set

- HollowCore™
- Magnetic drivers
- Universal driver head fits 4X more fasteners
- Removes rusted and stripped bolts
- Color coded ID markings
- Wrench ready HEX shanks
- Chrome plated
- Forged steel shanks
- Deep well sockets



| Part # | Mfg #      | Description         | Price |
|--------|------------|---------------------|-------|
| 162394 | 48-22-2502 | 2-Pc Nut Driver Set |       |

### 7 Pc Hollow Shaft Metric Nut Driver Set

- Includes:
  - 5 mm (48-22-2431)
  - 5.5mm (48-22-2432)
  - 6mm (48-22-2433)
  - 7mm (48-22-2434)
  - 8mm (48-22-2435)
  - 10mm (48-22-2436)
  - 13mm (48-22-2437)
  - 9/16" Driver
- 3" Hollow shaft depth
- Forged steel HEX shanks



| Part # | Mfg #      | Description         | Price |
|--------|------------|---------------------|-------|
| 241916 | 48-22-2417 | 7 Pc Nut Driver Set |       |

Tools

## Screwdrivers & Bits

Tools

### 7 PC Magnetic HollowCore™ SAE Nut Driver Set

- Universal driver head fits 4X more fasteners
- Removes rusted and stripped bolts
- Color coded ID markings
- Wrench ready HEX shanks
- Chrome plated
- Forged steel shanks
- Deep well sockets
- Includes 9/16" driver



| Part # | Mfg #      | Description         | Price |
|--------|------------|---------------------|-------|
| 161964 | 48-22-2507 | 7-Pc Nut Driver Set |       |
| 242650 | 48-22-2517 | 7-Pc Nut Driver Set |       |

### Shockwave® Impact Duty™ Bits

- Steel heat treated to control hardness
- Forged tip for maximum grip
- Geometric design provides the shock absorption zone

#### Shockwave® Reduced Diameter Dry wall Phillips Insert Bit



| Part # | Mfg #      | Dia  | Lgth | Pkg Qty | Phillips | Price |
|--------|------------|------|------|---------|----------|-------|
| 141257 | 48-32-4444 | 1/4" | 1"   | 2       | #2       |       |

### Shockwave™ Impact Locking Bit Holder

- Dual magnets
- Optimized shockzone
- Auto-locking design:
  - Fits all inserts and 1/4" HEX bits
- Quick release collar
  - One handed bit changes



| Part # | Mfg #      | Dia  | Lgth   | Pkg Qty | Phillips | Price |
|--------|------------|------|--------|---------|----------|-------|
| 244547 | 48-32-4531 | 1/4" | 2.875" | 1       | -        |       |
| 241968 | 48-32-4533 | 1/4" | 12"    | 1       | -        |       |

### Shockwave® Impact Duty™ Phillips Power Bit



| Part # | Mfg #      | Dia  | Lgth | Pkg Qty | Phillips | Price |
|--------|------------|------|------|---------|----------|-------|
| 141259 | 48-32-4602 | 1/4" | 2"   | 5       | #2       |       |
| 164161 | 48-32-4461 | 1/4" | 2"   | 1       | #1       |       |

### Shockwave® Impact Duty™ Square Recess Insert Bit



48-32-4421



48-32-4471

| Part # | Mfg #      | Dia  | Lgth   | Pkg Qty | Phillips | Price |
|--------|------------|------|--------|---------|----------|-------|
| 141262 | 48-32-4421 | 1/4" | 1"     | 2       | #1       |       |
| 141266 | 48-32-4471 | 1/4" | 2"     | 1       | #1       |       |
| 141263 | 48-32-4422 | 1/4" | 1"     | 2       | #2       |       |
| 141265 | 48-32-4605 | 1/4" | 1"     | 5       | #2       |       |
| 141268 | 48-32-4606 | 1/4" | 2"     | 5       | #2       |       |
| 141264 | 48-32-4423 | 1/4" | 1"     | 2       | #3       |       |
| 141269 | 48-32-4473 | 1/4" | 2"     | 1       | #3       |       |
| 141270 | 48-32-4572 | 1/4" | 3-1/2" | 1       | #2       |       |

### Shockwave® Torx® Power Bit



| Part # | Mfg #      | Dia  | Lgth | Pkg Qty | Torx | Price |
|--------|------------|------|------|---------|------|-------|
| 164162 | 48-32-4482 | 1/4" | 2"   | T10     |      |       |
| 141271 | 48-32-4483 | 1/4" | 2"   | 1       | T15  |       |
| 164163 | 48-32-4486 | 1/4" | 2"   | T27     |      |       |
| 141274 | 48-32-4487 | 1/4" | 2"   | 1       | T30  |       |

### Shockwave® Impact Torx® Power Bit

- OPTIMIZED SHOCKZONE™
- PRECISE FIT CUSTOM MACHINED TIP™
- CUSTOM ALLOY76™ STEEL



| Part # | Mfg #      | Lgth   | Pkg Qty | Torx | Price |
|--------|------------|--------|---------|------|-------|
| 164166 | 48-32-4436 | 1"     | 2       | T25  |       |
| 141273 | 48-32-4485 | 2"     | 1       | T25  |       |
| 219698 | 48-32-4561 | 3-1/2" | 1       | T25  |       |
| 141272 | 48-32-4484 | 2"     | 1       | T20  |       |

## Screwdrivers & Bits

### SHOCKWAVE™ Impact Phillips Power Bit

- OPTIMIZED SHOCKZONE™
- PRECISE FIT CUSTOM MACHINED TIP™
- CUSTOM ALLOY76™ STEEL



| Part#  | Mfg#       | Drive Size | Length | Pk Qty | Price |
|--------|------------|------------|--------|--------|-------|
| 164171 | 48-32-4604 | 2          | 1"     | 25     |       |
| 182487 | 48-32-4762 | 2          | 2"     | 25     |       |
| 141258 | 48-32-4462 | 2          | 2"     | 1      |       |
| 164174 | 48-32-4564 | 2          | 3-1/2" | 5      |       |
| 141261 | 48-32-4562 | 2          | 3-1/2" | 1      |       |
| 164175 | 48-32-4802 | 2          | 6"     | 1      |       |
| 164164 | 48-32-4563 | 3          | 3-1/2" | 1      |       |
| 141251 | 48-32-4411 | 1          | 1"     | 2      |       |
| 141255 | 48-32-4601 | 2          | 1"     | 5      |       |
| 141256 | 48-32-4413 | 3          | 1"     | 2      |       |
| 141254 | 48-32-4412 | 2          | 1"     | 2      |       |
| 141260 | 48-32-4463 | 3          | 2"     | 1      |       |
| 164173 | 48-32-5004 | 2          | 2"     | 15     |       |

### SHOCKWAVE™ Impact Square Power Bit

- OPTIMIZED SHOCKZONE™
- PRECISE FIT CUSTOM MACHINED TIP™
- CUSTOM ALLOY76™ STEEL



| Part#  | Mfg#       | Drive Size | Length | Pk Qty | Price |
|--------|------------|------------|--------|--------|-------|
| 164165 | 48-32-4573 | 3          | 3-1/2" | 1      |       |
| 141267 | 48-32-4472 | 2          | 2"     | 1      |       |
| 164176 | 48-32-4805 | 2          | 6"     | 1      |       |

### Shockwave® Bit Sets

#### 74PC Shockwave® Impact Duty Driver Bit Set

- Includes:
- (1) SHOCKWAVE™ Compact Magnetic Bit Holder
- (1) 1/4" Magnetic Nut Driver
- (1) 5/16" Magnetic Nut Driver
- (1) 3/8" Socket Adapter
- Phillips Bit
  - (2) 1" P1, (11) 1" P2, (1) 1" PR2, (3) 1" P3
- Square Bit
  - (2) 1" SQ1, (4) S1" SQ2, (2) 2" SQ3
- Slotted Bit
  - (1) 1" #8, (2) 1" #10
- INSERT BIT HEX
  - (1) 1/4", (1) 1/8", (1) 3/16", (1) 9/64", (1) 5/32"
- HexPower Groove Bit
  - (1) 3mm 312, (1) 4mm 312, (1) 5mm 312, (1) 6mm 312
- TORX® Bit
  - (1) 1" T10, (2) 1" T15, (4) 1" T20, (7) 1" T25, (2) 1" T27, (2) 1" T30
- Power Groove Bit
  - (2) P2 2", (1) P3 2", (2) SQ2 2", (1) SQ3 2", (1) T20 2"
  - (1) T25 2" (1) P2 3 1/2", (1) SQ2 3 1/2", (1) T25 3 1/2"
- Double Ended Bit
  - (1) T20/T25, (1) P2/SL #10, (1) P2/SQ2, (1) P2/T25



| Part # | Mfg #      | Description          | Price |
|--------|------------|----------------------|-------|
| 251490 | 48-32-4062 | 74-Piece Impact Duty |       |

#### 22-Piece Shockwave® Puck Bit Dispenser

- Includes:
- Magnetic bit holder
- Phillips: (1) #1, (3) #2, (2) #3
- Square recess: (1) #1, (3) #2, (1) #3
- Torx: (1) T10, (1) T15, (1) T20, (1) T25, (1) T27, (1) T30
- Slotted: (1) 1/8", (1) 3/16", (1) 1/4", (1) 9/32"



| Part # | Mfg #      | Description                 | Price |
|--------|------------|-----------------------------|-------|
| 143668 | 48-32-4011 | 22-Piece Puck Bit Dispenser |       |

#### 7 Pc TORX® Insert Bit Kit

- Kit includes:
- (1) TORX® Bit 1" T10
- (1) TORX® Bit 1" T15
- (1) TORX® Bit 1" T20
- (1) TORX® Bit 1" T25
- (1) TORX® Bit 1" T27
- (1) TORX® Bit 1" T30
- (1) TORX® Bit 1" T40

| Part # | Mfg #      | Description | Price |
|--------|------------|-------------|-------|
| 164159 | 48-32-4615 | 7-Piece     |       |

## Screwdrivers & Bits

Tools

### Right Angle Drive Unit

- For use with Milwaukee 1/2" d-handle drills
- Provides 2 additional drilling speeds
- Includes coupling No. 42-90-0175 for 0234-6 and 0244-1
- For 50% more torque or 50% more speed



| Part # | Mfg #      | Description            | Price |
|--------|------------|------------------------|-------|
| 162598 | 48-06-2871 | Right Angle Drive Unit |       |

### 11-Piece Shockwave® Impact Duty™ 30° Knuckle™ Pivoting Bit Holder Bit Set

- Locks at 0° or 30° angle
- Maximum torque: 2,000 in-lbs
- Includes:
  - Phillips bits: 1" P Shockwave® 30° Knuckle™ pivoting bit holder 1, P2 & P3
  - Square bits: 1" SQ1 & SQ2
  - Slotted bits: 1" SL1/8", SL 3/16", SL1/4", SL9/32"
  - Torx® bits: 1" T25



| Part # | Mfg #      | Description                        | Price |
|--------|------------|------------------------------------|-------|
| 146101 | 48-32-2301 | 11-Pc Bit Set & Knuckle Bit Holder |       |

### 7 Pc SHOCKWAVE™ Hex Security Insert Bit Set



| Part # | Mfg #      | Description  | Price |
|--------|------------|--------------|-------|
| 237357 | 48-32-4619 | 7-Pc Bit Set |       |

### Shockwave® Nut Drivers

#### Shockwave® Magnetic Nut Driver

- Steel heat treated to control hardness
- Color-coded rings for size identification
- Chamfered edge



| Part # | Mfg #      | Size           | Pkg Qty | Price |
|--------|------------|----------------|---------|-------|
| 141231 | 49-66-4502 | 1/4" x 1-7/8"  | 1       |       |
| 141243 | 49-66-4522 | 1/4" x 1-7/8"  | 3       |       |
| 141247 | 49-66-4532 | 1/4" x 2-9/16" | 1       |       |
| 228380 | 49-66-4732 | 1/4" x 2-9/16" | 10      |       |

### Shockwave® Nut Drivers (Continued)

#### Shockwave® Magnetic Nut Driver

| Part # | Mfg #      | Size            | Pkg Qty | Price |
|--------|------------|-----------------|---------|-------|
| 140360 | 49-66-4503 | 5/16" x 1-7/8"  | 1       |       |
| 141236 | 49-66-4506 | 7/16" x 1-7/8"  | 1       |       |
| 141244 | 49-66-4523 | 5/16" x 1-7/8"  | 3       |       |
| 228381 | 49-66-4733 | 5/16" x 2-9/16" | 10      |       |
| 141248 | 49-66-4533 | 5/16" x 2-9/16" | 1       |       |
| 141245 | 49-66-4525 | 3/8" x 1-7/8"   | 3       |       |
| 141249 | 49-66-4535 | 3/8" x 2-9/19"  | 1       |       |
| 141246 | 49-66-4526 | 7/16" x 1-7/8"  | 3       |       |
| 141250 | 49-66-4536 | 7/16" x 2-9/16" | 1       |       |
| 164177 | 49-66-4537 | 1/2" x 2-9/16"  | 1       |       |
| 141234 | 49-66-4505 | 3/8" x 1-7/8"   | 1       |       |

#### Set



| Part # | Mfg #      | Size   | Pkg Qty | Price |
|--------|------------|--------|---------|-------|
| 141241 | 49-66-4562 | 1-7/8" | 4       |       |
| 141237 | 49-66-4561 | 1-7/8" | 3       |       |

#### SHOCKWAVE™ 1/4" Hex Adapter SQ 3/8"

- Proprietary steel and heat treat process for maximum strength and durability
- Heavy duty construction for fastening capabilities in all impacts



| Part # | Mfg #      | Description              | Price |
|--------|------------|--------------------------|-------|
| 153737 | 48-03-4405 | 1/4" Hex Adapter SQ 3/8" |       |

#### SHOCKWAVE™ 1/2" Square to 1/4" Hex Adapter

- Proprietary steel and heat treat process for maximum strength and durability
- Heavy duty construction for fastening capabilities in all impacts



| Part # | Mfg #      | Description                                | Price |
|--------|------------|--|-------|
| 164154 | 48-03-4410 | SHOCKWAVE™ 1/2" Square to 1/4" Hex Adapter |       |

## Screwdrivers & Bits

### SHOCKWAVE™ Square Socket Adapter

- Proprietary steel and heat treat process
- Heavy duty construction



| Part # | Mfg #      | Description                    | Price |
|--------|------------|--------------------------------|-------|
| 164155 | 48-32-5030 | 1/4" Hex to 1/4" Square Socket |       |
| 154029 | 48-32-5031 | 1/4" Hex to 3/8" Square Socket |       |
| 164157 | 48-32-5032 | 1/4" Hex to 1/2" Square Socket |       |

### Bit Sets

#### 38-Piece Universal Quik-Lok™ Drill & Drive Set

- Made of premium grade S2 tool steel
- Titanium hex shank bits
- Magnetic nut drivers



| Part # | Mfg #      | Description                       | Price |
|--------|------------|-----------------------------------|-------|
| 138409 | 48-32-1500 | 38Pc Quick-Lok™ Drill & Drive Set |       |

#### 4-Piece Universal Replacement Bit Set

- Includes:
  - ECX Bit #1 & #2
  - Phillips #1 & #2
  - Slotted 3/16" & 1/4"
  - Square #1 & #2



| Part # | Mfg #      | Description              | Price |
|--------|------------|--------------------------|-------|
| 142609 | 48-22-2110 | 4-Pc Replacement Bit Set |       |

#### Installation Kit for Concrete Screws

- (1) 1/4" Hex Drive Bit
- (1) 3/16" x 7" with 1/4" Hex Rotary Hammer Drill Bit
- (1) 5/16" Hex Drive Bit
- (1) 5/32" x 7" with 1/4" Hex Rotary Hammer Drill Bit
- (1) Drive Sleeve
- (1) #2 Phillips Driver Bit
- (1) #3 Phillips Driver Bit



| Part # | Mfg #      | Description | Price |
|--------|------------|-------------|-------|
| 169685 | 48-20-7497 | 6-Pc Set    |       |

### SHOCKWAVE™ Impact Duty Drill & Drive Set

- Custom machine tip
- Custom alloy 76 steel
- 60 Piece kit include:
  - (1) Compact bit holder
  - (1) 6" Bit holder
  - Socket Adapter: 3/8"
  - Magnetic nut drivers: 1/4" & 5/16"
  - Hex drill bits: 1/16", 3/32", 1/8", 5/32", 3/16", 1/4"
  - Double ended power bits: PH2/SQ2, PH2/T25, PH2/SL#10, T20/T25
  - Insert driver bits: PH1, (6) PH2, PR2, (2) PH3, SQ1, (3) SQ2, SQ3, T10, T15, (2) T20, (3) T25, T30, SL#6, SL#10, Hex 3/16", Hex 1/4"
  - 2" Power Bits: PH1, (4) PH2, (2) PH3, SQ1, (3) SQ2, SQ3, (2) T20, (2) T25, T30, SL#10



| Part # | Mfg #      | Description | Price |
|--------|------------|-------------|-------|
| 241621 | 48-32-4029 | 60-Pc Set   |       |

Tools

## Screwdrivers & Bits

Tools

### Screwdrivers

#### Regular Grip Screwdriver - Electrical Style



| Part # | Mfg # | Blade Dia | Blade Length | Price |
|--------|-------|-----------|--------------|-------|
| 006380 | C22M  | 1/8"      | 2"           |       |

### Nut Drivers

#### CONNEXT™ Pre-Assembled Magnetic Hex Driver - Long Lengths



- CONNEXT™ Quick change handles
- Magnetic hex chuck driver shaft components
- Use with Zip-In® and "A" hex head screws

| Part # | Mfg # | Hex Dia | Shaft Length | Grips  | Price |
|--------|-------|---------|--------------|--------|-------|
| 006416 | HHD1  | 1/4"    | 6-7/8"       | Red    |       |
| 006417 | HHD2  | 5/16"   | 6-7/8"       | Yellow |       |

#### CONNEXT™ Pre-Assembled Magnetic Hex Driver - Standard Lengths



- CONNEXT™ Quick change handles
- Magnetic hex chuck driver shaft components
- Use with Zip-In® and "A" hex head screws

| Part # | Mfg # | Hex Dia | Shaft Length | Grips | Price |
|--------|-------|---------|--------------|-------|-------|
| 132792 | HHD1S | 1/4"    | 3"           | Red   |       |

#### CONNEXT™ Pre-Assembled Magnetic Hex Driver - Stubby



- CONNEXT™ Quick change handle
- Magnetic hex chuck driver shaft components
- Use with Zip-In® and "A" hex head screws

| Part # | Mfg # | Hex Dia | Shaft Length | Grips  | Price |
|--------|-------|---------|--------------|--------|-------|
| 132795 | HHD2T | 5/16"   | 2-1/4"       | Yellow |       |

### Dual-Sided Hex Chuck Driver

- Reversible
- Red: 1/4"
- Yellow: 5/16"



| Part # | Mfg # | Hex Dia    | Shaft Length | Price |
|--------|-------|------------|--------------|-------|
| 231525 | MSHC  | 1/4"/5/16" | 2"           |       |

### Power Bits

#### Phillips Power Bit

- 1/4" Shank diameter



| Part # | Mfg # | Point Size | O/A Length | Price |
|--------|-------|------------|------------|-------|
| 006444 | MBLP3 | 2          | 1-15/16"   |       |

#### Magnetic Hex Driver Bit

- 1/4" Shank diameter



| Part # | Mfg #   | Hex Opening | Nose Diameter | Price |
|--------|---------|-------------|---------------|-------|
| 006447 | MSH1/4  | 1/4"        | 7/16"         |       |
| 006449 | MSH5/16 | 5/16"       | 1/2"          |       |
| 006448 | MSH3/8  | 3/8"        | 9/16"         |       |

#### Long Style Hex Driver Bit

- 1/4" Shank diameter



| Part # | Mfg #    | Hex Opening | Nose Dia | Qty | Price |
|--------|----------|-------------|----------|-----|-------|
| 006446 | MSHL1/4  | 1/4"        | 7/16"    | 1   |       |
| 025655 | MSHL5/16 | 5/16"       | 1/2"     | 1   |       |

#### Extra Long Style Hex Driver Bit

- 1/4" Shank diameter



| Part # | Mfg #     | Hex Opening | O/A Length | Price |
|--------|-----------|-------------|------------|-------|
| 025042 | MSHML1/4  | 1/4"        | 4"         |       |
| 023240 | MSHXL1/4  | 1/4"        | 6"         |       |
| 096867 | MSHXL5/16 | 5/16"       | 6"         |       |

### Power Bit Extension

- Ball bearing on holder provides a positive lock on 1/4" hex
- Tempered steel
- Black finish
- 9/16" Nose diameter



| Part # | Mfg # | Hex Opening | O/A Length | Price |
|--------|-------|-------------|------------|-------|
| 006378 | BHE6  | 1/4"        | 6"         |       |
| 006377 | BHE10 | 1/4"        | 10"        |       |

## Screwdrivers & Bits

### Power Driver Hex Adapters

#### Quick Change Hex Adapter



| Part # | Mfg # | Hex Dia | Shank Dia | O/A Length | Price |
|--------|-------|---------|-----------|------------|-------|
| 006407 | HAD1  | 1/4"    | 3/4"      | 1-3/4"     |       |

### Miscellaneous Tools

#### Tensioning Tool with Manual Cut Off and Grips



| Part # | Mfg # | Description     | Price |
|--------|-------|-----------------|-------|
| 061800 | TY4G  | Notched Gripper |       |



## Screwdrivers & Bits

Tools

### Screwdrivers

#### 4-In-One Pocket Mini Screwdriver

- Includes:
  - 3/32" & 1/16" Slotted bit
  - #0 & #000 Phillips bit



| Part # | Mfg # | Color        | Price |
|--------|-------|--------------|-------|
| 136199 | 24008 | Black/Yellow |       |

#### 6-In-One Screwdriver

- Includes:
  - 1/4" & 3/16" Slotted bit
  - #1 & #2 Phillips bit
  - 1/4" & 5/16" Hex nut driver



| Part # | Mfg # | Color | Price |
|--------|-------|-------|-------|
| 028106 | 24006 | Red   |       |



**Screwdrivers & Bits**

**Cushion Grip Screwdrivers**

**Stubby Heavy-Duty Square Shank Screwdriver - Keystone Tip**



| Part # | Mfg # | Shank Tip | Shank Length | Overall Length | Price |
|--------|-------|-----------|--------------|----------------|-------|
| 111152 | 600-1 | 1/4"      | 1-1/2"       | 3-7/16"        |       |

**Heavy-Duty Square Shank Screwdriver - Keystone Tip**



| Part # | Mfg # | Shank Tip | Shank Length | Overall Length | Price |
|--------|-------|-----------|--------------|----------------|-------|
| 107644 | 600-4 | 1/4"      | 4"           | 8-11/32"       |       |

**Round Shank Screwdriver - Cabinet Tip**



| Part # | Mfg #  | Shank Tip | Shank Length | Overall Length | Price |
|--------|--------|-----------|--------------|----------------|-------|
| 107645 | 601-6  | 3/16"     | 6"           | 9-3/4"         |       |
| 115682 | 601-10 | 3/16"     | 10"          | 13-3/4"        |       |

**Heavy-Duty Round Shank Screwdriver - Keystone Tip**



| Part # | Mfg # | Shank Tip | Shank Length | Overall Length | Price |
|--------|-------|-----------|--------------|----------------|-------|
| 107646 | 602-6 | 5/16"     | 6"           | 10-15/16"      |       |

**Miniature Cushion Grip Screwdriver - Phillips Tip**



| Part # | Mfg # | Tip Size | Shank Length | Overall Length | Price |
|--------|-------|----------|--------------|----------------|-------|
| 120232 | 604-3 | #0       | 3"           | 5-3/4"         |       |

**Miniature Cushion Grip Screwdriver - Cabinet Tip**



| Part # | Mfg # | Tip Size | Shank Length | Overall Length | Price |
|--------|-------|----------|--------------|----------------|-------|
| 121303 | 607-3 | 3/32"    | 3"           | 5-3/4"         |       |
| 121432 | 608-4 | 1/8"     | 4"           | 6-3/4"         |       |

**Stubby Round Shank Screwdriver - Profilated® Phillips Tip**



| Part # | Mfg # | Point Size | Shank Length | Overall Length | Price |
|--------|-------|------------|--------------|----------------|-------|
| 111153 | 603-1 | #2         | 1-1/2"       | 3-7/16"        |       |

**Round Shank Screwdriver - Profilated® Phillips Tip**

- B - Wire bending



| Part # | Mfg #  | Point Size | Shank Length | Overall Length | Price |
|--------|--------|------------|--------------|----------------|-------|
| 106813 | 603-4  | #2         | 4"           | 8-5/16"        |       |
| 114527 | 603-6  | #3         | 6"           | 11"            |       |
| 115681 | 603-10 | #2         | 10"          | 14-5/16"       |       |

**Cushion Grip Screwdriver Sets**

**4-Piece Mini Cushion Grip Screwdriver Set**

- Includes:
  - 604-3 Phillips tip #0
  - 606-2 Keystone tip 1/16"
  - 607-3 Cabinet tip 3/32"
  - 608-3 Cabinet tip 1/8"



| Part # | Mfg # | Description             | Price |
|--------|-------|-------------------------|-------|
| 106815 | 85484 | 4-Piece Mini Driver Set |       |

**Screwdrivers & Bits**

Tools

**8-Piece Cushion Grip Screwdriver Set**

- Includes (1) cabinet-tip, (3) keystone-tip, (4) Phillips-tip screwdrivers in styles:

- 600-1
- 601-3
- 600-4
- 602-6
- 603-1
- 603-3
- 603-4
- 603-6



| Part # | Mfg # | Description | Price |
|--------|-------|-------------|-------|
| 113764 | 85078 | 8-Piece Set |       |

**Screw-Holding Screwdrivers**

**Slotted Screw-Holding Screwdriver**



| Part # | Mfg # | Shank Tip | Shank Length | Overall Length | Price |
|--------|-------|-----------|--------------|----------------|-------|
| 106814 | K36   | 1/4"      | 6"           | 9-3/4"         |       |

**Cushion Grip Nut Drivers**

**Stubby Nut Driver - 1-1/2" Hollow Shank**

- Full hollow shank for long bolts or studs
- Meets or exceeds applicable AMSE/ANSI specifications



| Part # | Mfg #    | Size  | Price |
|--------|----------|-------|-------|
| 106819 | 610-1/4  | 1/4"  |       |
| 106820 | 610-5/16 | 5/16" |       |

**Magnetic Tip Stubby Nut Driver - 1-1/2" Hollow Shank**

- Rare Earth magnetic tip
- Full hollow shank for long bolts or studs
- Meets or exceeds applicable AMSE/ANSI specifications



| Part # | Mfg #     | Size  | Price |
|--------|-----------|-------|-------|
| 109254 | 610-1/4M  | 1/4"  |       |
| 109255 | 610-5/16M | 5/16" |       |

**Magnetic Tip Nut Driver - 3" Hollow Shank**

- Rare Earth magnetic tip
- Handle end is color-coded for easy identification
- Chrome-plated



| Part # | Mfg #     | Size  | Price |
|--------|-----------|-------|-------|
| 109256 | 630-1/4M  | 1/4"  |       |
| 109257 | 630-5/16M | 5/16" |       |

**Nut Driver - 3" Hollow Shank**

- Standard length for most applications
- Fits over long bolts and studs



| Part # | Mfg #    | Size  | Price |
|--------|----------|-------|-------|
| 106818 | 630-1/4  | 1/4"  |       |
| 106817 | 630-5/16 | 5/16" |       |
| 111184 | 630-3/8  | 3/8"  |       |
| 111185 | 630-7/16 | 7/16" |       |
| 111183 | 630-1/2  | 1/2"  |       |
| 111154 | 630-5/8  | 5/8"  |       |

**Magnetic Tip Nut Driver - 6" Hollow Shank**

- Rare Earth magnetic tip
- Handle end is color-coded for easy identification
- Chrome-plated



| Part # | Mfg #     | Hex Size | Shaft Lgth | Price |
|--------|-----------|----------|------------|-------|
| 110347 | 646-1/4M  | 1/4"     | 6"         |       |
| 110346 | 646-5/16M | 5/16"    | 6"         |       |
| 112223 | 618-5/16M | 5/16"    | 18"        |       |

**Cushion Grip Nut Driver Sets**

**Magnetic Tip Stubby Nut Driver Set - 1-1/2" Hollow Shank**

- Full hollow shank for long bolts or studs
- Meets or exceeds applicable AMSE / ANSI specifications



| Part # | Mfg # | Description  | Price |
|--------|-------|--------------|-------|
| 125143 | 610M  | 1/4" & 5/16" |       |

## Screwdrivers & Bits

### Magnetic Tip Nut Driver Set - 3" Hollow Shank

- Rare Earth magnetic tip
- Cushion grip handle
- Color-coded handle end
- Internal flanges provide solid, twist-resistant shaft anchor
- Chrome-plated shaft helps prevent corrosion



| Part # | Mfg # | Description  | Price |
|--------|-------|--------------|-------|
| 125644 | 630M  | 1/4" & 5/16" |       |

### Magnetic Tip Nut Driver Set - 6" Hollow Shank

- Rare Earth magnetic tip
- Handle end is color-coded for easy identification
- Chrome-plated



| Part # | Mfg # | Description  | Price |
|--------|-------|--------------|-------|
| 106816 | 646M  | 1/4" & 5/16" |       |

### 4-Piece Nut Driver Set - 3" Hollow Shank

- Color-coded handle end
- Cushion grip handle
- Chrome-plated
- Internal flanges provide solid, twist-resistant shaft anchor



| Part # | Mfg # | Description               | Price |
|--------|-------|---------------------------|-------|
| 141334 | 633   | 1/4", 5/16", 3/8" & 9/16" |       |

### 7-Piece Magnetic Tip Cushion Grip Nut Driver Set



| Part # | Mfg # | Description | Price |
|--------|-------|-------------|-------|
| 111285 | 631M  | 3" Shank    |       |

### Screwdriver/Nut Driver Combinations

#### 10-in-1 Screwdriver/Nut Driver

- End of handle is marked to quickly identify tool
- Includes:
  - 5/16" & 1/4" Nut drivers
  - #1 & #2 Phillips
  - 1/4" & 3/16" Slotted
  - #10 & #15 TORX®
  - #1 & #2 Square-recess
- Cushion grip handle



| Part # | Mfg # | Description                    | Price |
|--------|-------|--------------------------------|-------|
| 107643 | 32477 | 10-in-1 Screwdriver/Nut Driver |       |

#### 11-in-1 Screwdriver/Nut Driver

- End of handle is marked to quickly identify tool
- Includes:
  - 3/8", 5/16" & 1/4" Nut drivers
  - #1 & #2 Phillips
  - 1/4" & 3/16" Slotted
  - #10 & #15 TORX®
  - #1 & #2 Square-recess
- Cushion grip handle



| Part # | Mfg # | Description                    | Price |
|--------|-------|--------------------------------|-------|
| 113299 | 32500 | 11-in-1 Screwdriver/Nut Driver |       |

#### 10-Fold™ 10-in-1 Screwdriver/Nut Driver

- Folding pocket-style 10-in-1 tool with interchangeable bits - (8) screwdriver sizes and (2) nut drivers
- Unfolds and locks at a 180° angle to provide a straight screwdriver
- Blast finish steel bits provide a firm hold to the fastener to reduce cam-out
- Contains:
  - 5/16" & 1/4" Nut drivers
  - #1 & #2 Phillips
  - 1/4" & 3/16" Slotted
  - T10 & T15 TORX
  - #1 & #2 Square-recess



| Part # | Mfg # | Description                  | Price |
|--------|-------|------------------------------|-------|
| 130688 | 32535 | 10-Blade Folding Screwdriver |       |

Tools

**Screwdrivers & Bits**

Tools

**11-in-1 Screwdriver/Nut Driver with Valve Removal/ Installation Bit**

- Includes a TR-4 Schrader® valve core installation/ removal and core extractor bit
- End of handle is marked to quickly identify tool
- Includes:
  - 3/8", 5/16" & 1/4" Nut drivers
  - #1 & #2 Phillips
  - 1/4" & 3/16" Slotted
  - #1 & #2 Square
  - Schrader valve core removal/ installation - extractor
- Cushion grip handle



| Part # | Mfg # | Description   | Price |
|--------|-------|---|-------|
| 130822 | 32527 | 11-in-1 Screwdriver/Nut Driver w/Schrader Valve Core Tool |       |

**Magnetic Screwdriver with 32-Piece Bit Set**

- Non-ratcheting screwdriver
- Tamperproof bit set in block includes:
  - TORX® - T7, T8, T10, T15, T20, T25, T27, T30, and T40
  - Fraction hex - 3/32", 7/64", 1/8", 9/64", 5/32", and 3/16"
  - Metric hex - 2mm, 2.5mm, 3mm, 4mm, and 5mm
  - Spanner - 4, 6, 8, and 10
  - Tri-Wing® - 1, 2, 3, and 4
  - TORQ-SET® - 6, 8, and 10
  - 1/4" Square to 1/4" hex adapter to drive sockets
- Cushion grip handle



| Part # | Mfg # | Description                 | Price |
|--------|-------|-----------------------------|-------|
| 114766 | 32510 | Screwdriver w/32-Pc Bit Set |       |

**Drill Bits**

**32-Piece Standard Tip Bit Set**

- Chrome-plated
- Internal flanges
- Heat-treated shaft
- Precision-machined tip
- Patented Tip-Ident® quickly identifies the screwdriver type and tip orientation
- PVC Black block for storage
- Block slides over most screwdriver shafts for easy bit access and installation
- Industrial strength, heat-treated bits
- Includes:
  - Hex bits: 5/64", 3/32", 7/64", 1/8", 9/64", 5/32" and 3/16"
  - Phillips bits: #0, #1, #2, and #3
  - Square recess bits: #1, #2 and #3
  - TORX® bits: T6, T7, T8, T10, T15, T20 and T25
  - Slotted bits: 3-4, 5-6, 6-8, 8-10, 10-12, and 12-14
  - Clutch bits: 5/32" and 3/16"
  - 1/4" Square to 1/4" hex adapter to drive sockets



| Part # | Mfg # | Description      | Price |
|--------|-------|------------------|-------|
| 114768 | 32526 | 32-Piece Bit Set |       |

---



---

## Screwdrivers & Bits

---

### Power Bits

#### Phillips Bit



| Part # | Mfg #   | Description                 | Price |
|--------|---------|-----------------------------|-------|
| 041954 | S41-306 | #2 Point, 1/4" Hex, 1" Long |       |

## Screwdrivers & Bits

Tools

### Screwdrivers & Bits

#### 9 in 1 Multi-Tool

- Slip-resistant grip
- Thick-walled shaft
- Included:
  - Bits
  - Valve core remover
  - Square #2
  - 1/2" Hex
  - 5/16" Hex
  - 3/8" Hex
  - Phillips #1 & #2
  - 3/16" and 1/4" slotted



| Part # | Mfg #   | Description       | Price |
|--------|---------|-------------------|-------|
| 165766 | 1839053 | 9-in-1 Multi-Tool |       |

#### 3" Shaft Magnetic Nut Drivers

- Secure hold
- Color-coded for quick identification
- Slip-resistant grip
- Hollowed shaft allows for use on long bolts
- Chrome-vanadium steel construction



| Part # | Mfg #   | Description        | Price |
|--------|---------|--------------------|-------|
| 171359 | 1839059 | Red, 1/4" x 3"     |       |
| 171360 | 1839060 | Yellow, 5/16" x 3" |       |

#### 6" Shaft Magnetic Nut Drivers

- Secure hold
- Color-coded for quick identification
- Slip-resistant grip
- Hollowed shaft allows for use on long bolts
- Chrome-vanadium steel construction



| Part # | Mfg #   | Description            | Price |
|--------|---------|------------------------|-------|
| 171362 | 1839068 | Red, 1/4" x 6"         |       |
| 171363 | 1839069 | Yellow, 5/16" x 6"     |       |
| 171364 | 1839074 | Set of 2, 1/4" & 5/16" |       |

### Precision Screwdriver Set

- Comfortable grips
- Maximum precision
  - Rotating head allows for precise adjustments
- Quick identification with easy-to-read tips
- Pouch included for storage
- Includes:
  - #0x3" Phillips, 1/16"x2", 3/32"x3", 1/8"x4", 1/8"x6" Slotted



| Part # | Mfg #   | Description | Price |
|--------|---------|-------------|-------|
| 174627 | 1891089 | 5-Pc Set    |       |



## Hand Sewer Machines

### Flexicore® Closet Augers

#### Regular Head Closet Auger

- With Flexicore double layer wire rope center



3FL

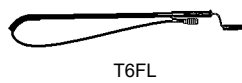

T6FL

| Part # | Mfg # | Description           | Price |
|--------|-------|-----------------------|-------|
| 093674 | 3FL   | 3' Flexicore (6/Ctn)  |       |
| 005064 | T6FL  | 6' Teletube Flexicore |       |

#### Down Head Closet Auger

- Flexicore double layer wire rope center

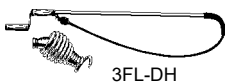

3FL-DH



T6FL-DH

| Part # | Mfg #   | Description           | Price |
|--------|---------|-----------------------|-------|
| 005068 | 3FL-DH  | 3' Flexicore          |       |
| 005063 | T6FL-DH | 6' Teletube Flexicore |       |

### Urinal Augers



| Part # | Mfg # | Description                                | Price |
|--------|-------|--|-------|
| 038683 | TU4   | Telescoping Teletube® - 48" Spring (6/Ctn) |       |

Tools

**Hand Sewer Machines**

Tools

**Petersen Drain Flushers**

- Multi-flex™ multiple ply construction, high flow rate flushing
- Flexible for insertion around bends, internal stiffener for easy insertion
- 3/4" Water hose coupling

Petersen



R193400



R193600



R193700

| Part # | Mfg #   | Description              | Price |
|--------|---------|--------------------------|-------|
| 008378 | R193400 | 102-001 1-1/2" Drain Jet |       |
| 008380 | R193600 | 102-003 3" Drain Jet     |       |
| 008904 | R193700 | 102-004 4" Drain Jet     |       |

**Suction Guns**

| Part # | Mfg #   | Description           | Price |
|--------|---------|-----------------------|-------|
| 080436 | R441825 | Last Drop Suction Gun |       |



**Hand Sewer Machines**

**Plungers**

**Rubber Plunger**

- Includes funnel-shaped cap that is retractable for use in flat sinks



| Part # | Mfg # | Type   | Handle | Price |
|--------|-------|--------|--------|-------|
| 183404 | 312-2 | Funnel | 20"    |       |

Tools



## Hand Sewer Machines

### Clog Buster™ Drain Flushers



Tools

| Part # | Mfg #        | Size        | Price |
|--------|--------------|-------------|-------|
| 002966 | CI1123DRAFLU | 1-1/2" - 3" |       |



## Hand Sewer Machines

### Drain Cleaning & Tools

#### Mighty Mini Sink Plunger

- 4" Black rubber cup
- 8" Plastic handle
- Barcode label



| Part # | Mfg #  | Description              | Price |
|--------|--------|--------------------------|-------|
| 053480 | 090288 | Mighty Mini Sink Plunger |       |

#### All Angle Power Plunger

- Flexible black rubber cup with 21" yellow handle
- Fully assembled with header card



| Part # | Mfg #  | Description   | Price |
|--------|--------|---------------|-------|
| 041779 | 090300 | Power Plunger |       |

Tools



## Hand Sewer Machines

### Plungers



| Part # | Mfg # | Description    | Price |
|--------|-------|----------------|-------|
| 008174 | 93-8  | Korky® Plunger |       |

Tools



## Hand Sewer Machines

### Snake-Oil™

- Highly recommended for use with all types of cables



| Part # | Mfg #  | Description | Price |
|--------|--------|-------------|-------|
| 010265 | SOQ-12 | 1 qt, 12/Pk |       |

## Power Sewer Machines

Tools

### Ken-Way Junior Drain Cleaner

- Cleans 1" to 4" drain and process lines
- All steel construction
- Can handle cable sizes 1/4" to 1/2"
- Three drum size options
- Chuckless design speeds cable feeding
- Air powered foot switch
- Heavy-duty 1/4 hp motor
- Dimensions: 14"H x 17-1/2"W x 11"D
- Weight without cable: 24 lbs



| Part # | Mfg # | Description  | Price |
|--------|-------|--|-------|
| 110571 | J045  | Ken-Way Jr. Drain Cleaner<br>w/Regular Drum & 3/8" x 50'<br>Blade End Cable & Blades |       |



## Power Sewer Machines

### Super-Vee™ Drain Cleaners

#### Super-Vee™ Drain Cleaner Kit

- Includes:
  - Basic unit (side action chuck, variable speed motor with reversing switch)
  - Case
  - HECS Cutter set
  - (1) Additional cartridge

| Part # | Mfg #   | Description                                    | Price |
|--------|---------|--|-------|
| 019540 | SV-C-WC | 1/4" x 50' (50HE1) & 3/8" x 35' (35HE2) Cables |       |

### Mini-Rooter™ Drain Cleaners

#### Mini-Rooter™ Drain Cleaner Kit

- Includes:
  - Basic unit (MR-200 drum, 1/3 hp motor with reverse switch, 10' power cord, ground fault interrupter, waterproof air foot switch, leather gloves and cable)
  - MRCS Cutter set (AH arrow head, BG boring gimlet, 1-1/2" U & 1-1/2" U-cutter, 2" SCB side cutter blade)

| Part # | Mfg # | Description                                | Price |
|--------|-------|--|-------|
| 005054 | MR-B  | 75' x 3/8" (75EM2) Cable & MRCS Cutter Set |       |

#### Mini-Rooter™ Drainer Cleaner Accessories



| Part # | Mfg # | Description        | Price |
|--------|-------|--------------------|-------|
| 028942 | MR-W  | Mini-Rooter™ Dolly |       |

### Flexicore Cables

- With male and female connectors 

| Part # | Mfg #  | Size        | Price |
|--------|--------|-------------|-------|
| 005072 | 50EM2  | 3/8" x 50'  |       |
| 027735 | 100EM5 | 3/4" x 100' |       |

### Replacement Cables



Basin Plug Head

| Part # | Mfg # | Description                     | Price |
|--------|-------|---------------------------------|-------|
| 020328 | 25HE1 | 1/4" x 25' w/El Basin Plug Head |       |
| 005073 | 50HE1 | 1/4" x 50' w/El Basin Plug Head |       |

### Cutters

#### Cutters for 3/8" Cable

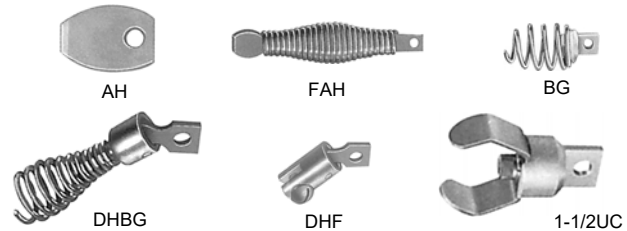

| Part # | Mfg #   | Description             | Price |
|--------|---------|-------------------------|-------|
| 005048 | AH      | Arrow Head              |       |
| 018911 | FAH     | Flex Arrow Head         |       |
| 005049 | BG      | Boring Gimlet           |       |
| 005051 | DHBG    | Down Head Boring Gimlet |       |
| 005052 | DHF     | Down Head Fitting       |       |
| 005065 | 1-1/2UC | 1-1/2" U-Cutter         |       |

#### Cutters for 5/8" & 3/4" Cable

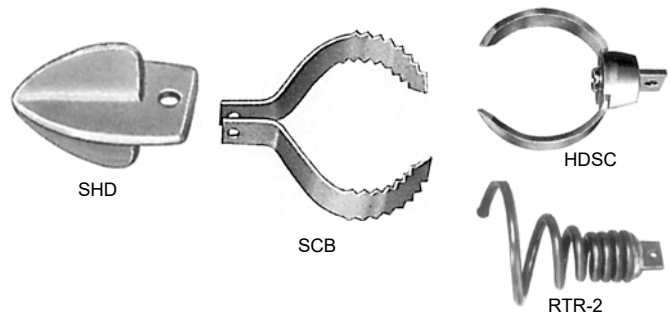

| Part # | Mfg # | Description                 | Price |
|--------|-------|-----------------------------|-------|
| 019877 | SHD   | Spear Head Starting Drill   |       |
| 005069 | 3SCB  | 3" Side Cutter Blade - 2-Pc |       |
| 005071 | 4SCB  | 4" Side Cutter Blade - 2-Pc |       |
| 017789 | 3HDSC | 3" Heavy-Duty Side Cutter   |       |
| 019876 | RTR-2 | Corkscrew Retrieving Tool   |       |

### Connectors

#### Basic Connector

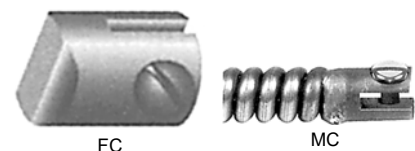

| Part # | Mfg #   | Description                    | Price |
|--------|---------|--------------------------------|-------|
| 019868 | 5/8FC   | 5/8" Female, Butt Weld         |       |
| 019870 | 3/4FC   | 3/4" Female, Butt Weld         |       |
| 005070 | 3/8E-FC | 3/8" Female, For 3/8" EM Cable |       |
| 019865 | 3/8MC   | 3/8" Male                      |       |



## Power Sewer Machines

Tools

### Connectors (Continued)

#### Basic Connector

| Part # | Mfg # | Description          | Price |
|--------|-------|----------------------|-------|
| 019867 | 1/2MC | 1/2" Male            |       |
| 019869 | 5/8MC | 5/8" Male, Butt Weld |       |
| 019975 | 3/4MC | 3/4" Male, Butt Weld |       |

#### Quick Fix Connector



| Part # | Mfg # | Description    | Price |
|--------|-------|----------------|-------|
| 019860 | 1/2QF | 1/2" Quick Fix |       |
| 019862 | 5/8QF | 5/8" Quick Fix |       |
| 017788 | 3/4QF | 3/4" Quick Fix |       |

#### Connector Screw

| Part # | Mfg # | Description                 | Price |
|--------|-------|-----------------------------|-------|
| 019864 | 5/8CS | 5/8", 5-Pack, For Butt Weld |       |
| 005050 | 3/4CS | 3/4", 5-Pack, For Butt Weld |       |

### D-25 Handy™ Drain Cleaner Heads

#### D-25 Handy™ Drain Cleaner Head - Down Head (DH)

- Flexicore™ cable units
- Can be attached to a drill



| Part # | Mfg #  | Description | Price |
|--------|--------|-------------|-------|
| 095198 | D-25-2 | 1/4" x 25'  |       |

### Flexicore® Wire Rope Center Drain Augers

#### Regular Head less Handle

- Includes rotary handle
- Hand wire only



| Part # | Mfg #   | Description | Price |
|--------|---------|-------------|-------|
| 043667 | L-25FL1 | 1/4" x 25'  |       |

#### Down Head less Handle

- Includes rotary handle
- Hand wire only



| Part # | Mfg #      | Description | Price |
|--------|------------|-------------|-------|
| 097172 | L-25FL1-DH | 1/4" x 25'  |       |

#### Flat Sewer Rods

- Oil tempered - rust ban coated
- Quick-Grip handle
- Roller head



#### Flat Sewer Rod for 4" - 6" Pipe

| Part # | Mfg # | Size        | Lgth | Price |
|--------|-------|-------------|------|-------|
| 032705 | 100D  | 3/4" x 1/8" | 100' |       |



## Refrigeration Tools

### Service Tools

| Part # | Mfg # | Description               | Price |
|--------|-------|---------------------------|-------|
| 181298 | 18978 | Schrader Rethreading Tool |       |
| 181299 | 18979 | Broken Schrader Remover   |       |

#### 4-In-1 Seal Kit

- Kit includes:
  - Core
  - Cap
  - Gasket
  - 4 "O"-Rings



| Part # | Mfg # | Size | Price |
|--------|-------|------|-------|
| 181296 | 18974 | 1/4" |       |

#### 4-In-1 Vacuum/Charge Ball Valve Tool

- 800 psi working pressure



| Part # | Mfg # | Size  | Side Port | Price |
|--------|-------|-------|-----------|-------|
| 181295 | 18971 | 1/4"  | No        |       |
| 181298 | 18978 | 1/4"  | Yes       |       |
| 181300 | 18985 | 5/16" | No        |       |

#### Gas Retention Valve

- 1/4" Female fl. x 1/4" Male fl.
- 500 psi working pressure
- Back seat valve feature to retain gas in hose when disconnecting
- Closes Schrader before disconnecting



| Part # | Mfg # | Size | Price |
|--------|-------|------|-------|
| 181302 | 18993 | 1/4" |       |

### Hoses

#### FlexFlow™ Low Loss Adapter Hoses

- 8" Bend radius
- 4,000 psi minimum burst
- 800 psi maximum working pressure
- Operating temperature -20° to 180°F
- 3-Pak includes a yellow, blue, & red hose



#### Compact Ball Valve Assemblies

| Part # | Mfg # | Size | Length | Color | Price |
|--------|-------|------|--------|-------|-------|
| 181631 | 29201 | 1/4" | 9"     | Blue  |       |
| 181633 | 29601 | 1/4" | 9"     | Red   |       |
| 181646 | 29980 | 1/4" | 9"     | 3 Pak |       |

### FlexFlow™ Assemblies

| Part # | Mfg # | Size | Length | Color  | Price |
|--------|-------|------|--------|--------|-------|
| 181564 | 25002 | 1/4" | 9"     | Yellow |       |
| 181565 | 25202 | 1/4" | 9"     | Blue   |       |
| 181566 | 25602 | 1/4" | 9"     | Red    |       |
| 181620 | 25980 | 1/4" | 9"     | 3 Pak  |       |

#### Large VolumePlus II™ Hose (3/8" Fl. Str. x 3/8" Fl. Str.)

- 3,000 psi burst
- 600 psi working pressure
- For vacuum and charging



| Part # | Mfg # | Size | Length | Price |
|--------|-------|------|--------|-------|
| 181289 | 14560 | 3/8" | 60"    |       |

#### Plus II™ Heavy Duty Charging/Vacuum Hose

- 8" Bend radius
- 3,000 psi minimum burst
- 600 psi maximum working pressure
- Operating temperature -22° to 176°F



| Part # | Mfg # | Size | Length | End Type         | Price |
|--------|-------|------|--------|------------------|-------|
| 181291 | 15648 | 3/8" | 48"    | 3/8"StrX3/8"Str  |       |
| 237904 | 15660 | 3/8" | 60"    | 3/8"StrX3/8"Str  |       |
| 236454 | 16236 | 3/8" | 36"    | 3/8"StrX1/4" 45° |       |
| 181540 | 19660 | 3/8" | 60"    | 3/8"StrX3/8" 45° |       |
| 246789 | 16248 | 3/8" | 48"    | 3/8"StrX1/4" 45° |       |

#### Plus II™ Heavy Duty Charging/Vacuum Hose

- 10" Bend radius
- 3,000 psi minimum burst
- 600 psi maximum working pressure
- Operating temperature -22° to 176°F



| Part # | Mfg # | Size | Length | End Type         | Price |
|--------|-------|------|--------|------------------|-------|
| 247829 | 16448 | 1/4" | 48"    | 1/4"Angle x 1/2" |       |
| 181292 | 15848 | 1/2" | 48"    | 1/2" x 1/2"      |       |
| 181543 | 20660 | 3/8" | 60"    | 3/8" x 3/8"      |       |

#### Plus II™ "B" Charging Hose

- 6" Bending radius
- 3,000 psi minimum burst
- 600 psi maximum working pressure
- Operating temperature -20° to 180°F



| Part # | Mfg # | Color  | Length | End Type            | Price |
|--------|-------|--------|--------|---------------------|-------|
| 181293 | 18160 | Yellow | 60"    | 3/8Str x 3/8 45°    |       |
| 181542 | 20460 | Yellow | 60"    | 1/4Str x 1/4 45°    |       |
| 181630 | 28060 | Red    | 60"    | (3/8) Str FlxStr Fl |       |

## Refrigeration Tools

Tools

### Plus II™ Hose with Compact Ball Valve End

- Full flow valve
- 6" Bending radius
- 4,000 psi minimum burst
- 800 psi maximum working pressure
- Operating temperature -20° to 180°F
- Uses standard gasket and valve opener
- 3-Pak includes a yellow, blue, and red hose



| Part # | Mfg # | Size | Length | Color | Price |
|--------|-------|------|--------|-------|-------|
| 181647 | 29985 | 1/4" | 60"    | 3 Pak |       |

### Plus II™ Charge Hose w/ Double Barrier Protection

- 6" Bending radius
- 4,000 psi minimum burst
- 800 psi maximum working pressure
- Operating temperature -20° to 180°F
- 3-Pak includes a yellow, blue, and red hose



| Part # | Mfg # | Size | Length | Color  | Price |
|--------|-------|------|--------|--------|-------|
| 181545 | 21024 | 1/4" | 24"    | Yellow |       |
| 181376 | 21060 | 1/4" | 60"    | Yellow |       |
| 181377 | 21260 | 1/4" | 60"    | Blue   |       |
| 181546 | 21312 | 1/4" | 12'    | Blue   |       |
| 181547 | 21636 | 1/4" | 36"    | Red    |       |
| 181378 | 21660 | 1/4" | 60"    | Red    |       |
| 181548 | 21712 | 1/4" | 12'    | Red    |       |
| 181550 | 21985 | 1/4" | 60"    | 3 Pak  |       |

### Plus II™ Hose with FlexFlow™ Valve

- 6" Bending radius
- 4,000 psi minimum burst
- 800 psi maximum working pressure
- Operating temperature -20° to 180°F
- Valve handle position shows when valve is opened or closed
- 3-Pak includes a yellow, blue, and red hose



| Part # | Mfg # | Size | Length | Color  | Price |
|--------|-------|------|--------|--------|-------|
| 181606 | 25060 | 1/4" | 60"    | Yellow |       |
| 181609 | 25260 | 1/4" | 60"    | Blue   |       |
| 181610 | 25660 | 1/4" | 60"    | Red    |       |
| 181623 | 25983 | 1/4" | 36"    | 3 Pak  |       |
| 181625 | 25984 | 1/4" | 48"    | 3 Pak  |       |
| 181627 | 25986 | 1/4" | 72"    | 3 Pak  |       |

### Plus II™ Hose with SealRight™ Fitting

- 45° End
- 6" Bending radius
- 4,000 psi minimum burst
- 800 psi maximum working pressure
- Operating temperature -20° to 180°F
- Low loss anti-blow back SealRight™ fitting
- Gaskets resist deterioration from existing CFC, HCFC and HFC refrigerants and oils
- Available with SealRight™ fittings on both ends
- 3-Pak includes a yellow, blue, and red hose



| Part # | Mfg # | Size | Length | Color  | Price |
|--------|-------|------|--------|--------|-------|
| 181556 | 22060 | 1/4" | 60"    | Yellow |       |
| 181558 | 22236 | 1/4" | 36"    | Blue   |       |
| 181559 | 22260 | 1/4" | 60"    | Blue   |       |
| 181560 | 22660 | 1/4" | 60"    | Red    |       |
| 181561 | 22983 | 1/4" | 36"    | 3 Pak  |       |
| 181340 | 22985 | 1/4" | 60"    | 3 Pak  |       |
| 181562 | 22986 | 1/4" | 72"    | 3 Pak  |       |

### Plus II™ Hose for Flare & Service Ports

- For 5/16" flare (1/2 – 20 thread) service ports for R-410A
- 6" Bending radius
- 4,000 psi minimum burst
- 800 psi maximum working pressure
- Operating temperature -20° to 180°F
- Compatible with both POE and PVE oils
- 3-Pak includes a yellow, blue, and red hose
- Yellow hose has 1/4" (7/16-20) compact ball valve



| Part # | Mfg # | Size | Length | Color | Price |
|--------|-------|------|--------|-------|-------|
| 181644 | 29485 | 1/4" | 60"    | 3 Pak |       |

## Quick Connects

| Part # | Mfg # | Description  | Price |
|--------|-------|--|-------|
| 181307 | 19010 | CH20 & CH14 for 1/4" Hose  |       |
| 181310 | 19011 | CH11 Gasket for 3/8" Hose  |       |
| 181313 | 19020 | CH20 for 1/4-1/2" Acme Hose  |       |
| 181314 | 19026 | 3/8" Quad Ring Pack (10Pk)   |       |
| 181315 | 19037 | 1/4" SealRight O-Ring (10PK)   |       |
| 181316 | 19040 | SealRight Repair Kit with Valve, Gasket, Plug, Spring, and 2 O-Rings |       |

## SealRight™ Quick Couplers

| Part # | Mfg # | Description                    | Price |
|--------|-------|--------------------------------|-------|
| 181317 | 19100 | Quick Cplg Set 19109&19209     |       |
| 249860 | 19203 | 90° 3/8"FM QC x 3/8" M Flr     |       |
| 181515 | 19208 | 45° 1/4"SealRight x 1/4" M Flr |       |
| 181516 | 19209 | 90° 1/4"SealRight x 1/4" M Flr |       |

## Refrigeration Tools

### Cylinder Valve Adapter

- Finger tight adapters fit 125 and 145 lb cylinders
- Seal remains seated



| Part # | Mfg # | Description                | Price |
|--------|-------|----------------------------|-------|
| 181320 | 19105 | 3/4" NPS x 1/4" Male Flare |       |

### Compact Ball Valve

- 4,000 psi minimum burst
- 800 psi maximum working pressure
- 5/16" for R-410A applications where 5/16" system ports are used



| Part # | Mfg # | Description                    | Price |
|--------|-------|--------------------------------|-------|
| 182367 | 93825 | 5/16" for Fml Flr x 1/4" M Flr |       |
| 182369 | 93843 | 1/4" 45° Compact Ball Valve    |       |

### Vacuum Pump Adapter

- Convert a 3/8" or 1/2" vacuum pump intake into 1/4" and 1/2" Acme R-134a compatible fittings



| Part # | Mfg # | Adapter | Flare | Ftgs | Price |
|--------|-------|---------|-------|------|-------|
| 181648 | 36019 | 3/8"    | 1/4"  | 1/2" |       |

### Auto A/C Fittings Couplers



| Part # | Mfg # | Description                                    | Price |
|--------|-------|--|-------|
| 181319 | 19102 | R-134a 1/4"Fml QCx3/8"M Fl                     |       |
| 181321 | 19109 | R-12 (1/4") SealRight x M Flr                  |       |
| 181512 | 19191 | R-12 1/4" fe QC x 90° 1/4" M Flr with Schrader |       |

### Quick Coupler with Schrader Core in Male End



| Part # | Mfg # | Description                  | Price |
|--------|-------|------------------------------|-------|
| 181380 | 19173 | 5/16" QC Fml x 1/4" Male Flr |       |

## Manifold Gauge Sets

### Manifold Parts & Accessories

| Part # | Mfg # | Description           | Price |
|--------|-------|-----------------------|-------|
| 181726 | 40279 | Manifold Hanging Hook |       |

## Manifold Gauge Sets (Continued)

### Manifold Parts & Accessories

| Part # | Mfg # | Description   | Price |
|--------|-------|---|-------|
| 236521 | 41082 | Titan 4-Valve Rebuild Kit   |       |
| 181364 | 42001 | Series 41 Manifold Only R22/404A/410A                               |       |
| 181809 | 42004 | Series 41 Manifold R22/404A/410A with 60" PLUS II Standard Fittings |       |

### Brute II™ Test and Charging Manifold

- 1/4" Hi-/lo-sides with 3/8" vacuum port
- Manifold and hose holder fittings: 1/4"-3/8"-1/4"-1/4"
- Front access for easy field recalibration
- Double "O" ring piston
- Contoured color-coded easy-grip handles



| Part # | Mfg # | Description                | Price |
|--------|-------|----------------------------|-------|
| 181835 | 46003 | Test and Charging Manifold |       |

### P51 Series Titan™ Digital Manifold

- Auto shut-off
- USB charging port
- Robust housing
- On board data logging
- 4-way TITAN valve block
- Includes:
  - Vacuum sensor
  - 2 temperature clamps
  - Backpack carrying case
  - Set of four manifold hoses (3 1/4" RYB and 1 3/8" yellow vacuum hose)
- Backlit display with auto-dimming
- Pressure hold mode displays rate of change for both vacuum and positive pressure measurements
- 126 refrigerant profiles stored in the instrument including new blends not currently on the Refprop database
- Maximum working pressure 700 psi
- System superheat and subcooling calculations
- Bluetooth capability for use with ManTooth app
- Re-chargeable battery with battery life indicator
- Displays vapor and liquid saturation temperatures



| Part # | Mfg #   | Description            | Price |
|--------|---------|------------------------|-------|
| 246160 | P51-870 | Titan Digital Manifold |       |

## Vacuum Gauges

| Part # | Mfg # | Description                                   | Price |
|--------|-------|---|-------|
| 182267 | 69071 | Gauge Coupler, 1/4" Fml Fl                    |       |
| 182268 | 69073 | Replacement Sensor for Models 69070 and 69075 |       |

## Refrigeration Tools

### Vacuum Gauges (Continued)

| Part # | Mfg # | Description           | Price |
|--------|-------|-----------------------|-------|
| 182286 | 69095 | Tee Fitting for 69080 |       |

#### Digital LCD Economy Vacuum Gauge

- Low battery indicator
- Simple On/Off controls
- Calibration standards traceable to NIST
- Sensor handles 450 psi positive pressure
- Automatic battery saver shuts gauge off after 20 minutes with no reading changes
- Includes 9V alkaline battery and hanging hook
- Thermal conductivity sensor automatically compensates for temperature with no calibration



| Part # | Mfg # | Description                     | Price |
|--------|-------|---------------------------------|-------|
| 182282 | 69080 | Battery, Hook, & Pouch Included |       |

#### Hand-Held Digital Vacuum Gauge

- 12" coiled sensor cord
- Low battery indicator
- Accuracy: +/- 20% of reading
- Automatic shut-off after 20 minutes
- Plug-in sensor (part #69087) handles 450 psi positive pressure
- Calibration standards traceable to NIST
- 32° to 122°F operating temperature range
- Magnetized on back for secure, upright positioning on any magnetized surface
- Displays 7 different units of vacuum (microns, milliTorr, Torr, millimeters of mercury, millibar, kiloPascal and Pascal)
- Thermal conductivity sensor automatically compensates for temperature



| Part # | Mfg # | Description                | Price |
|--------|-------|----------------------------|-------|
| 181363 | 69086 | Hand-Held with Carry Pouch |       |

### Omni™ Digital Vacuum Gauge

- 450 psi proof pressure
- (2) AAA batteries included
- 45° degree bend for fitting
- Audio and visual signal when target vacuum level is reached
- Automatic power down and time out
- Low battery indicator and automatic power-down when inactive
- 32°F to 104°F Working temperature
- Electronic paper display for clear visibility
- Power savings – multiple time-out selections
- Adapter fittings available



| Part # | Mfg # | Description       | Price |
|--------|-------|-------------------|-------|
| 231050 | 69020 | With 1/4" Coupler |       |

### Superevac™ LCD Vacuum Gauge

- 3 Second response time
- Automatic calibration
- D cell battery power
- Accuracy: ± 20% of reading
- 5-1/2' Coiled sensor cable —1/4" male flare connection
- Calibration standards traceable to NIST
- Case protects electronic circuitry and sensor
- 32° to 120°F Operating temperature range
- Automatic shut-off 20 minutes after power up
- Normal handling/jarring will not affect the LCD reading



| Part # | Mfg # | Description                 | Price |
|--------|-------|-----------------------------|-------|
| 182269 | 69075 | Full Range Complete in Case |       |

### Vacuum Pumps & Oil

| Part # | Mfg # | Description                                   | Price |
|--------|-------|---|-------|
| 181303 | 18997 | Grappler Rod/Nut Assy for Vacuum/Charge Valve |       |
| 182337 | 93047 | Bullet Drive Coupling with Spider             |       |
| 182338 | 93050 | Coupling Spider for 93047                     |       |

## Refrigeration Tools

### Bullet™ Vacuum Pump

- 28 oz.(7cfm) or 30 oz.(5cfm) oil capacity
- 16.25" L x 6" W x 11.5" H
- 1/4" x 3/8" x 3/8" Intake
- Heavy duty rotors and bearings
- Heavy duty steel handle
- Power cord: 6' motor mounted switch
- Tethered port caps stay with the pump
- Metal with rubber overlay base for stability
- Large oil sight glass for easy monitoring of oil level
- Large brass oil drain for easy access to oil changes
- Intake filter screen keeps damaging particles from entering the pump
- Internal intake check valve prevents oil backup into the system during a power failure
- Wide-mouth oil reservoir port which doubles as pump exhaust-threaded to attach garden hose



| Part # | Mfg # | CFM | Volts | HZ | Phase | Price |
|--------|-------|-----|-------|----|-------|-------|
| 224708 | 93605 | 5   | 115   | 60 | 1     |       |
| 182366 | 93600 | 7   | 115   | 60 | 2     |       |

### Bullet™ Vacuum Pump Cover Assembly

| Part # | Mfg # | Description         | Price |
|--------|-------|---------------------|-------|
| 246632 | 93650 | Pump Cover Assembly |       |

### Supervac™ CFM Pump

- 34 oz. oil capacity
- 16.25" L x 6" W x 11.5" H
- 1/4" and 3/8" Male flare intake
- Built-in vacuum indicator gauge
- Heavy duty rotors and bearings
- Heavy duty steel handle with lift hook
- Tethered port caps stay with the pump
- Metal with rubber overlay base for stability
- Gas ballast valve keeps oil cleaner and longer
- Large oil sight glass for easy monitoring of oil level
- Large brass oil drain for easy access to oil changes
- Intake filter screen keeps damaging particles from entering the pump
- Internal intake check valve prevents oil backup into the system during a power failure
- Wide-mouth oil reservoir port which doubles as pump exhaust-threaded to attach garden hose



| Part # | Mfg # | CFM | Volts | HZ | Phase | Price |
|--------|-------|-----|-------|----|-------|-------|
| 181344 | 96560 | 6   | 115   | 60 | 1     |       |

### Vacuum Pump Oil

- Recommend using the current mineral-based pump oil when working with both R-12 and R-134a A/C systems



| Part # | Mfg # | Size   | Qty Per Case | Price |
|--------|-------|--------|--------------|-------|
| 181362 | 93092 | Quart  | 12           |       |
| 193501 | 93096 | Gallon | 6            |       |

### Miscellaneous Tools

| Part # | Mfg # | Description          | Price |
|--------|-------|----------------------|-------|
| 181538 | 19302 | CH14 Openers, 10 Pak |       |

### Deluxe Ratchet Hand Bender Kit

- Reverse bending mandrel
- Index marks to locate bends
- Trouble free ratchet mechanism
- Quick change bending mandrels and shoes
- Hard copper must be annealed before bending
- Complete tube bender kit includes all items required to bend 1/4", 5/16", 3/8", 1/2", 5/8", 3/4" and 7/8" tubing



| Part # | Mfg # | Description             | Price |
|--------|-------|-------------------------|-------|
| 214566 | 60325 | Ratchet Hand Bender Kit |       |

### Digital Electronic Charging Scale

- Mechanical overload protection and "OL" alert on LCD
- Minus (-) reading shows weight removed from the platform
- Single point load cell strain gauge
- Removable control module on retractable 5' coiled cord
- Calibration standards traceable to NIST
- Convert standard 68802 and 68800 scales to programmable with upgrade kits 68804 and 68805



| Part # | Mfg # | Description               | Price |
|--------|-------|---------------------------|-------|
| 182255 | 68802 | Electronic Scale 110 lbs. |       |

## Refrigeration Tools

Tools

### Mini-Split Tool Kit

- Includes R-410A service tools and:
  - Heat pump manifold  
—Designed to handle all mini-split refrigerants & pressures
  - 60" PLUS II Hoses  
—4,000 psi minimum burst  
—800 psi Max working pressure  
—RYB 1/4" with 1/4" flare fittings
  - Eccentric cone flare tool  
—For 3/16" to 3/4" O.D. tubing
  - Hex key set  
—5/32", 3/16", 5mm and 6mm
  - Vacuum/charge valve with side port  
—5/16" x 1/4" x 1/4" (18986)
  - Adjustable metric torque wrench  
—16, 17, 21, 22, 24, 26, 27, & 29 mm flare nuts
  - 45° R-410A coupler 5/16" fml quick coupler x 1/4" m flr
  - Tube cutter and deburring tool
  - 16" Tool bag  
—Nylon, strap included, 25 pockets



| Part # | Mfg # | Description                       | Price |
|--------|-------|-----------------------------------|-------|
| 182248 | 60991 | R-22/407C/410A Heat Pump Manifold |       |

### Repair Parts Kit

- Five 1/8" gaskets
- Five 1/8" valve openers
- One hundred 3/16"-1/4" gaskets
- Ten 1/4" Adjust-a-Valve openers
- Ten 1/4" flat valve openers
- Ten 3/8" gaskets
- Ten 1/2"-5/8" gaskets
- Ten cylinder valve flat gaskets
- Ten SealRight™ "O" rings
- Four SealRight™ plug and seal assemblies
- Four 1/4" SealRight™ nut and clip



| Part # | Mfg # | Description  | Price |
|--------|-------|--------------|-------|
| 181305 | 19003 | Complete Kit |       |

### Recovery Machine Components and Parts

| Part # | Mfg # | Description                                  | Price |
|--------|-------|--|-------|
| 188504 | 67002 | ManTooth PT Dual with Rubber Boot (tethered) |       |
| 226828 | 67020 | ManTooth V (Vacuum-only) w/ Side Grip        |       |
| 226830 | 67023 | ManTooth PTV Dual w/ Side Grip               |       |
| 182379 | 95231 | Piston Cup                                   |       |
| 182380 | 95325 | High Pressure Switch                         |       |
| 238680 | 95338 | Low Pressure Switch                          |       |
| 238681 | 95451 | High Pressure Gauge                          |       |

### Recovery Machine Components and Parts (Continued)

| Part # | Mfg # | Description                        | Price |
|--------|-------|------------------------------------|-------|
| 213654 | 95730 | YJ-LTE Refrigerant Recovery System |       |
| 181361 | 95760 | RecoverXLT 115V/60 Hz              |       |

## Sheet Metal Tools

### Snips for Metal and Vinyl

#### Max2000™ Aviation Snips

- An adjustable crossover disk assures an optimal length of cut that remains smooth and accurate
- Machined serrations on outside face of cutting edge
- Thicker, stronger steel handle resists abuse and will not collapse under normal use
- Length: 10-3/4"



M2001



M2002



M2003

| Part # | Mfg # | Description                        | Price |
|--------|-------|------------------------------------|-------|
| 032962 | M2001 | Cuts Left, Red Ergonomic Grip      |       |
| 032963 | M2002 | Cuts Right, Green Ergonomic Grip   |       |
| 032964 | M2003 | Combination, Yellow Ergonomic Grip |       |

#### Max2000™ Bulldog Aviation Snips

- Designed for notching and trimming
- Ideal for cutting multiple layers or "S" cleats



| Part # | Mfg # | Description        | Price |
|--------|-------|--------------------|-------|
| 032965 | M2005 | Red Ergonomic Grip |       |

#### Max2000™ Offset Aviation Snips

- Cuts straight line and 5" diameter circles



M2006



M2007

| Part # | Mfg # | Description                             | Price |
|--------|-------|---|-------|
| 036461 | M2006 | Cuts Offset Left, Red Ergonomic Grip    |       |
| 036462 | M2007 | Cuts Offset Right, Green Ergonomic Grip |       |

#### Andy™ Classic Snips

- Suitable for mild curve cuts, straight shearing, or cutting multiple layers of sheet metal
- Lightweight aluminum handle
- 3" Cutting length



| Part # | Mfg # | Description | Price |
|--------|-------|-------------|-------|
| 006451 | M12A  | 12" Length  |       |

#### Andy™ Pattern Snips

- Ground blade edge
- Suitable for mild curve cuts, straight shearing, or cutting multiple layers of sheet metal
- Lightweight aluminum handle
- Larger handle loops
- Extended blade tips
- 3-1/4" Cutting length



| Part # | Mfg # | Description | Price |
|--------|-------|-------------|-------|
| 057978 | M14N  | 14" Length  |       |

## Sheet Metal Tools

Tools

### Awls

#### Scratch Awl

- High carbon alloy tool steel blade polished to resist rust
- May be re sharpened many times
- Easy-to-spot orange handles are shock and shatter resistant

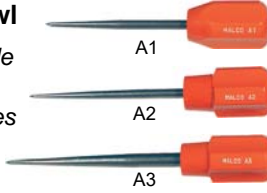

| Part # | Mfg # | Blade Dia | Nom Length | Price |
|--------|-------|-----------|------------|-------|
| 006370 | A1    | 7/32"     | 5-3/4"     |       |
| 006371 | A2    | 1/4"      | 6-1/4"     |       |
| 006373 | A3    | 3/8"      | 7-1/2"     |       |

### Scribers

#### Pocket Size Sheet Metal Scriber

- Five teeth produce 10 scribing depths
- Compact scribe stores in pocket, pouch or tool box
- Use hang hole or magnet to keep handy on the job



| Part # | Mfg # | Min/Max Adjustments | Price |
|--------|-------|---------------------|-------|
| 038068 | A40   | 1/8" - 1" Depths    |       |

#### Adjustable Sheet Metal Scriber

- Measure, mark and scribe in one easy operation
- Depth up to 12-1/2"
- Compact design
- Durable construction
- Constructed of rust resistant nickel plated steel
- Knob assembly with hardened steel bolt insert will not strip out
- Uses Zip-In® sheet metal screw making point replacement easy



| Part # | Mfg # | Min/Max Adjustments   | Price |
|--------|-------|-----------------------|-------|
| 006376 | A60   | 1/4" - 12-1/2" Depths |       |

### Dividers

- Length: 11"
- Scratch awl points are easily re sharpened or replaced
- Nickel-plated steel body



| Part # | Mfg # | Description             | Price |
|--------|-------|-------------------------|-------|
| 006515 | #18   | 32" Max Circle Diameter |       |
| 006522 | #24   | 42" Max Circle Diameter |       |

### Dividers (Continued)

| Part # | Mfg # | Description                    | Price |
|--------|-------|--------------------------------|-------|
| 021655 | RP2   | Divider Points for #18 and #27 |       |

### Folding Tools

- Folding seams are formed from two steel halves, permanently joined together



| Part # | Mfg # | Width | Folding Depths | Price |
|--------|-------|-------|----------------|-------|
| 006512 | 12F   | 12"   | 3/8" and 1"    |       |
| 006516 | 18F   | 18"   | 3/8" and 1"    |       |

### Duct Tools and Accessories

#### Duct Stretcher

- Wheels can be changed to other side of tool for applications where side of duct is close to wall or obstruction



| Part # | Mfg # | Description       | Price |
|--------|-------|-------------------|-------|
| 006386 | DS1   | 16"               |       |
| 006388 | DS2   | 16" Offset Handle |       |
| 025654 | DS3   | 12" Locking       |       |

### TurboShear™ Drills

#### TurboShear™

- Attaches to the chuck of a 1200 rpm, 12V cordless or an A/C electric drill
- Makes fast cuts in sheet metal
- Capable of making precise 6" x 6" square hole cuts
- 20 Gauge capacity in spiral duct
- 18 Gauge capacity in galvanized steel
- Material must be pre-set or held by an assistant
- Shear cuts to the left
- Use TSDC drill clamp for 1-hand operation



| Part # | Mfg # | Description                    | Price |
|--------|-------|--------------------------------|-------|
| 067222 | TS1   | TurboShear™ Sheet Metal Cutter |       |



## Sheet Metal Tools

### Hole Cutters

#### "Gold Standard" Hole Cutter

- Cuts holes up to 12" diameter in 20 gauge sheet metal
- Use with any standard 1/4" electric drill
- Cast aluminum body
- All wearing parts made of special heat-treated steel



| Part # | Mfg # | Hole Diameter | Price |
|--------|-------|---------------|-------|
| 006408 | HC1   | 2" - 12"      |       |

### REDLINE™ Hand Tools

#### 5-Blade Pipe Crimper

- One-hand operation latch
- Soft-touch, non-slip handle insert
- Ergonomically contoured handles



| Part # | Mfg # | Throat Depth | Price |
|--------|-------|--------------|-------|
| 131064 | C5R   | 1-5/8"       |       |

#### Hand Notcher

- One-hand operation latch
- Soft-touch, non-slip handle insert
- Ergonomically contoured handles
- Opening maximizes handle leverage



| Part # | Mfg # | Throat Depth | Price |
|--------|-------|--------------|-------|
| 132797 | N1R   | 13/16"       |       |
| 132798 | N2R   | 1"           |       |

### Hand Seamer with Forged Steel Jaw

- One-hand operation latch
- Soft-touch, non-slip handle insert
- Ergonomically contoured handles
- Opening maximizes handle leverage

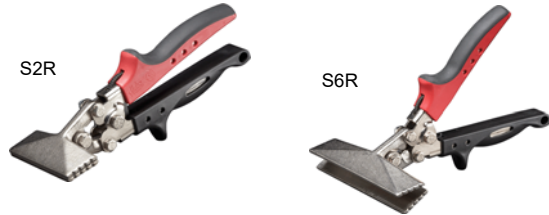

| Part # | Mfg # | Jaw Depth | Jaw Width | Price |
|--------|-------|-----------|-----------|-------|
| 132799 | S2R   | 1-1/4"    | 3-1/4"    |       |
| 132801 | S6R   | 1-1/4"    | 6"        |       |

### Offset Hand Seamer with Forged Steel Jaw

- One-hand operation latch
- Soft-touch, non-slip handle insert
- Ergonomically contoured handles
- Opening maximizes handle leverage



| Part # | Mfg # | Jaw Depth | Jaw Width | Price |
|--------|-------|-----------|-----------|-------|
| 132800 | S3R   | 1-1/4"    | 3-1/4"    |       |

### Snap Lock Punch for Siding

- One-hand operation
- Ergonomic handles
- Opening maximizes handle leverage



| Part # | Mfg # | Length | Throat Depth | Price |
|--------|-------|--------|--------------|-------|
| 006483 | SL1R  | 8"     | 3/8"         |       |

## Sheet Metal Tools

Tools

### Crimpers

#### Single Crimper with Red Grip

- Fast, easy to use and lightweight
- Handy lock makes tool pocket sized
- Length: 8"



| Part # | Mfg # | Throat Depth | Price |
|--------|-------|--------------|-------|
| 020268 | SC1   | 1-1/4"       |       |

### Riveting Tools

#### 2-in-1 Hand Riveter

- Adjustment features a single long stroke and a short ratchet action



| Part # | Mfg #  | Capacity  | Price |
|--------|--------|---|-------|
| 006518 | 2-IN-1 | 1/8"-3/16" Rivet w/Steel Mandrel,<br>3/32- 5/32" Rivet w/SS Mandrel<br>8"Long |       |

### Fiberglass Flex Duct Tools

#### Tensioning Tool

- Hardened steel stampings with weather resistant nickel chrome finish
- Vinyl grips with hand stops
- Tensioning adjustment knob and auto cut-off mechanism



| Part # | Mfg # | Description                          | Price |
|--------|-------|--------------------------------------|-------|
| 006499 | TY6   | High Leverage Tie Tool, Auto Cut-Off |       |

#### Tie Tool

- Action tie tools feature long wearing, serviceable parts
- Comfortable handles reduce the pinch point area
- Works on all ties including thin designs



| Part # | Mfg # | Description    | Price |
|--------|-------|----------------|-------|
| 006498 | TY4   | Manual Cut-Off |       |

### Flex Duct Cutter and Shear

- Double edged knife blade
- Thumb operated latch
- Easily resharpenable
- Handles feature non-slip vinyl grips



| Part # | Mfg # | Description      | Price |
|--------|-------|------------------|-------|
| 006389 | FDC1  | Flex Duct Cutter |       |

## Sheet Metal Tools

### Snips

#### Long Straight Cutting Snips

- 3" Long forged alloy steel blades
- One handed locking
- Flush bolt design
- Rust protection
- Serrated Jaws
- Ergonomic handles
- Ruler markings on blade



| Part # | Mfg #      | Description           | Price |
|--------|------------|-----------------------|-------|
| 219080 | 48-22-4037 | 3" Alloy Steel Blades |       |

#### Aviation Snips

- One handed locking
- Thumb lock
- Flush bolt design
- Forged alloy steel blades
- Rust protection
- Serrated jaws
- Ergonomic handles
- Up to 22-gauge stainless & 18-gauge cold rolled steel



| Part # | Mfg #      | Cut        | Price |
|--------|------------|------------|-------|
| 150224 | 48-22-4020 | Left Angle |       |
| 150220 | 48-22-4030 | Straight   |       |

#### Aviation Snips

- One handed metal lock
- Ergonomic grips
- Flush pivot design
- Forged serrated blades bolt lock
- Up to 22-gauge stainless & 18-gauge cold rolled steel



| Part # | Mfg #      | Cut               | Price |
|--------|------------|-------------------|-------|
| 238535 | 48-22-4510 | Left              |       |
| 150222 | 48-22-4010 | Left              |       |
| 238536 | 48-22-4520 | Right             |       |
| 238537 | 48-22-4530 | Straight          |       |
| 238543 | 48-22-4537 | Long Cut Straight |       |

### Offset Snips

- One handed metal lock
- Ergonomic grips
- Lanyard hole
- Flush pivot design
- Forged serrated blades bolt lock
- Up to 22-gauge stainless & 18-gauge cold rolled steel

| Part # | Mfg #      | Cut               | Price |
|--------|------------|-------------------|-------|
| 238538 | 48-22-4512 | Left              |       |
| 238540 | 48-22-4522 | Right             |       |
| 163182 | 48-22-4022 | Right             |       |
| 238542 | 48-22-4532 | Straight Offset   |       |
| 238544 | 48-22-4538 | Long Cut Straight |       |
| 163183 | 48-22-4032 | Straight Offset   |       |
| 219079 | 48-22-4038 | Long Offset Left  |       |

**Snip set Includes**  
**Left cut (48-22-4512)**  
**Right Cut (48-22-4522)**

| Part # | Mfg #      | Description   | Price |
|--------|------------|---------------|-------|
| 238548 | 48-22-4523 | 2-Pc Snip Set |       |

### Bulldog Snips



| Part # | Mfg #      | Cut          | Price |
|--------|------------|--------------|-------|
| 163647 | 48-22-4000 | Straight Cut |       |

### Bulldog Aviation Snips

- One handed metal lock
- Ergonomic grips
- Lanyard hole
- Flush pivot design
- Forged serrated blades bolt lock
- Up to 22-gauge stainless & 18-gauge cold rolled steel



| Part # | Mfg #      | Description            | Price |
|--------|------------|------------------------|-------|
| 238545 | 48-22-4500 | Bulldog Aviation Snips |       |

Tools

## Sheet Metal Tools

Tools

### Angle Snips

- One handed locking
- Flush bolt design
- Serrated jaws
- Forged alloy steel blades
- Ergonomic handles
- Rust protection - hard chrome plated blades
- Up to 22-gauge stainless & 18-gauge cold rolled steel



| Part # | Mfg #      | Cut         | Price |
|--------|------------|-------------|-------|
| 163488 | 48-22-4011 | Right Angle |       |
| 162739 | 48-22-4021 | Right Angle |       |

### Angle Snips

- One handed metal lock
- Ergonomic grips
- Lanyard hole
- Flush pivot design
- Forged serrated blades bolt lock
- Up to 22-gauge stainless & 18-gauge cold rolled steel



| Part # | Mfg #      | Cut         | Price |
|--------|------------|-------------|-------|
| 238546 | 48-22-4511 | Left Angle  |       |
| 238547 | 48-22-4521 | Right Angle |       |

### 3-Piece Aviation Snips Set

- One-handed locking
- Flush bolt design
- Forged alloy steel blades
- Rust protection
- Serrated jaws
- Ergonomic handles
- Up to 22-gauge stainless & 18-gauge cold rolled steel
- Set includes:
  - Straight cutting snips (48-22-4030)
  - Right cutting snips (48-22-4020)
  - Left cutting snips (48-22-4010)



| Part # | Mfg #      | Description             | Price |
|--------|------------|-------------------------|-------|
| 238549 | 48-22-4533 | 3-Pc Aviation Snips Set |       |

### Miscellaneous Tools

#### Classic Thinner

- 40% Larger Handles
- Cuts up to 20ga Cold Rolled Steel/22ga Stainless Steel
- Bolt lock technology - Blades will not loosen
- All-metal contoured handles for durability and comfort
- Forged strength design
- Rust Resistant



| Part # | Mfg #      | Description | Price |
|--------|------------|-------------|-------|
| 175014 | 48-22-4002 | 12"         |       |

#### Offset Compound Tinner

- 40% Larger Handles
- Cuts up to 20ga Cold Rolled Steel/22ga Stainless Steel
- Bolt lock technology - Blades will not loosen
- All-metal contoured handles for durability and comfort
- Forged strength design
- Rust Resistant



| Part # | Mfg #      | Description     | Price |
|--------|------------|-----------------|-------|
| 175015 | 48-22-4005 | Compound Offset |       |

#### Lightweight Tinner

- 40% Larger Handles
- Cuts up to 24ga Cold Rolled Steel/26ga Stainless Steel
- Best-in-class 3 1/2" Replaceable Blades
- All-metal contoured handles for durability and comfort
- Rust Resistant



| Part # | Mfg #      | Description | Price |
|--------|------------|-------------|-------|
| 175016 | 48-22-4006 | 13"         |       |

#### Replacement Blades

- Lightweight replacement blades for (48-22-4006) tinner snips



| Part # | Mfg #      | Description    | Price |
|--------|------------|----------------|-------|
| 175017 | 48-22-4007 | For 48-22-4006 |       |

## Sheet Metal Tools

### Bulldog Tinner

- 40% Larger Handles
- Cuts up to 16ga Cold Rolled Steel/18ga Stainless Steel
- Bolt lock technology - Blades will not loosen
- All-metal contoured handles for durability and comfort
- Forged strength design
- Rust Resistant



| Part # | Mfg #      | Description | Price |
|--------|------------|-------------|-------|
| 175111 | 48-22-4001 | 16"         |       |

### Job Site Straight Scissors

- Iron carbide edge blades
- Smooth blades for burr-free cuts
- All metal core
- Bolt lock technology
- Rust protection
- Large handle loops
- Ruler markings on blade
- Index finger groove



| Part # | Mfg #      | Description       | Price |
|--------|------------|-------------------|-------|
| 168966 | 48-22-4041 | Straight Scissors |       |

### Duckbill Tinner

- 40% Larger Handles
- Cuts up to 22ga Cold Rolled Steel/24ga Stainless Steel
- Bolt lock technology - Blades will not loosen
- All-metal contoured handles for durability and comfort
- Forged strength design
- Rust Resistant



| Part # | Mfg #      | Description | Price |
|--------|------------|-------------|-------|
| 175114 | 48-22-4004 | 10"         |       |

### Job Site Offset Scissors

- Iron carbide edge blades
- Micro-Serrated blades
- All metal core
- Bolt lock technology
- Rust protection
- Large handle loops
- Ruler markings on blade
- Index finger groove



| Part # | Mfg #      | Description     | Price |
|--------|------------|-----------------|-------|
| 168964 | 48-22-4040 | Offset Scissors |       |

### Seamers

- Forged head design
- Chrome plated - rust resistance
- Symmetrical handles



| Part # | Mfg #      | Description     | Price |
|--------|------------|-----------------|-------|
| 175012 | 48-22-6000 | 3" Speed Seamer |       |

### 5-Blade Crimper

- Reinforced crimper ribs
- Heavy duty spring
- Chrome plated - rust resistance
- Symmetrical handles



| Part # | Mfg #      | Description             | Price |
|--------|------------|-------------------------|-------|
| 175013 | 48-22-6001 | Up to 22ga rolled steel |       |

**Sheet Metal Tools**

Tools

**Sheet Metal Tools**

**5-Blade Crimper**

- All steel construction and nickel-plating
- Produces indentations in stove pipe and round duct
- Crimps 24 gauge CRSM and 24 gauge SSSM



| Part # | Mfg # | Handle Color | Length | Price |
|--------|-------|--------------|--------|-------|
| 106830 | 86550 | Blue         | 9"     |       |

**Hand Notcher**

- Creates 30° "V"-shaped cuts in sheet metal
- Forged, high impact steel jaw with 13/16" maximum throat depth
- All steel construction with nickel-plated and black-oxide finish



| Part # | Mfg # | Handle Color | Length | Price |
|--------|-------|--------------|--------|-------|
| 106831 | 86551 | Blue         | 8-1/2" |       |

**Straight Hand Seamer - 3-1/4" Jaw**

- Bending and flattening sheet and non-ferrous metals
- 3-1/4" Wide forged, high impact steel jaws are marked in 1/4" increments
- All steel construction and nickel-plated



| Part # | Mfg # | Handle Color | Length | Price |
|--------|-------|--------------|--------|-------|
| 106828 | 86553 | Blue         | 8-3/8" |       |

**Offset Hand Seamer**

- Compound-leverage mechanism easily bends, seams and flattens sheet metal
- For use in overhead and confined areas
- Broader jaw model for forming wider folds
- Folds 22 gauge CRSM and 24 gauge SSSM
- Jaw marked in 1/4" (6 mm) increments
- Heavy-duty jaw/handle linkage
- Steel construction and nickel-chrome plated hardware
- Vinyl grips with handle stops



| Part # | Mfg # | Handle Color | Length | Price |
|--------|-------|--------------|--------|-------|
| 106829 | 86552 | Blue         | 8"     |       |

**Offset Seamer Tong**

- Hot drop-forged
- Bending depth indicators marked in 1/4" increments
- Bends 22 gauge CRSM
- Cushioned handles



| Part # | Mfg # | Handle Color | Length | Price |
|--------|-------|--------------|--------|-------|
| 108257 | 86554 | Red          | 9-3/4" |       |

**Folding Tool**

- (2) Folding depths:
  - 3/8" (10mm)
  - 1" (925mm)
- Handy sight gauges
- Made of heavy-duty 16 gauge steel



| Part # | Mfg # | Description | Price |
|--------|-------|-------------|-------|
| 108249 | 88980 | 12" Long    |       |
| 108250 | 88981 | 18" Long    |       |
| 108252 | 88982 | 24" Long    |       |

**Duct Stretcher**

- Aligns and pulls ductwork together, easing installation of drive cleats
- Offset handle protects hand



| Part # | Mfg # | OAL | Price |
|--------|-------|-----|-------|
| 108255 | 89565 | 16" |       |

**Sheet Metal Tools**

**Cutting and Notching Tools**

**Tinner Snips**

- 6" Angled, hollow-ground cutting edge for cutting full 3-1/2" (89 mm) straight cuts and wide curves
- Easily replaceable cutting blades made of high-carbon steel
- Cutting capacity:
  - 22 Gauge cold-rolled sheet metal
  - 26 Gauge stainless steel sheet metal
- Not for use on hardened wire, nails, or any other rounded surface
- Lightweight magnesium handles



| Part # | Mfg # | Handle Color | Length | Price |
|--------|-------|--------------|--------|-------|
| 108246 | 3100  | Gray         | 13"    |       |

**Snap Lock Punch**

- Compound-leverage mechanism for greater control and easy operation
- Drop-forged steel jaw easily punches 3/8" (9.5mm) wide impressions on metal edges to easily join pieces of sheet metal, duct, or pipe
- All-steel construction and nickel-chrome plated hardware provide long life and durability
- Vinyl grips with handle stops for added comfort and easy operation



| Part # | Mfg # | Handle Color | Length | Price |
|--------|-------|--------------|--------|-------|
| 108254 | 86560 | Blue         | 8"     |       |

**Cutting and Notching Snips**

**Journeyman Offset Snips**

- Soft touch grips
- Klein Kurve® handles

**JOURNEYMAN**



J2100L



J2102S



J2101R



J2106S

| Part # | Mfg #  | Overall Length | Cutting Pattern | Color Code | Price |
|--------|--------|----------------|-----------------|------------|-------|
| 130818 | J2100L | 9-1/2"         | Left/Str        | Red/Blk    |       |
| 130819 | J2101R | 9-1/2"         | Right/Str       | Grn/Blk    |       |

**Cutting and Notching Snips (Continued)**

**Journeyman Offset Snips**

| Part # | Mfg #  | Overall Length | Cutting Pattern     | Color Code | Price |
|--------|--------|----------------|---------------------|------------|-------|
| 130820 | J2102S | 9-1/2"         | Straight            | Yel/Blk    |       |
| 130821 | J2106S | 10-1/2"        | Straight Long Blade | Yel/Blk    |       |

**Aviation Snips**



1100L

1101R

1102S

2100L

2101R

2102S

2103

| Part # | Mfg # | Overall Length | Cutting Pattern | Color Code | Price |
|--------|-------|----------------|-----------------|------------|-------|
| 106833 | 1100L | 9-3/4"         | Left            | Red        |       |
| 106832 | 1101R | 9-3/4"         | Right           | Green      |       |
| 108247 | 1102S | 10-1/8"        | Straight        | Yellow     |       |
| 106835 | 2100L | 9-1/2"         | Offset Left     | Red        |       |
| 106836 | 2101R | 9-1/2"         | Offset Right    | Green      |       |
| 108248 | 2102S | 9-1/2"         | Offset Str      | Yellow     |       |
| 106834 | 2103  | 9-1/4"         | Notch           | Yellow     |       |

Tools

**Sheet Metal Tools**

**General Purpose Tools**

**Offset Snips**

- 1-1/2" Cut length



796



797



| Part # | Mfg # | Model | Description | Length  | Price |
|--------|-------|-------|-------------|---------|-------|
| 017927 | 16202 | 796   | Cuts Right  | 10-1/2" |       |
| 017926 | 16207 | 797   | Cuts Left   | 10-1/2" |       |

Tools



## Sheet Metal Tools

### Sheet Metal Tools

#### Aviation Snips

- Comfortable grip
- High-carbon steel blades with reinforce chrome silicon spring
- Color-coded handle inserts and splines



| Part # | Mfg #   | Description             | Price |
|--------|---------|-------------------------|-------|
| 177210 | 1891133 | Aviation Snips Left Cut |       |
| 177211 | 1891134 | Aviation Snip Right Cut |       |

#### Hand Seamers

- Comfortable grip
- High-carbon steel blades with reinforced chrome silicon spring
- Quick notification with 1/4" depth marks on blades



| Part # | Mfg #   | Description           | Price |
|--------|---------|-----------------------|-------|
| 174605 | 1891183 | 3" Offset Hand Seamer |       |
| 174604 | 1891185 | 3" Hand Seamer        |       |

#### Folding Tools

- Built for both 3/8" (10mm) and 1" (25mm) folds
- Equipped with sight holes for proper depth alignment



| Part # | Mfg #   | Description      | Price |
|--------|---------|------------------|-------|
| 174607 | 1891146 | 12" Folding Tool |       |
| 174608 | 1890985 | 18" Folding Tool |       |
| 174610 | 1890986 | 24" Folding Tool |       |

#### Hole Cutters

- Lightweight aluminum frame, with a milled bit
- Inch and metric scales
- Fits into any corded or cordless drill with a 1/4" or larger chuck



| Part # | Mfg #   | Description           | Price |
|--------|---------|-----------------------|-------|
| 175060 | 1891191 | 2" to 12" Hole Cutter |       |

### Miscellaneous Tools

| Part # | Mfg #   | Description            | Price |
|--------|---------|------------------------|-------|
| 158489 | 30051SH | Sharpie Black Fine Tip |       |

**Shovels**

Tools

**Shovels**



**Round Point Shovel with Long Handle**

- 14 Gauge steel head and ferrule
- Shovel blades and shanks are 1-piece rustproof, taper-formed, then heat treated
- Handle length: 47"



| Part # | Mfg # | Model | Blade Size       | Price |
|--------|-------|-------|------------------|-------|
| 008693 | 52300 | 170   | 8-5/8" x 11-1/2" |       |

## Shovels

### Heavy-Duty Commercial Shovels

#### Round Point Shovel with Long Fiberglass Handle

- 12 Gauge steel head and ferrule
- Closed back
- Wood reinforced fiberglass handle
- Handle length: 48-1/2"
- Overall length: 59-1/4"
- 100% American made



| Part # | Mfg # | Description             | Price |
|--------|-------|-------------------------|-------|
| 136120 | 92515 | 12ga Round Point Shovel |       |

### Spades

#### Drain Spade D-Grip with Fiberglass Handle

- 12 Gauge steel head and ferrule
- Closed back
- Wood reinforced fiberglass handle
- Handle length: 32"
- Overall length: 40"
- 100% American made



| Part # | Mfg # | Description              | Price |
|--------|-------|--------------------------|-------|
| 136121 | 92535 | 12ga Drain Spade, Closed |       |

### Floral & Speciality Shovels

#### Mud Shovel with Long Fiberglass Handle

- 14 Gauge steel head and ferrule
- Closed back
- Wood reinforced fiberglass handle
- Handle length: 48-1/2"
- Overall length: 59"
- 100% American made



| Part # | Mfg # | Description             | Price |
|--------|-------|-------------------------|-------|
| 136122 | 92705 | 14ga Mud Shovel, Closed |       |

#### Trunk Shovel with D-Grip Steel Handle

- 14 Gauge steel head and ferrule
- Closed back
- Steel handle
- Handle length: 24-1/2"
- Overall length: 32-3/4"
- 100% American made



| Part # | Mfg # | Description              | Price |
|--------|-------|--------------------------|-------|
| 147666 | 92712 | 14ga Trunk Shovel, Steel |       |

## Trouble Lights/Extension Cords

Tools

### Extension Cords

#### Orange Extension Cord

- 12/3 SJT
- Super heavy duty
- Outdoor/ Grounded
- Safety orange color



| Part # | Mfg #  | Description      | Price |
|--------|--------|------------------|-------|
| 224081 | E25005 | 12/3 SJT, 25 ft. |       |
| 224082 | E25006 | 12/3 SJT, 50 ft. |       |

### Shop Heater

- Fan forced wire element
- Three settings: 750/1500 watts
- Adjustable thermostat
- Wide stable base and adjustable tilt
- All metal body
- Long 6 ft. cord
- Padded carry handle
- Box: 10" x 7" x 11.5"



| Part # | Mfg #  | Description          | Price |
|--------|--------|----------------------|-------|
| 224080 | H90101 | Portable Shop Heater |       |

### Work Lights

#### Trouble Light with Metal Cage

- Industrial quality
- 16/3 SJT
- 3-Prong side outlets



| Part # | Mfg #  | Description      | Price |
|--------|--------|------------------|-------|
| 224083 | E25021 | 16/3 SJT, 25 ft. |       |

#### Portable Halogen Work Light

- 500 Watt
- 6 ft. Grounded
- Power cord
- Adjustable frame



| Part # | Mfg #  | Description             | Price |
|--------|--------|-------------------------|-------|
| 190131 | E25250 | 6 ft Grounded, 500 Watt |       |



---

---

## Trouble Lights/Extension Cords

---

---

### Work Lights

#### Fluorescent Trouble/Work Light

| Part # | Mfg #     | Description                                     | Price |
|--------|-----------|---|-------|
| 140727 | D12812025 | 6' Orange Trouble Light<br>with Grounded Outlet |       |

Tools

---

---

**Trouble Lights/Extension Cords**

---

---

Tools

**Light Bulbs**

**Rough Service Light Bulb**

- *Multi-support filament*
- *Lasts twice as long as a standard bulb*
- *Frosted to reduce glare*



| Part # | Mfg # | Description      | Price |
|--------|-------|------------------|-------|
| 002314 | 8502  | 100 Watt Frosted |       |

## Wrenches

### Wrenches

#### Cheater Pipe Wrench

- 3 Length design
  - 10" Mode
  - 18" Mode
  - 24" Mode
- Overbite jaw
- Dual coil springs
- Ergonomic handle form
- Ergonomic hook jaw design
- Tether-ready handle loop



| Part # | Mfg #      | Description         | Price |
|--------|------------|---------------------|-------|
| 187995 | 48-22-7314 | Cheater Pipe Wrench |       |

#### Steel Pipe Wrench

- Overbite Jaw
- Dual coil springs
- Ergonomic handle form
- Ergonomic hook jaw design
- Through hardened jaws
- Tether-ready handle loop



| Part # | Mfg#       | Size | Length | Price |
|--------|------------|------|--------|-------|
| 187996 | 48-22-7110 | 10"  |        |       |
| 187998 | 48-22-7114 | 14"  |        |       |
| 187997 | 48-22-7112 | 12"  |        |       |
| 187999 | 48-22-7118 | 18"  |        |       |

#### Aluminum Pipe Wrench

- Overbite Jaw
- Dual coil springs
- Ergonomic handle form
- Ergonomic hook jaw design
- Through hardened jaws
- Tether-ready handle loop



| Part # | Mfg#       | Size | Length  | Price |
|--------|------------|------|---------|-------|
| 188000 | 48-22-7210 | 10"  | 13-1/2" |       |
| 188001 | 48-22-7212 | 12"  | 15"     |       |
| 188002 | 48-22-7214 | 14"  | 17"     |       |
| 188003 | 48-22-7218 | 18"  | 20-1/2" |       |
| 188004 | 48-22-7224 | 24"  | 27"     |       |

### Adjustable Wrench

- Proprietary adjustment screw
- Ergonomic handle form
- Tether-ready handle loop
- Parallel jaws won't slip or damage finish surfaces
- Adjustment screw gears for smooth adjustment
- Chrome plated for rust protection and durability
- Laser etched ruler for easy-to-read, accurate size adjustment



| Part # | Mfg#       | Size         | Price |
|--------|------------|--------------|-------|
| 187479 | 48-22-7400 | (2Pc) 6"&10" |       |
| 187485 | 48-22-7406 | 6"           |       |
| 187484 | 48-22-7408 | 8"           |       |
| 187482 | 48-22-7410 | 10"          |       |
| 187481 | 48-22-7412 | 12"          |       |
| 187480 | 48-22-7415 | 15"          |       |

#### Wide Jaw Adjustable Wrench

- Wide-jaw design for increased jaw capacity in confined environments
- Proprietary Adjustment Screw
- Ergonomic handle form
- Parallel jaws won't slip or damage finish surfaces
- Adjustment screw gears designed for smooth adjustments
- Chrome plated for rust protection and durability
- Laser etched ruler for easy-to-read, accurate size adjustment



| Part # | Mfg #      | Description | Price |
|--------|------------|-------------|-------|
| 187483 | 48-22-7508 | 8"          |       |

#### Basin Wrench

- Forged, spring-loaded jaw
- Ergonomic handle design for maximum comfort and one-handed use
- Ratchet-ready handle design for maximum speed and torque
- Easy to adjust telescoping handle 10"-17"
- Screwdriver ready through hole handle design for maximum leverage and break-away torque
- Pivoting jaws up to 90° for access to tight spaces



| Part # | Mfg #      | Description    | Price |
|--------|------------|----------------|-------|
| 186460 | 48-22-7001 | 1.25" Capacity |       |
| 186462 | 48-22-7002 | 2.5" Capacity  |       |

## Wrenches

Tools

### 7-Pc Combination Wrench Set

- MAX BITE™ open-end grip
- I-beam handle design
- Ink-filled size labels
- Organized storage solution
- Includes: 3/8", 7/16", 1/2", 9/16", 11/16", 3/4", 5/8"



| Part # | Mfg #      | Description | Price |
|--------|------------|-------------|-------|
| 241912 | 48-22-9407 | 7 Pieces    |       |

### 15-Pc Combination Wrench Set - SAE



| Part # | Mfg #      | Description | Price |
|--------|------------|-------------|-------|
| 240520 | 48-22-9415 | 15 Pieces   |       |

### 15-Pc Combination Wrench Set - Metric



| Part # | Mfg #      | Description | Price |
|--------|------------|-------------|-------|
| 240521 | 48-22-9515 | 15 Pieces   |       |

### Miscellaneous Tools

#### 50-Pc 1/4" Drive Ratchet & Socket Set

- SAE & Metric



| Part # | Mfg #      | Description | Price |
|--------|------------|-------------|-------|
| 250082 | 48-22-9004 | 50 Pieces   |       |



## Wrenches

### Wrenches

#### Heavy-Duty Straight Pipe Wrench

- *Sturdy, cast iron housing and I-beam hand with full floating forged hook jaw, nonstick adjustment nut and replaceable hook and heel jaws*



| Part # | Mfg # | Model | Nom Size | Pipe Capacity | Price |
|--------|-------|-------|----------|---------------|-------|
| 008714 | 31010 | 10    | 10"      | 1-1/2"        |       |
| 008686 | 31020 | 14    | 14"      | 2"            |       |
| 008695 | 31025 | 18    | 18"      | 2-1/2"        |       |
| 029928 | 31030 | 24    | 24"      | 3"            |       |

#### Aluminum Handle Straight Pipe Wrench

- *Nearly 40% lighter than comparable cast iron models of the same size*
- *Jaws and all other parts identical to RIDGID heavy-duty wrenches*



| Part # | Mfg # | Model | Nom Size | Pipe Capacity | Price |
|--------|-------|-------|----------|---------------|-------|
| 008768 | 31090 | 810   | 10"      | 1-1/2"        |       |
| 054899 | 47057 | 812   | 12"      | 2"            |       |
| 008770 | 31095 | 814   | 14"      | 2"            |       |
| 008772 | 31100 | 818   | 18"      | 2-1/2"        |       |
| 008774 | 31105 | 824   | 24"      | 3"            |       |
| 026610 | 31115 | 848   | 48"      | 6"            |       |

#### Aluminum Handle Offset Pipe Wrench

- *Nearly 50% lighter than comparable cast iron models of the same size*
- *Features a jaw opening parallel to the handle and narrower hook jaw head which provides easy entry into tight spots*



| Part # | Mfg # | Model | Nom Size | Pipe Capacity | Price |
|--------|-------|-------|----------|---------------|-------|
| 022973 | 31125 | 18    | 18"      | 2-1/2"        |       |

#### Strap Wrench

- *Best for any polished pipe*
- *Strong, woven nylon strap gives tight grip*
- *Polyurethane-coated strap prevents scratching*
- *Replacement straps available*



| Part # | Mfg # | Model | Handle Length | Strap Length | Strap Width | Pipe Capacity | OD Tube Capacity | Price |
|--------|-------|-------|---------------|--------------|-------------|---------------|------------------|-------|
| 008700 | 31340 | 2     | 11-3/4"       | 17"          | 1-1/8"      | 2"            | 3-1/2"           |       |

#### Hex Wrench

- *Gives multi-sided, secure grip on all hex nuts, square nuts, unions, and valve packing nuts*



| Part # | Mfg # | Model | Description | Nom Size | Pipe Capacity   | Price |
|--------|-------|-------|-------------|----------|-----------------|-------|
| 008571 | 31305 | E110  | Offset Hex  | 9-1/2"   | 1-1/8" - 2-5/8" |       |

Tools

**Wrenches**

**Spud Wrench**

- Narrow jaws to fit into tight places
- Smooth, toothless jaws ideal for square or rectangular stock



| Part # | Mfg # | Size | Pipe Capacity | Price |
|--------|-------|------|---------------|-------|
| 008717 | 31400 | 12"  | 3/8" - 2-5/8" |       |

**Adjustable Wrench**

- High strength forged, precision broached superior strength
- Wider and deeper jaws increased bite and grip surface
- Nickel plated superior corrosion resistance
- Acid etched scales English and metric readings



| Part # | Mfg # | Model | Nom Size | Pipe Capacity | Price |
|--------|-------|-------|----------|---------------|-------|
| 050314 | 86902 | 756   | 6"       | 3/4"          |       |
| 050315 | 86907 | 758   | 8"       | 7/8"          |       |
| 050323 | 86912 | 760   | 10"      | 1-1/8"        |       |
| 050320 | 86917 | 762   | 12"      | 1-5/16"       |       |

**Basin Wrench**

- Spring-loaded jaws of forged alloy steel
- Tension plug holds head in any position up to 90° angle



| Part # | Mfg # | Model | Description       | Nom Size  | Pipe Capacity   | Price |
|--------|-------|-------|-------------------|-----------|-----------------|-------|
| 008658 | 31175 | 1017  | Telescoping Basin | 10" - 17" | 3/8" - 1-1/4"   |       |
| 022327 | 31180 | 1019  | Telescoping Basin | 10" - 17" | 1-1/4" - 2-1/2" |       |

**Faucet and Sink Installer (Plastic Nut Basin Wrench)**

- Designed to reach and turn plastic mounting nuts on faucets, sprayers and ballcocks
- Used to fasten and remove plastic basin nuts, supply line nuts, and 7/8" and 1" hex nuts
- Notched ends are designed to self-center on 2, 3, 4 and 6 tab nuts and to fit on metal hex nuts
- Strainer basket attachment holds drain unit in place while tightening strainer nut
- High strength plastic with aluminum inserts



| Part # | Mfg # | Model | Length  | Price |
|--------|-------|-------|---------|-------|
| 034146 | 57003 | 2006  | 10-1/4" |       |

**OneStop™ Wrench**

- (2) Tools in one
- Provides exact size surface wrenches needed for angle stop and compression coupling installation



| Part # | Mfg # | Model | Description     | Price |
|--------|-------|-------|-----------------|-------|
| 065524 | 27023 | 2002  | OneStop™ Wrench |       |

Tools

**Wrenches**

**Wrench Parts**



| Part # | Mfg # | Description             | For Model          | Price |
|--------|-------|-------------------------|--------------------|-------|
| 008614 | 31675 | Heel Jaw & Pin Assembly | 18, 818, E-18, S4A |       |

## Wrenches

Tools

### Wrenches

#### Chrome Adjustable Wrench

- Longer jaws grip better, avoiding slippage or nut round off
- Measurement scales are handy for sizing nuts, pipe and tube diameters
- Greater jaw capacity supports larger nuts and bolts
- Thinner jaws for greater access in tight spaces
- Precise jaw design grips tight the first time
- Four thread knurl and non-protruding jaws provide greater capacity
- Minimal head width improves performance in confined spaces
- Chrome vanadium steel construction



| Part # | Mfg #   | Length | Capacity | Price |
|--------|---------|--------|----------|-------|
| 058194 | R114800 | 4-1/2" | 1/2"     |       |
| 058195 | R114900 | 6-1/4" | 15/16"   |       |
| 058196 | R115000 | 8"     | 1-3/16"  |       |
| 058197 | R115100 | 10"    | 1-3/8"   |       |
| 058198 | R115200 | 12"    | 1-1/2"   |       |

#### Code Blue® Adjustable Wrench

- Longer jaws grip better, avoiding slippage or nut round off
- Measurement scales are handy for sizing nuts, pipe and tube diameters
- Greater jaw capacity supports larger nuts and bolts
- Thinner jaws for greater access in tight spaces
- Precise jaw design grips tight the first time
- Four thread knurl and non-protruding jaws provide greater capacity
- Minimal head width improves performance in confined spaces
- Code Blue® grips are designed for durability and comfort



| Part # | Mfg #   | Length | Capacity | Price |
|--------|---------|--------|----------|-------|
| 117996 | R115560 | 8"     | 1-1/2"   |       |

### Radiator Nipple Wrench

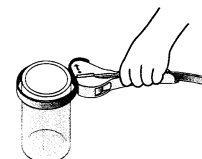

| Part # | Mfg #   | Description                         | Price |
|--------|---------|-------------------------------------|-------|
| 029136 | R126145 | Rubber Strap Wrench, 3/8" to 5-1/2" |       |

### Drain Wrench

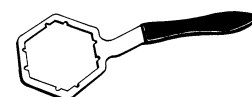

| Part # | Mfg #   | Description  | Price |
|--------|---------|--------------|-------|
| 032867 | R124710 | Drain Wrench |       |

## Wrenches

### Adjustable Wrenches

#### Standard-Jaw Design Adjustable Wrench - Plastic Dipped Handles

- Plastic dipped handles
- Forged heat treated alloy steel for maximum strength and lightweight
- High polish chrome finish



| Part # | Mfg #  | Length | Capacity | Price |
|--------|--------|--------|----------|-------|
| 111292 | D506-4 | 4-1/2" | 1/2"     |       |

#### Adjustable Wrench - Extra Capacity Plastic Handle

- Excellent in confined spaces
- High polish chrome finish



| Part # | Mfg #   | Length  | Capacity | Price |
|--------|---------|---------|----------|-------|
| 112170 | D507-6  | 6-3/8"  | 15/16"   |       |
| 107650 | D507-8  | 8-3/8"  | 1-1/8"   |       |
| 106824 | D507-10 | 10-3/8" | 1-5/16"  |       |
| 123781 | D507-12 | 12-3/8" | 1-1/2"   |       |

### Ratcheting Box Wrenches

#### Fully Reversible Ratcheting Refrigeration Wrench

- Fully reversible ratchet wrenches designed for refrigeration packing gland nuts and valve stem sockets
- Also designed for beam clamp installation
- Wrenches are compact in size, with clearly marked sockets for four nut sizes
- Chrome finish



| Part # | Mfg # | Socket Sizes                                 | Price |
|--------|-------|--|-------|
| 113965 | 68310 | 3/16" & 5/16" Square<br>x 1/4" & 3/8" Square |       |

### Ratcheting Box Wrench Sets

#### 3-Piece Fully Reversible Ratcheting Offset Box Wrench Set

- Includes:
  - 68234 1/4" x 5/16"
  - 68236 3/8" x 7/16"
  - 68238 1/2" x 9/16"



| Part # | Mfg # | Socket Sizes | Price |
|--------|-------|--------------|-------|
| 106827 | 68244 | 3-Piece Set  |       |

### L-Style Hex Keys Sets

- Long side for accessing hard-to-reach places
- Short side for higher torque situations and low clearances

#### 12-Piece L-Style Hex Ball-End Caddy Set - Inch

- Includes:
  - BL2 .050"
  - BL4 1/16"
  - BL5 5/64"
  - BL6 3/32"
  - BL7 7/64"
  - BL8 1/8"
  - BL9 9/64"
  - BL10 5/23"
  - BL12 3/16"
  - BL14 7/32"
  - BL16 1/4"
  - BL20 5/16"



| Part # | Mfg # | Description         | Price |
|--------|-------|---------------------|-------|
| 112667 | BLK12 | 12-Piece Set - Inch |       |

### Folding Hex Key Sets

#### 9-Key Hex Set

- Sizes:
  - 5/64"
  - 3/32"
  - 7/64"
  - 1/8"
  - 9/64"
  - 5/32"
  - 3/16"
  - 7/32"
  - 1/4"



| Part # | Mfg # | Description   | Price |
|--------|-------|---------------|-------|
| 106826 | 70591 | 4-1/4" Length |       |

## Wrenches

### Wrenches

#### Digital Adjustable Torque Wrench

- Adjustable spanner head
- Digital torque value readout
- +/- 2% accuracy
- CW and CCW operation
- Water contact indicator
- Peak hold and track mode selectable
- Auto sleep (after about 5 minutes idle)
- 50 data memory for recall and joint torque auditing
- 4 user units of measure (ft. lb., in. lb., N-m, kg-cm)
- Buzzer & LED indicator for the 9 pre-set target torques



| Part # | Mfg # | Description       | Price |
|--------|-------|-------------------|-------|
| 236431 | 60648 | 3/8" Square Drive |       |

#### Fan Blade Puller

- Hardened 4140 chrome moly steel
- Pull off fan blades
- Four fingers attach to the fan blade
- Fits 1-3/4" hub maximum
- Remove pulleys or sheaves
- Remove squirrel cage type blower wheels



| Part # | Mfg # | Description               | Price |
|--------|-------|---------------------------|-------|
| 182165 | 60590 | Complete Fan Blade Puller |       |

#### Heavy Duty Ratchet Wrench

- Reversible
- 1/2" and 9/16" Hex openings at one end
- Square 3/16" and 1/4" at the other end



| Part # | Mfg # | Description | Price |
|--------|-------|-------------|-------|
| 182169 | 60612 | 7" Long     |       |

#### Offset Service Wrench

- Knuckle saver design
- 1/4" and 3/16" Hex openings at one end
- Square 3/8" and 5/16" at the other end



| Part # | Mfg # | Description           | Price |
|--------|-------|-----------------------|-------|
| 182172 | 60616 | Offset Service Wrench |       |

#### Standard Straight Ratchet Wrench

- Reversible
- 1/4" and 3/16" Hex openings at one end
- Square 3/8" and 5/16" at the other end



| Part # | Mfg # | Description              | Price |
|--------|-------|--------------------------|-------|
| 182171 | 60613 | Standard Straight Wrench |       |

### Precision Torque Wrench Kit

- Packaged blow-molded storage carry case
- Exact tightening to 10-8 N-M or 7.4-59 ft. lb
- Newton-meters and foot-pound scales are marked
- Interchangeable open end adapters  
 60650 (6 Heads): Sizes: 17, 22, 24, 26, 27 & 29 mm  
 60652 (8 Heads): Sizes: 16, 17, 21, 24, 26, 27 & 29 mm



| Part # | Mfg # | Description                 | Price |
|--------|-------|-----------------------------|-------|
| 182242 | 60650 | Torque Wrench Kit w/6 Heads |       |
| 182243 | 60652 | Torque Wrench Kit w/8 Heads |       |

### Parts & Accessories

| Part # | Mfg # | Description     | Price |
|--------|-------|-----------------|-------|
| 182167 | 60609 | Hex Key Adapter |       |

## Wrenches

### Ratchet Wrenches

#### Ratchet Wrench



- For installing or servicing heating, air conditioning or refrigeration units

| Part # | Mfg # | Square                   | Hex | Price |
|--------|-------|--------------------------|-----|-------|
| 006478 | RRW3  | 3/16", 1/4", 5/16", 3/8" | -   |       |

#### Hex Key Wrench Insert



| Part # | Mfg #   | Square | Hex   | Price |
|--------|---------|--------|-------|-------|
| 006479 | RRW3/16 | 1/4"   | 3/16" |       |

### Hex Keys

#### Folding Hex Key Set

- Professional quality
- Produced from tough alloy steel



| Part # | Mfg # | Description             | Price |
|--------|-------|-------------------------|-------|
| 006503 | W29   | (9) Keys, Deluxe Pocket |       |

---



---

## Wrenches

---

Tools

### Razorback™ Wrench

- Remove shower and sink drains from top or bottom with just one hand
- T-Handle rotates 180°



| Part # | Mfg # | Description       | Price |
|--------|-------|-------------------|-------|
| 093510 | 73055 | Razorback™ Wrench |       |



**Wrenches**

**Tools**

**Smart Dumbell®**

- Installs or removes drains without cross-bars (Kohler, American Standard)
- Heavy duty die-cast aluminum
- Prevents scratching of decorative finishes
- Use crescent wrench or large Phillips screwdriver to turn the tool



| Part # | Mfg # | Length | Price |
|--------|-------|--------|-------|
| 008104 | 4554  | 6"     |       |

**Basin Wrenches**

**Eureka Cleanout Plug Wrench**

- Fits slotted or square countersunk cleanout plugs
- Strong, malleable iron



| Part # | Mfg # | Description          | Price |
|--------|-------|----------------------|-------|
| 083108 | 4567  | Cleanout Plug Wrench |       |

Tools

## Wrenches

Tools

### Golden Tool™ Tools

#### Golden Grip® Internal Pipe Wrench

- *Installs or extracts pipe nipples from the inside*



| Part # | Mfg # | Description | Price |
|--------|-------|-------------|-------|
| 080112 | 97250 | Single 1/2" |       |

#### Golden Extractor™ Tub Drain Tool

- *Standard 3/8" drive ratchet to extract or install tub drains*



| Part # | Mfg # | Description    | Price |
|--------|-------|----------------|-------|
| 083657 | 97258 | Universal Size |       |

## Wrenches

### Faucet Nut Splitter

- Splits old or new zinc or brass nuts in seconds
- Fits over all 1/2" faucet shanks
- Aluminum with a chisel tip of hardened tool steel



| Part # | Mfg # | Description         | Price |
|--------|-------|---------------------|-------|
| 120323 | NS-1  | Faucet Nut Splitter |       |

### Plumber's T-Handle Torque Tools

- Unique locking collar
- Slips internally when proper torque achieved



| Part # | Mfg # | Socket | Type       | in-lbs | Price |
|--------|-------|--------|------------|--------|-------|
| 022114 | 2-SH  | 5/16"  | Std No-Hub | 60     |       |

## Wrenches

Tools

### Plumbing Specialty Tools

#### 4-Way Key—Carded

- Plated steel
- For sizes 1/4", 9/32", 5/16", 11/32"



| Part # | Mfg #   | For:                    | Price |
|--------|---------|-------------------------|-------|
| 041932 | J40-005 | Valve, Faucet, Sillcock |       |

#### Extract-A-Drain Tub Drain Removal Tool

- Removes old or rusty drains
- Fits both 1-1/4" and 1-1/2" tub drains
- Prevents damage to your tub's finish
- Jaws expand to firmly grip inside of drain



| Part # | Mfg #   | Description | Price |
|--------|---------|-------------|-------|
| 057806 | J40-018 | Carded      |       |

#### Compression Sleeve Puller

- Removes leaking compression sleeves without damaging walls
- For 5/8" compression units
- Carded



| Part # | Mfg #   | Description                | Price |
|--------|---------|----------------------------|-------|
| 054587 | J40-021 | Comp Sleeve Puller, Carded |       |

#### Faucet Handle Puller

- Plated steel
- Carded
- Removes faucet and valve handles



| Part # | Mfg #   | Description   | Price |
|--------|---------|---------------|-------|
| 054584 | J40-010 | Standard Unit |       |

### Wrenches

#### Element Wrench

- For removing heater elements
- Zinc-plated steel
- Individually bagged



| Part # | Mfg #   | Description | Price |
|--------|---------|-------------|-------|
| 041934 | J36-101 | Heavy-Duty  |       |

### No-Hub Torque Wrench

- Automatically releases at 60 in/lb
- Ratchets one way
- Built-in reversing lever
- Chrome vanadium socket



| Part # | Mfg #   | Description          | Price |
|--------|---------|----------------------|-------|
| 041933 | T60-060 | No Hub Torque Wrench |       |

### Basin Wrench

- 1-1/4" Jaw capacity
- Spring-hinged jaw
- Swivel head operates for left or right side
- Use on basin nuts, ballcocks, and flush valves



| Part # | Mfg #   | Description                  | Price |
|--------|---------|------------------------------|-------|
| 041935 | B11-010 | 10" - 17" Telescoping        |       |
| 227750 | B11-012 | 9-1/2" - 16-1/2" Telescoping |       |

### Radiator Spud Wrench

- Plated malleable iron
- For use as spud key and wrench



| Part # | Mfg #   | Description                  | Price |
|--------|---------|------------------------------|-------|
| 041936 | J40-030 | Plated Malleable Iron Wrench |       |

### 4-Way Plug Wrench



| Part # | Mfg #   | Description             | Price |
|--------|---------|-------------------------|-------|
| 021060 | J40-040 | Countersunk Plug Wrench |       |

### 4-Way P.O. Plug Wrench

- For installing or removing basket strainers, tub drains and P.O. plugs



| Part # | Mfg #   | Description | Price |
|--------|---------|-------------|-------|
| 041937 | J40-026 | Wrench      |       |

## Wrenches

### Moen® Stem & Cartridge Wrench

- Removes Moen® stems and cartridges
- Works on plastic/brass faucet/shower valves
- Carded



| Part # | Mfg #   | Description | Price |
|--------|---------|-------------|-------|
| 054583 | J45-015 | Carded      |       |

### Spanner/Strainer Wrench

- Plated malleable iron
- Used for basket strainer jam nuts



| Part # | Mfg #   | Description                  | Price |
|--------|---------|------------------------------|-------|
| 041941 | J40-024 | Plated Malleable Iron Wrench |       |

### Do All Plumber's Wrench

- Longer, more comfortable handle
- Fits most standard size basket strainers including Opella, Duo, Twist Lock and PB Duo and any strainer which uses a standard 3-3/8" locknut
- Fits most shower stall drains
- Carded



| Part # | Mfg #   | Description | Price |
|--------|---------|-------------|-------|
| 054595 | J40-019 | Carded      |       |

### Universal Drain Wrench

- Die cast aluminum
- Installs & removes tub drains and closet spuds
- Use crescent wrench or screwdriver to turn tool



| Part # | Mfg #  | Description | Price |
|--------|--------|-------------|-------|
| 050424 | J45010 | 6" Long     |       |



Sensible Products



Sensible Products

## Wrenches

Tools

### Fan Blade & Blower Wheel Pullers

- Removes fan blades/blower wheels that are frozen to a motor shaft
- Can be used to apply pushing or pulling force
- Includes (4) pulling hooks and (3) set screws
- Accommodates 5/8" belt drive and 1/2" or less direct drive motor shafts



| Part # | Mfg # | Description           | Price |
|--------|-------|-----------------------|-------|
| 136604 | UP-1  | "The Ultimate Puller" |       |

**Aluminum Venting**

**Aluminum Duct**  
**Aluminum Pipe**



| Part # | Mfg #  | Size     | Price |
|--------|--------|----------|-------|
| 014515 | 32ALVP | 3" x 24" |       |
| 015382 | 42ALVP | 4" x 24" |       |
| 075826 | 45ALVP | 4" x 60" |       |
| 015709 | 62ALVP | 6" x 24" |       |

**Aluminum Elbow**

• Box quantity: 12



| Part # | Mfg # | Size | Price |
|--------|-------|------|-------|
| 014306 | 3AL90 | 3"   |       |
| 015192 | 4AL90 | 4"   |       |
| 015617 | 6AL90 | 6"   |       |

Venting

## Aluminum Venting

### Ventilation Products

#### Versa Cap™ Flue and Hot Stack Cap

- Non-clogging positive draft design
- Adjustable clamp fitting
- UL Listed



| Part # | Mfg #  | Pipe OD           | Single Wall | Price |
|--------|--------|-------------------|-------------|-------|
| 006171 | 6-3050 | 2-7/8" - 5"       | 3" & 4"     |       |
| 006172 | 6-5070 | 4-7/8" - 7"       | 5" & 6"     |       |
| 006173 | 6-7090 | 6-7/8" - 9"       | 7" & 8"     |       |
| 006170 | 6-1200 | 11-7/8" - 14-1/2" | 12" & 14"   |       |
| 006174 | 6-9011 | 8-7/8" - 11"      | 9" & 10"    |       |

#### Concentric Vents

- Concentric vents make it easier to have a two-pipe installation for high efficiency furnaces
- These vents simplify installation and only require one hole through the wall or roof where the pipes terminate.
- Without using these vents, the installation would require cutting two holes through the home, one for each pipe.
- These vents save time and money by reducing the amount of work required.
- Available in 2in, 3in or 4in intake vent sizes.



| Part # | Mfg #     | Description | Price |
|--------|-----------|-------------|-------|
| 176893 | CVENTCAP2 | 2"          |       |
| 227475 | CVENTCAP3 | 3"          |       |

#### Horizontal Vent Termination Kits

- Horizontal vent kits for use in venting high efficiency fossil fuel appliances.
- The low profile kit hides the vent from view



| Part # | Mfg #   | Description | Price |
|--------|---------|-------------|-------|
| 179529 | HVENT-2 | 2"          |       |
| 179530 | HVENT-3 | 3"          |       |

### Duct Fans

- An efficient way to increase air circulation, keep room temperatures consistent, and lower heating and cooling costs.
- Metal construction, powerful no-maintenance motors and a one-use thermal fuse means these fans will be up to the task for years.
- Straightforward installation into any 120V system with detailed instructions, templates, and diagrams.
- Available in many sizes. A great way to give slow vents a boost.



| Part # | Mfg #    | Description | Price |
|--------|----------|-------------|-------|
| 200007 | 625-AF6  | 6"          |       |
| 200008 | 625-AF8  | 8"          |       |
| 200009 | 625-AF10 | 10"         |       |
| 224964 | 625-AF12 | 12"         |       |

#### Plastic Wide Mouth Dryer Vent Hood

- Hood, aluminum pipe and collar



| Part # | Mfg #   | Description | Price |
|--------|---------|-------------|-------|
| 172199 | 650-023 | 4" Brown    |       |





## Aluminum Venting

### Aluminum Duct Aluminum Pipe



| Part # | Mfg #  | Size     | Price |
|--------|--------|----------|-------|
| 192713 | ALP244 | 4" x 24" |       |

### Aluminum Fittings 90° Aluminum Elbow



| Part # | Mfg #  | Size | Price |
|--------|--------|------|-------|
| 192715 | 4005-4 | 4"   |       |

Venting

## Chimney Liners

### Metalbest Flexible Aluminum Chimney Liner Kits

- Solution for gas-fired heat venting
- Eliminates chimney flue deterioration
- Aluminum Liner Kit includes:
  - 2-Ply Aluminum Flexi-liner
  - Round top (RV)
  - Flashing with 3" collar
  - Motor guard



| Part # | Part #  | Size | Length | Price |
|--------|---------|------|--------|-------|
| 031689 | AF25-03 | 3"   | 25'    |       |
| 031800 | AF35-03 | 3"   | 35'    |       |
| 015210 | AF25-04 | 4"   | 25'    |       |
| 020303 | AF35-04 | 4"   | 35'    |       |
| 020304 | AF35-05 | 5"   | 35'    |       |
| 020305 | AF35-06 | 6"   | 35'    |       |

Venting

---

---

**Draft Diverters**

---

---

**Galvanized Diverters**

**Galv Vertical Draft Diverter**



| Part # | Mfg #  | Size | Price |
|--------|--------|------|-------|
| 011100 | WA3508 | 8"   |       |

Venting

## Dryer Venting

### Dryer Venting

#### Aluminum Elbow & Pipe

- All aluminum



| Part # | Mfg #   | Description           | Price |
|--------|---------|-----------------------|-------|
| 051185 | D04-027 | 4" x 90° Swivel Elbow |       |
| 051184 | D04-028 | 4" x 24" Pipe         |       |

#### Vinyl Vent Hose

- Wire reinforced vinyl
- For bathroom fan vent kit



| Part # | Mfg #   | Size     | Price |
|--------|---------|----------|-------|
| 014952 | D04-062 | 3" x 50' |       |
| 015494 | D04-050 | 4" x 50' |       |

#### Aluminum Vent Hood

- For clothes dryers or exhaust fans
- Complete with damper and flange plate



| Part # | Mfg #   | Size | Price |
|--------|---------|------|-------|
| 007995 | D04-024 | 4"   |       |

#### Louvered Dryer Vent Hood

- Includes:
  - Hood
  - Aluminum pipe
  - Collar

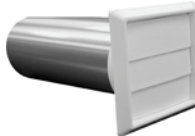

| Part # | Mfg #   | Size | Color | Price |
|--------|---------|------|-------|-------|
| 046324 | D04-025 | 4"   | White |       |
| 046325 | D04-026 | 4"   | Brown |       |

#### Dryer Vent Hood

- PVC
- Pre-punched mounting holes
- Weather proof 12" aluminum extension



| Part # | Mfg #   | Size | Price |
|--------|---------|------|-------|
| 081179 | D04-012 | 4"   |       |

#### Metal Clamp for Dryer Vent

- Heavy-duty all metal design
- Excellent for use with metal ducting



| Part # | Mfg #   | Size | Price |
|--------|---------|------|-------|
| 014355 | D04-015 | 3"   |       |
| 015229 | D04-016 | 4"   |       |

### Dryer Duct

#### Flexible Aluminum Foil Ducting

- Ideal for exhausting clothes dryers and bathroom fans
- Will not support combustion
- No fire or UL ratings



| Part # | Mfg #   | Size    | Price |
|--------|---------|---------|-------|
| 090879 | D04-057 | 4" x 8' |       |

#### Flexible Aluminum Ducting

- Ideal for exhausting clothes dryers
- Bendable to any configuration



| Part # | Mfg #   | Size     | Price |
|--------|---------|----------|-------|
| 030873 | D04-054 | 4" x 25' |       |

**Dryer Venting**

**Wall Vents**

**Louver Hood Faceplate**

| Part # | Mfg # | Description          | Price |
|--------|-------|----------------------|-------|
| 097306 | 20328 | 6" White Hood, 12/Pk |       |

**Mini Louver Fresh Air Intake**

- Plastic
- Screens are 1/4" x 1/4" molded grid
- Fixed louvers
- Works for thru-wall as well as eave venting

| Part # | Mfg # | Description               | Price |
|--------|-------|---------------------------|-------|
| 097307 | 20332 | 6" White Fresh Air Intake |       |

Venting

**Exhaust Fans**

**WhisperGreen® Ventilating Fans**

**WhisperGreen® Fan with Built-In Control**

- Continuous and spot ventilation
- Constant CFM - built-in intelligence performs at a constant CFM regardless of elbows and other factors - when the fan faces static pressure, it automatically increases speed to reach desired CFM
- Variable speed control - CustomVent™ allows fan to run continuously at a pre-set lower level of 30-70 CFMs that can be elevated to a maximum of 80 CFMs when the switch is turned on and turn (or via SmartAction™ Motion Sensor) - high/low delay timer (adj from 30 seconds to 60 minutes) returns fan to the minimum CFM level
- Built-in damper prevents backdraft
- Energy Star® rated



| Part # | Mfg #     | CFM     | Options       | Price |
|--------|-----------|---------|---------------|-------|
| 140061 | FV-08VKM3 | 30 - 80 | Motion Sensor |       |
| 130694 | FV-13VKM3 | 0 - 130 | Motion Sensor |       |

**WhisperGreen Select™ Ventilating Fans  
One Fan - Multiple IAQ Solutions**

- Pick-A-Flow speed selector
- Plug 'N Play modules allow further customization
- Features a DC Motor with SmartFlow® technology
- Flex-Z Fast installation bracket
- Power rating: 120 volts and 60 Hz



| Part # | Mfg #       | CFM      | Noise (Sones) | Price |
|--------|-------------|----------|---------------|-------|
| 170246 | FV-05-11VK2 | 50 - 113 | <0.3          |       |
| 170245 | FV-11-15VK2 | 110-150  | <0.7          |       |

**WhisperGreen Select™ - With Built-in LED Lights**



| Part # | Mfg #        | CFM     | Noise (Sones) | Price |
|--------|--------------|---------|---------------|-------|
| 170014 | FV-05-11VKL2 | 50-110  | <0.3          |       |
| 170244 | FV-11-15VKL2 | 110-150 | <0.9          |       |

**WhisperGreen Select™ - Multi-Speed**



| Part # | Mfg #        | CFM    | Noise (Sones) | Price |
|--------|--------------|--------|---------------|-------|
| 173493 | FV-05-11VKS2 | 50-110 | <0.3          |       |

**WhisperGreen Select™ - Multi-Speed w/ LED Lights**



| Part # | Mfg #      | CFM    | Noise (Sones) | Price |
|--------|------------|--------|---------------|-------|
| 173964 | FV0511VKS2 | 50-110 | <0.3          |       |

**WhisperGreen® Ventilating Fan  
Single Speed**

- SmartFlow™ technology for optimal CFM output
- Fully enclosed DC motor for long life – rated for 60,000 hours continuous run
- Detachable dual 4" or 6" duct adaptor included
- Fits in 2 x 8 construction
- Energy Star® rated



| Part # | Mfg #    | CFM | Noise (Sones) | Price |
|--------|----------|-----|---------------|-------|
| 139499 | FV-08VK3 | 80  | <0.3          |       |

**WhisperCeiling™ Ventilating Fans**

- Low noise levels
- Low power consumption
- Long run times or continuous operation
- Built-in damper prevents backdraft
- Energy Star® rated



| Part # | Mfg #    | CFM | Noise (Sones) | Price |
|--------|----------|-----|---------------|-------|
| 134328 | FV-11VQ5 | 110 | <0.3          |       |

Venting

**Exhaust Fans**

**WhisperGreen® Ventilating Fans  
(Continued)**

**WhisperCeiling™ Ventilating Fans**

| Part # | Mfg #    | CFM | Noise (Sones) | Price |
|--------|----------|-----|---------------|-------|
| 133419 | FV-15VQ5 | 150 | <0.3          |       |

**WhisperWall™ Ventilating Fan**

- Through-the-wall installation
- Low noise levels
- Low input wattage



| Part # | Mfg #    | CFM | Noise (Sones) | Price |
|--------|----------|-----|---------------|-------|
| 132993 | FV-08WQ1 | 70  | 1.1           |       |

**WhisperFit-Lite™ Low Profile Fan/Light/Night-Light**

- Optional 3" duct adapter is included
- (2) 18W Compact fluorescent lamps provide overhead lighting
- 4-Watt night-light
- Energy Star® rated



| Part # | Mfg #     | CFM | Noise (Sones) | Price |
|--------|-----------|-----|---------------|-------|
| 136613 | FV-05VFL2 | 50  | 0.3           |       |
| 130047 | FV-08VFL2 | 80  | 0.5           |       |

**WhisperLite™ Fan/Light**

- Low noise level
- Low power consumption
- Long run times or continuous operation
- Energy Star® rated



| Part # | Mfg #       | CFM | Noise (Sones) | Price |
|--------|-------------|-----|---------------|-------|
| 243547 | FV-0511VQL1 | 110 | 0.5           |       |

**WhisperGreen® Ventilating Fans  
(Continued)**

**WhisperLite™ Fan/Light**

| Part # | Mfg #     | CFM | Noise (Sones) | Price |
|--------|-----------|-----|---------------|-------|
| 133418 | FV-15VQL5 | 150 | 0.9           |       |

**WhisperWarm™ Fan/Heater/Light/Night- Light**

- Low noise level
- 30.6W Power consumption
- 1400W Heating element
- 25W Heater fan
- For 4" duct size
- Night light feature
- (2) 18W Compact fluorescent bulb
- UL Listed



| Part # | Mfg #    | CFM | Noise (Sones) | Price |
|--------|----------|-----|---------------|-------|
| 133063 | FV11VHL2 | 110 | 0.7           |       |

**WhisperValue™ Super Low Profile Ventilating Fan**



| Part # | Mfg #       | CFM | Noise (Sones) | Price |
|--------|-------------|-----|---------------|-------|
| 231574 | FV-0510VS1  | 50  | 1.3           |       |
| 237920 | FV-0510VSL1 | 50  | 1.3           |       |

**WhisperValue™ Super Low Profile Ventilation Fan/Light**

- Energy Star® rated



| Part # | Mfg #     | CFM | Noise (Sones) | Price |
|--------|-----------|-----|---------------|-------|
| 134285 | FV-08VSL1 | 80  | 1.5           |       |

Venting

**Exhaust Fans**

**WhisperFit™ EZ Fan**

- The fastest, easiers, retrofit, ENERGY STAR® fan available
- Built-In Pick-A-Flow™ speed selector
- Flex-Z Fast™ Installation bracket
- Low profile 5-5/8" housing depth fits in 2x6 construction



| Part # | Mfg #       | CFM    | Noise (Sones) | Price |
|--------|-------------|--------|---------------|-------|
| 177128 | FV-08-11VF5 | 80-110 | 1.5           |       |

**WhisperFit™ EZ Fan with Light**

- The fastest, easiers, retrofit, ENERGY STAR® fan available
- Built-In Pick-A-Flow™ speed selector
- Flex-Z Fast™ Installation bracket
- Low profile 5-5/8" housing depth fits in 2x6 construction



| Part # | Mfg #        | CFM    | Noise (Sones) | Price |
|--------|--------------|--------|---------------|-------|
| 177130 | FV-08-11VFL5 | 80-110 | 1.5           |       |

**WhisperFit™ EZ Fan with SmartAction® Motion Sensor**

- Motion sensor with 20 min delay off timer automatically activates fan when someone enters room
- The fastest, easiers, retrofit, ENERGY STAR® fan available
- Built-In Pick-A-Flow™ speed selector
- Flex-Z Fast™ Installation bracket
- Low profile 5-5/8" housing depth fits in 2x6 construction



| Part # | Mfg #        | CFM    | Noise (Sones) | Price |
|--------|--------------|--------|---------------|-------|
| 177129 | FV-08-11VFM5 | 80-110 | 1.5           |       |

**WhisperRecessed LED™ Fan/Light Combo**

- Incorporates a powerfule, yet quiet 80 CFM fan behind an elegant recessed LED light
- Includes a dimmable 14W GU24 base LED lamp
- 6-1/2" Aperture and advanced luminaire design
- Adjustable lamp positional



| Part # | Mfg #     | CFM    | Noise (Sones) | Price |
|--------|-----------|--------|---------------|-------|
| 231495 | FV-08VRE2 | 80 CRM | <0.8          |       |

**WhisperGreen-Lite™ Ventilating Fans**

**Single-Speed WhisperGreen-Lite™ Fan**

- Built-in intelligence allows fan to perform at a constant CFM regardless of elbows and other factors that might hinder performance
- Electronic ballast technology with (2) Energy-Star® qualified 18W compact, flicker-free fluorescent lamps and a 4W night-light
- Built-in damper to prevent backdraft
- Energy Star® rated



| Part # | Mfg #     | CFM | Noise (Sones) | Price |
|--------|-----------|-----|---------------|-------|
| 139924 | FV-08VKL3 | 80  | <0.3          |       |

Venting



**Exhaust Fans**

**Variable-Speed WhisperGreen-Lite™ Fan**

- Built-in intelligence allows fan to perform at a constant CFM regardless of elbows and other factors that might hinder performance
- Electronic ballast technology with (2) Energy-Star® qualified 18W compact, flicker-free fluorescent lamps and a 4W night-light
- Variable speed control - CustomVent™ allows fan to run continuously at a pre-set lower level of 30-70 CFMs that can be elevated to a maximum of 80 CFMs when the switch is turned on and turn (or via SmartAction™ Motion Sensor) - high/low delay timer (adj from 30 seconds to 60 minutes) returns fan to the minimum CFM level
- Built-in damper to prevent backdraft
- VKML Suffix - Motion Sensor
- Energy Star® rated



| Part # | Mfg #      | Duct | CFM | Noise (Sones) | Price |
|--------|------------|------|-----|---------------|-------|
| 139800 | FV-13VKML3 | 6"   | 130 | <0.3          |       |

**EcoVent Ventilating Fans**

**EcoVent™ Fan with Veri-Boost™ Cost Effective, Spot Ventilation Solution**

- 70 CFM fan delivers strong performance w/ peace of mind
- Built-In Veri-Boost™ switch provides a 20 CFM boost when needed
- Small grille design



FV-07VBA1 - Fan Housing  
FV-07VBB1 - Motor/Grille Assembly  
(Both required to complete unit)

| Part # | Mfg #     | Description                               | Price |
|--------|-----------|---|-------|
| 170242 | FV-07VBA1 | Housing Can, Duct Adaptor, & Junction Box |       |
| 170241 | FV-07VBB1 | Motor & Grille                            |       |

**Switches**

**Multi-Function Control WhisperControl Switch**

- Multi-switch combination saves space and adds convenience
- Common feed shunted internally to all switches
- Includes matching wall plate
- Commercial grade
- Elegant styling provides multiple controls in a single-gang wall box
- 4-Function control - single pole/double throw on-off-on top switch, two single pole on-off switches



| Part # | Mfg #       | Color | Functions | Price |
|--------|-------------|-------|-----------|-------|
| 163969 | FV-WCSW31-W | White | 3         |       |
| 145404 | FV-WCSW41-W | White | 4         |       |

**WhisperControl Condensation Sensor**

- Automatically turns on when relative humidity and temperature change is detected
- 30 Minute countdown timer
- Manual On/Off control
- Compatible with single-speed fans or fan/lights
- Stylish design with wall plate included
- LED Indicator
- Energy Star®, LEED for Homes, ASHRAE 62.2, and CALGreen compliant
- 1-Year limited warranty



| Part # | Mfg #      | Color        | Description  | Price |
|--------|------------|--------------|--------------|-------|
| 144623 | FV-WCCS1-W | White        | On/Off       |       |
| 148246 | FV-WCCS1-A | Light Almond | On/Off       |       |
| 145403 | FV-WCCS2-W | White        | On/Off/Light |       |

**Parts & Accessories**

**WhisperGreen Select™ Condensation Sensor Plug 'N Play Module**

- Helps prevent mold and mildew
- Sensor detects relative humidity and temperature to anticipate dew point, automatically turning the fan on to control humidity
- Humidity (RH) sensitivity adjustment enables fine tuning for moist conditions and for satisfying CALGreen requirements
- Activates a 20 minute delay off timer for the fan



| Part # | Mfg #    | Description         | Price |
|--------|----------|---------------------|-------|
| 170250 | FV-CSVK1 | Condensation Sensor |       |

Venting

**Exhaust Fans**

**WhisperGreen Select™ SmartAction® Motion Sensor Plug 'N Play Module**

- Automatically activates when someone enters the room
- Once the settings have been applied, the fan becomes truly automatic
- This module also activates a 20 minute delay off timer for the fan



| Part # | Mfg #    | Description   | Price |
|--------|----------|---------------|-------|
| 170248 | FV-MSVK1 | Motion Sensor |       |

**WhisperGreen Select™ NiteGlo™ LED Light Plug 'N Play Module**

- A photocell automatically turns on the 1 watt LED night light when darkness is sensed in the room
- High/Low brightness switch enables you to fine tune the photocell to work in conjunction with the darkness level of your bathroom
- This module also activates an automatic 20 minute delay off timer for the fan



| Part # | Mfg #    | Description             | Price |
|--------|----------|-------------------------|-------|
| 170249 | FV-NLVK1 | NigtGlo LED Night Light |       |

**WhisperGreen Select™ Multi-Speed with Time Delay Plug 'N Play Module**

- Allows you to select the proper CFM settings to satisfy ASHRAE 62.2 continuous ventilation requirements
- High/Low delay timer returns the fan to the preset CFM level after a period of time set by the user
- The fan runs continuously at a preset lower level (0, 30-100 or 0, 50-120 CFM, in 10 CFM increments), then elevates to a maximum level of operation (50-80-110 or 110-130-150 CFM) when the wall switch is turned on, or when the motion sensor or condensation sensor module is activated



| Part # | Mfg #      | Description               | Price |
|--------|------------|---------------------------|-------|
| 170247 | FV-VS15VK1 | Multi-Speed w/ Time Delay |       |

**FlexDamper™ All-In-One Radiation Damper**

- Folded ceramic curtain style damper meets both combustible and non-combustible UL assemblies
- Allows for versatile two-stage construction; during framing and after finishes
- Easy access to fan, motor and damper for maintenance
- UL approved for most Panasonic 10 1/4" 50 – 150 CFM fans, fan/lights and fans with motion sensor
- Galvanized steel frame with 165°F fusible link



| Part # | Mfg #     | CFM              | Noise (Sones) | Price |
|--------|-----------|------------------|---------------|-------|
| 224658 | PC-RD05C5 | Radiation Damper |               |       |

Venting

**Exhaust Fans**

**Quantum Inline Fans**  
**Quantum Ventilation System**

- Complete exhaust system includes:
  - Inline plastic combi- fan
  - Multi-position metal bracket
  - Duct connection collar
- Capable of multi-point exhaust
- Energy Star® rated



| Part # | Mfg #        | Description   | Price |
|--------|--------------|---|-------|
| 080159 | 99-NBQ-COMBI | 4", 5", 6" , 180/240/270 CFM, 3-in-1 Inline System, White |       |

Venting

## Power Venters

### Draft Inducers

- *Inline Auto-Draft® inducers*
- *Quick and easy to install*
- *Vari-Draft control permits adjustments to the individual job requirement*
- *115V 60Hz*

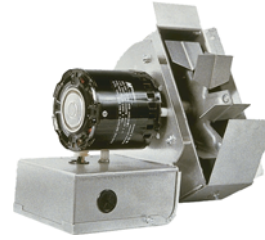

| Part # | Mfg # | Smokepipe Size | RPM       | Watts | Amps | HP Open | Price |
|--------|-------|----------------|-----------|-------|------|---------|-------|
| 010374 | D-3   | 5" - 8"        | 1,550 rpm | 74W   | .96A | 1/20 hp |       |

Venting

## QC Venting

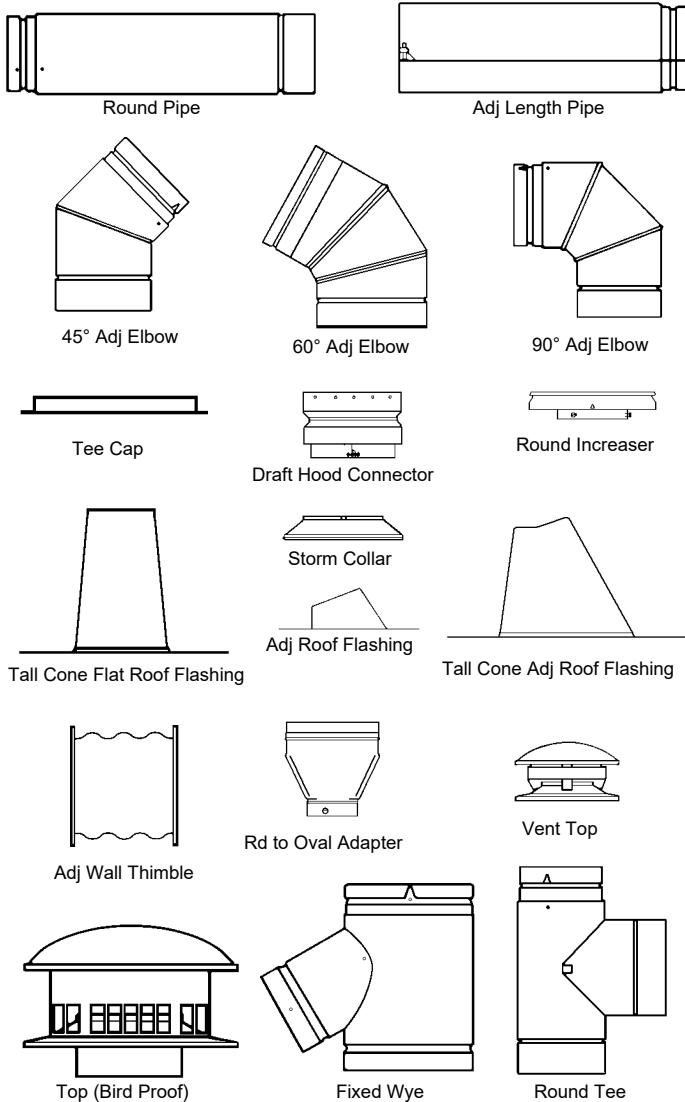

### 12" Gas Vent Round

| Part # | Mfg #   | Description                  | Price |
|--------|---------|------------------------------|-------|
| 187423 | RP1236  | 12" x 36" Round Pipe         |       |
| 187422 | RP1218  | 12" x 18" Round Pipe         |       |
| 008345 | 12QC-18 | 18" Round Pipe               |       |
| 008346 | 12QC-30 | 30" Round Pipe               |       |
| 187428 | 12R45-S | 45° Fixed Elbow              |       |
| 008337 | 12QC-AF | Adj Roof Flashing            |       |
| 008364 | 12QC-RT | Top                          |       |
| 187431 | 12RSC-S | Storm Collar                 |       |
| 008358 | 12QC-TC | Tee Cap                      |       |
| 008362 | 12QC-TF | Tall Cone Flat Roof Flashing |       |
| 008368 | 12QC-TS | Tee                          |       |

### 14" Gas Vent Round

| Part # | Mfg #   | Description                  | Price |
|--------|---------|------------------------------|-------|
| 008348 | 14QC-30 | 30" Round Pipe               |       |
| 008373 | 14QC-45 | 45° Fixed Elbow              |       |
| 008338 | 14QC-AF | Adj Roof Flashing            |       |
| 008365 | 14QC-RT | Top                          |       |
| 008353 | 14QC-SC | Storm Collar                 |       |
| 008359 | 14QC-TC | Tee Cap                      |       |
| 008355 | 14QC-TF | Tall Cone Flat Roof Flashing |       |
| 008369 | 14QC-TS | Tee                          |       |

### 16" Gas Vent Round

| Part # | Mfg #   | Description                  | Price |
|--------|---------|------------------------------|-------|
| 008350 | 16QC-30 | 30" Round Pipe               |       |
| 008339 | 16QC-AF | Adj Roof Flashing            |       |
| 008366 | 16QC-RT | Top                          |       |
| 008354 | 16QC-SC | Storm Collar                 |       |
| 008356 | 16QC-TF | Tall Cone Flat Roof Flashing |       |

### Type "B" Gas QC Vent Pipe & Fittings

#### 10" Gas Vent Round

| Part # | Mfg #   | Description                  | Price |
|--------|---------|------------------------------|-------|
| 008343 | 10QC-18 | 18" Round Pipe               |       |
| 008344 | 10QC-30 | 30" Round Pipe               |       |
| 187411 | RP1036  | 36" Round Pipe               |       |
| 008371 | 10QC-45 | 45° Fixed Elbow              |       |
| 008336 | 10QC-AF | Adj Roof Flashing            |       |
| 008340 | 10QC-AJ | 18" Adj Length Pipe          |       |
| 008363 | 10QC-RT | Top                          |       |
| 187419 | RSC10   | Storm Collar                 |       |
| 008357 | 10QC-TC | Tee Cap                      |       |
| 008361 | 10QC-TF | Tall Cone Flat Roof Flashing |       |
| 008367 | 10QC-TS | Tee                          |       |

### Model C Universal Cap

- Used as ventilation cap as well as a Type B gas vent termination

| Part # | Mfg #  | Description | Price |
|--------|--------|-------------|-------|
| 187418 | RTOP10 | 10" Cap     |       |
| 187430 | RTOP12 | 12" Cap     |       |

**RV Round Venting**



Round Pipe

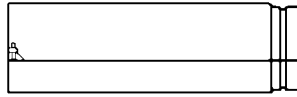

Adj Length Pipe

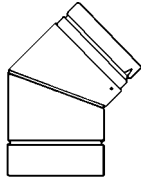

45° Adj Elbow

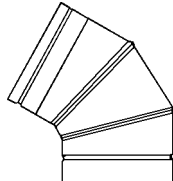

60° Adj Elbow

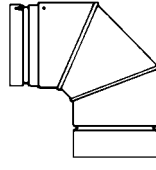

90° Adj Elbow

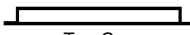

Tee Cap

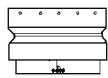

Draft Hood Connector

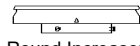

Round Increaser

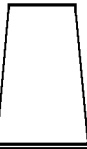

Tall Cone Flat Roof Flashing

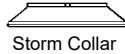

Storm Collar

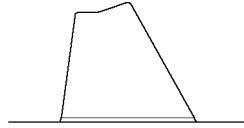

Tall Cone Adj Roof Flashing



Adj Roof Flashing

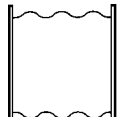

Adj Wall Thimble

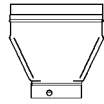

Rd to Oval Adapter

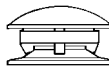

Vent Top

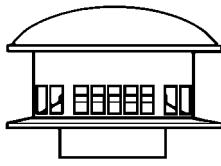

Top (Bird Proof)

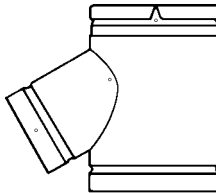

Fixed Wye

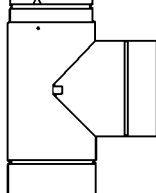

Round Tee

**Type "B" Gas RV Vent Pipe & Fittings**

**3" Gas Vent Round**

| Part # | Mfg #    | Description                     | Price |
|--------|----------|---------------------------------|-------|
| 009690 | 3RV-6    | 6" Round Pipe                   |       |
| 009685 | 3RV-12   | 12" Round Pipe                  |       |
| 009686 | 3RV-18   | 18" Round Pipe                  |       |
| 009687 | 3RV-2    | 24" Round Pipe                  |       |
| 009688 | 3RV-3    | 36" Round Pipe                  |       |
| 066532 | 3RV-4    | 48" Round Pipe                  |       |
| 009689 | 3RV-5    | 60" Round Pipe                  |       |
| 052598 | 3RV-60   | 45°/60° Adjustable Elbow        |       |
| 009790 | 3RV-90   | 90° Adjustable Elbow            |       |
| 009657 | 3RV-AF12 | Adj Roof Flashing 6/12 to 12/12 |       |
| 009676 | 3RV-AJ   | 12" Adj Length Pipe             |       |
| 009663 | 3RV-DH   | Draft Hood Connector            |       |

**Type "B" Gas RV Vent Pipe & Fittings (Continued)**

**3" Gas Vent Round**

| Part # | Mfg #    | Description                   | Price |
|--------|----------|-------------------------------|-------|
| 009774 | 3RV-FSPU | 3" Quick Grip Firestop/Spacer |       |
| 053951 | 3RV-HWT  | High Wind Top                 |       |
| 009668 | 3RV-I4   | 3" x 4" Increaser             |       |
| 009669 | 3RV-I5   | 3" x 5" Increaser             |       |
| 096904 | 3RV-I6   | 3" x 6" Increaser             |       |
| 009760 | 3RV-RT   | Vent Top                      |       |
| 009729 | 3RV-SC   | Storm Collar                  |       |
| 009748 | 3RV-TC   | Tee Cap                       |       |
| 009754 | 3RV-TF   | Tall Cone Flat Roof Flashing  |       |
| 009653 | 3RV-TFA  | Tall Cone Adj Roof Flashing   |       |
| 009766 | 3RV-TS   | Tee                           |       |
| 043482 | 3RV-WT   | Adj Wall Thimble              |       |

**4" Gas Vent Round**

| Part # | Mfg #       | Description                     | Price |
|--------|-------------|---------------------------------|-------|
| 009696 | 4RV-6       | 6" Round Pipe                   |       |
| 009691 | 4RV-12      | 12" Round Pipe                  |       |
| 009692 | 4RV-18      | 18" Round Pipe                  |       |
| 009693 | 4RV-2       | 24" Round Pipe                  |       |
| 009694 | 4RV-3       | 36" Round Pipe                  |       |
| 041120 | 4RV-4       | 48" Round Pipe                  |       |
| 009695 | 4RV-5       | 60" Round Pipe                  |       |
| 009675 | 4RV-3RA     | 3" Rheem Adapter                |       |
| 009794 | 4RV-90      | 90° Adjustable Elbow            |       |
| 009658 | 4RV-AF12    | Adj Roof Flashing 6/12 to 12/12 |       |
| 009677 | 4RV-AJ      | 12" Adj Length Pipe             |       |
| 009678 | 4RV-AJ18    | 18" Adj Length Pipe             |       |
| 009664 | 4RV-DH      | Draft Hood Connector            |       |
| 052600 | 4RV-EL45/60 | 45°/60° Adjustable Ell          |       |
| 009775 | 4RV-FSPU    | 4" Quick Grip Firestop/Spacer   |       |
| 053952 | 4RV-HWT     | Hi-Wind Cap                     |       |
| 009670 | 4RV-I5      | 4" x 5" Increaser               |       |
| 009671 | 4RV-I6      | 4" x 6" Increaser               |       |
| 009761 | 4RV-RT      | Top Vent (Bird Proof)           |       |
| 009730 | 4RV-SC      | Storm Collar                    |       |
| 009749 | 4RV-TC      | Tee Cap                         |       |
| 009755 | 4RV-TF      | Tall Cone Flat Roof Flashing    |       |
| 009654 | 4RV-TFA     | Tall Cone Adj Roof Flashing     |       |
| 009767 | 4RV-TS      | Tee                             |       |
| 037624 | 4RV-WT      | Adj Wall Thimble                |       |
| 009779 | 4RV-WV4     | Round to Oval Adapter           |       |

## RV Round Venting

### 5" Gas Vent Round

| Part # | Mfg #     | Description                     | Price |
|--------|-----------|---------------------------------|-------|
| 009702 | 5RV-6     | 6" Round Pipe                   |       |
| 009697 | 5RV-12    | 12" Round Pipe                  |       |
| 009698 | 5RV-18    | 18" Round Pipe                  |       |
| 009699 | 5RV-2     | 24" Round Pipe                  |       |
| 009700 | 5RV-3     | 36" Round Pipe                  |       |
| 041121 | 5RV-4     | 48" Round Pipe                  |       |
| 009701 | 5RV-5     | 60" Round Pipe                  |       |
| 009783 | 5RV4-FY   | 4" Fixed Wye s/4" Snout         |       |
| 114028 | 5RV43FY   | 5" x 4" x 3" Fixed Wye          |       |
| 009780 | 5RV-5/6WV | Round to Oval Adapter           |       |
| 052601 | 5RV-60    | 45°/60° Adjustable Elbow        |       |
| 009795 | 5RV-90    | 90° Adjustable Elbow            |       |
| 009655 | 5RV-AF    | Adj Roof Flashing Flat to 6/12  |       |
| 009659 | 5RV-AF12  | Adj Roof Flashing 6/12 to 12/12 |       |
| 009679 | 5RV-AJ    | 12" Adj Length Pipe             |       |
| 009680 | 5RV-AJ18  | 18" Adj Length Pipe             |       |
| 009665 | 5RV-DH    | Draft Hood Connector            |       |
| 009776 | 5RV-FSPU  | 5" Quick Grip Firestop/Spacer   |       |
| 053953 | 5RV-HWT   | Hi-Wind Top                     |       |
| 009672 | 5RV-I6    | 5" x 6" Increaser               |       |
| 009762 | 5RV-RT    | Vent Top                        |       |
| 009731 | 5RV-SC    | Storm Collar                    |       |
| 009750 | 5RV-TC    | Tee Cap                         |       |
| 009756 | 5RV-TF    | Tall Cone Flat Roof Flashing    |       |
| 009768 | 5RV-TS    | Tee                             |       |

### 6" Gas Vent Round

| Part # | Mfg #     | Description                     | Price |
|--------|-----------|---------------------------------|-------|
| 009708 | 6RV-6     | 6" Round Pipe                   |       |
| 009703 | 6RV-12    | 12" Round Pipe                  |       |
| 009704 | 6RV-18    | 18" Round Pipe                  |       |
| 009705 | 6RV-2     | 24" Round Pipe                  |       |
| 009706 | 6RV-3     | 36" Round Pipe                  |       |
| 009707 | 6RV-5     | 60" Round Pipe                  |       |
| 009781 | 6RV-5/6WV | Round to Oval Adapter           |       |
| 052602 | 6RV-60    | 45°/60° Adjustable Elbow        |       |
| 009796 | 6RV-90    | 90° Adjustable Elbow            |       |
| 009656 | 6RV-AF    | Adj Roof Flashing Flat to 6/12  |       |
| 009660 | 6RV-AF12  | Adj Roof Flashing 6/12 to 12/12 |       |
| 009681 | 6RV-AJ    | 12" Adj Length Pipe             |       |
| 009666 | 6RV-DH    | Draft Hood Connector            |       |
| 009777 | 6RV-FSPU  | 6" Quick Grip Firestop/Spacer   |       |
| 053954 | 6RV-HWT   | Hi-Wind Cap                     |       |
| 009673 | 6RV-I7    | 6" x 7" Increaser               |       |
| 009674 | 6RV-I8    | 6" x 8" Increaser               |       |

### Type "B" Gas RV Vent Pipe & Fittings (Continued)

#### 6" Gas Vent Round

| Part # | Mfg #  | Description                  | Price |
|--------|--------|------------------------------|-------|
| 009763 | 6RV-RT | Vent Top                     |       |
| 009732 | 6RV-SC | Storm Collar                 |       |
| 009751 | 6RV-TC | Tee Cap                      |       |
| 009757 | 6RV-TF | Tall Cone Flat Roof Flashing |       |
| 009769 | 6RV-TS | Tee                          |       |

#### 7" Gas Vent Round

| Part # | Mfg #    | Description                     | Price |
|--------|----------|---------------------------------|-------|
| 009714 | 7RV-6    | 6" Round Pipe                   |       |
| 009709 | 7RV-12   | 12" Round Pipe                  |       |
| 009710 | 7RV-18   | 18" Round Pipe                  |       |
| 009711 | 7RV-2    | 24" Round Pipe                  |       |
| 009712 | 7RV-3    | 36" Round Pipe                  |       |
| 009713 | 7RV-5    | 60" Round Pipe                  |       |
| 009788 | 7RV-45   | 45° Adjustable Elbow            |       |
| 009797 | 7RV-90   | 90° Adjustable Elbow            |       |
| 009661 | 7RV-AF   | Adj Roof Flashing Flat to 6/12  |       |
| 062593 | 7RV-AF12 | Adj Roof Flashing 6/12 to 12/12 |       |
| 009764 | 7RV-RT   | Vent Top                        |       |
| 009733 | 7RV-SC   | Storm Collar                    |       |
| 009752 | 7RV-TC   | Tee Cap                         |       |
| 009758 | 7RV-TF   | Tall Cone Flat Roof Flashing    |       |
| 009770 | 7RV-TS   | Tee                             |       |

#### 8" Gas Vent Round

| Part # | Mfg #    | Description                    | Price |
|--------|----------|--------------------------------|-------|
| 009720 | 8RV-6    | 6" Round Pipe                  |       |
| 009715 | 8RV-12   | 12" Round Pipe                 |       |
| 009716 | 8RV-18   | 18" Round Pipe                 |       |
| 009717 | 8RV-2    | 24" Round Pipe                 |       |
| 009718 | 8RV-3    | 36" Round Pipe                 |       |
| 009719 | 8RV-5    | 60" Round Pipe                 |       |
| 009789 | 8RV-45   | 45° Adjustable Elbow           |       |
| 009798 | 8RV-90   | 90° Adjustable Elbow           |       |
| 009682 | 8RV-AJ   | 12" Adj Length Pipe            |       |
| 009662 | 8RV-AF   | Adj Roof Flashing Flat to 6/12 |       |
| 088718 | 8RV-AF12 | Adj Roof Flashing 6/12 - 12/12 |       |
| 009667 | 8RV-DH   | Draft Hood Connector           |       |
| 009765 | 8RV-RT   | Vent Top                       |       |
| 009734 | 8RV-SC   | Storm Collar                   |       |
| 009753 | 8RV-TC   | Tee Cap                        |       |
| 009759 | 8RV-TF   | Tall Cone Flat Roof Flashing   |       |
| 009771 | 8RV-TS   | Tee                            |       |

Venting

## Stainless Steel All Fuel Venting

### Chimney Systems

- Rugged all fuel chimney
- Meets all UL® requirements
- Model SSII-Type HT tested to 2100°F
- Model SSII tested UL®-103 max temp of 1700°F
- Gravity venting only

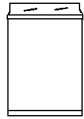

Insulated Pipe

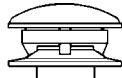

Round Top

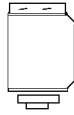

Insulated Tee w/Cap



15° Insulated Elbow

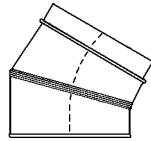

30° Insulated Elbow



Dripless Adptr w/Coupler

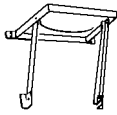

Wall Support Kit

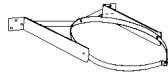

Wall Band

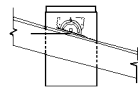

Roof Support



Ceiling Support

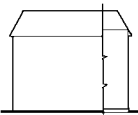

Attic Insulation Shield

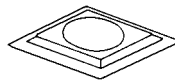

Fire Stop/Wall Spacer

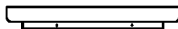

Finishing Collar

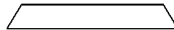

Storm Collar

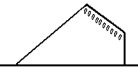

Adjustable Flashing

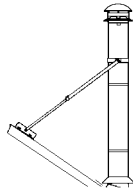

Roof Brace Kit



Locking Band

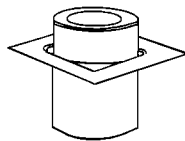

Joist Shield

### SSII-Type HT 6" Insulated Pipe & Fittings

| Part # | Mfg #      | Description                           | Price |
|--------|------------|---------------------------------------|-------|
| 001049 | 6UT-9      | 6" x 9" Pipe                          |       |
| 001047 | 6UT-18     | 6" x 18" Pipe                         |       |
| 001048 | 6UT-36     | 6" x 36" Pipe                         |       |
| 001030 | 6T-AF6     | 0/12 - 6/12 Adj Flashing              |       |
| 001029 | 6T-AF12    | 6/12 - 12/12 Adj Flashing             |       |
| 001032 | 6T-CT      | Round Top                             |       |
| 001033 | 6T-DSA     | Dripless Smoke Pipe Adapter           |       |
| 001034 | 6T-DSAC    | Dripless Smoke Pipe Adapter w/Coupler |       |
| 070232 | 6T-EL15KIT | 15° Elbow Kit                         |       |
| 001036 | 6T-FC      | Finishing Collar                      |       |

### Chimney Systems (Continued)

#### SSII-Type HT 6" Insulated Pipe & Fittings

| Part # | Mfg #   | Description                      | Price |
|--------|---------|----------------------------------|-------|
| 001037 | 6T-FSP  | Ceiling Support, Sq Plate        |       |
| 001038 | 6T-IT   | Tee                              |       |
| 021232 | 6T-JS   | Joist Shield                     |       |
| 001039 | 6T-LB   | Locking Band                     |       |
| 021355 | 6T-RBK  | Roof Brace Kit                   |       |
| 001040 | 6T-RSP  | Roof Support Package             |       |
| 001041 | 5/6T-SC | 6" Metal Storm Collar            |       |
| 001043 | 6T-TF   | 0 - 2/12 Tall Cone Roof Flashing |       |
| 074623 | 6T-TPS  | Fire Stop/Trim Collar w/Spacer   |       |
| 001044 | 6T-WB   | Wall Band                        |       |
| 001046 | 6T-WSK  | Wall Support Kit                 |       |

#### SSII-Type HT 7" Insulated Pipe & Fittings

| Part # | Mfg #      | Description                  | Price |
|--------|------------|------------------------------|-------|
| 001059 | 7UT-18     | 7" x 18" Pipe                |       |
| 001060 | 7UT-36     | 7" x 36" Pipe                |       |
| 001050 | 7TAF-6     | 6/12 Flashing                |       |
| 070237 | 7T-EL30KIT | 30° Elbow Kit                |       |
| 001051 | 7T-CT      | Round Top                    |       |
| 001053 | 7T-FSP     | Finish Support Pkg, Sq Plate |       |
| 001054 | 7T-IT      | Tee                          |       |

#### SSII-Type HT 8" Insulated Pipe & Fittings

| Part # | Mfg #      | Description                           | Price |
|--------|------------|---------------------------------------|-------|
| 081186 | 8UT-6      | 8" x 6" Insulated Pipe                |       |
| 001081 | 8UT-9      | 8" x 9" Insulated Pipe                |       |
| 001079 | 8UT-18     | 8" x 18" Insulated Pipe               |       |
| 080939 | 8UT-24     | 8" x 24" Insulated Pipe               |       |
| 001080 | 8UT-36     | 8" x 36" Insulated Pipe               |       |
| 001062 | 8T-AF6     | Adj Flashing                          |       |
| 001065 | 8T-CT      | Round Top                             |       |
| 001066 | 8T-DSAC    | Dripless Smoke Pipe Adapter w/Coupler |       |
| 070234 | 8T-EL15KIT | 15° Elbow Kit                         |       |
| 001069 | 8T-FSP     | Ceiling Support, Sq Plate             |       |
| 001070 | 8T-IT      | Tee                                   |       |
| 001071 | 8T-JS      | Joist Shield                          |       |
| 001072 | 8T-LB      | Locking Band                          |       |
| 001056 | 7/8T-SC    | 8" Metal Storm Collar                 |       |
| 001076 | 8T-WB      | Wall Band                             |       |
| 001078 | 8T-WSK     | Wall Support Kit                      |       |



---

---

## Stainless Steel All Fuel Venting

---

---

### SSII-Type HT 10" Insulated Pipe & Fittings

| Part # | Mfg #   | Description              | Price |
|--------|---------|--------------------------|-------|
| 070246 | 10UT-36 | 10" x 36" Insulated Pipe |       |

### SSII 10" Insulated Fittings

| Part # | Mfg #    | Description                | Price |
|--------|----------|----------------------------|-------|
| 066181 | 10SAF-12 | 2/12 to 6/12 Roof Flashing |       |
| 012309 | 10S-CT   | Round Chimney Top          |       |
| 012314 | 10S-SC   | Storm Collar               |       |

Venting

## WV Oval Venting

### Gas Vent Oval Pipe & Fittings

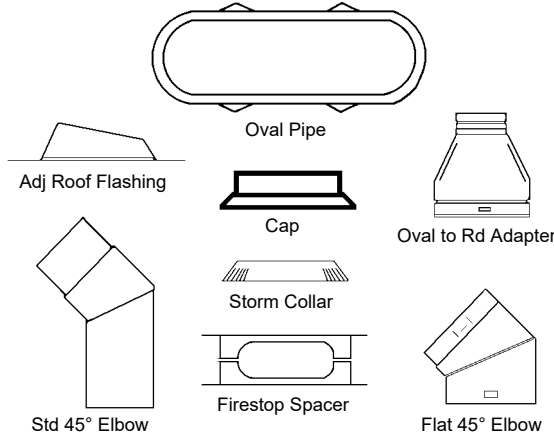

#### 4" Gas Vent Oval

| Part # | Mfg #   | Description              | Price |
|--------|---------|--------------------------|-------|
| 007919 | 4OV-12  | 12" Oval Pipe            |       |
| 007920 | 4OV-2   | 24" Oval Pipe            |       |
| 007921 | 4OV-3   | 36" Oval Pipe            |       |
| 007922 | 4OV-4   | 48" Oval Pipe            |       |
| 007923 | 4OV-5   | 60" Oval Pipe            |       |
| 007924 | 4OV-45F | Flat 45° Elbow           |       |
| 007925 | 4OV-45S | Standard 45° Elbow       |       |
| 012142 | 4OV-4RV | Oval to 4" Round Adapter |       |
| 089500 | 4OV-FS  | Firestop Spacer          |       |
| 012145 | 4OV-SC  | Storm Collar             |       |
| 007918 | 4OV-TS  | Oval to Round Tee        |       |
| 007917 | 4OV-TC  | Tee Cap                  |       |

#### 5"/6" Gas Vent Oval

| Part # | Mfg #     | Description              | Price |
|--------|-----------|--------------------------|-------|
| 012135 | 5/6OV-12  | 12" Oval Pipe            |       |
| 012136 | 5/6OV-2   | 24" Oval Pipe            |       |
| 012138 | 5/6OV-4   | 48" Oval Pipe            |       |
| 012139 | 5/6OV-5   | 60" Oval Pipe            |       |
| 012143 | 5/6OV-5RV | 5" Oval to Round Adapter |       |
| 012144 | 5/6OV-6RV | 6" Oval to Round Adapter |       |
| 012140 | 5/6OV-T5  | Oval to 5" Round Tee     |       |
| 012147 | 5/6OV-TC  | Tee Cap                  |       |

Venting

**Roof & Chimney Caps**

**Venting Caps**

**634/634M Black Roof Cap**

- Built-in backdraft damper and bird screen
- 24 Gauge CRCQ Steel, black electrically-bonded finish



| Part # | Mfg # | Description                       | Price |
|--------|-------|-----------------------------------|-------|
| 002548 | 634   | For 3-1/4" x 10" or 8" Round Duct |       |
| 074322 | 634M  | For 3-1/4" x 10" or 6" Round Duct |       |

**636 Black Roof Cap**

- Built-in backdraft damper and birdscreen
- 24 Gauge CRCQ Steel, black electrically-bonded finish



| Part # | Mfg # | Description             | Price |
|--------|-------|-------------------------|-------|
| 082892 | 636   | For 3" or 4" Round Duct |       |

**639 Black Wall Cap**

- Spring-loaded backdraft damper
- Built-in bird screen
- Steel baked black enamel finish
- 24 Gauge CRCQ Steel, black electrically-bonded finish



| Part # | Mfg # | Description                       | Price |
|--------|-------|-----------------------------------|-------|
| 002550 | 639   | Black Steel for 3-1/4" x 10" Duct |       |

**641 Aluminum Wall Cap**

- Built-in backdraft damper and birdscreen
- Aluminum natural finish



| Part # | Mfg # | Description                      | Price |
|--------|-------|----------------------------------|-------|
| 002551 | 641   | Aluminum for 6" Round Duct       |       |
| 024789 | 642   | Aluminum for 3" or 4" Round Duct |       |

**643 Aluminum Wall Cap**

- Built-in backdraft damper
- Aluminum natural finish



| Part # | Mfg # | Description                | Price |
|--------|-------|----------------------------|-------|
| 081057 | 643   | Aluminum for 8" Round Duct |       |

**885-BL Black Wall Cap**

- 4" to 3" Transition included
- Built-in bird screen
- 24 Gauge CRCQ Steel, black electrically bonded epoxy finish
- Built-in damper



| Part # | Mfg # | Description                   | Price |
|--------|-------|-------------------------------|-------|
| 145669 | 885BL | Black for 3" or 4" Round Duct |       |

**BVDS Exhaust Vent**

- Bath & kitchen
- High density polyethylene
- 1-1/4" Removable mesh screen
- Removable stem



| Part # | Mfg #      | Size | Color | Price |
|--------|------------|------|-------|-------|
| 233071 | BVDS-4-BLK | 4"   | Black |       |

**Exhaust Fans**

**Exhaust Fan Finish Pack**

- To be used with RDH housing pack
- 120V
- 4" Duct diameter
- 2.5 Sones
- Recommended room size: 75 Sq Ft

| Part # | Mfg # | CFM | Sones | Price |
|--------|-------|-----|-------|-------|
| 234406 | 80RDF | 80  | 2.5   |       |

**Exhaust Fan Rough-In Kit**

- Contains housing and radiation damper

| Part # | Mfg # | CFM              | Sones | Price |
|--------|-------|------------------|-------|-------|
| 234407 | RDH   | Radiation Grille |       |       |

Venting

**Plastic High Temperature Sealants**

**Silicone Sealants**

**100% Silicone Sealant Squeeze Tube**

- 100% silicone
- Will not crack, shrink or peel
- Interior/exterior use
- Solvent clean-up, not paintable



| Part # | Mfg # | Size      | Color | Price |
|--------|-------|-----------|-------|-------|
| 128598 | 0810  | 2.8 fl oz | White |       |
| 008384 | 0820  | 2.8 fl oz | Clear |       |

Venting

**Plastic High Temperature Sealants**

**Silicone Caulk**

**Silicone Construction Caulk**

- For indoor or outdoor use
- Permanently flexible
- -60°F - +450°F Water and weatherproof
- Insulates electrically and thermally room temperature vulcanizing



| Part # | Mfg # | Description    | Price |
|--------|-------|----------------|-------|
| 059844 | 12W   | 10.3 oz, White |       |
| 059845 | 12C   | 10.3 oz, Clear |       |

**Silicone Seal Carded**

- For indoor or outdoor use
- Permanently flexible
- -60°F - +450°F Water and weatherproof
- Insulates electrically and thermally room temperature vulcanizing



3W



3C

| Part # | Mfg # | Description                             | Price |
|--------|-------|---|-------|
| 059842 | 3W    | 3 oz, White Mildew Resistant<br>FDA/NSF |       |
| 059843 | 3C    | 3 oz, Clear USDA/FDA/NSF                |       |

Venting

**Stainless Steel Venting**

**FasNSeal® Adapters**

**Weil McLain Tee Appliance Adapter**



| Part # | Mfg #  | Size | Price |
|--------|--------|------|-------|
| 041443 | 300358 | 3"   |       |

**FasNSeal® Single-Wall Special Gas Vent**

**Vent Length Pipe**

- Use to vent category II, III and IV appliances



| Part # | Mfg #  | Size     | Price |
|--------|--------|----------|-------|
| 040346 | 300001 | 3" x 6"  |       |
| 040347 | 300015 | 3" x 12" |       |
| 040348 | 300045 | 3" x 18" |       |
| 040349 | 300060 | 3" x 24" |       |
| 040350 | 300075 | 3" x 36" |       |
| 041867 | 300076 | 4" x 36" |       |
| 041863 | 300002 | 4" x 6"  |       |
| 041864 | 300016 | 4" x 12" |       |
| 041866 | 300061 | 4" x 24" |       |

**Adjustable Vent Length Pipe**

- Use to add length to straight length of FasNSeal® pipe
- Adds 2" - 14" of length
- Requires at least 2" overlap for a secure connection



| Part # | Mfg #  | Size     | Price |
|--------|--------|----------|-------|
| 046673 | 300250 | 3" x 18" |       |

**45° Elbow**

- Allows for better condensate management and less back pressure



| Part # | Mfg #  | Size | Price |
|--------|--------|------|-------|
| 041868 | 300131 | 4"   |       |

**90° Elbow**

- Use to go from horizontal to vertical runs or vertical to horizontal runs
- Use to turn vent 90°



| Part # | Mfg #  | Size | Price |
|--------|--------|------|-------|
| 040352 | 300160 | 3"   |       |
| 041869 | 300161 | 4"   |       |

**Bird Screen**

- Use for 3" and 4" standard through-the-wall terminations



| Part # | Mfg #  | Size | Price |
|--------|--------|------|-------|
| 040356 | 300186 | 3"   |       |
| 041873 | 300187 | 4"   |       |

**Horizontal Drip Tee**

- Use to manage condensate in horizontal runs



| Part # | Mfg #  | Size | Price |
|--------|--------|------|-------|
| 040354 | 300236 | 3"   |       |
| 041872 | 300237 | 4"   |       |

**Wall Thimble with Adjustable Vent Length Pipe**

- Use for through-the-wall termination
- Fits between standard wall studs



| Part # | Mfg #  | Size | Price |
|--------|--------|------|-------|
| 040353 | 300280 | 3"   |       |
| 041871 | 300281 | 4"   |       |

Venting

## Work Gloves

### Work Gloves

#### Demolition Gloves

- Built-in terry cloth sweat wipe
- Velcro Closure for a secure fit
- Breathable Lining - Moisture wicking lining provides all day comfort
- Molded Knuckle Protection - TPR pad provides ultimate knuckle protection
- Palms and Finger Tips reinforced with Armortex® for ultimate durability and grip
- Smartswipe™ Knuckle



| Part # | Mfg #      | Size        | Price |
|--------|------------|-------------|-------|
| 229541 | 48-22-8735 | Small       |       |
| 186454 | 48-22-8731 | Medium      |       |
| 186456 | 48-22-8732 | Large       |       |
| 186457 | 48-22-8733 | Extra Large |       |
| 186458 | 48-22-8734 | 2X Large    |       |

#### Fingerless Work Gloves

- Fingerless design for ultimate dexterity
- Reinforced and padded palm
- Built-in terry cloth sweat wipe
- Hook & loop closure for a secure fit
- Breathable lining provides all day comfort



| Part # | Mfg #      | Size        | Price |
|--------|------------|-------------|-------|
| 224333 | 48-22-8745 | Small       |       |
| 224334 | 48-22-8741 | Medium      |       |
| 224335 | 48-22-8742 | Large       |       |
| 224336 | 48-22-8743 | Extra Large |       |
| 224337 | 48-22-8744 | 2X Large    |       |

#### Free-Flex Work Gloves

- Built-in terry cloth sweat wipe
- Free-Flex cuff for all day comfort
- Breathable lining provides all day comfort reinforced thumb seam
- High dexterity finger tips provide dexter when handling small objects
- Smartswipe™ Fingertips, Knuckles and Palms



| Part # | Mfg #      | Size        | Price |
|--------|------------|-------------|-------|
| 224343 | 48-22-8715 | Small       |       |
| 224346 | 48-22-8711 | Medium      |       |
| 224347 | 48-22-8712 | Large       |       |
| 224348 | 48-22-8713 | Extra Large |       |
| 224349 | 48-22-8714 | 2X Large    |       |

### Performance Work Gloves

- Built-in terry cloth sweat wipe
- Breathable lining provides all day comfort
- Hook & loop closure for a secure fit
- High dexterity finger tips provide dexterity when handling small objects
- Smartswipe™ Fingertips, Knuckles and Palms



| Part # | Mfg #      | Size        | Price |
|--------|------------|-------------|-------|
| 224338 | 48-22-8725 | Small       |       |
| 224339 | 48-22-8721 | Medium      |       |
| 224340 | 48-22-8722 | Large       |       |
| 224341 | 48-22-8723 | Extra Large |       |
| 224342 | 48-22-8724 | 2X Large    |       |

#### Cut Level 1 Dipped Gloves

- ANSI & EN cut rating 1
- Textured nitrile palm
- SMARTSWIPE™ palm and fingertips
- High dexterity design
- Nylon/lycra blend material
- TDM cut rating C, Abrasion rating 3, Tear rating 2, Puncture rating 1
- Breathable glove design



| Part # | Mfg #      | Size        | Price |
|--------|------------|-------------|-------|
| 244551 | 48-22-8900 | Small       |       |
| 244552 | 48-22-8901 | Medium      |       |
| 243227 | 48-22-8902 | Large       |       |
| 243228 | 48-22-8903 | Extra Large |       |
| 244553 | 48-22-8904 | 2X Large    |       |

#### Cut Level 5 Dipped Gloves

- SMARTSWIPE™ palm and fingertips
- High dexterity design
- Abrasion rating 4, puncture rating 4
- TDM cut rating E
- Nylon & HPPE liner material
- Double dipped nitrile w/ sandy texture finish



| Part # | Mfg #      | Size        | Price |
|--------|------------|-------------|-------|
| 247748 | 48-22-8950 | Small       |       |
| 247750 | 48-22-8951 | Medium      |       |
| 247751 | 48-22-8952 | Large       |       |
| 247752 | 48-22-8953 | Extra Large |       |
| 247753 | 48-22-8954 | 2X Large    |       |

Work Wear

**Gloves, Ear Plugs, Goggles, ETC**

**Gloves**

**Journeyman Utility Gloves (K1)**

- *Supple, breathable, durable synthetic leather palm*
- *2-Way stretch spandex padded top features form-fitting elasticity*
- *Reinforced thumb, index finger and fingertips add protection*
- *Concealed interior seam stitching prevents snagging*
- *Wide opening elastic cuff*
- *Contact points on index finger and thumb feature smooth surface for improved handling of objects*

**JOURNEYMAN**™



| Part # | Mfg # | Size    | Price |
|--------|-------|---------|-------|
| 106850 | 40052 | Medium  |       |
| 106851 | 40053 | Large   |       |
| 106852 | 40054 | X-Large |       |

**Journeyman™ Heavy-Duty Protection Gloves (K3)**

- *Streamlined high-density accordion knuckle panel reduces impact*
- *High profile, impact absorbing molded Thermal Plastic Rubber (TPR) finger protection*
- *Non-slip rubberized Zeus™ Carino® finger and thumb grippers and panel on heel of hand provide grip control and longer wear*
- *Synthetic leather with breathable mesh side insert finger panels*
- *2-Ply synthetic leather palm with anatomically die cut Ethylene Vinyl Acetate (EVA) foam padded impact zones*
- *Thermal Plastic Rubber (TRP) cuff strap with hook and loop closure*
- *Neoprene cuff allows easier access with additional wrist protection and comfort*

**JOURNEYMAN**™



| Part # | Mfg # | Size  | Price |
|--------|-------|-------|-------|
| 106857 | 40063 | Large |       |

WORK WEAR



**Gloves, Ear Plugs, Goggles, ETC**

**Gloves**

**Disposable Latex Glove**

- Extra large
- Reversible



| Part # | Mfg #     | Type       | Size | Price |
|--------|-----------|------------|------|-------|
| 060105 | 390-50177 | Heavy-Duty | XL   |       |

Work Wear

**Gloves, Ear Plugs, Goggles, ETC**

**Gloves**

**X10 Knucklehead Glove**

- Synthetic leather palm
- Elastic wrist
- High visibility orange



| Part # | Mfg #      | Description       | Price |
|--------|------------|-------------------|-------|
| 148262 | 21242HOL   | Large             |       |
| 148263 | 21242HOXL  | Extra Large       |       |
| 148135 | 21242HOXXL | Extra Extra Large |       |

**Split Cowhide Double Palm Glove**

- Knuckle strap
- Wing thumb
- Polyethylene safety cuff



| Part # | Mfg #     | Description | Price |
|--------|-----------|-------------|-------|
| 122046 | 4503CDPXL | Extra Large |       |

**String Knit Cotton/Polyester Glove**

- Ambidextrous
- PVC Dots on both sides
- Natural color



| Part # | Mfg # | Description | Price |
|--------|-------|-------------|-------|
| 122623 | 3825L | Large       |       |

**A Grade Gold Deerskin Palm Glove**

- Black stretch back
- Velcro closure
- Mechanics style
- Heatlok lined



| Part # | Mfg #    | Description       | Price |
|--------|----------|-------------------|-------|
| 129331 | 2150HM   | Medium            |       |
| 129332 | 2150HXL  | Extra Large       |       |
| 129346 | 2150HXXL | Extra Extra Large |       |

**High Visibility Terry Lined Yellow Knit No Logo Glove**

- Black rubber palm hides dirt
- Rubber palm
- Super fit
- Precurved design promotes easy flexing



| Part # | Mfg #     | Description | Price |
|--------|-----------|-------------|-------|
| 144702 | 3396HYNL  | Large       |       |
| 144701 | 3396HYNXL | Extra Large |       |

**High Visibility Yellow Knit Glove**

- Summer version
- Black rubber palm hides dirt
- Rubber palm
- Super fit
- Precurved design promotes easy flexing



| Part # | Mfg #   | Description | Price |
|--------|---------|-------------|-------|
| 122621 | 3397HYL | Large       |       |

**High Visibility Yellow Knit No Logo Glove**

- Rubber palm
- Excellent wear and resistance
- Super fit



| Part # | Mfg #     | Description | Price |
|--------|-----------|-------------|-------|
| 140861 | 3397HYNM  | Medium      |       |
| 140863 | 3397HYNL  | Large       |       |
| 140858 | 3397HYNXL | Extra Large |       |

**High Visibility Superdex Gloves**

- Nylon shell
- 15 Gauge liner
- 100% Launderable
- Pre-curved finger design
- Ultra cool & breathable coating
- Micro foam nitrile coated palm



| Part # | Mfg #     | Description | Price |
|--------|-----------|-------------|-------|
| 159170 | 3228HVYL  | Large       |       |
| 159171 | 3228HVYXL | Extra Large |       |

Work Wear

**Gloves, Ear Plugs, Goggles, ETC**

**High Visibility Orange Knit Glove**

- Summer version
- Black rubber palm hides dirt
- Precurved design promotes easy flexing
- Rubber palm
- Super fit



| Part # | Mfg #   | Description | Price |
|--------|---------|-------------|-------|
| 122620 | 3397HOL | Large       |       |

**High Visibility Orange Knit No Logo Glove**

- Rubber palm
- Excellent wear and resistance
- Super fit

| Part # | Mfg #     | Description | Price |
|--------|-----------|-------------|-------|
| 140860 | 3397HONM  | Medium      |       |
| 140862 | 3397HONL  | Large       |       |
| 140859 | 3397HONXL | Extra Large |       |

**SuperDex Gray Nitrile Palm Dipped Glove**

- Lightweight black nylon liner
- Knit wrist
- Black/gray



| Part # | Mfg #  | Description | Price |
|--------|--------|-------------|-------|
| 169298 | 3270L  | Large       |       |
| 169299 | 3720XL | Extra Large |       |

**OXXA X-Pro Flex Gloves**

- Micro foam nitrile palm coating nylon shell



| Part # | Mfg #  | Description | Price |
|--------|--------|-------------|-------|
| 159172 | 51-290 | Medium      |       |
| 159173 | 51-290 | Large       |       |

**Disposable Nitrile Glove**

- Textured fingertips
- Powder-free
- 5 - 6 Mil
- 100/Box

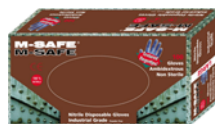

| Part # | Mfg # | Description | Price |
|--------|-------|-------------|-------|
| 121772 | 3276L | Large       |       |

**Gloves (Continued)**

**Disposable Nitrile Glove**

| Part # | Mfg #  | Description | Price |
|--------|--------|-------------|-------|
| 133593 | 3276XL | Extra Large |       |

## Gloves, Ear Plugs, Goggles, ETC

### Gloves Gloves



| Part # | Mfg #   | Description                  | Price |
|--------|---------|------------------------------|-------|
| 030870 | G50-204 | Leather Palm Low Safety Cuff |       |

### Brown Cotton Jersey Work Gloves

- 100% Brown cotton
- One size fits all
- Knit wrist
- 8 oz



| Part # | Mfg #   | Description | Price |
|--------|---------|-------------|-------|
| 030869 | G50-200 | Brown       |       |

### Disposable Latex Gloves

- 50 per box
- Powder free
- Large



| Part # | Mfg #  | Description | Price |
|--------|--------|-------------|-------|
| 224077 | G50212 | Blue Latex  |       |

### Vinyl Disposable Gloves

- 8 Pack
- Powder free
- Heavy-duty, multi-purpose
- One size fits all



| Part # | Mfg #  | Description | Price |
|--------|--------|-------------|-------|
| 190128 | G50302 | Blue Vinyl  |       |

### Blue Nitrile Gloves

- Powdered
- (50) Pair per box
- Thickness: 3 mil



| Part # | Mfg #  | Description         | Price |
|--------|--------|---------------------|-------|
| 227056 | G50230 | Blue Nitrile, LG/XL |       |

### Gloves (Continued) Blue Nitrile Gloves

| Part # | Mfg #  | Description        | Price |
|--------|--------|--------------------|-------|
| 226327 | G50231 | Blue Nitrile, M/LG |       |

### Disposable Respirators

#### Dust Mask

- Disposable
- Non Toxic



| Part # | Mfg #  | Description       | Price |
|--------|--------|-------------------|-------|
| 175628 | G30021 | Box of Dust Masks |       |

### Safety Hats

#### White Safety Hat

- Meets ANSI z89.1 requirements
- Short peak design creates greater upward visibility
- Comfortable 4-point suspension with terry cloth sweatbands



| Part # | Mfg #  | Description                            | Price |
|--------|--------|--|-------|
| 188732 | H40002 | Fits Sizes 6-1/2-8                     |       |
| 188735 | H40004 | Fits Sizes 6-1/2-8, Ratchet Suspension |       |

### Miscellaneous Work Wear

#### Cotton Canvas Drop Cloth

- 8 oz.
- Absorbs and traps spills
- Washable and reusable



| Part # | Mfg #  | Description | Price |
|--------|--------|-------------|-------|
| 188740 | G02010 | 6' x 9'     |       |

**Gloves, Ear Plugs, Goggles, ETC**

**Cowhide Drivers Gloves**

**Elastic Back Rough Rider Gloves**

- Made from top-grain leather
- Deep oil tanned
- Sewn with inset, keystone thumb
- Bound at cuff with leather
- Elastic back for an easy-on easy-off fit



| Part # | Mfg #  | Size  | Qty    | Price |
|--------|--------|-------|--------|-------|
| 051840 | 2500-L | Large | 1 Pair |       |

**Latex and Vinyl Coated Gloves**

**Yellow Flock Lined Latex Cleaning Gloves**

- 18 Mil natural latex
- Unsupported
- Soft flock lining absorbs moisture for easy off and on



| Part # | Mfg #  | Size  | Qty    | Price |
|--------|--------|-------|--------|-------|
| 051851 | 6000-L | Large | 1 Pair |       |

**Side Split Leather Gloves**

**Premium Side Split Leather Palm Gloves**

- Blue
- Side-split leather work gloves for longer wear and better protection
- Safety cuff



| Part # | Mfg #  | Size  | Qty    | Price |
|--------|--------|-------|--------|-------|
| 051839 | 2110-L | Large | 1 Pair |       |

**Hearing Protection**

**MAX Ear Plugs**

- Preshaped foam
- NRR33 Rated



| Part # | Mfg # | Description | Qty    | Price |
|--------|-------|-------------|--------|-------|
| 051843 | 9500  | Uncorded    | 100/Pk |       |

**Howard Leight Quiet Ear Plugs**

- Corded



| Part # | Mfg # | Description | Qty | Price |
|--------|-------|-------------|-----|-------|
| 051844 | 9522  | Corded      |     |       |

**Grain Leather Gloves**

**Rough Rider Grain Leather Palm Gloves**

- Made from top-grain leather
- Deep oil tanned
- Lined with 100 grams 3M Thinsulate insulation
- Heavy yellow canvas
- Knit wrists



| Part # | Mfg #  | Size  | Qty    | Price |
|--------|--------|-------|--------|-------|
| 051841 | 2160-L | Large | 1 Pair |       |

**Jersey Gloves**

| Part # | Mfg #  | Size       | Qty    | Price |
|--------|--------|------------|--------|-------|
| 051837 | 1100-L | 9 oz Large | 1 Pair |       |

**Double Palm and Chore Cotton Gloves**

**Galeton Gold Cotton Chore Cotton Gloves**

- 18 oz Quilted gold cotton chore
- Two layers of soft cotton
- Insulated against heat and cold
- Knit wrist



| Part # | Mfg #  | Size  | Qty    | Price |
|--------|--------|-------|--------|-------|
| 051838 | 3112-L | Large | 1 Pair |       |

**Disposable Respirators**

**Nuisance Dust Mask**

- Filters pollen, dust and other non-toxic particles from the air
- Withstands hot and humid conditions
- Double-shell construction resists collapse
- Easily adjustable nosepiece



| Part # | Mfg # | Description | Qty    | Price |
|--------|-------|-------------|--------|-------|
| 051842 | 9700  | Dust Mask   | 50/Box |       |

Work Wear

## Work Gear

### Work Wear

#### GridIron™ Zip-to-Thigh Bib Overall

- Freeflex™
- No Days Off™
- 2" Adjustable waist
- Durable metal buckles
- 100g high-loft insulation
- Tarnish resistant metal zippers
- Pockets include:
  - 2 front hand pockets
  - 2 large back pockets
  - 3 side leg pockets
  - Utility chest pocket
  - Tape measure & hammer loops



| Part # | Mfg #    | Waist   | Inseam | Price |
|--------|----------|---------|--------|-------|
| 241320 | 261B-SS  | 28"-30" | 28"    |       |
| 241319 | 261B-SR  | 28"-30" | 30"    |       |
| 241321 | 261B-ST  | 28"-30" | 32"    |       |
| 241317 | 261B-MS  | 32"-34" | 28"    |       |
| 241316 | 261B-MR  | 32"-34" | 30"    |       |
| 241318 | 261B-MT  | 32"-34" | 32"    |       |
| 241314 | 261B-LS  | 36"-38" | 28"    |       |
| 241313 | 261B-LR  | 36"-38" | 30"    |       |
| 241315 | 261B-LT  | 36"-38" | 32"    |       |
| 241323 | 261B-XLS | 40"-42" | 28"    |       |
| 241322 | 261B-XLR | 40"-42" | 30"    |       |
| 241324 | 261B-XLT | 40"-42" | 32"    |       |
| 241308 | 261B-2XS | 44"-46" | 28"    |       |
| 241307 | 261B-2XR | 44"-46" | 30"    |       |
| 241309 | 261B-2XT | 44"-46" | 32"    |       |
| 241311 | 261B-3XS | 48"-50" | 28"    |       |
| 241310 | 261B-3XR | 48"-50" | 30"    |       |
| 241312 | 261B-3XT | 48"-50" | 32"    |       |

#### Hooded Jacket - Black

- GridIron™ Ripstop polyester
- FreeFlex™ Mobility
- Wind and water resistant
- 100g of High-loft insulation
- Fitted hood
- Rib knit cuffs and waist



| Part # | Mfg #   | Size        | Price |
|--------|---------|-------------|-------|
| 224060 | 252B-S  | Small       |       |
| 224061 | 252B-M  | Medium      |       |
| 224062 | 252B-L  | Large       |       |
| 224063 | 252B-XL | Extra Large |       |
| 224065 | 252B-2X | 2X Large    |       |

### Work Wear (Continued)

#### Hooded Jacket - Black

| Part # | Mfg #   | Size     | Price |
|--------|---------|----------|-------|
| 224066 | 252B-3X | 3X Large |       |

#### WorkSkin™ Cold Weather Base Layer - Gray

- Fast wicking sweat zones move moisture away from under arms and upper back
- Durable body fabric
- Drop tail extended back
- Seamless shoulders



| Part # | Mfg #   | Size        | Price |
|--------|---------|-------------|-------|
| 224068 | 401G-S  | Small       |       |
| 224069 | 401G-M  | Medium      |       |
| 224070 | 401G-L  | Large       |       |
| 224071 | 401G-XL | Extra Large |       |
| 224072 | 401G-2X | 2X Large    |       |
| 224073 | 401G-3X | 3X Large    |       |

#### WorkSkin™ Light Weight Performance Shirt

- CoolCore® fabric
- Seamless shoulders
- Drop tail extended back
- Fast wicking sweat zones extend down the back and under the arms



| Part # | Mfg #   | Size        | Price |
|--------|---------|-------------|-------|
| 238077 | 410G-S  | Small       |       |
| 238078 | 410G-M  | Medium      |       |
| 238079 | 410G-L  | Large       |       |
| 238080 | 410G-XL | Extra Large |       |
| 238081 | 410G-2X | 2X Large    |       |
| 238082 | 410G-3X | 3X Large    |       |

#### WorkSkin™ Light Weight Performance Shirt High Visibility

- CoolCore® fabric
- Seamless shoulders
- Drop tail extended back
- Fast wicking sweat zones extend down the back and under the arms



| Part # | Mfg #   | Size   | Price |
|--------|---------|--------|-------|
| 238055 | 410HV-S | Small  |       |
| 238056 | 410HV-M | Medium |       |
| 238058 | 410HV-L | Large  |       |



## Work Gear

### Work Wear (Continued)

#### WorkSkin™ Light Weight Performance Shirt High Visibility

| Part # | Mfg #    | Size        | Price |
|--------|----------|-------------|-------|
| 238059 | 410HV-XL | Extra Large |       |
| 238061 | 410HV-2X | 2X Large    |       |
| 238063 | 410HV-3X | 3X Large    |       |

#### Fleece Lined Beanie

- One size fits all
- Polyester material wicks sweat
- Abrasion and snag resistant
- 98% Polyester, 2% spandex



| Part # | Mfg # | Color | Price |
|--------|-------|-------|-------|
| 238994 | 502G  | Gray  |       |
| 238996 | 502B  | Black |       |
| 238995 | 502R  | Red   |       |

#### Stocking Cap

| Part # | Mfg # | Color | Price |
|--------|-------|-------|-------|
| 224089 | 501G  | Gray  |       |
| 224090 | 501R  | Red   |       |

Work Wear

## Heated Gear

### Heated Jackets

#### All Kits Include

- (1) M12™ Heated Jacket
- (1) M12 REDLITHIUM™ 2.0 Compact Battery Pack (48-11-2420)
- (1) M12™ Lithium-ion Battery Charger (48-59-2401)
- (1) M12™ Battery Holder with 2.1A USB Charger

#### M12™ 3-in-1 Heated Jacket - Black

- Chest and back zones
- Up to 8 hours of run-time
- GridIron™ Ripstop polyester
- Low profile battery
- Washer and dryer safe
- FREEFLEX™ Mobility
- 3 Heat settings: High, Med, Low



#### Kits

| Part # | Mfg #     | Size        | Price |
|--------|-----------|-------------|-------|
| 224038 | 251B-21S  | Small       |       |
| 224039 | 251B-21M  | Medium      |       |
| 224041 | 251B-21L  | Large       |       |
| 224042 | 251B-21XL | Extra Large |       |
| 224043 | 251B-212X | 2X Large    |       |
| 224044 | 251B-213X | 3X Large    |       |

#### Jacket Only (Less Battery Pack)

| Part # | Mfg #     | Size        | Price |
|--------|-----------|-------------|-------|
| 224032 | 251B-20S  | Small       |       |
| 224033 | 251B-20M  | Medium      |       |
| 224034 | 251B-20L  | Large       |       |
| 224035 | 251B-20XL | Extra Large |       |
| 224036 | 251B-202X | 2X Large    |       |
| 224037 | 251B-203X | 3X Large    |       |

### M12™ Heated Jacket - Black

- Chest and back zones
- Up to 8 hours of run-time
- TOUGHSHELL™ Stretch polyester
- Low profile battery
- Washer and dryer safe
- FREEFLEX™ Mobility
- 3 Heat settings: High, Med, Low



#### Kits

| Part # | Mfg #     | Size        | Price |
|--------|-----------|-------------|-------|
| 223832 | 202B-21S  | Small       |       |
| 223833 | 202B-21M  | Medium      |       |
| 223834 | 202B-21L  | Large       |       |
| 223835 | 202B-21XL | Extra Large |       |
| 252064 | 202B-212X | 2X Large    |       |
| 252065 | 202B-213X | 3X Large    |       |

#### Jacket Only (Less Battery Pack)

| Part # | Mfg #     | Size        | Price |
|--------|-----------|-------------|-------|
| 223817 | 202B-20S  | Small       |       |
| 223827 | 202B-20M  | Medium      |       |
| 223828 | 202B-20L  | Large       |       |
| 223829 | 202B-20XL | Extra Large |       |
| 223830 | 202B-202X | 2X Large    |       |
| 223831 | 202B-203X | 3X Large    |       |

### M12™ Heated Jacket - Gray

- Chest and back zones
- Up to 8 hours of run-time
- TOUGHSHELL™ Stretch polyester
- Low profile battery
- Washer and dryer safe
- FREEFLEX™ Mobility
- 3 Heat settings: High, Med, Low



#### Kits

| Part # | Mfg #     | Size        | Price |
|--------|-----------|-------------|-------|
| 223852 | 201G-21S  | Small       |       |
| 223853 | 201G-21M  | Medium      |       |
| 223854 | 201G-21L  | Large       |       |
| 223855 | 201G-21XL | Extra Large |       |
| 223856 | 201G-212X | 2X Large    |       |
| 223857 | 201G-213X | 3X Large    |       |



## Heated Gear

### Jacket Only (Less Battery Pack)

| Part # | Mfg #     | Size        | Price |
|--------|-----------|-------------|-------|
| 223841 | 201G-20S  | Small       |       |
| 223842 | 201G-20M  | Medium      |       |
| 223848 | 201G-20L  | Large       |       |
| 223849 | 201G-20XL | Extra Large |       |
| 223850 | 201G-202X | 2X Large    |       |
| 223851 | 201G-203X | 3X Large    |       |

### M12™ Heated Jacket - Red

- Chest and back zones
- Up to 8 hours of run-time
- TOUGHSHELL™ Stretch polyester
- Low profile battery
- Waster and dryer safe
- FREEFLEX™ Mobility
- 3 Heat settings: High, Med, Low



#### Kits

| Part # | Mfg #     | Size        | Price |
|--------|-----------|-------------|-------|
| 223865 | 202R-21S  | Small       |       |
| 223866 | 202R-21M  | Medium      |       |
| 223973 | 202R-21L  | Large       |       |
| 223974 | 202R-21XL | Extra Large |       |
| 223975 | 202R-212X | 2X Large    |       |
| 223976 | 202R-213X | 3X Large    |       |

### Jacket Only (Less Battery Pack)

| Part # | Mfg #     | Size        | Price |
|--------|-----------|-------------|-------|
| 223858 | 202R-20S  | Small       |       |
| 223859 | 202R-20M  | Medium      |       |
| 223860 | 202R-20L  | Large       |       |
| 223861 | 202R-20XL | Extra Large |       |
| 223862 | 202R-202X | 2X Large    |       |
| 223864 | 202R-203X | 3X Large    |       |

### M12™ Heated Jacket - Realtree Xtra® Camo

- Chest and back zones
- Up to 8 hours of run-time
- TOUGHSHELL™ Stretch polyester
- Low profile battery
- Waster and dryer safe
- FREEFLEX™ Mobility
- 3 Heat settings: High, Med, Low



#### Kits

| Part # | Mfg #     | Size        | Price |
|--------|-----------|-------------|-------|
| 223983 | 221C-21S  | Small       |       |
| 223984 | 221C-21M  | Medium      |       |
| 223985 | 221C-21L  | Large       |       |
| 223986 | 221C-21XL | Extra Large |       |
| 223988 | 221C-212X | 2X Large    |       |
| 223989 | 221C-213X | 3X Large    |       |

### Jacket Only (Less Battery Pack)

| Part # | Mfg #     | Size        | Price |
|--------|-----------|-------------|-------|
| 223977 | 221C-20S  | Small       |       |
| 223978 | 221C-20M  | Medium      |       |
| 223979 | 221C-20L  | Large       |       |
| 223980 | 221C-20XL | Extra Large |       |
| 223981 | 221C-202X | 2X Large    |       |
| 223982 | 221C-203X | 3X Large    |       |

### M12™ Women's Heated Jacket - Black

- Chest and back zones
- Up to 8 hours of run-time
- TOUGHSHELL™ Stretch polyester
- Low profile battery
- Waster and dryer safe
- FREEFLEX™ Mobility
- 3 Heat settings: High, Med, Low



#### Kits

| Part # | Mfg #     | Size        | Price |
|--------|-----------|-------------|-------|
| 223990 | 231B-21S  | Small       |       |
| 223992 | 231B-21M  | Medium      |       |
| 223993 | 231B-21L  | Large       |       |
| 223994 | 231B-21XL | Extra Large |       |

## Heated Gear

### Heated Jackets (Continued)

#### M12™ Women's Heated Jacket - Black Kits

| Part # | Mfg #     | Size     | Price |
|--------|-----------|----------|-------|
| 223995 | 231B-212X | 2X Large |       |

#### M12™ Women's Heated AXIS™ Jacket

- Quick-heat function
- One-touch LED controller with 3 heat settings
- Up to (8) hours of run-time w/ M12™ REDLITHIUM™ 2.0 compact battery
- Washer and dryer safe
- Reinforced high-wear zones
- 100% Polyester insulation keeps heat in
- (3) Out zip pockets, (1) inner zip pocket, (1) low-profile battery pocket



| Part # | Mfg #    | Size   | Price |
|--------|----------|--------|-------|
| 252149 | 233B-20M | Medium |       |

### Heated Hoodies

All kits include

- (1) M12™ Heated Hoodie
- (1) M12™ REDLITHIUM™ Battery (48-11-2401)
- (1) M12™ Lithium-ion Battery Charger (48-59-2401)
- (1) M12™ Battery Holder

#### M12™ Heated Hoodie - Black

- Chest and back zones
- Up to 6 hours of run-time
- Waffle weave lining traps heat
- Washer and dryer safe
- Durable utility pockets
- 3 Heat settings: High, Med, Low



Kits

| Part # | Mfg #     | Size        | Price |
|--------|-----------|-------------|-------|
| 224014 | 302B-21S  | Small       |       |
| 252066 | 302B-21M  | Medium      |       |
| 224016 | 302B-21L  | Large       |       |
| 224017 | 302B-21XL | Extra Large |       |
| 224018 | 302B-212X | 2X Large    |       |
| 224019 | 302B-213X | 3X Large    |       |

### Hoodie Only (Less Battery Pack)

| Part # | Mfg #     | Size        | Price |
|--------|-----------|-------------|-------|
| 224008 | 302B-20S  | Small       |       |
| 224009 | 302B-20M  | Medium      |       |
| 224010 | 302B-20L  | Large       |       |
| 224011 | 302B-20XL | Extra Large |       |
| 224012 | 302B-202X | 2X Large    |       |
| 227263 | 302B-203X | 3X Large    |       |

#### M12™ Heated Hoodie - Gray

- Chest and back zones
- Up to 6 hours of run-time
- Waffle weave lining traps heat
- Washer and dryer safe
- Durable utility pockets
- 3 Heat settings: High, Med, Low



Kits

| Part # | Mfg #     | Size        | Price |
|--------|-----------|-------------|-------|
| 224002 | 302G-21S  | Small       |       |
| 224003 | 302G-21M  | Medium      |       |
| 224004 | 302G-21L  | Large       |       |
| 224005 | 302G-21XL | Extra Large |       |
| 224006 | 302G-212X | 2X Large    |       |
| 224007 | 302G-213X | 3X Large    |       |

### Hoodie Only (Less Battery Pack)

| Part # | Mfg #     | Size        | Price |
|--------|-----------|-------------|-------|
| 223996 | 302G-20S  | Small       |       |
| 223997 | 302G-20M  | Medium      |       |
| 223998 | 302G-20L  | Large       |       |
| 223999 | 302G-20XL | Extra Large |       |
| 224000 | 302G-202X | 2X Large    |       |
| 224001 | 302G-203X | 3X Large    |       |

#### M12™ Heated Hoodie - Red

- Chest and back zones
- Up to 6 hours of run-time
- Waffle weave lining traps heat
- Washer and dryer safe
- Durable utility pockets
- 3 Heat settings: High, Med, Low



Kits

| Part # | Mfg #    | Size   | Price |
|--------|----------|--------|-------|
| 224026 | 302R-21S | Small  |       |
| 224027 | 302R-21M | Medium |       |

## Heated Gear

### Heated Hoodies (Continued)

#### M12™ Heated Hoodie - Red Kits

| Part # | Mfg #     | Size        | Price |
|--------|-----------|-------------|-------|
| 224028 | 302R-21L  | Large       |       |
| 224029 | 302R-21XL | Extra Large |       |
| 224030 | 302R-212X | 2X Large    |       |
| 224031 | 302R-213X | 3X Large    |       |

#### Hoodie Only (Less Battery Pack)

| Part # | Mfg #     | Size        | Price |
|--------|-----------|-------------|-------|
| 224022 | 302R-20L  | Small       |       |
| 224021 | 302R-20M  | Medium      |       |
| 224020 | 302R-20S  | Large       |       |
| 224023 | 302R-20XL | Extra Large |       |
| 224024 | 302R-202X | 2X Large    |       |
| 224025 | 302R-203X | 3X Large    |       |

#### M12™ Heated Vest - Black

- Up to 6 hours of run-time
- GridIron™ Ripstop polyester
- Thermal fleece lining
- 3 Heat settings: High, Med, Low



#### Kits

- (1) M12™ Heated Vest - Black (Vest Only) (271B-20)
- (1) M12™ REDLITHIUM™ Battery (48-11-2401)
- (1) M12™ Battery Holder

| Part # | Mfg #     | Size        | Price |
|--------|-----------|-------------|-------|
| 224054 | 271B-21S  | Small       |       |
| 224055 | 271B-21M  | Medium      |       |
| 224056 | 271B-21L  | Large       |       |
| 224057 | 271B-21XL | Extra Large |       |
| 224058 | 271B-212X | 2X Large    |       |
| 224059 | 271B-213X | 3X Large    |       |

#### Vest Only (Less Battery Pack)

| Part # | Mfg #     | Size        | Price |
|--------|-----------|-------------|-------|
| 224045 | 271B-20S  | Small       |       |
| 224046 | 271B-20M  | Medium      |       |
| 224049 | 271B-20L  | Large       |       |
| 224050 | 271B-20XL | Extra Large |       |
| 224051 | 271B-202X | 2X Large    |       |

### Heated Hoodies (Continued)

#### M12™ Heated Vest - Black Vest Only (Less Battery Pack)

| Part # | Mfg #     | Size     | Price |
|--------|-----------|----------|-------|
| 224053 | 271B-203X | 3X Large |       |

### Heated Hand Warmers

#### Kits Include

- (1) M12™ Cordless heated hand warmer only
- (1) M12™ REDLITHIUM™ battery (48-11-2401)
- (1) M12™ Lithium-ion battery charger (48-59-2401)
- (1) M12™ Battery holder

#### M12™ Cordless Black Heated Hand Warmer



| Part # | Mfg #   | Description            | Price |
|--------|---------|------------------------|-------|
| 160200 | 2322-21 | Black Hand Warmer Kit  |       |
| 160199 | 2322-20 | Black Hand Warmer Only |       |

#### M12™ Cordless Realtree Xtra® Camo Heated Hand Warmer



| Part # | Mfg #   | Description           | Price |
|--------|---------|-----------------------|-------|
| 160198 | 2321-21 | Camo Hand Warmer Kit  |       |
| 160197 | 2321-20 | Camo Hand Warmer Only |       |

## Safety Glasses

### Nemesis® Safety Glasses

- *Soft-touch temples*
- *99.9% UV resistant*
- *Single lens wrap-around*



| Part # | Mfg #           | Lense Type   | Price |
|--------|-----------------|--------------|-------|
| 146053 | SAFETYGNEMESCLR | Clear        |       |
| 105548 | SAFETYGSMOKED   | Smoke Mirror |       |
| 201450 | SAFETYGBLUE     | Blue Mirror  |       |
| 128696 | SAFETYGCAMO     | Camo/Bronze  |       |

### Hellraiser Safety Glasses



| Part # | Mfg #        | Lense Type | Price |
|--------|--------------|------------|-------|
| 135022 | SAFETYGCLEAR | Clear      |       |
| 135023 | SAFETYGSMOKE | Smoke      |       |

**Safety Glasses**

**Safety Glasses**

**Sportster Safety Glasses**

- Curved, wrap-around lenses
- Super-light
- 99% UV-A & UV-B Protection



| Part # | Mfg #   | Description    | Qty    | Price |
|--------|---------|----------------|--------|-------|
| 080260 | 9200042 | Indoor/Outdoor | 1 Pair |       |

Work Wear

---



---

**Shoe Covers**

---



---

**Shoe Covers**

**Waterproof Shoe Cover**

- Skid-proof soles
- Waterproof
- Multiuse or disposable
- Dispenser box
- Designed to fit over a size 18 work boot
- Dark blue



| Part # | Mfg # | Description                       | Price |
|--------|-------|-----------------------------------|-------|
| 138851 | 20361 | Waterproof Shoe Covers, Box of 50 |       |

---

---

**Shoe Covers**

---

---

**Shoe Covers**  
**Shoe Liner Booty**



| Part # | Mfg #  | Description                  | Price |
|--------|--------|------------------------------|-------|
| 145266 | SC-1   | Bx/50 Pair Shoe Liner Bootie |       |
| 237939 | SC-1WP | Bx/40 Pair Shoe Liner Bootie |       |

*Work Wear*



## Shoe Covers

### Shoe Covers

#### Disposable Shoe Covers

- Blue-spun polypropylene, non-waterproof
- Fits over shoe sizes 5-15



| Part # | Mfg #     | Description              | Price |
|--------|-----------|--------------------------|-------|
| 076120 | 390-50176 | Shoe Covers - 50 Per Box |       |

Work Wear



## Shoe Covers

### Yaktrax® Ice Traction Devices

#### Yaktrax® Icewalker

- Ultra lightweight ice traction
- Easy on/off
- Spikeless patented skid lock coil system
- Abrasion resistant 1.2mm steel coil
- Rust-resistant and crush-resistant
- 100% Satisfaction guaranteed



| Part # | Mfg # | Size              | Color | Fits Shoe Size:                          | Price |
|--------|-------|-------------------|-------|--|-------|
| 130634 | 08601 | Small             | Black | Men's 5 to 8-1/2, Women's 6-1/2 to 10    |       |
| 128220 | 08603 | Medium            | Black | Men's 9 to 11, Women's 10-1/2 to 12-1/2  |       |
| 128219 | 08605 | Large/Extra-Large | Black | Men's 11-1/2 to 13-1/2, Women's 13 to 15 |       |

Work Wear

## **General Conditions**

This price service has been designed to assist you in estimating your jobs. It is our sincere desire to maintain the necessary inventory to satisfy your requirements, but we do not stock all of the items in this catalog.

All orders are subject to approval by our credit department, and the possession of this price service is not to be construed as an offer to sell.

All prices are subject to change without notice and due to market conditions over which we have no control, cannot be guaranteed. Orders will be accepted on the basis of the market price prevailing at the time of shipment.

We cannot be held responsible for any errors or omissions in the price service.

## **Taxes**

Sales tax will be added to all invoices unless you have furnished us with a Sales Tax Exemption Certificate for your purchases.

## **Return Goods**

Materials may be returned for credit with prior approval and authorization from our office. Any material claimed defective that is covered by factory warranty must be accompanied by the necessary warranty information. When authorization to return goods is requested, the date of the purchase and our invoice number must be given to either our salesperson or the office.

## **Special Materials or Non-Stock Orders**

Orders for non-stock or special items cannot be cancelled or returned for credit without factory approval. If approval is obtained, credit will be allowed for the net salvage value allowed by the factory.

## **Warranty**

The products we sell are guaranteed only to the extent of the manufacturer's warranty. No allowances will be made for labor, damage or kindred claims, and Plumb Supply Company cannot be held liable for any product liability claims, freight shortages or other claims over which we have no control.



W A T E R

C O N C E P T S

# Professional Plumbing Showroom

## 11 Locations Across Iowa

Ames      Des Moines      Iowa City  
Cedar Rapids      Fort Dodge      Ottumwa  
Waterloo      Davenport      Mason City  
Spirit Lake      Waukee

Consultations by Appointment

For more information please visit  
[www.waterconcepts.net](http://www.waterconcepts.net)

# “Two Great Traditions Combined”

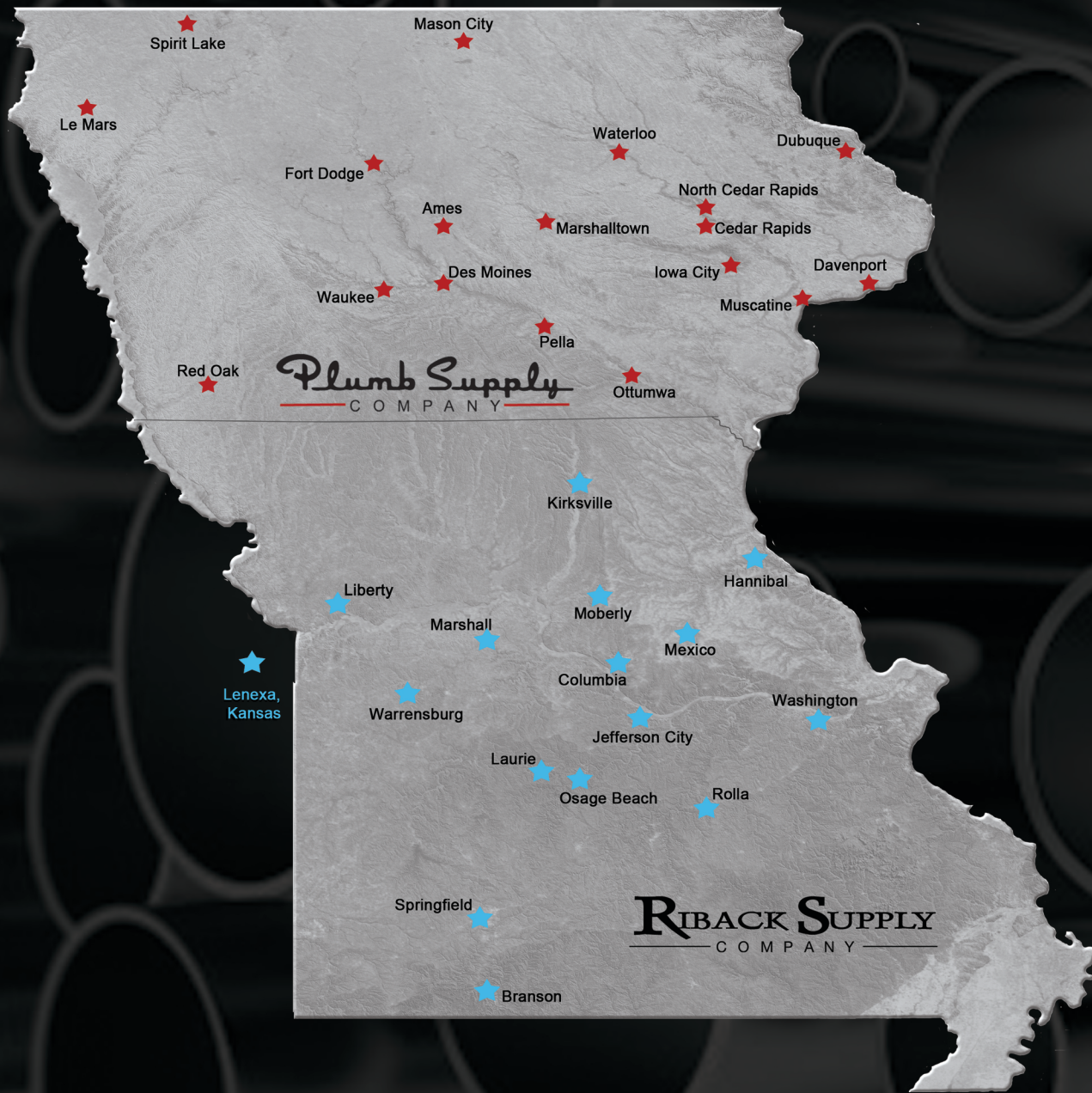

[www.plumbsupply.com](http://www.plumbsupply.com)  
[www.facebook.com/PlumbSupplyCompany](https://www.facebook.com/PlumbSupplyCompany)

*Corporate Office*  
*515-262-9511*  
*1622 NE 51st Ave*  
*Des Moines, IA 50313*