



# Plumb Supply

COMPANY

2019

Plumbing Products

Vol. 3

## **General Conditions**

This price service has been designed to assist you in estimating your jobs. It is our sincere desire to maintain the necessary inventory to satisfy your requirements, but we do not stock all of the items in this catalog.

All orders are subject to approval by our credit department, and the possession of this price service is not to be construed as an offer to sell.

All prices are subject to change without notice and due to market conditions over which we have no control, cannot be guaranteed. Orders will be accepted on the basis of the market price prevailing at the time of shipment.

We cannot be held responsible for any errors or omissions in the price service.

## **Taxes**

Sales tax will be added to all invoices unless you have furnished us with a Sales Tax Exemption Certificate for your purchases.

## **Return Goods**

Materials may be returned for credit with prior approval and authorization from our office. Any material claimed defective that is covered by factory warranty must be accompanied by the necessary warranty information. When authorization to return goods is requested, the date of the purchase and our invoice number must be given to either our salesperson or the office.

## **Special Materials or Non-Stock Orders**

Orders for non-stock or special items cannot be cancelled or returned for credit without factory approval. If approval is obtained, credit will be allowed for the net salvage value allowed by the factory.

## **Warranty**

The products we sell are guaranteed only to the extent of the manufacturer's warranty. No allowances will be made for labor, damage or kindred claims, and Plumb Supply Company cannot be held liable for any product liability claims, freight shortages or other claims over which we have no control.





# Table of Contents

## Appliances

Disposers.....	1
----------------	---

## Commercial Specialty Fixtures

Commercial Specialty Fixtures.....	10
------------------------------------	----

## Drains, Carriers, & Sumps

Closet Carriers.....	11
Lavatory Carriers.....	13
Urinal Carriers.....	14
Cast Iron Floor Drains.....	15
Cast Iron Roof Drains.....	25
Cleanouts.....	29
Drain Trap Sealers.....	33
Equalizer Chambers & End Caps.....	34
Grease Traps.....	36
Interceptors.....	38
Plastic Floor Drains.....	39
Sewage Ejectors.....	49
Sumps - Pits & Septic Tanks.....	54
Sump Pumps.....	70
Trench Drains.....	91

## Faucets & Valves

Aerators.....	95
Bar Faucets.....	100
Hot Water Dispensers.....	136
Body Sprays.....	138
Commercial.....	144
Self-Closing Faucets.....	161
Commercial Shower Faucets.....	163
Lavatory Faucets - Commercial.....	168
Commercial.....	179
Commercial - Institutional Faucets.....	190
Commercial.....	196
Commercial - Institutional Faucets.....	203
Commercial.....	206
Commercial - Institutional Faucets.....	210
Digital Shower Trim.....	211
Faucet Accessories.....	214



# Table of Contents

## Faucets & Valves (Continued)

Faucet Handles.....	216
Flush Valves.....	229
Generic Replacement Parts.....	245
Kitchen Faucets & Accessories.....	247
Soap Dispensers.....	269
Kitchen Faucets & Accessories.....	271
Soap Dispensers.....	284
Kitchen Faucets & Accessories.....	286
Soap Dispensers.....	306
Kitchen Faucets & Accessories.....	308
Soap Dispensers.....	322
Kitchen Faucets & Accessories.....	323
Soap Dispensers.....	327
Kitchen Faucets & Accessories.....	328
Lavatory - Single Hole.....	347
Lavatory Faucets - Single Hole.....	356
Lavatory - Single Hole.....	375
Lavatory Faucets - 4" Center.....	392
Lavatory - Centerset.....	404
Lavatory - Widespread.....	415
Laundry/Utility Faucets.....	461
Personal Showers & Accessories.....	469
Handheld Showers.....	510
Rough-In Valves.....	516
Shower Heads, Arms & Flanges.....	539
Shower Faucets.....	584
Steam Generator Components.....	715
Tub & Shower Faucets.....	718
Tub Faucets.....	773
Tub Spouts.....	832
Wall Hydrants.....	854
Yard Hydrants.....	861

## Fire Safety

Fire Safety.....	864
Screwdrivers & Bits.....	866
Sheet Metal Tools.....	867
Soldering & Brazing.....	868



# Table of Contents

## Pipe Fittings

Aqua-PEX Fittings.....	869
Black Steel Fittings.....	882
Brass Fittings.....	893
Brass Flare Fittings.....	897
Brass Fittings.....	898
Brass OD Compression Fittings.....	900
Cast Iron Fittings.....	903
Chrome-Plated Fittings.....	904
Copper Grooved CTS Fittings.....	905
Copper Pressure Fittings.....	906
Copper Ftgs-Cleaned&Bagged.....	922
Copper DWV Fittings.....	924
CPVC Schedule 80 Fittings.....	928
CPVC (CTS) Fittings.....	934
Dielectric Unions.....	937
Flexible Couplings.....	938
Flexible Gas Fittings.....	943
Flo Control PVC Fittings.....	949
Galvanized Steel Fittings.....	950
Geothermal Fittings.....	955
Grooved Fittings.....	957
Insert Fittings.....	974
Iron & Carbon Steel Fittings & Nipples.....	978
John Guest Fittings.....	980
Lab Waste Fittings.....	981
LXT Fittings.....	985
MegaPress Gas Fittings.....	987
MegaPress Stainless Fittings.....	991
Orion Rionfuse Fittings.....	998
Polysulfone Push-Fittings.....	999
ProPress.....	1000
ProPress System.....	1007
PVC - DWV Fittings.....	1012
PVC Schedule 40 Fittings.....	1024
PVC Schedule 80 Fittings.....	1033
PVC Sewer Fittings.....	1041
Rigid Couplings & Repair Clamps.....	1047
Sharkbite Fittings.....	1048
Soil No-Hub Fittings.....	1053
Refrigeration Press Fittings.....	1059
Soil SV Fittings.....	1061





# Table of Contents

## Pipe Fittings (Continued)

Steel - Forged Carbon FTGS.....	1068
SS 304/316 150# Nipples.....	1073
SS 304/316 3000# Socket Weld FTGS.....	1077
SS 316 Compression FTGS.....	1079
SS 304/316 150# FTGS.....	1080
SS 304 Weld FTGS.....	1085
SS Sanitary Clamp Fittings.....	1087
SS Sanitary BW Fittings.....	1090
TecTite Fittings.....	1092
Viega-PEX Fittings.....	1095
Viega PEX Tools.....	1101
Viega Manifolds.....	1102
Watts-PEX Fittings.....	1104
Watts Quick Connect Fittings.....	1111
Weld Fittings.....	1112
Zurn-PEX Fittings.....	1116

## Lavatories

Pedestal Lavatories.....	1124
Top-Mount Lavatories.....	1143
Under-Mount Lavatories.....	1163
Vessel Bowl Lavatories.....	1180
Wall Hung Lavatories.....	1189

## Cleaners & Lubricants

Cleaners.....	1197
Lubricants.....	1200

## Pipe

Acid Waste Pipe.....	1203
Aluminum Tubing.....	1204
Black Steel Pipe.....	1206
Cast Iron Pipe.....	1209
Copper Pipe.....	1210
CPVC Pipe.....	1214
Flexible Gas Pipe.....	1218
Gas Flex Connectors.....	1220
Galvanized Steel Pipe.....	1222
Linesets.....	1224



## Table of Contents

### Pipe (Continued)

Niron Pipe.....	1226
PEX Tubing.....	1227
PEX Tubing - Radiant.....	1236
Polyethylene Pipe.....	1238
PVC Pipe.....	1242
Stainless Steel Pipe.....	1246
Underground Gas Pipe & Ftgs.....	1249
Vinyl Tubing.....	1255

### Piping Supplies & Accessories

Anchors.....	1258
Cable Ties.....	1265
DWV Pipe Hangers.....	1269
Duct Hangers.....	1270
Flashings.....	1271
Trap Primers.....	1274
Hanger Straps.....	1276
Heating Cables.....	1281
Innerlynx Modular Seal.....	1282
Pipe Pier.....	1283
Plastic Hangers.....	1285
Potable Water Expansion.....	1291
Pipe Cutting Oil.....	1293
Pressure Gauges.....	1296
Sealants, Cements & Lubricants.....	1297
Soldering & Brazing.....	1317
Spacer Caps.....	1346
Stainless Steel Clamps.....	1348
Steel Hangers.....	1350
Struts.....	1359
Strut Hangers.....	1362
Threaded Rods, Bolts, Nuts, & Gaskets.....	1367
Tubing Brackets.....	1374
Vacuum Breakers.....	1380

### Plumbing Miscellaneous

Access Panels.....	1382
Adhesives & Sealants.....	1385
Boxes.....	1389
Caulk.....	1399



# Table of Contents

## Plumbing Miscellaneous (Continued)

Chemicals.....	1406
Cleanouts & Covers.....	1414
Concrete Mix & Gravel.....	1419
Fire Caulk.....	1421
Ice Maker Kits.....	1423
Lavatory Insulation Kits.....	1426
Log Lighters.....	1428
Pans.....	1431
Putty.....	1433
Shock Arrestors.....	1438
Stud Guards.....	1443
Test Plugs & Balls.....	1446
Miscellaneous.....	1448
Test Plugs & Balls.....	1449
Vents.....	1458

## Showers

Pan Lining/Solvent/Sheet Lead.....	1463
Showers.....	1465
Shower Bases & Accessories.....	1488
Shower Bases.....	1501
Shower Doors.....	1502
Shower Rods.....	1513
Shower Walls.....	1515

## Sinks

Bar/Entertainment Cast Iron Sinks.....	1528
Bar/Entertainment Stainless Steel Sinks.....	1531
Bar/Entertainment Composite Sinks.....	1549
Commercial Stainless Steel Sinks.....	1552
Copper Sinks.....	1568
Kitchen Cast Iron Sinks.....	1569
Kitchen Fireclay Sinks.....	1591
Kitchen Composite Sinks.....	1593
Kitchen Sink Accessories.....	1624
Kitchen Stainless Steel Sinks.....	1633
Kitchen Sink Accessories.....	1653
Kitchen Stainless Steel Sinks.....	1654
Floor Sinks.....	1689
Mop & Utility Sinks.....	1691





# Table of Contents

## Supplies & Fittings

Adapters.....	1711
Closet Kits.....	1712
Closet Supplies.....	1714
Dishwasher Supply Hoses.....	1718
Escutcheons.....	1722
Lavatory Kits.....	1727
Lavatory Supplies.....	1731
Nuts & Washers.....	1737
Stops - Angle.....	1739
Stops - Straight.....	1746
Washing Machine Supply Hoses.....	1750
Water Heater Supply Hoses.....	1751

## Toilets

Bidet's & Bidet Faucets.....	1753
Bolts & Caps.....	1756
Bowl Wax.....	1762
Closet Flanges, Spuds, & Flush Ells.....	1766
Commercial Closets.....	1777
Closet Bowls.....	1785
Closet Tanks.....	1802
Elongated Closets.....	1820
Gaskets.....	1855
Macerating Toilet Systems.....	1860
One-Piece Closets.....	1862
Round Front Closets.....	1874
Tank Parts.....	1891

## Toilet Seats

Commercial Toilet Seats.....	1916
Residential Plastic Toilet Seats.....	1921
Residential Wood Toilet Seats.....	1933

## Tools

Drill Bits.....	1938
Flaring Tools.....	1956
Work Lights.....	1959
Flashlights.....	1965
Hammers.....	1966



# Table of Contents

## Tools (Continued)

Hole Saws.....	1969
HVAC Testing Tools.....	1975
Knives & Replacement Blades.....	1985
Levels.....	1990
Miscellaneous Tools.....	1993
Pipe Cutters - Copper.....	2019
Pipe Cutters - PEX.....	2026
Pipe Cutters - Plastic.....	2027
Pipe Cutters - Soil Pipe.....	2030
Pipe Cutters - Steel.....	2031
Pipe Taps.....	2032
Pipe Threaders.....	2033
Pliers & Wire Strippers.....	2037
Power Tools - M12 and Misc.....	2045
Power Tools - M18.....	2067
Power Tool Accessories.....	2098
Power Tools.....	2104
Refrigeration Tools.....	2105
Rulers & Tape Measures.....	2113
Saws & Blades.....	2114
Screwdrivers & Bits.....	2127
Hand Sewer Machines.....	2140
Power Sewer Machines.....	2147
Refrigeration Tools.....	2150
Sheet Metal Tools.....	2156
Shovels.....	2165
Trouble Lights/Extension Cords.....	2167
Wrenches.....	2168

## Tub Showers

Fiberglass Tub Showers.....	2183
Tub Shower Doors.....	2189
Vikrell - Sterling Tub Showers.....	2191

## Tubs

Airbaths.....	2197
Soaking Tubs.....	2212
Tub Walls.....	2242



# Table of Contents

## Tubular, Strainers, Bathwastes & Drains

Bath Wastes.....	2243
Disposer Flanges.....	2263
Disposer Kits.....	2266
Disposer Flanges.....	2267
Extension Tubes & Elbows.....	2268
Grid Drains & PO Plug Drains.....	2271
J-Bends.....	2279
P-Traps.....	2280
S-Traps.....	2284
Shower Drains.....	2285
Sink Strainers.....	2293
Sink Wastes.....	2306
Tailpieces.....	2310
Washers, Nuts & Stoppers.....	2313
Urinals.....	2317

## Valves

Backflow Valves.....	2328
Backwater Valves.....	2337
Ball Valves - Potable.....	2344
Ball Valves.....	2355
Ball Valves - Non-Potable.....	2356
Butterfly Valves - Non-Potable.....	2364
Butterfly Valves.....	2367
Check Valves - Potable.....	2368
Check Valves - Non-Potable.....	2370
Check Valves.....	2371
Check Valves - Non-Potable.....	2372
Gas Stop Valves.....	2377
Gate Valves - Non-Potable.....	2379
Gate Valves.....	2382
Globe Valves.....	2383
Hose Bibbs.....	2384
Meter Valves.....	2387
Relief Valves.....	2389
Sillcock Valves.....	2395
Stop Valves.....	2396
Valves - Miscellaneous.....	2398
Wye Strainers.....	2403





# Table of Contents

## Vanity Cabinets & Hardware

Miscellaneous Accessories.....	2407
Towel Bars & Rings.....	2414
Bath Accessories.....	2422
Towel Bars & Rings.....	2428
Paper & Tissue Holders.....	2444
Robe Hooks.....	2455
Misc Accessories.....	2466
Grab Bars.....	2470
Medicine Cabinets & Mirrors.....	2482
Vanities.....	2490
Vanity Tops.....	2498

## Water Heaters

Commercial Electric Water Heaters.....	2499
Commercial Gas Water Heaters.....	2501
Indirect Water Heaters.....	2505
Residential Electric Water Heaters.....	2507
Residential Gas Water Heaters.....	2513
Tankless Water Heaters.....	2521
Water Heater Accessories.....	2526

## Water Fountains & Coolers

Water Fountains & Coolers.....	2529
--------------------------------	------

## Water Systems

Enviroplug - Bentonite.....	2562
Jet Pumps.....	2563
Submersible Pumps.....	2566
Water Service Accessories.....	2569
Water System Accessories.....	2576
Water System Tanks.....	2582

## Water Treatment

Reverse Osmosis Systems.....	2583
Water Conditioners.....	2585
Water Filter Cartridges.....	2586
Water Softeners.....	2593
Water Treatment Chemicals.....	2596



# Table of Contents

## Water Works

Miscellaneous Water Works.....	2598
Water Meters.....	2599
Water Service Fittings.....	2601
Water Service Stops.....	2606

## Whirlpools

Whirlpools.....	2611
-----------------	------

## Work Wear

Gloves, Ear Plugs, Goggles, ETC.....	2634
Work Gear.....	2640
Heated Gear.....	2642
Safety Glasses.....	2649
Shoe Covers.....	2650

## Repair Parts

Airease Repair Parts & Accessories.....	2654
American Standard Repair Parts.....	2655
Basco Repair Parts.....	2656
Bell & Gossett Repair Parts.....	2657
Bradley Washfountain Repair Parts.....	2659
Chicago Faucet Repair Parts.....	2660
Dearborn Brass Repair Parts.....	2665
Delta Faucet Repair Parts.....	2666
Elkay Repair Parts.....	2687
Empire Comfort Repair Parts.....	2689
Fenner Drives Repair Parts.....	2690
General Filter Repair Parts.....	2691
Gerber Repair Parts.....	2692
Gibson Repair Parts & Accessories.....	2694
Hi-Velocity (Energy Savings Products) Repair Parts.....	2695
Honeywell Repair Parts.....	2696
Hydron Module Repair Parts.....	2699
Kohler Repair Parts.....	2700
Malco Repair Parts.....	2715
McDonnell & Miller Repair Parts.....	2716
Moen Repair Parts.....	2717
EL Mustee Repair Parts.....	2721
Lochinvar Repair Parts.....	2722



# Table of Contents

## Repair Parts (Continued)

Navien Repair Parts.....	2723
Reznor Repair Parts.....	2726
Ruud Water Heater Repair Parts.....	2730
Schwank Repair Parts.....	2735
Sloan Repair Parts.....	2736
Speakman Repair Parts.....	2744
T & S Brass Repair Parts.....	2745
Taco Repair Parts.....	2747
Thermolec Repair Parts.....	2748
Triangle Tube Repair Parts.....	2749
Union Brass Repair Parts.....	2750
Ruud Heating & AC Repair Parts.....	2751
Repair Parts: WalRich.....	2781
Water Right Repair Parts.....	2782
Watts Regulator Repair Parts.....	2783
Weil McLain Repair Parts.....	2784
Westinghouse/Philco Repair Parts.....	2790
Repair Parts: White Rodgers.....	2794
Woodford Repair Parts.....	2804
Yellow Jacket Repair Parts.....	2807
Zoeller Repair Parts.....	2808



## Disposers

### Waste Disposers

#### Superba® Batch Feed Disposal

- SoundSeal™ technology helps maintain a quiet kitchen environment
- MultiGrind® technology grinds food in two stages
- Jam-Sensor™ circuit technology (KCDS100T)
- Manual reset overload protector
- 7-Year limited warranty



Part #	Mfg #	Description	Price
106185	KBDS100T	1 hp Batch Feed	

#### Superba® Continuous Feed Disposal

- SoundSeal™ technology helps maintain a quiet kitchen environment
- MultiGrind® technology grinds food in two stages
- Jam-Sensor™ circuit technology (KCDS100T)
- Manual reset overload protector
- 5-Year limited warranty



KCDS075T

KCDS100T

Part #	Mfg #	Description	Price
119129	KCDI075B	3/4 hp Continuous Feed	
106183	KCDS075T	3/4 hp Continuous Feed	
106184	KCDS100T	1 hp Continuous Feed	

#### Continuous Feed Waste Disposal

- 1725 RPMS

Part #	Mfg #	Description	Price
257864	KGIC300H	1/2 hp	

#### Splash Guard

- Fits models: W10834224, W10171104A, W10171104, W10171487A, W10171487

Part #	Mfg #	Description	Price
242085	W11087190	Disposer Splash Guard	



## Disposers

### Disposals

#### Whirlpool Gold® Continuous-Feed Disposal

- 1,725 rpm
- ABS grind chamber, galv steel grinding wheel & shredder ring
- Stainless steel swivel impellers
- XE - Stainless steel sink flange with 1-piece plastic stopper
- Overload protector with manual reset
- 1-Year full warranty



GC1000XE



GC2000PE



GC2000XE

Part #	Mfg #	Description	Price
106182	GC2000XE	1/2 hp	
106181	GC1000XE	1/3 hp	
113309	GC5000XE	3/4 hp	

#### Whirlpool In-Sink Disposer

- Continuous-feed operation
- Galvanized steel grinding wheel & shredder ring
- Stainless steel swivel impellers



Part #	Mfg #	Description	Price
257862	WG1202XH	1/2 hp	

#### Disposal Installation Accessories

Part #	Mfg #	Description	Price
130928	4211615	Splash Guard Gasket	
138619	8174328A	Mounting Assembly for GC1000/GC2000	
147388	8174355A	Mounting Assembly for GC5000XEA	

## Disposers

### Garbage Disposers

#### GX Series Garbage Disposal

- VORTEX™ motor
- Universal Xpress Mount™
- Power cord pre installed
- SoundSHIELD™ insulation
- Compact design
- Continuous feed
- Manual reset button
- 6-Year Limited Warranty



Part #	Mfg #	Description	Price
188748	GX50C	1/2" HP	
188746	GX75C	3/4" HP	

#### GX Pro Series Garbage Disposal

- VORTEX™ motor
- Universal Xpress Mount™
- Power cord pre installed
- Compact design
- Continuous feed
- 2-Year Limited Warranty



Part #	Mfg #	Description	Price
188750	GXP33C	1/3" HP	
188749	GXP50C	1/2" HP	

\*Lifeshine® Anti-Tarnish Lifetime Finish

## Disposers

### Garbage Disposal

#### Badger Garbage Disposals

- Dura-Drive® Induction Motor
- Galvanized Steel Construction
- InSinkErator We Come To You® In-Home Full Service Limited Warranty Covers parts and labor
- Made in the USA
- Quick Lock® Sink Mount allows for easy installation and garbage disposal replacement

Part #	Mfg #	Description	Price
102419	Badger-5-XP	Badger 5-XP 3/4 HP Disposal	
005590	Badger-5	Badger 5 1/2 HP Disposal	
005589	Badger 1	Badger 1 1/3 HP Disposal	

#### Contractor 333 Garbage Disposal

- 3/4 HP Dura-Drive® Induction Motor
- Stainless Steel Drive Components
- Quick Lock® mounting for fast, easy installation

Part #	Mfg #	Description	Price
005659	333	333 Contractor 3/4 HP Disposal	

#### Pro Series Food Waste Disposal

- Auto-Reverse Grind System Feature
- SoundSeal® technology delivers quieter performance.
- MultiGrind® technology

Part #	Mfg #	Description	Price
175312	Pro-750	Pro 750 3/4 HP Disposal	
170728	Pro-800	Pro 800 7/8 HP Disposal	
210788	Pro-1000LP	Pro 1000LP 1.0 HP Disposal	
160835	Pro-1100XL	Pro 1100XL 1.1 HP Disposal	

#### Continuous Feed Garbage Disposal

- 1/3 HP
- Safe to use with septic systems

Part #	Mfg #	Description	Price
005595	FWD-1	1/3 HP	
005596	FWD-2	1/2 HP	

### Insinkerator Parts and Accessories



Part #	Mfg #	Description	Price
105430	08302	RSB-00 Removable Sound Baffle	
048156	3173DA	Mounting Assembly	
123321	QLM-00	Quick Lock Mounting Assembly	



Part #	Mfg #	Description	Price
128560	09959	DMG-00 Deluxe Mounting Gasket	
005652	1010A	Mounting Gasket	
005655	1470	Discharge Gasket-Fits all models	
005653	70368	Mounting Gasket-Fits continuous feed models	
025715	70966	Baffle Gasket	
128559	SMG-00	Standard Mounting Gasket	



Part #	Mfg #	Description	Price
005663	4310	Plastic Stopper Assembly - Fits All Continuous Feed Models	
005666	5032	Stopper Assembly f/333SS	

#### SinkTop Button

STS-00

Part #	Mfg #	Description	Price
066102	STC-SN	Button Only, Satin Nickel	
117437	STC-ORB	Button Only, Oil Rubbed Bronze	
203616	STC-MB	Button Only, Matte Black	

## Disposers

### SinkTop Switch™ Outlet Kit

- 6' air tube
- Air-activated
- 1-1/4" hole diameter
- 2" Countertop thickness
- Mounts to sink or countertop
- Includes button & power module



Single

Part #	Mfg #	Description	Price
045272	STS-00	Dual Outlet, Chrome/White	
244685	STS-00SN	Dual Outlet, Satin Nickel	

### Wrench



Part #	Mfg #	Description	Price
128561	08305	WRN-00 JamBuster® Wrenchette	



## Disposers

### Disposers

#### Legend Series 9930 Disposer

- High-speed 2,600 rpm permanent magnet motor
- 115V, 60Hz
- Stainless steel, rust free grinding components
- Sound insulated for quiet operation
- Continuous feed
- Safe for properly sized septic tanks
- Professional 3-bolt mount system
- 5-Year in-home service warranty
- Lifetime corrosion warranty



Part #	Mfg #	Description	Price
106093	9930	1/2 hp	

#### On/Off Fiber Optic Controller for Garbage Disposer

- Conveniently operates the disposer with a press of a button
- Remote switch has no wiring connections or code restrictions
- Requires 3/8" drill hole



Part #	Mfg #	Finish	Price
140037	FRC4016	Fiber Optic Controller Base Unit	
140038	FOS4017-SN	Satin Nickel	
140041	FOS4017-CHBL	Chrome & Black	

## Disposers

### Disposers

#### The Perfect Grind® Garbage Disposal

- Permanent magnet high RPM means high torque and less jams
- No name stamped into the rim of the flange, creating a smooth, clean look
- Stellar antimicrobial technology
- No de-jamming tool is required
- Full sound insulation
- Perfect Grind® comes with:
  - Removable splash guard
  - Thermoset polymer drain housing
  - Permanently lubricated, sleeve type bearings
  - Cast stainless steel impellers
  - Stainless steel grind ring, balanced turntable & balanced armature shaft
  - Power cord factory installed
  - ABS hopper & manual reset
  - Rubberized Thermoplastic Housing



### Square Style Push Button



Part #	Mfg #	Finish	Price
240166	MT952SC	Satin Chrome	
129133	MT952BRS	Brushed Stainless	
120498	MT952BRN	Brushed Nickel	
181624	MT952CPB	Pol Chrome	

Part#	Mfg#	Horse Power	Price
234591	MT333-3CFWD3B	1/3	
234592	MT444-3CFWD3B	1/2	
234593	MT555-3CFWD3B	5/8	
234595	MT666-3CFWD3B	3/4	
234597	MT888-3CFWD3B	1-1/4	

### Waste Disposer Parts

#### "Classic Touch" Waste Disposer Air Switch

- Can be used with all continuous feed waste disposers
- UL Approved
- 1-3/8" Mounting hole
- Air actuated - no tools required



Part #	Mfg #	Finish	Price
101372	MT951CPB	Pol Chrome	
063585	MT951BRN	Brushed Nickel	
083101	MT951BRS	Brushed Stainless	
082563	MT951ORB	Oil Rubbed Bronze	
095043	MT951VB	Venetian Bronze™	
085323	MT951BL	Black	
095759	MT951PVDBB	Brushed Bronze	
128878	MT951PN	Polished Nickel	
167961	MT951SC	Satin Chrome	

\*PVD Finish

**www.plumbsupply.com • Serving our Customers Since 1946 • www.waterconcepts.net**



## Disposer Switches

### Disposer Switches

#### Waste Disposal Air Switch

- Air activated
- Work with all continuous feed waste disposers with power cords
- UL Approved



Part #	Mfg #	Finish	Price
115920	2822-ORB	Oil Rubbed Bronze	
115918	2822-SN	Satin Nickel	
115917	2822-PCH	Polished Chrome	

#### Waste Disposal Air Switch

- Air activated
- Includes 3 ft. power cord
- 1-5/8" Maximum deck thickness
- Works with all continuous feed waste disposers with power cords



Part #	Mfg #	Finish	Price
243482	2834-MBK	Matte Black	

---

---

## Disposers

---

---

### Garbage Disposal Cords

- 16/3 Gauge wire

Part #	Mfg #	Description	Price
041966	3GARBDISPCORD	3' Straight Plug Disposal Cord	
109985	6GARBDISPCORD	6' Straight Plug Disposal Cord	

## Commercial Specialty Fixtures

### Safety Fixtures

#### Laboratory Swing Activated Facewash Fixture

- Space saving design
- Chrome-plated brass pipe and fittings
- Exceeds minimum water flow of 3 gpm at 30 psi
- One step activation meets ANSI standard Z358.1-2009



Part #	Mfg #	Description	Price
075737	S19-270E	Facewash Fixture	

#### Halo Wall-Mounted Eyewash Station with Plastic Bowl

- Galvanized steel supply and waste pipes protected with BradTect® safety yellow coating
- Includes universal identification sign and inspection tag
- Exceeds minimum water flow of 0.4 gpm at 30 psi
- Barrier-free design
- Complies with ANSI standard Z358.1



Part #	Mfg #	Description	Price
147462	S19224EW	Eyewash Station w/Plastic Bowl	

#### Halo Combination Drench Shower/Eyewash Fixture with Plastic Bowl & Showerhead

- SpinTec™ showerhead provides consistent distribution of water
- Galvanized steel protected with BradTect® safety yellow coating
- Includes universal identification sign and inspection tag
- Drench shower exceeds minimum water flow of 20 gpm at 30 psi
- Eyewash exceeds minimum water flow of 0.4 gpm at 30 psi
- Complies with ANSI standard Z358.1



Part #	Mfg #	Description	Price
147465	S19314EW	Eyewash, Plastic Bowl, & Showerhead	

#### Halo Eye-Face Wash, Plastic Showerhead (No Bowl)

- SpinTec™ showerhead provides consistent distribution of water
- Galvanized steel protected with BradTect® safety yellow coating
- Includes universal identification sign and inspection tag
- Drench shower exceeds minimum water flow of 20 gpm at 30 psi
- Eye-Face Wash exceeds minimum water flow of 3 GPM at 30 PSI
- Complies with ANSI standard Z358.1



Part #	Mfg #	Description	Price
147467	S19314GG	Eye-Face wash, Plastic Showerhead (No Bowl)	

## Closet Carriers

### Industry Standard Closet Carriers

#### Industry Standard Single Horizontal Adjustable Closet Carrier

- 4" No-hub waste and 2" no-hub vent connections
- Epoxy-coated cast iron compression seal faceplate assembly
- Adjustable epoxy-coated cast iron foot supports
- Adjustable for standard and wheelchair height
- Adjustable ABS nipple with integral test cap and neoprene bowl gasket, plated hardware and chrome cap nuts
- Suffix XH = Extra-heavy 500 lbs carrier (ASME A112.6.1M) with 3/4" - 10" stainless steel studs



Part #	Mfg #	Description	Price
046399	ISCA-101-L	LH Carrier	
046398	ISCA-101-R	RH Carrier	

#### Industry Standard Back-to-Back Horizontal Adjustable Closet Carrier

- 4" No-hub waste and 2" no-hub vent connections
- Epoxy-coated cast iron compression seal faceplate assembly
- Adjustable epoxy-coated cast iron foot supports
- Adjustable for standard and wheelchair height
- Adjustable ABS nipple with integral test cap and neoprene bowl gasket, plated hardware and chrome cap nuts
- Suffix XH = Extra-heavy 500 lbs carrier (ASME A112.6.1M) with 3/4" - 10" stainless steel studs



Part #	Mfg #	Description	Price
046400	CA-101-D	Back-to-Back	
046397	CA-100-DPF	Back-to-Back Horiz Fitting	
080991	ISCA-101-D-XH	X-Heavy Carrier	

#### Industry Standard Single Vertical Adjustable Closet Carrier

- 4" No-hub waste and 2" no-hub vent connections
- Epoxy-coated cast iron fitting
- Adjustable epoxy-coated cast iron foot supports
- Adjustable ABS nipple with integral test cap and neoprene bowl gasket, plated hardware and chrome cap nuts
- Suffix XH = Extra-heavy 500 lbs carrier (ASME A112.6.1M) with 3/4" - 10" stainless steel studs



Part #	Mfg #	Description	Price
047573	CA-121	Single Carrier	

#### Industry Standard Back-to-Back Vertical Adjustable Closet Carrier

- 4" No-hub waste and 2" no-hub vent connections
- Epoxy-coated cast iron fitting
- 4" No-hub side inlet(s)
- Adjustable epoxy-coated cast iron foot supports
- Adjustable ABS nipple with integral test cap and neoprene bowl gasket, plated hardware and chrome cap nuts
- Suffix XH = Extra-heavy 500 lb carrier (ASWE A112.6.1M) with 3/4" - 10" stainless steel studs



Part #	Mfg #	Description	Price
058952	ISCA-121-D	Back-to-Back Carrier	
080995	CA-121-D-XH	Back-to-Back X-Heavy Carrier	

#### Industry Standard Back-to-Back Vertical Adjustable Closet Carrier with Side Inlet

- 4" No-hub waste and 2" no-hub vent connections
- Epoxy-coated cast iron fitting
- 4" No-hub side inlet(s)
- Adjustable epoxy-coated cast iron foot supports
- Adjustable ABS nipple with integral test cap and neoprene bowl gasket, plated hardware and chrome cap nuts
- Suffix XH = Extra-heavy 500 lbs carrier (ASWE A112.6.1M) with 3/4" - 10" stainless steel studs



Part #	Mfg #	Description	Price
056404	ISCA-131-D	Back-to-Back Carrier, Side Inlet	

## Closet Carriers

### Industry Standard Closet Carriers (Continued)

#### Industry Standard Back-to-Back Vertical Adjustable Closet Carrier with Side Inlet

Part #	Mfg #	Description	Price
080996	CA-131-D-XH	Back-to-Back X-Heavy Carrier, Side Inlet	

#### Industry Standard Single Vertical Adjustable Closet Carrier with Side Inlet

- 4" No-hub waste and 2" no-hub vent connections
- 4" No-hub side inlet(s)
- Adjustable epoxy-coated cast iron foot supports
- Adjustable for standard and wheelchair height
- Adjustable ABS nipple with integral test cap and neoprene bowl gasket, plated hardware and chrome cap nuts
- Suffix XH = Extra-heavy 500 lbs carrier (ASWE A112.6.1M) with 3/4" - 10" stainless steel studs



Part #	Mfg #	Description	Price
056399	CA-131-L	Single LH Side Inlet	
080998	CA-131-L-XH	X-Heavy Single RH Side Inlet	
055272	CA-131-R	Single RH Side Inlet	
080999	CA-131-R-XH	X-Heavy Single RH Side Inlet	
064722	ISCA-131-2	Back-to-Back Carrier	
081000	CA-131-2-XH	Back-to-Back Carrier, (2) Side Inlets	
086306	ISCA-131-L/R/2	Carrier Fitting Only, less Faceplate	

### Carrier Parts

Part #	Mfg #	Description	Price
078051	IS-FP-1	Industry Standard Faceplate Assembly	
079633	IS-FP-1-XH	Industry Standard XH Faceplate Assembly	
105974	RPC-1	SS Carpet Marker	
061546	CA-1	Neoprene Wall Hung Closet Gasket	
069554	CA-100-PFH	(4) Chrome-Plated Cap Nuts	

### Carrier Parts (Continued)

Part #	Mfg #	Description	Price
046395	CA-100-LPF	Left-Hand Horizontal Fitting	
080211	CA-100-LPF-A	Left-Hand Horizontal Fitting w/Auxiliary Connection	
067334	CA-100-PN8-61	8" Threaded ABS Nipple	
067306	CA-100-PN24-61	24" Threaded ABS Nipple	
046394	CA-100-RPF	Right-Hand Horizontal Fitting	
080212	CA-100-RPF-A	Right-Hand Horizontal Fitting w/Auxiliary Connection	
079631	CA-N8-61	8" Smooth Nipple for IS-FP-1	
079632	CA-N24-61	24" Smooth Nipple for IS-FP-1	
047572	CA-120-PF	Vertical Fitting for ISCA-121	



## Lavatory Carriers

### Lavatory & Sink Carriers

#### Floor Mounted Lavatory Carrier with Concealed Arms

- Heavy gauge steel uprights with integral welded feet
- Adjustable epoxy-coated cast iron arms with leveling screws and basin locking device, upper tie rod and plated hardware
- Suffix D = Back-to-back carrier



Part #	Mfg #	Description	Price
097611	WCA-411	Lavatory Carrier	
108987	WCA-411-WC	Lavatory Carrier	
129655	WCA-411-D	Lavatory Carrier	

**Specify CA-411-WC for 27" x 20" lavatories**

#### Wall-Mount Lavatory Carrier

- Concealed arm

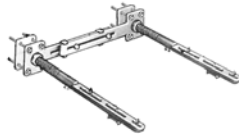

Part #	Mfg #	Description	Price
047571	CA-461	Concealed Arms w/Back Plate	

#### Floor-Mount Concealed Arm Track Lavatory Carrier

- Epoxy-coated heavy gauge steel offset uprights with welded feet
- Steel cross plate with integral mounting brackets
- Sliding adjustable arm brackets
- Adjustable cast iron concealed arms with mounting clips, leveling screws and basin locking device



Part #	Mfg #	Description	Price
046315	TCA-411	Single Floor-Mount Lavatory Carrier	

---



---

**Urinal Carriers**

---



---

**Urinal Carriers**

**Floor-Mount Urinal Carrier**



Part #	Mfg #	Description	Price
046318	CA-311	Single Plate	
046319	CA-321	With Bearing Plate	

## Cast Iron Floor Drains

### Floor Drains

#### Floor Drain with Round Strainer

- Epoxy-coated cast iron floor drain with anchor flange
- Reversible clamping collar with primary and secondary weepholes
- Adjustable round nickel bronze strainer
- No hub (standard) outlet
- Options:
  - Suffix A5 = 5" Diameter strainer
  - Suffix A6 = 6" Diameter strainer
  - Suffix A7 = 7" Diameter strainer
  - Suffix A8 = 8" Diameter strainer
  - Suffix P = Push-On Outlet



Part #	Mfg #	Description	Price
046362	FD-102-A5	For 2" Pipe	
046359	FD-102-P-A5	For 2" Pipe	
047700	FD-102-A6	For 2" Pipe	
072715	FD-102-P-A6	For 2" Pipe	
072718	FD-102-A7	For 2" Pipe	
072719	FD-102-P-A7	For 2" Pipe	
072722	FD-102-A8	For 2" Pipe	
072723	FD-102-P-A8	For 2" Pipe	
046363	FD-103-A5	For 3" Pipe	
057311	FD-103-A6	For 3" Pipe	
072714	FD-103-P-A6	For 3" Pipe	
062369	FD-103-A7	For 3" Pipe	
048308	FD-103-P-A7	For 3" Pipe	
072724	FD-103-A8	For 3" Pipe	
072725	FD-103-P-A8	For 3" Pipe	
046365	FD-104-A5	For 4" Pipe	
072717	FD-104P-A6	For 4" Pipe	
072720	FD-104-A7	For 4" Pipe	
072721	FD-104-P-A7	For 4" Pipe	
072726	FD-104-A8	For 4" Pipe	
072728	FD-104-P-A8	For 4" Pipe	

#### Floor Drain with Extended Rim Strainer

- Epoxy-coated cast iron floor drain with anchor flange
- Reversible clamping collar with primary and secondary weepholes
- Adjustable round nickel bronze extended rim strainer
- No hub (standard) outlet
- Options:
  - Suffix P = Push-On outlet
  - Suffix ER7 = 7" Diameter strainer



Part #	Mfg #	Description	Price
072747	FD-102-ER7	For 2" Pipe	
072748	FD-102-P-ER7	For 2" Pipe	
072750	FD-104-ER7	For 4" Pipe	
072751	FD-104-P-ER7	For 4" Pipe	

#### Floor Drain with Square Strainer

- Epoxy-coated cast iron floor drain with anchor flange
- Reversible clamping collar with primary and secondary weepholes
- Adjustable square nickel bronze strainer
- No hub (standard) outlet
- Options:
  - Suffix M5 = 5" x 5" Strainer
  - Suffix M6 = 6" x 6" Strainer



Part #	Mfg #	Description	Price
072752	FD-102-M5	For 2" Pipe	
104073	FD-102-M8	For 2" Pipe	
072753	FD-103-M5	For 3" Pipe	
076863	FD-103-M6	For 3" Pipe	
072755	FD-104-M5	For 4" Pipe	

#### On-Grade Adjustable Floor Drain

- On-grade epoxy-coated cast iron floor drain with anchor flange and weepholes
- Adjustable round nickel bronze strainer
- No hub (standard) outlet
- Options:
  - Suffix A5 = 5" Diameter strainer
  - Suffix A6 = 6" Diameter strainer
  - Suffix P = Push-on outlet



Part #	Mfg #	Description	Price
048855	FD-202-A5	For 2" Pipe	
046367	FD-202-P-A5	For 2" Pipe	
048858	FD-202-A6	For 2" Pipe	
048856	FD-203-A5	For 3" Pipe	

## Cast Iron Floor Drains

### Floor Drains (Continued)

#### On-Grade Adjustable Floor Drain

Part #	Mfg #	Description	Price
046368	FD-203-P-A5	For 3" Pipe	
048859	FD-203-A6	For 3" Pipe	
048857	FD-204-A5	For 4" Pipe	
046369	FD-204-P-A5	For 4" Pipe	
048860	FD-204-A6	For 4" Pipe	

#### On-Grade Adjustable Floor Drain with Square Heavy-Duty Strainer

- On-grade epoxy-coated cast iron floor drain with anchor flange and weepholes
- Adjustable square nickel bronze strainer
- No hub (standard) outlet
- Options:
  - Suffix M5 = 5" Square strainer
  - Suffix P = Push-on outlet



Part #	Mfg #	Description	Price
046409	FD-202-P-M51	For 2" Pipe	
106626	FD-203-P-M51	For 3" Pipe	

### Area Drains

#### Area Drain with 7" Adjustable Top

- Epoxy-coated cast iron area drain with anchor flange and weepholes
- 7" adjustable top with heel proof ductile iron grate
- No hub (standard) outlet
- Options:
  - Suffix 1 = Nickel bronze top



Part #	Mfg #	Description	Price
245895	FD-300-1	Nickel Bronze Top	

#### Area Drain with 8" Fixed Top

- Epoxy-coated cast iron area drain with anchor flange, weepholes
- 8" Fixed top with ductile iron grate
- No hub (standard) outlet
- Options:
  - Suffix P = Push-on
  - Suffix 5 = Sediment bucket



Part #	Mfg #	Description	Price
070846	FD-322-P-Y	For 2" Pipe	

### Area Drains (Continued)

#### Area Drain with 8" Fixed Top

Part #	Mfg #	Description	Price
050036	FD-322-P-Y-5	For 2" Pipe	
070845	FD-323-P-Y	For 3" Pipe	
050037	FD-323-P-Y-5	For 3" Pipe	
050038	FD-324-P-Y-5	For 4" Pipe	

#### Area Drain with 12" Fixed Top

- Epoxy-coated cast iron area drain with anchor flange, weepholes
- 12" Fixed top with ductile iron grate
- No hub (standard) outlet
- Options:
  - Suffix P = Push-on outlet
  - Suffix 5 = Sediment bucket



Part #	Mfg #	Description	Price
070253	FD-343-P-Y-5	For 3" Pipe	
122645	FD-343-Y-5	For 3" Pipe	
075858	FD-344-P-Y-5	For 4" Pipe	
077739	FD-344-Y-5	For 4" Pipe	

#### Iowa Garage Drain

- Epoxy-coated cast iron garage drain with anchor flange
- 8" dia Fixed top with ductile iron grate
- Sediment bucket with weepholes
- No hub (standard) outlet
- Options:
  - Suffix P = Push-on outlet



Part #	Mfg #	Description	Price
107737	FD-813-P	For 3" Pipe	
102192	FD-814-P	For 4" Pipe	

### Components for Floor Drains

#### Area Drain Top Assembly



Part #	Mfg #	Description	Price
049895	FD-320-Y-4	8" Dia Ductile Iron, Fixed	
046383	FD-340-4	12" Dia Ductile Iron, Adj	
070245	FD-340-Y-4	12" Dia Ductile Iron, Fixed	

## Cast Iron Floor Drains

### Components for Floor Drains (Continued)

#### Area Drain Top Assembly

Part #	Mfg #	Description	Price
076460	FD-360-4	15" Dia Ductile Iron, Adj	

#### Grate/Top Assembly

Part #	Mfg #	Description	Price
046202	G-1	4" x 9" Oval NB Funnel	

#### B3 Cast Iron Body

- For FD-100, FD-310, FD-320, FD-330, RD-200
- Options:
  - Suffix P = Push-on outlet



Part #	Mfg #	Connection	Price
046148	B3-2	2" No-Hub	
046152	B3-2P	2" Push-On	
046149	B3-3	3" No-Hub	
046153	B3-3P	3" Push-On	
046150	B3-4	4" No-Hub	
046154	B3-4P	4" Push-On	

#### B4-34 Cast Iron Body

- Fits CO-200, CO-1200, FD-200, FD-300, FD-1200
- Options:
  - Suffix P = Push-on outlet



Part #	Mfg #	Connection	Price
046163	B4-34-2	2" No-Hub	
046166	B4-34-2P	2" Push-On	
046164	B4-34-3	3" No-Hub	
046167	B4-34-3P	3" Push-On	
046165	B4-34-4	4" No-Hub	
046169	B4-34-4P	4" Push-On	

#### Adjustable Strainer

Part #	Mfg #	Description	Price
046171	A5-1	5" Dia Strainer	
046173	A6-1	6" Dia Strainer	
046174	A7-1	7" Dia Strainer	
046175	A8-1	8" Dia Strainer	
049891	ER7-1	7" Dia Nickel Bronze Extended Rim	

### Components for Floor Drains (Continued)

#### Adjustable Strainer

Part #	Mfg #	Description	Price
046182	M5-1	5" Sq Strainer	
046184	M6-1	6" Sq Strainer	
046185	M8-1	8" Sq Strainer	
046188	L6-1	6" Sq HD Strainer	

## Cast Iron Floor Drains

### Commercial Flashing Drains

#### Finish Line™ Round Adjustable Flashing Drain

- Cast iron no-hub connection
- ABS on cast- small head
- Adjustable AFTER the pour
- Adjustable height: round 1-1/4" or square 5/16"-1-1/4"
- Cast iron base adapter with ABS clamping collar, coring sleeve, head adapter and poly coring plug
- Nickel bronze or stainless steel strainers for use in pedestrian traffic areas

Part #	Mfg #	Conn.	Material	Dia.	Price
183896	833-225NR	2"	Nickel Bronze	5-1/2"	

#### Finish Line™ Square Adjustable Flashing Drain

- Cast iron no-hub connection
- ABS on cast- large head
- Adjustable AFTER the pour
- Adjustable height: round 1-1/4" or square 5/16"-1-1/4"
- Cast iron base adapter with ABS clamping collar, coring sleeve, head adapter and poly coring plug
- Nickel bronze or stainless steel strainers for use in pedestrian traffic areas

Part #	Mfg #	Conn.	Material	Dia.	Price
223875	833-23NQ	3"	Nickel Bronze	5-1/2"	

#### Finish Line™ Round Adjustable Flashing Drain

- Cast iron no-hub connection
- Adjustable AFTER the pour
- (-D) Ductile on cast- large head or ABS on cast
- Adjustable height: round 1-1/4" or square 5/16"-1-1/4"
- Cast iron base adapter with ductile iron or ABS clamping collar, coring sleeve, head adapter and poly coring plug
- Nickel bronze or stainless steel strainers for use in pedestrian traffic areas
- Ductile iron strainers for heavy-duty applications

Part #	Mfg #	Conn.	Material	Dia.	Price
251613	833-22NR	2"	Nickel Bronze	6-1/2"	
251614	833-23NR	3"	Nickel Bronze	6-1/2"	
183897	833-22DNR	2"	Nickel Bronze	6-1/2"	
183899	833-23DNR	3"	Nickel Bronze	6-1/2"	
183900	833-24DNR	4"	Nickel Bronze	6-1/2"	
257713	833-23DIR	3"	Round Ductile	6-1/2"	
257712	833-24DIR	4"	Round Ductile	6-1/2"	

### Rough-In Drain

Part #	Mfg #	Ring/Strainer	Connection	Price
247980	833-24F	Coring Plug	4" No-Hub	

#### Finish Line™ Round Adjustable Flashing Drain

- Cast iron no-hub connection
- Ductile on cast- small head
- Adjustable AFTER the pour
- Adjustable height: round 1-1/4" or square 5/16"-1-1/4"
- Cast iron base adapter with ductile iron clamping collar, coring sleeve, head adapter and poly coring plug
- Nickel bronze or stainless steel strainers for use in pedestrian traffic areas

Part #	Mfg #	Conn.	Material	Dia.	Price
183898	833-235DNR	3"	Nickel Bronze	5-1/2"	

#### Finish Line™ Adjustable Flashing Drain (Nickel Bronze)

- Cast iron push-joint connection
- Ductile on cast - small head
- Adjustable AFTER the pour
- Adjustable height: round 1-1/4" or square 5/16"-1-1/4"
- Cast iron base adapter with ductile iron clamping collar, coring sleeve, head adapter, poly coring plug and neoprene push-joint gasket
- Nickel bronze or stainless steel strainers for use in pedestrian traffic areas



Part #	Mfg #	Connection	Type	Dia.	Price
183909	833-625DNQ	2"	Square	5-7/8"	
183910	833-625DNR	2"	Round	5-1/2"	
183912	833-635DNR	3"	Round	5-1/2"	

#### Finish Line™ Adjustable Flashing Drain (Nickel Bronze—Push-Joint Connection)

- Ductile on cast-large head
- Adjustable AFTER the pour
- Adjustable height: round 1-1/4" or square 5/16"-1-1/4"
- Cast iron base adapter with ductile iron clamping collar, coring sleeve, head adapter, poly coring plug and neoprene push-joint gasket
- Nickel bronze or stainless steel strainers for use in pedestrian traffic areas
- Ductile iron strainers for heavy-duty applications



Part #	Mfg #	Connection	Type	Dia.	Price
183911	833-62DNR	2"	Round	6-1/2"	
183914	833-63DNQ	3"	Square	7"	



## Cast Iron Floor Drains

### Commercial Flashing Drains (Continued)

#### Finish Line™ Adjustable Flashing Drain (Nickel Bronze—Push-Joint Connection)

Part #	Mfg #	Connection	Type	Dia.	Price
183916	833-63DNR	3"	Round	6-1/2"	
183917	833-64DNR	4"	Round	6-1/2"	

#### Rough-In Drain

Part #	Mfg #	Ring/Strainer	Connection	Price
183913	833-63DF	Coring Plug	2" Push-Joint	

#### Halo™ Ductile Iron Adjustable Flashing Floor Drain

##### (Deck Flange-No-Hub Connection-Nickel Bronze)

- Head adjusts up to 3/4" above flush to accommodate most flooring types
- Finish Line™ models are adjustable AFTER the pour
- Installs easily in cored concrete floors or corrugated decks
- Great for loft remodels, second floor utility rooms/laundry rooms, etc.
- Adjustable height- **Square:** 1-5/16"-2" **Round:** 1"-2"



822-3DN

Part #	Mfg #	Connection	Type	Dia.	Price
247365	822-F2DNR	2"	Round	5-1/2"	
183874	822-F3DNQ	3"	Square	5-7/8"	
183875	822-F3DNR	3"	Round	5-1/2"	

#### Halo™ Drain

Part #	Mfg #	Connection	Type	Dia.	Price
187754	822-2DNR	2"	Round	5-1/2"	
183835	822-3DNR	3"	Round	5-1/2"	

### Standard No-Hub Connection Flashing Drain

- Cast iron base adapter with ABS clamping collar and head adapter
- Acme threads are stronger than pipe threads and prevent cross-threading
- Ductile iron head/collar available
- Nickel bronze and stainless steel strainers for use in pedestrian traffic areas
- Cast iron strainers for use in heavy-duty applications
- Flange diameter: 8-1/2"



863-23

#### Round Nickel Bronze Ring & Strainer

Part #	Mfg #	Conn.	Adj. Height	Dia.	Price
184026	863-22NR	2"	4-3/4"-6-3/4"	6-1/2"	

#### Cast Iron Ring & Strainer

Part #	Mfg #	Conn.	Adj. Height	Dia.	Price
184028	863-23I	3"	5-3/8"-7-3/8"	6-5/8"	
184029	863-24I	4"	5-3/8"-7-3/8"	6-5/8"	

## Commercial Floor Sinks

### Cast Iron Square Floor Sink No-Hub Connection

- 8" Diameter, 6" sump height, 8-5/8" overall height
- Acid-resistant porcelain enamel coating (ARE)
- Perfect for high heat discharge applications
- Model **(861-284X12)** includes:  
—Open-half ARE cast iron grate

Part #	Mfg #	Connection	Price
169123	861-282X	2" No-Hub	
153824	861-284X12	4" No-Hub	

### Cast Iron Round Floor Sink No-Hub Connection

- 9" Diameter, 6" sump depth, 8-1/4" overall height
- Acid-resistant porcelain enamel coating (ARE)
- Perfect for high heat discharge applications
- Floor sink: porcelain-coated (ARE) cast iron
- Strainer: porcelain-coated (ARE) cast iron, nickel-bronze, or 301 stainless steel

Part #	Mfg #	Connection	Price
222418	860-292X	2" No-Hub	



## Cast Iron Floor Drains

### Cast Iron Square Floor Sink No-Hub Connection

- 12" Diameter
- 6" sump height
- 9" overall height
- Perfect for high heat discharge applications
- Available with flange and clamping collar for above-grade applications
- (-ARE) Acid-resistant porcelain enamel coating
- (-F) 2-1/2" Top to flange



861-23XF

Part #	Mfg #	Connection	Price
251609	861-22XF	2" No-Hub	
184011	861-23X	3" No-Hub	
251611	861-23XF	3" No-Hub	
184012	861-24X	4" No-Hub	
251612	861-24XF	4" No-Hub	

### Commercial On-Grade Drains

#### Fat Max™ Large-Capacity On-Grade Floor Drain (Cast Iron Strainer/Body—No-Hub Connection)

- 13" Flange diameter
- Low profile design with anchor flange for a solid installation



860-23i

Part #	Mfg #	Conn.	Dia.	Height	Price
175947	860-23i	3" No-Hub	9"	6-3/4"	
222575	860-24i	4" No-Hub	9"	6-3/4"	

#### Finish Line™ Ductile Iron Adjustable Round Floor Drain with No-Hub Connection

- Adjustable AFTER the pour
- Ductile iron base adapter, coring sleeve, head adapter and poly coring plug
- Nickel bronze or stainless steel strainer for use in pedestrian traffic areas
- Adjustable height: 0-1" Round, square 5/16"-1"

Part #	Mfg #	Conn.	Dia.	Finish	Price
183881	832-25DNR	2"	5-1/2"	Nickel Bronze	

#### Finish Fixture

Part #	Mfg #	Conn.	Dia.	Finish	Price
167192	832-3DHNR	—	5-1/2"	Nickel Bronze	

#### Finish Line™ Ductile Iron Adjustable Round or Square Floor Drain with Push-Joint Connection

- Adjustable AFTER the pour
- Ductile iron base adapter, coring sleeve, head adapter and poly coring plug
- Nickel bronze or stainless steel strainer for use in pedestrian traffic areas
- Ductile iron strainers for use in heavy-duty applications
- Completed assembly heights:  
—Pre-pour: 5-3/8"-6-5/8" After-pour: 1-1/4"



Part #	Mfg #	Conn.	Dia.	Finish	Price
239244	832-63DNR	3"	6-1/2"	Nickel Bronze	
242967	832-64DNR	4"	6-1/2"	Nickel Bronze	
241234	832-63DNQ	3"	7"	Nickel Bronze	

#### Rough-In Drain

Part #	Mfg #	Ring/Strainer	Connection	Price
241272	832-63DF	Coring Plug	3" Push-Joint	

#### Finish Fixture

Part #	Mfg #	Ring/Strainer	Finish	Price
257525	832-4DHNQ	7"	Square Nickel Brz	

#### Finish Line™ Round On-Grade Floor Drain with No-Hub Connection

- Adjustable AFTER the pour
- Ductile iron base adapter, coring sleeve, head adapter and poly coring plug
- Nickel bronze or stainless steel strainers for use in pedestrian traffic areas
- Ductile iron strainers for use in heavy-duty applications
- Completed assembly heights:  
—Pre-pour: 5-1/4"-6-1/2" After-pour: 1-1/4"

Part #	Mfg #	Conn.	Dia.	Finish	Price
183886	832-3DIR	3"	6-1/2"	Ductile Iron	
183887	832-3DNR	3"	6-1/2"	Nickel Bronze	
183890	832-4DIR	4"	6-1/2"	Ductile Iron	

#### On-Grade Round Adjustable Floor Drain MIP Thread (Nickel Bronze)

- MIP thread connection adapts to standard FIP adapters

Part #	Mfg #	Conn.	Dia.	Height	Price
046080	842-2ILNR	2" MIP	4-1/2"	2-3/8"	
183955	842-4ILNR	4" MIP	6-1/2"	2-3/8"	

## Cast Iron Floor Drains

### Nickel Bronze Non-Adjustable Square Floor Drain (No-Hub Connection)

- Great for tile floors
- For use in pedestrian traffic areas



Part #	Mfg #	Conn.	Dia.	Height	Price
183983	844-23NQ	3" No-Hub	5-7/8"	2-3/8"	

### Residential Floor Drains

#### Bell Trap Floor Drain

- No-hub connection
- Bell trap is designed into sump area



Part #	Mfg #	Conn.	Dia.	Height	Price
247358	866-3I	3" No-Hub	9"	4-3/8"	

#### St. Louis Style Floor Drain

- Cast iron inside-caulk connection
- Enamel-coated cast iron



Part #	Mfg #	Conn.	Dia.	Height	Price
183982	844-0SL	3"	7"	3-1/2"	
183978	844-02SL	2"	4-7/8"	2-3/8"	
183979	844-04SL	4"	9-1/4"	4"	

### Commercial Accessories

#### 863 Series Condensate Funnel for Floor Drains

- Designed to receive drips, condensate lines or waste water from indirect waste lines
- Prevents splashing and direct waste into floor drain
- Two stainless steel, washer-head screws included

Part #	Mfg #	Finish	Size	Type	Price
184033	863-FN	Nickel Bronze	2" x 4"	Round	

#### DeckAnchor™ Drain Adapter

- Ductile iron



Part #	Mfg #	Connection	Price
242284	836-2	2" No-Hub	

### Dome Bottom Strainer

- For 12" x 12" cast iron floor sink



Part #	Mfg #	Material	Price
184025	861-AD	Aluminum	

### Extension Nipple

- Fits under Halo™ head or Finish Line™ coring sleeve

Part #	Mfg #	Material	Price
157652	822-EX3	Ductile Iron	

### FinishLine™ Ductile Iron Extension Nipple

Part #	Mfg #	Min	Max	Price
160328	832-EX4	2"	4"	

### Round Ductile Iron Strainer with Screws

- Fits: 822 series, 832 series, 833 series, 842 series, 843 series, 844 series, & 863 series

Part #	Mfg #	Diameter	Screw Centers	Price
162698	842-SD4	6-1/8"	4-7/8"	

### Aluminum External Water Dam



Part #	Mfg #	Height	Finish	Price
184051	868-15WD	2"	—	
177083	868-WD	2-3/16"	Epoxy-Coated	

### Fat Max™ Strainer

Part #	Mfg #	Material	Price
161707	860-GI	Cast Iron	
226910	860-GN	Nickel Bronze	

### Nickel Bronze Square Replacement Drain Strainer

- Fits: 822 series, 832 series, 833 series, 842 series, 843 series, 844 series, & 863 series
- Fat max strainers and accessories can be ordered separately
- Screws included

Part #	Mfg #	Diameter	Screw Centers	Price
183975	842-SNQ4	6-5/8"	4-7/8"	

## Cast Iron Floor Drains

### Full Grate for Cast Iron Floor Sinks

- Acid-resistant porcelain enamel coating (ARE)

Part #	Mfg #	Material	Sink Size	Price
251690	861-5IN	Nickel Bronze	12" x 12"	

### Open-Half Grate for Cast Iron Floor Sinks

- Acid-resistant porcelain enamel coating (ARE)



860-RGN

Part #	Mfg #	Material	Sink Size	Price
222419	860-592I	ARE Cast Iron	9" Dia.	
180121	860-RGN2	Nickel Bronze	9" Dia.	
184016	861-52I	ARE Cast Iron	12" x 12"	
251610	861-52IN	Nickel Bronze	12" x 12"	
170816	861-582I	ARE Cast Iron	8" x 8"	

### Open-Quarter Grate for Cast Iron Floor Sinks

Part #	Mfg #	Material	Sink Size	Price
184019	861-53IN	Nickel Bronze	12" x 12"	

### FinishLine® Plug Wrench

- Zinc-coated steel
- Designed for 834 series FinishLine™



Part #	Mfg #	Material	Sink Size	Price
247961	832-P	Plug Wrench		

### Round Replacement Drain Strainer with Screws (Cast 304 Stainless Steel)

- Fits: 822 series, 832 series, 833 series, 842 series, 843 series, 844 series, & 863 series
- Fat max strainers and accessories can be ordered separately

Part #	Mfg #	Diameter	Screw Centers	Price
183972	842-SCS4	6-1/8"	4-7/8"	

### Round Replacement Drain Strainer with Screws (Stamped 430 Stainless Steel)

- 18 Gauge thickness (16 gauge for model 842-SS4)
- Fits: 822 series, 832 series, 833 series, 842 series, 843 series, 844 series, & 863 series
- Fat max strainers and accessories can be ordered separately

Part #	Mfg #	Diameter	Screw Centers	Price
183976	842-SS4	6-1/16"	4-7/8"	

### Sump Receiver

- Epoxy-coated sump receiver plate



Part #	Mfg #	Plate size	For:	Price
187169	868-S	11-1/2"	3"-6" Roof Drains	

### 4-Piece 868 Series Underdeck Clamp Kit

Part #	Mfg #	Kit Includes:	Price
176373	868-15U	2 Clamping Bars, Thread Rod, Nuts & Washers	

### Underdeck Clamp Kit for 3"-6" Roof Drains

- Clamping plate, thread rod, nuts & washers

Part #	Mfg #	Size	Material	Price
182805	868-C	11"	Epoxy Coated	

## Residential Accessories

### Replacement Strainers for Floor Drains

- Fits: Pittsburgh style drain, St. Louis style drain, and Philadelphia style vent cap
- Epoxy-coated cast iron
- 3/8" Thickness

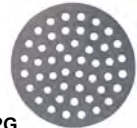

844-02G

Part #	Mfg #	Style	Diameter	Price
183980	844-0G	St. Louis	6-3/8"	
183977	844-02G	St. Louis	4-7/16"	
183985	844-S4	Pittsburgh	6-3/4"	

### Floor Drain Strainers for General Purpose

- Cast iron strainers are 1/4" thick and epoxy-coated for corrosion-resistance



846-S5P

Part #	Mfg #	Size	Price
183990	846-S7PK	6-1/4"	

## Cast Iron Floor Drains

### Residential Accessories (Continued)

#### Floor Drain Strainers for General Purpose

Part #	Mfg #	Size	Price
183986	846-S11PK	6-5/8"	
183987	846-S15PK	7"	
183988	846-S17PK	8"	
183989	846-S19PK	8-7/8"	

#### Floor Drain Strainers for 866 Series Bell Trap Drain



Part #	Mfg #	Size	Price
253028	866-2S	4-9/16"	

#### Gripper™ Stainless Steel Pipe Strainer

- Gripping fingers fit snugly inside pipe keeping strainer securely in place
- Heavy gauge stainless steel is 100% corrosion proof



Part #	Mfg #	Pipe Size	Price
056942	847-2	2"	
154067	847-3	3"	
230800	847-4PK1	4" Clamshell	

#### Replace-It™ Floor Drain

- Replace rusted or broken cast iron strainers or bar grates
- Heavy gauge stainless steel
- Adjustable screw clips to fit almost any drain
- 7¼" diameter fits 3¼" – 6¾" drain openings
- 9¼" diameter fits 5¼" – 8¾" drain openings



Part #	Mfg #	Description	Price
035410	847-7	7.25" fits 3.25"-6.25" drain openings	

### Commercial Accessories

#### Replacement Drain Strainers

Part #	Mfg #	Dia	Thickness	Type	Price
257145	842-SI3	5-5/8"	5/8"	Round	



## Cast Iron Floor Drains

### Floor Drains

#### P-325 Replacement Floor Drain Cover

- Heavy pattern cast iron
- Green enamel painted
- Screwholes available upon request

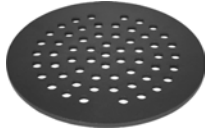

Part #	Mfg #	Size	Thickness	Weight	Price
072996	P-325-06	6"	1/4"	18 lbs	
023606	P-325-638	6-3/8"	1/4"		
015707	P-325-612	6-1/2"	1/4"	20 lbs	
015746	P-325-658	6-5/8"	1/4"	22 lbs	
015723	P-325-634	6-3/4"	1/4"	25 lbs	
015751	P-325-678	6-7/8"	1/4"		
015754	P-325-07	7"	1/4"	26 lbs	
015761	P-325-714	7-1/4"	1/4"	27 lbs	
029355	P-325-08	8"	1/4"	32 lbs	
033558	P-325-10	10"	5/16"	32 lbs	
012333	P-325-11	11"	5/16"		

## Cast Iron Roof Drains

### Roof Drains

#### RD-100 Series Large Area Roof Drain

- Epoxy-coated cast iron
- Includes flashing clamp with integral gravel stop, self-locking polyethylene dome, and no hub (standard) outlet
- Options:
  - Suffix B = Sump receiver
  - Suffix D = Under deck clamp
  - Suffix F = Adjustable extension flange
  - Suffix K = Ductile iron dome
  - Suffix R = 2" External water dam
  - Suffix W = Adjustable internal water dam
  - Suffix SO = Side outlet (2", 3", 4" only)



Part #	Mfg #	Description	Price
046410	RD102	For 2" Pipe	
073212	RD102BD	For 2" Pipe	
046792	RD102D	For 2" Pipe	
128371	RD102F	For 2" Pipe	
128393	RD102FK	For 2" Pipe	
128397	RD102FKW	For 2" Pipe	
128377	RD102FW	For 2" Pipe	
128407	RD102W	For 2" Pipe	
046142	RD103	For 3" Pipe	
073219	RD103BD	For 3" Pipe	
073224	RD103BDFKW	For 3" Pipe	
073220	RD103BDK	For 3" Pipe	
073221	RD103BDW	For 3" Pipe	
046793	RD103D	For 3" Pipe	
079955	RD103DF	For 3" Pipe	
127561	RD103DFKR	For 3" Pipe	
110615	RD103DFWK80	For 3" Pipe	
245512	RD103DFKSO	For 3" Pipe	
245511	RD103DFKWSO	For 3" Pipe	
128372	RD103F	For 3" Pipe	
100373	RD103FDK	For 3" Pipe	
109045	RD103FDK80	For 3" Pipe	
109046	RD103FDK80R	For 3" Pipe	
128394	RD103FK	For 3" Pipe	
128400	RD103FKW	For 3" Pipe	
128379	RD103FW	For 3" Pipe	
079154	RD103W	For 3" Pipe	
046413	RD104	For 4" Pipe	
046418	RD104BDF	For 4" Pipe	
050486	RD104BDFK	For 4" Pipe	
070376	RD104BDFKW	For 4" Pipe	

### Roof Drains (Continued)

#### RD-100 Series Large Area Roof Drain

Part #	Mfg #	Description	Price
073241	RD104BDFW	For 4" Pipe	
073240	RD104BDW	For 4" Pipe	
046794	RD104D	For 4" Pipe	
100381	RD104DFKW	For 4" Pipe	
110616	RD104DFWK80	For 4" Pipe	
245509	RD104DFKWSO	For 4" Pipe	
071018	RD104DK	For 4" Pipe	
245510	RD104DFKSO	For 4" Pipe	
128373	RD104F	For 4" Pipe	
100375	RD104FDK	For 4" Pipe	
109044	RD104FDK80R	For 4" Pipe	
106140	RD104FK	For 4" Pipe	
106141	RD104FKR	For 4" Pipe	
128401	RD104FKW	For 4" Pipe	
128380	RD104FW	For 4" Pipe	
067786	RD104K	For 4" Pipe	
067787	RD104R	For 4" Pipe	
079156	RD104W	For 4" Pipe	
128374	RD105F	For 5" Pipe	
128396	RD105FK	For 5" Pipe	
128402	RD105FKW	For 5" Pipe	
128382	RD105FW	For 5" Pipe	
128409	RD105W	For 5" Pipe	
046414	RD106	For 6" Pipe	
128375	RD106F	For 6" Pipe	
109043	RD106FDK80R	For 6" Pipe	
106142	RD106FK	For 6" Pipe	
106143	RD106FKR	For 6" Pipe	
128403	RD106FKW	For 6" Pipe	
128384	RD106FW	For 6" Pipe	
072117	RD106K	For 6" Pipe	
079158	RD106W	For 6" Pipe	



## Cast Iron Roof Drains

### High Volume Roof Drain

- Epoxy-coated cast iron roof drain with flashing clamp and integral gravel stop
- Self-locking ductile iron dome
- No hub (standard) outlet
- Options:
  - Suffix D = Underdeck clamp
  - Suffix F = Adjustable extension flange
  - Suffix K = Ductile iron dome
  - Suffix K80 - Aluminum dome
  - Suffix W = Adjustable internal water dam



### Components for Roof Drains

#### B2 Cast Iron Body

- For FD-340, FD-360, FD-450, FD-460, RD-100
- Options:
  - Suffix P = Push-on outlet



Part #	Mfg #	Description	Price
093419	RD304D	For 4" Pipe	
093421	RD304DF	For 4" Pipe	
242002	RD306DF	For 6" Pipe	
246037	RD306DFK	For 6" Pipe	
067167	RD308BDFK	For 8" Pipe	
128413	RD308D	For 8" Pipe	
242008	RD308DF	For 8" Pipe	
128460	RD308DK	For 8" Pipe	
109040	RD308FDK80	For 8" Pipe	
128442	RD308DW	For 8" Pipe	
128376	RD308F	For 8" Pipe	
106144	RD308FK	For 8" Pipe	
128404	RD308FKW	For 8" Pipe	
128385	RD308FW	For 8" Pipe	
128411	RD308W	For 8" Pipe	
100385	RD308WFDK	For 8" Pipe	
100379	RD310FDK	For 10" Pipe	
100386	RD310WFDK	For 10" Pipe	

Part #	Mfg #	Connection	Price
046109	B22	2" No-Hub	
046124	B23	3" No-Hub	
046143	B23P	3" Push-On	
046131	B24	4" No-Hub	
046144	B24P	4" Push-On	
046138	B25	5" No-Hub	
046139	B26	6" No-Hub	

#### B15 Cast Iron Body

- Fits RD-300

Part #	Mfg #	Connection	Price
066713	B154	4" No-Hub	
066715	B156	6" No-Hub	
066717	B158	8" No-Hub	
066718	B1510	10" No-Hub	

### Body Collar & Clamp for Floor Drains

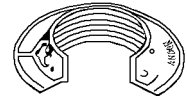

Part #	Mfg #	Description	Price
046170	B3XYC	Reversible Clamp Collar for FD-100, FD-300; FC-1 Hardware Included	

### Downspout Nozzle

- Cast nickel bronze
- No-hub connection
- Anchor flange
- Countersunk mounting holes



### Sediment Bucket for Floor Drain



Part #	Mfg #	Description	Price
081019	RD943NH	For 3" Pipe	
079163	RD944NH	For 4" Pipe	
076950	RD946NH	For 6" Pipe	
077687	RD948NH	For 8" Pipe	

Part #	Mfg #	Description	Price
046312	B1B	For FD-100, FD-160, FD-200, FD-390-E	
046313	B2B	For FD-340, FD-450, FD-460	
046314	B3B	For FD-300, FD-320, FD-330, FD-390	

## Cast Iron Roof Drains

### Components for Roof Drains (Continued)

#### Sediment Bucket for Floor Drain

Part #	Mfg #	Description	Price
076469	SB11	Bucket for 8" x 8" Floor Sink	

#### Roof Drain Component

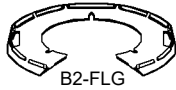

B2-FLG

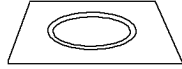

B2-S



B2-DM

Part #	Mfg #	Description	Price
066719	B15DC	Deck Clamp	
066720	B15FLG	Flashing Clamp	
073377	B2DC	Deck Clamp for RD-100 Roof Drain	
046270	B2DM	Poly Dome for B2 Body	
046271	B2-KDM	Iron Dome for BD-FLG Drain Ring	
046272	B2KDM80	Aluminum Dome, for RD100/RD300	
100020	B3KDM	RD-200 Ductile Iron Dome	
047214	B2W	Water Level Regulator Flange w/Nipple	
073379	B15F	Adjustable Extension Flange	
066725	B15W	Water Level Regulator Flange w/Nipple	
046347	34B	Gasketed Brass CO Plug	
073378	B2F	Adjustable Extension Flange	
046310	B2S	24" x 24" Sump Receiver for RD-100	
066724	B15S	Sump Receiver	
085643	WDGASKET	25' Roll Gasket	
046269	B2FLG	Flashing Ring & Gravel Stop for RD-100, RD-150 Series	
047228	B2R	External Water Dam	

### Components for Roof Drains (Continued)

#### Hardware Pack

Part #	Mfg #	Description	Price
046191	FC2	Bolts, Washers & Nuts for Roof Drain	
046192	FC3	Bolts, Washers & Nuts for Deck Clamps	
046193	FC4	Bolts, Washers & Nuts for Extensions	
066726	FC6	Hardware Pack for RD-300 Flashing Clamp	
066727	FC7	Hardware Pack for RD-300 Deck Clamp	
066728	FC8	Hardware Pack for RD-300 Extension	

#### Hardware Pack

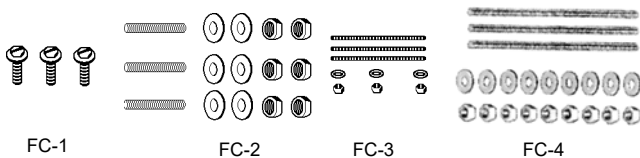

FC-1

FC-2

FC-3

FC-4

Part #	Mfg #	Description	Price
046190	FC1	Cap Screw w/Integral Washer	



## Cast Iron Roof Drains

### Commercial Roof Drains

#### 868 Series Light Commercial Cast Iron Roof Drain (No-Hub Connection)

- Dome strainer: polyethylene or epoxy-coated cast aluminum
- Gravel guard/flashing clamp: epoxy-coated cast aluminum
- Drain body: enamel-coated cast iron
- Polyethylene dome strainer is U.V. resistant



868-14M

Part #	Mfg #	Conn.	Strainer	Price
184052	868-14M	4" No-Hub	Cast Aluminum	

#### Cast Iron Roof Drain with No-Hub Connection

- Enamel-coated cast iron body, gravel guard and dome strainer
- 9-1/2" Overall height, 5" body height
- 15" Flange diameter, 13-5/8" gravel guard diameter
- Low-profile dome strainer twist-locks into gravel guard



868-150

Part #	Mfg #	Connection	Price
184047	868-1503	3" No-Hub	
184048	868-1504	4" No-Hub	
184049	868-1506	6" No-Hub	
184050	868-1508	8" No-Hub	

## Cleanouts

### Round Commercial Covers

#### Finish Line™ Adjustable Cleanout Cover Sch. 40 Hub Connection

- Includes head adapter, ring and cover
- Medium-duty nickel bronze & stainless steel
- Tenzalloy covers for pedestrian traffic areas



834-4HN

Part #	Mfg #	Finish	Size	Price
104805	834-4HNR	Nickel Bronze	6-1/2"	

### Square Commercial Covers

#### Finish Line™ Cleanout Cover for Adjustable Cleanout

- Includes head adapter, ring and cover
- Medium-duty nickel bronze & stainless steel
- Tenzalloy covers for pedestrian traffic areas



834-4HN

Part #	Mfg #	Finish	Size	Price
183922	834-4HNQ	Nickel Bronze	6-5/8"	

### Commercial Rough-In Cleanouts

#### Finish Line™ Rough-In Cleanout for Adjustable Cleanout

- ABS/PVC base adapter, ABS coring sleeve
- High-impact polymer coring plug (ring & cover)

Part #	Mfg #	Material	Sch. 40 Hub	Price
104802	834-3PF	PVC	3" x 4"	
104804	834-4PF	PVC	4"	

### Round Commercial Cleanouts

#### Finish Line™ Cleanout Sch. 40 Hub Connection

- Adjustable after the pour
- ABS/PVC Base adapter with polypro cleanout plug, ABS coring sleeve and head adapter - poly coring plug
- For use in pedestrian traffic areas
- Pre-pour height: (3"x4") and (4")
- 5-1/4"-6-1/2" and 5-1/2"-6-3/4"
- After-pour height: 0-1-1/4" and 5/16"-1-1/4"



834-3PN

Part #	Mfg #	Finish	Conn.	Dia	Price
109644	834-3PNR	Nickel Bronze	3"x4"	6-1/2"	
134395	834-4PNR	Nickel Bronze	4"	6-1/2"	

### Adjustable Cleanout with Solvent Weld Connection

- Nickel bronze, stainless steel or ductile iron ring and cover
- ABS or PVC base adapter (A) or (P)
- Includes 3-1/2" polypro plug situated in base adapter
- Brass female thread inserts accept cover screws
- 3-1/2" MIP thread top housing adapts to any FIP adapter
- Pre-pour adjustable height:  
—3" Hub 5-1/8"-6-1/4" or 4" hub 5-3/8"-6-1/2"
- Adapter height: 3" hub 4-3/8" or 4" hub 4-5/8"
- Ring and cover also available in cast brass
- Nickel bronze, stainless steel, and tenzalloy for use in pedestrian traffic areas
- Ductile iron covers for use in heavy-duty applications



852-4PNR

Part #	Mfg #	Finish	Conn.	Dia	Price
176359	852-4PI	Ductile Iron	4"	6-1/2"	
066994	852-3PNR	Nickel Bronze	3"	6-1/2"	
066993	852-4PNR	Nickel Bronze	4"	6-1/2"	
159919	852-4PSR	304 Stainless	4"	6-1/2"	
048555	852-4PTR	Tenzalloy	4"	6-1/2"	

### Adjustable On-Grade Cleanout (Cast Metal Ring and Cover)

- Brass female thread inserts for cover screws
- Highly polished cast metal
- Pre-doped polypro plug included



#### Cast Nickel Ring and Cover with PVC Adapter

Part #	Mfg #	Size	Price
082635	852-2PNR	2"	

### Standard Adjustable Cleanout ABS/MIP Thread

- Slotted polypropylene cleanout plug included
- Nickel bronze, stainless steel, tenzalloy, and ABS covers for use in pedestrian traffic areas
- Cast iron covers for use in heavy-duty applications

Ring/Cover Dia.	Round	Square	Cast Iron
2" Cleanout	4-1/2"	—	—
3" Cleanout	5-1/2"	5-5/8"	6-1/8"
4" Cleanout	6-1/2"	7"	6-5/8"

Part #	Mfg #	Finish	Conn.	Plug	Price
183996	852-4LNR	Nickel Bronze	4" MIP	3-1/2"	

## Cleanouts

### On-Grade Solvent Weld Connection Cleanout

- Adapter body: ABS or PVC
- Over 1-1/2" vertical adjustment available
- Polypro plug with threaded brass insert for cover screw included
- Plug size is identical to connection size
- Cover screw: stainless, Phillips head, 1/4"-20
- Set screws: square head, 1/4"-20
- Nickel bronze and tenzallooy covers for use in pedestrian traffic areas
- Cast iron covers for use in heavy duty applications also available with nickel bronze veneer



851-44I

#### Cast Iron Cover

Part #	Mfg #	Adj. Height	Conn.	Dia	Price
170393	851-44I	4-1/2"-6-1/4"	4" PVC	6"	

#### Nickel Bronze Cover

Part #	Mfg #	Adj. Height	Conn.	Dia	Price
146437	851-46I	6"-7-3/4"	6" PVC	8-1/2"	
159090	851-44N	3-3/4"-4-3/4"	4" PVC	6"	

### Square Commercial Cleanouts

#### Finish Line™ Cleanout Sch. 40 Hub Connection

- Adjustable after the pour
- ABS/PVC Base adapter with polypro cleanout plug, ABS coring sleeve and head adapter - poly coring plug
- For use in pedestrian traffic areas
- Pre-pour height: (3"x4") and (4")
- 5-1/4"-6-1/2" and 5-1/2"-6-3/4"
- After-pour height: 0-1-1/4" and 5/16"-1-1/4"



834-3PN

Part #	Mfg #	Finish	Conn.	Dia	Price
183918	834-3PNQ	Nickel Bronze	3"x4"	6-5/8"	
222106	834-3PSQ	Stainless	3"x4"	6-5/8"	
222105	834-4PSQ	Stainless	4"	6-5/8"	

### Adjustable Cleanout with Solvent Weld Connection

- Nickel bronze, stainless steel or ductile iron ring and cover
- ABS or PVC base adapter
- Includes 3-1/2" polypro plug situated in base adapter
- Brass female thread inserts accept cover screws
- 3-1/2" MIP thread top housing adapts to any FIP adapter
- Pre-pour adjustable height: —3" Hub 5-1/8"-6-1/4" or 4" hub 5-3/8"-6-1/2"
- Adapter height: 3" hub 4-3/8" or 4" hub 4-5/8"
- Ring and cover also available in cast brass
- Nickel bronze, stainless steel, and tenzallooy for use in pedestrian traffic areas
- Ductile iron covers for use in heavy-duty applications



852-4PNQ

Part #	Mfg #	Finish	Conn.	Dia	Price
165265	852-3PNQ	Nickel Bronze	3"	6-5/8"	
105295	852-4PNQ	Nickel Bronze	4"	6-5/8"	

### Standard Adjustable Cleanout ABS/MIP Thread

- Slotted polypropylene cleanout plug included
- For use in pedestrian traffic areas
- Cast iron covers for use in heavy-duty applications



852-3LNQ

Ring/Cover Dia.	Round	Square	Cast Iron
2" Cleanout	4-1/2"	—	—
3" Cleanout	5-1/2"	5-5/8"	6-1/8"
4" Cleanout	6-1/2"	7"	6-5/8"

Part #	Mfg #	Finish	Conn.	Plug	Price
183995	852-3LNQ	Nickel Bronze	3" MIP	2-1/2"	
150591	852-4LNQ	Nickel Bronze	4" MIP	3-1/2"	

### Cleanout Plugs

#### Cleanout Bushing/Kit

- Bushing body: white or black ABS
- Bushing fits inside Sch. 40 pipe
- Cleanout plug: —White or black polypropylene
- Plugs have threaded brass inserts
- Cleanout bushing kits includes **(875-8450P)**: —16 Gauge stainless steel cleanout cover —3/4" Stainless steel screw —Diameter measurements match connection



875-4P



875-8230P  
Bushing Kit

Part #	Mfg #	Conn.	Color	Plug Size	Price
184060	875-8450P	4" Hub	White	3-1/2"	

## Cleanouts

### Floor Cleanouts

#### Floor Cleanout with Adjustable Round Top

- Epoxy-coated cast iron floor cleanout
- 5" Round adjustable gasketed nickel bronze top
- Removable gas-tight gasketed brass cleanout plug
- No hub (standard) outlet
- Options:
  - Suffix P = Push-on outlet
  - Suffix 34B = Gasketed bronze plug



Part #	Mfg #	Description	Price
071032	CO-202-P-R34B	For 2" Pipe	
046422	CO-202-P-R	For 2" Pipe	
046423	CO-203-P-R	For 3" Pipe	
050403	CO-203-R	For 3" Pipe	
072135	CO-203-P-R-34 B	For 3" Pipe	
046088	CO-204-R	For 4" Pipe	
071027	CO-204-P-R34B	For 4" Pipe	
046424	CO-204-P-R	For 4" Pipe	

#### Floor Cleanout with Heavy-Duty Top

- Epoxy-coated cast iron floor cleanout
- 5" Round adjustable gasketed heavy-duty nickel bronze top
- Removable gas-tight, gasketed, brass cleanout plug
- No hub (standard) outlet
- Options:
  - Suffix C = Membrane clamp
  - Suffix P = Push-on outlet
  - Suffix 34B = Gasketed bronze plug



Part #	Mfg #	Description	Price
053407	CO-202-P-RX-3 4B	For 2" Pipe	
095785	CO-203-RX	For 3" Pipe	
073385	CO-203-P-RX	For 3" Pipe	
053410	CO-203-P-RX-3 4B	For 3" Pipe	
148705	CO-204-RX	For 4" Pipe	
053411	CO-204-P-RX-3 4B	For 4" Pipe	
070371	CO-204-P-RX-C -34B	For 4" Pipe	

#### Floor Cleanout with Heavy-Duty Iron Top

- Epoxy-coated cast iron floor cleanout
- 5" Round adjustable gasketed heavy-duty ductile iron top
- Removable gas-tight, gasketed, brass cleanout plug
- No hub (standard) outlet
- Options:
  - Suffix P = Push-on outlet



Part #	Mfg #	Description	Price
074657	CO-204-P-RX4	For 4" Pipe	
105615	CO-204-RX-4	For 4" Pipe	

#### Floor Cleanout with Large Heavy-Duty Adjustable Round Top

- Epoxy-coated cast iron floor cleanout
- 8" Round adjustable gasketed heavy-duty ductile iron top
- Removable gas-tight gasketed brass cleanout plug
- No hub (standard) outlet
- Options:
  - Suffix P = Push-on outlet
  - Suffix 1 = Nickel bronze top
  - Suffix 6 = Vandal proof



Part #	Mfg #	Description	Price
245329	CO-266-1-6	For 6" Pipe	
069806	CO-266-P	For 6" Pipe	

#### Floor Cleanout with Large Round Top, Tile Recess

- Epoxy-coated cast iron floor cleanout
- 5" Round adjustable gasketed nickel bronze top
- Removable gas-tight gasketed brass cleanout plug
- No hub (standard) outlet
- Options:
  - Suffix P = Push-on outlet



Part #	Mfg #	Description	Price
246031	CO-204-T-P	For 4" Pipe	

**Cleanouts**

**Components for Cleanouts**

**Adjustable Cleanout Top**



Part #	Mfg #	Description	Price
046354	R-1	5" Dia Nickel Bronze	
046356	RX-1	5" Dia HDNickel Bronze	
245330	RX-1-6	5" Dia HD Vandal Proof Nickel Bronze	
046352	RX-4	5" Dia Ductile Iron	
046357	S-1	5" Sq Nickel Bronze	

**Extra Heavy-Duty Access Housing**

- Epoxy-coated cast iron housing
- Anchor flanges
- Heavy-duty ductile iron cover



Part #	Mfg #	Description	Price
055469	CO-300-MF	Extra Heavy-Duty Access Housing	



## Drain Trap Sealers

### Drain Trap Sealers

#### SureSeal® Floor Drain Trap Seal



- Certified to ASSE 1072 for use in any drain, in any location
- Blocks the emission of noxious sewer gases from backing-up into living or work areas



Part #	Mfg #	Size	Price
153297	2FLDRNTRPSEAL	2"	
153298	3FLDRNTRPSEAL	3"	
153299	312FLDRNTRPSE A	3-1/2"	
153300	4FLDRNTRPSEAL	4"	

#### Glue On Nozzle

- Cast nickel brass
- Solvent weld
- For PVC pipe



Part #	Mfg #	Size	Price
158330	82708	6"	

### Drain Traps

#### EZ Economy Trap Kit - No Brush

- Transparent
- U Bend Type - blow molded
- Kit includes:
  - (1) Blow molded trap
  - (1) Cross
  - (1) Tee
  - (3) Red caps



Part #	Mfg #	Size	Price
194257	83113	3/4"	

### Standard SmartTrap Kit

- Transparent
- Can be used for most applications requiring a automatic shut down
- Kit includes:
  - (1) Standar trap
  - (1) Cross
  - (1) Tee
  - (1) Red cap
  - (1) Male adapter
  - (1) Cleaning brush
  - (1) Float switch assembly
  - (1) 72" Cable



Part #	Mfg #	Size	Price
193350	83210	3/4"	

## Equalizer Chambers & End Caps

### Infiltrator® Chamber System for Septic Leachfields

- Direct replacement for stone and pipe leachfields
- Patented microleaching™ sidewall
- Open chamber bottom
- Polyolefin construction
- Meets AASHTO load ratings of H-10

### THERE IS A BETTER WAY ... THE INFILTRATOR® DESIGNED TO SOLVE PROBLEMS

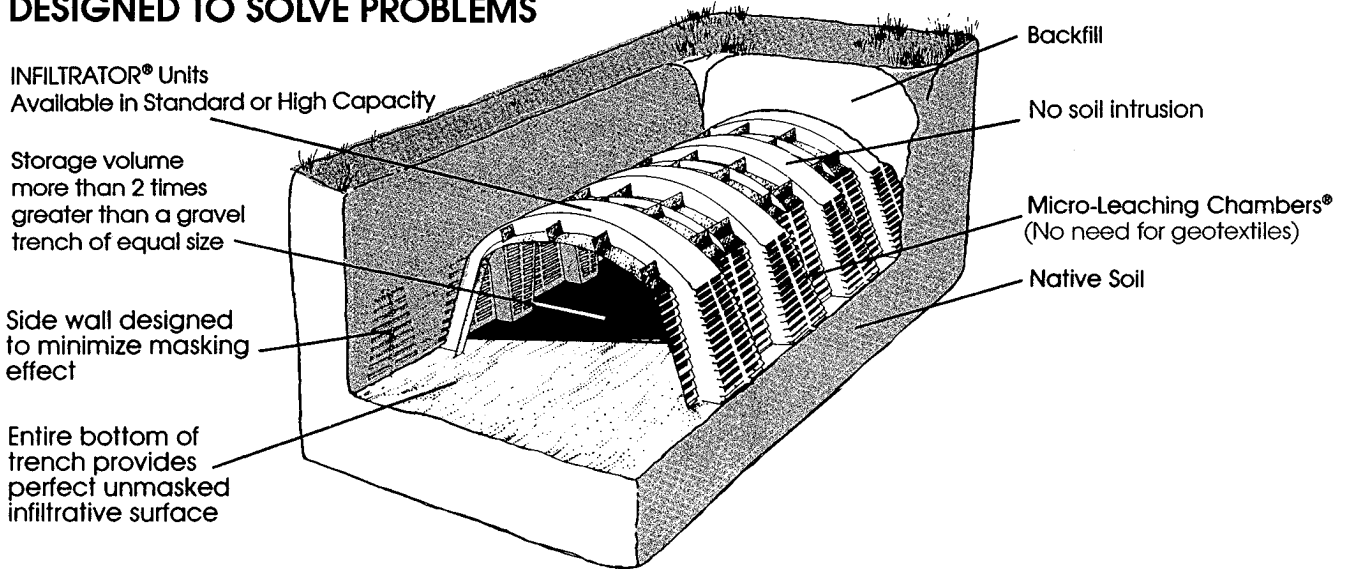

**Quick4® Standard Chamber**

- Ideal for curved and straight systems
- Contour Swivel Connection™ permits 10° turns right or left
- MultiPort™ end cap allows multiple piping options
- Effective length: 48"



Part #	Mfg #	Description	Size	Trench Width	Storage Volume	Price
091914	Q4STD	Standard Septic Chamber	34" x 53" x 12"	36"	43.5 gal	
087691	Q4STDE	Standard MultiPort™ End Cap				

### Quick4® Equalizer® 24 Low Profile Chamber

- 8" Chamber height allows shallow installations with 4" of cover
- Contour Swivel Connection™ permits 15° turns right or left
- Flat end cap construction offers stability
- Simple overlap design for easy installation
- Universal end cap design fits on either end of trench
- Effective length: 48"



Part #	Mfg #	Description	Size	Storage Volume	Price
133198	Q4STDLP	Low Profile Chamber	16" x 53" x 8"	17 gal	
117082	Q4EQ24LP	Equalizer® 24 Low Profile Chamber	16"W x 53"L x 8"H	17 gal	
117083	Q4EQ24LPEN	Equalizer® 24 Low Profile End Cap			

## Equalizer Chambers & End Caps

### Quick4 Equalizer® Chamber

- Ideal for curved and straight systems
- Contour Swivel Connection™ permits 15° turns right or left
- MultiPort™ end cap allows multiple piping options
- Effective length: 48"
- HD= Heavy Duty



Part #	Mfg #	Description	Size	Trench Width	Storage Volume	Price
091913	Q4EQ24HD	Equalizer® 24 Septic Chamber, Heavy Duty	16" x 53" x 11"	18"	21 gal	
232804	Q4EQ24	Equalizer® 24 Septic Chamber	34" x 53" x 12"	18"	43 gal	
091915	Q4EQ24E	Equalizer® 24 MultiPort™ End Cap				

### Quick4® Plus Standard Low Profile Chamber

- Maximum strength through center structural columns
- 8" Chamber height allows shallow installations with 6" of soil
- Contour Swivel Connection™ permits 10° turns right or left
- Flat end cap construction offers stability
- Simple overlap design for easy installation
- Universal end cap design fits on either end of trench
- Effective length: 48"



Part #	Mfg #	Description	Price
133200	Q4+E	Quick4 Plus Flat End Cap	



**Grease Traps**

**Grease Interceptors**

**Endura® Grease Interceptor**

- Injection molded thermoplastic
- Includes flow control fitting



Part #	Mfg #	Flow Rate	Grease Capacity	Conn Size	Price
102872	3920A02	20 gpm	46 lbs	2"	

## Grease Traps

### Grease Interceptors

#### PDI Certified Grease Interceptor

- Recessed or floor mounted epoxy-coated steel
- Gasketed epoxy-coated steel skid-proof cover
- External cast iron flow control fitting
- Removable baffle assembly
- Deep seal trap with cleanout
- No hub (standard) connections



Part #	Mfg #	Flow Rate	Grease Cap	Dimensions	Price
046328	WD-10	10 gpm	20 lbs	21-3/4"L x 14"W x 12"H	
046332	WD-15	15 gpm	30 lbs	22"L x 15"W x 14"H	
046333	WD-20	20 gpm	40 lbs	24"L x 15-3/4"W x 15"H	
046335	WD-25	25 gpm	50 lbs	26"L x 16-1/2"W x 16-1/2"H	
060996	WD-35	35 gpm	70 lbs	30"L x 18"W x 19"H	
060439	WD-50	50 gpm	100 lbs	32"L x 22"W x 21-1/2"H	

## Interceptors

### Interceptors

#### SI-742 Hair, Plaster & Sediment Interceptor

- Epoxy-coated
- 10" Clearance required above cover to remove sediment basket
- Includes:
  - Removable stainless steel sediment basket
  - Gasketed cover
  - 2" IPS Threaded connections



Part #	Mfg #	Description	Price
060240	SI-742	Cast Iron Interceptor	

## Plastic Floor Drains

### Commercial On-Grade Drains

#### Adjustable On-Grade Drain Sch. 40 Hub Connection

- Acme threads are stronger than pipe threads and prevent cross-threading
- Ductile iron head adapter available
- Square ring is great for floor tile
- For use in pedestrian traffic areas
- Pre-threaded trap primer port for knockout connection



842-3PN

#### Nickel Bronze

Part #	Mfg #	Conn.	Height	Shape	Dia.	Price
037144	842-2PNR	2"x3"	4-3/8"-5-1/8"	Rnd	5-1/2"	
037145	842-3PNR	3"x4"	4-3/8"-5-1/8"	Rnd	5-1/2"	
152046	842-2PNQ	2"x3"	4-3/8"-5-1/8"	Sqr	5-7/8"	
141597	842-3PNQ	3"x4"	4-3/8"-5-1/8"	Sqr	5-7/8"	
183949	842-36PNQ	3"x4"	5-1/8"-6-1/4"	Sqr	7"	
183958	842-4PNQ	4"	5-3/8"-6-1/2"	Sqr	7"	
037146	842-4PNR	4"	5-3/8"-6-1/2"	Rnd	6-1/2"	

#### Stainless Steel

Part #	Mfg #	Conn.	Height	Shape	Dia.	Price
167242	842-2PSQ	2"x3"	4-3/8"-5-1/8"	Sqr	5-7/8"	
156484	842-2PSR	2"x3"	4-3/8"-5-1/8"	Rnd	5-1/2"	
186755	842-3PSR	3"x4"	4-3/8"-5-1/8"	Rnd	5-1/2"	
160105	842-4PSR	4"	5-3/8"-6-1/2"	Rnd	6-1/2"	

#### Cast Iron

Part #	Mfg #	Conn.	Height	Shape	Dia.	Price
183957	842-4PI	4"	5-3/4"-6-7/8"	Rnd	6-5/8"	

#### Adjustable On-Grade Drain ABS MIP Thread

- MIP thread models adapt to any standard FIP adapter



842-3LP

Part #	Mfg #	Conn.	Material	Shape	Dia.	Price
183948	842-2LNQ	2"	Nkl Brz	Sqr	4-1/2"	
144663	842-2LNR	2"	Nkl Brz	Rnd	4-1/2"	
183950	842-3LNQ	2"	Nkl Brz	Sqr	5-7/8"	
183951	842-3LNR	3"	Nkl Brz	Rnd	5-1/2"	
183953	842-3LP	3"	Gray	Rnd	5-1/2"	
183956	842-4LP	4"	Gray	Rnd	6-1/2"	

#### Little Max™ Standard PVC On-Grade Drain (Sch. 40 Hub Solvent Weld Connection)

- Strainer ring can be used as a clamping collar for above-grade applications
- 8-1/2" Flange diameter



864-3

Part #	Mfg #	Conn.	O.D.	Height	Price
055523	864-2P	2"	7-1/4"	4-1/4"	
042815	864-3P	3"	7-1/4"	4-3/8"	
064349	864-4P	4"	7-1/4"	5-1/8"	

#### On-Grade Floor Drain with Sch. 40 Hub Connection

- Use in pedestrian areas
- 3 brass thread inserts secure strainer screws



Part #	Mfg #	Conn.	Material	Shape	Dia.	Price
073790	843-2PNR	2" x 3"	Nkl Brz	Rnd	4-1/2"	
253055	843-3PS	3" x 4"	18 GA SS	RND	5-1/2"	

#### Finish Line™ Adjustable On-Grade Drain Sch. 40 Hub Connection

- Adjustable after the pour
- PVC base adapter, ABS coring sleeve and head adapter, poly coring plug
- For use in pedestrian traffic areas
- Pre-pour height: 5-1/2"-6-3/4"  
—5-1/4"-6-1/2" (for models **832-36PNR & 832-36PSQ**)
- After pour height: **round:** 1-1/4", **square:** 5/16"-1-1/4"
- Model (**832-2PNR-V**) is vandal resistant



Complete with Round Nickel



Square Finish Fixture  
832-4HNQ



Rough-In Drain

Part #	Mfg #	Conn.	Material	Shape	Dia.	Price
112776	832-2PNR	2"	Nkl Brz	Rnd	6-1/2"	
223442	832-2PNR-V	2"	Nkl Brz	Rnd	6-1/2"	
177005	832-2PNQ	2"	Nkl Brz	Sqr	7"	
102013	832-36PNR	3" x 4"	Nkl Brz	Rnd	6-1/2"	
222104	832-36PSQ	3" x 4"	304 SS	Rnd	7"	
173891	832-4PNQ	4"	Nkl Brz	Sqr	7"	
112777	832-4PNR	4"	Nkl Brz	Rnd	6-1/2"	

## Plastic Floor Drains

### Rough-In Drain

Part #	Mfg #	Conn.	Rng/Strnr	Adj. Hgt	Price
141802	SC8322PF	2"	Coring Plug	5-1/2x6-3/4"	
106619	832-36PF	3" x 4"	Coring Plug	5-1/4-6-1/2"	
106620	832-4PF	4"	Coring Plug	5-1/2x6-3/4"	

### Finish Fixture

Part #	Mfg #	Conn.	Material	Shape	Dia.	Price
125925	832-4HNQ	—	Nkl Brz	Round	7"	
104806	SC8324HNR	—	Nkl Brz	Round	6-1/2"	
153804	832-4HSR	—	304 SS	Round	6-1/2"	

### FinishLine™ Adjustable On-Grade Drain Sch. 40 Hub Connection—5-1/2" Top

- PVC sch. 40 connection
- Adjustable AFTER the pour
- ABS/PVC base adapter, ABS coring sleeve, head adapter and poly coring plug
- For use in pedestrian traffic areas
- After-pour height: round: 0"-1" square: 5/16"-1"



832-25PN

Part #	Mfg #	Conn.	Material	Shape	Dia.	Price
183883	832-25PNQ	2"x3"	Nkl Brz	Sqr	5-7/8"	
159368	832-25PNR	2"x3"	Nkl Brz	Rnd	5-1/2"	
183885	832-35PSR	3"x4"	304 SS	Rnd	5-1/2"	
146439	832-35PNR	3"x4"	Nkl Brz	Rnd	5-1/2"	

### Rough-In Drain

Part #	Mfg #	Conn.	Ring/Strainer	Price
183882	832-25PF	2" x 3" Hub	Coring Plug	
183884	832-35PF	3" x 4" Hub	Coring Plug	

### Finish Fixture

Part #	Mfg #	Conn.	Material	Shape	Dia.	Price
183888	832-3HNR	—	Nkl Brz	Round	5-1/2"	

### Fat Max™ Large Capacity On-Grade PVC Floor Drain with Sch. 40 Hub Solvent Weld Connection

- 12" Flange diameter
- Low profile design with anchor flange for a solid installation



860-3PZ

#### With PVC Strainer

- 8-1/2" Top diameter
- ABS Sand bucket included with model (860-3PS) only

Part #	Mfg #	Conn.	O.D.	Height	Price
184001	860-2P	2"	9"	6-3/8"	
169589	860-3P	3"x4"	9"	6-3/8"	
133651	860-3PS	3"x4"	9"	6-3/8"	
177007	860-4P	4"	9"	6-3/8"	

#### With Nickel Bronze Ring & Strainer

- 9-3/8" Top diameter

Part #	Mfg #	Conn.	O.D.	Height	Price
158247	860-4PN	4"	9-3/4"	7-3/8"	
255965	860-6PN	6"	9-3/4"	8-5/8"	

#### With Stainless Steel Ring & Strainer

- 9-3/8" Top diameter, includes mesh debris basket

Part #	Mfg #	Conn.	O.D.	Height	Price
184002	860-3PZW	3"x4"	9-3/4"	7-3/8"	

#### With Cast Iron Ring & Strainer

- 8-1/2" Top diameter
- ABS debris bucket included with model (860-4PIU) only

Part #	Mfg #	Conn.	O.D.	Height	Price
153505	860-2PI	2"	9-3/8"	6-3/8"	
104593	860-3PI	3" x 4"	9-3/8"	6-3/8"	
100410	860-4PI	4"	9-3/8"	6-3/8"	
153829	860-4PIU	4"	9-3/8"	6-3/8"	

## Plastic Floor Drains

### Commercial Flashing Drains

#### Flashing Drain Sch. 40 Hub Connection

- ABS/PVC base adapter with ABS clamping collar and head adapter
- Acme threads are stronger than pipe threads and prevent cross-threading
- Ductile iron head/collar available
- Square strainer is perfect for floor tile
- For use in pedestrian traffic areas
- Adjustable height: 4-3/8"-6-3/8"



Part #	Mfg #	Conn.	Material	Shape	Dia.	Price
177006	863-32NQ	2"	Nk Br ABS	Sqr	7"	
184030	863-42NR	2"	Nk Br/PVC	Sqr	6-1/2"	
099062	863-425NR	2"	Nk Br/PVC	Rnd	5-1/2"	
156427	863-425NQ	4"	Nk Br/PVC	Sqr	5-7/8"	
099063	863-435NR	3"	Nk Br/PVC	Rnd	5-1/2"	
137420	863-435SQ	3"	SS/PVC	Sqr	5-7/8"	
137418	863-435SR	3"	SS/PVC	Rnd	5-1/2"	
126091	863-435NQ	3"	Nk Br/PVC	Sqr	5-7/8"	
099064	863-445NR	4"	Nk Br/PVC	Rnd	5-1/2"	

#### Finish Line™ Adjustable Flashing Drain-5-1/2" Tops

- Cast-iron no-hub connection, ABS on cast
- Adjustable AFTER the pour
- Cast iron base adapter with ABS clamping collar, coring sleeve, head adapter and poly coring plug
- Nickel bronze and stainless steel strainers for use in pedestrian traffic areas

Part #	Mfg #	Conn.	Material	Shape	Dia.	Price
246340	833-235NR	3"	Nkl Brz	Rnd	5-1/2"	

#### Finish Line™ Adjustable Flashing Drain-5-1/2" Tops

- Sch. 40 Hub connection-small head
- Adjustable AFTER the pour
- ABS/PVC base adapter with ABS clamping collar, coring sleeve, head adapter and poly coring plug
- Nickel bronze and stainless steel strainers for use in pedestrian traffic areas
- Adjustable height: round: 0-1", square: 5/16"-1"

Part #	Mfg #	Conn.	Material	Shape	Dia.	Price
182823	833-25PNR	2"	Nkl Brz	Rnd	5-1/2"	
226058	833-25PNQ	2"	Nkl Brz	Sqr	5-7/8"	
236706	833-25PF	2"	PVC	Coring Plug	5.5	
236705	833-35PF	3"	PVC	Coring Plug	5.5	

### Finish Line™ Adjustable Flashing Drain-6-1/2" Tops

- Sch. 40 hub connection-large head
- Adjustable AFTER the pour
- PVC base adapter with ABS clamping collar, coring sleeve, head adapter and poly coring plug
- Nickel bronze and stainless steel strainers for use in pedestrian traffic areas
- Adjustable height: round: 0-1", square: 5/16"-1"

Part #	Mfg #	Conn.	Material	Shape	Dia.	Price
183902	833-2PNQ	2"	Nkl Brz	Sqr	7"	
183906	833-3PNQ	3"	Nkl Brz	Sqr	7"	
183907	833-3PNR	3"	Nkl Brz	Rnd	6-1/2"	
183908	833-4PNR	4"	Nkl Brz	Rnd	6-1/2"	

#### Rough-In Drain

Part #	Mfg #	Conn.	Ring/Strainer	Price
183905	833-3PF	3" Hub	Coring Plug	

### Finish Line™ Halo Drain™ Adjustable Flashing Drain with Sch. 40 Hub Connection & Deck Flange

- Outlet welds over 2" and inside 3", or over 3" and inside 4"
- Head adjusts up to 3/4" above flush to accommodate most flooring types
- Adjustable AFTER the pour: 1"-2" adjustable height
- Installs easily in cored concrete floors or corrugated decks
- Great for loft remodels, second floor utility rooms/laundry rooms, etc



Part #	Mfg #	Conn.	Material	Dia.	Price
183873	822-F2PNR	2"x3"	Nickel Bronze	5-1/2"	
183876	822-F3PNR	3"x4"	Nickel Bronze	5-1/2"	

#### Halo™ Drain

- Adjustable heights:  
—3/4" Rnd NB — 1/2" Stainless— 5/16"-3/4" Sqr NB

Part #	Mfg #	Conn.	Material	Shape	Dia	Price
164747	822-2PNQ	2"x3"	Nkl Brz	Sqr	5-7/8"	
135477	822-2PNR	2"x3"	Nkl Brz	Rnd	5-1/2"	
130083	822-3PNR	3"x4"	Nkl Brz	Rnd	5-1/2"	
183833	822-2PS	2"x3"	18ga SS	Rnd	5-1/2"	
183837	822-3PS	3"x4"	18ga SS	Rnd	5-1/2"	

## Plastic Floor Drains

### Commercial Floor Sinks

#### Fat Max™ PVC Floor Sink with PVC Strainer

- New white color provides a cleaner appearance in floor sink applications
- Low profile design with anchor flange for a solid installation
- Independent lab tests show no distortion from water temperatures up to 180°F
- Tough, impact resistant PVC construction
- Strainers for pedestrian traffic
- 12" Flange diameter with 8-1/2" top diameter



860-W3

Part #	Mfg #	Conn.	O.D. Dia.	Height	Price
170284	860-W2P	2" Hub	9"	6-3/8"	
180120	860-W3P	3" x 4" Hub	9"	6-3/8"	

#### Little Max™ Compact PVC Floor Sink (Solvent Weld Connection)

- New white color provides a cleaner appearance in floor sink applications
- Strainer ring can be used as a clamping collar for above-grade applications
- Stainless steel lift handle for strainer
- Brass thread inserts with stainless steel rim/collar screws
- 8-1/2" Flange diameter, 7-1/4" rim/collar screws
- (864-W3P2)— Open-half strainer installed



864-W2P

Part #	Mfg #	Connection	Height	Price
184034	864-W2P	2" Hub	4-1/4"	
184035	864-W3P	3" Hub	4-3/8"	
184036	864-W3P2	3" Hub	4-3/8"	

### Square Max™ PVC Square Floor Sink

- Sump area is 54% larger than most PVC square floor sinks
- Low profile design with anchor flange for a clean appearance and a solid installation. Clamping collar available
- All inner surfaces are pitched, no standing water in sump area
- Independent lab tests show no distortion from water temperatures up to 180°F
- Tough, impact resistant PVC construction
- PVC and nickel bronze strainers for pedestrian traffic.
- Ductile iron strainer for heavy-duty applications
- 14-1/8" Flange diameter
- 10-11/16" top diameter for PVC strainer & sink only



861-2PX

#### No Strainer—Sink Only

Part #	Mfg #	Conn.	O.D.	Height	Price
099069	861-2PX	2" Hub	11-3/16"	7-7/16"	
099070	861-3PX	3x4" Hub	11-3/16"	8-5/16"	
121524	861-4PX	4" Hub	11-3/16"	7-7/16"	

#### With PVC Strainer

Part #	Mfg #	Conn.	O.D.	Height	Price
117523	861-2P	2" Hub	11-3/16"	7-7/16"	
099046	861-3P	3x4" Hub	11-3/16"	8-5/16"	
153202	8614-P	4" Hub	11-3/16"	7-7/16"	

#### With Nickel Bronze Ring & Strainer

- 10-3/4" Top diameter

Part #	Mfg #	Conn.	O.D.	Height	Price
153822	861-3PN	3x4" Hub	11-3/4"	8-3/4"	
153823	861-4PN	4" Hub	11-3/4"	7-1/16"	

#### With Ductile Iron Ring & Strainer

- 10-5/8" Top diameter

Part #	Mfg #	Conn.	O.D.	Height	Price
184013	861-2PI	2" Hub	11-3/4"	8"	
170848	861-3PI	3x4" Hub	11-3/4"	8-3/8"	
184024	861-6PI	6" Hub	11-3/4"	10-1/16"	



## Plastic Floor Drains

### Commercial Roof Drains

#### Planter Area Drain with PVC Solvent Weld Sch. 40 Hub Connection

- Perfect for indoor atrium's, green roof installations, ground-level plant boxes, etc.
- All corrosion-resistant materials
- 10" flange diameter
- Clamping collar and gravel guard: ABS
- Debris cover: stainless steel mesh
- Dome strainer: U.V. resistant polypropylene
- Provides an economical, adjustable alternative to heavy cast iron models



867-L3PP

Part #	Mfg #	Conn.	Lower Body Height	Price
168856	867-L4PP	4" Hub	4"	

#### Light Commercial 867 Series Solvent Weld Roof-Drain with Sch. 40 Hub Connection

- Uses "key and keyhole" alignment system on dome strainer and gravel guard
- 8" Clamping collar: ABS or enamel-coated cast iron
- Polypro strainer & PVC gravel guard are U.V. resistant
- 10" Flange, 8-1/8" overall height, 4" drain body height
- Brass thread inserts accept collar and clamp screws
- Options: **STP2**—2" overflow standpipe installed



867-P4

Part #	Mfg #	Conn.	Strainer	Body	Price
184043	867-A4	4" Hub	Polyethylene	ABS	
141232	867-P2	2" Hub	Polyethylene	PVC	
140122	867-P3	3" Hub	Polyethylene	PVC	
141233	867-P4	4" Hub	Polyethylene	PVC	
184045	867-P4STP2	4" Hub	Polyethylene	PVC	

#### 868Series Solvent Weld Connection Roof Drain

- Gravel guard/flashing clamp: aluminum
- Polyethylene dome strainer is U.V. resistant
- Aluminum dome strainer and gravel guard are epoxy-coated
- Brass thread inserts accept collar and clamp screws
- Options: **(W)**—2-3/16" external water dam



868-P4M

Part #	Mfg #	Conn.	Strainer	Body	Price
238859	868-P3	3" Hub	Polyethylene	PVC	
187166	868-P3M	3" Hub	Cast Aluminum	PVC	
187168	868-P3M-W	3" Hub	Cast Aluminum	PVC	
184053	868-P4	4" Hub	Polyethylene	PVC	
187163	868-P4M	4" Hub	Cast Aluminum	PVC	
187167	868-P4M-W	4" Hub	Cast Aluminum	PVC	

### Commercial Roof Drains (Continued)

#### 868Series Solvent Weld Connection Roof Drain

Part #	Mfg #	Conn.	Strainer	Body	Price
159987	868-P6	6" Hub	Polyethylene	PVC	
187928	868-P6M	6" Hub	Cast Aluminum	PVC	
187929	868-P6M-W	6" Hub	Cast Aluminum	PVC	

### Residential Floor Drains

#### PVC Bell Trap Drain

- Solvent weld connection
- Bell-type trap is designed into sump area



866-2P

Part #	Mfg #	Connection	Size	Price
157491	866-2P	1-1/2" Hub x 2" Spigot	6"x2-3/16"	
184037	866-34P	Over 3" Inside 4" Hub	9"x4-1/2"	

#### Inside Pipe Drain

- Solvent welds inside pipe, flush to floor
- Also great for direct vent furnaces, water heaters, and/or to cover any open ended pipe



845-3

Part #	Mfg #	Sch. 40 Hub	Dia.	Height	Price
101141	845-3P	3"	3-1/2"	1-1/2"	
127396	845-4P	4"	4-1/2"	1-7/8"	

#### Weld One™ PVC Integral Trap Floor Drain

- Proven performance, improved design
- Drain body is sonic welded, NOT GLUED
- Deeper outlet reduces slab cracks
- Threaded, 1/2" FIP knockout trap primer port
- Outlet provides proper slope to connecting pipe
- Strainer options include round and square nickel bronze and stainless steel, or heavy-duty ductile iron



800-P

#### Polypro Strainer

- (-PBW) Includes backwater device

Part #	Mfg #	Sch. 40 Hub	Drain Body	Price
010027	SC800P	2"	Gray PVC	
010028	800-PBW	2"	Gray PVC	

#### Nickel Bronze Ring & Strainer

Part #	Mfg #	Sch.40 Hub	Body	Shape	Price
171524	800-PNQ	2"	Gray PVC	Sqr	
166747	800-PNR	2"	Gray PVC	Rnd	

## Plastic Floor Drains

### 304 Stainless Steel Ring & Strainer

Part #	Mfg #	Sch.40 Hub	Body	Shape	Price
246762	800-PSQ	2"	Gray PVC	Sqr	
159889	800-PSR	2"	Gray PVC	Rnd	

### Quad Drain™ General Purpose Floor Drain

- PVC or ABS with low profile design
- Standard hub, or full-slip connections available to fit 2" and 3" Sch. 40 pipe
- Full-slip connections allow adjust-to-grade installations. —Full-slip models are gray PVC without screws
- Nickel bronze and stainless steel strainers for use in pedestrian traffic areas
- Ductile iron strainers for heavy-duty applications
- **Option s:** Add letter suffix  
—H-2" FIP threaded drain throat for stand pipe



841-2A

### Polypro Strainer

Part #	Mfg #	Connection	Material	Price
183938	841-29PL	2" Full-Slip	PVC	
133238	841-2A	2" x 3" Hub	ABS	
024860	SC8412P	2" x 3" Hub	PVC	
106746	841-2P-H	2" x 3" Hub	PVC	

### Nickel Bronze Ring & Strainer

Part #	Mfg #	Description	Price
156003	841-2PNR	2" x 3" Hub	PVC
183941	841-39PNR	3" Full-Slip	PVC

### PVC Solvent Weld Floor Drain with Snap-In Strainer

- 430 Stainless steel strainer
- Strainer finger grip slots in drain body to prevent slipping and turning



Part #	Mfg #	HubxInside Fit	Size	Price
144768	840-27P	2" x 3"	4-3/8" x 1-3/4"	

### PVC General Purpose Solvent Weld Floor Drain (Nickel Bronze Ring & Strainer)

- Brass inserts in drain body make strainer replacement fast and easy



Part #	Mfg #	HubxInside Fit	Size	Price
225331	840-20PNR	2" x 3"	4-1/2" x 2-9/16"	
183929	840-30PNR	3" x 4"	4-1/2" x 2-9/16"	

### Residential Shower Drains

#### PVC Shower Pan Drain with Cast Metal Ring and Strainer and 2" Sch. 40 Hub Connection

- Beveled drain body and mounting holes for easy subfloor installation
- Machine screws and threaded brass inserts in drain body and top housing
- 3-15/16"-5-15/16" Adjustable height



821-200PS

Part #	Mfg #	Shape	Dia.	Material	Price
101693	SC821200PNR	Rnd	4-1/2"	Cast Nickel Brz	
066082	821-200PNQ	Sqr	4-1/2"	Cast Nickel Brz	
137709	821-200PRBR	Rnd	4-1/2"	Oil Rubbed Bronze	
126392	821-200PRBQ	Sqr	4-1/2"	Oil Rubbed Bronze	
137422	821-200PSR	Rnd	4-1/2"	Matte 304 SS	
137423	821-200PSQ	Sqr	4-1/2"	Matte 304 SS	

#### PVC Shower Pan Drain with Screw-On Strainer

- 430 Stainless steel strainer
- Available with brass inserts in head adapter for machine screws or pilot holes for standard screws
- Models available with either (gray) plastic rim around strainer, or no strainer rim
- Beveled drain body and mounting holes for easy subfloor installation
- 3-5/8"-5-5/8" Adjustable height



821-200

Part #	Mfg #	Conn.	Dia.	Strainer Rim	Price
223380	821-200P	2" Hub	4-3/8"	Plastic	
079009	821-2080P	2" Hub	4-1/4"	—	

#### PVC Shower Pan Drain with Adapter and Strainer (Sch. 40 Hub Connection)

- Head adapter available separately
- Beveled drain body and mounting holes for easy subfloor installation
- Square pattern is perfect for tile floors
- 4-3/8"-6-3/8" Adjustable height



821-2PQCP

Part #	Mfg #	Shape	Dia.	Material	Price
045481	821-2PCP	Rnd	4-1/8"	Chrome- Plated	
137292	821-2PQCP	Sqr	4-1/8"	Chrome- Plated	
137334	821-2PQRB	Sqr	4-1/8"	Oil Rubbed Bronze	

## Plastic Floor Drains

### Large Capacity Shower Pan Drain with Cast Metal Ring and Strainer & 3" Sch. 40 Hub Connection

- For large tile floor showers and showers with multiple heads or body-spray options
- Larger head/strainer and 3" connection provides increased flow capacity
- 4-3/8"-6-3/8" Adjustable height
- Top housing & flashing collar-ABS, adapter body-PVC
- Options: **(V)** vandal-resistant strainer screws



863-435N

Part #	Mfg #	Shape	Dia.	Material	Price
184031	863-435CQ	Rnd	5-7/8"	Pol. 304 Stnlss	
223441	863-435-SQ-V	Sqr	5-7/8"	Cast 304 Stnlss	

### Shower Pan Drain with Tile-In Head (2" Sch. 40 Hub Connection)

- Stainless Steel tile-in tray
- Works with any décor – no need to match the finish of fixture trim
- Contemporary design creates the look of a seamless tile floor. Water "disappears" into the drainage slot
- Removable hair strainer included with ABS models
- Installs easily – no special techniques or tools needed



821-2PTQ

Part #	Mfg #	Head Size	Material	Price
182020	821-2PTQ	5"	PVC/Stainless	
223911	821-T2PT4A	4"	ABS	
182808	821-T2PTQ	5"	PVC/Stainless	

### 825 Series Solvent Weld Shower Module Drain Snap-in Stainless Steel Strainer

- Strainer fingers grip slots in top to prevent slipping and turning
- 430 stainless steel strainer
- Male-thread top: PVC
- Washers: rubber, polyethylene
- Female-thread body: ABS or PVC
- 1-1/2" Hub connection is also 2" spigot
- Do not use putty with plastic shower drains



825-27P

Part #	Mfg #	Conn.	Size	Material	Price
152845	825-27A	2" Hub	4-1/4"x2-5/8"	ABS	
066772	825-27P	2" Hub	4-1/4"x2-5/8"	PVC	

### Commercial Accessories

#### Debris Baskets



860-UM

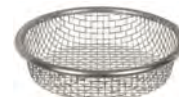

832-UM



864-UM

Part #	Mfg #	Size	Material	Price
142621	860-UM	4-1/4"	Stainless Steel	
167856	832-UM	4-1/4"	Stainless Steel	
171792	864-UM	Mesh Screen	Stainless Steel	

#### Fat Max™ PVC Bucket:



860-



860-S

Part #	Mfg #	Bucket	Material	For:	Price
095324	860-S	Sand	PVC	Sump Area	
171527	860-U	Debris	PVC	Sump Area	
253372	860-WS	Sand	PVC	Sump Area	
184009	860-WU	Debris	PVC/SS	Sump Area	

#### Fat Max™ Strainers

- Dome bottom strainers are used for drain outlets

Part #	Mfg #	Strainer Type	Material	Price
166922	860-D	Dome Bottom w/Lift Hdl	ABS	
184007	860-GP	Full w/Lift Hdl	PVC	
184008	860-WGP2	Open-Half	PVC	

#### Locating Bristles with Screw

- Flexible
- For FinishLine™ adjustable floor drain



Part #	Mfg #	Color	Price
238288	832-W	Red	

#### Square Max™ Flat Bottom Strainer

- For use with drain outlets
- DO NOT use on drains with 6" hub connection



Part #	Mfg #	Diameter	Material	Price
153830	861-6	5-1/16"	PVC	

## Plastic Floor Drains

### Fat Max™ Dome Bottom Strainer

- 2-1/2" Tall x 5-1/16" diameter
- DO NOT use on drains with 6" hub connection



Part #	Mfg #	Diameter	Material	Price
099072	861-D	5-1/16"	PVC	

### PVC Fitting Socket Drain Adapter

- FIP thread x Sch. 40 spigot connection
- Fits into Sch. 40 hub
- 1/2" FIP tapped/plugged trap primer connection
- Combine these adapters with any of our 842-\_L\_ drains or 852-\_L\_ cleanout tops

Part #	Mfg #	FIP x Spigot	Size	Price
183971	842-93P	(3)	4-1/16" x 5/8"	

### Gray PVC Round Replacement Strainer with Screws

- Fits: 822 series, 832 series, 833 series, 842 series, 843 series, 844 series, & 863 series
- Fat max strainers and accessories can be ordered separately



Part #	Mfg #	Diameter	Screw Centers	Price
127876	842-SP4	6-1/16"	4-7/8"	

### Little Max™ PVC Sand Bucket

Part #	Mfg #	Fits Inside:	Sink Type	Price
089244	864-S	Sump Area	On-Grade Drain	
244614	864-WS	Sump Area	Floor Sink	

### Little Max™ PVC Strainer for On-Grade Floor Drains

Part #	Mfg #	Description	Price
151995	864-GP	Loose Set with Lift Handle	

### Two Adjusting Shims for On-Grade Drains

- Includes two 3/4" screws



Part #	Mfg #	Drain Top Size	Price
102453	832-S4	6-1/2"	

### Square Max™ Strainers

- Factory installed



Part #	Mfg #	Strainer	Material	Ring	Price
121330	861-5	Full w/Lift Hdl	PVC	No	
152210	861-5CI	Full/Heel Proof	Ductile Iron	Yes	
184020	861-5CIG	Full/Heel Proof	Ductile Iron	No	
184022	861-5N	Full	Nickel Brz	No	
155111	861-5NR	Full	Nickel Brz	Yes	
103146	861-51	Open-Half	PVC	No	
184014	861-51N	Open-Half	Nickel Brz	No	
153832	861-51NR	Open-Half	Nickel Brz	Yes	
099073	861-53	Open-Quarter	PVC	No	
168225	861-53NR	Open-Quarter	PVC	Yes	

### PVC Trap Primer Drain Adapter

- FIP thread x Sch. 40 hub connection
- 1/2" FIP tapped/plugged trap primer connection
- Combine these adapters with any of our 842-\_L\_ drains or 852-\_L\_ cleanout

Part #	Mfg #	FIP x Hub	Size	Price
183959	842-83PT	(3")	4-11/16" x 3-3/8"	

### Dome Screen For 867 Series Roof Drains

Part #	Mfg #	Material	Price
184046	867-UM	Stainless Steel	

### Underdeck Clamp Kit

- 8" thread rod, (2)14" clamping bars, (4) washers & nuts

Part #	Mfg #	For:	Price
184044	867-C	867 Series Roof Drains	

## Residential Accessories

### Extension Adapter

- 832 Series floor drains
- Fits between coring sleeve and finish fixture - extends finish fixture 2" (min) to 33 8" (max) above body

Part #	Mfg #	Description	Price
237304	832-EX3	Extension Adapter	



## Plastic Floor Drains

### Round-to-Square Strainer Adapter Kit

- Converts 821 drains with round stamped strainers to square
- Simply remove the round strainer from the drain head, attach the square adapter using two screws and snap the new square strainer in place
- Kit includes round-to-square adapter, square stainless steel strainer, two sets of screws and an illustrated instruction sheet

Part #	Mfg #	Finish	Price
181135	821-2QARB	Oil Rubbed Bronze	
249980	821-2QAS	Stainless Steel	
181134	821-2QASN	Satin	

### Weld One™ & Quad Drain™ Replacement Strainers

#### New Pattern PolyPro

Part #	Mfg #	Dia.	Thickness	Color	Price
158175	801A2	6-1/8"	7/16"	Black	
133941	801-P2	6-1/8"	7/16"	White	
153761	801-PG2	6-1/8"	7/16"	Gray	

#### Old Pattern PolyPro

- 3/8" Thickness

Part #	Mfg #	Dia.	Screw Centers	Color	Price
010030	801-P	6-3/4"	5-1/2"	White	

#### Metal Ring & Strainer

- 3/16" Thickness

Part #	Mfg #	Diameter	Screw Centers	Price
158902	801-SR2	6-1/2"	4-7/8"	



## Plastic Floor Drains

### Commercial Drains

#### Floor Drain w/ Adjustable Barrel & Round Cover

- Easy-leveling strainer mount to correct tilted drains



Part #	Mfg #	Size	Finish	Price
252085	74120	6"	Bronze	
252083	74150	6"	Nickel	

#### Floor Drain w/ Grate & Plastic Barrel



Part #	Mfg #	Size	Finish	Price
252090	72110	6"	Stainless Steel	
252086	72150	6"	Nickel	
252089	72180	6"	Chrome	

#### Three-Quarter Top Grate for Floor Sink



Part #	Mfg #	Size	Price
251977	42752	3/4	

**Sewage Ejectors**

**Sewage Pumps**

**LE40 Series Cast Iron Submersible Sewage Pump**

- 2" Solids handling
- 2" FNPT Discharge
- 4/10 hp Oil filled, thermally protected motor
- 55 gpm @ 10' Head
- Vortex style polymer impeller
- Stainless steel rotor shaft and fasteners
- Automatic models feature a mercury-free adjustable wide angle float with series plug
- 10' Quick-disconnect cord
- 3-Year warranty



Part #	Mfg #	Description	Cord	Price
120996	LE41A	115V Auto	10'	

**LE50 Series Cast Iron Submersible Sewage Pump**

- 2" Solids handling
- 2" FNPT Discharge
- 1/2 hp Hermetically sealed motor, oil filled with thermal overload protection
- 112 gpm @ 25' Maximum head
- 2-Vane corrosion resistant HYTREL® impeller
- Stainless steel rotor shaft and fasteners
- Automatic models feature a mercury-free adjustable wide angle float switch with series plug
- 10' Quick-disconnect cord
- 3-Year warranty



Part #	Mfg #	Description	Cord	Price
120997	LE51A	115V Auto	10'	

**Grinder Pumps/Systems**

**LSGX200-Series Omnivore® 2-Stage Grinder Pump**

- 1-1/4" NPT + flange discharge
- V-Slice® Cutter
- One-Piece cast iron
- Open volute design
- Dual-shaft seals
- 25' Quick-dissconnect power cord
- Twin stainless steel impellers
- Hardened 440 stainless steel cutting system



Part #	Mfg #	Description	Price
134596	LSGX202A	208V, 2 hp, Auto	

**ProVore 380 Simplex Grinder Systems**

- 2" Discharge
- 41 Gallon capacity
- V-Slice® cutter technology
- Heavy-duty polyethylene basin & cover
- Above or below floor level installation



Part #	Mfg #	Description	Price
159481	P382XPRG10	115V, 1 hp, Auto	1

**Elongated Toilets**

**Ascent II Macerating Toilet System**

- 1-1/2" Vent
- LED lights
- Touch pad buttons
- QuickFlip™ discharge & vent connectors
- RazorCut™ technology
- IST™ Switch sensing
- CleanConnect™ seal
- Removable access cover
- Solid state electronic switch system
- 1" Discharge with integral check valve
- Auxiliary inlets accept 1-1/2" or 1" pipe
- Built-in alarm with 9V battery back-up
- WaterSense certified product: 1.28 gpf



Part #	Mfg #	Type	Color	Price
126942	ASCENT2ES	Complete System	White	W



## Sewage Ejectors

### Dominator® Wastewater and Sewage Ejector Pumps

- Cast iron pump housings and cover with protective epoxy coating for corrosion and rust resistance
- Mechanical-type seals
- Thermal overload protection

### 9SN Series Oil-Filled Submersible Sewage Pump

- 70 gpm @ 10' Head
- Solids handling to 2"
- 2" FPNT Discharge
- Automatic operation with piggyback mechanical float; on level 9" to 14", off lever 2" to 6"
- 4/10 hp



Part #	Mfg #	Model	Description	Price
143068	509204	9SN-CIA-RF	115V Auto/Manual, 20' Cord	

## Sewage Ejectors

### Sewage Waste Pumps

#### 264 "Waste-Mate" Cast Iron Submersible Sewage/Effluent\*/Dewatering Pump

- 60 gpm @ 10' Head
- Passes 2" spherical solids
- Non-clogging vortex impeller
- 2" NPT Discharge
- Float operated, submersible (NEMA 6) 2-pole switch
- 4/10 Horsepower
- Suffix:
  - BN Includes Piggyback variable float



264 Automatic

Part #	Mfg #	Description	Cord	Price
028952	264-0001	115V Auto	15'	
028953	BN264	115V Manual	15'	

#### 266 "Waste-Mate" Cast Iron Submersible Sewage/Effluent\*/Dewatering Pump

- 89 gpm @ 10' Head
- Passes 2" spherical solids
- Non-clogging vortex impeller
- 2" NPT Discharge
- Float operated, submersible (NEMA 6) 2-pole switch
- 1/2 Horsepower



Part #	Mfg #	Description	Cord	Price
140834	N266	115V Manual	15'	

#### 267 "Waste-Mate" Cast Iron Submersible Sewage/Effluent\*/Dewatering Pump

- 89 gpm @ 10' of head
- Passes 2" spherical solids
- Non-clogging vortex impeller
- 2" NPT Discharge
- Float operated
- 1/2 Horsepower



Part #	Mfg #	Description	Cord	Price
036900	267-0001	115V Auto	10'	
057327	N267-0002	115V	10'	

### Multi-Stage Effluent Turbine Submersible Pumps

- Corrosion resistant
- 1-1/4" NPT discharge
- 10' jacketed power cord
- Heavy wall stainless steel pump shell
- No external capacitors or relays required for starting



Part #	Mfg #	HP	Voltage	Stages	Price
240149	5031-0005	1/2	115	5	

### Qwik Jon® Systems

#### Qwik Jon® System

- Includes:
  - Qwik Jon® tank
  - Lid and gasket
  - 2" Solids-handling Zoeller-built pump
  - Floor flange extender kit with wax rings
  - Check valve
  - Discharge pipe to lid
  - Qwik Jon® fittings and hardware
  - Installation instructions



Part #	Mfg #	Pump	Power	Price
033165	100-0006	WM264	0.4 hp/115V	

### Grinder Pumps

#### The Shark® 810/815 Series Progressive Cavity Grinder Pump

- 1-1/4" NPT discharge
- Carbon/ceramic tandem seals
- Hydraulic stainless steel rotor and Buna N stator
- Stainless steel cutter plate/cutter
- Stainless steel shaft and hardware
- Corrosion-resistant, powder coated epoxy finish



Part #	Mfg #	Description	Cord	Price
203229	815-0004	230V Nonautomatic	20'	

## Sewage Ejectors

### The Shark® 820 Series Cast Iron Grinder Pump

- 1-1/4" NPT Vertical discharge
- Balanced bronze impeller
- Corrosion-resistant powder coated epoxy finish
- Stainless steel cutter plate/cutter, shaft, and hardware



Part #	Mfg #	Description	Cord	Price
126811	820-0004	230V Manual	20'	

### The Shark® 840 Series Reversible Grinder Pump

- Durable heavy-duty finned cast iron construction
- Cutters can automatically alternate direction
- Tandem seals with leak detection
- 1-1/4" NPT Vertical discharge
- Balanced bronze impeller
- Corrosion resistant power coated epoxy finish
- Stainless steel screws, bolts and lifting bail
- 2 Horsepower



Part #	Mfg #	Description	Cord	Price
039415	840-0004	230V Manual/Auto	20'	

### Shark® 803/805/807 Series Grinder Pump

**Cast iron grinder series for difficult residential applications where ejectors struggle**

- 803 - 1/2 HP, 805 - 3/4 HP, 807 - 1 HP
- Performance up to 55' (16.8 m)
- 115/230 V grinders for residential use without commercial grinder costs
- Oil filled for optimal heat dissipation
- Proven Tri-Slice® cutter technology -three independent cutting channels provide over 250,000 cuts per minute
- Stainless steel cutter and plate
- Automatic and nonautomatic available
- 100% factory tested



Part #	Mfg #	Description	Price
178218	803-0001	115/230V Manual/Auto	15'
178219	805-0001	115/230V Manual/Auto	15'
178220	807-0001	115/230V Manual/Auto	15'

## Sewage Ejectors

### Submersible Sewage Pumps

#### E7055 Series Sewage Pump

- *Handles 2" solids through a 2" discharge*
- *Energy efficient permanent split capacitor (PSC) motor*
- *Rated for continuous duty use*
- *Dual carbon/ceramic seals plus one Buna N seal*
- *Upper and lower sealed ball bearings*
- *Stainless steel fasteners*
- *Cast iron impeller*
- *3-year warranty*



Part #	Mfg #	Motor HP	GPM@ 10ft	GPH@ 10ft	Max Head	Discharge	Amps@ 10ft	Switch	Price
140124	E7055-NS	1/2 Hp	89	5340	23'	2"	7.0	No Switch	

**Sumps - Pits & Septic Tanks**

**Pre-Assembled Sewage Systems**

**Pro370 Series Simplex Sewage System**

- 21" x 30" Sewage system
- 2" Solids handling
- Separate access cover
- QuickTree® float system
- Capacity: 41 gallons
- Anti-flotation collar
- Molded torque-stops
- Integrally molded handles
- Unique integrated cord seal technology
- Integral rubber cover seals
- 3-Year warranty



Part #	Mfg #	Description	Price
118393	P372LE41	115V, 4/10 hp, 60 lbs, 2" Discharge	
143626	P372LE51	115V, 1/2 hp, 64 lbs, 2" Discharge	

**Pro380 Series Simplex Sewage System**

- 24" x 24" Sewage system
- Shallow system design
- 2" Solids handling
- Separate access cover
- QuickTree® float system
- Capacity: 41 gallon
- Anti-flotation collar
- Molded torque-stops
- Integrally molded handles
- Unique integrated cord seal technology
- Integral rubber cover seals
- 3-Year warranty



Part #	Mfg #	Description	Price
121918	P382LE41	115V, 4/10 hp, 60 lbs, 2" Discharge	

**Basin Extension**

- Includes gasket, stainless steel bolts, longer QuickTree® for float mounting and discharge pipe extension



Part #	Mfg #	Description	Price
122733	X8	8" For Pro370 and Pro380	

**SPAC-Series Assembled Sump Pump Package**

- 1/3 or 1/2 hp
- Molded pump support platform
- 1-1/2" Sch. 40 PVC discharge pipe
- 18" x 22" polyethylene sump pit & cover
- Gasket & hardware included - radon ready
- Two 4" inlet hubs with rubber grommet seals



Part #	Mfg #	Power	HP	Price
166221	SPAC-237	115V	1/3 hp	

**Sump Pump Parts & Accessories**

**Basin & Cover Assembly**

Part #	Mfg #	Description	Price
143685	K001107	Basin & Cover Assembly for Pro380 Series	

**Sump Pump Hose Kit**

- Polyethylene
- Includes:
  - 1-1/2" Threaded adapter
  - Hose clamp



Part #	Mfg #	Description	Price
045580	DHK-245	1-1/2" x 24' Flexible Hose	

**Sump Pump Pit & Cover**

- 18"Dia x 22"H (Inside dimensions)
- Overall height: 25"
- Poly sump pit, smooth wall
- 4" Rubber inlet grommet included
- 18" Cover with gasket seal and bolts (SC18)



Part #	Mfg #	Description	Price
122476	SP1822	Sump Pump Assembly Pit	

## Sumps - Pits & Septic Tanks

### Drainosaur® Water Removal Systems

#### Drainosaur® Water Removal System

- 5 Gallon polypropylene tank
- Easy-to-remove filter trap
- 1/3 hp
- 45 gpm @ 5' Head
- Cast iron pump housing with protective epoxy coating
- Diaphragm switch activator



Part #	Mfg #	Model	Description	Price
006000	506055	WRS-6	115V Auto, 8' Cord	

#### Compact Drainosaur® Water Removal System

- 3-1/2 Gallon tank
- 1/3 hp
- 45 gpm @ 5' Head
- Cast iron pump housing with protective epoxy coating
- Diaphragm switch activator



Part #	Mfg #	Model	Description	Price
022320	506065	WRSC-6	115V Auto, 8' Cord	

### Packaged Sewage Systems

#### Simplex Package with Structural Foam Polyethylene Basins and Steel Covers

- Package contains an Eliminator® Series Pump, automatic switch, rotational molded polyethylene basin, inlet hub, gas-tight cover assembly and check valve
  - Cover assembly includes all discharge, vent and installation hardware
  - 18" x 30" Basins includes 4" inlet hub in either cast iron caulking hub or snap-in vinyl configuration
- 9S Medium Commercial, Agricultural and Light Industrial**

- Handles solids up to 2"
- Wastewater and sewage ejector pump
- 4/10 hp
- 2" or 3" Discharge with a maximum lift of 18'
- Auto operation with adjustable piggyback mechanical float switch; on level 11" to 16", off level 4" to 8"



Part #	Mfg #	Model	Description	Price
116057	509009	9S-SMPX	18" x 30", CI Hub, 1-Pc Lid	



**Sumps - Pits & Septic Tanks**

**Simplex Sewage Package Systems - Indoor**

**Simplex 2" Vent Job-Ready Sewage  
Package Indoor System**

- 2" PVC Discharge pipe, 30" long
- Pump passes 2" spherical solids



**18" x 30" Poly Structural Foam Basin**

Part #	Mfg #	Pump	Price
080610	912-0007	M264 Auto	



## Sumps - Pits & Septic Tanks

### Distribution Boxes

- Injection molded HDPE
- Non-corrosive
- Speed leveler in each outlet
- Snap-in pipe seals



7HD2



9HD2

Part #	Mfg #	Description	Price
037035	7HD2	14-1/2" x 16" x 16", 7-Hole Distribution Box	
036192	9HD2	15" x 15" x 22", 9-Hole Distribution Box	

### Distribution Box Lid

Part #	Mfg #	Description	Price
089256	B4-RL	16" x 16" Domed Lid for 7HD2	

### Distribution Box Riser

- Stackable, watertight, gastight



Part #	Mfg #	Description	Price
140304	B1	6" x 11" x 11" Riser for 4HD2	
077309	B4	16" x 16" Square Riser for 7HD2	

### Speed Levelers™

- To control effluent flow from a distribution box



Part #	Mfg #	Description	Price
036193	SL-4	Black & Yellow for 4" PVC Pipe	

### Drop Box

- Inlet and outlet are at same level



Part #	Mfg #	Description	Price
140230	DB6	6-Hole Drop Box w/Lid	

### Effluent Filters

#### EF-4 Residential Series Effluent Filter

- Removes solids down to 1/16"
- Combo includes:
  - 4" Standard length (14" rise) T-Baffle™ EF-4 Filter
  - B4035 Bushing
  - Optional SD-4 solids deflector



Part #	Mfg #	Description	Price
079277	EF4	Effluent Filter Only	

---



---

## Sumps - Pits & Septic Tanks

---



---

### Effluent Filters

#### PL-122 Effluent Filter

- Offers over 122 linear feet of 1/16" filter slots
- Shuts off the flow of effluent when filter is removed for cleaning
- Accepts 3" and 4" Sch 40 and SDR 35 Pipe



Part #	Mfg #	Description	Price
070198	PL122	Rated for 1,500-3,000 GPD	

## Sumps - Pits & Septic Tanks

### Effluent Filters

#### PL-68 Effluent Filter

- Offers 68 linear feet of 1/16" filter slots
- Accepts 3/4" PVC handle
- Housing can be used as inlet or outlet tee
- Gasket prevents bypass
- NSF Certified



Part #	Mfg #	Description	Price
131723	30130	PL-68 Polypropylene Filter Cartridge	

### Septic Tank Risers

- Brings septic access to grade
- Watertight and airtight
- Made of UV-protected, shatter-resistant, high density polyethylene
- Structural ribs inside prevent frost from adhering in frost prone areas

#### Riser - 12" Diameter



Part #	Mfg #	Description	Price
135885	3017	6" Riser	

#### Riser - 20" Diameter



Part #	Mfg #	Description	Price
126819	3009	6" Riser	
126818	3009-12	12" Riser	

#### Riser - 24" Diameter



Part #	Mfg #	Description	Price
123426	3008	6" Riser	

### Septic Tank Riser Covers and Grates

#### Riser Cover

- HDPE Construction

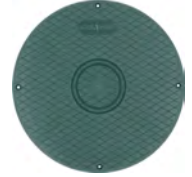

Part #	Mfg #	Description	Price
135886	3017-C12	12" Diameter	

#### Grated Riser Cover

- Stainless steel screws included
- HDPE Construction



Part #	Mfg #	Description	Price
134206	3008-G24	24" Diameter	

#### Heavy-Duty Riser Cover

- Stainless steel screws included
- Skid resistant surface
- HDPE Construction
- Factory installed gasket



Part #	Mfg #	Description	Price
126817	3017-C20	20" Diameter	
123425	3008-HD24	24" Diameter	

### Septic Tank Riser Accessories

#### Riser-To-Riser Adapter



Part #	Mfg #	Description	Price
126816	3009-RTR-20	Riser-To-Riser Adapter, 20" Dia	
123424	3009-RTR-24	Riser-To-Riser Adapter, 24" Dia	

## Sumps - Pits & Septic Tanks

### Distribution Boxes

#### 20" Distribution Box

- Use as rain drain for gutters, driveways and sub-surface drainage
- Use as distribution box or drop box for onsite septic system
- Seal accepts 2", 3", 4" or 6" pipe



Part #	Mfg #	Description	Price
126820	3017-207	20" Drain, Valve & Meter Box with Cover	

### Butyl Sealants



Part #	Mfg #	Size	Price
123428	3110-1	1/2" x 21'	

## Sumps - Pits & Septic Tanks

### Septic Tanks

#### MultiTank Single Compartment Septic Tank

- *Lightweight*
- *High strength engineered resin*
- *Watertight seamless construction*
- *Safe and unique access riser system*
- *Patented COEX-4 multi-layer co-extrusion process*
- *CSA, NSF, and IAPMO Certified*
- *P - Plumbing included*



Part #	Mfg #	Total Volume	Working Volume	Dimensions	Wt	Price
112514	RMT-300-1P	325 gal	300 gal	54" x 45" x 50"	120 lbs	

#### Septic Tank Accessories

Part #	Mfg #	Description	Price
109635	STAR-PP18	Pump Platform	

### Fralo Septic Tanks

- *High strength engineered resin*
- *Watertight seamless construction*
- *Low profile*
- *50-Year warranty*
- *P - Plumbing included*



#### Septic Tank Riser

- *24" ID Riser*
- *Watertight connection*
- *Extra-strong flat top design*
- *Anti-slip surface*



Part #	Mfg #	Description	Price
084373	STAR-24R6	6" Septic Riser	
084374	STAR-24R12	12" Septic Riser	

## Sumps - Pits & Septic Tanks

### Infiltrator® Septic Tanks

- Thick, triple-wall design manufactured with proprietary state-of-the-art rotomolding technology
- Permanent, factory-installed structural bulkheads
- Reinforced access ports
- No special installation, backfill or water filling procedures are required; can be pumped dry
- Resistant to flotation in high water table conditions
- Can be installed with 6" to 48" of soil cover (check regulatory codes)
- Flat bottom



#### TW - Pump Tank

Part #	Mfg #	Total Volume	Diameter	Height	Price
123364	TW-300	313 gal	50"	50"	

#### TW - Dual Compartment Septic Tank

Part #	Mfg #	Total Volume	Working Volume*	Length	Width	Height	Price
123363	TW-1500-2P	1,762 gal	1,523 gal	170.1"	66"	50.7"	

\* Based upon 39.75" liquid level

#### TW - Riser

Part #	Mfg #	Size	Price
137192	TWRIS-B2406	24" x 6"	
137193	TWRIS-B2412	24" x 12"	

### IM-1530 Septic Tank

- Polypropylene construction
- Lightweight plastic construction and inboard lifting lugs allow for easy delivery and handling
- Integral heavy-duty green lids that interconnect with TW™ risers and pipe riser solutions
- Structurally reinforced access ports eliminate distortion during installation and pump-outs
- Reinforced structural ribbing and fiberglass bulkheads offer additional strength
- Can be installed with 6" to 48" of cover
- Can be pumped dry during pump-outs
- Suitable for use as a septic tank, pump tank, or rainwater (non-potable) tank
- No special water filling requirements are necessary
- The tank may be backfilled with suitable native soil



Part #	Mfg #	Description	Price
171348	IM1530A/2P	1,530 Gal Working Capacity, 175.6"L x 61.7"W	



## Sumps - Pits & Septic Tanks

### Sewage Basins

#### Structural Foam Basin - 18" x 30"

- Increased volume capacity
- Less cycling time
- 30 Gallon



Part #	Mfg #	Description	Price
081194	M3-24003-D	Basin with 4" CI Inlet Grommet	

#### Recessed Rolled Top Basin - 18" x 30"

Part #	Mfg #	Description	Price
123782	B24002RRT	Basin with 4" Inlet Grommet Hub	

### Sump Pit Basins

Part #	Mfg #	Description	Price
028101	1830PIT	18" x 30" Fiberglass Pit w/4" CI Hub	
081198	1830SEWAGE 2SF	18" x 30" Structural Foam Sewage Basin (M3-24033-D) & 2" Grommet Style Vent Cover (C18SF-0155S)	

### Sewage Basin Covers

#### Grommet Style Sewage Basin Cover

Part #	Mfg #	Description	Price
116220	C18LP	18" Structural Foam Slotted	
010067	C18SS-0155S	18" Simplex 14ga SS, 2" Discharge x 3" Vent	
069200	C18SS-O146P	18" Simplex 14ga SS, 1-1/2" Discharge x 3" Vent	
084932	C24SSL-0146 P	24" Simplex 14ga SS, 1-1/2" Discharge x 3" Vent	

### Structural Foam E-Series Covers



Part #	Mfg #	Description	Price
180532	E-C18G-2	18" Simplex 18ga, (1) 1-1/2", (2) 2", (1) ECG, Screws & Gasket	
185980	E-C18G-3	18" Simplex 18ga, (1) 1-1/2", (1) 2", (1) 3 Grommet, (1) ECG, Screws and Gasket	
180284	E-C18EWSF	18" Solid Foam Cover	

### Extensions

Part #	Mfg #	Description	Price
077352	E1806EXT	6" Extension for 18x30 PolyPit	



---

---

## Sumps - Pits & Septic Tanks

---

---

### Sewage Basins

#### Fiberglass Basin

- *Chop-hoop filament wound tank*
- *Includes:*
  - (1) 18" Simplex steel cover 2" V&D
  - (1) 18" x 30" Fiberglass pit with 4" CI hub

Part #	Mfg #	Inside Dia	Capacity	Price
028099	FB18X030	18"	33 gal	

---



---

## Sumps - Pits & Septic Tanks

---



---

### Sump Pump Basins

#### Corrugated Pit and Lid

- Includes:
  - (1) 18" x 24" Pit
  - (1) 18" Sump lid (SL02)
- Pit Capacity:
  - 11 Gallons to inlet
  - 12 Gallons to lid



Part #	Mfg #	Description	Price
132547	COMBO	Sump Pit & Lid	

#### Components

Part #	Mfg #	Description	Price
122993	SUMP	Pit Only, 18"x24"	
122994	SL02	Lid Only, 18"	

### GoldFlo® Plain End Dual-Wall Pipe



Part #	Mfg #	Size	Price
087343	24GF20NP	24" x 20'	

## Sumps - Pits & Septic Tanks

### Basins

#### Filament Wound Reinforced Polyester Fiberglass Basins

- Available in 18", 24" 30", 36", 42", 48" and 60" inside diameters.
- Depths available up to 240" in increments of 6"
- Available with or without anti-float bottoms
- Winding process is computer controlled for accuracy, consistent thickness and extraordinary strength
- Manufactured to the ASTM D 3753 Standard Specification for Glass - Fiber Reinforced Polyester Manholes and Wet Wells
- Designed to withstand wall collapse or buckling based on:
  - Hydrostatic pressure of 62.4 lbs. per square foot
  - Saturated soil weight of 120 lbs. per cubic foot
  - Soil modulus of 700 lbs. per square foot
  - Tensile strength of 100,000 to 150,000 PSI



Part #	Mfg #	Description	Price
238488	24X48AF	24" x 48" Anti-Float	
238489	24X60AF	24" x 60" Anti-Float	
238490	24X72AF	24" x 72" Anti-Float	

#### SF20 Sump Basin

- 20 Gallon capacity
- Heavy duty structural foam injection
- Ultra strong, reinforced bottom will not flex
- Cover mounting metal inserts included
- Gas and radon tight
- Odor
- Dozens of cover options available



Part #	Mfg #	Description	Price
238491	SF20-60913	18" x 20"	

#### SF30BA Basic 30 Gallon Sewage Basin

- Heavy duty construction
- Ultra strong, reinforced bottom will not flex
- Cover mounting metal inserts included on basin
- Gas, radon and odor tight
- Dozens of cover options available
- Size: 18" x 30"
- Capacity: 30 Gallons
- Material: Injection Molded Polyethylene Structural Foam



Part #	Mfg #	Description	Price
238496	SF30BA	18" x 30"	

#### Jackel SF24x36 72 Gallon Sewage Basin

- Heavy duty construction
- Strongest, thickest rim, the 360 degree EZ Grab™ handle
- Ultra strong, reinforced bottom will not flex
- Gas, radon and odor tight
- Metal inserts
- Dozens of cover options available
- Size: 24" x 36"
- Capacity: 72 Gallons
- Material: Injection Molded Polyethylene Structural Foam



Part #	Mfg #	Description	Price
238498	SF24X36	24" x 36"	

## Sumps - Pits & Septic Tanks

### Basin Covers

#### SF2000E Cover

- For use with our 18" diameter basins
- Heavy duty construction
- 4-Bolt, Gas and odor tight
- Includes: (1) 4" Inlet Hub, (2) 2" Flanges, (1) 3" Flange, (1) 1-1/2" Flange, (1) Cord Grommet, (4) Bolts and Washers, (1) Roll of Sealing Tape
- Also available in 0.075" thick steel
- Diameter: 20-1/2"
- Bolt Circle: 19-1/2"
- Structural Thickness: 5/8"
- Material: Injection Molded Polyethylene Structural Foam
- Application: Sump or Sewage Pumps



Part #	Mfg #	Description	Price
238492	SF2000E	20-1/2" Diameter	

#### SF60913 Cover

- For use on Jackel-SF20 and Jackel-SF22 basins
- Heavy duty structural foam injection molded construction
- Perfect for pedestal sump pumps
- Slotted design provides maximum versatility
- Works with all sump pumps
- Size: 18" Diameter
- Structural Thickness: 1/4"
- Material: Injection Molded Polyethylene Structural Foam
- Application: Pedestal or Submersible Sump Pumps



Part #	Mfg #	Description	Price
238493	SF60913	18" Diameter	

### SF22B Cover

- For use on SF20 and SF22 basins
- Heavy duty structural foam injection molded construction
- Solid design provides maximum versatility
- Perfect for use with submersible sump pumps
- Diameter: 20-1/2"
- Bolt Circle: 19-1/2"
- Structural Thickness: 5/8"
- Material: Injection Molded Polyethylene Structural Foam
- Application: Submersible Sump Pumps



Part #	Mfg #	Description	Price
238494	SF22BSEAL	20-1/2" Diameter	

### SF16101 Cover

- For use with our Jackel-SF20, SF22, SF30, and FLARE45™ basins
- Recognized T-Top™ design
- Heavy duty construction
- 1-1/4", 1-1/2", 2" or 3" slip connection discharge flange
- 2" or 3" threaded vent flange
- Reusable PVC seal
- 8 bolt, gas, radon and odor tight
- Diameter: 20-1/2"
- Bolt Circle: 19-1/2"
- Structural Thickness: 11/16"
- Material: Injection Molded Polyethylene Structural Foam
- Application: Sewage Pumps



Part #	Mfg #	Description	Price
238499	SF16101	20-1/2" Diameter	

## Sumps - Pits & Septic Tanks

### SF114 Cover

- For use with our Jackel-SF20, SF22, SF30, and FLARE45™ basins
- Split cover for easy pump access
- Heavy duty construction
- 1-1/4", 1-1/2", 2" or 3" slip connection discharge flange
- 2" or 3" threaded vent flange
- Reusable PVC seal
- 8 bolt, gas, radon and odor tight
- Diameter: 20-1/2"
- Bolt Circle: 19-1/2"
- Structural Thickness: 1-1/4"
- Material: Injection Molded Polyethylene Structural Foam
- Application: Sewage Pumps



Part #	Mfg #	Description	Price
238500	SF114	20-1/2" Diameter	

### SF24S Cover

- For use with our 24" diameter basins
- Heavy duty construction
- Available with a 1-1/4", 1-1/2", 2" or 3" discharge flange and 2" or 3" vent flange and a 6" access opening
- 12-bolt, gas, radon and odor tight
- 1" thick
- Can support 1,000 pounds
- Diameter: 28"
- Bolt Circle: 26-1/2"
- Structural Thickness: 1"
- Material: Injection Molded Polyethylene Structural Foam
- Application: Sewage Pumps



Part #	Mfg #	Description	Price
238504	SF24S-BL	28" Diameter	

### SF24B Cover

- For use with our 24" diameter basins
- Heavy duty construction
- Comes with cut outs for 1-1/4", 1-1/2", 2" or 3" discharge and 2" or 3" vent and a 6" access opening
- 12-bolt, gas, radon and odor tight
- 1" thick
- Can support 1,000 pounds
- Diameter: 28"
- Bolt Circle: 26-1/2"
- Structural Thickness: 1"
- Material: Injection Molded Polyethylene Structural Foam
- Application: Sewage Pumps



Part #	Mfg #	Description	Price
238503	SF24B-BL	28" Diameter	

### Jackel E-Series Inlet or Discharge Hub

- Water and vapor tight seal with no caulking
- Quick and easy installation
- Fits Basins with 18" - 36" Diameter
- Inlet Size: 1", 1-1/4", 1-1/2", 2", 3", 4", or 6"
- Application: Sump and Sewage Basins (18" - 36" Diameter)
- Material: Flexible PVC



Part #	Mfg #	Description	Price
238507	E125H	1-1/4" Inlet Hub	
238508	E150H	1-1/2" Inlet Hub	
238509	E200H	2" Inlet Hub	
238510	E300H	3" Inlet Hub	
238511	E400H	4" Inlet Hub	

### Jackel Cast Iron Hub

- 4-Bolt Configuration



Part #	Mfg #	Description	Price
238512	CIH4X24	4" Cast Iron Hub	



## Sumps - Pits & Septic Tanks

### Jackel Universal Combo Hub

- Water and vapor tight seal
- Fits 3" or 4" DWV SCH. 40/80 plastic pipe
- Fits Basins with 18" - 60" Diameter
- Code Approved
- Quick and easy to install
- No tools required
- Inlet Size: 3" or 4"
- Application: Sump or Sewage Basins (18" - 60" Diameter)
- Material: Hard PVC



Part #	Mfg #	Description	Price
238513	JH4-01	4" Universal Combo Hub	

### Jackel SF16101B

- For use with our Jackel-SF20, SF22, SF30, and FLARE45™ basins
- Recognized T-Top™ design
- Heavy duty construction
- Solid design allows for installation flexibility
- Reusable PVC seal
- 8 bolt, gas, radon and odor tight
- Diameter: 20-1/2"
- Bolt Circle: 19-1/2"
- Structural Thickness: 11/16"
- Material: Injection Molded Polyethylene Structural Foam
- Application: Sewage Pumps



Part #	Mfg #	Description	Price
238552	SF16101B	20-1/2" Diameter	

### Radon/Sump Dome Side Discharge

- Top vent

Part #	Mfg #	Description	Price
163388	SMR114-V	Top Vent	

**Sump Pumps**

**Sump Pumps**

**230 Series Aluminum Submersible Sump Pump**

- 3/8" Solids handling
- 1-1/2" Discharge
- 1/3 hp, 60Hz, 3,450 rpm
- Polypropylene and powder-coated aluminum construction
- Vortex-style impeller of high temp engineered thermoplastic
- Stainless steel rotor shaft
- 10' Quick-disconnect power cord
- 3-Year warranty



Part #	Mfg #	Description	Price
115238	237VMF	115V Auto, Vertical Magnetic Float	

**250 Series Cast Iron Submersible Sump Pump**

- 1/2" Solids handling
- 1-1/2" Discharge
- 1/3 hp Hermetically sealed motor, oil filled with thermal overload protection
- Heavy-duty cast iron pump with epoxy powder coat finish
- Vortex engineered polymer impeller
- Three switching options
- Energy saving model - efficient motor reduces electrical usage by up to 40%
- Permanently sealed and lubricated bearings
- 10' Quick-disconnect cord, unless noted otherwise
- 3-Year warranty



Part #	Mfg #	Description	Price
131287	251-2	115V Auto, Mercury-Free Float, 25' Cord Length	
120994	253	115V Auto, Mercury-Free Float, with Series Plug	
114396	257VMF	115V Auto, Vertical Magnetic Float	

**280 Series Cast Iron Submersible Sump Pump**

- 3/4" Solid handling
- 1-1/2" Discharge
- 1/2 hp Hermetically sealed motor, oil filled with thermal overload protection
- One-piece "Uni-body" casting
- Vortex engineered impeller
- 55 gpm @ 10' Head
- Permanently lubricated upper and lower bearings
- Stainless steel removable bottom screen, rotor shaft, and fasteners
- 10' Quick-disconnect cord, unless noted otherwise
- 3-Year warranty



Part #	Mfg #	Description	Price
122552	283-2	115V Auto w/Piggy-back, 25' Cord Length	
122533	287VMF	115V Auto, Vertical Magnetic Float	

**290 Series 3/4 hp Submersible Effluent/Sump Pumps**

- Semi-open impeller permitting passage of solids up to 3/4"
- 416 stainless steel rotor shaft
- 1-1/2" Discharge
- Epoxy powder coat finish
- All fasteners - corrosion resistant SS
- Maximum fluid temperature: 140°F
- Permanently lubricated upper and lower ball bearing
- Stainless steel bottom screen - easily removable
- For on-site waste water systems, liquid waste transfer, and commercial heavy-duty sump pump applications



Part #	Mfg #	Description	Price
169221	297	Vert magnetic float for smaller pits - will operate in a 10" diameter sump	

**Sump Pumps**

**441 Series Battery Back-Up Emergency Sump Pump System**

- 3-Stage charger
- Wiring with slip connectors
- Use with 120V primary pump
- Adapts to 1-1/2 or 1-1/4 discharge
- Battery not included



Part #	Mfg #	Description	Price
123666	441	12V Deep Cycle Battery	

**442 Series StormCell® Battery Back-Up Pump**

- Energy efficient 12V DC Pump
- Professional-grade 10 amp charger/controller
- Suitable with Wet Cell, AGM gel-type batteries
- Microprocessor with energy efficient Switch Mode Technology
- Single battery: Group 27 or 31 batteries
- Remote wall-mount user interface with LCD display
- Audio alarm (features a self-reset after silence)
- 9-volt battery backup – operates alarm in standby mode for up to 72 hours
- Blue LED Pump-Run light
- Auxiliary contacts: 24VDC, 100 mA max
- Compact “snap-on” activation float with integral alarm float (1-1/4" & 1-1/2" pipe)
- High water float acts as a redundant “on” float for the pump
- Tee and fittings for standard installations
- Green LED AC power light and audible notification of power lost



-25A

Part #	Mfg #	Amps	Battery	Price
225640	44210AEY E	10	Single	

**450 Series Aluminum Submersible Sump Pump**

- 3/8" Solids handling
- 1-1/2" Discharge
- 1/2 hp Hermetically sealed motor, oil filled with thermal overload protection
- 7.5A, 60Hz, 3,450 rpm
- Polypropylene and powder-coated aluminum construction
- Vortex-style impeller of high temp engineered thermoplastic
- Stainless steel rotor shaft
- Permanently lubricated upper and lower bearings
- 10' Quick-disconnect power cord
- 2-Year warranty



Part #	Mfg #	Description	Price
121529	457VMF	115V Auto, Vertical Magnetic Float	

**HT40 Series High-Temp Submersible Sump Pump**

- For hot water applications up to 200°F
- 3/4" Solid handling
- 1-1/2" Discharge
- 4/10 hp, 12A
- Vortex impeller, made of temperature engineered thermoplastic
- Cast iron construction with all stainless and brass fasteners
- 416 Stainless steel rotor shaft
- Oil, filled thermally protected motor
- Permanently lubricated bearings
- Unitized shaft seal
- 10' UL Approved power cord with quick disconnect



Part #	Mfg #	Description	Price
136540	HT41A	115V Automatic	

**Sump Pumps**

**LSG200 Series Omnivore Grinder Pump**

- 1-Pc uni body cast iron housing
- Oil-filled, thermally protected motor
- 316 Stainless steel impeller
- 300 Series SS rotor shaft
- Dual seals
- Advanced v-slice®
- Stainless steel fasteners
- Clog-free volute design
- Solid state starting circuit
- Horizontal 1-1/4" FNPT discharge
- 25' Power cord with quick-disconnect
- Piggy back plug with wide angle float



**SBX Series Sump Box System**

- Fully assembled
- S35 Pump
- Unique debris filter tray
- Large 41 gallon capacity
- Easy access cover requires no tools to open
- Easy to service float switches located in holders under access cover
- Sealed covers radon-ready
- Molded polyethylene basin material
- Basin dimensions: 18-3/4"H x 24"W x 32"L



Part #	Mfg #	HP	Volts	Price
125195	LSG202A	2 HP	208-230	

Part #	Mfg #	Description	Price
123910	SBX35	115V, 1/3 hp, Complete System	

**PRG Series ProVore® Grinder Pump**

- 1 HP
- 10' Cord length
- 2" Discharge lines
- V-Slice® cutter
- Automatic: wide angle
- 115V or 230V single phase
- Heavy cast iron construction
- Oil-filled, thermally protected motor
- Hardened stainless steel cutter & plate



**SumpJet® Water Powered Back-Up Sump Pump**

- 1-1/2" Discharge
- Powered by municipal water supply and requires no electricity
- Compact, high-efficiency design
- Removes 2 gallons of sump water per 1 gallon used
- Built-in backflow prevention
- Built-in screen with removable foot valve
- 3/4" NPT Water inlet connection with optional hose connector included
- Fully automatic
- Completely assembled
- 3-Year warranty



Part #	Mfg #	HP	Volts	Price
159512	PRG101-A	1 Hp	115V	

Part #	Mfg #	Description	Price
113773	SJ10	Water Powered Back-Up Pump	

**S37 Builder's Series Submersible Sump Pump**

- 35 gpm @ 10' Head
- 1/4" Solids handling
- Vortex style thermoplastic impeller
- 1-1/2" Discharge
- 10' Cord
- Vertical float switch
- 1/3 hp
- 2-Year warranty



**Sump Pump Accessories**

**"The Brick" Submersible Sump Pump Platform**

- Raises sump pump 2.5" off the bottom of your pit
- Durable poly - will not corrode
- 2-Year warranty



Part #	Mfg #	Description	Price
124984	S37	115V Auto	

Part #	Mfg #	Description	Price
121934	4445000	Fits Liberty Sump Pump Series: 220, 230, 240, 250, 270 & 280	

**Sump Pumps**

**Drain Pumps**

**404 Drain Pump**

- 3/8" Solids handling
- 1/3 hp Oil-filled, hermetically sealed motor with thermal protection
- 25 gpm @ 10' Head
- Fully automatic operation
- Maintenance-free, permanently lubricated sealed bearings
- Factory pre-assembled, ready to install
- Separate access cover
- Integrally molded rubber gasket for gas-tight seal
- 10' 3-Wire power cord with grounded plug
- 3-Year warranty



Part #	Mfg #	Description	Price
120995	404	115V, 1-1/2" FPT Inlet, Discharge and Vent	

**Utility Pumps**

**260 Model Submersible Utility Pump**

- Pumps down to within 1/8" of base
- 1-1/4" Discharge with 5/8" garden hose adapter
- 1/6 hp
- 2-Year warranty



Part #	Mfg #	Description	Price
121916	260	115V, Non-Automatic 1/6 hp	

**331 Model Cast Aluminum Portable Transfer Pump**

- 1/2 hp, 8A, 60Hz, 7,500 rpm
- One-piece pump and motor housing with integral carry handle
- Epoxy powder coat finish
- Glass reinforced thermoplastic impeller
- Includes 3/4" brass garden hose adapters and suction screen
- On/off switch
- Permanently lubricated ball bearings
- Large prime plug with internal funnel design
- Easily replaced motor brushes
- Maximum discharge head: 105'
- Maximum suction lift: 15'
- 20' Cord
- 3-Year warranty



Part #	Mfg #	Description	Price
110244	331	115V Portable Transfer Pump	

**ELV-Series Sump Pump System with OilTector®**

- 25' Cord
- 1-1/2" Discharge
- 3/4" Solids handling
- 10.4 Full load amps
- Automatic with control



Part #	Mfg #	Description	Price
186891	ELV290	115V, 3/4 HP	



Sump Pumps

Alarms

- For sump, sewage and effluent

**ALM-2 Indoor High Liquid Level Alarm**

- NEMA 1 Indoor rated
- 86 dB Alarm
- Red alarm light
- Green "power-on" light
- Low battery chirp
- Automatic reset
- Test/silence feature
- Plugs into a 115V outlet



Part #	Mfg #	Description	Price
121275	ALM-2-1	115V Indoor Alarm w/9V Battery Back-Up & 10' Float Cord	

**ALM-2W Indoor/Outdoor High Liquid Level Alarm**

- Meets type 3R watertight standards
- Thermoplastic enclosure
- Red alarm beacon, 360° visible
- 85 dB Horn
- Test/silence switch
- Green power-on indicator
- 20' Float cord



Part #	Mfg #	Description	Price
124533	ALM-2W	115V Indoor/Outdoor Alarm	

**ALM-Pa Indoor Alarm with Probe Sensor**

- Compact probe mounted sensor (snaps on 1-1/4" or 1-1/2" discharge pipe)
- Auxiliary contacts
- Visual and audio alarm



Part #	Mfg #	Description	Price
122840	ALM-P1	115V Indoor Alarm with 9V Battery Back-Up & Probe Sensor	

Accessories

**Ball/Check Valve Combination**

- Heavy-duty PVC
- 125 psi
- Vertical or horizontal installation
- Union for easy assembly
- Compact design



Part #	Mfg #	Size	Price
124087	BCV200	2"	

**Quiet Check Valve**

- Heavy-duty PVC
- Spring-loaded valve reduces "water hammer" effect
- Rated: 125 psi
- Vertical or horizontal installation
- Maximum fluid temp: 160°F



Part #	Mfg #	Description	Price
122776	QCV150	1-1/2"	
122777	QCV200	2"	

**Cast Iron Anti-Siphon Check Valve**

- Heavy-duty cast iron construction
- Integrated heavy weight nitrile ball check valve
- Anti-siphon features breaks suction to prevent unwanted tank siphonage
- Rated: 125 psi



Part #	Mfg #	Size	Price
134601	ACV125	1-1/4" NPT	

**Cast Iron High Temp Check Valve**

- Heavy-duty cast iron body
- High-temperature rubber flapper - 200°F
- Rated: 125 psi
- Vertical or horizontal installation



Part #	Mfg #	Size	Price
142300	HCV150	1-1/2" Female NPT	



**Sump Pumps**

**Flanged 90° Grinder Elbow**

- Provides vertical discharge for non-guide rail installations
- 1-1/4" FNPT Outlet
- Heavy cast iron construction
- Powder coated for corrosion resistance
- Includes sealing grommet and stainless steel bolts



Part #	Mfg #	Description	Price
125196	G90	Fits Omnivore LSG Series	

**Float Control**



Part #	Mfg #	Description	Price
138310	K001001	115V w/Series Plug, 10' Cord	

**Pilot Duty Switch**

Part #	Mfg #	Description	Price
134600	K001134	115V, 20' Cord	

**Power Cord**

Part #	Mfg #	Description	Price
132706	K001008	25' 115V Quick Connect Cord Kit	

**Sump Pumps**

**Water Leak Detectors**

**Lyric™ Wi-Fi Water Leak and Freeze Detector w/ Cable Sensor**

- Includes 3(AA) batteries
- 3 Year battery life
- Notification messages and audible alerts
- Use to detect temperatures that can freeze pipes, and humidity that could damage valuables
- Runs on WiFi - no extra hub or hardware purchase required
- Reusable even after detecting an incident
- Wall or floor mount



Part #	Mfg #	Description	Price
189828	CHW3610W1001/ U	Battery Operated Leak Detector Alarm, 7" x 2-1/2"	
189829	CHWES41013/U	4 ft Cable Sensor for Lyric™ Wi-Fi Water Leak and Freeze Detector	

## Sump Pumps

### Water Wizard 5-Series Submersible Utility Pumps

#### 5-MSP Oil-Filled Submersible Utility Pump

- cCSAus Listed
- 1/6 hp Shaded pole motor with overload protection
- 1,200 gph @ 1' Head
- 26.3' Maximum lift
- Pumps down to 1/8"
- 60Hz, 380 Watts, 5 Amps
- Designed for continuous duty
- Epoxy-coated cast aluminum housing
- 1" FNPT Discharge includes garden hose adapter
- Bottom inlet has removable screen for cleaning



Part #	Mfg #	Model	Description	Price
006006	505000	5-MSP	115V Manual, 10' Cord	

### ES Series Submersible Sump/Effluent Pumps

#### ES33 Automatic Submersible Sump/Effluent Pump

- Handles up to 3/8" solids
- Energy saving
- 1-1/2" FNPT Vertical discharge
- 115V
- Diaphragm pressure switch
- Automatic operation with vertical diaphragm switch



Part #	Mfg #	Model	Description	Price
108533	506420	ES33D1-10	1/3 hp	

### Big John® Submersible Sump Pumps

#### 6 Series Oil-Filled Sump Pump

- 45 gpm @ 5' Head
- 1-1/2" FNPT Discharge 18' max head
- Non-adjustable pressure switch; on level 7" to 10", off level 1" to 4"
- Rated UL/CSA
- 1/3 hp



6-CIA

Part #	Mfg #	Model	Description	Price
006008	LG6CIA	6-CIA	115V Auto, 8' Cord	
006009	506171	6-CIA-RFS*	115V Auto, 10' Cord	

\*RFS - Auto with adjustable piggyback mechanical float switch; On level 9" to 10-1/2", off level 2" to 3"

### 8 Series Oil-Filled Sump Pump

- 10A, 830 Watts
- 4/10 hp Shaded pole motor
- 1-1/2" Discharge
- Auto operation with non-adjustable pressure switch activates; On level 7" to 10", off level 1" to 4"
- CBM & CBA Models are cast bronze
- CIM & CIA Models are epoxy-coated CI
- UL/CSA Rated



Part #	Mfg #	Model	Description	Price
006011	508157	8-CIA	115V Auto, 10' Cord	

### Sump Pump Switch Repair Kits

Part #	Mfg #	Model	Description	Price
005995	599300	SPRK-1	Switch Repair Kit	
005996	599320	SPRK-2	For 6-CIA,8-CIA,8-CBA	

### Auxiliary Condensate Overflow Safety Switch

- Can install switch to activate audible and/or visual alarm
- ABS housing and float
- Low voltage
- Lead wires
- UR / C-CSA listing



Part #	Mfg #	Model	Description	Price
005991	599122	ACS-2	48 VAC/VDC, 5Amp Max	

### Piggyback Switches

- Convert any manual pump to an automatic pump

#### Piggyback Wide Angle Mechanical Float Switch



Part #	Mfg #	Model	Cord	Max HP	Price
021359	599118	RFSN6*	10' Cord	1/2	
027212	599117	RFSN9*	15' Cord	1/2	

\* Comes with a 120V piggyback plug; ratings for 208V & 230V apply if plug is removed



## Sump Pumps

### Submersible Sump Pumps

#### ST Series Sump Pump

- Cast iron/cast aluminum construction
- Energy efficient permanent split capacitor (PSC) motor
- Piggy-back dual float switch with protective cage
- Continuous duty rated
- Dual carbon/ceramic seals
- 10' power cord
- Will fit in 10" diameter sump pit
- 3-Year warranty when purchased from and installed by a contractor, otherwise 18 months
- Water cooled



ST1033-NS

Part #	Mfg #	Motor HP	GPM@ 10ft	GPH@ 10ft	Max Head	Discharge	Amps@ 10ft	Switch	Price
165293	ST1033-NS	1/3 Hp	46	2770	29'	1.5"	3.8	No Switch	

#### S3 Series Sump Pump

- Cast iron / stainless steel construction
- Energy efficient permanent split capacitor (PSC) motor
- Continuous duty rated
- Stainless steel shaft
- Dual carbon/ceramic seals
- 20' Pump cord (S3050 & S3100), 10' Pump cord (S3033)
- 4-Year warranty when purchased from and installed by a contractor, otherwise 3 year
- Water cooled



S3033-NS

Part #	Mfg #	Motor HP	GPM@ 10ft	GPH@ 10ft	Max Head	Discharge	Amps@ 10ft	Switch	Price
166538	S3033-NS	1/3 Hp	50	3000	30'	1.5"	4.0	No Switch	
189194	S3050-NS	1/2 Hp	65	3900	33'	2"	4.3	No Switch	
189189	S3100-NS	1 Hp	92	5520	52'	2"	11.5	No Switch	

#### S5 Series Sump Pump

- Continuous duty construction
- Cast iron housing
- Energy efficient permanent split capacitor (PSC) motor
- Stainless steel shaft
- Upper and lower ball bearings
- Dual carbon ceramic seals with additional third shaft seal
- Dynamically balanced cast iron impeller
- Stainless steel fasteners & removable strainer
- 20' cord length
- 5-Year Warranty
- Water cooled



S5033-NS

Part #	Mfg #	Motor HP	GPM@ 10ft	GPH@ 10ft	Max Head	Discharge	Amps@ 10ft	Switch	Price
231144	S5033-NS	1/3 Hp	59	3540	26'	1.5"	4.0	No Switch	



## Sump Pumps

### Submersible Sump Pumps (Continued)

#### S5 Series Sump Pump

Part #	Mfg #	Motor HP	GPM@ 10ft	GPH@ 10ft	Max Head	Discharge	Amps@ 10ft	Switch	Price
157546	S5050-NS	1/2 Hp	83	4980	36'	2"	6.8	No Switch	

#### The Cast Iron Sump Pump

- Cast Iron Sump/Effluent pump
- Energy efficient permanent split capacitor (PSC) motor
- Includes built-in vertical switch
- 6 Blade vortex impeller
- Upper and lower ball bearings
- Carbon ceramic plus Buna N shaft seals
- Thermally protected
- Stainless steel fasteners
- Strainer limits solids to 1/2"
- 10' Pump cord
- 3 Year limited warranty



Part #	Mfg #	Motor HP	GPM@ 10ft	GPH@ 10ft	Max Head	Discharge	Amps@ 10ft	Switch	Price
246530	CIS-33V	1/3 Hp	53	3,200		1.5"	5	Vertical Switch	

### Controllers & Switches

#### Deluxe Controller with Dual Float Switch

- Monitors pump and power conditions
- Sounds an alarm when a problem is detected
- Begins pumping cycle when either float rises 1/4" and runs the pump an additional 10 seconds after the float returns to its original positions



Part #	Mfg #	Description	Price
144717	DFC2	Deluxe Controller w/ Dual Float Switch	

#### Enhanced Controller with Dual Float Switch

- Available w/ a dual float or vertical switch
- Activates pump weekly to exercise and extend pump life
- Pump run time is adjustable



Part #	Mfg #	Description	Price
222432	DFC15	Enhanced Controller w/ Dual Float Switch	



## Sump Pumps

### Standard Dual Float Controller

- Two micro reed activated floats for added reliability
- Protective cage prevents debris from interfering with floats
- Switch is mounted independent from pump, allowing user to adjust the height of pump activation



Part #	Mfg #	Description	Price
141072	DFC1	Standard Controller w/ Dual Float Switch	

### Sump Pump Combination Systems

#### Included with System

- Primary & Backup Pumps
- (3) 1-1/2" Standard no hub couplings
- (2) Standard check valves with hardware
- Sump Foot - Raises and secures both pumps
- Backup System controller/charger with fluid sensor
- Primary Pump controller enhanced controller with caged dual float switch (DFC1.5)
- Battery Box

#### Pro Series PS-C11 Combination Sump Pump System

- Designed for use with wet cell or AGM / maintenance free batteries
- Dual float switches provide dependable activation for each pump
- Unique monitoring controller sounds an alarm if maintenance is needed
- Pumps are securely attached to raised Sump Foot with stainless steel screws to prevent movement or breakage

ST1033 Primary Pump

PHCC-1000 Backup - 1000 GPH at 10', 12 VDC



Part #	Mfg #	Motor HP	GPH@ 10ft	Max Head	Discharge	Amps@ 10ft	Voltage	Price
146226	PS-C11	1/3 Hp	2770	29'	1-1/2"	3.8	115V, 60Hz	

#### Pro Series PS-C22 Combination Sump Pump System

- Remote terminals for connection to a security system or auto-dialer
- Designed for use with wet cell or AGM / maintenance free batteries
- Dual float switches provide dependable activation for each pump
- Unique monitoring controller sounds an alarm if maintenance is needed and runs pump weekly to test for proper operation
- Pumps are securely attached to raised Sump Foot with stainless steel screws to prevent movement or breakage

ST1033 Primary Pump

PHCC-1730 Backup - 1730 GPH at 10', 12 VDC



Part #	Mfg #	Motor HP	GPH@ 10ft	Max Head	Discharge	Amps@ 10ft	Voltage	Price
141757	PS-C22	1/3 Hp	2770	29'	1-1/2"	3.8	115V, 60Hz	





## Sump Pumps

### Pro-Series PS-C33 Combination Sump Pump

- Remote terminals for connection to a security system or auto-dialer
- Designed for use with wet cell or AGM / maintenance free batteries
- Can accommodate two (2) standby batteries to double the run time
- Caged dual float switches provide dependable activation for each pump
- Pumps are securely attached to raised Sump Foot with stainless steel screws to prevent movement or breakage



**S3033 Primary Pump**

**PHCC-2400 Backup - 2400 GPH at 10', 12VDC**

Part #	Mfg #	Motor HP	GPH@ 10ft	Max Head	Discharge	Amps@ 10ft	Voltage	Price
133829	PS-C33	1/3 Hp	3000	30'	1-1/2"	4.0	115V, 60Hz	

### Backup Pumps

#### Pro Series PHCC-1000 Battery Backup Sump Pump System

- Stainless steel shaft, rulon seal, and rustproof housing provide long-lasting, reliable operation
- Trickle charger maintains the battery at full charge
- System continuously monitors the battery and power conditions to ensure dependable operation and sounds an alarm when:
  - The AC power is out or the circuit breaker has blown
  - The battery fluid is low and water needs to be added
  - The pump was activated
  - The battery is discharged, defective or the terminals need cleaning
- Alarm can be silenced



Part #	Mfg #	Motor Type	Max Head	GPH@ 10ft	Amps@ 10ft	Power Input	Price
157717	PHCC-1000	Brush DC	15 ft	1000	6.5	115VAC, 60Hz	

#### Pro Series PHCC-2400 Battery Backup Sump Pump System

- Recharges automatically
- Monitors system conditions and alarms when:
  - Battery needs water, is discharged or needs to be replaced
  - Battery cable is loose or corroded
  - Power plug is disconnected, fuse is blown or circuit breaker is tripped
  - Pump is clogged or broken
  - Backup pump has been activated
- Alarm can be silenced during a power outage
- Displays percentage of power remaining in the battery
- Runs pump weekly to test for proper operation
- Can run directly on AC power, automatically switches to battery when AC fails
- Output terminals for connection to a security system or auto-dialer
- Accommodates up to two (2) B-2200 batteries for 100 hours of pumping - either (2)B22220 or (2)B12-90 batteries



Part #	Mfg #	Motor Type	Max Head	GPH@ 10ft	Amps@ 10ft	Power Input	Price
132436	PHCC-2400	Brush DC	17 ft	2400	16	115VAC, 60Hz	

## Sump Pump Parts & Accessories

### Batteries & Acid

#### Pro Series Standby Battery

- Helps run pump longer
- Works with all PHCC Backup and Combo Systems
- Accommodate the battery fluid sensor (wet cell batteries)



B-2200

Acid sold separately (wet cell batteries)

Part #	Mfg #	Description	Price
086614	B-2200	Reserve Cap @ 25 Amps: 182 min	

#### Pro Series Sealed Battery

- Maintenance free
- Sealed, absorbed glass mat (AGM)
- 



Part #	Mfg #	Description	Price
142173	B12-90	12 VDC, 90 Amp Hours	

#### Battery Acid

- Activates wet cell battery
- Flexible pour spout



Part #	Mfg #	Description	Price
133830	Z-PACK	6 Quarts	

### Accessories

Part #	Mfg #	Description	Price
242160	2400AGMC	Controller Reman ONTR	
247817	PS-WS	Water Sensor Accessory	

#### Jumper Cable

- 12 Gauge wires
- 40" Length
- 3/8" and 5/16" ring terminals
- 1-Year Warranty



Part #	Mfg #	Description	Price
133832	PJC	Parallel Jumper Cable	

#### Sump Foot

- Pre-drilled holes
- Made of high impact polypropylene
- Keeps pumps out of dirt and debris
- 1-Year Warranty



SF2

Part #	Mfg #	Description	Price
181869	SF2	For Single Primary or Backup Pump	

#### Check Valve

- Flapper opens 100%
- Used on primary pumps for combo systems
- 1-Year Warranty



1141003

Part #	Mfg #	Description	Price
180041	1141003	Screw-In, 1-1/2"	

#### Quick Connect Main Pipe

- Pre-assembled with:
  - 1-1/2" Rubber coupling
  - 1-1/2" Check valve
  - 1-1/2" NPT Female adapter
  - Pre-Drilled weep hole
  - Discharge pipe
  - 1-1/2" NPT Threaded male adapter



PS-MP

Part #	Mfg #	Description	Price
178522	PS-MP	Total Length: 14.25"	

## Sump Pump Parts & Accessories

### WiFi Module

- The PHCC Pro Series CONNECT Line of Pumps have the ability to send email or text notifications when there is an issue or needed maintenance



#### Notification with the USB Data Port:

- With USB data port simply plug/attach the Pro Series CONNECT Module to your Pro Series 2400 Backup system and the module will act as a gateway to the internet
- Receive specific text or email alerts telling you exactly what is going on in the home

#### Notification with the Remote Terminal

- Connects to a home security, auto dialer, or other dry contact based device
- Receive text or email alerts, notifying you of an issue or needed maintenance

Part #	Mfg #	Description	Price
234089	PS-WIFI	Pro Series CONNECT WiFi Module	

### Water Alarm

- Solid state circuitry is extremely sensitive and reliable
- 110dB alarm can be heard throughout the house
- Alarm will sound up to 3 days
- Battery will last 24-48 months



Part #	Mfg #	Description	Price
157047	PWA	9V Alkaline Battery (Not Included)	

## Sump Pumps

### Sump Pump Discharge Kits

- *Ideal for discharging water out of the basement sump to a safe location outside the home*



- *Kit includes:*
  - 1-1/4" x 24' Corrugated polyethylene hose
  - ABS Threaded 1-1/2" MNPT x 1-1/4" barbed adapter
  - ABS Threaded 1-1/4" MNPT x 1-1/4" barbed adapter
  - Galvanized steel clamp

Part #	Mfg #	Model	Description	Price
010307	599303	SPDK	1-1/4" & 1-1/2", Black	

## Sump Pumps

### Submersible Effluent or Dewatering Pump

#### 53 "Mighty-Mate" Cast Iron Submersible Pump

- 34 gpm @ 10' Head
- Passes 1/2" spherical solids
- Non-clogging vortex impeller
- 1-1/2" NPT Discharge
- Float operated
- 3/10 Horsepower



Part #	Mfg #	Description	Cord	Price
027850	M53	115V Auto	9'	

#### 137 "Flow-Mate" Cast Iron Submersible Pump

- 79 gpm @ 10' Head
- Passes 5/8" spherical solids
- Non-clogging vortex impeller
- 1-1/2" NPT Discharge
- Float operated
- 1/2 Horsepower



Part #	Mfg #	Description	Cord	Price
073136	M137	115V Auto	10'	

#### 150 Series Effluent Pumps

- Effluent or dewatering submersible pump for septic tank, low pressure pipe (LPP) and enhanced flow STEP systems



Part #	Mfg #	Description	Cord	Price
113977	N153	115V	20'	

### Backup Systems

#### Aquanot 508 Battery Back-Up System

- 12 volt highly efficient non corrosive pump construction
- Integrated check valve
- Quick disconnect discharge
- Aluminum seal pocket & cooling plate



Part #	Mfg #	Description	Price
168030	508-0005	Battery Back-Up Pump	

#### Premium Series Submersible Pump

- 43 gpm
- Max operating system: 130°F
- 3/10 HP
- 115V
- 1 Phase
- 9.7 Amps



Part #	Mfg #	Description	Cord	Price
221303	63-0001	115V	10'	

#### 98 "Flow-Mate" Cast Iron Submersible Pump

- 61 gpm @ 10' Head
- Passes 1/2" spherical solids
- Vortex impeller design
- 1-1/2" NPT Discharge
- Float operated submersible
- 1/2 Horsepower



Part #	Mfg #	Description	Cord	Price
050443	M98	115V Auto	15'	

#### Aquanot® Flood Alert® High Water Alarm

- Operates on (3) AAA batteries
- Low battery alarm
- On/off silence switch
- Stainless steel sensor contacts
- Solid state electronic components
- 5' Lead wire
- AC Power adapter capability, requires Class 2 transformer:
  - Input: 120VAC/60Hz,
  - Output: 4.5VDC/150 mA, tip positive, type B plug
- 1-Year limited warranty



Part #	Mfg #	Description	Price
035746	10-0763	High Water Alarm	

#### Aquanot® Deep-Cycle Battery

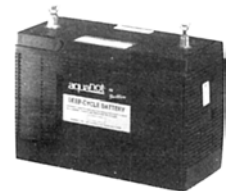

10-0761

Part #	Mfg #	Description	Price
093946	10-1450	AGM Deep Cycle	



## Sump Pumps

### Backup Systems (Continued)

#### Aquanot® Deep-Cycle Battery

Part #	Mfg #	Description	Price
053828	10-0761	Wet Battery	

#### Basement Sentry™ 12V Back-up System

- For clear water
- Includes:
  - Non-corrosive pump
  - Self-contained 10A battery recharger
  - Pump alarm
  - Battery case
  - Fittings
- Battery burn-out and overcharge protection
- Not recommended for installation with over 12' total dynamic head



Part #	Mfg #	Description	Price
028011	507-0005	Adapt Check Valve to Pipe	

#### Home-Guard Max Pump Back-up System

- Water powered emergency back-up sump pump system
- Anticorrosive PVC construction
- Performs at 80 psi
- Removes up to 2 gallons per gallon used
- 2-Year limited warranty



Part #	Mfg #	Description	Price
121999	503-0005	Water Operated Back-up Sump Pump	

### Preassembled Sump Pump Systems

#### Pro Pak Series Sump Pump

- Comes fully assembled and ready to install
- Automatic operation
- 7-1/2 Hours continuous pumping on a fully charged battery
- Battery burn out and overcharge protection
- 12V Deep cycle marine battery not included
- Includes:
  - 115VAC Primary pump
  - Model 507 basement sentry backup system with pump, check valve, float switch and piping
  - Plumbed in 1-1/2" Sch 40 PVC pipe
- 3-Year warranty on entire system



Part #	Mfg #	Description	Price
126635	507-0008	M53 Sump Pump, 507 Backup System	

### Oil Smart Systems

#### Oil Smart Simplex Control Panel

- Oil Smart Liquid Alarm Switch
- Oil Smart Pump Switch (10-2282)
- 115 Volts, Single Phase
- 30 Amp Motor Start Relay
- Pump HOA Switch
- Top Mounted Red Alarm Beacon Light
- 81-84 Decibel Rated Alarm Horn
- Horn Silence and Alarm Test Switches
- Alarm Automatically Resets
- Dry Auxiliary Alarm Contacts
- Separate Circuit Protection for Alarm
- Circuit Breaker Protection
- Pump "Run" Indicator Light



Part #	Mfg #	Description	Price
200252	10-2516	Oil Smart System Kit	



## Sump Pumps

### "Full-Flow" Unichecks

#### Inline Check Valve

- Rubber coupling with stainless steel clamps
- Threads into pump discharge
- Pre-drilled weephole
- 4.3 PSI, 10' (3 m) of head
- Vertical installation only
- 12 per carton



Part #	Mfg #	Description	Price
181152	30-0238	1-1/2"	
157786	019768	1-1/2"	

#### ABS Plastic Union (Slip x Slip)

- Checks backflow of water and sewer gas
- Neoprene gasket and flapper, weighted with heavy stainless steel metal backing plates and stainless steel rivet
- Reduces motor and pump noise
- Stops electrolysis
- Vertical or horizontal installation



Part #	Mfg #	Size	Price
013924	30-0021	2"	

#### PVC Union (Slip x Slip)

- Checks backflow of water and sewer gas
- Flapper bends over radius - no sharp 90° edges - lengthens life of flapper hinge
- PVC Plastic check body bolted together
- Vertical or horizontal installation



Part #	Mfg #	Size	Price
012917	30-0181	1-1/2" or 1-1/4"	

### "Quiet Check" PVC Solvent Weld with Union Check Valve (Comp)

- Checks backflow of water and sewer gas
- Corrosion resistant, nonmetallic parts
- Buna-N flapper, double shielded with PVC
- Buna-N compression ring seals
- Reduces motor and pump noise from plumbing system
- Designed for both horizontal and vertical usage
- Pressure rating: 25 psi at 57'
- Consult factory if use over 130°F required
- Suitable for installation below basin cover
- Compression union solvent weld end fittings



Part #	Mfg #	Pipe Size	Body	Price
130543	30-0040	1-1/2"	White	
133711	30-0042	2"	White	

#### Full-Flow Unichheck

- 50 psi @ 130°F
- No restrictions
- Stops backflow of water
- Stainless steel bolts
- Vertical or horizontal installation
- Standard, 1-1/4", 1-1/2", 2", 3" female NPT pipe
- Neoprene polyester reinforced flapper
- Corrosion-resistant, powder coated epoxy finish
- Suitable for installation below basin cover



Part #	Mfg #	Pipe Size	Body	Price
078441	30-152	2"	Cast Iron	

### Tri-Check™

#### PVC Check Valve/Ball Valve/Union Combination

- Check valve full flow design
- Neoprene gasket and flapper weighted stainless steel backing plates and rivet
- Installed on vertical or horizontal pipe
- All stainless steel screws
- Extra wide hinge to reduce stress
- Rated for 25 psi (58' of head)



Part #	Mfg #	Size	Price
092618	30-0100	1-1/2"	
092619	30-0101	2"	

## Sump Pumps

### A-Pak Alarm Systems

#### Indoor/Outdoor A-Pak® II Alarm System

- NEMA 4X Thermoplastic alarm panel
- Horn and light warn of high liquid levels
- Test and silence switch
- Auxiliary dry high level alarm 5A contacts
- 115VAC Operates on separate circuit from pump
- Use with liquids to: 140°F (60°C)
- Horn rated at 88 dB at 10'
- UL Listed for US and Canada



Part #	Mfg #	Description	Price
080330	10-0126	115V, 1-Ph w/15' Float Switch	

#### Indoor Apak® Alarm System

- NEMA 1 enclosure
- Automatic alarm reset
- Horn is rated 87 decibels at 10' (3 m)
- 2 AA battery backup (not included)
- 15' (5 m) alarm reed switch
- 6' (2 m) power cord



Part #	Mfg #	Description	Price
233485	10-4011	120V	

### Accessories

#### Pump Stand

- Reduces potential clogging by debris
- Made of durable, non-corrosive ABS
- Attaches securely to pump
- Raises pump 2" (5 cm) off bottom of basin
- Provides the ability to raise intake by adding sections of 1-1/2" or 2" PVC piping
- Accommodates sump, dewatering and effluent applications
- Adapts to 49,50,70,98,137/139,140, and 150 Series pumps



Part #	Mfg #	Description	Price
179512	10-2421	Pump Stand	

## Sump Pumps

### Tank Alarm Systems

#### Tank Alert® I Alarm System

- Warns of high or low liquid levels
- For use in lift pump chambers, sump pump basins, holding tanks, and water sewage systems
- NEMA 1 (Indoor) alarm panel and sensor float control switch
- Loud horn plus panel light alarm
- Plugs into receptacle or hard wire
- Low voltage and isolated for 120V power line
- UL Listed; miscellaneous signal appliance
- CSA Certified
- 3-Year limited warranty



Part #	Mfg #	Model	Description	Price
010082	1003104	101-01H	120VAC High Level	

## Sump Pumps

### Plumbing Valves

#### Silent Rubber Hose Check Valve

- One-piece ABS plastic housing
- No gasket on valve body
- Valves certified leak proof and pressure tested
- 1-1/2" Full Flow is optimized to fit only 1-1/2" pipe offering 17% improved flow capability
- Nested flapper
- All mounting hardware included

Part #	Mfg #	Description	Price
113017	CV00SL15	1-1/2" Check Valve	

#### Silent True Union Swing Check Valve

- Injection molded ABS thermoplastic
- O-Ring seal
- For heavy-duty use on home ejector pumps
- Easy to remove for regular cleaning or inspections
- Installs vertically or horizontally

Part #	Mfg #	Description	Price
113018	CVUNSL15	1-1/2" Check Valve	

## Trench Drains

### Trench Drainage Systems

#### FastTrack™ Trench Drain

- 72" Long, sloped and neutral channels molded from tough, lightweight HDPE material
- Grate anchors and Slide-to-Align construction covers included
- Solid, snap-lock joints. Integral rebar anchors and bottom outlet
- A variety of grating options and accessories to suit most applications

#### Channels



Part #	Mfg #	Description	Price
217304	865-S1	Sloped w/ Construction Cover, 6'	
220832	865-S2	Sloped w/ Construction Cover, 6'	
220833	865-S3	Sloped w/ Construction Cover, 6'	
220834	865-S4	Sloped w/ Construction Cover, 6'	
220835	865-S6	Sloped w/ Construction Cover, 6'	

#### Grates

Part #	Mfg #	Description	Price
221087	865-GGD	Perforated Galv Steel w/Screws, 36"	

## Trench Drains

### Channel Drains & Accessories

#### Dura Slope™ Trench Drain System

- Flanges on bottom of channel provide lip for anchoring
- Lightweight 4 foot modular sections
- May be cut to any length

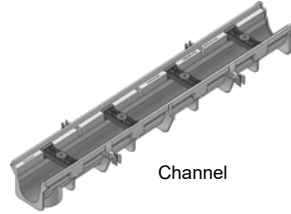

Channel



DS-340

Part #	Mfg #	Description	Color	Price
095381	DS-090N	3.99" Deep Neutral Dura Slope Channel	Gray	
095382	NDSDS091	3.99" to 4.33" Deep Dura Slope Channel	Gray	
095383	DS-091N	4.33" Deep Neutral Dura Slope Channel	Gray	
095384	DS-092	4.33" to 4.67" Deep Dura Slope Channel	Gray	
095385	DS-093	4.67" to 5.01" Deep Dura Slope Channel	Gray	
095386	DS-094	5.01" to 5.34" Deep Dura Slope Channel	Gray	
095387	DS-094N	5.34" Deep Neutral Dura Slope Channel	Gray	
095388	DS-095	5.34" to 5.68" Deep Dura Slope Channel	Gray	
095389	DS-096	5.68" to 6.01" Deep Dura Slope Channel	Gray	
095390	DS-097	6.01" to 6.35" Deep Dura Slope Channel	Gray	
095391	DS-097N	6.35" Deep Neutral Dura Slope Channel	Gray	
095392	DS-098	6.35" to 6.69" Deep Dura Slope Channel	Gray	
095393	DS-099	6.69" to 7.02" Deep Dura Slope Channel	Gray	
095394	DS-100	7.02" to 7.36" Deep Dura Slope Channel	Gray	
069719	DS-100N	7.36" Deep Neutral Dura Slope Channel	Gray	
068598	DS-101	7.36" to 7.69" Deep Dura Slope Channel	Gray	
068599	DS-102	7.69" to 8.03" Deep Dura Slope Channel	Gray	
068593	DS-103	8.03" to 8.37" Deep Dura Slope Channel	Gray	
069720	DS-103N	8.37" Deep Neutral Dura Slope Channel	Gray	
068594	DS-104	8.37" to 8.70" Deep Dura Slope Channel	Gray	
068595	DS-105	8.70" to 9.04" Deep Dura Slope Channel	Gray	
068597	DS-106N	9.37" Deep Neutral Dura Slope Channel	Gray	
069721	DS-107	9.37" to 9.70" Deep Dura Slope Channel	Gray	
094408	DS-340	2' Outlet Catch Basin	Gray	

#### Dura Slope™ Grate

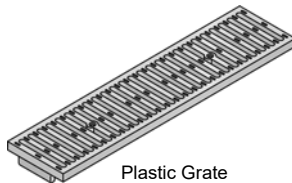

Plastic Grate

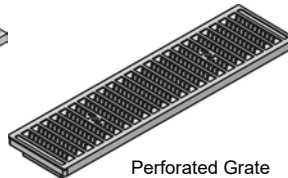

Perforated Grate



DS-231,

Part #	Mfg #	Description	Color	Price
069731	DS-221	2' Galv Steel Channel Grate	Steel	
069732	NDSDS231	2' Cast Iron Channel Grate	Black	
103500	DS-670	2' Poly Grate	Gray	



## Trench Drains

### Channel Drains & Accessories (Continued)

#### Dura Slope™ Grate

Part #	Mfg #	Description	Color	Price
069733	DS-232	2' Ductile Iron Channel Grate	Black	
069735	661LG	2' Plastic Channel Grate	Gray	
068601	663	2' Plastic Channel Grate	Black	
069737	664	2' Plastic Channel Grate	Sand	

#### Dura Slope™ Accessories

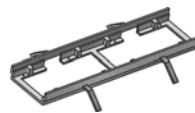

DS-200



DS-227

Part #	Mfg #	Description	Color	Price
068606	DS-122	ProFit Grate Lock	Gray	
160492	DS-123	Frame & End Cap Screws 12/Bag	Gray	
094407	NDSDS224	Universal End Cap	Gray	
094409	DS-227	Universal End Outlet	Gray	
069730	NDSDS126	Bottom Outlet Adapter	Gray	
068607	629	Grate Screws FH #1/4 - 20 x 1-1/2"	Steel	
094936	DS-200	Ductile Iron Frame	Black	

### Drainage Products

#### 12" Square Catch Basin Grate



Part #	Mfg #	Description	Color	Price
087628	1210	12" x 12" Square Grate	Gray	

#### Universal Catch Basin Outlet



1243



1245



1206

Part #	Mfg #	Description	Color	Price
069740	1243	3" & 4" Universal Locking Outlet	Black	
073053	1266	6" Universal Locking Outlet	Black	
069741	1245	3" & 4" Offset Universal Locking Outlet	Black	
069739	1206	6" Universal Plug Adapter	Black	

## Trench Drains

### Trench Drainage Systems

#### Z886 Perma-Trench® System

- 6" Wide, pre-sloped system
- High density polyethylene composite drain channel with 75% bottom slope -Models with -N Suffix are no slope
- All sections are 80" modular lengths with integral top fram, inter-locking ends and radiused bottom
- Combination tie-down/leveling devices at 20" intervals
- Dura-coated cast iron grate unless otherwise specified



### Trench Drainage Systems (Continued)

#### Z883 Perma-Trench® Shallow System

Part #	Mfg #	Description	Price
170514	P883-E2	6" W, 3.5" D 2" No-Hub End Outlet	

Part #	Mfg #	Shallow	Deep	GPM	Price
170493	P8601	3.50"	4.10"	93	
170495	P8602	4.10"	4.70"	122	
170496	P8603	4.70"	5.30"	152	
170497	P8604	5.30"	5.90"	183	
170498	P8605	5.90"	6.50"	214	
171050	P8606	6.50"	7.10"	245	
170499	P8607	7.10"	7.70"	276	
170500	P8608	7.70"	8.30"	308	
178807	P8609	8.30"	8.90"	339	
172910	P8610	8.90"	9.50"	371	
171146	P8612	10.10"	10.70"	435	
176030	P8612N	10.70"	10.70"		

#### Z886

Part #	Mfg #	Description	Price
170505	P886-E3	3" No-Hub End Outlet	
170506	P886-E4	4" No-Hub End Outlet	
170504	P886-U4	4" No-Hub Bottom Outlet	

#### Z883 Perma-Trench® Shallow System

- 6" Wide
- High density polyethylene composite drain channel with 3.5" depth
- All sections are 40" modular lengths with integral top fram, inter-locking ends and radiused bottom
- Combination tie-down/leveling devices at 20" intervals
- Dura-coated cast iron grate unless otherwise specified



Part #	Mfg #	Description	Price
170512	P883	6" Wide, 3.5" Depth	
170513	P883-E1	6" W, 3.5" D w/ Closed End Cap	

## Aerators

### Aerators

#### Water Efficient 1.5 gpm Aerator



Part #	Mfg #	Description	Price
173223	RP53343RB	Venetian Bronze®	
173222	RP53343SS	Stainless*	

#### RP330 Aerator

- For Classic series kitchen and lavatory models and e-FLOW™ lavatory models
- 15/16" - 27 Male thread
- 2.2 gpm @ 60 psi



Part #	Mfg #	Description	Price
003614	RP330	Chrome	
003616	RP330PB	Polished Brass*	

#### RP18508 Aerator

- For Signature® and Waterfall® series standard kitchen models, Innovations® collection two handle lavatory models, and C-Spout series lavatory models
- 15/16" - 27 Male thread
- 2.2 gpm @ 60 psi



Part #	Mfg #	Description	Price
026970	RP18508	Chrome	

#### RP19754 Aerator

- 1.5 gpm



Part #	Mfg #	Finish	Price
123353	RP19754	Chrome	

#### RP54977 Aerator

- 1.5 gpm

Part #	Mfg #	Description	Price
139326	RP54977	Chrome	

### Vandal-Resistant Aerator



Part #	Mfg #	Description	Price
032115	RP246	Chrome	

#### RP5202 Vandal-Resistant Aerator



Part #	Mfg #	Description	Price
027030	RP5202	Aerator	

#### RP61342 Aerator



Part #	Mfg #	Description	Price
176597	RP61342	Aerator	

#### RP31704 Vandal Resistant Aerator

- .5 gpm

Part #	Mfg #	Description	Price
050500	RP31704	Chrome, .5 gpm	

#### RP71110 Vandal Resistant Aerator

- 2.2 GPM



Part #	Mfg #	Description	Price
173239	RP71110	Aerator, 2.2 gpm	

#### Rp64451 Aerator Assembly



Part #	Mfg #	Description	Price
158132	RP64451	Aerator Assy	

\* Brilliance® Anti-Tarnish Lifetime Finishes

## Aerators

### RP37018 Aerator

- 2.2 GPM



Part #	Mfg #	Description	Price
187840	RP37018RB	Venetian Bronze®	
167613	RP37018SS	Stainless*	

### Michael Graves™ Aerator

- Swivel



Part #	Mfg #	Description	Price
144734	RP40372	Chrome	

### RP43516 Aerator

- 2.2 GPM



Part #	Mfg #	Description	Price
182276	RP43516SS	Aerator	

### RP43166 Aerator

- 2.2 GPM



Part #	Mfg #	Description	Price
168387	RP43166	Chrome	

### Classic RP60983 Aerator

- 1.5 gpm



Part #	Mfg #	Description	Price
133924	RP60983	Chrome	

### Classic RP72730 Aerator

- 1.0 gpm



Part #	Mfg #	Description	Price
256754	RP72730	Aerator	

### RP52657 Aerator



Part #	Mfg #	Description	Price
237260	RP52657	Chrome	

### RP46827 Aerator



Part #	Mfg #	Description	Price
169284	RP46827	Chrome	

### RP47667 Aerator



Part #	Mfg #	Description	Price
156042	RP47667	Chrome	

### RP43774 Water Efficient Aerator



Part #	Mfg #	Description	Price
230933	RP43774	Insert, 1.5 gpm	

\* Brilliance® Anti-Tarnish Lifetime Finishes

## Aerators

### Victorian® Aerator

• 2.2 gpm



Part #	Mfg #	Description	Price
205162	RP37018	Chrome	

### Water Efficient Aerator Insert

• 1.8 gpm



Part #	Mfg #	Description	Price
179821	RP70746	Insert - 1.8 gpm	

### Water Efficient Aerator Insert

• 1.5 gpm



Part #	Mfg #	Description	Price
131096	RP52216	Insert, 1.5 gpm	

### RP76076 Aerator

Part #	Mfg #	Description	Price
169550	RP76076	Aerator	

### RP63039 Aerator

Part #	Mfg #	Description	Price
165426	RP63039	Aerator, 1.5 gpm	

### RP53349 Water Efficient Aerator

• 1.5 gpm



Part #	Mfg #	Description	Price
188598	RP53349	Chrome	

### RP63137 Aerator - Round Spray



Part #	Mfg #	Description	Price
135198	RP63137	Chrome, Round Spray	

### RP18454 Aerator

• 2.2 gpm



Part #	Mfg #	Description	Price
018485	RP18454	Aerator, 2.2 gpm	

### RP53339 Water Efficient Aerator

• 1.5 gpm



Part #	Mfg #	Description	Price
164431	RP53339	Chrome	

### Water Efficient TT Aerator

• .5 GPM



Part #	Mfg #	Description	Price
169533	RP73806	TT Aerator - .5 gpm	

### RP53343SS Water Efficient Aerator

• 1.5 GPM



Part #	Mfg #	Description	Price
225108	RP53343SS	Stainless	

\* Brilliance® Anti-Tarnish Lifetime Finishes

[www.plumbsupply.com](http://www.plumbsupply.com) • Serving our Customers Since 1946 • [www.waterconcepts.net](http://www.waterconcepts.net)

## Aerators

### Water Efficient Aerator

- .5 gpm
- Removal wrench included



Part #	Mfg #	Description	Price
144084	RP71111	Aerator .5 gpm	

### Commercial Aerators

Part #	Mfg #	Description	Price
133081	060640A	Aerator, 1.5 gpm	
155596	060641A	Commercial Aerator	
259276	060724A	Aerator, 2.2 gpm	

### Aerator Key



Part #	Mfg #	Description	Price
139056	RP60730	Aerator Key	

### Miscellaneous

#### Commercial Cartridge Kit

- Self-closing

Part #	Mfg #	Description	Price
238657	060848A	Self Closing Cartridge Kit	



### Spring-Flo® Aerators

- Three-screen slotted aerator



Part #	Mfg #	Description	Price
010270	38D	Aerator	

THE BOLD LOOK OF **KOHLER**®

### Valve Repair Aerators

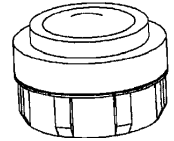

Part #	Mfg #	Description	Price
182884	41007-CP	Aerator, Chrome	
182688	59619-0	Aerator Kit, White	
160583	59728-CP	Aerator, Polished Chrome	
182891	74405-BN	Aerator Assy, *Br Nickel	
151599	78868	Aerator Wrench	
091813	78250-CP	Aerator, Polished Chrome	
167560	79402-BN	Aerator Kit, *Br Nickel	
153112	86125-BL	Aerator Assy, Black	
248648	1000952-SR	Aerator, 2.5 gpm 13/16"-27 THD, *Bright Nickel	
182746	1008772-CP	Aerator Assy, Pol Chrome	
182873	1010751-CP	Aerator, Polished Chrome	
157663	1013354-CP	Aerator Kit, Chrome	
166360	1018320-VF	Aerator, *Polished Brass	
185614	1019975	Aerator Key	
152069	1021672-CP	Aerator Kit, Chrome	
156775	1031237-VF	Aerator Assy, *Pol Brass	
179683	1031237-VS	Aerator Assy, *Stainless	
183217	1054421	Aerator Kit	
154016	1061023	Aerator Kit	
183234	1089003	Aerator Kit	
159120	1097762-BN	Aerator Kit, *Brushed Nickel	
172609	1097762-CP	Aerator Kit, Pol Chrome	
151595	1098361-G	Aerator Kit, Br Chrome	
148302	1101642-CP	Aerator PCA Jr Spray-.5GPM	
156817	1103116	Aerator Insert	
225412	1103470-VF	Aerator Kit, 1.5 GPM	
154664	1103459-BN	Aerator Kit, *Br Nickel	
249425	1103460-CP	Aerator Kit, 1.5 GPM	
168958	1103463-CP	Aerator Kit, Pol Chrome	
167835	1103464-BC	Aerator Kit, Bright Chrome	
183241	1103468-BV	Aerator Kit, *Br Bronze	
188297	1103468-SN	Aerator Kit, *Pol Nickel	

\* Brilliance® Anti-Tarnish Lifetime Finishes



## Aerators

### Valve Repair (Continued)

#### Aerators

Part #	Mfg #	Description	Price
168114	1103470-CP	Aerator Kit, Pol Chrome	
152180	1103470-BN	Aerator Kit *Brushed Nickel	
149773	1104546	Aerator	
172748	1105050-BN	Aerator Kit, *Brushed Nickel	
159677	1105050-VF	Aerator Kit,*Polished Brass	
183242	1105674	Aerator Assy	
160675	1106716-CP	Aerator Kit,Pol Chrome	
183244	1108235-BC	Aerator Kit, Bright Chrome	
179514	1138478	Aerator Assy	
153618	1139282	Aerator	
187955	1139285	Laminar	
173751	1139286	Aerator	
173752	1139287	Laminar	
164808	1139289	Laminar	
252256	1160594	Large Aerator, .35 GPM	
162923	1160595	Aerator	
164064	1171998-BC	Aerator Assy, Bright Chr	
187011	1203940-BC	Aerator Assy, Bright Chr	
244290	1268817-CP	Large Female Aerator Kit 1.2 GPM, Polished Chrome	
222933	1088956	Aerator Kit	



### Valve Repair

#### Aerators



Part #	Mfg #	Description	Price
007264	3919	2.2 gpm Male Thread	
007265	3924	Aerator, Chrome	
124741	100112	Monticello Aerator, 2.2 gpm	
248618	101878	Monticello Aerator, Chrome	
247335	128878	Aerator Kit, Chrome	
007201	20200	Aerator, Swivel	
247404	52016F22	Commercial Aerator, Vandal Resistant, 2.2 gpm, Chrome	
247406	52016F15	Commercial Aerator, Vandal Resistant, 1.5 gpm, Chrome	

## Bar Faucets

### Single-Handle Beverage Faucets

#### Wellspring™ Contemporary 1-Hdl Beverage Faucet

- 4-7/8" Reach, 8-3/4" high arch swivel spout
- Solid brass construction
- 1/4-Turn washerless ceramic valving
- Aquifer water filtration system
- Stainless steel hose
- Aerator
- Not for use with hot water or reverse osmosis filtration



Part #	Mfg #	Description	Handle(s)	Finish	Price
126116	K-6665-BL	1-Hole	ADA RH Lever	Matte Black	
054179	K-6665-BN	1-Hole	ADA RH Lever	*Brushed Nickel	
081147	K-6665-BV	1-Hole	ADA RH Lever	*Brushed Bronze	
053689	K-6665-CP	1-Hole	ADA RH Lever	Polished Chrome	
061789	K-6665-G	1-Hole	ADA RH Lever	Brushed Chrome	
099309	K-6665-VS	1-Hole	ADA RH Lever	*Stainless	

#### Wellspring™ Traditional 1-Hdl Beverage Faucet

- 3" Reach, 7-5/8" high arch swivel spout
- Flow rate: 1.6 gpm
- Solid brass construction
- 1/4-Turn washerless ceramic valving
- Aquifer water filtration system
- Stainless steel hose
- Aerator
- Not for use with hot water or reverse osmosis filtration



**K-201 or K-202 Aquifer® replacement cartridge required for -F models only**

Part #	Mfg #	Description	Handle(s)	Finish	Price
053690	K-6666-CP	1-Hole	ADA RH Lever	Polished Chrome	
058757	K-6666-BN	1-Hole	ADA RH Lever	*Brushed Nickel	
079291	K-6666-BV	1-Hole	ADA RH Lever	*Brushed Bronze	
068916	K-6666-G	1-Hole	ADA RH Lever	Brushed Chrome	
173262	K-6666-SN	1-Hole	ADA RH Lever	*Polished Nickel	
099558	K-6666-VS	1-Hole	ADA RH Lever	*Stainless	
147009	K-6666-2BZ	1-Hole	ADA RH Lever	Oil Rubbed Bronze	

\* Vibrant Limited Lifetime Finish

## Bar Faucets

### Single-Handle Bar Faucets

#### Artifacts™ 1-Hdl Bar Sink Faucet

- 7" Reach, 13-1/16" high, 360° swivel spout
- Metal construction
- Ceramic disc valve
- Flow rate: 1.8 gpm



Part #	Mfg #	Description	Handle(s)	Finish	Price
177653	K-99264-CP	1-Hole, Less Side Spray	ADA Lever	Polished Chrome	
181994	K-99264-VS	1-Hole, Less Side Spray	ADA Lever	*Stainless	
221769	K-99264-2BZ	1-Hole, Less Side Spray	ADA Lever	Oil Rubbed Bronze	

#### Artifacts™ 1-Hdl Pull-Out Bar Faucet

- 7-5/8" Reach, 16" high, 360° swivel spout
- Stainless steel construction
- DockNetik™ magnetic docking system
- Ceramic disc valves
- ProMotion™ quiet braided hose
- MasterClean™ sprayface with three spray functions
  - Sweep™
  - BerrySoft™
  - Aerated
- Flow rate: 1.8 gpm



Part #	Mfg #	Description	Handle(s)	Finish	Price
176274	K-99261-CP	1-Hole, Pull-Out Spray	ADA Lever	Polished Chrome	
175224	K-99261-SN	1-Hole, Pull-Out Spray	ADA Lever	Polished Nickel	
178216	K-99261-VS	1-Hole, Pull-Out Spray	ADA Lever	*Stainless	
181832	K-99261-2BZ	1-Hole, Pull-Out Spray	ADA Lever	Oil Rubbed Bronze	

#### Artifacts™ 1-Hdl Bar Sink Faucet with Victorian Spout Design

- 7" Reach, 12-9/16" high, 360° rotation
- Metal construction
- Ceramic disc valve
- Temperature memory
- Flexible supply lines included
- Available with 7" swing spout reach
- 3-hole escutcheon available; sold separately, K-99272
- Flow rate: 1.5 gpm @ 60 psi



Part #	Mfg #	Description	Handle(s)	Finish	Price
228213	99267-SN	1-Hole, Less Side Spray	ADA Lever	*Polished Nickel	

\* Vibrant Limited Lifetime Finish

[www.plumbsupply.com](http://www.plumbsupply.com) • Serving our Customers Since 1946 • [www.waterconcepts.net](http://www.waterconcepts.net)

## Bar Faucets

### Single-Handle Bar Faucets (Continued)

#### Artifacts™ 1-Hdl Bar Sink Faucet with Victorian Spout Design

Part #	Mfg #	Description	Handle(s)	Finish	Price
228101	99267-VS	1-Hole, Less Side Spray	ADA Lever	*Stainless	

#### Artifacts® Gentleman's™ Bar Sink Faucet

- 7-5/16" Reach, 13-13/16" high
- Metal construction
- Ceramic disc valves
- Temperature memory
- Meets CalGreen requirements for kitchen faucets
- Flow rate: 1.8 gpm @ 60 psi



Part #	Mfg #	Description	Handle(s)	Finish	Price
186568	K-99268-CP	1-Hole, Less side spray	ADA Lever	Polished Chrome	
187197	K-99268-SN	1-Hole, Less side spray	ADA Lever	*Polished Nickel	
224613	K-99268-VS	1-Hole, Less side spray	ADA Lever	*Stainless	
222409	K-99268-2BZ	1-Hole, Less side spray	ADA Lever	Oil Rubbed Bronze	

#### Evoke® 1-Hdl Secondary Kitchen Faucet

- 7" Reach, 8.5" high, 360° swivel spout
- Metal construction
- One-piece, self-contained ceramic disc valve allows both volume and temperature control
- High-temperature limit setting
- Flow rate: 2.2 gpm



Part #	Mfg #	Description	Handle(s)	Finish	Price
156997	K-6335-CP	2-Hole, w/ Side Spray	ADA Lever	Polished Chrome	
130196	K-6335-VS	2-Hole, w/ Side Spray	ADA Lever	*Stainless	

#### Forté® 1-Hdl Entertainment Kitchen Faucet

- 7-3/4" Reach, 10-1/8" high swivel spout
- Metal construction
- Washerless ceramic valving, flexible supplies
- Remote valve
- Aerator



Part #	Mfg #	Description	Handle(s)	Finish	Price
100637	K-10443-CP	2-Hole, Less Side Spray	ADA Lever	Polished Chrome	
100634	K-10443-VS	2-Hole, Less Side Spray	ADA Lever	*Stainless	

\* Vibrant Limited Lifetime Finish

[www.waterconcepts.net](http://www.waterconcepts.net) • Serving our Customers Since 1946 • [www.plumbsupply.com](http://www.plumbsupply.com)

## Bar Faucets

### Karbon® Articulating Bar/Lavatory Faucet

- 6" Reach spout
- Silver tube
- Metal and carbon fiber construction
- Brass valve bodies
- Integral sprayhead
- 1-5/16" Diameter remote joystick valve
- Touch-activated drain
- Flow rate: 1.5 gpm
- Meets EPA WaterSense® criteria



Part #	Mfg #	Description	Handle(s)	Finish	Price
158431	K-6268-C11-CP	1-Hdl 8", Touch-Activated Drain	ADA Joystick	Polished Chrome	
224859	K-6268-C11-VS	1-Hdl 8", Touch-Activated Drain	ADA Joystick	*Stainless	
187801	K-6268-C12-VS	2-Hole, Less Side Spray	ADA Joystick Lever	*Stainless	

### Purist® 1-Hdl Secondary Kitchen Faucet

- 6" Reach, 9-7/8" high, 360° swivel spout
- Metal construction
- One-piece, self-contained ceramic disc valve allows both volume and temperature control
- High-temperature limit setting
- Flow rate: 1.8 gpm



Part #	Mfg #	Description	Handle(s)	Finish	Price
144810	K-7509-BL	1-Hole, Less Side Spray	ADA Lever	Matte Black	
138740	K-7509-CP	1-Hole, Less Side Spray	ADA Lever	Polished Chrome	
140239	K-7509-VS	1-Hole, Less Side Spray	ADA Lever	*Stainless	
174406	K-7506-BL	1-Hole, Pull-Out Spray	ADA Lever	Matte Black	
134878	K-7506-CP	1-Hole, Pull-Out Spray	ADA Lever	Polished Chrome	
137619	K-7506-VS	1-Hole, Pull-Out Spray	ADA Lever	*Stainless	

### Simplice® 1-Hdl Bar Faucet

- 7-1/4" Reach, 13" high, 180° spout rotation
- Ceramic disc valves
- Temperature memory
- Flexible supply lines included
- Flow rate: 1.5 gpm



Part #	Mfg #	Description	Handle(s)	Finish	Price
241287	K-22034-CP	1-Hole, Less Side Spray	ADA Lever	Polished Chrome	

\* Vibrant Limited Lifetime Finish

[www.plumbsupply.com](http://www.plumbsupply.com) • Serving our Customers Since 1946 • [www.waterconcepts.net](http://www.waterconcepts.net)

## Bar Faucets

### Two-Handle Bar Faucets

#### Artifacts® 2-Hdl Bridge Bar Faucet

- 7" Reach, 12-9/16" high spout
- 8-1/16" From deck to aerator
- Premium metal construction
- MasterClean® sprayface
- ProMotion® hose technology
- Maximum flow rate: 1.5 gpm



Part #	Mfg #	Description	Handle(s)	Finish	Price
236587	76520-4-SN	4-Hole, 8"cc, Matching Side Spray	Lever	*Polished Nickel	

#### Coralais® 2-Hdl Gooseneck Bar Faucet

- 4" Reach, 11-3/16" high spout
- Metal construction
- Washerless ceramic valving
- Aerator



K-15275

Part #	Mfg #	Description	Handle(s)	Finish	Price
081404	K-15275-4-CP	4"cc	ADA Levers	Polished Chrome	

#### Essex® 2-Hdl Bar Faucet

- 5-1/2" Reach, 14-1/4" high spout
- 10-1/16" From deck to aerator
- Brass construction
- Brass valve bodies
- Quarter-turn washerless ceramic disc valves
- Flow rate: 2.2 gpm



Part #	Mfg #	Description	Handle(s)	Finish	Price
056207	K-8761-CP	1-Hole, Less Side Spray	Wrist Blade Levers	Polished Chrome	
100159	K-8761-VS	1-Hole, Less Side Spray	Wrist Blade Levers	*Stainless	

#### HiRise 2-Hdl Bar Faucet

- 7" Reach, 14-1/8" high swing spout
- Stainless steel construction
- Flow rate: 2.2 gpm



Part #	Mfg #	Description	Handle(s)	Finish	Price
183145	K-7342-4-S	1-Hole, Less Side Spray	ADA Lever	Polished Stainless	

\* Vibrant Limited Lifetime Finish

[www.waterconcepts.net](http://www.waterconcepts.net) • Serving our Customers Since 1946 • [www.plumbsupply.com](http://www.plumbsupply.com)



**Bar Faucets**

**Two-Handle Bar Faucets (Continued)**

**HiRise 2-Hdl Bar Faucet**

Part #	Mfg #	Description	Handle(s)	Finish	Price
108815	K-7342-4-BS	1-Hole, Less Side Spray	ADA Lever	Brushed Stainless	

\* Vibrant Limited Lifetime Finish

[www.plumbsupply.com](http://www.plumbsupply.com) • Serving our Customers Since 1946 • [www.waterconcepts.net](http://www.waterconcepts.net)

## Bar Faucets

### Single-Handle Bar Faucets

#### Addison™ 1-Hdl Pull-Down Spray Bar/Prep Faucet

- 6-25/64" Reach, 14-19/32" high spout swivels 360°
- 9-1/2" From deck to aerator
- 62" Long hose
- Touch-Clean® 2-function Multi-Flow™ spray head with MagnaTite® docking
- 3/8" Compression fittings
- 2-1/2" Maximum deck thickness
- 32" Minimum supply lines below deck included
- DIAMOND Seal® technology
- Water-efficient product: 1.5 gpm @ 60 psi



Part #	Mfg #	Description	Handle(s)	Finish	Price
137945	9992-DST	1- or 3-Hole 8"cc, Pull-Down Spray, Lead-Free	ADA Lever	Chrome	
152922	9992-AR-DST	1- or 3-Hole 8"cc, Pull-Down Spray, Lead-Free	ADA Lever	Arctic Stainless®	
173741	9992-CZ-DST	1- or 3-Hole 8"cc, Pull-Down Spray, Lead-Free	ADA Lever	Champagne Bronze™	
135524	9992-RB-DST	1- or 3-Hole 8"cc, Pull-Down Spray, Lead-Free	ADA Lever	Venetian Bronze®	

#### Addison™ Touch2O 1-Hdl Pull-Down Spray Bar/Prep Faucet

- Touch2O® Technology controls water flow
- 6-25/64" Reach, 14-13/32" high spout swivels 360°
- 9-1/2" From deck to aerator
- Touch-Clean® two-function Multi-Flow™ spray head with MagnaTite® docking
- 62" Long hose
- 3/8" Compression fittings
- 2-1/2" Maximum deck thickness
- 32" Minimum supply lines below deck included
- DIAMOND Seal® technology
- Water-efficient product: 1.5 gpm @ 60 psi



Part #	Mfg #	Description	Handle(s)	Finish	Price
134744	9992T-DST	1- or 3-Hole 8"cc, Pull-Down Spray, Lead-Free	ADA Lever	Chrome	
152921	9992T-AR-DST	1- or 3-Hole 8"cc, Pull-Down Spray, Lead-Free	ADA Lever	Arctic Stainless®	
134745	9992T-RB-DST	1- or 3-Hole 8"cc, Pull-Down Spray, Lead-Free	ADA Lever	Venetian Bronze®	

\* Brilliance® Anti-Tarnish Lifetime Finishes

[www.waterconcepts.net](http://www.waterconcepts.net) • Serving our Customers Since 1946 • [www.plumbsupply.com](http://www.plumbsupply.com)

## Bar Faucets

### Allora® 1-Hdl Pull-Down Spray Bar/Prep Faucet

- 6-7/8" Reach, 14-1/2" high
- High-arc spout swivels 360°
- 8-5/16" From deck to aerator
- 62" Long hose
- MagnaTite® docking
- DIAMOND Seal® technology
- 3/8" Compression fittings
- 2-1/2" Maximum deck thickness
- 32" Minimum supply lines below deck included
- Water-efficient product: 1.8 gpm @ 60 psi



Part #	Mfg #	Description	Handle(s)	Finish	Price
116873	999-DST	1-Hole, Pull-Down Spray, Lead-Free	ADA Lever	Chrome	
150201	999-AR-DST	1-Hole, Pull-Down Spray, Lead-Free	ADA Lever	Arctic Stainless®	

### Artesso® 1-Hdl Pull-Down Prep Faucet

- 7-9/16" Reach, 14" high, 360° spout swivel
- 7-3/8" From deck to aerator
- 3" Maximum deck thickness
- Touch-Clean® nozzles
- MagneDock® technology
- DIAMOND™ seal technology
- Two-function wand: spray and stream
- Euro-motion Diamond™ valve with InnoFlex® waterways
- Flow rate: 1.8 gpm @ 60 psi



Part #	Mfg #	Description	Handle(s)	Finish	Price
243594	63925LF-PC	1-Hole, Pull-Down Spray, Lead Free	ADA Lever	Chrome	

### Leland® 1-Hdl Pull-Down Spray Bar/Prep Faucet

- 6-11/16" Reach, 14" high, high-arc spout swivels 360°
- 7-7/16" From deck to aerator
- 62" Long hose
- Touch-Clean® 2-function spray
- MagnaTite® magnetic docking
- DIAMOND Seal® technology
- 62" Long hose
- 3/8" Compression fittings
- 2-1/2" Maximum deck thickness
- 32" Minimum supply lines below deck included
- Water-efficient product: 1.8 gpm @ 60 psi



Part #	Mfg #	Description	Handle(s)	Finish	Price
152833	1997LF	1-Hole, Lead Free	ADA Lever	Chrome	
152918	1997LF-AR	1-Hole, Lead Free	ADA Lever	Arctic Stainless®	
152919	1997LF-CZ	1-Hole, Lead Free	ADA Lever	Champagne Bronze™	
238291	1997LF-PN	1-Hole, Lead Free	ADA Lever	Polished Nickel*	

\* Brilliance® Anti-Tarnish Lifetime Finishes

[www.plumbsupply.com](http://www.plumbsupply.com) • Serving our Customers Since 1946 • [www.waterconcepts.net](http://www.waterconcepts.net)

## Bar Faucets

### Single-Handle Bar Faucets (Continued)

#### Leland® 1-Hdl Pull-Down Spray Bar/Prep Faucet

Part #	Mfg #	Description	Handle(s)	Finish	Price
152460	1997LF-RB	1-Hole, Lead Free	ADA Lever	Venetian Bronze®	

#### Cassidy™ 1-Hdl Pull-Down Spray Bar/Prep Faucet

- 6-3/8" Reach, 14-1/2" high
- High-arc pull-down swivels 360°
- 9-5/32" From deck to aerator
- 62" Long hose
- 3/8" Compression fittings
- 2-1/2" Maximum deck thickness
- DIAMOND Seal® technology
- MagnaTite® docking
- Water-efficient product: 1.8 gpm @ 60 psi



Part #	Mfg #	Description	Handle(s)	Finish	Price
152827	9997-DST	1-Hole, Pull-Down Spray, Lead Free	ADA Lever	Chrome	
152831	9997-AR-DST	1-Hole, Pull-Down Spray, Lead Free	ADA Lever	Arctic Stainless®	
152832	9997-CZ-DST	1-Hole, Pull-Down Spray, Lead Free	ADA Lever	Champagne Bronze™	
251293	9997-PN-DST	1-Hole, Pull-Down Spray, Lead Free	ADA Lever	Polished Nickel*	
152028	9997-RB-DST	1-Hole, Pull-Down Spray, Lead Free	ADA Lever	Venetian Bronze®	

#### Cassidy™ Touch2O 1-Hdl Pull-Down Spray Bar/Prep Faucet

- 6-3/8" Reach, 14-1/2" high
- High-arc pull-down swivels 360°
- 9-5/32" From deck to aerator
- 62" Long hose
- 3/8" Compression fittings
- 2-1/2" Maximum deck thickness
- DIAMOND Seal® technology
- MagnaTite® docking
- Water-efficient product: 1.8 gpm @ 60 psi
- Touch feature to activate on/off



Part #	Mfg #	Description	Handle(s)	Finish	Price
152818	9997T-DST	1-Hole, Pull-Down Spray, Lead Free Touch2O	ADA Lever	Chrome	
152819	9997T-AR-DST	1-Hole, Pull-Down Spray, Lead Free Touch2O	ADA Lever	Arctic Stainless®	
152821	9997T-CZ-DST	1-Hole, Pull-Down Spray, Lead Free Touch2O	ADA Lever	Champagne Bronze™	
152822	9997T-RB-DST	1-Hole, Pull-Down Spray, Lead Free Touch2O	ADA Lever	Venetian Bronze®	

\* Brilliance® Anti-Tarnish Lifetime Finishes

## Bar Faucets

### Classic® 1-Hdl Bar/Prep Faucet

- 5" Reach, 10" high spout swivels 180°
- 6" From deck to aerator
- 3/8" Compression fittings
- 2-1/2" Maximum deck thickness
- 32" Minimum supply lines below deck included
- DIAMOND Seal® technology
- Water-efficient product: 1.5 gpm @ 60 psi



Part #	Mfg #	Description	Handle(s)	Finish	Price
127174	1903-DST	2-Hole, Lead-Free	ADA Lever	Chrome	
127175	1903-RB-DST	2-Hole, Lead-Free	ADA Lever	Venetian Bronze®	
127176	1903-SS-DST	2-Hole, Lead-Free	ADA Lever	Stainless*	

### Contemporary 1-Hdl Bar/Prep Faucet

- 5-1/16" Reach, 11-5/16" high 360° swivel spout
- 7-1/4" From deck to aerator
- 1-1/2" Maximum deck thickness
- 3/8" Staggered copper supply lines with 1/2" fittings
- DIAMOND Seal® technology
- Flow rate: 1.5 gpm @ 60 psi



Part #	Mfg #	Description	Handle(s)	Finish	Price
172799	1959LF	1-Hole, Lead Free	ADA Lever	Chrome	
171466	1959LF-AR	1-Hole, Lead Free	ADA Lever	Arctic Stainless®	
173908	1959LF-BL	1-Hole, Lead Free	ADA Lever	Matte Black	
186905	1959LF-CZ	1-Hole, Lead Free	ADA Lever	Champagne Bronze™	

### Essa™ 1-Hdl Pull-Down Spray Bar/Prep Faucet

- 6-5/8" Reach, 14-1/2" high 360° swivel spout
- 9-5/32" From deck to aerator
- 3/8" O.D. straight, staggered pex supply lines
- DIAMOND Seal® technology
- MagnaTite® magnetic docking
- Touch-Clean® sprayhead
- 1-1/2" Minimum clearance to back splash
- Flow rate: 1.8 gpm @ 60 psi



Part #	Mfg #	Description	Handle(s)	Finish	Price
182660	9913-DST	1-Hole, Lead Free	ADA Lever	Chrome	
221462	9913-BL-DST	1-Hole, Lead Free	ADA Lever	Matte Black	
181638	9913-AR-DST	1-Hole, Lead Free	ADA Lever	Arctic Stainless®	
177302	9913-RB-DST	1-Hole, Lead Free	ADA Lever	Venetian Bronze®	

\* Brilliance® Anti-Tarnish Lifetime Finishes

[www.plumbsupply.com](http://www.plumbsupply.com) • Serving our Customers Since 1946 • [www.waterconcepts.net](http://www.waterconcepts.net)

## Bar Faucets

### Essa® Touch2O® 1-Hdl Pull-Down Bar/Prep Faucet

- 9-3/8" Reach, 16" high 360° swivel spout
- 9-21/32" From deck to aerator
- 3/8" O.D. straight, staggered pex supply lines
- DIAMOND Seal® technology
- MagnaTite® magnetic docking
- LED indicator light signals on-off, water temperature and when batteries run low
- Uses 6 (AA) or 6 (C) batteries
- Optional 120V AC adapter available



Part #	Mfg #	Description	Handle(s)	Finish	Price
228092	9913T-DST	1-Hole, Lead Free Touch2O	ADA Lever	Chrome	
185893	9913T-AR-DST	1-Hole, Lead Free Touch2O	ADA Lever	Arctic Stainless®	
185309	9913T-BL-DST	1-Hole, Lead Free Touch2O	ADA Lever	Matte Black	
187515	9913T-RB-DST	1-Hole, Lead Free Touch2O	ADA Lever	Venetian Bronze®	

### Esque™ 1-Hdl Pull-Down Spray Bar/Prep Faucet

- 6-7/8" Reach, 14-1/2" high, 360° swivel spout
- 1 or 3-hole 8" installation
- 3/8" Compression fittings
- 8-1/2" Deck to outlet
- MagnaTite® Docking
- DIAMOND™ Seal technology
- Soft, rubber Touch-Clean® spray holes
- Integrated InnoFlex® PEX supply lines
- Optional escutcheon available for purchase separately
- Flow rate: 1.8 gpm @ 60 psi
- (-T) Touch2O® technology



Part #	Mfg #	Description	Handle(s)	Finish	Price
240446	9981-AR-DST	1-Hole, Lead Free	ADA Lever	Arctic Stainless™	
243287	9981-BL-DST	1-Hole, Lead Free	ADA Lever	Matte Black	
237621	9981-RB-DST	1-Hole, Lead Free	ADA Lever	Venetian Bronze	
253171	9981T-BL-DST	1-Hole, Lead Free, Touch2O® Technology	ADA Lever	Matte Black	
116054	9978-DST	2-Hole, Pull-Down Spray, Lead-Free	ADA Lever	Chrome	
157589	9978-AR-DST	2-Hole, Pull-Down Spray, Lead-Free	ADA Lever	Arctic Stainless®	
116052	9978-RB-DST	2-Hole, Pull-Down Spray, Lead-Free	ADA Lever	Venetian Bronze®	

\* Brilliance® Anti-Tarnish Lifetime Finishes



## Bar Faucets

### Leland® 1-Hdl Pull-Down Spray Bar/Prep Faucet

- 6-11/16" Reach, 14" high 360° swivel spout
- 7-7/16" From deck to aerator
- 62" Long hose
- 3/8" Compression fittings
- 2-1/2" Maximum deck thickness
- 32" Minimum InnoFlex® supply lines
- DIAMOND Seal® technology
- MagnaTite® docking
- WaterSense® certified product: 1.8 gpm @ 60 psi



Part #	Mfg #	Description	Handle(s)	Finish	Price
168155	9678-DST	1-Hole, Pull-Down Spray	ADA Lever	Chrome	
173070	9678-AR-DST	1-Hole, Pull-Down Spray	ADA Lever	Arctic Stainless®	
168154	9678-RB-DST	1-Hole, Pull-Down Spray	ADA Lever	Venetian Bronze®	
242060	9678-SP-DST	1-Hole, Pull-Down Spray	ADA Lever	Spotshield Stainless	
178230	9678T-AR-DST	1-Hole, Pull-Down Spray, Touch2O	ADA Lever	Arctic Stainless®	
173330	9678T-RB-DST	1-Hole, Pull-Down Spray, Touch2O	ADA Lever	Venetian Bronze®	
251895	9678T-SP-DST	1-Hole, Pull-Down Spray, Touch2O	ADA Lever	Spotshield Stainless	

### Litze® 1-Hdl Bar Faucet

- 6" Reach, 11-5/8" high 360° swivel spout
- 8-5/16" From deck to aerator
- 3" Maximum deck thickness
- 3/8" Staggered copper supply lines with 1/2" adapters
- Flow rate: 1.8 gpm @ 60 psi



Part #	Mfg #	Description	Handle(s)	Finish	Price
254760	61044LF-PN	1-Hole	ADA Industrial Lever	Polished Nickel	

### Mateo™ 1-Hdl Pull-Down Spray Bar/Prep Faucet

- 9-1/4" Reach, 15-1/2" high spout
- 8-5/8" From deck to aerator
- 3/8" Compression fittings
- DIAMOND Seal® technology
- MagnaTite® docking
- WaterSense® certified product: 1.8 gpm @ 60 psi



Part #	Mfg #	Description	Handle(s)	Finish	Price
224178	9983-DST	1-Hole, Pull-Down Spray	ADA Lever	Chrome	
188940	9983-AR-DST	1-Hole, Pull-Down Spray	ADA Lever	Arctic Stainless®	
188221	9983-RB-DST	1-Hole, Pull-Down Spray	ADA Lever	Venetian Bronze®	

\* Brilliance® Anti-Tarnish Lifetime Finishes

[www.plumbsupply.com](http://www.plumbsupply.com) • Serving our Customers Since 1946 • [www.waterconcepts.net](http://www.waterconcepts.net)

## Bar Faucets

### Mateo™ 1-Hdl Pull-Down Spray Bar/Prep Faucet w/ Touch2O

- 9-1/4" Reach, 16" high spout
- 9-1/8" From deck to aerator
- 3/8" Compression fittings
- Diamond coated ceramic cartridge
- LED indicator light signals on-off, water temperature and when batteries run low
- Uses 6AA (included) or 6 C (optional) batteries
- Optional (EP73954) 120V AC adapter available (3 prong grounded outlet required)



Part #	Mfg #	Description	Handle(s)	Finish	Price
187812	9983T-AR-DST	1-Hole, Pull-Down Spray, Touch2O	ADA Lever	Arctic Stainless®	
236880	9983T-RB-DST	1-Hole, Pull-Down Spray, Touch2O	ADA Lever	Venetian Bronze®	

### Pilar® 1-Hdl Bar/Prep Faucet

- 6-5/8" Reach, 9-1/2" high, high-arc spout swivels 180°
- 7" From deck to aerator
- 3/8" Compression fittings
- 2-1/2" Maximum deck thickness
- 32" Minimum supply lines below deck included
- DIAMOND Seal® technology
- Water-efficient product: 1.5 gpm @ 60 psi



Part #	Mfg #	Description	Handle(s)	Finish	Price
126691	1980-DST	2-Hole, Lead-Free	ADA Lever	Chrome	
134751	1980-AR-DST	2-Hole, Lead-Free	ADA Lever	Arctic Stainless®	
126184	1980-RB-DST	2-Hole, Lead-Free	ADA Lever	Venetian Bronze®	

### Pilar® Electronic 1-Hdl Bar/Prep Faucet

- Touch2O® Technology controls water flow
- 6-5/8" Reach, 9-1/2" high, high-arc spout swivels 180°
- 6-59/64" From deck to aerator
- 3/8" Compression fittings
- 2-1/2" Maximum deck thickness
- 32" Minimum supply lines below deck included
- DIAMOND Seal® technology
- Water-efficient product: 1.5 gpm @ 60 psi



Part #	Mfg #	Description	Handle(s)	Finish	Price
134736	1980T-DST	2-Hole, Lead-Free	ADA Lever	Chrome	
134733	1980T-AR-DST	2-Hole, Lead-Free	ADA Lever	Arctic Stainless®	

\* Brilliance® Anti-Tarnish Lifetime Finishes

[www.waterconcepts.net](http://www.waterconcepts.net) • Serving our Customers Since 1946 • [www.plumbsupply.com](http://www.plumbsupply.com)

## Bar Faucets

### Pivotal® 1-Hdl Bar/Prep Faucet

- 6" Reach, 12" high 120° swivel spout
- 1/2" IPS connection
- 2-1/2" Maximum deck thickness
- Euromotion ceramic cartridge
- Optional 4" escutcheon sold separately
- Flow rate: 1.5 gpm @ 60 psi



Part #	Mfg #	Description	Handle(s)	Finish	Price
258676	1993LF	1-Hole, Lead Free	ADA Lever	Chrome	

### Pivotal™ 1-Hdl Pull-Down Spray Bar/Prep Faucet

- 6-13/16" Reach, 14-5/16" high 360° swivel spout
- 2-1/2" Maximum deck thickness
- 3/8" Staggered copper supply lines with 1/2" fittings
- Two-function wand; aerated stream or spray
- DIAMOND Seal® technology
- Quick Snap® connect hose
- Flow rate: 1.8 gpm @ 60 psi



Part #	Mfg #	Description	Handle(s)	Finish	Price
257147	9993-AR-DST	1-Hole, Lead-Free	ADA Lever	Artic Stainless®	
257834	9993-KS-DST	1-Hole, Lead-Free	ADA Lever	Black Stainless®	

### Traditional 1-Hdl Bar/Prep Faucet

- 4-7/8" Reach, 11-7/8" high 360° swivel spout
- 7-7/8" From deck to aerator
- 1-1/2" Maximum deck thickness
- 3/8" Staggered copper supply lines with 1/2" fittings
- DIAMOND Seal® technology
- Flow rate: 1.5 gpm @ 60 psi



Part #	Mfg #	Description	Handle(s)	Finish	Price
171969	1953LF	1-Hole, Lead Free	ADA Lever	Chrome	
172793	1953LF-AR	1-Hole, Lead Free	ADA Lever	Arctic Stainless®	
171215	1953LF-RB	1-Hole, Lead Free	ADA Lever	Venetian Bronze®	

\* Brilliance® Anti-Tarnish Lifetime Finishes

[www.plumbsupply.com](http://www.plumbsupply.com) • Serving our Customers Since 1946 • [www.waterconcepts.net](http://www.waterconcepts.net)

## Bar Faucets

### Trinsic® 1-Hdl Pull-Down Spray Bar/Prep Faucet

- 6-1/2" Reach, 13" high, high-arc spout swivels 360°
- 8-7/16" From deck to aerator
- Touch-Clean® two-function spray
- MagnaTite® magnetic docking
- DIAMOND Seal® technology
- 62" Long hose
- 3/8" Compression fittings
- 2-1/2" Maximum deck thickness
- 32" Minimum supply lines below deck included
- Water-efficient product: 1.8 gpm @ 60 psi



Part #	Mfg #	Description	Handle(s)	Finish	Price
145280	9959-DST	1- or 3-Hole, Lead-Free	ADA Lever	Chrome	
141854	9959-AR-DST	1- or 3-Hole, Lead-Free	ADA Lever	Arctic Stainless®	
183769	9959-BL-DST	1- or 3-Hole, Lead-Free	ADA Lever	Matte Black	
144863	9959-CZ-DST	1- or 3-Hole, Lead-Free	ADA Lever	Champagne Bronze™	

### Touch2O® Trinsic® 1-Hdl Pull-Down Bar/Prep Faucet

- 6-1/2" Reach, 13" high, high-arc spout swivels 360°
- 8-7/16" From deck to aerator
- Touch2O® on/off functionality
- Touch-Clean® two-function spray head
- MagnaTite® magnetic docking
- DIAMOND Seal® technology
- 62" Long hose
- 3/8" Compression fittings
- Water-efficient product: 1.8 gpm @ 60 psi



Part #	Mfg #	Description	Handle(s)	Finish	Price
150098	9959T-DST	1-Hole, Lead-Free	ADA Lever	Chrome	
147922	9959T-AR-DST	1-Hole, Lead-Free	ADA Lever	Arctic Stainless®	
147797	9959T-CZ-DST	1-Hole, Lead-Free	ADA Lever	Champagne Bronze™	

### Victorian® 1-Hdl Pull-Down Spray Bar/Prep Faucet

- 6-5/8" Reach, 14" high, high-arc pull-down spout swivels 360°
- 7-5/8" From deck to aerator
- 62" Long hose
- Touch-Clean® two-function spray head
- MagnaTite® magnetic docking
- DIAMOND Seal® technology
- 3/8" Compression fittings
- 2-1/2" Maximum deck thickness
- 32" Minimum supply lines below deck included
- Water-efficient product: 1.8 gpm @ 60 psi



Part #	Mfg #	Description	Handle(s)	Finish	Price
116773	9955-RB-DST	2-Hole, Pull-Down Spray, Lead-Free	ADA Lever	Venetian Bronze®	

\* Brilliance® Anti-Tarnish Lifetime Finishes

[www.waterconcepts.net](http://www.waterconcepts.net) • Serving our Customers Since 1946 • [www.plumbsupply.com](http://www.plumbsupply.com)

## Bar Faucets

### Single-Handle Bar Faucets (Continued)

#### Victorian® 1-Hdl Pull-Down Spray Bar/Prep Faucet

Part #	Mfg #	Description	Handle(s)	Finish	Price
116872	9955-SS-DST	2-Hole, Pull-Down Spray, Lead-Free	ADA Lever	Stainless*	

### Two-Handle Bar Faucets

#### Classic 2-Hdl Bar Faucet with 10-3/4" High Spout

- 4-1/16" Reach, 10-13/32" high spout swivels 360°
- 7-19/32" From deck to aerator
- 1/2" IPS connection
- 1" Maximum deck thickness
- Water-efficient product: 1.5 gpm @ 60 psi



2170



2171



2171LF-WBHHD

Part #	Mfg #	Description	Handle(s)	Finish	Price
139312	2170LF	4"cc, 10-3/4" GN Spout, Lead-Free	Clear Knob	Chrome	
138337	2171LF	4"cc, 10-3/4" GN Spout, Lead-Free	ADA Blade	Chrome	
146556	2171LF-WBHHD	2- or 3-Hole 4"cc, 10-3/4" GN Spout, Lead-Free	ADA Blade	Chrome	
164856	2179LF	2- or 3-Hole 4"cc 360° Swivel Spout	ADA Blade	Chrome	

#### Classic 2-hdl Bar Faucet with 11" High Spout

- 4-1/8" Reach, 11" high spout swivels 360°
- 7-11/16" From deck to aerator
- 1/4 Turn handle stops
- 1/2" - 14 NPSM threaded male inlet shanks
- Water-efficient product: 1.5 gpm @ 60 psi

-LHP Less Handle Package, Handles sold separately



Part #	Mfg #	Description	Handle(s)	Finish	Price
003838	2172LF-LHP	2- or 3-Hole, 4"cc 11" Swivel Spout	Less Handles	Chrome	

#### Foundations Core-B 2-Handle Bar Prep Faucet

- Solid brass fabricated body
- 2-Handle deck-mount
- 5" Long, 11" high spout, swings 360°
- 1/4-Turn handle stops
- Washerless stem cartridge
- 1/2"-14 NPSM Threaded male inlet shanks
- 1.5 gpm @ 60 psi



Part #	Mfg #	Description	Handle(s)	Finish	Price
136058	B28910LF	2 or 3-Hole 4"cc, Lead-Free	ADA Lever	Chrome	

\* Brilliance® Anti-Tarnish Lifetime Finishes

[www.plumbsupply.com](http://www.plumbsupply.com) • Serving our Customers Since 1946 • [www.waterconcepts.net](http://www.waterconcepts.net)

## Bar Faucets

### Victorian 2-Hdl Bar/Prep Faucet

- 5-1/8" Reach, 8-3/4" high 360° swivel spout
- 6-1/2" From deck to aerator
- 3/8" Compression fittings
- 2-1/4" Maximum deck thickness
- DIAMOND Seal® technology
- 1.5 gpm @ 60 psi



Part #	Mfg #	Description	Handle(s)	Finish	Price
194534	2155-DST	2 or 3-Hole 4"cc, Lead Free	ADA Lever	Chrome	
157682	2155-RB-DST	2 or 3-Hole 4"cc, Lead Free	ADA Lever	Venetian Bronze®	
151671	2155-SS-DST	2 or 3-Hole 4"cc, Lead Free	ADA Lever	Stainless*	

### Commercial Bar/Prep Faucets

#### Commercial DIAMOND™ Seal 1-Hdl Bar/Prep Faucet

- 5" Reach, 10" high spout
- Vandal-resistant handles
- Adjustable handle limit stop
- 3/8" Compression fittings
- DIAMOND Seal® technology
- 1.5 gpm @ 60 psi



Part #	Mfg #	Description	Handle(s)	Finish	Price
004113	710LF-HDF	2-Hole, Rigid Spout, Lead-Free	ADA Lever	Chrome	

#### Commercial 2-Hdl Deck-Mount Bar Faucet

- Cast brass body
- Hot/cold handle indicators
- 4-1/2" Reach, 12" high rigid/swing spout
- 1.5 gpm Aerator
- 1/2" IPS Shanks



Part #	Mfg #	Description	Handle(s)	Finish	Price
128150	27C4832	4"cc VR Aerator, CER-TECK® Cartridge	ADA Hooded Blade	Chrome	
132868	27C4845	4"cc Flow Control Aerator, CER-TECK® Cartridge	ADA Wrist Blade	Chrome	

\* Brilliance® Anti-Tarnish Lifetime Finishes



## Bar Faucets

### Beverage Faucets

#### Traditional Beverage Faucet

- Cold water only
- Compatible with reverse osmosis systems
- 5" Reach, 8" high, high-arc spout swivels 360°
- 6-7/8" From deck to aerator
- 3/8" Compression fittings
- 2-1/2" Maximum deck thickness
- 32" Minimum supply lines below the deck included
- DIAMOND Seal® technology
- 1.5 gpm @ 60 psi



Touch

Part #	Mfg #	Description	Handle(s)	Finish	Price
143984	1914-DST	1-Hole, Lead-Free	ADA Lever	Chrome	
145842	1914-AR-DST	1-Hole, Lead-Free	ADA Lever	Arctic Stainless®	
154428	1914-CZ-DST	1-Hole, Lead-Free	ADA Lever	Champagne Bronze™	
143305	1914-RB-DST	1-Hole, Lead-Free	ADA Lever	Venetian Bronze®	
143467	1914-SS-DST	1-Hole, Lead-Free	ADA Lever	Stainless*	
169386	1914T-AR	1-Hole, Lead-Free	Touch Activated	Arctic Stainless®	
189397	1914T-RB	1-Hole, Lead-Free	Touch Activated	Venetian Bronze®	
167295	1914T-SS	1-Hole, Lead-Free	Touch Activated	Stainless*	

#### Transitional Beverage Faucet

- Cold water only
- Compatible with reverse osmosis systems
- 5" Reach, 7-53/64" high, spout swivels 360°
- 6-7/8" From deck to aerator
- 3/8" Compression fittings
- 2-1/2" Maximum deck thickness
- DIAMOND Seal® technology
- Water-efficient product: 1.5 gpm @ 60 psi



Touch

Part #	Mfg #	Description	Handle(s)	Finish	Price
144735	1977-DST	1-Hole, Lead-Free	ADA Lever	Chrome	
144004	1977-AR-DST	1-Hole, Lead-Free	ADA Lever	Arctic Stainless®	
256227	1977-BL-DST	1-Hole, Lead-Free	ADA Lever	Matte Black	
144864	1977-CZ-DST	1-Hole, Lead-Free	ADA Lever	Champagne Bronze™	
146235	1977-RB-DST	1-Hole, Lead-Free	ADA Lever	Venetian Bronze®	
144736	1977-SS-DST	1-Hole, Lead-Free	ADA Lever	Stainless*	
168523	1977T	1-Hole, Lead-Free	Touch Activated	Chrome	
169406	1977T-AR	1-Hole, Lead-Free	Touch Activated	Arctic Stainless®	
177443	1977T-RB	1-Hole, Lead-Free	Touch Activated	Venetian Bronze®	

\* Brilliance® Anti-Tarnish Lifetime Finishes

## Bar Faucets

### Single-Handle Bar Faucets

#### Artesso™ 1-Hdl Bar Faucet

- 6-1/32" Reach, 13-9/64" high, 360° swing spout
- 9-1/16" From deck to aerator
- Ceramic cartridge
- 2-1/2" Maximum deck thickness
- Maximum flow: 1.80 gpm @ 60 psi



Part #	Mfg #	Description	Handle(s)	Finish	Price
182916	61025LF-PC	1-Hole, Less Side Spray	ADA Lever	Polished Chrome	
178323	61025LF-PN	1-Hole, Less Side Spray	ADA Lever	Polished Nickel*	
175925	61025LF-RB	1-Hole, Less Side Spray	ADA Lever	Venetian Bronze®	
176300	61025LF-SS	1-Hole, Less Side Spray	ADA Lever	Stainless*	

#### Artesso™ 1-Hdl Pull Down Prep Faucet

- 7-9/16" Reach, 14" high, 360° swivel spout
- 7-3/8" From deck to aerator
- MagneDock®
- DIAMOND™
- Touch-Clean® nozzles
- Euro-motion Diamond™ valve with InnoFlex® waterways
- Two-function wand: spray and stream
- Accommodates up to 3" deck thickness



Part #	Mfg #	Description	Handle(s)	Finish	Price
254551	63925LF-PN	1-Hole, Pull-Down Spray	ADA Lever	Polished Nickel*	
240174	63925LF-RB	1-Hole, Pull-Down Spray	ADA Lever	Venetian Bronze	

#### Talo® 1-Hdl Pull-Down Bar Faucet

- 6-19/64" Reach, 14-7/8" high, 360° swing spout
- 8-15/16" From deck to aerator
- DIAMOND™ seal technology
- Euro-motion Diamond™ valve with InnoFlex® waterways
- Touch-Clean® nozzles
- MagneDock® technology
- 2-function pull-down wand: spray and stream
- Accommodates up to 3" deck thickness
- Maximum flow: 1.8 gpm @ 60 psi



Part #	Mfg #	Description	Handle(s)	Finish	Price
134884	63903LF-BZ	1-Hole, Pull-Down Spray	ADA Lever	Brushed Bronze*	
168126	63903LF-PN	1-Hole, Pull-Down Spray	ADA Lever	Polished Nickel*	
134076	63903LF-RB	1-Hole, Pull-Down Spray	ADA Lever	Venetian Bronze®	
131851	63903LF-SS	1-Hole, Pull-Down Spray	ADA Lever	Stainless*	

\* Brilliance® Anti-Tarnish Lifetime Finishes

## Bar Faucets

### Talo® 1-Hdl Pull-Down Bar/Prep Faucet With SmartTouch® Technology

- 6-19/64" Reach, 14-7/8" high, 360° swing spout
- 8-15/16" From deck to aerator
- SmartTouch® technology with TempID™
- MagneDock® technology
- DIAMOND™ seal technology
- Euro-motion Diamond™ valve with InnoFlex® waterways
- Touch-Clean® nozzles
- Two function pull-down wand: spray and stream
- Accommodates up to 3" deck thickness
- Maximum flow: 1.8 gpm @ 60 psi



Part #	Mfg #	Description	Handle(s)	Finish	Price
186831	64903LF-PN	1-Hole, Pull-Down Spray w/ SmartTouch®	ADA Lever	Polished Nickel*	
145310	64903LF-RB	1-Hole, Pull-Down Spray w/ SmartTouch®	ADA Lever	Venetian Bronze®	

### Solna™ 1-Hdl Pull-Down Bar Faucet

- 12-7/16" Reach, 7-1/16" high, 360° swing spout
- 7-1/16" From deck to aerator
- MagneDock® technology
- DIAMOND™ seal technology
- Euro-motion Diamond™ valve with InnoFlex® waterways
- 2-function wand: spray and stream
- Hidden pull-down spray
- Accommodates up to 3" deck thickness
- Maximum flow: 1.80 gpm @ 60 psi



Part #	Mfg #	Description	Handle(s)	Finish	Price
155649	63920LF-BL	1-Hole, Pull-Down Spray Head	ADA Lever	Matte Black	
154641	63920LF-PC	1-Hole, Pull-Down Spray Head	ADA Lever	Polished Chrome	
139264	63920LF-SS	1-Hole, Pull-Down Spray Head	ADA Lever	Stainless*	
162503	64920LF-SS	1-Hole, PD Spray w/SmartTouch® & 13-5/16" Reach	ADA Lever	Stainless*	

### Belo™ 1-Hdl Pull-Down Bar Faucet

- 6-1/2" Reach, 13-1/2" high, 360° swing spout
- 8-1/4" From deck to aerator
- Touch-Clean® nozzles
- MagneDock® technology
- DIAMOND™ seal technology
- 2-function pull-down wand: spray and stream
- Accommodates up to 3" deck thickness
- Maximum flow: 1.8 gpm @ 60 psi



Part #	Mfg #	Description	Handle(s)	Finish	Price
164834	63952LF-PC	1-Hole, Pull-Down Spray	ADA Lever	Polished Chrome	
133484	63952LF-SS	1-Hole, Pull-Down Spray	ADA Lever	Stainless*	

\* Brilliance® Anti-Tarnish Lifetime Finishes

[www.plumbsupply.com](http://www.plumbsupply.com) • Serving our Customers Since 1946 • [www.waterconcepts.net](http://www.waterconcepts.net)

**Bar Faucets**

**Litze™ 1-Hdl Bar Faucet**

- 6" Reach, 360° Spout rotation
- 11-5/8" High arc spout (61043LF)
- 11-1/2" High angled spout (61063LF and 61064LF)
- 11-5/16" High square spout and 5-7/8" reach (61054LF)
- 8-3/8" From deck to aerator
- Ceramic disc cartridge
- 3/8" staggered copper supply lines with 1/2" adapters
- Maximum flow rate: 1.8 gpm @ 60 psi



Arc Spout  
61043LF



Angled Spout



Square Spout

Part #	Mfg #	Description	Handle(s)	Finish	Price
251261	61043LF-GL	1-Hole, Less Side Spray	ADA Knurled Lever	Luxe Gold	
248243	61043LF-PN	1-Hole, Less Side Spray	ADA Knurled Lever	Polished Nickel	
242564	61054LF-PN	1-Hole, Less Side Spray	ADA Industrial Lever	Polished Nickel	
242786	61054LF-SS	1-Hole, Less Side Spray	ADA Industrial Lever	Stainless*	
244845	61053LF-BLGL	1-Hole, Less Side Spray	ADA Knurled Lever	Matte Black/Luxe Gold	
249637	61053LF-PC	1-Hole, Less Side Spray	ADA Knurled Lever	Chrome	
242036	61063LF-BLGL	1-Hole, Less Side Spray	ADA Knurled Lever	Matte Black/Luxe Gold	
251483	61064LF-SS	1-Hole, Less Side Spray	ADA Industrial Lever	Stainless*	

**Venuto® 1-Hdl Pull-Down Bar Faucet**

- 6-1/2" Reach, 14-1/2" high spout
- 8-3/4" From deck to aerator
- DIAMOND™ seal technology
- Euro-motion Diamond™ valve with InnoFlex® waterways
- Touch-clean® nozzles
- MagneDock® technology
- 2-function pull-down wand: spray and stream
- Mounts to 3" deck thickness
- Maximum flow: 1.80 gpm @ 60 psi



Part #	Mfg #	Description	Handle(s)	Finish	Price
175078	63970LF-BLST	1-Hole, Pull-Down Spray	ADA Lever	Matte Black/Soft Touch®	
131557	63970LF-SS	1-Hole, Pull-Down Spray	ADA Lever	Stainless*	

**Vuelo® 1-Hdl Pull-Down Bar Faucet**

- 7-1/8" Reach, 15" high, 360° swing spout
- DIAMOND™ seal technology
- MagneDock® technology
- 2-function wand: spray and stream
- Accommodates up to 3" deck thickness
- Maximum flow: 1.80 gpm @ 60 psi



Part #	Mfg #	Description	Handle(s)	Finish	Price
150874	63955LF-SS	1-Hole, Pull-Down Spray	ADA Lever	Stainless*	

\* Brilliance® Anti-Tarnish Lifetime Finishes

## Bar Faucets

### Vuelo™ 1-Hdl Pull Down Prep With SmartTouch®

- 7-1/8" Reach, 15-1/2" high, 360° swing spout
- SmartTouch® technology with TempID™
- DIAMOND™ seal technology
- Two-function wand: spray and stream
- MagneDock® magnetic docking
- Accommodates up to 3" deck thickness
- 1.80 gpm @ 60 psi



Part #	Mfg #	Description	Handle(s)	Finish	Price
185274	64955LF-SSCO	1-Hole, Pull-Down Spray	ADA Lever	Stainless Steel/Cocoa Brz™	

## Two-Handle Bar Faucets

### Tresa® 2-Hdl Bar Faucet

- 6-3/8" Reach, 11-1/2" high spout
- 8-3/16" From deck to aerator
- Solid brass faucet body
- Ceramic cartridges
- Accommodates up to 3" deck thickness
- Maximum flow: 1.8 gpm @ 60 psi



Part #	Mfg #	Description	Handle(s)	Finish	Price
175926	62936LF-PC	1-Hole, Single function spray	ADA Lever	Polished Chrome	
170006	62936LF-PN	1-Hole, Single function spray	ADA Lever	Polished Nickel*	
138291	62936LF-RB	1-Hole, Single function spray	ADA Lever	Venetian Bronze®	
136999	62936LF-SS	1-Hole, Single function spray	ADA Lever	Stainless*	

## Beverage Faucets

### Traditional 1-Hdl Beverage Faucet

- 5" Reach, 9-7/64" high, 360° swing spout
- 6-51/64" From deck to aerator
- DIAMOND™ seal technology
- Air gap included
- Works with RO systems, filtered water systems or as a cold water tap
- Mounts to 4" deck thickness (-2-3/4" with air gap)
- Integrated supply tubes
- Maximum flow: 1.50 gpm @ 60 psi



Part #	Mfg #	Description	Handle(s)	Finish	Price
148274	61310LF-BZ	1-Hole, Single function spray	ADA Lever	Brushed Bronze*	
166055	61310LF-PC	1-Hole, Single function spray	ADA Lever	Polished Chrome	
148651	61310LF-RB	1-Hole, Single function spray	ADA Lever	Venetian Bronze®	

\* Brilliance® Anti-Tarnish Lifetime Finishes

[www.plumbsupply.com](http://www.plumbsupply.com) • Serving our Customers Since 1946 • [www.waterconcepts.net](http://www.waterconcepts.net)

---



---

**Bar Faucets**

---



---

**Beverage Faucets (Continued)****Traditional 1-Hdl Beverage Faucet**

Part #	Mfg #	Description	Handle(s)	Finish	Price
153514	61310LF-SS	1-Hole, Single function spray	ADA Lever	Stainless*	

**Euro 1-Hdl Beverage Faucet**

- 5" Reach, 9-1/3" high, 360° swing spout
- 6-51/64" From deck to aerator
- DIAMOND™ seal technology
- Air gap included
- Works with RO systems, filtered water systems or as a cold water tap
- Mounts to 4" deck thickness (2-3/4" with air gap)
- Integrated supply tubes
- Maximum flow: 1.50 gpm @ 60 psi



Part #	Mfg #	Description	Handle(s)	Finish	Price
170375	61320LF-PC	1-Hole, Single function spray	ADA Lever	Polished Chrome	
154450	61320LF-SS	1-Hole, Single function spray	ADA Lever	Stainless*	

\* Brilliance® Anti-Tarnish Lifetime Finishes



## Bar Faucets

### One-Handle Bar Faucets

#### Align™ 1-Hdl Bar Faucet

- 6-3/4" Reach, 13-3/4" high 360° swivel spout
- 6-7/8" From deck to aerator
- 3/8" Compression connections
- Stream or spray mode
- 1255™ Duralast™ cartridge
- Reflex™ pulldown system with 68" braided hose
- 2-1/2" Maximum deck thickness
- Flow rate: 1.5 gpm



Part #	Mfg #	Description	Handle(s)	Finish	Price
168241	5965	1-Hole, Pull-Down Spray	ADA Lever	Chrome	
249161	5965BL	1-Hole, Pull-Down Spray	ADA Lever	Matte Black	
165260	5965SRS	1-Hole, Pull-Down Spray	ADA Lever	Spot Resist Stainless	

#### Arbor™ 1-Hdl Pull-Down Spray Bar Faucet

- 6-9/16" Reach, 14-3/8" spout height
- 3/8" Compression connections
- Hydrolock® quick connect installation
- Stream or spray mode
- Pullout spray with 68" braided hose
- Flow rate: 1.5 gpm



Part #	Mfg #	Description	Handle(s)	Finish	Price
155965	5995	1- or 3-Hole, Pull-Down Spray	ADA Lever	Chrome	
160817	5995BL	1- or 3-Hole, Pull-Down Spray	ADA Lever	Matte Black	
136632	5995ORB	1- or 3-Hole, Pull-Down Spray	ADA Lever	Oil Rubbed Bronze	
168034	5995SRS	1- or 3-Hole, Pull-Down Spray	ADA Lever	Spot Resist Stainless	

#### Brantford™ 1-Hdl Pull-Down Spray Bar Faucet

- 6-9/16" Reach, 14-3/8" high 360° swivel spout
- 8-3/8" From deck to aerator
- 3/8" Compression connections
- Stream or spray mode
- 1255™ Duralast™ cartridge
- Reflex™ pulldown system with 68" braided hose
- 2-1/2" Maximum deck thickness
- Flow rate: 1.5 gpm



Part #	Mfg #	Description	Handle(s)	Finish	Price
171142	5985	1- or 3-Hole, Pull-Down Spray	ADA Lever	Chrome	
144725	5985ORB	1- or 3-Hole, Pull-Down Spray	ADA Lever	Oil Rubbed Bronze	
162357	5985SRS	1- or 3-Hole, Pull-Down Spray	ADA Lever	Spot Resist Stainless	

\* Lifeshine® Anti-Tarnish Lifetime Finish

[www.plumbsupply.com](http://www.plumbsupply.com) • Serving our Customers Since 1946 • [www.waterconcepts.net](http://www.waterconcepts.net)

## Bar Faucets

### Camerist™ 1-Hdl Bar Faucet

- 5-1/4" Spout reach, 11" high spout
- 7-1/2" From deck to aerator
- 3/8" Compression fittings
- 1255™ Duralast™ cartridge
- 2-1/2" Maximum deck thickness
- Flow rate: 1.5 gpm



Part #	Mfg #	Description	Handle(s)	Finish	Price
083855	4905	2-Hole, Less Side Spray	ADA Lever	Chrome	
115146	4905ORB	2-Hole, Less Side Spray	ADA Lever	Oil Rubbed Bronze	
173695	4905SRS	2-Hole, Less Side Spray	ADA Lever	Spot Resist Stainless	

### Chateau 1-Hdl High Arc Bar Faucet

- 4-1/2" Spout reach, 10-1/2" high spout
- 3/8" Compression fittings
- Duralock™ quick connect
- 1255™ duralast™ cartridge
- Aerated stream spray
- Flow rate: 1.5 gpm



Part #	Mfg #	Description	Handle(s)	Finish	Price
247377	4904SRS	2-Hole, Less Side Spray	ADA Lever	Spot Resist Stainless	

### Etch 1-Hdl Pull-Down Spray Bar Faucet

- 6-1/2" Reach, 15-1/2" high, 360° swivel spout
- 9-1/2" From deck to aerator
- 3/8" Compression connections
- Stream or spray mode
- 1255™ Duralast™ cartridge
- Reflex™ pulldown system with 68" braided hose
- 3-1/2" Maximum deck thickness
- Flow rate: 1.5 gpm



Part #	Mfg #	Description	Handle(s)	Finish	Price
189230	S62608	1-Hole, Pull-Down Spray	ADA Lever	Chrome	
175001	S62608SRS	1-Hole, Pull-Down Spray	ADA Lever	Spot Resist Stainless	

\* Lifeshine® Anti-Tarnish Lifetime Finish

## Bar Faucets

### Notch™ 1-Hdl Pull-Down Spray Bar Faucet

- 6-1/16" Reach, 14-1/2" high 360° swivel spout
- 9" From deck to aerator
- 3/8" Compression fittings
- Reflex™ pulldown system offers smooth operation, easy movement and secure docking
- 68" Braided hose
- 1255™ Duralast™ cartridge
- Flow rate: 1.5 gpm



Part #	Mfg #	Description	Handle(s)	Finish	Price
187635	6124SRS	1-Hole, Pull-Down Spray	ADA Lever	Spot Resist Stainless	

### STo 1-Hdl Pull-Down Spray Bar Faucet

- 7" Reach, 14-5/8" high 360° swivel spout
- 7-7/8" From deck to aerator
- 3/8" Compression connections
- 1255™ Duralast™ cartridge
- Reflex™ pulldown system with 68" braided hose
- 2-1/2" Maximum deck thickness
- Flow rate: 1.5 gpm



Part #	Mfg #	Description	Handle(s)	Finish	Price
163254	S62308	1-Hole, Pull-Down Spray	ADA Lever	Chrome	
162501	S62308BL	1-Hole, Pull-Down Spray	ADA Lever	Matte Black	
168491	S62308SRS	1-Hole, Pull-Down Spray	ADA Lever	Spot Resist Stainless	

### Weymouth™ 1-Hdl High Arc Bar Faucet

- 6-1/8" reach, 7-13/16" high
- LifeShine® finish
- Aerated stream
- 1255™ Duralast™ cartridge
- Flexible supplies with 3/8" compression fittings
- Flow rate: 1.5 gpm



Part #	Mfg #	Description	Handle(s)	Finish	Price
237785	S62101NL	1-Hole	ADA Lever	Polished Nickel	

\* Lifeshine® Anti-Tarnish Lifetime Finish

[www.plumbsupply.com](http://www.plumbsupply.com) • Serving our Customers Since 1946 • [www.waterconcepts.net](http://www.waterconcepts.net)

## Bar Faucets

### Woodmere® 1-Hdl Pull-Down Spray Bar Faucet

- 6-3/4" Reach, 13-1/4" spout height
- 7-7/16" From deck to aerator
- 3/8" Compression connections
- 1255™ Duralast™ cartridge
- Reflex™ pulldown system with 68" braided hose
- 2-1/2" Maximum deck thickness
- Flow rate: 1.5 gpm



Part #	Mfg #	Description	Handle(s)	Finish	Price
223186	6615SRS	1-Hole, Pull-Down Spray	ADA Lever	Spot Resist Stainless	

### Two-Handle Bar Faucets

#### Chateau™ 2-Hdl Bar Faucet

- 4-9/16" Reach, 10-1/2" high spout
- 7-1/8" From deck to aerator
- 3/8" Ball nose connections
- 1" Maximum deck thickness
- Flow rate: 1.5 gpm



Part #	Mfg #	Description	Handle(s)	Finish	Price
055066	4903	2-Hole, Less Side Spray	ADA Blade	Chrome	
253090	4903BC	2-Hole, Less Side Spray	ADA Blade	Brushed Chrome	

### Beverage Faucets

#### Sip Modern 1-Hdl Beverage Faucet

- Cold water only
- 11" High spout
- 8-13/16" From deck to aerator
- 3/8" Compression inlet connection
- 1234 Duralast™ cartridge
- WaterSense® certified: 1.5 gpm



Part #	Mfg #	Description	Handle(s)	Finish	Price
167280	S5530SRS	1-Hole, Cold Water Only	ADA Lever	Spot Resist Stainless	

\* Lifeshine® Anti-Tarnish Lifetime Finish

[www.waterconcepts.net](http://www.waterconcepts.net) • Serving our Customers Since 1946 • [www.plumbsupply.com](http://www.plumbsupply.com)

## Bar Faucets

### Sip Traditional 1-Hdl Beverage Faucet

- Cold water only
- 4-9/16" Reach, 11" high spout
- 8-3/4" From deck to aerator
- 3/8" Compression fittings
- 1234 Duralast™ cartridge
- WaterSense® certified: 1.5 gpm



Part #	Mfg #	Description	Handle(s)	Finish	Price
184852	S5510ORB	1-Hole, Cold Water Only	ADA Lever	Oil Rubbed Bronze	

### Sip Transitional 1-Hdl Beverage Faucet

- Cold water only
- 5" Reach, 11" high spout
- 8-9/16" From deck to aerator
- 3/8" Compression fittings
- 1234 Duralast™ cartridge
- WaterSense® certified: 1.5 gpm



Part #	Mfg #	Description	Handle(s)	Finish	Price
173397	S5520	1-Hole, Cold Water Only	ADA Lever	Chrome	
215563	S5520ORB	1-Hole, Cold Water Only	ADA Lever	Oil Rubbed Bronze	
170254	S5520SRS	1-Hole, Cold Water Only	ADA Lever	Spot Resist Stainless	

### Sip Filtration System

- For S5510, S5520 and S5530 Sip Beverage Faucets



Part#	Mfg#	Description	Price
173396	S5500	0.7 gpm, Undermount Dry Change System	

\* Lifeshine® Anti-Tarnish Lifetime Finish

[www.plumbsupply.com](http://www.plumbsupply.com) • Serving our Customers Since 1946 • [www.waterconcepts.net](http://www.waterconcepts.net)

**Bar Faucets**

**Bar Faucets**

**Blanco Meridian™ 1-Hdl Bar Faucet**

- 7" Reach, 7-3/4" height
- 360° Swivel spout
- Ceramic disc cartridge
- Installation in a 1-3/8" hole
- 2.5 GPM flow rate
- 1-3/4" Maximum deck thickness



Part #	Mfg #	Description	Handle(s)	Finish	Price
189614	440953	1-Hole, Less Spray	Lever	Chrome	

**Blanco Artona™ Pull-Down Bar Faucet**

- 6-7/8" Reach, 13-5/8" height
- 180° spout swivel
- Ceramic disk cartridge
- Solid brass body
- 2.2 GPM flow rate
- Installation in a 1-3/8" hole
- 2-1/4" Maximum deck thickness



Part #	Mfg #	Description	Handle(s)	Finish	Price
227463	442040	1-Hole, Pull-Down Spray, 2.2 GPM	Lever	Stainless/Cafe Brown	
238121	442043	1-Hole, Pull-Down Spray, 2.2 GPM	Lever	Stainless/Truffle	



## Bar Faucets

### Single-Handle Bar Faucets

#### P4H 1-Hdl Bar Faucet

- Ceramic cartridge
- Optional deck plate included
- Maximum flow rate: 1.5 gpm @ 60 psi



Part #	Mfg #	Description	Handle(s)	Finish	Price
242710	P4H-320SS	1-or 3-Hole	ADA Lever	Stainless Steel	

### Two-Handle Bar Faucets

#### P4B 2-Hdl Bar Faucet

- Ceramic cartridges
- Maximum flow rate: 2.2 gpm @ 60 psi



Part #	Mfg #	Description	Handle(s)	Finish	Price
141374	P4B-320C	4"cc 3-Hole, Goose Neck Spout	ADA Metal Lever	Chrome	
141375	P4B-320SS	4"cc 3-Hole, Goose Neck Spout	ADA Metal Lever	Stainless Steel	

#### P4C 2-Hdl Bar Faucet

- Washerless cartridges
- Maximum flow rate: 2.2 gpm @ 60 psi



Part #	Mfg #	Description	Handle(s)	Finish	Price
141390	P4C-320CB	4"cc 3-Hole, Goose Neck Spout	ADA Metal Wrist Blade	Chrome	

## Bar Faucets

### Point-Of-Use Drinking Faucets

#### MT1873 The Little Gourmet® Francis Anthony Point-of-Use Cold Water Faucet

- Height: 8"
- Spout reach: 4"
- Reverse osmosis filtration
- 1/4" Turn ceramic cartridge
- Traditional double curved body



Part #	Mfg #	Description	Handle(s)	Finish	Price
238569	MT1873-NL/VB	1-Hole Point-of-Use Drinking Faucet	Curved Lever	Venetian Bronze	

#### MT600 Little Gourmet® Point-Of-Use Cold Water Faucet

- Height: 11-1/4"
- Spout reach: 3-3/4"
- Can be used as a water filtration faucet, bar or food prep faucet
- Reverse-osmosis filtration
- 1/4-Turn ceramic disc cartridge
- Comes with flange
- Meets NSF standards



Part #	Mfg #	Description	Handle(s)	Finish	Price
049360	MT600-NL/BRN	1-Hole Point-of-Use Drinking Faucet	Lever	Brushed Nickel	
088745	MT600-NL/BRS	1-Hole Point-of-Use Drinking Faucet	Lever	Brushed Stainless	
048786	MT600-NL/CPB	1-Hole Point-of-Use Drinking Faucet	Lever	Polished Chrome	
073745	MT600-NL/ORB	1-Hole Point-of-Use Drinking Faucet	Lever	Oil Rubbed Bronze	
087276	MT600-NL/VB	1-Hole Point-of-Use Drinking Faucet	Lever	Venetian Bronze™	

#### MT620 Little Gourmet® Point-Of-Use Cold Water Faucet

- Height: 11"
- Spout reach: 3-3/4"
- Can be used as a water filtration faucet, bar or food prep faucet
- Reverse-osmosis filtration
- 1/4-Turn ceramic disc cartridge
- Meets NSF standards



Part #	Mfg #	Description	Handle(s)	Finish	Price
089173	MT620-NL/BRS	1-Hole Point-of-Use Drinking Faucet	Lever	Brushed Stainless	

\*PVD Finish

## Bar Faucets

### MT1103 Little Gourmet® Point-Of-Use Cold Water Faucet

- Height: 9-1/2"
- Spout reach: 5-5/8"
- Can be used as a water filtration faucet, bar or food prep faucet
- Reverse-osmosis filtration
- 1/4-Turn ceramic disc cartridge
- Meets NSF standards



Part #	Mfg #	Description	Handle(s)	Finish	Price
095364	MT1103/BRN	1-Hole Point-of-Use Drinking Faucet	Lever	Brushed Nickel	

### MT1843 The Little Gourmet® Francis Anthony Contemporary Point-Of-Use Instant Cold Water Faucet

- 1/4 Turn ceramic cartridge
- These faucets are constructed with lead free brass
- 1-3/16" minimum to 1-3/8" maximum mounting hole required
- This drinking faucet is ICC listed
- Reverse Osmosis Safe



Part #	Mfg #	Description	Handle(s)	Finish	Price
156983	MT1843-NL/CPB	1-Hole Point-of-Use Drinking Faucet	Lever	Polished Chrome	

### The Little Gourmet® Francis Anthony Instant Hot Water Dispenser

- Tank Included
- 1/4 Turn ceramic cartridge
- 1-3/16" Minimum to 1-3/8" maximum mounting hole required
- IAPMO listed
- Reverse osmosis safe
- Hot water tank provides 60 cups of 190 degree water per hour



Part #	Mfg #	Description	Handle(s)	Finish	Price
236964	MT1850DIY-NL/PVDP N	1-Hole Instant Hot Water Dispenser	Lever	Polished Nickel	

## Parts & Accessories

### Mountain Pure® Water Filter System

- 99.9% Removal
- Anti-microbial
- 1250 Gallon capacity
- 1/4" Turn automatic shut off valve



Part #	Mfg #	Description	Price
240697	MT1250XL	1250 Gallon Capacity	

\*PVD Finish

**www.plumbsupply.com • Serving our Customers Since 1946 • www.waterconcepts.net**

**Bar Faucets**

**Glass Fillers**

- 3" Reach, 8-1/4" height
- 100% Lead-free waterway system
- Stainless steel gooseneck



Part #	Mfg #	Description	Handle(s)	Finish	Price
041063	LK-1110	1-Hole	Push Lever	Chrome	

**Single Handle Bar Faucets**

**Avado® Low Flow Pull-Down Bar Faucet**

- 7-1/4" Reach, 14-1/8" high spout, 360° spout rotation
- Brass material
- Ceramic disc valves
- 3-Function spray: Aerated, spray, pause
- Stainless steel coil hand spray hose
- Forward only lever handle
- 1/2"-14 NPSM
- 2-1/2" Maximum countertop thickness
- 6-7/8" Deck clearance
- Solid brass waterway construction
- Flow rate: 1.5 gpm



Part #	Mfg #	Description	Handle(s)	Finish	Price
248515	LKAV4032CR	1-Hole, Pull-Down Spray	Forward Only ADA Lever	Chrome	

**Gourmet Low Flow Pull-Down Bar Faucet**

- 7" Reach, 14-7/8" spout height, 360° spout swing rotation
- 7-3/8" Deck clearance
- 2-1/2" Countertop thickness
- Brass construction
- Ceramic disc valve
- 1/2"-14 NPSM
- Spray functions: aerated, spray
- Maximum flow rate: 1.5 gpm



Part #	Mfg #	Description	Handle(s)	Finish	Price
250719	LKGT3032AS	1-Hole, Pull-Down Spray	Forward Only ADA Lever	Antique Steel	

**Bar Faucets**

**Gourmet Low Flow Pull-Out Bar Faucet**

- 8-3/4" Reach, 7-3/8" spout height, 110° spout swing rotation
- 5" Deck clearance
- 2-1/2" Countertop thickness
- Brass construction
- Ceramic disc valve
- Spray functions: aerated, spray
- 3/8" Female compression hose assembly
- Maximum flow rate: 1.75 gpm



Part #	Mfg #	Description	Handle(s)	Finish	Price
240191	LKGT1042CR	1-Hole, Pull-Out Spray	ADA Lever	Chrome	

**Two-Handle Bar Faucets**

**2-Hdl Everyday Bar Faucet**

- 3-9/16" Reach, 11-11/16" spout height, 360° swing spout
- Brass construction
- Ceramic disc valve
- 3/8" Compression hose assembly
- 9" Maximum deck clearance
- Maximum flow rate 1.5 gpm



Part #	Mfg #	Description	Handle(s)	Finish	Price
172754	LK2477CR	2-Hole, No Spray Type	ADA Lever	Chrome	

## Bar Faucets

### Two-Handle Bar Faucets

#### Grand Two-Handle Bar Faucet

- 4-9/16" Reach, 7-11/16" From deck to aerator
- Brass waterway construction with 1/2" - 14 NPSM connection
- 1/4 turn premium grade ceramic cartridges (Type I)
- Sleek design
- 1/2" IPS connections
- Flow rate: 1.8 gpm
- 100% Pressure system tested



Part #	Mfg #	Description	Handles	Finish	Price
226649	192-5887	4"cc, 2-Hole	ADA Lever	Brushed Nickel	
230525	192-5888	4"cc, 2-Hole	ADA Lever	Oil Rubbed Bronze	

#### Majestic Two-Handle Bar Faucet

- 4-9/16" Reach, 7-3/4" From deck to aerator
- Brass waterway construction with 1/2" - 14 NPSM connection
- 1/4 turn premium grade ceramic cartridges (Type I)
- Sleek design
- 1/2" IPS connections
- Flow rate: 1.8 gpm
- 100% Pressure system tested



Part #	Mfg #	Description	Handles	Finish	Price
186819	192-5892	4"cc, 2-Hole	ADA Lever	Chrome	
186820	192-5893	4"cc, 2-Hole	ADA Lever	Brushed Nickel	
186821	192-5894	4"cc, 2-Hole	ADA Lever	Oil Rubbed Bronze	



## Bar Faucets

### Single-Handle Kitchen Faucets

#### Francis Anthony Point-of-Use Kitchen Faucet

- 4" Reach, 8" high
- Lead free brass
- Reverse osmosis safe
- 1/4" Turn ceramic cartridge
- Includes connection hardware to connect to 1/4" tubing



Part #	Mfg #	Finish	Price
242674	MT1803-NL/MB	Matte Black	

#### Francis Anthony Point-of-Use Kitchen Faucet with Traditional Double Curved Body & Curved Handle

- 4-1/16" Reach, 8" high
- Lead free brass
- Reverse osmosis safe
- 1/4" Turn ceramic cartridge
- Includes connection hardware to connect to 1/4" tubing
- Compatible with MT1250XL, MT660, and MT662-2 filtration systems
- Also compatible with MT670-2 water chiller
- Not to be used with Gourmet® hot tank MT641-3



Part #	Mfg #	Finish	Price
245506	MT1873-NL/PVDPN	PVD Polished Nickel	

#### Point-of-Use Kitchen Faucet

- 3-3/4" Reach, 10-3/4" high
- 1/4" Turn ceramic cartridge
- 1/2"-1-3/8" mounting hole required
- Reverse osmosis safe
- Includes connection hardware to connect to 1/4" tubing



Part #	Mfg #	Finish	Price
242209	MT600-NL/MB	Matte Black	
242014	MT600-NL/PN	Polished Nickel	

### Contemporary Cold Water Kitchen Faucet

- Single tilt lever
- 4-1/8" Reach, 10" high
- 1/4" Turn ceramic cartridge
- 1-3/8" mounting hole required
- Reverse osmosis safe
- Includes connection hardware to connect to 1/4" tubing



Part #	Mfg #	Finish	Price
242526	MT635-NL/SC	Chrome	

### Air Gap Units

#### Reverse Osmosis Air Gap

- For Mountain point-of-use faucets
- Mounting hole 1-1/4"



Part #	Mfg #	Finish	Price
105180	AG600S/BRS	Brushed Stainless	

\*PVD Finish

## Hot Water Dispensers

### Hot/Cold Water Dispensers

#### GN1100 Indulge™ Contemporary ADA Lever Hot Water Dispenser

- Gooseneck spout
- F-201 Filtration System included
- Hot Only - dispenses 60 cups of water filtered near-boiling water per hour
- Adjustable thermostat control
- Durable all brass faucet construction
- 1/2 Gallon tank capacity
- 5-Year We Come To You™ warranty



Part #	Mfg #	Model	Faucet Finish/Color	Price
092146	F-GN1100C	GN-1100C Less Tank	Chrome	

#### Hot100 Instant Hot Water Dispenser

- 2/3 gallon tank delivers 60 cups of near boiling 200°F water per hour
- 1-Year We Come To You™ In-Home Service Warranty
- Tool-free tank connections and dry-start protection to ease installation
- Easy-to-adjust temperature control
- Easy-push button activation
- 115 volts, 750 watts, 6.25 amps



Part #	Mfg #	Model	HP	Grind Stages	Warranty	Price
177386	Hot100-C	Hot100-C	Chrome			

#### H-View -SS Instant Hot Water Dispenser

- Includes 2/3 gallon Stainless Steel tank that delivers 60 cups/hour of near-boiling 200°F water
- Compact all metal dispenser construction
- InSinkErator 3-Year We Come To You® In-Home Full Service Limited Warranty Covers parts and labor
- UL listed
- 115 volts, 750 watts, 6.25 amps



Part #	Mfg #	Model	HP	Grind Stages	Warranty	Price
121727	H-VIEW-SS-C	H-View-SS-C	Chrome			
133548	H-VIEW-SS-SN	H View-SS-SN	Satin Nickel			

## Hot Water Dispensers

### HC-View -SS-C Instant Hot Water Dispenser

- Includes 2/3 gallon Stainless Steel tank that delivers 60 cups/hour of near-boiling 200°F water and cool drinking water
- Compact all metal dispenser construction
- InSinkErator 3-Year We Come To You® In-Home Full Service Limited Warranty Covers parts and labor
- UL listed
- 115 volts, 750 watts, 6.25 amps
- Available in two finishes: Chrome and Satin Nickel



Part #	Mfg #	Model	HP	Grind Stages	Warranty	Price
157394	HC-VIEW-SS-C	HC-View-SS-C	Chrome			

## Body Sprays

### Body Sprays

#### MasterShower® Round Body Spray

- Spray settings:  
-Full spray  
-Massaging pulse spray  
-Pause option
- Flow rate: 1.5 gpm
- 1/2" NPT Connection



Part #	Mfg #	Finish	Price
063508	K-8510-BN	*Brushed Nickel	
059581	K-8510-CP	Polished Chrome	

#### MasterShower® Invigorating Body Spray

- Spray settings:  
-Wide strong spray  
-Concentrated pulse  
-Wide pulse
- Flow rate: 2.5 gpm
- 1/2" NPT Connection



Part #	Mfg #	Finish	Price
053754	K-8509-BN	*Brushed Nickel	
053753	K-8509-CP	Polished Chrome	

#### WaterTile® Round Single-Function Body Spray

- Fully adjustable sprayface pivots for targeted hydromassage spray
- Low-profile design
- MasterClean™ sprayface
- Flow rate: 2.0 gpm
- 1/2" NPT Connection



#### Stimulating Spray 27-Nozzle

Part #	Mfg #	Finish	Price
226673	K-8013-AK-AF	*French Gold	
111830	K-8013-AK-BN	*Brushed Nickel	
111832	K-8013-AK-BV	*Brushed Bronze	
111829	K-8013-AK-CP	Polished Chrome	
172080	K-8013-AK-SN	Polished Nickel	
147040	K-8013-AK-2BZ	Oil Rubbed Bronze	

#### Soothing Spray 54-Nozzle

Part #	Mfg #	Finish	Price
111826	K-8014-BN	Brushed Nickel	
111828	K-8014-BV	*Brushed Bronze	

### Body Sprays (Continued)

#### WaterTile® Round Single-Function Body Spray

#### Soothing Spray 54-Nozzle

Part #	Mfg #	Finish	Price
111825	K-8014-CP	Polished Chrome	
117069	K-8014-G	Brushed Chrome	
148317	K-8014-SN	*Polished Nickel	
250811	K-8014-TT	*Titanium	
234057	K-8014-VNT	Vintage Nickel	
147041	K-8014-2BZ	Oil Rubbed Bronze	

#### WaterTile™ Square Relaxing Body Spray

- Soothing spray
- Low-profile design
- MasterClean™ sprayface is full adjustable and pivots to target
- Flow rate: 2.5 gpm
- 1/2" NPT Connection



#### Soothing Spray 54-Nozzle

Part #	Mfg #	Finish	Price
094758	K-8002-AF	*French Gold	
090050	K-8002-BN	*Brushed Nickel	
095056	K-8002-BV	*Brushed Bronze	
086261	K-8002-CP	Polished Chrome	
093812	K-8002-G	Brushed Chrome	
149149	K-8002-SN	*Polished Nickel	
147035	K-8002-2BZ	Oil Rubbed Bronze	

#### Stimulating Spray 22-Nozzle

Part #	Mfg #	Finish	Price
134325	K-8003-AF	*French Gold	
090237	K-8003-BN	*Brushed Nickel	
116359	K-8003-BV	*Brushed Bronze	
086262	K-8003-CP	Polished Chrome	
089031	K-8003-G	Brushed Chrome	
149150	K-8003-SN	Polished Nickel	
246216	K-8003-TT	Titanium*	
147037	K-8003-2BZ	Oil Rubbed Bronze	

\* Vibrant Limited Lifetime Warranty

[www.waterconcepts.net](http://www.waterconcepts.net) • Serving our Customers Since 1946 • [www.plumbsupply.com](http://www.plumbsupply.com)

## Body Sprays

### Body Sprays

#### Square Body Spray

- 30° Up and down adjustment
- 2.5 gpm @ 80 psi
- 1/2" Rough-in
- Solid brass construction
- Touch-Clean® soft, rubber nubbins
- Matching finish spray face



Part #	Mfg #	Finish	Price
144689	50150	Chrome	
252835	50150-BL	Matte Black	
160833	50150-CZ	Champagne Bronze™	
175031	50150-PN	Polished Nickel*	
144643	50150-RB	Venetian Bronze®	
143549	50150-SS	Stainless*	

#### Surface Mount Body Spray

- 2.5 gpm @ 80 psi
- 1/2" Rough-in
- Solid brass construction
- Touch-Clean® soft, rubber nubbins
- Matching finish spray face
- Full body spray setting



Part #	Mfg #	Finish	Price
128477	50102	Chrome	
254598	50102-BL	Matte Black	
145828	50102-CZ	Champagne Bronze™	
176411	50102-PN	Polished Nickel*	
125763	50102-RB	Venetian Bronze®	
126248	50102-SS	Stainless*	

#### Baliza® Round Body Spray Trim

- 1.5 GPM @ 80 PSI
- Flush mount installation
- 1/2" Rough-in
- 3-1/2" Height and width
- Requires (R84100) rough-in
- Requires one of these sprayheads; (SH8411, SH84101, SH84102, or SH84103)



Showerhead Not Included

Part #	Mfg #	Description	Price
189225	T84613-PC	Chrome	
233021	T84613-PN	Polished Nickel*	

#### Baliza® Square Body Spray Trim

- 1.5 gpm @ 80 psi
- Flush mount installation
- 1/2" Rough-in
- 3-1/2" Height and width
- Requires (R84100) rough-in
- Requires one of these sprayheads; (SH8411, SH84101, SH84102, or SH84103)



Showerhead Not Included

Part #	Mfg #	Description	Price
189408	T84913-PC	Polished Chrome	
215452	T84913-BN	Brushed Nickel	
251057	T84913-NK	Luxe Nickel	
247918	T84913-RB	Venetian Bronze	

#### H2Okinetic Technology™ Round Body Spray Trim

- Requires 1/2" R50001 body spray rough-in
- Adjusts both vertically and horizontally
- Features patented H2Okinetic Technology™



Part #	Mfg #	Finish	Price
138259	T50001	Chrome	
161956	T50001-PN	Polished Nickel*	
136044	T50001-RB	Venetian Bronze®	
136378	T50001-SS	Stainless*	

#### H2Okinetic Technology™ Square Body Spray Trim

- Requires 1/2" R50001 body spray rough-in
- Adjusts both vertically and horizontally
- Features H2Okinetic Technology™



Part #	Mfg #	Description	Price
154287	T50050	Chrome	
161487	T50050-RB	Venetian Bronze®	
159201	T50050-SS	Stainless*	



## Body Sprays

### HydraChoice™ Body Spray Round Trim

- 1.0 gpm @ 80 psi
- Flush mount installation
- 3-1/2" height and width
- 1/2" rough-in
- Rough, trim and spray head require for complete unit
- Rough and spray head sold separately



Part #	Mfg #	Description	Price
170572	T50010	Chrome	
258458	T50010-BL	Matte Black	
217420	T50010-CZ	Champagne Bronze™	
190342	T50010-PN	Polished Nickel*	
171108	T50010-RB	Venetian Bronze®	
170079	T50010-SS	Stainless*	

### HydraChoice™ Max Body Spray Round Trim

- 1/2" Rough-in
- 3-1/2" height and width
- Optional RP82501 reduces flow rate to 1.0 gpm
- Flush mount installation



Part #	Mfg #	Description	Price
243454	T84613-GL	Luxe Gold	
227115	T84613-NK	Luxe Nickel*	

### HydraChoice™ Body Spray Square Trim

- 1.0 gpm @ 80 psi
- Flush mount installation
- 3-1/2" height and width
- 1/2" rough-in
- Rough, trim and spray head required for complete unit
- Rough and spray head sold separately



Part #	Mfg #	Description	Price
179827	T50210	Chrome	
246492	T50210-BL	Matte Black	
251641	T50210-PN	Polished Nickel*	
178601	T50210-RB	Venetian Bronze®	
171797	T50210-SS	Stainless*	

### Square Body Jet with H2Okinetic Technology™

- Jet rotates 360°, adjustable in all directions
- H2Okinetic® technology
- Includes standard 1/2" rough-in



Part #	Mfg #	Finish	Price
145888	50101	Chrome	
149237	50101-RB	Venetian Bronze®	
168934	50101-SS	Stainless*	

### Round Body Jet H2Okinetic Technology™

- Jet rotates 360°, adjustable in all directions
- H2Okinetic® technology
- Includes standard 1/2" rough-in



Part #	Mfg #	Description	Price
153743	50100	Chrome	
158575	50100-RB	Venetian Bronze®	
151426	50100-SS	Stainless*	

### HydraChoice™ MAX Spray Heads

- Spray heads adjust up to 50° in any direction once extended
- H2Okinetic® Technology
- Spray head automatically extends 1-11/32" out of the wall when water is turned on
- Spray heads are interchangeable

#### Soothing Spray



Part #	Mfg #	Description	Price
251058	SH84100-NK	Luxe Nickel	
189409	SH84100-PC	Polished Chrome	



## Body Sprays

### Massaging Spray



Part #	Mfg #	Description	Price
227073	SH84101-NK	Luxe Nickel*	
189226	SH84101-PC	Polished Chrome	
238518	SH84101-RB	Venetian Bronze	

### Invigorating Spray



Part #	Mfg #	Description	Price
243455	SH84102-GL	Luxe Gold	
250849	SH84102-PC	Chrome	

### HydraChoice™ Spray Heads

- Must order rough (R50200) and trim (T50010 or T50210) separately
- Spray head automatically extends 1-11/32" out of the wall when water is turned on
- Spray heads are interchangeable
- Spray heads adjust up to 50° in any direction once extended
- H2Okinetic® Technology and Touch-Clean® spray holes

### Max Spray



Part #	Mfg #	Description	Price
247350	SH84103-BL	Matte Black	
228225	SH84103-BN	Brushed Nickel*	
251059	SH84103-NK	Luxe Nickel	
245900	SH84103-PN	Polished Nickel*	

### Full Spray



Part #	Mfg #	Description	Price
170573	SH5000	Chrome	
229411	SH5000-CZ	Champagne Bronze™	
171110	SH5000-RB	Venetian Bronze®	
170647	SH5000-SS	Stainless*	

### Invigorating Spray



Part #	Mfg #	Description	Price
179828	SH5002	Chrome	
246493	SH5002-BL	Matte Black	
171111	SH5002-RB	Venetian Bronze®	
170648	SH5002-SS	Stainless*	

### Soothing Spray



Part #	Mfg #	Description	Price
245677	SH5003	Chrome	
258466	SH5003-BL	Matte Black	
171112	SH5003-RB	Venetian Bronze®	
170649	SH5003-SS	Stainless*	

### Massaging Spray



Part #	Mfg #	Description	Price
179680	SH5005	Chrome	
258467	SH5005-BL	Matte Black	
190343	SH5005-PN	Polished Nickel*	
171113	SH5005-RB	Venetian Bronze®	

## Body Sprays

### Body Sprays (Continued)

#### HydraChoice™ Spray Heads Massaging Spray

Part #	Mfg #	Description	Price
170080	SH5005-S S	Stainless*	

#### Loki™ Body Spray Trim and Rough

- Maximum flow rate: 2.0 gpm @ 80 psi



Part #	Mfg #	Description	Price
162481	84121-BL	Matte Black	
158119	84121-BN	Brushed Nickel*	
253058	84121-BZ	Brushed Bronze*	
157191	84121-PC	Chrome	
169999	84121-PN	Polished Nickel*	
164988	84121-RB	Venetian Bronze®	

#### Vesi Body Spray Trim and Rough

- Surface mount
- Touch-Clean® technology
- 1/2" rough-in flows 2.0 gpm



Part #	Mfg #	Description	Price
138230	84110-BB	Brass*	
177375	84110-BL	Matte Black	
126053	84110-BN	Brushed Nickel*	
130687	84110-BZ	Brushed Bronze*	
129973	84110-PC	Chrome	
148742	84110-PN	Polished Nickel*	
254652	84110-NK	Luxe Nickel	
125996	84110-RB	Venetian Bronze®	

### Body Spray Rough-Ins

#### HydraChoice™ Body Spray Rough



Part #	Mfg #	Description	Price
170078	R50200	1/2" Rough-In	

#### Custom Shower System Body Spray Rough-In

- H2Okinetic® spray
- 3-3/4" diameter spray face
- Adjust spray horizontally and vertically
- 1.6 gpm @ 80 psi
- Order rough separately (R50001)



Part #	Mfg #	Description	Price
135507	R50001	1.6 gpm H2O Body Spray Rough-In, Brass*	

#### Baliza® Body Spray Rough



Part #	Mfg #	Description	Price
189227	R84100	1/2" Rough-In	

## Body Sprays

### Body Sprays

#### Round Mosaic Body Spray

- 3-1/4" Spray head
- Single spray
- Flush mounting
- 1/2" IPS; CC



Part #	Mfg #	Finish	Price
155174	TS1322	Chrome	
166317	TS1322BN	Brushed Nickel	
217378	TS1322NL	Polished Nickel	
161558	TS1322ORB	Oil Rubbed Bronze	

#### Square Mosaic Body Spray

- 3-1/4" Diameter sprayhead
- Single spray
- Flush mounting
- 1/2" IPS; CC



Part #	Mfg #	Finish	Price
170114	TS1320	Chrome	
141011	TS1320BN	Brushed Nickel	
152812	TS1320ORB	Oil Rubbed Bronze	

#### Round Mosaic 2-Function Body Spray

- 3-1/4" Spray head, 5-3/8" overall
- 1/2" CC;IPS connections
- Spray face tilts 20° in any direction
- 2-Function
  - Full spray
  - Targeted massage



**Requires Rough-In: S1300**

**1" Extension available: 155656**

Part #	Mfg #	Finish	Price
186315	TS1422	Chrome	
221185	TS1422BN	Brushed Nickel	
239855	TS1422ORB	Oil Rubbed Bronze	

#### Square Mosaic 2-Function Body Spray

- 3-1/4" Spray head, 5-3/8" overall
- 1/2" CC;IPS connections
- Spray face tilts 20° in any direction
- 2-Function
  - Full spray
  - Targeted massage



**Requires Rough-In: S1300**

**1" Extension available: 155656**

Part #	Mfg #	Finish	Price
221010	TS1420BN	Brushed Nickel	
186119	TS1420ORB	Oil Rubbed Bronze	

#### Single Function Body Spray

- Metallic spray face and shell
- Brass swivel ball assembly
- 1/2" IPS connection
- Flow rate: 1.75 gpm



Part #	Mfg #	Finish	Price
097432	A501	Chrome	
095829	A501BN	Brushed Nickel	
108133	A501ORB	Oil Rubbed Bronze	
109620	A501WR	Wrought Iron	

### Body Spray Rough-Ins

#### Body Spray Rough-In Box

- 1/2"CC/IPS connections



Part#	Mfg#	Description	Price
141009	S1300	Fits 2x4 wall	

## Commercial - Institutional Faucets

### Commercial Single-Handle Kitchen Faucets

#### Commercial 1-Hdl Kitchen Faucet

- 8-11/16" Reach, 6-3/4" high spout
- 4-3/4" From deck to aerator
- Vandal-resistant handles
- Adjustable handle limit stop
- 3/8" Compression fittings
- Water-efficient product: 1.5 gpm @ 60 psi



Part #	Mfg #	Description	Handle(s)	Finish	Price
060979	100LF-HDF	3-Hole 8"cc, Lead-Free	ADA Lever	Chrome	
143877	101LF-HDF	1-Hole, Lead-Free	ADA Lever	Chrome	
141017	400LF-HDF	4-Hole 8"cc, Side Spray, Lead-Free	ADA Lever	Chrome	

### Commercial Two-Handle Service Sink Faucets

#### Teck™ Commercial Service 2-Hdl Sink & Bar Faucet

- Heavy-duty cartridges
- Tuf-Teck™ compression structures
- 8" Long, rigid vacuum breaker spout
- Integral stops
- Top brace
- Cross handles with hot/cold indicators
- Flow rate: 4.0 gpm @ 60 psi



Part #	Mfg #	Description	Handle(s)	Finish	Price
023647	28T9	2-Hole 8"cc Wall-Mount	Cross	Rough Chrome	
237100	28C9LH	8"cc Wall-Mount, 1/4 Turn	Lever	Rough Chrome	

#### HDF® Commercial Wall-Mount Service Sink Faucet

- CAST BRASS two handle wallmount sink faucet
- Polished chrome-plated finish
- BRASS swing spout
- Supplied with adjustable centers – 175 mm to 235 mm (6.87" to 9.25")
- ADA compliant color indexed 102 mm (4") metal hooded blade handles with vandal resistant screws
- Control mechanism is a 1/4 turn cylinder type with brass stem, stainless steel plate and replaceable non-metallic seats



Part #	Mfg #	Description	Handle(s)	Finish	Price
178321	28P4402LF	2-Hole 8"cc Wall-Mount, 8.06" Swing Spout, 1.5 GPM	ADA Hooded Blade	Chrome	
159166	28P4902LF	2-Hole 8"cc Wall-Mount, 8.06" GN Swing Spout, 1.5 GPM	ADA Hooded Blade	Chrome	

\* Brilliance® Anti-Tarnish Lifetime Finishes

www.waterconcepts.net • Serving our Customers Since 1946 • www.plumbsupply.com

## Commercial - Institutional Faucets

### Commercial Kitchen Accessories

#### Basin Mounted Liquid Soap Dispenser

- 4" Nozzle reach
- 2-11/16"
- 3" Maximum deck thickness



Part #	Mfg #	Description	Handle(s)	Finish	Price
185576	44000	32oz White Translucent Bottle	-	Chrome	

#### Electronic Soap Dispenser

- 5-1/2" Long, 4" high
- Non-metal spout
- 2" Maximum deck thickness
- Battery operated, batteries included



Part #	Mfg #	Description	Handle(s)	Finish	Price
238798	DESD-250	1-Hole Deck Mount	-	Chrome	

\* Brilliance® Anti-Tarnish Lifetime Finishes

[www.plumbsupply.com](http://www.plumbsupply.com) • Serving our Customers Since 1946 • [www.waterconcepts.net](http://www.waterconcepts.net)

## Commercial - Institutional Faucets

### Commercial Electronic Metering Lavatory Faucets

#### Proximity® HDF® Sensing Electronic Lavatory Faucet

- Hands-free activation
- 5-3/10" Reach, 4-1/5" high metal spout
- 2-1/2" Maximum deck thickness
- 4" Escutcheon plate included
- Surface mounted control box
- Battery powered uses four "AA" cells (Included with 590-PLGHDF)
- Hardwired model is 24VAC to 6VDC (590-PLGHDFHW)
- Vandal resistant laminar outlet
- Mixing valve required
- Flow rate: 0.50 gpm @ 60 psi



Part #	Mfg #	Description	Handle(s)	Finish	Price
159951	591-PLGHDF	1-Hole, Battery Operated, 0.5 gpm	ADA Electronic	Chrome	

#### Proximity® Sensing Electronic Lavatory Faucet

- Hands-free activation
- 5-1/3" Reach, 5-1/2" high cast brass spout
- 2-1/2" Maximum deck thicknesses
- Hardwired or battery operated
- Surface mounted control box
- Entire chrome-plated Ara® spout is sensed
- Adjustable sensing range, auto shut-off, metering mode, and periodic rinse feature
- Anti-rotation pin
- Vandal resistant outlet
- Mixing valve required
- WaterSense® certified product: 1.5 gpm @ 60 psi (630TP320)
- Flow rate: 0.35 gpm @ 60 psi (631TP390)



Part #	Mfg #	Description	Handle(s)	Finish	Price
237881	630TP320	1-Hole, Hardwired, Laminar Outlet	ADA Electronic	Chrome	
256331	630TP350	1-Hole, Hardwired, Laminar Outlet	ADA Electronic	Chrome	
251459	631TP320	1-Hole, Battery Operated, Laminar Outlet	ADA Electronic	Chrome	
245309	631TP390	1-Hole, Battery Operated, Spray Outlet	ADA Electronic	Chrome	

\* Brilliance® Anti-Tarnish Lifetime Finishes

[www.waterconcepts.net](http://www.waterconcepts.net) • Serving our Customers Since 1946 • [www.plumbsupply.com](http://www.plumbsupply.com)



## Commercial - Institutional Faucets

### Proximity® Teck® Sensing Electronic Lavatory Faucet

- Hands-free activation
- 4-4/5" Reach, 9-5/8" high spout
- 2-1/2" Maximum deck thicknesses
- Surface mounted control box
- Single inlet supply
- Entire spout is sensed
- Adjustable sensing range, auto shut-off, metering mode, and periodic rinse feature
- Forged brass solenoid valve
- Vandal resistant outlet
- Mixing valve required
- Transformer required for hardwire operation
- Serviceable filter screen upstream of the valve
- WaterSense® certified product: 1.5 gpm @ 60 psi



Part #	Mfg #	Description	Handle(s)	Finish	Price
248695	620TP3320	1-Hole, Hardwired	ADA Electronic	Chrome	
249230	621TP3320	1-Hole, Battery Operated	ADA Electronic	Chrome	
249773	621TP3320-SS	1-Hole, Battery Operated	ADA Electronic	Stainless*	

### DEMD Electronic Lavatory Faucet—Single Supply

- Sensor detects user's hand to activate water flow
- 6-3/10" Reach, 11-2/5" high spout
- (6) 1.5V batteries
- Adjustable maximum run time and optional remote control below
- 1-1/4" Maximum deck thicknesses
- Above deck electronics
- Red light indicator blinks when battery is low
- Cold water or pre-mixed only
- Vandal resistant wrench flat spray outlet
- WaterSense Certified: 0.5 gpm @ 60 psi



Part #	Mfg #	Description	Handle(s)	Finish	Price
159957	DEMD-201LF	1-Hole, Battery Operated, Gooseneck Spout	ADA Electronic	Chrome	

\* Brilliance® Anti-Tarnish Lifetime Finishes

## Commercial - Institutional Faucets

### DEMD Electronic Lavatory Faucet with Side Mixer

- Sensor detects user's hand to activate water flow
- 6-3/10" Reach, 11-2/5" high spout
- (6) 1.5V batteries included
- Adjustable maximum run time and optional remote control below
- 1-1/4" Maximum deck thicknesses
- Above deck electronics
- Red/blue indicator
- Red light indicator blinks when battery is low
- Vandal resistant wrench flat spray outlet
- WaterSense Certified: 0.5 gpm @ 60 psi



Part #	Mfg #	Description	Handle(s)	Finish	Price
248847	DEMD-211LF	1-Hole, Battery Operated, Gooseneck Spout	ADA Electronic	Chrome	

### DEMD Electronic Faucet for Cold or Pre-Mixed Water

- Vandal resistant wrench flat spray outlet
- 2" maximum deck thicknesses
- Adjustable sensor range
- Optional 4" cover plate available
- Battery operated, batteries included
- WaterSense Certified: 0.5gpm @ 60 psi



Part #	Mfg #	Description	Handle(s)	Finish	Price
158275	DEMD-301LF	1-Hole, Battery Operated, Rigid Spout	ADA Electronic	Chrome	

### DEMD Electronic Lavatory Faucet

- Battery operation
- For cold or pre-mixed water
- Standard infrared sensing
- Above-deck solenoid and battery
- Vandal resistant wrench flat spray outlet
- Maximum flow rate: 0.5 gpm



Part #	Mfg #	Description	Handle(s)	Finish	Price
161899	DEMD-101LF-NS	1-Hole, Battery Operated	ADA Electronic	Nickel Stainless	

\* Brilliance® Anti-Tarnish Lifetime Finishes

[www.waterconcepts.net](http://www.waterconcepts.net) • Serving our Customers Since 1946 • [www.plumbsupply.com](http://www.plumbsupply.com)

## Commercial - Institutional Faucets

### DEMD Dual-Inlet Electronic Lavatory Faucet with Side Mixer

- Battery operated
- Standard infrared sensing
- Above deck mixer to adjust water temperature
- Vandal-resistant wrench flat spray outlet
- WaterSense certified product: 0.5 gpm



For Hardwire -Order 060704A and 060974A

For Plug-in- Order 060958A

For optional remote control sensor adjustment, see 060967A

Part #	Mfg #	Description	Handle(s)	Finish	Price
227361	DEMD-111LF	1-Hole, Battery Operated, Rigid Spout	ADA Electronic	Chrome	
238136	DEMD-111LF-NS	1-Hole, Battery Operated, Rigid Spout	ADA Electronic	Nickel Stainless	

### Electronic Lavatory Faucet with Side Mixer

- Battery operated
- 4-2/5" Reach, 5-3/5" high
- 2" Maximum deck thickness
- Vandal resistant wrench flat spray outlet
- WaterSense certified product: 0.50 gpm @ 60 psi



Part #	Mfg #	Description	Handle(s)	Finish	Price
239580	DEMD-311LF	1-Hole, Battery Operated	ADA Electronic	Chrome	

### Touchless Commercial Electronic Faucet with Proximity™ Sensing Technology

- Battery operated (591TP1 model)
- Hardwire operated (591TP0 model)
- 2-1/2" Maximum deck thickness
- 4-8/25" Deck to aerator height
- Includes solenoid valve
- Flow rate: 0.5 gpm



Part #	Mfg #	Description	Handle(s)	Finish	Price
239375	591TP1250	3-Hole 4"cc, 0.5 gpm, Battery Operated	ADA Electronic	Chrome	
181104	591TP0250	3-Hole 4"cc, 0.5 gpm, Hardwire Operated	ADA Electronic	Chrome	

\* Brilliance® Anti-Tarnish Lifetime Finishes

[www.plumbsupply.com](http://www.plumbsupply.com) • Serving our Customers Since 1946 • [www.waterconcepts.net](http://www.waterconcepts.net)

## Commercial - Institutional Faucets

### Innovations® Commercial Electronic Lavatory Faucet

- 5-1/4" Reach, 3-7/8" high rigid spout
- 2-3/8" From deck to aerator
- Hand-free operation
- H2Optics® technology, no external adjustments required
- Self-adaptive technology
- Mixing valve required
- 1-1/2" Maximum deck thicknesses
- No lift rod hole or grid strainer
- 4" Anti-rotation cover plate
- Powered by (4) C batteries
- Operates with a 45 second max run time
- WaterSense Certified: 0.5 gpm @ 60 psi



590



591



Part #	Mfg #	Description	Handle(s)	Finish	Price
070221	590LF-LGHGMHDF	1-Hole 4"cc, 0.5gpm	ADA Electronic	Chrome	
156000	591LF-LGHGMHDF	3-Hole 4"cc, 0.5 gpm	ADA Electronic	Chrome	

### Teck® Commercial Electronic Lavatory Faucet

- Hands-free operation, integral waterproof sensor and connector
- Cast 1-piece body
- No mixing valve included
- WaterSense Certified



591T1250



590T1150



Part #	Mfg #	Description	Handle(s)	Finish	Price
133882	590T1120	1-Hole, Hi-Rise Spout, 1.5 gpm VR Antimicrobial	ADA Electronic	Chrome	
136718	590T1150	1-Hole, Hi-Rise Spout, 0.5 gpm VR Non-Aerating	ADA Electronic	Chrome	
232466	590T0150	1-Hole, Hi-Rise Spout, 0.5 gpm VR Laminar	ADA Electronic	Chrome	
157518	591T0220	3-Hole 4"cc, Cast Spout, 1.5 gpm VR Laminar	ADA Electronic	Chrome	
250990	591T0290	3-Hole 4"cc, Hardwire, 0.35 gpm VR Spray Outlet	ADA Electronic	Chrome	
093591	591T1250	3-Hole 4"cc, No Lift-Rod Hole, 0.5 gpm VR Outlet	ADA Electronic	Chrome	
135638	591T1268	3-Hole 4"cc, No Lift Rod Hole, 1.0 gpm VR Non-Aerating	ADA Electronic	Chrome	
158277	591T0268TR	3-Hole 4"cc Hardwire Operated, 1.0 gpm	ADA Electronic	Chrome	
228266	591-PLGHDFHW	3-Hole 4"cc, 7.5" Forged Cover Plate	ADA Electronic	Chrome	

\* Brilliance® Anti-Tarnish Lifetime Finishes

## Commercial - Institutional Faucets

### Teck® Proximity® Sensing Commercial Electronic Faucet

- Proximity® Sensing Technology
- (4) C Batteries or Hardwired
- Adjustable sensing range and timeout
- Forged brass solenoid valve
- Surface mount housing
- Mixing valve required
- WaterSense Certified



Part #	Mfg #	Description	Handle(s)	Finish	Price
212094	590TP1120	1-Hole, Battery Operated, Hi-Rise Spout, 1.5 gpm	ADA Electronic	Chrome	
258765	590TP1150	1-Hole, Battery Operated, Hi-Rise Spout, 1.0 gpm	ADA Electronic	Chrome	
170501	590TP1160	1-Hole, Battery Operated, Hi-Rise Spout, 1.0 gpm	ADA Electronic	Chrome	
258144	590TP0220	1-Hole, Hardwire Operated, Hi-Rise Spout, 1.0 gpm	ADA Electronic	Chrome	
174957	590T0158TR	1-Hole, Hardwire Operated, Hi-Rise Spout 0.5 gpm	ADA Electronic	Chrome	
178568	590-PLGHDF	1-Hole, Battery Operated, Low Spout, 0.5 gpm	ADA Electronic	Chrome	
204949	590-PLGHDFHW	1-Hole, Hardwire Operated, 0.5 gpm	ADA Electric	Chrome	

### Commercial Electronic Lavatory Faucet

- Battery operated
- H2Optics® technology - no external adjustments required
- 1-Piece cast main body with integral sensor and rigid spout
- Adjustable sensing range and timeout
- Audible low battery indicator
- WaterSense Certified



1501T4630



Part #	Mfg #	Description	Handle(s)	Finish	Price
117300	1501T3320	Deck-Mount, 1.5 gpm VR Aerator	ADA Electronic	Chrome	

### Single-Handle Commercial Lavatory Faucets

#### Delta® HDF® DIAMOND™ Seal 1-Hdl Lavatory Faucet

- Heavy-duty commercial product
- Hot/cold indicators
- 3/8" OD Straight, staggered supply tubes
- DIAMOND™ Valve with Innoflex™ PEX waterways
- WaterSense Certified



511-HGM-HDF-DS



523-HDF-DST



Part #	Mfg #	Description	Handle(s)	Finish	Price
139551	511LF-HDF	4"cc, less Pop-Up and Lift-Rod Hole, 1.5 or 0.5gpm, Lead-Free	ADA Lever	Chrome	
004046	515LF-HDF	2- or 3-Hole, Metal Pop-Up, 1.5 gpm VR, Lead-Free	ADA Lever	Chrome	
132280	523-HDF-DST	4"cc, 4-1/2" Spout, Grid Strainer, No Lift-Rod Hole, Lead-Free	ADA Lever	Chrome	

\* Brilliance® Anti-Tarnish Lifetime Finishes

[www.plumbsupply.com](http://www.plumbsupply.com) • Serving our Customers Since 1946 • [www.waterconcepts.net](http://www.waterconcepts.net)

## Commercial - Institutional Faucets

### Delta® HDF® 1-Hdl Centerset Lead-Free Lavatory Faucet

- Single handle lavatory deck faucets for exposed mounting on 3-hole sinks
- All metal fabricated body
- 5" Spout
- Vandal-resistant aerator or spray outlet
- Heavy-duty commercial product
- 3/8" OD Straight, staggered copper supply tubes with 3/8" fittings
- Low flow rate: 1.5 gpm @ 60 psi
- HGM Suffix: flow rate: 0.5 gpm @ 60 psi



Part #	Mfg #	Description	Handle(s)	Finish	Price
139369	501LF-HDF	3-Hole 4"cc, 4-1/2" Spout, Less Pop-Up Drain, Lead-Free	ADA Lever	Chrome	
139181	501LF-HGMHDF	3-Hole 4"cc, 4-1/2" Spout, Less Pop-Up Drain, Lead-Free	ADA Lever	Chrome	
146181	520LF-HGMHDF	3-Hole 4"cc, 4-1/2" Spout, Metal Pop-Up Drain, Lead-Free	ADA Lever	Chrome	
004049	520LF-HDF	4"cc, 5" Spout, Metal Pop-Up Drain, Lead-Free	ADA Lever	Chrome	
139371	511LF-HGMHDF	4"cc, 5" Spout, No Lift-Rod Hole, Lead-Free	VR ADA Elbow	Chrome	
132282	523LF-HGMHDF	4"cc, 4-1/2" Spout, Grid Strainer, Lead-Free	VR ADA Lever	Chrome	

### Teck® 22C Commercial 1-Hdl Centerset Lavatory Faucet

- Rigid spout
- Cast brass
- Ceramic cartridge with rotational limit stop
- Vandal-resistant 3-1/2" ADA lever handle with color index
- 3/8" Compression fittings
- WaterSense Certified



Part #	Mfg #	Description	Handle(s)	Finish	Price
086626	22C101	4"cc less Pop-Up, 1.5 gpm VR Aerator, 5.32" Reach	ADA Lever	Chrome	
103994	22C121	4"cc less Pop-Up, 1.5gpm VR Aerator w/Antimicrobial, 5.75" Reach	ADA Lever	Chrome	
099974	22C131	4"cc less Pop-Up, 1.5 gpm VR Aerator	ADA Lever	Chrome	
093894	22C151	4"cc less Pop-Up, 0.5 gpm VR Aerator	ADA Lever	Chrome	
186094	22C191	4"cc less Pop-Up, 0.35gpm VR Aerator	ADA Lever	Chrome	
114941	22C301	4"cc with Pop-Up, 1.5 gpm VR Aerator, 5.75" Reach	ADA Lever	Chrome	
089047	22C601	1-Hole less Pop-Up, 1.5 gpm VR Aerator, 5.32" Reach	ADA Lever	Chrome	
145920	22C631	1-Hole less Pop-Up, 1.5 gpm VR, 5.75" Reach	ADA Lever	Chrome	
082015	22C651	1-Hole less Pop-Up, 1.5 gpm VR Non-Aerating, 5.75" Reach	ADA Lever	Chrome	
185789	22C851	1-Hole w/ Metal Pop-Up, 0.5gpm VR Aerator	ADA Lever	Chrome	

\* Brilliance® Anti-Tarnish Lifetime Finishes



## Commercial - Institutional Faucets

### Delta® Commercial 1-Hdl Mixing Faucet

- Gooseneck spout
- Washerless
- Vandal-resistant 6" elbow lever handle
- High temperature limit stop
- Vandal-resistant set screws
- WaterSense Certified



Part #	Mfg #	Description	Handle(s)	Finish	Price
253752	24T2623-R4	2-Hole 6"Reach 12"High Gooseneck, 1.5gpm VR Laminar	ADA Lever Blade	Chrome	
142333	24T2643-R7	2-Hole less Pop-Up, 12.7" Gooseneck, 1.5 gpm Aerator	ADA Lever Blade	Chrome	
025157	24T2643	2-Hole Heavy Duty Gooseneck, 1.5 gpm Laminar	ADA Lever Blade	Chrome	
084527	24T2643-R4	2-Hole Heavy Duty Gooseneck 6" Reach, 1.5 gpm Laminar	ADA Lever Blade	Chrome	
114177	24T2673-R4	2-Hole Heavy Duty Gooseneck, 1.0 gpm Laminar	ADA Lever Blade	Chrome	

### Teck® Commercial Bedpan Cleanser - Foot Pedal Mixing

- Double pedal self-close WM valve with inlet stops and outlet volume control stop



Part #	Mfg #	Description	Handle(s)	Finish	Price
137794	54T1454A	Double Pedal Self-Close WM Valve, Rigid Spout	Foot pedal	Chrome	

### Teck® 86T Commercial 1-Hdl Washdown Urinal Valve

- Supply metering urinal valve



86T503

Part #	Mfg #	Description	Handle(s)	Finish	Price
023639	86T502	Back Inlet Supply, Inlet Cover Tube, Wall Flange	ADA Brass Oscillating Lever	Chrome	
023642	86T503	Top Inlet Supply	ADA Brass Oscillating Lever	Chrome	

\* Brilliance® Anti-Tarnish Lifetime Finishes

[www.plumbsupply.com](http://www.plumbsupply.com) • Serving our Customers Since 1946 • [www.waterconcepts.net](http://www.waterconcepts.net)

## Commercial - Institutional Faucets

### E-Lav Faucet Accessories

#### Teck® Commercial Rough-In Box for E-Lav Faucets

- Control box rough-in
- For recessed wall mounting
- 10" square metal box with cover
- Hot and cold inlet supplies
- Point of use thermostatic mixing valve
- Integral check valves
- Max flow: 11 gpm @ 45 psi
- Factory assembled waterway components with stops

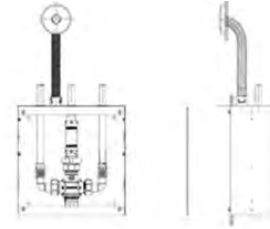

Part #	Mfg #	Description	Handle(s)	Finish	Price
158278	ELAVT0008ARI	Electronic control box, ONLY with Thermostatic Mixing Valve			

### Two-Handle Commercial Lavatory Faucets

#### Single Shank 2-Hdl Mixing Faucet

- 4-1/2" Long, 14-1/4" high rigid spout
- Red/blue indicators
- Standard aerator
- 3/8" Compression fittings
- 2" Max deck thickness
- CER-TECK cartridges
- WaterSense® certified product: 1.5 gpm @ 60 psi
- (25C3837) Vandal resistant aerator
- (25C3847) Standard aerator outlet



Part #	Mfg #	Description	Handle(s)	Finish	Price
250316	25C3837	4"cc, 1-Hole, Vandal Resistant Aerator	Balanced Lever	Chrome	
098041	25C3847	4"cc, 1-Hole, Standard Aerator Outlet	Balanced Lever	Chrome	

#### HDF Commercial 2-Hdl Centerset Lavatory Faucet

- 3-1/4" High, 5-1/4" reach rigid spout
- Red/blue indicators
- 2" From deck to aerator
- 1-3/8" Maximum deck thickness
- Vandal resistant aerator
- 1/2" IPS shanks
- Large wrist blade handles
- WaterSense® certified product: 1.2 gpm at 60 psi
- Lifetime faucet and finish warranty



2529LF-HDF



Part #	Mfg #	Description	Handle(s)	Finish	Price
146470	2529LF-LGHDF	4"cc, 2-Hole, L/Grid Strainer, No Lift Rod Hole, Lead-Free	ADA Wrist Blade	Chrome	
146469	2529LF-HDF	4"cc, 2-Hole, Grid Strainer, No Lift Rod Hole, Lead-Free	ADA Wrist Blade	Chrome	
169851	2529LF-HDM	4"cc, 2-Hole Metal Pop-Up, No Lift Rod Hole, Lead-Free	ADA Wrist Blade	Chrome	
177528	2529LF-LGHGMHDF	4"cc, 2-Hole Less Drain, No Lift Rod Hole, Lead Free	ADA Wrist Blade	Chrome	

\* Brilliance® Anti-Tarnish Lifetime Finishes

[www.waterconcepts.net](http://www.waterconcepts.net) • Serving our Customers Since 1946 • [www.plumbsupply.com](http://www.plumbsupply.com)

## Commercial - Institutional Faucets

### Tract-Pack Commercial 2-Hdl Lavatory Faucet

- 5-1/4" Spout reach, 3-1/4" high
- 4" Centers
- 1/2"-14 NPSM threaded male inlet shanks
- 2" From deck to aerator
- 1/4 Turn handle stops
- WaterSense® certified product: 1.2 gpm @ 60 psi



Part #	Mfg #	Description	Handle(s)	Finish	Price
179444	2500LF-TP	2- or 3-hole 4"cc, Lead Free Less Drain and Lift Rod	ADA Blade	Chrome	

### Teck® 21C/21T Commercial 2-Hdl ADA Lever Faucet

- Cast brass body
- Compression
- Vandal-resistant lever handles with hot/cold handle indicators
- WaterSense Certified



21\_142



21\_143

Part #	Mfg #	Description	Handle(s)	Finish	Price
090422	21C122	4"cc, less Pop-Up, Cer-Teck® 1.5gpm	ADA Hooded Blade	Chrome	
122353	21C124	4"cc, less Pop-Up, Cer-Teck® 1.5 gpm	ADA Blade	Chrome	
120989	21C134	4"cc, less Pop-Up, Cer-Tek®, 1.5gpm	ADA Blade	Chrome	
090395	21C142	4"cc, less Pop-Up, Cer-Teck®, 1.5gpm	ADA Hooded Blade	Chrome	
096543	21C143	4"cc, Less Pop-Up, Cer-Teck®, 1.5gpm	ADA Lever	Chrome	
097794	21C144	4"cc, less Pop-Up, Cer-Teck®, 1.5gpm	ADA Blade	Chrome	
110742	21C153	4"cc, less Pop-Up, Cer-Teck®. 0.5gpm	ADA Hooded Lever	Chrome	
110718	21C154	4"cc, Less Pop-Up, Cer-Teck® 0.5gpm	ADA Blade Handles	Chrome	
023648	21T143	4"cc, less Pop-Up, Tuf-Teck®	ADA Lever	Chrome	

### HDF Commercial 2-Hdl Widespread Lavatory Faucet

- 5-1/4" Spout reach
- 6-16" Centers
- Vandal resistant metal wrist blade handles
- 1/2" IPS connection
- 1/4 Turn handle stop
- WaterSense® Certified: 1.20 gpm @ 60 psi



3549LF-WFHDF



Part #	Mfg #	Description	Handle(s)	Finish	Price
154527	3549LF-WFHDF	6-16" Centers, 3-Hole w/ Grid Strainer, 1.5gpm	ADA Wrist Blade	Chrome	
019941	3549LF-WFLGHDF	6-16" Centers, 3-Hole Less Grid Drain, 1.2gpm	ADA Wrist Blade	Chrome	

\* Brilliance® Anti-Tarnish Lifetime Finishes

[www.plumbsupply.com](http://www.plumbsupply.com) • Serving our Customers Since 1946 • [www.waterconcepts.net](http://www.waterconcepts.net)

## Commercial - Institutional Faucets

### HDF Commercial 2-Hdl Widespread Lavatory Faucet with Gooseneck Spout

- 5-3/4" Reach, 11" high rigid spout
- Vandal resistant metal wrist blade handles
- 3/8" O.D. copper supply tube inlets with 1/2"-14 NPSM adapters
- WaterSense Certified



Part #	Mfg #	Description	Handle(s)	Finish	Price
004014	3579LF-WFLGHDF	6-16" Centers, 3-Hole Less Drain 1.5gpm	ADA Wrist Blade	Chrome	

### Teck® 23C/23T Commercial 2-Hdl Widespread Deck Faucet

- 4-1/2" Cast spout or 12" high rigid/swivel gooseneck spout
- Cast brass body
- Tuf-Teck™ or Cer-Teck® cartridges
- Red/blue indicators
- WaterSense Certified



Part #	Mfg #	Description	Handle(s)	Finish	Price
259533	23C322	6-12"ws, 4-1/2" Spout, 1.5 gpm VR Laminar Aerator	ADA Hooded Blade	Chrome	
252253	23C332	6-12"ws, 4-1/2" Spout, 1.5 gpm VR Aerator	ADA Hooded Blade	Chrome	
144765	23C333	6"-12"ws, 4-1/2" Spout, 1.5 gpm VR Aerator	ADA Lever	Chrome	
122169	23C334	6"-12"ws, 4-1/2" Spout, 1.5 gpm VR Aerator	ADA Blade	Chrome	
128775	23C335	6"-12"ws, 4-1/2" Spout, 1.5 gpm VR Aerator	ADA Blade w/ San Hood	Chrome	
256360	23C354	6"-12"ws, 4-1/2" Spout, 0.5 gpm VR Spray Outlet	ADA Blade w/ San Hood	Chrome	
121785	23C622	6-12"ws, 4-1/2"GN Spout, 1.5 gpm VR Laminar Aerator	ADA Hooded Blade	Chrome	
259540	23C622-R4	6-12"ws, 6"GN Spout, 1.5 gpm VR Laminar Aerator	ADA Hooded Blade	Chrome	
179874	23C624-R4	6"-12"ws, 6"GN Spout, Cer-Teck®, 1.5 gpm	ADA Blade	Chrome	
076341	23C642	6"-12"ws, Rigid/Swivel Inline Spt, Cer-Teck® 1.5 gpm	ADA Hooded Blade	Chrome	
172229	23C644-R7	6"-12"ws, Rigid/Swivel 9" Spout, Cer-Teck® 1.5 gpm	ADA Blade	Chrome	
084625	23C644	6"-12"ws, Rigid/Swivel Inline Spt, Cer-Teck® 1.5 gpm	ADA Blade	Chrome	
125332	23C652	6"-12"ws, GN, Cer-Teck®, 0.5 gpm VR Non-A	ADA Hooded Blade	Chrome	

### Teck® 26C3 Commercial 2-Hdl Mixing Deck Lavatory Faucet

- Swing-spout or rigid/swivel gooseneck spout
- Heavy-duty cast brass deck-mount mixing faucet
- Vandal resistant color indexed metal handles
- Cer-Teck® 1/4" turn ceramic structures
- WaterSense® Certified
- (-TI) Handle temperature indicators



Part #	Mfg #	Description	Handle(s)	Finish	Price
128940	26C3143	8"cc, 8" Wallform Spout, 1.5 gpm Standard Aerator Outlet	ADA Hooded Lever	Chrome	
244575	26C3144	8"cc, 8" Wallform Spout, 1.5 gpm Standard Aerator Outlet	ADA Blade w/ San Hood	Chrome	

\* Brilliance® Anti-Tarnish Lifetime Finishes

www.waterconcepts.net • Serving our Customers Since 1946 • www.plumbsupply.com

## Commercial - Institutional Faucets

### Two-Handle Commercial Lavatory Faucets (Continued)

#### Teck® 26C3 Commercial 2-Hdl Mixing Deck Lavatory Faucet

Part #	Mfg #	Description	Handle(s)	Finish	Price
244178	26C3144-TI	8"cc, 8" Wallform Spout, 1.5 gpm Standard Aerator Outlet	ADA Blade w/ San Hood	Chrome	
138209	26C3232	8"cc, 8" Tubular Spout, 1.5 gpm VR Aerator	ADA Hooded Blade	Chrome	
138208	26C3922-R7	8"cc, 9" GN Spout, 1.5 gpm VP Laminar Outlet	ADA Hooded Blade	Chrome	
134018	26C3924	8"cc, 6" GN Spout, 1.5 gpm VR Laminar Outlet	ADA Blade w/ San Hood	Chrome	
142893	26C3924-R7	8"cc, 9" GN Spout, 1.5 gpm VR Laminar Outlet	ADA Blade w/ San Hood	Chrome	
119648	26C3933	8"cc, 9" GN Spout, 1.5 gpm VR Aerator	ADA Hooded Lever	Chrome	
126759	26C3935	8"cc, 6" GN Spout, 1.5 gpm VR Aerator	ADA Wrist w/ San Hood	Chrome	
132452	26C3943	8"cc, 6" GN Spout, 1.5 gpm Standard Aerator	ADA Hooded Lever	Chrome	
249265	26C3943-R7	8"cc, 6" GN Spout, 1.5 gpm Standard Aerator	ADA Hooded Blade	Chrome	
116979	26C3942-R7	8"cc, 9" GN Spout, 1.5 gpm Standard Aerator	ADA Hooded Blade	Chrome	
106042	26C3944	8"cc, 6" GN Spout, 1.5 gpm Standard Aerator	ADA Blade w/ San Hood	Chrome	
244177	26C3944-TI	8"cc, 6" GN Spout, 1.5 gpm Standard Aerator	ADA Blade w/ San Hood	Chrome	
136107	26C3954	8"cc, 10.4" GN Spout, 0.5gpm Vandar Resistant Aerator	ADA Blade w/ San Hood	Chrome	
243800	26C3972	8"cc, 6" GN Spout, 1.0 gpm Laminar Outlet	ADA Hooded Blade	Chrome	

\* R7 Spout - gooseneck spout with flow control

#### Teck® Commercial 2-Hdl Faucet

- Swing spout or rigid/swivel gooseneck spout
- Cast brass body
- Tuf-Teck™ or Cer-Teck® cartridges
- WaterSense Certified



Part #	Mfg #	Description	Handle(s)	Finish	Price
145946	27C2144	8"ws, less Spray, Cer-Teck®, 8" Swing Spout, 1.5 gpm	ADA Blade	Chrome	
134090	27C2142	8"ws, less Spray, Cer-Teck®, 8" Swing Spout, 1.5 gpm	ADA Hooded Blade	Chrome	
112066	27C2244	8"ws, less Spray, Cer-Teck®, 8" Tubular Swing Spout, 1.5 gpm	ADA Blade	Chrome	
126744	27C2924	8"ws, less Spray, Cer-Teck®, 6" Swing Spout, 1.5 gpm	ADA Blade	Chrome	
186319	27C2924-LS-TI	8"ws, Cer-Teck®, 10.4"GN Spt, 1.5gpm VR	ADA Blade	Chrome	
148054	27C2924-LS-R7TI	8"ws, Cer-Teck®, 12.7"GN Spt, 1.5gpm VR	ADA Blade	Chrome	
096942	27C2942	8"ws, less Spray, Cer-Teck®, 10.4" GN, 1.5 gpm	ADA Hooded Blade	Chrome	
100858	27C2944	8"ws, less Spray, Cer-Teck®, 10.4" GN, 1.5 gpm	ADA Blade	Chrome	
186017	27C2974-R5	8"ws, less Spray, Cer-Teck®, 6"Reach 10.4"H Spout, 1.0GPM	ADA Blade	Chrome	
086543	27C2943-R7	8"ws, less Spray, Cer-Teck®, 10.4" GN, 1.5 gpm VR	ADA Lever Blade	Chrome	
129492	27C2944-R7	8"ws, less Spray, Cer-Teck®, 9" GN, 1.5 gpm	ADA Blade	Chrome	
126613	27C2945-R7	8"ws, less Spray, Cer-Teck®, 12.7" GN, 1.5 gpm	ADA Wrist Blade	Chrome	
137791	27C2954	8"ws, less Spray, Cer-Teck®, 10.4" GN, 0.5 gpm Non-Aerating	ADA Blade	Chrome	
255372	27C4222	4"cc, Less Pop-Up, Cer-Teck®, 8" Tubular Swing Spout, 1.5 gpm	ADA Blade	Chrome	
125349	27C4242	4"cc, less Pop-Up, Cer-Teck®, 8" Tubular Swing Spout, 1.5 gpm	ADA Hooded Blade	Chrome	
136796	27C4244	4"cc, less Pop-Up, Cer-Teck®, 8" Tubular Swing Spout, 1.5 gpm	ADA Blade	Chrome	

\* Brilliance® Anti-Tarnish Lifetime Finishes

**www.plumbsupply.com • Serving our Customers Since 1946 • www.waterconcepts.net**



## Commercial - Institutional Faucets

### Two-Handle Commercial Lavatory Faucets (Continued)

#### Teck® Commercial 2-Hdl Faucet

Part #	Mfg #	Description	Handle(s)	Finish	Price
125374	27C4263	4"cc, less Pop-Up, Cer-Teck®, 8" Tubular Swing Spout	ADA Lever Blade	Chrome	
138210	27C4323	4"cc, less Pop-Up, Cer-Teck®, 6" Tubular Swing Spout, 1.5 gpm	ADA Lever Blade	Chrome	
137627	27C4343	4"cc, less Pop-Up, Cer-Teck®, 6" Tubular Swing Spout, 1.5 gpm	ADA Lever Blade	Chrome	
102836	27C4822	4"cc, less Pop-Up, Cer-Teck®, 4.5" Gooseneck Spout, 1.5 gpm	ADA Hooded Blade	Chrome	
094801	27C4842	4"cc, less Pop-Up, Cer-Teck®, 4.5" GN, 1.5 gpm	ADA Hooded Blade	Chrome	
096878	27C4854	4"cc, less Pop-Up, Cer-Teck®, 4.5" GN, 0.5 gpm	ADA Blade	Chrome	
166594	27C4874	4"cc, less Pop-Up, Cer-Teck®, 4.5" GN, 1.0 gpm	ADA Blade	Chrome	
114942	27C4844	4"cc, less Pop-Up, Cer-Teck®, 10.5" GN, 1.5 gpm	ADA Blade	Chrome	
151088	27C4922	4"cc, less Pop-Up, Cer-Teck®, 10.4" GN, 1.5 gpm	ADA Hooded Blade	Chrome	
099746	27C4924	4"cc, less Pop-Up, Cer-Teck® 10.4" GN, 1.5 gpm VR	ADA Blade	Chrome	
229388	27C4925	4"cc, less Pop-Up, Cer-Teck®, 10.4" GN Spout, VR 1.5 gpm	6" Wrist Blade	Chrome	
159485	27C4932	4"cc, less Pop-Up, Cer-Teck®, 10.4" GN Spout, VR 1.5 gpm	ADA Hooded Blade	Chrome	
166615	27C4934	4"cc, less Pop-Up, Cer-Teck®, 10.4" GN, 1.5 gpm	ADA Blade	Chrome	
109804	27C4943	4"cc, less Pop-Up, Cer-Teck®, 10.4" GN, 1.5 gpm	ADA Lever Blade	Chrome	
106041	27C4944	4"cc, less Pop-Up, Cer-Teck®, 10.4" GN, 1.5 gpm	ADA Blade	Chrome	
136549	27C4944-R7	4"cc, less Pop-Up, Cer-Teck®, 9" GN, 1.5 gpm	ADA Blade	Chrome	
129160	27C4952	4"cc, less Pop-Up, Cer-Teck®, 10.4" GN, 0.5 gpm VR Non-A	ADA Hooded Blade	Chrome	

#### Teck® Commercial 2-Hdl Wall-Mount Faucet

- Cast brass body
- Cer-Teck™ cartridges
- Hot/cold handle indicators
- 1.5 gpm Aerator

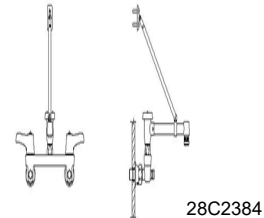

28C2384

Part #	Mfg #	Description	Handle(s)	Finish	Price
098109	28C2383	8"cc, w/Integral Stops, Rigid Spt w/Pail Hook, Angle Vac Breaker	ADA Lever Blade	Chrome	
124515	28C2384	8"cc, w/Integral Stops, Rigid Spout w/Pail Hook, Angle Vac Breaker	ADA Blade	Chrome	
155835	28C2385	8"cc, w/Integral Stops, Rigid Spt w/ Pail Hook, Angle Vac Breaker	ADA Wrist Blade	Chrome	
166691	28C2985	8"cc, w/Integral Stops, 16-1/2" Rigid Spt w/ Pail Hook, Vac Breaker	ADA Wrist Blade	Chrome	
142892	28C4424	8"cc, less Integral Stops, 11" Tubular Swing, 1.5 gpm VR Laminar	ADA Blade	Chrome	
128153	28C4433	8"cc, less Integral Stops, 11" Tubular Swing, 1.5 gpm VR Aerator	ADA Lever Blade	Chrome	
145606	28C6944	8"cc, w/Integral Stops, 10.4" GN, 1.5 gpm Aerator	ADA Blade	Chrome	

\* Brilliance® Anti-Tarnish Lifetime Finishes



## Commercial - Institutional Faucets

### Surgeon & Laboratory Lavatory Faucets

#### Deck-Mount Pure Water Faucet

- Self-close Celcon® valve
- Gooseneck spout with Tygon® liner
- Double action spring loaded handle
- Raised lockwasher to provide positive gripping
- Forged brass turret with vandal resistant locking pins
- (-DW) Distilled water or (-DI) Dionized water

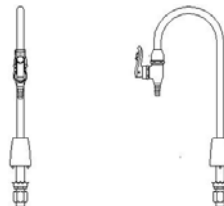

Part #	Mfg #	Description	Handle(s)	Finish	Price
080326	W6635DI	1-Hole Dionized Water Faucet	Spring Loaded	Chrome	

#### Internal Celcon® Valve for Distilled Water Faucet

- 3/8" NPT inlet
- 6 Serration built-in nozzle
- Double action spring loaded handle
- For W6635 pure water faucet

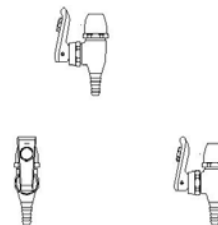

Part #	Mfg #	Description	Price
243838	W6629DW	Internal Celcon Valve	

### Bathroom Accessories - Commercial

#### 20VA Hardwire Transformer

- 20VA Hardwire Transformer for up to 10 - 590, 590HDF or 860T series
- or up to 5 - 3000T, 1500T, 590T, 591T, 590TP, 591TP, 1600T, 81THWA, DEMD, 600T, 630TP and 620TP Series, 110/24 VAC Class II



Part #	Mfg #	Description	Price
133437	060704A	20VA Hardwire Transformer for up to 10	

#### 20VA Hardwire Transformer



Part #	Mfg #	Description	Price
071703	RP32508	20VA	

#### Hardwire Converter with Battery Back-Up



Part #	Mfg #	Description	Handle(s)	Finish	Price
137040	061047A	Hardwire Conversion Kit			

\* Brilliance® Anti-Tarnish Lifetime Finishes

[www.plumbsupply.com](http://www.plumbsupply.com) • Serving our Customers Since 1946 • [www.waterconcepts.net](http://www.waterconcepts.net)

## Commercial - Institutional Faucets

### 40VA Hardwire Transformer

- 40VA
- 3000T, 1500T, 590T, 591T, 590TP, 591TP, 1600T, 81THWA, DEMD, 600T, 630TP, and 620TP
- 110/24 VAC Class II



Part #	Mfg #	Description	Price
181330	060771A	40VA Hardwire Transformer for up to 10	

### Ball Valve

- Two ball valves assembled at 180° in deck-mount turret-assembled shank, brass locknut, raised lock washer for positive grip - vandal resistant locking pins on turret (can be removed in field if not required)

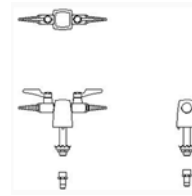

Part #	Mfg #	Description	Price
166283	W6225AIR	Two ball valves in deck mount turret	

### Cast Metal Plate



Part #	Mfg #	Description	Handle(s)	Finish	Price
256332	061305A	4", Polished Chrome			

### Toe Tester Spout

- Forged brass
- Chrome-plated finish
- 1/2" NPS inlet/outlet

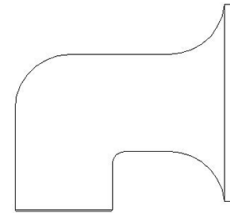

Part #	Mfg #	Description	Price
227234	060605A	Polished Chrome	

### Plug-In Transformer



Part #	Mfg #	Description	Price
074976	RP32856	Plug-In Transformer	

\* Brilliance® Anti-Tarnish Lifetime Finishes

[www.waterconcepts.net](http://www.waterconcepts.net) • Serving our Customers Since 1946 • [www.plumbsupply.com](http://www.plumbsupply.com)

## Self-Closing Faucets

### Two-Handle Self-Closing Commercial Lavatory Faucets

#### Teck® 86T Commercial 2-Hdl Metering Faucet

- 5-1/10" Reach
- Cast brass body
- Vandal-resistant handles
- Metering, slow-close lever style
- Red/blue indicators
- 2-3/8" Maximum deck thickness
- 0.5 gpm Vandal-resistant outlet
- No lift rod hole



Part #	Mfg #	Description	Handle(s)	Finish	Price
036185	86T1153	2-Hole 4"cc	ADA Levers	Chrome	

#### HDF Commercial 2-Hdl Self-Closing Faucet

- 5" Reach spout
- 1-7/8" From deck to aerator
- Vandal resistant handles
- Metering, slow-close push style
- 1-3/8" Maximum deck thickness
- No lift rod hole
- 1/2" IPS shanks
- WaterSense Certified



Part #	Mfg #	Description	Handle(s)	Finish	Price
166354	2507LF-HDF	2-Hole, 4"cc, Less Pop-Up 0.5 gpm	Metering	Chrome	
003878	2517LF-HDF	2-Hole, 4"cc, Grid Strainer 0.5 gpm	Metering	Chrome	

### One-Handle Self-Closing Commercial Lavatory Faucets

#### Teck® 87T Commercial 1-Hdl Metering Hand wash Faucet

- 5-2/5" Reach
- Cast brass body
- Metering slow close cartridge
- 2-1/2" Maximum deck thickness
- (87T105) Single outlet
- (87T111) Mixing tee and checks
- (2) Body-mounted stainless steel anti-rotation locking pins
- 0.5 gpm Vandal-resistant spout outlet



87T111

Part #	Mfg #	Description	Handle(s)	Finish	Price
114830	87T105	1-Hole	ADA Lever	Chrome	
123905	87T111	1-Hole	ADA Lever	Chrome	
122556	87T151	4"cc Cover Plate with Center Faucet Hole, (2) Hold Down Shanks		-Chrome	

\* Brilliance® Anti-Tarnish Lifetime Finishes

[www.plumbsupply.com](http://www.plumbsupply.com) • Serving our Customers Since 1946 • [www.waterconcepts.net](http://www.waterconcepts.net)

## Self-Closing Faucets

### HDF Self-Closing Commercial Faucet

- 4-1/4" Rigid spout reach
- 1-1/2" From deck to aerator
- Vandal resistant handle
- Metering, self-close push style
- 1-1/8" max deck thickness
- Vandal resistant spray outlet
- 1/2" threaded male inlet shank



Part #	Mfg #	Description	Handle(s)	Finish	Price
164453	701LF-HDF	1-Hole	Push	Chrome	

\* Brilliance® Anti-Tarnish Lifetime Finishes

[www.waterconcepts.net](http://www.waterconcepts.net) • Serving our Customers Since 1946 • [www.plumbsupply.com](http://www.plumbsupply.com)

## Commercial Shower Faucets

### Commercial MultiChoice™ Universal Valve Trim

#### Commercial Teck™ ADA 1-Hdl Shower Trim

- Fits MultiChoice® universal valve
- Red/blue label on escutcheon
- Vacuum breaker
- ADA compliant, adjustable handshower slide or showerhead with arm and flange
- Vandal-resistant blade handle
- Handle adjusts temperature
- Back-to-back capability
- 1/2" Universal inlets/outlets
- Male threads with stops; please select valve with screwdriver stops



Part #	Mfg #	Description	Handle(s)	Finish	Price
138721	T13H132	Shower Trim Only, 1.5 gpm	ADA Lever	Chrome	
135549	T13H152	Shower Only, Handshower 24" SS Grab Bar 70"Hose	ADA Lever	Chrome/White	
226497	T13H152-25	Shower Only, Handshower 36" SS Grab Bar 69"-92" Hose	ADA Lever	Chrome/White	
095261	T13H153	Shower Only, 24" Grab Bar, 70" Vinyl Hose, 2.5 gpm	ADA Lever Blade	Chrome	

### Commercial Tub&Shower Trim

#### Monitor® 13 Series Tub & Shower Trim

- For use with MultiChoice® universal rough-in valve
- Handle adjusts temperature
- Touch-Clean® showerhead
- Sweat onto 1/2" C.W.T. or thread onto 1/2" IPS
- WaterSense® certified: 2.0 gpm @ 80 psi



Part #	Mfg #	Description	Handle(s)	Finish	Price
149576	T13491	5-1/2" Pull-Up Div Spout	ADA Lever	Chrome	
173860	T13491-SSLHD	4-3/4" Pull-Up Div Spout, Less Showerhead	ADA Lever	Stainless*	

#### Classic Monitor® 13 Series Tub & Shower Trim

- For use with MultiChoice® universal rough-in valve
- Push-button diverter
- Handle adjusts temperature
- Slip onto 1/2" C.W.T.
- Removable threaded adapter for 1/2" IPS
- Touch-Clean® showerhead
- WaterSense® certified: 1.5 gpm @ 80 psi



Part #	Mfg #	Description	Handle(s)	Finish	Price
163324	T13691-SOS-15	4-3/4" Non-Div Spt, Push-Button Div on Trim	ADA Lever	Chrome	

\* Brilliance® Anti-Tarnish Lifetime Finishes

[www.plumbsupply.com](http://www.plumbsupply.com) • Serving our Customers Since 1946 • [www.waterconcepts.net](http://www.waterconcepts.net)

## Commercial Shower Faucets

### Monitor® 13 Series Commercial 1-Hdl Tub & Shower Trim

- Fits MultiChoice™ universal valve
- Vandal-resistant blade handle
- Handle adjusts temperature
- Touch-Clean® showerhead
- Sweat onto 1/2" CWT or thread onto 1/2" IPS
- WaterSense® certified product  
2.0 gpm @ 80 psi



Part #	Mfg #	Description	Handle(s)	Finish	Price
100907	T13490	Tub & Shower Trim, 5-1/2" Pull-Up Tub Spout	ADA Blade	Chrome	
095921	T13090	Trim Only with Pressure Balance Cartridge	ADA Blade	Chrome	

### Brass Bent Showerarm

- Metal set screw wall flange



Part #	Mfg #	Description	Handle(s)	Finish	Price
225137	060710A	Brass bent Showerarm			

### Teck® Commercial Tub&Shower Trim

Trim Only, Requires Valve: R10000-UNWS

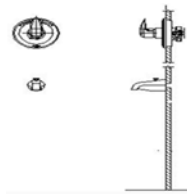

Part #	Mfg #	Description	Handle(s)	Finish	Price
157956	T13H202	Valve Trim with Tub Spout, Less Showerhead	ADA Lever	Chrome	
163535	T13H252	Valve Trim w/ Tub Spout, 24" Slidebar w/HH 1.5gpm	ADA Lever	Chrome	
185508	T13H252-25	Valve Trim w/Tub Spout, 36" Slidebar w/HH 1.5gpm	ADA Lever	Chrome	
100914	T13H253	Valve Trim w/Tub Spout, 24" Slidebar w/HH 1.5gpm	ADA Lever Blade	Chrome	
185506	T13H282	Valve Trim w/Tub Spout, H2Okinetic® Shwrhead 1.5gpm	ADA Lever	Chrome	
187232	T13H283	Valve Trim w/Tub Spout, H2Okinetic® Shwrhead 1.5gpm	ADA Blade	Chrome	

### Teck® Commercial Tub & Dual Shower Trim

Trim Only, Requires valve: R1000-UNWS

Part #	Mfg #	Description	Handle(s)	Finish	Price
166138	T13H932	Shower Trim, Div, HH on Slidebar, 1.5gpm Shwrhead	ADA Lever	Chrome	
179353	T13H962-20	Shower Trim, Div, HHw/ 69" Hose on Slidebar, VR 1.5gpm	ADA Lever	Chrome	
242880	T13H982	Shower Trim, Div, HH on 24"Slidebar, H2O 1.5 gpm Head	ADA Lever	Chrome	

\* Brilliance® Anti-Tarnish Lifetime Finishes

www.waterconcepts.net • Serving our Customers Since 1946 • www.plumbsupply.com



## Commercial Shower Faucets

### Teck® Commercial Thermostatic Tub & Shower w/ Diverter Valve for Dual Showers

- MultiChoice® universal thermostatic dual shower
- 3-Function showerhead, arm, and flange
- Metal lever volume control handle with temperature adjustment
- Showerhead flow rate: 2.0 gpm

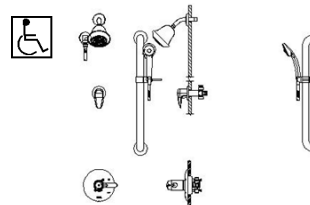

Requires R10700-UNWS Rough-In Valve

Part #	Mfg #	Description	Handle(s)	Finish	Price
173716	T17TH225	Shower Trim, Div, HH on 24" Slidebar 2.0 gpm	ADA Lever	Chrome	

### Commercial Shower Packages

#### Teck® MultiChoice® Universal Pressure Balance Shower Trim

- Heavy duty forged brass valve body
- Back-to-back capability, integral screwdriver stops
- 30° Vandal resistant cast wall mount showerhead



Requires R10000-UNWS Rough-In Valve

Part #	Mfg #	Description	Handle(s)	Finish	Price
166416	T13H162	Shower Trim w/ VR Showerhead 1.5 gpm	ADA Lever	Chrome	
108826	T13H163	Shower Trim w/ VR Showerhead 1.5 gpm	ADA Blade	Chrome	
164428	T13H152-05	Shower Trim w/ 36" Slidebar w/HH 1.5gpm	ADA Lever	Chrome	
179352	T13H152-20	Shower Trim w/ 24" Slidebar, 69" Hose w/HH 1.5gpm	ADA Lever	Chrome	
185374	T13H182	Shower Trim w/H2Okinetic® Showerhead 1.5gpm	ADA Lever	Chrome	
102894	T13H183	Shower Trim w/H2Okinetic® Showerhead 1.5 gpm	ADA Blade Lever	Chrome	

#### Teck® MultiChoice® Universal Shower Package

- Integral checks in the cartridge prevent cross flow between Hot and Cold water inlets
- Non-Removable Blue/Red visual cover indicator for Cold, Mixing and Hot handle positions
- Standard 24" Stainless Steel Bar with ADA Slide handshower and shower diverter valve-backflow protection provided by two integral check valves in handshower
- Includes:
  - Dual shower trim
  - Diverter
  - Handshower
  - Grab bar
- Flow rate: 1.5 gpm @ 80 psi



Part #	Mfg #	Description	Handle(s)	Finish	Price
149708	T13H332	Shower Trim, Div, HH, 24" ADA Slidebar	ADA Lever	Chrome	
187744	T13H332-20	Shower Trim, Div, HH, 24" ADA Slidebar 69" Hose	ADA Lever	Chrome	

\* Brilliance® Anti-Tarnish Lifetime Finishes

[www.plumbsupply.com](http://www.plumbsupply.com) • Serving our Customers Since 1946 • [www.waterconcepts.net](http://www.waterconcepts.net)

## Commercial Shower Faucets

### Commercial Shower Packages (Continued)

#### Teck® MultiChoice® Universal Shower Package

Part #	Mfg #	Description	Handle(s)	Finish	Price
166745	T13H332-25	Shower Trim, Div, HH, 36" ADA Slidebar 69" Hose	ADA Lever	Chrome	
175425	T13H323-20	Shower Trim, Div, HH, 24" ADA SlideBar 69" Hose	ADA Blade	Chrome	
179351	T13H362-20	Shwr Trim, Div, HH, 24" ADA Slidebar 69" Hose & VR SH 1.5gpm Chrome		ADA Lever	

#### Teck® MutliChoice® Universal Thermostatic Shower Trim

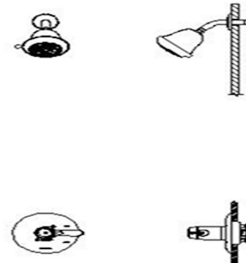

Part #	Mfg #	Description	Handle(s)	Finish	Price
160522	T17TH125	Thermo Trim, 2.0gpm 3-Function Showerhead	ADA Lever	Chrome	
228459	T17TH135	Thermo Trim, 2.0 gpm Touch-Clean® Showerhead	ADA Lever	Chrome	
153022	T17TH155	Thermo Trim, 2.5gpm HHw/ 24" Slidebar less Showerhead	ADA Lever	Chrome	
186759	T17TH305	Thermo Trim, 2.5gpm HH w/ 24" Slidebar NO fixed Shwrhd	ADA Lever	Chrome	
173005	T17TH325	Thermo Trim, 2.5gpm HHw/ 24" Slidebar Touch-Clean® SH	ADA Lever	Chrome	
257534	T17TH335	Thermo Trim, 2.5gpm HHw/ 24" Slidebar	ADA Lever	Chrome	

#### Volume Control Valve with Integral Stop

- In-wall volume control valve
- WM rigid spout w/double check in-line vacuum breaker  
br - spray holder
- Bedpan sprayer w/self-close stop and hose

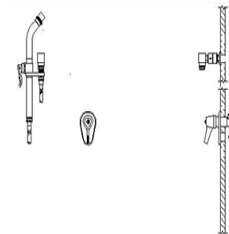

Part #	Mfg #	Description	Handle(s)	Finish	Price
185314	54T-1254	Volume Control Valve, WM Rigid Spout & Bedpan Sprayer	-	Chrome	

\* Brilliance® Anti-Tarnish Lifetime Finishes

[www.waterconcepts.net](http://www.waterconcepts.net) • Serving our Customers Since 1946 • [www.plumbsupply.com](http://www.plumbsupply.com)

## Commercial Shower Faucets

### Commercial Handshowers & Showerheads

#### Personal Handshower

- Single-function white handshower
- Push button on-off control
- Touch-Clean® spray holes
- ADA adjustable slide
- 24" Grab bar
- 60"-82" Stretchable metal hose
- 90° Wall supply elbow
- Backflow protection with 2 integral check valves in handshower
- Flow rate: 2.5 gpm @ 80 psi



Part #	Mfg #	Description	Handle(s)	Finish	Price
052226	RPW324HDF	Handshower, 24" Grab Bar Slide	-	White/Stainless	

\* Brilliance® Anti-Tarnish Lifetime Finishes

**Commercial - Lavatory**

**Single-Handle Commercial Lavatory Faucets**

**Coralais® Commercial 1-Hdl Lavatory Faucet with Plugged Lift Rod Hole**

- 4-1/4" Reach spout
- Metal construction
- Flexible connections
- Red/blue indicator
- Vandal-resistant aerator



Part #	Mfg #	Description	Handle(s)	Finish	Price
226369	K-15199-4NDRA-C P	4"cc, Less Drain VR Aerator 1.5gpm	ADA Lever	Polished Chrome	

**July™ Commercial 1-Hdl Lavatory Faucet**

- 4-3/8" Reach spout
- Ceramic disc valves
- Temperature memory
- Vandal-resistant aerator
- Lift rod not included



Part #	Mfg #	Description	Handle(s)	Finish	Price
189089	K-97282-4-CP	.5 gpm, Less Drain	ADA Lever	Polished Chrome	
186393	K-97283-4-CP	.5 gpm, Grid Drain	ADA Lever	Polished Chrome	

**Two-Handle Commercial Lavatory Faucets**

**Forte® Widespread Bathroom Sink Faucet with Pop-Up Drain and Sculpted Lever Handles**

- 5-1/8" Reach spout
- Metal construction
- Vandal-resistant aerator
- Brass valve bodies
- Fluid design lines
- Red and blue index rings



Part #	Mfg #	Description	Handle(s)	Finish	Price
179824	K-10269-4-CP	8"cc, 2.2 gpm, Pop-Up Drain, Flexible Conn	ADA Lever	Polished Chrome	

**Two-Handle Commercial Institutional Lavatory Faucets**

**Cannock™ Wash Sink Faucet**

- 4" Reach spout with rose spray
- 8-3/8" wall-to-spout outlet
- Brass construction
- Velvet® valves
- Adjustable flanges



Part #	Mfg #	Description	Handle(s)	Finish	Price
055218	K-8892-RP	Wall Mount, Less Drain	ADA Lever	Rough Plate	

\* Vibrant Limited Lifetime Warranty

[www.waterconcepts.net](http://www.waterconcepts.net) • Serving our Customers Since 1946 • [www.plumbsupply.com](http://www.plumbsupply.com)

## Commercial - Lavatory

### Knoxford™ 2-Hdl Commercial Service Sink Faucet

- 8-inch centers
- Solid brass construction
- 4-7/8" wall-to-spout outlet
- Internal NPT connections
- Velvet® valves with brass valve bodies
- Includes vacuum breaker and pail hook
- 2-1/4" threaded spout for hose connection



Part #	Mfg #	Description	Handle(s)	Finish	Price
076816	K-8905-CP	Wall-Mount, Less Drain	ADA Lever	Polished Chrome	
078254	K-8905-RP	Wall-Mount, Less Drain	ADA Lever	Rough Plate	

### Triton® Bowe® Cannock™ Wash Sink Faucet

- 3-11/16" Reach spout with rose spray
- 7-5/16" wall-to-spout outlet
- Brass construction
- External NPT connections
- Adjustable flanges
- WaterSense® certified: 1.2 gpm @ 60 psi



Part #	Mfg #	Description	Handle(s)	Finish	Price
258694	K-730T70-4AJR-SR	Wall-Mount, Less Drain	ADA Lever	*Bright Nickel	

### Triton® Bowe™ Commercial Centerset Lavatory Sink Faucet—Less Drain and Lift Rod

- For 4" centers
- 3-15/16" Spout reach
- Brass valve bodies
- Solid brass construction
- Includes flexible supply lines
- 1/4-Turn washerless ceramic disc valves
- Vandal-resistant aerated flow (-ANA)
- Vandal-resistant outlet with laminar flow (-ANL)
- Maximum flow rate: 0.5 gpm @ 60 psi



Part #	Mfg #	Description	Handle(s)	Finish	Price
243121	K-400T20-4AKA-C P	4"cc, 1.0 gpm, Less Drain	ADA Lever	Polished Chrome	
243122	K-400T20-5AKA-C P	4"cc, 1.0 gpm, Less Drain	ADA Wristblade	Polished Chrome	
237912	K-400T20-4ANA-C P	4"cc,0.5 gpm, Less Drain	ADA Lever	Polished Chrome	
237579	K-400T20-5ANL-CP	4"cc,0.5 gpm, Less Drain	ADA Wristblade	Polished Chrome	

\* Vibrant Limited Lifetime Warranty

[www.plumbsupply.com](http://www.plumbsupply.com) • Serving our Customers Since 1946 • [www.waterconcepts.net](http://www.waterconcepts.net)

## Commercial - Lavatory

### Triton® Bowe™ Commercial Widespread Lavatory Sink Faucet—Less Drain and Lift Rod

- 3-Hole installation
- 5-3/16" Gooseneck spout reach
- Brass construction, brass valve bodies
- Includes flexible supply lines
- 1/4-Turn washerless ceramic disc valves
- Vandal-resistant aerated flow (-ANA)
- Vandal-resistant outlet with laminar flow (-ANL)
- Maximum flow rate: 1.0 gpm @ 60 psi



Part #	Mfg #	Description	Handle(s)	Finish	Price
243123	K-400T70-4AKA-C P	4"cc, 1.0 gpm, Less Drain	ADA Lever	Polished Chrome	
243124	K-400T70-5AKA-C P	4"cc, 1.0 gpm, Less Drain	ADA Wristblade	Polished Chrome	
258744	K-400T70-5ANL-CP	4"cc, 0.5 gpm, Less Drain	ADA Wristblade	Polished Chrome	
242689	K-800T70-5AKA-C P	8"-16"cc, 1.0 gpm, Less Drain	ADA Wristblade	Polished Chrome	
245310	K-800T70-5ANA-C P	8"-16"cc, 0.5 gpm, Less Drain	ADA Wristblade	Polished Chrome	

### Triton® Bowe™ Commercial Widespread Lavatory Sink Faucet—Less Drain and Lift Rod

- 8" Centers
- 9-5/16" Gooseneck swing/rigid spout reach
- Brass construction, brass valve bodies
- 1/4-Turn washerless ceramic disc valves
- Vandal-resistant aerated flow
- Maximum flow rate: 1.8 gpm @ 60 psi



Part #	Mfg #	Description	Handle(s)	Finish	Price
247251	K-810T70-5AFA-CP	8"cc, 1.8 gpm, Less Drain	ADA Wristblade	Polished Chrome	

### Triton® Commercial 2-Hdl Lavatory Faucet with Gooseneck Spout—Less Drain

- 5-1/4" Reach gooseneck spout
- Brass construction, brass valve bodies
- Standard aerator  
—(K-7305-KE) vandal-resistant aerator
- 1/4-Turn washerless ceramic disc valves
- Flexible connections unless stated



Wristblade



Part #	Mfg #	Description	Handle(s)	Finish	Price
053695	K-7304-K-CP	8"-16"cc, 2.2 gpm, Less Drain	Less Handles	Polished Chrome	
227877	K-7304-5A-CP	8"-16"cc, 2.2 gpm, Less Drain	ADA Wristblade	Polished Chrome	
094882	K-7305-5A-CP	4"cc, 1.5 gpm, Less Drain	ADA Wrist Blade	Polished Chrome	
114857	K-7305-KE-CP	4"cc, 1.5 gpm, Less Drain	Less Handles	Polished Chrome	

\* Vibrant Limited Lifetime Warranty

[www.waterconcepts.net](http://www.waterconcepts.net) • Serving our Customers Since 1946 • [www.plumbsupply.com](http://www.plumbsupply.com)



## Commercial - Lavatory

### Triton® Commercial 2-Hdl Widespread Lavatory Faucet with Rigid Connections—Less Handles & Drain

- 5-1/4" Reach gooseneck spout
- Brass construction, brass valve bodies
- Variety of handle style options
- Rigid connections allow installation on 12" centers
- 1/4-Turn washerless ceramic disc valves
- Low-flow aerator option available
- Maximum flow rate: 2.2 gpm @ 60 psi



Part #	Mfg #	Description	Handle(s)	Finish	Price
077941	K-7313-K-CP	12"cc, 2.2 gpm, Less drain	Less Handles	Polished Chrome	

### Triton® Commercial 2-Hdl Lavatory Faucet with Less Drain, and Handles

- Brass construction, brass valve bodies
- Quarter-turn washerless ceramic disc valves
- Standard aerator
- Variety of handle style options
- Low-flow aerator option available
- Flow rate: 2.0 gpm



Part #	Mfg #	Description	Handle(s)	Finish	Price
053694	K-7443-K-CP	8"cc, Less Drain	Less Handles	Polished Chrome	

### Triton® Shelf-Back Commercial 2-Hdl Lavatory Faucet

- 1-1/4" Spout reach
- Brass construction
- Valvet® valves
- Grid drain with tailpiece
- Flow rate: 2.0 gpm



Part #	Mfg #	Description	Handle(s)	Finish	Price
182519	K-8046-3A-CP	5-1/2"cc, Grid Drain with tailpiece	Cross Handles	Polished Chrome	
105520	K-8046-4A-CP	5-1/2"cc, Grid Drain with tailpiece	Lever Handles	Polished Chrome	
167211	K-8046-5A-CP	5-1/2"cc, Grid Drain with tailpiece	Wrist blade Handles	Polished Chrome	

### Triton® Shelf-Back Service Sink 2-Hdl Lavatory Faucet

- 3-3/8" Goodeneck spout reach
- Brass construction, brass valve bodies
- Valvet® valves
- Low-flow aerator option available
- Flow rate: 2.2 gpm
- Less drain



Part #	Mfg #	Description	Handle(s)	Finish	Price
247420	K-7302-5A-CP	5-1/2"cc Less Drain	ADA Wristblade	Polished Chrome	

\* Vibrant Limited Lifetime Warranty

[www.plumbsupply.com](http://www.plumbsupply.com) • Serving our Customers Since 1946 • [www.waterconcepts.net](http://www.waterconcepts.net)

## Commercial - Lavatory

### Triton® Shelf-Back Commercial 2-Hdl Lavatory Faucet with Pop-Up Drain & Lift Rod

- 1-1/4" Spout reach
- 1-1/4" Tailpiece and aerator
- For 5-1/2" centers
- Brass construction, brass valve bodies
- Valvet® valves
- Low-flow aerator option available
- Flow rate: 2.0 gpm



Cross Handles



Standard Handles

Part #	Mfg #	Description	Handle(s)	Finish	Price
054186	K-8040-2A-CP	5-1/2"cc, Pop-Up Drain, Lift Rod, Tailpiece	Standard	Polished Chrome	
085412	K-8040-3A-CP	5-1/2"cc, Pop-Up Drain, Lift Rod, Tailpiece	Cross	Polished Chrome	

### Triton® Wall-Mount Valve Trim

- Push button diverters
- Cross handles
- Integral diverter mechanism



Requires valve K-303-K

Part #	Mfg #	Description	Handle(s)	Finish	Price
182397	K-T7751-3-CP	Push Button	ADA Cross Handles	Polished Chrome	
244775	K-T7751-4-CP	Push Button	ADA Lever Handles	Polished Chrome	

### Triton® Commercial 2-Hdl Widespread Lavatory Faucet with Gooseneck Spout—Less Drain and Handles

- 5-1/4" Reach spout
- Brass construction
- Flow rate: 2.0 gpm
- Rigid connections allows installation on 8" centers (K-7303-KC-CP) or 12" centers (7313-KE-CP)



Requires Handles: K-16012-2, K-16012-3, K-16012-4 or K-16012-5

Part #	Mfg #	Description	Handle(s)	Finish	Price
182510	K-7303-KC-CP	8"cc, Less Drain, 8" Connections & Rose Spray	Less Handles	Polished Chrome	
182511	K-7313-KE-CP	8"cc, Less Drain, 12" Connections	Less Handles	Polished Chrome	

\* Vibrant Limited Lifetime Warranty

[www.waterconcepts.net](http://www.waterconcepts.net) • Serving our Customers Since 1946 • [www.plumbsupply.com](http://www.plumbsupply.com)

**Commercial - Lavatory**

**Touchless™ Commercial Institutional Lavatory Faucets**

**Commercial Sculpted Touchless AC-Powered Lavatory Faucet with Insight™ Technology—Less Drain**

- 5-3/4" Spout reach or 5" reach for (K-13461-CP)
- Brass construction
- Above-deck serviceable
- Vandal-resistant aerator
- 24" Flexible supplies
- Temperature mixer  
—Not included with (K-13461-CP)
- Waterproof shroud protects electronic components



**DC-Powered**  
**Includes Two AAA Batteries**

Part #	Mfg #	Description	Handle(s)	Finish	Price
127701	K-13460-CP	1-Hole, Mixer, DC, Includes (2) AAA Batteries		Polished Chrome	
131019	K-13461-CP	1-Hole, less Mixer, DC, Includes (2) AAA Batteries		Polished Chrome	

**AC-Powered**

Part #	Mfg #	Description	Handle(s)	Finish	Price
148859	K-13462-CP	1-Hole, Mixer, AC		Polished Chrome	
134611	K-13462-VS	1-Hole, Mixer, AC		*Stainless	

**Cell-Powered by 30-Year Hybrid Energy System**

Part #	Mfg #	Description	Handle(s)	Finish	Price
134202	K-7515-CP	1-Hole, Mixer, Hybrid with 30-Yr 3.6V Energy Cell		Polished Chrome	

**Geometric Touchless™ Commercial Lavatory Faucet with Insight™ Technology—Less Drain**

- 6-3/4" Spout reach
- Brass construction
- Above-counter battery and valve
- Vandal-resistant aerator
- Factory set 30 second max continual run cycle
- Temperature mixer  
—Not included with (K-13467-CP) or (K-7516-VS)
- Flow rate: .5 gpm
- Waterproof shroud protects electronic components



**DC-Powered**  
**Includes Two AAA Batteries**

Part #	Mfg #	Description	Handle(s)	Finish	Price
150834	K-13466-CP	1-Hole, DC, (2) AAA Batteries		Polished Chrome	
178641	K-13466-VS	1-Hole, DC, (2) AAA Batteries		*Stainless	
185040	K-13467-CP	1-Hole, DC, (2) AAA Batteries		Polished Chrome	

\* Vibrant Limited Lifetime Warranty

[www.plumbsupply.com](http://www.plumbsupply.com) • Serving our Customers Since 1946 • [www.waterconcepts.net](http://www.waterconcepts.net)

**Commercial - Lavatory**

**AC-Powered**  
**Includes Two AAA Batteries**

Part #	Mfg #	Description	Handle(s)	Finish	Price
183004	K-13468-CP	1-Hole, AC, (2) AAA Batteries		Polished Chrome	
190187	K-13468-VS	1-Hole, AC, (2) AAA Batteries		*Stainless	

**Powered by 30-Year Hybrid Energy Cell/System**  
**5-5/16" Spout Reach**

Part #	Mfg #	Description	Handle(s)	Finish	Price
142168	K-7516-VS	1-Hole, Hybrid with 30-Yr 3.6V Energy Cell		*Stainless	
183148	K-7517-CP	1-Hole, Hybrid with 30-Yr 3.6V Energy Cell		Polished Chrome	

**Gooseneck Touchless Commercial Lavatory Faucet with Insight™ Technology—Less Drain**

- 6-3/16" Reach
- Brass construction
- 9" From deck to aerator
- 24" flexible supply hoses
- Vandal-resistant aerator
- Model (K-13472-CP) includes temperature mixer
- Above-counter battery and valve for easy installation and maintenance
- Waterproof shroud protects electronic components
- Flow Rate: 0.5 gpm



**DC-Powered**  
**Includes Two AAA Batteries**

Part #	Mfg #	Description	Handle(s)	Finish	Price
148385	K-13472-CP	1-Hole, DC (2) AAA Batteries	-	Polished Chrome	
130167	K-13473-CP	1-Hole, DC (2) AAA Batteries	-	Polished Chrome	

**Powered by 30-Year Hybrid Energy Cell/System**

Part #	Mfg #	Description	Handle(s)	Finish	Price
189288	K-7519-CP	1-Hole, Hybrid with 30-Yr 3.6V Energy Cell, 6-3/16" Reach		Polished Chrome	

**Sculpted Touchless Commercial Lavatory Faucet with Insight™ Technology**

- 5-3/4" Spout reach
- Brass construction
- Less drain
- Above-counter valve
- Vandal-resistant aerator
- Without temperature mixer
- 24" flexible supply hoses
- Flow rate: 0.5 gpm



**Powered by 30-Year Hybrid Energy Cell/System**

Part #	Mfg #	Description	Handle(s)	Finish	Price
136894	K-7514-CP	1-Hole Hybrid with 30-Yr 3.6V Energy Cell	-	Polished Chrome	

**\* Vibrant Limited Lifetime Warranty**

## Commercial - Lavatory

Powered by AC Power Supply

Part #	Mfg #	Description	Handle(s)	Finish	Price
135202	K-13463-CP	1-Hole AC Power Supply	-	Polished Chrome	

### Purist® Touchless™ Wall-Mounted Faucet Trim with 9" 90-Degree Spout and Insight™ Technology

- 9-1/8" Reach spout
- Brass construction
- Flow rate: 0.5 gpm



Requires: K-11830-NA Wall-Mount Valve

Part #	Mfg #	Description	Handle(s)	Finish	Price
182961	K-T11839-VS	2-Hole, Insight™ Technology		*Stainless	

## Commercial Shower Faucets

### Industrial Exposed Shower with Reversible Yoke

- Two-handle industrial exposed shower
- Solid brass construction for durability and reliability
- For 6" centers
- Four-arm handles
- Valvet® valves with brass valve bodies
- Adjustable showerhead delivers 2.5 gallons per minute spray
- Yoke reversible for either top or bottom supplies
- Wall-mount brackets



Part #	Mfg #	Description	Handle(s)	Finish	Price
155744	K-7254-CP	Industrial Exposed Shower with Showerhead	Cross	Polished Chrome	

## Commercial Faucet Accessories

### Brockway™ Soap Dish

- 4-15/16"L x 1-21/64"H x 3-1/8"W
- Solid brass construction
- Drainage holes
- For use with Brockway™ wash sink



Part #	Mfg #	Description	Handle(s)	Finish	Price
055219	K-8880-BC	Bright Chrome			

\* Vibrant Limited Lifetime Warranty

[www.plumbsupply.com](http://www.plumbsupply.com) • Serving our Customers Since 1946 • [www.waterconcepts.net](http://www.waterconcepts.net)

## Commercial - Lavatory

### Double Floor-Mount Foot Control

- 7-3/4" L x 3" H x 2-1/4" W
- Brass construction
- Loose key stops
- Self-closing mixing valve
- 3/8" NPT inside-threaded inlets
- Machined aluminum finish on pedals
- Intended for use with cold, hot, or tempered water



Part #	Mfg #	Description	Handle(s)	Finish	Price
130692	K-13808-CP	Polished Chrome			

### Escutcheon Round Plate for Insight™ Deck-Mount Faucet



Part #	Mfg #	Description	Handle(s)	Finish	Price
130091	K-13478-A-CP	4"		Polished Chrome	
161694	k-13478-A-VS	4"		*Stainless	

### Lavatory Sink Gooseneck Spout

- 5" Reach
- Flange
- Brass construction
- Standard aerator
- External NPT connection
- Maximum flow rate: 2.5 gpm @ 60 psi



Part #	Mfg #	Description	Handle(s)	Finish	Price
074985	K-13770-CP	5" Reach	-	Polished Chrome	

### Non-Aerated Vandal-Resistant Spray

- Premium metal construction
- 11/16" x 1"
- 0.5 gpm
- Pack of six



Part #	Mfg #	Description	Handle(s)	Finish	Price
143724	K-18016-CP	13/16" Male	-	Polished Chrome	

\* Vibrant Limited Lifetime Warranty

[www.waterconcepts.net](http://www.waterconcepts.net) • Serving our Customers Since 1946 • [www.plumbsupply.com](http://www.plumbsupply.com)



## Commercial - Lavatory

### Touchless™ Round AC Valve and Sensor Kit

- Required for Purist® and Falling Water® wall-mount Touchless™ faucets
- Insight™ adaptive infrared technology
- 0.5 gallons per minute flow rate



Part #	Mfg #	Description	Handle(s)	Finish	Price
182999	K-11843-NA	AC Power Supply		N/A	

### Triton® Lever Handles for Centerset Base Faucet

- Solid brass construction
- Polished chrome and vandal-resistant red and blue index buttons
- Required to complete:
  - Triton® centerset lavatory and
  - Triton® kitchen sink with escutcheon faucets



Part #	Mfg #	Description	Handle(s)	Finish	Price
053696	K-16010-4-CP	Centerset	ADA Lever	Polished Chrome	

### Triton® Lever Handles for Widespread Base Faucet

- Solid brass construction
- Polished chrome and vandal-resistant red and blue index buttons
- Required to complete:
  - Triton® widespread lavatory
  - Triton® widespread kitchen sink faucets



Part #	Mfg #	Description	Handle(s)	Finish	Price
053698	K-16012-4-CP	Widespread	ADA Lever	Polished Chrome	
053699	K-16012-5-CP	Widespread	ADA Wristblade	Polished Chrome	

### Triton® Cross Handles for Centerset Base Faucet

- Solid brass construction
- Required to complete:
  - Triton® centerset lavatory and
  - Triton® kitchen sink with escutcheon faucets
- Polished chrome and vandal-resistant red and blue index buttons



Part #	Mfg #	Description	Handle(s)	Finish	Price
055250	K-16010-3-CP	Centerset	ADA Cross	Polished Chrome	

\* Vibrant Limited Lifetime Warranty

[www.plumbsupply.com](http://www.plumbsupply.com) • Serving our Customers Since 1946 • [www.waterconcepts.net](http://www.waterconcepts.net)

---



---

**Commercial - Lavatory**

---



---

**Loose Key Stop Assembly**



Part #	Mfg #	Description	Handle(s)	Finish	Price
246216	39213-CP	Loose Key Stop Assembly			

\* Vibrant Limited Lifetime Warranty

[www.waterconcepts.net](http://www.waterconcepts.net) • Serving our Customers Since 1946 • [www.plumbsupply.com](http://www.plumbsupply.com)

## Commercial - Institutional Faucets

### Electronic Lavatory Faucets

#### M-Power Sensor-Operated Lavatory Faucet

- One piece, cast brass
- Flexible stainless steel supply lines
- Vandal resistant below-deck box with included mounting hardware
- Touch free operation with sensor activation distance from 3" to 12"
- Vandal mode: 30 second time-out feature
- Sentinel flow: eliminates stagnant water supply lines every 24 hours
- Metering mode feature: adjustable run time from 10 to 180 seconds
- Battery 4(AA) with AC compatibility
- Battery life: up to 8 years (typical alkaline battery life at 150 uses per day)
- Flow rate: 0.5 gpm vandal-resistant multi-stream laminar flow



Part #	Mfg #	Description	Handle(s)	Finish	Price
187317	CA8301	4"cc, 3-Hole	Sensor	Chrome	

#### M-Power Sensor-Operated Lavatory Faucet

- Two piece clamshell design
- Flexible stainless steel supply lines
- Vandal mode: 30 second time-out feature
- Sentinel flow: eliminates stagnant water in supply lines every 24 hours
- Maintenance/Cleaning Mode: Allows for a 30 second deactivation for maintenance or cleaning
- Battery 4(AA) or AC powered
- Battery life: Up to 6 years or 350,000 cycles
- In-line filters included
- Flow rate: 0.5 gpm vandal-resistant multi-stream laminar flow



Part #	Mfg #	Description	Handle(s)	Finish	Price
181563	8551AC	1-Hole, Modern Design	Sensor	Chrome	

### Single-Handle Lavatory Faucets

#### M-Dura 1-Hdl Lavatory Faucet

- Solid brass construction
- Chrome finish
- 1/2" IPS connections
- Solid brass waterways
- 6" Lever handle w/red and blue temperature indicators
- 110° arc of handle
- Flow rate: 2.2 gpm  
0.5 gpm (8416F05)



Part #	Mfg #	Description	Handle(s)	Finish	Price
115759	8416	4"cc, 2- or 3-Hole	ADA Lever	Chrome	
214929	8416F05	4"cc, 2- or 3-Hole	ADA Lever	Chrome	

\*Lifeshine® Anti-Tarnish Lifetime Finish

[www.plumbsupply.com](http://www.plumbsupply.com) • Serving our Customers Since 1946 • [www.waterconcepts.net](http://www.waterconcepts.net)

## Commercial - Institutional Faucets

### M-Dura 1-Hdl Lavatory Faucet

- Solid brass construction
- Chrome finish
- 1/2" IPS connections
- Solid brass waterways
- 110° arc of handle
- Flow rate: 2.2 gpm



Part #	Mfg #	Description	Handle(s)	Finish	Price
095264	8413	4"cc, 2- or 3-Hole	ADA Lever	Chrome	

### M-Biton 1-Hdl Lavatory Faucet

- Metal construction
- 1/2" IPS connections or flex supply lines (3/8" compression fittings)
- 1255™ Duralast™ cartridge
- Flow rate: 1.5 gpm



Part #	Mfg #	Description	Handle(s)	Finish	Price
194164	8430	4"cc, 3-Hole Less Drain, 1/2" IPS	ADA Lever	Chrome	
244326	8430CBN	4"cc, 3-Hole Less Drain, 1/2" IPS	ADA Lever	Classic Brushed Nickel	
190348	8439	4"cc, 3-Hole Less Drain, Flexible Supplies	ADA Lever	Chrome	

### M-Press 1-Hdl Metering Lavatory Faucet

- Brass construction
- Designed to deliver either tempered or ambient water
- Vandal resistant
- Optional 4" deck plate sold separately (99551)
- Cycle time adjusts 5 to 60 seconds
- Operates with water supply line pressures of 20 to 125 psi
- Factory preset to automatically shut off after 10 seconds
- Flow rate: 0.5 gpm vandal resistant multi-stream laminar flow



Part #	Mfg #	Description	Handle(s)	Finish	Price
187765	8894	1-Hole, 1/2" IPS	Metering	Chrome	

### M-Press 1-Hdl Metering Lavatory Faucet

- 6" Reach, 3-3/4" high spout
- 2-1/8" From deck to aerator
- Solid brass construction
- Vandal resistant
- Optional 4" deck plate available, 99550
- Flow rate: 0.5 gpm



Part #	Mfg #	Description	Handle(s)	Finish	Price
195911	8884	1-Hole, 1/2" IPS	Metering	Chrome	

\*Lifeshine® Anti-Tarnish Lifetime Finish

[www.waterconcepts.net](http://www.waterconcepts.net) • Serving our Customers Since 1946 • [www.plumbsupply.com](http://www.plumbsupply.com)

## Commercial - Institutional Faucets

### Two-Handle Lavatory Faucets

#### M-Biton Commercial 2-Hdl Lavatory Faucet

- 6-11/64" Spout Reach
- 2-9/32" From deck to aerator
- 1/2" IPS connections
- Vandal resistant screws
- 1224 Cartridge design
- 4" Wrist blade style handles
- Flow rate: 1.2 gpm  
0.5 gpm (8800F05)



Part #	Mfg #	Description	Handle(s)	Finish	Price
030085	8800	2- or 3-Hole, Less Drain	Wrist Blade	Chrome	
215924	8800F05	2- or 3-Hole, Less Drain	Wrist Blade	Chrome	
193737	8820	2- or 3-Hole, Metal Pop-Up Drain	Wrist Blade	Chrome	

#### B-Biton Commercial Medium-Duty 2-Hdl Lavatory Faucet

- 6-11/64" Spout reach, 3-11/32" spout height
- 2-9/32" From deck to aerator
- 1/2" IPS
- Vandal resistant screws
- Drain NOT included
- Flow rate: 1.2 gpm



Part #	Mfg #	Description	Handle(s)	Finish	Price
155636	8915	2- or 3-Hole, Less Drain	ADA Lever	Chrome	
156059	8218	2- or 3-Hole, Grid Drain	ADA Lever	Chrome	

#### M-Biton Commercial 2-Hdl Clinic Faucet

- 4-3/4" Spout reach, 8-7/8" high spout
- 5-1/8" From deck to aerator
- 1/2" IPS connections
- Vandal resistant screws
- 1224 Cartridge design
- Flow rate: 1.2 gpm



Part #	Mfg #	Description	Handle(s)	Finish	Price
148053	8948	2- or 3-Hole	ADA Blade	Chrome	

\*Lifeshine® Anti-Tarnish Lifetime Finish

[www.plumbsupply.com](http://www.plumbsupply.com) • Serving our Customers Since 1946 • [www.waterconcepts.net](http://www.waterconcepts.net)

## Commercial - Institutional Faucets

### M-Biton Commercial 2-Hdl Clinic Faucet

- 4-9/16" Spout reach, 10-1/2" high spout
- 7-1/8" From deck to aerator
- 1/2" IPS connections
- Vandal resistant screws
- 1224 Cartridge design
- Flow rate: 1.2 gpm



Part #	Mfg #	Description	Handle(s)	Finish	Price
007358	8938	2- or 3-Hole	ADA Blade	Chrome	

### M-Dura Commercial Two-Handle Pantry Faucet

- 1/2" IPS connection
- Solid cast brass construction
- Vandal resistant torque screw
- Durable ceramic cartridge
- Drain & spout not included



Part #	Mfg #	Description	Handle(s)	Finish	Price
240089	8274	2-Hole Centerset, Less Spout	ADA Lever	Chrome	

### M-Dura Commercial 2-Hdl Lavatory Faucet

- 5-1/2" Spout reach, 4-1/2" spout height
- 2-7/8" From deck to aerator
- 1/2" IPS
- Vandal resistant aerator
- Drain NOT included
- Flow rate: 2.2 gpm



Part #	Mfg #	Description	Handle(s)	Finish	Price
136369	8210	2-Hole, Less Drain	ADA Lever	Chrome	
198811	8215	2-Hole, Less Drain	ADA Blade	Chrome	

### M-Dura Commercial 2-Hdl Pantry Faucet

- 3-5/8" Spout reach, 9-1/2" high spout
- 6-1/4" From deck to aerator
- 1/2" IPS connections
- Vandal resistant laminar flow aerator
- WaterSense® certified: 1.2 gpm
- (-SM) Flow rate: 2.2 gpm



8278  
Decal Handle



8278SM  
Smooth Handle

Part #	Mfg #	Description	Handle(s)	Finish	Price
199920	8278	2- or 3-Hole	ADA Decal Blade	Chrome	
243018	8278SM	2- or 3-Hole	ADA Smooth Blade	Chrome	

\*Lifeshine® Anti-Tarnish Lifetime Finish

[www.waterconcepts.net](http://www.waterconcepts.net) • Serving our Customers Since 1946 • [www.plumbsupply.com](http://www.plumbsupply.com)



## Commercial - Institutional Faucets

### Commercial Kitchen Faucets

#### M•Dura 1-Handle Commercial Brass Kitchen Faucet

- 9" Reach spout
- 3/8" Compression connection
- 22" Stainless steel supply lines
- Adjustable temperature limit stops
- Aerator is limited to 2.2 gpm Maximum
- Solid brass construction
- Optional 8" deck plate



Part #	Mfg #	Description	Handle(s)	Finish	Price
146800	8701	1- or 3-Hole	ADA Lever	Chrome	

#### M-Biton 2-Hdl Kitchen Faucet

- 8-3/4" Spout reach, 12-1/2" high
- 9-1/2" From deck to aerator
- 1/2" IPS connections
- Vandal resistant screws
- 4" Wrist blade handles
- 1224 Cartridge design
- Flow rate: 1.5 gpm



Part #	Mfg #	Description	Handle(s)	Finish	Price
017161	8799	3-Hole	ADA Wrist Blade	Chrome	

#### M-Biton 2-Hdl Kitchen Faucet

- 8-1/2" Reach, 13" high spout
- 9-1/2" From deck to aerator
- 1/2" IPS connections
- Vandal resistant screws
- 1224 Cartridge
- Flow rate: 1.5 gpm



Part #	Mfg #	Description	Handle(s)	Finish	Price
089246	8792	3-Hole	ADA Lever	Chrome	

#### M-Dura 2-Hdl Kitchen Faucet

- 8" Reach, 13-1/4" high spout
- 1/2" IPS connections
- Vandal resistant torx head screws
- 4" Wrist blade handles
- Flow rate: 2.2 gpm



Part #	Mfg #	Description	Handle(s)	Finish	Price
199719	8225	3-Hole	ADA Lever	Chrome	
116521	8289	2- or 3-Hole	ADA Wrist Blades	Chrome	

\*Lifeshine® Anti-Tarnish Lifetime Finish

[www.plumbsupply.com](http://www.plumbsupply.com) • Serving our Customers Since 1946 • [www.waterconcepts.net](http://www.waterconcepts.net)

## Commercial - Institutional Faucets

### M-Dura 1-Hdl Multi-Purpose Faucet

- 6-3/4" Spout reach, 10-3/4" high spout
- 5-3/4" From deck to aerator
- 3/8" Compression connection x 24" braided polymer supply lines
- 1255™ Duralast™ cartridge
- Flow rate: 1.5 gpm



Part #	Mfg #	Description	Handle(s)	Finish	Price
207904	8138	3-Hole with Side Spray	ADA Lever	Chrome	

### Service Sink Faucets

#### M-Dura 2-Hdl Wall-Mount Service Sink Faucet

- 9.38" Spout reach
- 1/2" Eccentric IPS connections
- Solid brass construction
- Vandal resistant torque screw
- Heavy-duty 1/4 turn ceramic disc cartridge
- Drain NOT included



Part #	Mfg #	Description	Handle(s)	Finish	Price
110751	8230	2-Hole Centerset, Wall-Mount	ADA Lever	Rough Chrome	

#### M-Dura 2-Hdl Wall-Mount Service Sink Faucet

- 10-1/4" Reach
- 1/2" IPS connections
- Brass construction
- Vacuum-breaker spout with garden hose thread
- Integral check stops
- With service stops
- Unrestricted flow



Part #	Mfg #	Description	Handle(s)	Finish	Price
027795	8124	2-Hole Centerset, Wall-Mount	ADA Lever	Chrome	

#### M-Dura 2-Hdl Wall-Mount Service Sink Faucet

- 12" Spout Reach
- 1/2" IPS connections
- Ceramic disc cartridge
- Flow rate: 1.5 gpm



Part #	Mfg #	Description	Handle(s)	Finish	Price
201039	8119	2-Hole Centerset, Wall-Mount	ADA Lever	Chrome	

\*Lifeshine® Anti-Tarnish Lifetime Finish

[www.waterconcepts.net](http://www.waterconcepts.net) • Serving our Customers Since 1946 • [www.plumbsupply.com](http://www.plumbsupply.com)

## Commercial - Institutional Faucets

### Commercial Faucet Accessories

#### M-Dura Commercial Double Bend Spout Assembly

- 10" Reach, 9-1/4" height
- 5-1/4" Height to aerator
- Includes 2.2 gpm aerator

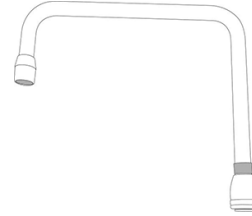

Part #	Mfg #	Description	Price
240090	S0009	Chrome	

#### M-Dura Commercial Gooseneck Spout Assembly

- Chrome-plated brass
- 5-1/4" Reach, 10" height
- 5-1/2" Height to aerator
- Includes 2.2 gpm aerator



Part #	Mfg #	Description	Price
243946	S0030	Chrome	

### Shower Trim

#### Commercial Posi-Temp® Shower Trim

- Heavy-duty brass
- 1222hd Cartridge design



Valve sold separately

Part #	Mfg #	Description	Handle(s)	Finish	Price
215321	T8375EP15	Shower Trim, 1/2" IPS, 1.5 gpm	ADA Lever	Chrome	
131233	8375	Shower Trim w/ Stops, 1/2" CC. 2.5 gpm	ADA Lever	Chrome	
034791	8370	Valve Trim Only. 1/2"	ADA Lever	Chrome	

\*Lifeshine® Anti-Tarnish Lifetime Finish

## Commercial - Institutional Faucets

### Commercial Align™ Transfer Valve Trim

- Built on M-PACT system
- Use with 3362 transfer valve
- 1/2" cc connection
- Three function, four port



Valve sold separately

Part #	Mfg #	Description	Handle(s)	Finish	Price
243259	T4192	Valve Trim Only, 3 Functions 4 Ports	ADA Lever	Chrome	

### Commercial Moentrol® Shower Trim

- 1/2" connections
- 1225™ Cartridge
- Check stops



Part #	Mfg #	Description	Handle(s)	Finish	Price
187826	8350	Valve Trim Only	ADA Lever	Chrome	

### Commercial Handheld Shower

- 30" Slide bar and drop elbow
- 69" Metal hose and mounting hardware included
- Single function with non-positive pause
- Includes integral double check valves
- Flow rate: 2.5 gpm



Part #	Mfg #	Description	Handle(s)	Finish	Price
240626	52710CBN	Classic Brushed Nickel			

\*Lifeshine® Anti-Tarnish Lifetime Finish

[www.waterconcepts.net](http://www.waterconcepts.net) • Serving our Customers Since 1946 • [www.plumbsupply.com](http://www.plumbsupply.com)

## Commercial - Institutional Faucets

### M-Dura Commercial Posi-Temp Shower Trim

- Metal construction
- Pressure balancing cycle valve design with 1/4 turn stops
- 1/2" CC connections
- Includes:
  - 3-Function transfer valve
  - Handheld Shower
  - 24" Grabbar slide
  - Drop Elbow
  - 69" Metal Hose
  - Mounting hardware
- Flow rate: 1.5 gpm



Part #	Mfg #	Description	Handle(s)	Finish	Price
236774	T9346GBM15	Shower Valve Trim w/ Handshower on 24" Grabbar	ADA Lever	Chrome	

### Commercial Posi-Temp Shower Trim

- Metal construction
- Pressure balancing cycle valve design with 1/4 turn stops
- 1/2" CC connections
- Includes:
  - 3-Function transfer valve
  - Showerhead
  - Handheld Shower
  - 30" Slidebar (NOT to be used as a grab bar)
  - Drop Elbow
  - 69" Metal Hose
  - Mounting hardware
- Flow rate: 1.5 gpm



Part #	Mfg #	Description	Handle(s)	Finish	Price
211636	T8342EP15	Includes T8342EP15 + 8371HD + 3360	ADA Lever	Chrome	
170267	8342EP15	Transfer Shower Only	ADA Lever	Chrome	

### Commercial Posi-Temp Shower Valve and Handshower

- Metal construction
- Pressure balancing cycle valve design with 1/4 turn stops
- Includes:
  - Handheld Shower
  - 30" Slidebar (NOT to be used as a grab bar)
  - Drop Elbow
  - 69" Metal Hose
  - Mounting hardware
- Flow rate: 2.5 gpm



8346



T9346

Part #	Mfg #	Description	Handle(s)	Finish	Price
206702	T8346	Shower Valve w/ HH Shower on 30" Slidebar	ADA Lever	Chrome	
089332	8346	Shower Valve w/ HH Shower on 30" Slidebar	ADA Lever	Chrome	
233875	T9346	Shower Valve w/ HH Shower on 30" Slidebar	ADA Lever	Chrome	

\*Lifeshine® Anti-Tarnish Lifetime Finish

[www.plumbsupply.com](http://www.plumbsupply.com) • Serving our Customers Since 1946 • [www.waterconcepts.net](http://www.waterconcepts.net)

## Commercial - Institutional Faucets

### Commercial Sidebar/ Grab Bar Shower Trim

- Handshower includes integral double check valves
- Single-setting handshower
- 69" Hose
- (52224GBM17) model includes eco-performance (EP) showerhead
- Flow rate: 2.5 gpm or EP 1.75 gpm



Part #	Mfg #	Description	Handle(s)	Finish	Price
243253	52224GBM17	Stainless Grab Bar Slide w/Handshower, 1.75 gpm	-	Chrome/Stainless	
229215	52224GBM25	Stainless Grab Bar Slide w/Handshower	-	Chrome/Stainless	

### Commercial Classic Slide Bar/Grab Bar Eco-Performance Handshower

- Single-function
- 3-1/4" Spray head diameter
- Includes:
  - Drop elbow
  - 69" Metal hose
  - Mounting hardware
  - 1-1/2" Dia slide bar grab bar
  - Easy cleaning rubber nozzles
- Double check valve included



Part #	Mfg #	Description	Handle(s)	Finish	Price
244910	52236GBM15C BN	Classic Brushed Nickel			

## Tub & Shower Trim

### Commercial Classic Posi-Temp® Shower Trim

- Shower arm has 1/2" IPS male threads
- Vandal resistant screws
- Single-function showerhead
- Brass rough-in valve: 8371HD
- 1222hd cartridge type
- Flow rate: 2.5 gpm



Part #	Mfg #	Description	Handle(s)	Finish	Price
244911	T8375CBN	Shower Trim Only	ADA Lever	Classic Brushed Nickel	

\*Lifeshine® Anti-Tarnish Lifetime Finish

[www.waterconcepts.net](http://www.waterconcepts.net) • Serving our Customers Since 1946 • [www.plumbsupply.com](http://www.plumbsupply.com)



## Commercial - Institutional Faucets

### Commercial Posi-Temp® Tub & Shower Trim

- Pressure balancing cycle valve design with 1/4 turn stops
- 1/2" CC connections
- Shower arm has 1/2" IPS male threads
- Diverter spout is 1/2" CC slip-fit design
- Vandal resistant screws
- Vandal resistant shower head
- 1255HD Brass cartridge design
- Flow rate: 2.5 gpm



Part #	Mfg #	Description	Handle(s)	Finish	Price
216680	8389	Tub & Shower Trim	ADA Lever	Chrome	

### Commercial Three-Function Transfer Valve Trim Kit

- Ceramic disc cartridge
- 360° handle rotation
- 1/2" CC connection
- Inlets and outlets on same plane
- Detent's at each flow position
- Vandal resistant screws



Part #	Mfg #	Description	Handle(s)	Finish	Price
244914	T8360CBN	3-Function Valve Only	ADA Lever	Brushed Nickel	

\*Lifeshine® Anti-Tarnish Lifetime Finish

## Commercial - Institutional Faucets

### Single-Handle Kitchen Faucets

#### Adapt-Faucet 1-Hdl Kitchen Faucet

- 9-1/2" L-Type swing spout
- Solid brass body construction
- Fits 1-1/16"-18 UNEF male body outlet
- 3/8" FNPT Outlet
- Mounting hardware included



Part #	Mfg #	Description	Handle(s)	Finish	Price
090794	613-ACP	1-Hole, Quatum™ Cartridge, E1 Aerator	ADA 369 Lever	CP	

#### Adapta-Faucet 1-Hdl Kitchen Faucet

- 14" Swing type spout
- Full flow outlet
- 1-1/16"-18 UNEF Female thread inlet
- 3/8" NPT Female outlet in tee



Part #	Mfg #	Description	Handle(s)	Finish	Price
127917	613-AL15E1CP	1-Hole, Quatum™ Cartridge, L13 Spout	ADA 369 Lever	CP	

### Pot Fillers

#### Wall-Mount Pot Filler

- 18" Double-jointed swing spout
- Solid brass body construction
- 1/2" FNPT Inlet with integral wall flange
- Secondary full-flow control valve with heat resistant lever handle
- Mounting hardware included
- Handles indexed hot and cold



Part #	Mfg #	Description	Handle(s)	Finish	Price
031697	515-CP	1-Hole, Quatum™ Cartridge, E31 Control Valve	ADA 369 Lever	CP	

### Two-Handle Sink Faucets

#### 50 Series 2-Hdl Deck-Mount Sink Faucet

- Solid brass body construction
- 3/8" OD Copper supply tubes
- Mounting hardware included
- Handles indexed hot and cold



Part #	Mfg #	Description	Handle(s)	Finish	Price
002890	50-CP	1-Hole, Quatum™ Cartridge, E3 Aerator, GN2A Spout	ADA 369 Lever	CP	

\* ForeverShine™ PVD Finish

**www.waterconcepts.net • Serving our Customers Since 1946 • www.plumbsupply.com**

## Commercial - Institutional Faucets

### 895 Series 2-Hdl Deck-Mount Sink Faucet

- 1/2" NPSM Supply inlet with coupling nut for 3/8" or 1/2" flexible riser
- Solid brass body construction
- Mounting hardware included
- Handles indexed hot and cold



Part #	Mfg #	Description	Handle(s)	Finish	Price
002945	895-317CP	4"cc, Quatum™ Cartridge, E3 Aerator, GN1A Spout	ADA 317 Wrist Blade	CP	
082264	895317E2805-5CP	4"cc, Quatum™ Cartridge, E2805-5 Aerator, GN1A Spout	ADA 317 Wrist Blade	CP	
023775	895-LESSPTCP	4"cc, Quatum™ Cartridge, less Spout	ADA 317 Wrist Blade	CP	

### 786 Series 2-Hdl Deck-Mount Sink Faucet

- 5-1/4" Rigid/swing gooseneck spout
- Solid brass body construction
- 1/2" NPSM Supply inlets with coupling nut for 3/8" or 1/2" flexible risers
- Mounting hardware included
- Handles indexed hot and cold



Part #	Mfg #	Description	Handle(s)	Finish	Price
002918	786-E3CP	8"cc, Quatum™ Cartridge E3 Aerator, GN2A Spout	ADA 317 Wrist Blade	CP	

### 815 Series 2-Hdl Wall-Mount Flushing Rim Sink Faucet

- 7-1/8" Rigid spout with pipe support
- Solid brass body construction
- "R" Adjustable 1/2" FNPT supply arms with integral service stop
- 3/4" Male hose thread outlet
- Mounting hardware included



Part #	Mfg #	Description	Handle(s)	Finish	Price
064156	815-VBCP	8"-13"cc, Quatum™ Cartridge, Pail Hook, 815-SVB Spout	ADA 319 Elbow Blade	CP	

### 2-Hdl Wall-Mount Sink Faucet

- 1/2"-14 NPT Male thread inlets



Part #	Mfg #	Description	Handle(s)	Finish	Price
123339	521-LESSPTCP	4"cc, Quatum™ Cartridge	ADA 369 Lever	CP	

\* ForeverShine™ PVD Finish

[www.plumbsupply.com](http://www.plumbsupply.com) • Serving our Customers Since 1946 • [www.waterconcepts.net](http://www.waterconcepts.net)

## Commercial - Institutional Faucets

### Manual 2-Hdl Deck Mount Hot and Cold Water Sink Faucet

- 8" Rigid/swing gooseneck spout reach
- ECAST® design
- Compensating softflo aerator
- 4" Vandal proof wristblade handle
- Quaturn™ compression operating cartridge
- 1/2" NPSM supply inlets and coupling nut for 3/8" or 1/2" flexible riser



Part #	Mfg #	Description	Handle(s)	Finish	Price
141641	1100-GN8AE3-317AB	8"cc, 2.2 gpm	ADA Wristblade	CP	
187822	1100-GN8AE35-317AB	8"cc, 1.5 gpm	ADA Wristblade	CP	

### Service Sink Faucets

#### 835 Series 2-Hdl Wall-Mount Service Sink Faucet

- Solid brass body construction
- Pail hook and wall brace
- Vacuum breaker spout
- 1/2" FNPT Inlets supplied from the top
- Mounting hardware included
- Handles indexed hot and cold



Part #	Mfg #	Description	Handle(s)	Finish	Price
002932	835-CP	6"cc, Quaturn™ Cartridge	633 Cross	CP	
017992	835-RCF	6"cc, Quaturn™ Cartridge	633 Cross	RCF	

#### 445 Series 2-Hdl Wall-Mount Service Sink Faucet

- Solid brass body construction
- 2-1/2" Offset inlet supply arm with 1/2" FNPT thread inlet
- Mounting hardware included
- Handles indexed hot and cold



Part #	Mfg #	Description	Handle(s)	Finish	Price
023770	445-LESSSPTCP	4"-8-3/8"cc, Quaturn™ Cartridge, E3 Aerator, less Spout	ADA 369 Lever	CP	

#### 540 Series 2-Hdl Wall-Mount Exposed Service Sink Faucet

- Solid brass body construction
- 3/8" Offset inlet supply arm with 1/2" FNPT thread inlet
- Loose wall flange
- Handles indexed hot and cold



540-LD



540-LDLESSSPT



Part #	Mfg #	Description	Handle(s)	Finish	Price
002895	540-LDCP	7-1/4"-8-3/4"cc, Quaturn™ Cartridge, E3 Aerator, S6 Spout	ADA 369 Lever	CP	
023771	540-LDLESSSPTCP	7-1/4"-8-3/4"cc, Quaturn™ Cartridge, less Spout	ADA 369 Lever	CP	

\* ForeverShine™ PVD Finish

## Commercial - Institutional Faucets

### 897 Series 2-Hdl Wall-Mount Exposed Service Sink Faucet

- With vacuum breaker spout
- Pail hook and wall brace
- Solid brass body construction
- Adjustable 1/2" FNPT supply arms
- 3/4" Male hose thread outlet
- Mounting hardware included
- Handles indexed hot and cold



Part #	Mfg #	Description	Handle(s)	Finish	Price
002949	897-CP	7-5/8"-8-3/4"cc, Quatum™ Cartridge, 897 VB Spout	ADA 369 Lever	CP	
002950	897-RCF	7-5/8"-8-3/4"cc, Quatum™ Cartridge, 897 VB Spout	ADA 369 Lever	RC	

### Pre-Rinse Faucets

#### 2-Hdl Deck-Mount Pre-Rinse Spray

- 44" Stainless steel flexible hose with insulated handle
- 23" Spring guide riser
- Integrated pipe support and hook assembly
- 1.0 gpm @ 60 psi Spray valve water conserving pre-rinse



Part #	Mfg #	Description	Handle(s)	Finish	Price
104242	919-SLCP	1-Hole, Quatum™ Cartridge, 90L Valve	less Hdl	CP	

\* ForeverShine™ PVD Finish

**www.plumbsupply.com • Serving our Customers Since 1946 • www.waterconcepts.net**

## Commercial - Institutional Faucets

### Single-Handle Lavatory Faucets

#### 1-Hdl Deck-Mount Lavatory Faucet with 5-1/4" Rigid/Swing Spout

- Single water inlet
- Solid brass body construction
- 1/2" NPSM Coupling nut for 3/8" or 1/2" flexible riser
- Mounting hardware included
- Cold indexed handle



Part #	Mfg #	Description	Handle(s)	Finish	Price
002875	350-CP	1-Hole, Quatum™ Cartridge, E3 Aerator	ADA 369 Lever	CP	

#### 1-Hdl Deck-Mount Lavatory Faucet with 4-5/8" Cast Brass Spout

- 1/2" NPSM Supply inlets for 3/8" or 1/2" flexible riser
- Mounting hardware included



Part #	Mfg #	Description	Handle(s)	Finish	Price
131091	420-CP	4"cc, Ceramic Mixing Cartridge, 1.5 gpm Non-Aerating Outlet	ADA Lever	CP	

#### Marathon™ 1-Hdl Deck-Mount Lavatory Faucet with 4-3/4" Cast Brass Spout

- Solid brass body construction
- 3/8" OD Copper supply tube inlets
- Temperature limit stop
- Mounting hardware included
- Volume control



Part #	Mfg #	Description	Handle(s)	Finish	Price
073566	2200-CP	1-Hole, Ceramic Mixing Cartridge, E12 Aerator	ADA Lever	CP	

### Electronic Lavatory Faucets

#### E-Tronic® 40 Sink Faucet

- Dual beam infrared sensor
- 6V Lithium CRP2 battery included
- Geberit Commander™ software compatible
- Replaces 116.606.21.1



Part #	Mfg #	Description	Handle(s)	Finish	Price
139528	116.606.AB.1	1-Hole, Dual Beam Infrared Sensor, Vandal Proof Spray	Electronic Sensor	CP	



## Commercial - Institutional Faucets

### HyTronic® Traditional Electronic Sensor Sink Faucet

- ECAST® construction
- Dual beam infrared sensor
- 6V lithium CRP2 battery included
- Includes optional 1.5 gpm insert
- Stainless steel hoses included
- Multiple field adjustable modes and ranges
- Compatible with Chicago Faucets Commander™ handheld programming unit



Part #	Mfg #	Description	Handle(s)	Finish	Price
136579	116.201.AB.1	1-Hole, Dual Beam Infrared Sensor	Electronic Sensor	Chrome	
149045	116.101.AB.1	1-Hole, Dual Beam Infrared Sensor	Electronic Sensor	Chrome	

**Commercial**

**Commercial Faucets**

**Hands-Free® Electric Scrub and Handwash Deck-Mount Faucet**

- 5-5/8" Reach, 11-5/8" spout height  
—Gooseneck spout
- 7-5/16" Deck clearance
- Sensor Operated
- Solid brass construction
- Electronic control module valve
- Vandal-resistant and water-resistant sensor control module
- Dual power AC and battery
- Adjustable sensor range
- Adjustable shut-off delay and time-out feature
- Maximum flow rate: 2.0 gpm
- NSF/ANSI 61 certified



Part#	Mfg#	Description	Handle(s)	Finish	Price
168437	LKB721C	1-Hole, No Spray Type	Hand-Free®	Chrome	

**Hands-Free® Electric Scrub and Handwash Wall-Mount Faucet**

- 7-1/2" Reach, 10-7/8" spout height  
—Gooseneck spout
- 6-5/8" Deck clearance
- Sensor Operated
- Solid brass construction
- Electronic control module valve
- Vandal-resistant and water-resistant sensor control module
- Dual power AC and battery
- Adjustable sensor range
- Adjustable shut-off delay and time-out feature
- Maximum flow rate: 2.0 gpm
- NSF/ANSI 61 certified



Part#	Mfg#	Description	Handle(s)	Finish	Price
144630	LKB722C	1-Hole, No Spray Type	ADA Hands Free	Chrome	

**Commercial**

**Harmony Low Flow 1-Hdl Pull-Down Kitchen Faucet**

- 8-1/2" Reach, 14-7/8" spout height, 360° swing spout rotation
- Solid brass waterway construction
- Forward only lever handle
- 3-Functions: Aerated, spray, pause
- Stainless steel coil hand spray hose
- 1/2"-14 NPSM
- 8-1/2" Deck clearance
- 2-1/2" Countertop thickness
- Ceramic disc valves
- Maximum flow rate: 1.5 gpm



Part#	Mfg#	Description	Handle(s)	Finish	Price
250418	LKHA4031AS	1-Hole, Pull Down Spray	ADA Lever	Antique Steel	

**4" Centerset 2-Hdl Scrub/Handwash Faucet with Exposed Deck and High Arc Spout**

- 8" Reach, 9" spout height
- Solid brass construction
- Choice of 3 handle options and 4 spout styles
- 1/2" NPSM male inlet shanks
- 6-1/2" Deck clearance
- Quarter turn ceramic disc cartridge
- Adjustable mounting up to 4" spread
- Includes spout swing restriction pin
- Replacement cartridge (45923C) for cold and (45924C) for hot
- NSF/ANSI 61 certified
- 2.2 gpm vandal-resistant aerator standard with 1.5 and .5 gpm insert included

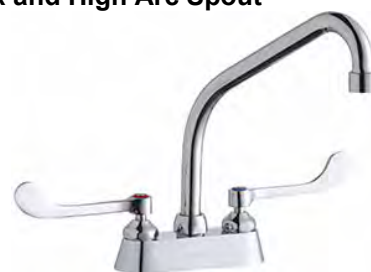

Part#	Mfg#	Description	Handle(s)	Finish	Price
181024	LK406HA08T6	2-Hole, No Spray Type	6"ADA Wrist blade	Chrome	

**2-Hdl Scrub/Handwash Wall-Mount Faucet**

- 3-1/2" reach, 8" spout height
- 5-3/8" Deck clearance
- 1/2"-14 NPSM
- NSF/ANSI 61 certified
- Maximum flow rate: 2.2 gpm



Part#	Mfg#	Description	Handle(s)	Finish	Price
168267	LKB400	2-Hole, No Spray	2" Lever	Chrome	

**Commercial**

**8" Centerset Faucet with Concealed Deck & Gooseneck Spout**

- 5" Reach, 8" spout height  
—(LK800GNO4T6) 4" reach
- Solid brass construction
- Choice of 3 handle options and 4 spout styles
- 3/8" Female compression hose assembly
- 5-1/2" Deck clearance
- Quarter turn ceramic disc cartridge
- Adjustable mounting up to 8" spread
- Includes spout swing restriction pin
- Replacement cartridge (45923C) for cold and (45924C) for hot
- NSF/ANSI 61 certified
- 2.2 gpm vandal-resistant aerator standard with 1.5 and .5 gpm insert included



Part#	Mfg#	Description	Handle(s)	Finish	Price
238051	LK800GN04T6	3-Hole, No Spray Type	ADA 6" Wrist blade	Chrome	
167994	LK800GN05T4	3-Hole, No Spray Type	ADA 4" Wrist blade	Chrome	
175742	LK800GN05T6	3-Hole, No Spray Type	ADA 6" Wrist blade	Chrome	
179345	LK800GN05L2	3-Hole, No Spray Type	ADA 2" Lever	Chrome	

**8" Centerset 2-Hdl Scrub & Handwash Faucet with Gooseneck Spout**

- 5-1/8" Reach, 11" spout height
- Solid brass construction
- Choice of 3 handle options
- 1/2" NPT female inlets
- 7-3/8" Deck clearance
- Quarter turn ceramic disc valve
- 8" Faucet hole spread
- Includes spout swing restriction pin
- Replacement cartridge (45923C) for cold and (45924C) for hot
- Optional external shut-off valve available
- NSF/ANSI 61 certified
- 2.2 gpm vandal-resistant aerator standard with 1.5 and .5 gpm insert included



Part#	Mfg#	Description	Handle(s)	Finish	Price
177337	LK940GN04L2H	2-Hole, No Spray	ADA 2" Lever	Chrome	
151707	LK940GN05T4S	2-Hole, No Spray	ADA 4" Wrist blade	Chrome	
186326	LK940GN05T6H	2-Hole, No Spray	ADA 6" Wrist blade	Chrome	

**Commercial**

**8" Centerset Foodservice Faucet with Arc Tube Spout**

- 10" reach, 6-13/16" spout height (10L2H)
- 12" Reach, 7-1/8" spout height (12T4H)
- Solid brass construction
- Choice of 3 handle options: 2" lever and 4" or 6" wristblade
- Quarter turn ceramic disc valve
- 1/2" NPT female inlets
- 4-3/16" Deck clearance
- Includes spout swing restriction pin
- Replacement cartridge 45923C for cold and 45924C for hot
- 8" Faucet hole spread
- NSF/ANSI 61 certified
- 2.2 gpm vandal-resistant aerator standard with .5 gpm insert included



Part#	Mfg#	Description	Handle(s)	Finish	Price
168416	LK940AT10L2H	2-Hole, No Spray	ADA 2" Lever	Chrome	
237109	LK940AT12T4H	2-Hole, No Spray	ADA 4" Wristblade	Chrome	

**Pre-Rinse 8" Centerset 2-Hdl Foodservice Faucet with Exposed Deck and Flexible Spout**

- 30" Reach, 41-1/8" spout height
- Solid brass construction
- 1/2"-14 NPT
- 5-1/2" Deck clearance
- Quarter turn ceramic disc valve
- 8" Faucet hole spread
- 360° swing spout rotation
- Includes spout swing restriction pin
- Replacement cartridge (45923C) for cold and (45924C) for hot
- NSF/ANSI 61 certified
- Flow rate: 1.6 gpm



Part#	Mfg#	Description	Handle(s)	Finish	Price
174008	LK843C	3-Hole, Pre-Rinse Spray	Lever	Chrome	

**Commercial**

**Pre-Rinse 8" Centerset 2-Hdl Foodservice Faucet with Flexible Spout**

- 30" Reach, 41-1/8" spout height
- Solid brass construction
- 1/2"-14 NPT
- Quarter turn ceramic disc valve
- Self closing valve
- 5-1/2" Deck clearance
- 8" Faucet hole spread
- 360° swing spout rotation
- Includes spout swing restriction pin
- 44" flexible stainless steel hose with insulated handle
- NSF/ANSI 61 certified
- Spray head flow rate: 1.6 gpm, faucet flow rate: 1.5 gpm



Part#	Mfg#	Description	Handle(s)	Finish	Price
237515	LK843AF10C	3-Hole, Pre-Rinse Spray, 10" Arc Tube Spout	Lever	Chrome	
162507	LK943AF08C	2-Hole, Pre-Rinse Spray, 8" Arc Tube Spout	Lever	Chrome	

**2-Hdl Commercial Faucet with Concealed Deck and Gooseneck Spout**

- 4" Reach, 11-5/16" spout height
- Dual control
- Solid brass construction
- Choice of 3 handle options and 3 spout styles
- 1-1/8" Unified screw thread, standard series
- 8-7/8" Deck clearance
- Quarter turn ceramic disc cartridge
- Includes spout swing restriction pin
- Replacement cartridge (45923C) for cold and (45924C) for hot
- NSF/ANSI 61 certified
- 1.5 gpm vandal-resistant aerator standard with 2.2 and .5 gpm insert included



Part#	Mfg#	Description	Handle(s)	Finish	Price
224401	LK500GN04T4	1-Hole, No Spray Type	4" ADA Wristblade	Chrome	

**2-Hdl Commercial Faucet with Exposed Deck and Gooseneck Spout**

- 4" Reach, 8-13/16" spout height
- Solid brass construction
- 6-3/16" Deck clearance
- 1/2" NPSM male valve connection
- Quarter turn ceramic disc cartridge
- Includes spout swing restriction pin
- Replacement cartridge (45923C) for cold and (45924C) for hot
- NSF/ANSI 61 certified
- 1.5 GPM water-saving aerator; optional 2.2 GPM aerator insert included



Part#	Mfg#	Description	Handle(s)	Finish	Price
244339	LK406GN04T4	2-Hole 4"cc, No Spray Type	4" ADA Wristblade	Chrome	



**Commercial**

**General Use 1-Hdl Gooseneck Spout Faucet**

- 5" Reach, 12-1/2" spout height
- Solid brass construction
- Circular brass base
- Removable cartridges
- Left or right lever handle
- 3/8" O.D. stainless flex valve connection
- Quarter turn ceramic disc cold valve
- 9-3/8" maximum deck clearance
- NSF/ANSI 61 certified
- Maximum flow rate: 1.5 gpm
- (-VR) Vandal resistant
- (-L) Lever handle on left side



Part#	Mfg#	Description	Handle(s)	Finish	Price
129350	LKD208513LC	1-Hole, No-Spray Type	ADA Lever, Left Side	Chrome	
248688	LKDVR208513C	1-Hole, No-Spray Type	ADA Lever, Right Side	Chrome	

**Classroom 1-Hdl Commercial Faucet with Gooseneck spout**

- 4" reach, 11-3/8" spout height
- Solid brass construction
- Choice of 3 handle options and spout styles
- 8-7/8" Maximum deck clearance
- 1/2"-14 NPSM
- Quarter turn ceramic disc cartridge
- Includes spout swing restriction pin  
-Replacement cartridge 45923C for cold
- NSF/ANSI 61 certified
- Maximum flow rate: 1.5 gpm



Part#	Mfg#	Description	Handle(s)	Finish	Price
175661	LK535GN04L2	1-Hole, No Spray Type	ADA 2" Lever	Chrome	

**Bar/Entertainment 2-Hdl Commercial Bar Faucet with Gooseneck spout**

- 5" reach, 12-1/2" spout height
- Solid brass construction
- Choice of 3 handle options and spout styles
- 2.6" Lever handle
- Removable cartridges
- 9-3/8" Maximum deck clearance
- 3/8" O.D stainless flex
- Quarter turn ceramic disc valve
- NSF/ANSI 61 certified
- Water saving flow Restrictor
- Maximum flow rate: 1.5 gpm



Part#	Mfg#	Description	Handle(s)	Finish	Price
168127	LKD208813C	1-Hole, No Spray Type	ADA Lever	Chrome	

**Commercial**

**3"—8" Adjustable Center 2-Hdl Foodservice Faucet with Hi Arc Spout**

- 10" Reach, 10-3/16" spout height
- Solid brass construction
- Choice of 3 handle options and 5 spout styles
- 1/2" NPT female inlets with 2" offset
- 7-11/16" Deck clearance
- Quarter turn ceramic disc valve
- 8" Faucet hole spread
- Includes spout swing restriction pin
- Replacement cartridge (45923C) for cold and (45924C) for hot
- NSF/ANSI 61 certified
- Flow rate: 1.5 gpm



Part#	Mfg#	Description	Handle(s)	Finish	Price
176398	LK945HA10L2T	2-Hole, No Spray Type	ADA 2" Lever	Chrome	

**Metered Lavatory Deck-Mount Faucet**

- Push-button
- 1-3/4" Deck clearance
- 4-1/8" Spout reach, 4-1/8" spout height
- Chrome plated brass
- Ceramic disc
- 1/2-14 NPSM



Part#	Mfg#	Description	Handle(s)	Finish	Price
236586	LK654	1-Hole	Push-Button	Chrome	

**Commercial Faucet Accessories**

**Ceramic Short Stem Cartridge with Square Mounting**

- Ceramic 1/4" turn cartridge

Part#	Mfg#	Description	Handle(s)	Finish	Price
155244	45923C	Right Hand, Cold			
155245	45924C	Left Hand, Cold			

## Commercial - Institutional Faucets

### Pre-rinse Units

#### 2-Hdl Easyinstall Wall-Mount Pre-Rinse Unit

- Wall-mount faucet (002832-40) with "pop and lock" riser installation feature
- 35-1/2" High, 15" overhang
- Spray valve (B-0107)
- 1/2" NPT Female eccentric flanged inlets (00AA)
- 18" Riser model (000369-40)
- Flexible stainless steel hose (B-0044-H)
- EPAct 2005 Compliant
- Installation kit sold separately (B-0230-K)



Part #	Mfg #	Description	Handle(s)	Finish	Price
037648	B-0133	8"cc	Lever	Pol Chrome	

#### Pre-Rinse Spray Valve

- Used on most T&S pre-rinse units
- Connects directly to T&S flexible stainless steel hose or roto-flex handle assembly



Part #	Mfg #	Description	Handle(s)	Finish	Price
010406	B-0107	Standard Spray Valve			

#### Pre-Rinse Spray Assembly

- Chrome-plated brass body
- 1/2" NPT male inlet fitting
- 1.42 GPM Self-closing angled spray valve (B-0107)
- 44" Flexible stainless steel hose w/ heat resistant handle and hold down ring



Part #	Mfg #	Description	Handle(s)	Finish	Price
220247	B-0950	Spray Assembly with Flex Hose & Spray Valve			

#### 2-Hdl Wall-Mount Pantry Faucet

- 8" Swing nozzle
- Adjustable centers from 7-3/4"-8-1/4"
- Stream regulator outlet, series 1
- 1/2" NPT female eccentric inlets with 2" flanges
- 1/4 turn Eterna compression cartridges with spring checks



Part #	Mfg #	Description	Handle(s)	Finish	Price
212764	B-2414	8"cc	Lever	Chrome	

**Commercial - Institutional Faucets**

**Sink Faucets**

**Commander® 2-Hdl Cast Brass Sink Faucet**

- *Integral stops*
- *1/4-Turn ceramic cartridges*
- *Vandal-resistant 4-arm handles with color-coded indexes*
- *Cast brass nozzle with 3/4" hose coupling discharge, pail hook and top brace*
- *1/2" NPTF Inlets*



Part #	Mfg #	Description	Price
047405	SC-5811-RCP	Rough Chrome-Plated Brass	

## Commercial - Institutional Faucets

### Service Faucets

- Vacuum breaker integral stops, adjustable wall brace, pail hook, and 3/4" hose thread on spout
- Four arm handles
- Chrome-plated



Part #	Mfg #	Description	Price
020372	830AA	8"cc	

**Kitchen Faucets & Accessories**



**Wall-Mount Sink Faucets**

**20 and 40 Washer-Type 2-Hdl Wall-Mount Faucet**

- Washer-type renew valves & seats
- Cast brass body on 8" centers
- Chrome-plated assembly
- Chrome metal blade type handles



24A



40A



49A

Part #	Mfg #	Description	Spout	Price
010493	24A-Q	1/4 Turn Valve, Female Flange Less Soap Dish	12"	
010497	40A-Q	1/4 Turn Valve, Female Flange w/Soap Dish	6"	
010500	49A-Q	1/4 Turn Valve, Female Flange w/Soap Dish	8"	



**Commercial - Institutional Faucets**

**Optima® System Faucets**

**EAF-350-ISM OptimaPlus® Battery Powered, Sensor Activated, Electronic Handwashing Faucet**

- IR-click feature
- Temperature adjustable
- Adjustable hot water limit set
- Mounting hardware included
- Bi-stable magnetic solenoid valve
- 6 Volt lithium CR-P2 commercial battery included
- Vandal resistant spray head: 0.5 gpm
- Water supply connection with flexible high pressure hose & strainer
- Double infrared sensor with automatic setting feature & microprocessor



Part #	Mfg #	Model	Description	Price
220677	3335159	EAF-350-ISM	1-Hole, Chrome	

**EBF-85 OptimaPlus® Battery Powered Hand Washing Faucet**

- Chrome-plated brass lavatory faucet with engineered plastic throat plate
- 0.5 Flow control aerator
- Fiber-Optic adaptive sensor
- Water-tight circuit control module
- Integral filtered solenoid valve
- (4) "C" Cell alkaline batteries



Part #	Mfg #	Model	Description	Price
022204	3315010	EBF-85-M	Back Check, 4" Trim Plate	

**Optima® Battery-Powered Deck-Mounted Mid Body Faucet**

- Commercial Grade, ADA Compliant, Electronic, SensorActivated, Die-Cast Metal Hand Washing Faucet with the following features:
- Double infrared sensors with automatic setup and indicator light
- Automatic self-adapting sensor technology
- Low battery indicator
- Magnetic solenoid valve
- Water supply connection with flexible high-pressure hose and strainer
- 6 Volt lithium 2CR5 commercial battery included
- Appropriate mounting hardware included
- Optional 24 hour sentinel activation
- 3 year limited warranty



Part #	Mfg #	Model	Description	GPF	Spud	Price
099272	3335000	EAF-150-CP			1-Hole, Chrome	

**Commercial - Institutional Faucets**

**EBF-650 Optima® Battery Powered, Sensor Activated Handwashing Faucet**

- 4" Centerset
- Flow rate: 0.5 gpm
- Chrome-plated cast brass
- Splash-proof circuit control module
- Serviceable filtered solenoid valve
- Mounting hardware included
- Sensor range adjustment screw
- Variable time out settings
- Metal jacketed wire protection
- Includes (4) AA-size batteries
- Vandal resistant spray head with pressure compensating flow control



Part #	Mfg #	Model	Description	Price
047688	3315025	EBF-650	Polished Chrome	

**ETF-610 Optima® Sensor Activated Handwashing Faucet with Pedestal Spout**

- 4" Trim plate
- Flow rate: 0.5 gpm
- (-LT) less transformer
- Chrome-plated cast brass
- Splash-proof circuit control module
- Serviceable filtered solenoid valve
- Mounting hardware included
- Sensor range adjustment screw
- Variable time out settings
- Metal jacketed wire protection
- Includes (4) AA-size batteries
- Vandal resistant spray head with pressure compensating flow control



Part #	Mfg #	Model	Description	Price
113455	3365293	ETF-610-4-LT	1-Hole	

**EFT-600 Optima® Sensor Activated Electronic Handwashing Faucet**

- 4" Centerset
- Flow rate: 0.5 gpm aerator spray head
- (-LT) less transformer
- Chrome-plated cast brass
- Splash-proof circuit control module
- Serviceable filtered solenoid valve
- Sensor range adjustment screw
- Variable time out settings
- Metal jacketed wire protection
- Modular quick-release sensor and solenoid connections
- Vandal resistant spray head with pressure compensating flow control



Part #	Mfg #	Model	Description	Price
049564	3365055	EFT-600-LT-CP	Polished Chrome	

**Commercial - Institutional Faucets**

**Optima® System Faucets (Continued)**

**EFT-600 Optima® Sensor Activated Electronic Handwashing Faucet**

Part #	Mfg #	Model	Description	Price
218769	3365055	EFT-600-LT-CP	Polished Chrome, Made in USA	
106967	3365330	EFT-600-P-CP	Polished Chrome	

**AC51-2.5 PVDSF Act-O-Matic Shower Head**

- "Cone within a cone" spray pattern
- Spring-loaded, self-cleaning spray disk
- Pressure-compensating flow: 2.5 gpm/9.4lpm



Part #	Mfg #	Finish	Price
206874	4021000	Polished Chrome	

**Commercial - Institutional Faucets**

**HydroGuard® Tempering Valves**

**HydroGuard® XP Series ES150 Emergency Tempering Valve with Cold Water Bypass**

- Advanced thermal actuator provides precise temperature control
- Internal cold water bypass ensures cold water flow in the event of loss of hot water
- Flow effectively shuts down upon loss of cold water supply when tested under the condition specified in ASSE 1071 standard
- Vandal-resistant locking mechanism to secure temperature setting
- Factory tested
- Checkstops to prevent cross flow
- 1/2" NPT Inlet and outlet connections
- Maximum operating pressure: 125 psi
- Maximum hot water temperature: 180°F
- Bypass flow rate @ 30 psid: 6.5 gpm
- Maximum flow with cold water shut-off: 0.5 gpm



Part #	Mfg #	Description	Price
074242	ES150-11	Temperature/Pressure Gauge on Outlet, Rough Bronze	

**LM495 Series Thermostatic Mixing Valve for Individual Lavatory Installations**

- Advanced thermal actuator improves performance at low flow
- Solid bronze construction enhances durability
- Adjustable temperature selection with lock down
- Union connections for easy maintenance
- Integral checks and screen prevents cross-flow and contamination
- Temperature control to ASSE 1069, 1070 down to 0.5 gpm
- Maximum operating pressure: 125 psi
- Maximum hot water temperature: 200°F



Part #	Mfg #	Description	Price
092105	LM495-1	1/2" NPT Female	

**e480 Series Under-the-Counter Combination Tempering Valve for Low Flow Control**

- Adjustable temperature selection with locknut to prevent tampering
- Advanced thermal actuator improves performance
- Temperature controls to ASSE 1070, down to 0.5 gpm
- Solid brass construction enhances durability
- Corrosion resistant internal components for extended life
- Integral checks with screens prevents cross flow and filter out debris
- Factory set to 105°F
- Maximum operating pressure: 125 psi
- Maximum hot water temperature: 180°F



Part #	Mfg #	Description	Price
101202	E480-10	3/8" Compression, Rough Bronze	

## Digital Shower Trim

### Digital Shower Interfaces

#### DTV+™ Digital Interface

- Can control shower outlets, audio output, chromatherapy, steam and lighting, allowing user to control their experience from a single interface
- System warm up & pause feature
- Duration/countdown timer
- Up to three interfaces can be connected to each system for alternate locations and applications
- Can control up to two digital valves to provide two different shower temperatures
- Six user definable presets provide easy to use selection of saved favorite settings
- Surface mount installation
- (-P) is compatible with Real Rain software and features 14 different language options



Requires K-99694 Interface Mounting Bracket & K-99695 System Controller Module

Part #	Mfg #	Description	Price
239262	K-99693-P-N A	NA	

#### DTV+™ Interface Mounting Bracket



Part #	Mfg #	Description	Price
173651	K-99694-BL	Matte Black	
174491	K-99694-BN	*Brushed Nickel	
174353	K-99694-CP	Polished Chrome	
175273	K-99694-SN	Polished Nickel	

### DTV Prompt® Digital Interface

- Digitally controlled
- High-temperature limit setting for added safety
- Mounts on finished wall surface
- One touch control of 2 valve outlets
- Interface includes a 2-ft cable
- Low profile design
- Selectable water-saving functionality
- Selectable Fahrenheit or Celsius
- Selectable outlet delivery



Part #	Mfg #	Description	Price
158665	K-527-0	White	
146693	K-527-1CP	Satin Chrome w/ Pol Chrome	
140766	K-527-1SN	Satin Nickel with Pol Nickel	
160202	K-527-7	Black	

### DTV Prompt® 3-Outlet Digital Interface

- Large, easy to read LCD display displays time and temperature
- Raised one touch buttons for simple and intuitive system control
- Provides independent control of up to three outlets
- Suitable for multi outlet shower or bath/shower applications
- System warm up and pause feature
- Duration/countdown timer feature



Requires: K-559 Mounting Bracket  
K-557-K 3-Port Valve

Part #	Mfg #	Description	Price
183587	K-558-0	White	
186522	K-558-7	Black Black	
174342	K-558-1CP	Satin Chrome w/ Pol Chrome	
176496	K-558-1SN	Satin Nickel with Pol Nickel	

\* Vibrant Limited Lifetime Warranty

[www.plumbsupply.com](http://www.plumbsupply.com) • Serving our Customers Since 1946 • [www.waterconcepts.net](http://www.waterconcepts.net)

## Digital Shower Trim

### DTV Prompt® Interface Mounting Bracket

- For surface mounting DTV prompt digital interface



Part #	Mfg #	Description	Price
186523	K-559-BL	Matte Black	
183588	K-559-BN	*Brushed Nickel	
174347	K-559-CP	Polished Chrome	
176497	K-559-SN	*Polished Nickel	

### DTV Components

#### DTV Prompt® Three-Port Thermostatic Valve



Part #	Mfg #	Description	Price
174343	K-557-K-NA	NA	

#### DTV+™ Digital Three-Port Thermostatic Valve



Part #	Mfg #	Description	Price
183586	K-557-K1-NA	NA	

#### DTV® Six-Port Thermostatic Valve

- Digitally controlled
- Internal brass mixing valve
- Scald hazard prevention
- Cross flow prevention
- Six independent water outlets
- Mounts within a standard 2x4 wall
- 3/4" NPT inlet and 1/2" NPT outlet connections
- Maximum flow rate: 21.0 gpm



Requires K-684 DTV Interface for DTV System

Requires K-695 DTV II Interface and K-638-K Media Module for DTV II System

Requires K-99693 DTV+ Interface, K-99695 DTV+ Controller Module, and K-97172 DTV+ Media Cable for DTV+ System

Part #	Mfg #	Description	Price
099356	K-682-K-NA	NA	

### DTV® Two-Port Thermostatic Valve



Part #	Mfg #	Description	Price
140767	K-528-K-NA	NA	

### DTV+™ System Controller Module

- Provides power to the interfaces and controls digital valves
- Integrated web pages for system set up and configuration using a computer/laptop connected via router or connection to home network
- Two ports for connecting digital valve(s)
- Eight ports for interface(s) and other system component connections
- One Ethernet port for hard wire connection to home network or via Wi-Fi adapter
- One jack for power cord connection



Requires K-99693 Digital Interface

Part #	Mfg #	Description	Price
173650	K-99695-NA	NA	

### DTV+™ Data Cable

- 30ft Cable length
- Cable length can be extended using standard CAT5 Ethernet cable and coupler



Requires K-682-K DTV® thermostatic valve & K-99695 DTV+ system controller module

Part #	Mfg #	Description	Price
173652	K-97172-NA	NA	

\* Vibrant Limited Lifetime Warranty

[www.waterconcepts.net](http://www.waterconcepts.net) • Serving our Customers Since 1946 • [www.plumbsupply.com](http://www.plumbsupply.com)



## Digital Shower Trim

### DTV+™ Amplifier Module

- Digitally controlled thermostatic mixing valve.
- Anti scald protection.
- Three independently controllable 1/2" outlets with copper tube connections.
- Up to 13 gpm maximum flow rate (8.0 gpm maximum flow from one outlet).
- 1/2" inlets with copper tube connections.
- Includes filter screens.
- High temperature limit setting for additional protection.



Part #	Mfg #	Description	Price
175274	K-99696-NA	NA	

### DTV+™ Conversion Kit for DTV I Interface

- Upgrade an existing installed primary interface (K-684) to the DTV+™ interface (K-99693)
- Kit includes cover plate, required cables, and a wiring connection adapter.
- DTV I landscape primary interfaces (K-683) cannot be upgraded to the new DTV+™ interface
- Requires K-99693 DTV+™ interface and K-99695 system controller module (sold separately)



Part #	Mfg #	Description	Price
189032	K-99702-NA	NA	

### DTV+™ Conversion Kit for DTV II Interface

- Upgrade an existing installed primary interface (k-695) to the DTV+™ interface (k-99693)
- DTV II landscape primary interfaces (k-694) cannot be upgraded to the new DTV+™ interface
- Requires k-99693 DTV+™ interface and k-99695 system controller module (sold separately)



Part #	Mfg #	Description	Price
187827	K-97170-NA	NA	

### DTV+™ Conversion Kit for DTV I/II Auxiliary Interface

- Upgrade an existing installed primary interface (k-686) to the DTV+™ interface (k-99693-p)
- DTV II landscape primary interfaces (k-685) & (k-657) cannot be upgraded to the new DTV+™ interface
- Requires k-99693-p digital interface (sold separately)



Part #	Mfg #	Description	Price
252638	K-97171-NA	NA	

### Speaker

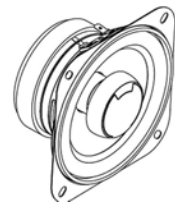

Part #	Mfg #	Description	Price
246541	1068186	Speaker	

### SoundTile® Speakers

- Can be used with any audio system and also integrated with the DTV II
- Mounts within standard 2- by 4-inch walls or ceilings
- Installs after finished wall is complete
- Sold in pairs



Requires K-10609-A or K-10609-B Cable Kit

Part #	Mfg #	Description	Price
143946	K-8033-AF	*French Gold	
113544	K-8033-BN	Brushed Nickel	
122133	K-8033-BV	*Brushed Bronze	
113120	K-8033-CP	Polished Chrome	
149147	K-8033-SN	*Polished Nickel	
162517	K-8033-2BZ	Oil Rubbed Bronze	

\* Vibrant Limited Lifetime Warranty

[www.plumbsupply.com](http://www.plumbsupply.com) • Serving our Customers Since 1946 • [www.waterconcepts.net](http://www.waterconcepts.net)

---

---

**Faucet Accessories**

---

---

**Faucet Parts & Accessories**

Faucet Hole Cover



Part #	Mfg #	Size	Price
008040	1275	1-3/4"	
008039	1274	2"	

**Faucet Accessories**

**Rinse Quiks**

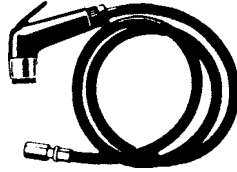

Part #	Mfg #	Description	Price
003059	R392500	MR-422-4 Rinse Quik	

**Rinse Quik Head**

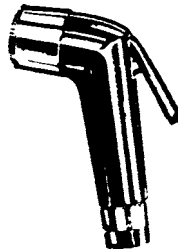

Part #	Mfg #	Description	Price
003058	R392900	MR-422 Head, Black	
117698	R392930	MR-427-C Head, Chrome	

## Faucet Handles

### Lavatory Faucet Handles

#### Addison™ Lever Handle Kit

- Sold in pairs



Part #	Mfg #	Description	Price
169215	H292	Chrome	
240655	H292SS	Stainless*	

#### Cassidy™ Handle Kit

- Sold in pairs
- For kitchen, bar/prep, deck-mount lavatory, and bidet applications



H295



H297



H298

Part #	Mfg #	Description	Price
151990	H295	Chrome	
152779	H295CZ	Champagne Bronze™	
165669	H295PN	Polished Nickel*	
150954	H295RB	Venetian Bronze®	
152780	H295SS	Stainless*	
151501	H297	Chrome	
152782	H297CZ	Champagne Bronze™	
160504	H297PN	Polished Nickel*	
152372	H297RB	Venetian Bronze®	
152783	H297SS	Stainless*	
152784	H298	Chrome	
152785	H298CZ	Champagne Bronze™	
157706	H298PN	Polished Nickel*	
152029	H298RB	Venetian Bronze®	
152786	H298SS	Stainless*	

#### Compel® Faucet Handles

Part #	Mfg #	Description	Price
172972	H261	Chrome	
175511	H261-SS	Stainless*	

### Metal Cross Handle Set



Part #	Mfg #	Description	Price
003467	H26	Chrome	

### Lahara™ Lever Handle Kit

- Sold in pairs



Part #	Mfg #	Description	Price
118892	H238	Chrome	
168302	H238-RB	Venetian Bronze®	
161560	H238-SS	Stainless*	

### Leland™ Lever Handle Kit

- SpotShield®



Part #	Mfg #	Description	Price
244702	RP63195AR	Arctic Stainless	

### Leland™ Lever Handle Kit

- Includes screws and finial for lavatory/bidet
- Sold in pairs



Part #	Mfg #	Description	Price
083847	H278	Chrome	
092300	H278RB	Venetian Bronze®	
082337	H278SS	Stainless*	

\* Brilliance® Anti-Tarnish Lifetime Finishes

## Faucet Handles

### Leland™ Porcelain Lever Handle kit

- Includes screws and finial for lavatory/bidet
- Sold in pairs



Part #	Mfg #	Description	Price
088850	H277	Chrome	

### Linden™ 14 Series Lavatory Handle Kit

- Metal lever



Part #	Mfg #	Description	Price
257940	RP84702SS	Stainless*	
242343	RP84702RB	Venetian Bronze	

### Linden™ Traditional Lever Handle Kit

- Sold in pairs



Part #	Mfg #	Description	Price
227684	H293	Chrome	
225670	H293RB	Venetian Bronze	

### Linden™ Lever Handle Kit

- Sold in pairs



Part #	Mfg #	Description	Price
159266	H294	Chrome	
150733	H294-SS	Stainless*	

### Rook™ Cross Handle Kit

- Sold in pairs



Part #	Mfg #	Description	Price
188958	HX5361-PC	Chrome	

### Stryke™ Handle Kit

- Includes set screw and allen wrench



Part #	Mfg #	Description	Price
258864	H550	Chrome	
259753	H550BL	Matte Black	
257874	H550CZ	Champagne Bronze™	
259430	H550SS	Stainless*	
258759	H551BL	Matte Black	
259789	H551CZ	Champagne Bronze™	
257796	H551SS	Stainless*	

### Trinsic™ Diverter Handle

- Includes set screw



Part #	Mfg #	Description	Price
239506	RP73365SS	Stainless*	

### Trinsic™ Lever Handle Kit

- Sold in pairs



Part #	Mfg #	Description	Price
167632	H259	Chrome	

\* Brilliance® Anti-Tarnish Lifetime Finishes

## Faucet Handles

### Vero™ Handle Kit

- Sold in pairs



Part #	Mfg #	Description	Price
171384	H253	Chrome	
164947	H253-SS	Stainless*	

### Classic Clear Knob Handles



Part #	Mfg #	Description	Price
003570	H21	Clear	

### Victorian® Metal Lever Handle Kit

- Includes screws and finial
- For kitchen, bar, lavatory, 2- or 3-H handle tub/shower, or bidet
- Sold in pairs



Part #	Mfg #	Description	Price
054268	H216	Chrome	
054273	H216RB	Venetian Bronze®	
061837	H216SS	Stainless*	

### Porcelain Lever Handle Kit

- Traditional style includes screws and finial
- For kitchen, bar, lavatory, 2- or 3-H handle tub/shower, or bidet
- Sold in pairs



Part #	Mfg #	Description	Price
045768	H212	Chrome	
063729	H212SS	Stainless*	
054267	H212RB	Venetian Bronze®	

### Metal Lever Handle

- Requires A24 accents



Part #	Mfg #	Description	Price
024068	H24	Chrome	
024045	A24	Chrome Handle Accent for H24	

### Lavatory Lever Handle With Set Screw

- For 500 series lavatory faucets



Part #	Mfg #	Description	Price
003518	RP17443	Chrome	
027044	RP17443PB	Polished Brass*	

### Traditional Lever Handle Kit

- Neo Style® includes screws and finials
- For kitchen, bar, lavatory 2- or 3-H tub/shower/bidet
- Sold in pairs



Part #	Mfg #	Description	Price
003448	H25	Chrome	

### Traditional® Metal Lever Handle Kit

- Includes screws and finial
- For kitchen, bar, lavatory, 2- or 3-H tub/shower, or bidet
- Sold in pairs



Part #	Mfg #	Description	Price
097619	H215SS	Stainless*	

### Small Blade Handle Kit

- Includes buttons, screws and finial
- For kitchen, bar, Centerset lavatory, 2-H tub/shower



Part #	Mfg #	Description	Price
003679	H28	Chrome	

\* Brilliance® Anti-Tarnish Lifetime Finishes

www.waterconcepts.net • Serving our Customers Since 1946 • www.plumbsupply.com



## Faucet Handles

### Roman Tub Faucet Handles

#### Cassidy™ Lever Roman Tub Handle Kit

- Metal handles
- Sold in pairs
- For Roman tub applications



H695



H697



H698

Part #	Mfg #	Description	Price
152963	H695	Chrome	
152965	H695CZ	Champagne Bronze™	
152966	H695PN	Polished Nickel*	
152943	H695RB	Venetian Bronze®	
152967	H695SS	Stainless*	
151506	H697	Chrome	
152976	H697CZ	Champagne Bronze™	
152977	H697PN	Polished Nickel*	
151695	H697RB	Venetian Bronze®	
151698	H697SS	Stainless*	
152971	H698	Chrome	
152972	H698CZ	Champagne Bronze™	
152973	H698PN	Polished Nickel*	
152974	H698RB	Venetian Bronze®	
152975	H698SS	Stainless*	

### Innovations Roman Tub Handles

- Metal Lever
- Requires accent A64 for complete handle set



H64

A64

Part #	Mfg #	Description	Price
024076	H64	Chrome	
024051	A64	Chrome Handle Accent	

### Lahara® Roman Tub Handle Assembly



Part #	Mfg #	Description	Price
162207	RP51289CZ	Champagne Bronze™	
173145	RP51289RB	Venetian Bronze®	
153569	RP51289SS	Stainless*	

### Leland™ Single Bath Handle

- Includes screws
- Sold as single handle



Part #	Mfg #	Description	Price
103162	H578	Chrome	
117385	H578RB	Venetian Bronze®	
099488	H578SS	Stainless*	

### Leland™ Lever Handle Kit

- Includes screws
- For Roman tub
- Sold in pairs



Part #	Mfg #	Description	Price
084239	H678	Chrome	
092299	H678RB	Venetian Bronze®	
084393	H678SS	Stainless*	

### Lockwood™ Lever Handle Kit

- Metal
- Sold individually



Part #	Mfg #	Description	Price
195898	H640SS	Stainless*	

\* Brilliance® Anti-Tarnish Lifetime Finishes

## Faucet Handles

### Single Blade Handle Kit - Transfer Valve



Part #	Mfg #	Description	Price
175929	RP62097	Transfer Valve Handle Kit	
155271	RP62097-SS	Transfer Valve Handle Kit	

### Victorian® Lever Handle Kit

- Metal lever
- For Roman tub
- Sold in pairs



Part #	Mfg #	Description	Price
054224	H616	Chrome	
145819	H616CZ	Champagne Bronze™	
054230	H616PB	Polished Brass	
054231	H616RB	Venetian Bronze®	
076076	H616SS	Stainless*	

### Victorian® Transfer Valve Lever Handle Kit



Part #	Mfg #	Description	Price
054240	H516PB	Polished Brass*	

### Windemere® Lever Handle Kit

- Metal lever
- For Roman tub
- Sold in pairs

Part #	Mfg #	Description	Price
250420	RP62150	Chrome	

### Shower Valve Faucet Handles

#### Addison™ 14 Series Lever Handle

- Recommend RP26853 wrench for installation



Part #	Mfg #	Description	Price
255389	RP61268RB	Venetian Bronze	
177447	RP61268SS	Stainless*	

#### Ara™ 14 Series Lever Handle



RP75437



RP79166

Part #	Mfg #	Description	Price
254640	RP75437SS	Square, Stainless*	
179368	RP79166SS	Round, Stainless*	

### Tub & Shower Clear Knob Handle



Part #	Mfg #	Description	Price
003525	H71	Clear	

### Medium Clear Knob Handle Kit

- Includes buttons, screws and finial
- For kitchen, lavatory with screwdriver stops, 2- or 3-H tub and shower, or 2714 & 2708 series models
- Sold in pairs



Part #	Mfg #	Description	Price
025031	H41	For CP/BS/NC/NN/WC/WH	

\* Brilliance® Anti-Tarnish Lifetime Finishes

## Faucet Handles

### Clear Knob Handle

- Includes hot/cold arrow buttons and screws
- For basin or 3-H tub/shower
- Sold as single handle



Part #	Mfg #	Description	Price
022373	H11	For CP/BS/NC/NN/WC/WH	

### Large Porcelain Cross Handle

- Includes arrow indicator and screw
- For Monitor® 1400 series
- Sold as single handle



Part #	Mfg #	Description	Price
003566	H77	Chrome	

### Large Blade Handle

- Includes screws
- For Monitor® 1300, 1400 series
- Sold as single handle



Part #	Mfg #	Description	Price
016915	H78	Chrome	

### Large Lever Handle

- For Monitor® 1300, 1400 series
- Sold as single handle



Part #	Mfg #	Description	Price
020138	H79	Chrome	

### Cassidy™ Monitor 13/14 Series Shower Handle

- Sold as single handle
- For shower and tub/shower valves



H795 Cross



H797 Lever



H798 Decorative

Part #	Mfg #	Description	Price
151994	H795	Chrome	
153013	H795CZ	Champagne Bronze™	
153023	H795PN	Polished Nickel*	
152946	H795RB	Venetian Bronze®	
152714	H795SS	Stainless*	
151515	H797	Chrome	

### Shower Valve Faucet Handles (Continued)

#### Cassidy™ Monitor 13/14 Series Shower Handle

Part #	Mfg #	Description	Price
153029	H797CZ	Champagne Bronze™	
153031	H797PN	Polished Nickel*	
152962	H797RB	Venetian Bronze®	
153033	H797SS	Stainless*	
153024	H798	Chrome	
153025	H798CZ	Champagne Bronze™	
153026	H798PN	Polished Nickel*	
153027	H798RB	Venetian Bronze®	
153028	H798SS	Stainless*	

#### Cassidy™ Diverter Trim Handle Options

- Sold as single handle
- Fits Cassidy transfer valve trim



H595 Cross



H597 Traditional



H598 Decorative

Part #	Mfg #	Description	Price
152988	H595	Chrome	
152991	H595-SS	Stainless*	
152990	H595-PN	Polished Nickel*	
152989	H595-CZ	Champagne Bronze™	
151551	H595-RB	Venetian Bronze®	
152238	H597	Chrome	
151701	H597-SS	Stainless*	
153012	H597-PN	Polished Nickel*	
153011	H597-CZ	Champagne Bronze™	
150952	H597-RB	Venetian Bronze®	
153006	H598	Chrome	
153010	H598-SS	Stainless*	
153008	H598-PN	Polished Nickel*	
153007	H598-CZ	Champagne Bronze™	
153009	H598-RB	Venetian Bronze®	

\* Brilliance® Anti-Tarnish Lifetime Finishes

[www.plumbsupply.com](http://www.plumbsupply.com) • Serving our Customers Since 1946 • [www.waterconcepts.net](http://www.waterconcepts.net)

## Faucet Handles

### Contemporary 14 Series Single Lever Handle Kit

- Sold as single handle
- For 14 Series shower and tub/shower valves



Part #	Mfg #	Description	Price
173915	RP75437SS	Stainless*	

### Innovation® 14 Series Single Lever Handle

- H74 requires A74 accent to complete handle



H74--A74

Part #	Mfg #	Description	Price
024080	H74	Handle, Chrome	
024056	A74	Accent, Chrome	

### Lahara® 14 Series Single Lever Handle Kit

- Sold as single handle
- For 14 Series shower and tub/shower valves
- Recommend RP26853 wrench for installation



Part #	Mfg #	Description	Price
164475	RP51304	Chrome	
177518	RP51304SS	Stainless*	

### Leland™ Lever Handle

- Sold as single handle
- For shower and tub/shower valves



Part #	Mfg #	Description	Price
083920	H778	Chrome	
093874	H778RB	Venetian Bronze®	
082328	H778SS	Stainless*	

### Vero® 14 Series Metal Lever Handle Kit



Part #	Mfg #	Description	Price
260107	RP51037	Chrome	

### Victorian® Metal Lever Handle

- Includes screw
- For 1400 series model
- Sold as single handle



H716

Part #	Mfg #	Description	Price
055893	H716	Chrome	
055784	H716RB	Venetian Bronze®	
075147	H716SS	Stainless*	
044573	H712	Chrome, Porcelain Accent	

### 14 Series Handle



Part #	Mfg #	Description	Price
185943	RP73376	Chrome	

### 14 Series Handle Assembly



Part #	Mfg #	Description	Price
171316	RP70639SS	Stainless*	

### Stryke™ Integrated Diverter Lever Handle

- Includes set screw and allen wrench



H559



H560

Part #	Mfg #	Description	Price
260571	H559	Chrome	
260934	H559BL	Matte Black	
259078	H559SS	Stainless*	
260168	H560SS	Stainless*	

\* Brilliance® Anti-Tarnish Lifetime Finishes

## Faucet Handles

### Single Metal Lever Handle Kit

- For 14 series shower and tub/shower trim



Part #	Mfg #	Description	Price
180772	RP52587SS	Stainless*	

### Handle Assembly

- For 14 series shower and tub/shower trim



Part #	Mfg #	Description	Price
185734	RP77090-SS	Stainless*	

\* Brilliance® Anti-Tarnish Lifetime Finishes

[www.plumbsupply.com](http://www.plumbsupply.com) • Serving our Customers Since 1946 • [www.waterconcepts.net](http://www.waterconcepts.net)

**Faucet Handles**

**Lavatory Faucet Handles**

**Baliza® Lavatory Handle Kit**

- ADA Compliant
- Handle kit assembly
- Sold in pairs



Part #	Mfg #	Description	Price
141934	HL505-BN	Brushed Nickel*	
171322	HL505-BZ	Brushed Bronze*	
144002	HL505-PC	Chrome	
159399	HL505-PN	Polished Nickel*	
139208	HL505-RB	Venetian Bronze®	

**Baliza® Cross Lavatory Handle Kit**

- ADA Compliant
- Handle kit assembly
- Sold in pairs



Part #	Mfg #	Description	Price
237126	HX505-PC	Chrome	
154639	HX505-RB	Venetian Bronze®	

**Cassidy™ Bidet Finial**



Part #	Mfg #	Description	Price
237714	RP73818PN	Polished Nickel*	

**Charlotte™ Lavatory Handle Kit**

- ADA Compliant
- Sold in pairs



Part #	Mfg #	Description	Price
180679	HL5385-BN	Brushed Nickel*	
177589	HL5385-PC	Chrome	
155366	HL5385-PN	Polished Nickel*	
144007	HL5385-PNC	Cocoa Bronze™/Pol Nickel	

**Charlotte™ Vessel Handle Kit**

- Handle kit assembly
- Sold in pairs



Part #	Mfg #	Description	Price
166544	HL5485-BN	Brushed Nickel*	
164023	HL5485-PNC	Cocoa Bronze™/Pol Nickel	

**Charlotte™ Vessel Wall-Mount Handle Kit**

- ADA Compliant
- Handle kit assembly
- Sold in pairs



Part #	Mfg #	Description	Price
147187	HL5885-PNC	Cocoa Bronze™/Pol Nickel	

**Levoir™ Diverter Handle Kit with Pressure Balance Valve**



HL75P98



HX75P98



Part #	Mfg #	Finish	Handle	Price
253990	HL75P98-PN	Polished Nickel*	Lever	
252811	HX75P98-SL	Luxe Steel,	Cross	

**Levoir™ Pressure Balance Tub Handle Kit**



HX60P9



HL60P9

Part #	Mfg #	Finish	Handle	Price
255369	HX60P98-GL	Luxe Gold,	Cross	

\* Brilliance® Anti-Tarnish Lifetime Finishes



**Faucet Handles**

**Levoir™ Widespread Low Lever Tub Handle Kit**



HX5397



HL5397

Part #	Mfg #	Finish	Handle	Price
255363	HX5397-GL	Luxe Gold, Cross		

**Litze™ Lavatory Handle Kit**



HL5333  
T-Lever



HL5334  
Industrial Lever



HL5332  
Lever



HL5335  
Extended

Part #	Mfg #	Description	Price
238666	HL5332-GL	Luxe Gold	
243569	HL5332-NK	Luxe Nickel	
229518	HL5332-NKTK	Luxe Nickel/Teak Wood	
243241	HL5332-PC	Chrome	
243592	HL5332-PCTK	Chrome/Teak Wood	
242863	HL5333-GL	Luxe Gold	
246559	HL5333-PC	Chrome	
230163	HL5333-NK	Luxe Nickel	
242289	HL5334-GL	Luxe Gold	
237552	HL5334-PC	Chrome	
246798	HL5334-PN	Polished Nickel*	
257508	HL5335-GL	Luxe Gold	

**Litze™ Tempassure® Thermostatic Valve with Diverter Trim Handle Kit**

- Textural knurling detail



Part #	Mfg #	Finish	Handle	Price
247037	HL7532-PC	Chrome	Lever	
240680	HL7532-PN	Polished Nickel*	Lever	
237819	HL7533-PC	Chrome	T-Lever	
254946	HL7533-GL	Luxe Gold	T-Lever	

**Litze™ Tempassure® Thermostatic Trim Handle Kit**



Part #	Mfg #	Finish	Handle	Price
245452	HL6032-GL	Luxe Gold	Lever	
243663	HL6032-NK	Luxe Nickel	Lever	
243244	HL6032-PC	Chrome	Lever	
243462	HL6033-GL	Luxe Gold	T-Lever	
230165	HL6033-NK	Luxe Nickel	T-Lever	
242291	HL6034-GL	Luxe Gold	Industrial Lever	
247289	HL6034-PC	Chrome	Industrial Lever	
257380	HL6034-PN	Pol Nickel*	Industrial Lever	

**Litze™ Sensori® Thermostatic Trim Handle Kit**

- T-Lever
- Textural knurling detail



Part #	Mfg #	Finish	Handle	Price
243452	HL6633-GL	Luxe Gold	T-Lever	

**Litze™ Sensori® Volume Control Trim Handle Kit**

- T-Lever
- Textural knurling detail
- 45-80 psi working pressure
- Rough-in sold separately



Part #	Mfg #	Finish	Handle	Price
243453	T66633-GL	Luxe Gold	T-Lever	

**Litze™ Diverter Trim Handle Kit**

- 3 and 6 setting



Industrail Lever

Part #	Mfg #	Finish	Handle	Price
245453	HL932-GL	Luxe Gold	Lever	
246928	HL933-NK	Luxe Nickel	T-Lever	
242293	HL934-GL	Luxe Gold	Industrial Lever	

\* Brilliance® Anti-Tarnish Lifetime Finishes

**Faucet Handles**

**Litze™ 1-Hdl Freestanding Tub Filler Handle Kit**



HL7032  
Lever



HL7034  
Industrail Lever



HL7033  
T-Lever

Part #	Mfg #	Finish	Handle	Price
245451	HL7032-GL	Luxe Gold	Lever	
248016	HL7032-NKTK	Luxe Gold/Teak Wood	Lever	
243465	HL7033-GL	Luxe Gold	T-Lever	
237824	HL7033-PC	Chrome	T-Lever	
245331	HL7034-PC	Chrome	Industrial Lever	

**Rook™ Lavatory Handle Kit**



HL5360



HX5361-NKB

Part #	Mfg #	Description	Price
185805	HL5360-NK	Lever, Luxe Nickel*	
233670	HL5360-NKBL	Luxe Nickel/Matte Black*	
249463	HX5360-PC	Chrome	
222019	HL5360-RB	Lever, Venetian Bronze®	
178558	HX5361-NKBL	Luxe Nickel/Matte Black*	
242403	HX5361-PN	Polished Nickel*	
238881	HX5361-RB	Cross, Venetian Bronze	

**Rook™ Sensori® Volume Control Trim**

- 45-80 psi working pressure
- Rough-in sold separately (R35600)



Part #	Mfg #	Description	Price
248927	T66661-NKBL	Luxe Nickel/Matte Black*	

**RSVP® Lavatory Faucet Handle Kit**

- Handle kit assembly
- ADA compliant
- Sold in pairs



Part #	Mfg #	Description	Price
215856	HL5390-BZ	Brushed Bronze*	
141153	HL5390-PC	Chrome	

**RSVP® Vessel Faucet Handle Kit**

- Handle kit assembly
- Sold in pairs



Part #	Mfg #	Description	Price
166344	HL5790-PC	Chrome	

**RSVP® Wall-Mount Lavatory Handle Kit**

- Handle kit assembly
- Sold in pairs



Part #	Mfg #	Description	Price
243118	HX5890-BN	Brushed Nickel*	
238280	HX5890-PC	Chrome	

**Siderna® Lavatory Handle Kit**

- ADA compliant
- Sold in pairs
- Includes inserts



Part #	Mfg #	Description	Price
155288	HL5380-BN	Brushed Nickel*, Metal Insert	
187947	HL5380-BL	Matte Black, Metal Insert	
168305	HL5380-PC	Chrome, Metal Insert	
222675	HL5381-PC	Chrome, Green Glass Inserts	

\* Brilliance® Anti-Tarnish Lifetime Finishes

## Faucet Handles

### Lavatory Faucet Handles (Continued)

#### Siderna® Lavatory Handle Kit

Part #	Mfg #	Description	Price
162475	HL5382-BL	Matte Black, Solar Gray Glass Insert	
173087	HL5382-BN	Brushed Nickel* Solar Gray Glass insert	
166142	HL5382-PC	Chrome, Solar Gray Glass Insert	

#### Siderna® Wall-Mount Lavatory Handles

- ADA Compliant
- Sold in pairs
- (HL5882) Includes solar gray glass



Part #	Mfg #	Description	Price
242989	HL5880-BL	Matte Black	
158693	HL5880-BN	Brushed Nickel*	
166849	HL5880-PC	Chrome	
227219	HL5882-PC	Chrome/Solar Gray Glass	
227206	HL5882-BL	Matte Black/Solar Gray Glass	

#### Tesla® Lavatory Handle Kit

- ADA Compliant
- Sold in pairs



Part #	Mfg #	Description	Price
229495	H252PN	Polished Nickel*	

#### Traditional Handle Kit

- Single Metal Lever
- Must order 2 handles for lav, roman tub, & bidet LHP faucets
- Mounting screws included



Part #	Mfg #	Description	Price
024384	HK36-PC	Chrome	
106279	HK36-BN	Brushed Nickel*	
055727	HK36-RB	Venetian Bronze®	

#### Traditional Handle Kit

- Single metal french Lever
- Must order 2 handles for lav, roman tub, & bidet LHP faucets
- Mounting screws included



Part #	Mfg #	Description	Price
114916	HK37C-BN	Cold, Brushed Nickel*	
128892	HK37H-BN	Hot, Brushed Nickel*	

#### Rook™ Lavatory Handle Insert Pairs



Part #	Mfg #	Description	Price
243038	RP78584WH	White	

### Roman Tub Faucet Handles

#### Baliza® Roman Tub Lever Handle Kit

- ADA Compliant
- Sold in pairs



Part #	Mfg #	Description	Price
141937	HL605-BN	Brushed Nickel*	
171313	HL605-BZ	Brushed Bronze*	
173815	HL605-PC	Chrome	
134880	HL605-PN	Polished Nickel*	

#### Baliza® Roman Tub Cross Handle Kit

- ADA Compliant
- Sold in pairs



Part #	Mfg #	Description	Price
250461	HX605-PN	Polished Nickel*	

\* Brilliance® Anti-Tarnish Lifetime Finishes

[www.plumbsupply.com](http://www.plumbsupply.com) • Serving our Customers Since 1946 • [www.waterconcepts.net](http://www.waterconcepts.net)

**Faucet Handles**

**Charlotte™ Roman Tub Handle Kit**

- ADA Compliant
- Sold in pairs



Part #	Mfg #	Description	Price
171231	HL685-PC	Chrome	
155368	HL685-PN	Polished Nickel*	
144792	HL685-PNCO	Cocoa Bronze™/Pol Nickel	

**Levoir™ Roman Tub Handle Kit**



Part #	Mfg #	Finish	Handle	Price
254001	HL698-PN	Polished Nickel*		

**Litze™ Roman Tub Handle Kit**



Part #	Mfg #	Finish	Handle	Price
243665	HL632-NK	Luxe Nickel	Lever	
243250	HL632-PC	Chrome	Lever	
254943	HL633-GL	Luxe Gold	T-Lever	
246931	HL633-NK	Luxe Nickel	T-Lever	

**Rook™ Roman Tub Handle Kit**



HX661



HL660

Part #	Mfg #	Description	Price
251560	HL660-NK	Luxe Nickel	
223102	HL660-NKBL	Luxe Nickel/Matte Black	
230917	HL660-PC	Chrome	
185520	HL660-RB	Venetian Bronze®	

**Roman Tub Faucet Handles (Continued)**

**Rook™ Roman Tub Handle Kit**

Part #	Mfg #	Description	Price
234249	HX661-NKBL	Luxe Nickel/Matte Black	
237556	HX661-PC	Chrome	

**RSVP® Roman Tub Handle Kit**

- Handle kit assembly
- Sold in pairs



Part #	Mfg #	Description	Price
160248	HL790-BN	Brushed Nickel*	
141155	HL790-PC	Chrome	

**Siderna® Roman Tub Handle Kit**

- ADA Compliant
- Sold in pairs
- Includes metal, green glass, or solar gray glass inserts



Part #	Mfg #	Description	Price
155290	HL680-BN	Br Nickel*, Metal Inserts	
187946	HL680-BL	Matte Black, Metal Inserts	
168304	HL680-PC	Chrome, Metal Inserts	
224584	HL681-PC	Chrome, Green Glass Inserts	
236606	HL682-BN	Brushed Nickel, Solar Gray	
162485	HL682-BL	Matte Black, Solar Gray Glass Inserts	

\* Brilliance® Anti-Tarnish Lifetime Finishes

## Flush Valves

### Manual Flushometers

#### Royal® Diaphragm Type Exposed Parts Flushometer

- Dual filtered by-pass
- Diaphragm, handle packing, stop seat and vacuum breaker molded from PERMEX™ rubber compound for chloramine resistance
- ADA Compliant metal oscillating non-hold-open handle with triple seal handle packing
- Free spinning vandal resistant stop cap
- Adjustable tailpiece
- High back pressure vacuum breaker flush connection with 1-piece bottom hex coupling nut
- Sweat solder adapter with cover tube and case set screw wall flange
- Valve body, cover, tailpiece and control stop manufactured per ASTM alloy class for semi-red brass
- Valve in compliance with applicable sections of ASSE 1037, ANSI/ASME 112.19.6 and military specification V-29193

#### Royal® Models 110/111 Exposed Water Closet Flushometer

- Exposed water closet flushometer, for floor mounted or wall hung top spud bowls
- 1" IPS Screwdriver Bak-Chek™ angle stop
- Spud coupling and flange for 1-1/2" top spud



Part #	Mfg #	Model	Description	GPF	Spud	Price
010190	3010100	110	Water Saver	3.5	1-1/2"	
010213	3010000	111-1.6	Low Consumption	1.6	1-1/2"	
121752	3910168	111-1.28	High Efficiency	1.28	1-1/2"	

#### Royal® Model 117 Exposed Service Sink Flushometer

- Exposed service sink flushometer, for use with top spud service sinks
- 1" IPS Screwdriver Bak-Chek™ angle stop
- Spud coupling and flange for 1-1/2" top spud



Part #	Mfg #	Model	Description	GPF	Spud	Price
010197	3010528	117	Hdl on Front of Valve	6.5	1-1/2"	

#### Royal® Model 180 Exposed Urinal Flushometer

- Exposed urinal flushometer, for 1-1/4" top spud urinals
- 1" IPS Screwdriver Bak-Chek™ angle stop
- Spud coupling and flange for 1-1/2" top spud



Part #	Mfg #	Model	Description	GPF	Spud	Price
010204	3012436	180-1	Low Consumption	1.0	1-1/2"	



## Flush Valves

### Royal® Model 186 Exposed Urinal Flushometer

- Exposed urinal flushometer, for 3/4" top spud urinals
- 3/4" IPS Screwdriver Bak-Chek™ angle stop
- Spud coupling and flange for 3/4" top spud



Part #	Mfg #	Model	Description	GPF	Spud	Price
010206	3012600	186	Water Saver	1.5	3/4"	
010209	3012636	186-1	Low Consumption	1.0	3/4"	
103256	3912697	186-0.5	Ultra Low Consumption	0.5	3/4"	

### Royal® Bedpan Washer Flushometer

- Dual-filter fixed by-pass diaphragm
- ADA Handle with triple seal packaging
- Vandal-resistant stop cap
- Vacuum breaker flush connection
- Sweat kit with cast set screw wall flange
- Non-hold open
- Fixed volume accuracy with CID® technology

Part #	Mfg #	Model	Description	Price
010110	3019726	ROYAL BPW 1000-1.6	Royal Bedpan Washer Flushometer	

### Regal® Diaphragm Type Exposed Flushometers

- ADA Compliant metal oscillating non-hold-open handle
- Vandal resistant stop cap
- Adjustable tailpiece
- Vacuum breaker flush connection
- Low consumption flush accuracy controlled by Para-Flo™ inside parts kit
- Handle packing, stop seat and vacuum breaker molded from PERMEX™ rubber compound for chloramine resistance
- Valve body, cover, tailpiece and control stop manufactured per ASTM alloy class for semi-red brass
- Valve in compliance with applicable sections of ASSE 1037, ANSI/ASME 112.19.6 and military specification V-29193

#### Regal® 110/111 Exposed Water Closet Flushometer

- Exposed water closet flushometer, for floor mounted or wall hung top spud bowls
- 1" IPS Screwdriver Bak-Chek™ angle stop
- Spud coupling, wall and spud flanges for 1-1/2" top spud



Part #	Mfg #	Model	Description	GPF	Spud	Price
024441	3080153	110-XL	Low Consumption	3.5	1-1/2"	
022984	3080053	111-XL	Low Consumption	1.6	1-1/2"	

\* XL variation includes ADA compliant handle, vandal resistant stop cap with set screw and sweat-solder adapter with cover tube and cast set screw wall flange



## Flush Valves

### Regal® XL 186 Exposed Urinal Flushometer

- Exposed urinal flushometer, for 3/4" top spud urinals
- 3/4" IPS Screwdriver Bak-Chek™ angle stop
- Spud coupling, wall and spud flanges for 3/4" top spud

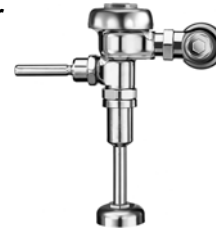

Part #	Mfg #	Model	Description	GPF	Spud	Price
074171	3082653	186-1.5	Low Consumption	3.5	3/4"	
022987	3082675	186-1-XL	Low Consumption	1.5	3/4"	

\* XL variation includes ADA compliant handle, vandal resistant stop cap with set screw and sweat-solder adapter with cover tube and cast set screw wall flange

- For floor mounted or wall hung top spud bowls
- Low consumption flush accuracy
- Vacuum breaker with flush connection
- Spud coupling and spud flange for 1-1/2" top spud
- Sweat solder adapter with cover tube and cast wall flange
- Non-hold open handle and no external volume adjustment
- 1" I.P.S. Screwdriver Bak-Chek® angle stop with vandal resistant stop cap
- (-DFB) Dual filtered bypass diaphragm



Part #	Mfg #	Model	Description	GPF	Spud	Price
197549	3780000	111	Low Consumption	1.6	1-1/2"	
149892	3780018	111-1.28 DFB	Low Consumption	1.28	1-1/2"	

### UpperCut® WES 111 Manual Exposed Water Closet Flushometer

- 11.5" Rough-in
- For floor mount or wall hung
- Permex® rubber diaphragm
- CID® flush accuracy technology
- Spud coupling and flange for 1-1/2" top spud
- Includes two adhesive backed metal wall plates
- Lifting handle UP initiates reduced flush — 1.1 gpf
- Pushing handle DOWN initiates full flush — 1.6 gpf
- Metal non-hold open handle with triple seal handle packing
- Sweat solder adapter with cover tube & cast wall flange with set screw
- (-DFB) dual filtered fixed bypass



Part #	Mfg #	Model	Description	GPF	Spud	Price
203258	3760005	WES 111 DFB	Water Saver	1.6/1.1	1-1/2"	

## Flush Valves

### Sensor Operated Flushometers

#### ECOS® Battery Powered Exposed Dual Flush Flushometer

- ADA Compliant ECOS® battery powered infrared sensor for automatic "No-Hands" operation
- Dual filtered by-pass
- Diaphragm, stop seat and vacuum breaker molded from PERMEX™ rubber compound for chloramine resistance
- Engineered metal cover assembly with replaceable lens window
- 3-Second flush delay
- Courtesy Flush™ override button
- Low battery flashing LED, (4) size AA batteries included
- Infrared sensor range adjustment screw
- Initial set-up range indicator light (10 min)
- Free spinning vandal resistant stop cap
- Adjustable tailpiece
- High back pressure vacuum breaker flush connection with 1-piece bottom hex coupling nut
- Sweat solder adapter with cover tube and case set screw wall flange
- Valve body, cover, tailpiece and control stop manufactured per ASTM alloy class for semi-red brass
- Valve in compliance with applicable sections of ASSE 1037 and ADA standard

Part #	Mfg #	Model	Description	GPF	Spud	Price
114096	3370400	8111-1.6/1.1	High Efficiency	1.1/1.6	1-1/2"	

#### Ecos® Sensor Hardwired Flushometer

- Valve: Diaphragm
- Valve Body Material: Semi-red Brass
- Fixture Type: Water Closet
- Fixture Connection: Top
- Rough-In Dimension: 11 ½" (292mm)
- Spud Coupling: 1 ½" (38mm)
- Supply Pipe: 1" (25mm)



Part #	Mfg #	Model	Description	GPF	Spud	Price
149907	3370420	111-1.6\1.1	Hardwired	1.6\1.1	1-1/2"	

#### Sloan® Optima® SMO Battery Powered Toilet Flush Valve

- Side mount sensor operated
- Battery powered infrared sensor for automatic no-hands operation
- Sweat solder adapter with cover tube and cast wall flange
- Type C battery
- Chrome-plated finish
- 11-1/2" Rough-in
- 1" IPS Supply inlet



Part #	Mfg #	Model	Description	GPF	Spud	Price
096030	3780114	111-SMO	Low Consumption	1.6	1-1/2"	

## Flush Valves

### Regal® Optima® SMO Battery Powered Toilet Flush Valve

- Side mount sensor operated
- Battery powered infrared sensor for automatic no-hands operation
- Type C battery
- Chrome-plated finish
- 11-1/2" Rough-in
- 3/4" IPS Supply inlet



Part #	Mfg #	Model	Description	GPF	Spud	Price
096379	3782614	186-1-SMO	Low Consumption	1.0	3/4"	

### G2 OptimaPlus® Battery Powered Exposed Water Closet Flushometers

- PERMEX™ synthetic rubber diaphragm with dual filtered fixed bypass
- Flex tube diaphragm designed for improved life and reduced maintenance
- ADA Compliant OptimaPlus® battery powered infrared sensor for automatic "No Hands" operation
- Infrared Sensor with multiple-focused, lobular sensing fields for high and low target detection
- Isolated latching solenoid operator, isolates magnetic components from water contact
- Engineered metal cover with replaceable lens window
- User friendly 3-second flush delay
- Courtesy Flush™ override button
- Four (4) Size AA batteries factory installed
- "Low Battery" flashing LED
- Infrared sensor range adjustment screw
- Initial set-up range indicator light (first 10 minutes)
- Free spinning, vandal resistant stop cap
- Adjustable tailpiece
- High back pressure vacuum breaker flush connection with 2-piece bottom hex coupling nut
- Sweat solder adapter with cover tube and cast set screw wall flange
- High copper, low zinc brass castings for dezincification resistance
- Fixed metering bypass and no external volume adjustment to ensure water conservation
- Flush accuracy controlled by CID™ Technology
- Diaphragm, stop seat and vacuum breaker to be molded from PERMEX™ rubber compound for chloramine resistance

#### G2 OptimaPlus® Models 8110/8111 Exposed Water Closet Flushometer

- Exposed, battery powered, sensor operated water closet flushometer for floor-mounted or wall hung top spud bowls
- 1" IPS Screwdriver Bak-Chek™ angle stop
- Spud coupling and flange for 1-1/2" top spud



Part #	Mfg #	Model	Description	GPF	Spud	Price
120162	3250289	8111	WaterSense Listed	1.28	1-1/2"	
069989	3250400	8111	Low Consumption	1.6	1-1/2"	

**Flush Valves**

**G2 OptimaPlus® Model 8180 Exposed Urinal Flushometers**

- Exposed, battery powered, sensor operated urinal flushometer
- 1" IPS Screwdriver Bak-Chek™ angle stop
- Spud coupling and flange for 1-1/4" top spud
- Supplied less handle opening and metal cap



Part #	Mfg #	Model	Description	GPF	Spud	Price
071223	3250406	8180-1	Low Consumption	1.0	1-1/4"	

**G2 OptimaPlus® Model 8186 Exposed Urinal Flushometers**

- Exposed, battery powered, sensor operated urinal flushometer
- 3/4" IPS Screwdriver Bak-Chek™ angle stop
- Spud coupling and flange for 3/4" top spud
- Supplied less handle opening and metal cap



Part #	Mfg #	Model	Description	GPF	Spud	Price
071218	3250403	8186	Water Saver	1.5	3/4"	
069988	3250401	8186-1	Water Saver	1.0	3/4"	

## Flush Valves

### Royal Optima™ Sensor Operated Exposed Flushometer

- Dual filtered by-pass
- OPTIMA® EL-1500-L self adaptive infrared sensor with indicator light
- Courtesy Flush™ override button
- Non-hold-open integral solenoid operator
- (2) Chrome-plated wall cover plates (for 2-gang electrical box) with vandal resistant screws
- Free spinning vandal resistant stop cap
- Adjustable tailpiece
- High back pressure vacuum breaker flush connection with 1-piece bottom hex coupling nut
- Sweat solder adapter with cover tube and case set screw wall flange
- Valve body, cover, tailpiece and control stop manufactured per ASTM alloy class for semi-red brass
- Valve in compliance with applicable sections of ASSE 1037, ANSI/ASME 112.19.6 and military specification V-29193, ADA standards

### Royal Optima® Exposed Sensor Operated Water Closet Flushometer

- Exposed sensor operated water closet flushometer, for floor mounted or wall-hung back spud bowls
- 1" IPS Screwdriver Bak-Chek™ angle stop
- Spud coupling and flange for 1-1/2" top spud



Part #	Mfg #	Model	Description	GPF	Spud	Price
029813	3450047	111ES-S	Low Consumption	1.6	1-1/2"	

### Royal Optima® Hardwired-1.28-OR-HW

- Flush Volume: 1.28 gpf (4.8 Lpf)
- Finish: Polished Chrome (CP)
- Wall Plate Finish: Polished Chrome
- Power Type: Hardwired (HW)
- Valve: Diaphragm
- Valve Body Material: Semi-red Brass
- Fixture Type: Water Closet
- Fixture Connection: Top
- Rough-In Dimension: 11 1/2" (292mm)
- Spud Coupling: 1 1/2" (38mm)
- Supply Pipe: 1" (25mm)
- Override: Electrical



Part #	Mfg #	Model	Description	GPF	Spud	Price
122555	3450049	111-1.28-ESS	Low Consumption	1.28	1-1/2"	

**Flush Valves**

**Royal Optima® Exposed Sensor Operated Urinal Flushometer**

- Exposed sensor operated water closet flushometer, for floor mounted or wall-hung back spud bowls
- 3/4" IPS screwdriver Bak-Chek™ angle stop
- Spud coupling and flange for 3/4" top spud



Part #	Mfg #	Model	Description	GPF	Spud	Price
010210	3452673	186-1ES-S	Low Consumption	1.0	3/4"	
130289	3452674	186-0.5ES-S	Low Consumption	0.5	3/4"	

**OptimaPlus™ Retro Fit Conversion Kit**

**G2® OptimaPlus RESS Royal Retro Conversion Kit**

- Battery powered, sensor operated G2® Model retrofit conversion kit for Sloan Royal®, Regal Pro® and Regal® flushometers
- Courtesy flush override button
- User friendly 3-second flush delay
- ADA Compliant
- Installation tools provided
- Chrome-plated metal handle cap



Part #	Mfg #	Model	Description	Price
069990	3325400	RESS-G2-C	1.6 Closet Retrofit Kit, with (2) Flush Regulators	
069991	3325402	RESS-G2-U	1.0 Optima Urinal Retrofit Kit, with (2) Flush Regulators	

**Sloan® Optima Plus® 8186 Sensor Exposed Flushometer for Wall Hung Urinals**

- 11.5" Rough-in
- Battery powered [(4) AA batteries included]
- Spud coupling and flange for 3/4" top spud
- Vacuum breaker with flush connection
- Courtesy Flush® override button
- WaterSense® certified product
- Sweat solder adapter with cover tube and cast wall flange
- 3/4" I.P.S. screwdriver bak-chek® angle stop with vandal resistant stop cap



Part #	Mfg #	Model	Description	GPF	Spud	Price
110746	3790013	8186-1	Low Consumption	1.0 gpf	3/4"	
122982	3790068	8186-0.5	Water Saver	0.5 gpf	3/4"	



## Flush Valves

### Sloan® Optima® 111-1.28 DFB ESS Sensor Activated, Exposed Water Closet Flushometer

- For floor-mounted or wall hung top spud bowls
- Vacuum breaker with flush connection
- Low consumption flush accuracy
- User friendly three second flush delay
- No external volume adjustment
- Courtesy Flush® override button
- WaterSense® certified product: 1.28 gpf/4.8 lpf
- Sweat solder adapter with cover tube and cast wall flange
- Optima® EL-1500 self-adaptive infrared sensor with indicator light
- I.P.S. screwdriver bak-chek® angle stop with vandal resistant stop cap



Part #	Mfg #	Model	Description	GPF	Spud	Price
227054	3770022	111-1.28	Low Consumption	1.28 gpf		
169363	3770009	111-1.28	Low Consumption	1.28 gpf		

### Sloan Optima Plus® 8111-1.6 Sensor Exposed Flushometer

- 11.5" Rough-in
- Courtesy flush® override button
- Vacuum breaker with flush connection
- For floor-mounted or wall hung top spud bowls
- Spud coupling and spud flange for 1/2" top spud
- Sweat solder adapter with cover tube and cast wall flange
- 1" I.P.S. Screwdriver Bak-Chek® angle stop with vandal resistant stop cap



Part #	Mfg #	Model	Description	GPF	Spud	Price
166534	3790011	8111	-	1.6	1-1/2"	

### Urinal Side-Mount Operator



Part #	Mfg #	Model	Description	Price
078317	0325105	EBV-89A-M	Metal Side-Mount Operator	

### Optima Flushometer Retrofit Kit

- ADA Compliant Optima® Smooth™ battery powered infrared sensor
- Sensor with automatic range adjustment
- Programmable automatic flushing system
- Tempered glass lens
- (4) Size C batteries included
- "Low Battery" flashing LED



Part #	Mfg #	Model	Description	Price
091328	3325201	EBV-200-A	Side Mount Operator Over the Handle Retrofit Kit	

## Flush Valves

### WES-111 Dual-Flush Flushometer

- Lifting handle up initiates reduced flush, eliminating liquid and paper waste, saving 1/2 gallon of water
- Pushing handle down initiates full flush, eliminating solid waste and paper
- Reduces water volume by up to 30% when activated upwards
- Antimicrobial coating on handle protects against germs
- PERMEX™ Synthetic rubber diaphragm with dual filtered fixed bypass
- Distinctive green ADA compliant metal non-hold-open handle with triple seal handle packing signifies water conserving device
- 1" IPS Screwdriver Bak-Chek™ angle stop
- Free spinning vandal resistant stop cap
- Adjustable tailpiece
- High back pressure vacuum breaker flush connection with 1-piece bottom hex coupling nut
- Spud coupling and flange for 1-1/2" top spud
- Includes (2) adhesive backed metal wall plates etched with instructions



Part #	Mfg #	Model	Description	GPF	Spud	Price
095310	3720000	WES-111	Low Consumption	1.6/1.1	1-1/2"	

### Optima® System Faucet Parts

#### Optima Plus® EBV500A Single Flush Retrofit Conversion Kit

- Battery powered, sensor-activated
- Chrome-plated infrared sensor housing
- For exposed closets or urinal flushometers
- Four (AA) alkaline batteries included
- "Low battery" and "user in view" flashing LED's
- Installation tools provided
- Non-hold-open true mechanical override full flush button
- No external volume adjustment to ensure water conservation



Part #	Mfg #	Model	Description	GPF	Spud	Price
162011	3325500	EBV-500-A	Water Saver	-		

### Electronic Faucet Parts

#### EBF-85 Faucet Parts

Part #	Mfg #	Model	Description	Price
044873	3315111	EBF-11-A	Module Assembly	

#### ETF-600/EFT-610 Faucet Parts

Part #	Mfg #	Model	Description	Price
022201	0365534	ETF-233	Transformer	

### Repair Kits

Part #	Mfg #	Model	Description	Price
092078	3315254	EBF-1011-A	Solenoid Replacement Kit, Includes Body, Enclosure, & Filter Plug	

## Flush Valves

### Manual Urinal Flush Valves

#### Manual Urinal Flushometer Valve

- Cast brass construction
- Piston valve technology
- Chloramine resistance on all rubber components exposed to waterway
- Vacuum breaker and control stop included
- ADA Lever on side



Part #	Mfg #	Description	Finish	Price
142915	K-13517-CP	1.28 gpf Manual Flush Valve	Polished Chrome	
142917	K-13518-CP	1.0 gpf Manual Flush Valve	Polished Chrome	

#### Manual Washdown Urinal Flushometer Valve

- Cast brass construction
- For urinal installations with 3/4" top spud coupling connection
- Chloramine resistance on all rubber components exposed to waterway
- Vacuum breaker and control stop included
- Locking stop cap and non-hold open design provide protection against vandalism



Part #	Mfg #	Description	Finish	Price
142919	K-13519-CP	0.5 gpf Manual Flush Valve	Polished Chrome	
142921	K-13520-CP	0.125 gpf Manual Flush Valve	Polished Chrome	

#### Primme™ Manual Urinal Flushometer Valve

- Fixture-mount design
- Cast brass construction
- Chloramine resistance
- Includes vacuum breaker and control stop
- Intended for urinal installations with 3/4" top spud coupling connection
- Piston valve technology with self-cleaning and anti-clogging features



Part #	Mfg #	Description	Finish	Price
230283	K-76317-CP	0.125 gpf Manual Flush Valve, Washdown Urinal	Polished Chrome	
243126	K-76318-CP	0.5 gpf Manual Flush Valve, Washdown Urinal	Polished Chrome	
239937	K-76319-CP	1.0 gpf Manual Flush Valve, Washdown Urinal	Polished Chrome	
239936	K-76322-CP	1.6 gpf Manual Flush Valve	Polished Chrome	

\*Vibrant Limited Lifetime Finish

[www.plumbsupply.com](http://www.plumbsupply.com) • Serving our Customers Since 1946 • [www.waterconcepts.net](http://www.waterconcepts.net)

## Flush Valves

### Manual Flush Valves

#### Manual Toilet Flushometer Valve

- Cast brass construction
- Piston valve technology
- Chloramine resistance on all rubber components exposed to waterway
- Vacuum breaker and control stop included
- ADA Lever on side



Part #	Mfg #	Description	Finish	Price
142913	K-13516-CP	1.6 gpf Manual Flush Valve	Polished Chrome	

#### Primme™ Manual Flushometer Valve

- Fixture mount design
- Cast brass construction
- Piston valve technology
- Chloramine resistance on rubber components
- Includes vacuum breaker and control stop
- WaterSense® certified: 1.28 gpf toilets



Part #	Mfg #	Description	Finish	Price
243125	76321-CP	1.28 gpf Manual Flush Valve	Polished Chrome	

### Commercial Electronic Flush Valves - DC Powered

#### Tripoint® Touchless™ DC Toilet Flushometer Valve

- Brass construction
- Includes (4) 1.5V AA batteries
- Electronic infrared sensor with TriPoint™ technology
- For toilet installations with 1-1/2" spud coupling connection
- Vacuum breaker and stop control included



Part #	Mfg #	Description	Finish	Price
101368	K-10956-SV-CP	1.28 gpf Exposed Flush Valve	Polished Chrome	
128704	K-10957-SV-CP	1.6 gpf Exposed Flush Valve	Polished Chrome	
107948	K-10958-CP	0.5 gpf Exposed Flush Valve	Polished Chrome	
222205	K-10958-SV-CP	0.5 gpf Touchless DC Flush Valve	Polished Chrome	
183752	K-10960-SV-CP	1.0 gpf Exposed Flush Valve	Polished Chrome	

\*Vibrant Limited Lifetime Finish

[www.waterconcepts.net](http://www.waterconcepts.net) • Serving our Customers Since 1946 • [www.plumbsupply.com](http://www.plumbsupply.com)

## Flush Valves

### Tripoint® Exposed Hybrid Flushometer for Toilet Installation

- Powered by the 30-year Hybrid Energy System
- Electronic infrared sensor with Tripoint™ technology for accurate activation
- Intended for toilet installations with 1-1/2-inch top spud coupling connection —3/4" Top spud for model (K-7546-CP)
- Piston valve technology offers reliable and accurate flushing performance across pressures
- Activation distance is factory set - no adjustments on-site
- Chloramine resistance on all rubber exposed to waterway
- Manual courtesy flush button (works without DC power)



Part #	Mfg #	Description	Finish	Price
181675	K-7531-CP	1.28 gpf Exposed Hybrid Flush Valve	Polished Chrome	
186311	K-7535-CP	1.60 gpf Exposed Hybrid Flush Valve	Polished Chrome	
172753	K-7539-CP	1.0 gpf Exposed Hybrid Flush Valve	Polished Chrome	
186312	K-7542-CP	1.0 gpf Exposed Hybrid Flush Valve	Polished Chrome	
238193	K-7456-CP	0.125 gpf Eposed Washdown Hybrid Flush Valve	Polished Chrome	

### Wave Touchless Washdown Flushometer Valve

- Fixture-mount design
- Includes two 1.5V AA batteries
- Slow-closing piston technology
- Manual override flushes even if the batteries have expired
- 24-Hour sentinel flush keeps trapway fresh
- Serviceable without turning water supply off
- Waterproof shroud protects electronic components
- Intended for urinal installations with 3/4" spud coupling connection



Part #	Mfg #	Description	Finish	Price
133010	K-10675-SV-CP	0.5 gpf Exposed Flush Valve	Polished Chrome	

### Wave Touchless Toilet 1.28 gpf Flushometer Valve

- Brass construction
- Fixture-mount design
- Includes 1.5 V AA batteries
- Slow-closing piston technology
- Manual override flushes even if the batteries have expired
- 24-Hour sentinel flush keeps trapway fresh
- Waterproof shroud protects electronic components
- Serviceable without turning water supply off
- Intended for toilet installations with 1-1/2" spud coupling connection



Part #	Mfg #	Description	Finish	Price
241414	K-10668-SV-CP	0.125 gpf Exposed Flush Valve	Polished Chrome	
133009	K-10673-SV-CP	1.28 gpf Exposed Flush Valve	Polished Chrome	

\*Vibrant Limited Lifetime Finish

[www.plumbsupply.com](http://www.plumbsupply.com) • Serving our Customers Since 1946 • [www.waterconcepts.net](http://www.waterconcepts.net)

## Flush Valves

### Wave Touchless Hybrid Flushometer

- Metal construction
- Top spud
- Piston technology
- 24-hour sentinel flush
- Manual courtesy flush button
- Powered by the 30-Year hybrid energy system
- Chloramine resistance on all rubber exposed to waterway
- For toilet installations with 3/4" top spud coupling connection
- Electronic infrared sensor with WAVE technology for accurate activation
- Activation distance is factory set - no adjustments on-site
- 24-Hour sentinel flush keeps trapway fresh



Part #	Mfg #	Description	Finish	Price
181092	K-7523-CP	1.6 gpf, Top Spud	Polished Chrome	
232339	K-7526-CP	0.5 gpf, Top Spud	Polished Chrome	
170203	K-7528-CP	0.125 gpf, Washdown Top Spud	Polished Chrome	

### Bedpan Washers

#### Bedpan Washer

- Brass construction
- Machined aluminum double foot control
- Self-closing 14" hinged pedal action
- 3/8" NPT inside threaded inlets
- Outlet to wall with volume control
- Elevated vacuum breaker
- Hose with angle spray nozzle
- Insulated handle and spray hook



Part #	Mfg #	Description	Finish	Price
063788	K-13960-CP	Double Foot Control	Polished Chrome	

\*Vibrant Limited Lifetime Finish

[www.waterconcepts.net](http://www.waterconcepts.net) • Serving our Customers Since 1946 • [www.plumbsupply.com](http://www.plumbsupply.com)



## Flush Valves

### Electronic Flush Valves - Commercial

- 5-Year limited warranty

#### M-Power™ Battery Powered Exposed Style Closet Flush Valve

- 1" IPS Supply and 1-1/2" top spud
- Adjustable sensor eyes
- Powered by (4) standard AA batteries (included)
- Low battery indicator light
- Piston flushing mechanism
- Self cleaning filter system
- 1.6 gpf & 24 Hour sentinel flush
- Manual override button
- Vandal resistant 1" IPS angle stop



8310

Part #	Mfg #	Description	Price
007351	8310	Battery Powered Closet Flush Valve	
165288	8310AC16	1.6 gpm 1-1/2" AC Powered Sensor	
251576	8310SR35	Electronic Exposed Water Closet Retro Fit Flush Valve	
238256	8311	Battery Powered Sensor Activated Closet Flush Valve	

#### M-Power™ Battery Powered Exposed Style Urinal Flush Valve

- Brass construction with chrome plated finish
- 3/4" IPS Supply and 3/4" Top stud
- Adjustable sensor eyes
- Powered by (4) standard AA batteries (included)
- Piston flushing mechanism
- Self cleaning filter system
- 1.0 gpf & 24 Hour sentinel flush
- Flush valve manual override button
- 3/4" IPS Angle stop valve



8312

Part #	Mfg #	Description	Price
096645	8312	Battery Powered Exposed Urinal Flush Valve	
165287	8312AC10	3/4" AC Powered Sensor Exposed Urinal Flush Valve	
177078	8315	3/4" Battery Powered Sensor Exposed Urinal Flush Valve	
238252	8316	3/4" Battery Powered Sensor Exposed Urinal Flush Valve	

\*Lifeshine® Anti-Tarnish Lifetime Finish

[www.plumbsupply.com](http://www.plumbsupply.com) • Serving our Customers Since 1946 • [www.waterconcepts.net](http://www.waterconcepts.net)

## Flush Valves

### Urinal Rinse Down Valves

- Polished chrome plate finish
- Oscillating handles or push buttons
- 1/2" NPT Female inlet
- 3/4" OD x 8" Long riser



732-CP

732-OH

Part #	Mfg #	Description	Price
002905	732-CP	NAIAD Chrome-Plated, Self-Closing Angle Valve	
002906	732-OH	NAIAD Self-Closing Angle Valve, Long Bonnet Non-Sag Oscillating Handle	

## Generic Replacement Parts

### Washers

#### Korky® EasySort® Washer



Part #	Mfg #	Description	Price
006192	180	1/4S Dk Brown Flat Faucet	
006193	181	1/4M Dk Blue Flat Faucet	
006194	182	1/4R Dk Green Flat Faucet	
006196	184	3/8R Gray Flat Faucet	
006197	185	3/8L Orchid Flat Faucet	
006198	186	1/2R Hot Pink Flat Faucet	
006183	150	1/4S Dk Brown Beveled Faucet	
006184	150-1	1/4M Dk Blue Beveled Faucet	
006185	151	1/4R Dk Green Beveled Faucet	
006186	152	1/4L Dk Purple Beveled Faucet	

#### Washer Kits

- In plastic utility case



Part #	Mfg #	Description	Price
028283	149	Korky Master Kit Asst	
006200	189	200 Pc Flat Assortment	

#### Hose Washer



Part #	Mfg #	Description	Price
006218	51	Hose Washer Display, 48 Clips with 8 Washers per Clip	

### Graphite String Packing



Part #	Mfg #	Size	Qty	Price
006202	2-1/2	21"	25/Pk	

#### O-Ring Kits

- 1/16" Wall thickness
- Made of Nitrile rubber



Part #	Mfg #	Description	Price
030030	POR62	400 O-Rings In 20 Sizes	
022925	K200	200 O-Rings in 12 Sized Plumber's Pack Kit	

## Generic Replacement Parts

### O-Rings

#### Buna-N O-Ring Kit

- (150) Assorted o-rings



Part #	Mfg #	Plastic Box	Price
135282	291-30380	(12) Compartments	

### Washers

#### Rubber Washer Kit

- Includes:
  - (150) Assorted washers
  - (6) 10-24 Bibb screws



Part #	Mfg #	Type of Washer Kit	Price
147954	291-30125	Flat	
147955	291-30225	Beveled	

#### Hose Washer

- Standard rubber hose washer



Part #	Mfg #	Hose Washer	Price
183399	291-30500	Rubber	

#### Supply Step Washer for Lavatory or Closet

- Deluxe rubber lavatory supply washer with brass friction ring



Part #	Mfg #	For	Height	Price
183397	290-20482	Closet	7/16"	

### Gaskets

#### No-Putty Gasket™

- Replaces plumbers putty, wont dry out, stain or smudge
- Self adhesive eliminates mess
- Creates a tight seal on all finishes and materials
- Fits all standard drain attachments
- Allows you to pre-fab fixtures
- Stands up to the toughest commercial cleaners



290-20320



290-20322



290-20324

Part #	Mfg #	Description	Price
183385	290-20320	4-1/4" O.D. x 3-3/8" I.D., For Kitchen Basket Strainer	
183395	290-20322	2" O.D. x 1-1/2" I.D., For Lav Drain & Kit Spray Hose Guide	
183396	290-20324	2-3/4" O.D. x 2" I.D., For Laundry&Bar Sink, Tub Drain	

#### Tub Overflow Gasket

- Molded sponge



Part #	Mfg #	Description	Price
184087	974-60116	Molded Tub Overflow Gasket	

### Parts & Accessories

Part #	Mfg #	Description	Price
248917	869-SF3	ProCheck™ Flapper & Carrier for 3" Backwater Valve	

## Kitchen Faucets & Accessories

### Pot Fillers

#### Artifacts™ Deck-Mount Pot Filler

- Brass construction
- Lever handles
- Articulating spout with 360° rotation, 22" extended reach
- Flow rate: 3.2 gpm



Part #	Mfg #	Holes	Mount	Handle(s)	Finish	Price
188552	K-99271-CP	1	Deck-Mount	Lever	Polished Chrome	
230775	K-99271-2BZ	1	Deck-Mount	Lever	Oil Rubbed Bronze	

#### Artifacts™ Wall-Mount Pot Filler

- Brass construction
- Lever handles
- Articulating spout with 360° rotation, 22" extended reach
- Flow rate: 3.2 gpm



Part #	Mfg #	Holes	Mount	Handle(s)	Finish	Price
183663	K-99270-CP	1	Wall-Mount	Lever	Polished Chrome	
227808	K-99270-SN	1	Wall-Mount	Lever	*Polished Nickel	
176375	K-99270-VS	1	Wall-Mount	Lever	*Stainless	
222913	K-99270-2BZ	1	Wall-Mount	Lever	Oil Rubbed Bronze	

#### HiRise® Deck-Mount Pot Filler

- Stainless steel
- ADA lever handles
- 22" Extended swing spout reach
- Flow rate: 4 gpm



Part #	Mfg #	Holes	Mount	Handle(s)	Finish	Price
091295	K-7323-4-BS	1	Deck-Mount	ADA Lever	Brushed Stainless	

#### HiRise® Wall-Mount Pot Filler

- Stainless steel
- ADA lever handles
- 24" Extended swing spout reach
- Flow rate: 4 gpm



Part #	Mfg #	Holes	Mount	Handle(s)	Finish	Price
093684	K-7322-4-BS	1	Wall-Mount	ADA Lever	Brushed Stainless	
114138	K-7322-4-S	1	Wall-Mount	ADA Lever	Polished Stainless	

\* Vibrant Limited Lifetime Finish

[www.plumbsupply.com](http://www.plumbsupply.com) • Serving our Customers Since 1946 • [www.waterconcepts.net](http://www.waterconcepts.net)

## Kitchen Faucets & Accessories

### Pull-Down Spray Kitchen Faucets

#### Artifacts® 1-Hdl Pull-Down Spray Kitchen Faucet

- 3-Function sprayhead:
  - Sweep™
  - BerrySoft™
  - Aerated stream
- DockNetik™ magnetic docking system
- Ceramic disc valves
- ProMotion® technology's light
- MasterClean™ sprayface
- Flow rate: 1.8 gpm @ 60 psi



Part #	Mfg #	Holes	Reach	Spout	Handle(s)	Finish	Price
175222	K-99259-CP	1	9-1/16"	360°	ADA Lever	Polished Chrome	
172618	K-99259-SN	1	9-1/16"	360°	ADA Lever	*Polished Nickel	
176859	K-99259-VS	1	9-1/16"	360°	ADA Lever	*Stainless	
177285	K-99259-2BZ	1	9-1/16"	360°	ADA Lever	Oil Rubbed Bronze	

#### Artifacts® 1-Hdl Pull-Down Spray Kitchen Faucet with ADA Lever Handle

- 9-1/16" Spout reach with 360° spout rotation
- 9-5/8" From deck to aerator
- 3-Function sprayhead:
  - Sweep™
  - BerrySoft™
  - Aerated stream
- DockNetik™ magnetic docking system
- Ceramic disc valves
- ProMotion® technology's light
- MasterClean™ sprayface
- Flow rate: 1.8 gpm @ 60 psi



Part #	Mfg #	Holes	Reach	Spout	Handle(s)	Finish	Price
234031	K-99260-CP	1	9-1/16"	360°	ADA Lever	Polished Chrome	
225039	K-99260-SN	1	9-1/16"	360°	ADA Lever	*Polished Nickel	
229640	K-99260-VS	1	9-1/16"	360°	ADA Lever	*Stainless	
222410	K-99260-2BZ	1	9-1/16"	360°	ADA Lever	Oil Rubbed Bronze	

\* Vibrant Limited Lifetime Finish

[www.waterconcepts.net](http://www.waterconcepts.net) • Serving our Customers Since 1946 • [www.plumbsupply.com](http://www.plumbsupply.com)



## Kitchen Faucets & Accessories

### Beckon™ 1-Hdl Electronic Pull-Down Spray Kitchen Faucet

- 8-7/16" Spout reach, 15-7/8" height, with 290° spout rotation
- Ceramic disc valves
- Response™ technology
- DockNetik™ magnetic docking system
- ProMotion® nylon hose and ball joint
- MasterClean™ sprayface
- Temperature memory
- 2-Function sprayhead can switch from stream to Sweep™ spray
- Meets CalGreen requirements for kitchen faucets
- Flow rate: 1.8 gpm @ 60 psi



Part #	Mfg #	Holes	Reach	Height	Spout	Handle(s)	Finish	Price
223360	K-99332-CP	1	8-7/16"	15-7/8"	290°	ADA Lever	Polished Chrome	
186936	K-99332-SN	1	8-7/16"	15-7/8"	290°	ADA Lever	*Polished Nickel	
185502	K-99332-VS	1	8-7/16"	15-7/8"	290°	ADA Lever	*Stainless	
224116	K-99332-2BZ	1	8-7/16"	15-7/8"	290°	ADA Lever	Oil Rubbed Bronze	

### Bellera® 1-Hdl Pull-Down Spray Kitchen Faucet with High Arc Spout

- 7-7/8" Spout reach, 10-3/16" height, with 360° spout rotation
- One-piece, self-contained ceramic disc valve
- Temperature memory
- Touch control for stream-to-spray water flow
- MasterClean™ sprayface
- ProMotion™ technology with nylon hose and ball joint
- Flexible connections
- 3-Function sprayhead with spray, aerated stream and pause settings
- Maximum flow rate: 1.8 gpm @ 60 psi



Part #	Mfg #	Holes	Reach	Height	Spout	Handle(s)	Finish	Price
143501	K-560-CP	1- or 3-Hole	7-7/8"	10-3/16"	360°	Side ADA Lever	Polished Chrome	
142788	K-560-VS	1- or 3-Hole	7-7/8"	10-3/16"	360°	Side ADA Lever	*Stainless	
147008	K-560-2BZ	1- or 3-Hole	7-7/8"	10-3/16"	360°	Side ADA Lever	Oil Rubbed Bronze	

### Cruette® 1-Hdl Pull-Down Spray Kitchen Faucet with Escutcheon and Lever Handle

- 7-7/8 Spout reach with 360° spout rotation
- Premium metal construction
- One-piece, self-contained ceramic disc
- Temperature memory
- Promotion™ nylon hose and ball joint
- Flexible supply lines
- 3-Function touch control sprayhead with spray, aerated stream and pause settings
- Maximum flow rate: 1.8 gpm @ 60 psi



Part #	Mfg #	Holes	Reach	Spout	Handle(s)	Finish	Price
143347	K-780-CP	1- or 3-Hole	7-7/8"	360°	ADA Lever	Polished Chrome	
142789	K-780-VS	1- or 3-Hole	7-7/8"	360°	ADA Lever	*Stainless	

\* Vibrant Limited Lifetime Finish

[www.plumbsupply.com](http://www.plumbsupply.com) • Serving our Customers Since 1946 • [www.waterconcepts.net](http://www.waterconcepts.net)

## Kitchen Faucets & Accessories

### Pull-Down Spray Kitchen Faucets (Continued)

#### Cruette® 1-Hdl Pull-Down Spray Kitchen Faucet with Escutcheon and Lever Handle

Part #	Mfg #	Holes	Reach	Spout	Handle(s)	Finish	Price
147013	K-780-2BZ	1- or 3-Hole	7-7/8"	360°	ADA Lever	Oil Rubbed Bronze	

#### Purist® Semi-Professional Pull-Down Spray Kitchen Faucet

- 10" Spout reach, 23-13/16" height with 90° handle rotation
- Premium metal construction
- Ceramic disc valves
- DockNetik® magnetic docking arm
- MaterClean™ sprayface
- Flexible supply lines included
- Temperature memory with high-temperature limit setting
- 3-Function sprayhead" Sweep® spray, boost, and aerated stream
- Maximum flow rate: 1.5 gpm @ 60 spi



Part #	Mfg #	Holes	Reach	Spout	Rotation	Handle(s)	Finish	Price
257939	K-24982-BL	1	10"	90°	ADA Lever	Matte Black		

#### Sensate™ Touchless Kitchen Faucet with 15-1/2" Pull-Down High-Arch Spout and ADA Lever Handle

- 8-7/16" Spout reach
- Premium metal construction
- Response technology.
- LED light indicates faucet is operational and ready to go.
- Two-function sprayhead with touch-control switches from stream to Sweep® spray.
- Temperature memory
- DockNetik™ magnetic docking system
- ProMotion™ nylon hose and ball joint
- MasterClean™ sprayface
- 3-Hole escutcheon kit available (K-1209172-CP/VS)
- Maximum flow rate: 1.8 gpm @ 60 psi



Part #	Mfg #	Holes	Reach	Handle(s)	Finish	Price
155920	K-72218-CP	1	8-7/16"	ADA Lever	Polished Chrome	
155627	K-72218-VS	1	8-7/16"	ADA Lever	*Stainless	
227210	K-72218-2BZ	1	8-7/16"	ADA Lever	Oil Rubbed Bronze	
155400	K-72218-B7-CP	1	8-7/16"	ADA Lever	Polished Chrome with Black Accents	
164432	K-72218-B7-VS	1	8-7/16"	ADA Lever	*Stainless with Black Accents	

\* Vibrant Limited Lifetime Finish

[www.waterconcepts.net](http://www.waterconcepts.net) • Serving our Customers Since 1946 • [www.plumbsupply.com](http://www.plumbsupply.com)

## Kitchen Faucets & Accessories

### Simplice® Pull-Down Spray Kitchen Faucet with High-Arch Gooseneck Spout and Lever Handle

- 9" Spout reach, 16-5/8" height with 360° spout rotation
- Premium metal construction
- One-piece, self-contained ceramic disc valve
- Temperature memory
- DockNetik magnetic docking system
- Promotion™ technology
- MasterClean™ sprayface
- Flexible supply lines and installation ring
- Touch control for stream-to-spray water flow
- 3-Function sprayhead allows you to switch from stream to Sweep® spray to pause
- Maximum flow rate: 1.8 gpm @ 60 psi



596-CP

Part #	Mfg #	Holes	Reach	Spout	Rotation	Handle(s)	Finish	Price
126049	K-596-BL	1- or 3-Hole	9"	16-5/8"	360°	ADA Lever	Matte Black	
118248	K-596-CP	1- or 3-Hole	9"	16-5/8"	360°	ADA Lever	Polished Chrome	
118247	K-596-VS	1- or 3-Hole	9"	16-5/8"	360°	ADA Lever	*Stainless	
145817	K-597-BL	1- or 3-Hole	8"	15-3/8"	360°	ADA Lever	Matte Black	
118250	K-597-CP	1- or 3-Hole	8"	15-3/8"	360°	ADA Lever	Polished Chrome	
118249	K-597-VS	1- or 3-Hole	8"	15-3/8"	360°	ADA Lever	*Stainless	

### Simplice™ Pull-Down Spray Kitchen Faucet with High-Arch Gooseneck Swing Spout and Lever Handle

- 9" Spout reach, 16-1/8" height with 360° spout rotation
- Premium metal construction
- One-piece, self-contained ceramic disc valve
- Remote valve configuration
- DockNetick™ magnetic docking system
- Promotion™ light, quiet nylon hose and ball joint
- MaterClean™ sprayface
- Temperature memory with high-temperature limit setting for added safety
- Flexible supply lines and installation ring
- 3-Function sprayhead allows you to switch from stream to Sweep® spray to pause



Part #	Mfg #	Holes	Reach	Spout	Rotation	Handle(s)	Finish	Price
121515	K-647-BL	2-Hole	9"	16-1/8"	360°	ADA Lever	Matte Black	
102467	K-647-CP	2-Hole	9"	16-1/8"	360°	ADA Lever	Polished Chrome	
102465	K-647-VS	2-Hole	9"	16-1/8"	360°	ADA Lever	*Stainless	
122062	K-649-BL	2-Hole	9"	16-1/8"	360°	ADA Lever	Matte Black	
102468	K-649-CP	2-Hole	8"	14-3/8"	360°	ADA Lever	Polished Chrome	
102466	K-649-VS	2-Hole	8"	14-3/8"	360°	ADA Lever	*Stainless	

\* Vibrant Limited Lifetime Finish

[www.plumbsupply.com](http://www.plumbsupply.com) • Serving our Customers Since 1946 • [www.waterconcepts.net](http://www.waterconcepts.net)

## Kitchen Faucets & Accessories

### Simplice™ Semi-Professional Pull-Down Spray Kitchen Faucet

- 9" Spout reach, 21-5/8" height with 90° handle rotation
- Premium metal construction
- Ceramic disc valves
- Remote valve configuration
- Magnetic docking arm
- MaterClean™ sprayface
- Flexible supply lines and escutcheon included
- Temperature memory with high-temperature limit setting
- 3-Function sprayhead allows you to switch from stream to Sweep® spray to pause
- Maximum flow rate: 1.5 gpm @ 60 psi



Part #	Mfg #	Holes	Reach	Spout	Rotation	Handle(s)	Finish	Price
257273	K-22033-BL	1- or 3-Hole	9"	21-5/8"	90° Handle	ADA Lever	Matte Black	
241289	K-22033-CP	1- or 3-Hole	9"	21-5/8"	90° Handle	ADA Lever	Polished Chrome	
244824	K-22033-VS	1- or 3-Hole	9"	21-5/8"	90° Handle	ADA Lever	*Stainless	

### Tournant™ Semi-Professional Pull-Down Kitchen Sink Faucet with High-Arch Gooseneck Swing Spout

- 10" Spout reach, 24-9/16" height, 360° rotation
- Lever handle
- Metal construction
- Ceramic disc valves
- Temperature memory
- Flexible supply lines
- MasterClean™ sprayface
- DockNetik® magnetic docking system
- Easy to clean coated hose and removable coil
- 3-function sprayhead: Sweep® spray, BerrySoft® spray, and aerated stream
- 3-hole escutcheon available, sold separately model number (K-99272)
- Maximum flow rate: 1.5 gpm @ 60 psi



Part #	Mfg #	Holes	Reach	Spout	Rotation	Handle(s)	Finish	Price
230291	K-77515-CP	1-or 3-Hole	10"	24-9/16"	360°	ADA Lever	Polished Chrome	
230293	K-77515-VS	1-or 3-Hole	10"	24-9/16"	360°	ADA Lever	*Stainless	
241290	K-77515-2BZ	1-or 3-Hole	10"	24-9/16"	360°	ADA Lever	Oil Rubbed Bronze	
233840	77515-SN	1-or 3-Hole	10"	24-9/16"	360°	ADA Lever	*Polished Nickel	

\* Vibrant Limited Lifetime Finish

www.waterconcepts.net • Serving our Customers Since 1946 • www.plumbsupply.com

## Kitchen Faucets & Accessories

### Vinnata® Pull-Down Spray Kitchen Faucet with High-Arch Gooseneck Swing Spout and Lever Handle

- 9-1/2" Spout reach, 16-5/8" height with 360° spout rotation
- Premium metal construction
- One-piece, self-contained ceramic disc valves
- Handle can be installed on right side, left side, or front of faucet
- Integral vacuum breaker
- Promotion™ light, quiet nylon hose and ball joint
- MaterClean™ sprayface
- Temperature memory with high-temperature limit setting for added safety
- Flexible supply lines and installation ring
- Two-function pull-down sprayhead with touch-control allows you to switch from stream to spray
- Includes 10-1/2" escutcheon for 3-hole installations 2-1/2" escutcheon for 1-hole installations
- Maximum flow rate: 1.8 gpm @ 60 psi



Part #	Mfg #	Holes	Reach	Spout	Handle(s)	Finish	Price
066120	K-690-BN	1- or 3-Hole	9-1/2"	16-5/8"	ADA Lever	*Brushed Nickel	
067235	K-690-BV	1- or 3-Hole	9-1/2"	16-5/8"	ADA Lever	*Brushed Bronze	
066118	K-690-CP	1- or 3-Hole	9-1/2"	16-5/8"	ADA Lever	Polished Chrome	
066119	K-690-G	1- or 3-Hole	9-1/2"	16-5/8"	ADA Lever	Brushed Chrome	
086139	K-690-SN	1- or 3-Hole	9-1/2"	16-5/8"	ADA Lever	*Polished Nickel	
097400	K-690-VS	1- or 3-Hole	9-1/2"	16-5/8"	ADA Lever	*Stainless	
147011	K-690-2BZ	1- or 3-Hole	9-1/2"	16-5/8"	ADA Lever	Oil Rubbed Bronze	
067523	K-691-BN	1- or 3-Hole	7-1/2"	15-1/8"	ADA Lever	*Brushed Nickel	
080215	K-691-BV	1- or 3-Hole	7-1/2"	15-1/8"	ADA Lever	*Brushed Bronze	
066121	K-691-CP	1- or 3-Hole	7-1/2"	15-1/8"	ADA Lever	Polished Chrome	
069880	K-691-G	1- or 3-Hole	7-1/2"	15-1/8"	ADA Lever	Brushed Chrome	
084666	K-691-SN	1- or 3-Hole	7-1/2"	15-1/8"	ADA Lever	*Polished Nickel	
097401	K-691-VS	1- or 3-Hole	7-1/2"	15-1/8"	ADA Lever	*Stainless	
147012	K-691-2BZ	1- or 3-Hole	7-1/2"	15-1/8"	ADA Lever	Oil Rubbed Bronze	

### Pull-Out Spray Kitchen Faucets

#### Coralais® 1-Hdl Kitchen Faucet with Pull-Out Matching Color Sprayhead and Rotating Spout

- 9" Reach, 11" high swivel spout
- Premium metal construction
- One-piece, self-contained ceramic disc valves
- Integral vacuum breaker
- Promotion™ light, quiet nylon hose and ball joint
- MaterClean™ sprayface
- Temperature memory with high-temperature limit setting for added safety
- Flexible supply lines
- Two-function pull-out sprayhead with touch-control switches from stream to spray
- Maximum flow rate: 1.8 gpm @ 60 psi



Part #	Mfg #	Holes	Reach	Height	Handle(s)	Finish	Price
055157	K-15160-96	1-Hole	9"	11"	ADA Lever	Biscuit	
067251	K-15160-BN	1-Hole	9"	11"	ADA Lever	*Brushed Nickel	

\* Vibrant Limited Lifetime Finish

[www.plumbsupply.com](http://www.plumbsupply.com) • Serving our Customers Since 1946 • [www.waterconcepts.net](http://www.waterconcepts.net)

## Kitchen Faucets & Accessories

### Pull-Out Spray Kitchen Faucets (Continued)

#### Coralais® 1-Hdl Kitchen Faucet with Pull-Out Matching Color Sprayhead and Rotating Spout

Part #	Mfg #	Holes	Reach	Height	Handle(s)	Finish	Price
055155	K-15160-CP	1-Hole	9"	11"	ADA Lever	Polished Chrome	

#### Elate™ 1-Hdl Pull-Out Spray Kitchen Faucet with High-Arch Swing Spout and 10-1/2" Escutcheon Plate

- 9" Spout reach, 12-11/16" height
- Premium metal construction
- One-piece, self-contained ceramic disc valve
- Temperature memory
- Integral pull-out sprayhead with retractable hose
- ProMotion™ light, quiet nylon hose and ball joint
- MasterClean™ sprayface
- Flexible supply lines
- 3-function sprayhead with touch-control switches from stream to spray to pause
- Maximum flow rate 1.8 gpm @ 60 psi



Part #	Mfg #	Holes	Reach	Height	Handle(s)	Finish	Price
136822	K-13963-CP	3-Hole	9"	12-11/16"	ADA Lever	Polished Chrome	
132863	K-13963-VS	3-Hole	9"	12-11/16"	ADA Lever	*Stainless	

#### Evoke® Pull-Out Spray Kitchen Faucet with Lever Handle

- 9" Spout reach, 11-5/16" height with 360° spout rotation
- Premium metal construction
- One-piece, self-contained ceramic disc valve
- Temperature memory with high temperature limit setting
- ProMotion® light, quiet nylon hose and ball joint
- MasterClean™ sprayface
- Flexible supply lines
- Maximum flow rate: 1.8 gpm @ 60 psi



Part #	Mfg #	Holes	Reach	Spout	Rotation	Handle(s)	Finish	Price
109267	K-6331-CP	1-Hole	9"	11-5/16"	360°	ADA Lever	Polished Chrome	
109791	K-6331-VS	1-Hole	9"	11-5/16"	360°	ADA Lever	*Stainless	

\* Vibrant Limited Lifetime Finish

[www.waterconcepts.net](http://www.waterconcepts.net) • Serving our Customers Since 1946 • [www.plumbsupply.com](http://www.plumbsupply.com)



## Kitchen Faucets & Accessories

### Fairfax® Kitchen Faucet with Pull-Out Matching Color Sprayhead, High Swing Spout, Lever Handle

- 9" Spout reach, 8-3/8" height
- Premium metal construction
- One-piece, self-contained ceramic disc valve
- Temperature memory with high temperature limit setting
- ProMotion® light, quiet nylon hose and ball joint
- MasterClean™ sprayface
- Integral vacuum breaker
- Flexible supply lines
- Includes 10" escutcheon for 3-hole installation and one white plug button
- 2-function sprayhead with touch-control allows you to switch from stream to spray
- Maximum flow rate: 1.8 gpm @ 60 psi



Part #	Mfg #	Holes	Reach	Height	Handle(s)	Finish	Price
057325	K-12177-BN	1-or 3-Hole	9"	8-3/8"	ADA Lever	*Brushed Nickel	
074253	K-12177-BV	1-or 3-Hole	9"	8-3/8"	ADA Lever	*Brushed Bronze	
053607	K-12177-CP	1-or 3-Hole	9"	8-3/8"	ADA Lever	Polished Chrome	
153199	K-12177-2BZ	1-or 3-Hole	9"	8-3/8"	ADA Lever	Oil Rubbed Bronze	

### Forté® 1-Hdl Pull-Out Spray Kitchen Faucet with High-Arch Swing Spout and Lever Handle

- 10-1/8" Spout reach
- Premium metal construction with flexible supply lines
- One-piece, self-contained ceramic disc valve
- Temperature memory with high temperature limit setting
- ProMotion® light, quiet nylon hose and ball joint
- MasterClean™ sprayface
- Maximum flow rate: 1.8 gpm @ 60 psi



Part #	Mfg #	Holes	Reach/Spout	Handle(s)	Finish	Price
085879	K-10433-BN	1-or 3-Hole	10-1/8"	ADA Lever	*Brushed Nickel	
086231	K-10433-BV	1-or 3-Hole	10-1/8"	ADA Lever	*Brushed Bronze	
085822	K-10433-CP	1-or 3-Hole	10-1/8"	ADA Lever	Polished Chrome	
085968	K-10433-G	1-or 3-Hole	10-1/8"	ADA Lever	Brushed Chrome	
086209	K-10433-VS	1-or 3-Hole	10-1/8"	ADA Lever	*Stainless	

### Purist® 1-Hdl Pull-Out Spray Kitchen Faucet with High-Arch Swing Spout and Lever Handle

- 8" Spout reach, 11-3/8" height with 360° spout rotation
- One-piece, self contained ceramic disc valve
- Premium metal construction with flexible supply lines
- Temperature memory
- MasterClean™ sprayface
- Promotion™ light, quiet nylon hose and ball joint
- 3-Function sprayhead with touch control: laminar flow, spray, and pause setting
- Coordinates with other products in the Purist® collection
- Maximum flow rate: 1.8 gpm @ 60 psi



Part #	Mfg #	Holes	Reach	Spout	Rotation	Handle(s)	Finish	Price
133738	K-7505-BL	1	8"	11-3/8"	360°	ADA Lever	Matte Black	

\* Vibrant Limited Lifetime Finish

[www.plumbsupply.com](http://www.plumbsupply.com) • Serving our Customers Since 1946 • [www.waterconcepts.net](http://www.waterconcepts.net)

## Kitchen Faucets & Accessories

### Pull-Out Spray Kitchen Faucets (Continued)

#### Purist® 1-Hdl Pull-Out Spray Kitchen Faucet with High-Arch Swing Spout and Lever Handle

Part #	Mfg #	Holes	Reach	Spout	Rotation	Handle(s)	Finish	Price
142997	K-7505-CP	1	8"	11-3/8"	360°	ADA Lever	Polished Chrome	
144006	K-7505-SN	1	8"	11-3/8"	360°	ADA Lever	Polished Nickel	
132656	K-7505-VS	1	8"	11-3/8"	360°	ADA Lever	*Stainless	

### Single-Handle Kitchen Faucets

#### Artifacts® Kitchen Faucet with High-Arch Swing Spout, Matching Finish Sidespray, Lever Handle

- 8-1/2" Spout reach, 14-11/16" height with 360° spout rotation
- Premium metal construction
- One-piece, self-contained ceramic disc valve
- 2-function sidespray with Sweep® spray and BerrySoft® spray
- Temperature memory
- ProMotion® technology
- MasterClean™ sprayface
- Available with 8-1/2" swing spout
- Maximum flow rate: 1.8 gpm @ 60 psi



Part #	Mfg #	Holes	Reach	Spout	Rotation	Handle(s)	Finish	Price
188551	K-99262-CP	2	8-1/2"	14-11/16"	360°	ADA Lever	Polished Chrome	
172619	K-99262-VS	2	8-1/2"	14-11/16"	360°	ADA Lever	*Stainless	
258332	K-99262-2BZ	2	8-1/2"	14-11/16"	360°	ADA Lever	Oil Rubbed Bronze	

#### Artifacts® Kitchen Faucet with High-Arch Swing Spout, Matching Sidespray, Lever Handle

- 8-1/2" Spout reach, 13-1/2" height with 360° spout rotation
- Premium metal construction with flexible supply lines
- One-piece, self-contained ceramic disc valve
- 2-function sidespray with Sweep® spray and BerrySoft® spray
- Temperature memory
- ProMotion® technology
- MasterClean™ sprayface
- Available with 9" swing spout reach
- For two-hole or four-hole installation (3-Hole escutcheon available, sold separately, K-99272)
- Maximum flow rate: 1.8 gpm @ 60 psi



Part #	Mfg #	Holes	Reach	Spout	Rotation	Handle(s)	Finish	Price
234156	K-99265-CP	2	8-1/2"	13-1/2"	360°	ADA Lever	Chrome	
222423	K-99265-VS	2	8-1/2"	13-1/2"	360°	ADA Lever	*Stainless	
239984	K-99265-2BZ	2	8-1/2"	13-1/2"	360°	ADA Lever	Oil Rubbed Bronze	

\* Vibrant Limited Lifetime Finish

[www.waterconcepts.net](http://www.waterconcepts.net) • Serving our Customers Since 1946 • [www.plumbsupply.com](http://www.plumbsupply.com)

## Kitchen Faucets & Accessories

### Carafe® Filtered Water Kitchen Faucet

- 7-3/4" Swivel spout reach with 360° rotation
- Brass construction
- One-piece, self-contained ceramic disc valve
- Temperature memory
- High-temperature limit setting
- Flexible connections and supplies
- Separate lever handle and filtration inlet hose for cold filtered water
- Quarter-turn washerless ceramic disc valve for filtered water
- Maximum flow rate: 2.0 gpm @ 60 psi



Part #	Mfg #	Holes	Reach	Spout	Rotation	Handle(s)	Finish	Price
123077	K-18865-VS	1	7-3/4"	9-5/8"	360°	ADA Lever	*Stainless	

### Coralais® Kitchen Faucet with Swing Spout

- 8-1/2" Spout reach
- Premium metal construction
- Flexible supply lines
- One-piece, self-contained ceramic disc valve
- Temperature memory
- High-temperature limit setting
- (-P) Ground joint connections
- (-TL) Ground joints and loop handle
- (-FL) Loop handle
- Maximum flow rate: 1.8 gpm @ 60 psi



#### Without Sidespray

Part #	Mfg #	Holes	Reach	Handle(s)	Finish	Price
077165	K-15171-F-BN	3	8-1/2"	ADA Lever	*Brushed Nickel	
073315	K-15171-F-CP	3	8-1/2"	ADA Lever	Polished Chrome	
169207	K-15171-F-G	3	8-1/2"	ADA Lever	Brushed Chrome	
231750	K-P15171-F-CP	3	8-1/2"	ADA Lever	Polished Chrome	

#### With Matching Finish Sidespray

Part #	Mfg #	Holes	Reach	Handle(s)	Finish	Price
066908	K-15172-F-CP	4	8-1/2"	ADA Lever	Polished Chrome	
068250	K-15172-F-BN	4	8-1/2"	ADA Lever	*Brushed Nickel	
069570	K-15172-F-G	4	8-1/2"	ADA Lever	Brushed Chrome	
067161	K-15176-F-CP	2	8-1/2"	ADA Lever	Polished Chrome	
102722	K-15176-FL-CP	2	10"	ADA Loop Lever	Polished Chrome	
168296	K-15176-TL-CP	2	10"	ADA Loop Lever	Polished Chrome	

#### With Matching Finish Sidespray in Escutcheon

Part #	Mfg #	Holes	Reach	Handle(s)	Finish	Price
067992	K-15173-F-CP	3	8-1/2"	ADA Lever	Polished Chrome	
177407	K-15173-F-G	3	8-1/2"	ADA Lever	Brushed Chrome	

\* Vibrant Limited Lifetime Finish

www.plumbsupply.com • Serving our Customers Since 1946 • www.waterconcepts.net

## Kitchen Faucets & Accessories

### Coralais® Kitchen Faucet with Swing Spout and Ground Joints

- 8-1/2" Spout
- Premium metal construction
- Ceramic disc valves
- Temperature memory
- High-temperature limit setting
- (-P) Ground joints
- Maximum flow rate: 1.8 gpm @ 60 psi



Part #	Mfg #	Holes	Reach	Handle(s)	Finish	Price
059546	K-15175-P-CP	1	8-1/2"	ADA Lever	Polished Chrome	
076028	K-15175-F-CP	1	8-1/2"	ADA Lever	Polished Chrome	

### Coralais® Project Pack Kitchen Faucet with Swing Spout, Escutcheon, and Sidespray

- 8-1/2" Reach, 8-5/8" high swivel spout
- For job business only
- Premium metal construction
- 3/8" Fitting on hoses fastnes directly to stops
- Contemporary/transitional styling
- Ceramic disc valves with flexible supply lines
- Temperature memory with high-temperature limit setting
- Maximum flow rate: 1.8 gpm @ 60 psi



Part #	Mfg #	Holes	Reach	SideSpray	Handle(s)	Finish	Price
077600	K-P15172-F-CP	4	8-1/2"	Chrome	ADA Lever	Polished Chrome	

### Fairfax® Kitchen Faucet with Arched Swing Spout and Lever Handle

- 9" Reach, 7-5/8" max handle height
- Premium metal construction
- Ceramic disc valves with flexible supply lines
- Temperature memory with high-temperature limit setting
- Includes one white ceramic plug button
- Maximum flow rate: 1.8 gpm @ 60 psi



#### Without Matching Finish Sidespray

Part #	Mfg #	Holes	Reach	Max Height	Handle(s)	Finish	Price
060931	K-12175-BN	1	9"	7-5/8"	ADA Lever	*Brushed Nickel	

#### With Matching Finish Sidespray

Part #	Mfg #	Holes	Reach	Max Height	Handle(s)	Finish	Price
056595	K-12176-BN	2	9"	7-5/8"	ADA Lever	*Brushed Nickel	

\* Vibrant Limited Lifetime Finish

## Kitchen Faucets & Accessories

### Forté® 1-Hdl Kitchen Faucet with 9-1/16" High-Arch Swing Spout

- 9-1/16" Spout reach
- Premium metal construction
- Temperature memory with high-temperature limit setting
- Ceramic disc valves with flexible supply lines
- Maximum flow rate: 1.8 gpm @ 60 psi



Without Sidespray

Part #	Mfg #	Holes	Reach	Handle(s)	Finish	Price
076901	K-10411-BN	3	9-1/16"	ADA Lever	*Brushed Nickel	
073752	K-10411-CP	3	9-1/16"	ADA Lever	Polished Chrome	
079964	K-10415-BN	1	9-1/16"	ADA Lever	*Brushed Nickel	
075691	K-10415-CP	1	9-1/16"	ADA Lever	Polished Chrome	
097380	K-10415-VS	1	9-1/16"	ADA Lever	*Stainless	

### With Matching Finish Sidespray

Part #	Mfg #	Holes	Reach	Handle(s)	Finish	Price
071115	K-10412-BN	4	9-1/16"	ADA Lever	*Brushed Nickel	
078528	K-10412-BV	4	9-1/16"	ADA Lever	*Brushed Bronze	
073593	K-10412-CP	4	9-1/16"	ADA Lever	Polished Chrome	
080380	K-10412-G	4	9-1/16"	ADA Lever	Brushed Chrome	
097379	K-10412-VS	4	9-1/16"	ADA Lever	*Stainless	
082556	K-10413-CP	3	9-1/16"	ADA Lever	Polished Chrome	
073770	K-10416-BN	2	9-1/16"	ADA Lever	*Brushed Nickel	
079114	K-10416-BV	2	9-1/16"	ADA Lever	*Brushed Bronze	
072094	K-10416-CP	2	9-1/16"	ADA Lever	Polished Chrome	
097378	K-10416-VS	2	9-1/16"	ADA Lever	*Stainless	

### Forté® Remote Valve Kitchen Faucet with High-Arch Swing Spout and Matching Sidespray

- 9" Reach, 11-5/8" high swivel spout
- Premium metal construction
- Temperature memory with high-temperature limit setting
- Ceramic disc valves with flexible supply lines
- 3-Hole installation
- Maximum flow rate: 1.8 gpm @ 60 psi



Part #	Mfg #	Holes	Reach	Max Height	Handle(s)	Finish	Price
080383	K-10430-BN	3	9"	11-5/8"	ADA Lever	*Brushed Nickel	
084359	K-10430-BV	3	9"	11-5/8"	ADA Lever	*Brushed Bronze	
083130	K-10430-CP	3	9"	11-5/8"	ADA Lever	Polished Chrome	
085927	K-10430-G	3	9"	11-5/8"	ADA Lever	Brushed Chrome	
097377	K-10430-VS	3	9"	11-5/8"	ADA Lever	*Stainless	

\* Vibrant Limited Lifetime Finish

[www.plumbsupply.com](http://www.plumbsupply.com) • Serving our Customers Since 1946 • [www.waterconcepts.net](http://www.waterconcepts.net)



## Kitchen Faucets & Accessories

### Karbon® 1-Hdl Articulating Deck-Mount Kitchen Faucet with 13" Tube Spout

- Spout reaches from less than 2" to over 13"
- 1-5/16" Diameter remote joystick valve
- Sturdy metal and carbon fiber construction
- Integral sprayhead
- Self-contained ceramic disc valve
- Flexible supply lines and installation ring
- Maximum flow rate: 1.8 gpm @ 60 psi



Part #	Mfg #	Holes	Tube Color	Joystick Dia.	Handle(s)	Finish	Price
139158	K-6227-C11-CP	2	Silver	1-5/16"	ADA Remote Lever	Polished Chrome	
114972	K-6227-C11-VS	2	Silver	1-5/16"	ADA Remote Lever	*Stainless	
140792	K-6227-C12-CP	2	Black	1-5/16"	ADA Remote Lever	Polished Chrome	
127936	K-6227-C12-VS	2	Black	1-5/16"	ADA Remote Lever	*Stainless	
154457	K-6227-C15-BV	2	Bronze	1-5/16"	ADA Remote Lever	*Brushed Bronze	

### Purist® 1-Hdl Kitchen Faucet with Swing Spout

- 8" Reach, 11-3/8" high, 360° swivel spout
- (K-7509) 6" reach, 9-7/8" high, 360° swivel spout
- Premium metal construction
- Self-contained ceramic disc valve
- Temperature memory
- Flexible supply lines and installation ring
- Maximum flow rate: 1.8 gpm @ 60 psi (K-7509) 1.5 gpm @ 60 psi



#### Without Sidespray

Part #	Mfg #	Holes	Reach	Spout Rotation	Height	Handle(s)	Finish	Price
147998	K-7507-BL	1	8"	360°	11-3/8"	ADA Lever	Matte Black	
138659	K-7507-CP	1	8"	360°	11-3/8"	ADA Lever	Pol Chrome	
154171	K-7507-VS	1	8"	360°	11-3/8"	ADA Lever	*Stainless	
255947	K-7509-SN	1	6"	360°	9-7/8"	ADA Lever	*Pol Nickel	

#### With Sidespray

Part #	Mfg #	Holes	Reach	Spout Rotation	Height	Handle(s)	Finish	Price
166749	K-7508-BL	2	8"	360°	11-3/8"	ADA Lever	Matte Black	
140343	K-7508-CP	2	8"	360°	11-3/8"	ADA Lever	Pol Chrome	
223583	K-7508-SN	2	8"	360°	11-3/8"	ADA Lever	*Pol Nickel	
176334	K-7508-VS	2	8"	360°	11-3/8"	ADA Lever	*Stainless	

\* Vibrant Limited Lifetime Finish

[www.waterconcepts.net](http://www.waterconcepts.net) • Serving our Customers Since 1946 • [www.plumbsupply.com](http://www.plumbsupply.com)



## Kitchen Faucets & Accessories

### Two-Handle Kitchen Faucets

#### Artifacts® 2-Hdl Bridge Kitchen Faucet

- 8-1/2" Reach, 13-1/2" high spout
- 9" From deck to aerator
- 360° Spout rotation
- Premium metal construction
- MasterClean™ sprayface
- Maximum flow rate: 1.5 gpm



-3M Prong Handles

Part #	Mfg #	Holes	Reach	Centers	Height	Handle(s)	Finish	Price
237091	76519-3M-CP	4	8-1/2"	8"cc	13-1/2"	Prong	Pol Chrome	
236588	76519-3M-VS	4	8-1/2"	8"cc	13-1/2"	Prong	*Stainless	
254553	76519-3M-2BZ	4	8-1/2"	8"cc	13-1/2"	Prong	Oil Rubbed Bronze	
237127	76519-4-VS	4	8-1/2"	8"cc	13-1/2"	Lever	*Stainless	
238693	76519-4-2BZ	4	8-1/2"	8"cc	13-1/2"	Lever	Oil Rubbed Bronze	

#### Coralais® Kitchen Faucet with High-Arch Gooseneck Swing Spout—Requires Handles

- 9" Reach for 8" centers with 11-1/2" high spout
- Premium metal construction
- Reversible quarter-turn washerless ceramic disc valves
- Requires **K-15850-4M** ergonomic lever handles (sold separately)
- Maximum flow rate: 1.8 gpm @ 60 psi



Part #	Mfg #	Holes	Reach	Centers	Height	Handle(s)	Finish	Price
066774	K-15888-K-CP	3	9"	8"	11-1/2"	ADA Lever	Pol Chrome	

#### Essex® Kitchen Faucet with High-Arch Gooseneck Spout and Handles

- 9-1/4" Reach, 15-1/2" high spout
- 9-5/16" From deck to aerator
- Solid-brass construction
- Ceramic disc valves
- Single-hole or three-hole installation (escutcheon sold separately)  
—Requires escutcheon for three-hole installations
- Maximum flow rate: 1.8 gpm @ 60 psi
- Accent side spray is included with model (K-8763-CP)



K-8763-C

Part #	Mfg #	Holes	Reach	Spout Height	Handle(s)	Finish	Price
082542	K-8762-CP	1	9-1/4"	15-1/2"	ADA Wrist Blade Lever	Polished Chrome	
056206	K-8763-CP	1	9-1/4"	15-1/2"	ADA Wrist Blade Lever	Polished Chrome	
100173	K-8763-VS	1	9-1/4"	15-1/2"	ADA Wrist Blade Lever	*Stainless	

\* Vibrant Limited Lifetime Finish

[www.plumbsupply.com](http://www.plumbsupply.com) • Serving our Customers Since 1946 • [www.waterconcepts.net](http://www.waterconcepts.net)

## Kitchen Faucets & Accessories

### Forte® 2-Hdl Kitchen Faucet with High-Arch Swing Spout and Matching Finish Sidespray

- 7-3/4" Reach swivel spout
- Premium metal construction
- UltraGlide™ engineered ceramic disc valves
- Two ergonomic handles pre-assembled on valves
- Flexible supply lines
- Maximum flow rate: 1.8 gpm @ 60 psi



Part #	Mfg #	Holes	Reach	Spout Height	Handle(s)	Finish	Price
113690	K-10445-BN	4	7-3/4"	10-1/8"	ADA Lever	*Brushed Nickel	
117451	K-10445-CP	4	7-3/4"	10-1/8"	ADA Lever	Polished Chrome	

### HiRise® Kitchen Faucet with 10" High-Arch Gooseneck Spout and Lever Handles

- 10-1/4" Reach, 17-1/2" high swivel spout
- Stainless steel construction
- Two quarter-turn washerless ceramic disc valves
- Coordinates with other HiRise® kitchen products
- Flexible supply lines and installation ring
- Maximum flow rate: 1.8 gpm @ 60 psi



Part #	Mfg #	Holes	Reach	Spout Rotation	Height	Handle(s)	Finish	Price
111514	K-7341-4-BS	1	10-1/4"	17-1/2"	360°	ADA Lever	Br. Stainless	
183144	K-7341-4-S	1	10-1/4"	17-1/2"	360°	ADA Lever	Pol Stainless	

### HiRise® Wall-Mount Bridge Kitchen Faucet with 13-7/8" High-Arch Gooseneck Spout and Lever Handles

- 10-1/4" Reach, 360° swivel spout, 8" Centers
- Stainless steel construction
- Two quarter-turn washerless ceramic disc valves
- UltraGlide™ engineered ceramic disc valves
- Coordinates with other HiRise® kitchen products
- Maximum flow rate: 1.8 gpm @ 60 psi



Part #	Mfg #	Centers	Reach	Spout Rotation	Height	Handle(s)	Finish	Price
183143	K-7338-4-BS	8"	10-1/4"	13-7/8"	360°	ADA Lever	Br. Stainless	
183366	K-7338-4-S	8"	10-1/4"	13-7/8"	360°	ADA Lever	Pol. Stainless	

### HiRise® Deck-Mount Bridge Kitchen Faucet with High-Arch Gooseneck Spout and Lever Handles

- 10-1/4" Reach, 18-1/8" high, 360° spout
- Stainless steel construction
- Two quarter-turn washerless ceramic disc valves
- UltraGlide™ engineered ceramic disc valves
- Two-hole installation for 8" centers
- Coordinates with other HiRise® kitchen products
- Maximum flow rate: 1.8 gpm @ 60 psi



Part #	Mfg #	Holes	Reach	Spout Rotation	Height	Handle(s)	Finish	Price
108813	K-7337-4-BS	2	10-1/4"	18-1/8"	360°	ADA Lever	Br. Stainless	

\* Vibrant Limited Lifetime Finish

[www.waterconcepts.net](http://www.waterconcepts.net) • Serving our Customers Since 1946 • [www.plumbsupply.com](http://www.plumbsupply.com)

## Kitchen Faucets & Accessories

### Two-Handle Kitchen Faucets (Continued)

#### HiRise® Deck-Mount Bridge Kitchen Faucet with High-Arch Gooseneck Spout and Lever Handles

Part #	Mfg #	Holes	Reach	Spout Rotation	Height	Handle(s)	Finish	Price
182348	K-7337-4-S	2	10-1/4"	18-1/8"	360°	ADA Lever	Pol Stainless	

#### Parq® Deck-Mount Bridge Kitchen Faucet with High-Arch Gooseneck Spout and Tri Handles

- 9" Spout reach, 14-11/16" High spout
- Metal construction
- Flexible supply lines
- Two quarter-turn washerless ceramic disc valves
- UltraGlide™ engineered ceramic disc valves
- 360° Swing spout with 8-1/2" clearance below spout
- Maximum flow rate: 1.8 gpm @ 60 psi



#### Without Sidespray

Part #	Mfg #	Holes	Reach	Spout Rotation	Height	Handle(s)	Finish	Price
181937	K-6130-3-SN	2	9"	14-11/16"	360°	ADA Cross	*Polished Nickel	
129974	K-6130-3-VS	2	9"	14-11/16"	360°	ADA Cross	*Stainless	
171794	K-6130-3-2BZ	2	9"	14-11/16"	360°	ADA Cross	Oil Rubbed Bronze	
128391	K-6130-4-CP	2	9"	14-11/16"	360°	ADA Lever	Polished Chrome	
138664	K-6130-4-VS	2	9"	14-11/16"	360°	ADA Lever	*Stainless	
247275	K-6130-4-2BZ	2	9"	14-11/16"	360°	ADA Lever	Oil Rubbed Bronze	

#### With Matching Finish Sidespray

- Ceramic disc valves
- MasterClean™ sprayface
- ProMotion light, quiet nylon hose and ball joint

Part #	Mfg #	Holes	Reach	Spout Rotation	Height	Handle(s)	Finish	Price
157759	K-6131-3-CP	3	9"	14-11/16"	360°	ADA Cross	Polished Chrome	
129976	K-6131-3-VS	3	9"	14-11/16"	360°	ADA Cross	*Stainless	
156202	K-6131-3-SN	3	9"	14-11/16"	360°	ADA Cross	Polished Nickel	
163693	K-6131-3-2BZ	3	9"	14-11/16"	360°	ADA Cross	Oil Rubbed Bronze	
134668	K-6131-4-CP	3	9"	14-11/16"	360°	ADA Lever	Polished Chrome	
245029	K-6131-4-SN	3	9"	14-11/16"	360°	ADA Lever	*Polished Nickel	
124195	K-6131-4-VS	3	9"	14-11/16"	360°	ADA Lever	*Stainless	
151399	K-6131-4-2BZ	3	9"	14-11/16"	360°	ADA Lever	Oil Rubbed Bronze	

\* Vibrant Limited Lifetime Finish

[www.plumbsupply.com](http://www.plumbsupply.com) • Serving our Customers Since 1946 • [www.waterconcepts.net](http://www.waterconcepts.net)

## Kitchen Faucets & Accessories

### Purist® Deck-Mount Bridge Kitchen Sink Faucet with 8-3/8" High Spout and Lever Handles

- 8-3/8" Spout reach, 12-1/2" height, 360° spout rotation
- Two quarter-turn washerless ceramic disc valves
- Flexible supply lines and installation ring
- Two-hole installation for 8" centers
- Coordinates with other products in the Purist® collection
- 360° Swing spout with 10" clearance below spout
- Available with or without sidespray
- Maximum flow rate: 1.8 gpm @ 60 psi



Without Sidespray

Part #	Mfg #	Holes	Reach	Spout Rotation	Height	Handle(s)	Finish	Price
226887	K-7547-4-CP	2	8-3/8"	12-1/2"	360°	ADA Lever	Polished Chrome	

With Matching Accent® Sidespray

Part #	Mfg #	Holes	Reach	Spout Rotation	Height	Handle(s)	Finish	Price
258499	K-7548-4-BL	2	8-3/8"	12-1/2"	360°	ADA Lever	Matte Black	
162844	K-7548-4-CP	2	8-3/8"	12-1/2"	360°	ADA Lever	Polished Chrome	
156873	K-7548-4-VS	2	8-3/8"	12-1/2"	360°	ADA Lever	*Stainless	

### Purist® Wall-Mount Bridge Kitchen Sink Faucet with 13-7/8" High Spout and Lever Handles

- 13-7/8" Spout reach, 7-7/8" height, 360° spout rotation
- UltraGlide ceramic disc valves
- Two-hole installation for 8" centers
- Maximum flow rate: 1.5 gpm @ 60 psi



Part #	Mfg #	Holes	Reach	Spout Rotation	Height	Handle(s)	Finish	Price
248104	K-7549-4-BL	2	13-7/8"	7-1/8"	360°	ADA Lever	Matte Black	

### Revival® Kitchen Faucet High-Arch Swing Spout and Matching Accent® Sidespray and Lever Handles

- 11-13-16" Spout reach, 13-3/4" spout height (16111 Model)
- 9-3/16" Spout reach, 12-3/16" spout height (16109 Model)
- Solid brass construction and brass valve bodies
- Ergonomic handle rotation
- Quarter-turn washerless ceramic disc valves
- UltraGlide™ engineered ceramic disc valves
- Coordinates with other products in the Revival® collection
- Flexible supply lines and installation ring
- Maximum flow rate: 1.8 gpm @ 60 psi



Part #	Mfg #	Holes	Reach	Spout Height	Handle(s)	Finish	Price
082554	K-16111-4-BN	4	11-13/16"	13-3/4"	Scroll Lever	*Brushed Nickel	
157679	K-16111-4-CP	4	11-13/16"	13-3/4"	Scroll Lever	Polished Chrome	
059948	K-16111-4-PB	4	11-13/16"	13-3/4"	Scroll Lever	Polished Brass	
054743	K-16111-4A-CP	4	11-13/16"	13-3/4"	Traditional Lever	Polished Chrome	
054863	K-16109-4A-BN	4	9-3/16"	12-3/16"	Traditional Lever	*Brushed Nickel	
070705	K-16109-4A-BV	4	9-3/16"	12-3/16"	Traditional Lever	*Brushed Bronze	

\* Vibrant Limited Lifetime Finish

[www.waterconcepts.net](http://www.waterconcepts.net) • Serving our Customers Since 1946 • [www.plumbsupply.com](http://www.plumbsupply.com)

## Kitchen Faucets & Accessories

### Two-Handle Kitchen Faucets (Continued)

#### Revival® Kitchen Faucet High-Arch Swing Spout and Matching Accent® Sidespray and Lever Handles

Part #	Mfg #	Holes	Reach	Spout Height	Handle(s)	Finish	Price
060583	K-16109-4A-CP	4	9-3/16"	12-3/16"	Traditional Lever	Polished Chrome	
070467	K-16109-4A-PB	4	9-3/16"	12-3/16"	Traditional Lever	Polished Brass	

### Faucet Accessories

#### Coralais® Decorative Lever Handles with Polished Chrome Insert

- Premium metal construction
- Separate control of hot and cold water
- For use with K-15888 and K-15889 Coralais kitchen® sink faucets



Part #	Mfg #	Description	Handle(s)	Finish	Price
053783	K-15850-4M-CP	Decorative	ADA Lever	Polished Chrome	

\* Vibrant Limited Lifetime Finish

[www.plumbsupply.com](http://www.plumbsupply.com) • Serving our Customers Since 1946 • [www.waterconcepts.net](http://www.waterconcepts.net)

**Kitchen Faucets & Accessories**

**Misc Accessories**

**Aquifer® Water Filtration System**

- Under-sink installation
- For cold water use only
- Quarter turn twist cartridge
- Coconut shell based carbon filter
- High impact plastic construction
- Filter head automatically turns off water supply when cartridge is removed
- Recommended for use with the Wellspring® beverage and Carafe® kitchen faucets
- Includes replacement cartridge



Singl

Part #	Mfg #	Cartridge	GPM	Price
239503	K-77685-NA	Single	0.85	
242839	K-77686-NA	Double	1.70	

**Aquifer® Replacement Filter Cartridges**

- For use with (K-77685) or (K-77686)
- Coconut shell based carbon filter
- Under-sink installation
- 1.70 gpm @ 60 psi
- 1/4" Turn twist cartridge
- For cold water use only
- Filter head turns off water supply when cartridge is removed



Part #	Mfg #	Qty	Price
242854	K-77688-NA	2 Pack	

**HiRise® Independent Sidespray with Valve**

- 90° progressive valve
- Spray pause function
- ProMotion® technology's light, quiet braided hose and ball joint
- Flow rate: 2.2 gpm



Part #	Mfg #	Material	Reach Spout	Price
108814	K-7344-4-BS	Brushed Stnlss	4-3/16"	
182350	K-7344-4-S	Polished Stnlss	4-3/16"	

**Accent® Kitchen Side Spray**

- Includes hose and sidespray holder
- MasterClean™ sprayface
- Coordinates with many faucet designs



Part #	Mfg #	Finish	Price
104810	K-10101-BN	*Brushed Nickel	
102596	K-10101-CP	Polished Chrome	

\* Vibrant Limited Lifetime Warranty

**Misc Accessories (Continued)**

**Accent® Kitchen Side Spray**

Part #	Mfg #	Finish	Price
102597	K-10101-G	Brushed Chrome	
173986	K-10101-2BZ	Oil Rubbed Bronze	

**Faucet Hole Cover for Sinks and Lavatories**



Part #	Mfg #	Finish	Dia.	Price
094134	K-8830-0	White	1-3/4"	
135394	K-8830-47	Almond	1-3/4"	
081702	K-8830-CP	Polished Chrome	1-3/4"	
065328	K-8830-PB	Polished Brass	1-3/4"	
173029	K-8830-VS	*Stainless	1-3/4"	
147019	K-8830-2BZ	Oil Rubbed Bronze	1-3/4"	

**Bellegrove™ Sponge Caddy**

- Comes included with K-6482



Part #	Mfg #	Finish	Price
188518	K-6545-ST	Stainless Steel	

**Dish Scraper**



Part #	Mfg #	Finish	Price
177433	K-8624-0	White	

**Lift Dish Rack**

- 19"L x 10-1/2"H x 14-1/2"W



Part #	Mfg #	Description	Price
227994	K-8631-CHR	Charcoal	

**Disinfecting Wipes Dispenser with Silicone Seal**

- Fits 30- to 35 wipes
- Easy one-touch lid opening
- Rust-resistant stainless steel



Part #	Mfg #	Finish	Price
190458	K-6382-0	Stainless/White	



## Kitchen Faucets & Accessories

### Prolific™ Colander and Wash bin

- Included with the K-5540 Prolific Sink



Part #	Mfg #	Finish	Price
173553	K-5544-0	White	

### In Step™ Paper Towel Holder



Part #	Mfg #	Finish	Price
227175	K-8618-0	White	
177432	K-8618-CHR	Charcoal	

### Reset™ Flexible Kitchen Mat

- Heat-resistant to 400°F
- Protects sink surface and cushions dishware
- Doubles as a dish drying mat on the countertop



Part #	Mfg #	Finish	Price
177054	8619-0	White	
183658	8619-CHR	Charcoal	

### Dishwasher Safe Silicone Drying Mat

- Heat-resistant to 500°F



Part #	Mfg #	Finish	Size	Price
190465	K-5472-0	White	11" x 15" x 3/8"	
190466	K-5472-CHR	Charcoal	11" x 15" x 3/8"	

### Touchless Foaming Soap Dispenser

- Works with foaming soap or liquid soap
- No-Touch operation
- Select high, medium, or low soap dispensing amount
- 8.45oz Capacity
- Four AAA batteries (not included)



Part #	Mfg #	Description	Price
232040	K-8637-0	White	

### Sponge Caddy



Part #	Mfg #	Finish	Price
171845	K-6377-0	White	

### Sponge Caddy for the Octave™

K-3842, K-3843, K-3844, or K-3845



Part #	Mfg #	Finish	Price
163370	K-6139-ST	Stainless Steel	

### Wine Glass Drying Rack



Part #	Mfg #	Finish	Price
235662	K-8628-CHR	Charcoal	

### Surface Swipe



Part #	Mfg #	Finish	Price
172617	K-6379-0	White	

### Utility Rack with Soaking Cup

- Expands 3" to fit most sinks (14.6" to 17.6")



Part #	Mfg #	Finish	Price
190459	K-5473-CHR	Stainless Charcoal	

### Air Gaps

#### Air Gap body with Cover

- Durable plastic body
- Solid-brass cap offers years of reliable performance



Part #	Mfg #	Finish	Price
183159	K-9110-CP	Polished Chrome	
222601	K-9110-VS	*Stainless	

\* Vibrant Limited Lifetime Warranty

[www.plumbsupply.com](http://www.plumbsupply.com) • Serving our Customers Since 1946 • [www.waterconcepts.net](http://www.waterconcepts.net)

---

---

**Kitchen Faucets & Accessories**

---

---

**Cleaners**

**Kohler® Cast Iron Cleaner**



Part #	Mfg #	Bottle Size	Price
119311	K-1012525	8 Ounces	

\* Vibrant Limited Lifetime Warranty

[www.waterconcepts.net](http://www.waterconcepts.net) • Serving our Customers Since 1946 • [www.plumbsupply.com](http://www.plumbsupply.com)

## Soap Dispensers

### Soap/Lotion Dispensers

#### Artifacts® Soap Dispenser

- 6-5/8" High Pump
- 5-1/4" Long spout
- Installation template included
- Premium metal and glass construction



Part #	Mfg #	Description	Price
230359	K-98630-BV	*Brushed Bronze	
243157	K-98630-CP	Polished Chrome	

#### Contemporary Soap/Lotion Dispenser

- Refillable from top with up to 16 oz liquid soap, dishwashing liquid, or hand lotion
- 3-7/16" High pump
- 3-1/16" Long spout
- May be installed in a pre-drilled sink hole or surfaces up to 2.5"
- Clam shell packed



Part #	Mfg #	Finish	Price
126092	K-1895-BL	Matte Black	
100745	K-1895-C-BN	*Brushed Nickel	
103610	K-1895-C-BV	*Brushed Bronze	
100746	K-1895-C-CP	Polished Chrome	
106253	K-1895-C-G	Brushed Chrome	
100747	K-1895-C-VS	*Stainless	

#### Contemporary Soap/Lotion Dispenser with 4" Spout

- Refillable from top with up to 16 oz liquid soap, dishwashing liquid or hand lotion
- 4-7/16" High pump



Part #	Mfg #	Description	Price
169803	K-1995-BL	Matte Black	
115893	K-1995-BN	*Brushed Nickel	
120314	K-1995-CP	Polished Chrome	
115894	K-1995-VS	*Stainless	

#### HiRise® Soap/Lotion Dispenser with 3-1/8" Pump

- Refillable from top with up to 16 oz liquid soap, dishwashing liquid or hand lotion
- 3-13/16" Long spout



Part #	Mfg #	Description	Price
139295	K-7346-BS	Brushed Stainless	

### Soap/Lotion Dispensers (Continued)

#### HiRise® Soap/Lotion Dispenser with 3-1/8" Pump

Part #	Mfg #	Description	Price
182349	K-7346-S	Polished Stainless	

#### Purist® Countertop Soap/Lotion Dispenser



Part #	Mfg #	Description	Price
228016	K-14379-BN	*Brushed Nickel	
164190	K-14379-CP	Polished Chrome	

#### Touchless Foaming Soap Dispenser

- Anti-drip spout
- 8.45-oz. capacity
- 20-second\* lighted timer
- Four AAA batteries (not included)
- Features hygienic, no-touch operation
- Works with foaming soap or liquid soap
- Easy-to-fill dispenser with soap-level window
- Select high, medium, or low soap dispensing amount



Part #	Mfg #	Description	Price
227995	K-8637-ST	Stainless Steel	

#### Traditional Soap/Lotion Dispenser—16 Fl Oz

- Refillable from top
- 3-7/16" High pump
- 3-7/16" Long spout
- May be installed in a pre-drilled sink hole or surfaces up to 2.5"
- Clam shell packed



Part #	Mfg #	Finish	Price
097717	K-1894-C-BN	*Brushed Nickel	
104617	K-1894-C-BV	*Brushed Bronze	
100743	K-1894-C-CP	Polished Chrome	
135463	K-1894-G-G	Brushed Chrome	
112851	K-1894-C-PB	*Polished Brass	
178563	K-1894-C-SN	*Polished Nickel	
100744	K-1894-C-VS	*Stainless	

\* Vibrant Limited Lifetime Warranty

[www.plumbsupply.com](http://www.plumbsupply.com) • Serving our Customers Since 1946 • [www.waterconcepts.net](http://www.waterconcepts.net)

## Soap Dispensers

### Soap/Lotion Dispensers (Continued)

#### Traditional Soap/Lotion Dispenser—16 Fl Oz

Part #	Mfg #	Finish	Price
147006	K-1894-C-2BZ	Oil Rubbed Bronze	

#### Traditional Design Soap/Lotion Dispenser

- Solid brass construction
- Refillable from top with up to 16 oz
- 5-1/2" High Pump
- 3-15/16" Long spout



Part #	Mfg #	Description	Price
189542	K-1994-CP	Polished Chrome	
225038	K-1994-SN	*Polished Nickel	
185194	K-1994-VS	*Stainless	

#### Transitional Soap/Lotion Dispenser

- Refillable from top with up to 16 oz
- 3-5/16" High pump
- 3-3/8" Long spout
- May be installed in a pre-drilled sink hole or surfaces up to 2"
- Clam shell packed



Part #	Mfg #	Finish	Price
149727	K-1893-BL	Matte Black	
098307	K-1893-C-BN	*Brushed Nickel	
114047	K-1893-C-BV	*Brushed Bronze	
100741	K-1893-C-CP	Polished Chrome	
105578	K-1893-C-G	Brushed Chrome	
178239	K-1893-C-SN	*Polished Nickel	
100742	K-1893-C-VS	*Stainless	
147005	K-1893-C-2BZ	Oil Rubbed Bronze	

#### Soap/Lotion Dispenser

- Solid brass construction
- Holds up to 8.5 ounces
- 3-3/4" high pump
- 2-11/16" spout



Part #	Mfg #	Description	Price
053686	K-9619-0	White	

#### Soap Dispenser

- 10-oz. capacity
- 3-5/8" High pump
- 6-11/16" Long spout
- Wide-mouth bottle for easy refilling
- Grip pad on base holds dispenser steady
- Ergonomic spout design for one-handed pumping



Part #	Mfg #	Description	Price
177434	K-6383-0	White	

\* Vibrant Limited Lifetime Warranty

[www.waterconcepts.net](http://www.waterconcepts.net) • Serving our Customers Since 1946 • [www.plumbsupply.com](http://www.plumbsupply.com)

## Kitchen Faucets & Accessories

### Single-Handle Kitchen Faucets

#### Artesso™ 1-Hdl Pull-Down Kitchen Faucet

- 8-3/4" Long, 15-5/8" high, 360° swivel spout
- Two-function spray
- One hole installation
- MagneDock® magnetic docking
- DIAMOND™ seal technology
- Euro-motion Diamond™ valve with InnoFlex® waterways
- Touch-Clean® nozzles
- Accommodates 3" deck thickness
- 1.80 gpm @ 60 psi



Part #	Mfg #	Description	Handle(s)	Finish	Price
177630	63025LF-PC	1- or 3-Hole, Pull-Down Spray	ADA Lever	Chrome	
178322	63025LF-PN	1- or 3-Hole, Pull-Down Spray	ADA Lever	Polished Nickel*	
170377	63025LF-RB	1- or 3-Hole, Pull-Down Spray	ADA Lever	Venetian Bronze®	
171626	63025LF-SS	1- or 3-Hole, Pull-Down Spray	ADA lever	Stainless*	
177873	64025LF-SS	1- or 3-Hole, Pull-Down Spray w/ SmartTouch® Tech	ADA lever	Stainless*	
225034	64025LF-PN	1- or 3-Hole, Pull-Down Spray w/ SmartTouch® Tech	ADA lever	Polished Nickel*	

#### Artesso™ 1-Hdl Articulating Arm Kitchen Faucet

- 20-13/16" High spout
- 21-1/2" High spout (64225LF models)
- 23" Above-deck exposed hose, arm rotates 360°
- Two-function spray
- Quick connect hoses
- MagneDock® magnetic docking
- DIAMOND™ seal technology
- Euro-motion Diamond™ valve with InnoFlex® waterways
- Touch-Clean® nozzles
- One hole installation
- Accommodates 3" deck thickness
- Optional escutcheon included for 3-hole mount
- 1.8 gpm @ 60 psi



Part #	Mfg #	Description	Handle(s)	Finish	Price
186425	63225LF-PC	1-or-3 Hole, Articulating Arm	ADA Lever	Chrome	
237811	63225LF-PN	1-or-3 Hole, Articulating Arm	ADA Lever	Polished Nickel*	
240173	63225LF-RB	1- or 3-Hole, Articulating Arm	ADA Lever	Venetian Bronze	
176921	63225LF-SS	1- or 3-Hole, Articulating Arm	ADA Lever	Stainless*	
231934	64225LF-SS	1- or 3-Hole, Articulating Arm w/ SmartTouch® Tech	ADA Lever	Stainless*	

\* Brilliance® Anti-Tarnish Lifetime Finishes

[www.plumbsupply.com](http://www.plumbsupply.com) • Serving our Customers Since 1946 • [www.waterconcepts.net](http://www.waterconcepts.net)

## Kitchen Faucets & Accessories

### Baliza™ 1-Hdl Pull-Out Kitchen Faucet

- 9-17/32" Reach, 8-3/64" high, 120° swing spout
- MagneDock® technology
- DIAMOND™ seal technology
- Euro-motion Diamond™ valve with InnoFlex® waterways
- Touch-Clean® nozzles
- 4-function wand: spray, stream, volume control, and pause
- Accommodates up to 3" deck thickness
- Maximum flow: 1.80 gpm @ 60 psi



Part #	Mfg #	Description	Handle(s)	Finish	Price
110033	63005LF-BZ	1-Hole, Pull-Out Spray	ADA Lever	Brushed Bronze*	
186666	63005LF-PC	1-Hole, Pull-Out Spray	ADA Lever	Chrome	
147534	63005LF-RB	1-Hole, Pull-Out Spray	ADA Lever	Venetian Bronze®	
156141	63005LF-SS	1-Hole, Pull-Out Spray	ADA Lever	Stainless*	

### Belo® 1-Hdl Pull-Down Kitchen Faucet

- 9-1/2" Long, 15" high, 360° swivel spout
- Touch-Clean® sprayhead
- Quick connect hoses
- MagneDock® magnetic docking
- Optional 10" escutcheon included for 3-hole mount
- 1.8 gpm @ 60 psi



Part #	Mfg #	Description	Handle(s)	Finish	Price
134898	63052LF-PC	1- or 3-Hole, Pull-Down Spray	ADA Lever	Chrome	
131294	63052LF-SS	1- or 3-Hole, Pull-Down Spray	ADA Lever	Stainless*	

### Coltello™ 1-Hdl Pull-Down Kitchen Faucet

- 9" Long, 16-3/4" high, 360° swivel spout
- 3" Maximum deck thickness
- 10-5/8" Deck to aerator
- MagneDock® magnetic docking
- Touch-Clean® sprayhead
- Two-function pull-down wand: spray and stream
- Quick connect hoses
- Optional escutcheon included for 3-hole mount
- 1.8 gpm @ 60 psi



Part #	Mfg #	Description	Handle(s)	Finish	Price
252852	63096LF-PC	1- or 3-Hole, Pull-Down Spray	ADA Lever	Chrome	

\* Brilliance® Anti-Tarnish Lifetime Finishes



## Kitchen Faucets & Accessories

### Litze™ 1-Hdl Articulating Kitchen Faucet

- 7-1/8" Reach, 21-1/2" high, 360° swivel spout
- MagneDock® magnetic docking
- Touch-Clean® sprayhead
- DIAMOND™ seal
- QuickSnap® connect hoses
- Euro-motion DIAMOND™ valve with InnoFlex® waterways
- Two function wand: aerated stream & spray
- Accommodates up to 3" deck thickness
- 3/8" O.D. straight, staggered PEX supply lines
- Dual-jointed articulating arm with 23" semi-flexible hose
- 1.8 gpm @ 60 psi



Part #	Mfg #	Description	Handle(s)	Finish	Price
260048	63143LF-PN	1-Hole, Articulating Arm w/ Finished Hose	ADA Lever	Polished Nickel	
246660	63243LF-BLGL	1-Hole, Articulating Arm	ADA Knurled Lever	Matte Black/Luxe Gold	
259538	63243LF-PC	1-Hole, Articulating Arm	ADA Knurled Lever	Chrome	
243175	63244LF-GL	1-Hole, Articulating Arm	ADA Industrial Lever	Luxe Gold	

### Litze™ SmartTouch™ 1-Hdl Articulating Kitchen Faucet

- 21-1/2" High, 360° swivel spout
- MagneDock® magnetic docking
- Touch-Clean® sprayhead
- DIAMOND™ seal
- TempID® indicator light
- QuickSnap® connect hoses
- Euro-motion DIAMOND™ valve with InnoFlex® waterways
- Two function wand: spray and stream
- Accommodates up to 3" deck thickness
- Dual-jointed articulating arm with 23" semi-flexible hose
- 1.8 gpm @ 60 psi



Part #	Mfg #	Description	Handle(s)	Finish	Price
242463	64244LF-GL	1-Hole, Articulating Arm	ADA Industrial Lever	Luxe Gold	
254759	64244LF-PN	1-Hole, Articulating Arm	ADA Industrial Lever	Polished Nickel	

\* Brilliance® Anti-Tarnish Lifetime Finishes

[www.plumbsupply.com](http://www.plumbsupply.com) • Serving our Customers Since 1946 • [www.waterconcepts.net](http://www.waterconcepts.net)

## Kitchen Faucets & Accessories

### Litze™ 1-Hdl Pull-Down Kitchen Faucet

- 8-11/16" Reach, 16" high arc spout
- 8-3/4" Reach, 14-1/8" high angle spout
- 9" Reach, 14" high square spout
- 8-3/8" Height from deck to aerator
- MagneDock® technology
- Accommodates up to 3" deck thickness
- Two-function pull down wand: spray and stream
- Euro-motion ceramic valve with InnoFlex® waterways
- Maximum flow rate: 1.8 gpm @ 60 psi



Square Spout  
63054LF



Arc Spout  
63043LF



Angle

Part #	Mfg #	Description	Handle(s)	Finish	Price
246659	63043LF-BLGL	1-Hole, Pull-Down Spray	ADA Knurled Lever	Matte Black/Luxe Gold	
243911	63043LF-GL	1-Hole, Pull-Down Spray	ADA Knurled Lever	Luxe Gold	
248246	63043LF-PC	1-Hole, Pull-Down Spray	ADA Knurled Lever	Chrome	
241038	63043LF-SS	1-Hole, Pull-Down Spray	ADA Knurled Lever	Stainless*	
252182	63044LF-SS	1-Hole, Pull-Down Spray	ADA Industrial Lever	Stainless*	
249242	63054LF-GL	1-Hole, Pull-Down Spray	ADA Industrial Lever	Luxe Gold	
242035	63063LF-BLGL	1-Hole, Pull-Down Spray	ADA Knurled Lever	Matte Black/Luxe Gold	
251605	63063LF-PN	1-Hole, Pull-Down Spray	ADA Knurled Lever	Polished Nickel	
246206	63063LF-SS	1-Hole, Pull-Down Spray	ADA Knurled Lever	Stainless*	
258248	63064LF-BLGL	1-Hole, Pull-Down Spray	ADA Industrial Lever	Matte Black/Luxe Gold	
257511	63064LF-GL	1-Hole, Pull-Down Spray	ADA Industrial Lever	Luxe Gold	
255460	63064LF-PN	1-Hole, Pull-Down Spray	ADA Industrial Lever	Polished Nickel	
255974	63064LF-SS	1-Hole, Pull-Down Spray	ADA Industrial Lever	Stainless*	

### Litze™ 1-Hdl Pull-Down Kitchen Faucet with Square Spout

- 9" Reach, 14" high
- 8-1/2" Height from deck to aerator
- MagneDock® technology
- Accommodates up to 3" deck thickness
- Two-function pull down wand: spray and stream
- Euro-motion ceramic valve with InnoFlex® waterways
- Maximum flow rate: 1.8 gpm @ 60 psi



Knurled Lever



Industrial

Part #	Mfg #	Description	Handle(s)	Finish	Price
243631	63053LF-BLGL	1-Hole, Pull-Down Spray	ADA Knurled Lever	Matte Black/Luxe Gold	
251023	63053LF-GL	1-Hole, Pull-Down Spray	ADA Knurled Lever	Luxe Gold	
247512	63053LF-PC	1-Hole, Pull-Down Spray	ADA Knurled Lever	Chrome	
251604	63053LF-PN	1-Hole, Pull-Down Spray	ADA Knurled Lever	Polished Nickel	
246848	63054LF-BLGL	1-Hole, Pull-Down Spray	ADA Industrial Lever	Matte Black/Luxe Gold	
243528	63054LF-SS	1-Hole, Pull-Down Spray	ADA Industrial Lever	Stainless*	

\* Brilliance® Anti-Tarnish Lifetime Finishes

[www.waterconcepts.net](http://www.waterconcepts.net) • Serving our Customers Since 1946 • [www.plumbsupply.com](http://www.plumbsupply.com)

## Kitchen Faucets & Accessories

### Litze™ SmartTouch® 1-Hdl Pull-Down Kitchen Faucet

- 9" Reach, 14-1/2" high, 360° swivel **square** spout
- 8-11/16" Reach, 16-1/2" high, 360° swivel **arc** spout
- 8-7/8" Reach, 14-5/8" high, 360° swivel **angled** spout
- TempID™-tap on/off functionality
- MagneDock® technology
- Accommodates up to 3" deck thickness
- Two-function pull down wand: spray and stream
- Euro-motion ceramic valve with InnoFlex® waterways
- Maximum flow rate: 1.8 gpm @ 60 psi
- Optional A/C adapter EP73957



Square Spout



Arc Spout



Angled Spout

Part #	Mfg #	Description	Handle(s)	Finish	Price
241894	64043LF-BLGL	1-Hole, Pull-Down Spray	ADA Knurled Handle	Matte Black/Luxe Gold	
250381	64043LF-GL	1-Hole, Pull-Down Spray	ADA Knurled Handle	Luxe Gold	
248245	64043LF-PN	1-Hole, Pull-Down Spray	ADA Knurled Handle	Polished Nickel	
259553	64044LF-BLGL	1-Hole, Pull-Down Spray	ADA Industrial Lever	Matte Black/Luxe Gold	
242468	64044LF-GL	1-Hole, Pull-Down Spray	ADA Industrial Lever	Luxe Gold	
246728	64044LF-PC	1-Hole, Pull-Down Spray	ADA Industrial Lever	Chrome	
250401	64044LF-SS	1-Hole, Pull-Down Spray	ADA Industrial Lever	Stainless*	
244474	64054LF-GL	1-Hole, Pull-Down Spray	ADA Industrial Lever	Luxe Gold	
249609	64054LF-PN	1-Hole, Pull-Down Spray	ADA Industrial Lever	Polished Nickel	
241788	64054LF-SS	1-Hole Pull-Down Spray	ADA Industrial Lever	Stainless*	
254519	64064LF-BLGL	1-Hole Pull-Down Spray	ADA Industrial Lever	Matte Black/Luxe Gold	
244846	64063LF-BLGL	1-Hole, Pull-Down Spray	ADA Knurled Handle	Matte Black/Luxe Gold	

### Solna® 1-Hdl Pull-Out Kitchen Faucet

- 8-25/32" Long, 11-11/16" high, 360° swivel spout
- Quick connect hoses
- 1.8 gpm @ 60 psi



Part #	Mfg #	Description	Handle(s)	Finish	Price
179678	63220LF-PC	1-Hole, Pull-Out Spray	ADA Lever	Chrome	
226382	63220LF-BL	1-Hole, Pull-Out Spray	ADA Lever	Matte Black	
168367	63220LF-SS	1-Hole, Pull-Out Spray	ADA Lever	Stainless*	

\* Brilliance® Anti-Tarnish Lifetime Finishes

[www.plumbsupply.com](http://www.plumbsupply.com) • Serving our Customers Since 1946 • [www.waterconcepts.net](http://www.waterconcepts.net)

## Kitchen Faucets & Accessories

### Solna® 1-Hdl Articulating Kitchen Faucet

- 20-9/16" High, 360° swivel spout
- MagneDock® magnetic docking
- Touch-Clean® sprayhead
- Two function spray
- 1-Hole installation
- Accommodates up to 3" deck thickness
- 1.8 gpm @ 60 psi



Part #	Mfg #	Description	Handle(s)	Finish	Price
225095	63221LF-PC	1-Hole, Articulating Arm	ADA Lever	Chrome	
185536	63221LF-BL	1-Hole, Articulating Arm	ADA Lever	Matte Black	
185410	63221LF-SS	1-Hole, Articulating Arm	ADA Lever	Stainless*	

### Solna® SmartTouch® 1-Hdl Articulating Kitchen Faucet

- 21-1/2" High, 360° swivel spout
- TempID™
- MagneDock® magnetic docking
- Touch-Clean® sprayhead
- Quick Snap® connect hoses
- Euro-motion Diamond™ valve with InnoFlex® waterways
- Dual-jointed articulating arm with semi-flexible hose
- 3/8" O.D. straight, staggered PEX supply lines
- Two function spray—spray and stream
- Dual integral check valves in sprayer
- Accommodates up to 3" deck thickness
- 1.8 gpm @ 60 psi



Part #	Mfg #	Description	Handle(s)	Finish	Price
248924	64221LF-BL	1-Hole, Articulating Arm	ADA Lever	Matte Black	

### Solna™ 1-Hdl Pull-Down Kitchen Faucet

- 9-3/32" Long, 15-11/16" high, 360° swing spout
- MagneDock™ magnetic docking
- DIAMOND™ seal technology
- Euro-motion Diamond™ valve with InnoFlex® waterways
- Two-function wand: spray and stream
- Hidden pull-down wand
- Accommodates up to 3" deck thickness
- Maximum flow rate: 1.80 gpm @ 60 psi



Part #	Mfg #	Description	Handle(s)	Finish	Price
158688	63020LF-BL	1-Hole, Pull-Down Spray	ADA Lever	Matte Black	
229427	63020LF-MW	1-Hole, Pull-Down Spray	ADA Lever	Matte White	
147982	63020LF-PC	1-Hole, Pull-Down Spray	ADA Lever	Chrome	

\* Brilliance® Anti-Tarnish Lifetime Finishes

[www.waterconcepts.net](http://www.waterconcepts.net) • Serving our Customers Since 1946 • [www.plumbsupply.com](http://www.plumbsupply.com)

## Kitchen Faucets & Accessories

### Single-Handle Kitchen Faucets (Continued)

#### Solna™ 1-Hdl Pull-Down Kitchen Faucet

Part #	Mfg #	Description	Handle(s)	Finish	Price
139265	63020LF-SS	1-Hole, Pull-Down Spray	ADA Lever	Stainless*	
147390	64020LF-BL	1-Hole, Pull-Down Spray w/ SmartTouch®	ADA Lever	Matte Black	
170374	64020LF-PC	1-Hole, Pull-Down Spray w/ SmartTouch®	ADA Lever	Chrome	
147389	64020LF-SS	1-Hole, Pull-Down Spray w/ SmartTouch®	ADA Lever	Stainless*	

#### Talo® 1-Hdl Pull-Down Kitchen Faucet

- 8-7/16" Long, 15-29/32" high, 360° swing spout
- Four function with pause and volume control
- Solid brass body
- MagneDock® magnetic docking
- 1.80 gpm @ 60 psi



Part #	Mfg #	Description	Handle(s)	Finish	Price
134882	63003LF-BZ	1-Hole, Pull-Down Spray	ADA Lever	Brushed Bronze*	
159858	63003LF-PC	1-Hole, Pull-Down Spray	ADA Lever	Chrome	
157812	63003LF-PN	1-Hole, Pull-Down Spray	ADA Lever	Polished Nickel*	
129710	63003LF-RB	1-Hole, Pull-Down Spray	ADA Lever	Venetian Bronze®	
131609	63003LF-SS	1-Hole, Pull-Down Spray	ADA Lever	Stainless*	
186830	64003LF-PN	1-Hole, Pull-Down Spray w/ SmartTouch®	ADA Lever	Polished Nickel*	
131217	64003LF-RB	1-Hole, Pull-Down Spray w/ SmartTouch®	ADA Lever	Venetian Bronze®	

#### Tresa® 1-Hdl Kitchen Faucet

- 9" Reach, 13-3/16" high, 360° swing spout
- Euro-motion DIAMOND™ valve with InnoFlex® waterways
- Accommodates up to 3" deck thickness
- Maximum flow: 1.8 gpm @ 60psi



Part #	Mfg #	Description	Handle(s)	Finish	Price
170565	61036LF-SS	1-Hole, Less Side Spray	ADA Lever	Stainless*	
163266	61136LF-PC	2-Hole, Matching Side Spray	ADA Lever	Chrome	
167498	61136LF-PN	2-Hole, Matching Side Spray	ADA Lever	Polished Nickel*	
174390	61136LF-RB	2-Hole, Matching Side Spray	ADA Lever	Venetian Bronze®	
156422	61136LF-SS	2-Hole, Matching Side Spray	ADA Lever	Stainless*	

\* Brilliance® Anti-Tarnish Lifetime Finishes

[www.plumbsupply.com](http://www.plumbsupply.com) • Serving our Customers Since 1946 • [www.waterconcepts.net](http://www.waterconcepts.net)

## Kitchen Faucets & Accessories

### Venuto® 1-Hdl Pull-Down Kitchen Faucet

- 9-1/2" Reach, 15-1/2" high, 360° swing spout
- MagneDock® technology
- DIAMOND™ seal technology
- Euro-motion Diamond™ valve with InnoFlex® waterways
- Touch-Clean® nozzles
- 2-function wand: spray and stream
- 3" Maximum deck thickness
- Maximum flow: 1.80 gpm @ 60 psi



Part #	Mfg #	Description	Handle(s)	Finish	Price
154741	63070LF-BLST	1-Hole, Pull-Down Spray	ADA Lever	Matte Black/Soft Touch®	
132301	63070LF-PC	1-Hole, Pull-Down Spray	ADA Lever	Chrome	
130516	63070LF-SS	1-Hole, Pull-Down Spray	ADA Lever	Stainless*	
131555	63070LF-SSST	1-Hole, Pull-Down Spray	ADA Lever	Stainless*/Soft Touch®	
132723	64070LF-PC	1-Hole, Pull-Down Spray w/ SmartTouch®	ADA Lever	Chrome	
131907	64070LF-SS	1-Hole, Pull-Down Spray w/ SmartTouch®	ADA Lever	Stainless*	

### Vuelo® 1-Hdl Pull-Down Kitchen Faucet

- 10-3/4" Long, 15-3/4" high, 360° swing spout
- DIAMOND™ seal technology
- Touch-Clean® nozzles
- MagneDock® magnetic docking
- Accommodates up to 3" deck thickness
- Maximum flow: 1.80 gpm @60 psi



Part #	Mfg #	Description	Handle(s)	Finish	Price
154158	63055LF-PC	1-Hole, Pull-Down Spray	ADA Lever	Chrome	
249181	63055LF-PCMW	1-Hole, Pull-Down Spray	ADA Lever	Chrome/Matte White	
156055	63055LF-SS	1-Hole, Pull-Down Spray	ADA Lever	Stainless*	
155144	63055LF-SSCO	1-Hole, Pull-Down Spray	ADA Lever	Stainless Steel/Cocoa Brz™	

### Vuelo® 1-Hdl Pull-Down Kitchen Faucet with SmartTouch®

- 10-1/4" Reach, 16-3/4" high, 360° swing spout
- SmartTouch® technology with TempID™
- MagneDock™ magnetic docking
- DIAMOND® seal technology
- Two-function wand: spray and stream
- Accommodates up to 3" deck thickness
- Flow rate: 1.80 gpm @ 60 psi



Part #	Mfg #	Description	Handle(s)	Finish	Price
158002	64355LF-SS	1-Hole, Pull-Down Spray w/ SmartTouch®	ADA Lever	Stainless*	
166423	64355LF-SSCO	1-Hole, Pull-Down Spray w/ SmartTouch®	ADA Lever	Stainless Steel/Cocoa Brz™	

\* Brilliance® Anti-Tarnish Lifetime Finishes



## Kitchen Faucets & Accessories

### Two-Handle Kitchen Faucets

#### Arteso™ 2-Hdl Bridge Kitchen Faucet

- 8-19/32" Reach, 13-21/34" high 360° swing spout
- 10-5/32" From deck to aerator
- Solid brass with one-piece waterway
- Ceramic cartridges
- Accommodates up to 3" deck thickness
- Includes matching side sprayer
- Maximum flow: 1.8 gpm @ 60 psi



Part #	Mfg #	Description	Handle(s)	Finish	Price
178172	62525LF-PC	3-Hole, Matching Side Spray	ADA Lever	Chrome	
177270	62525LF-SS	3-Hole, Matching Side Spray	ADA Lever	Stainless*	

#### Litze™ 2-Hdl Bridge Kitchen Faucet

- 8-9/16" Reach, 13-3/8" high 360° swing spout
- 8-1/4" Reach, 13-1/2" high 360° swing spout (62563LF)
- 10-7/16" From deck to aerator, 10-7/8" for model 62563LF
- Solid brass with one-piece waterway
- Ceramic cartridges
- Accommodates up to 3" deck thickness
- Includes matching side sprayer
- Optional decorative center hole cover available RP90934
- Maximum flow: 1.8 gpm @ 60 psi



62554LF  
Square Spout



62544LF  
Arc Spout



62563LF  
Angled Spout

Part #	Mfg #	Description	Handle(s)	Finish	Price
250046	62544LF-PC	2- or 3-Hole, Matching Side Spray	ADA Lever	Chrome	
242785	62554LF-SS	2- or 3-Hole, Matching Side Spray	ADA Lever	Stainless*	
255715	62563LF-BLGL	2- or 3-Hole, Matching Side Spray	ADA Lever	Matte Black/Luxe Gold	

#### Tresa® 2-Hdl Bridge Kitchen Faucet

- 9-27/32" Reach, 10-21/32" high 360° swing spout
- 7-3/8" From deck to aerator
- Solid brass one-piece waterway
- Ceramic cartridges
- Accommodates up to 3" deck thickness
- Maximum flow: 1.8 gpm @ 60 psi



Part #	Mfg #	Description	Handle(s)	Finish	Price
150686	62436LF-PC	2-Hole, Less Side Spray	ADA lever	Polished Chrome	
146887	62436LF-RB	2-Hole, Less Side Spray	ADA Lever	Venetian Bronze®	
155363	62436LF-SS	2-Hole, Less Side Spray	ADA Lever	Stainless*	
155225	62536LF-PC	3-Hole, Matching Side Spray	ADA Lever	Polished Chrome	
170004	62536LF-PN	3-Hole, Matching Side Spray	ADA Lever	Polished Nickel*	
138290	62536LF-RB	3-Hole, Matching Side Spray	ADA Lever	Venetian Bronze ®	
151760	62536LF-SS	3-Hole, Matching Side Spray	ADA Lever	Stainless*	

\* Brilliance® Anti-Tarnish Lifetime Finishes

[www.plumbsupply.com](http://www.plumbsupply.com) • Serving our Customers Since 1946 • [www.waterconcepts.net](http://www.waterconcepts.net)

## Kitchen Faucets & Accessories

### Tresa® 2-Hdl Kitchen Faucet

- 9" Reach, 13-3/16" high spout
- 9-5/8" From deck to aerator
- Includes matching side sprayer
- Solid brass faucet body
- Ceramic cartridges
- Accommodates up to 3" deck thickness
- Maximum flow: 1.8 gpm @ 60 psi



Part #	Mfg #	Description	Handle(s)	Finish	Price
189228	62136LF-PC	2-Hole, Matching Side Spray	ADA Lever	Polished Chrome	
252062	62136LF-PN	2-Hole, Matching Side Spray	ADA Lever	Polished Nickel	
140344	62136LF-SS	2-Hole, Matching Side Spray	ADA Lever	Stainless*	

### Pot Fillers

#### Artesso® Pot Filler

- 20-3/8" Reach
- Wall-mount
- Dual shut-offs
- Cold water only
- Maximum flow rate: 4.0 gpm @ 60 psi



Part #	Mfg #	Description	Handle(s)	Finish	Price
242576	62825LF-PC			Polished Chrome	
251955	62825LF-RB			Venetian Bronze	
243119	62825LF-SS			Stainless*	

#### Euro Pot Filler

- 23-1/4" Reach
- Wall-mount
- Dual shut-offs
- Cold water only
- Maximum flow rate: 4.0 gpm @ 60 psi



Part #	Mfg #	Description	Handle(s)	Finish	Price
242006	62820LF-BL			Matte Black	
242472	62820LF-GL			Luxe Gold	
249610	62820LF-PN			Polished Nickel	
131637	62820LF-RB			Venetian Bronze®	
130279	62820LF-SS			Stainless*	

\* Brilliance® Anti-Tarnish Lifetime Finishes

## Kitchen Faucets & Accessories

### Traditional Pot Filler

- 23-1/4" Spout reach
- Wall-mount
- Dual shut-offs
- Cold water only
- Maximum flow rate: 4.0 gpm @ 60 psi



Part #	Mfg #	Description	Handle(s)	Finish	Price
130184	62810LF-PC		Polished Chrome		
228658	62810LF-PN		Polished Nickel		
131638	62810LF-RB		Venetian Bronze		
131639	62810LF-SS		Stainless*		

### Deck-Mount Traditional Pot Filler

- 20-1/2" Reach, 17" high
- 14-3/4" Spout outlet to deck
- Deck-Mount
- Dual shut-offs
- Cold water only
- Maximum flow rate: 4.0 gpm @ 60 psi



Part #	Mfg #	Description	Handle(s)	Finish	Price
135061	62710LF-RB		Venetian Bronze®		

### Deck-Mount Euro Pot Filler

- 20-1/2" Reach, 17" high
- 14-3/4" Spout outlet to deck
- Deck-mount
- Dual shut-offs
- Cold water only
- Maximum flow rate: 4.0 gpm @ 60 psi



Part #	Mfg #	Description	Handle(s)	Finish	Price
189234	62720LF-SS		Stainless*		

## Kitchen Accessories

### Artesso™ Air Gap

- Polyethylene body
- 1-7/8" Diameter, 2-1/8" long brass cap
- 5/8" dishwasher inlet, 7/8" outlet



Part #	Mfg #	Description	Handle(s)	Finish	Price
222289	69060-PC	Polished Chrome			
222290	69060-RB	Venetian Bronze			
222291	69060-SS	Stainless*			

\* Brilliance® Anti-Tarnish Lifetime Finishes

[www.plumbsupply.com](http://www.plumbsupply.com) • Serving our Customers Since 1946 • [www.waterconcepts.net](http://www.waterconcepts.net)

## Kitchen Faucets & Accessories

### Classic Air Gap

- Polyethylene body
- 1-5/8" Diameter, 2-1/8" long brass cap
- 5/8" Dishwasher inlet, 7/8" outlet



Part #	Mfg #	Description	Handle(s)	Finish	Price
152292	72020	Chrome			
134116	72020-RB	Venetian Bronze®			
169379	72020-SS	Stainless*			

### Dish Towel Hook



Part #	Mfg #	Description	Handle(s)	Finish	Price
255451	RP50279RB	Venetian Bronze			

### Venuto® Bud Vase

- Installation hardware included
- Mounts to 3" deck thickness
- 6-7/8" Overall height



Part #	Mfg #	Description	Handle(s)	Finish	Price
170378	RP42879	Chrome			
091631	RP42879SS	Stainless*			

### Baliza™ Escutcheon

- Includes installation hardware
- Accommodates up to 3" deck thickness
- 8" On center



Part #	Mfg #	Description	Handle(s)	Finish	Price
156838	RP50271BZ	10", Brushed Bronze*			
187514	RP50271SS	10", Stainless*			

\* Brilliance® Anti-Tarnish Lifetime Finishes

---



---

**Kitchen Faucets & Accessories**

---



---

**Litze™ Hole Cover**

- 1/3" overall height
- Includes installation hardware
- Accommodates up to 3" deck thickness
- Maximum flow rate: 1.8 gpm @ 60 psi



Part #	Mfg #	Description	Handle(s)	Finish	Price
242557	RP90934BL	Matte Black			
242784	RP90934SS	Stainless*			

**Vuelo® Escutcheon**

- Includes installation hardware
- Accommodates up to 3" deck thickness
- 8" On center
- (Not for use w/ SmartTouch® models)



Part #	Mfg #	Description	Handle(s)	Finish	Price
154160	RP64475PC	8", Polished Chrome			
176964	RP64475SS	8", Stainless*			

**Talo® Escutcheon**

- Includes installation hardware
- Accommodates up to 3" deck thickness
- 8" On center
- (Not for use w/ SmartTouch® models)



Part #	Mfg #	Description	Handle(s)	Finish	Price
154706	RP60281RB	10", Venetian Bronze®			
179625	RP60281SS	10", Stainless*			

\* Brilliance® Anti-Tarnish Lifetime Finishes

<a href="http://www.plumbsupply.com">www.plumbsupply.com</a> • Serving our Customers Since 1946 • <a href="http://www.waterconcepts.net">www.waterconcepts.net</a>
--------------------------------------------------------------------------------------------------------------------------------------------------------------------

## Soap Dispensers

### Soap Dispensers

#### Artesso™ Soap/Lotion Dispenser

- Accommodates up to 3" deck thickness
- Refillable from above the deck
- 15-Ounce bottle
- 2-3/4" Overall height
- Includes installation hardware



Part #	Mfg #	Finish	Price
244246	RP75675PC	Polished Chrome	
225035	RP75675PN	Polished Nickel	
177874	RP75675SS	Stainless*	
231786	RP75675RB	Venetian Bronze®	

#### Baliza® Soap/Lotion Dispenser

- Installation hardware included
- Mounts to 3" deck thickness
- 5-11/16" Overall height
- 13-Ounce bottle
- Refillable from above the deck



Part #	Mfg #	Finish	Price
186339	RP50274	Polished Chrome	
134883	RP50274BZ	Brushed Bronze*	
157813	RP50274PN	Polished Nickel*	
132303	RP50274RB	Venetian Bronze®	
131610	RP50274SS	Stainless*	

#### Belo® Soap/Lotion Dispenser

- Installation hardware included
- Accommodates up to 3" deck thickness
- 5-5/8" Overall height
- 13 oz Bottle
- Refillable from above the deck



Part #	Mfg #	Finish	Price
133485	RP49589SS	Stainless*	

#### Tresa™ Soap/Lotion Dispenser

- Includes installation hardware
- Accommodates up to 3" deck thickness
- 5-1/2" Overall height
- Refillable from above the deck



Part #	Mfg #	Finish	Price
159191	RP61024PC	Polished Chrome	
156137	RP61024RB	Venetian Bronze®	
166189	RP61024SS	Stainless*	

#### Soap/Lotion Dispenser

- 3 or 4-hole 8" installation
- Large capacity 13-ounce bottle
- Refillable from above the deck
- Order RP30395 vented refill funnel separately



Part #	Mfg #	Finish	Price
237525	RP50781SP	SpotShield Stainless	

#### Soap/Lotion Dispenser

- 13 ounce bottle
- Refillable from above the deck
- 2-1/2" Maximum deck thickness
- Includes RP30395 refill funnel
- Fits hole size 1-3/8" +/- 1/8"



Part #	Mfg #	Finish	Price
239828	RP71543PN	Polished Nickel*	

#### Solna® Soap/Lotion Dispenser

- Includes installation hardware
- Accommodates up to 3" deck thickness
- Refillable from above the deck
- 15-Ounce bottle
- 2-3/4" Overall height



Part #	Mfg #	Finish	Price
242552	RP79275BL	Matte Black	
253496	RP79275GL	Luxe Gold	
225096	RP79275PC	Polished Chrome	
251606	RP79275PN	Polished Nickel*	
181489	RP79275SS	Stainless*	



---



---

**Soap Dispensers**

---



---

**Vuelo® Soap/Lotion Dispenser**

- *Installation hardware included*
- *Mounts to 3" deck thickness*
- *5-11/16" Overall height*
- *13-Ounce height*
- *Refillable from above the deck*



Part #	Mfg #	Finish	Price
158003	RP64473SS	Stainless*	
162940	RP64473SSC O	Stainless/Cocoa Bronze™	

## Kitchen Faucets & Accessories

### Pot Filler Faucets

#### Traditional Wall-Mount Pot Filler Faucet

- Single-hole wall mount
- Dual-handle design for easy operation
- 24" Dual jointed swing spout
- On/off control by rotating handle 90°
- Rough into 1/2" stub out
- 1/2" IPS Inlets
- Cold water connection only
- Washerless ceramic valving
- Flow rate: 4.3 gpm @ 60 psi



Part #	Mfg #	Description	Handle(s)	Finish	Price
140946	1177LF	1-Hole, Lead-Free	ADA Lever	Chrome	
159217	1177LF-AR	1-Hole, Lead-Free	ADA Lever	Arctic Stainless™	
183316	1177LF-CZ	1-Hole, Lead-Free	ADA Lever	Champagne Bronze™	
224275	1177LF-PN	1-Hole, Lead-Free	ADA Lever	Polished Nickel	
140944	1177LF-RB	1-Hole, Lead-Free	ADA Lever	Venetian Bronze®	
140945	1177LF-SS	1-Hole, Lead-Free	ADA Lever	Stainless*	

#### Contemporary Wall-Mount Pot Filler Faucet

- Single-hole wall mount
- Dual-handle design for easy operation
- 24" Dual jointed swing spout
- On/off control by rotating handle 90°
- Rough into 1/2" stub out
- 1/2" IPS Inlets
- Cold water connection only



Part #	Mfg #	Description	Handle(s)	Finish	Price
177308	1165LF	1-Hole, Lead-Free	ADA Lever	Chrome	
243842	1165LF-BL	1-Hole, Lead-Free	ADA Lever	Matte Black	
171595	1165LF-AR	1-Hole, Lead-Free	ADA Lever	Arctic Stainless™	
242350	1165LF-CZ	1-Hole, Lead-Free	ADA Lever	Champagne Bronze™	
257299	1165LF-KS	1-Hole, Lead-Free	ADA Lever	Black Stainless	
180916	1165LF-SS	1-Hole, Lead-Free	ADA Lever	Stainless*	

\* Brilliance® Anti-Tarnish Lifetime Finishes

## Kitchen Faucets & Accessories

### Pull-Down Kitchen Faucets

#### Addison® 1-Hdl Pull-Down Spray Kitchen Faucet

- 10-11/32" Reach, 15-9/16" high pull-down spout swivels 360°
- 9-1/16" From deck to aerator
- Touch-Clean® two-function Multi-Flow™ spray head with MagnaTite® docking
- 62" Long hose
- 3/8" Compression fittings
- 2-1/2" Maximum deck thickness
- Optional 10-1/2" escutcheon included
- 32" Minimum supply lines below deck included
- Water-efficient product: 1.5 gpm @ 60 psi



Part #	Mfg #	Description	Handle(s)	Finish	Price
134963	9192-DST	1-Hole, Pull-Down Spray, Lead-Free	ADA Lever	Chrome	
152920	9192-AR-DST	1-Hole, Pull-Down Spray, Lead-Free	ADA Lever	Arctic Stainless™	
155788	9192-CZ-DST	1-Hole, Pull-Down Spray, Lead-Free	ADA Lever	Champagne Bronze™	
134964	9192-RB-DST	1-Hole, Pull-Down Spray, Lead-Free	ADA Lever	Venetian Bronze®	

#### Addison® Touch2O 1-Hdl Pull-Down Spray Kitchen Faucet

- Touch2O® Technology controls water flow
- 10-11/32" Reach, 15-3/8" high pull-down spout swivels 360°
- 8-25/32" From deck to aerator
- Touch-Clean® two-function Multi-Flow™ spray head with MagnaTite® docking
- 62" Long hose
- 3/8" Compression fittings
- 2-1/2" Maximum deck thickness
- Optional 10-1/2" escutcheon included
- 32" Minimum supply lines below deck included
- Water-efficient product: 1.5 gpm @ 60 psi



Part #	Mfg #	Description	Handle(s)	Finish	Price
134738	9192T-DST	1-Hole, Pull-Down Spray, Lead-Free	ADA Lever	Chrome	
156060	9192T-AR-DST	1-Hole, Pull-Down Spray, Lead-Free	ADA Lever	Arctic Stainless™	
161615	9192T-CZ-DST	1-Hole, Pull-Down Spray, Lead-Free	ADA Lever	Champagne Bronze™	
134741	9192T-RB-DST	1-Hole, Pull-Down Spray, Lead-Free	ADA Lever	Venetian Bronze®	

\* Brilliance® Anti-Tarnish Lifetime Finishes

[www.plumbsupply.com](http://www.plumbsupply.com) • Serving our Customers Since 1946 • [www.waterconcepts.net](http://www.waterconcepts.net)

## Kitchen Faucets & Accessories

### Allora® 1-Hdl Pull-Down Spray Kitchen Faucet

- 9-7/8" Reach, 15-9/16" high spout swivels 360°
- 7-3/4" From deck to aerator
- Touch-Clean® pull-down two-function spray head with MagnaTite® docking
- 62" Long hose
- 3/8" Compression fittings
- 2-1/2" Maximum deck thickness
- 32" Minimum supply lines below deck included
- Water-efficient product: 1.8 gpm @ 60 psi



989-DST



989-SD-DST

Part #	Mfg #	Description	Handle(s)	Finish	Price
116875	989-DST	1-Hole, Pull-Down Spray, Lead-Free	ADA Lever	Chrome	
147898	989-AR-DST	1-Hole, Pull-Down Spray, Lead-Free	ADA Lever	Arctic Stainless™	

### Cassidy™ 1-Hdl Pull-Down Spray Kitchen Faucet

- 9-3/8" Reach, 15-1/2" high
- High-arc pull-down swivels 360°
- 9-5/32" From deck to aerator
- 62" Long hose
- 3/8" Compression fittings
- 32" minimum InnoFlex® supply lines below the deck included
- 2-1/2" Maximum deck thickness
- Euro-motion DIAMOND™ valve
- MagnaTite® docking
- WaterSense® certified product: 1.8 gpm @ 60 psi



Part #	Mfg #	Description	Handle(s)	Finish	Price
152825	9197-DST	1- or 3-Hole, Pull-Down Spray, Lead Free	ADA Lever	Chrome	
152267	9197-AR-DST	1- or 3-Hole, Pull-Down Spray, Lead Free	ADA Lever	Arctic Stainless™	
152274	9197-CZ-DST	1- or 3-Hole, Pull-Down Spray, Lead Free	ADA Lever	Champagne Bronze™	
227742	9197-PN-DST	1- or 3-Hole, Pull-Down Spray, Lead Free	ADA Lever	Polished Nickel	
152027	9197-RB-DST	1- or 3-Hole, Pull-Down Spray, Lead Free	ADA Lever	Venetian Bronze®	

\* Brilliance® Anti-Tarnish Lifetime Finishes

## Kitchen Faucets & Accessories

### Cassidy™ 1-Hdl Pull-Down Spray Touch2O® Kitchen Faucet

- 9-3/8" Reach, 15-1/2" high
- High-arc pull-down swivels 360°
- 9-5/32" From deck to aerator
- 62" Long hose
- 3/8" Compression fittings
- 32" minimum InnoFlex® supply lines below the deck included
- 2-1/2" Maximum deck thickness
- Euro-motion DIAMOND™ valve
- MagnaTite® docking
- WaterSense® certified product: 1.8 gpm @ 60 psi
- Touch feature to activate on/off



Part #	Mfg #	Description	Handle(s)	Finish	Price
152816	9197T-DST	1- or 3-Hole, Pull-Down Spray, Lead Free Touch2O	ADA Lever	Chrome	
152710	9197T-AR-DST	1- or 3-Hole, Pull-Down Spray, Lead Free Touch2O	ADA Lever	Arctic Stainless™	
152817	9197T-CZ-DST	1- or 3-Hole, Pull-Down Spray, Lead Free Touch2O	ADA Lever	Champagne Bronze™	
152151	9197T-RB-DST	1- or 3-Hole, Pull-Down Spray, Lead Free Touch2O	ADA Lever	Venetian Bronze®	

### Esque™ 1-Hdl Pull-Down Kitchen Faucet

- 9-3/16" reach, 15-11/16" high
- High-arc pull-down spout swivels 360°
- 8-15/16" From deck to aerator
- 3/8" O.D. straight, staggered PEX supply tubes
- Red/blue indicator markings
- Dual integral check valves in sprayer
- Quick Snap® connect hoses
- ShieldSpray™ technology
- Touch-Clean® sprayhead
- MagnaTite® magnetic docking
- (-DST) DIAMOND Seal® technology
- (-T) Touch2O® technology



Part #	Mfg #	Description	Handle(s)	Finish	Price
234652	9181-DST	1- or 3-Hole Pull-Down Spray, Lead Free	ADA Lever	Chrome	
230642	9181-AR-DST	1- or 3-Hole Pull-Down Spray, Lead Free	ADA Lever	Arctic Stainless™	
236830	9181-RB-DST	1- or 3-Hole, Pull-Down Spray, Lead Free	ADA Lever	Venetian Bronze®	
240761	9181-BL-DST	1- or 3-Hole Pull-Down Spray, Lead Free	ADA Lever	Matte Black	
234649	9181T-DST	1- or 3-Hole Pull-Down Spray, Lead Free	ADA Lever	Chrome	
236430	9181T-AR-DST	1- or 3-Hole Pull-Down Spray, Lead Free	ADA Lever	Arctic Stainless™	
238921	9181T-BL-DST	1- or 3-Hole Pull-Down Spray, Lead Free	ADA Lever	Matte Black	
231091	9181T-RB-DST	1- or 3-Hole Pull-Down Spray, Lead Free	ADA Lever	Venetian Bronze®	

\* Brilliance® Anti-Tarnish Lifetime Finishes

[www.plumbsupply.com](http://www.plumbsupply.com) • Serving our Customers Since 1946 • [www.waterconcepts.net](http://www.waterconcepts.net)

## Kitchen Faucets & Accessories

### Essa™ 1-Hdl Pull-Down Spray Kitchen Faucet

- 9-3/8" Reach, 15-3/4" high 360° swivel spout
- 8-3/4" From deck to aerator
- 3/8" O.D. straight, staggered pex supply lines
- 1- or 3-Hole (escutcheon included)
- DIAMOND™ Valve
- MagnaTite® magnetic docking
- Touch-Clean® sprayhead
- 1.8 gpm @ 60 psi



Part #	Mfg #	Description	Handle(s)	Finish	Price
180317	9113-DST	1- or 3-Hole 8"cc, Pull-Out Spray, Lead Free	ADA Lever	Chrome	
180390	9113-AR-DST	1- or 3-Hole 8"cc, Pull-Out Spray, Lead Free	ADA Lever	Arctic Stainless™	
179486	9113-BL-DST	1- or 3-Hole 8"cc, Pull-Out Spray, Lead Free	ADA Lever	Matte Black	
177300	9113-RB-DST	1- or 3-Hole 8"cc, Pull-Out Spray, Lead Free	ADA Lever	Venetian Bronze®	

### Essa™ 1-Hdl Pull-Down Spray Touch2O® Kitchen Faucet

- 9-3/8" Reach, 16" high 360° swivel spout
- 9-21/32" From deck to aerator
- 3/8" O.D. straight, staggered pex supply lines
- 1- or 3-Hole (escutcheon included)
- DIAMOND™ Valve
- MagnaTite® magnetic docking
- Touch-Clean® sprayhead
- 1.8 gpm @ 60 psi
- Touch2O® touch feature to activate on/off



Part #	Mfg #	Description	Handle(s)	Finish	Price
185200	9113T-DST	1- or 3-Hole 8"cc, Pull-Out Spray, Lead Free Touch2O	ADA Lever	Chrome	
179996	9113T-AR-DST	1- or 3-Hole 8"cc, Pull-Out Spray, Lead Free Touch2O	ADA Lever	Arctic Stainless™	
185307	9113T-BL-DST	1- or 3-Hole 8"cc, Pull-Out Spray, Lead Free Touch2O	ADA Lever	Matte Black	
181845	9113T-RB-DST	1- or 3-Hole 8"cc, Pull-Out Spray, Lead Free Touch2O	ADA Lever	Venetian Bronze®	

### Fuse™ 1-Hdl Pull-Down Kitchen Faucet

- 9" Reach, 16" high-arc spout swivels 360°
- 3/8" Compression fittings
- Optional 10" escutcheon
- Touch-Clean® 2-function sprayhead
- Magnetic docking systems secures sprayer to spout
- Water-efficient product: 1.8 gpm @ 60 psi



Part #	Mfg #	Description	Handle(s)	Finish	Price
145372	9158-SB-DST	1- or 3-Hole 8"cc, Pull-Down Spray, Lead-Free	ADA Lever	Stainless & Cracked Pepper	
152863	9158-SR-DST	1- or 3-Hole 8"cc, Pull-Down Spray, Lead-Free	ADA Lever	Stainless & Chili Pepper	
152517	9158-SW-DST	1- or 3-Hole 8"cc, Pull-Down Spray, Lead-Free	ADA Lever	Stainless & Snowflake White	

\* Brilliance® Anti-Tarnish Lifetime Finishes

[www.waterconcepts.net](http://www.waterconcepts.net) • Serving our Customers Since 1946 • [www.plumbsupply.com](http://www.plumbsupply.com)



## Kitchen Faucets & Accessories

### Kate® 1-Hdl Pull-Down Kitchen Faucet with Soap Dispenser

- 9-1/4" Reach, 14-5/16" high-arc spout swivels 360°
- MagnaTite® docking
- DIAMOND™ seal valve
- 3/8" O.D. straight, staggered PEX supply lines
- Includes matching finish soap dispenser
- Water-efficient product: 1.8 gpm @ 60 psi



Part #	Mfg #	Description	Handle(s)	Finish	Price
123519	16970-SD-DST	3-Hole 6-16"cc, Pull-Down Spray, Lead-Free	ADA Lever	Chrome	

### Leland® 1-Hdl Pull-Down Spray Kitchen Faucet

- 9-3/16" Reach, 14-7/8" high, pull-down spout swivels 360°
- 7-7/8" From deck to aerator
- Touch-Clean® two-function spray head with MagnaTite® docking
- 59" Long hose
- 3/8" Compression fittings
- 2-1/2" Maximum deck thickness
- 32" Minimum supply lines below deck included
- Water-efficient product: 1.8 gpm @ 60 psi ("WE" models: 1.5 gpm @ 60 psi)



978-DST



978-SD-DST



9178-DST

Part #	Mfg #	Description	Handle(s)	Finish	Price
117359	978-DST	2-Hole, Pull-Down Spray, Lead-Free	ADA Lever	Chrome	
130201	978-WE-DST	2-Hole, Pull-Down Spray, Water Efficient, Lead-Free	ADA Lever	Chrome	
222231	978-RBWE-DST	2-Hole, Pull-Down Spray, Water Efficient, Lead-Free	ADA Lever	Venetian Bronze®	
154935	978-AR-DST	2-Hole, Pull-Down Spray, Lead-Free	ADA Lever	Arctic Stainless™	
165324	978-ARWE-DST	2-Hole, Pull-Down Spray, Water Efficient, Lead-Free	ADA Lever	Arctic Stainless™	
116996	978-RB-DST	2-Hole, Pull-Down Spray, Lead-Free	ADA Lever	Venetian Bronze®	
134160	9178-DST	1-Hole or 8"cc, Pull-Down Spray, Escutcheon, Lead-Free	ADA Lever	Chrome	
133915	9178-RB-DST	1-Hole or 8"cc, Pull-Down Spray, Escutcheon, Lead-Free	ADA Lever	Venetian Bronze®	
153721	9178-AR-DST	1-Hole or 8"cc, Pull-Down Spray, Escutcheon, Lead-Free	ADA Lever	Arctic Stainless™	
236501	9178-SP-DST	1-Hole or 8"cc, Pull-Down Spray, Escutcheon, Lead-Free	ADA Lever	SpotShield Stainless®	
188501	9178T-DST	1-Hole, Pull-Down Spray Touch2O Technology	ADA Lever	Chrome	
170732	9178T-AR-DST	1-Hole, Pull-Down Spray Touch2O Technology	ADA Lever	Arctic Stainless™	
171780	9178T-RB-DST	1-Hole, Pull-Down Spray Touch2O Technology	ADA Lever	Venetian Bronze®	
231609	9178T-SP-DST	1-Hole, Pull-Down Spray Touch2O Technology	ADA Lever	Spotshield Stainless	

\* Brilliance® Anti-Tarnish Lifetime Finishes

[www.plumbsupply.com](http://www.plumbsupply.com) • Serving our Customers Since 1946 • [www.waterconcepts.net](http://www.waterconcepts.net)

### Mateo™ 1-Hdl Pull-Down Spray Kitchen Faucet

- 9-1/4" Reach, 15-1/2" high swivel spout
- 8-5/8" From deck to aerator
- 3/8" O.D. straight, staggered PEX supply lines
- Two-function wand: aerated stream or spray
- Dual integral check valves in sprayer
- Flow rate: 1.8 gpm @ 60 psi
- RP81914 Escutcheon required for 3-hole



Part #	Mfg #	Description	Handle(s)	Finish	Price
187864	9183-DST	1-Hole, Pull-Down Spray, Lead Free	ADA Lever	Chrome	
187326	9183-AR-DST	1-Hole, Pull-Down Spray, Lead Free	ADA Lever	Arctic Stainless™	
258180	9183-KS-DST	1-Hole, Pull-Down Spray, Lead Free	ADA Lever	Black Stainless	
187404	9183-RB-DST	1-Hole, Pull-Down Spray, Lead Free	ADA Lever	Venetian Bronze®	

### Mateo™ Touch2O® 1-Hdl Pull-Down Spray Kitchen Faucet

- 9-1/4" Reach, 16" high swivel spout
- 8-1/8" From deck to aerator
- 3/8" O.D. straight, staggered PEX supply lines
- 6 (AA) or 6 (C) batteries
- Optional (EP73954) 120V AC adapter available
- LED indicator light signals on-off
- Dual integral check valves in sprayer
- Flow rate: 1.8 gpm @ 60 psi
- RP81914 Escutcheon required for 3-hole



Part #	Mfg #	Description	Handle(s)	Finish	Price
225576	9183T-DST	1-Hole, Pull-Down Spray Touch2O Technology, Lead Free	ADA Lever	Chrome	
188527	9183T-AR-DST	1-Hole, Pull-Down Spray Touch2O Technology, Lead Free	ADA Lever	Arctic Stainless™	
189610	9183T-RB-DST	1-Hole, Pull-Down Spray Touch2O Technology, Lead Free	ADA Lever	Venetian Bronze®	

### Pivotal® 1-Hdl Highrise Exposed Hose Pull-Down Kitchen Faucet

- 10-3/16" Reach, 18-11/16" highrise spout swivels 360°
- 6-5/8" Deck to outlet
- MagnaTite® docking
- DIAMOND™ seal valve
- Two-function wand; aerated stream or spray
- 2-1/2" Maximum deck thickness
- Dual integral check valves in sprayer
- 3/8" O.D. straight, staggered PEX supply tubes
- Optional 8" escutcheon available (RP92233)
- Flow rate: 1.8 gpm @ 60 psi



Part #	Mfg #	Description	Handle(s)	Finish	Price
258682	9693-KS-DST	1 - or 3-Hole, Pull-Down Spray, Lead Free	ADA Lever	Black Stainless	

\* Brilliance® Anti-Tarnish Lifetime Finishes

[www.waterconcepts.net](http://www.waterconcepts.net) • Serving our Customers Since 1946 • [www.plumbsupply.com](http://www.plumbsupply.com)

## Kitchen Faucets & Accessories

### Pivotal® 1-Hdl Pull-Down Kitchen Faucet

- 9-1/2" Reach, 15-1/2" high-arc spout swivels 360°
- MagnaTite® docking
- DIAMOND™ seal valve
- QuickSnap® connect hose
- Touch-Clean® two-function sprayhead
- 2-1/2" Maximum deck thickness
- 3/8" O.D. straight, staggered PEX supply lines
- Optional 8" escutcheon available
- Flow rate: 1.8 gpm @ 60 psi
- (-T) Touch2O® technology



Part #	Mfg #	Description	Handle(s)	Finish	Price
254657	9193T-DST	1 - or 3-Hole, Pull-Down Spray, Lead Free	ADA Lever	Chrome	
257831	9193T-KS-DST	1 - or 3-Hole, Pull-Down Spray, Lead Free	ADA Lever	Black Stainless	
252901	9193-AR-DST	1 - or 3-Hole, Pull-Down Spray, Lead Free	ADA Lever	Artic Stainless	
252744	9193-KS-DST	1 - or 3-Hole, Pull-Down Spray, Lead Free	ADA Lever	Black Stainless	

### Pivotal® Temp2O® 1-Hdl Pull-Down Kitchen Faucet

- 9-1/2" Reach, 15-1/2" high-arc spout swivels 360°
- MagnaTite® docking
- DIAMOND™ seal valve
- Integrated TempSense™ LED light
- Touch-Clean® two-function sprayhead
- Battery operated (6 AA included)
- 2-1/2" Maximum deck thickness
- 3/8" O.D. straight, staggered InnoFlex® PEX supply lines
- Optional 8" escutcheon available
- Optional A/C adapter EP73954 may be ordered separately
- Flow rate: 1.8 gpm @ 60 psi



Part #	Mfg #	Description	Handle(s)	Finish	Price
252786	9193T-AR-DST	1 - or 3-Hole, Pull-Down Spray, Lead Free	ADA Lever	Artic Stainless	

\* Brilliance® Anti-Tarnish Lifetime Finishes

## Kitchen Faucets & Accessories

### Pivotal® Touch2O® 1-Hdl Pull-Down Bar/Prep Faucet

- 6-13/16" Reach, 14-3/4" high-arc spout swivels 360°
- MagnaTite® docking
- DIAMOND™ seal valve
- Integrated TempSense™ LED light
- Touch-Clean® two-function sprayhead
- Battery operated (6 AA included)
- 2-1/2" Maximum deck thickness
- 3/8" O.D. straight, staggered InnoFlex® PEX supply lines
- Optional 8" escutcheon available
- Optional A/C adapter EP73954 may be ordered separately
- Flow rate: 1.8 gpm @ 60 psi



Part #	Mfg #	Description	Handle(s)	Finish	Price
252787	9993T-AR-DST	1 - or 3-Hole, Pull-Down Spray, Lead Free	ADA Lever	Artic Stainless	

### Talbott™ 1-Hdl Pull-Down Spray Kitchen Faucet

- 8-7/16" Reach, 14-1/2" high pull-down spout swivels 360°
- 7-1/4" From deck to outlet
- Touch-Clean® two-function sprayhead
- MagnaTite® docking
- DIAMOND™ seal valve
- Quick Snap® connect hoses
- 2-1/2" Maximum deck thickness
- Includes optional escutcheon
- 3/8" O.D. straight, staggered PEX supply lines
- InnoFlex® Pex-C supply lines included
- Water-efficient product: 1.8 gpm @ 60 psi



Part #	Mfg #	Description	Handle(s)	Finish	Price
253622	16968-RBSD-DST	1, 2, 3, or 4-Hole Pull-Down Spray, Lead Free	ADA Lever	Venetian Bronze	

### Trinsic™ Touch2O® 1-Hdl Pull-Down Spray Kitchen Faucet

- 9-1/2" Reach, 15-11/16" high-arc pull-down spout swivels 360°
- 8-7/16" From deck to aerator
- Touch2O® technology controls water flow
- Touch-Clean® two-function spray head with MagnaTite® docking
- 62" Long hose
- 3/8" Compression fittings
- 2-1/2" Maximum deck thickness
- 32" Minimum supply lines below deck included
- Water-efficient product: 1.8 gpm @ 60 psi



Part #	Mfg #	Description	Handle(s)	Finish	Price
148248	9159T-DST	1-Hole, Pull-Down Spray, Lead-Free	ADA Lever	Chrome	
144027	9159T-AR-DST	1-Hole, Pull-Down Spray, Lead-Free	ADA Lever	Arctic Stainless™	
235283	9159T-BL-DST	1-Hole, Pull-Down Spray, Lead-Free	ADA Lever	Matte Black	

\* Brilliance® Anti-Tarnish Lifetime Finishes

[www.waterconcepts.net](http://www.waterconcepts.net) • Serving our Customers Since 1946 • [www.plumbsupply.com](http://www.plumbsupply.com)

## Kitchen Faucets & Accessories

### Pull-Down Kitchen Faucets (Continued)

#### Trinsic™ Touch2O® 1-Hdl Pull-Down Spray Kitchen Faucet

Part #	Mfg #	Description	Handle(s)	Finish	Price
147734	9159T-CZ-DST	1-Hole, Pull-Down Spray, Lead-Free	ADA Lever	Champagne Bronze™	

#### Trinsic™ Touch2O® 1-Hdl Pull-Down Spray Bar/Prep Faucet

- 6-1/2" Reach, 13" pull-down spout swivels 360°
- 7" From deck to outlet
- Touch-Clean® two-function spray head
- MagnaTite® docking
- 62" Long hose
- 3/8" Compression fittings
- 2-1/4" Maximum deck thickness
- Dual integral check valves in sprayer
- InnoFlex® Pex-C supply lines included
- Electronic valve with euromotion DIAMOND™ valve
- Water-efficient product: 1.8 gpm @ 60 psi



Part #	Mfg #	Description	Handle(s)	Finish	Price
250526	9959T-BL-DST	1-Hole, Pull-Down Spray, Lead-Free	ADA Lever	Matte Black	

#### Trinsic™ 1-Hdl Pull-Down Spray Kitchen Faucet

- 9-1/2" Reach, 15-11/16" high pull-down spout swivels 360°
- 8-7/16" From deck to aerator
- Touch-Clean® two-function spray head with MagnaTite® docking
- 62" Long hose
- 3/8" Compression fittings
- 2-1/2" Maximum deck thickness
- 32" Minimum supply lines below deck included
- Water-efficient product: 1.8 gpm @ 60 psi



Part #	Mfg #	Description	Handle(s)	Finish	Price
142115	9159-DST	1-Hole, Pull-Down Spray, Lead-Free	ADA Lever	Chrome	
185377	9159-BL-DST	1-Hole, Pull-Down Spray, Lead-Free	ADA Lever	Matte Black	
141126	9159-AR-DST	1-Hole, Pull-Down Spray, Lead-Free	ADA Lever	Arctic Stainless™	
147269	9159-CZ-DST	1-Hole, Pull-Down Spray, Lead-Free	ADA Lever	Champagne Bronze™	
259752	9159-KS-DST	1-Hole, Pull-Down Spray, Lead-Free	ADA Lever	Black Stainless™	

\* Brilliance® Anti-Tarnish Lifetime Finishes

[www.plumbsupply.com](http://www.plumbsupply.com) • Serving our Customers Since 1946 • [www.waterconcepts.net](http://www.waterconcepts.net)

## Kitchen Faucets & Accessories

### Trinsic® Pro 1-Hdl Pull-Down Kitchen Faucet

- 9-1/2" Reach, 18-7/18" high spring spout
- 8-1/8" From deck to aerator
- Touch-Clean® sprayhead
- MagnaTite® magnetic docking
- DIAMOND Seal® technology
- 3/8" Compression fittings
- Maximum flow rate: 1.8 gpm



Part #	Mfg #	Description	Handle(s)	Finish	Price
226605	9659-DST	1-Hole, Pull-Down Spray Spring Spout	ADA Lever	Chrome	
225266	9569-AR-DST	1-Hole, Pull-Down Spray Spring Spout	ADA Lever	Arctic Stainless™	
243479	9659-KS-DST	1-Hole, Pull-Down Spray Spring Spout	ADA Lever	Black Stainless	

### Trinsic® Pro 1-Hdl Pull-Down Kitchen Faucet with Touch2O®

- 9-1/2" Reach, 19-1/2" high spring spout
- 8-7/16" From deck to aerator
- 3/8" Compression fittings
- Touch activated faucet
- On-off indicator light signals when batteries run low
- Automatic water flow shut-off after four minutes if the water is left running
- TempSense LED light indicates water temperature
- Battery operated (6 AA included) for up to 2 year battery life or 6 C (not included) for up to 5 year battery life
- Battery box can be mounted to cabinet with included mounting hardware
- Optional A/C adapter EP73954 may be ordered separately
- MagnaTite docking
- DIAMOND Seal® technology
- Touch-Clean spray holes
- Maximum flow rate: 1.8 gpm



Part #	Mfg #	Description	Handle(s)	Finish	Price
229558	9659T-DST	1 or 3-Hole, Pull-Down Spray Spring Spout	ADA Lever	Chrome	
228075	9659T-AR-DST	1 or 3-Hole, Pull-Down Spray Spring Spout	ADA Lever	Arctic Stainless™	
247761	9659T-KS-DST	1 or 3-Hole, Pull-Down Spray Spring Spout	ADA Lever	Black Stainless™	

\* Brilliance® Anti-Tarnish Lifetime Finishes

[www.waterconcepts.net](http://www.waterconcepts.net) • Serving our Customers Since 1946 • [www.plumbsupply.com](http://www.plumbsupply.com)



## Kitchen Faucets & Accessories

### Victorian® 1-Hdl Pull-Down Spray Kitchen Faucet

- 9-1/8" Reach, 14-1/4" high spout swivels 360°
- 7-3/8" From deck to aerator
- Touch-Clean® two-function spray head with MagnaTite® docking
- 62" Long hose
- 3/8" Compression fittings
- 2-1/2" Maximum deck thickness
- 32" Minimum supply lines below deck included
- Water-efficient product: 1.8 gpm @ 60 psi



Part #	Mfg #	Description	Handle(s)	Finish	Price
116511	955-RB-DST	2-Hole, Pull-Down Spray, Lead-Free	ADA Lever	Venetian Bronze®	
116868	955-SS-DST	2-Hole, Pull-Down Spray, Lead-Free	ADA Lever	Stainless*	

### Pull-Out Kitchen Faucets

#### Cassidy™ 1-Hdl Pull-Out Spray Kitchen Faucet

- 10-11/16" Reach, 10-11/16" high 120° swivel spout
- 7-15/16" From deck to aerator
- 54" Long hose
- 3/8" Compression fittings
- Order RP61607 for 1.5 gpm hose adapter
- 2-1/2" Max deck thickness
- 32" Minimum InnoFlex® supply lines
- DIAMOND™ Valve
- 1.8 gpm @ 60 psi



Part #	Mfg #	Description	Handle(s)	Finish	Price
158926	4197-DST	1- or 3-Hole 8"cc, Pull-Out Spray, Lead Free	ADA Lever	Chrome	
161452	4197-AR-DST	1- or 3-Hole 8"cc, Pull-Out Spray, Lead Free	ADA Lever	Arctic Stainless™	
164888	4197-CZ-DST	1- or 3-Hole 8"cc, Pull-Out Spray, Lead Free	ADA Lever	Champagne Bronze™	
226002	4197-PN-DST	1- or 3-Hole 8"cc, Pull-Out Spray, Lead Free	ADA Lever	Polished Nickel	
160254	4197-RB-DST	1- or 3-Hole 8"cc, Pull-Out Spray, Lead Free	ADA Lever	Venetian Bronze®	

#### Collins™ 1-Hdl Pull-Out Spray Kitchen Faucet

- 9" Reach, 8-11/16" high 120° swivel spout
- 6-13/16" From deck to aerator
- 54" Long hose
- 3/8" O.D. straight, staggered PEX supply tubes
- 2-1/2" Max deck thickness
- DIAMOND™ seal valve technology
- MagnaTite® magnetic docking
- Touch-Clean® sprayhead
- 1.8 gpm @ 60 psi



Part #	Mfg #	Description	Handle(s)	Finish	Price
241924	4140-DST	1- or 3-Hole 8"cc, Pull-Out Spray, Lead Free	ADA Lever	Chrome	
237196	4140-AR-DST	1- or 3-Hole 8"cc, Pull-Out Spray, Lead Free	ADA Lever	Arctic Stainless™	

\* Brilliance® Anti-Tarnish Lifetime Finishes

[www.plumbsupply.com](http://www.plumbsupply.com) • Serving our Customers Since 1946 • [www.waterconcepts.net](http://www.waterconcepts.net)

## Kitchen Faucets & Accessories

### Foundations® Core-B 1-Hdl Pull-Out Spray Kitchen Faucet

- 9-5/8" Reach, 10" high pull-out spout swivels 120°
- 6-11/16" From deck to aerator
- 59" Long hose
- 1/2" IPS Connection
- 2-1/2" Maximum deck thickness
- Optional 8" escutcheon included
- Water-efficient product: 1.8 gpm @ 60 psi



Part #	Mfg #	Description	Handle(s)	Finish	Price
133790	B4310LF	1- or 3-Hole 8"cc, Pull-Out Spray, Lead-Free	ADA Lever	Chrome	
138458	B4310LF-SS	1- or 3-Hole 8"cc, Pull-Out Spray, Lead-Free	ADA Lever	Stainless*	

### Linden™ 1-Hdl Pull-Out Spray Kitchen Faucet

- 9-7/8" Reach, 12-5/16" high pull-down spout swings 360°
- 9-9/16" From deck to aerator
- Touch-Clean® pull-down Multi-Flow™ three-function spray head
- 54" Long hose
- 3/8" Compression fittings
- 2-1/2" Maximum deck thickness
- Optional 10-1/2" escutcheon included
- 32" Minimum supply lines below deck included
- Water-efficient product: 1.5 gpm @ 60 psi



Part #	Mfg #	Description	Handle(s)	Finish	Price
134272	4153-DST	1- or 3-Hole, Pull-Down Spray, Lead-Free	ADA Lever	Chrome	
134747	4153-RB-DST	1- or 3-Hole, Pull-Down Spray, Lead-Free	ADA Lever	Venetian Bronze®	
156074	4153-AR-DST	1- or 3-Hole, Pull-Down Spray, Lead-Free	ADA Lever	Arctic Stainless™	

### Linden™ 1-Hdl Pull-Out Spray Kitchen Faucet

- 10" Reach, 8" high pull-out spout swivels 120°
- 5-3/4" From deck to aerator
- Touch-Clean® three-function Multi-Flow™ spray head
- 54" Long hose
- 3/8" Compression fittings
- 2-1/2" Maximum deck thickness
- Optional 10-1/2" escutcheon included
- 32" Minimum supply lines below deck included
- Water-efficient product: 1.5 gpm @ 60 psi



Part #	Mfg #	Description	Handle(s)	Finish	Price
126608	4353-DST	1- or 3-Hole, Pull-Out Spray, Lead-Free	ADA Lever	Chrome	
155381	4353-AR-DST	1- or 3-Hole, Pull-Out Spray, Lead-Free	ADA Lever	Arctic Stainless™	
126690	4353-RB-DST	1- or 3-Hole, Pull-Out Spray, Lead-Free	ADA Lever	Venetian Bronze®	

\* Brilliance® Anti-Tarnish Lifetime Finishes

## Kitchen Faucets & Accessories

### Palo® 1-Hdl Pull-Out Spray Kitchen Faucet

- 9" Reach, 8-3/16" high pull-out spout swivels 120°
- 6-1/2" From deck to aerator
- Touch-Clean® two-function spray head
- 54" Long hose
- 3/8" Compression fittings
- 2-1/2" Maximum deck thickness
- Optional 10-1/2" escutcheon included
- 32" Minimum supply lines below deck included
- Water-efficient product: 1.8 gpm @ 60 psi



467-DST



467-SD-DST

Part #	Mfg #	Description	Handle(s)	Finish	Price
117360	467-DST	1- or 3-Hole, Pull-Out Spray, Lead-Free	ADA Lever	Chrome	
117361	467-SS-DST	1- or 3-Hole, Pull-Out Spray, Lead-Free	ADA Lever	Stainless*	
117362	467-SD-DST	2- or 4-Hole, Pull-Out Spray, Soap Dispenser, Lead-Free	ADA Lever	Chrome	

### Pivotal® 1-Hdl Pull-Out Spray Kitchen Faucet

- 9-3/8" Reach, 11" high pull-out spout swivels 360°
- Touch-Clean® two-function spray head
- 58" Long hose
- 3/8" Compression fittings
- 2-1/2" Maximum deck thickness
- Optional 8" escutcheon included
- InnoFlex® PEX supply lines
- Water-efficient product: 1.8 gpm @ 60 psi



Part #	Mfg #	Description	Handle(s)	Finish	Price
253414	4193-AR-DST	1- or 3-Hole, Pull-Out Spray, Lead-Free	ADA Lever	Artic Stainless™	

### Signature® 1-Hdl Pull-Out Spray Kitchen Faucet

- 9" Reach, 8" high spout swivels 120°
- 6-5/8" From deck to aerator
- Touch-Clean® 2-function spray head
- 54" Long hose
- 3/8" Compression fittings
- 2-1/2" Maximum deck thickness
- Optional 10-3/4" escutcheon included
- 32" Minimum supply lines below deck included
- Water-efficient product: 1.8 gpm @ 60 psi



470-DST

Part #	Mfg #	Description	Handle(s)	Finish	Price
117363	470-DST	1-Hole or 8"cc, Pull-Out Spray, Lead-Free	ADA Lever	Chrome	
117366	470-WH-DST	1-Hole or 8"cc, Pull-Out Spray, Lead-Free	ADA Lever	White	
134748	470-AR-DST	1-Hole or 8"cc, Pull-Out Spray, Lead-Free	ADA Lever	Arctic Stainless™	
117364	470-BL-DST	1-Hole or 8"cc, Pull-Out Spray, Lead-Free	ADA Lever	Matte Black	

\* Brilliance® Anti-Tarnish Lifetime Finishes

[www.plumbsupply.com](http://www.plumbsupply.com) • Serving our Customers Since 1946 • [www.waterconcepts.net](http://www.waterconcepts.net)

## Kitchen Faucets & Accessories

### Trinsic™ 1-Hdl Pull-Out Spray Kitchen Faucet

- 9-1/4" Reach, 12-21/32" high 360° swivel spout
- 6-39/64" From deck to aerator
- 54" Long hose
- 3/8" Compression fittings
- Order RP61607 for 1.5 gpm hose adapter
- 2-1/4" Max deck thickness
- 32" Minimum InnoFlex® supply lines
- 1.8 gpm @ 60 psi
- Euro-Motion DIAMOND™ Valve



Part #	Mfg #	Description	Handle(s)	Finish	Price
160863	4159-DST	1- or 3-Hole 8"cc, Pull-Out Spray, Lead Free	Lever	Chrome	
179785	4159-BL-DST	1- or 3-Hole 8"cc, Pull-Out Spray, Lead Free	Lever	Matte Black	
165335	4159-AR-DST	1- or 3-Hole 8"cc, Pull-Out Spray, Lead Free	Lever	Arctic Stainless™	

### Single-Handle Kitchen Faucets

#### Cassidy™ 1-Hdl Kitchen Faucet

- 10-1/8" Reach, 16" high 360° swivel spout
- 10-1/8" From deck to aerator
- 3/8" Compression fittings
- Order RP52216 for 1.5 gpm aerator insert
- 2-1/2" Max deck thickness
- 2-Hole 4" installation
- Matching finish spray
- 32" Minimum InnoFlex® supply lines
- DIAMOND™ Valve
- 1.8 gpm @ 60 psi



Part #	Mfg #	Description	Handle(s)	Finish	Price
164870	4297-DST	2-Hole 4"cc, Lead Free	ADA Lever	Chrome	
162366	4297-AR-DST	2-Hole 4"cc, Lead Free	ADA Lever	Arctic Stainless™	
163172	4297-CZ-DST	2-Hole 4"cc, Lead Free	ADA Lever	Champagne Bronze™	
248790	4297-PN-DST	2-Hole 4"cc Lead Free	ADA Lever	Polished Nickel	
162621	4297-RB-DST	2-Hole 4"cc, Lead Free	ADA Lever	Venetian Bronze®	

#### Classic™ 1-Hdl Kitchen Faucet

- 8-11/16" Reach, 6-3/4" high spout swivels 170°
- 4-3/4" From deck to aerator
- 3/8" Compression fittings
- 2-1/2" Maximum deck thickness
- 32" Minimum supply lines below deck included
- Water-efficient product: 1.8 gpm @ 60 psi



100-DST



175-DS

Part #	Mfg #	Description	Handle(s)	Finish	Price
129288	100-DST	3-Hole 8"cc, Lead-Free	ADA Lever	Chrome	
180643	100-SS-DST	3-Hole 8"cc, Lead-Free	ADA Lever	Stainless*	

\* Brilliance® Anti-Tarnish Lifetime Finishes

www.waterconcepts.net • Serving our Customers Since 1946 • www.plumbsupply.com

## Kitchen Faucets & Accessories

### Single-Handle Kitchen Faucets (Continued)

#### Classic™ 1-Hdl Kitchen Faucet

Part #	Mfg #	Description	Handle(s)	Finish	Price
151159	100-BH-DST	3-Hole 8"cc, Lead-Free, Hot & Cold Indicators	ADA Lever	Chrome	
003745	101-DST	1-Hole, Lead-Free	ADA Lever	Chrome	
126979	175-DST	2-Hole, Side Spray, Lead-Free	ADA Lever	Chrome	
134650	300-DST	3-Hole 8"cc, Side Spray	ADA Lever	Chrome	
129287	400-DST	4-Hole 8"cc, Side Spray, Lead-Free	ADA Lever	Chrome	
217805	400-SS-DST	4-Hole 8"cc, Side Spray, Lead-Free	ADA Lever	Stainless*	
156139	400LF-WF	4-Hole 8"cc, Side Spray, Lead-Free	ADA Lever	Chrome	

#### Classic™ 1-Hdl Kitchen Faucet

- 8" Reach, 7-3/16" high 360° swivel spout
- 5" From deck to aerator
- 1-1/4" Maximum deck thickness
- RP30393 adds 1" to maximum deck thickness
- Straight, staggered supply tubes
- Flow rate: 1.8 gpm @ psi
- Order RP19754 for 1.5 gpm aerator



Part #	Mfg #	Description	Handle(s)	Finish	Price
155099	100LF-WF	3-Hole 8"cc, Lead Free	ADA Lever	Chrome	
166483	101LF-WF	1-Hole, Lead Free	ADA Lever	Chrome	

#### Collins™ 1-Hdl Kitchen Faucet

- 9-3/16" Reach spout swivels 170°
- 5-7/32" From deck to aerator
- 3/8" Compression fittings
- 2-1/2" Maximum deck thickness
- 32" Minimum supply lines below deck included
- Flow rate: 1.8 gpm @ 60 psi
- (-E) Water-Efficient flow rate: 1.5 gpm @ 60 psi



140



340



440

Part #	Mfg #	Description	Handle(s)	Finish	Price
127889	140-DST	3-Hole 8"cc, Lead-Free	ADA Lever	Chrome	
052162	140-SS-DST	3-Hole 8"cc, Lead-Free	ADA Lever	Stainless*	
168085	140-WE-DST	3-Hole 8"cc, Lead Free 1.5 gpm	ADA Lever	Chrome	
126822	141-DST	1-Hole, Lead-Free	ADA Lever	Chrome	
129963	141-SS-DST	1-Hole, Lead-Free	ADA Lever	Stainless*	
130727	141-WH-DST	1-Hole, Lead-Free	ADA Lever	White	
129807	340-DST	3-Hole 8"cc, Integral Spray, Lead-Free	ADA Lever	Chrome	
055838	340-SS-DST	3-Hole 8"cc, Integral Spray, Lead-Free	ADA Lever	Stainless*	
127488	340-WH-DST	3-Hole 8"cc, Integral Spray, Lead-Free	ADA Lever	White	
126572	440-DST	4-Hole 8"cc, Side Spray, Lead-Free	ADA Lever	Chrome	
124987	440-WE-DST	4-Hole 8"cc, Side Spray, 1.5 gpm, Lead-Free	ADA Lever	Chrome	
126658	440-SS-DST	4-Hole 8"cc, Side Spray, Lead-Free	ADA Lever	Stainless*	

\* Brilliance® Anti-Tarnish Lifetime Finishes

[www.plumbsupply.com](http://www.plumbsupply.com) • Serving our Customers Since 1946 • [www.waterconcepts.net](http://www.waterconcepts.net)



## Kitchen Faucets & Accessories

### Single-Handle Kitchen Faucets (Continued)

#### Collins™ 1-Hdl Kitchen Faucet

Part #	Mfg #	Description	Handle(s)	Finish	Price
125395	440-SSWE-DST	4-Hole 8"cc, Side Spray, 1.5 gpm, Lead-Free	ADA Lever	Stainless*	
126660	440-WH-DST	4-Hole 8"cc, Side Spray, Lead-Free	ADA Lever	White	
126384	441-DST	2-Hole, Side Spray, Lead-Free	ADA Lever	Chrome	
126532	441-SS-DST	2-Hole, Side Spray, Lead-Free	ADA Lever	Stainless*	
127243	441-WH-DST	2-Hole, Side Spray, Lead-Free	ADA Lever	White	

#### Foundations® Core-B 1-Hdl Kitchen Faucet

- 9-1/2" Reach, 8-3/8" high spout swivels 360°
- 6-5/8" From deck to aerator
- 1/2" IPS Connection
- 1-1/2" Maximum deck thickness
- Water-efficient product: 1.8 gpm @ 60 psi



Part #	Mfg #	Description	Handle(s)	Finish	Price
130008	B1310LF	3-Hole 8"cc, Lead-Free	ADA Lever	Chrome	
226360	B1310LF-SS	3-Hole 8"cc, Lead-Free	ADA Lever	Stainless*	
139598	B3310LF	3-Hole 8"cc, Integral Spray, Lead-Free	ADA Lever	Chrome	
240957	B3310LF-SS	3-Hole 8"cc, Integral Spray, Lead-Free	ADA Lever	Stainless*	
139599	B4410LF	4-Hole 8"cc, Side Spray, Lead-Free	ADA Lever	Chrome	
186142	B4410LF-SS	4-Hole 8"cc, Side Spray, Lead-Free	ADA Lever	Stainless*	

#### Linden™ 1-Hdl Kitchen Faucet with Side Spray

- 9-13/16" Reach, 11-3/8" high spout swivels 120°
- 5-7/8" From deck to aerator
- 3/8" Compression fittings
- 2-1/2" Maximum deck thickness
- Optional 10-1/2" escutcheon included
- 32" Minimum supply lines below deck included
- Water-efficient product: 1.8 gpm @ 60 psi



Part #	Mfg #	Description	Handle(s)	Finish	Price
144955	3353-DST	3-Hole, Integral Spray, Lead-Free	ADA Lever	Chrome	
160540	3353-AR-DST	3-Hole, Integral Spray, Lead Free	ADA Lever	Arctic Stainless®	
147214	3353-RB-DST	3-Hole, Integral Spray, Lead-Free	ADA Lever	Venetian Bronze®	
136869	4453-DST	2 or 4-Hole, Side Spray, Lead-Free	ADA Lever	Chrome	
163166	4453-AR-DST	2 or 4-Hole, Side Spray, Lead-Free	ADA Lever	Arctic Stainless™	
135898	4453-RB-DST	2 or 4-Hole, Side Spray, Lead-Free	ADA Lever	Venetian Bronze®	
137036	1353-DST	1-Hole, Less Side Spray, Lead Free	ADA Lever	Chrome	
136216	1353-AR-DST	1-Hole, Less Side Spray, Lead Free	ADA Lever	Arctic Stainless™	
138450	1353-RB-DST	1-Hole, Less Side Spray, Lead Free	ADA Lever	Venetian Bronze®	

\* Brilliance® Anti-Tarnish Lifetime Finishes



## Kitchen Faucets & Accessories

### Pilar® Touch2O® 1-Hdl Kitchen Faucet with Spray

- 10-1/2" Reach, 13" high, high-arc spout swivels 180°
- 9-3/4" From deck to aerator
- 3/8" Compression fittings
- 2-1/2" Maximum deck thickness
- 32" Minimum supply lines below deck included
- Water-efficient product: 1.8 gpm @ 60 psi
- DIAMOND™ Valve



Part #	Mfg #	Description	Handle(s)	Finish	Price
125911	4380-DST	3-Hole 6"-16"ws, Side Spray, Lead-Free	ADA Lever	Chrome	
134750	4380-AR-DST	3-Hole 6"-16"ws, Side Spray, Lead-Free	ADA Lever	Arctic Stainless™	
125913	4380-RB-DST	3-Hole 6"-16"ws, Side Spray, Lead-Free	ADA Lever	Venetian Bronze®	

### Trinsic® 1-Hdl Kitchen Faucet

- 8-1/4" Reach, 12-5/8" high 360° swivel spout
- 7" From deck to aerator
- 3/8" Compression fittings
- 1-1/8" Maximum deck thickness
- Water-efficient product: 1.8 gpm @ 60 psi



Part #	Mfg #	Description	Handle(s)	Finish	Price
152923	1159LF	1-Hole, Less Side Spray	ADA Lever	Chrome	
151619	1159LF-AR	1-Hole, Less Side Spray	ADA Lever	Arctic Stainless™	

### Victorian® 1-Hdl Kitchen Faucet

- 9-3/8" Reach, 9" high spout swivels 180°
- 6" From deck to aerator
- 3/8" Compression fittings
- 2-1/2" Maximum deck thickness
- 32" Minimum supply lines below deck included
- Water-efficient product: 1.8 gpm @ 60 psi



Part #	Mfg #	Description	Handle(s)	Finish	Price
068297	155-DST	3-Hole 6"-16"ws, Side Spray, Lead-Free	ADA Lever	Chrome	
128022	155-RBDST	3-Hole 6"-16"ws, Side Spray, Lead-Free	ADA Lever	Venetian Bronze®	
128021	155-SSDST	3-Hole 6"-16"ws, Side Spray, Lead-Free	ADA Lever	Stainless*	

\* Brilliance® Anti-Tarnish Lifetime Finishes

[www.plumbsupply.com](http://www.plumbsupply.com) • Serving our Customers Since 1946 • [www.waterconcepts.net](http://www.waterconcepts.net)

## Kitchen Faucets & Accessories

### Two-Handle Kitchen Faucets

#### Cassidy™ 2-Hdl Kitchen Faucet

- 8-21/32" Reach, 13-15/32" high 360° swivel spout
- 8-11/32" Deck to aerator
- 1/2" IPS connection
- 1-3/4" Maximum deck thickness
- 1.8 gpm @ 60 psi (Order RP52216 aerator insert for 1.5 gpm)



Part #	Mfg #	Description	Handle(s)	Finish	Price
151677	2497LF	3 or 4 Hole, 8"cc, Matching Side Spray, Lead Free	ADA Lever	Chrome	
155756	2497LF-AR	3 or 4 Hole, 8"cc, Matching Side Spray, Lead Free	ADA Lever	Arctic Stainless™	
152924	2497LF-CZ	3 or 4 Hole, 8"cc, Matching Side Spray, Lead Free	ADA Lever	Champagne Bronze™	
251292	2497LF-PN	3 or 4 Hole, 8"cc, Matching Side Spray, Lead Free	ADA Lever	Polished Nickel*	
152926	2497LF-RB	3 or 4 Hole, 8"cc, Matching Side Spray, Lead Free	ADA Lever	Venetian Bronze®	

#### Classic 2-Hdl Kitchen Faucet

- Standard spout swivels 360°
- 9" Reach, 7-7/16" high
- 5" From deck to aerator
- Blade handles
- 1/2" IPS connection
- 7/8" Maximum deck thickness
- Flow rate: 1.8 gpm @ 60 psi



Part #	Mfg #	Description	Handle(s)	Finish	Price
153632	2100-LF	3-Hole 8"cc, Lead-Free	Blade	Chrome	
154112	2400-LF	4-Hole 8"cc White Side Spray, Lead-Free	Blade	Chrome	
154096	2102-LF	3-Hole 8"cc, Lead-Free	Knobs	Chrome	
153712	2402-LF	4-Hole 8"cc White Side Spray, Lead-Free	Knobs	Chrome	

#### Foundations® Core-B 2-Hdl Kitchen Faucet

- 9-1/4" Reach, 6-7/16" high spout swivels 360°
- 5-3/8" From deck to aerator
- 1/2" IPS Connection
- 1-1/8" Maximum deck thickness
- Water-efficient product: 1.8 gpm @ 60 psi



Part #	Mfg #	Description	Handle(s)	Finish	Price
135568	B2310LF	3-Hole 8"cc, Lead-Free	ADA Lever	Chrome	
160747	B2312LF	3-Hole 8"cc, Lead-Free	Crystal Knobs	Chrome	
135944	B2410LF	4-Hole 8"cc, Side Spray, Lead-Free	ADA Lever	Chrome	
161067	B2412LF	4-Hole 8"cc, Side Spray, Lead-Free	Crystal Knobs	Chrome	

\* Brilliance® Anti-Tarnish Lifetime Finishes

## Kitchen Faucets & Accessories

### Pillar Series 2-Hdl Kitchen Faucet

- 10-1/2" Reach, 13" high, high-arc spout swivels 180°
- 9-3/4" From deck to aerator
- 3/8" Compression fittings
- 2-1/2" Maximum deck thickness
- Water-efficient product: 1.8 gpm @ 60 psi
- ADA Compliant



Part #	Mfg #	Description	Handle(s)	Finish	Price
144333	2480-DST	4-Hole 6-16"ws, Side Spray, Lead-Free	ADA Metal Lever	Chrome	
145786	2480-AR-DST	4-Hole 6-16"ws, Side Spray, Lead-Free	ADA Metal Lever	Arctic Stainless™	
148628	2480-RB-DST	4-Hole 6-16"ws, Side Spray, Lead-Free	ADA Metal Lever	Venetian Bronze®	

### Victorian® 2-Hdl Kitchen Faucet

- Tall high-arc spout
- 9" Reach, 9" high spout swivels 360°
- 6" From deck to aerator
- 3/8" Compression fittings
- 2-1/2" Maximum deck thickness
- Side spray with 45" hose length
- Water-efficient product: 1.8 gpm @ 60 psi



Part #	Mfg #	Description	Handle(s)	Finish	Price
148292	2256-DST	4-Hole 6"-16"ws, Side Spray, Lead-Free	ADA Metal Lever	Chrome	
152551	2256-RB-DST	4-Hole 6"-16"ws, Side Spray, Lead-Free	ADA Metal Lever	Venetian Bronze®	
148482	2256-SS-DST	4-Hole 6"-16"ws, Side Spray, Lead-Free	ADA Metal Lever	Stainless*	

### Windemere® 2-Hdl Kitchen Faucet

- 8" Reach, 11-5/8" high spout swivels 360°
- 6-3/4" From deck to aerator
- 1/2" - 14 NPSM threaded male inlet shanks
- Minimum 2-1/2" Clearance to back splash
- Flow rate: 1.8 gpm @ 60 psi



Part #	Mfg #	Description	Handle(s)	Finish	Price
174237	21996LF	4-Hole 8"cc, Side Spray, Lead Free	ADA Lever	Chrome	
189169	21996LF-OB	4-Hole 8"cc, Side Spray, Lead Free	ADA Lever	Oil Rubbed Bronze	
186851	21996LF-SS	4-Hole 8"cc, Side Spray, Lead Free	ADA Lever	Stainless*	

\* Brilliance® Anti-Tarnish Lifetime Finishes

## Soap Dispensers

### Soap/Lotion Dispensers

#### Soap/Lotion Dispenser

- 13 oz Bottle
- Replaced RP1000
- Refillable from above the deck
- Includes refill funnel



Part #	Mfg #	Description	Price
044358	RP1001	Chrome	
134749	RP1001AR	Arctic™ Stainless	
075150	RP1001BL	Black	
044441	RP1001BS	Biscuit	
246443	RP1001KS	Black Stainless	
074041	RP1001RB	Venetian Bronze®	
054299	RP1001SS	Stainless*	
025434	RP21904	Soap Dispenser Bottle	

#### Soap/Lotion Dispenser

- 13 oz Bottle
- Fits hole size: 1-3/8" +/- 1/8"
- Refillable from above the deck
- Includes refill funnel



Part #	Mfg #	Description	Price
250593	RP91950	Chrome	
249909	RP91950AR	Arctic™ Stainless	
252753	RP91950KS	Black Stainless	

#### Soap/Lotion Dispenser Assembly

- 2-7/8" Height



Part #	Mfg #	Description	Price
225404	RP82129SP	SpotShield Stainless	

#### Allora® Soap/Lotion Dispenser

- 12.5 oz Bottle
- Refillable from above the deck
- 2-13/16" Maximum deck thickness



Part #	Mfg #	Finish	Price
147899	RP47280AR	Arctic™ Stainless	
106170	RP47280SS	Stainless*	

### Contemporary Touch20® Soap Dispenser

- Battery operated (6 AA included)
- Mounting hardware included
- Refillable from above the deck
- 3" Maximum deck thickness



Part #	Mfg #	Description	Price
175421	72065T	Chrome	
173907	72065T-AR	Arctic Stainless™	
185537	72065T-BL	Matte Black	
251534	72065T-CZ	Champagne Bronze™	
184460	72065T-SS	Stainless*	

#### Cassidy™ Soap/Lotion Dispenser

- 13 oz Bottle
- Refillable from above the deck
- 2-1/2" Maximum deck thickness



Part #	Mfg #	Description	Price
151965	RP71543	Chrome	
152684	RP71543AR	Arctic Stainless™	
152823	RP71543CZ	Champagne Bronze™	
152824	RP71543RB	Venetian Bronze®	

#### Classic® Soap/Lotion Dispenser

- 13 oz Bottle
- Refillable from above the deck
- 2-1/2" Maximum deck thickness



Part #	Mfg #	Description	Price
134634	RP1002	Chrome	
146137	RP1002AR	Arctic Stainless™	
134625	RP1002RB	Venetian Bronze®	
135384	RP1002SS	Stainless*	

#### Leland® Soap/Lotion Dispenser

- 13 oz Bottle
- Refillable from above the deck
- 2-1/2" Maximum deck thickness



Part #	Mfg #	Description	Price
122280	RP50813	Chrome	
154936	RP50813AR	Arctic Stainless™	
165391	RP50813CZ	Champagne Bronze™	

\* Brilliance® Anti-Tarnish Lifetime Finishes

## Soap Dispensers

### Soap/Lotion Dispensers (Continued)

#### Leland® Soap/Lotion Dispenser

Part #	Mfg #	Description	Price
122725	RP50813RB	Venetian Bronze®	
121289	RP50813SS	Stainless*	

#### Pilar® Soap/Lotion Dispenser

- 13 oz Bottle
- Refillable from above the deck
- 2-1/2" Maximum deck thickness



Part #	Mfg #	Description	Price
125914	RP50781	Chrome	
134737	RP50781AR	Arctic Stainless™	
259434	RP50781BL	Matte Black	
151143	RP50781CZ	Champagne Bronze™	
236863	RP50781PN	Polished Nickel	
125917	RP50781RB	Venetian Bronze®	
125916	RP50781SS	Stainless*	

#### Traditional Touch Soap Dispenser

- Touch2O.xt Technology offers both touch and proximity sensing technology to activate
- Battery operated (6 AA included)
- Mounting hardware included
- Refillable from above the deck
- 3" Maximum deck thickness



Part #	Mfg #	Description	Price
188595	72045T-AR	Arctic Stainless™	
222071	72045T-CZ	Champagne Bronze™	
189399	72045T-RB	Venetian Bronze®	
236805	72045T-SS	Stainless*	

#### Transitional Touch2O.xt® Soap/Lotion Dispenser

- 13 oz Bottle
- Refillable from above the deck
- 3" Maximum deck thickness
- Touch2O.xt® Technology offers both touch and proximity sensing technology to activate
- Hands-free activation
- Programmable at the spout
- Drip-free performance
- Battery operated (6 AA included)
- Fits pre-drilled 1-1/8"-1-1/2" holes
- Includes (RP30395) refill funnel



Part #	Mfg #	Description	Price
185147	72055T	Chrome	
172454	72055T-AR	Arctic Stainless	
225926	72055T-BL	Matte Black	
187583	72055T-SS	Stainless*	

#### Victorian® Soap/Lotion Dispenser

- 13 oz Bottle
- Refillable from above the deck
- 1-1/2" Maximum deck thickness
- Includes (RP30395) refill funnel



Part #	Mfg #	Description	Price
073318	RP37039RB	Venetian Bronze®	
072072	RP37039SS	Stainless*	

\* Brilliance® Anti-Tarnish Lifetime Finishes

## Kitchen Faucets & Accessories

### Pot Fillers

#### Modern Pot Filler

- Wall-mount
- 1/2" IPS
- Flow rate: 5.5 gpm



Part #	Mfg #	Description	Handle(s)	Finish	Price
189229	S665	1-Hole	ADA Lever	Chrome	
168490	S665SRS	1-Hole	ADA Lever	Spot Resist Stainless	

#### Traditional Pot Filler

- Wall-Mount
- 1/2" IPS
- Aerated stream
- Flow rate: 5.5 gpm



Part #	Mfg #	Description	Handle(s)	Finish	Price
204102	S664	1-Hole	ADA Lever	Chrome	
113776	S664ORB	1-Hole	ADA Lever	Oil Rubbed Bronze	
189554	S664SRS	1-Hole	ADA Lever	Spot Resist Stainless	

### Pull-Down Spray Kitchen Faucets

#### Aberdeen™ 1-Hdl Pull-Down Spray Kitchen Faucet

- 7-7/8" Reach, 14-5/8" high spout
- 7-3/8" From deck to aerator
- Reflex™ pulldown system with 68" braided hose
- Hydrolock® Quick connect system
- Flexible supplies with 3/8" compression fittings
- 1255™ Duralast™ cartridge
- WaterSense® certified: 1.5 gpm



Part #	Mfg #	Description	Handle(s)	Finish	Price
068863	7490C	2-Hole, Pull-Down Spray	ADA Lever	Chrome	
129337	7590CSL	2-Hole, Pull-Down Spray	ADA Lever	Classic Stainless	
087510	7590ORB	2-Hole, Pull-Down Spray	ADA Lever	Oil Rubbed Bronze	

\* Lifeshine® Anti-Tarnish Lifetime Finish

[www.waterconcepts.net](http://www.waterconcepts.net) • Serving our Customers Since 1946 • [www.plumbsupply.com](http://www.plumbsupply.com)



## Kitchen Faucets & Accessories

### Arbor™ 1-Hdl Pull-Down Spray Kitchen Faucet

- 7-7/8" Reach, 15-1/2" high swivel spout
- 8-1/4" From deck to aerator
- 3/8" Compression fittings
- 1255™ Duralast™ cartridge
- WaterSense® certified: 1.5 gpm
- Model **(7594EWORB)** includes MotionSense Wave™ and is powered by 6 AA batteries or optional AC adapter with power splitter



Part #	Mfg #	Description	Handle(s)	Finish	Price
145145	7594BL	1- or 3-Hole, Pull-Down Spray	ADA Lever	Matte Black	
136634	7594C	1- or 3-Hole, Pull-Down Spray	ADA Lever	Chrome	
252624	7594EWORB	1- or 3-Hole, Pull-Down Spray, MotionSense™	ADA Lever	Oil Rubbed Bronze	
135943	7594ORB	1- or 3-Hole, Pull-Down Spray	ADA Lever	Oil Rubbed Bronze	
153795	7594SRS	1- or 3-Hole, Pull-Down Spray	ADA Lever	Spot Resist Stainless	

### Arbor™ MotionSense™ 1-Hdl Pull-Down Spray Kitchen Faucet

- 7-7/8" Reach, 15-1/2" high swivel spout
- 8-1/4" From deck to aerator
- 3/8" Compression fittings
- 1255™ Duralast™ cartridge
- Powered by (6) AA batteries
- WaterSense® certified: 1.5 gpm



Part #	Mfg #	Description	Handle(s)	Finish	Price
163151	7594EC	1- or 3-Hole, Pull-Down Spray w/ Motion Sense™	ADA Lever	Chrome	
157056	7594EORB	1- or 3-Hole, Pull-Down Spray w/ Motion Sense™	ADA Lever	Oil Rubbed Bronze	
151596	7594ESRS	1- or 3-Hole, Pull-Down Spray w/ Motion Sense™	ADA Lever	Spot Resist Stainless	

### Align™ 1-Hdl Pull-Down Spray Kitchen Faucet

- 7-17/32" Reach, 15-5/8" high 360° swivel spout
- 9-1/2" From deck to aerator
- 3/8" Compression fittings
- 1255™ Duralast™ cartridge
- Optional 141002 escutcheon available for 3-hole application
- WaterSense® certified: 1.5 gpm



Part #	Mfg #	Description	Handle(s)	Finish	Price
171772	7565	1-Hole, Pull-Down Spray	ADA Lever	Chrome	
159429	7565SRS	1-Hole, Pull-Down Spray	ADA Lever	Spot Resist Stainless	

\* Lifeshine® Anti-Tarnish Lifetime Finish

[www.plumbsupply.com](http://www.plumbsupply.com) • Serving our Customers Since 1946 • [www.waterconcepts.net](http://www.waterconcepts.net)

## Kitchen Faucets & Accessories

### Align™ MotionSense™ 1-Hdl Pull-Down Spray Kitchen Faucet

- 7-1/2" Reach, 15-5/8" high 360° swivel spout
- 9-1/2" From deck to aerator
- 3/8" Compression fittings
- 1255™ Duralast™ cartridge
- Powered by (6) AA batteries or option AC adapter with power splitter
- WaterSense® certified: 1.5 gpm



Part #	Mfg #	Description	Handle(s)	Finish	Price
185534	7565ESRS	1-Hole, Pull-Down Spray w/ MotionSense™	ADA Lever	Spot Resist Stainless	

### Align™ 1-Hdl Pre-Rinse Spring Pull-Down Spray Kitchen Faucet

- 10" Reach, 22-1/2" high swivel spout
- 8-3/4" From deck to aerator
- 3/8" Compression fittings
- 1255™ Duralast™ cartridge
- PowerClean™ spray technology
- 2-1/2" Maximum deck thickness
- 68" Braided hose
- WaterSense® certified: 1.5 gpm
- Model (5923EWSRS) includes MotionSense Wave™ and is powered by 6 AA batteries or optional AC adapter with power splitter



Part #	Mfg #	Description	Handle(s)	Finish	Price
221768	5923	1-Hole, Pull-Down Spray	ADA Lever	Chrome	
246588	5923BL	1-Hole, Pull-Down Spray	ADA Lever	Black	
253062	5923EWSRS	1-Hole, Pull-Down Spray, MotionSense™	ADA Lever	Spot Resist Stainless	
187906	5923SRS	1-Hole, Pull-Down Spray	ADA Lever	Spot Resist Stainless	

### Brantford™ 1-Hdl Pull-Down Spray Kitchen Faucet

- 15.72" High arc spout rotates 360°
- Hydrolock® quick connect installation
- Pull-out spray with 68" braided hose
- Flexible supply lines with 3/8" compression fittings
- Maximum flow: 2.2 gpm



Part #	Mfg #	Description	Handle(s)	Finish	Price
147215	7185C	1- or 3-Hole, Pull-Down Spray	ADA Side Lever	Chrome	
163584	7185SRS	1- or 3-Hole, Pull-Down Spray	ADA Side Lever	Spot Resist Stainless	
143931	7185ORB	1- or 3-Hole, Pull-Down Spray	ADA Side Lever	Oil Rubbed Bronze	

\* Lifeshine® Anti-Tarnish Lifetime Finish

[www.waterconcepts.net](http://www.waterconcepts.net) • Serving our Customers Since 1946 • [www.plumbsupply.com](http://www.plumbsupply.com)

## Kitchen Faucets & Accessories

### Brantford™ with Motion Sense™ 1-Hdl Pull-Down Spray Kitchen Faucet

- 7-7/8" Reach, 15-1/2" high spout
- 8-1/4" From deck to aerator
- 3/8" Compression fittings
- 1255™ Duralast™ cartridge
- Powered by (6) AA batteries
- WaterSense® certified: 1.5 gpm



Part #	Mfg #	Description	Handle(s)	Finish	Price
176530	7185EORB	1- or 3-Hole, Pull-Down Spray w/ Motion Sense™	ADA Lever	Oil Rubbed Bronze	
161568	7185ESRS	1- or 3-Hole, Pull-Down Spray w/ Motion Sense™	ADA Lever	Spot Resist Stainless	

### Etch 1-Hdl Pull Down Spray Kitchen Faucet-1/4

- 8-1/4" Reach, 17-3/16" high swing spout
- 3/8" Connections, flexible supplies
- 68" Braided hose
- Duralock quick connect installation
- 1255™ Duralast cartridge
- WaterSense® certified: 1.5 gpm



Part #	Mfg #	Description	Handle(s)	Finish	Price
181277	S72608	1 Hole, Pull-Down Spray	ADA Lever	Chrome	
175000	S72608SRS	1 Hole, Pull-Down Spray	ADA Lever	Spot Resist Stainless	

### Notch™ 1-Hdl Pull-Down Spray Kitchen Faucet

- 7-13/16" Reach, 16-1/4" high spout
- 8-5/8" From deck to aerator
- 68" Braided hose
- 3/8" Connections with flexible supplies
- 1255™ Duralast™ cartridge
- WaterSense® certified: 1.5 gpm



Part #	Mfg #	Description	Handle(s)	Finish	Price
220017	9124C	1 Hole, Pull-Down Spray	ADA Lever	Chrome	
189422	9124ORB	1-Hole, Pull-Down Spray	ADA Lever	Oil Rubbed Bronze	
187327	9124SRS	1 Hole, Pull-Down Spray	ADA Lever	Spot Resist Stainless	

\* Lifeshine® Anti-Tarnish Lifetime Finish

[www.plumbsupply.com](http://www.plumbsupply.com) • Serving our Customers Since 1946 • [www.waterconcepts.net](http://www.waterconcepts.net)

## Kitchen Faucets & Accessories

### Sleek™ 1-Hdl Pull-Down Spray Kitchen Faucet

- 7-5/8" Reach, 15-9/16", 360° rotating spout
- 68" Braided hose
- Reflex™ pulldown system
- 1255™ Duralast™ cartridge
- PowerClean™ Spray technology
- Duralock™ quick connect installation
- Flexible supply lines with 3/8" compression fittings



Part #	Mfg #	Description	Handle(s)	Finish	Price
237587	7864	1-Hole, Pull-Down Spray	ADA Lever	Chrome	
241734	7864BL	1-Hole, Pull-Down Spray	ADA Lever	Matte Black	
241488	7864SRS	1-Hole, Pull-Down Spray	ADA Lever	Spot Resist Stainless	

### Sleek™ MotionSense Wave™ 1-Hdl Pull-Down Spray Kitchen Faucet

- 7-5/8" Reach, 15-9/16", 360° rotating spout
- 68" Braided hose
- Reflex™ pulldown system
- 1255™ Duralast™ cartridge
- PowerClean™ Spray technology
- Duralock™ quick connect installation
- Deckplate included
- Flexible supply lines with 3/8" compression fittings
- Flow rate: 1.5 gpm
- Hands-free—Powered by 6 AA batteries or optional AC adapter



Part #	Mfg #	Description	Handle(s)	Finish	Price
248525	7864EWSRS	1- or 3-Hole, Pull-Down Spray w/ Motion Sense™	ADA Lever	Spot Resist Stainless	

### Sto 1-Hdl Pull-Down Spray Kitchen Faucet

- 9" Reach, 17-1/4" high, 360° rotating spout
- Reflex™ pulldown system
- 68" Braided hose
- 3/8" Connection, flexible supplies
- 1255™ Duralast™ cartridge
- WaterSense® certified: 1.5 gpm



Part #	Mfg #	Description	Handle(s)	Finish	Price
168239	S72308	1 Hole, Pull-Down Spray	ADA Lever	Chrome	
243553	S72308BL	1 Hole, Pull-Down Spray	ADA Lever	Matte Black	
166429	S72308SRS	1 Hole, Pull-Down Spray	ADA Lever	Spot Resist Stainless	

\* Lifeshine® Anti-Tarnish Lifetime Finish

[www.waterconcepts.net](http://www.waterconcepts.net) • Serving our Customers Since 1946 • [www.plumbsupply.com](http://www.plumbsupply.com)

## Kitchen Faucets & Accessories

### Woodmere® 1-Hdl Pull-Down Spray Kitchen Faucet

- 7-7/8" Reach, 16-7/8" high spout
- 9-9/16" From deck to aerator
- 3/8" Compression fittings
- 1255™ Duralast™ cartridge
- Reflex™ system with 68" braided hose
- 2-1/2" Maximum deck thickness
- WaterSense® certified: 1.5 gpm



Part #	Mfg #	Description	Handle(s)	Finish	Price
223207	7615ORB	1-Hole, Pull-Down Spray	ADA Lever	Oil Rubbed Bronze	
221550	7615SRS	1-Hole, Pull-Down Spray	ADA Lever	Spot Resist Stainless	

### Pull-Out Spray Kitchen Faucets

#### 90 Degree™ 1-Hdl Pull-Out Spray Kitchen Faucet

- 9-13/16" Reach, 12-3/8" high swivel spout
- 11-5/16" From deck to aerator
- Flexible supply Lines with 3/8" compression fittings
- 1255™ Duralast™ cartridge
- WaterSense® certified: 1.5 gpm



Part #	Mfg #	Description	Handle(s)	Finish	Price
171013	S7597SRS	1 Hole, Pull-Out Spray	ADA Lever	Spot Resist Stainless	

#### Arbor™ 1-Hdl Pull-Out Spray Kitchen Faucet

- 8-1/8" reach, 12-1/8" high 360° swivel spout
- 10-1/8" From deck to aerator
- 3/8" Compression fittings
- 1255™ Duralast™ cartridge
- WaterSense® certified: 1.5 gpm



Part #	Mfg #	Description	Handle(s)	Finish	Price
157001	7294BL	1- or 3-Hole, Pull-Down Spray	ADA Lever	Matte Black	
156048	7294C	1- or 3-Hole, Pull-Down Spray	ADA Lever	Chrome	
165939	7294ORB	1- or 3-Hole, Pull-Down Spray	ADA Lever	Oil Rubbed Bronze	
153839	7294SRS	1- or 3-Hole, Pull-Down Spray	ADA Lever	Spot Resist Stainless	

\* Lifeshine® Anti-Tarnish Lifetime Finish

[www.plumbsupply.com](http://www.plumbsupply.com) • Serving our Customers Since 1946 • [www.waterconcepts.net](http://www.waterconcepts.net)

## Kitchen Faucets & Accessories

### Brantford™ 1-Hdl Pull-Out Spray Kitchen Faucet

- 10" Reach, 9-15/16" high swing spout
- 6-15/16" From deck to aerator
- 3/8" Compression connections
- 68" Braided hose
- Duralock quick connect installation
- 1255™ Duralast cartridge
- WaterSense® certified: 1.5 gpm



Part #	Mfg #	Description	Handle(s)	Finish	Price
221479	7295SRS	1- or 3-Hole, Pull-Out Spray	ADA Lever	Spot Resist Stainless	

### Camerist® 1-Hdl Pull-Out Spray Kitchen Faucet

- 9" Reach, 9-1/12" high swing spout
- 3/8" Connections, flexible supplies
- 68" Hose
- Hydrolock® quick connect installation
- Spray functions: aerated, rinse and veggie
- Pause button temporarily stops the flow of water
- Integral vacuum breaker
- Maximum flow: 2.5 gpm



Part #	Mfg #	Description	Handle(s)	Finish	Price
096703	7545C	1- or 3-Hole, Pull-Out Spray	ADA Lever	Chrome	
102245	7545ORB	1- or 3-Hole, Pull-Out Spray	ADA Lever	Oil Rubbed Bronze	
162356	7545SRS	1- or 3-Hole, Pull-Out Spray	ADA Lever	Spot Resist Stainless	

### Integra® 1-Hdl Pull-Out Spray Kitchen Faucet

- 9-5/8" Reach spout, 10-5/8" high swing spout
- 3/8" Connections with flexible supplies
- 68" Hose
- Hydrolock® quick connect installation
- Spray functions: stream or spray
- Includes optional escutcheon
- WaterSense® certified: 1.5 gpm



Part #	Mfg #	Description	Handle(s)	Finish	Price
063242	67315C	1- or 3-Hole, Pull-Out Spray	ADA Lever	Chrome	
168493	67315SRS	1- or 3-Hole, Pull-Out Spray	ADA Lever	Spot Resist Stainless	

\* Lifeshine® Anti-Tarnish Lifetime Finish

[www.waterconcepts.net](http://www.waterconcepts.net) • Serving our Customers Since 1946 • [www.plumbsupply.com](http://www.plumbsupply.com)



## Kitchen Faucets & Accessories

### Method™ 1-Hdl Pull-Out Spray Kitchen Faucet

- 8-17/32" Reach, 9-3/16" high spout
- 3/8" compression connection
- 68" Braided hose
- Deckplate included
- Duralast® cartridge
- Duralock™ quick connect
- PowerClean™ spray technology
- Spray functions: aerated stream, powerful cleaning rinse
- Flow rate: 1.5 gpm



Part #	Mfg #	Description	Handle(s)	Finish	Price
237849	7585SRS	1- or 3-Hole, Pull-Out Spray	ADA Lever	Spot Resist Stainless	

### Tilt™ 1-Hdl Pull-Out Spray Kitchen Faucet

- 9-1/16" Reach, 10-7/16" 110° rotating spout
- 9" From deck to aerator
- 3/8" Compression fittings
- 1255™ Duralast™ cartridge
- Flow rate: 2.5 gpm



Part #	Mfg #	Description	Handle(s)	Finish	Price
225856	7626SRS	1 Hole, Pull-Out Spray	ADA Lever	Spot Resist Stainless	

### Voss™ 1-Hdl Pull-Out Spray Kitchen Faucet

- 9-25/64" Reach, 12-19/64" high spout
- 7-23/64" From deck to aerator
- Reflex™ system with 68" braided hose
- 3/8" Compression fittings
- 1255™ Duralast™ cartridge
- 2-1/2" Maximum deck thickness
- WaterSense® certified: 1.5 gpm



Part #	Mfg #	Description	Handle(s)	Finish	Price
245250	9125C	1-Hole, Pull-Out Spray	ADA Lever	Chrome	
187350	9125SRS	1-Hole, Pull-Out Spray	ADA Lever	Spot Resist Stainless	
187180	9125ORB	1-Hole, Pull-Out Spray	ADA Lever	Oil Rubbed Bronze	

\* Lifeshine® Anti-Tarnish Lifetime Finish

[www.plumbsupply.com](http://www.plumbsupply.com) • Serving our Customers Since 1946 • [www.waterconcepts.net](http://www.waterconcepts.net)

## Kitchen Faucets & Accessories

### Single-Handle Kitchen Faucets

#### Align™ 1-Hdl Kitchen Faucet

- 8" Reach, 15-5/16" high 360° rotating spout
- 9-5/8" From deck to aerator
- 3/8" Connections, flexible supplies
- 1255™ Duralast™ cartridge
- WaterSense® certified: 1.5 gpm



Part #	Mfg #	Description	Handle(s)	Finish	Price
167803	7165	2-Hole, Matching Side Spray	ADA Lever	Chrome	
180852	7365	1-Hole, Less Side Spray	ADA Lever	Chrome	
177175	7365SRS	1-Hole, Less Side Spray	ADA Lever	Spot Resist Stainless	

#### Arbor® 1-Hdl Kitchen Faucet

- 8-1/8" Reach, 15-1/2" high 360° swivel spout
- 12-1/2" From deck to aerator
- 3/8" Compression fittings
- 1255™ Duralast™ cartridge
- WaterSense® certified: 1.5 gpm



Part #	Mfg #	Description	Handle(s)	Finish	Price
185345	7790SRS	2-Hole, Matching Side Spray	ADA Lever	Spot Resist Stainless	

#### Banbury® 1-Hdl Kitchen Faucet

- 9" Reach, 7-1/2" high
- Duralock™ quick connect system
- 1-5/8" Maximum deck thickness
- 3/8" Compression fittings
- 1255™ Duralast™ cartridge
- Flow rate: 1.5 gpm



Part #	Mfg #	Description	Handle(s)	Finish	Price
252034	7050SRS	3-Hole, Less Side Spray	ADA Lever	Spot Resist Stainless	

#### Banbury® 1-Hdl Kitchen Faucet with Matching Side Spray

- 9" Reach, 7-1/4" high
- 4-1/2" From deck to aerator
- 3/8" Compression fittings
- 1255™ Duralast™ cartridge
- WaterSense® certified: 1.5 gpm



Part #	Mfg #	Description	Handle(s)	Finish	Price
164962	87690SRS	4-Hole, Matching Side Spray	ADA Lever	Spot Resist Stainless	

\* Lifeshine® Anti-Tarnish Lifetime Finish

[www.waterconcepts.net](http://www.waterconcepts.net) • Serving our Customers Since 1946 • [www.plumbsupply.com](http://www.plumbsupply.com)

## Kitchen Faucets & Accessories

### Belfield™ 1-Hdl Kitchen Faucet

- 10" Reach, 10" high spout
- 7-7/8" From deck to aerator
- 3/8" Compression fittings
- 1255™ Duralast™ cartridge
- WaterSense® certified: 1.5 gpm



Part #	Mfg #	Description	Handle(s)	Finish	Price
185237	7245C	4-Hole, Matching Side Spray	ADA Lever	Chrome	
223083	7245ORB	4-Hole, Matching Side Spray	ADA Lever	Oil Rubbed Bronze	
229186	7240SRS	1- or 3-Hole, Less Side Spray	ADA Lever	Spot Resist Stainless	

### Brantford™ 1-Hdl Kitchen Faucet

- 8-1/8" Reach, 15-1/2" high 360° swivel spout
- 12-1/2" From deck to aerator
- 3/8" Compression fittings
- 1255™ Duralast™ cartridge
- WaterSense® certified: 1.5 gpm



Part #	Mfg #	Description	Handle(s)	Finish	Price
166241	7735SRS	2-Hole, Matching Side Spray	ADA Lever	Spot Resist Stainless	
204740	7735ORB	2-Hole, Matching Side Spray	ADA Lever	Oil Rubbed Bronze	

### Camerist™ 1-Hdl Kitchen Faucet

- 9-1/4" Reach, 8-1/8" high spout
- 6-1/8" From deck to aerator
- 3/8" Compression fittings
- 1255™ Duralast™ cartridge
- WaterSense® certified: 1.5 gpm



Part #	Mfg #	Description	Handle(s)	Finish	Price
099151	7825	1- or 3-Hole, Less Side Spray	ADA Lever	Chrome	
117369	7825ORB	1- or 3-Hole, Less Side Spray	ADA Lever	Oil Rubbed Bronze	
174083	7825SRS	1- or 3-Hole, Less Side Spray	ADA Lever	Spot Resist Stainless	
088084	7840	2- or 4-Hole, Matching Side Spray	ADA Lever	Chrome	
113915	7840ORB	2- or 4-Hole, Matching Side Spray	ADA Lever	Oil Rubbed Bronze	
174447	7840SRS	2- or 4-Hole, Matching Side Spray	ADA Lever	Spot Resist Stainless	

\* Lifeshine® Anti-Tarnish Lifetime Finish

[www.plumbsupply.com](http://www.plumbsupply.com) • Serving our Customers Since 1946 • [www.waterconcepts.net](http://www.waterconcepts.net)

## Kitchen Faucets & Accessories

### Chateau® 1-Hdl Kitchen Faucet

- 9-1/8" Reach, 6-3/4" high swing spout
- 3/8" Connections, flexible supplies
- Hydrolock® quick connect installation
- Maximum flow: 2.0 gpm



Part #	Mfg #	Description	Handle(s)	Finish	Price
037482	7423	1-Hole, Less Side Spray	ADA Lever	Chrome	
029728	7425	8"cc, 3-Hole, Less Side Spray	ADA Lever	Chrome	
248673	7425SRS	8"cc, 3-Hole, Less Side Spray	ADA Lever	Spot Resist Stainless	
147853	67425	8"cc, 3-Hole, Less Side Spray (Bulk 12/Pk)	ADA Lever	Chrome	
037058	67430	8"cc, 4-Hole, Matching Side Spray	ADA Lever	Chrome	
029729	7430	8"cc, 4-Hole, Matching Side Spray	ADA Lever	Chrome	
243789	7430SRS	8"cc, 4-Hole, Matching Side Spray	ADA Lever	Spot Resist Stainless	

### Chateau® 1-Hdl Low Arc Kitchen Faucet

- 9-1/8" Reach, 6-11/16" high spout
- 3/8" Compression connections, flexible supplies
- Duralock® quick connect installation
- Maximum flow: 1.5 gpm



Part #	Mfg #	Description	Handle(s)	Finish	Price
029731	7434	3-Hole, Matching Side Spray	ADA Lever	Chrome	

### Torrance™ 1-Hdl Kitchen Faucet

- 9" Reach, 7-1/2" spout height
- 5-3/8" From deck to aerator
- 3/8" Connections, flexible supplies
- Duralock™ quick connect system
- 1255 Cartridge design
- Maximum flow: 1.5 gpm



Part #	Mfg #	Description	Handle(s)	Finish	Price
236537	7081	1- or 3-Hole, Less Side Spray	ADA Lever	Chrome	
241672	7081SRS	1- or 3-Hole, Less Side Spray	ADA Lever	Spot Resist Stainless	
236879	7082SRS	1- or 3-Hole, Matching Side Spray	ADA Lever	Spot Resist Stainless	

\* Lifeshine® Anti-Tarnish Lifetime Finish

## Kitchen Faucets & Accessories

### Waterhill™ 1-Hdl Kitchen Faucet

- 9-3/8" Reach, 12-1/4" high spout
- 8-1/2" from deck to aerator
- 3/8" Connections, flexible supplies
- 1255™ Duralast™ cartridge
- Maximum flow: 1.5 gpm



Part #	Mfg #	Description	Handle(s)	Finish	Price
100453	S711	3-Hole, Matching Side Spray	ADA Lever	Chrome	

### Weymouth 1-Hdl Kitchen Faucet

- 8-1/4" Reach, 10-1/2" high 360° rotating spout
- 7-1/2" From deck to aerator
- Flexible supply line with 3/8" compression Fitting
- 1255™ Duralast™ cartridge
- WaterSense® certified: 1.5 gpm



Part #	Mfg #	Description	Handle(s)	Finish	Price
185236	S72101	2-Hole, Matching Side Spray	ADA Lever	Chrome	
183889	S72101NL	2-Hole, Matching Side Spray	ADA Lever	Polished Nickel	
164050	S72101SRS	2-Hole, Matching Side Spray	ADA Lever	Spot Resist Stainless	
179531	S72101ORB	2-Hole, Matching Side Spray	ADA Lever	Oil Rubbed Bronze	

### Whitmore™ 1-Hdl Kitchen Faucet

- 8-5/32" Reach, 12-15/16" high 360° rotating spout
- Powerful cleaning rinse
- Flexible supply line with 3/8" compression Fitting
- Duralock™ Quick connect
- 1255™ Duralast™ cartridge
- Includes coordinating side spray and soap/lotion dispenser
- WaterSense® certified: 1.5 gpm



Part #	Mfg #	Description	Handle(s)	Finish	Price
249123	87044SRS	3 or 4 Hole, Matching Side Spray & Soap Dispenser	ADA Lever	Spot Resist Stainless	

## Two-Handle Kitchen Faucets

### Belfield™ Two-Handle Kitchen Faucet

- 9-1/2" Reach, 9-11/32" high spout
- 7-3/8" From deck to aerator
- 1/2" IPS connections
- 1224™ Cartridge design
- WaterSense® certified: 1.5 gpm



Part #	Mfg #	Description	Handle(s)	Finish	Price
252700	7250C	3-Hole, Less Side Spray	ADA Lever	Chrome	

\* Lifeshine® Anti-Tarnish Lifetime Finish

[www.plumbsupply.com](http://www.plumbsupply.com) • Serving our Customers Since 1946 • [www.waterconcepts.net](http://www.waterconcepts.net)

## Kitchen Faucets & Accessories

### Two-Handle Kitchen Faucets (Continued)

#### Belfield™ Two-Handle Kitchen Faucet

Part #	Mfg #	Description	Handle(s)	Finish	Price
224947	7250ORB	3-Hole, Less Side Spray	ADA lever	Oil Rubbed Bronze	
243146	7255ORB	4-Hole, Matching Side Spray	ADA Lever	Oil Rubbed Bronze	

#### Waterhill™ Two-Handle Bridge Kitchen Faucet

- 9-3/8" Reach, 11-15/32" high
- 7-3/4" From deck to aerator
- 1/2" IPS connections
- 1224 Cartridge
- WaterSense® certified: 1.5 gpm



Part #	Mfg #	Description	Handle(s)	Finish	Price
158775	S713	2- or 4-Hole, Matching SideSpray	ADA Lever	Chrome	
105506	S713ORB	2- or 4-Hole, Matching SideSpray	ADA Lever	Oil Rubbed Bronze	
187303	S713SRS	2- or 4-Hole, Matching SideSpray	ADA Lever	Spot Resist Stainless	
103954	S713WR	2- or 4-Hole, Matching SideSpray	ADA Lever	Wrought Iron	

#### Waterhill™ Two-Handle Kitchen Faucet

- 9-3/8" Reach, 12-1/4" high 360° rotating spout
- 8-1/2" From deck to aerator
- 1/2" IPS Connections, 3/8" tubing
- 1224 Cartridge
- Flow rate: 2.0 gpm



Part #	Mfg #	Description	Handle(s)	Finish	Price
168354	S712	8"cc, 4-Hole, Matching Side Spray	ADA Lever	Chrome	
110155	S712ORB	8"cc, 4-Hole, Matching Side Spray	ADA Lever	Oil Rubbed Bronze	

### Kitchen Faucet Accessories

#### Kitchen Faucet Adapter Kit



Part #	Mfg #	Description	Price
189586	169031	Kitchen Faucet Adapter	

\* Lifeshine® Anti-Tarnish Lifetime Finish

[www.waterconcepts.net](http://www.waterconcepts.net) • Serving our Customers Since 1946 • [www.plumbsupply.com](http://www.plumbsupply.com)



---

---

## Kitchen Faucets & Accessories

---

---

Wand Kit



Part #	Mfg #	Description	Price
244132	161150ORB	Oil Rubbed Bronze	

\* Lifeshine® Anti-Tarnish Lifetime Finish

[www.plumbsupply.com](http://www.plumbsupply.com) • Serving our Customers Since 1946 • [www.waterconcepts.net](http://www.waterconcepts.net)

## Soap Dispensers

### Kitchen Faucet Accessories

#### Traditional Soap/Lotion Dispenser

- Top lifts off for easy refill
- 18 oz Refillable bottle
- Mounts in 1-1/8" diameter hole



Part #	Mfg #	Finish	Price
140198	3944	Chrome	
119049	3944ORB	Oil Rubbed Bronze	
153722	3944SRS	Spot Resist Stainless	

#### Soap/Lotion Dispenser

- 3.13" Height
- 2.75" Spout reach
- 2-1/4" Max deck thickness
- 1-1/8" Hole diameter
- 18 oz refillable bottle



Part #	Mfg #	Finish	Price
122900	3942	Chrome	
129743	3942BL	Matte Black	
146576	3942W	Glacier	
155791	3942SRS	Spot Resist Stainless	

#### Modern Soap/Lotion Dispenser

- 5" Height
- 3.50" Spout reach
- 3-1/2" Max deck thickness
- 1-1/8" Hole diameter
- 18 oz refillable bottle



Part #	Mfg #	Finish	Price
171272	S3947C	Chrome	
180915	S3947SRS	Spot Resist Stainless	

#### Traditional Soap Dispenser

- 5" Height
- 3.50" Spout Reach
- 3-1/2" Max deck thickness
- 1-1/8" Hole diameter
- 18 oz refillable bottle



Part #	Mfg #	Finish	Price
215706	S3945C	Chrome	
180906	S3945ORB	Oil Rubbed Bronze	
170788	S3945SRS	Spot Resist Stainless	

#### Transitional Soap/Lotion Dispenser

- 3.78" Reach
- Press down, pump action
- 18 oz Refillable bottle
- Mounts in 1-1/8" diameter hole



Part #	Mfg #	Finish	Price
216312	S3946C	Chrome	
227909	S3946BL	Matte Black	
168814	S3946ORB	Oil Rubbed Bronze	
168813	S3946SRS	Spot Resist Stainless	

#### Transitional (2) Soap/Lotion Dispenser

- 5" Height
- 3.5" Reach
- 3-1/2" Max deck thickness
- 1-1/8" Hole diameter
- 18 oz refillable bottle



Part #	Mfg #	Finish	Price
213250	S3948C	Chrome	
175002	S3948SRS	Spot Resist Stainless	

\*Lifeshine® Anti-Tarnish Lifetime Finish

[www.waterconcepts.net](http://www.waterconcepts.net) • Serving our Customers Since 1946 • [www.plumbsupply.com](http://www.plumbsupply.com)

**Kitchen Faucets**

**Pot Fillers**

**Blanco Cantata™ Pot Filler**

- Cold water only
- Ceramic disc cartridge
- 2.2 GPM flow rate



Part #	Mfg #	Description	Handle(s)	Finish	Price
156122	441194	Wall Mounted, 21-3/4" Reach		Lever Chrome	
150486	441195	Wall Mounted, 21-3/4" Reach		Lever Satin Nickel	

**Pull-Down Spray Kitchen Faucets**

**Blanco Artona™ 1-Hdl Pull-Down Kitchen Faucet**

- 8-5/8" Reach, 15-3/4" height
- 180° Swivel spout
- Solid brass body
- Ceramic disk cartridge
- Dual spray feature
- 2-1/4" Max deck thickness
- Installation in a 1-3/8" hole



Part #	Mfg #	Description	Handle(s)	Finish	Price
223603	442023	1-Hole, Pull-Down Spray, 2.2 GPM	Lever	Stainless/Anthracite	
238373	442024	1-Hole, Pull-Down Spray, 2.2 GPM	Lever	Stainless/Cafe Brown	
226948	442027	1-Hole, Pull-Down Spray, 2.2 GPM	Lever	Stainless/Truffle	
242593	442028	1-Hole, Pull-Down Spray, 2.2 GPM	Lever	Stainless/White	
245065	442034	1-Hole, Pull-Down Spray, 1.5 GPM	Lever	Stainless/Metallic Grey	

**Blanco Atura™ 1-Hdl Pull-Down Kitchen Faucet**

- 9" Reach, 16-3/8" height
- 360° Swivel spout
- Solid brass body
- Ceramic disk cartridge
- Color coded hot and cold supply lines
- 2-1/4" Max deck thickness
- Installation in a 1-3/8" hole



Part #	Mfg #	Description	Handle(s)	Finish	Price
247065	442206	1-Hole, Pull-Down Spray, 2.2 GPM	Lever	Stainless	

**Kitchen Faucets**

**Blanco Culina™ 1-Hdl Pull-Down Kitchen Faucet**

- 8-5/8" Reach, 21-1/2" height
- 360° Swivel spout, 7-1/4" spout height
- Flexible steel spring spout
- Ceramic disc cartridge
- Dual spray feature
- Quick release magnetic hand spray
- 2" Max deck thickness
- Installation in a 1-3/8" hole



Part #	Mfg #	Description	Handle(s)	Finish	Price
154207	441407	1-Hole, Pull-Down Spray, 1.8 GPM	Lever	Satin Nickel	
166181	441331	1-Hole, Pull-Down Spray, 2.2 GPM	Lever	Chrome	
148052	441332	1-Hole, Pull-Down Spray, 2.2 GPM	Lever	Satin Nickel	

**Blanco Culina™ Mini 1-Hdl Pull-Down Kitchen Faucet**

- 7-7/8" Reach, 17-1/8" height
- Ceramic disc cartridge
- Installation in a 1-3/8" hole
- 2.2 GPM flow rate
- Solid brass construction



Part #	Mfg #	Description	Handle(s)	Finish	Price
172246	441622	1-Hole, Pull-Down Spray, Lead Free	Lever	Chrome	
224665	441623	1-Hole, Pull-Down Spray, Lead Free	Lever	Satin Nickel	
189613	441624	1-Hole, Pull-Down Spray, Lead Free 1.8GPM	Lever	Chrome	

**Blanco Empressa™ 1-Hdl Pull-Down Kitchen Faucet**

- 9" Reach, 16-1/4" height
- Ceramic disc cartridge
- Dual pull down-spray
- Installation in a 1-3/8" hole
- 1.5 GPM flow rate



Part #	Mfg #	Description	Handle(s)	Finish	Price
249568	442500	1-Hole, Pull-Down Spray, 1.5 GPM	Lever	Stainless Steel	
249562	442503	1-Hole, Pull-Down Spray, 1.5 GPM	Lever	Oil Rubbed Bronze	

**Kitchen Faucets**

**Blanco Meridian™ Semi Professional 1-Hdl Pull-Down Kitchen Faucet**

- 8-3/8" Reach, 19-1/4" height
- 360° Swivel spout
- Ceramic disc cartridge
- 3-1/2" Maximum deck thickness
- Installation in a 1-3/8" hole



Part #	Mfg #	Description	Handle(s)	Finish	Price
241891	441408	1-Hole, Pull-Down Spray, 1.8 GPM	Lever	Chrome	
169561	441409	1-Hole, Pull-Down Spray, 1.8 GPM	Lever	Satin Nickel	
242509	441753	1-Hole, Pull-Down Spray, 1.5 GPM	Lever	Chrome	
144538	440558	1-Hole, Pull-Down Spray, 2.2 GPM	Lever	Chrome	
148480	440557	1-Hole, Pull-Down Spray, 2.2 GPM	Lever	Satin Nickel	

**Blanco Napa™ 1-Hdl Pull-Down Kitchen Faucet**

- 9-1/4" Reach, 9-3/8" height
- 180° Swivel spout
- Ceramic disc cartridge
- 2-1/4" Maximum deck thickness
- Installation in a 1-3/8" hole



Part #	Mfg #	Description	Handle(s)	Finish	Price
189530	441507	1-Hole, Pull-Down Spray, Lead Free	Lever	Stainless	

**Blanco Sonoma™ 1-Hdl Pull-Down Kitchen Faucet**

- 8-1/2" Reach, 15-1/2" height
- 180° Swivel spout
- Dual pull-down spray
- Toggle spray function
- Ergonomic pull-down spray
- Ceramic disc cartridge
- Installation in a 1-3/8" hole



Part #	Mfg #	Description	Handle(s)	Finish	Price
245040	442055	1-Hole, Pull-Down Spray, 1.5 gpm	Lever	Stainless/Cinder	
187221	441649	1-Hole, Pull-Down Spray, 1.8 gpm	Lever	Stainless	
240491	442064	1-Hole, Pull-Down Spray, 2.2 gpm	Lever	Stainless/Cafe Brown	
239074	442065	1-Hole, Pull-Down Spray, 2.2 gpm	Lever	Stainless/Cinder	
237246	442066	1-Hole, Pull-Down Spray, 2.2 gpm	Lever	Stainless/Truffle	
250513	442068	1-Hole, Pull-Down Spray, 2.2 gpm	Lever	Stainless/White	

**Kitchen Faucets**

**Pull-Out Spray Kitchen Faucets**

**Blanco Alta Compact™ Pull-Out Kitchen Faucet**

- 8" Reach, 6" height
- 130° Swivel spout
- Ceramic disk cartridge
- Extendable dual pull-out spray
- 1-3/4" Maximum deck thickness
- Installation in a 1-3/8" hole
- 2.2 GPM flow rate



Part #	Mfg #	Description	Handle(s)	Finish	Price
183129	441484	1-Hole, Pull-Out Spray, Lead Free	Lever	Anthracite/Chrome	
251397	441486	1-Hole, Pull-Out Spray, Lead Free	Lever	Satin Nickel	
240225	441491	1-Hole, Pull-Out Spray, Lead Free	Lever	White/Chrome	

**Blanco Linus™ 1-Hdl Pull-Out Kitchen Faucet**

- 8-1/2" Reach, 11" height
- 140° Swivel spout, 9-3/4" spout height
- Ceramic disc cartridge
- 1-3/4" Max deck thickness
- Installation in a 1-3/8" hole
- Lead free



Part #	Mfg #	Description	Handle(s)	Finish	Price
182721	441403	1-Hole, Pull-Out Dual Spray, 2.2 GPM	Lever	Chrome	
161084	441404	1-Hole, Pull-Out Dual Spray, 2.2 GPM	Lever	Satin Nickel	
162025	441198	1-Hole, Pull-Out Stream Only, 2.2 GPM	Lever	Cafe Brown	
132055	441199	1-Hole, Pull-Out Stream Only, 2.2 GPM	Lever	Anthracite	
178473	441431	1-Hole, Pull-Out Dual Spray, 1.8 GPM	Lever	Satin Nickel	



**Soap Dispensers**

**Soap Dispensers**

**Alta™ Soap Dispenser**

- Solid brass construction
- Reservoir approximately 15 oz.
- Installation cutout hole size 1-3/8"



Part #	Mfg #	Description	Overall Size	Price
168089	440046	Chrome	3-3/4" H x 4-1/2" W	
174403	440047	Satin Nickel	3-3/4"H x 4-1/2"W	

**Artona™ Soap Dispenser**

- 4-13/16"H x 4-1/4"W
- Solid brass construction
- Reservoir approximately: 12 oz
- Installation cutout hole size 1-3/8"



Part #	Mfg #	Description	Overall Size	Price
243036	442049	Stainless Finish/Anthracite	4-13/16"H x 4-1/4"W	
237984	442051	Stainless Finish/Cinder	4-13/16"H x 4-1/4"W	
245066	442052	Stainless Finish/Metallic Grey	4-13/16"H x 4-1/4"W	

**Napa™ Soap Dispenser**

- 3-3/4"H x 3-1/8"W
- Solid brass construction
- Reservoir approximately 12 oz
- Installation cutout hole size 1-3/8"



Part #	Mfg #	Description	Overall Size	Price
250759	441756	Stainless Finish	3-3/4"H x 3-1/8"W	

**Sonoma™ Soap Dispenser**

- 2-1/4"H x 3-1/8"W
- Solid brass construction
- Reservoir approximately 12 oz
- Installation cutout hole size 1-3/8"



Part #	Mfg #	Description	Overall Size	Price
182726	441757	Chrome	2-1/4"H x 3-1/8"W	
185937	441758	Stainless Steel	2-1/4"H x 3-1/8"W	



## Kitchen Faucets & Accessories

### Single-Handle Kitchen Faucets

#### Maxwell® 1-Hdl Kitchen Faucet

- 8" Elliptical spout
- Ceramic disc cartridge with temperature limit stops
- Brass and copper waterways
- Limited lifetime warranty



40-122

Part #	Mfg #	Description	Handle(s)	Finish	Price
132123	40-110	8"cc	ADA Solid Lever	Chrome	

### Two-Handle Kitchen Faucets

#### Classic 2-Hdl Wall-Mount Kitchen Faucet

- Interchangeable swing spout
- Cast brass body
- Lead free waterway
- Compression cartridges
- Hot and cold indicator
- 2.2 gpm maximum aerator @ 60 psi
- Soap dish included with model (42-631)



Part #	Mfg #	Description	Handle(s)	Finish	Price
191972	42-631	2-Hole, 12" Spout	ADA Lever	Chrome	
194226	42-691	2-Hole, 8" Spout	ADA Lever	Chrome	

### Two-Handle Bar Faucets

#### Classics™ Two Handle Bar Faucet

- 8-1/8" Gooseneck spout
- Cast brass underbody
- Compression cartridge
- Hot and cold indicator
- Includes integrated deck plate
- Compression stems with renewable brass seats
- 1/2" NPSM supply connections with brass coupling nuts
- 2.2 gpm @ 60 psi maximum aerator



Part #	Mfg #	Description	Handle(s)	Finish	Price
239581	07-49-251	3-Hole	ADA Lever	Chrome	

\*Physical Vapor Deposition (PVD) Limited Lifetime Finish

[www.waterconcepts.net](http://www.waterconcepts.net) • Serving our Customers Since 1946 • [www.plumbsupply.com](http://www.plumbsupply.com)

## Kitchen Faucets & Accessories

### Pull-Down Kitchen Faucets

#### Grand Single-Handle Pull-Down Kitchen Faucet

- 15-9/16" High spout, 9-1/4" Reach
- 7-15/16" From deck to aerator
- 6"-8"cc, 360° swing spout
- Copper waterway construction with 1/2"-14 NPSM connection
- Premium grade ceramic cartridge (Type G)
- 60" Quick connect flexible nylon hose
- Screw on weight
- Flow rate: 1.8 gpm
- 100% pressure system tested



Part #	Mfg #	Description	Handles	Finish	Price
226870	191-6600	1 or 3-Hole, Pull-Down Spray, 1.8 gpm	ADA Lever	Chrome	
223339	191-6601	1 or 3-Hole, Pull-Down Spray, 1.8 gpm	ADA Lever	Brushed Nickel	
229586	191-6639	1 or 3-Hole, Pull-Down Spray, 1.8 gpm	ADA Lever	Oil Rubbed Bronze	

#### Prestige Single-Handle Pull-Down Kitchen Faucet

- 15-13/16" High spout, 9-1/4" Reach
- 9" From deck to aerator
- 360° swing spout
- Copper waterway construction with 1/2"-14 NPSM connection
- Premium grade ceramic cartridge (Type G)
- 60" Quick connect flexible nylon hose
- Screw on weight
- Flow rate: 1.8 gpm
- 100% pressure system tested



Part #	Mfg #	Description	Handles	Finish	Price
186828	191-7716	1 or 3-Hole Pull-Down Spray, 1.8 gpm	ADA Lever	Chrome	
186825	191-7717	1 or 3-Hole Pull-Down Spray, 1.8 gpm	ADA Lever	Brushed Nickel	
186826	191-7718	1 or 3-Hole, Pull-Down Spray, 1.8 gpm	ADA Lever	Oil Rubbed Bronze	

#### Noble Single-Handle Pull-Down Kitchen Faucet

- 15" High spout, 11-13/16" Reach
- 8-3/8" From deck to aerator
- 360° swing spout
- Copper waterway construction with 1/2"-14 NPSM connection
- Premium grade ceramic cartridge (Type G)
- 60" Quick connect flexible nylon hose
- Screw on weight
- Flow rate: 1.8 gpm
- 100% pressure system tested



Part #	Mfg #	Description	Handles	Finish	Price
229705	191-7698	1- or 3-Hole Pull-Down Spray, 1.8 gpm	ADA Lever	Brushed Nickel	

## Kitchen Faucets & Accessories

### Single Handle Kitchen Faucets

#### Noble Single-Handle Kitchen Faucet

- 7" High spout, 9-3/16" Reach
- 5-3/4" From deck to aerator
- 8"cc 360° swing spout
- Copper waterway construction with 1/2"-14 NPSM connection
- Premium grade ceramic cartridge (Type H)
- Flow rate: 1.8 gpm
- 100% Pressure system tested



Part #	Mfg #	Description	Handles	Finish	Price
186056	191-6572	1- or 3-Hole, Less Side Spray	ADA Lever	Chrome	
186057	191-6574	6"-8"cc 4-Hole, With Side Spray	ADA Lever	Chrome	
228347	191-6575	6"-8"cc 4-Hole, With Side Spray	ADA Lever	Brushed Nickel	

### Two Handle Kitchen Faucets

#### Majestic Two-Handle Kitchen Faucet

- 13-1/2" High spout, 9-11/16" Reach
- 9" From deck to aerator
- brass waterway construction with 1/2" - 14 NPSM connection
- 49" Quick connect hose
- 1/4 Turn premium grade ceramic cartridges (Type I)
- Flow rate: 1.8 gpm
- 100% Pressure system tested



Part #	Mfg #	Description	Handles	Finish	Price
232079	191-7703	8"cc, 4-Hole	ADA Levers	Chrome	

**Kitchen Faucets & Accessories**

**Pull-Down Kitchen Faucets**

**Avado® Pull-Down Semi-professional Kitchen Faucet**

- 8-1/4" Reach, 21-1/8" high spout
- Brass material
- 2-Function spray
- Ceramic disc valves
- 255° Spout rotation
- 3/8" Compression hose assembly
- Stainless steel braided hand spray hose
- 2-1/2" Maximum countertop thickness
- 11-5/8" Deck clearance
- Low flow models:  
—(LKLFAV2031CR)
- Flow rate: 1.75 gpm or 1.5 gpm for low flow models



Part #	Mfg #	Description	Handle(s)	Finish	Price
144407	LKAV2031NK	1-Hole, Pull-Down Spray	ADA Lever	Brushed Nickel	

**Avado® Pull-Down Kitchen Faucet**

- 7-7/8" Reach, 18-7/8" high spout
- Brass material
- 2-Function spray
- Ceramic disc valves
- 360° Spout rotation
- 3/8" Compression hose assembly
- Stainless steel braided hand spray hose
- 2-1/2" Maximum countertop thickness
- 11-1/4" Deck clearance
- Flow rate: 1.75 gpm



Part #	Mfg #	Description	Handle(s)	Finish	Price
186384	LKAV1031NK	1-Hole, Pull-Down Spray	ADA Lever	Brushed Nickel	

**Avado® Semi-Professional Pull-Down Kitchen Faucet**

- 8-1/2" Reach, 24-1/4" high spout
- Brass material
- 3-Function spray:  
-Aerated  
-Spray  
-Pause
- Ceramic disc valves
- 360° Spout rotation
- Stainless steel coil hand spray hose
- 2-1/2" Maximum countertop thickness
- 8-1/2" Deck clearance
- Flow rate: 1.5 gpm (2.2 gpm flow regular included with faucet)



Part #	Mfg #	Description	Handle(s)	Finish	Price
146080	LKAV4061CR	1-Hole, Pull-Down Spray	ADA Lever	Chrome	

**Kitchen Faucets & Accessories**

**Pull-Down Kitchen Faucets (Continued)**

**Avado® Semi-Professional Pull-Down Kitchen Faucet**

Part #	Mfg #	Description	Handle(s)	Finish	Price
148288	LKAV4061LS	1-Hole, Pull-Down Spray	ADA Lever	Lustrous Steel	

**Everyday Quick-Connect Pull-Down Spray Kitchen Faucet**

- 9" Reach, 15-3/4" high spout
- Solid brass waterway construction
- 3-Function spray:
  - Aerated
  - Spray
  - Pause
- Forward only handle
- 360° Spout rotation
- 3/8" Female compression hose assembly
- 7-3/8" Deck clearance
- 2-1/2" Maximum countertop thickness
- Ceramic disc valve
- Flow rate: 1.5 gpm installed with 2.2 gpm regulator included



Part #	Mfg #	Description	Handle(s)	Finish	Price
187687	LK6000LS	1-Hole, Quick-Connect Pull-Down Spray	ADA Lever	Lustrous Steel	

**Explore™ Pull-Down Bridge Kitchen Faucet**

- 9-1/4" Reach, 17-1/8" high spout
- 3-Function spray:
  - Aerated
  - Spray
  - Pause
- 360° Spout rotation
- 1/2"-14 NPSM
- 8-5/8" Deck clearance
- Ceramic disc valves
- Flow rate: 1.5 gpm



Part #	Mfg #	Description	Handle(s)	Finish	Price
185489	LKEC2037AS	3-Hole, Pull-Down Spray	ADA Lever	Antique Steel	
172971	LKEC2037CR	3-Hole, Pull-Down Spray	ADA Lever	Chrome	
169805	LKEC2037LS	3-Hole, Pull-Down Spray	ADA Lever	Lustrous Steel	



**Kitchen Faucets & Accessories**

**Explore™ Pull-Down Spray Kitchen Faucet**

- 9-1/4" Reach, 17-7/8" high spout
- Solid brass waterway construction
- 3-Function spray:
  - Aerated
  - Spray
  - Pause
- Forward only handle
- 360° Spout rotation
- 1/2"-14 NPSM
- Ceramic disc valve
- 2-1/2" Countertop thickness
- 9-1/2" Deck clearance



Part #	Mfg #	Description	Handle(s)	Finish	Price
180841	LKEC2031AS	1-Hole, Pull-Down Spray	ADA Lever	Antique Steel	
181148	LKEC2031LS	1-Hole, Pull-Down Spray	ADA Lever	Lustrous Steel	

**Pull-Out Spray Kitchen Faucets**

**Gourmet® 1-Hdl Pull-Out Spray Kitchen Faucet**

- 10-1/8" Reach
- Solid brass construction
- Removable ceramic disc cartridge
- 110° Swing spout
- 5" Maximum countertop thickness (mid-rise)
- 2-1/2" Maximum countertop thickness (hi-rise)
- Flexible hose with 3/8" compression
- Maximum flow rate: 1.75 gpm @ 60 psi
- Low flow rate: 1.5 gpm @ 60 psi
- **LKLFGT** models have low flow



Part #	Mfg #	Description	Handle(s)	Finish	Price
172019	LKGT1041NK	1-Hole, Pull-Out Spray	ADA Lever	Brushed Nickel	
155037	LKLFGT1041CR	1-Hole, Pull-Out Spray	ADA Lever	Chrome	

**Gourmet® 1-Hdl Pull-Out Spray Kitchen Faucet**

- 9-5/8" Reach, 13-1/16" spout height
- Solid brass construction
- Ceramic disc valve
- 360° Spout rotation
- 2-1/2" Countertop thickness
- 3/8" Female compression hose assembly
- Chrome plated brass hand spray hose
- Low flow rate: 1.75 gpm @ 60 psi



Part #	Mfg #	Description	Handle(s)	Finish	Price
237646	LKGT2041CR	1-Hole, Pull-Out Spray	ADA Lever	Chrome	

**Kitchen Faucets & Accessories**

**Kitchen Faucets**

**Allure® 1-Hdl Kitchen Faucet**

- 8" Reach, 13-3/4" spout height
- Stainless steel construction
- Ceramic disc valve
- 1/2" IPT
- 360° Spout rotation
- 2-1/2" Maximum countertop thickness
- 7-3/4" Deck clearance
- Maximum flow rate: 1.5 gpm



Part #	Mfg #	Description	Handle(s)	Finish	Price
158462	LK7921SSS	1-Hole, No Spray Type		ADA lever	Satin Stnlss Steel
152148	LK7922SSS	2-Hole, Side Spray		ADA Lever	Satin Stnlss Steel

**1-Hdl Everyday Kitchen Faucet**

- 8" Reach, 6" Spout height
- Brass construction
- Ceramic disc valve
- 360° Swing spout
- 2-1/2" Maximum countertop thickness
- 4-7/8" Deck clearance
- 3/8" Female compression hose assembly
- Maximum flow rate: 1.5 gpm



Part #	Mfg #	Description	Handle(s)	Finish	Price
142798	LK1500CR	1-Hole, No Spray Type		ADA Lever	Chrome
177162	LK1501CR	1-Hole, Side Spray		ADA Lever	Chrome

**1-Hdl Everyday Kitchen Faucet with Escutcheon and Side Spray**

- 8" Reach, 6" Spout height
- Brass construction
- Ceramic disc valve
- 360° Swing spout
- 2-1/2" Maximum countertop thickness
- 5" Deck clearance
- 3/8" Female compression hose assembly
- Maximum flow rate: 1.5 gpm

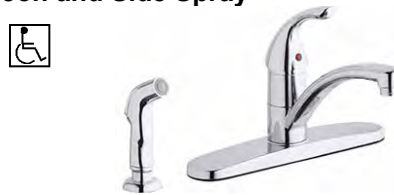

Part #	Mfg #	Description	Handle(s)	Finish	Price
185692	LK1001CR	1-Hole, Side Spray		ADA Lever	Chrome

**Kitchen Faucets & Accessories**

**Remote Handle Everyday Kitchen Faucet with Side Spray**

- 8" Reach, 11-1/2" Spout height
- Brass construction
- Ceramic disc valve
- 360° Swing spout
- 2-1/2" Maximum countertop thickness
- 10-3/8" Deck clearance
- 3/8" Female compression hose assembly
- Maximum flow rate: 1.5 gpm



Part #	Mfg #	Description	Handle(s)	Finish	Price
186030	LK3001CR	3-Hole, Side Spray	ADA Lever	Chrome	

**Utility Kitchen Faucets**

**Pursuit™ 1-Hdl Flexible Spout 2-Function Spray Utility Faucet**

- 8-3/8" Reach, 14-3/8" Spout height
- Solid brass waterway construction
- Ceramic disc valve
- 360° Swing spout
- 2-1/2" Maximum countertop thickness
- 7-3/8" Deck clearance
- Forward only lever handle
- 3/8" Female compression hose assembly
- Maximum flow rate: 1.5 gpm



Part #	Mfg #	Description	Handle(s)	Finish	Price
175964	LK2500CR	1-Hole, No Spray Type	ADA Lever	Chrome	

**Pot Fillers**

**Avado® Wall-Mount Pot Filler**

- Brass construction
- Articulating spout with 360° rotation, 24" extended reach
- Ceramic disc valves
- 1/2" NPT female
- Flow rate: 4 gpm



Part #	Mfg #	Description	Handle(s)	Finish	Price
167038	LKAV4091CR	1-Hole, Wall-Mount	ADA Lever	Chrome	

**Kitchen Faucets & Accessories**

**Explore™ Wall-Mount Pot Filler**

- Brass construction
- 24" Spout reach
- Ceramic disc valves
- 1/2" NPT female connection
- Flow rate: 4.0 gpm



Part #	Mfg #	Description	Handle(s)	Finish	Price
213184	LKEC2091LS	1-Hole, Wall-Mount	ADA Lever	Lustrous Steel	

**Faucet Accessories**

**Avado™ Soap/Lotion Dispenser**

- 3-1/2" Spout reach, 3-1/2" height
- Brass construction



Part #	Mfg #	Description	Handle(s)	Finish	Price
163756	LK325LS	1-Hole		Lustrous Steel	

**Explore™ Soap/Lotion Dispenser**

- 3-1/2" Spout reach, 4-1/2" height
- Brass construction



Part #	Mfg #	Description	Handle(s)	Finish	Price
185490	LK330AS	1-Hole		Antique Steel	
173659	LK330CR	1-Hole		Chrome	
182196	LK330LS	1-Hole		Lustrous Steel	

**Gourmet® Harmony™ Soap/Lotion Dispenser**

- 3-1/2" Spout reach, 4-3/8" height
- Brass construction



Part #	Mfg #	Description	Handle(s)	Finish	Price
188721	LKGT1054NK	1-Hole		Brushed Nickel	

---

---

**Kitchen Faucets & Accessories**

---

---

**Faucet Hole Cover**

- *Brushed stainless steel*



Part #	Mfg #	Size	Finish	Price
238534	LK126	1-3/4"	Brushed Stainless Steel	

## Kitchen Faucets & Accessories

### Single-Handle Kitchen Faucets

#### P4B Builder Series 1-Hdl Pull-Out Kitchen Fau

- Ceramic cartridge
- Optional deckplate included
- Max flow rate: 2.2 gpm @ 60 psi



Part #	Mfg #	Description	Handle(s)	Finish	Price
141370	P4B-150C	8"cc 1- or 3-Hole, Pull-Out Spray	ADA Metal Lever	Chrome	
141371	P4B-150SS	8"cc 1- or 3-Hole, Pull Out Spray	ADA Metal Lever	Stainless	

#### P4B Builder Series 1-Hdl Kitchen Faucet

- Ceramic cartridge
- Optional deckplate included
- Max flow rate: 1.5 gpm @ 60 psi



Part #	Mfg #	Description	Handle(s)	Finish	Price
234721	P4B-140C	2- or 4-Hole, Matching Side Spray	ADA Metal Lever	Chrome	
234723	P4B-140SS	2- or 4-Hole, Matching Side Spray	ADA Metal Lever	Stainless	

#### P4B Builder Series 1-Hdl Pull-Down Kitchen Faucet

- Ceramic cartridge
- Quick connect feature
- Optional deckplate included
- Max flow rate: 1.8 gpm @ 60 psi



Part #	Mfg #	Description	Handle(s)	Finish	Price
234724	P4B-151C	1- or 3-Hole, Pull-Down Spray	ADA Metal Lever	Chrome	
173989	P4B-151SS	1- or 3-Hole, Pull-Down Spray	ADA Metal Lever	Stainless	

#### P4C Classic Series 1-Hdl Kitchen Faucet

- Stainless steel ball valve
- Max flow rate: 2.2 gpm @ 60 psi



Part #	Mfg #	Description	Handle(s)	Finish	Price
141386	P4C-100C	8"cc 1- or 3-Hole, less Side Spray	ADA Metal Lever	Chrome	
158742	P4C-100SS	8"cc 1 or 3-Hole, less Side Spray	ADA Metal Lever	Stainless	
141387	P4C-140C	8"cc 4-Hole, Matching Side Spray	ADA Metal Lever	Chrome	
158744	P4C-140SS	8"cc 4-Hole, Matching Side Spray	ADA Metal Lever	Stainless	



## Kitchen Faucets & Accessories

### P4C Classic Series 1-Hdl Pull-Out Kitchen Faucet

- Ceramic cartridge
- Optional deckplate included
- Max flow rate: 1.5 gpm



Part #	Mfg #	Description	Handle(s)	Finish	Price
143140	P4C-150C	1- or 3-Hole, Pull-Out Spray	ADA Metal Lever	Chrome	
147875	P4C-150SS	1- or 3-Hole, Pull-Out Spray	ADA Metal Lever	Stainless	

### P4H Series 1-Hdl Kitchen Faucet

- Ceramic cartridge
- Optional deckplate included
- With side spray
- Max flow rate: 1.5 gpm @ 60 psi



Part #	Mfg #	Description	Handle(s)	Finish	Price
235480	P4H-140C	2- or 4-Hole, Matching Side Spray	ADA Metal Lever	Chrome	
235481	P4H-140SS	2- or 4-Hole, Matching Side Spray	ADA Metal Lever	Stainless	

### P4H Series 1-Hdl Pull-Down Kitchen Faucet

- Ceramic cartridge
- Optional deckplate included
- Max flow rate: 1.8 gpm @ 60 psi



Part #	Mfg #	Description	Handle(s)	Finish	Price
235456	P4H-150C	1- or 3-Hole, Pull-Down Spray	ADA Metal Lever	Chrome	
235457	P4H-150SS	1- or 3-Hole, Pull-Down Spray	ADA Metal Lever	Stainless	

### P4V Value Series 1-Hdl Kitchen Faucet

- Metal lever handle
- Stainless steel ball valve
- Black side spray
- Max flow rate: 1.5 gpm



Part #	Mfg #	Description	Handle(s)	Finish	Price
239977	P4V-140C	4-Hole, with Side Spray	ADA Metal Lever	Chrome	

## Kitchen Faucets & Accessories

### Two-Handle Kitchen Faucets

#### P4B Builder Series 2-Hdl Kitchen Faucet

- Ceramic cartridges
- Max flow rate: 2.2 gpm @ 60 psi



Part #	Mfg #	Description	Handle(s)	Finish	Price
141372	P4B-200C	8"cc 4-Hole, less Side Spray	ADA Metal Lever	Chrome	
141373	P4B-240C	8"cc 4-Hole, Matching Side Spray	ADA Metal Lever	Chrome	

#### P4B Builder Series 2-Hdl with Goose Neck Spout

- Metal lever handles
- Ceramic cartridges
- Goose neck spout
- Less spray



Part #	Mfg #	Description	Handle(s)	Finish	Price
143545	P4B-260C	8"cc 4-Hole, Matching Side Spray	ADA Metal Lever	Chrome	
164418	P4B-260SS	4-Hole, 8"cc with Side Spray	ADA Lever	Stainless Steel	
244829	P4B-250C	3-Hole, 8"cc Less Side Spray	ADA Lever	Stainless Steel	
158740	P4B-250SS	8"cc 3-Hole, less Side Spray	ADA Metal Lever	Stainless	

#### P4C Classic Series 2-Hdl Kitchen Faucet

- Washerless cartridges
- Max flow rate: 2.2 gpm @ 60 psi



Part #	Mfg #	Description	Handle(s)	Finish	Price
141389	P4C-200C	8"cc 3-Hole, less Side Spray	Metal Wing	Chrome	

#### P4C Classic Series 2-Hdl Kitchen Faucet

- Acrylic round handles
- Washerless cartridges
- Max flow rate: 1.5 gpm



Part #	Mfg #	Description	Handle(s)	Finish	Price
235466	P4V-242C	4-Hole, Black Side Spray	Acrylic Round	Chrome	



## Kitchen Faucets & Accessories

### P4V Value Series 2-Hdl Kitchen Faucet

- Washerless cartridges
- Acrylic round handles
- Max flow rate: 1.5 gpm @ 60 psi



Part #	Mfg #	Description	Handle(s)	Finish	Price
148250	P4V-202C	8"cc 3-Hole, less Side Spray	Acrylic Round	Chrome	

**Kitchen Faucets & Accessories**

**Kitchen and Bar Faucets**

**Kitchen Pull-Out Faucet**

- 7-1/6" Reach, 8-1/16" high spout swivels 120°
- 5-3/8" From deck to aerator
- Single lever control
- WaterSense® certified: 1.8 gpm



Part #	Mfg #	Description	Handle(s)	Finish	Price
186604	P18550LF	1- or 3-Hole 8"cc, Pull-Out Spray	Lever	Chrome	
186605	P18550LF-SS	1- or 3-Hole 8"cc, Pull-Out Spray	Lever	Stainless	

**Single Handle Pull-Down Kitchen Faucet**

- 8" Reach, 7" high spout
- 7-1/16" From deck to aerator
- Single lever control
- 1/2"-14 NPSM threaded male inlet
- Maximum flow rate: 1.80 gpm @ 60 psi



Part #	Mfg #	Description	Handle(s)	Finish	Price
240041	P188103LF	1- or 3-Hole, Pull-Down Spray	ADA Lever	Chrome	
240077	P188103LF-SS	1- or 3-Hole, Pull-Down Spray	ADA Lever	Stainless	

**Single Handle Kitchen Faucet**

- 8" Reach, 7-1/2" high spout swivels 360°
- 5-1/8" From deck to aerator
- Single lever control
- WaterSense® certified: 1.8 gpm



Part #	Mfg #	Description	Handle(s)	Finish	Price
147952	P110LF	3-Hole 8"cc, Less Side Spray	Lever	Chrome	
155203	P115LF	4-Hole 8"cc, With Side Spray	Lever	Chrome	

**Single Handle Kitchen Faucet**

- 8" Reach, 7-1/2" high spout swivels 360°
- 5-1/8" From deck to aerator
- Single lever control
- WaterSense® certified: 1.8 gpm



Part #	Mfg #	Description	Handle(s)	Finish	Price
225947	P114LF	3-Hole, 8"cc, With Side Spray	Lever	Chrome	

\* Brilliance® Anti-Tarnish Lifetime Finishes

[www.waterconcepts.net](http://www.waterconcepts.net) • Serving our Customers Since 1946 • [www.plumbsupply.com](http://www.plumbsupply.com)

**Kitchen Faucets & Accessories**

**Single Handle Kitchen Faucet**

- 8-7/8" Reach, 7-1/2" high spout swivels 360°
- Single lever control
- Washerless ball valve
- 1/2"-14 NPSM Threaded male inlet shanks
- WaterSense® certified: 1.8 gpm



Part #	Mfg #	Description	Handle(s)	Finish	Price
252417	P188201LF	1- or 3-Hole 8"cc Less Side Spray	Lever	Chrome	

**Two-Handle Kitchen Faucet**

- 8-1/16" Reach, 6-1/16" high spout
- 4-13/16" From deck to aerator
- Single lever control
- Lead Free
- 1/2" - 14 NPSM threaded male inlet shanks
- WaterSense® certified: 1.8 gpm



Part #	Mfg #	Description	Handle(s)	Finish	Price
188080	P226LF	4-Hole, 8"cc With Side Spray	Blade Lever	Chrome	
174015	P221LF	3-Hole, 8"cc Less Side Spray	Blade Lever	Chrome	

**Two-Handle Kitchen Faucet**

- 9" Spout reach, 12-1/2" high arc spout
- 8-5/8" From deck to aerator
- 1/2" - 14 NPSM threaded male inlet adapters
- WaterSense® Certified: 1.8 gpm



Part #	Mfg #	Description	Handle(s)	Finish	Price
160343	P299568LF	3-Hole 8"cc, Less Side Spray	Blade Lever	Chrome	

**Two-Handle Bar/Prep Faucet**

- 5-1/32" Spout reach
- 7-7/8" From deck to aerator
- 1/2"-14 NPSM threaded male inlet shanks
- WaterSense® Certified: 1.8 gpm @ 60 psi



Part #	Mfg #	Description	Handle(s)	Finish	Price
189928	P288LF	3-Hole 4"cc, Less Side Spray	Blade Lever	Chrome	

\* Brilliance® Anti-Tarnish Lifetime Finishes

**Kitchen Faucets & Accessories**

**Faucet Handles**

**Two Blade Handle Kit**

- Includes buttons and screws



Part #	Mfg #	Description	Handle(s)	Finish	Price
212272	RP43997	Two Blade Handle Kit	Blade Lever	Chrome	

\* Brilliance® Anti-Tarnish Lifetime Finishes

[www.waterconcepts.net](http://www.waterconcepts.net) • Serving our Customers Since 1946 • [www.plumbsupply.com](http://www.plumbsupply.com)



## Kitchen Faucets & Accessories



### Kitchen Faucets

#### E400 Single-Handle Kitchen Faucet

- *Washerless cartridge*



Part #	Mfg#	Description	Handle(s)	Finish	Price
124490	E401M	8"cc, Side Spray	Metal Loop Handle	Polished Chrome	

## Kitchen Faucets & Accessories

### Single-Handle Kitchen Faucets

#### Classic 1-Hdl Kitchen Faucet

- Washerless cartridge
- Brass waterway
- 1/2" NPT Hookup



Part #	Mfg #	Description	Handle(s)	Finish	Price
089227	FT-200	8"cc less Hose & Spray	ADA Lever	Chrome	

## Lavatory - Single Hole

### Single-Handle Lavatory Faucets

#### Alteo® 1-Hdl Lavatory Faucet with Pop-up Drain

- 5" Reach, 7-7/8" high spout
- Metal construction
- One-piece, self-contained ceramic disc valve
- Includes 6-1/4" escutcheon plate for three-hole sinks
- WaterSense® certified product: 1.5 gpm



Part #	Mfg #	Description	Handle(s)	Finish	Price
165726	K-45800-4-BN	1- or 3-Hole, Pop-Up Drain	ADA Lever	*Brushed Nickel	
165561	K-45800-4-CP	1- or 3-Hole, Pop-Up Drain	ADA Lever	Polished Chrome	
167966	K-458004-2BZ	1- or 3-Hole, Pop-Up Drain	ADA Lever	Oil Rubbed Bronze	

#### Artifacts® 1-Hdl Lavatory Faucet with Pop-Up Drain and 1-1/4" Tailpiece

- 5-11/16" Reach, 6-15/16" high spout
- Flexible supplies
- Laminar flow
- WaterSense® certified product: 1.5 gpm



Part #	Mfg #	Description	Handle(s)	Finish	Price
162837	K-72762-9M-BN	1 Hole, Pop-Up Drain	ADA Lever	*Brushed Nickel	
176272	K-72762-9M-CP	1 Hole, Pop-Up Drain	ADA Lever	Polished Chrome	
174457	K-72762-9M-SN	1 Hole, Pop-Up Drain	ADA Lever	*Polished Nickel	
189857	K-72762-9M-VNT	1 Hole, Pop-Up Drain	ADA Lever	Vintage Nickel	
171402	K-72762-9M-2BZ	1 Hole, Pop-Up Drain	ADA Lever	Oil Rubbed Bronze	

#### Artifacts® Gentleman's® 1-Hdl Lavatory Faucet with Pop-Up Drain and 1-1/4" Tailpiece

- 7-5/16" Reach, 13-1/16" high spout
- Overflow included
- Temperature memory
- Leak-free ceramic disc valves
- High-temperature limit setting
- WaterSense® certified product: 1.2 gpm



Part #	Mfg #	Description	Handle(s)	Finish	Price
243156	K-72763-9M-CP	1-Hole, Metal Pop-Up Drain	ADA Lever	Polished Chrome	

\* Vibrant Limited Lifetime Warranty

[www.plumbsupply.com](http://www.plumbsupply.com) • Serving our Customers Since 1946 • [www.waterconcepts.net](http://www.waterconcepts.net)

## Lavatory - Single Hole

### Composed® 1-Hdl Lavatory Faucet with Pop-Up Drain and 1-1/4" Tailpiece

- 5-15/16" Reach, 4-3/4" high spout
- WaterSense® certified product: 1.2 gpm



Part #	Mfg #	Description	Handle(s)	Finish	Price
229526	K-73167-4-CP	1 Hole, Pop-Up Drain	ADA Lever	Chrome	
241949	K-73167-4-TT	1 Hole, Pop-Up Drain	ADA Lever	*Titanium	
232640	K-73050-7-CP	1 Hole, Pop-Up Drain	ADA Knob	Chrome	
233835	K-73050-7-TT	1 Hole, Pop-Up Drain	ADA Knob	*Titanium	

### Composed® 1-Hdl Lavatory Tower Faucet with Pop-Up Drain and 1-1/4" Tailpiece

- 7-1/16" Reach, 10-1/16" high spout
- (K-73159-7) 7-1/8" Reach, 8" high spout
- Temperature memory
- Pre-attached flexible supply lines
- WaterSense® certified product: 1.2 gpm



Part #	Mfg #	Description	Handle(s)	Finish	Price
241849	K-73054-7-CP	1-Hole, Pop-Up Drain	ADA Cylindrical	Chrome	
231770	K-73159-7-CP	1-Hole, Pop-Up Drain	ADA Cylindrical	Chrome	
251584	K-73159-7-TT	1-Hole, Pop-Up Drain	ADA Cylindrical	*Titanium	

### Composed® 1-Hdl Lavatory Tall Faucet with Pop-Up Drain and 1-1/4" Tailpiece

- 7-1/8" Reach, 11-5/16" high spout
- Temperature memory
- Pre-attached flexible supply lines
- WaterSense® certified product: 1.2 gpm



Part #	Mfg #	Description	Handle(s)	Finish	Price
253287	K-73053-4-CP	1-Hole, Pop-Up Drain	ADA Joystick	Chrome	
252978	K-73053-4-TT	1-Hole, Pop-Up Drain	ADA Joystick	*Titanium	

\* Vibrant Limited Lifetime Warranty

[www.waterconcepts.net](http://www.waterconcepts.net) • Serving our Customers Since 1946 • [www.plumbsupply.com](http://www.plumbsupply.com)

## Lavatory - Single Hole

### Devonshire® 1-Hdl Lavatory Faucet with Pop-Up Drain and 1-1/4" Tailpiece

- 4-7/8" Reach, 8-13/16" high spout
- Flexible supplies
- 6" Escutcheon plate includes for 3-hole installation
- WaterSense® certified product



Part #	Mfg #	Description	Handle(s)	Finish	Price
170296	K-193-4-CP	1- or 3-Hole, Pop-Up Drain	ADA Lever	Polished Chrome	
169497	K-193-4-BN	1- or 3-Hole, Pop-Up Drain	ADA Lever	*Brushed Nickel	
171979	K-193-4-BV	1- or 3-Hole, Pop-Up Drain	ADA Lever	*Brushed Bronze	
171971	K-193-4-PB	1- or 3-Hole, Pop-Up Drain	ADA Lever	*Polished Brass	
172074	K-193-4-SN	1- or 3-Hole, Pop-Up Drain	ADA Lever	*Polished Nickel	
170292	K-193-4-2BZ	1- or 3-Hole, Pop-Up Drain	ADA Lever	Oil Rubbed Bronze	

### Elate™ 1-Hdl Lavatory Faucet with Pop-Up Drain and 1-1/4" Tailpiece

- 4-7/8" Reach, 6-9/16" high
- Ceramic disc valves
- Temperature memory
- High temperature limit setting
- Includes flexible supply lines
- WaterSense® certified product: 1.2 gpm



Part #	Mfg #	Description	Handle(s)	Finish	Price
244420	K-99491-4-CP	1-Hole, Pop-Up Drain w/ Overflow	ADA Lever	Polished Chrome	

### Fairfax® 1-Hdl Lavatory Faucet with Pop-Up Metal Drain, 1-1/4" Tailpiece, and Aerator

- 5" Reach spout
- Solid metal construction
- Washerless ceramic valving, flexible supplies
- 6" Escutcheon plate included with **K-12181** models
- Maximum flow rate: 1.2 gpm



K12181-CP



K12182-CP



Part #	Mfg #	Description	Handle(s)	Finish	Price
053609	K-12181-CP	4"cc, 6" Escutcheon Plate, Metal Drain	ADA Lever	Polished Chrome	
059787	K-12181-BN	4"cc, 6" Escutcheon Plate, Metal Drain	ADA Lever	*Brushed Nickel	
153198	K-12181-2BZ	4"cc, 6" Escutcheon Plate, Metal Drain	ADA Lever	Oil Rubbed Bronze	
053614	K-12182-CP	1-Hole, Metal Drain	ADA Lever	Polished Chrome	
056232	K-12182-BN	1-Hole, Metal Drain	ADA Lever	*Brushed Nickel	
154864	K-12182-2BZ	1-Hole, Metal Drain	ADA Lever	Oil Rubbed Bronze	

\* Vibrant Limited Lifetime Warranty

**www.plumbsupply.com • Serving our Customers Since 1946 • www.waterconcepts.net**

## Lavatory - Single Hole

### Forté® Lavatory Faucet with Metal Pop-Up Drain, 1-1/4" Tailpiece, and Sculpted Lever Handle

- 5-1/8" Reach spout
- Solid brass construction
- One-piece ceramic valve
- Temperature memory
- High-temperature limit setting
- **(K-10216-4-CP)** includes plastic pop-up drain
- Maximum flow rate: 1.5 gpm



Part #	Mfg #	Description	Handle(s)	Finish	Price
096961	K-10215-4-CP	1-Hole, Metal Pop-Up Drain with 1-1/4" Tailpiece	ADA Sculpted Lever	Polished Chrome	
095489	K-10215-4-BN	1-Hole, Metal Pop-Up Drain with 1-1/4" Tailpiece	ADA Sculpted Lever	*Brushed Nickel	
104046	K102154G	1-Hole, Metal Pop-Up Drain with 1-1/4" Tailpiece	ADA Sculpted Lever	*Brushed Chrome	

### Honesty™ 1-Hdl Lavatory Faucet with Pop-Up Drain

- 5-11/16" Reach, 4-3/4" high spout
- Brass construction
- One-piece, self-contained ceramic disc valve
- Flexible supplies
- WaterSense® certified product: 1.5 gpm



Part #	Mfg #	Description	Handle(s)	Finish	Price
177286	K-99760-4-CP	1-Hole, Pop-Up Drain	ADA Lever	Polished Chrome	

### July™ 1-Hdl Lavatory Faucet with Pop-Up Drain

- 4-3/8" Reach, 4-13/16" high spout
- Brass construction
- Ceramic disc valve
- Escutcheon included with model **(K-98146-4-CP)**
- WaterSense® certified product: 1.5 gpm



Part #	Mfg #	Description	Handle(s)	Finish	Price
165844	K-16027-4-CP	1-Hole, Pop-Up Drain	ADA Lever	Polished Chrome	
170448	K-16027-4-G	1-Hole, Pop-Up Drain	ADA Lever	Brushed Chrome	
166688	K-98146-4-CP	1- or 3-Hole with Escutcheon, Pop-Up Drain	ADA Lever	Polished Chrome	

\* Vibrant Limited Lifetime Warranty

[www.waterconcepts.net](http://www.waterconcepts.net) • Serving our Customers Since 1946 • [www.plumbsupply.com](http://www.plumbsupply.com)



## Lavatory - Single Hole

### Margaux® Lavatory Faucet with Joystick Handle—Touch-Activated Drain with Tailpiece and Overflow

- 5-3/8" Spout reach
- Brass construction
- Ceramic disc valve
- WaterSense® certified product 1.5 gpm



Part #	Mfg #	Description	Handle(s)	Finish	Price
155283	K-16230-4-AF	1-Hole, Touch-Activated Drain with Overflow	ADA Joystick	*French Gold	
106169	K-16230-4-BN	1-Hole, Touch-Activated Drain with Overflow	ADA Joystick	*Brushed Nickel	
186601	K-16230-4-BV	1-Hole, Touch-Activated Drain with Overflow	ADA Joystick	*Brushed Bronze	
109272	K-16230-4-CP	1-Hole, Touch-Activated Drain with Overflow	ADA Joystick	Polished Chrome	
183017	K-16230-4-SN	1-Hole, Touch-Activated Drain with Overflow	ADA Joystick	Polished Nickel	

### Margaux® Tall Lavatory Faucet with Joystick Handle—Touch-Activated Drain with Tailpiece and Overflow

- 6-3/8" Spout reach
- Brass construction
- Ceramic disc joystick valve actuation
- Flexible connections
- WaterSense® certified: 1.2gpm



Part #	Mfg #	Description	Handle(s)	Finish	Price
226610	K-16231-4-AF	1-Hole, Touch-Activated Drain with Overflow	ADA Joystick	*French Gold	
112655	K-16231-4-CP	1-Hole, Touch-Activated Drain with Overflow	ADA Joystick	Polished Chrome	

### Purist® Lavatory Faucet with Pop-Up Drain, Tailpiece, and Straight Lever Handle

- Solid brass construction
- 5-1/2" Spout reach
- Ceramic disc valve
- Temperature memory
- Low spout design
- WaterSense® certified product 1.5 gpm



Part #	Mfg #	Description	Handle(s)	Finish	Price
087293	K-14402-4A-CP	1-Hole, Low Spout Design	ADA Straight Lever	Polished Chrome	
083540	K-14402-4A-BN	1-Hole, Low Spout Design	ADA Straight Lever	*Brushed Nickel	
137209	K-14402-4A-BGD	1-Hole, Low Spout Design	ADA Straight Lever	*Moderne Brushed Gold	
100730	K-14402-4A-BV	1-Hole, Low Spout Design	ADA Straight Lever	*Brushed Bronze	
244655	K-14402-4A-RGD	1-Hole, Low Spout Design	ADA Straight Lever	*Rose Gold	
141119	K-14402-4A-SN	1-Hole, Low Spout Design	ADA Straight Lever	Polished Nickel	

\* Vibrant Limited Lifetime Warranty

**www.plumbsupply.com • Serving our Customers Since 1946 • www.waterconcepts.net**

## Lavatory - Single Hole

### Refinia® 1-Hdl Lavatory Faucet with Pop-Up Drain

- 4-1/2" Reach, 6-7/8" high spout
- Ceramic disc valve
- Optional escutcheon included for 1- or -hole installation
- WaterSense® certified product: 1.5 gpm



Part #	Mfg #	Description	Handle(s)	Finish	Price
166531	K-5313-4-BN	1- or 3-Hole, Pop-Up Drain	ADA Lever	*Brushed Nickel	
167293	K-5313-4-CP	1- or 3-Hole, Pop-Up Drain	ADA Lever	Pol Chrome	

### Stance® 1-Hdl Lavatory Faucet—Touch-Activated Drain with Tailpiece and Overflow

- Solid brass construction
- 6-3/8" Spout reach
- Ceramic disc valve
- Flexible connections
- 8-1/2" High spout for **K-14760** models or 13-7/16" tall high spout for **K-14761** models
- WaterSense® certified product 1.5 gpm



Part #	Mfg #	Description	Handle(s)	Finish	Price
134405	K-14760-4-BN	1-Hole, 8-1/2" High Spout	ADA Lever	*Brushed Nickel	
134877	K-14760-4-CP	1-Hole, 8-1/2" High Spout	ADA Lever	Polished Chrome	

### Toobi™ Lavatory Faucet with Pop-Up Drain, Tailpiece, and Knob Handle

- 4" Spout reach
- Brass construction
- One-piece, self-contained ceramic disc valve
- Temperature memory
- Flexible connections
- Maximum flow rate: 1.5 gpm



Part #	Mfg #	Description	Handle(s)	Finish	Price
149686	K-8959-7-BN	1-Hole, Pop-Up Drain with Tailpiece	Knob	*Brushed Nickel	
148622	K-8959-7-CP	1-Hole, Pop-Up Drain with Tailpiece	Knob	Polished Chrome	

\* Vibrant Limited Lifetime Warranty

[www.waterconcepts.net](http://www.waterconcepts.net) • Serving our Customers Since 1946 • [www.plumbsupply.com](http://www.plumbsupply.com)

## Lavatory - Single Hole

### Two-Handle Lavatory Faucets

#### Bancroft™ Monoblock 2-Hdl Lavatory Faucet with Pop-Up Metal Drain, 1-1/4" Tailpiece, and 6" Escutcheon

- 4-7/8" Reach spout
- Metal construction
- Brass valve bodies
- Flexible connections
- Maximum flow rate: 1.5 gpm



K-10579-4



K-10579-4P



#### Metal Lever Handles

Part #	Mfg #	Description	Handle(s)	Finish	Price
153390	K-10579-4-2BZ	1-Hole or 4"cc, Metal Drain	ADA Metal Lever	Oil Rubbed Bronze	
099751	K-10579-4-BN	1-Hole or 4"cc, Metal Drain	ADA Metal Lever	*Brushed Nickel	
101444	K-10579-4-BV	1-Hole or 4"cc, Metal Drain	ADA Metal Lever	*Brushed Bronze	
091753	K-10579-4-CP	1-Hole or 4"cc, Metal Drain	ADA Metal Lever	Polished Chrome	
096957	K-10579-4-SN	1-Hole or 4"cc, Metal Drain	ADA Metal Lever	*Polished Nickel	

#### Ceramic Lever Handles

Part #	Mfg #	Description	Handle(s)	Finish	Price
098776	K-10579-4P-BN	1-Hole or 4"cc, Metal Drain	ADA Ceramic Lever	*Brushed Nickel	
182987	K-10579-4P-BV	1-Hole or 4"cc Metal Drain	ADA Ceramic Lever	*Brushed Bronze	
087741	K-10579-4P-CP	1-Hole or 4"cc Metal Drain	ADA Ceramic Lever	Polished Chrome	
098002	K-10579-4P-SN	1-Hole or 4"cc Metal Drain	ADA Ceramic Lever	*Polished Nickel	

### Vessel Faucets

#### Composed™ 1-Hdl Vessel Faucet Including Pop-Up Drain with 1-1/4" Tailpiece

- Metal construction
- 7-1/8" Reach spout
- 8-3/4" Faucet height, 8" from deck to aerator
- WaterSense® certified: 1.2 gpm



Part #	Mfg #	Description	Handle(s)	Finish	Price
226560	K-73168-4-CP	1-Hole, Pop-up Drain	ADA Lever	Chrome	

\* Vibrant Limited Lifetime Warranty

[www.plumbsupply.com](http://www.plumbsupply.com) • Serving our Customers Since 1946 • [www.waterconcepts.net](http://www.waterconcepts.net)

## Lavatory - Single Hole

### Fairfax® 1-Hdl Vessel Faucet

- 5" Reach spout
- 11-15/16" Faucet height, 7-1/2" from deck to aerator
- Solid metal construction
- Washerless ceramic valving, flexible supplies
- Maximum flow rate: 1.2 gpm



Part #	Mfg #	Description	Handle(s)	Finish	Price
068895	K-12183-BN	1-Hole, less Drain & Lift Rod	ADA Lever	*Brushed Nickel	
063449	K-12183-CP	1-Hole, less Drain & Lift Rod	ADA Lever	Polished Chrome	
152682	K-12183-2BZ	1-Hole, less Drain & Lift Rod	ADA Lever	Oil Rubbed Bronze	

### Forté® Vessel Faucet with Touch-Activated Drain, Tailpiece, and 1 Sculpted Lever Handle

- Solid brass construction
- Without overflow
- 5-1/8" Reach spout
- 12-3/8" Faucet height, 7-7/8" from deck to aerator
- One-piece ceramic valve temperature memory
- High-temperature limit setting
- Maximum flow rate: 1.2 gpm



Part #	Mfg #	Description	Handle(s)	Finish	Price
095568	K-10217-4-BN	1-Hole, Tall, Touch-activated Drain with Tailpiece	ADA Sculpted Lever	*Brushed Nickel	
095598	K-10217-4-CP	1-Hole, Tall, Touch-activated Drain with Tailpiece	ADA Sculpted Lever	Polished Chrome	
103935	K-10217-4-G	1-Hole, Tall, Touch-activated Drain with Tailpiece	ADA Sculpted Lever	Brushed Chrome	

### Purist® 1-Hdl Vessel Faucet with Touch Activated Drain, Tailpiece, and No Overflow

- 6-1/4" Reach
- 12" Faucet height, 6-1/2" from deck to aerator
- Solid brass construction
- Ceramic disc valve
- Temperature memory
- WaterSense® certified product 1.5 gpm



Part #	Mfg #	Description	Handle(s)	Finish	Price
132490	K-14404-4A-BGD	1-Hole	ADA Lever	*Moderne Brushed Gold	
259256	K-14404-4A-BL	1-Hole	ADA Lever	Matte Black	
087208	K-14404-4A-BN	1-Hole	ADA Lever	*Brushed Nickel	
129662	K-14404-4A-BV	1-Hole	ADA Lever	*Brushed Bronze	
085446	K-14404-4A-CP	1-Hole	ADA Lever	Polished Chrome	

\* Vibrant Limited Lifetime Warranty

[www.waterconcepts.net](http://www.waterconcepts.net) • Serving our Customers Since 1946 • [www.plumbsupply.com](http://www.plumbsupply.com)

## Lavatory - Single Hole

### Toobi™ Vessel Faucet with Touch Activated Drain, Tailpiece, Knob Handle, and No Overflow

- 4" Spout reach
- 11-5/16" Faucet height, 7-7/8" from deck to aerator
- Brass construction
- One-piece, self-contained ceramic disc valve
- Temperature memory
- Flexible connections
- Maximum flow rate: 1.5 gpm



Part #	Mfg #	Description	Handle(s)	Finish	Price
144913	K-8990-7-BN	1-Hole, Tall, Touch-Activated Drain with Tailpiece	Knob	*Brushed Nickel	
143744	K-8990-7-CP	1-Hole, Tall, Touch-Activated Drain with Tailpiece	Knob	Polished Chrome	

\* Vibrant Limited Lifetime Warranty

[www.plumbsupply.com](http://www.plumbsupply.com) • Serving our Customers Since 1946 • [www.waterconcepts.net](http://www.waterconcepts.net)

## Lavatory Faucets - Single Hole

### Single-Handle Lavatory Faucets

#### Addison™ 1-Hdl Lavatory Faucet

- 5-1/16" Reach
- 10-1/4" High spout, 5-3/4" from deck to aerator
- 3/8" Compression fittings
- Hot/cold indicator
- 2-1/2" Maximum deck thickness
- Includes optional 5-3/4" escutcheon
- 32" Minimum InnoFlex® supply lines below deck
- WaterSense® certified product, 1.2 gpm @ 60 psi
- Euro-motion DIAMOND™ valve



Part #	Mfg #	Description	Handle(s)	Finish	Price
132558	592-DST	1- or 3-Hole 4"cc, Metal Pop-Up Drain, LF	ADA Lever	Chrome	
137600	592-CZ-DST	1- or 3-Hole 4"cc, Metal Pop-Up Drain, LF	ADA Lever	Champagne Bronze™	
131815	592-RB-DST	1- or 3-Hole 4"cc, Metal Pop-Up Drain, LF	ADA Lever	Venetian Bronze®	
132559	592-SS-DST	1- or 3-Hole 4"cc, Metal Pop-Up Drain, LF	ADA Lever	Stainless*	

#### Addison™ 1-Hdl Lavatory Faucet with Touch ™ Technology

- 5-1/6" Reach, 9-7/16" high rigid spout
- 6-1/4" From deck to aerator
- Hands-Free Activation  
-Touch feature to activate on/off
- 3/8" Compression fittings
- 2-1/2" Maximum deck thicknesses
- Battery operated with box that can be mounted to cabinet including hardware
- 32" Minimum InnoFlex® supply lines below the deck
- TempSense™ LED light
- Euro-motion DIAMOND™ valve
- WaterSense® certified product: 1.20 @ 60 psi



Part #	Mfg #	Description	Handle(s)	Finish	Price
142467	592T-DST	1- or 3-Hole 4"cc, Metal Pop-Up Drain, Lead-Free	ADA Lever	Chrome	
153045	592T-CZ-DST	1- or 3-Hole 4"cc, Metal Pop-Up Drain, Lead-Free	ADA Lever	Champagne Bronze™	
148213	592T-RB-DST	1- or 3-Hole 4"cc, Metal Pop-Up Drain, Lead-Free	ADA Lever	Venetian Bronze®	
141682	592T-SS-DST	1- or 3-Hole 4"cc, Metal Pop-Up Drain, Lead-Free	ADA Lever	Stainless*	

\* Brilliance® Anti-Tarnish Lifetime Finishes



## Lavatory Faucets - Single Hole

### Ara® 1-Hdl Lavatory Faucet

- 5-3/16" Reach, or 5-3/16" reach w/ channel spout
- 6-3/8" high rigid spout or rigid channel spout
- 4-1/8" From deck to aerator
- 3/8" Compression fittings
- 2-1/4" Maximum deck thickness
- Optional 6" escutcheon included
- 32" Minimum InnoFlex® supply lines
- Euro-motion valve
- WaterSense® certified product: 1.2 gpm @ 60 psi
- Less Pop-Up (-LPU Models)
- 



Part #	Mfg #	Description	Handle(s)	Finish	Price
166552	567LF-MPU	1- or 3-Hole 4"cc, Metal Pop-Up, LF	ADA Lever	Chrome	
233358	567LF-BLMPU	1- or 3-Hole 4"cc, Metal Pop-Up, LF	ADA Lever	Matte Black	
162252	567LF-SSMPU	1- or 3-Hole 4"cc, Metal Pop-Up, LF	ADA Lever	Stainless*	
236396	567LF-BLLPU	1- or 3-Hole 4"cc, Less Drain, LF	ADA Lever	Matte Black	
177881	567LF-SSLPU	1- or 3-Hole 4"cc, Less Drain, LF	ADA Lever	Stainless*	
184425	568LF-SSLPU	1- or 3-Hole 4"cc, Less Drain, LF Channel Spout	ADA Lever	Stainless*	
242734	568LF-BLLPU	1- or 3-Hole 4"cc Less Drain, LF Channel Spout	ADA Lever	Matte Black	
225636	568LF-LPU	1- or 3-Hole 4"cc, Less Drain, LF Channel Spout	ADA Lever	Chrome	
165654	568LF-MPU	1- or 3-Hole 4"cc, Metal Pop-Up, LF Channel Spout	ADA Lever	Chrome	
233357	568LF-BLMPU	1- or 3-Hole 4"cc, Metal Pop-Up, LF Channel Spout	ADA Lever	Matte Black	
160230	568LF-SSMPU	1- or 3-Hole 4"cc, Metal Pop-Up, LF Channel Spout	ADA Lever	Stainless*	

### Ashlyn™ 1-Hdl Lavatory Faucet

- 5-1/8" Reach, 6-11/16" high rigid spout
- 3-7/16" From deck to aerator
- Red/blue indicator
- 1-1/4" Minimum clearance to backsplash
- 3/8" Compression fittings
- 2-1/2" Maximum deck thickness
- Optional 6" escutcheon included
- 32" Minimum InnoFlex® supply lines below the deck
- DIAMOND™ Valve
- WaterSense® certified product: 1.2 gpm @ 60 psi



Part #	Mfg #	Description	Handle(s)	Finish	Price
173152	564-MPU-DST	1- or 3-Hole 4"cc, Metal Pop-Up, Lead Free	ADA Lever	Chrome	
171541	564-RBMPU-DST	1- or 3-Hole 4"cc, Metal Pop-Up, Lead Free	ADA Lever	Venetian Bronze®	
171217	564-SSMPU-DST	1- or 3-Hole 4"cc, Metal Pop-Up, Lead Free	ADA Lever	Stainless*	

\* Brilliance® Anti-Tarnish Lifetime Finishes

[www.plumbsupply.com](http://www.plumbsupply.com) • Serving our Customers Since 1946 • [www.waterconcepts.net](http://www.waterconcepts.net)

## Lavatory Faucets - Single Hole

### Cassidy™ 1-Hdl Lavatory Faucet

- 5-13/32" Reach, 6-13/16" high spout
- 5-7/32" From deck to aerator
- Channel spout:  
5" Reach, 6-13/16" high  
4-11/16" From deck to aerator
- 1/2" IPS connection
- 2-1/8" Maximum deck thickness
- 2-1/2" Minimum clearance to backsplash
- Euro-motion valve
- WaterSense® certified product, 1.2 gpm @ 60 psi



597LF



598LF



Part #	Mfg #	Description	Handle(s)	Finish	Price
152720	597LF-MPU	1- or 3-Hole 4"cc, Metal Pop-Up Drain, Lead Free	ADA Lever	Chrome	
152721	597LF-CZMPU	1- or 3-Hole 4"cc, Metal Pop-Up Drain, Lead Free	ADA Lever	Champagne Bronze™	
159649	597LF-PNMPU	1- or 3-Hole 4"cc, Metal Pop-Up Drain, Lead Free	ADA Lever	Polished Nickel	
152723	597LF-RBMPU	1- or 3-Hole 4"cc, Metal Pop-Up Drain, Lead Free	ADA Lever	Venetian Bronze®	
152724	597LF-SSMPU	1- or 3-Hole 4"cc, Metal Pop-Up Drain, Lead Free	ADA Lever	Stainless*	
150662	598LF-MPU	1- or 3-Hole 4"cc, MPU Drain w/ Channel Spout, LF	ADA Lever	Chrome	
152726	598LF-CZMPU	1- or 3-Hole 4"cc, MPU Drain w/ Channel Spout, LF	ADA Lever	Champagne Bronze™	
188712	598LF-PNMPU	1- or 3-Hole 4"cc, MPU Drain w/ Channel Spout, LF	ADA Lever	Polished Nickel	
152440	598LF-RBMPU	1- or 3-Hole 4"cc, MPU Drain w/ Channel Spout, LF	ADA Lever	Venetian Bronze®	
152730	598LF-SSMPU	1- or 3-Hole 4"cc, MPU Drain w/ Channel Spout, LF	ADA Lever	Stainless*	

### Compel® 1-Hdl Lavatory Faucet

- 6-7/16" Reach, 7-3/8" high rigid spout
- 3-3/16" From deck to aerator
- Red/blue indicators
- Stream shaper
- 3/8" Compression fittings
- 2-1/2" Maximum deck thicknesses
- 3/2" Minimum InnoFlex® supply lines below the deck
- Euro-motion DIAMOND™ valve
- WaterSense® certified product: 1.2 gpm @ 60 psi



Part #	Mfg #	Description	Handle(s)	Finish	Price
175582	561-MPU-DST	1- or 3-Hole 4"cc, Metal Pop-Up Drain, Lead Free	ADA Lever	Chrome	
178492	561-SSMPU-DST	1- or 3-Hole 4"cc, Metal Pop-Up Drain, Lead Free	ADA Lever	Stainless*	
152787	561-LPU-DST	1- or 3-Hole 4"cc, Less Drain, Lead Free	ADA Lever	Chrome	
176470	561-SSLPU-DST	1- or 3-Hole 4"cc, Less Drain, Lead Free	ADA Lever	Stainless*	

\* Brilliance® Anti-Tarnish Lifetime Finishes

## Lavatory Faucets - Single Hole

### Compel® 1-Hdl Lavatory Faucet with Touch20.xt® Technology

- 5" Reach, 8-1/4" high rigid spout
- 4" From deck to aerator
- Hands-free activation
- TempSense™ LED light
- Stream shaper
- Red/blue indicator
- 3/8" Compression fittings
- 2-1/2" Maximum deck thicknesses
- Optional 6" escutcheon included
- 32" Minimum InnoFlex® supply lines below the deck
- Coordinating insulator
- Euro-motion DIAMOND™ valve
- Uses (6) AA batteries (included) or (6) C batteries (optional)
- WaterSense® certified product: 1.2 gpm @ 60 psi



Part #	Mfg #	Description	Handle(s)	Finish	Price
182204	561T-SS-DST	1- or 3-Hole, Plastic Pop-Up Drain, Lead Free	ADA Lever	Stainless*	

### Dryden™ 1-Hdl Lavatory Faucet

- 5-3/8" Reach, 5-3/4" high rigid spout
- 7-3/4" Faucet height, 3-7/8" from deck to aerator
- 3/8" Compression fittings
- 2-7/8" Maximum deck thickness or 2-3/4" with riser
- 32" Minimum supply lines below deck included
- Includes optional 6" escutcheon (551 model)
- DIAMOND™ valve
- WaterSense® certified product: 1.2 gpm @ 60 psi



Part #	Mfg #	Description	Handle(s)	Finish	Price
131286	551-DST	1- or 3-Hole 4"cc, MPU Drain, Lead-Free	ADA Lever	Chrome	
143552	551-CZ-DST	1- or 3-Hole 4"cc, MPU Drain, Lead-Free	ADA Lever	Champagne Bronze™	
176967	551-PN-DST	1- or 3-Hole 4"cc, MPU Drain, Lead-Free	ADA Lever	Polished Nickel*	
131462	551-RB-DST	1- or 3-Hole 4"cc, MPU Drain, Lead-Free	ADA Lever	Venetian Bronze®	
232319	551-SP-DST	1- or 3-Hole 4"cc, MPU Drain, Lead-Free	ADA Lever	SpotShield Stainless	
130963	551-SS-DST	1- or 3-Hole 4"cc, MPU Drain, Lead-Free	ADA Lever	Stainless*	

\* Brilliance® Anti-Tarnish Lifetime Finishes

## Lavatory Faucets - Single Hole

### Dryden™ 1-Hdl Touch2O® Lavatory Faucet

- 5-3/8" Reach, 8-1/4" high rigid spout
- 4-3/8" From deck to aerator
- 3/8" Compression fittings
- 2" Maximum deck thickness, or 2-1/4" with riser
- 32" Minimum InnoFlex® supply lines below the deck
- Coordinating insulator
- Battery operated 4 (AA) or 6 (C)
- Hands-free activation
- DIAMOND™ Valve
- WaterSense® certified product: 1.2 gpm @ 60 psi



Part #	Mfg #	Description	Handle(s)	Finish	Price
163644	551T-DST	1- or 3-Hole 4"cc, Plastic Pop-Up, Lead Free	ADA Lever	Chrome	
174124	551T-CZ-DST	1- or 3-Hole 4"cc, Plastic Pop-Up, Lead Free	ADA Lever	Champagne Bronze™	
162516	551T-RB-DST	1- or 3-Hole 4"cc, Plastic Pop-Up, Lead Free	ADA Lever	Venetian Bronze®	
160834	551T-SS-DST	1- or 3-Hole 4"cc, Plastic Pop-Up, Lead Free	ADA Lever	Stainless*	

### Haywood™ 1-Hdl Centerset Lavatory Faucet

- 5-1/2" Reach, 6-1/4" high spout
- DIAMOND™ valve
- Plastic pop-up drain
- 3/8" Compression fittings
- 2-1/8" Maximum deck thickness
- Optional escutcheon included
- Includes InnoFlex® pex-c supply lines
- WaterSense® certified product: 1.20 gpm @ 60 psi



Part #	Mfg #	Description	Handle(s)	Finish	Price
220503	15999-DST	1-or 3-Hole 4"cc, Plastic Pop-Up	ADA Lever	Chrome	
228580	15999-SS-DST	1- or 3-Hole 4"cc, Plastic Pop-Up, Lead Free	ADA Lever	Stainless*	
221967	15999-RB-DST	1-or 3-Hole 4"cc, Plastic Pop-Up	ADA Lever	Venetian Bronze	

### Lahara® 1-Hdl Lavatory Faucet

- 5-1/2" Reach, 6-15/16" high rigid spout
- 7-1/2" High rigid spout (with escutcheon)
- 4-1/2" From deck to aerator
- Red/blue indicator
- 1/2" IPS Connection
- 2-3/4" Maximum deck thickness
- 2-1/8" Maximum deck thickness (with escutcheon)
- Optional 6-1/2" escutcheon included
- 32" Minimum InnoFlex® supply lines below deck
- DIAMOND® valve
- WaterSense® certified product: 1.2 gpm @ 60 psi



Part #	Mfg #	Description	Handle(s)	Finish	Price
132347	538-MPU-DST	1- or 3-Hole 4"cc, Metal Pop-Up Drain, Lead-Free	ADA Lever	Chrome	

\* Brilliance® Anti-Tarnish Lifetime Finishes

[www.waterconcepts.net](http://www.waterconcepts.net) • Serving our Customers Since 1946 • [www.plumbsupply.com](http://www.plumbsupply.com)

## Lavatory Faucets - Single Hole

### Single-Handle Lavatory Faucets (Continued)

#### Lahara® 1-Hdl Lavatory Faucet

Part #	Mfg #	Description	Handle(s)	Finish	Price
148950	538-CZMPU-DST	1- or 3-Hole 4"cc, Metal Pop-Up Drain, Lead-Free Bronze™	ADA Lever	Champagne	
132136	538-RBMPU-DST	1- or 3-Hole 4"cc, Metal Pop-Up Drain, Lead-Free	ADA Lever	Venetian Bronze®	
132894	538-SSMPU-DST	1- or 3-Hole 4"cc, Metal Pop-Up Drain, Lead-Free	ADA Lever	Stainless*	

#### Lahara™ 1-Hdl Lavatory Faucet with Touch2O™ Technology

- 5-1/2" Reach, 7-5/16" high rigid spout
- 7-7/8" High rigid spout (with escutcheon)
- TempSense™ LED light
- 5" From deck to aerator
- 3/8" Compression fittings
- Hands-free activation
- 2-1/4" Maximum deck thickness
- 1-5/8" Maximum deck thickness (with escutcheon)
- 32" Minimum InnoFlex® supply lines below the deck
- Coordinating insulator
- Battery operated (6AA) or 6(C)
- DIAMOND™ valve
- WaterSense® certified product: 1.2 gpm @ 60 psi



Part #	Mfg #	Description	Handle(s)	Finish	Price
141460	538T-DST	1- or 3-Hole 4"cc, Plastic Pop-Up, Lead-Free	ADA Lever	Chrome	
146435	538T-RB-DST	1- or 3-Hole 4"cc, Plastic Pop-Up, Lead-Free	ADA Lever	Venetian Bronze®	
140806	538T-SS-DST	1- or 3-Hole 4"cc, Plastic Pop-Up, Lead-Free	ADA Lever	Stainless*	

#### Linden™ 1-Hdl Centerset Lavatory Faucet

- 5-1/4" Reach, 8-1/8" high rigid spout
- 5-1/4" From deck to aerator
- 3/8" Compression fittings
- 2-1/2" Maximum deck thickness
- Includes optional escutcheon
- 32" Minimum InnoFlex® supply lines below the deck
- DIAMOND™ valve
- WaterSense® certified product: 1.2 gpm @ 60 psi



Part #	Mfg #	Description	Handle(s)	Finish	Price
143818	594-MPU-DST	1- or 3-Hole 4"cc, Metal Pop-Up Drain, Lead-Free	ADA Lever	Chrome	
144798	594-CZMPU-DST	1- or 3-Hole 4"cc, Metal Pop-Up Drain, Lead-Free	ADA Lever	Champagne Bronze™	
144563	594-RBMPU-DST	1- or 3-Hole 4"cc, Metal Pop-Up Drain, Lead-Free	ADA Lever	Venetian Bronze®	
143528	594-SSMPU-DST	1- or 3-Hole 4"cc, Metal Pop-Up Drain, Lead-Free	ADA Lever	Stainless*	

\* Brilliance® Anti-Tarnish Lifetime Finishes

[www.plumbsupply.com](http://www.plumbsupply.com) • Serving our Customers Since 1946 • [www.waterconcepts.net](http://www.waterconcepts.net)



## Lavatory Faucets - Single Hole

### Modern 1-Hdl Lavatory Faucet

- 4-1/2" Reach, 6-7/8" height
- 4-3/8" From deck to aerator
- 3/8" Compression fittings
- 2-1/4" Maximum deck thickness
- Optional 6" escutcheon included
- WaterSense® certified: 1.2 gpm



Part #	Mfg #	Description	Handle(s)	Finish	Price
233896	567LF-PP	1- or 3-Hole 4"cc, 50/50 Pop-Up, LF	ADA Lever	Chrome	
227957	567LF-SSPP	1- or 3-Hole 4"cc, 50/50 Pop-Up, LF	ADA Lever	Stainless*	

### Modern 1-Hdl Project Pack Lavatory Faucet

- 4-1/4" Reach, 4-1/4" height
- 3/8" Compression fittings
- 2-1/4" Maximum deck thickness
- Includes braided supply lines
- Optional 6" escutcheon not included (RP47973)
- WaterSense® certified: 1.2 gpm
- (-MPU) Metal drain with pop-up type fitting with plated flange and stopper



Part #	Mfg #	Description	Handle(s)	Finish	Price
244718	573LF-MPU-PP	1- or 3-Hole 4"cc, Metal Pop-Up Drain, Lead Free	ADA Lever	Chrome	

### Modern 1-Hdl Project Pack Lavatory Faucet

- 4-3/4" Reach, 4-7/8" height
- 3/8" Compression fittings
- 2-1/4" Maximum deck thickness
- Includes braided supply lines
- Plastic pop-up drain included
- Optional 6" escutcheon not included (RP76702)
- WaterSense® certified: 1.2 gpm



Part #	Mfg #	Description	Handle(s)	Finish	Price
246372	581LF-PP	1-or 3-Hole 4"cc, Plastic Pop-Up Drain, Lead Free	ADA Lever	Chrome	

\* Brilliance® Anti-Tarnish Lifetime Finishes



## Lavatory Faucets - Single Hole

### Modern 1-Hdl Project Pack Lavatory Faucet

- 4-1/4" Reach, 4-1/4" height
- 3/8" Compression fittings
- 2-1/2" Maximum deck thickness
- Includes braided supply lines
- Plastic pop-up drain included
- Optional 6" escutcheon not included (RP76702)
- WaterSense® certified: 1.2 gpm



Part #	Mfg #	Description	Handle(s)	Finish	Price
257925	534LF-PP	1-or 3-Hole 4"cc, Plastic Pop-Up Drain, Lead Free	ADA Lever	Chrome	

### Trinsic 1-Hdl Project Pack Lavatory Faucet

- 4-13/16" Reach, 3-3/4" height
- 3/8" Compression fittings
- 50/50 Pop-up
- Ceramic valve
- 2-1/4" Maximum deck thickness
- Optional 6" escutcheon not included (RP78359)
- WaterSense® certified: 1.2 gpm



Part #	Mfg #	Description	Handle(s)	Finish	Price
246918	559LF-PP	1- or 3-Hole 4"cc, 50/50 Pop-Up, Lead Free	ADA Lever	Chrome	
239187	559LF-BLLPU	1- or 3-Hole 4"cc, Less Pop-Up, Lead Free	ADA Lever	Matte Black	

### Pivotal™ 1-Hdl Centerset Lavatory Faucet

- 5-9/16" Reach, 5-13/16" high spout
- 3/8" Compression fittings
- 2.97" Maximum deck thickness
- DIAMOND™ valve
- InnoFlex® Pex-C supply
- Includes optional escutcheon
- WaterSense® certified product: 1.2 gpm @ 60 psi
- (-MPU) Metal pop-up drain **or** (-LPU) Less pop-up drain



Part #	Mfg #	Description	Handle(s)	Finish	Price
245292	599-BLMPU-DST	1- or 3-Hole 4"cc, Metal Pop-Up Drain, Lead Free	ADA Lever	Matte Black	
259141	599-LPU-DST	1- or 3-Hole 4"cc, Less Pop-Up Drain, Lead Free	ADA Lever	Chrome	
242400	599-MPU-DST	1- or 3-Hole 4"cc, Metal Pop-Up Drain, Lead Free	ADA Lever	Chrome	
259790	599-PNMPU-DST	1- or 3-Hole 4"cc, Metal Pop-Up Drain, Lead Free	ADA Lever	Polished Nickel*	
244366	599-SSLPU-DST	1- or 3-Hole 4"cc, Less Pop-Up Drain, Lead Free	ADA Lever	Stainless*	
240251	599-SSMPU-DST	1- or 3-Hole 4"cc, Metal Pop-Up Drain, Lead Free	ADA Lever	Stainless*	

\* Brilliance® Anti-Tarnish Lifetime Finishes

[www.plumbsupply.com](http://www.plumbsupply.com) • Serving our Customers Since 1946 • [www.waterconcepts.net](http://www.waterconcepts.net)

## Lavatory Faucets - Single Hole

### Soline™ 1-Hdl Lavatory Faucet

- 5-1/8" Reach, 7-1/8" rigid spout
- 1/2" IPS connection
- Ceramic valve cartridge
- 2-1/8" Maximum deck thickness
- Optional escutcheon included
- Includes plastic pop-up drain with flange and stopper
- WaterSense® certified product: 1.2 gpm @ 60 psi



Part #	Mfg #	Description	Handle(s)	Finish	Price
259529	15714LF-ECO	1- or 3-Hole 4"cc, Plastic Pop-Up Drain, Lead Free	ADA Lever	Chrome	

### Stryke™ 1-Hdl Lavatory Faucet

- 5-5/8" Reach, 6-27/32" rigid spout
- 3/8" Compression fittings
- 2-1/4" Maximum deck thickness
- DIAMOND™ seal valve
- Laminar flow
- Red/blue indicator
- Diamond coated ceramic cartridge
- 3/8" O.D. straight, staggered InnoFlex® PEX-C supply lines below the deck
- WaterSense® certified product: 1.2 gpm @ 60 psi
- Optional 6" escutcheon included
- Choose from lever handle kit H550 or helo handle kit H551
- (-MPU) Metal pop-up drain
- (-LHP) Less handle package



Part #	Mfg #	Description	Handle(s)	Finish	Price
259220	576-BLMPU-LHP-D	1- or 3-Hole 4"cc, Metal Pop-Up Drain, Lead Free ST	ADA Lever	Matte Black	
257875	576-CZMPU-LHP-D	1- or 3-Hole 4"cc, Metal Pop-Up Drain, Lead Free ST	ADA Lever	Champagne Bronze	
258862	576-MPU-LHP-DST	1- or 3-Hole 4"cc, Metal Pop-Up Drain, Lead Free	ADA Lever	Chrome	
257749	576-SSMPU-LHP-D	1- or 3-Hole 4"cc, Metal Pop-Up Drain, Lead Free ST	ADA Lever	Stainless*	

\* Brilliance® Anti-Tarnish Lifetime Finishes

## Lavatory Faucets - Single Hole

### Stryke™ 1-Hdl Mid-Height Riser Lavatory Faucet

- 4-13/16" Reach, 7-9/16" high rigid spout
- 3/8" Compression fittings
- 2-3/4" Maximum deck thickness
- DIAMOND™ seal valve
- Laminar flow
- Red/blue indicator
- Diamond coated ceramic cartridge
- 3/8" O.D. straight, staggered InnoFlex® PEX supply lines below the deck
- WaterSense® certified product: 1.2 gpm @ 60 psi
- Drain assembly sold separately
- Choose from lever handle kit H550SS or helo handle kit H551SS
- (-LHP) Less handle package



Part #	Mfg #	Description	Handle(s)	Finish	Price
258758	676-BLLHP-DST	1-Hole, Less Pop-Up Drain, Lead Free	Less Handle	Matte Black	
260913	676-SSLHP-DST	1-Hole, Less Pop-Up Drain, Lead Free	Less Handle	Stainless*	

### Tesla™ 1-Hdl Lavatory Faucet

- 4-11/16" Reach, 5-5/8" high rigid spout
- 4-11/16" From deck to aerator
- Red/blue indicator
- 3/8" Compression fittings
- 2-1/8" Maximum deck thickness
- Includes optional 6-1/8" escutcheon
- 32" Minimum InnoFlex® supply lines below the deck
- DIAMOND™ valve
- WaterSense® certified product: 1.2 gpm @ 60 psi



Part #	Mfg #	Description	Handle(s)	Finish	Price
245535	552LF-SSLPU	1- or 3-Hole 4"cc, Less Pop-Up Drain, Lead Free	ADA Joystick	Stainless*	
181551	552LF-MPU	1- or 3-Hole 4"cc, Metal Pop-Up Drain, Lead Free	ADA Joystick	Chrome	
182329	552LF-PNMPU	1- or 3-Hole 4"cc, Metal Pop-Up Drain, Lead Free	ADA Joystick	Polished Nickel*	
179651	552LF-SSMPU	1- or 3-Hole 4"cc, Metal Pop-Up Drain, Lead Free	ADA Joystick	Stainless*	

\* Brilliance® Anti-Tarnish Lifetime Finishes

## Lavatory Faucets - Single Hole

### Tesla™ 1-Hdl Lavatory Faucet with Touch2O® Technology

- 4-11/16" Reach, 6-1/8" high rigid spout
- 5-3/16" From deck to aerator
- Hands-free activation
- Red/blue indicators markings
- TempSense™ LED light
- 3/8" Compression fittings
- 2-1/8" Maximum deck thickness
- 3/2" Minimum InnoFlex® supply lines below the deck
- Optional 6" escutcheon included
- Coordinating insulator
- Uses (6) AA (included) or (6) C (optional) batteries
- DIAMOND Seal® Technology
- WaterSense certified: 1.2 gpm @ 60 psi



Part #	Mfg #	Description	Handle(s)	Finish	Price
184959	552TLF	1- or 3-Hole, Plastic Pop-Up Drain, Lead Free	ADA Joystick	Chrome	
259878	552TLF-PN	1- or 3-Hole, Plastic Pop-Up Drain, Lead Free	ADA Joystick	Polished Nickel*	
186437	552TLF-SS	1- or 3-Hole, Plastic Pop-Up Drain, Lead Free	ADA Joystick	Stainless*	

### Trinsic™ 1-Hdl Lavatory Faucet

- 5" Reach, 6-1/4" high rigid spout
- 2-3/8" From deck to spout
- Red/blue indicator
- 3/8" Compression fittings
- 3/2" Minimum InnoFlex® supply lines below the deck
- Euro-motion DIAMOND™ valve
- WaterSense® certified product: 1.2 gpm @ 60 psi



Part #	Mfg #	Description	Handle(s)	Finish	Price
235620	559LF-BLMPU	1- or 3-Hole 4"cc, Metal Pop-Up Drain, Lead-Free	ADA Lever	Matte Black	
152798	559LF-CZMPU	1- or 3-Hole 4"cc, Metal Pop-Up Drain, Lead-Free	ADA Lever	Champagne Bronze™	
152796	559LF-LPU	1- or 3-Hole 4"cc, Less Pop-Up Drain, Lead-Free	ADA Lever	Chrome	
151400	559LF-MPU	1- or 3-Hole 4"cc, Metal Pop-Up Drain, Lead-Free	ADA Lever	Chrome	
152799	559LF-RBMPU	1- or 3-Hole 4"cc, Metal Pop-Up Drain, Lead-Free	ADA Lever	Venetian Bronze®	
152797	559LF-SSLPU	1- or 3-Hole 4"cc, Less Pop-Up Drain, Lead-Free	ADA Lever	Stainless*	
152800	559LF-SSMPU	1- or 3-Hole 4"cc, Metal Pop-Up Drain, Lead-Free	ADA Lever	Stainless*	

\* Brilliance® Anti-Tarnish Lifetime Finishes

## Lavatory Faucets - Single Hole

### Trinsic™ 1-Hdl High-Arc Lavatory Faucet

- 5-9/16" Reach, 8-7/8" high spout
- 360° swivel spout
- 5-3/4" From deck to spout
- Red/blue indicator
- Overflows in push pop-up drain
- 3" Maximum deck thickness
- 35" Minimum InnoFlex® supply lines below the deck
- 3/8" Compression fittings
- Euro-motion DIAMOND™ valve
- WaterSense® certified: 1.2 gpm @ 60 psi



Part #	Mfg #	Description	Handle(s)	Finish	Price
178645	559HA-DST	1-Hole, Metal Push Pop-Up Drain, Lead-Free	ADA Lever	Chrome	
235451	559-HA-BL-DST	1-Hole, Metal Push Pop-Up Drain, Lead-Free	ADA Lever	Matte Black	
238316	559HA-CZ-DST	1-Hole, Metal Push-Pop-Up Drain, Lead-Free	ADA Lever	Champagne Bronze™	
187577	559HA-RB-DST	1-Hole, Metal Push-Pop-Up Drain, Lead-Free	ADA Lever	Venetian Bronze®	
185164	559HA-SS-DST	1-Hole, Metal Push-Pop-Up Drain, Lead-Free	ADA Lever	Stainless*	

### Vero™ 1-Hdl Lavatory Faucet

- 4-25/32" Reach, 7-25/32" high rigid spout
- 5-1/4" From deck to spout
- 1/2" IPS Connection
- 2-31/32" Maximum deck thickness
- Euro-motion Diamond™ valve
- WaterSense® certified product: 1.2 gpm @ 60 psi



Part #	Mfg #	Description	Handle(s)	Finish	Price
134765	553LF	1- or 3-Hole 4"cc, Metal Push Pop-Up Drain, Lead-Free	ADA Lever	Chrome	
143242	553LF-CZ	1- or 3-Hole 4"cc, Metal Push Pop-Up Drain, Lead-Free	ADA Lever	Champagne Bronze™	
146665	553LF-RB	1- or 3-Hole 4"cc, Metal Push Pop-Up Drain, Lead-Free	ADA Lever	Venetian Bronze®	
134766	553LF-SS	1- or 3-Hole 4"cc, Metal Push Pop-Up Drain, Lead-Free	ADA Lever	Stainless*	

### Victorian® 1-Hdl Lavatory Channel Faucet

- 5-1/8" Reach, 8-1/4" high rigid channel spout
- 4-1/8" From deck to spout
- 1/2" IPS connection
- 2-1/2" Maximum deck thickness
- Euro-motion valve
- WaterSense® certified product: 1.2 gpm @ 60 psi



Part #	Mfg #	Description	Handle(s)	Finish	Price
117180	554LF	1 or 3-Hole 4"cc, Metal Pop-Up Drain, Lead-Free	ADA Lever	Chrome	
146395	554LF-CZ	1 or 3-Hole 4"cc, Metal Pop-Up Drain, Lead-Free	ADA Lever	Champagne Bronze™	
129905	554LF-RB	1 or 3-Hole 4"cc, Metal Pop-Up Drain, Lead-Free	ADA Lever	Venetian Bronze®	
145762	554LF-SS	1 or 3-Hole 4"cc, Metal Pop-Up Drain, Lead-Free	ADA Lever	Stainless*	

\* Brilliance® Anti-Tarnish Lifetime Finishes

[www.plumbsupply.com](http://www.plumbsupply.com) • Serving our Customers Since 1946 • [www.waterconcepts.net](http://www.waterconcepts.net)

## Lavatory Faucets - Single Hole

### Victorian® 1-Hdl Lavatory Faucet

- 5-3/8" Reach, 8-3/4" high rigid spout
- 4-5/8" From deck to aerator
- 1/2" IPS connection
- Includes optional 6-1/8" escutcheon for 3-hole installation (555 model)
- 1-3/8" Maximum deck thickness
- Euro-motion valve
- WaterSense® certified product: 1.2 gpm @ 60 psi



Part #	Mfg #	Description	Handle(s)	Finish	Price
144344	555LF	1- or 3-Hole 4"cc, Metal Pop-Up Drain, Lead-Free	ADA Lever	Chrome	
166040	555LF-CZ	1- or 3-Hole 4"cc, Metal Pop-Up Drain, Lead-Free	ADA Lever	Champagne Bronze™	
147493	555LF-RB	1- or 3-Hole 4"cc, Metal Pop-Up Drain, Lead-Free	ADA Lever	Venetian Bronze®	
152154	555LF-SS	1- or 3-Hole 4"cc, Metal Pop-Up Drain, Lead-Free	ADA Lever	Stainless*	

### Virage® 1-Hdl Lavatory Faucet

- 6-3/16" Reach, 7-1/16" high rigid spout
- 5-1/8" From deck to aerator
- 1/2-14 NPSM threaded inlets
- 3" Maximum deck thickness
- Ceramic disc cartridge
- Hidden laminar flow aerator
- WaterSense® certified product: 1.5 gpm @ 60 psi
- Drain sold separately



Part #	Mfg #	Description	Handle(s)	Finish	Price
252509	65030LF-PC	1-Hole, Less Drain, Lead Free	ADA Lever	Chrome	

### Zura® 1-Hdl Lavatory Faucet

- 5" Reach, 5-7/8" high rigid spout
- 3/8" Compression fittings
- 2-1/4" Deck thickness
- Diamond Seal® technology
- Euromotion DIAMOND™ valve
- Escutcheon included
- InnoFlex® Pex-C supply lines
- WaterSense certified product: 1.2 gpm @ 60 psi
- (-LPU) Less pop-up drain, no lift rod hole



Part #	Mfg #	Description	Handle(s)	Finish	Price
232266	574-MPU-DST	1-or 3-Hole 4"cc, Metal Pop-Up	ADA Lever	Chrome	
230993	574-CSMPU-DST	1-or 3-Hole 4"cc, Metal Pop-Up	ADA Lever	Chrome/Matte Black	
229312	574-SSMPU-DST	1-or 3-Hole 4"cc, Metal Pop-Up	ADA Lever	Stainless*	
238810	574-LPU-DST	1- or 3-Hole 4"cc Less Pop-Up Drain, Lead Free	ADA Lever	Chrome	
242759	574-SSLPU-DST	1- or 3-Hole 4"cc Less Pop-Up Drain, Lead Free	ADA Lever	Stainless*	

\* Brilliance® Anti-Tarnish Lifetime Finishes



## Lavatory Faucets - Single Hole

### Zura® 1-Hdl Lavatory Faucet with Touch2O® Technology

- 5" Reach, 6-7/16" high rigid spout
- 3/8" Compression fittings
- 2-1/4" Deck thickness
- Diamond Seal® technology
- Euromotion DIAMOND™ valve
- Plastic pop-up drain included
- InnoFlex® Pex-C supply lines
- WaterSense certified product: 1.2 gpm @ 60 psi



Part #	Mfg #	Description	Handle(s)	Finish	Price
249636	574T-SS-DST	1-or 3-Hole 4"cc, Plastic Pop-Up	ADA Lever	Stainless*	

### Vessel Faucets

#### Addison™ 1-Hdl Vessel Faucet

- 5" Spout Reach
- 14-1/2" Faucet height, 10" from deck to aerator
- 3/8" Compression fittings
- Hot/cold indicator
- 2-1/2" Maximum deck thickness
- 32" Minimum InnoFlex® supply lines below deck
- Drain sold separately
- Euro-motion DIAMOND™ valve
- WaterSense® certified product, 1.2 gpm @ 60 psi



Part #	Mfg #	Description	Handle(s)	Finish	Price
132560	792-DS	1-Hole, High Spout w/ Riser, Less Drain, LF	ADA Lever	Chrome	
137599	792-CZ-DST	1-Hole, High Spout w/ Riser, Less Drain, LF	ADA Lever	Champagne Bronze™	
132562	792-RB-DST	1-Hole, High Spout w/ Riser, Less Drain, LF	ADA Lever	Venetian Bronze®	
132561	792-SS-DST	1-Hole, High Spout w/ Riser, Less Drain, LF	ADA Lever	Stainless*	

#### Ara® 1-Hdl Vessel Faucet

- 5-3/8" Reach, or 5-3/16" reach w/ channel spout
- 13-3/8" High rigid spout, or 6-3/8" high w/ channel spout
- 11-1/8" From deck to aerator
- Red/blue indicator
- 3/8" Compression fittings
- 2-1/4" Maximum deck thickness
- 32" Minimum InnoFlex® supply lines
- Euro-motion ceramic valve
- WaterSense® certified product: 1.2 gpm @ 60 psi



767LF



768LF



Part #	Mfg #	Description	Handle(s)	Finish	Price
173773	767LF	1-Hole, Less Drain, Lead-Free	ADA Lever	Chrome	
241580	767LF-BL	1-Hole, Less Drain, Lead-Free	ADA Lever	Matte Black	
171989	767LF-SS	1-Hole, Less Drain, Lead-Free	ADA Lever	Stainless*	
172916	768-LF	1-Hole, Less Drain, Lead-Free Channel Spout	ADA Lever	Chrome	

\* Brilliance® Anti-Tarnish Lifetime Finishes

[www.plumbsupply.com](http://www.plumbsupply.com) • Serving our Customers Since 1946 • [www.waterconcepts.net](http://www.waterconcepts.net)

## Lavatory Faucets - Single Hole

### Vessel Faucets (Continued)

#### Ara® 1-Hdl Vessel Faucet

Part #	Mfg #	Description	Handle(s)	Finish	Price
243223	768LF-BL	1-Hole, Less Drain, Lead-Free Channel Spout	ADA Lever	Matte Black	
171040	768LF-SS	1-Hole, Less Drain, Lead-Free Channel Spout	ADA Lever	Stainless*	

#### Cassidy™ 1-Hdl Vessel Lavatory Faucet with Riser

- 5-13/32" Reach, 11-9/16" high spout
- 10" From deck to aerator
- Channel Spout:  
5" Reach, 11-9/16"  
9-17/32" From deck to aerator
- 1/2" IPS connection
- 2-1/8" Maximum deck thickness
- Euro-motion valve
- WaterSense® certified product: 1.2 gpm @ 60 psi



Part #	Mfg #	Description	Handle(s)	Finish	Price
152731	797LF	1-Hole, Less Drain, Lead Free	ADA Lever	Chrome	
152732	797LF-CZ	1-Hole, Less Drain, Lead Free	ADA Lever	Champagne Bronze™	
253475	797LF-PN	1-Hole, Less Drain, Lead Free	ADA Lever	Polished Nickel*	
152246	797LF-RB	1-Hole, Less Drain, Lead Free	ADA Lever	Venetian Bronze®	
152733	797LF-SS	1-Hole, Less Drain, Lead Free	ADA Lever	Stainless*	
152735	798LF	1-Hole, Less Drain, Lead Free, Channel Spout	ADA Lever	Chrome	
152736	798LF-CZ	1-Hole, Less Drain, Lead Free, Channel Spout	ADA Lever	Champagne Bronze™	
157022	798LF-PN	1-Hole, Less Drain, Lead Free, Channel Spout	ADA Lever	Polished Nickel*	
152244	798LF-RB	1-Hole, Less Drain, Lead Free, Channel Spout	ADA Lever	Venetian Bronze®	
151765	798LF-SS	1-Hole, Less Drain, Lead Free, Channel Spout	ADA Lever	Stainless*	

#### Compel® 1-Hdl Vessel Faucet

- 5" Reach
- 13-5/8" Faucet height, 9-7/16" from deck to aerator
- Red/blue indicators
- 3/8" Compression fittings
- 2-1/2" Maximum deck thicknesses
- 32" Minimum InnoFlex® supply lines below the deck
- Euro-motion DIAMOND™ valve
- Drain sold separately
- WaterSense® certified product: 1.2 gpm @ 60 psi



Part #	Mfg #	Description	Handle(s)	Finish	Price
152792	761-DST	1-Hole with Riser, Less Drain, Lead Free	ADA Lever	Chrome	
176599	761-SS-DST	1-Hole with Riser, Less Drain, Lead Free	ADA Lever	Stainless*	

\* Brilliance® Anti-Tarnish Lifetime Finishes

www.waterconcepts.net • Serving our Customers Since 1946 • www.plumbsupply.com

## Lavatory Faucets - Single Hole

### Dryden™ 1-Hdl Vessel Faucet

- 5-3/8" Reach
- 13-5/16" Faucet height, 8-7/8" from deck to aerator
- 3/8" Compression fittings
- 2-7/8" Maximum deck thickness or 2-3/4" with riser
- 32" Minimum supply lines below deck included
- Includes optional 6" escutcheon (551 model)
- DIAMOND™ valve
- WaterSense® certified product: 1.2 gpm @ 60 psi



Part #	Mfg #	Description	Handle(s)	Finish	Price
116273	751-DST	1-Hole, w/Riser, Less Drain, Lead-Free	ADA Lever	Chrome	
159472	751-CZ-DST	1-Hole, w/Riser, Less Drain Lead-Free	ADA Lever	Champagne Bronze™	
175035	751-PN-DST	1-Hole, w/Riser, Less Drain Lead-Free	ADA Lever	Polished Nickel*	
116275	751-RB-DST	1-Hole, w/Riser, Less Drain Lead-Free	ADA Lever	Venetian Bronze®	
134574	751-SS-DST	1-Hole, w/Riser, Less Drain Lead-Free	ADA Lever	Stainless*	

### Dryden™ 1-Hdl Touch2O® Vessel Faucet

- 5-3/8" Reach
- 13" Faucet height, 9-1/8" from deck to aerator
- 3/8" Compression fittings
- 2" Maximum deck thickness, or 2-1/4" with riser
- 32" Minimum InnoFlex® supply lines below the deck
- Coordinating insulator
- Battery operated 4 (AA) or 6 (C)
- Hands-free activation
- DIAMOND™ Valve
- WaterSense® certified product: 1.2 gpm @ 60 psi



Part #	Mfg #	Description	Handle(s)	Finish	Price
169524	751T-RB-DST	1-Hole, w/ Riser Less Drain, Lead Free	ADA Lever	Venetian Bronze®	
174261	751T-SS-DST	1-Hole, w/ Riser Less Drain, Lead Free	ADA Lever	Stainless*	

### Linden™ 1-Hdl Vessel Faucet

- 5-1/4" Reach
- 12-5/8" Faucet height, 9-3/4" from deck to aerator
- 3/8" Compression fittings
- 2-1/2" Maximum deck thickness
- Includes optional escutcheon
- 32" Minimum InnoFlex® supply lines below the deck
- DIAMOND™ valve
- Drain sold separately
- WaterSense® certified product: 1.2 gpm @ 60 psi



Part #	Mfg #	Description	Handle(s)	Finish	Price
148239	794-DST	1-Hole, with Riser Less Drain, Lead-Free	ADA Lever	Chrome	
156759	794-CZ-DST	1-Hole, with Riser Less Drain, Lead-Free	ADA Lever	Champagne Bronze™	
149632	794-RB-DST	1-Hole, with Riser Less Drain, Lead-Free	ADA Lever	Venetian Bronze®	

\* Brilliance® Anti-Tarnish Lifetime Finishes

[www.plumbsupply.com](http://www.plumbsupply.com) • Serving our Customers Since 1946 • [www.waterconcepts.net](http://www.waterconcepts.net)

## Lavatory Faucets - Single Hole

### Vessel Faucets (Continued)

#### Linden™ 1-Hdl Vessel Faucet

Part #	Mfg #	Description	Handle(s)	Finish	Price
144936	794-SS-DST	1-Hole, with Riser Less Drain, Lead-Free	ADA Lever	Stainless*	

#### Pivotal™ 1-Hdl Mid-Height Vessel Lavatory Faucet

- 6-1/4" Reach, 7" high spout
- 3/8" Compression fittings
- 2-1/8" Maximum deck thickness
- DIAMOND™ valve
- InnoFlex® Pex-C supply
- Less pop-up drain
- WaterSense® certified product: 1.2 gpm @ 60 psi



Part #	Mfg #	Description	Handle(s)	Finish	Price
242143	699-DST	1-Hole, Less Pop-Up Drain, Lead Free	ADA Lever	Chrome	
258228	699-PN-DST	1-Hole, Less Pop-Up Drain, Lead Free	ADA Lever	Polished Nickel*	
244478	699-SS-DST	1-Hole, Less Pop-Up Drain, Lead Free	ADA Lever	Stainless*	

#### Pivotal™ 1-Hdl Tall-Height Vessel Lavatory Faucet

- 5-5/8" Reach, 10-1/4" high spout
- 3/8" Compression fittings
- 2-1/8" Maximum deck thickness
- DIAMOND™ valve
- InnoFlex® Pex-C supply
- Less pop-up drain
- WaterSense® certified product: 1.2 gpm @ 60 psi



Part #	Mfg #	Description	Handle(s)	Finish	Price
246036	799-SS-DST	1-Hole, Less Pop-Up Drain, Lead Free	ADA Lever	Stainless*	

#### Tesla™ 1-Hdl Vessel Faucet

- 4-1/2" Reach
- 13-13/16" Faucet height, 9-3/4" from deck to aerator
- Handle rotates 22°
- 3/8" Compression fittings
- 2-1/2" Maximum deck thickness
- DIAMOND™ valve
- Drain sold separately
- WaterSense® certified product: 1.20 gpm @ 60 psi



Part #	Mfg #	Description	Handle(s)	Finish	Price
189236	752LF	1-Hole, with Riser Less Drain, Lead Free	ADA Lever	Chrome	

\* Brilliance® Anti-Tarnish Lifetime Finishes

www.waterconcepts.net • Serving our Customers Since 1946 • www.plumbsupply.com

## Lavatory Faucets - Single Hole

### Trinsic™ 1-Hdl Vessel Faucet

- 6-1/8" Reach
- 13-1/2" Faucet height, 9-5/16" from deck to aerator
- Red/blue indicator
- 3/8" Compression fittings
- 32" Minimum InnoFlex® supply lines below the deck
- Euro-motion DIAMOND™ valve
- Drain sold separately
- WaterSense® certified product: 1.2 gpm @ 60 psi



Part #	Mfg #	Description	Handle(s)	Finish	Price
183984	759-DST	1-Hole, with Riser, Less Drain, Lead Free	ADA Lever	Chrome	
182885	759LF-CZ-DST	1-Hole, with Riser, Less Drain, Lead Free	ADA Lever	Champagne Bronze™	
240379	759-BL-DST	1-Hole with Riser, Less Drain, Lead Free	ADA Lever	Matte Black	
185471	759-RB-DST	1-Hole, with Riser, Less Drain, Lead Free	ADA Lever	Venetian Bronze®	
186410	759-SS-DST	1-Hole, with Riser, Less Drain, Lead Free	ADA Lever	Stainless*	

### Vero™ 1-Hdl Vessel Faucet

- 4-25/32" Reach
- 11-13/16" Faucet height, 9-9-32" from deck to aerator
- 1/2" IPS Connection
- 2-5/16" Maximum deck thickness
- Drain sold separately
- WaterSense® certified product: 1.2 gpm @ 60 psi



Part #	Mfg #	Description	Handle(s)	Finish	Price
134767	753-LF	1-Hole with Riser, Less Drain, Lead-Free	ADA Lever	Chrome	
155302	753LF-CZ	1-Hole with Riser, Less Drain, Lead-Free	ADA Lever	Champagne Bronze™	
146151	753LF-RB	1-Hole with Riser, Less Drain, Lead-Free	ADA Lever	Venetian Bronze®	
134768	753LF-SS	1-Hole with Riser, Less Drain, Lead-Free	ADA Lever	Stainless*	

### Victorian® 1-Hdl Vessel Faucet w/ Channel Spout

- 5-1/8" Reach
- 12-5/8" Faucet height, 8-9/16" from deck to aerator
- 1/2" IPS connection
- 2-1/2" Maximum deck thickness
- Euro-motion valve
- Drain sold separately
- WaterSense® certified product: 1.2 gpm @ 60 psi



Part #	Mfg #	Description	Handle(s)	Finish	Price
117188	754LF	1-Hole, Less Drain, Lead-Free	ADA Lever	Chrome	
159765	754LF-CZ	1-Hole, Less Drain, Lead-Free	ADA Lever	Champagne Bronze™	
144236	754LF-RB	1-Hole, Less Drain, Lead-Free	ADA Lever	Venetian Bronze®	
142970	754LF-SS	1-Hole, Less Drain, Lead-Free	ADA Lever	Stainless*	

\* Brilliance® Anti-Tarnish Lifetime Finishes

[www.plumbsupply.com](http://www.plumbsupply.com) • Serving our Customers Since 1946 • [www.waterconcepts.net](http://www.waterconcepts.net)



## Lavatory Faucets - Single Hole

### Victorian® 1-Hdl Vessel Faucet

- 5-3/8" Reach
- 12-5/8" Faucet height, 8-1/2" from deck to aerator
- 1/2" IPS connection
- Euro-motion valve
- Drain sold separately
- WaterSense® certified product: 1.2 gpm @ 60 psi



Part #	Mfg #	Description	Handle(s)	Finish	Price
171166	755LF	1-Hole, Less Drain, Lead-Free	ADA Lever	Chrome	
159222	755LF-CZ	1-Hole, Less Drain, Lead-Free	ADA Lever	Champagne Bronze™	
117194	755LF-RB	1-Hole, Less Drain, Lead-Free	ADA Lever	Venetian Bronze®	
166910	755LF-SS	1-Hole, Less Drain, Lead-Free	ADA Lever	Stainless*	

### Zura 1-Hdl Vessel Lavatory Faucet

- 5" Rigid spout reach, 10-3/4" height
- 3/8" Compression fittings
- 2-1/2" Maximum deck thickness
- Euromotion DIAMOND™ seal
- Drain sold separately
- InnoFlex® pex-c supply lined included
- WaterSense® certified product: 1.20 gpm @ 60 psi



Part #	Mfg #	Description	Handle(s)	Finish	Price
229314	774-SS-DST	1-Hole, Less Drain, Lead-Free	ADA Lever	Stainless*	

\* Brilliance® Anti-Tarnish Lifetime Finishes

[www.waterconcepts.net](http://www.waterconcepts.net) • Serving our Customers Since 1946 • [www.plumbsupply.com](http://www.plumbsupply.com)



## Lavatory - Single Hole

### Single-Handle Lavatory Faucets

#### Baliza® 1-Hdl Lavatory Faucet

- 5-5/16" Reach, 6-29/32" high spout
- 4-5/16" From deck to aerator
- 3-1/2" Maximum deck thickness
- Optional 4" escutcheon (RP61619)
- WaterSense® certified product: 1.5 gpm @ 60 psi



Part #	Mfg #	Description	Handle(s)	Finish	Price
143662	65005LF-BN	1-Hole, Metal Pop-Up	ADA Lever	Brushed Nickel*	
168980	65005LF-BZ	1-Hole, Metal Pop-Up	ADA Lever	Brushed Bronze*	
184106	65005LF-PC	1-Hole, Metal Pop-Up	ADA Lever	Chrome	
134881	65005LF-PN	1-Hole, Metal Pop-Up	ADA Lever	Polished Nickel*	
174382	65005LF-RB	1-Hole, Metal Pop-Up	ADA Lever	Venetian Bronze®	

#### Charlotte™ 1-Hdl Lavatory Faucet

- 5-1/16" Reach, 5-3/4" high spout
- 32" InnoFlex supply lines
- 3" Maximum deck thickness
- WaterSense® certified: 1.5 gpm @ 60 psi



Part #	Mfg #	Description	Handle(s)	Finish	Price
170567	65085LF-BN	1-Hole, Less Drain	ADA Lever	Brushed Nickel*	
170566	65085LF-PC	1-Hole, Less Drain	ADA Lever	Chrome	
164831	65085LF-PN	1-Hole, Less Drain	ADA Lever	Polished Nickel*	
242405	65085LF-PNCO	1-Hole, Less Drain	ADA Lever	Cocoa Bronze/Pol Nickel	

#### Charlotte™ Electronic Lavatory Faucet with Proximity

- 5" Reach, 7-3/8" high spout
- 6" From Deck to aerator
- Features SmartTouch Plus™ hands-free activation
- TempIQ™ temperature control technology
- 2-1/2" Maximum deck thickness
- Drain sold separately
- WaterSense® certified product: 1.5 gpm @ 60 psi



Part #	Mfg #	Description	Handle(s)	Finish	Price
157006	65685LF-BN	1-Hole, Less Drain	SmartTouch™	Brushed Nickel*	
238159	65685LF-PNCO	1-Hole, Less Drain	SmartTouch™	Cocoa Bronze & Polished Nickel	

\* Brilliance® Anti-Tarnish Lifetime Finishes

[www.plumbsupply.com](http://www.plumbsupply.com) • Serving our Customers Since 1946 • [www.waterconcepts.net](http://www.waterconcepts.net)

## Lavatory - Single Hole

### Levoir™ 1-Hdl Lavatory Faucet

- 5-1/2" Reach, 6-1/2" high spout
- 5-1/4" From deck to aerator
- 3-3/4" Maximum deck thickness
- Ceramic cartridge
- Textural knurling detail
- Hidden water-efficient laminar flow aerator
- Maximum flow rate: 1.5 gpm @ 60 psi
- Metal pop-up drain included



Part #	Mfg #	Description	Handle(s)	Finish	Price
250584	65098LF-GL	1-Hole, Metal Pop-Up Drain	ADA Lever	Luxe Gold	
253987	65098LF-PN	1-Hole, Metal Pop-Up Drain	ADA Lever	Polished Nickel*	
259626	65098LF-PC	1-Hole, Metal Pop-Up Drain	ADA Lever	Chrome	
253870	65098LF-SL	1-Hole, Metal Pop-Up Drain	ADA Lever	Luxe Steel	

### Levoir™ 1-Hdl Wall-Mount Lavatory Faucet

- 9-1/8" Reach, 2-3/4" high spout
- Ceramic cartridge
- Hidden water-efficient laminar flow aerator
- Maximum flow rate: 1.5 gpm @ 60 psi
- Drain sold separately
- Rough-in R65700 required



Part #	Mfg #	Description	Handle(s)	Finish	Price
255716	T65798LF-GL	1-Hole, Less Drain	ADA Lever	Luxe Gold	
253261	T65798LF-SL	1-Hole, Less Drain	ADA Lever	Luxe Steel	

### Litze™ 1-Hdl Lavatory Faucet

- 5-1/2" Reach, 7-1/2" high spout
- 5-9/16" From deck to aerator
- 2-1/2" Maximum deck thickness
- Ceramic cartridge
- Textural knurling detail
- Hidden water-efficient laminar flow aerator
- Maximum flow rate: 1.5 gpm @ 60 psi
- Drain sold separately



Part #	Mfg #	Description	Handle(s)	Finish	Price
247978	65035LF-GL	1-Hole, Less Drain	ADA Lever	Luxe Gold	
245084	65035LF-PC	1-Hole, Less Drain	ADA Lever	Chrome	
257378	65035LF-PN	1-Hole, Less Drain	ADA Lever	Polished Nickel	

\* Brilliance® Anti-Tarnish Lifetime Finishes

[www.waterconcepts.net](http://www.waterconcepts.net) • Serving our Customers Since 1946 • [www.plumbsupply.com](http://www.plumbsupply.com)

## Lavatory - Single Hole

### Litze™ 1-Hdl Wall-Mount Lavatory Faucet

- 8-3/4" Reach, 3-7/16" high spout
- Ceramic cartridge
- Drain sold separately
- Textural knurling detail
- Hidden water-efficient laminar flow aerator
- Maximum flow rate: 1.5 gpm @ 60 psi
- Rough-in (**R65700**) required for installation



Part #	Mfg #	Description	Handle(s)	Finish	Price
232588	T65735LF-GL	1-Hole, Less Drain	ADA Lever	Luxe Gold	
239009	T65735LF-NK	1-Hole, Less Drain	ADA Lever	Luxe Nickel	
237817	T65735LF-PC	1-Hole, Less Drain	ADA Lever	Chrome	
244065	T65735LF-PN	1-Hole, Less Drain	ADA Lever	Polished Nickel	

### Odin™ 1-Hdl Lavatory Faucet

- 4-7/16" Reach, 6-1/2" high spout
- Laminar flow aerator
- Integrated supply line hoses, 34" long connect to 3/8" OD compression stop fittings
- 3" Maximum deck thickness
- WaterSense® certified product: 1.5 gpm @ 60 psi



Part #	Mfg #	Description	Handle(s)	Finish	Price
177284	65075LF-BL	1-Hole, Less Drain	ADA Lever	Matte Black	
165340	65075LF-BN	1-Hole, Less Drain	ADA Lever	Brushed Nickel*	
164975	65075LF-BNBL	1-Hole, Less Drain	ADA Lever	Matte Black/Brushed Nickel	
171594	65075LF-PC	1-Hole, Less Drain	ADA Lever	Chrome	

### Odin™ 1-Hdl Lavatory Faucet

- 5-1/4" Reach, 8-5/8" high spout
- 5-9/16" Deck to aerator height
- 3" Maximum deck thickness
- Hidden laminar flow aerator
- 1/2-14 NPSM threaded inlets
- Ceramic disc cartridge with metal stem
- WaterSense® certified product: 1.5 gpm @ 60 psi



Part #	Mfg #	Description	Handle(s)	Finish	Price
246731	65175LF-BL	1-Hole, Less Drain	ADA Lever	Matte Black	
243535	65175LF-BN	1-Hole, Less Drain	ADA Lever	Brushed Nickel*	
257509	65175LF-GL	1-Hole, Less Drain	ADA Lever	Luxe Gold	
247513	65175LF-PC	1-Hole, Less Drain	ADA Lever	Chrome	

\* Brilliance® Anti-Tarnish Lifetime Finishes

**www.plumbsupply.com • Serving our Customers Since 1946 • www.waterconcepts.net**

## Lavatory - Single Hole

### Odin™ Jason Wu 1-Hdl Lavatory Faucet

- 4-3/4" Reach, 9-1/8" high spout
- 6" From deck to aerator
- 2-1/2" Maximum deck thickness
- Includes optional base that must be used with metal sinks
- SmartTouch Plus™ hands-free activation
- TempIQ™ temperature Control
- Drain sold separately
- WaterSense® certified product: 1.5 gpm @ 60 psi



Part #	Mfg #	Description	Handle(s)	Finish	Price
156567	65675LF-BL	1-Hole, Less Drain	ADA Lever	Matte Black	
225076	65675LF-BN	1-Hole, Less Drain	ADA Lever	Brushed Nickel*	
188916	65675LF-PC	1-Hole, Less Drain	ADA Lever	Chrome	

### Rook™ SmartTouch Plus™ 1-Hdl Lavatory Faucet

- 5-13/16" Reach, 6-3/8" high spout
- 3-1/4" From deck to aerator
- Drain sold separately
- WaterSense® certified product: 1.5 gpm @ 60 psi
- Optional escutcheon (RP80414)



Part #	Mfg #	Description	Handle(s)	Finish	Price
178561	65960LF-NK	1-Hole, Less Drain	ADA Lever	Luxe Nickel*	

### Rook™ 1-Hdl Lavatory Faucet

- 7-1/4" High spout
- Single hole installation
- Ceramic cartridge
- Metal pop-up included
- 3" From deck to aerator
- 2-1/2" Maximum deck thickness
- WaterSense® certified product: 1.5 gpm @ 60 psi
- **(65060LF-PN) dimensions:**  
-6-3/8" Reach
- **(65061LF-NK) dimensions:**  
-5-7/16" Reach



Part #	Mfg #	Description	Handle(s)	Finish	Price
248186	65060LF-PC	1-Hole, Less Drain	ADA Lever	Chrome	
223518	65060LF-PN	1-Hole, Less Drain	ADA Lever	Polished Nickel*	
247398	65060LF-NK	1-Hole, Less Drain	ADA Lever	Luxe Nickel	
226987	65060LF-NKBL	1-Hole, Less Drain	ADA Lever	Luxe Nickel/Matte Black*	
240302	65060LF-RB	1-Hole, Less Drain	ADA Lever	Venetian Bronze	
189088	65061LF-NK	1-Hole, Less Drain Channel Spout	ADA Lever	Luxe Nickel*	
188714	65061LF-NKBL	1-Hole, Less Drain Channel Spout	ADA Lever	Luxe Nickel/Matte Black*	
230915	65061LF-PC	1-Hole, Less Drain Channel Spout	ADA Lever	Chrome	

\* Brilliance® Anti-Tarnish Lifetime Finishes

## Lavatory - Single Hole

### Single-Handle Lavatory Faucets (Continued)

#### Rook™ 1-Hdl Lavatory Faucet

Part #	Mfg #	Description	Handle(s)	Finish	Price
188523	65061LF-RB	1-Hole, Less Drain Channel Spout	ADA Lever	Venetian Bronze®	

#### Siderna® 1-Hdl Lavatory Faucet

- 5" Reach, 8-3/16" high spout
- One hole mount
- Drain sold separately
- WaterSense® certified product: 1.5 gpm @ 60 psi



Part #	Mfg #	Description	Handle(s)	Finish	Price
175549	65080LF-BL	1-Hole, Less Drain	ADA Lever	Matte Black	
143498	65080LF-BN	1-Hole, Less Drain	ADA Lever	Brushed Nickel*	
141650	65080LF-PC	1-Hole, Less Drain	ADA Lever	Chrome	

#### Sotria™ 1-Hdl Lavatory Faucet

- 4-55/64" Reach, 5-5/8" high spout
- 4-9/16" From deck to aerator
- 1/2-14 NPSM threaded inlets
- 1-1/8" Minimum - 1-1/2" maximum hole size
- 3" Maximum deck thickness
- Spout features hidden cache laminar flow
- WaterSense® certified product: 1.5 gpm @ 60 psi



Part #	Mfg #	Description	Handle(s)	Finish	Price
225005	65050LF-PC	1-Hole, Metal Pop-Up Drain	ADA Lever	Chrome	
178247	65050LF-BL	1-Hole, Metal Pop-Up Drain	ADA Lever	Matte Black	
187907	65050LF-NK	1-Hole, Metal Pop-Up Drain	ADA Lever	Polished Nickel*	

#### Sotria™ 1-Hdl Lavatory Faucet with Channel Spout

- 5-19/32" Reach, 5-21/64" high spout
- 3-15/16" From deck to aerator
- 1/2-14 NPSM threaded inlets
- 1-1/8" Minimum - 1-1/2" maximum hole size
- 3" Maximum deck thickness
- WaterSense® certified product: 1.5 gpm @ 60 psi



Part #	Mfg #	Description	Handle(s)	Finish	Price
181996	65051LF-BL	1-Hole, Metal Pop-Up Drain w/ Channel Spout	ADA Lever	Matte Black	
180744	65051LF-PC	1-Hole, Metal Pop-Up Drain w/ Channel Spout	ADA Lever	Chrome	

\* Brilliance® Anti-Tarnish Lifetime Finishes

**www.plumbsupply.com • Serving our Customers Since 1946 • www.waterconcepts.net**



**Lavatory - Single Hole**

**Vettis™ 1-Hdl Lavatory Faucet**

- 6-7/8" Reach, 4-7/8" high spout
- 4" From deck to aerator
- 3" Maximum deck thickness
- Metal pop-up drain included
- 25 mm ceramic disc cartridge
- Hidden laminar flow stream straightener
- Optional red/blue temperature indicating glide ring
- WaterSense® certified product: 1.5 gpm @ 60 psi



Part #	Mfg #	Description	Handle(s)	Finish	Price
243770	65088LF-PC	1-Hole, Metal Pop-Up Drain	ADA Lever	Chrome	

**Vettis™ 1-Hdl Lavatory Faucet**

- 6-7/8" Reach, 4-7/8" high spout
- 4" From deck to aerator
- 3" Maximum deck thickness
- Metal pop-up drain included
- 25 mm ceramic disc cartridge
- Optional red/blue temperature indicating glide ring
- WaterSense® certified product: 1.5 gpm @ 60 psi
- (-ECO) Eco performance flow rate: 1.2 gpm @ 60 psi



Open Channel Spout



Part #	Mfg #	Description	Handle(s)	Finish	Price
251047	65086LF-NKPC-E CO	1-Hole, Metal Pop-Up Drain, Open Channel Spout	ADA Lever	Luxe Nickel/Chrome	
245208	65086LF-PC-ECO	1-Hole, Metal Pop-Up Drain, Open Channel Spout	ADA Lever	Chrome	
247290	65088LF-BL	1-Hole, Metal Pop-Up Drain	ADA Lever	Matte Black	

**Virage® 1-Hdl Lavatory Faucet**

- 6-3/16" Reach, 7-1/16" high spout
- 5-1/8" From deck to aerator
- 3" Maximum deck thickness
- 1/2-14 NPSM threaded inlets
- Hidden water-efficient, laminar flow aerator
- Ceramic disc cartridge with metal stem
- Drain sold separately
- WaterSense certified product: 1.5 gpm @ 60 psi



Part #	Mfg #	Description	Handle(s)	Finish	Price
247306	65030LF-BN	1-Hole, Less Drain	ADA Lever	Brushed Nickel*	
248234	65030LF-PN	1-Hole, Less Drain	ADA Lever	Polished Nickel*	
240343	65030LF-RB	1-Hole, Less Drain	ADA Lever	Venetian Bronze	

\* Brilliance® Anti-Tarnish Lifetime Finishes



## Lavatory - Single Hole

### Two-Handle Lavatory Faucets

#### Loki® 2-Hdl Lavatory Faucet

- 5-13/16" Reach, 8-9/16" high spout
- 120° Swivel spout
- 73/4" From deck to aerator
- Recommended 1-3/8" hole size
- 3-5/16" Maximum deck thickness
- WaterSense® certified product: 1.5 gpm @ 60 psi



Part #	Mfg #	Description	Handle(s)	Finish	Price
131817	65172LF-BN	1-Hole, Metal Pop-Up Drain	ADA Lever	Brushed Nickel*	

### Vessel Faucets

#### Baliza® 1-Hdl Vessel Faucet

- 5-5/16" Reach, 12-5/16" high spout
- Grid strainer with overflow assembly
- 28 mm Ceramic disc cartridge with metal stem
- WaterSense® certified product: 1.5 gpm @ 60 psi



Part #	Mfg #	Description	Handle(s)	Finish	Price
134243	65105LF-RB	1-Hole, Grid Drain w/ Overflow	ADA Lever	Venetian Bronze®	

#### Rook™ 1-Hdl Vessel Faucet

- 5-3/8" Reach, 10-1/4" high rigid spout
- 9-1/16" Spout outlet to deck
- 1/2-14 NPSM threaded inlets
- Ceramic cartridge
- Optional escutcheon (RP80414) available
- 2 1/2 Maximum deck thickness
- Drain sold separately
- Watersense® certified product: 1.5 gpm @ 60 psi



Part #	Mfg #	Description	Handle(s)	Finish	Price
258911	65461LF-GL	1-Hole, Less Drain	ADA Lever	Luxe Gold	
223159	65461LF-NK	1-Hole, Less Drain	ADA Lever	Luxe Nickel*	
259524	65461LF-NKBL	1-Hole, Less Drain	ADA Lever	Luxe Nickel/Matte Black	
185517	65461LF-RB	1-Hole, Less Drain	ADA Lever	Venetian Bronze®	

\* Brilliance® Anti-Tarnish Lifetime Finishes

[www.plumbsupply.com](http://www.plumbsupply.com) • Serving our Customers Since 1946 • [www.waterconcepts.net](http://www.waterconcepts.net)

## Lavatory - Single Hole

### Siderna 1-Hdl Vessel Faucet

- 5" Reach, 12-1/4" high spout
- 1/2-14 NPSM Connection
- 1-1/8" to 1-1/2" Maximum hole size
- 2-1/2" Maximum deck thickness
- Drain sold separately



Part #	Mfg #	Description	Handle(s)	Finish	Price
188671	65480LF-BL	1-Hole, Less Drain	Lever	Matte Black	
155107	65480LF-BN	1-Hole, Less Drain	Lever	Brushed Nickel*	
158284	65480LF-PC	1-Hole, Less Drain	Lever	Chrome	

### Tresa® 1-Hdl Vessel Faucet

- 6-3/4" Reach, 9-3/4" high spout
- Spout features hidden water-efficient aerator
- 2" Maximum deck thickness
- WaterSense® certified product: 1.5 gpm @60 psi
- Drain sold separately



Part #	Mfg #	Description	Handle(s)	Finish	Price
190138	65436LF-PC	1-Hole, Less Drain	ADA Lever	Chrome	
188974	65436LF-PN	1-Hole, Less Drain	ADA Lever	Polished Nickel*	

\* Brilliance® Anti-Tarnish Lifetime Finishes

## Lavatory - Single Hole

### Single-Handle Lavatory Faucets

#### 90 Degree™ 1-Hdl Low Arc Lavatory Faucet

- 4-1/4" Reach, 6-5/16" high spout
- 3-13/16" From deck to aerator
- 3/8" Compression connections
- 1255™ Duralast™ cartridge
- WaterSense® certified: 1.5 gpm



Part #	Mfg #	Description	Handle(s)	Finish	Price
130738	S6700	1-Hole, Metal Pop-Up Drain	ADA Lever	Chrome	
143953	S6700BN	1-Hole, Metal Pop-Up Drain	ADA Lever	Brushed Nickel	

#### 90 Degree™ 1-Hdl Channel Spout Lavatory Faucet

- 4-3/16" Reach, 6-5/16" high spout
- 3-13/16" from deck to aerator
- 3/8" Compression fittings
- 1255™ Duralast™ cartridge
- WaterSense® certified: 1.5 gpm



Part #	Mfg #	Description	Handle(s)	Finish	Price
167270	S6705	1-Hole, Metal Pop-Up Drain	ADA Lever	Chrome	
174373	S6705BN	1-Hole, Metal Pop-Up Drain	ADA Lever	Brushed Nickel	

#### Align™ 1-Hdl Lavatory Faucet

- 5" Reach 6-3/8" Height
- 3-5/16" From deck to aerator
- 3/8" Compression connections
- 1255™ Duralast™ cartridge
- WaterSense® Certified: 1.5 gpm



Part #	Mfg #	Description	Handle(s)	Finish	Price
177515	6190	1- or 3-Hole, Metal Pop-Up Drain	ADA Lever	Chrome	
252821	6190BL	1- or 3-Hole, Metal Pop-Up Drain	ADA Lever	Matte Black	
176388	6190BN	1- or 3-Hole, Metal Pop-Up Drain	ADA Lever	Brushed Nickel	

#### Align™ 1-Hdl Low Arc Lavatory Faucet

- 4.998" Reach, 4.893" high spout
- 3/8" Compression fittings
- Optional 3-hole deck escutcheon available
- 1255™ Duralast™ cartridge
- WaterSense® certified: 1.5 gpm



Part #	Mfg #	Description	Handle(s)	Finish	Price
170256	6191	1- or 3-Hole, Metal Pop-Up Drain	ADA Lever	Chrome	

\*Lifeshine® Anti-Tarnish Lifetime Finish

[www.plumbsupply.com](http://www.plumbsupply.com) • Serving our Customers Since 1946 • [www.waterconcepts.net](http://www.waterconcepts.net)

## Lavatory - Single Hole

### Arris™ 1-Hdl Lavatory Faucet

- 5-1/2" Reach, 6-5/8" high spout
- 5-5/8" From deck to aerator
- 3/8" fittings
- 1255™ Duralast™ cartridge
- WaterSense® certified: 1.5 gpm



Part #	Mfg #	Description	Handle(s)	Finish	Price
160879	S43001	1-Hole, Metal Pop-Up Drain	ADA Lever	Chrome	
214530	S43001BN	1-Hole, Metal Pop-Up Drain	ADA Lever	Brushed Nickel	

### Belfield™ 1-Hdl High Arc Lavatory Faucet

- 5-1/2" Reach, 10-5/8" high spout
- Includes optional 3-hole deck plate
- 1255™ Duralast™ cartridge
- Flexible supply lines with 3/8" compression fittings
- WaterSense certified: 1.2 gpm



Part #	Mfg #	Description	Handle(s)	Finish	Price
239764	6402ORB	1- or 3-Hole, Metal Pop-up Waste Assy	ADA Lever	Oil Rubbed Bronze	

### Brantford™ 1-Hdl Low Arc Lavatory Faucet

- 4-7/8" Reach, 6-5/8" high spout
- 4-13/16" From deck to aerator
- 3/8" Connections with flexible supplies
- 1255™ Duralast™ cartridge
- Escutcheon for 3-hole application included
- WaterSense® certified: 1.5 gpm



Part #	Mfg #	Description	Handle(s)	Finish	Price
124008	6600	1- or 3-Hole, Metal Waste	ADA Lever	Chrome	
124009	6600BN	1- or 3-Hole, Metal Waste	ADA Lever	Brushed Nickel	
122466	6600ORB	1- or 3-Hole, Metal Waste	ADA Lever	Oil Rubbed Bronze	

### Chateau® 1-Hdl Lavatory Faucet

- 4-3/8" Reach
- 2" From deck to aerator
- 1/2" IPS Connections
- 1255™ Duralast™ cartridge
- WaterSense® certified: 1.5 gpm



L4621



Part #	Mfg #	Description	Handle(s)	Finish	Price
177165	L4605	4" cc Less Drain	ADA Lever	Chrome	
017155	L4621	4"cc, Drain	ADA Lever	Chrome	
020083	L4621P	4"cc, Drain	ADA Lever	Polished Brass	

\*Lifeshine® Anti-Tarnish Lifetime Finish

[www.waterconcepts.net](http://www.waterconcepts.net) • **Serving our Customers Since 1946** • [www.plumbsupply.com](http://www.plumbsupply.com)

## Lavatory - Single Hole

### Single-Handle Lavatory Faucets (Continued)

#### Chateau® 1-Hdl Lavatory Faucet

Part #	Mfg #	Description	Handle(s)	Finish	Price
084503	L4621BC	4"cc, 50/50 Drain	ADA Lever	Chrome	
020082	L4625	4"cc, Drain, 3/8" x 16" Tubing	ADA Lever	Chrome	
120610	L64624	4"cc, Drain, 3/8" x 16" Tubing, Bulk (12/Pk)	ADA Lever	Chrome	
191634	64621	4"cc, 50/50 Drain	Acrylic Knob	Chrome	

#### Chateau® 1-Hdl Lavatory Faucet

- 4-3/8" Reach, 5-3/4" high spout
- 2" From deck to aerator
- Acrylic knob handle, tilt-on/tilt-off
- 3/8" Compression fittings
- 1255™ Duralast™ cartridge



Part #	Mfg #	Description	Handle(s)	Finish	Price
029189	64625	3-Hole, 50/50 Waste Assembly	Acrylic Knob	Chrome	

#### Doux™ 1-Hdl High Arc Lavatory Faucet Valve

- 5-1/4" Reach, 4-1/2" high spout
- 3/8" IPS Connections
- 1255™ Duralast™ cartridge
- Escutcheon for 3-hole application included
- WaterSense® certified: 1.2 gpm



Part #	Mfg #	Description	Handle(s)	Finish	Price
253203	S6910BL	1- or 3-Hole, Metal Pop-Up Waste	ADA Lever	Matte Black	

#### Eva™ 1-Hdl High Arc Lavatory Faucet Valve and Trim

- 5-1/16" Reach, 6-5/8" high spout
- 4-7/8" From deck to aerator
- 3/8" IPS Connections
- 1255™ Duralast™ cartridge
- Escutcheon for 3-hole application included
- WaterSense® certified: 1.5 gpm



Part #	Mfg #	Description	Handle(s)	Finish	Price
124010	6400	1-Hole, Pop-Up Drain	ADA Lever	Chrome	
123689	6400BN	1-Hole, Pop-Up Drain	ADA Lever	Brushed Nickel	
122464	6400ORB	1-Hole, Pop-Up Drain	ADA Lever	Oil Rubbed Bronze	

\*Lifeshine® Anti-Tarnish Lifetime Finish

[www.plumbsupply.com](http://www.plumbsupply.com) • Serving our Customers Since 1946 • [www.waterconcepts.net](http://www.waterconcepts.net)

## Lavatory - Single Hole

### Genta™ 1-Hdl Lavatory Faucet

- 4-9/16" Reach, 8-1/2" high spout
- 4-1/16" From deck to aerator
- 3/8" Compression fittings
- 1255™ Duralast™ cartridge
- Escutcheon for 3-hole application included
- WaterSense® certified: 1.2 gpm



Part #	Mfg #	Description	Handle(s)	Finish	Price
236519	6702	1-Hole, Metal Pop-Up Drain	ADA Lever	Chrome	

### Gibson™ 1-Hdl Lavatory Faucet

- 6-7/16" Reach, 7-15/16" high spout
- 3/8" Compression fittings
- 1255™ Duralast™ cartridge
- Metal pop-up drain included
- Includes optional 3-hole escutcheon
- WaterSense® certified: 1.2 gpm



Part #	Mfg #	Description	Handle(s)	Finish	Price
243059	6145	1- or 3-Hole, Metal Pop-Up Drain	ADA Lever	Chrome	

### Icon™ 1-Hdl Lavatory Faucet

- 5" Reach, 8-1/2" high spout
- 4" From deck to aerator
- 3/8" Compression fittings
- 1255™ Duralast™ cartridge
- Escutcheon for 3-hole application included
- WaterSense® certified: 1.2 gpm



Part #	Mfg #	Description	Handle(s)	Finish	Price
102249	S6500	1- or 3-Hole, Metal Pop-Up Drain	ADA Lever	Chrome	
102250	S6500BN	1- or 3-Hole, Metal Pop-Up Drain	ADA Lever	Brushed Nickel	

\*Lifeshine® Anti-Tarnish Lifetime Finish

[www.waterconcepts.net](http://www.waterconcepts.net) • Serving our Customers Since 1946 • [www.plumbsupply.com](http://www.plumbsupply.com)



## Lavatory - Single Hole

### Kingsley™ 1-Hdl Lavatory Faucet

- 5.309" Reach
- 3" From deck to aerator
- 3/8" Compression fittings
- 1255™ Duralast™ cartridge
- Escutcheon for 3-hole application included
- WaterSense® certified: 1.5 gpm



Part #	Mfg #	Description	Handle(s)	Finish	Price
094153	6102	1- or 3-Hole, Metal Pop-Up Drain	ADA Lever	Chrome	
082932	6102BN	1- or 3-Hole, Metal Pop-Up Drain	ADA Lever	Brushed Nickel	
076542	6102ORB	1- or 3-Hole, Metal Pop-Up Drain	ADA Lever	Oil Rubbed Bronze	
161363	6102P	1- or 3-Hole, Metal Pop-Up Drain	ADA Lever	Polished Brass	
087278	6102WR	1- or 3-Hole, Metal Pop-Up Drain	ADA Lever	Wrought Iron	

### Method™ 1-Hdl Lavatory Faucet

- 3" Reach, 4-1/4" spout height
- 3-1/2" From deck to aerator
- 3/8" Compression fittings
- 1255™ Duralast™ cartridge
- Escutcheon for 3-hole application included
- WaterSense® certified: 1.5gpm



Part #	Mfg #	Description	Handle(s)	Finish	Price
137865	6810	1- or 3-hole, Metal Pop-Up Drain	ADA Lever	Chrome	
134861	6810BN	1- or 3-hole, Metal Pop-Up Drain	ADA Lever	Brushed Nickel	

### Rizon 1-Hdl Low Arc Lavatory Faucet

- 4-7/32" Reach, 6-1/4" high spout
- 3-27/64" From deck to aerator
- 3/8" Compression fittings
- 1255™ Duralast™ cartridge
- Escutcheon for 3-hole application included
- WaterSense® certified: 1.5 gpm



Part #	Mfg #	Description	Handle(s)	Finish	Price
178140	6900	1-Hole, Metal Pop-Up Drain	ADA Lever	Chrome	
242325	6900BN	1-Hole, Metal Pop-Up Drain	ADA Lever	Brushed Nickel	

\*Lifeshine® Anti-Tarnish Lifetime Finish

[www.plumbsupply.com](http://www.plumbsupply.com) • Serving our Customers Since 1946 • [www.waterconcepts.net](http://www.waterconcepts.net)

## Lavatory - Single Hole

### Rothbury™ 1-Hdl Lavatory Faucet

- 5/16" Reach, 3-3/16" high spout
- 2-1/16" From deck to aerator
- 3/8" Flexible supply lines
- 1255™ Duralast™ cartridge
- Escutcheon for 3-Hole application included
- WaterSense® certified: 1.5 gpm



Part #	Mfg #	Description	Handle(s)	Finish	Price
124011	S6202	1- or 2-Hole, Pop-Up Drain	ADA Lever	Chrome	
124012	S6202BN	1- or 2-Hole, Pop-Up Drain	ADA Lever	Brushed Nickel	
124013	S6202ORB	1- or 2-Hole, Pop-Up Drain	ADA Lever	Oil Rubbed Bronze	

### Voss™ 1-Hdl Lavatory Faucet

- 4-5/8" Reach
- 4-11/16" From deck to aerator
- 3/8" Compression fittings
- 1255™ Duralast™ cartridge
- Escutcheon for 3-hole application included
- WaterSense® certified: 1.5 gpm



Part #	Mfg #	Description	Handle(s)	Finish	Price
150545	6903	1- or 3-Hole, Metal Pop-Up Drain	ADA Lever	Chrome	
151188	6903BN	1- or 3-Hole, Metal Pop-Up Drain	ADA Lever	Brushed Nickel	
153393	6903ORB	1- or 3-Hole, Metal Pop-Up Drain	ADA Lever	Oil Rubbed Bronze	

### Weymouth™ 1-Hdl Lavatory Faucet

- 5-1/2" Reach
- 5-1/4" From deck to aerator
- 3/8" Compression fittings
- 1255™ Duralast™ cartridge
- WaterSense® certified: 1.5 gpm



Part #	Mfg #	Description	Handle(s)	Finish	Price
225651	S42107NL	1- or 3-Hole, Metal Pop-Up Drain	ADA Lever	Polished Nickel	

### Waterhill™ 1-Hdl Lavatory Faucet

- 5-3/8" Reach
- 4-5/32" From deck to aerator
- 1/2" IPS connections will accept standard ball nose connection for 3/8" tubing
- 1255™ Duralast™ cartridge
- Escutcheon for 3-hole application included
- WaterSense® certified: 1.5 gpm



Part #	Mfg #	Description	Handle(s)	Finish	Price
109169	S411	1- or 3-Hole, Metal Pop-Up Drain	ADA Lever	Chrome	

\*Lifeshine® Anti-Tarnish Lifetime Finish

[www.waterconcepts.net](http://www.waterconcepts.net) • Serving our Customers Since 1946 • [www.plumbsupply.com](http://www.plumbsupply.com)

## Lavatory - Single Hole

### Single-Handle Lavatory Faucets (Continued)

#### Waterhill™ 1-Hdl Lavatory Faucet

Part #	Mfg #	Description	Handle(s)	Finish	Price
083439	S411BN	1- or 3-Hole, Metal Pop-Up Drain	ADA Lever	Brushed Nickel	
102921	S411ORB	1- or 3-Hole, Metal Pop-Up Drain	ADA Lever	Oil Rubbed Bronze	

#### Wynford™ 1-Hdl Lavatory Faucet

- 4-5/8" Reach
- 5" From deck to aerator
- 3/8" Compression fittings
- 1255™ Duralast™ cartridge
- Escutcheon for 3-hole application included
- WaterSense® certified: 1.5 gpm



Part #	Mfg #	Description	Handle(s)	Finish	Price
186314	4500	1- or 3-Hole, Metal Pop-Up Drain	ADA Lever	Chrome	
185269	4500BN	1- or 3-Hole, Metal Pop-Up Drain	ADA Lever	Brushed Nickel	
218319	4500ORB	1- or 3-Hole, Metal Pop-Up Drain	ADA Lever	Oil Rubbed Bronze	

### Vessel Faucets

#### 90 Degree™ 1-Hdl Vessel Faucet

- 4-1/4" Reach, 12-11/16" Height
- 9-1/8" From deck to aerator
- 3/8" Compression connections
- 1255™ Duralast™ cartridge
- WaterSense® certified: 1.5 gpm



Part #	Mfg #	Description	Handle(s)	Finish	Price
127409	S6711	1-Hole, Less Drain	ADA Lever	Chrome	
141003	S6711BN	1-Hole, Less Drain	ADA Lever	Brushed Nickel	

\*Lifeshine® Anti-Tarnish Lifetime Finish

[www.plumbsupply.com](http://www.plumbsupply.com) • Serving our Customers Since 1946 • [www.waterconcepts.net](http://www.waterconcepts.net)

## Lavatory - Single Hole

### Align™ 1-Hdl Vessel Faucet

- 4-1/2" Reach, 12-3/32" high spout
- 9" From deck to aerator
- 3/8" Compression fittings
- 1255™ Duralast® cartridge
- WaterSense® certified: 1.5 gpm
- Drain sold separately: 140780



Part #	Mfg #	Description	Handle(s)	Finish	Price
190197	6192BN	1- or 3-Hole, Metal Pop-Up Drain	ADA Lever	Brushed Nickel	

### Wynford™ 1-Hdl Vessel Faucet

- 5-1/4" Reach, 10-3/4" high spout
- 9" From deck to aerator
- 3/8" Compression fittings
- 1255™ Duralast™ cartridge
- WaterSense® certified: 1.2 gpm



Part #	Mfg #	Description	Handle(s)	Finish	Price
251528	4507	1-Hole	ADA Lever	Chrome	
220143	4507BN	1-Hole	ADA Lever	Brushed Nickel	
181281	4507ORB	1-Hole	ADA Lever	Oil Rubbed Bronze	

\*Lifeshine® Anti-Tarnish Lifetime Finish

[www.waterconcepts.net](http://www.waterconcepts.net) • Serving our Customers Since 1946 • [www.plumbsupply.com](http://www.plumbsupply.com)

## Lavatory - Single Hole

### Single-Handle Lavatory Faucets

#### P4C Classic Series 1-Hdl Lavatory Faucet

- *Stainless steel ball valve*
- *Max flow rate: 1.5 gpm @ 60 psi*
- *-CL = Less Drain*



Part #	Mfg #	Description	Handle(s)	Finish	Price
141391	P4C-500C	4"cc, Brass Pop-Up Drain	ADA Metal Lever	Chrome	
155686	P4C-500CL	4"cc, Less Pop-Up Drain	ADA Metal Lever	Chrome	
141392	P4C-500BN	4"cc, Brass Pop-Up Drain	ADA Metal Lever	Brushed Nickel	

#### P4B Builder Series 1-Hdl Lavatory Faucet

- *Ceramic cartridges*
- *Brass Pop-Up*
- *Optional escutcheon plate included*
- *Max flow rate: 1.2 gpm @ 60 psi*



Part #	Mfg #	Description	Handle(s)	Finish	Price
234725	P4B-500C	1- or 3-Hole, Brass Pop-Up Drain	ADA Metal Lever	Chrome	
234726	P4B-500BN	1- or 3-Hole, Brass Pop-Up Drain	ADA Metal Lever	Brushed Nickel	
234727	P4B-500ORB	1- or 3-Hole, Brass Pop-Up Drain	ADA Metal Lever	Oil Rubbed Bronze	

#### P4H 1-Hdl Lavatory Faucet

- *Ceramic cartridge*
- *Brass pop-up drain*
- *Optional deck plate included*
- *Max flow rate: 1.2 gpm @ 60 psi*



Part #	Mfg #	Description	Handle(s)	Finish	Price
242717	P4H-500C	1- or 3-Hole, Brass Pop-Up Drain	ADA Metal Lever	Chrome	
242712	P4H-500BN	1- or 3-Hole, Brass Pop-Up Drain	ADA Metal Lever	Brushed Nickel	

## Lavatory Faucets - 4" Center

### Single-Handle Lavatory Faucets

#### Artifacts® Gentleman's Lavatory Faucet for 4" Centers with Pop-Up Drain and Tailpiece

- 7-5/16" Spout reach
- Temperature memory
- High-temperature limit setting
- Leak-free ceramic disc valves
- WaterSense certified: 1.2 gpm @ 60 psi



Part #	Mfg #	Description	Handle(s)	Finish	Price
247731	K-72763-9M-BN	4"cc, Metal Pop-Up, 1.2 gpm	Lever	*Brushed Nickel	
247734	K-72763-9M-2BZ	4"cc, Metal Pop-Up, 1.2 gpm	Lever	Oil Rubbed Bronze	

#### Coralais® Lavatory Faucet for 4" Centers with Pop-Drain, Lift Rod, Tailpiece, and Lever Handle

- 4-3/16" Stationary spout reach
- Solid brass construction
- Red/blue indexing on handle
- Temperature memory
- Flexible connections
- One-piece, self-contained ceramic disc valve
- Maximum flow rate: 1.2 gpm @ 60 psi  
—0.5 gpm for (K-15198-4RA-CP) model
- Model **(K-15198-4RA-CP)** includes metal throat plate and vandal-resistant aerator
- (-P) Project pack (six per case)



#### Metal Pop-Up Drain

Part #	Mfg #	Description	Handle(s)	Finish	Price
253775	K-15182-4NDRA-C P	4"cc, Less Drain, 1.2 gpm	ADA Lever	Polished Chrome	
257685	K-15182-4NDRA-G	4"cc, Less Drain, 1.2 gpm	ADA Lever	Brushed Chrome	
223147	K-15182-4RA-CP	4"cc, Metal Pop-Up, 1.2 gpm	ADA Lever	Polished Chrome	
223148	K-15182-4RA-G	4"cc, Metal Pop-Up, 1.2 gpm	ADA Lever	Brushed Chrome	
232103	K-P15182-4RA-CP	4"cc, Metal Pop-Up, 1.2 gpm, Project Pack	ADA Lever	Polished Chrome	

#### Plastic Pop-Up Drain

Part #	Mfg #	Description	Handle(s)	Finish	Price
223149	K-15182-4DRA-CP	4"cc, Plastic Pop-Up, 1.2 gpm	ADA Lever	Polished Chrome	
223150	K-15182-4DRA-G	4"cc, Plastic Pop-Up, 1.2 gpm	ADA Lever	Brushed Chrome	

#### Grid Drain with Tailpiece

Part #	Mfg #	Description	Handle(s)	Finish	Price
102721	K-15198-4RA-CP	4"cc, Grid Drain, 0.5 gpm	ADA Lever	Polished Chrome	

\* Vibrant Limited Lifetime Warranty

[www.waterconcepts.net](http://www.waterconcepts.net) • Serving our Customers Since 1946 • [www.plumbsupply.com](http://www.plumbsupply.com)



## Lavatory Faucets - 4" Center

### Two-Handle Lavatory Faucets

#### Alteo® Lavatory Faucet for 4" Centers with Pop-Up Drain, Tailpiece, and Lever Handles

- 5" Reach spout
- Metal construction
- 1/4-Turn washerless ceramic disc valves
- Integrated supply hoses with 3/8" compression connection
- WaterSense® certified product: 1.2 gpm



Part #	Mfg #	Description	Handle(s)	Finish	Price
149113	K-45100-4-2BZ	4"cc, Pop-Up Drain with Tailpiece	ADA Lever	Oil Rubbed Bronze	
141714	K-45100-4-BN	4"cc, Pop-Up Drain with Tailpiece	ADA Lever	*Brushed Nickel	
141713	K-45100-4-CP	4"cc, Pop-Up Drain with Tailpiece	ADA Lever	Polished Chrome	

#### Archer® Lavatory Faucet for 4" Centers with Pop-Up Drain, Tailpiece, and Lever Handles

- 4" Reach spout
- Brass construction
- 1/4-Turn washerless ceramic disc valves
- WaterSense® certified product: 1.5 gpm



Part #	Mfg #	Description	Handle(s)	Finish	Price
120240	K-11075-4-BN	4"cc, Pop-Up Drain with Tailpiece	ADA Lever	*Brushed Nickel	
109875	K-11075-4-CP	4"cc, Pop-Up Drain with Tailpiece	ADA Lever	Polished Chrome	

#### Coralais® Lavatory Faucet for 4" Centers with Metal Pop-Drain, Lift Rod, Tailpiece, and Lever Handles

- 4-7/16" Stationary spout reach
- Solid metal construction
- Red/blue indexing on handle
- One-piece, self-contained ceramic disc valve



#### Metal Pop-Up Drain

Part #	Mfg #	Description	Handle(s)	Finish	Price
223151	K-15241-4RA-CP	4"cc, Metal Pop-Up & Lift Rod, 1.2 gpm	ADA Lever	Polished Chrome	
223152	K-15241-4RA-G	4"cc, Metal Pop-Up & Lift Rod, 1.2 gpm	ADA Lever	Brushed Chrome	

#### Plastic Pop-Up Drain

Part #	Mfg #	Description	Handle(s)	Finish	Price
223153	K-15241-4DRA-CP	4"cc, Plastic Pop-Up & Lift Rod, 1.2 gpm	ADA Lever	Polished Chrome	
223154	K-15241-4DRA-G	4"cc, Plastic Pop-Up, Lift Rod, 1.2 gpm	ADA Lever	Brushed Chrome	
233112	K-P15241-4DRA-C P	4"cc, Plastic Pop-Up & Lift Rod, 1.2 gpm	ADA Lever	Polished Chrome	

#### Grid Drain

Part #	Mfg #	Description	Handle(s)	Finish	Price
228127	K-15243-4RA-CP	4"cc, Grid Drain & Lift Rod, 0.5 gpm	ADA Lever	Polished Chrome	

\* Vibrant Limited Lifetime Warranty

[www.plumbsupply.com](http://www.plumbsupply.com) • Serving our Customers Since 1946 • [www.waterconcepts.net](http://www.waterconcepts.net)

## Lavatory Faucets - 4" Center

### Coralais® Lavatory Faucet for 4" Centers with Plug for Lift Rod Hole and Lever Handles—Less Drain

- 4-7/16" Stationary spout reach
- Solid metal construction
- Ceramic disc valves
- Red/blue indexing on handle
- Vandal-resistant aerator
- Maximum flow rate: 0.5 gpm



Part #	Mfg #	Description	Handle(s)	Finish	Price
227922	K-15240-4NDRA-C P	4"cc, Vandal-Resistant .5gpm Aerator, Less Drain	ADA Lever	Polished Chrome	

### Devonshire® Lavatory Faucet for 4" Centers with Pop-Up Drain, Tailpiece, Lift Rod, and Lever Handles

- 4-3/4" Reach spout
- Metal construction
- Brass valve bodies
- 1/4-Turn washerless ceramic disc valves
- Meets EPA WaterSense® criteria



Part #	Mfg #	Description	Handle(s)	Finish	Price
122023	K-393-N4-BN	4"cc, Pop-Up Drain with Lift Rod & Tailpiece	ADA Lever	*Brushed Nickel	
086605	K-393-N4-BV	4"cc, Pop-Up Drain with Lift Rod & Tailpiece	ADA Lever	*Brushed Bronze	
122018	K-393-N4-CP	4"cc, Pop-Up Drain with Lift Rod & Tailpiece	ADA Lever	Polished Chrome	
088698	K-393-N4-PB	4"cc, Pop-Up Drain with Lift Rod & Tailpiece	ADA Lever	*Polished Brass	
188708	K-393-N4-SN	4"cc, Pop-Up Drain with Lift Rod & Tailpiece	ADA Lever	*Polished Nickel	
146968	K-393-N4-2BZ	4"cc, Pop-Up Drain with Lift Rod & Tailpiece	ADA Lever	Oil Rubbed Bronze	

### Fairfax® 2-Hdl Lavatory Faucet for 4" Centers with Pop-Up Drain, Tailpiece, Lift Rod, and Lever Handles

- 4-1/2" Spout reach
- Metal construction.
- Brass valve bodies.
- Quarter-turn washerless ceramic disc valves
- Maximum flow rate: 1.2 gpm @ 60 psi



Part #	Mfg #	Description	Handle(s)	Finish	Price
075675	K-12266-4-BN	4"cc, 4-1/2" Reach Spout	ADA Lever	*Brushed Nickel	
075672	K-12266-4-CP	4"cc, 4-1/2" Reach Spout	ADA Lever	Polished Chrome	
135656	K-12266-4-2BZ	4"cc, 4-1/2" Reach Spout	ADA Lever	Oil Rubbed Bronze	

\* Vibrant Limited Lifetime Warranty

[www.waterconcepts.net](http://www.waterconcepts.net) • Serving our Customers Since 1946 • [www.plumbsupply.com](http://www.plumbsupply.com)

## Lavatory Faucets - 4" Center

### Forté® 2-Hdl Lavatory Faucet for 4" Centers with Metal Pop-Up Drain, Tailpiece, and Lever Handles

- 5-1/8" Stationary spout reach
- Metal construction, brass valve bodies
- Reversible quarter-turn washerless ceramic disc valves
- Flexible connections
- Maximum flow rate: 1.5 gpm
- Meets EPA WaterSense® criteria



**K-10270-4**  
Sculptured



**K-10270-4A**  
Traditional



Part #	Mfg #	Description	Handle(s)	Finish	Price
071894	K-10270-4-BN	4"cc, Metal Drain	ADA Sculptured Lever	*Brushed Nickel	
071117	K-10270-4-CP	4"cc, Metal Drain	ADA Sculptured Lever	Polished Chrome	
076726	K-10270-4-G	4"cc, Metal Drain	ADA Sculptured Lever	Brushed Chrome	
072093	K-10270-4A-BN	4"cc, Metal Drain	ADA Traditional Lever	*Brushed Nickel	
073409	K-10270-4A-CP	4"cc, Metal Drain	ADA Traditional Lever	Polished Chrome	
072794	K-10270-4A-G	4"cc, Metal Drain	ADA Traditional Lever	Brushed Chrome	

### Kelston® Lavatory Faucet for 4" Centers with Metal Pop-Up Drain, Tailpiece, and Lever Handles

- 4-1/2" Reach spout
- Brass construction
- 1/4-Turn washerless ceramic disc valves
- WaterSense® certified product: 1.5 gpm



Part #	Mfg #	Description	Handle(s)	Finish	Price
136351	K-13490-4-BN	4"cc, Metal Drain	ADA Lever	*Brushed Nickel	
132069	K-13490-4-CP	4"cc, Metal Drain	ADA Lever	Polished Chrome	
146988	K-13490-4-2BZ	4"cc, Metal Drain	ADA Lever	Oil Rubbed Bronze	

### Refinia® Lavatory Faucet for 4" Centers with Pop-Up Drain, Tailpiece, and Lever Handles

- 4-1/2" Spout reach
- Metal construction
- 1/4-Turn washerless ceramic disc valves
- Integrated supply hoses with 3/8" compression connection
- WaterSense® certified product 1.5 gpm



Part #	Mfg #	Description	Handle(s)	Finish	Price
141699	K-5316-4-BN	4"cc, Pop-Up Drain with Tailpiece	ADA Lever	*Brushed Nickel	
141039	K-5316-4-CP	4"cc, Pop-Up Drain with Tailpiece	ADA Lever	Polished Chrome	

\* Vibrant Limited Lifetime Warranty

**www.plumbsupply.com • Serving our Customers Since 1946 • www.waterconcepts.net**

## Lavatory Faucets - 4" Center

### Revival® Centerset Lavatory Faucet for 4" Centers with Metal Pop-Up Drain, Lift Rod & Tailpiece

- 5-1/4" Reach spout
- Brass construction, brass valve bodies
- Quarter-turn washerless ceramic disc valves
- Maximum flow rate: 1.2 gpm
- Meets EPA WaterSense® criteria



Part #	Mfg #	Description	Handle(s)	Finish	Price
060858	K-16100-4A-BN	4"cc, Metal Drain	ADA Traditional Lever	*Brushed Nickel	
088760	K-16100-4A-PB	4"cc, Metal Drain	ADA Traditional Lever	*Polished Brass	

\* Vibrant Limited Lifetime Warranty

[www.waterconcepts.net](http://www.waterconcepts.net) • Serving our Customers Since 1946 • [www.plumbsupply.com](http://www.plumbsupply.com)

## Lavatory Faucets - 4" Center

### Single-Handle Lavatory Faucets

#### Classic C-Spout 1-Hdl Centerset Lavatory Faucet

- 5-1/2" Reach, 5-9/16" high rigid spout
- Red/blue indicator
- 14" flexible supplies with 3/8" compression fittings
- Ceramic cartridge with temperature limit stop
- (1-Hole): 2-1/4" deck to aerator and 2" max. deck thickness
- (3-Hole): 2-1/2" deck to aerator and 1-3/4" max. deck thickness
- Optional escutcheon included
- WaterSense® certified product, 1.5 gpm @ 60 psi



Part #	Mfg #	Description	Handle(s)	Finish	Price
127740	583LF-W	1- or 3-Hole 4"cc, 50/50 Pop-Up Drain, Lead-Free	ADA Lever	Chrome	
127741	583LF-SSWF	1- or 3-Hole 4"cc, 50/50 Pop-Up Drain, Lead-Free	ADA Lever	Stainless*	

#### Classic 1-Hdl Centerset Lavatory Faucet

- 5" Reach, 4-7/8" high rigid spout
- 1-11/16" From deck to aerator
- DIAMOND™ valve
- 3/8" Compression fittings
- 2" Maximum deck thickness
- 32" Minimum InnoFlex® supply lines below deck included
- WaterSense® certified product: 1.2 gpm @ 60 psi
- No lift rod hole (501)  
50/50 Pop-Up (520-DST)  
Metal Pop-Up (520-MPU-DST)  
Plastic Pop-Up (520-PPU-DST)



520-DST



522-DST



Part #	Mfg #	Description	Handle(s)	Finish	Price
127072	500-DST	3-Hole 4"cc, Lift-Rod Hole, Lead-Free	ADA Lever	Chrome	
127928	501-DST	3-Hole 4"cc, No Lift-Rod Hole, Lead-Free	ADA Lever	Chrome	
239497	501-HGM-DST	2-Hole 4"cc, Metal Pop-up Drain	ADA Lever	Chrome	
156696	501LF-WF	2-or3-Hole 4"cc, No Lift-Rod Hole, Lead-Free	ADA Lever	Chrome	
128275	520-TPM-DST	3-Hole 4"cc, Metal Pop-Up Drain, Tract-Pack, Lead-Free	ADA Lever	Chrome	
191968	520-TP-DST	3-Hole 4"cc, Tract-Pack, Lead-Free	ADA Lever	Chrome	
152145	520-DST	3-Hole 4"cc, 50/50 Pop-Up Drain, Lead-Free	ADA Lever	Chrome	
119503	520-MPU-DST	3-Hole 4"cc, Metal Pop-Up Drain, Lead-Free	ADA Lever	Chrome	
121837	520-SSMPU-DST	3-Hole 4"cc, Metal Pop-Up Drain, Lead-Free	ADA Lever	Stainless*	
130362	520-SSPPU-DST	3-Hole 4"cc, Plastic Pop-Up Drain, Lead-Free	ADA Lever	Stainless*	
127185	522-MPU-DST	3-Hole 4"cc, Metal Pop-Up Drain, Lead-Free	Clear Knob	Chrome	

\* Brilliance® Anti-Tarnish Lifetime Finishes

[www.plumbsupply.com](http://www.plumbsupply.com) • Serving our Customers Since 1946 • [www.waterconcepts.net](http://www.waterconcepts.net)

## Lavatory Faucets - 4" Center

### Foundations® Core-B 1-Hdl Centerset Lavatory Faucet

- 4-1/4" Reach, 5-7/16" high rigid spout
- 2-1/16" From deck to aerator
- Red/blue indicator
- 1/2" IPS connection
- 1/4" Threaded mounting studs
- 1-1/8" Maximum deck thickness
- WaterSense® certified product, 1.5 gpm @ 60 psi
- Less Pop-Up (B501LF)
- Metal Pop-Up (B510LF, B512LF)
- Models with "LH" no drain and no lift rod hole



B501



B510



Part #	Mfg #	Description	Handle(s)	Finish	Price
140909	B501LF	3-Hole 4"cc, less Pop-Up, Lead-Free	ADA Lever	Chrome	
216675	B501LF-LH	3-Hole 4"cc, less Pop-Up, Lead-Free	ADA Lever	Chrome	
130713	B510LF	3-Hole 4"cc, Metal Pop-Up, Lead-Free	ADA Lever	Chrome	
134117	B510LF-SS	3-Hole 4"cc, Metal Pop-Up, Lead-Free	ADA Lever	Stainless*	
130007	B512LF	3-Hole 4"cc, Metal Pop-Up, Lead-Free	Clear Knob	Chrome	

### Two-Handle Lavatory Faucets

#### Addison™ 2-Hdl Centerset Lavatory Faucet

- 5" Reach, 7" high rigid spout
- 4-7/8" From deck to aerator
- 3/8" Compression fittings
- 2-1/4" Maximum deck thickness
- 3/2" Minimum InnoFlex® supply lines below the deck included
- DIAMOND™ Valve
- WaterSense® Certified product, 1.2 gpm @ 60 psi



Part #	Mfg #	Description	Handle(s)	Finish	Price
162736	2592-CZMPU-DST	3-Hole 4"cc, Metal Pop-Up Drain, Lead-Free	ADA Lever	Champagne Bronze™	
153046	2592-MPU-DST	3-Hole 4"cc, Metal Pop-Up Drain, Lead-Free	ADA Lever	Chrome	
153047	2592-RBMPU-DST	3-Hole 4"cc, Metal Pop-Up Drain, Lead-Free	ADA Lever	Venetian Bronze®	
153049	2592-SSMPU-DST	3-Hole 4"cc, Metal Pop-Up Drain, Lead-Free	ADA Lever	Stainless*	

\* Brilliance® Anti-Tarnish Lifetime Finishes



## Lavatory Faucets - 4" Center

### Ashlyn™ 2-Hdl Centerset Lavatory Faucet

- 5-1/16" Reach, 5-9/16" high rigid spout
- 4-9/16" From deck to aerator
- Red/blue indicator
- 1-1/4" Minimum clearance to backsplash
- 3/8" Compression fittings
- 2-1/4" Maximum deck thickness
- 3/2" Minimum InnoFlex® supply lines below the deck [
- DIAMOND™ Valve
- WaterSense® certified product: 1.2 gpm @ 60 psi



Part #	Mfg #	Description	Handle(s)	Finish	Price
170825	2564-MPU-DST	3-Hole 4"cc, Metal Pop-Up Drain, Lead-Free	ADA Lever	Chrome	
172088	2564-RBMPU-DST	3-Hole 4"cc, Metal Pop-Up Drain, Lead-Free	ADA Lever	Venetian Bronze®	
170524	2564-SSMPU-DST	3-Hole 4"cc, Metal Pop-Up Drain, Lead-Free	ADA Lever	Stainless*	

### Cassidy™ 2-Hdl Centerset Lavatory Faucet

- 5-13/32" Reach, 6-1/4" high rigid spout
- 4-25/32" From deck to aerator
- 1/2" IPS Connection
- 1-5/8" Maximum deck thickness
- WaterSense® certified product: 1.2 gpm @60 psi
- (-LHP) Less handle package



Part #	Mfg #	Description	Handle(s)	Finish	Price
152739	2597LF-CZMPU	3-Hole 4"cc, Metal Pop-Up Drain, Lead Free	ADA Lever	Champagne Bronze™	
152760	2597LF-CZMPU-LHP	3-Hole 4"cc, Metal Pop-Up Drain, Lead Free	Less Handles	Champagne Bronze™	
152737	2597LF-MPU	3-Hole 4"cc, Metal Pop-Up Drain, Lead Free	ADA Lever	Chrome	
152168	2597LF-MPU-LHP	3-Hole 4"cc, Metal Pop-Up Drain, Lead Free	Less Handles	Chrome	
153342	2597LF-PNMPU	3-Hole 4"cc, Metal Pop-Up Drain, Lead Free	ADA Lever	Polished Nickel*	
185454	2597LF-PNMPU-LHP	3-Hole 4"cc, Metal Pop-Up Drain, Lead Free	Less Handles	Polished Nickel	
152741	2597LF-RBMPU	3-Hole 4"cc, Metal Pop-Up Drain, Lead Free	ADA Lever	Venetian Bronze®	
152761	2597LF-RBMPU-LHP	3-Hole 4"cc, Metal Pop-Up Drain, Lead Free	Less Handles	Venetian Bronze®	
152742	2597LF-SSMPU	3-Hole 4"cc, Metal Pop-Up Drain, Lead Free	ADA Lever	Stainless*	
152762	2597LF-SSMPU-LHP	3-Hole 4"cc, Metal Pop-Up Drain, Lead Free	Less Handles	Stainless*	

### Classic 2-Hdl Centerset Lavatory Faucet

- 5-1/4" Reach, 3-1/4" high rigid spout
- 2" From deck to aerator
- 1/2" IPS Connection
- 1-9/16" Maximum deck thickness
- Hot/cold indicators
- WaterSense® certified product, 1.2 gpm @ 60 psi
- Metal Pop-Up (2520LF)  
Less Pop-Up (2500LF, 2510LF, 2502LF, 2512LF)



Part #	Mfg #	Description	Handle(s)	Finish	Price
146034	2500LF	2-or 3-Hole 4"cc, Less Pop-Up, Lead-Free	ADA Blade	Chrome	

\* Brilliance® Anti-Tarnish Lifetime Finishes

[www.plumbsupply.com](http://www.plumbsupply.com) • Serving our Customers Since 1946 • [www.waterconcepts.net](http://www.waterconcepts.net)

## Lavatory Faucets - 4" Center

### Two-Handle Lavatory Faucets (Continued)

#### Classic 2-Hdl Centerset Lavatory Faucet

Part #	Mfg #	Description	Handle(s)	Finish	Price
155420	2510LF	2-or3-Hole 4"cc, Less Pop-Up, Lead-Free	ADA Blade	Chrome	
146337	2502LF	2-or3-Hole 4"cc, Less Pop-Up, Lead-Free	Clear Knob	Chrome	
155784	2512LF	2-or3-Hole 4"cc, Less Pop-Up, Lead-Free	Clear Knob	Chrome	
146107	2520LF-MPU	3-Hole 4"cc, Metal Pop-Up Drain, Lead-Free	ADA Blade	Chrome	
146035	2522LF-MPU	3-Hole 4"cc, Metal Pop-Up Drain, Lead-Free	Clear Knob	Chrome	

#### Classic 2-Hdl Centerset Lavatory Faucet

- 5-1/4" Reach, 3-1/4" high rigid spout
- 2" From deck to aerator
- 1/2" IPS Connection
- 1-9/16" Maximum deck thickness
- WaterSense® certified product: 1.2 gpm @ 60 psi
- Metal Pop-Up (2503LF)  
Less Pop-Up (2523LF)



Part #	Mfg #	Description	Handle(s)	Finish	Price
145730	2503LF	2-or3-Hole 4"cc, Less Pop-Up, Lead-Free	ADA Lever	Chrome	
152826	2503LF-SS	2-or 3-Hole 4"cc, Less Pop-Up, Lead-Free	ADA Lever	Stainless*	
144382	2523LF-MPU	3-Hole 4"cc, Metal Pop-Up Drain, Lead-Free	ADA Lever	Chrome	
143810	2523LF-SSMPU	3-Hole 4"cc, Metal Pop-Up Drain, Lead-Free	ADA Lever	Stainless*	

#### Dryden™ 2-Hdl Centerset Lavatory Faucet

- 4-11/16" Reach, 6-5/8" high rigid spout
- 4-1/8" From deck to aerator
- 3/8" Compression fittings
- 1/2" IPS Connection
- 2-1/4" Maximum deck thickness
- 32" Minimum InnoFlex® supply lines below the deck
- DIAMOND™ valve
- WaterSense® certified product, 1.2 gpm @ 60 psi



Part #	Mfg #	Description	Handle(s)	Finish	Price
158894	2551-MPU-DST	3-Hole 4"cc, Metal Pop-Up Drain, Lead-Free	ADA Lever	Chrome	
166667	2551-CZMPU-DST	3-Hole 4"cc, Metal Pop-Up Drain, Lead-Free	ADA Lever	Champagne Bronze™	
178256	2551-PNMPU-DST	3-Hole 4"cc, Metal Pop-Up Drain, Lead-Free	ADA Lever	Polished Nickel*	
156559	2538-SSMPU-DST	3-Hole 4"cc, Metal Pop-Up Drain, Lead-Free	ADA Lever	Venetian Bronze®	
116280	2551-SSMPU-DST	3-Hole 4"cc, Metal Pop-Up Drain, Lead-Free	ADA Lever	Stainless*	

\* Brilliance® Anti-Tarnish Lifetime Finishes

## Lavatory Faucets - 4" Center

### Foundations® Core-B 2-Hdl Centerset Lavatory Faucet

- 4-5/16" Reach, 3-3/4" high rigid spout
- 2-3/8" From deck to aerator
- 1/2" IPS Connection
- 1" Maximum deck thickness
- WaterSense® certified product: 1.2 gpm @ 60 psi



Part #	Mfg #	Description	Handle(s)	Finish	Price
136366	B2510LF	3-Hole 4"cc, Metal Pop-Up Drain, Lead-Free	ADA Lever	Chrome	
132471	B2510LF-SS	3-Hole 4"cc, Metal Pop-Up Drain, Lead-Free	ADA Lever	Stainless*	
165753	B2512LF	3-Hole 4"cc, Metal Pop-Up Drain, Lead-Free	Crystal Knobs	Chrome	

### Haywood™ 2-Hdl Centerset Lavatory Faucet

- 5-1/16" Reach, 4-3/4" high rigid spout
- 3" From deck to aerator
- Solid brass body
- 1/4 Turn handle stops
- WaterSense® certified product: 1.2 gpm @ 60 psi



Part #	Mfg #	Description	Handle(s)	Finish	Price
220855	25999LF	3-Hole 4"cc, Plastic Pop-Up Drain	ADA Lever	Chrome	
248535	25999LF-SS	3-Hole 4"cc, Plastic Pop-Up Drain	ADA Lever	Stainless*	

### Lahara® 2-Hdl Centerset Lavatory Faucet

- 5" Reach, 6-3/8" high
- 4-5/8" From deck to aerator
- 3/8" Compression fittings
- 2-1/4" Maximum deck thickness
- 32" Minimum InnoFlex® supply lines below the deck
- DIAMOND™ valve
- WaterSense® certified product: 1.2 gpm @ 60 psi



Part #	Mfg #	Description	Handle(s)	Finish	Price
150258	2538-CZMPU-DST	3-Hole 4"cc, Metal Pop-Up Drain, Lead-Free	ADA Lever	Champagne Bronze™	
153783	2538-MPU-DST	3-Hole 4"cc, Metal Pop-Up Drain, Lead-Free	ADA Lever	Chrome	
153784	2538-RBMPU-DST	3-Hole 4"cc, Metal Pop-Up Drain, Lead-Free	ADA Lever	Venetian Bronze®	
153785	2538-SSMPU-DST	3-Hole 4"cc, Metal Pop-Up Drain, Lead-Free	ADA Lever	Stainless*	

\* Brilliance® Anti-Tarnish Lifetime Finishes

[www.plumbsupply.com](http://www.plumbsupply.com) • Serving our Customers Since 1946 • [www.waterconcepts.net](http://www.waterconcepts.net)

## Lavatory Faucets - 4" Center

### Linden™ 2-Hdl Centerset Lavatory Faucet

- 4-7/8" Reach, 5-3/4" high rigid spout
- 4-1/2" From deck to aerator
- 3/8" Compression fittings
- 2-1/4" Maximum deck thickness
- 32" Minimum InnoFlex® supply lines below the deck
- DIAMOND™ valve
- WaterSense® certified product: 1.2 gpm @ 60 psi



2594

2593



Part #	Mfg #	Description	Handle(s)	Finish	Price
190194	2593-MPU-DST	3-Hole 4"cc, Metal Pop-Up Drain, Lead-Free	ADA Lever	Chrome	
190240	2593-RBMPU-DST	3-Hole 4"cc, Metal Pop-Up Drain, Lead-Free	ADA Lever	Venetian Bronze®	
223604	2593-SSMPU-DST	3-Hole 4"cc, Metal Pop-Up Drain, Lead-Free	ADA Lever	Stainless*	
159723	2594-CZMPU-DST	3-Hole 4"cc, Metal Pop-Up Drain, Lead-Free	ADA Lever	Champagne Bronze™	
157475	2594-MPU-DST	3-Hole 4"cc, Metal Pop-Up Drain, Lead-Free	ADA Lever	Chrome	
157328	2594-RBMPU-DST	3-Hole 4"cc, Metal Pop-Up Drain, Lead-Free	ADA Lever	Venetian Bronze®	
157456	2594-SSMPU-DST	3-Hole 4"cc, Metal Pop-Up Drain, Lead-Free	ADA Lever	Stainless*	

### Stryke™ 2-Hdl Centerset Lavatory Faucet

- 4-13/16" Reach, 7-3/8" high rigid spout
- Red/blue indicators
- 3/8" Compression fittings
- 2-1/4" Maximum deck thickness
- Includes InnoFlex® Pex-C supply lines
- DIAMOND™ valve
- WaterSense® certified product: 1.2 gpm @ 60 psi



Part #	Mfg #	Description	Handle(s)	Finish	Price
259535	25776-BLMPU-DST	3-Hole 4"cc, Metal Pop-Up Drain, Lead-Free	ADA Lever	Matte Black	
257614	257766-BLMPU-DST	3-Hole 4"cc, Metal Pop-Up Drain, Lead-Free	ADA Cross	Matte Black	
257047	257766-MPU-DST	3-Hole 4"cc, Metal Pop-Up Drain, Lead-Free	ADA Cross	Chrome	

### Tesla® 2-Hdl Centerset Lavatory Faucet

- 4-1/2" Reach, 6-1/2" high rigid spout
- 5-11/16" From deck to aerator
- Red/blue indicators
- 3/8" Compression fittings
- 2-1/4" Maximum deck thickness
- 32" Minimum InnoFlex® supply lines below the deck
- DIAMOND™ valve
- WaterSense® certified product: 1.2 gpm @ 60 psi



Part #	Mfg #	Description	Handle(s)	Finish	Price
223378	2552-MPU-DST	3-Hole 4"cc, Metal Pop-Up Drain, Lead Free	ADA Lever	Chrome	
258836	2552-PNMPU-DST	3-Hole 4"cc, Metal Pop-Up Drain, Lead Free	ADA Lever	Polished Nickel*	
187678	2552-SSMPU-DST	3-Hole 4"cc, Metal Pop-Up Drain, Lead Free	ADA Lever	Stainless*	

\* Brilliance® Anti-Tarnish Lifetime Finishes

## Lavatory Faucets - 4" Center

### Victorian™ 2-Hdl Centerset Lavatory Faucet

- 5-1/8" Reach, 6-1/4" high rigid spout
- 4" From deck to aerator
- 3/8" Compression fittings
- 2-1/4" Maximum deck thickness
- 32" Minimum InnoFlex® supply lines below the deck
- DIAMOND™ valve
- WaterSense® certified product: 1.2 gpm @ 60 psi



Part #	Mfg #	Description	Handle(s)	Finish	Price
173065	2555-CZMPU-DST	3-Hole 4"cc, Metal Pop-Up Drain, Lead-Free	ADA Lever	Champagne Bronze™	
161099	2555-MPU-DST	3-Hole 4"cc, Metal Pop-Up Drain, Lead-Free	ADA Lever	Chrome	
162273	2555-PBMPU-DST	3-Hole 4"cc, Metal Pop-Up Drain, Lead-Free	ADA Lever	Polished Brass*	
156749	2555-RBMPU-DST	3-Hole 4"cc, Metal Pop-Up Drain, Lead-Free	ADA Lever	Venetian Bronze®	
156750	2555-SSMPU-DST	3-Hole 4"cc, Metal Pop-Up Drain, Lead-Free	ADA Lever	Stainless*	

### Windemere® 2-Hdl Centerset Lavatory Faucet

- 5-1/8" Reach, 5-7/8" high rigid spout
- 3-17/32" From deck to aerator
- Hot/cold indicators
- 1/2" IPS Connection
- 1-1/8" Maximum deck thickness
- WaterSense® certified product: 1.2 gpm @ 60 psi



Part #	Mfg #	Description	Handle(s)	Finish	Price
135103	B2596LF	3-Hole 4"cc, Metal Pop-Up Drain, Lead-Free	ADA Lever	Chrome	
133542	B2596LF-OB	3-Hole 4"cc, Metal Pop-Up Drain, Lead-Free	ADA Lever	Oil Rubbed Bronze	
157251	B2596LF-PB	3-Hole 4"cc, Metal Pop-Up Drain, Lead-Free	ADA Lever	Polished Brass*	
133218	B2596LF-SS	3-Hole 4"cc, Metal Pop-Up Drain, Lead-Free	ADA Lever	Stainless*	

### Woodhurst™ 2-Hdl Centerset Lavatory Faucet

- 5-1/4" Reach, 6-9/16" high rigid spout
- 1/4" Turn handle stops
- 1/2" IPS Connection
- 1-3/8" Maximum deck thickness
- Washerless stem cartridge valve
- Supply lines not included
- WaterSense® certified product: 1.2 gpm @ 60 psi
- (-MPU) Metal pop up drain with plated flange and stopper



Part #	Mfg #	Description	Handle(s)	Finish	Price
251721	2532LF-MPU	4"cc 3-Hole, Metal Pop-Up Drain, Lead Free	ADA Lever	Chrome	
251178	2532LF-RBMPU	4"cc 3-Hole, Metal Pop-Up Drain, Lead Free	ADA Lever	Venetian Bronze®	
250049	2532LF-SSMPU	4"cc 3-Hole, Metal Pop-Up Drain, Lead Free	ADA Lever	Stainless*	

\* Brilliance® Anti-Tarnish Lifetime Finishes

[www.plumbsupply.com](http://www.plumbsupply.com) • Serving our Customers Since 1946 • [www.waterconcepts.net](http://www.waterconcepts.net)



## Lavatory Faucets - 4" Center

### Single-Handle Lavatory Faucets

#### Chateau Single-Handle Lavatory Faucet

- 4-3/8" Spout reach
- 2" From deck to aerator
- 50/50 Pop-Up Drain
- 1255™ Duralast™ cartridge
- Pivot action lever style handle
- Flow rate: 1.2 gpm



Part #	Mfg #	Description	Handle(s)	Finish	Price
126359	L64621	4"cc, 1/2" IPS Connections	ADA Lever	Chrome	
037061	L64625	4"cc, 3/8" Compression Connections	ADA Lever	Chrome	

### Two-Handle Lavatory Faucets

#### Belfield 2-Hdl Lavatory Faucet

- 4.82" reach
- 1/2" IPS connection size
- WaterSense® certified



Part #	Mfg #	Description	Handle(s)	Finish	Price
243061	6401	4"cc, Metal Pop-Up Drain	ADA Lever	Chrome	
249632	6401BN	4"cc, Metal Pop-Up Drain	ADA Lever	Brushed Nickel	
246511	6401ORB	4"cc, Metal Pop-Up Drain	ADA Lever	Oil Rubbed Bronze	

#### Boardwalk™ 2-Hdl Lavatory Faucet

- 5-3/16" Reach, 4-3/16" high spout
- 3-1/4" From deck to aerator
- 1/2" IPS Connection
- 1234 Cartridge design
- WaterSense® certified: 1.2 gpm



Part #	Mfg #	Description	Handle(s)	Finish	Price
237055	6010SRN	4"cc, Metal Pop-Up Drain	ADA Lever	SpotResist Brushed Nickel	

#### Brantford™ 2-Hdl Lavatory Faucet

- 5-1/16" Reach, 5" high spout
- 3-1/2" From deck to aerator
- 1/2" IPS Connection
- 1234 Cartridge design
- WaterSense® certified: 1.5 gpm



Part #	Mfg #	Description	Handle(s)	Finish	Price
105029	6610	4"cc, Metal Pop-Up Drain	ADA Lever	Chrome	
102294	6610BN	4"cc, Metal Pop-Up Drain	ADA Lever	Brushed Nickel	
102285	6610ORB	4"cc, Metal Pop-Up Drain	ADA Lever	Oil Rubbed Bronze	

\*Lifeshine® Anti-Tarnish Lifetime Finish

[www.waterconcepts.net](http://www.waterconcepts.net) • Serving our Customers Since 1946 • [www.plumbsupply.com](http://www.plumbsupply.com)



## Lavatory Faucets - 4" Center

### Chateau™ 2-Hdl Lavatory Faucet

- 4-15/16" Reach, 3-5/16" high spout
- 2-5/8" From deck to aerator
- 1/2" IPS Connection
- 1234 Duralast™ cartridge
- Includes hot and cold temperature indicators
- WaterSense® certified: 1.2 gpm



Part #	Mfg #	Description	Handle(s)	Finish	Price
076481	4925	4"cc, Metal Pop-Up Drain	ADA Lever	Chrome	

### Danika™ 2-Hdl Lavatory Faucet

- 4-5/8" Reach, 6-1/16" high spout
- 5-1/8" From deck to aerator
- 1/2" IPS connection
- 1224 cartridge design
- Plastic pop-up drain with lift rod
- WaterSense® certified: 1.2 gpm



Part #	Mfg #	Description	Handle(s)	Finish	Price
243806	WS84633	4"cc, Plastic Pop-Up Drain w/ Lift rod	ADA Lever	Chrome	

### Dartmoor™ 2-Hdl Lavatory Faucet

- 6-1/16" Reach, 5-15/16" high spout
- 4-1/4" From deck to aerator
- 1/2" IPS Connection
- 1234 Cartridge design
- WaterSense® certified: 1.5 gpm



Part #	Mfg #	Description	Handle(s)	Finish	Price
224173	6802	4"cc, Metal Pop-Up Drain	ADA Lever	Chrome	
225130	6802ORB	4"cc, Metal Pop-Up Drain	ADA Lever	Oil Rubbed Bronze	

### Eva™ 2-Hdl Lavatory Faucet

- 3-7/8" Reach, 6-3/16" high spout
- 4-1/2" From deck to aerator
- 1/2" IPS Connection
- 1224 Cartridge design
- WaterSense® certified: 1.5 gpm



Part #	Mfg #	Description	Handle(s)	Finish	Price
094488	6410	4"cc, Metal Pop-Up Drain, High Arc Spout	ADA Lever	Chrome	
097628	6410BN	4"cc, Metal Pop-Up Drain, High Arc Spout	ADA Lever	Brushed Nickel	
096046	6410ORB	4"cc, Metal Pop-Up Drain, High Arc Spout	ADA Lever	Oil Rubbed Bronze	

\*Lifeshine® Anti-Tarnish Lifetime Finish

[www.plumbsupply.com](http://www.plumbsupply.com) • Serving our Customers Since 1946 • [www.waterconcepts.net](http://www.waterconcepts.net)

## Lavatory Faucets - 4" Center

### Gibson 2-Hdl Lavatory Faucet

- 4-3/16" Reach, 7-15/16" high spout
- 5-23/32" From deck to aerator
- 1/2" IPS connection
- 1234 Cartridge design
- WaterSense® certified: 1.2 gpm



Part #	Mfg #	Description	Handle(s)	Finish	Price
227081	6150	4"cc, Pop-Up Drain	ADA Lever	Chrome	

### Glyde™ 2-Hdl High Arc Lavatory Faucet

- 6-1/16" Reach, 5-7/8" high spout
- 1/2" IPS connection
- 1234 Cartridge design
- WaterSense® certified: 1.2 gpm



Part #	Mfg #	Description	Handle(s)	Finish	Price
239269	6172	4"cc, Metal Pop-Up Drain	ADA Lever	Chrome	

### Icon™ 2-Hdl Lavatory Faucet

- 5-3/4" Reach, 8-1/2" high spout
- 5-3/8" From deck to aerator
- 1/2" IPS Connection
- 1234 Duralast® cartridge
- WaterSense® certified: 1.2 gpm



Part #	Mfg #	Description	Handle(s)	Finish	Price
196523	S6510	4"cc, Metal Pop-Up Drain	ADA Lever	Chrome	
096171	S6510BN	4"cc, Metal Pop-Up Drain	ADA Lever	Brushed Nickel	

### Kingsley™ 2-Hdl Lavatory Faucet

- 5-5/8" Reach, 3-1/4" high spout
- 2" From deck to aerator
- 1/2" IPS connection
- 1224 Cartridge design
- WaterSense® certified: 1.5 gpm



Part #	Mfg #	Description	Handle(s)	Finish	Price
070913	6101	4"cc, Metal Pop-Up Drain	ADA Lever	Chrome	
077651	6101BN	4"cc, Metal Pop-Up Drain	ADA Lever	Brushed Nickel	
083434	6101ORB	4"cc, Metal Pop-Up Drain	ADA Lever	Oil Rubbed Bronze	

\*Lifeshine® Anti-Tarnish Lifetime Finish

[www.waterconcepts.net](http://www.waterconcepts.net) • Serving our Customers Since 1946 • [www.plumbsupply.com](http://www.plumbsupply.com)

## Lavatory Faucets - 4" Center

### Kingsley™ 2-Hdl Lavatory Faucet

- 4-3/8" Reach, 6-3/4" high spout
- 4-1/2" From deck to aerator
- 1/2" IPS connections
- 1224 Cartridge design
- WaterSense® certified: 1.5 gpm



Part #	Mfg #	Description	Handle(s)	Finish	Price
084409	6121	4"cc, Meta Pop-Up Drain	ADA lever	Chrome	
104394	6121BN	4"cc, Meta Pop-Up Drain	ADA lever	Brushed Nickel	
079298	6121ORB	4"cc, Meta Pop-Up Drain	ADA lever	Oil Rubbed Bronze	
094233	6121WR	4"cc, Meta Pop-Up Drain	ADA lever	Wrought Iron	

### Voss™ 2-Hdl Lavatory Faucet

- 6-1/8" High, 5-3/8" reach spout
- 4-3/4" From deck to aerator
- 1/2" IPS connections
- 1224 cartridge design
- WaterSense® certified: 1.5 gpm



Part #	Mfg #	Description	Handle(s)	Finish	Price
152309	6901	4"cc, Metal Pop-Up Drain, High Arc Spout	ADA Lever	Chrome	
251638	6901BG	4"cc, Metal Pop-Up Drain, High Arc Spout	ADA Lever	Brushed Gold	
160697	6901BN	4"cc, Metal Pop-Up Drain, High Arc Spout	ADA Lever	Brushed Nickel	

### Wynford™ 2-Hdl Lavatory Faucet

- 4-1/2" Spout reach, 5-3/4" high spout
- 4-1/4" From deck to aerator
- 1/2" IPS connection
- 1224 Cartridge
- WaterSense® certified: 1.5 gpm



Part #	Mfg #	Description	Handle(s)	Finish	Price
188953	4505	4"cc, Metal Pop-Up	ADA Lever	Chrome	
220421	4505BN	4"cc, Metal Pop-Up	ADA Lever	Brushed Nickel	
186958	4505ORB	4"cc, Metal Pop-Up	ADA Lever	Oil Rubbed Bronze	

\*Lifeshine® Anti-Tarnish Lifetime Finish

[www.plumbsupply.com](http://www.plumbsupply.com) • Serving our Customers Since 1946 • [www.waterconcepts.net](http://www.waterconcepts.net)

---

---

## Lavatory - Centerset

---

---

### Single-Handle Lavatory Faucets

#### E200 Single Handle Lavatory Faucet

- *Washerless cartridge*
- *E200MM includes metal handle and metal throat plate*



Part #	Mfg#	Description	Price
078933	E200M	4"cc Metal Post Handle with Chrome Plated Brass Pop-Up	



## Lavatory - Centerset

### Single-Handle Lavatory Faucets

#### Hardwater® 1-Hdl Lavatory Faucet

- 4-7/8" Spout reach
- Brass escutcheon plate
- Maximum aerator: 2.2 gpm @ 60 psi
- Supplied with 1/4" nominal copper tubes with 1/2" compression tubes
- Ceramic disc cartridge with temperature limit stops
- Limited lifetime warranty



Part #	Mfg #	Description	Handle(s)	Finish	Price
027529	40-501	4"cc, Less Lift Hole	ADA Loop Lever	Chrome	
017219	40-524	4"cc, Metal Pop-Up, Chrome-Plated Tailpiece	ADA Loop Lever	Chrome	

### Commercial Two-Handle Lavatory Faucets

#### Commercial 2-Hdl Lavatory Faucet

- 5-1/2" Gooseneck spout reach
- 1/2" NPSM supply connection
- Vandal resistant metal handles
- 1-5/8" Maximum deck thickness
- Cast brass end valves and spout body
- Ceramic disc cartridges G0086986 & G0086987
- Maximum aerator: 0.5 gpm @ 60 psi



Part #	Mfg #	Description	Handle(s)	Finish	Price
243886	CO-44-105-61	3-Hole, Less Drain Assembly	ADA Wrist Blade	Chrome	

\*Physical Vapor Deposition (PVD) Limited Lifetime Finish

[www.plumbsupply.com](http://www.plumbsupply.com) • Serving our Customers Since 1946 • [www.waterconcepts.net](http://www.waterconcepts.net)

## Lavatory Faucets

### Two-Handle Lavatory Faucets

#### P4B Builders Series 2-Hdl Lavatory Faucet

- Washerless cartridges
- Max flow rate: 1.5 gpm @ 60 psi



Part #	Mfg #	Description	Handle(s)	Finish	Price
141376	P4B-400C	4"cc 3-Hole, Brass Pop-Up Drain	ADA Metal Lever	Chrome	
141377	P4B-400BN	4"cc 3-Hole, Brass Pop-Up Drain	ADA Metal Lever	Brushed Nickel	
141378	P4B-400ORB	4"cc 3-Hole, Brass Pop-Up Drain	ADA Metal Lever	Oil Rubbed Bronze	

#### P4B Builders Series 2-Hdl Lavatory Faucet

- Metal lever handles
- Ceramic cartridges
- Max flow rate: 1.2 gpm



Part #	Mfg #	Description	Handle(s)	Finish	Price
235412	P4B-420C	4"cc 3-Hole, Brass Pop-Up Drain	ADA Metal Lever	Chrome	
235413	P4B-420BN	4"cc 3-Hole, Brass Pop-Up Drain	ADA Metal Lever	Brushed Nickel	
235414	P4B-420ORB	4"cc 3-Hole, Brass Pop-Up Drain	ADA Metal Lever	Oil Rubbed Bronze	

#### P4C Classic Series 2-Hdl Lavatory Faucet

- Washerless cartridges
- Max flow rate: 1.5 gpm @ 60 psi



Part #	Mfg #	Description	Handle(s)	Finish	Price
141393	P4C-400C	4"cc 3-Hole, Brass Pop-Up Drain	ADA Metal Wing	Chrome	
154377	P4C-402C	4"cc 3-Hole, Brass Pop-Up Drain	Acrylic Round	Chrome	

#### P4V Value Series 2-Hdl Lavatory Faucet

- Washerless cartridges
- Acrylic round handles
- Max flow rate: 1.2 gpm @ 60 psi



Part #	Mfg #	Description	Handle(s)	Finish	Price
157443	P4V-402C	4"cc 3-Hole, Brass Pop-Up Drain	Acrylic Round	Chrome	
148251	P4V-402-CL	4"cc 3-Hole, Less Pop-Up Drain	Acrylic Round	Chrome	





## Lavatory Faucets

### Single Handle Lavatory Faucets

#### P4V Vaule Series 1-Hdl Lavatory Faucet

- Acylic round handle
- Stainless steel ball valve
- Brass pop-up
- Max flow rate: 1.2 gpm



Part #	Mfg #	Description	Handle(s)	Finish	Price
239975	P4V-502C	4"cc 3-Hole, Brass Pop-Up Drain	Acrylic Round	Chrome	

**Lavatory - Centerset**

**Lavatory Faucets**

**Single Handle Lavatory Faucet**

- 3-29/32" Spout reach
- Metal pop-up drain  
—(P136LF) includes plastic pop-up drain
- 1/2" -14 NPSM threaded male inlet adapters
- Flow rate: 1.5 gpm @ 60 psi



Part #	Mfg #	Description	Handle(s)	Finish	Price
155204	P136LF	3-Hole 4"cc, Plastic Pop-Up	Lever	Chrome	
155205	P136LF-M	3-Hole 4"cc, Metal Pop-Up	Lever	Chrome	
186607	P136LF-BN-M	3-Hole 4"cc, Metal Pop-Up	Lever	Brushed Nickel	

**Single Handle Lavatory Faucet**

- 3-29/32" Spout reach
- Metal grid drain
- 1-23/32" From deck to aerator
- 1/2"-14 NPSM threaded male inlet adapters
- WaterSense® certified: 1.2 gpm



Part #	Mfg #	Description	Handle(s)	Finish	Price
189925	P138LF-M	3-Hole 4"cc, Metal Grid Drain	Lever	Chrome	

**Single Handle Lavatory Faucet**

- 4" Spout Reach
- 1/4" O.D. copper supply lines
- Plastic pop-up drain
- WaterSense® Certified: 1.5 gpm



Part #	Mfg #	Description	Handle(s)	Finish	Price
221812	P188620LF-M	3-Hole 4"cc, Plastic Pop-Up	Lever	Chrome	
232962	P188620LF-OB-M	3-Hole 4"cc, Plastic Pop-Up	Lever	Oil Rubbed Bronze	

**Single Handle Lavatory Faucet**

- 5" Spout Reach
- 4-1/8" From deck to aerator, 6-11/16" height
- Ceramic valve
- 50/50 Plastic pop-up drain
- Optional 6" escutcheon
- WaterSense® Certified: 1.2 gpm @ 60 psi



Part #	Mfg #	Description	Handle(s)	Finish	Price
252407	P188624LF	1- or 3-Hole, Plastic Pop-Up	Transitional Lever	Chrome	

\* Brilliance® Anti-Tarnish Lifetime Finishes

[www.waterconcepts.net](http://www.waterconcepts.net) • Serving our Customers Since 1946 • [www.plumbsupply.com](http://www.plumbsupply.com)

**Lavatory - Centerset**

**Two-Handle Lavatory Faucet**

- 4" Spout reach
- Metal pop-up drain
- 1/2" -14 NPSM threaded male inlet adapters
- Flow rate: 1.5 gpm @ 60 psi



Part #	Mfg #	Description	Handle(s)	Finish	Price
147951	P246LF-M	3-Hole 4"cc, Metal Pop-Up	Lever	Chrome	

**Two-Handle Lavatory Faucet**

- 3-7/8 Spout reach
- Metal pop-up drain
- 4" Spout height deck to aerator
- Washerless stem cartridge valve
- 1/2"-14 NPSM threaded male inlet shanks
- Includes matching finish pop-up drain assembly
- WaterSense® certified: 1.20 gpm @ 60 psi



Part #	Mfg #	Description	Handle(s)	Finish	Price
240042	P299695LF	3-Hole, 4"cc Metal Pop-Up	ADA Lever	Chrome	
240079	P299695LF-BN	3-Hole, 4"cc Metal Pop-Up	ADA Lever	Brushed Nickel	

\* Brilliance® Anti-Tarnish Lifetime Finishes

## Lavatory - Centerset

### Single-Handle Lavatory Faucets

#### Noble Single-Handle Centerset Lavatory Faucet

- Brass pop-up drain
- 2Pc zinc body with zinc handle
- Copper waterway construction w/ 1/2"-14 NPSM connection
- Premium grade ceramic cartridge (Type G)
- Flow rate: 1.2 GPM
- 100% Pressure system tested



Part #	Mfg #	Description	Handles	Finish	Price
186054	201-7693	4"cc, Brass Pop-Up, 1.2 gpm	ADA Lever	Chrome	
226644	201-7694	4"cc, Brass Pop-Up, 1.2 gpm	ADA Lever	Brushed Nickel	
229590	192-5880	4"cc, Brass Pop-Up, 1.2 gpm	ADA Lever	Oil Rubbed Bronze	

### Two-Handle Lavatory Faucets

#### Majestic Two-Handle Centerset Lavatory Faucet

- Brass pop-up drain
- 5-1/4" High spout, 4-5/16" Reach
- 4-3/16" From deck to aerator
- 1-Piece solid brass spout, zinc handle, zinc deck plate
- Brass waterway construction w/ 1/2"-14 NPSM connection
- 1/4 Turn premium grade ceramic cartridges (Type 1)
- Flow rate: 1.2 GPM
- 100% Pressure system tested



Part #	Mfg #	Description	Handles	Finish	Price
186822	201-6608	4"cc, Brass Pop-Up, 1.2 gpm	ADA Levers	Chrome	
186823	201-6609	4"cc, Brass Pop-Up, 1.2 gpm	ADA Levers	Brushed Nickel	
186824	201-6610	4"cc, Brass Pop-Up, 1.2 gpm	ADA Levers	Oil Rubbed Bronze	

#### Noble Two-Handle Centerset Lavatory Faucet

- Brass pop-up drain
- 3-3/16" High spout, 6-11/16" Reach
- 1-5/8" From deck to aerator
- 2-Piece zinc body with zinc handle
- Brass waterway construction w/ 1/2"-14 NPSM connection
- 1/4 Turn premium grade ceramic cartridges (Type 1)
- Flow rate: 1.2 GPM
- 100% Pressure system tested



Part #	Mfg #	Description	Handles	Finish	Price
186055	201-7695	186824			
232194	201-7696	4"cc, Brass Pop-Up, 1/2 gpm	ADA Levers	Brushed Nickel	

## Lavatory - Widespread

### Two-Handle Widespread Lavatory Faucets

#### Alteo® 2-Hdl Lavatory Faucet for 8" or 16" Centers with Pop-Up Drain and Tailpiece

- 4-1/2" Spout reach
- Metal construction
- 1/4-Turn washerless ceramic disc valves
- UltraGlide valve with Dry Stem technology
- Maximum flow rate: 1.2 gpm
- Meets EPA WaterSense® criteria



Part #	Mfg #	Description	Handle(s)	Finish	Price
141725	K-45102-4-BN	8"-16"ws, Pop-Up Drain with Tailpiece	ADA Lever	*Brushed Nickel	
141726	K-45102-4-CP	8"-16"ws, Pop-Up Drain with Tailpiece	ADA Lever	Polished Chrome	
152340	K-45102-4-2BZ	8"-16"ws, Pop-Up Drain with Tailpiece	ADA Lever	Oil Rubbed Bronze	

#### Archer™ 2-Hdl Lavatory Faucet for 8" or 16" Centers with Pop-Up Drain and Tailpiece

- 4" Spout reach
- Fluid design lines
- 1/4-Turn washerless ceramic disc valves
- Maximum Flow Rate: 1.2 gpm



Part #	Mfg #	Description	Handle(s)	Finish	Price
111423	K-11076-4-BN	8"-16"ws, Metal Drain	ADA Lever	*Brushed Nickel	
111584	K-11076-4-CP	8"-16"ws, Metal Drain	ADA Lever	Polished Chrome	

#### Artifacts® Bell Design Stationary Spout with Aerator and Pop-Up drain with 1-1/4" Tailpiece

- 5-3/8" Reach, 4-11/16" high spout
- Brass construction
- Handles sold separately
- Laminar flow
- WaterSense® certified product: 1.5 gpm



Part #	Mfg #	Description	Handle(s)	Finish	Price
162098	K-72759-BN	Widespread, Pop-Up Drain with Tailpiece	Less Handles	*Brushed Nickel	
185184	K-72759-BV	Widespread, Pop-Up Drain with Tailpiece	Less Handles	*Brushed Bronze	
165049	K-72759-CP	Widespread, Pop-Up Drain with Tailpiece	Less Handles	Polished Chrome	
162835	K-72759-SN	Widespread, Pop-Up Drain with Tailpiece	Less Handles	*Polished Nickel	
184810	K-72759-VNT	Widespread, pop-Up Drain with Tailpiece	Less Handles	Vintage Nickel	
168450	K-72759-2BZ	Widespread, Pop-Up Drain with Tailpiece	Less Handles	Oil Rubbed Bronze	

\* Vibrant Limited Lifetime Warranty

[www.plumbsupply.com](http://www.plumbsupply.com) • Serving our Customers Since 1946 • [www.waterconcepts.net](http://www.waterconcepts.net)

## Lavatory - Widespread

### Artifacts® Column Design Stationary Spout with Aerator and Pop-Up Drain with 1-1/4" Tailpiece

- 6-5/8" Reach, 8-1/2" high spout
- Handles sold separately
- Laminar flow
- WaterSense® certified product: 1.2 gpm



Part #	Mfg #	Description	Handle(s)	Finish	Price
166094	K-72760-BN	Widespread, Pop-Up Drain with Tailpiece	Less Handles	*Brushed Nickel	
162838	K-72760-BV	Widespread, Pop-Up Drain with Tailpiece	Less Handles	*Brushed Bronze	
169554	K-72760-CP	Widespread, Pop-Up Drain with Tailpiece	Less Handles	Polished Chrome	
169988	K-72760-SN	Widespread, Pop-Up Drain with Tailpiece	Less Handles	*Polished Nickel	
176330	K-72760-2BZ	Widespread, Pop-Up Drain with Tailpiece	Less Handles	Oil Rubbed Bronze	
231695	K-72760-VNT	Widespread, Pop-Up Drain with Tailpiece	Less Handles	Vintage Nickel	

### Artifacts® Flume Sink Spout and Touch-Activated Drain

- 6-1/16" Reach, 5" high spout
- Includes metal touch-activated drain
- Handles sold separately
- Quick-Connect® hose connections
- WaterSense® certified product: 1.2 gpm



**Required Accessories:**

- K-98068-4 Widespread Bathroom Sink Faucet Handles  
or  
K-98068-3M Widespread Bathroom Sink Faucet Handles Codes/Standards  
or  
K-98068-9M Widespread Bathroom Sink Faucet Handles  
or  
K-98068-3 Widespread Bathroom Sink Faucet Handles

Part #	Mfg #	Description	Handle(s)	Finish	Price
257025	K-72761-BN	Widespread, Touch-Activated Drain	Less Handles	*Brushed Nickel	
242030	K-72761-SN	Widespread, Touch-Activated Drain	Less Handles	*Polished Nickel	
252772	K-72761-2BZ	Widespread, Touch-Activated Drain	Less Handles	Oil Rubbed Bronze	

### Artifacts® Tea Design Stationary Spout with Aerator and Pop-Up Drain with 1-1/4" Tailpiece

- 5-3/8" Reach, 4-11/16" high spout
- Handles sold separately
- Laminar flow
- WaterSense® certified product: 1.5 gpm



Part #	Mfg #	Description	Handle(s)	Finish	Price
183652	K-72758-BN	Widespread, Pop-Up Drain with Tailpiece	Less Handles	*Brushed Nickel	
183653	K-72758-BV	Widespread, Pop-Up Drain with Tailpiece	Less Handles	*Brushed Bronze	
176273	K-72758-CP	Widespread, Pop-Up Drain with Tailpiece	Less Handles	Polished Chrome	
183654	K-72758-SN	Widespread, Pop-Up Drain with Tailpiece	Less Handles	*Polished Nickel	

\* Vibrant Limited Lifetime Warranty

[www.waterconcepts.net](http://www.waterconcepts.net) • Serving our Customers Since 1946 • [www.plumbsupply.com](http://www.plumbsupply.com)



## Lavatory - Widespread

### Two-Handle Widespread Lavatory Faucets (Continued)

#### Artifacts® Tea Design Stationary Spout with Aerator and Pop-Up Drain with 1-1/4" Tailpiece

Part #	Mfg #	Description	Handle(s)	Finish	Price
162840	K-72758-2BZ	Widespread, Pop-Up Drain with Tailpiece	Less Handles	Oil Rubbed Bronze	

#### Artifacts® Handles for Widespread Lavatory Faucets

- UltraGlide engineered ceramic disc valves

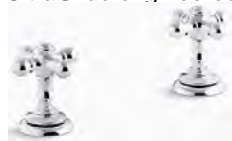

Cross



Prong



Lever



Swing

#### Cross Handles

Part #	Mfg #	Description	Handle(s)	Finish	Price
249239	K-98068-3-BV		Cross	Polished Chrome	
243714	K-98068-3-CP		Cross	Polished Chrome	

#### Prong Handles

Part #	Mfg #	Description	Handle(s)	Finish	Price
162099	K-98068-3M-BN		Prong	*Brushed Nickel	
185185	K-98068-3M-BV		Prong	*Brushed Bronze	
166632	K-98068-3M-CP		Prong	Polished Chrome	
242031	K-98068-3M-SN		Prong	*Polished Nickel	
184813	K-98068-3M-VNT		Prong	Vintage Nickel	
162841	K-98068-3M-2BZ		Prong	Oil Rubbed Bronze	

#### Lever Handles

Part #	Mfg #	Description	Handle(s)	Finish	Price
166095	K-98068-4-BN		Lever	*Brushed Nickel	
176830	K-98068-4-BV		Lever	*Brushed Bronze	
165050	K-98068-4-CP		Lever	Polished Chrome	
162836	K-98068-4-SN		Lever	*Polished Nickel	
188089	K-98068-4-VNT		Lever	Vintage Nickel	
171400	K-98068-4-2BZ		Lever	Oil Rubbed Bronze	

#### Swing Lever Handles

Part #	Mfg #	Description	Handle(s)	Finish	Price
162839	K-98068-9M-BV		Swing Lever	*Brushed Bronze	
170165	K-98068-9M-CP		Swing Lever	Polished Chrome	
169996	K-98068-9M-SN		Swing Lever	*Polished Nickel	
178609	K-98068-9M-2BZ		Swing Lever	Oil Rubbed Bronze	

\* Vibrant Limited Lifetime Warranty

[www.plumbsupply.com](http://www.plumbsupply.com) • Serving our Customers Since 1946 • [www.waterconcepts.net](http://www.waterconcepts.net)

## Lavatory - Widespread

### Bancroft™ 2-Hdl Lavatory Faucet for 8"-16" Centers with Pop-Up Drain, Lift Rod, and 1-1/4" Tailpiece

- 4-7/8" Reach spout
- Metal construction
- Brass valve bodies
- Flexible connections
- 1/4" turn washerless ceramic disc valves
- Flow rate: 1.2 gpm
- Meets EPA WaterSense® criteria



K-10577-4



K-10577-4P



#### Metal Lever Handles

Part #	Mfg #	Description	Handle(s)	Finish	Price
096178	K-10577-4-BN	8"-16"ws, Metal Drain	ADA Metal Lever	*Brushed Nickel	
111078	K-10577-4-BV	8"-16"ws, Metal Drain	ADA Metal Lever	*Brushed Bronze	
087294	K-10577-4-CP	8"-16"ws, Metal Drain	ADA Metal Lever	Polished Chrome	
103486	K-10577-4-SN	8"-16"ws, Metal Drain	ADA Metal Lever	*Polished Nickel	
151325	K-10577-4-2BZ	8"-16"ws, Metal Drain	ADA Metal Lever	Oil Rubbed Bronze	

#### Ceramic Lever Handles

Part #	Mfg #	Description	Handle(s)	Finish	Price
087742	K-10577-4P-CP	8"-16"ws, Metal Drain	ADA Ceramic Lever	Polished Chrome	

### Composed™ 2-Hdl Lavatory Faucet for 8"-16" Centers with Metal Pop-Up Drain

- 5-15/16" Reach spout
- 3-7/8" From deck to aerator
- Metal construction
- Cross or lever handles
- Quick-connect hose
- Flow rate: 1.2 gpm



Part #	Mfg #	Description	Handle(s)	Finish	Price
224845	K-73060-3-CP	8"-16"ws, Metal Drain	ADA Cross	Polished Chrome	
241950	K-73060-3-TT	8"-16"ws, Metal Drain	ADA Cross	*Titanium	
224853	K-73060-4-CP	8"-16"ws, Metal Drain	ADA Lever	Polished Chrome	
231723	K-73060-4-TT	8"-16"ws, Metal Drain	ADA Lever	*Titanium	

\* Vibrant Limited Lifetime Warranty

[www.waterconcepts.net](http://www.waterconcepts.net) • Serving our Customers Since 1946 • [www.plumbsupply.com](http://www.plumbsupply.com)

## Lavatory - Widespread

### Components™ Widespread Lavatory Tube Spout

- 6-5/16" Spout reach
- For 8" or 16" centers
- Includes metal touch-activated drain with 1-1/4" tailpiece
- WaterSense® certified: 1.2 gpm



Part #	Mfg #	Description	Reach	Finish	Price
257031	K-77967-BL	8"-16"ws, Spout Only	6-5/16"	Matte Black	
258813	K-77967-3TR	8"-16"ws, Spout Only	6-5/16"	*Ombre Titanium/Rose Gold	

### Components™ Widespread Lavatory Tube Spout with Row Design

- 6-5/16" Row spout reach
- For 8" or 16" centers
- Includes metal touch-activated drain with 1-1/4" tailpiece
- WaterSense® certified: 1.2 gpm



Part #	Mfg #	Description	Reach	Finish	Price
258684	K-77969-BL	8"-16"ws, Spout Only	6-5/16"	Matte Black	

### Coralais® Lavatory Faucet for 8"-16" Centers with Lever Handles

- 4-1/4" Reach spout
- Solid metal construction
- 1.2 GPM maximum flow rate
- Red/blue indexing on handles
- Handles pre-assembled on valves
- Quick-connect hose connectors
- UltraGlide engineered ceramic disc valves
- Model **(K-15261-4NDRA-CP)** does not include drain, lift rod, or tailpiece
- Meets EPA WaterSense® criteria



Part #	Mfg #	Description	Handle(s)	Finish	Price
188344	K-15265-4NDRA-CP	8"-16"ws, Red & Blue Indicators, Less Pop-Up Drain	ADA Lever	Polished Chrome	
061790	K-15261-4RA-CP	8"-16"ws, Red & Blue Indicators, Pop-Up Drain	ADA Lever	Polished Chrome	
226365	K-15261-4RA-G	8"-16"ws, Red & Blue Indicators, Pop-Up Drain	ADA Lever	Brushed Chrome	

\* Vibrant Limited Lifetime Warranty

[www.plumbsupply.com](http://www.plumbsupply.com) • Serving our Customers Since 1946 • [www.waterconcepts.net](http://www.waterconcepts.net)

## Lavatory - Widespread

### Devonshire® 2-Hdl Lavatory Faucet for 8"-16" Centers

- 4-3/4" Reach spout
- Metal construction
- Brass valve bodies
- 1/4-Turn washerless ceramic disc valves
- WaterSense® certified product: 1.2 gpm



Part #	Mfg #	Description	Handle(s)	Finish	Price
146969	K-394-4-2BZ	8"-16"ws	ADA Lever	Oil Rubbed Bronze	
068213	K-394-4-BN	8"-16"ws	ADA Lever	*Brushed Nickel	
084602	K-394-4-BV	8"-16"ws	ADA Lever	*Brushed Bronze	
068212	K-394-4-CP	8"-16"ws	ADA Lever	Polished Chrome	
076829	K-394-4-PB	8"-16"ws	ADA Lever	*Polished Brass	
181953	K-394-4-SN	8"-16"ws	ADA Lever	*Polished Nickel	

### Fairfax® 2-Hdl Lavatory Faucet for 8" - 16" Centers

- 5" Reach, 4-1/2" high spout
- Brass construction
- 1/4-Turn washerless ceramic valving
- WaterSense® certified product: 1.2 gpm



Part #	Mfg #	Description	Handle(s)	Finish	Price
057322	K-12265-4-BN	8"-16"ws,	ADA Lever	*Brushed Nickel	
053615	K-12265-4-CP	8"-16"ws,	ADA Lever	Polished Chrome	
127814	K-12265-4-2BZ	8"-16"ws,	ADA Lever	Oil Rubbed Bronze	

### Finial® Traditional Lavatory Faucet for 8" - 16" Centers with Metal Pop-Up Drain, Lift Rod, and Tailpiece

- 5" Reach, 6-1/4" high stationary spout
- Brass construction
- Brass valve bodies
- 1/4-Turn washerless ceramic disc valves
- Watersense® certified product: 1.2 gpm



Part #	Mfg #	Description	Handle(s)	Finish	Price
075051	K-310-4M-AF	8"-16"ws, Metal Pop-Up	ADA Lever	*French Gold	
056366	K-310-4M-BN	8"-16"ws, Metal Pop-Up	ADA Lever	*Brushed Nickel	
073511	K-310-4M-BV	8"-16"ws, Metal Pop-Up	ADA Lever	*Brushed Bronze	
054005	K-310-4M-CP	8"-16"ws, Metal Pop-Up	ADA Lever	Polished Chrome	
061723	K-310-4M-SN	8"-16"ws, Metal Pop-Up	ADA Lever	*Polished Nickel	
162512	K-310-4M-2BZ	8"-16"ws, Metal Pop-Up	ADA Lever	Oil Rubbed Bronze	

\* Vibrant Limited Lifetime Warranty

[www.waterconcepts.net](http://www.waterconcepts.net) • Serving our Customers Since 1946 • [www.plumbsupply.com](http://www.plumbsupply.com)

## Lavatory - Widespread

### Forté® 2-Hdl Lavatory Faucet for 8" - 16" Centers with Pop-Up Drain and Tailpiece

- 5-1/8" Reach stationary spout
- Metal construction, brass valve bodies
- Ceramic disc valves
- Fluid design lines
- Maximum flow rate: 1.2 gpm
- Meets EPA WaterSense® criteria
- Model (K-10273) includes plastic pop-up drain



K-10272-4



K-10272-4A



#### Sculpted Lever Handles

Part #	Mfg #	Description	Handle(s)	Finish	Price
072960	K-10272-4-BN	8"-16"ws, Metal Drain	ADA Sculpted Lever	*Brushed Nickel	
069925	K-10272-4-CP	8"-16"ws, Metal Drain	ADA Sculpted Lever	Polished Chrome	
072247	K-10272-4-G	8"-16"ws, Metal Drain	ADA Sculpted Lever	Brushed Chrome	

#### Traditional Lever Handles

Part #	Mfg #	Description	Handle(s)	Finish	Price
074936	K-10272-4A-BN	8"-16"ws, Metal Drain	ADA Traditional Lever	*Brushed Nickel	
073410	K-10272-4A-CP	8"-16"ws, Metal Drain	ADA Traditional Lever	Polished Chrome	
074760	K-10272-4A-G	8"-16"ws, Metal Drain	ADA Traditional Lever	Brushed Chrome	

### Kelston® 2-Hdl Lavatory Faucet for 8" - 16" Centers with Pop-Up Drain and Tailpiece

- 4-1/2" Reach spout
- Brass construction and valve bodies
- Pop-up drain with tailpiece
- 1/4-Turn washerless ceramic disc valve
- Flow rate: 1.2 gpm



Part #	Mfg #	Description	Handle(s)	Finish	Price
146989	K-13491-4-2BZ	8"-16"cc	ADA Lever	Oil Rubbed Bronze	
124521	K-13491-4-BN	8"-16"cc	ADA Lever	*Brushed Nickel	
124937	K-13491-4-CP	8"-16"cc	ADA Lever	Polished Chrome	

### Loure® 2-Hdl Lavatory Faucet for 8" - 16" Centers with Pop-Up Drain, Tailpiece and 8-1/4" Tall Spout

- 3-7/8" Reach spout
- Brass construction, brass valve bodies
- Fluid design lines
- WaterSense® certified product: 1.2 gpm
- 14-3/8" tall spout for (K-14662-4-CP) model



Part #	Mfg #	Description	Handle(s)	Finish	Price
144348	K-14661-4-BN	8"-16"cc, 8-1/4" Tall Spout	ADA Lever	*Brushed Nickel	
139112	K-14661-4-CP	8"-16"cc, 8-1/4" Tall Spout	ADA Lever	Polished Chrome	
142545	K-14661-4-SN	8"-16"cc, 8-1/4" Tall Spout	ADA Lever	*Polished Nickel	
173998	K-14662-4-CP	8"-16"cc, 14-3/8" Tall Spout	ADA Lever	Polished Chrome	

\* Vibrant Limited Lifetime Warranty

[www.plumbsupply.com](http://www.plumbsupply.com) • Serving our Customers Since 1946 • [www.waterconcepts.net](http://www.waterconcepts.net)

## Lavatory - Widespread

### Margaux® 2-Hdl Lavatory Faucet for 8" - 16" Centers with Pop-Up Drain, Tailpiece, and Lift Rod

- 5-3/8" Reach stationary spout
- Brass construction, brass valve bodies
- Fluid design lines
- WaterSense® certified product: 1.2 gpm



K-16232-4

K-16232-3



Part #	Mfg #	Description	Handle(s)	Finish	Price
239794	K-16232-3-AF	8"cc	ADA Cross	*French Gold	
134192	K-16232-3-BN	8"cc	ADA Cross	*Brushed Nickel	
114264	K-16232-3-BV	8"cc	ADA Cross	*Brushed Bronze	
110486	K-16232-3-CP	8"cc	ADA Cross	Polished Chrome	
113684	K-16232-3-SN	8"cc	ADA Cross	*Polished Nickel	
133955	K-16232-4-AF	8"cc	ADA Lever	*French Gold	
109778	K-16232-4-BN	8"cc	ADA Lever	*Brushed Nickel	
122138	K-16232-4-BV	8"cc	ADA Lever	*Brushed Bronze	
107346	K162324CP	8"cc	ADA Lever	Polished Chrome	
135075	K-16232-4-SN	8"cc	ADA Lever	*Polished Nickel	

### Memoirs® Stately 2-Hdl Lavatory Faucet for 8" - 16" Centers with Pop-Up Drain, Lift Rod, and 1-1/4"

- 5" Reach stationary spout
- Brass construction, brass valve bodies
- 1/4" Turn washerless ceramic disc valves
- Handles pre-assembled on valves
- Flexible connections
- Flow rate: 1.2 gpm



Deco Lever  
Handles

Lever

Part #	Mfg #	Description	Handle(s)	Finish	Price
075009	K-454-4S-BV	8"-16"ws	ADA Lever	*Brushed Bronze	
053660	K-454-4S-BN	8"-16"ws	ADA Lever	*Brushed Nickel	
074959	K-454-4V-BN	8"-16"ws	ADA Deco Lever	*Brushed Nickel	
077017	K-454-4V-BV	8"-16"ws	ADA Deco Lever	*Brushed Bronze	
077190	K-454-4V-CP	8"-16"ws	ADA Deco Lever	Polished Chrome	
170474	K-454-4V-2BZ	8"-16"ws	ADA Deco Lever	Oil Rubbed Bronze	

### Pinstripe® Pure 2-Hdl Lavatory Faucet for 8" - 16" Centers

- 5" Reach spout
- Low stationary spout
- Metal construction
- Brass valve bodies
- Pop-up drain with lift rod and tailpiece
- Quarter-turn washerless ceramic disc valves
- Flow rate: 1.2 gpm



-4A

-3B



Part #	Mfg #	Description	Handle(s)	Finish	Price
089499	K-13132-3B-BN	8"-16"ws	Cross	*Brushed Nickel	

\* Vibrant Limited Lifetime Warranty

[www.waterconcepts.net](http://www.waterconcepts.net) • Serving our Customers Since 1946 • [www.plumbsupply.com](http://www.plumbsupply.com)



**Lavatory - Widespread**

**Two-Handle Widespread Lavatory Faucets (Continued)**

**Pinstripe® Pure 2-Hdl Lavatory Faucet for 8" - 16" Centers**

Part #	Mfg #	Description	Handle(s)	Finish	Price
084756	K-13132-3A-CP	8"-16"ws	Cross	Polished Chrome	
089942	K-13132-3B-SN	8"-16"ws	Cross	*Polished Nickel	
099065	K-13132-4A-CP	8"-16"ws	ADA Levers	Polished Chrome	
112661	K-13132-4A-SN	8"-16"ws	ADA Levers	*Polished Nickel	

**Purist® 2-Hdl Low Handle Lavatory Faucet with 8" - 16" Centers with Pop-Up Drain, Lift Rod, and Tailpiece**

- 5-1/2" Reach spout, 8-1/2" height
- Brass construction, brass valve bodies
- Low gooseneck stationary spout
- Quarter-turn washerless ceramic disc valves
- Flow rate: 1.2 gpm

Tailpiece



Part #	Mfg #	Description	Handle(s)	Finish	Price
170302	K-14406-3-BGD	8"-16"ws	Cross	*Modern Brushed Gold	
257287	K-14406-3-BL	8"-16"ws	Cross	Matte Black	
074666	K-14406-3-BN	8"-16"ws	Cross	*Brushed Nickel	
227809	K-14406-3-BV	8"-16"ws	Cross	*Brushed Bronze	
067401	K-14406-3-CP	8"-16"ws	Cross	Polished Chrome	
147218	K-14406-3-SN	8"-16"ws	Cross	*Polished Nickel	
179563	K-14406-4-BGD	8"-16"ws	ADA Lever	*Modern Brushed Gold	
084014	K-14406-4-BN	8"-16"ws	ADA Lever	*Brushed Nickel	
250503	K-14406-4-BL	8"-16"ws	ADA Lever	Matte Black	
089431	K-14406-4-BV	8"-16"ws	ADA Lever	*Brushed Bronze	
069648	K-14406-4-CP	8"-16"ws	ADA Lever	Polished Chrome	
241951	K-14406-4-RGD	8"-16"ws	ADA Lever	*Rose Gold	
131007	K-14406-4-SN	8"-16"ws	ADA Lever	*Polished Nickel	

**Purist® Lavatory Faucet for 8" - 16" Centers with Pop-Up Drain, Lift Rod, Tailpiece, and 2 High Handles**

- 5-1/2" Reach, 8-1/2" height
- Brass construction, brass valve bodies
- Low or high gooseneck stationary spout
- Quarter-turn washerless ceramic disc valves
- Flow rate: 1.2 GPM



Part #	Mfg #	Description	Handle(s)	Finish	Price
093334	K-14407-3-BN	8"-16"ws, Low Spout	Cross	*Brushed Nickel	
107275	K-14407-3-BV	8"-16"ws, Low Spout	Cross	*Brushed Bronze	
099017	K-14407-3-CP	8"-16"ws, Low Spout	Cross	Polished Chrome	
090275	K-14407-3-SN	8"-16"ws, Low Spout	Cross	*Polished Nickel	

\* Vibrant Limited Lifetime Warranty

[www.plumbsupply.com](http://www.plumbsupply.com) • Serving our Customers Since 1946 • [www.waterconcepts.net](http://www.waterconcepts.net)

**Lavatory - Widespread**

**Two-Handle Widespread Lavatory Faucets (Continued)**

**Purist® Lavatory Faucet for 8"- 16" Centers with Pop-Up Drain, Lift Rod, Tailpiece, and 2 High Handles**

Part #	Mfg #	Description	Handle(s)	Finish	Price
086386	K-14407-4-BN	8"-16"ws, Low Spout	ADA Lever	*Brushed Nickel	
154172	K-14407-4-BV	8"-16"ws, Low Spout	ADA Lever	*Brushed Bronze	
071838	K-14407-4-CP	8"-16"ws, Low Spout	ADA Lever	Polished Chrome	
080265	K-14408-4-BN	8"-16"ws, High Spout	ADA Lever	*Brushed Nickel	

**Purist® and Lavatory Faucet for 8"- 16" Centers with Pop-Up Drain, Lift Rod, Tailpiece, and 2 Low Handles**

- 5" Reach spout, 3-15/16" height
- Brass construction, Brass valve bodies
- Low gooseneck stationary spout
- Reversible quarter-turn washerless ceramic disc valves
- WaterSense® certified product: 1.2 gpm



Part #	Mfg #	Description	Handle(s)	Finish	Price
251716	K-14410-3-BL	8"-16"ws	Cross	Matte Black	
080659	K-14410-3-BN	8"-16"ws	Cross	*Brushed Nickel	
099335	K-14410-3-CP	8"-16"ws	Cross	Polished Chrome	
244782	K-14410-4-BGD	8"-16"ws Gold	ADA Lever	*Moderne Brushed	
073846	K-14410-4-BN	8"-16"ws	ADA Lever	*Brushed Nickel	
132502	K-14410-4-BV	8"-16"ws	ADA Lever	*Brushed Bronze	
076750	K-14410-4-CP	8"-16"ws	ADA Lever	Polished Chrome	
082407	K-14410-4-SN	8"-16"ws	ADA Lever	*Polished Nickel	

**Purist® 2-Hdl Dual Controlled Wall-Mount Lavatory Faucet with Stationary Spout—Less Drain and Valve**

- 8-1/4" 35° spout from wall to center of drain —6-1/4" reach for model (K-T14413)
- Brass construction
- Ceramic disc valves
- Fluid design lines
- Flow rate: 1.2 GPM



Requires valve: **K-410-K**

Part #	Mfg #	Description	Handle(s)	Finish	Price
087559	K-T14413-4-CP	8"cc, Wall-mount	ADA Lever	Polished Chrome	
076197	K-T14415-3-BN	8"cc, Wall-mount	Cross	*Brushed Nickel	
093592	K-T14415-3-BV	8"cc, Wall-mount	Cross	*Brushed Bronze	
073309	K-T14415-3-CP	8"cc, Wall-mount	Cross	Polished Chrome	
090590	K-T14415-3-SN	8"cc, Wall-mount	Cross	*Polished Nickel	
080499	K-T14415-4-BN	8"cc, Wall-mount	ADA Lever	*Brushed Nickel	
093380	K-T14415-4-BV	8"cc, Wall-mount	ADA Lever	*Brushed Bronze	

\* Vibrant Limited Lifetime Warranty

[www.waterconcepts.net](http://www.waterconcepts.net) • Serving our Customers Since 1946 • [www.plumbsupply.com](http://www.plumbsupply.com)

## Lavatory - Widespread

### Two-Handle Widespread Lavatory Faucets (Continued)

#### Purist® 2-Hdl Dual Controlled Wall-Mount Lavatory Faucet with Stationary Spout—Less Drain and Valve

Part #	Mfg #	Description	Handle(s)	Finish	Price
069751	K-T14415-4-CP	8"cc, Wall-mount	ADA Lever	Polished Chrome	

#### Purist® 2-Hdl Dual Controlled Wall-Mount Lavatory Faucet with Stationary 90° Spout—Less Drain and

- 9" Reach spout
- Brass construction
- Flow rate: 1.2 gpm



Part #	Mfg #	Description	Handle(s)	Finish	Price
113683	K-T14414-3-BN	8"cc, Wall-Mount	Cross	*Brushed Nickel	
222958	K-T14414-3-BGD	8"cc, Wall-Mount Gold	Cross	*Moderne Brushed	
169051	K-T14414-3-BV	8"cc, Wall-Mount	Cross	*Brushed Bronze	
167356	K-T14414-3-CP	8"cc, Wall-Mount	Cross	Polished Chrome	
096083	K-T14414-4-BN	8"cc, Wall-Mount	ADA Lever	*Brushed Nickel	
186403	K-T14414-4-BV	8"cc, Wall-Mount	ADA Lever	*Brushed Bronze	
098011	K-T14414-4-CP	8"cc, Wall-Mount	ADA Lever	Polished Chrome	
229144	K-T14414-4-SN	8"cc, Wall-Mount	ADA Lever	*Polished Nickel	

#### Purist® 2-Hdl Dual Controlled Wall-Mount Lavatory Faucet Trim—Less Drain

- 6-3/4" Stationary spout reach
- Brass construction
- Fluid design lines
- Low-flow aerator option available
- WaterSense® certified product: 1.2 gpm
- **Requires wall-mount valve [K-410-K]**



Part #	Mfg #	Description	Handle(s)	Finish	Price
065121	K-T14413-3-CP	8"cc, Wall-Mount	ADA Lever	Polished Chrome	
255179	T14413-3-BL	8"cc, Wall-Mount	ADA Lever	Matte Black	

#### Refinia® Lavatory Faucet for 8" - 16" Centers with Pop-Drain, Tailpiece, and Two Lever Handles

- 4-1/2" Reach spout
- Metal construction
- Quarter turn washerless ceramic disc valves
- Features UltraGlide Valve with Dry Stem technology
- Meets EPA WaterSense® criteria
- Maximum flow rate: 1.2 gpm



Part #	Mfg #	Description	Handle(s)	Finish	Price
141700	K-5317-4-BN	8"-16"ws, Pop-Up Drain with Tailpiece	ADA Lever	*Brushed Nickel	
141701	K-5317-4-CP	8"-16"ws, Pop-Up Drain with Tailpiece	ADA Lever	Polished Chrome	

\* Vibrant Limited Lifetime Warranty

[www.plumbsupply.com](http://www.plumbsupply.com) • Serving our Customers Since 1946 • [www.waterconcepts.net](http://www.waterconcepts.net)

## Lavatory - Widespread

### Revival® Lavatory Faucet for 8" - 16" Centers with Pop-Up Drain, Tailpiece, and Two Lever Handles

- 5-1/4" Reach stationary spout, 4-1/8" height
- Brass construction, brass valve bodies
- Quarter-turn washerless ceramic disc valves
- Complements Revival® suite
- WaterSense certified product: 1.2 gpm



-4A Handles

Part #	Mfg #	Description	Handle(s)	Finish	Price
054869	K-16102-4A-BN	8"-16"ws, Pop-Up Drain with Tailpiece	ADA Traditional Lever	*Brushed Nickel	
066584	K-16102-4A-BV	8"-16"ws, Pop-Up Drain with Tailpiece	ADA Traditional Lever	*Brushed Bronze	
053625	K-16102-4A-PB	8"-16"ws, Pop-Up Drain with Tailpiece	ADA Traditional Lever	Polished Brass	

### Revival® 2-Hdl Wall-Mount Lavatory Faucet Trim

- 9-1/4" Reach spout
- Brass construction
- Flow rate: 1.2 gpm
- **Requires two-handle ceramic valve [K-410-K]**



Part #	Mfg #	Description	Handle(s)	Finish	Price
236808	T16106-4A-BV	8"-16"ws, Less Drain	ADA Traditional Lever	*Brushed Bronze	

### Stillness® Lavatory Faucet for 8" - 16" Centers with Pop-Up Drain, Tailpiece, Liftrod, and Two Lever Handles

- 3-7/8" Reach stationary spout
- Brass construction, brass valve bodies
- Quarter-turn washerless ceramic disc valves
- Flow rate: 1.5 gpm



Part #	Mfg #	Description	Handle(s)	Finish	Price
066490	K-942-4-BN	8"-16"ws, Pop-Up Drain with Tailpiece	ADA Lever	*Brushed Nickel	
063698	K-942-4-CP	8"-16"ws, Pop-Up Drain with Tailpiece	ADA Lever	Polished Chrome	

### Stillness® Laminar 2-Hdl Wall-Mount Lavatory Faucet Trim with Two Lever Handles—Less Drain

- 5-5/16" Reach spout
- Brass construction
- Flow rate: 2.0 gpm
- **Requires two-handle ceramic valve [K-410-K]**



Part #	Mfg #	Description	Handle(s)	Finish	Price
101643	K-T945-4-BN	8"ws, Less Drain	ADA Lever	*Brushed Nickel	
093585	K-T945-4-CP	8"ws, Less Drain	ADA Lever	Polished Chrome	

\* Vibrant Limited Lifetime Warranty

[www.waterconcepts.net](http://www.waterconcepts.net) • Serving our Customers Since 1946 • [www.plumbsupply.com](http://www.plumbsupply.com)

## Lavatory - Widespread

### Stillness® 2-Hdl Dual Control Wall-Mounted Lavatory Faucet Trim—Less Drain

- 4-9/16"-6-1/16" Stationary spout reach
- Brass construction
- Fluid design lines
- WaterSense® certified product: 1.2 gpm
- **Requires wall-mount valve [K-410-K]**



Part #	Mfg #	Description	Handle(s)	Finish	Price
062815	K-T944-4-CP	8"ws, Less Drain	ADA Lever	Polished Chrome	

### IV Georges Brass® Widespread Lavatory Faucet with High Country™ Swing Spout and Lever Handles

- 5" Reach, 11-7/8" high spout
- Brass construction, brass valve bodies
- Quarter-turn washerless ceramic disc valves.
- Metal pop-up drain with lift rod and tailpiece
- Flow rate: 1.2 gpm



Part #	Mfg #	Description	Handle(s)	Finish	Price
076960	K-6813-4-BN	8"-16"ws, Metal Pop-Up	ADA Lever	*Brushed Nickel	
182867	K-6813-4-BV	8"-16"ws, Metal Pop-Up	ADA Lever	*Brushed Bronze	
136917	K-6813-4-SN	8"-16"ws, Metal Pop-Up	ADA Lever	*Polished Nickel	

### Single-Handle Widespread Lavatory Faucets

#### Loure® Tall Lavatory Faucet with Lever Handle and Touch-Activated Drain with Tailpiece and Overflow

- One-piece, self-contained ceramic disc valve
- 5-1/4" Reach spout
- Metal construction
- 2" Diameter valve
- Flow rate: 1.2 gpm



Part #	Mfg #	Description	Handle(s)	Finish	Price
141510	K-14660-4-BN	8"cc, 2-Hole	ADA Lever	*Brushed Nickel	
143000	K-14660-4-CP	8"cc, 2-Hole	ADA Lever	Polished Chrome	

### Lavatory Faucet Handles

#### Components™ Widespread Lavatory Sink Handles

- For 8" or 16" centers
- UltraGlide ceramic disc valves
- Handles pre-assembled on valves



Part #	Mfg #	Description	Reach	Finish	Price
257034	K-77974-4-BL	8"-16"ws, Handles Only	Lever	Matte Black	
258815	K-77974-4-TT	8"-16"ws, Handles Only	Lever	*Titanium	

\* Vibrant Limited Lifetime Warranty

[www.plumbsupply.com](http://www.plumbsupply.com) • Serving our Customers Since 1946 • [www.waterconcepts.net](http://www.waterconcepts.net)

## Lavatory - Widespread

### Components™ Oyl Design Widespread Lavatory Sink Handles

- For 8" or 16" centers
- UltraGlide ceramic disc valves
- Handles pre-assembled on valves



Part #	Mfg #	Description	Reach	Finish	Price
258001	K-77974-8-BL	8"-16"ws, Handles Only	Knob	Matte Black	

### Lavatory Rough-In Valves

#### Dual-Controlled Wall-Mount Lavatory Rough-In Valve

- Brass construction
- Quarter-turn ceramic disc valves
- Requires valve trim (sold separately)
- WaterSense compliant when paired with appropriate trim
- Maximum flow rate: 2.2 gpm @ 60 psi



Part #	Mfg #	Description	Price
062816	K-410-K-NA	2-Hdl Ceramic Valve	

\* Vibrant Limited Lifetime Warranty

[www.waterconcepts.net](http://www.waterconcepts.net) • Serving our Customers Since 1946 • [www.plumbsupply.com](http://www.plumbsupply.com)



## Lavatory Faucets - Widespread

### Two-Handle Widespread Lavatory Faucets

#### Baliza® 2-Hdl Mini-Widespread Lavatory Faucets

- 5-1/16" Reach, 6-1/4" high spout
- 4-3/16" From deck to aerator
- 1-1/2" Maximum deck thickness
- Spout features hidden water-efficient aerator
- WaterSense® certified product: 1.5 gpm @ 60 psi



Handles Sold Separately

Requires HL505 or HX505 Handle Package

Part #	Mfg #	Description	Handle(s)	Finish	Price
173816	65505LF-PCLHP	3-Hole 4"cc, Metal Pop-Up	Less Handles	Chrome	
186748	65505LF-PNLHP	3-Hole 4" cc, Metal Pop-Up	Less Handle	Polished Nickel*	
219255	65505LF-RBLHP	3-Hole 4" cc, Metal Pop-Up	Less Handle	Venetian Bronze	

#### Baliza® 2-Hdl Widespread Lavatory Faucet

- 5-5/16" Reach, 6-1/2" high spout
- 4-5/16" From deck to aerator
- 3" Maximum deck thickness
- Spout features hidden water-efficient aerator
- WaterSense® certified product: 1.5 gpm @ 60 psi



Handles Sold Separately

Requires HL505 or HX505 Handle Package

Part #	Mfg #	Description	Handle(s)	Finish	Price
141933	65305LF-BNLHP	3-Hole, Metal Pop-Up	Less Handles	Brushed Nickel*	
171321	65305LF-BZLHP	3-Hole, Metal Pop-Up	Less Handles	Brushed Bronze*	
144001	65305LF-PCLHP	3-Hole, Metal Pop-Up	Less Handles	Chrome	
159398	65305LF-PNLHP	3-Hole, Metal Pop-Up	Less Handles	Polished Nickel*	
139207	65305LF-RBLHP	3-Hole, Metal Pop-Up	Less Handles	Venetian Bronze®	

#### Charlotte™ 2-Hdl Widespread Lavatory Faucet

- 5" Reach, 7-3/8" high spout
- 5-5/8" From deck to aerator
- 2-1/2" Maximum deck thickness
- Spout features hidden water-efficient, laminar flow aerator
- WaterSense® certified product: 1.5 gpm @ 60 psi



Handles Sold Separately

Requires H5385 Handle Package

Part #	Mfg #	Description	Handle(s)	Finish	Price
180678	65385LF-BNLHP	3-Hole, Metal Pop-Up	Less Handles	Brushed Nickel*	
177588	65385LF-PCLHP	3-Hole, Metal Pop-Up	Less Handles	Chrome	
155365	65385LF-PNCOLHP	3-Hole, Metal Pop-Up	Less Handles	Cocoa Brz™/Pol Nickel	

\* Brilliance® Anti-Tarnish Lifetime Finishes

[www.plumbsupply.com](http://www.plumbsupply.com) • Serving our Customers Since 1946 • [www.waterconcepts.net](http://www.waterconcepts.net)

## Lavatory Faucets - Widespread

### Two-Handle Widespread Lavatory Faucets (Continued)

#### Charlotte™ 2-Hdl Widespread Lavatory Faucet

Part #	Mfg #	Description	Handle(s)	Finish	Price
144005	65385LF-PNLHP	3-Hole, Metal Pop-Up	Less Handles	Polished Nickel*	

#### Levoir™ 2-Hdl Widespread Lavatory Faucet

- 5-19/16" Reach, 6" high spout
- 4-15/16" From deck to aerator
- 3-3/16" Maximum deck thickness
- WaterSense® certified product: 1.5 gpm @ 60 psi



**Handles Sold Separately**

**Requires HL5397, HL5398, HX5397, or HX5398 Handle Package**

Part #	Mfg #	Description	Handle(s)	Finish	Price
255362	65398LF-GLLHP	3-Hole, Metal Pop-Up	Less Handles	Luxe Gold	
255112	65398LF-PNLHP	3-Hole, Metal Pop-Up	Less Handles	Polished Nickel*	

#### Litze™ 2-Hdl Widespread Lavatory Faucet

- 5-9/16" Reach, 7" high spout
- 5" From deck to aerator
- 2-1/2" Maximum deck thickness
- WaterSense® certified product: 1.5 gpm @ 60 psi



**Handles Sold Separately**

**Requires HL5334, HL5332, or HL5333, Handle Package**

Part #	Mfg #	Description	Handle(s)	Finish	Price
238665	65335LF-GLLHP	3-Hole, Metal Pop-Up	Less Handles	Luxe Gold	
229517	65335LF-NKLHP	3-Hole, Metal Pop-Up	Less Handles	Luxe Nickel	
237551	65335LF-PCLHP	3-Hole, Metal Pop-Up	Less Handles	Chrome	
257377	65335LF-PNLHP	3-Hole, Metal Pop-Up	Less Handles	Polished Nickel*	

#### Litze™ 2-Hdl Widespread Lavatory Faucet

- 5-9/16" Reach, 4-15/16" high spout
- 3" From deck to aerator
- 2-1/2" Maximum deck thickness
- WaterSense® certified product: 1.5 gpm @ 60 psi



**Handles Sold Separately**

**Requires HL5334, HL5332, or HL5333, Handle Package**

Part #	Mfg #	Description	Handle(s)	Finish	Price
243450	65337LF-GLLHP	3-Hole, Metal Pop-Up	Less Handles	Luxe Gold	
233752	65337LF-NKLHP	3-Hole, Metal Pop-Up	Less Handles	Luxe Nickel	
243240	65337LF-PCLHP	3-Hole, Metal Pop-Up	Less Handles	Chrome	
246797	65337LF-PNLHP	3-Hole, Metal Pop-Up	Less Handles	Polished Nickel*	

\* Brilliance® Anti-Tarnish Lifetime Finishes

## Lavatory Faucets - Widespread

### Odin™ 2-Hdl Widespread Lavatory Faucet

- 4-3/4" Reach, 9" high spout
- 6-1/8" From deck to aerator
- 2" Maximum deck thickness
- Spout features hidden water-efficient aerator
- WaterSense® certified product: 1.5 gpm @ 60 psi



Part #	Mfg #	Description	Handle(s)	Finish	Price
180052	65375LF-BN	3-Hole, Less Drain	ADA Lever	Brushed Nickel*	
231306	65375LF-BL	3-Hole, Less Drain	ADA Lever	Matte Black	
157992	65375LF-PC	3-Hole, Less Drain	ADA Lever	Chrome	

### Providence™ Classic 2-Hdl Widespread Lavatory Faucet

- 4-3/4" Reach, 7" high spout
- 4-3/4" From deck to aerator
- 1-1/8" Maximum deck thickness
- Order RP10612 for additional 1" mounting aids
- Handles sold separately
- WaterSense® certified product: 1.5 gpm @ 60 psi



Part #	Mfg #	Description	Handle(s)	Finish	Price
185169	6520LF-BNLHP	3 Hole,	Less Handles	Brushed Nickel*	
227901	6520LF-PCLHP	3 Hole,	Less Handles	Chrome	
163846	6520LF-RBLHP	3-Hole	Less Handles	Venetian Bronze®	

### Rook™ 2-Hdl Widespread Lavatory Faucet — Less Handles

- 5-3/4" Reach, 4-11/16" high spout
- 3" From deck to aerator
- 1/4" Turn handle stops
- 1/2-14 NPSM threaded inlets
- Flexible hose connections
- WaterSense® certified product: 1.5 gpm @ 60 psi



Handles Sold Separately (-LHP)

Requires HL5360 or HX5361 Handle Package

Part #	Mfg #	Description	Handle(s)	Finish	Price
237553	65360LF-PCLHP	3-Hole, Metal Pop-Up Drain	Less Handles	Chrome	
250559	65360LF-PNLHP	3-Hole, Metal Pop-Up Drain	Less Handles	Polished Nickel*	
178557	65360LF-NKBLHP	3-Hole, Metal Pop-Up Drain Black*	Less Handles	Luxe Nickel/Matte	
185804	65360LF-NKLHP	3-Hole, Metal Pop-Up Drain	Less Handles	Luxe Nickel*	
222406	65360LF-RBLHP	3-Hole, Metal Pop-Up Drain	Less Handles	Venetian Bronze®	
227119	65361LF-NKLHP	3-Hole, Metal Pop-Up Drain w/ Channel Spout	Less Handles	Luxe Nickel	
223090	65361LF-NKBLHP	3-Hole, Metal Pop-Up Drain w/ Channel Spout Black*	Less Handles	Luxe Nickel/Matte	
188956	65361LF-PCLHP	3-Hole, Metal Pop-Up Drain w/ Channel Spout	Less Handles	Chrome	

\* Brilliance® Anti-Tarnish Lifetime Finishes

[www.plumbsupply.com](http://www.plumbsupply.com) • Serving our Customers Since 1946 • [www.waterconcepts.net](http://www.waterconcepts.net)

## Lavatory Faucets - Widespread

### Two-Handle Widespread Lavatory Faucets (Continued)

#### Rook™ 2-Hdl Widespread Lavatory Faucet — Less Handles

Part #	Mfg #	Description	Handle(s)	Finish	Price
222018	65361LF-RBLHP	3-Hole, Metal Pop-Up Drain w/ Channel Spout	Less Handles	Venetian Bronze	

#### RSVP® Lavatory Faucet

- 5" Reach, 8" high spout
- 3-13/16" From deck to aerator
- Ceramic cartridge
- WaterSense® certified product: 1.20 gpm @ 60 psi



Handles sold separately

Requires HL5390 or HX5390 handle package

Part #	Mfg #	Description	Handle(s)	Finish	Price
145029	65390LF-BNLHP	3-Hole, Metal Pop-Up	Less Handles	Brushed Nickel*	
141152	65390LF-PCLHP	3-Hole, Metal Pop-Up	Less Handles	Chrome	

#### Siderna™ 2-Hdl Widespread Lavatory Faucet

- 6" Reach, 8-1/2" high spout
- 5-27/32" From deck to aerator
- 2-1/2" Maximum deck thickness
- Spout features hidden water-efficient, laminar flow aerator
- Handles feature neodymium rare earth magnets to simplify installation and provide secure, flush fit
- WaterSense® certified product: 1.5 gpm @ 60 psi



Handles Sold Separately

Requires HL5380, HL5382 or HL5381 Handle Package

Part #	Mfg #	Description	Handle(s)	Finish	Price
162474	65380LF-BLLHP	3-Hole, Less Drain	Less Handles	Matte Black	
155285	65380LF-BNLHP	3-Hole, Less Drain	Less Handles	Brushed Nickel*	
166141	65380LF-PCLHP	3-Hole, Less Drain	Less Handles	Chrome	

#### Sotria™ 2-Hdl Widespread Lavatory Faucet

- 5-3/4" Reach, 5-13/32" high spout
- 4-1/2" From deck to aerator
- 2-1/2" Maximum deck thickness
- Handles feature neodymium rare earth magnets to simplify installation and provide secure, flush kit
- WaterSense® certified product: 1.5 gpm @ 60 psi



Part #	Mfg #	Description	Handle(s)	Finish	Price
222393	65350LF-PC	3-Hole Installation, Metal Pop-Up	ADA Lever	Chrome	
177372	65350LF-BL	3-Hole Installation, Metal Pop-Up	ADA Lever	Matte Black	
173228	65350LF-NK	3-Hole Installation, Metal Pop-Up	ADA Lever	Luxe Nickel*	

\* Brilliance® Anti-Tarnish Lifetime Finishes

www.waterconcepts.net • Serving our Customers Since 1946 • www.plumbsupply.com

## Lavatory Faucets - Widespread

### Two-Handle Widespread Lavatory Faucets (Continued)

#### Sotria™ 2-Hdl Widespread Lavatory Faucet

Part #	Mfg #	Description	Handle(s)	Finish	Price
179424	65350LF-PN	3-Hole Installation, Metal Pop-Up	ADA Lever	Polished Nickel*	

#### Sotria™ 2-Hdl Widespread Lavatory Faucet with Channel Spout

- 5-19/32" Reach, 5-21/64" high spout
- 3-15/16" From deck to aerator
- 2-1/2" Maximum deck thickness
- 1/4 Turn handle stops
- WaterSense® certified product: 1.5 gpm @ 60 psi



Part #	Mfg #	Description	Handle(s)	Finish	Price
182225	65351LF-BL	3-Hole, Channel Spout, Metal Pop-Up	ADA Lever	Matte Black	
180762	65351LF-NK	3-Hole, Channel Spout, Metal Pop-Up	ADA Lever	Luxe Nickel*	
179425	65351LF-PN	3-Hole, Channel Spout, Metal Pop-Up	ADA Lever	Polished Nickel*	
245633	65351LF-PC	3-Hole, Channel Spout, Metal Pop-Up	ADA Lever	Chrome	

#### Tresa® 2-Hdl Widespread Lavatory Faucet

- 6-1/2" Reach, 7-1/2" high spout
- 4-3/16" From deck to aerator
- 2-1/4" Maximum deck thickness
- Spout features hidden water-efficient aerator
- WaterSense® certified product: 1.5 gpm @ 60 psi



Part #	Mfg #	Description	Handle(s)	Finish	Price
155248	65336LF-PC	3-Hole, Metal Pop-Up	ADA Lever	Chrome	
172780	65336LF-PN	3-Hole, Metal Pop-Up	ADA Lever	Polished Nickel*	
145562	65336LF-RB	3-Hole, Metal Pop-Up	ADA Lever	Venetian Bronze®	
130947	65338LF-BN	3-Hole, Metal Pop-Up	ADA Cross	Brushed Nickel*	
119045	65338LF-PC	3-Hole, Metal Pop-Up	ADA Cross	Chrome	
174833	65338LF-PN	3-Hole, Metal Pop-Up	ADA Cross	Polished Nickel*	
120624	65338LF-RB	3-Hole, Metal Pop-Up	ADA Cross	Venetian Bronze®	

#### Tresa® 2-Hdl Widespread Bridge Lavatory Faucet

- 6-1/2" Reach, 9-1/4" high spout
- 5-1/2" From deck to aerator
- 3" Maximum deck thickness
- Spout features hidden water-efficient aerator
- Includes optional decorative center hole cover
- Drain sold separately
- WaterSense® certified product: 1.5 gpm @ 60 psi



Part #	Mfg #	Description	Handle(s)	Finish	Price
188609	65536LF-BN	2- or 3-Hole, Less Drain 7" Reach	ADA Cross	Brushed Nickel*	
175059	65538LF-BN	2- or 3-Hole, Less Drain	ADA Cross	Brushed Nickel*	
134901	65538LF-PC	2- or 3-Hole, Less Drain	ADA Cross	Chrome	

\* Brilliance® Anti-Tarnish Lifetime Finishes

[www.plumbsupply.com](http://www.plumbsupply.com) • Serving our Customers Since 1946 • [www.waterconcepts.net](http://www.waterconcepts.net)



## Lavatory Faucets - Widespread

### Two-Handle Widespread Lavatory Faucets (Continued)

#### Tresa® 2-Hdl Widespread Bridge Lavatory Faucet

Part #	Mfg #	Description	Handle(s)	Finish	Price
171918	65538LF-PN	2- or 3-Hole, Less Drain	ADA Cross	Polished Nickel*	
174389	65538LF-RB	2- or 3-Hole, Less Drain	ADA Cross	Venetian Bronze®	

#### Vesi® Curve 2-Hdl Widespread Lavatory Faucet

- 5-1/4" Reach, 4-1/4" high spout
- 2-1/8" From deck to aerator
- 1-1/8" Maximum deck thickness
- Order RP10612 for additional 1" mounting aids
- WaterSense® certified product: 1.5 gpm @ 60 psi



Part #	Mfg #	Description	Handle(s)	Finish	Price
129689	65340LF-BN	3-Hole, Metal Pop-Up	ADA Lever	Brushed Nickel*	
142835	65340LF-BZ	3-Hole, Metal Pop-Up	ADA Lever	Brushed Bronze*	
156801	65340LF-PC	3-Hole, Metal Pop-Up	ADA Lever	Chrome	
185767	65340LF-RB	3-Hole, Metal Pop-Up	ADA Lever	Venetian Bronze®	

#### Vesi® Channel 2-Hdl Widespread Lavatory Faucet

- 5-1/4" Reach, 4-1/4" high spout
- 1-3/4" From deck to aerator
- 1-1/8" Maximum deck thickness
- Order RP10612 for additional 1" mounting aids
- WaterSense® certified product: 1.5 gpm @ 60 psi



Part #	Mfg #	Description	Handle(s)	Finish	Price
130804	65345LF-BN	3-Hole, Metal Pop-Up	ADA Lever	Brushed Nickel*	
130243	65345LF-BZ	3-Hole, Metal Pop-Up	ADA Lever	Brushed Bronze*	
130971	65345LF-PC	3-Hole, Metal Pop-Up	ADA Lever	Chrome	
172035	65345LF-RB	3-Hole, Metal Pop-Up	ADA Lever	Venetian Bronze®	

#### Vettis™ 2-Hdl Widespread Lavatory Faucet

- 6-5/16" Reach, 4-7/8" high spout
- 4" From deck to aerator
- 2-1/2" Maximum deck thickness
- WaterSense® certified product: 1.5 gpm @ 60 psi



Part #	Mfg #	Description	Handle(s)	Finish	Price
259503	65388LF-NK	3-Hole, Metal Pop-Up	ADA Lever	Luxe Nickel	

\* Brilliance® Anti-Tarnish Lifetime Finishes

www.waterconcepts.net • Serving our Customers Since 1946 • www.plumbsupply.com



## Lavatory Faucets - Widespread

### Vettis™ 2-Hdl Widespread Lavatory Faucet with Channel Spout

- 6-3/4" Reach, 4-7/8" high open flow spout
- 4" From deck to aerator
- 2-1/2" Maximum deck thickness
- WaterSense® certified product: 1.2 gpm @ 60 psi



Part #	Mfg #	Description	Handle(s)	Finish	Price
245811	65386LF-NKPC-ECO	3-Hole, Metal Pop-Up	ADA Lever	Luxe Nickel/Chrome	
241637	65386LF-PC-ECO	3-Hole, Metal Pop-Up	ADA Lever	Chrome	

### Virage® 2-Hdl Widespread Lavatory Faucet

- 5-9/16" Reach, 7-27/32" high spout
- 4-7/8" From deck to aerator
- WaterSense® certified product: 1.5 gpm @ 60 psi



Part #	Mfg #	Description	Handle(s)	Finish	Price
133559	65330LF-BN	3-Hole, Metal Pop-Up	ADA Lever	Brushed Nickel*	
136563	65330LF-BZ	3-Hole, Metal Pop-Up	ADA Lever	Brushed Bronze*	
129978	65330LF-PC	3-Hole, Metal Pop-Up	ADA Lever	Chrome	
134903	65330-LF-PN	3-Hole, Metal Pop-Up	ADA Lever	Polished Nickel*	
137491	65330-LF-RB	3-Hole, Metal Pop-Up	ADA Lever	Venetian Bronze®	

## Widespread Vessel Faucets

### Charlotte™ 2-Hdl Widespread Vessel Faucet

- 5" Reach, 12-3/4" high spout
- 11" From deck to aerator
- 2-1/2" Maximum deck thickness
- Spout features hidden water-efficient, laminar flow aerator
- WaterSense® certified product: 1.5 gpm @ 60 psi



Handles Sold Separately

Requires HL5485 Handle Package

Part #	Mfg #	Description	Handle(s)	Finish	Price
166543	65485LF-BNLHP	3-Hole, Grid Strainer	Less Handles	Brushed Nickel*	
159769	65485LF-PNCOLHP	3-Hole, Grid Strainer	Less Handles	Cocoa Brz™/Pol Nickel	

\* Brilliance® Anti-Tarnish Lifetime Finishes

[www.plumbsupply.com](http://www.plumbsupply.com) • Serving our Customers Since 1946 • [www.waterconcepts.net](http://www.waterconcepts.net)

## Lavatory Faucets - Widespread

### RSVP® 2-hdl Widespread Vessel Faucet

- 5" Reach, 13" high spout
- 9-13/16" From deck to aerator
- Spout features hidden water-efficient, laminar flow aerator
- Additional decorative finial's available
- WaterSense® certified product: 1.5 gpm @ 60 psi



Handles Sold Separately

Requires HL5790 or HX5790 Handle Package

Part #	Mfg #	Description	Handle(s)	Finish	Price
165647	65790LF-PCLHP	3-Hole, Less Drain	Less Handles	Chrome	

### Virage® 2-Hdl Widespread Vessel Faucet

- 5-9/16" Reach, 12-11/32" high spout
- 9-9/16" From deck to aerator
- 3" Maximum deck thickness
- Spout features hidden water-efficient, laminar flow aerator
- WaterSense® certified product: 1.5 gpm @ 60 psi



Part #	Mfg #	Description	Handle(s)	Finish	Price
135948	65430LF-BN	3-Hole, Grid Drain	ADA Lever	Brushed Nickel*	
160243	65430LF-PC	3-Hole, Grid Drain	ADA Lever	Chrome	
131327	65430LF-RB	3-Hole, Grid Drain	ADA Lever	Venetian Bronze®	

## Wall-Mount Lavatory Faucets

### Ara® 2-Hdl Wall-Mount Lavatory Faucet

- 8" Spout reach, 2-1/8" height
- Ceramic valve
- 1/2" IPS connection
- WaterSense® certified product: 1.2 gpm @ 60 psi



Part #	Mfg #	Description	Handle(s)	Finish	Price
237672	T3567LF-BLWL	3-Hole, Less Pop-Up Drain	ADA Lever	Matte Black	

\* Brilliance® Anti-Tarnish Lifetime Finishes

[www.waterconcepts.net](http://www.waterconcepts.net) • Serving our Customers Since 1946 • [www.plumbsupply.com](http://www.plumbsupply.com)

## Lavatory Faucets - Widespread

### Charlotte™ 2-Hdl Wall-Mount Vessel Faucet

- 8-1/4" Spout reach
- 1-1/2" Hole size
- Adjustable roughing in dimensions: 2-1/8" to 3-1/4"
- 1/2" IPS inlets
- WaterSense® certified product: 1.5 gpm @ 60 psi



Handles Sold Separately

Requires HL5885 Handle Package

Part #	Mfg #	Description	Handle(s)	Finish	Price
175355	65885LF-BNLHP	3-Hole, Grid Drain	Less Handles	Brushed Nickel*	
147185	65885LF-PNCOLHP	3-Hole, Grid Drain	Less Handles	Cocoa Brz™/Pol Nickel	

### Levoir™ 1-Hdl Wall-Mount Lavatory Faucet

- 9-1/8" Spout reach
- Ceramic cartridge
- Integrated rotary valve
- Hidden water-efficient, laminar flow aerator
- WaterSense® certified product: 1.5 gpm @ 60 psi
- (-ECO) 1.2 gpm @ 60 psi



Drain Sold Separately

Requires Rough-In: R65700

Part #	Mfg #	Description	Handle(s)	Finish	Price
252430	T65798LF-SL-ECO	1-Hole, Less Drain	Cross Handle	Luxe Steel	

### Litze™ 1-Hdl Wall-Mount Lavatory Faucet

- 8-3/4" Spout reach
- Spout features hidden water-efficient, laminar flow aerator
- Ceramic cartridge
- WaterSense® certified product: 1.5 gpm @ 60 psi



Drain Sold Separately

Requires Rough-In: R65700

Part #	Mfg #	Description	Handle(s)	Finish	Price
248014	T65735LF-NKTK	1-Hole, Less Drain	ADA Lever	Luxe Nickel/Teak Wood	

\* Brilliance® Anti-Tarnish Lifetime Finishes

[www.plumbsupply.com](http://www.plumbsupply.com) • Serving our Customers Since 1946 • [www.waterconcepts.net](http://www.waterconcepts.net)

## Lavatory Faucets - Widespread

### Odin™ 2-Hdl Wall-Mount Vessel Faucet

- 8-1/2" Spout length
- Spout features hidden water-efficient, laminar flow aerator
- 3-1/4" Maximum deck thickness
- WaterSense® certified product: 1.5 gpm @ 60 psi



Part #	Mfg #	Description	Handle(s)	Finish	Price
169579	65875LF-BL	3-Hole, Less Drain	ADA Lever	Matte Black	
222154	65875LF-BN	3-Hole, Less Drain	ADA Lever	Brushed Nickel*	
182728	65875LF-PC	3-Hole, Less Drain	ADA Lever	Chrome	

### RSVP® 2-Hdl Wall-Mount Vessel Faucet — Less Handles

- 8-5/8" Spout reach
- Hidden water-efficient, laminar flow aerator
- Ceramic cartridge
- WaterSense® certified product: 1.5 gpm @ 60 psi
- Drain sold separately



Part #	Mfg #	Description	Handle(s)	Finish	Price
243117	65890LF-BNLHP	3-Hole, Less Drain	ADA Lever	*Brushed Nickel	
238278	65890LF-PCLHP	3-Hole, Less Drain	ADA Lever	Chrome	

### Siderna™ 2-Hdl Wall-Mount Vessel Faucet

- 6-3/4" - 8-1/2" Adjustable spout reach
- 3-1/2" Maximum deck thickness
- Spout features hidden water-efficient, laminar flow aerator
- WaterSense® certified product: 1.5 gpm @ 60 psi



Handles Sold Separately

Requires HL5880, HL5881, or HL5882 Handle Package

Part #	Mfg #	Description	Handle(s)	Finish	Price
242988	65880LF-BLLHP	3-Hole, Less Drain	Less Handles	Matte Black	
158692	65880LF-BNLHP	3-Hole, Less Drain	Less Handles	Brushed Nickel*	
166848	65880LF-PCLHP	3-Hole, Less Drain	Less Handles	Chrome	

\* Brilliance® Anti-Tarnish Lifetime Finishes

[www.waterconcepts.net](http://www.waterconcepts.net) • Serving our Customers Since 1946 • [www.plumbsupply.com](http://www.plumbsupply.com)

## Lavatory Faucets - Widespread

### Sotria™ 2-Hdl Wall-Mount Vessel Faucet

- 8-7/16" Reach
- 1-1/2" Recommended hole size
- Rough-in dimensions: 2-1/8" to 3-1/2"
- 1/2" IPS inlets
- WaterSense® certified product: 1.5 gpm @ 60 psi



Requires Rough-In Valve: R65800

Part #	Mfg #	Description	Handle(s)	Finish	Price
242177	T65851LF-BL	3-Hole, Less drain	ADA Lever	Matte Black	
177245	T65851LF-NK	3-Hole, Less drain	ADA Lever	Polished Nickel*	
180634	T65851LF-PC	3-Hole, Less drain	ADA Lever	Chrome	

### Tresa® 2-Hdl Wall-Mount Lavatory Faucet

- 7" Spout reach
- 1-1/8" Maximum wall thickness
- WaterSense® certified product



Part #	Mfg #	Description	Handle(s)	Finish	Price
173166	65836LF-BN	3-Hole, Grid Drain	ADA Lever	Brushed Nickel*	
174016	65836LF-PC	3-Hole, Grid Drain	ADA Lever	Chrome	
146635	65836LF-RB	3-Hole, Grid Drain	ADA Lever	Venetian Bronze®	

### Vettis™ 2-Hdl Wall-Mount Lavatory Faucet

- 8-1/2" Spout reach
- 1-1/2" Recommended hole size
- 1/2" IPS inlets
- WaterSense® certified product: 1.2 gpm @ 60 psi



Drain Sold Separately

Requires Rough-In: R65700

Part #	Mfg #	Description	Handle(s)	Finish	Price
255096	T65886LF-BL-ECO	3-Hole, Less Drain	ADA Lever	Matte Black	

### Virage® 2-Hdl Wall-Mount Vessel Faucet

- 8-1/2" Spout reach
- 1-1/2" Recommended hole size
- Rough-in dimensions: 2-1/8" to 3-1/2"
- 1/2" IPS inlets
- WaterSense® certified product: 1.5 gpm @ 60 psi



Part #	Mfg #	Description	Handle(s)	Finish	Price
188544	65830LF-BZ	3-Hole, Less Drain	ADA Lever	Brushed Bronze*	
200581	65830LF-PN	3-Hole, Less Drain	ADA Lever	Polished Nickel	

\* Brilliance® Anti-Tarnish Lifetime Finishes

[www.plumbsupply.com](http://www.plumbsupply.com) • Serving our Customers Since 1946 • [www.waterconcepts.net](http://www.waterconcepts.net)

## Lavatory Faucets - 8" Center

### Two-Handle Widespread Lavatory Faucets

#### Addison™ 2-Hdl Widespread Lavatory Faucet

- 5" Reach, 6-5/8" high rigid spout
- 4-1/2" From deck to aerator
- 1/2" IPS Connection
- 1-1/16" Maximum deck thickness
- WaterSense® certified product, 1.2 gpm @ 60 psi



Part #	Mfg #	Description	Handle(s)	Finish	Price
131027	3592LF	3-Hole 6"-16"ws, Metal Pop-Up Drain, Lead-Free	ADA Lever	Chrome	
138277	3592LF-CZ	3-Hole 6"-16"ws, Metal Pop-Up Drain, Lead-Free	ADA Lever	Champagne Bronze™	
145414	3592LF-RB	3-Hole 6"-16"ws, Metal Pop-Up Drain, Lead-Free	ADA Lever	Venetian Bronze®	
147552	3592LF-SS	3-Hole 6"-16"ws, Metal Pop-Up Drain, Lead-Free	ADA Lever	Stainless*	

#### Ara™ 2-Hdl Widespread Lavatory Faucet

- 5-3/8" Reach, 4-3/16" high rigid spout
- 3-3/16" From deck to aerator
- Red/blue indicators
- 3/8" Compression fittings
- 2-1/4" Maximum deck thickness
- 32" Minimum InnoFlex® supply lines below the deck
- DIAMOND™ Valve
- WaterSense® certified product: 1.2 gpm @ 60 psi



Part #	Mfg #	Description	Handle(s)	Finish	Price
237795	3567-BLMPU-DST	3-Hole 4-16"ws Metal Pop-Up Drain, Lead-Free	ADA Lever	Matte Black	
165651	3567-MPU-DST	3-Hole 4-16"ws, Metal Pop-Up Drain, Lead-Free	ADA Lever	Chrome	
162242	3567-SSMPU-DST	3-Hole 4-16"ws Metal Pop-Up Drain, Lead-Free	ADA Lever	Stainless*	

#### Ara™ 2-Hdl Channel Spout Widespread Lavatory Faucet

- 5-1/8" Reach, 4-3/16" rigid spout
- 3-3/16" From deck to aerator
- Red/blue indicators
- 3/8" Compression fittings
- 2-1/4" Maximum deck thickness
- 32" Minimum InnoFlex® supply lines below the deck
- DIAMOND™ valve
- WaterSense® certified product: 1.2 gpm @ 60 psi



Part #	Mfg #	Description	Handle(s)	Finish	Price
238227	3568LF-BLMPU	3-Hole 4-16"ws, Metal Pop-Up Drain, Lead-Free	ADA Lever	Matte Black	
165655	3568LF-MPU	3-Hole 4-16"ws, Metal Pop-Up Drain, Lead-Free	ADA Lever	Chrome	
165881	3568LF-SSMPU	3-Hole 4-16"ws, Metal Pop-Up Drain, Lead-Free	ADA Lever	Stainless*	

\* Brilliance® Anti-Tarnish Lifetime Finishes



## Lavatory Faucets - 8" Center

### Ashlyn™ 2-Hdl Widespread Lavatory Faucet

- 5-1/8" Reach, 5-1/4" high rigid spout
- 4-1/8" From deck to aerator
- Red/blue indicators
- 3/8" Compression fittings
- 2-1/4" Maximum deck thickness
- 32" Minimum InnoFlex® supply lines below the deck
- Optional gray/black set screw covers included
- 1-1/4" Minimum hole size to install EZAnchor™ top down mounting
- DIAMOND™ Valve
- WaterSense® certified product: 1.2 gpm @ 60 psi



Part #	Mfg #	Description	Handle(s)	Finish	Price
172337	3564-MPU-DST	3-Hole 4-1/2"-16"ws, MPU Drain, Lead Free	ADA Lever	Chrome	
171445	3564-RBMPU-DST	3-Hole 4-1/2"-16"ws, MPU Drain, Lead Free	ADA Lever	Venetian Bronze®	
170922	3564-SSMPU-DST	3-Hole 4-1/2"-16"ws, MPU Drain, Lead Free	ADA Lever	Stainless*	

### Cassidy™ 2-Hdl Widespread Lavatory Faucet

- 5-13/32" Reach, 5-13/16" high rigid spout
- 4-5/16" From deck to aerator
- 1/2" IPS Connection
- 1-3/32" Maximum deck thickness
- WaterSense® certified product: 1.2 gpm @ 60 psi
- LHP - Less handle program (sold separately)
- **Handles sold separately for -LHP models**
  - (H295 cross, H297 traditional lever, H298 decorative)



Part #	Mfg #	Description	Handle(s)	Finish	Price
152744	3597LF-CZMPU	3-Hole 6-16"ws, Metal Pop-Up Drain, Lead-Free	ADA Lever	Champagne Bronze™	
152775	3597LF-CZMPU-LH P	3-Hole 6-16"ws, Metal Pop-Up Drain, Lead-Free	Less Handles	Champagne Bronze™	
152743	3597LF-MPU	3-Hole 6-16"ws, Metal Pop-Up Drain, Lead-Free	ADA Lever	Chrome	
151499	3597LF-MPU-LHP	3-Hole 6-16"ws, Metal Pop-Up Drain, Lead-Free	Less Handles	Chrome	
188303	3597LF-PNMPU	3-Hole 6-16"ws, Metal Pop-Up Drain, Lead-Free	ADA Lever	Polished Nickel*	
160503	3597LF-PNMPU-LH P	3-Hole 6-16"ws, Metal Pop-Up Drain, Lead-Free	Less Handles	Polished Nickel*	
151693	3597LF-RBMPU	3-Hole 6-16"ws, Metal Pop-Up Drain, Lead-Free	ADA Lever	Venetian Bronze®	
150953	3597LF-RBMPU-LH P	3-Hole 6-16"ws, Metal Pop-Up Drain, Lead-Free	Less Handles	Venetian Bronze®	
151696	3597LF-SSMPU	3-Hole 6-16"ws, Metal Pop-Up Drain, Lead-Free	ADA Lever	Stainless*	
152776	3597LF-SSMPU-LH P	3-Hole 6-16"ws, Metal Pop-Up Drain, Lead-Free	Less Handles	Stainless*	

\* Brilliance® Anti-Tarnish Lifetime Finishes

[www.plumbsupply.com](http://www.plumbsupply.com) • Serving our Customers Since 1946 • [www.waterconcepts.net](http://www.waterconcepts.net)

## Lavatory Faucets - 8" Center

### Cassidy™ 2-Hdl Low Arc Spout Widespread Lavatory Faucet

- 5-17/32" Reach, 4-1/32" high rigid spout
- 2-3/4" From deck to aerator
- 1/2" IPS Connection
- 1-3/32" Maximum deck thickness
- WaterSense® certified product: 1.2 gpm @ 60 psi
- **Handles sold separately**
- (H295 cross, H297 traditional lever, H298 decorative)



Part #	Mfg #	Description	Handle(s)	Finish	Price
152773	3595LF-CZMPU-LH P	3-Hole 6-16"ws, Metal Pop-Up Drain, Lead-Free	Less Handles	Champagne Bronze™	
151991	3595LF-MPU-LHP	3-Hole 6-16"ws, Metal Pop-Up Drain, Lead-Free	Less Handles	Chrome	
157705	3595LF-PNMPU-LH P	3-Hole 6-16"ws, Metal Pop-Up Drain, Lead-Free	Less Handles	Polished Nickel*	
152371	3595LF-RBMPU-LH P	3-Hole 6-16"ws, Metal Pop-Up Drain, Lead-Free	Less Handles	Venetian Bronze®	
152774	3595LF-SS-MPU-LH	3-Hole 6-16"ws, Metal Pop-Up Drain, Lead-Free	Less Handles	Stainless*	

### Classic 2-Hdl Widespread Lavatory Faucet

- 5-1/4" Reach, 3-7/8" high rigid spout
- 2-3/8" From deck to aerator
- 1/2" IPS connection
- 1-1/8" Maximum deck thickness
- WaterSense® certified product: 1.52 gpm @ 60 psi



Part #	Mfg #	Description	Handle(s)	Finish	Price
152536	3530LF-MPU	3-Hole, 6-16"ws, Metal Pop-up Drain, Lead Free	ADA Lever	Chrome	
154425	3530LF-SSMPU	3-Hole, 6-16"ws, Metal Pop-up Drain, Lead Free	ADA Lever	Stainless*	
003996	3544LF-WFMPU	3-Hole, 6-16"ws, Metal Pop-up Drain, Lead Free	Clear Knobs	Chrome	

### Compel™ 2-Hdl Widespread Lavatory Faucet

- 6-7/16" Reach, 7-3/8" high rigid spout
- 3-3/16" From deck to aerator
- Stream shaper
- Red/blue indicators
- 3/8" Compression fittings
- 2-1/4" Maximum deck thickness
- 32" Minimum InnoFlex® supply lines below the deck
- DIAMOND™ Valve
- WaterSense certified product: 1.2 gpm @ 60 psi



Part #	Mfg #	Description	Handle(s)	Finish	Price
150797	3561-MPU-DST	3-Hole, 4-16"ws, Metal Pop-Up, Lead Free	ADA Lever	Chrome	
152793	3561-SSMPU-DST	3-Hole, 4-16"ws, Metal Pop-Up, Lead Free	ADA Lever	Stainless*	

\* Brilliance® Anti-Tarnish Lifetime Finishes

[www.waterconcepts.net](http://www.waterconcepts.net) • Serving our Customers Since 1946 • [www.plumbsupply.com](http://www.plumbsupply.com)

## Lavatory Faucets - 8" Center

### Dryden™ 2-Hdl Widespread Lavatory Faucet

- 4-11/16" Reach, 6-1/4" high rigid spout
- 3-3/4" From deck to aerator
- 1/2" IPS Connection
- 1-1/8" Maximum deck thickness
- WaterSense® certified product: 1.2 gpm @ 60 psi



Part #	Mfg #	Description	Handle(s)	Finish	Price
145759	3551LF	3-Hole 6-16"ws, Metal Pop-Up Drain, Lead-Free	ADA Lever	Chrome	
146205	3551LF-CZ	3-Hole 6-16"ws, Metal Pop-Up Drain, Lead-Free	ADA Lever	Champagne Bronze™	
171145	3551LF-PN	3-Hole 6-16"ws, Metal Pop-Up Drain, Lead-Free	ADA Lever	Polished Nickel*	
145760	3551LF-RB	3-Hole 6-16"ws, Metal Pop-Up Drain, Lead-Free	ADA Lever	Venetian Bronze®	
237808	3551LF-SP	3-Hole 6-16"ws, Metal Pop-Up Drain, Lead-Free	ADA Lever	SpotShield™ Stainless	
145761	3551LF-SS	3-Hole 6-16"ws, Metal Pop-Up Drain, Lead-Free	ADA Lever	Stainless*	

### Haywood™ 2-Hdl Widespread Lavatory Faucet

- 5-1/16" Reach, 4-1/8" high rigid spout
- 2-1/2" From deck to aerator
- Quick-Snap® installation
- 3/8" O.D. copper supply tubes
- WaterSense® certified product: 1.2 gpm @ 60 psi



Part #	Mfg #	Description	Handle(s)	Finish	Price
220854	35999LF	3-Hole 6-16"ws, Plastic Pop-Up Drain, Lead-Free	ADA Lever	Chrome	

### Lahara™ 2-Hdl Widespread Lavatory Faucet

- 5" Reach, 5-7/8" high rigid spout
- 3-5/8" From deck to aerator
- 3/8" Compression fittings
- 2-1/4" Maximum deck thickness
- 32" Minimum InnoFlex® supply lines below the deck
- DIAMOND™ valve
- WaterSense® certified product, 1.2 gpm @ 60 psi



Part #	Mfg #	Description	Handle(s)	Finish	Price
161970	3538-CZMPU-DST	3-Hole 4-16"ws, Metal Pop-Up Drain, Lead-Free	ADA Lever	Champagne Bronze™	
154151	3538-MPU-DST	3-Hole 4-16"ws, Metal Pop-Up Drain, Lead-Free	ADA Lever	Chrome	
150464	3538-RBMPU-DST	3-Hole 4-16"ws, Metal Pop-Up Drain, Lead-Free	ADA Lever	Venetian Bronze®	
153972	3538-SSMPU-DST	3-Hole 4-16"ws, Metal Pop-Up Drain, Lead-Free	ADA Lever	Stainless*	

\* Brilliance® Anti-Tarnish Lifetime Finishes

[www.plumbsupply.com](http://www.plumbsupply.com) • Serving our Customers Since 1946 • [www.waterconcepts.net](http://www.waterconcepts.net)

## Lavatory Faucets - 8" Center

### Linden™ 2-Hdl Widespread Lavatory Faucet

- 4-7/8" Reach, 5-1/8" high rigid spout
- 3-7/8" From deck to aerator
- 3/8" Compression fittings
- 2-1/4" Maximum deck thickness
- 32" Minimum InnoFlex® supply lines below the deck
- DIAMOND® Valve
- WaterSense® certified product: 1.2 gpm @ 60 psi



3594

3593

Part #	Mfg #	Description	Handle(s)	Finish	Price
222861	3593-MPU-DST	3-Hole 4-16"ws, Metal Pop-Up Drain, Lead-Free	ADA Lever	Chrome	
224690	3593-RBMPU-DST	3-Hole 4-16"ws , Metal Pop-Up Drain, Lead-Free	ADA Lever	Venetian Bronze®	
225507	3593-SSMPU-DST	3-Hole 4-16"ws , Metal Pop-Up Drain, Lead-Free	ADA Lever	Stainless*	
171887	3594-CZMPU-DST	3-Hole 4-16"ws , Metal Pop-Up Drain, Lead-Free	ADA Lever	Champagne Bronze™	
175373	3594-MPU-DST	3-Hole 4-16"ws, Metal Pop-Up Drain, Lead-Free	ADA Lever	Chrome	
167041	3594-RBMPU-DST	3-Hole 4-16"ws , Metal Pop-Up Drain, Lead-Free	ADA Lever	Venetian Bronze®	
157476	3594-SSMPU-DST	3-Hole 4-16"ws , Metal Pop-Up Drain, Lead-Free	ADA Lever	Stainless*	

### Pivotal™ 2-Hdl Widespread Lavatory Faucet

- 5-9/16" Reach, 5-1/2" high rigid spout
- 2-1/4" Maximum deck thickness
- 1/4 Turn stops
- 3/8" Compression fittings
- Includes InnoFlex® Pex-C supply lines
- WaterSense® certified product: 1.2 gpm @ 60 psi
- (-MPU) Metal pop-up drain



Part #	Mfg #	Description	Handle(s)	Finish	Price
252087	3599LF-MPU	3-Hole 8-16"ws, Metal Pop-Up Drain, Lead-Free	ADA Lever	Chrome	
250440	3599LF-BLMPU	3-Hole 8-16"ws, Metal Pop-Up Drain, Lead-Free	ADA Lever	Matte Black	
241002	3599LF-SSMPU	3-Hole 8-16"ws, Metal Pop-Up Drain, Lead-Free	ADA Lever	Stainless*	

### Stryke™ 2-Hdl Widespread Lavatory

- 4-13/32" Reach, 6-25/32" rigid spout
- DIAMOND® Valve
- 1/4 Turn stops
- 3/8" Compression fittings
- 2-1/4" Maximum deck thickness
- Red/blue indicator markings
- Minimum InnoFlex® Pex-C supply lines below the deck
- WaterSense® certified product: 1.2 gpm @ 60 psi



Part #	Mfg #	Description	Handle(s)	Finish	Price
260038	35776-MPU-DST	3-Hole 8-16"ws, Metal Pop-Up Drain, Lead-Free	ADA Lever	Chrome	
259435	35776-BLMPU-DST	3-Hole 8-16"ws, Metal Pop-Up Drain, Lead-Free	ADA Lever	Matte Black	
260001	35776-SSMPU-DST	3-Hole 8-16"ws, Metal Pop-Up Drain, Lead-Free	ADA Lever	Stainless*	

\* Brilliance® Anti-Tarnish Lifetime Finishes

[www.waterconcepts.net](http://www.waterconcepts.net) • Serving our Customers Since 1946 • [www.plumbsupply.com](http://www.plumbsupply.com)

## Lavatory Faucets - 8" Center

### Tesla™ 2-Hdl Widespread Lavatory

- 4-5/8" Reach, 6-1/16" high rigid spout
- 5-3/16" From deck to aerator
- Red/blue indicators
- 3/8" Compression fittings
- 2-1/4" Maximum deck thickness
- 3/2" Minimum InnoFlex® supply lines below the deck
- DIAMOND® Valve
- WaterSense® certified product: 1.2 gpm @ 60 psi



Part #	Mfg #	Description	Handle(s)	Finish	Price
184422	3552-MPU-DST	3-Hole 4-16"ws, Metal Pop-Up Drain, Lead Free	ADA Lever	Chrome	
181115	3552-SSMPU-DST	3-Hole 4-16"ws, Metal Pop-Up Drain, Lead Free	ADA Lever	Stainless*	
229497	3552-PNMPU-DST	3-Hole 4-16"ws, Metal Pop-Up Drain, Lead Free	ADA Lever	Polished Nickel	

### Trinsic® 2-Hdl Widespread Lavatory Faucet

- 5" Reach, 7-3/4" high rigid spout
- 4-15/16" From deck to aerator
- Red/blue indicators
- 3/8" Compression fittings
- 2-1/4" Maximum deck thickness
- 3/2" Minimum InnoFlex® supply lines below the deck included
- DIAMOND™ Valve
- WaterSense® certified product: 1.2 gpm @ 60 psi



Part #	Mfg #	Description	Handle(s)	Finish	Price
152801	3559-MPU-DST	3-Hole 4-16"ws, Metal Pop-Up, Lead Free	ADA Lever	Chrome	
233023	3559-BLMPU-DST	3-Hole 4-16"ws, Metal Pop-Up, Lead Free	ADA Lever	Matte Black	
152802	3559-CZMPU-DST	3-Hole 4-16"ws, Metal Pop-Up, Lead Free	ADA Lever	Champagne Bronze™	
152803	3559-RBMPU-DST	3-Hole 4-16"ws, Metal Pop-Up, Lead Free	ADA Lever	Venetian Bronze®	
152804	3559-SSMPU-DST	3-Hole 4-16"ws, Metal Pop-Up, Lead Free	ADA Lever	Stainless*	

### Vero™ 2-Hdl Widespread Lavatory Faucet

- 4-25/32" Reach, 6-3/8" high rigid spout
- 2-5/8" From deck to spout
- Stream straightener
- 1/2" IPS Connection
- 1-1/8" Maximum deck thickness
- WaterSense® certified product: 1.2 gpm @ 60 psi



Part #	Mfg #	Description	Handle(s)	Finish	Price
134769	3553LF	3-Hole 6-16"ws, Metal Push Pop-Up Drain, LF	ADA Lever	Chrome	
161458	3553LF-CZ	3-Hole 6-16"ws, Metal Push Pop-Up Drain, LF	ADA Lever	Champagne Bronze™	
145309	3553LF-RB	3-Hole 6-16"ws, Metal Push Pop-Up Drain, LF	ADA Lever	Venetian Bronze®	
134770	3553LF-SS	3-Hole 6-16"ws, Metal Push Pop-Up Drain, LF	ADA Lever	Stainless*	

\* Brilliance® Anti-Tarnish Lifetime Finishes

[www.plumbsupply.com](http://www.plumbsupply.com) • Serving our Customers Since 1946 • [www.waterconcepts.net](http://www.waterconcepts.net)



## Lavatory Faucets - 8" Center

### Victorian® 2-Hdl Widespread Lavatory Faucet

- 5-1/8" Reach, 5-15/16" high rigid spout
- 3-3/4" From deck to aerator
- 1/4" Turn stops
- 3/8" Compression fittings
- 2-1/4" Maximum deck thickness
- 3/2" Minimum InnoFlex® supply lines below the deck
- DIAMOND™ valve
- WaterSense® certified product: 1.2 gpm @ 60 psi



Part #	Mfg #	Description	Handle(s)	Finish	Price
222973	3555-MPU-DST	3-Hole 4-16"ws, Metal Pop-Up Drain, Lead-Free	ADA Lever	Chrome	
054265	3555-PBMPU-DST	3-Hole 4-16"ws, Metal Pop-Up Drain, Lead-Free	ADA Lever	Polished Brass	
185504	3555-RBMPU-DST	3-Hole 4-16"ws, Metal Pop-Up Drain, Lead-Free	ADA Lever	Venetian Bronze®	
187807	3555-SSMPU-DST	3-Hole 4-16"ws, Metal Pop-Up Drain, Lead Free	ADA Lever	Stainless*	

### Windemere® 2-Hdl Widespread Lavatory Faucet

- 4-5/8" Reach, 6-13/16" high rigid spout
- 5" From deck to aerator
- Hot/cold indicators
- 1/2" IPS Connection
- 1-1/8" Maximum deck thickness
- WaterSense® certified product, 1.2 gpm @ 60 psi



Part #	Mfg #	Description	Handle(s)	Finish	Price
132681	B3596LF	3-Hole 6-16"ws, Metal Pop-Up Drain, Lead-Free	ADA Lever	Chrome	
131932	B3596LF-OB	3-Hole 6-16"ws, Metal Pop-Up Drain, Lead-Free	ADA Lever	Oil Rubbed Bronze	
136126	B3596LF-SS	3-Hole 6-16"ws, Metal Pop-Up Drain, Lead-Free	ADA Lever	Stainless*	

### Woodhurst™ 2-Hdl Widespread Lavatory Faucet

- 5-1/4" Reach, 6" high rigid spout
- 1/4 turn handle stops
- 1/2" IPS Connection
- 1/2"-14 NPSM adapters
- 1-3/16" Maximum deck thickness
- Washerless stem cartridge valve
- WaterSense® certified product: 1.2 gpm @ 60 psi



Part #	Mfg #	Description	Handle(s)	Finish	Price
253678	3532LF-MPU	3-Hole 8-16"ws, Metal Pop-Up Drain, Lead-Free	ADA Lever	Chrome	
251182	3532LF-RBMPU	3-Hole 8-16"ws, Metal Pop-Up Drain, Lead-Free	ADA Lever	Venetian Bronze	
251195	3532LF-SSMPU	3-Hole 8-16"ws, Metal Pop-Up Drain, Lead-Free	ADA Lever	Stainless*	

\* Brilliance® Anti-Tarnish Lifetime Finishes

[www.waterconcepts.net](http://www.waterconcepts.net) • Serving our Customers Since 1946 • [www.plumbsupply.com](http://www.plumbsupply.com)



## Lavatory Faucets - 8" Center

### Zura® 2-Hdl Widespread Lavatory Faucet

- 5" Reach, 5-1/2" high rigid spout
- 3/8" Compression fittings
- 2-1/4" Maximum deck thickness
- DIAMOND™ Seal valve
- Includes InnoFlex® Pex-C supply lines
- WaterSense® certified product: 1.20 gpm @ 60 psi



Part #	Mfg #	Description	Handle(s)	Finish	Price
228205	3574-MPU-DST	3-Hole 8-16"WS, Metal Pop-Up Drain, Lead-Free	ADA Lever	Chrome	
239010	3574-CSMPU-DST	3-Hole 8-16"WS, Metal Pop-Up Drain, Lead-Free	ADA Lever	Chrome/Matte Black	
234248	3574-SSMPU-DST	3-Hole 8-16"WS, Metal Pop-Up Drain, Lead-Free	ADA Lever	Stainless*	

### Wall-Mount Lavatory Faucets

#### Addison™ 2-Hdl Widespread Wall-Mount Lavatory Faucet

- 7-5/8" Reach, rigid spout
- 1/2"-14 NPT threaded female inlets
- Accommodates wall thicknesses from 1/8" to 1-1/8"
- Must order R3500-WL rough separately
- WaterSense® certified product: 1.2 gpm @ 60 psi



Part #	Mfg #	Description	Handle(s)	Finish	Price
249677	T3592LF-RBWL	3-Hole 8"cc Less Drain, Lead Free	ADA Lever	Venetian Bronze	

#### Ara™ 2-Hdl Widespread Wall-Mount Lavatory Faucet

- 7-5/8" Reach, rigid spout
- Accommodates wall thicknesses from 1/8" to 1-1/8"
- Must order R3500-WL rough separately
- Order RP7387 for .5 gpm and RP73838 for 1.0 gpm water efficient flow restrictors
- WaterSense® certified product: 1.2 gpm @ 60 psi



Part #	Mfg #	Description	Handle(s)	Finish	Price
165665	T3567LF-WL	3-Hole 8"cc, Less Drain, Lead-Free	ADA Lever	Chrome	
162248	T3567LF-SSWL	3-Hole 8"cc, Less Drain, Lead-Free	ADA Lever	Stainless*	

#### Ara® 2-Hdl Channel Spout Widespread Lavatory Faucet

- 7-5/8" Reach, rigid spout
- Accommodates wall thicknesses from 1/8" to 1-1/8"
- Must order R3500-WL rough separately
- Order RP7387 for .5 gpm and RP73838 for 1.0 gpm water efficient flow restrictors
- WaterSense® certified product: 1.20 gpm @ 60 psi



Part #	Mfg #	Description	Handle(s)	Finish	Price
165666	T3568LF-WL	3-Hole 8"cc, Less Drain, Lead-Free w/ Channel Spout	ADA Lever	Chrome	
168010	T3568LF-SSWL	3-Hole 8"cc, Less Drain, Lead-Free w/ Channel Spout	ADA Lever	Stainless*	

\* Brilliance® Anti-Tarnish Lifetime Finishes

[www.plumbsupply.com](http://www.plumbsupply.com) • Serving our Customers Since 1946 • [www.waterconcepts.net](http://www.waterconcepts.net)

## Lavatory Faucets - 8" Center

### Cassidy™ 2-Hdl Widespread Wall-Mount Lavatory Faucet

- 8-3/4" Reach, rigid spout
- 3-1/4" Handle length
- Accommodates wall thicknesses from 1/8" to 1-1/8"
- Cast brass body
- 1/2"-14 NPT threaded female inlets
- Drain sold separately
- WaterSense® certified: 1.2 gpm



Requires Valve: R3500-WL

Part #	Mfg #	Description	Handle(s)	Finish	Price
248791	T3597LF-PNWL	3-Hole 8"cc, Less Drain, Lead-Free	ADA Lever	Polished Nickel*	
224827	T3597LF-RBWL	3-Hole 8"cc, Less Drain, Lead-Free	ADA Lever	Venetian Bronze®	

### Compel™ 2-Hdl Widespread Wall-Mount Lavatory Faucet

- 7" Reach, rigid spout
- Red/blue indicators
- Accommodates wall thicknesses from 1/8"-1-1/8"
- (R3500-WL) Order rough separately
- WaterSense® certified product: 1.2 gpm @ 60 psi



Part #	Mfg #	Description	Handle(s)	Finish	Price
226262	T3561LF-WL	3-Hole 8"cc, Less Drain, Lead Free	ADA Lever	Chrome	
187076	T3561LF-SSWL	3-Hole 8"cc, Less Drain, Lead Free	ADA Lever	Stainless*	

### Dryden™ 2-Hdl Widespread Wall-Mount Lavatory Faucet

- 8-5/16" Reach, rigid spout
- Red/blue indicators
- Accommodates wall thicknesses from 1/8"-1-1/8"
- WaterSense® certified product: 1.2 gpm @ 60 psi



Rough-In Valve Required: R3500-WL

Part #	Mfg #	Description	Handle(s)	Finish	Price
257383	T3551LF-PNWL	3-Hole 8"cc, Less Drain, Lead Free	ADA Lever	Polished Nickel	
221999	T3551LF-RBWL	3-Hole 8"cc, Less Drain, Lead Free	ADA Lever	Venetian Bronze®	
186406	T3551LF-SSWL	3-Hole 8"cc, Less Drain, Lead Free	ADA Lever	Stainless*	

\* Brilliance® Anti-Tarnish Lifetime Finishes

## Lavatory Faucets - 8" Center

### Pivotal™ Wall-Mount 2-Hdl Lavatory Faucet

- 9" Reach, rigid spout
- 1/4 Turn stops
- Ceramic valve type
- 1/2"-14 NPT threaded female inlets
- Accommodates wall thickness from 1/8" to 1/8"
- WaterSense® certified product: 1.2 gpm @ 60 psi
- Drain sold separately



**Rough-In Valve Required: R3500-WL**

Part #	Mfg #	Description	Handle(s)	Finish	Price
251683	T3599LF-BLWL	3-Hole 8"cc Less Drain, Lead Free	ADA Lever	Matte Black	

### Tesla™ Wall-Mount 1-Hdl Lavatory Faucet

- 9" Reach, rigid spout
- Red/blue indicator markings
- Accommodates wall thickness from 0" to 1"
- Drain sold separately
- WaterSense® certified product: 1.2 gpm @ 60 psi



**Rough-In Valve Required: R3510-WL**

Part #	Mfg #	Description	Handle(s)	Finish	Price
223867	T552LF-SSWL	3-Hole 8"cc, Less Drain, Lead Free	ADA Lever	Stainless*	

### Trinsic™ Wall-Mount 1-Hdl Lavatory Faucet

- 7-1/2" Reach, rigid spout
- Accommodates wall thicknesses from 1/8"-1-1/8"
- Order (RP73805) for 1.0 gpm water efficient aerator  
Order (RP73806) for 0.5 gpm water efficient aerator
- Euro-motion valve
- WaterSense® certified product: 1.2 gpm @ 60 psi



**Requires R3510-WL Rough-In Valve**

Part #	Mfg #	Description	Handle(s)	Finish	Price
188137	T3559LF-WL	2-Hole 4- 8" cc, Less Drain, Lead Free	ADA Lever	Chrome	
152807	T3559LF-CZWL	2-Hole 4- 8" cc, Less Drain, Lead Free	ADA Lever	Champagne Bronze™	
190504	T3559LF-RBWL	2-Hole 4- 8" cc, Less Drain, Lead Free	ADA Lever	Venetian Bronze®	
152001	T3559LF-SSWL	2-Hole 4- 8" cc, Less Drain, Lead Free	ADA Lever	Stainless*	
237953	T3559LF-BLWL	2-Hole 4- 8" cc, Less Drain, Lead Free	ADA	Matte Black	

\* Brilliance® Anti-Tarnish Lifetime Finishes

## Lavatory Faucets - 8" Center

### Zura® 2-Hdl Wall-Mount Vessel Faucet

- 8-1/2" Reach
- 1/2"-14 NPT threaded female inlets
- Accommodates wall thicknesses from 1/8" to 1-1/8"
- Drain sold separately
- WaterSense® certified product: 1.2 gpm @ 60 psi



Requires R3500-WL Rough-In Valve

Part #	Mfg #	Description	Handle(s)	Finish	Price
228887	T3574LF-SSWL	3-Hole 8"cc, Less Drain, Lead Free	ADA Lever	Stainless*	

### Zura® 1-Hdl Wall-Mount Vessel Faucet

- 9-3/16" Reach
- 2-1/4" to 3-1/4" Rough-in depth
- Drain sold separately
- WaterSense® certified product: 1.20 gpm @ 60 psi



Requires R3510-WL Rough-In Valve

Part #	Mfg #	Description	Handle(s)	Finish	Price
229600	T574LF-WL	2-Hole 4"cc, Less Drain, Lead-Free	ADA Lever	Chrome	
229145	T574LF-SSWL	2-Hole, 4"cc, Less Drain, Lead-Free	ADA Lever	Stainless*	

\* Brilliance® Anti-Tarnish Lifetime Finishes

## Lavatory Faucets - 8" Center

### Two-Handle Widespread Lavatory Faucets

#### 90 Degree™ 2-Hdl Lavatory Faucet

- 4-5/8" Reach, 4-1/16" high spout
- 3-7/8" From deck to aerator
- 1/2" IPS connections
- 1224 Cartridge design
- WaterSense certified: 1.5 gpm



Requires Valve: 9000

Part #	Mfg #	Description	Handle(s)	Finish	Price
132632	TS6720	8"-16" ws, Metal Pop-Up	ADA Lever	Chrome	
167312	TS6720BN	8"-16" ws, Metal Pop-Up	ADA Lever	Brushed Nickel	

#### Align™ 2-Hdl Lavatory Faucet

- 5-9/16" Reach, 6-13/32" high spout
- 4-17/64" From deck to aerator
- Hydrolock™ quick connect system
- 1/2" IPS connections
- 1224 Cartridge design
- WaterSense® certified: 1.5 gpm



Requires Valve: 9000

Part #	Mfg #	Description	Handle(s)	Finish	Price
174588	T6193	8"-16"ws	ADA Lever	Chrome	
253545	T6193BL	8"-16"ws	ADA Lever	Matte Black	
186108	T6193BN	8"-16"ws	ADA Lever	Brushed Nickel	

#### Arris™ 2-Hdl Lavatory Faucet

- 5-3/4" Reach, 5-5/64" high spout
- 4-3/64" From deck to aerator
- Duralock™ quick connect system
- 1234™ Duralast™ cartridge
- WaterSense® certified: 1.2 gpm



Part #	Mfg #	Description	Handle(s)	Finish	Price
212033	TS43002	8"-16"ws, Metal Pop-Up	ADA Lever	Chrome	
180729	TS43002BN	8"-16"ws, Metal Pop-Up	ADA Lever	Brushed Nickel*	

\*Lifeshine® Anti-Tarnish Lifetime Finish

## Lavatory Faucets - 8" Center

### Belfield™ 2-Hdl Lavatory Faucet

- 5-1/2" Reach, 6-1/4" high spout
- 1-1/4" Maximum deck thickness
- Duralock™ quick connect system
- M•PACT valve system
- 1/2" IPS connection
- 1234™ Duralast™ cartridge
- WaterSense® certified: 1.2 gpm



Part #	Mfg #	Description	Handle(s)	Finish	Price
242061	T6405	8"-16", Metal Pop-Up	ADA Lever	Chrome	
251957	T6405BN	8"-16", Metal Pop-Up	ADA Lever	Brushed Nickel	
242024	T6405ORB	8"-16", Metal Pop-Up	ADA Lever	Oil Rubbed Bronze	

### Brantford™ 2-Hdl Lavatory Faucet

- 5" Reach, 5" high spout
- 3-1/2" From deck to aerator
- 1/2" IPS connections
- 1224 Cartridge design
- WaterSense® certified: 1.5 gpm



Requires Valve: 9000

Part #	Mfg #	Description	Handle(s)	Finish	Price
109274	T6620	8"-16"ws	ADA Lever	Chrome	
102295	T6620BN	8"-16"ws	ADA Lever	*Brushed Nickel	
102286	T6620ORB	8"-16"ws	ADA Lever	Oil Rubbed Bronze	

### Chateau™ 2-Hdl Lavatory Faucet

- 5-1/2" Reach
- 4-1/4" From deck to aerator
- 1/2" IPS shanks
- Duralock™ quick connect system
- 1234 Cartridge design
- WaterSense® certified: 1.5 gpm



Part #	Mfg #	Description	Handle(s)	Finish	Price
081364	4945	8"-16"ws, Metal Pop-Up	ADA Lever	Chrome	

\*Lifeshine® Anti-Tarnish Lifetime Finish



## Lavatory Faucets - 8" Center

### Dartmoor™ 2-Hdl Lavatory Faucet

- 5-1/16" Reach, 5-1/8" high spout
- 4-1/16" From deck to aerator
- 1/2" IPS connections
- 1234 Duralast® cartridge
- WaterSense® certified: 1.2 gpm



Requires Valve: 9000

Part #	Mfg #	Description	Handle(s)	Finish	Price
189423	T6805	8"-16" ws, Metal Pop-Up Drain	ADA Lever	Chrome	
189284	T6805BN	8"-16" ws, Metal Pop-Up Drain	ADA Lever	*Brushed Nickel	
222888	T6805ORB	8"-16" ws, Metal Pop-Up Drain	ADA Lever	Oil Rubbed Bronze	

### Doux™ 2-Hdl Lavatory Faucet

- 4-15/16" Reach, 7-3/4" high spout
- 1-1/4" Maximum deck thickness
- 1/2" IPS connections
- Duralock™ quick connect system
- 1234™ Duralast™ Cartridge
- WaterSense® certified: 1.2 gpm



Requires Valve: 9000, 69000

Part #	Mfg #	Description	Handle(s)	Finish	Price
252390	TS6925BL	8"-16" ws, Metal Pop-Up Drain	ADA Lever	Matte Black	

### Eva™ 2-Hdl Lavatory Faucet

- 4-7/8" Reach, 6" high spout
- 4" From deck to aerator
- 1/2" IPS connections
- 1224 Cartridge design
- WaterSense® certified: 1.5 gpm



Requires Valve: 9000

Part #	Mfg #	Description	Handle(s)	Finish	Price
098737	T6420	8"-16"ws, Metal Pop-Up Drain	ADA Lever	Chrome	
097223	T6420BN	8"-16"ws, Metal Pop-Up Drain	ADA Lever	*Brushed Nickel	
096177	T6420ORB	8"-16"ws, Metal Pop-Up Drain	ADA Lever	Oil Rubbed Bronze	

\*Lifeshine® Anti-Tarnish Lifetime Finish

## Lavatory Faucets - 8" Center

### Glyde™ 2-Hdl Lavatory Faucet

- 5-3/4" Reach, 5-3/4" high spout
- 4-3/16" From deck to aerator
- 1/2" IPS connections
- 1234 Cartridge design
- WaterSense® certified: 1.2 gpm



Part #	Mfg #	Description	Handle(s)	Finish	Price
229218	T6173	8"-16"ws, Metal Pop-Up Drain	ADA Lever	Chrome	
221490	T6173BN	8"-16"ws, Metal Pop-Up Drain	ADA Lever	*Brushed Nickel	

### Kingsley™ 2-Hdl Lavatory Faucet

- 5-1/8" Reach, 7" high spout
- 4-7/16" From deck to aerator
- Hydrolock™ quick connect system
- 1/2" IPS connections
- 1224 Cartridge design
- WaterSense® certified: 1.5 gpm



Requires Valve: 9000

Part #	Mfg #	Description	Handle(s)	Finish	Price
108631	T6125	8"-16"ws, Metal Pop-Up Drain	ADA Lever	Chrome	
079236	T6125BN	8"-16"ws, Metal Pop-Up Drain	ADA Lever	Brushed Nickel	
077212	T6125ORB	8"-16"ws, Metal Pop-Up Drain	ADA Lever	Oil Rubbed Bronze	
176395	T6125P	8"-16"ws, Metal Pop-Up Drain	ADA Lever	*Polished Brass	
078880	T6125WR	8"-16"ws, Metal Pop-Up Drain	ADA Lever	Wrought Iron	

### Kingsley™ 2-Hdl Low Arc Lavatory Faucet

- 4-1/2" Reach, 3-1/4" high spout
- 1-9/16" From deck to aerator
- 1/2" IPS connections
- 1234™ Duralast™ cartridge
- WaterSense® certified: 1.2 gpm to 1.5 gpm



Requires Valve: 9000

Part #	Mfg #	Description	Handle(s)	Finish	Price
188505	T6105	8"-16"ws, Metal Pop-Up Drain	ADA Lever	Chrome	
074527	T6105BN	8"-16"ws, Metal Pop-Up Drain	ADA Lever	Brushed Nickel	
079642	T6105ORB	8"-16"ws, Metal Pop-Up Drain	ADA Lever	Oil Rubbed Bronze	

\*Lifeshine® Anti-Tarnish Lifetime Finish

[www.waterconcepts.net](http://www.waterconcepts.net) • Serving our Customers Since 1946 • [www.plumbsupply.com](http://www.plumbsupply.com)

## Lavatory Faucets - 8" Center

### Method™ 2-Hdl Low Arc Bathroom Faucet

- 3-3/4" Reach, 5" high spout
- 3-1/2" From deck to aerator
- 1/2" IPS connections
- 1234™ Duralast™ cartridge
- Maximum Flow: 1.5 gpm



Requires Valve: 9000

Part #	Mfg #	Description	Handle(s)	Finish	Price
237106	T6820BN	8"-16"ws, Metal Pop-Up Drain	ADA Lever	Brushed Nickel	

### Rizon™ 2-Hdl Low Arc Bathroom Faucet

- 5-5-16" Reach, 4-21/64" high spout
- 3-1/2" From deck to aerator
- 1/2" IPS connections
- 1234™ Duralast™ cartridge
- Maximum Flow: 1.5 gpm



Requires Valve: 9000

Part #	Mfg #	Description	Handle(s)	Finish	Price
236529	T6920	8"-16"ws, Metal Pop-Up Drain	ADA Lever	Chrome	

### Rothbury™ 2-Hdl Low Arc Bathroom Faucet

- 5-1/4" Reach, 3.176" high spout
- 2.094" From deck to aerator
- 1/2" IPS connections
- 1234™ Duralast™ cartridge
- WaterSense® certified: 1.2 gpm



Requires Valve: 9000

Part #	Mfg #	Description	Handle(s)	Finish	Price
117450	TS6205	8"-16"ws, Metal Pop-Up Drain	ADA Lever	Chrome	
120014	TS6205BN	8"-16"ws, Metal Pop-Up Drain	ADA Lever	Brushed Nickel	
113886	TS6205ORB	8"-16"ws, Metal Pop-Up Drain	ADA Lever	Oil Rubbed Bronze	

\*Lifeshine® Anti-Tarnish Lifetime Finish

[www.plumbsupply.com](http://www.plumbsupply.com) • Serving our Customers Since 1946 • [www.waterconcepts.net](http://www.waterconcepts.net)

## Lavatory Faucets - 8" Center

### Voss™ 2-Hdl Lavatory Faucet

- 4-3/4" Reach, 5-7/8" high spout
- 4-1/2" From deck to aerator
- 1/2" IPS connection
- 1224 Cartridge design
- WaterSense® certified: 1.5 gpm



Requires Valve: 9000

Part #	Mfg #	Description	Handle(s)	Finish	Price
150271	T6905	8"-16" ws, Metal Pop-Up Drain	ADA Lever	Chrome	
251845	T6905BG	8"-16" ws, Metal Pop-Up Drain	ADA Lever	Brushed Gold	
150370	T6905BN	8"-16" ws, Metal Pop-Up Drain	ADA Lever	Brushed Nickel	
152283	T6905ORB	8"-16" ws, Metal Pop-Up Drain	ADA Lever	Oil Rubbed Bronze	

### Waterhill® 2-Hdl Lavatory Faucet

- 5-3/4" Reach, 5-25/32" high spout
- 3-7/32" From deck to aerator
- 1/2" IPS connection
- 1224 Cartridge design
- WaterSense® certified: 1.5 gpm



Requires Valve: 9000

Part #	Mfg #	Description	Handle(s)	Finish	Price
111447	TS418	8"-16" ws, Metal Pop-Up Drain	ADA Lever	Chrome	
149152	TS418BN	8"-16" ws, Metal Pop-Up Drain	ADA Lever	Brushed Nickel	
197452	TS418NL	8"-16" ws, Metal Pop-Up Drain	ADA Lever	Polished Nickel	
105946	TS418ORB	8"-16" ws, Metal Pop-Up Drain	ADA Lever	Oil Rubbed Bronze	

### Weymouth™ 2-Hdl Lavatory Faucet

- 5-3/4" Spout reach
- 3" Handle Reach
- 5-1/4" From deck to aerator
- 1224 Cartridge design
- WaterSense® certified: 1.5gpm



- Requires Valve: 9000

Part #	Mfg #	Description	Handle(s)	Finish	Price
156108	TS42108	8"-16" ws, Metal Pop-Up Drain	ADA Lever	Chrome	
148352	TS42108BN	8"-16" ws, Metal Pop-Up Drain	ADA Lever	Brushed Nickel	
181593	TS42108NL	8"-16" ws, Metal Pop-Up Drain	ADA Lever	Polished Nickel	
143065	TS42114	8"-16" ws, Metal Pop-Up Drain	Cross Handles	Chrome	
157720	TS42114BN	8"-16" ws, Metal Pop-Up Drain	Cross Handles	Brushed Nickel	
152844	TS42114NL	8"-16" ws, Metal Pop-Up Drain	Cross Handles	Polished Nickel	
175571	TS42114ORB	8"-16" ws, Metal Pop-Up Drain	Cross Handles	Oil Rubbed Bronze	

\*Lifeshine® Anti-Tarnish Lifetime Finish

[www.waterconcepts.net](http://www.waterconcepts.net) • Serving our Customers Since 1946 • [www.plumbsupply.com](http://www.plumbsupply.com)

## Lavatory Faucets - 8" Center

### Wynford™ 2-Hdl Lavatory Faucet

- 4-5/8" Spout reach, 6-1/2" high spout
- 4-38" From deck to aerator
- 1234™ Duralast™ cartridge design
- WaterSense® certified: 1.5 gpm



- **Requires Valve: 9000**

Part #	Mfg #	Description	Handle(s)	Finish	Price
190527	T4520	8"-16" ws, Metal Pop-Up Drain	ADA Lever	Chrome	
178606	T4520BN	8"-16" ws, Metal Pop-Up Drain	ADA Lever	Brushed Nickel	
184811	T4520NL	8"-16" ws, Metal Pop-Up Drain	ADA Lever	Polished Nickel	
189588	T4520ORB	8"-16" ws, Metal Pop-Up Drain	ADA Lever	Oil Rubbed Bronze	
187212	T4524	8"-16" ws, Metal Pop-Up Drain	ADA Cross	Chrome	

### Wall-Mount Lavatory Faucets

#### 90° Wall-Mount Lavatory Faucet

- 6-7/8" Spout length
- 2-5/8" Handle reach
- 3" Minimum clearance from aerator to vessel sink
- 1224 Cartridge design
- WaterSense® certified: 1.2 gpm



Part #	Mfg #	Description	Handle(s)	Finish	Price
143560	TS6730	8" ws, Less Drain	ADA Lever	Chrome	
141000	TS6730BN	8" ws, Less Drain	ADA Lever	Brushed Nickel	

### Kingsley™ 2-Hdl Wall-Mount Lavatory Faucet

- 7" Spout length
- 2-7/8" Handle reach
- 3" Minimum clearance from aerator to vessel sink
- 1/2" Copper connections
- 1224 Cartridge design
- WaterSense® certified: 1.5 gpm



Part #	Mfg #	Description	Handle(s)	Finish	Price
248899	T6107	8" ws, Less Drain	ADA Lever	Chrome	
103738	T6107BN	8" ws, Less Drain	ADA Lever	Brushed Nickel	
103984	T6107ORB	8" ws, Less Drain	ADA Lever	Oil Rubbed Bronze	

\*Lifeshine® Anti-Tarnish Lifetime Finish

[www.plumbsupply.com](http://www.plumbsupply.com) • Serving our Customers Since 1946 • [www.waterconcepts.net](http://www.waterconcepts.net)

## Lavatory Faucets - 8" Center

### Voss™ 2-Hdl Wall-Mount Lavatory Faucet

- 7-3/8" Spout reach
- 3-1/2" Handle reach
- 3" Minimum clearance from aerator to vessel sink
- 1224 Cartridge design
- WaterSense® certified: 1.5 gpm



Requires Valve: 9700

Part #	Mfg #	Description	Handle(s)	Finish	Price
152308	T6906	8" ws, Less Drain	ADA Lever	Chrome	
158203	T6906BN	8" ws, Less Drain	ADA Lever	*Brushed Nickel	

### Weymouth™ 2-Hdl Wall-Mount Lavatory Faucet

- 7.84" Spout reach
- 4" Handle reach
- 3" Minimum clearance from aerator to vessel sink
- 1-3/4" Max wall thickness
- 1224 Cartridge design
- Drain sold separately
- WaterSense® certified: 1.5 gpm



Requires Valve: 9700

Part #	Mfg #	Description	Handle(s)	Finish	Price
186664	TS42112	8"ws, Less Drain	Cross Handles	Chrome	

\*Lifeshine® Anti-Tarnish Lifetime Finish

[www.waterconcepts.net](http://www.waterconcepts.net) • Serving our Customers Since 1946 • [www.plumbsupply.com](http://www.plumbsupply.com)



## Lavatory Faucets

### Lavatory Faucets

#### 172 Washer-Type 2-Hdl Slantback Lavatory Faucet

- Renew valves & seats
- Solid cast brass valves & spout
- Adjustable centers 4" - 8"
- Chrome finish
- Chrome metal handles



Part #	Mfg #	Description	Price
026010	172	With Pop-Up Drain Assembly	

#### 170 Series Ledgeback Lavatory Faucet

- Solid brass valves
- Renewable valves & seats
- Chrome finish
- Metal handles
- Die cast zinc spout
- Adjustable centers
- 1/2 NPSM supplies



Part #	Mfg #	Description	Price
026009	170	Compression Valves, Metal Handles, With Pop-Up	



## Lavatory - Widespread

### Widespread Lavatory Faucets

#### P4B Builders Series 2-Hdl Lavatory Faucet

- Washerless cartridges
- Max flow rate: 1.5 gpm @ 60 psi



Part #	Mfg #	Description	Handle(s)	Finish	Price
170252	P4B-480C	8"cc 3-Hole, Brass Pop-Up Drain	ADA Metal Lever	Chrome	
180290	P4B-480BN	8"cc 3-Hole, Brass Pop-Up Drain	ADA Metal Lever	Brushed Nickel	

#### P4C Classic Series 2-Hdl Lavatory Faucet

- 11-3/16" Spout
- Quick Connect installation
- WaterSense® certified: 1.5 gpm @ 60 psi



Part #	Mfg #	Description	Handle(s)	Finish	Price
245223	P4C-480CLB	8"cc 3-Hole, Less Pop-Up Drain	ADA Wristblade	Chrome	

## Laundry/Utility Faucets

### Single-Handle Laundry Faucets

#### Simplice® 1-Hdl Laundry Faucet

- Metal construction
- 8-1/16" Spout reach with 120° rotation
- Two-function pull-out sprayhead  
—Sweep® spray
- MasterClean™ sprayface
- Ceramic disc valves
- Includes flexible supply lines
- Flow rate: 4.0 gpm @ 20 psi



Part #	Mfg #	Description	Handle(s)	Finish	Price
258688	22035-BL	3-Hole 4"cc, Pull-Out Spout	Lever	Matte Black	
241288	22035-CP	3-Hole 4"cc, Pull-Out Spout	Lever	Polished Chrome	
247544	22035-VS	3-Hole 4"cc, Pull-Out Spout	Lever	Stainless*	

### Two-Handle Laundry Faucets

#### Coralais® 2-Hdl Laundry Faucet

- 6" Reach swivel spout
- Metal construction
- Reversible 1/4-turn washerless ceramic valving



Plain Spout

Threaded

Part #	Mfg #	Description	Handle(s)	Finish	Price
083147	K-152704-CP	4"cc, Plain Spout	ADA Levers	Polished Chrome	
087122	K-152714-CP	4"cc, Threaded Spout	ADA Levers	Polished Chrome	

#### Trend® 2-Hdl Laundry Faucet with Threaded Swing Spout and Metal Blade Handles

- 5-1/2" Reach spout
- Brass construction
- Compression valving



Part #	Mfg #	Description	Handle(s)	Finish	Price
067157	K-11935-U-CP	4"cc, Threaded Spout	ADA Blades	Polished Chrome	

\* Vibrant Limited Lifetime Finish

[www.plumbsupply.com](http://www.plumbsupply.com) • Serving our Customers Since 1946 • [www.waterconcepts.net](http://www.waterconcepts.net)

**Laundry/Utility Faucets**

**Utility Faucets**

**Kinlock™ Service Sink Faucet with Top-Mounted Wall Brace**

- Solid brass construction
- 4-5/8" threaded spout
- 7-1/4" Wall-to-spout outlet (8907)
- 8-5/8" Wall-to-spout outlet (8908)
- Inside-threaded couplings
- Vacuum breaker
- Top-mounted Wall brace; pail hook
- Double lever handles are ADA-compliant
- Valvet® valves with brass valve bodies
- Loose-key stops included with model (K-7320-4-CP)



Part #	Mfg #	Description	Handle(s)	Finish	Price
168573	K-8907-CP	8"cc, Wall Brace	ADA Lever	Polished Chrome	
180263	K-8908-CP	8"cc, Wall Brace, Loose Key Stops in Shanks	ADA Lever	Polished Chrome	

**Triton® Utility Sink Faucet with Gooseneck Spout**

- 7-3/4" fixed gooseneck spout
- Solid brass construction with Valvet® valves and brass valve bodies
- Adjustable flanges
- 1/2" IPS inside-threaded inlets
- 2.2 gallons per minute
- Rosespray gooseneck spout included with model (K-7320-4-CP)



Part #	Mfg #	Description	Handle(s)	Finish	Price
178456	K-7319-3-CP	8"cc, Gooseneck Spout Rose spray	ADA Cross	Polished Chrome	
181902	K-7320-4-CP	8"cc, Gooseneck Spout	ADA Lever	Polished Chrome	

\* Vibrant Limited Lifetime Finish

[www.waterconcepts.net](http://www.waterconcepts.net) • Serving our Customers Since 1946 • [www.plumbsupply.com](http://www.plumbsupply.com)

## Laundry/Utility Faucets

### Single-Handle Specialty Faucets

#### Classic Basin Faucet

- 1-Hole Installation
- 4" Long, 3-5/8" high
- 1-1/2" From deck to aerator
- 1/4-Turn handle stop
- 1/2" IPS Connection
- 2" diameter escutcheon
- 1-1/8" maximum deck thickness
- WaterSense® certified product:  
1.5 gpm @ 60 psi



Part #	Mfg #	Description	Handle(s)	Finish	Price
156900	2302LF	1-Hole	Crystal Knob	Chrome	

#### Cast Brass Single Hole Basin Faucet

- Polished chrome plated
- Color indexed metal handle
- Metal hold-down package
- CAST BRASS single basin faucet
- Polished chrome plated
- CER-TECK® 1/4 turn ceramic structure
- Color indexed metal handle with vandal resistant screw
- Metal hold-down package
- Chrome Finish
- Outlet#: 4 - Standard 1.5 GPM (5.7 L/Min) Flow Control Aerator
- Handle#: 1 - Five Flute Handles

Part #	Mfg #	Description	Handle(s)	Finish	Price
054089	23C1041	1-Hole	Indexed Metal	Chrome	

#### Classic 1-Hdl Basin Faucet

- 1-Hole installation
- 4" Long, 5-7/8" high 360° swivel spout (-WF)
- 6" Long, 8-3/4" high 360° swivel spout (-06ELH)
- 2-1/4" From deck to aerator
- 3/8" O.D. inlets
- 1/2" IPS adapters
- 1-9/16" Max deck thickness
- Flow rate: 1.5 gpm @ 60 psi



Part #	Mfg #	Description	Handle(s)	Finish	Price
156196	570LF-WF	1-Hole	ADA Lever	Chrome	
166051	570LF-06ELH	1-Hole	VR Elbow Handle	Chrome	

\* Brilliance® Anti-Tarnish Lifetime Finishes

[www.plumbsupply.com](http://www.plumbsupply.com) • Serving our Customers Since 1946 • [www.waterconcepts.net](http://www.waterconcepts.net)

## Laundry/Utility Faucets

### Two-Handle Specialty Faucets

#### Classic 2-Hdl Laundry Faucet with Hose Thread Spout

- 2 or 3 Hole 4" installation
- **2131LF** 7" Long, 4-5/8" high, 360° swivel spout
- **2121LF** 6" Long, 5-1/4" high, 360° swivel spout
- 1/2" IPS connection
- Spout has hose thread
- 1-1/8" Max deck thickness
- RP76691 adds 1-1/4" to max deck thickness



Part #	Mfg #	Description	Handle(s)	Finish	Price
152471	2131LF	2- or 3-Hole 4"cc	Blade Handles	Chrome	
191969	2121LF	2- or 3-Hole 4"cc	Blade Handles	Chrome	

#### Classic 2-Hdl Laundry Faucet

- 2 or 3 Hole 4" installation
- **2133LF** 5-5/8" Long, 6-1/2" high spout
- **2123LF** 6" Long, 5-1/4" high spout
- 3-31/32" From deck to aerator
- 1/2" IPS connection
- Spout has stream straightener
- 1-1/8" Max deck thickness
- RP76691 adds 1-1/4" to max deck thickness



2121LF



2123LF

Part #	Mfg #	Description	Handle(s)	Finish	Price
152755	2133LF	2- or 3-Hole 4"cc	Blade Handles	Chrome	
191970	2123LF	2- or 3-Hole 4"cc	Blade Handles	Chrome	

\* Brilliance® Anti-Tarnish Lifetime Finishes

[www.waterconcepts.net](http://www.waterconcepts.net) • Serving our Customers Since 1946 • [www.plumbsupply.com](http://www.plumbsupply.com)



## Laundry/Utility Faucets

### Laundry Faucets

#### Chateau 2-Hdl Laundry Faucet

- 5-7/16" Spout reach, 6-5/8" high
- 4-63/64" From deck to aerator
- Inlet shanks will accept 3/8" ball nose connections
- 1224 Cartridge design



74998

4975

Part #	Mfg #	Description	Handle(s)	Finish	Price
034988	74998	4"cc, Threaded Spout	Mini Blade	Chrome	
007310	4975	4"cc, Non-Threaded Spout	Acrylic Knob	Chrome	

#### M-Dura 1-Hdl Laundry Faucet

- 6" Spout reach, 3" high
- 1/2" IPS supply shanks
- 1/4" turn ceramic disc cartridge
- Vandal resistant aerator
- Optional 4" deck plate sold separately
- Flow rate: 0.5 gpm
- Drain not included



Part #	Mfg #	Description	Handle(s)	Finish	Price
253599	8161	1-Hole	ADA Lever	Chrome	

\*Lifeshine® Anti-Tarnish Lifetime Finish

[www.plumbsupply.com](http://www.plumbsupply.com) • Serving our Customers Since 1946 • [www.waterconcepts.net](http://www.waterconcepts.net)



## Laundry Faucets

### Two-Handle Laundry Faucets

#### Gerber Classics Clamp-On 2-Hdl Laundry Faucet

- Cast spout with hose connection
- Clamp-on mounting
- Cast brass body
- Compression cartridges
- 10-Year limited warranty



Part #	Mfg #	Description	Handle(s)	Finish	Price
004720	49-530	1/2" IPS/Sweat	ADA Lever	Rough Brass	

\*Physical Vapor Deposition (PVD) Limited Lifetime Finish

[www.waterconcepts.net](http://www.waterconcepts.net) • Serving our Customers Since 1946 • [www.plumbsupply.com](http://www.plumbsupply.com)

**Laundry/Utility Faucets**

**Utility Faucets**

**8" Centerset Service and Utility Wall-Mount Faucet**

- 6-1/2" Reach, 3-7/8" high spout
- Solid brass construction
- 1/2" NPT female inlet
- Quarter turn ceramic disc valve
- 1/2" Deck clearance
- 8" Faucet hole spread
- NSF/ANSI 61 certified



Part #	Mfg #	Overall Size	Holes	Depth	Drain Opening	Price
189274	LKB940C	2-Hole, No Spray type	ADA 2" Lever	Chrome		

**4" - 8-3/8" Adjustable Centers Service and Utility Wall-Mount Faucet**

- 5-1/2" Reach, 3-1/2" high spout  
—Bucket hook spout
- Solid brass construction
- 1/2" NPT female inlet
- Brass stem assembly valve
- 3/8" Compression hose assembly
- 4" Faucet hole spread
- Flow rate: 2.2 gpm
- NSF/ANSI 61 certified



Part #	Mfg #	Overall Size	Holes	Depth	Drain Opening	Price
170294	LK400	2-Hole, No Spray Type	ADA 2" Lever	Chrome		

**Service & Utility Wall-Mount Faucet**

- 3-3/16" Reach, 4" spout height
- Chrome plated brass
- 1/2" NPT female inlets
- Brass stem assembly valve
- Sold as pair (C) or individually (CH or CP)
- NSF/ANSI 61 certified
- Maximum flow rate: 2.5 gpm



Part #	Mfg #	Overall Size	Holes	Depth	Drain Opening	Price
161287	LK69CP	1-Hole, No Spray Type	ADA Cross	Chrome		



## Laundry/Utility Faucets

### Laundry Faucets

#### P4C 2-Hdl Laundry Faucet

- Metal wing handles
- Washerless cartridges
- Max flow rate: 2.2 gpm @ 60 psi



Part #	Mfg #	Description	Handle(s)	Finish	Price
235459	P4C-386CA	4"cc	Metal Wing	Chrome	

\* Brilliance® Anti-Tarnish Lifetime Finishes

[www.waterconcepts.net](http://www.waterconcepts.net) • Serving our Customers Since 1946 • [www.plumbsupply.com](http://www.plumbsupply.com)

**Personal Showers & Accessories**

**Handshowers**

**Artifacts® Single-Function Handshower**

- Full hydromassage spray
- MasterClean™ 3-5/8" sprayface
- Katalyst® air-induction spray
- Hose sold separately
- WaterSense® certified: 2.0 gpm



Part #	Mfg #	Description	Price
166101	K-72776-BN	3-5/8", *Brushed Nickel	
171980	K-72776-BV	3-5/8", *Brushed Bronze	
166448	K-72776-CP	3-5/8", Polished Chrome	
165046	K-72776-SN	3-5/8", *Polished Nickel	
227883	K-72776-VNT	3-5/8", Vintage Nickel	
168455	K-72776-2BZ	3-5/8", Oil Rubbed Bronze	

**Awaken® G90 Multi-Function Handshower**

- Spray modes: wide coverage, intense drenching, and targeted spray.
- Thumb tab for diverting sprays
- MasterClean™ sprayface
- Hose sold separately
- WaterSense® certified: 2.0 gpm
- Contemporary design



Part #	Mfg #	Description	Price
160256	K-72414-CP	3-9/16", Polished Chrome	
160467	K-72414-BN	3-9/16", *Brushed Nickel	
259387	K-72415-BL	4-5/16", Matte Black	
160257	K-72415-CP	4-5/16", Polished Chrome	
160285	K-72415-BN	4-5/16", *Brushed Nickel	
240064	K-72415-2BZ	4-5/16", Oil Rubbed Bronze	

**Awaken® B90 Multi-Function Handshower**

- Spray modes: wide coverage, intense drenching, and targeted spray.
- Thumb tab for diverting sprays
- MasterClean™ sprayface
- Hose sold separately
- Transitional design



**3-3/4" Awaken Multi-Function Handshower**

Part #	Mfg #	Description	Price
160260	K-72420-CP	2.0 gpm, Polished Chrome	

**Handshowers (Continued)**

**Awaken® B90 Multi-Function Handshower**

**3-3/4" Awaken Multi-Function Handshower**

Part #	Mfg #	Description	Price
160469	K-72420-BN	2.0 gpm, *Brushed Nickel	
177745	K-99248-BN	1.5 gpm, w/Eco-Boost *Br Nickel	
187830	K-99248-CP	1.5 gpm w/Eco-Boost, Pol Chrome	

**4-5/8" Awaken Multi-Function Handshower**

Part #	Mfg #	Description	Price
159627	K-72421-CP	2.0 gpm, Polished Chrome	
159539	K-72421-BN	2.0 gpm, *Brushed Nickel	
229505	K-72421-2BZ	2.0 gpm, Oil Rubbed Bronze	

**Bancroft™ Multi-Function Handshower**

- Spray modes: wide coverage, massage, soft aerated and reduced-flow
- MasterClean™ wide spray face
- Flow rate: 2.5 gpm



Part #	Mfg #	Description	Price
255826	K-22163-BN	*Brushed Nickel	
255825	K-22163-CP	Polished Chrome	
103945	K-22163-BV	*Brushed Bronze	
255397	K-22163-PB	*Polished Brass	
255827	K-22163-2BZ	Oil Rubbed Bronze	

**Exhale® B120 Multi-Function Handshower**

- Spray modes: full coverage, drenching, pulsating, silk spray
- Flow rate: 2.0 gpm



Part #	Mfg #	Description	Price
251573	K-72595-BN	*Brushed Nickel	
235081	K-72595-CP	Polished Chrome	
222215	K-72595-SN	*Polished Nickel	

\* Vibrant Limited Lifetime Warranty

[www.plumbsupply.com](http://www.plumbsupply.com) • Serving our Customers Since 1946 • [www.waterconcepts.net](http://www.waterconcepts.net)

## Personal Showers & Accessories

### Flipside™ 01 Multi-Function Handshower

- Flipstream Technology™
- Four unique, experiential spray patterns: Koverage™ (full), Kotton™ (downpour), Komotion™ (soft) and Kurrent™ (massage)
- Adjustable angle for various user heights



### Forté® Multi-Function Handshower with Katalyst®

- MasterClean™ sprayface
- Katalyst® air-induction technology
- Spray modes: full coverage, pulsating massage, and silk spray
- Flow rate: 2.5 gpm



Part #	Mfg #	Description	Price
127529	K-17493-BN	2.5 gpm, *Brushed Nickel	
127698	K-17493-CP	2.5 gpm, Polished Chrome	
219544	K-17493-SN	2.5 gpm, *Polished Nickel	
154376	K-17493-2BZ	2.5 gpm, Oil Rubbed Bronze	
166463	K-45425-BN	2.0 gpm, *Brushed Nickel	
156710	K-45425-CP	2.0 gpm, *Polished Chrome	
166464	K-45425-2BZ	2.0 gpm, *Oil Rubbed Bronze	

Part #	Mfg #	Description	Price
255829	K-22165-BN	2.5 gpm *Brushed Nickel	
255828	K-22165-CP	2.5 gpm Polished Chrome	
258692	K-22165-G-CP	1.75 gpm Polished Chrome	
258962	K-22165-2BZ	2.5 gpm Oil Rubbed Bronze	

### Flipside™ 02 Multi-Function Handshower

- Flipstream Technology™
- Four unique, experiential spray patterns: Koverage™ (full), Kotton™ (downpour), Komotion™ (soft) and Kurrent™ (massage)
- Adjustable angle for various user heights



### Kelston® Single-Function Handshower

- MasterClean™ sprayface
- Flow rate: 2.5 gpm
- Hose sold separately



Part #	Mfg #	Description	Price
124358	K-17492-BN	2.5 gpm, *Brushed Nickel	
125908	K-17492-CP	2.5 gpm, Polished Chrome	
148318	K-17492-SN	2.5 gpm, *Polished Nickel	
156153	K-45426-BN	2.0 gpm, *Brushed Nickel	
227812	K-45426-SN	2.0 gpm, *Polished Nickel	
157761	K-45426CP	2.0 gpm, Polished Chrome	

Part #	Mfg #	Description	Price
126468	K-10343-BN	*Brushed Nickel	
117160	K-10343-CP	Polished Chrome	
146987	K-10343-2BZ	Oil Rubbed Bronze	

### Forté® Multi-Function Handshower

- MasterClean™ sprayface
- Spray modes: wide coverage, massage, soft aerated and reduced-flow
- Ergonomic sprayhead pivots for targeted massage



### MasterShower® Hotel Handshower Kit

- Easy-grip ring
- Flexible spray nozzles
- Includes
  - acrylic soap dish
  - adjustable mounting bracket
  - 60-inch metal shower hose
  - (K-8516) MasterShower sidebar kit
  - (K-8502) Relaxing multifunction handshower
  - (K-9513) wall supply elbow and vacuum breaker



Part #	Mfg #	Description	Price
131641	K-10298-BN	1.75 gpm, *Brushed Nickel	
113848	K-10298-CP	1.75 gpm, Polished Chrome	

Part #	Mfg #	Description	Price
129954	K-8520-PB	2.5 gpm, *Polished Brass	

\* Vibrant Limited Lifetime Warranty

[www.waterconcepts.net](http://www.waterconcepts.net) • Serving our Customers Since 1946 • [www.plumbsupply.com](http://www.plumbsupply.com)



## Personal Showers & Accessories

### MasterShower® Multi-Function Handshower

- Spray modes: wide strong spray, concentrated pulse and wide pulse
- Easy-grip ring offers smooth switch of spray options
- MasterClean™ sprayface
- Flow rate: 2.5 gpm



Part #	Mfg #	Description	Price
053756	K-8501-BN	*Brushed Nickel	
053755	K-8501-CP	Polished Chrome	

### Purist® Multi-Function Handshower

- Spray modes: wide coverage, medium coverage and concentrated
- Ergonomic sprayhead pivots for precise adjustment
- MasterClean™ sprayface
- WaterSense® certified: 1.75 gpm



Part #	Mfg #	Description	Price
243636	K-978-BGD	*Moderne Brushed Gold	
113292	K-978-CP	Polished Chrome	

### MasterShower® Multi-Function Relaxing Handshower

- Spray modes: wide soft coverage, slow pulse massage and soft aerated
- Easy-grip ring offers smooth switch of spray options
- MasterClean™ sprayface
- Flow rate: 2.5 gpm



Part #	Mfg #	Description	Price
053758	K-8502-BN	*Brushed Nickel	
053757	K-8502-CP	Polished Chrome	

### Purist® Multi-Function Handshower

- Katalyst® air-induction technology
- Spray modes: full coverage, pulsating massage and silk spray
- MasterClean™ spray nozzles
- WaterSense® certified: 2.5 gpm



Part #	Mfg #	Description	Price
258279	K-22166-BL	Matte Black	
258634	K-22166-CP	Polished Chrome	

### MasterShower® Multi-Function 3-Way Relaxing Eco Handshower

- Spray modes: wide soft coverage, slow pulse massage and soft aerated spray settings
- Easy-grip ring offers smooth switch of spray options
- Easy clean flexible spray nozzles



Part #	Mfg #	Description	Price
114787	K-8543-CP	Polished Chrome	

### Shift™ Multi-Function Square Handshower

- Wide coverage and concentrated spray settings
- Shower hose not included



#### Black Handle

Part #	Mfg #	Description	Price
134409	K-14788-BN	2.5,*Brushed Nickel	
139116	K-14788-CP	2.5, Polished Chrome	
151107	K-14788-SN	2.5, *Polished Nickel	
150615	K-45203-CP	2.0, Polished Chrome	

### Memoirs® Single-Function Handshower

- Full spray
- Ergonomic sprayhead
- MasterClean™ sprayface
- Flow rate: 2.5 gpm
- Shower hose sold separately



Part #	Mfg #	Description	Price
093410	K-419-BN	*Brushed Nickel	
093763	K-419-BV	*Brushed Bronze	
093740	K419CP	Polished Chrome	
165827	K-419-2BZ	Oil Rubbed Bronze	

#### Grey Handle

Part #	Mfg #	Description	Price
154352	K-14788-GR-B N	2.5, *Brushed Nickel	
148092	K-14788-GR-C P	2.5, Polished Chrome	
158853	K-14788-GR-S N	2.5, *Polished Nickel	

\* Vibrant Limited Lifetime Warranty

[www.plumbsupply.com](http://www.plumbsupply.com) • Serving our Customers Since 1946 • [www.waterconcepts.net](http://www.waterconcepts.net)

**Personal Showers & Accessories**

**Handshowers (Continued)**

**Shift™ Multi-Function Square Handshower**

**Grey Handle**

Part #	Mfg #	Description	Price
160959	K-45203-GR-C P	2.0, Polished Chrome	

**Shift™ Multi-Function Ellipse Handshower**

- Wide coverage and concentrated spray settings
- Shower hose not include



-A

**Metallic Handle**

Part #	Mfg #	Description	Price
150205	K-10257-A-BN	2.5 gpm, *Br Nickel	
154956	K-10257-A-CP	2.5 gpm, Polished Chrome	
245467	K-10257-A-SN	2.5 gpm, *Polished Nickel	
147484	K-45415-A-CP	2.0 gpm, Polished Chrome	

**Black Handle**

Part #	Mfg #	Description	Price
245701	K-10257-BN	2.5 gpm, *Brushed Nickel	
118880	K-10257-CP	2.5 gpm, Polished Chrome	
256137	K-10257-2BZ	2.5 gpm, Oil Rubbed Brnz	
183573	K-45415-CP	2.0 gpm, Polished Chrome	

**Stillness® Multi-Function Handshower**

- Spray modes: wide coverage, massage, soft aerated, and reduced-flow
- Sprayhead pivots
- MasterClean™ sprayface
- Flow rate: 2.5 gpm
- Shower hose not included



Part #	Mfg #	Description	Price
093406	K-973-BN	*Brushed Nickel	

**Handshower Sets**

**Awaken® B110 Slidebar Kit**

- Includes:
  - Multi-function handshower
  - Slidebar
  - Hose
- MasterClean™ sprayface
- Wide coverage, intense drenching, targeted massage, and reduce-flow sprays
- Transitional design
- WaterSense® certified: 2.0 gpm



**Premium**

- 36" Slidebar
- 60" Metal hose

Part #	Mfg #	Description	Price
173841	K-99899-BN	*Brushed Nickel	
173208	K-99899-CP	Polished Chrome	

**Deluxe**

- 24" Slidebar
- 60" Smooth Hose

Part #	Mfg #	Description	Price
182424	K-99243-BN	*Brushed Nickel	
175220	K-99243-CP	Polished Chrome	
186415	99243-2BZ	Oil Rubbed Bronze	

**Awaken® G110 Slidebar Kit**

- Includes:
  - Multi-function handshower
  - Slidebar
  - Hose
- MasterClean™ sprayface
- Contemporary design
- WaterSense® certified: 2.0 gpm



**Premium**

- 34" Slidebar
- 60" Metal hose

Part #	Mfg #	Description	Price
176051	K-99898-BN	*Brushed Nickel	
174961	K-99898-CP	Polished Chrome	

\* Vibrant Limited Lifetime Warranty

[www.waterconcepts.net](http://www.waterconcepts.net) • Serving our Customers Since 1946 • [www.plumbsupply.com](http://www.plumbsupply.com)

## Personal Showers & Accessories

### Deluxe

- 24" Slidebar
- 60" Smooth hose

Part #	Mfg #	Description	Price
178400	K-99242-BN	*Brushed Nickel	
188401	K-99242-CP	Polished Chrome	
237229	K-99242-2BZ	Oil Rubbed Bronze	

### Awaken® B90 Handshower Kit

- Includes:
  - Multi-function handshower
  - 24" Slidebar
  - 60" Ribbon hose
- MasterClean™ sprayface
- Wide coverage, intense drenching, or targeted massage
- WaterSense® certified: 2.0 gpm
- Transitional design



Part #	Mfg #	Description	Price
160427	K-98362-BN	*Brushed Nickel	
160264	K-98362-CP	Polished Chrome	

### Awaken® G90 Handshower Kit

- Includes:
  - Multi-function handshower
  - 24" Slidebar
  - 60" Ribbon hose
- MasterClean™ sprayface
- Wide coverage, intense drenching, or targeted massage
- WaterSense® certified: 2.0 gpm
- Contemporary design



Part #	Mfg #	Description	Price
160471	K-98361-BN	*Brushed Nickel	
160263	K-98361-CP	Polished Chrome	

### Contemporary Handshower Kit

- Includes:
  - Multi-function handshower
  - Slide bar with Stillness/Purist® trim
  - 60" Hose and supply elbow
- MasterClean™ sprayface
- Full-coverage, therapeutic massage, soft-aerated, and water-saving eco spray options
- Flow rate: 2.5 gpm



Part #	Mfg #	Description	Price
130326	K-9059-BN	*Brushed Nickel	
119139	K-9059-CP	Polished Chrome	

### Converge® Handshower Kit

- Includes:
  - Brass ball joint
  - 7-1/2" Showerarm
  - MasterShower® 60" metal hose
- 1/2" NPT connection
- MasterClean™ sprayface
- Magnetic docking
- 5-Setting handshower
  - Full coverage
  - Silk spray
  - Infinity spray
  - Two combination sprays
- Flow rate: 2.5 gpm



Part #	Mfg #	Description	Price
247333	K-30363-CP	Polished Chrome	

### Devonshire® Essentials Performance Showering Kit

- Includes:
  - Lever handle
  - Multi-function showerhead
  - Multi-function handshower
  - Showerarm with diverter
  - Shower hose
  - Slidebar kit
  - Rite-Temp® valve trim
- Wide coverage, therapeutic massage, and soft aerated spray settings
- Requires 304/KK-P304 Series Rite-Temp® Valves



Part #	Mfg #	Description	Price
146962	K-10825-4-2BZ	Oil Rubbed Bronze	

\* Vibrant Limited Lifetime Warranty

[www.plumbsupply.com](http://www.plumbsupply.com) • Serving our Customers Since 1946 • [www.waterconcepts.net](http://www.waterconcepts.net)

**Personal Showers & Accessories**

**Forté Handshower Kit**

- Includes
  - Supply elbow
  - Slidebar & trim
  - Vacuum breaker
  - MasterShower®60" metal hose (K-9514)
- MasterClean™ sprayface
- WaterSense® certified: 1.75 gpm



**MasterShower® Hotel Handshower Kit**

- Includes:
  - Multi-function handshower
  - 25" Slidebar
  - 60" Metal hose
  - Vacuum breaker
  - Wall elbow
- Flow rate: 2.5 gpm



Part #	Mfg #	Description	Price
246645	K-76466-BN	*Brushed Nickel	

Part #	Mfg #	Description	Price
058890	K-8520-CP	Polished Chrome	

**Forté Multi-Function Handshower Kit**

- Includes
  - Multi-function handshower
  - 30" Slidebar & trim
  - 60" metal hose
- Full coverage, pulsating massage, and silk spray
- Katalyst® air induction
- MasterClean™ sprayface
- Flow rate: 2.5 gpm



Part #	Mfg #	Description	Price
258098	K-22177-CP	Polished Chrome	

**Purist® Handshower Kit**

- Includes:
  - Multi-function handshower
  - 25" Slidebar & trim
  - 60" Metal hose
  - Vacuum breaker
  - Wall supply elbow
- Flow rate: 1.75 gpm



Part #	Mfg #	Description	Price
233134	K-76467-CP	Polished Chrome	

**Hotel Handshower Kit**

- Includes:
  - Shift handshower
  - 24-3/4" Slidebar
  - 60" Metal hose
- MasterClean™ sprayface
- Wide coverage or concentrated sprays
- Flow rate: 2.5 gpm



Part #	Mfg #	Description	Price
128070	K-8487-BN	*Brushed Nickel	
128069	K-8487-CP	Polished Chrome	

**Purist® Multi-Function Handshower Kit**

- Includes:
  - Multi-function handshower
  - 30" Slidebar & trim
  - 60" Metal hose
- Katalyst® air-induction
- Full coverage, pulsating massage, and silk spray
- Flow rate: 2.5 gpm



Part #	Mfg #	Description	Price
258498	K-22178-CP	Polished Chrome	

\* Vibrant Limited Lifetime Warranty

[www.waterconcepts.net](http://www.waterconcepts.net) • Serving our Customers Since 1946 • [www.plumbsupply.com](http://www.plumbsupply.com)

## Personal Showers & Accessories

### Handshower Slidebars

#### Handshower Slidebar

- Durable metal construction
- Handshower sold separately



Part #	Mfg #	Description	Price
105841	K-8524-AF	30", *French Gold	
243635	K-8524-BGD	30", *Moderne Br. Gold	
258275	K-8524-BL	30", Matte Black	
099005	K-8524-BN	30", *Brushed Nickel	
095601	K-8524-BV	30", *Brushed Bronze	
251662	K-8524-TT	30", *Titanium	
128703	K-9069-BN	24", *Brushed Nickel	
099004	K-8524-CP	30", Pol Chrome	
103933	K-8524-G	30", Brushed Chrome	
127182	K-8524-PB	30", *Pol Brass	
111915	K-8524-SN	30", *Pol Nickel	
147045	K-8524-2BZ	30", Oil Rubbed Bronze	
129831	K-9069-CP	24", Polished Chrome	

#### Artifacts® Handshower Slidebar

- 30" Slidebar
- Adjustable mounting bracket



Part #	Mfg #	Description	Price
172099	K-72798-BN	30", *Brushed Nickel	
221954	K-72798-BV	30", *Brushed Bronze	
162737	K-72798-CP	30", Polished Chrome	
165047	K-72798-SN	30", Polished Nickel	
168453	K-72798-2BZ	30", Oil Rubbed Bronze	

### Awaken® Handshower Slidebar

- Adjustable mounting brackets
- Adjustable angle of handshower



Part #	Mfg #	Description	Price
159537	K-98341-BN	24", *Brushed Nickel	
159970	K-98341-CP	24", Polished Chrome	
228344	K-98341-2BZ	24", Oil Rubbed Bronze	

### Awaken® Deluxe Handshower Slidebar

- Adjustable mounting brackets offer installation flexibility
- Adjustable angle of handshower
- Wall-Mount



Part #	Mfg #	Description	Price
177744	K-98342-BN	24", *Brushed Nickel	
188365	K-98342-CP	24", Polished Chrome	
224771	K-98343-BN	36", *Brushed Nickel	
172836	K-98343-CP	36", Pol Chrome	

### Awaken® Deluxe Handshower Slidebar with Integrated Water Supply

- Adjustable mounting brackets offer installation flexibility
- Adjustable angle of handshower
- Wall-Mount
- Integrated water supply allows water to be plumbed directly through bottom bracket of slidebar



Part #	Mfg #	Description	Price
170222	K-98344-BN	36",*Brushed Nickel	
173521	K-98344-CP	36", Polished Chrome	

\* Vibrant Limited Lifetime Warranty

[www.plumbsupply.com](http://www.plumbsupply.com) • Serving our Customers Since 1946 • [www.waterconcepts.net](http://www.waterconcepts.net)



**Personal Showers & Accessories**

**Handshower Slidebars (Continued)**

**Awaken® Deluxe Handshower Slidebar with Integrated Water Supply**

Part #	Mfg #	Description	Price
240063	K-98344-2BZ	36", Oil Rubbed Bronze	

**MasterShower® 22-3/4" Shower Slidebar**

- Includes soap dish and adjustable mounting bracket
- For use with MasterShower® handshower systems



Part #	Mfg #	Description	Price
069306	K-9516-BN	22-3/4", *Brushed Nickel	
061895	K-9516-CP	22-3/4", Polished Chrome	
080313	K-9516-G	22-3/4", Brushed Chrome	
081388	K-9516-PB	22-3/4", *Polished Brass	
092355	K-9516-SN	22-3/4", *Polished Nickel	

**Artifacts® Slidebar Trim**



Part #	Mfg #	Description	Price
172100	K-72799-BN	*Brushed Nickel	
221956	K-72799-BV	*Brushed Bronze	
173114	K-72799-CP	Polished Chrome	
173104	K-72799-SN	Polished Nickel	
168454	K-72799-2BZ	Oil Rubbed Bronze	

**Forté Slidebar Trim Kit**

- Escutcheon's and bar inserts
- Requires K-8524 basic slidebar



Part #	Mfg #	Finish	Price
105842	K-349-AF	*French Gold	
102073	K-349-BKB	Brushed Black	
099007	K-349-BN	*Brushed Nickel	
101758	K-349-BV	Vibrant Brushed Bronze	

\* Vibrant Limited Lifetime Warranty

**Handshower Slidebars (Continued)**

**Forté Slidebar Trim Kit**

Part #	Mfg #	Finish	Price
099006	K-349-CP	Polished Chrome	
103934	K-349-G	Brushed Chrome	
127183	K-349-PB	*Polished Brass	
151109	K-349-SN	*Polished Nickel	
147030	K-349-2BZ	Oil Rubbed Bronze	

**Loure® Slidebar Trim**



Part #	Mfg #	Finish	Price
146702	K-14790-BN	*Brushed Nickel	
142828	K-14790-CP	Polished Chrome	
142548	K-14790-SN	*Polished Nickel	

**Memoirs® Slidebar Trim Kit**

- For use with K-8524 and K-9069 Slidebars



Part #	Mfg #	Description	Price
104808	K-421-BN	*Brushed Nickel	
097634	K-421-BV	*Brushed Bronze	
111149	K-421-CP	Polished Chrome	

**Stillness® Slidebar Trim Kit**

- Escutcheon's
- Requires K-8524 basic slidebar



Part #	Mfg #	Finish	Price
244780	K-974-BGD	*Moderne Brushed Gold	
103526	K-974-BN	*Brushed Nickel	
121478	K-974-BV	*Brushed Bronze	
099539	K-974-CP	Polished Chrome	
111914	K-974-SN	*Polished Nickel	
251663	K-974-TT	*Titanium	



## Personal Showers & Accessories

### Shower Hoses

#### MasterShower® Shower Hose



Part #	Mfg #	Description	Price
087917	K-8593-AF	72", *French Gold	
072507	K-8593-BN	72", *Brushed Nickel	
071258	K-8593-CP	72", Polished Chrome	
073079	K-8593-G	72", Brushed Chrome	
082428	K-8593-PB	72", Polished Brass	
092356	K-8593-SN	72", *Polished Nickel	
096187	K-9514-AF	60", *French Gold	
221714	K-9514-BGD	60", Moderne Brushed Gold	
258277	K-9514-BL	60", Matte Black	
056368	K-9514-BN	60", *Brushed Nickel	
076705	K-9514-BV	60", *Brushed Bronze	
053896	K-9514-CP	60", Polished Chrome	
054493	K-9514-G	60", Brushed Chrome	
066447	K-9514-PB	60", *Polished Brass	
054535	K-9514-SN	60", *Polished Nickel	
225786	K-9514-VNT	60", Vintage Nickel	
147046	K-9514-2BZ	60", Oil Rubbed Bronze	

#### Awaken® Ribbon Hose



Part #	Mfg #	Description	Price
159802	K-45981-BN	72", Brushed Nickel	
160262	K-45981-CP	72", Polished Chrome	
187241	K-45981-2BZ	72", Oil Rubbed Bronze	
159538	K-45982-BN	60", Brushed Nickel	
159971	K-45982-CP	60", Polished Chrome	
172782	K-45982-SN	60", Polished Nickel	
166465	K-45982-2BZ	60", Oil Rubbed Bronze	

### Awaken® Smooth Shower Hose



Part #	Mfg #	Description	Price
183660	K-98359-BN	60", *Brushed Nickel	
188511	K-98359-CP	60", Polished Chrome	
248240	K-98359-SN	60", *Polished Nickel	
187934	K-98359-2BZ	60", Oil Rubbed Bronze	
178070	K-98360-2BZ	72", Oil Rubbed Bronze	

### Showerarm-Mount Handshower Cradles

#### Artifacts® Wall-Mount Handshower Holder with Supply Elbow

- Mounts to the end of showerarm
- Bracket pivots and rotates
- Includes check valve for backflow prevention



Part #	Mfg #	Description	Price
163763	K-72797-BN	*Brushed Nickel	
181401	K-72797-BV	*Brushed Bronze	
166447	K-72797-CP	Polished Chrome	
174117	K-72797-SN	*Polished Nickel	
225785	K-72797-VNT	Vintage Nickel	
171399	K-72797-2BZ	Oil Rubbed Bronze	

#### Awaken® Handshower Cradle

- Mounts to the end of showerarm
- Brass ball joint pivots



Part #	Mfg #	Description	Price
160284	K-98771-BN	*Brushed Nickel	
160266	K-98771-CP	Polished Chrome	
231346	K-98771-2BZ	Oil Rubbed Bronze	

### Shower Supply Elbows

#### Artifacts® Wall-Mount Supply Elbow



Part #	Mfg #	Description	Price
174432	K-72796-BN	*Brushed Nickel	

\* Vibrant Limited Lifetime Warranty

[www.plumbsupply.com](http://www.plumbsupply.com) • Serving our Customers Since 1946 • [www.waterconcepts.net](http://www.waterconcepts.net)

**Personal Showers & Accessories**

**Shower Supply Elbows (Continued)**

**Artifacts® Wall-Mount Supply Elbow**

Part #	Mfg #	Description	Price
177297	K-72796-BV	*Brushed Bronze	
173113	K-72796-CP	Polished Chrome	
165048	K-72796-SN	*Polished Nickel	
168458	K-72796-2BZ	Oil Rubbed Bronze	

**Awaken® Wall-Mount Supply Elbow**

- (98351) Models include check valve



Part #	Mfg #	Description	Price
165689	K-98350-BN	*Brushed Nickel	
173207	K-98350-CP	Polished Chrome	
186417	K-98350-2BZ	Oil Rubbed Bronze	
167878	K-98351-CP	Polished Chrome	
183061	K-98351-BN	*Brushed Nickel	

**Bancroft™ Wall-Mount Supply Elbow**



Part #	Mfg #	Finish	Price
103946	K-22173-BV	*Brushed Bronze	
257847	K-22173-CP	Polished Chrome	
255622	K-22173-PB	*Polished Brass	

**Bancroft™ Wall-Mount Supply Elbow**

- Check valve included



Part #	Mfg #	Finish	Price
255218	K-22173-BN	*Brushed Nickel	
255217	K-22173-2BZ	Oil Rubbed Bronze	

**Exhale® Wall-Mount Supply Elbow**



Part #	Mfg #	Description	Price
237748	K-98352-CP	Polished Chrome	

**Forté® Wall-Mount Supply Elbow**



Part #	Mfg #	Finish	Price
105761	K-355-AF	*French Gold	

**Forté® Wall-Mount Supply Elbow**

- Check valve included



Part #	Mfg #	Finish	Price
255831	K-22174-BN	*Brushed Nickel	
255830	K-22174-CP	Polished Chrome	
255832	K-22174-2BZ	Oil-Rubbed Bronze	

**MasterShower® Wall-Mount Supply Elbow**



Part #	Mfg #	Finish	Price
056367	K-9513-BN	*Brushed Nickel	
073981	K-9513-BV	*Brushed Bronze	
054687	K-9513-CP	Polished Chrome	
064220	K-9513-PB	*Polished Brass	
057110	K-9513-SN	*Polished Nickel	

\* Vibrant Limited Lifetime Warranty

[www.waterconcepts.net](http://www.waterconcepts.net) • Serving our Customers Since 1946 • [www.plumbsupply.com](http://www.plumbsupply.com)

## Personal Showers & Accessories

### Memoirs® Wall-Mount Supply Elbow

- Check valve included



Part #	Mfg #	Finish	Price
260911	K-22171-BN	*Brushed Nickel	

### Purist® Wall-Mount Supply Elbow

- Check valve included



Part #	Mfg #	Finish	Price
259240	K-22172-BN	*Brushed Nickel	
255833	K-22172-CP	Polished Chrome	
255212	K-22172-SN	*Polished Nickel	

### Stillness® Wall-Mount Supply Elbow



Part #	Mfg #	Finish	Price
221713	K-976-BGD	*Moderne Brushed Gold	
258276	K-976-BL	Matte Black	
093408	K-976-BN	*Brushed Nickel	
099896	K-976-BV	*Brushed Bronze	

### Handshower Wall Brackets

#### Awaken® Handshower Fixed Wall Bracket



Part #	Mfg #	Description	Price
241836	K-98347-CP	Polished Chrome	

### Awaken® Handshower Wall Bracket



Part #	Mfg #	Description	Price
165688	K-98348-BN	*Brushed Nickel	
166723	K-98348-CP	Polished Chrome	
252619	K-98348-2BZ	Oil Rubbed Bronze	

### Bancroft® Adjustable Handshower Wall Bracket



Part #	Mfg #	Description	Price
106286	K-10599-BKB	Brushed Black	
106260	K-10599-BN	*Brushed Nickel	
103947	K-10599-BV	*Brushed Bronze	
105303	K-10599-CP	Polished Chrome	
100056	K-10599-SN	Polished Nickel	
147026	K-10599-2BZ	Oil Rubbed Bronze	

### Exhale® Wall-Mount Handshower Holder

- Includes check valve for backflow prevention
- Integrated handshower bracket fits most handshowers



Part #	Mfg #	Description	Price
228093	K-98354-BN	*Brushed Nickel	
226968	K-98354-CP	Polished Chrome	
242513	K-98354-TT	*Titanium	

### Exhale® Adjustable Handshower Wall Bracket



Part #	Mfg #	Description	Price
237749	K-98349-CP	Polished Chrome	

\* Vibrant Limited Lifetime Warranty

[www.plumbsupply.com](http://www.plumbsupply.com) • Serving our Customers Since 1946 • [www.waterconcepts.net](http://www.waterconcepts.net)

**Personal Showers & Accessories**

**Forté® Adjustable Handshower Wall Bracket**



Part #	Mfg #	Description	Price
105760	K-352-AF	*French Gold	
090512	K-352-BN	*Brushed Nickel	
092040	K-352-BV	*Brushed Bronze	
097252	K-352-CP	Polished Chrome	
101753	K-352-G	Brushed Chrome	
099029	K-352-PB	Polished Brass	
135071	K-352-SN	Polished Nickel	
156622	K-352-2BZ	Oil Rubbed Bronze	

**Loure® Wall-Mount Handshower Holder**



Part #	Mfg #	Description	Price
134412	K-14791-BN	*Brushed Nickel	
139095	K-14791-CP	Polished Chrome	
183016	K-14791-SN	*Polished Nickel	

**Memoirs® Adjustable Wall-Mount Bracket**



Part #	Mfg #	Description	Price
093412	K-422-BN	*Brushed Nickel	
116360	K-422-BV	*Brushed Bronze	
097989	K-422-CP	Polished Chrome	
165828	K-422-2BZ	Oil Rubbed Bronze	

**MasterShower® Fixed Wall-Mount Bracket**



Part #	Mfg #	Description	Price
062696	K-8515-BN	*Brushed Nickel	
076706	K-8515-BV	*Brushed Bronze	

**Handshower Wall Brackets (Continued)**

**MasterShower® Fixed Wall-Mount Bracket**

Part #	Mfg #	Description	Price
082245	K-8515-PB	Polished Brass	
122119	K-8515-SN	*Polished Nickel	

**MasterShower® Adjustable Wall Bracket**



Part #	Mfg #	Description	Price
074644	K-9515-BN	*Brushed Nickel	
094127	K-9515-BV	*Brushed Bronze	
060470	K-9515-CP	Polished Chrome	
089124	K-9515-PB	*Polished Brass	
182869	K-9515-SN	*Polished Nickel	

**Stillness® Adjustable Wall-Mount Bracket**



Part #	Mfg #	Description	Price
093407	K-975-BN	*Brushed Nickel	
094227	K-975-CP	Polished Chrome	
131006	K-975-SN	*Polished Nickel	

**Toobi™ Wall-Mount Handshower Holder**

- *Pivots to keep handshower perfectly positioned*
- *Includes check valve for backflow prevention*
- *Handshower holder and wall supply into one*



Part #	Mfg #	Description	Price
154353	K-8987-BN	*Brushed Nickel	
150833	K-8987-CP	Polished Chrome	

\* Vibrant Limited Lifetime Warranty

**Personal Showers & Accessories**

**Showerarm Diverters**

**Awaken® Showerarm Diverter**

- Switches water between showerhead or handshower, or both at same time.
- Mounts on end of showerarm
- Showerarm not included



Part #	Mfg #	Description	Price
160428	K-98770-BN	*Brushed Nickel	
160265	K-98770-CP	Polished Chrome	

**HydroRails®**

**HydroRail® Wall-Mount -H Shower/Bath Column**

- For use with shower only installations
- Converts fixed showerhead to a handshower and slidebar combo
- Adjustable slidebar bracket
- Includes: column, bracket, and slidebar
- Handshower and hose sold separately



27" Bar

Part #	Mfg #	Description	Price
223373	K-45903-SN	*Polished Nickel	

18" Bar

Part #	Mfg #	Description	Price
248736	K-45904-BN	*Brushed Nickel	
183272	K-45904-CP	Polished Chrome	

**HydroRail® Wall-Mount -R Beam Shower Column**

- For use in shower only installations
- (2) Position diverter for rainhead showerhead or handshower operation
- Check valve installed in diverter valve for backflow prevention



Part #	Mfg #	Description	Price
153560	K-45212-BN	*Brushed Nickel	
155348	K-45212-CP	Polished Chrome	
183571	K-45212-SN	*Polished Nickel	
187820	K-45212-2BZ	Oil Rubbed Bronze	

**HydroRail® -R Beam Bath/Shower Column**

- For use in bath and shower installations
- Adjustable slidebar bracket
- Showerhead, handshower, and hose sold separately



Part #	Mfg #	Description	Price
156213	K-45210-BN	*Brushed Nickel	
154955	K-45210-CP	Polished Chrome	
172660	K-45210-2BZ	Oil Rubbed Bronze	

**HydroRail® Wall-Mount -R Arch Shower Column**

- For use and shower installations
- Adjustable slidebar bracket
- Diverter at base of column for toggling between handshower and rainhead
- Showerhead, handshower, and hose sold separately



Part #	Mfg #	Description	Price
147926	K-45211-BN	*Brushed Nickel	
147754	K-45211-CP	Polished Chrome	
161085	K-45211-2BZ	Oil Rubbed Bronze	

**HydroRail® -R Arch Bath and Shower Column**

- For use in bath and shower installations
- (2) Position diverter for rainhead, showerhead or handshower operation
- Check valve installed in diverter valve for backflow prevention

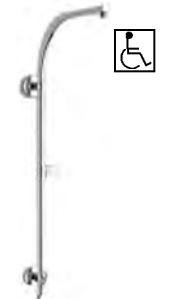

Part #	Mfg #	Description	Price
166320	K-45209-BN	*Brushed Nickel	
153864	K-45209-CP	Polished Chrome	
173805	K-45209-2BZ	Oil Rubbed Bronze	
249502	K-45209-SN	Vibrant Polished Nickel	

\* Vibrant Limited Lifetime Warranty

[www.plumbsupply.com](http://www.plumbsupply.com) • Serving our Customers Since 1946 • [www.waterconcepts.net](http://www.waterconcepts.net)



## Personal Showers & Accessories

### HydroRail® -S Bath/Shower Column

- For use in bath and shower installations
- (2) Position diverter for rainhead, showerhead, or handshower operation
- Check valve installed in diverter valve for backflow prevention



Part #	Mfg #	Description	Price
171873	K-45905-BN	*Brushed Nickel	
158627	K-45905-CP	Polished Chrome	
224086	K-45905-SN	*Polished Nickel	
173098	K-45905-2BZ	Oil Rubbed Bronze	

### -S Shower HydroRail®

- For use in shower installations
- Slidebar bracket
- Diverter for easy toggling between handshower and showerhead
- Showerhead, handshower, and hose sold separately



Part #	Mfg #	Description	Price
169699	K-45906-BN	*Brushed Nickel	
171042	K-45906-CP	Polished Chrome	
222214	K-45906-SN	*Polished Nickel	
189562	K-45906-2BZ	Oil Rubbed Bronze	

### HydroRail-S™ Shower Column Kit with Awaken®

- For use in shower installations
- MasterClean™ sprayface
- Slidebar bracket
- Diverter for easy toggling between handshower and showerhead
- Patent-pending technology
- Includes K-72419 Awaken® showerhead, K-72415 Awaken® handshower, K-45906 HydroRail-S™ shower column, and K-45982 Awaken® 60" ribbon hose
- WaterSense® certified product: 2.0 gpm



Part #	Mfg #	Description	Price
190495	K-76471-BN	*Brushed Nickel	
189969	K-76471-CP	Polished Chrome	

### HydroRail-R™ Arch Shower Column Kit with Moxie® Rainhead & Flipside® Handshower

- Premium metal construction
- Slidebar bracket
- Diverter at base
- Moxie® Syncs with Bluetooth®
- Includes K-99105-E Moxie rainhead, K-45425 Flipside handshower, K-45211 HydroRail-R arch shower column, and K-9514 MasterShower® 60-inch metal hose
- WaterSense® certified product: 2.0 gpm



Part #	Mfg #	Description	Price
236801	K-76475-BN	Brushed Nickel*	
245536	K-76475-CP	Polished Chrome	
224759	K-76475-2BZ	Oil Rubbed Bronze	

\* Vibrant Limited Lifetime Warranty

[www.waterconcepts.net](http://www.waterconcepts.net) • Serving our Customers Since 1946 • [www.plumbsupply.com](http://www.plumbsupply.com)



---



---

**Personal Showers & Accessories**

---



---

**HydroRail-S™ Shower Column Kit with Artifacts® & Katalyst® Air-Induction Sp**

- Metal construction
- Slidebar bracket
- Diverter at column base
- MasterClean™ sprayface
- Kit includes:
  - K-72774 Artifacts® showerhead
  - K-72776 Artifacts® handshower
  - K-45906 HydroRail-S™ shower column
  - K-9514 MasterShower® 60" metal hose
- WaterSense® certified product: 2.0 gpm



Part #	Mfg #	Description	Price
242661	K-76472-CP	Polished Chrome	
229263	K-76472-BN	*Brushed Nickel	
252669	K-76472-2BZ	Oil Rubbed Bronze	

\* Vibrant Limited Lifetime Warranty

[www.plumbsupply.com](http://www.plumbsupply.com) • Serving our Customers Since 1946 • [www.waterconcepts.net](http://www.waterconcepts.net)

## Personal Showers & Accessories

### Diverter Trim for Deck Mount Tub Faucets

#### Bancroft® Deck-Mount Handshower Holder

- Handshower sold separately
- Hoses included



Part #	Mfg #	Description	Price
100092	K-10573-BN	*Brushed Nickel	
110809	K-10573-BV	*Brushed Bronze	
105020	K-10573-CP	Polished Chrome	
116738	K-10573-SN	*Polished Nickel	
147024	K-10573-2BZ	Oil Rubbed Bronze	

#### Forté® Deck-Mount Handshower Holder

- Handshower sold separately
- Hoses Included



Part #	Mfg #	Description	Price
118966	K-368-AF	*French Gold	
094725	K-368-BN	*Brushed Nickel	
106792	K-368-BV	*Brushed Bronze	
098058	K-368-CP	Polished Chrome	
113092	K-368-G	Brushed Chrome	
161690	K-368-2BZ	Oil Rubbed Bronze	

#### Loure® Bath- or Deck-Mount 2-Way Diverter Valve

- Valve has backflow protection
- 2-3/8" High, 2-1/2" width
- Can be mounted up to 1-1/4" thickness



Part #	Mfg #	Description	Price
150899	K-14677-BN	*Brushed Nickel	
142805	K-14677-CP	Polished Chrome	

### Loure® Bath- or Deck-Mount Handshower Holder

- Handshower sold separately
- Hoses included



Part #	Mfg #	Description	Price
134406	K-14789-BN	*Brushed Nickel	
142806	K-14789-CP	Polished Chrome	
223374	K-14789-SN	*Polished Nickel	

#### Memoirs® Deck-Mount Handshower Holder

- Handshower sold separately
- Hoses included



Part #	Mfg #	Description	Price
097074	K-424-BN	*Brushed Nickel	
114262	K-424-BV	*Brushed Bronze	
094596	K-424-CP	Polished Chrome	

#### Stillness® Bath- or Deck-Mount Handshower Holder

- Handshower sold separately
- Hoses included



Part #	Mfg #	Description	Price
094120	K-977-BN	*Brushed Nickel	
093466	K-977-CP	Polished Chrome	

#### Deck-Mount Handshower Holder

- Handshower sold separately
- Hoses included



Part #	Mfg #	Description	Price
064421	K-8548-BN	*Brushed Nickel	
056216	K-8548-CP	Polished Chrome	

\* Vibrant Limited Lifetime Warranty

[www.waterconcepts.net](http://www.waterconcepts.net) • Serving our Customers Since 1946 • [www.plumbsupply.com](http://www.plumbsupply.com)

## Personal Showers & Accessories

### Bath- or Deck-Mount 2-Way Diverter Valve with Handshower Cradle

- Handshower sold separately
- Valve has backflow protection
- 69" decorative hose included
- 36" high-pressure hose included
- Flow rate: 15 gpm with 1/2" lines  
25 gpm with 3/4" lines



Part #	Mfg #	Description	Price
059247	K-8549-BN	*Brushed Nickel	
073983	K-8549-BV	* Brushed Bronze	
054122	K-8549-CP	Polished Chrome	
056904	K-8549-G	Brushed Chrome	
055649	K-8549-PB	*Polished Brass	
086142	K-8549-SN	* Polished Nickel	

### Bath- or Deck-Mount 2-Way Diverter Valve

- Handshower sold separately
- Valve has backflow protection
- 69" Decorative hose included
- 36" High-pressure hose included
- Flow rate: 15 gpm with 1/2" lines  
25 gpm with 3/4" lines



Part #	Mfg #	Description	Price
086888	K-9530-AF	*French Gold	
059882	K-9530-BN	*Brushed Nickel	
075015	K-9530-BV	*Brushed Bronze	
058400	K-9530-CP	Polished Chrome	
066446	K-9530-PB	*Polished Brass	
111917	K-9530-SN	*Polished Nickel	
104507	K-9530-2BZ	Oil Rubbed Bronze	

### Deck-Mount Transfer Valve/Vacuum Breaker

- Trim only, valve not included

Required Valve 408-K or 409-K



Part #	Mfg #	Description	Price
092009	K-T9540-4-BN	*Brushed Nickel	
116578	K-T9540-4-CP	Polished Chrome	

\* Vibrant Limited Lifetime Warranty

[www.plumbsupply.com](http://www.plumbsupply.com) • Serving our Customers Since 1946 • [www.waterconcepts.net](http://www.waterconcepts.net)

**Personal Showers & Accessories**

**Handshowers**

**Baliza® Handheld Shower**

- 3-Setting



Part #	Mfg #	Description	Price
209087	RP63167BN	Brushed Nickel*	

**Baliza® Wall-Mount Handheld Shower**

- 3-Function handshower:
  - Full
  - Massage
  - Aerated spray
- Touch-Clean® nozzles
- Wall elbow included
- 60" - 82" Stretchable metal hose
- WaterSense® certified product: 2.0 gpm @ 80 psi



Part #	Mfg #	Description	Price
175332	85810-BN	Brushed Nickel*	
171320	85810-BZ	Brushed Bronze*	
173270	85810-PC	Chrome	
245902	85810-PN	Polished Nickel*	
177180	85810-RB	Venetian Bronze®	

**Charlotte® Wall-Mount Handheld Shower**

- Single function spray
- 60" - 82" Stretchable metal hose
- Wall mount bracket and elbow included
- WaterSense® certified product: 2.0 gpm @ 80 psi



Part #	Mfg #	Description	Price
240658	85885-PC	Chrome	
156699	85885-PNCO	Cocoa Bronze & Pol Nickel	

**Levoir™ Wall-Mount Handheld Shower**

- H2Okinetic® technology
- Four-function handshower
  - H2Okinetic® spray
  - Massage spray
  - Full spray
  - Pause
- 60"-82" stretchable finished metal hose
- Dual check valves for backflow prevention
- Wall mount bracket with integrated hose connection and integrated elbow
- WaterSense® certified product: 1.75 gpm @ 80 psi



Part #	Mfg #	Description	Price
253995	88898-PN	Polished Nickel*	

**Litze™ Wall-Mount Handheld Shower**

- H2Okinetic® technology
- Three-function handshower
  - H2Okinetic® spray
  - Massage spray
  - Pause
- 60"-82" stretchable metal hose
- Textural knurling detail on handshower
- Wall-mount bracket with integrated hose connection
- WaterSense® certified product: 2.0 gpm @ 60 psi



Part #	Mfg #	Description	Price
243463	88835-GL	Luxe Gold	
248017	88835-NK	Luxe Nickel	

**Odin™ Wall-Mount Handheld Shower**

- Single-function handshower
- H2Okinetic® technology with self-cleaning spray holes
- 60"-82" Stretchable metal hose
- Wall mount bracket and elbow included
- WaterSense® certified product: 2.0 gpm @ 80 psi



Part #	Mfg #	Description	Price
248112	88875-BL	Matte Black	
157996	88875-BN	Brushed Nickel*	

\* Brilliance® Anti-Tarnish Lifetime Finishes

**Personal Showers & Accessories**

**Rook™ Wall-Mount Handshower**

- Three-function handshower  
-H2Okinetic® spray  
-Massage spray  
-Pause
- H2Okinetic® technology
- 60"-82" Stretchable metal hose
- Wall-mount bracket with integrated hose connection
- Watersense® certified product: 2.0 gpm @ 80 psi



Part #	Mfg #	Description	Price
223097	88861-NKBL	Luxe Nickel/Matte Black	
227076	88861-NK	Luxe Nickel	
226799	88861-RB	Venetian Bronze®	

**Vettis™ Wall-Mount Handheld Shower**

- Three-function handshower  
-H2Okinetic® spray  
-Massage spray  
-Pause
- 60"-82" Stretchable metal hose
- Wall mount bracket included



Part #	Mfg #	Description	Price
249066	88888-PC	Chrome	

**Siderna® Wall-Mount Handheld Shower**

- Single function spray
- 60" - 82" Stretchable metal hose
- Wall mountable elbow included
- WaterSense® certified product: 2.0 gpm @ 80 psi



Part #	Mfg #	Description	Price
166805	85880-PC	Chrome	
188214	85880-BN	Brushed Nickel*	

**Vesi® Wall-Mount Handheld Shower**

- Single function spray
- Solid brass construction
- 60"-82" Stretchable metal hose
- WaterSense® certified product: 2.0 gpm @ 80 psi
- Requires wall mount elbow (RP36004) sold separately



Part #	Mfg #	Description	Price
086433	RP41202-BN	Brushed Nickel*	
098408	RP41202-BZ	Brushed Bronze*	
246264	RP41202-RB	Venetian Bronze	

**Sotria™ Wall-Mount Handheld Shower**

- Single-function handshower
- 60" - 82" Stretchable metal hose
- Wall elbow and bracket included
- WaterSense® certified product: 2.0 gpm @ 80 psi



Part #	Mfg #	Description	Price
181333	88850-NK	Luxe Nickel*	
184226	88850-PC	Chrome	
228063	88850-PN	Polished Nickel	

**Virage® Wall-Mount Handheld Shower**

- Single function handshower
- Touch-Clean® nozzles
- 60" - 82" Stretchable metal hose
- Wall mount bracket and elbow included
- WaterSense® certified: 2.0 gpm @ 80 psi



Part #	Mfg #	Description	Price
145294	85830-BN	Brushed Nickel*	
135232	85830-BZ	Brushed Bronze*	
129972	85830-PC	Chrome	
165832	85830-PN	Polished Nickel*	
161086	85830-RB	Venetian Bronze®	

\* Brilliance® Anti-Tarnish Lifetime Finishes



**Personal Showers & Accessories**

**Handshower with Slide Bars**

**Baliza® Slide Bar Handheld Shower**

- Single-function handshower
- 23-1/4" Long slidebar w/ adjustable slide
- 60"-82" Stretchable metal hose
- Wall mount elbow included
- WaterSense® certified: 2.0 gpm @ 80 psi



Part #	Mfg #	Description	Price
184792	85710-BN	Brushed Nickel*	
171584	85710-PC	Polished Chrome	
175146	85710-PN	Polished Nickel*	
170981	85710-RB	Venetian Bronze®	

**Levoir™ Slide Bar Handheld Shower**

- H2Okinetic® technology
- Four-function handshower
  - H2Okinetic® spray
  - Massage spray
  - Full spray
  - Pause
- 23-25/32" Long slide bar
- 60"-82" stretchable finished metal hose
- Slide bar with integrated hose connection
- Wall bar includes integrated elbow
- WaterSense® certified product: 1.75 gpm @ 80 psi



Part #	Mfg #	Description	Price
255370	88798-GL	Luxe Gold	
252808	88798-SL	Luxe Steel	

**Charlotte™ Slide Bar Handheld Shower**

- Single function spray
- 23-1/4" Long slide bar
- 60" - 82" Stretchable metal hose
- Wall mount elbow included
- WaterSense® certified product: 2.0 gpm @ 80 psi



Part #	Mfg #	Description	Price
155371	85785-BN	Brushed Nickel*	
171233	85785-PC	Chrome	
210823	85785-PN	Polished Nickel*	
147477	85785-PNCO	Cocoa Bronze & Pol Nickel	

**Litze™ Slide Bar Handheld Shower**

- H2Okinetic® technology
- Three-function handshower
  - H2Okinetic® spray
  - Massage spray
  - Pause
- 22-1/2" Long slide bar
- 60"-82" stretchable finished metal hose
- Slide bar with integrated hose connection
- Textural knurling detail on handshower
- Maximum flow rate: 2.0 gpm @ 60 psi
- Model **88735-PC** includes wheel



88735-P

Part #	Mfg #	Description	Price
242294	85735-GL	Luxe Gold	
245454	88735-GL	Luxe Gold	
237822	88735-PC	Chrome	

**Euro Slide Bar Handheld Shower**

- Three-function handshower
  - Full
  - Massage
  - Aerated spray
- 35" Long slide bar
- 60"-82" Stretchable metal hose
- Handshower includes wall mount elbow
- WaterSense® certified product: 2.0 gpm @ 80 psi



Part #	Mfg #	Description	Price
188613	85521-BL	Matte Black	
135873	85521-BN	Brushed Nickel*	

**Odin™ Slide Bar Handheld Shower**

- Single function handshower
- H2Okinetic® technology with self-cleaning spray holes
- 60"-82" metal hose
- 24" Long slide bar
- Wall mount elbow included
- WaterSense® certified: 2.0 gpm @ 80 psi



Part #	Mfg #	Description	Price
162482	88775-BL	Matte Black	
165339	88775-BN	Brushed Nickel*	

\* Brilliance® Anti-Tarnish Lifetime Finishes



**Personal Showers & Accessories**

**Rook™ Slide Bar Handheld Shower**

- Three-function handshower  
-Spray  
-Massage spray  
-Pause
- H2Okinetic® technology with self-cleaning spray holes
- 60"-82" Metal hose
- 26-3/4" Long slide bar
- WaterSense® certified: 2.0 gpm @ 80 psi



Part #	Mfg #	Description	Price
185781	88761-NK	Luxe Nickel*	
188716	88761-NKBL	Luxe Nickel*/Matte Black	
188965	88761-PC	Polished Chrome	
250464	88761-PN	Polished Nickel	
222753	88761-RB	Venetian Bronze	

**RSVP® Slide Bar Handheld Shower**

- Single-function handshower
- 60"-82" Stretchable metal hose
- 34" Long slide bar
- Includes vacuum breaker and wall mount elbow
- WaterSense® certified product: 2.0 gpm @ 80 psi



Part #	Mfg #	Description	Price
119122	89710-PC	Polished Chrome	

**Siderna® Wall-Mount Handheld Shower**

- Single-function handshower
- Touch-Clean® nozzles
- 25" Long slide bar with adjustable slide
- 60" - 82" Stretchable metal hose
- Wall elbow included
- WaterSense® certified product: 2.0 gpm @ 80 psi



Part #	Mfg #	Description	Price
242230	85780-BL	Matte Black	
176444	85780-BN	Brushed Nickel*	
169305	85780-PC	Polished Chrome	

**Sotria® Wall-Mount Handheld Shower**

- Single function handshower
- H2Okinetic® technology with self-cleaning spray holes
- 18-3/8" Long slide bar
- 60" - 82" Stretchable metal hose
- Wall elbow included
- WaterSense® certified product: 2.0 gpm @ 80 psi



Part #	Mfg #	Description	Price
177376	88750-BL	Matte Black	
223947	88750-NK	Luxe Nickel*	
184217	88750-PC	Polished Chrome	

**Vettis™ Slide Bar Handheld Shower**

- Three-function handshower  
-H2Okinetic® spray  
-Massage spray  
-Pause
- 27-13/16" Long slide bar
- 60"-82" Stretchable metal hose
- WaterSense® certified product: 2.0 gpm @ 80 psi



Part #	Mfg #	Description	Price
252517	88788-BL	Matte Black	
251064	88788-NK	Luxe Nickel*	

**Virage® Slide Bar Handheld Shower**

- Single function spray
- 24" Long slide bar
- 60"-82" Stretchable metal hose
- WaterSense® certified: 2.0 gpm @ 80 psi



Part #	Mfg #	Description	Price
143200	85730-BN	Brushed Nickel*	
158222	85730-BZ	Brushed Bronze*	
137212	85730-PC	Polished Chrome	
159771	85730-RB	Venetian Bronze®	

\* Brilliance® Anti-Tarnish Lifetime Finishes

## Personal Showers & Accessories

### Handshowers

#### ActivTouch® Handshower

- Handshower only, less hose (59424)
- Handshower w/ 60"-82" hose (55424)
- Plated spray face
- Push button spray selection
- 2.5 gpm @ 80 psi (55424.59424)
- 2.0 gpm @ 80 psi (59424-20)
- 9-Setting handshower:
  - Pause
  - Fast massage
  - Full spray with massage
  - Soft drench spray
  - Soft drench spray with massage
  - Soft full spray
  - Shampoo rinsing spray
  - Shampoo rinsing spray with massage
  - Full body spray



Part #	Mfg #	Finish	Price
146610	55424	Chrome	
159508	55424-RB	Venetian Bronze®	
134980	55424-SS	Stainless*	
143067	59424-PK	Chrome	
165001	59424-RB	Venetian Bronze®	
147870	59424-SS	Stainless*	

#### Ara™ Wall-Mount Handshower

- Single setting H2Okinetic®
- Self-cleaning spray holes
- 60" -82" Stretchable metal hose
- 2.0 gpm @ 80 psi



Part #	Mfg #	Finish	Price
168496	55567	Chrome	
165294	55567-SS	Stainless*	

#### Cassidy™ Handshower

- 3-Setting
- Self-cleaning spray holes
- Handshower ONLY
- WaterSense® certified product:  
2.0 gpm @ 80 psi



Part #	Mfg #	Finish	Price
189823	59433-PK	Chrome	

### Handshowers (Continued)

#### Cassidy™ Handshower

Part #	Mfg #	Finish	Price
187689	59433-CZ-PK	Champagne Bronze™	
250943	59433-PN-PK	Polished Nickel*	
159595	59433-RB-PK	Venetian Bronze®	
166258	59433-SS-PK	Stainless*	

#### Cassidy™ Wall-Mount Handshower

- Adjustable wall mount
- Self-cleaning spray holes
- 60" to 82" Stretchable metal hose
- 3-Setting handshower:
  - Pause
  - H2Okinetic® spray
  - Massage spray



Part #	Mfg #	Finish	Price
155252	55433	Chrome	
170383	55433-CZ	Champagne Bronze™	
165670	55433-PN	Polished Nickel*	
151570	55433-RB	Venetian Bronze®	
151703	55433-SS	Stainless*	

#### Cassidy™ Shower-Mount Handshower

- Self-cleaning H2Okinetic® spray
- 60" - 82" Stretchable metal hose
- 3-Setting handshower
- Shower arm mount
- Shower arm and flange sold separately
- WaterSense® certified product:  
2.0 gpm @ 80 psi



Part #	Mfg #	Finish	Price
159428	54433-PK	Chrome	
156181	54433-CZ-PK	Champagne Bronze™	
257028	54433-PN-PK	Polished Nickel*	
156096	54433-SS-PK	Stainless*	

\* Brilliance® Anti-Tarnish Lifetime Finishes

## Personal Showers & Accessories

### Classic White Shower-Mount Handshower

- Full body spray pattern plus pause
- 2.5 gpm @ 80 psi



Part #	Mfg #	Finish	Price
058413	59344-B-PK	Chrome	
001193	59344-WHB-PK	White	

### Classic Palm® Shower-Mount Handshower

- Change spray modes with pushbutton
- Includes double check valves for backflow prevention
- Maximum flow: 2.5 gpm @ 80 psi
- Less mount and hose (59456-PK)



Part #	Mfg #	Finish	Price
166769	54456-PK	Chrome	
145936	54456-SS-PK	Stainless*	
147742	59456-PK	Chrome, Less Hose	
166862	59456-SS-PK	Stainless*, Less Hose	

### Classic Handshower - 4-Spray

- Spray settings:
  - Full body spray
  - Massaging spray
  - Crossing full spray
  - Crossing full spray with massage
- 2.5 gpm (59456)
- 2.0 gpm (59465-20)



Part #	Mfg #	Finish	Price
001206	59465-PK	Chrome	
182015	59465-WH-PK	White	

### Classic ADA Handshower

- ADA Compliant
- Spray settings:
  - Full body spray
  - Pause
- 2.5 gpm (59462)
- 2.0 gpm (59462-20)
- 1.5 gpm (59462-15)



59462-B

59462-WHB

Part #	Mfg #	Finish	Price
001202	59462-WH-PK	White, 2.5 gpm	
001201	59462-B-PK	Chrome, 2.5 gpm	
001200	59462-WHB-PK	White, 2.5 gpm	
158279	59462-WH15-PK	White, 1.5 gpm	
153370	59462-B15-BG	Chrome, 1.5 gpm	
156070	59462-WHB15-BG	White, 1.5 gpm	

### Classic Handshower

- Spray settings:
  - Full body spray
  - Fast massage
  - Full spray with massage
  - High efficiency
  - Pause
- WaterSense® certified



Part #	Mfg #	Finish	Price
206638	59434-15-BG	Chrome, 1.5 gpm	
247822	59434-18-PK	Chrome, 1.75 gpm	
252317	59434-SS18-PK	Stainless*, 1.75 gpm	

### Classic Adjustable Spray Handshower

- 2.5 gpm @ 80 psi
- Adjusts from wide to narrow spray
- Acrylic handle



Part #	Mfg #	Finish	Price
176381	59480	Chrome, 2.5 gpm	

\* Brilliance® Anti-Tarnish Lifetime Finishes

## Personal Showers & Accessories

### Single-Setting Hand Shower



Part #	Mfg #	Finish	Price
139142	RP46680	Chrome	

### Classic Fixed Wall-Mount Handshower

- Full spray pattern with pause
- 2.5 gpm @ 80 psi



59410-B-PK

Part #	Mfg #	Finish	Price
001182	59410-B-PK	Chrome	
001183	59410-WHB-PK	White	

### Classic Wall-Mount Handshower

- Single-setting
- Touch-Clean® spray holes
- 60" UltraFlex® hose
- 2.5 gpm @ 80 psi



Part #	Mfg #	Finish	Price
156921	59310-WH-PK	White	

### Classic Fixed Wall-Mount Handshower

- 4-Setting handshower
- 60" UltraFlex® hose



Part #	Mfg #	Finish	Price
001213	59348-PK	Chrome	
186138	59348-WH-PK	White	

### Contemporary ActivTouch® Wall-Mount Handshower

- 60" to 82" Stretchable metal hose
- Adjustable Showerarm mount
- 9-Setting handshower:
  - Pause
  - Fast massage
  - Full spray with massage
  - Soft drench spray
  - Soft drench spray with massage
  - Soft full spray
  - Shampoo rinsing spray
  - Shampoo rinsing spray with massage
- Full body spray
- 2.5 gpm (54424)
- 2.0 gpm (54424-20)



Part #	Mfg #	Finish	Price
147151	54424-PK	Chrome	
147741	54424-SS-PK	Stainless*	
162115	54424-RB-PK	Venetian Bronze®	

### Delta Shower Arm-Mount Handshower

- 3-Function handshower
- 69" Long hose
- Dual check valves
- Maximum flow: 2.5 gpm @ 80 psi



Part #	Mfg #	Finish	Price
089806	56613	Chrome	
173091	56613-CZ	Champagne Bronze™	
145597	56613-RB	Venetian Bronze®	
101750	56613-SS	Stainless*	

### Delta Single-Function Wall-Mount Handshower

- 69" Long flexible hose with brass connections
- Dual check valves
- 2.0 gpm @ 80 psi
- Full body spray



Part #	Mfg #	Finish	Price
139704	55011	Chrome	

\* Brilliance® Anti-Tarnish Lifetime Finishes

## Personal Showers & Accessories

### Delta Single-Function Wall-Mount Handshower

- 69" Long flexible hose with brass connections
- Dual check valves
- 2.0 gpm @ 80 psi
- Full body spray



Part #	Mfg #	Finish	Price
135452	55013	Chrome	
137767	55013-RB	Venetian Bronze®	
139373	55013-SS	Stainless*	

### Compel Wall-Mount Handshower

- Single-setting
- 2.5 gpm @ 80 psi
- 60" - 82" Stretchable metal hose
- Wall-mounting bracket included
- Dual check valves



Part #	Mfg #	Finish	Price
136176	55085	Chrome	
235179	55085-BL	Matte Black	
136500	55085-SS	Stainless*	
158971	55085-RB	Venetian Bronze®	

### Delta Five-Function Wall-Mount Handshower

- 69" Flexible hose with brass connections
- Certified dual check valves
- 2.5 gpm @ 80 psi
- (5) Functions:
  - Full body spray
  - Massage spray
  - Full spray with massage
  - Soft drench spray
  - Soft drench spray with massage



Part #	Mfg #	Finish	Price
143533	55021	Chrome	
145827	55021-CZ	Champagne Bronze™	
142776	55021-RB	Venetian Bronze®	
143493	55021-SS	Stainless*	

### Delta Full Spray Push Button Handshower

- Push button pause control
- TouchClean®



Part #	Mfg #	Finish	Price
150233	75009WH	White, less Hose	

### Handshower - 3-Setting



Part #	Mfg #	Finish	Price
162711	RP48769RB	Venetian Bronze®	

### Addison Single-Function Wall-Mount Handshower

- 60" - 82" Stretchable metal hose
- Dual check valves
- 2.0 gpm @ 80 psi
- Full body spray



Part #	Mfg #	Finish	Price
129270	57923	Chrome	
139330	57923-CZ	Champagne Bronze™	
126352	57923-RB	Venetian Bronze®	
128925	57923-SS	Stainless*	

### Handshower - Single Setting

- Handshower ONLY



Part #	Mfg #	Finish	Price
155274	RP46683SS	Stainless*	

\* Brilliance® Anti-Tarnish Lifetime Finishes



## Personal Showers & Accessories

### H2OKinetic® 3-Setting Universal Handshower

- Touch-Clean® spray holes
- 3-Settings
  - Pause
  - Massaging spray
  - H2OKinetic® spray
- Certified dual check valves
- WaterSense® certified: 1.75 gpm @ 80 psi



Part #	Mfg #	Finish	Price
250315	59799-BL-PK	Matte Black	

### Dryden™ Wall-Mount Single-Function Handshower

- 69" Long flexible hose with brass connections
- 2.0 gpm @ 80 psi
- Full body spray
- Certified dual check valves
- Includes mounting bracket



Part #	Mfg #	Finish	Price
137501	55051	Chrome	
166666	55051-CZ	Champagne Bronze™	
176966	55051-PN	Polished Nickel*	
135703	55051-SS	Stainless*	
136731	55051-RB	Venetian Bronze®	

### In2ition® Universal Shower Arm-Mount Two-In-One Handshower

- 60" Stretchable metal hose
- MagnaTite® docking
- 4-Settings
  - Pause
  - Massaging spray
  - H2OKinetic spray
  - H2OKinetic spray with massage
- 2.5 gpm @ 80 psi



Part #	Mfg #	Finish	Price
248273	58472-CZ	Champagne Bronze™	

### In2ition® Universal Shower Arm-Mount Two-In-One Handshower

- 60" Stretchable metal hose
- MagnaTite® docking
- Touch-Clean® spray holes
- 4-Settings
  - Pause
  - Massaging spray
  - H2OKinetic spray
  - H2OKinetic spray with massage
- 1.75 gpm @ 80 psi



Part #	Mfg #	Finish	Price
224660	58473	Chrome	
255532	58473-PN	Polished Nickel*	
227959	58473-RB	Venetian Bronze	
224659	58473-SS	Stainless*	

### Leland® Wall-Mount Handshower

- 69" Long hose
- 2.0 gpm @ 80 psi
- Single-setting handshower: full body spray



Part #	Mfg #	Finish	Price
137030	55020	Chrome	
147480	55020-CZ	Champagne Bronze™	
137956	55020-RB	Venetian Bronze®	
134025	55020-SS	Stainless*	

### Palm® Shower Arm-Mount Handshower

- 82" Long hose
- WaterSense® certified: 2.0 gpm @ 80 psi
- Pause feature
- Spray settings:
  - Full Body
  - Fast Massage
  - Full spray with massage



Part #	Mfg #	Finish	Price
189382	54488-PK	Chrome	
243499	54488-RB-PK	Venetian Bronze	
253146	54488-SS-PK	Stainless*	

\* Brilliance® Anti-Tarnish Lifetime Finishes

www.waterconcepts.net • Serving our Customers Since 1946 • www.plumbsupply.com



## Personal Showers & Accessories

### Ribbon Wall-Mount Handshower

- Single-setting H2Okinetic®
- 60" - 82" Stretchable hose
- Face rotates 360°
- Adjustable wall mount
- Maximum flow: 2.0 gpm @ 80 psi
- (-PK) Handshower only



Part #	Mfg #	Finish	Price
175118	55421	Chrome	
258506	55421-BL	Matte Black	
169731	55421-RB	Venetian Bronze®	
158686	55421-SS	Stainless*	
165991	59421-PK	Handshower ONLY, Chrome	
259485	59421-SS-PK	Handshower ONLY, Stainless*	

### Temp20 Shower-Mount Handshower

- LED digital temperature display powered by AAA batteries
- Soft, rubber spray holes
- Includes 60"-82" hose
- Spray settings:
  - Full body
  - Full spray with massage
  - Massaging
  - Shampoo rinsing
  - Shampoo rinsing with massage
  - Soft drench
- WaterSense® certified: 2.0 gpm @ 80 psi



Part #	Mfg #	Finish	Price
186896	54446-SS-PK	Stainless*	

### Temp20 Wall-Mount Handshower

- LED digital temperature display powered by AAA batteries
- Soft, rubber spray holes
- Includes 60"-82" hose
- Spray settings:
  - Full body
  - Full spray with massage
  - Massaging
  - Shampoo rinsing
  - Shampoo rinsing with massage
  - Soft drench
- WaterSense® certified: 2.0 gpm @ 80 psi



Part #	Mfg #	Finish	Price
190437	55446	Chrome	

### Handshowers (Continued)

#### Temp20 Wall-Mount Handshower

Part #	Mfg #	Finish	Price
234620	55446-SS	Stainless*	

#### Tesla Handshower

- 4-Setting H2Okinetic
- Touch-Clean spray holes
- Push-button spray selection
- 2.0 gpm @ 80 psi



Part #	Mfg #	Finish	Price
186786	59552-PK	Chrome	
182712	59552-SS-PK	Stainless*	

#### Tesla™ Wall-Mount Handshower

- 60" Metal hose
- 2.0 gpm @ 80 psi
- 4-Spray handshower
- Touch-Clean® nozzles
- H2Okinetic Technology® Handshower



Part #	Mfg #	Finish	Price
177024	55552	Chrome	
227990	55552-SS	Stainless*	

#### Traditional Adjustable Wall-Mount Handshower

- 5-Spray
- 60" to 82" Stretchable hose
- Moveable faceplate switches between spray patterns
- Maximum flow: 2.5 gpm @ 80 psi



Part #	Mfg #	Finish	Price
147254	59515	Chrome	
147184	59515-SS	Stainless*	
146300	59515-RB	Venetian Bronze®	
145373	59515-PB	Polished Brass*	

\* Brilliance® Anti-Tarnish Lifetime Finishes

[www.plumbsupply.com](http://www.plumbsupply.com) • Serving our Customers Since 1946 • [www.waterconcepts.net](http://www.waterconcepts.net)

## Personal Showers & Accessories

### Traditional Showerarm-Mount Handshower

- 5-Spray
- 60" to 82" Stretchable hose
- Moveable faceplate switches between spray patterns
- Maximum flow: 2.5 gpm @ 80 psi



Part #	Mfg #	Finish	Price
150927	59355-PK	Chrome	
147517	59355-RB-PK	Venetian Bronze®	
166674	59355-PB-PK	Polished Brass*	

### Traditional 5-Spray Handshower

- Less hose



Part #	Mfg #	Finish	Price
150676	59478-PK	Chrome	
147740	59478-RB-PK	Venetian Bronze®	
157447	59478-SS-PK	Stainless*	
157513	59478-PB-PK	Polished Brass *	

### Transitional Handshower

- 5-Setting H2Okinetic®
- Touch-Clean® spray holes
- Soft-touch handle
- Handshower ONLY
- WaterSense® certified product: 2.0 gpm @ 80 psi



Part #	Mfg #	Finish	Price
155333	59445-PK	Chrome	
159237	59445-CZ-PK	Champagne Bronze™	
157710	59445-RB-PK	Venetian Bronze®	
158017	59445-SS-PK	Stainless*	

### Transitional Shower-Mount Handshower

- Spray settings: pause, full body spray, full spray w/massage, H2Okinetic™ spray, massage spray
- Touch-Clean® spray holes
- Soft-Touch® handle
- Shower arm mount
- 60" to 82" Stretchable metal hose
- 28" Long wall bar w/ adjustable slide
- 2.0 gpm @ 80 psi



Part #	Mfg #	Finish	Price
157846	54445-PK	Chrome	
173185	54445-CZ-PK	Champagne Bronze™	
153956	54445-RB-PK	Venetian Bronze®	
154921	54445-SS-PK	Stainless*	

### Transitional Wall-Mount Handshower

- Spray settings: pause, full body spray, full spray w/massage, H2Okinetic™ spray, massage spray
- Touch-Clean® spray holes
- Soft-Touch® handle
- Adjustable wall-mount
- 60" to 82" Stretchable metal hose
- 2.0 gpm @ 80 psi



Part #	Mfg #	Finish	Price
174192	55445	Chrome	
154980	55445-CZ	Champagne Bronze™	
157238	55445-RB	Venetian Bronze®	
157887	55445-SS	Stainless*	

### Vero™ Wall-Mount Handshower

- Single-setting handshower
- 69" Long hose
- 2.5 gpm @ 80 psi



Part #	Mfg #	Finish	Price
139042	55530	Chrome	
135467	55530-SS	Stainless*	
150725	55530-RB	Venetian Bronze®	
143544	55530-CZ	Champagne Bronze™	

\* Brilliance® Anti-Tarnish Lifetime Finishes

www.waterconcepts.net • Serving our Customers Since 1946 • www.plumbsupply.com

## Personal Showers & Accessories

### Zura™ H20kinetic® 5-Setting Wall-Mount Handshower

- Single-setting handshower
- 1/2" IPS connection
- 1.75 gpm @ 80 psi



Part #	Mfg #	Finish	Price
233362	55140-BL	Matte Black	
259282	55140-CZ	Champagne Bronze	
251642	55140-PN	Polished Nickel*	
230133	55140-SS	Stainless*	

### Victorian® Roman Tub Deck Mount Handshower with Transfer Valve

- Handle not included
- Full body spray setting
- Includes trim and rough-in
- Double check valves for
- WaterSense® certified product: 2.0 gpm @ 80 psi



Requires handle kit: H512 or H516

Part #	Mfg #	Finish	Price
054243	RP33791LHP	Chrome	
054248	RP33791PBLHP	Polished Brass*	

### Fundamentals™ 4-Setting Shower Mount Handshower

- Touch-Clean® spray holes
- Spray settings:
  - Full body
  - Fast massage
  - Full spray with massage
  - Pause
- 2.5 gpm @ 80 psi



Part #	Mfg #	Finish	Price
148310	59202-PK	Chrome	
221170	59202-WH-PK	White	

### 3-Setting Shower Mount Handshower

- 69" Long hose
- 2.5 gpm @ 80 psi
- Full spray, massage spray & soft aerated spray patterns



54613

Part #	Mfg #	Finish	Price
099457	54613	Chrome	
172502	54613-CZ	Champagne Bronze™	
097286	54613-RB	Venetian Bronze®	
092346	54613-SS	Stainless*	
173715	RP48770CZ	Handshower Only, Champagne Bronze™	
152204	RP48770SS	Handshower Only, Stainless*	

### 3-Setting Wall-Mount Universal Handshower

- 60"-82" Long hose
- Touch-Clean® spray holes
- Spray settings:
  - Pause
  - H20Kinetic spray
  - Massaging spray
- WaterSense® certified: 1.75 gpm @ 80 psi



Part #	Mfg #	Finish	Price
244519	55799	Chrome	
244430	55799-BL	Matte Black	
243544	55799-SS	Stainless*	

### Premium Universal Shower Arm-Mount Handshower

- 60" Long hose
- Watersense® certified: 2.0 gpm @ 80 psi
- Touch-Clean® spray holes
- 5 Spray settings:
  - Full body
  - Fast massage
  - Full spray w/ massage
  - Shampoo
  - Rinsing-Soft drench



Part #	Mfg #	Finish	Price
190226	54436-PK	Chrome	
189808	54436-SS-PK	Stainless*	

\* Brilliance® Anti-Tarnish Lifetime Finishes

## Personal Showers & Accessories

### Premium Universal Wall-Mount Handshower

- 60" Long hose
- WaterSense® certified:  
2.0 gpm @ 80 psi
- Touch-Clean® spray holes
- 5 Spray settings:
  - Full body
  - Full spray with massage
  - Massaging
  - Shampoo rinsing
  - Pause



### Universal 5-Setting Handshower

- WaterSense® certified:  
2.0 gpm @ 80 psi
- H2Okinetic® technology
- Touch-Clean® spray holes
- Spray settings:
  - Full body spray
  - Full spray with massage
  - H2Okinetic® spray
  - Massaging spray



Part #	Mfg #	Finish	Price
222979	55436-PK	Chrome	

Part #	Mfg #	Finish	Price
242096	59140-PK	Chrome	
258224	59140-PN-PK	Polished Nickel*	
231949	59140-SS-PK	Stainless*	

### Premium Universal Handshower

- WaterSense® certified:  
2.0 gpm @ 80 psi
- Touch-Clean® spray holes
- Spray settings:
  - Full body
  - Full spray with massage
  - Massaging
  - Shampoo rinsing
  - Pause



### Universal Temp20® 6-Setting Handshower

- WaterSense® certified:  
2.0 gpm @ 80 psi
- Touch-Clean® spray holes
- Spray settings:
  - Full body
  - Full spray with massage
  - Massaging
  - Shampoo rinsing spray with massage
  - Drenching



Part #	Mfg #	Finish	Price
190168	59436-PK	Chrome	
190170	59436-SS-PK	Stainless*	

Part #	Mfg #	Finish	Price
214751	59446-SS-PK	Chrome	

### Universal 5-Setting High Velocity Handshower

- WaterSense® certified:  
1.75 gpm @ 80 psi
- Touch-Clean® spray holes
- 60"-82" Stretchable metal hose
- Spray settings:
  - Full body spray
  - Full spray with massage
  - High efficiency spray
  - Fast spray



### Premium Universal Shower Arm-Mount Handshower

- 7-spray/massaging hand shower
- Touch-Clean spray holes
- 60" Long Hose
- WaterSense® certified: 2.0 gpm @ 80 psi



Part #	Mfg #	Finish	Price
255953	54434-18-PK	Chrome	

Part #	Mfg #	Finish	Price
241047	59346-PB-PK	Polished Brass*	
189642	59346-PK	Chrome	
190398	59346-SS-PK	Stainless*	
236849	59346-RB-PK	Venetian Bronze®	

\* Brilliance® Anti-Tarnish Lifetime Finishes

## Personal Showers & Accessories

### Premium Universal Handshower

- 7-spray/massaging hand shower
- Touch-Clean® spray holes
- WaterSense® certified: 2.0 gpm @ 80 psi



Part #	Mfg #	Finish	Price
222582	59426-PK	Chrome	
229504	59426-PB-PK	Polished Brass	
190500	59426-RB-PK	Venetian Bronze®	
222697	59426-SS-PK	Stainless*	

### Trinsic® Roman Tub Handshower

- TouchClean®
- WaterSense® certified: 1.75 gpm @ 80 psi



Part #	Mfg #	Finish	Price
249224	RP73384	Chrome	

### 7-Setting Adjustable Wall-Mount Handshower

- 7-spray/massaging hand shower
- Touch-Clean® spray holes
- 60-82" Stretchable hose
- WaterSense® certified: 2.0 gpm @ 80 psi



Part #	Mfg #	Finish	Price
229895	59716	Chrome	
222656	59716-RB	Venetian Bronze®	
190416	59716-SS	Stainless*	

### Handshowers with Slidebar

#### ActivTouch Slidebar Handshower

- Touch-Clean® spray holes
- 24" Long wall bar with adjustable slide
- 60-82" Metal hose
- 9-Setting Handshower
- 2.0 gpm @ 80 psi



Part #	Mfg #	Finish	Price
244636	51549	Chrome	
237309	51549-RB	Venetian Bronze®	
229766	51549-SS	Stainless*	

#### Addison® Slidebar Handshower

- 69" Long hose
- 24" Long wall bar with adjustable slide
- 2.0 gpm @ 80 psi
- All metal construction
- Single-setting handshower: full body spray



Part #	Mfg #	Finish	Price
127101	59210	Chrome	
137610	59210-CZ	Champagne Bronze™	
125983	59210-RB	Venetian Bronze®	
134062	59210-SS	Stainless*	

#### Ara™ Slidebar Handshower

- Single setting H2Okinetic®
- Self-cleaning spray holes
- 60"-82" Stretchable metal hose
- 28" Slidebar
- 2.0 gpm @ 80 psi



Part #	Mfg #	Finish	Price
167399	51567	Chrome	
164922	51567-SS	Stainless*	

\* Brilliance® Anti-Tarnish Lifetime Finishes

[www.plumbsupply.com](http://www.plumbsupply.com) • Serving our Customers Since 1946 • [www.waterconcepts.net](http://www.waterconcepts.net)



## Personal Showers & Accessories

### Cassidy™ Slidebar Handshower

- Self-cleaning H2Okinetic spray
- 60"-82" Stretchable metal hose
- 3-Setting handshower:
  - Pause
  - H2Okinetic spray
  - Massage spray
- WaterSense® certified product: 2.0 gpm @ 80 psi



Part #	Mfg #	Finish	Price
153944	51308	Chrome	
159236	51308-CZ	Champagne Bronze™	
161955	51308-PN	Polished Nickel*	
155287	51308-RB	Venetian Bronze®	
155689	51308-SS	Stainless*	

### Classic Palm® Grab Bar Handshower

- Touch-clean spray holes
- Push-button spray selection
- 24" Wall grab bar w/ ADA adjustable slide
- 4-Setting handshower
- 2.5 gpm @ 80 psi



Part #	Mfg #	Finish	Price
154395	52008-DS	Chrome	

### Classic Slidebar 5-Spray Handshower

- (5) Spray patterns
- Wall bar w/ adjustable slide
- 70" Ultra Flex hose (51599)
- 60"-82" metal stretchable hose w/ vacuum breaker (51599-DS)
- Maximum flow: 2.0 gpm @ 80 psi



Part #	Mfg #	Finish	Price
227962	51599	Chrome	
097754	51599-DS	Chrome	
228185	51599-SSDS	Stainless*	

### Classic 7-Setting Glide Rail Handshower

- (7) Spray settings
- 24" Wall bar w/ adjustable slide
- 60"-82" Stretchable metal hose
- 2.0 gpm @ 80 psi



Part #	Mfg #	Finish	Price
149509	51751	Chrome	

### Classic Slidebar 2-Setting Handshower

- Dual check valve for backflow protection
- Maximum flow: 2.5 gpm @ 80 psi



Part #	Mfg #	Finish	Price
001159	51501-WH	24" Slidebar, White	
166856	51502-WH	30" Slidebar, White	

### Classic Wall-Bar 7-Spray Handshower

- (7) Spray patterns - not a positive shut-off
- Wall bar with adjustable slide
- 2.5 gpm @ 80 psi
- 60" - 82" Stretchable metal hose



51704

Part #	Mfg #	Finish	Price
032711	51701	24" Bar, Chrome	

\* Brilliance® Anti-Tarnish Lifetime Finishes



## Personal Showers & Accessories

### Classic Slidebar 7-Spray Handshower

- 2.5 gpm @ 80 psi
- 7-Setting handshower
  - Pause
  - Full body spray
  - Full spray w/ massage
  - Fast massage
  - Shampoo rinsing spray
  - Soft drench spray
  - Soft drench spray w/ massage



Part #	Mfg #	Finish	Price
151879	51708	Chrome	
223062	51708-PB	Polished Nickel*	
148637	51708-SS	Stainless*	
151401	51708-RB	Venetian Bronze	

### Universal Adjustable Grab Bar Handshower

- ADA Slide mechanism
- White push button handshower
- 60" - 82" Stretchable metal hose—(DS models)
- 70" UltraFlex hose—(UF models)
- 24" Grab bar slide (52001, 52002)
- 36" Grab bar slide (52003)



52001-DS      52002-DS

Part #	Mfg #	Finish	Price
037861	52001-DS	White/Stainless	
243994	52001-UF	Stainless*	
037858	52002-DS	White	
037862	52003-DS	White/Stainless	

### Fundamentals™ Single-Function Slidebar Handshower

- 69" Long flexible hose with brass connections
- 24" Wall bar
- 2.0 gpm @ 80 psi
- Full body spray



Part #	Mfg #	Finish	Price
136905	57011	Chrome	

### Traditional Slidebar Handshower

- 82" hose
- Supports up to 500 lbs of force
- Grab/slide bar diameter 1-1/4"
- ActivTouch
- Spray settings:
  - Full body
  - Fast massage
  - Full spray with massage
  - Shampoo rinsing
  - Shampoo rinsing with massage
  - Soft drench
  - Soft drench with massage
  - Soft full
- WaterSense® certified: 2.0 gpm



Part #	Mfg #	Finish	Price
181016	51900	Chrome	
186618	51900-RB	Venetian Bronze®	
181017	51900-SS	Stainless*	

### Premium Transitional Slidebar Handshower

- 69" Long flexible hose with brass connections
- Full spray, massage spray, and aerated soft spray
- 24" Wall bar
- 2.5 gpm @ 80 psi



Part #	Mfg #	Finish	Price
135121	57014	Chrome	
147900	57014-CZ	Champagne Bronze™	
134897	57014-RB	Venetian Bronze®	
135193	57014-SS	Stainless*	

### Premium Traditional Slidebar Handshower

- 69" Long flexible hose with brass connections
- Full spray, massage spray, and aerated soft spray
- 24" Wall bar
- 2.5 gpm @ 80 psi



Part #	Mfg #	Finish	Price
137069	57021	Chrome	
146422	57021-CZ	Champagne Bronze™	
144570	57021-PB	Polished Brass*	

\* Brilliance® Anti-Tarnish Lifetime Finishes

[www.plumbsupply.com](http://www.plumbsupply.com) • Serving our Customers Since 1946 • [www.waterconcepts.net](http://www.waterconcepts.net)

## Personal Showers & Accessories

### Handshowers with Slidebar (Continued)

#### Premium Traditional Slidebar Handshower

Part #	Mfg #	Finish	Price
135419	57021-RB	Venetian Bronze®	
135030	57021-SS	Stainless*	

#### Dryden™ Slidebar Single-Function Handshower

- 69" Long flexible hose with brass connections
- 24" Wall bar with adjustable slide; not to be used as a grab bar; not ADA compliant
- 2.0 gpm @ 80 psi
- Certified dual check valves



Part #	Mfg #	Finish	Price
137741	57051	Chrome	
154747	57051-CZ	Champagne Bronze™	
175032	57051-PN	Polished Nickel*	
137126	57051-RB	Venetian Bronze®	
136972	57051-SS	Stainless*	

#### Glide Rail Handshower

- Full body spray
- 70" Hose
- 24" Slidebar
- 2.5 gpm @ 80 psi



Part #	Mfg #	Finish	Price
001166	51551-WH	White	
149850	51551-WHB	White/Chrome	

#### H2Okinetic® 3-Setting Slidebar Handshower

- Touch-Clean® spray holes
- Spray settings include
  - H2Okinetic spray
  - Full body spray
  - Full spray with massage
  - Massaging spray
  - Pause
- 60"-82" stretchable hose
- 24" wall bar with adjustable slide
- WaterSense® certified: 1.75 gpm @ 80 psi



Part #	Mfg #	Finish	Price
240289	51799	Chrome	
243017	51799-BL	Matte Black	
241006	51799-SS	Stainless*	

#### Rizu™ Slidebar Single-Function Handshower

- 69" Long hose
- 24" Long wall bar with adjustable slide
- 2.5 gpm @ 80 psi
- Full body spray



Part #	Mfg #	Finish	Price
136767	57085	Chrome	
186835	57085-CZ	Champagne Bronze™	
135080	57085-SS	Stainless*	
161069	57085-RB	Venetian Bronze®	

#### Universal Temp2O® Handshower w/ Wall Bar

- (6) Setting handshower
- LED color changing digital temperature display
- Touch-Clean™ spray holes
- 60"-82" Stretchable metal hose
- Push-button spray selection
- 24" Slidebar
- 2.0 gpm @ 80 psi



Part #	Mfg #	Finish	Price
182004	51406	Chrome	
171540	51406-RB	Venetian Bronze®	
188073	51406-SS	Stainless*	

\* Brilliance® Anti-Tarnish Lifetime Finishes

## Personal Showers & Accessories

### Tesla™ Handshower w/ Slidebar

- (4) Setting handshower
- H2Okinetic Technology®
- Touch-Clean® nozzles
- 24" Wall bar
- 60" Metal hose
- 2.0 gpm @ 80 psi



Part #	Mfg #	Finish	Price
185041	51552	Chrome	
182339	51552-PN	Polished Nickel*	
180598	51552-SS	Stainless*	

### Palm® Handshower with Contemporary Slidebar/Grab Bar

- Spray settings:
  - Full body
  - Fast massage
  - Full spray with massage
- 82" Hose
- 1-1/4" Slidebar diameter
- Supports up to 500 lbs
- 2.0 gpm @ 80 psi



Part #	Mfg #	Finish	Price
189822	51400	Chrome	
186152	51400-SS	Stainless*	

### Premium Traditional Slidebar 5-Spray Handshower

- Spray settings: full spray, fast massage, full spray with massage, aerated spray, and trickle
- Rub clean nozzle
- Double-check valve for back-flow protection
- 60" to 82" Stretchable stainless steel hose
- 29" Long wall bar with adjustable mount
- 2.5 gpm @ 80 psi



Part #	Mfg #	Finish	Price
160756	51508	Chrome	
147262	51508-SS	Stainless*	
147368	51508-RB	Venetian Bronze®	
168995	51508-PB	Polished Brass *	

### Universal 5-Setting Slidebar Handshower

- Touch-Clean® spray holes
- 82" Hose
- 24" Slidebar
- 5-Setting handshower
  - Pause
  - H2Okinetic® spray
  - Massaging spray
  - Full body spray
  - Full spray with massage
- WaterSense® certified product: 2.0 gpm @ 80 psi



Part #	Mfg #	Finish	Price
231275	51559	Chrome	
153210	51559-RB	Venetian Bronze®	
232467	51559-SS	Stainless*	

### Universal 7-Setting Slide Bar Handshower

- Touch-Clean® spray holes
- Includes 82" hose
- Spray settings:
  - Full body spray
  - Fast massage spray
  - Full spray with massage
  - Shampoo rinsing spray
  - Drenching spray
  - Soft drench with full spray
  - Pause feature
- WaterSense® certified: 2.0 gpm @ 80 psi



Part #	Mfg #	Finish	Price
239461	51589	Chrome	
243341	51589-RB	Venetian Bronze	
241929	51589-SS	Stainless*	

### Vero™ Slidebar Handshower

- 69" Long hose
- 26-15/16" Long wall bar with adjustable slide
- 2.5 gpm @ 80 psi



Part #	Mfg #	Finish	Price
137235	57530	Chrome	
173122	57530-CZ	Champagne Bronze™	
146667	57530-RB	Venetian Bronze®	
135446	57530-SS	Stainless*	

\* Brilliance® Anti-Tarnish Lifetime Finishes

[www.plumbsupply.com](http://www.plumbsupply.com) • Serving our Customers Since 1946 • [www.waterconcepts.net](http://www.waterconcepts.net)

## Personal Showers & Accessories

### Zura H20kinetic® Slidebar Handshower

- 60"-82" Stretchable metal hose
- 24" Adjustable wall bar
- Dual check valves for backflow protection
- WaterSense® certified: 1.75 gpm



Part #	Mfg #	Finish	Price
232654	51140	Chrome	
235033	51140-BL	Matte Black	
230701	51140-SS	Stainless*	

### Handshower Components

#### End Cap, Screw, and Top Elbow



Part #	Mfg #	Finish	Price
248671	RP72432SS	Stainless*	

#### Handshower Wall Supply Elbow

- 1/2" IPS Female inlet
- 1/2" IPS Male outlet



Part #	Mfg #	Finish	Price
089463	50560	Chrome	
235180	50560-BL	Matte Black	
137609	50560-CZ	Champagne Bronze™	
089465	50560-PB	Polished Brass*	
089466	50560-PN	Polished Nickel*	
089468	50560-RB	Venetian Bronze®	
089470	50560-SS	Stainless*	

### Brass Handshower Wall Supply Elbow

- Replaces standard showerarm
- Brass construction



Part #	Mfg #	Finish	Price
061578	U4980-PK	Chrome	
146299	U4980-RB-PK	Venetian Bronze®	
147748	U4980-SS-PK	Stainless*	

### Square Wall Supply Elbow

- 1/2" IPS Female inlet
- 1/2" IPS Male outlet



Part #	Mfg #	Finish	Price
151583	50570	Chrome	
233361	50570-BL	Matte Black	
159238	50570-CZ	Champagne Bronze™	
175033	50570-PN	Polished Nickel*	
151554	50570-RB	Venetian Bronze®	
150717	50570-SS	Stainless*	

### Contemporary Mounting Bracket



Part #	Mfg #	Finish	Price
248674	RP64240SS	Stainless*	

### Handshower Showerarm Diverter

- Use to divert water between showerhead and hand shower
- 1/2" IPS Female inlet
- 1/2" IPS Male outlet
- Brass construction



Part #	Mfg #	Finish	Price
089471	50650	Chrome	
143548	50650-CZ	Champagne Bronze™	
089473	50650-PB	Polished Brass*	

\* Brilliance® Anti-Tarnish Lifetime Finishes

[www.waterconcepts.net](http://www.waterconcepts.net) • Serving our Customers Since 1946 • [www.plumbsupply.com](http://www.plumbsupply.com)

## Personal Showers & Accessories

### Handshower Components (Continued)

#### Handshower Showerarm Diverter

Part #	Mfg #	Finish	Price
089476	50650-RB	Venetian Bronze®	
089477	50650-SS	Stainless*	

#### Universal Handshower 3-Way Showerarm Diverter

- Brass construction
- ADA Flip lever control
- 1/2" IPS Female inlet
- 1/2" IPS Male outlet



Part #	Mfg #	Finish	Price
118482	U4929-PK	Chrome	
145374	U4929-PB-PK	Polished Brass*	
147527	U4929-RB-PK	Venetian Bronze®	
120931	U4929-SS-PK	Stainless*	

#### 3-Way Showerarm Diverter with Handshower Mount

- Brass construction
- ADA Flip lever control
- 1/2" IPS Female inlet
- 1/2" IPS Male outlet



Part #	Mfg #	Finish	Price
147746	U4920-PK	Chrome	
166596	U4920-CZ-PK	Champagne Bronze™	
173120	U4920-PN-PK	Polished Nickel*	
160909	U4920-SS-PK	Stainless Steel	
147530	U4920-RB-PK	Venetian Bronze®	

#### Handshower 3-Way Showerarm Diverter

- Brass construction
- (1) Inlet and (2) outlets



Part #	Mfg #	Finish	Price
001228	U4923-PK	Chrome	
117672	U4923SSPK	Stainless*	
090755	U4923RBPk	Venetian Bronze®	
025325	U4923PBPK	Polished Brass *	

#### Handshower Showerarm Diverter

- Brass construction



Part #	Mfg #	Finish	Price
001226	U4922-PK	Chrome	

#### Handshower Universal Adjustable Showerarm Mount

- 1/2" IPS Female inlet
- 1/2" IPS Male outlet



Part #	Mfg #	Finish	Price
039553	U3401-PK	Chrome	
168036	U3401-PB-PK	Polished Brass*	
131271	U3401-RB-PK	Venetian Bronze®	
147747	U3401-SS-PK	Stainless*	
194915	U3401-WH-PK	White	

#### Handshower Wall Supply Elbow/Mount

- Replaces standard shower arm
- 1/2" IPS female inlet
- 1/2" IPS male outlet



Part #	Mfg #	Finish	Price
120567	U4985-PK	Chrome	
162712	U4985-RB-PK	Venetian Bronze®	
149600	U4985-SS-PK	Stainless*	

#### Handshower Showerarm Wall-Mount



U3001-PK



RP61294S



U4005-SS

Part #	Mfg #	Finish	Price
041386	U3001-PK	Chrome	
237695	U3001-PB-PK	Polished Brass*	
043138	U3001-WH-PK	White	
147745	U4005-PK	Chrome	
170373	U4005-CZ-PK	Champagne Bronze™	
155307	U4005-PB-PK	Polished Brass*	
117673	U4005-RB-PK	Venetian Bronze®	

\* Brilliance® Anti-Tarnish Lifetime Finishes



## Personal Showers & Accessories

### Handshower Components (Continued)

#### Handshower Showerarm Wall-Mount

Part #	Mfg #	Finish	Price
117674	U4005-SS-PK	Stainless*	
141199	RP61294	Chrome	
136458	RP61294-SS	Stainless	
141476	RP61294-RB	Venetian Bronze®	
150132	RP61294-CZ	Champagne Bronze™	

#### Square Wall Mount Bracket

- Adjustable wall mount
- Concealed installation screws



Part #	Mfg #	Finish	Price
168704	U4010-PK	Handshower Mount, Chrome	
246494	U4010-BL-PK	Handshower Mount, Matte Black	
189850	U4010-RB-PK	Handshower Mount, Venetian Bronze®	
162696	U4010-SS-PK	Handshower Mount, Stainless	

#### Handshower Pin-Mount Swivel Connector



Part #	Mfg #	Finish	Price
001175	U4002-PK	Chrome, Plastic Connector	
001176	U4002-WH-PK	Chrome/White	
001251	U5002-PK	Chrome, Metal Connector	
149179	U5002-PB-PK	Polished Brass*	

#### Universal Volume Control

- Volume control with trickle feature
- Brass construction
- 1/2" IPS female inlet
- 1/2" IPS male outlet



Part #	Mfg #	Finish	Price
001211	U4760-PK	Chrome	

### Handshower Components (Continued)

#### Universal Volume Control

Part #	Mfg #	Finish	Price
156135	U4760-PB-PK	Polished Brass*	
173767	U4760-RB-PK	Venetian Bronze®	
095041	U4760-SS-PK	Stainless*	

#### Shower Arm Pin Mount



Part #	Mfg #	Finish	Price
001190	U4301-PK	Chrome	

#### Handshower Pin Wall-Mount

- For use with pin-mount swivel connectors



U5001-PK

Part #	Mfg #	Finish	Price
001249	U5001-PK	Clear Pin, Chrome Back	
001247	U5001-A-PK	Chrome Pin and Back	

#### Universal All Brass Pin Wall-Mount



Part #	Mfg #	Finish	Price
026410	U9501-PK	Chrome	
229502	U9501-PB-PK	Polished Brass*	

#### Adapter for Handshower to Hose

- Quick connect
- 1/2" IPS female inlet
- 1/2" IPS male outlet



Part #	Mfg #	Finish	Price
157779	U7500	Chrome	

\* Brilliance® Anti-Tarnish Lifetime Finishes



## Personal Showers & Accessories

### UltraFlex® Handshower Hose

- UltraFlex® hose and gaskets



Part #	Mfg #	Finish	Price
168959	RP64157	Chrome	
258223	RP64157PN	Polished Nickel*	
161692	RP64157RB	Venetian Bronze®	
144825	RP64157SS	Stainless*	

### UltraFlex® Ribbon Hose



Part #	Mfg #	Finish	Price
001222	U490R-60-PK	60" Black/Chrome	
001224	U490R-70-PK	70" Black/Chrome	
001225	U490R-84-PK	84" Black/Chrome	

### Handshower Stretchable Metal Hose

- (1) Conical and (1) hex all-brass nut
- 60" - 82" Length



Part #	Mfg #	Finish	Price
022707	U495D-60-PK	Chrome	
165863	U495D-CZ60-PK	Champagne Bronze	
148873	U495D-PB60-PK	Polished Brass*	
172180	U495D-PN60-PK	Polished Nickel*	
117671	U495D-RB60-PK	Venetian Bronze	
048383	U495D-SS60-PK	Stainless	

### Handshower Stainless Steel Hose

- (1) Conical and (1) hex all-brass nut



Part #	Mfg #	Finish	Price
001240	U495S-60PK	60", Chrome	
001241	U495S-69PK	69", Chrome	

### Hose - Handshower for R4700



Part #	Mfg #	Finish	Price
178457	RP40664RB	Venetian Bronze®	
118049	RP40664	Chrome	

### UltraFlex® Ribbon Hand Shower Hose

- Two chrome metal conical hose notes



Part #	Mfg #	Finish	Price
001234	U494R-60-PK	White/Chrome	
019829	U494R-84-PK	White/Chrome	

### Handshower Vacuum Breaker

- Atmospheric with Brass Shield
- 1/2" IPS female inlet
- 1/2" IPS male outlet



Part #	Mfg #	Finish	Price
001218	U4900-PK	Chrome	
164861	U4900-RB-PK	Venetian Bronze®	
164847	U4900-SS-PK	Stainless*	

### Emerge™ Angular Shower Column Assembly

- 3-Way diverter
- 15" Overhead shower arm
- 60"-82" Metal hose
- Integrated hose supply
- Showerhead and handshower sold separately
- 26" Option for tub/shower application
- 18" Option for shower application



Part #	Mfg #	Finish	Price
252741	58410	18", Chrome	
251935	58410-SS	18", Stainless*	
259726	58420	26", Chrome	
256205	58420-SS	26", Stainless*	

### Emerge™ Contemporary Shower Column Assembly

- 3-Way diverter
- 15" Overhead shower arm
- 60"-82" Metal hose
- Integrated hose supply
- Showerhead and handshower sold separately



Part #	Mfg #	Finish	Price
253322	58810	18", Chrome	
251111	58810-SS	18", Stainless*	

\* Brilliance® Anti-Tarnish Lifetime Finishes

[www.plumbsupply.com](http://www.plumbsupply.com) • Serving our Customers Since 1946 • [www.waterconcepts.net](http://www.waterconcepts.net)

## Personal Showers & Accessories

### Handshower Components (Continued)

#### Emerge™ Contemporary Shower Column Assembly

Part #	Mfg #	Finish	Price
253445	58820	26", Chrome	
253105	58820-SS	26", Stainless	

#### Universal Adjustable ADA Grab Bar Assembly

- 60" - 82" Stretchable metal hose
- 24" Decorative 1-1/4" wall grab bar
- ADA Slide mechanism
- Lifetime faucet and finish warranty



Part #	Mfg #	Finish	Price
106572	56302	Chrome	
162219	56302-PB	Polished Brass*	
147241	56302-RB	Venetian Bronze®	
121009	56302-SS	Stainless	

#### Universal Adjustable Slide Bar/Grab Bar Assembly

- 60"-82" Stretchable metal hose
- 24" Contemporary slide/grab bar (51600)
- 24" Angular modern slide/grab bar (51500)
- Hand shower sold separately
- Includes round wall elbow



Part #	Mfg #	Finish	Price
236526	51500	Chrome	
245362	51500-SS	Stainless*	
240694	51600	Chrome	
257663	51600-RB	Venetian Bronze®	
241696	51600-SS	Stainless*	

### Adjustable Pin-Mount Wall Bar



Part #	Mfg #	Finish	Price
001172	55024	24" Chrome	

### Adjustable Wall Bar

- 29" Long adjustable
- Concealed screws



Part #	Mfg #	Finish	Price
084676	55083	Chrome	
149112	55083-RB	Venetian Bronze®	
164464	55083-SS	Stainless*	

### Universal Adjustable Wall Bar

- Pivot slide mechanism
- Rotatable hand shower mount



Part #	Mfg #	Finish	Price
245294	55044-PK	24" Chrome	
248044	55044-RB-PK	24" Venetian Bronze	
248401	55044-SS-PK	24" Stainless	

\* Brilliance® Anti-Tarnish Lifetime Finishes

www.waterconcepts.net • Serving our Customers Since 1946 • www.plumbsupply.com

## Personal Showers & Accessories

### Grab Bar Wall Anchor



Part #	Mfg #	Finish	Price
150480	RP72402	Wall Anchor	

### Universal Grab Bar Hand Shower Mount

- Multiple mounting options
- Rotatable hand shower mount
- Accommodates conical hose nuts
- Fits 1-1/2" & 1-1/4" round grab bars or Angular Modern grab bar / slide bar



Part #	Mfg #	Finish	Price
240887	U6500	Chrome	

### ADA Grab Bar Handshower Mount

- Fits 1-1/2" to 1-1/4" grab bars
- Rotatable hand shower mount



Part #	Mfg #	Finish	Price
148470	U6300-WH	White	
151564	U6300	Black	
190499	U6400-RB	Venetian Bronze®	
185523	U6400-SS	Stainless*	

### Slide Mechanism Contemporary



Part #	Mfg #	Finish	Price
170304	RP64239	Chrome	
248672	RP64239SS	Stainless*	

### Bar Slide

BAS-3BX



Part #	Mfg #	Finish	Price
041665	BAS-3BX	Chrome/Clear Knob	
001149	BAS-4BX	Chrome/Clear Lever	

\* Brilliance® Anti-Tarnish Lifetime Finishes

## Handheld Showers

### Handheld Showers

#### Attract™ with Magnetix™ Handheld Shower

- 6-Function handshower
- 1/2" IPS connection
- Magnetix™ docking system
- 5-1/2" Diameter spray head
- 60" Double interlock spiral metal hose
- Flow rate: 1.75 gpm



Part #	Mfg #	Finish	Price
253560	26603	Chrome	

#### Eco-Performance Handheld Shower

- Double check valve included
- 1-1/8" Diameter spray head
- Single-Function
- Flow rate: 1.75 gpm



Part #	Mfg #	Finish	Price
225334	155891	Chrome	

#### Eco-Performance Handheld Shower



Part #	Mfg #	Finish	Price
249631	176015BN	Chrome	

### Eco-Performance Multi-Function Handshower

- 5-Function
  - Rinse
  - Downpour
  - Massage
  - Full spray
  - Relaxing massage
- Double check valve included
- 4-3/8" Diameter spray head
- Flow rate: 1.75 gpm



Part #	Mfg #	Finish	Price
247424	189315ORB	Oil Rubbed Bronze	

### Fina Eco-Performance Handshower

- Single-function
- Adjustable wall bracket
- 1-1/8" Diameter spray head
- Double check valve included
- 69" Double interlock spiral metal hose
- WaterSense® certified: 2.0 @ 80 psi



Part #	Mfg #	Finish	Price
177264	S11705EP	Chrome	

### Twist Handheld Shower

- 4-Function:
  - Full spray
  - Invigorating spray
  - Targeted massage
  - Combination
- 3-3/4" Diameter spray head
- Flow rate: 2.0 gpm



Part #	Mfg #	Finish	Price
155021	160042	Chrome	
152716	160042BN	Brushed Nickel	

### Weymouth® Eco-Performance Handshower

- Single function:
  - Full spray
- 3-3/8" Diameter spray head
- Double check valve included
- Flow rate: 2.0 transitioning to 1.75 gpm



Part #	Mfg #	Finish	Price
247960	154305	Chrome	

\*Lifeshine® Anti-Tarnish Lifetime Finish

www.waterconcepts.net • Serving our Customers Since 1946 • www.plumbsupply.com

## Handheld Showers

### 164927 Handshower

- 4-Function  
-combination;  
-full spray  
-invigorating spray  
-targeted massage
- 4-3/8" Diameter spray head
- Flow rate: 2.0 gpm



Part #	Mfg #	Finish	Price
165107	164927	Chrome	
162434	164927BN	Brushed Nickel	
177361	164927ORB	Oil Rubbed Bronze	

### 164928 Handshower

- 4-Function  
-combination  
-full spray  
-invigorating spray  
-targeted massage
- 4-3/64" Diameter spray head
- Flow rate: 2.0 gpm



Part #	Mfg #	Finish	Price
214885	164928	Chrome	
216521	164928BN	Brushed Nickel	

### Magnetix Eco-Performance Handshower

- 6-Spray functions:
  - Rinse
  - Massage
  - Downpour
  - Invigorating spray
  - Relaxing massage
  - Soothing massage
- 5-1/2" Diameter
- 59" Hose
- Flow rate: 1.75 gpm



Part #	Mfg #	Finish	Price
249063	3662EP	Chrome	
247112	3662EPBN	Brushed Nickel	
245059	3662EPORB	Oil Rubbed Bronze	

### Handshower w/ Wall-Mount Bracket

- 4-Function  
-Combination  
-Full spray  
-Invigorating spray  
-Targeted massage
- 4-3/8" Diameter
- 69" Hose
- Flow rate: 2.0 gpm



Drop elbow sold separately

Part #	Mfg #	Finish	Price
213870	3636EP	Chrome	
167392	3636EPBN	Brushed Nickel	
177838	3636EPORB	Oil Rubbed Bronze	

### Eco Handshower w/ Wall-Mount Bracket

- Single function
- 4" Spray face diameter
- 59" Spiral metal hose (chrome)  
69" Spiral metal hose (BN, ORB)
- Double check valve in handle
- Adjustable wall bracket
- Flow rate: 2.0 gpm or EP 2.0 gpm



Drop Elbow sold separately

Part #	Mfg #	Finish	Price
187074	3865EP	Chrome, 2.0 gpm	
218688	3865EPBN	Brushed Nickel, 2.0 gpm	

\*Lifeshine® Anti-Tarnish Lifetime Finish

[www.plumbsupply.com](http://www.plumbsupply.com) • Serving our Customers Since 1946 • [www.waterconcepts.net](http://www.waterconcepts.net)

## Handheld Showers

### Eco-Performance Handshower

- 5-function:
  - Rinse
  - Massage
  - Downpour
  - Full spray
  - Relaxing massage
- 4-3/8" Spray head
- Vacuum breaker
- 69" Double interlock spiral hose
- 30" Slide bar with push button
- Drop ell sold separately
- Double check valve included
- WaterSense certified" 1.75 gpm



Part #	Mfg #	Finish	Price
247102	3558EP	Chrome	

### Multi-Function Handshower w/ Slidebar

- 4-Function
  - Full spray
  - Invigorating spray
  - Targeted spray
  - Combination
- 4-3/8" Diameter spray head
- 30" Slidebar
- 69" Hose
- Flow rate: 2.0 gpm



Drop Elbow sold separately

Part #	Mfg #	Finish	Price
174190	3667EP	Chrome	
168137	3667EPBN	Brushed Nickel	
163213	3667EPORB	Oil Rubbed Bronze	

### 90° Handshower w/ Slidebar

- Single-Function
- 3-1/8" Diameter spray head
- 30" Slidebar
- 69" Double interlock spiral metal hose
- Flow rate: 2.0



Part #	Mfg #	Finish	Price
144532	S3879EP	Chrome	
143956	S3879EPBN	Brushed Nickel	

### Single-Function Handshower w/ Slidebar

- Full spray
- 4-1/4" Diameter spray head
- 24" Slide bar
- 59" Hose
- Flow rate: 2.0 gpm



Drop Elbow sold separately

Part #	Mfg #	Finish	Price
188038	3668EP	Chrome	
211749	3668EPBN	Brushed Nickel	
164767	3668EPORB	Oil Rubbed Bronze	

### Single-Function Handshower w/ Slidebar Contemporary

- Full spray
- 1-1/8" Diameter spray head
- 30" Slidebar
- 69" Hose
- Flow rate: 2.0 gpm



Drop Elbow sold separately

Part #	Mfg #	Finish	Price
175134	3887EP	Chrome	
178442	3887EPBN	Brushed Nickel	

### Multi-Function Handshower w/Slidebar

- 4-Function
  - Full spray
  - Invigorating spray
  - Targeted spray
  - Combination
- 4" Diameter spray head
- 30" Slidebar
- 69" Hose
- Flow rate: 2.0 gpm



Drop Elbow sold separately

Part #	Mfg #	Finish	Price
186316	3669EP	Chrome	

\*Lifeshine® Anti-Tarnish Lifetime Finish



## Handheld Showers

### Handheld Showers (Continued)

#### Multi-Function Handshower w/Slidebar

Part #	Mfg #	Finish	Price
213131	3669EPBN	Brushed Nickel	
171004	3669EPORB	Oil Rubbed Bronze	

#### Single-Function Handshower w/Slidebar

- Full spray
- 4" Diameter spray head
- 24" Slide bar
- 59" Hose
- Flow rate: 2.0 gpm



Drop Elbow sold separately

Part #	Mfg #	Finish	Price
155978	3868EP	Chrome	
180462	3868EPBN	Brushed Nickel	
208223	3868EPORB	Oil Rubbed Bronze	

#### Single Function Handshower w/ Slidebar

- 69" Double interlock metal hose
- Double check valve in handshower
- 30" Slidebar
- Flow rate: 2.5 gpm or EP 1.75 gpm



Drop Elbow sold separately

Part #	Mfg #	Finish	Price
196262	3869EP	Chrome, 1.75 gpm	
187625	3869EPBN	Brushed Nickel, 1.75 GPM	
235663	3869EPWR	Wrought Iron, 1.75 GPM	

#### Twist Handshower w/Slidebar

- 4-Function  
-Drench  
-Immerse  
-Shine  
-Smooth
- 30" Slide bar
- 69" Hose
- Flow rate: 2.0 gpm



Drop Elbow sold separately

Part #	Mfg #	Finish	Price
167320	S3870EP	Chrome	
176387	S3870EPBN	Brushed Nickel	
151016	S3870EPORB	Oil Rubbed Bronze	

#### Weymouth Handshower w/ Slidebar

- Full spray
- 3" Diameter spray head
- 30" Slidebar
- 69" Hose
- Flow rate: 2.0 gpm



Drop Elbow sold separately

Part #	Mfg #	Finish	Price
212955	S12107EP	Chrome	
215022	S12107EPBN	Brushed Nickel	
183893	S12107EPNL	Polished Nickel	
176304	S12107EPOR	Oil Rubbed Bronze	

### Handshower Accessories

#### Handshower Bracket



Part #	Mfg #	Finish	Price
171940	155694	Chrome	
151186	155694BN	Brushed Nickel	
208234	155694ORB	Oil Rubbed Bronze	

\*Lifeshine® Anti-Tarnish Lifetime Finish

[www.plumbsupply.com](http://www.plumbsupply.com) • Serving our Customers Since 1946 • [www.waterconcepts.net](http://www.waterconcepts.net)

## Handheld Showers

### Handshower Bracket



Part #	Mfg #	Finish	Price
186317	114348	Chrome	

### Handshower Bracket/Drop Elbow

- 1/2" IPS connections



Part #	Mfg #	Finish	Price
223633	A755BN	Brushed Nickel	

### Showerarm Cradle for Handshower

- 1/2" IPS connections



Part #	Mfg #	Finish	Price
172225	A701BN	Brushed Nickel	
210488	A701	Chrome	
210171	A701ORB	Oil Rubbed Bronze	

### Drop Elbow

- 1/2" IPS



Part #	Mfg #	Finish	Price
023038	A725	Chrome	
091745	A725BN	Brushed Nickel	
049466	A725NL	Polished Nickel	
081084	A725ORB	Oil Rubbed Bronze	
042166	A725P	Polished Brass	
235664	A725WR	Wrought Iron	

### Drop Elbow

- 1/2" IPS



Part #	Mfg #	Finish	Price
167327	A721	Chrome	

### Handshower Accessories (Continued)

#### Drop Elbow

Part #	Mfg #	Finish	Price
174375	A721BN	Brushed Nickel	

#### Handheld Shower Hose

- Metal construction
- 1/2" IPS
- 69" Length

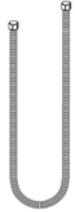

Part #	Mfg #	Finish	Price
064175	A726	Chrome	
114863	A726BR	Brown	
195494	A726ST	Satine	

#### 59" Handheld Shower Hose

- 1/2" IPS connections

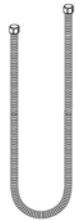

Part #	Mfg #	Finish	Price
172226	155748BN	Brushed Nickel	

#### 90°™ 30" Slidebar

- (-SR) Spot resist



Part #	Mfg #	Finish	Price
223874	A742	30" Length, Chrome	
247764	A742SRN	30" Length, Brushed Nickel	

\*Lifeshine® Anti-Tarnish Lifetime Finish

[www.waterconcepts.net](http://www.waterconcepts.net) • Serving our Customers Since 1946 • [www.plumbsupply.com](http://www.plumbsupply.com)

---

---

## Handheld Showers

---

---

### Annex Shower Rail Trim

- 1/2" IPS connections
- Trim only - showerhead and handheld sold separately



Part #	Mfg #	Finish	Price
240029	TS3661NHBN	Brushed Nickel	
248614	TS3661NHOR	Oil Rubbed Bronze	
	B		

\*Lifeshine® Anti-Tarnish Lifetime Finish

[www.plumbsupply.com](http://www.plumbsupply.com) • Serving our Customers Since 1946 • [www.waterconcepts.net](http://www.waterconcepts.net)

## Rough-In Valves

### Tub & Shower Rough-In Valves

#### Modern MultiChoice® Universal Tub & Shower/Shower Rough-In Valve

- 1/2" Universal outlets, inlets/outlets have male threads
- Back-to-back capability
- 1/2" Universal inlets accept 1/2" copper, 1/2" iron pipe, PEX or CPVC adapters
- Cartridge ships with trim



Part #	Mfg #	Description	Handle(s)	Finish	Price
103001	R60000-UNBX	1/2" Rough-In, Single Box Model			
231643	R60000-UNWS	1/2" Rough-In, With Stops			
231003	R60000-PX	1/2" Rough-In, Pex Crimp Inlets with Universal Outlets			

#### Shower Only

Part #	Mfg #	Description	Handle(s)	Finish	Price
168148	R6000-UNBXHF	1/2" Rough-In, High Flow Single Box Model			
253354	R60000-UNWSHF	1/2" Rough-In, High Flow with Stops Single Box Model			

#### Charlotte® Diverter Rough-In Valve

- Forged brass body



Part #	Mfg #	Description	Handle(s)	Finish	Price
138774	R60700	1/2" Rough-In, 3-Port 6-Function Diverter			

#### Baliza® Single-Handle Freestanding Tub Filler Rough-In

- 3-3/4" Maximum floor thickness
- Maximum flow: 14.5 gpm @ 60 psi



Part #	Mfg #	Description	Handle(s)	Finish	Price
169122	R70100	1/2" Rough-In, Forged Brass Body			

#### Baliza® Two-Handle Freestanding Tub Filler Rough-In

- 4-3/4" Maximum floor thickness
- Maximum flow: 12 gpm @ 60 psi
- (-WS) with stops



Part #	Mfg #	Description	Handle(s)	Finish	Price
165674	R70200	1/2" Rough-In, Forged Brass Body			

\* Brilliance® Anti-Tarnish Lifetime Finishes

[www.waterconcepts.net](http://www.waterconcepts.net) • Serving our Customers Since 1946 • [www.plumbsupply.com](http://www.plumbsupply.com)

## Rough-In Valves

### Tub & Shower Rough-In Valves (Continued)

#### Baliza® Two-Handle Freestanding Tub Filler Rough-In

Part #	Mfg #	Description	Handle(s)	Finish	Price
245877	R70200-WS	1/2" Rough-In, Forged Brass Body, With Stops			

#### Baliza® One-Handle Freestanding Tub Filler Rough-In

- 3-3/4" Maximum floor thickness
- Maximum flow 14.5 gpm @ 60 psi



Part #	Mfg #	Description	Handle(s)	Finish	Price
163378	R70100-WS	1/2" Rough-In, Forged Brass Body			

#### Two-Handle Roman Tub Rough-In Valve

- Flexible deck or ledge mount
- Adjustable rough-in for thin or thick deck installations
- 8"-16" Maximum widespread



Part #	Mfg #	Description	Handle(s)	Finish	Price
117391	R62707	3-Hole, 8"-16" cc	-	-	
095062	R64707	4-Hole, 8"-16"cc	-	-	

#### Two-Handle Wall-Mount Tub Filler Rough In Valve

- Lead free brass body
- 1/2" NPT female inlets
- Must order trim separately
- Includes valves and plasterguards



Part #	Mfg #	Description	Handle(s)	Finish	Price
246628	R70400	3-Hole, 8"cc	-	-	

\* Brilliance® Anti-Tarnish Lifetime Finishes

[www.plumbsupply.com](http://www.plumbsupply.com) • Serving our Customers Since 1946 • [www.waterconcepts.net](http://www.waterconcepts.net)

## Rough-In Valves

### Custom Shower System Rough-In

#### Euro Sensori® Thermostatic Temperature Control Rough-In Valve

- Flow rate: 12 gpm @ 60 psi
- Accepts single function thermostatic cartridge that ships with sensor trim
- Must also order Sensori® trim



Part #	Mfg #	Description	Price
127290	R66000-WS	3/4" Rough-In Thermostatic Temperature Control Rough with Stops	

#### Sensori® Volume Control Rough-In Valve

- 3/4" rough-in
- Max flow 9.1 gpm @ 60 psi per volume control
- Volume controls are required for every outlet and every set of body sprays (up to max flow)
- Extension kit not required. Rough accommodates up to 3 1/4" wall thickness
- Provides precise handle alignment
- 1-piece brass construction cartridge and stem
- Solid brass extension sleeve



Part #	Mfg #	Description	Price
228243	R35600	3/4" Rough-in Volume Control	

### Lavatory Rough-In Valves

#### Lavatory Wall-Mount Rough-In Valve

- Solid brass body
- 1/2" NPT supply threads
- Adjustable rough-in: 2-1/4"-3-3/4"
- Integrated plasterguard/test cap
- Single handle, single hole.
- Must order trim separately



Part #	Mfg #	Description	Handle(s)	Finish	Price
230649	R65700	1-Hole	1	-	

#### Sotria™ Wall-Mount Lavatory Rough

- 1/2" NPT rough-in
- Lead free brass body
- Must order trim separately
- 3-Hole, 8" center-to-center



Part #	Mfg #	Description	Handle(s)	Finish	Price
177246	R65800	3-Hole, 8" center-to-center	-	-	

\* Brilliance® Anti-Tarnish Lifetime Finishes



## Rough-In Valves

### Shower Rough-In Valves

#### Shower Trim Rough-In Valve

- Accepts single-function (13/14), dual-function (17), or dual-function thermostatic (17T) cartridge
- Cartridge ships with trim kit



Part #	Mfg #	Description	Price
092547	R10000-UNWS	Universal Valve Body with Stops, MIP/Swt	
134053	R10000-UNBXHF	Universal Valve Body less Stops, MIP/Swt - Single Box Model w/ High Flow, No Tub Outlet	
249618	R10000-PFS-PX	Universal Valve Body less Stops, PEX Crimp	
092548	R10000-PX	Universal Valve Body less Stops, PEX	
140394	R10000-MF	MultiChoice® Universal Valve, PEX Cold Expansion Connection	
092545	R10000-IP	Universal Valve Body IPS Inlets/Outlets	

#### Delta® Diverter Rough-In Valve

- 3-Port, 6-setting diverter with 3 individual and 3 shared positions
- 2-Port, 3-setting diverter with 2 individual and 1 shared position
- 1/2" Universal inlets/outlets
- Cartridge ships with trim
- For use with three or six function diverter
- Forged brass body



Part #	Mfg #	Description	Price
133926	R11000	Three or Six Function 3-Port Diverter Rough	

#### Jetted Shower Rough-In with Extra Outlet - 6 Setting with Stops

- Use with 14, 17 & 17T Series shower trims
- Use with 14 & 17 Series shower trims
- Order T18017-XO for Jetted Shower XO® trim
- Order T18037-XO for Jetted Shower XO® trim
- 3 port, 6 position diverter
- 1/2" universal inlets/outlets, male threads
- High flow capability for shower only applications
- Back-to-back capability



Part #	Mfg #	Description	Price
138221	R18000-XO	3-Port 6-Position Diverter	
175619	R18000-XOWS	3-Port 6-Position Diverter, With Stops	

\* Brilliance® Anti-Tarnish Lifetime Finishes

[www.plumbsupply.com](http://www.plumbsupply.com) • Serving our Customers Since 1946 • [www.waterconcepts.net](http://www.waterconcepts.net)

## Rough-In Valves

### MultiChoice® Universal Valve with Integrated Diverter Rough

- Shower Only
- Monitor® pressure balance valve keeps water temperature within a safe  $\pm 3^{\circ} F$  ( $\pm 1.6^{\circ} C$ ), helping to protect you from sudden changes in hot or cold water pressure
- Rough-in only
- Back-to-back installation capability



Part #	Mfg #	Description	Price
226549	R22000	Universal Valve w/ Integrated Diverter, w/o Stops	
237310	R22000-WS	Universal Valve w/ Integrated Diverter, With Stops	

### MultiChoice® Universal Tub & Shower Rough-In Valve

- Cartridge ships with trim
- Monitor® pressure balance valve
- Accepts single, dual, or dual thermostatic cartridge
- Features integrated 90-degree tub drop & PEX shower riser
- Can be tested with air (200 PSI) or water (300 PSI) without valve using supplied test cap



Part #	Mfg #	Description	Price
246874	R10000-PFT-MF	Pex Crimp Cold Expansion with Tub Drop	
249619	R10000-PFT-PX	Pex Crimp with Tub Drop	
246875	R10000-PFS-MF	Pex Cold Expansion Shower Only	
259095	R10000-PFS-MFW S	Pex Cold Expansion with Stops & Tub Drop	

## Roman Tub Rough-In Valves

### 2-Hdl Roman Tub Rough-In Valve

- Flexible deck or ledge mounting arrangement
- Self-locating basis
- Tighten/adjust from above deck
- Adjust to 2-1/4" maximum deck thickness or adjust to 2-1/4" maximum thickness after mud and tile
- No thick deck kit required



Part #	Mfg #	Description	Price
075435	R2707	3-Hole 8"-16"cc Deck-Mount, 18 gpm Flexible Mounting	
173479	R2707-PX	3-Hole 8"-16"cc Deck-Mount, 18 gpm, 1/2" PEX Crimp Connections	
052946	R2700	3-Hole 8"-16"cc Deck-Mount, 18 gpm Flexible Mounting	

\* Brilliance® Anti-Tarnish Lifetime Finishes

[www.waterconcepts.net](http://www.waterconcepts.net) • Serving our Customers Since 1946 • [www.plumbsupply.com](http://www.plumbsupply.com)

## Rough-In Valves

### 2-Hdl Roman Tub Faucet w/Handshower Rough-In Valve

- Flexible deck or ledge mounting arrangement
- Includes handshower rough-in
- Self-locating bases
- Tighten/adjust from above deck
- Adjust to 2-1/4" maximum deck thickness or adjust to 2-1/4" maximum thickness after mud and tile
- No thick deck kit required



Part #	Mfg #	Description	Price
075261	R4707	4-Hole 8"-16"cc Deck-Mount, 18 gpm	
173482	R4707-PX	4-Hole 8"-16"cc Deck-Mount, 18 gpm, 1/2" PEX Crimp Connections	
175951	R4707-MF	4-Hole 8"-16"cc Deck-Mount, 18 gpm, PEX Expansion Connections	

### 1-Hdl Floor Mount Tub Filler Rough-In

- Floor mount installations
- Tighten/adjust from above floor
- Adjust to 2-1/2" max. deck thickness
- Test caps and plaster guard included
- Order trim separately



Part #	Mfg #	Description	Price
162069	R4700-FL	1-Hole Installation, Less Stops	
172242	R4700-FLWS	1-Hole Installation, With Stops	

### Lavatory Wall-Mount Rough-In Valves

#### Two Handle Wall-Mount Lavatory Rough-In

- 1/2" IPS connection
- 2-3/4" +/- 1/2" mounting depth
- Compatible with 2 handle Delta® wall-mount trims



Part #	Mfg #	Description	Price
162246	R3500-WL	3-Hole 8"cc, Trim sold separately	

#### Single Handle Wall-Mount Lavatory Rough

- Max rough-in depth 2-3/4"
- 1/2" IPS connection



Part #	Mfg #	Description	Price
190502	R3510-WL	2-Hole 8"cc, Trim sold separately	

\* Brilliance® Anti-Tarnish Lifetime Finishes

[www.plumbsupply.com](http://www.plumbsupply.com) • Serving our Customers Since 1946 • [www.waterconcepts.net](http://www.waterconcepts.net)

## Rough-In Valves

### Commercial Shower Valves

#### MultiChoice® Universal Dual Rough-In Valve

- Includes diverter valve for dual showers
- Forged brass body
- Back-to-back installation
- Square plasterguard allows for right angle cuts
- Thin wall mounting
- For use with MultiChoice® Universal single or dual function trim.
- Cartridge, handle, and flange ships with trim
- 1/2" outlets and connections



For use with MultiChoice® Universal T13H and T17TH series with diverter valve for dual showers

Part #	Mfg #	Description		Price
095471	R10700-UNWS	Valve Body with Stops, In-Wall 2-Outlet Div Vlv	-	N/A

#### MultiChoice® Universal Rough Valve Body

- Forged brass body
- Back-to-back installation capabilities
- Square plasterguard allows for right angle cuts
- Thin wall mounting
- 1/2" outlets and connections



Part #	Mfg #	Description		Price
150688	R10000-MFWS	Valve Body with Pex Cold Expansion with Stops	-	N/A
092549	R10000-PXWS	Valve Body with PEXCrimp with Stops	-	N/A

### Thermostatic Mixing Valve

- Point of use thermostatic mixing valve
- Integral check valves in hot and cold inlets
- Forged brass body
- 3/8" Compression fittings
- Maximum flow: 5.8 gpm @ 45 psi



Part #	Mfg #	Description		Price
171431	R3070-MIXLF	Valve Body with 3/8" Compression w/ Integral Check Valves	-	-

\* Brilliance® Anti-Tarnish Lifetime Finishes

## Rough-In Valves

### Thermostatic Brass Mixing Valve

- *Thermostatic element senses the outlet water temperature and reacts to maintain a constant delivery temperature even under changing flows or variations in supply temperatures or pressures*
- *Brass body*
- *Inlets/outlets: 1/2" copper sweat*
- *Maximum flow rate: 11.0 gpm @ 145 psi*



Part #	Mfg #	Description		Price
168956	R2570-MIXLF	Valve Body with 1/2" Swt w/ Integral Check Valve	-	N/A

### Mixing Valve

- *Solid brass body*
- *Valve only with built-in check valves*
- *Mechanical mixer with adjustable temperature setting, temperature control handle, and screw to lock in temperature selection*
- *3/8" Compression inlets and outlet connections*
- *Maximum rated working pressure @ 125 PSI*



Part #	Mfg #	Description		Price
063095	R2910-MIXLF	Valve Only, Mechanical Mixer with Integral Check Valves	-	

\* Brilliance® Anti-Tarnish Lifetime Finishes

[www.plumbsupply.com](http://www.plumbsupply.com) • Serving our Customers Since 1946 • [www.waterconcepts.net](http://www.waterconcepts.net)

## Tub & Shower Valves

### Two-Handle Lavatory Rough-In Valves

#### Widespread 2-Hdl Lavatory Rough-In Valve

- Metal drain assembly
- Hydrolock™ quick connect installation



Part #	Mfg #	Description	Price
049457	9000	8"-16"ws, 1/2" IPS	
070902	69000	8"-16"ws, 1/2" IPS, Bulk (6/Pk)	

#### Wall-Mount Widespread 2-Hdl Lavatory Rough-In Valve

- 8" center
- 1/2" connections



Part #	Mfg #	Description	Price
158210	9700	8"cc, 1/2" Copper Connections	

### Tub & Shower Rough-In Valves

#### Arris™ Double Riser Concrete Mounting Kit

- 1/2" NPT; CC
- Built in quarter turn stops



Part #	Mfg #	Description	Handle(s)	Finish	Price
253539	TS50110	1/2"NPT:CC Single-Hole Floor Mount			

#### Two-Function Posi-Temp or Moentrol Transfer Rough-In Valve

- Two-function transfer valve - 2 discrete outputs
- 180° rotational control
- 162154 Cartridge



Part #	Mfg #	Description	Handle(s)	Finish	Price
168714	3375	1/2" cc			

#### Three-Function M•PACT® Transfer Rough-In Valve

- (2) Discrete outputs and (1) shared mode
- 180° Rotational control
- 116719 Cartridge



Part #	Mfg #	Description	Price
131044	3372	1/2"cc	

\*Lifeshine® Anti-Tarnish Lifetime Finish

[www.waterconcepts.net](http://www.waterconcepts.net) • Serving our Customers Since 1946 • [www.plumbsupply.com](http://www.plumbsupply.com)



## Tub & Shower Valves

### Volume Control Rough-In Valve

- Brass construction
- 3/4" IPS connections
- Ceramic disc cartridge
- Flow rate: 13 gpm @ 60 psi



Part #	Mfg #	Description	Handle(s)	Finish	Price
095818	S3600	3/4" IPS			

### Commercial Three-Function Transfer Valve

- 1/2" CC
- Inlets and outlets on same plane
- Valve operates 2 distinct functions but can be plumbed for 2 distinct functions
- Ceramic disc cartridge



Part #	Mfg #	Description	Handle(s)	Finish	Price
154584	3360	1/2" cc			

### Commercial Posi-Temp® Pressure-Balancing Valve

- 4-Port
- 1/4 Turn stops
- Adjustable temperature limit stop
- 1222HD Cartridge design
- Accommodates back to back installations



8371HD

Part #	Mfg #	Description	Handle(s)	Finish	Price
237946	8370HD	1/2"cc/IPS with 1/4 Turn Stops			
154585	8371HD	1/2"cc/IPS with 1/4 Turn Stops			
215006	8373HD	1/2" PEX with 1/4 Turn Stops			

### Posi-Temp® M•PACT® Pressure Balancing Cycling Rough-In Valve

- 4-Port
- Temperature limit stops
- Cycling valve
- Meets pressure-balancing safety codes
- Without volume control



2520, 62320



62370

Part #	Mfg #	Description	Price
106351	2570	1/2"cc with 1/4 Turn Stops	
087781	62370	1/2"cc with 1/4 Turn Stops , #2570 Bulk (12/Pk)	

\*Lifeshine® Anti-Tarnish Lifetime Finish

[www.plumbsupply.com](http://www.plumbsupply.com) • Serving our Customers Since 1946 • [www.waterconcepts.net](http://www.waterconcepts.net)

## Tub & Shower Valves

### M•PACT® Common Valve System

- 4-Port
- 1/2" CC
- 12/Pk



Part #	Mfg #	Description	Handle(s)	Finish	Price
191635	62720	1/2"cc, 4-Port Bulk 12/Pk			

### M•PACT® Moentrol® with Transfer Connection

- 1/2" cc connection includes pressure balancing check stops volume control
- Two outlets; four



Part #	Mfg #	Description	Handle(s)	Finish	Price
155059	3350	1/2" cc with Stops, 2 Independent Functions, 1255 Cartridge			
049429	3330	1/2" cc with Stops, 2 Independent Functions, 1 Shared			

### M•PACT® Moentrol® Pressure Balancing Valve with Volume Control

- Brass construction
- 1225 Cartridge design
- Pressure balancing, four port valve design with volume control and integral checks, 1/2" CC or IPS connections
- Adjustable temperature limit stop to control maximum hot water temperature
- Pressure balancing mechanism maintain selected discharge temperature to  $\pm 2^{\circ}\text{F}$



Part #	Mfg #	Description	Handle(s)	Finish	Price
154990	3510	1/2" IPS			
068643	3520	1/2" CC			
191636	63170	1/2" CC #3570 Bulk (12/Pk)			

### M•PACT® Posi-Temp® Pressure Balancing Valve

- Brass construction
- 1/2" cc or IPS connections
- Four port, cycle valve
- Adjustable temperature limit stop
- Pressure balancing mechanism maintain selected discharge temperature to  $\pm 2^{\circ}\text{F}$



Part #	Mfg #	Description	Handle(s)	Finish	Price
093103	2510	1/2" IPS connections			
196031	62300	1/2" IPS connections, #2510 Bulk (12/Pk)			
043774	2520	1/2"cc with Stops			
022872	62320	1/2"cc with Stops, #2520 Bulk (12/Pk)			
130013	62380	1/2" PEX with Stops, Bulk (12/Pk)			

\*Lifeshine® Anti-Tarnish Lifetime Finish

[www.waterconcepts.net](http://www.waterconcepts.net) • Serving our Customers Since 1946 • [www.plumbsupply.com](http://www.plumbsupply.com)

## Tub & Shower Valves

### ExactTemp® M•PACT® Thermostatic Valve

- Brass construction
- 3/4" IPS connections
- Thermostatic valve design with integral check stops
- Factory established temperature range from 80° F to 120° F
- Flow: 18 gpm @ 60 psi



Must be used with at least one S3600 Valve

Part #	Mfg #	Description	Handle(s)	Finish	Price
095817	S3371	3/4" IPS connections			

### Roman Tub Rough-In Valves

#### Adjustable 2-Hdl Roman Tub Rough-In Valve

- Installs on 10"cc minimum
- To be installed on rough decks up to 3-3/8" (4792)  
To be installed on rough decks up to 2-5/8" (9792)
- Accommodates 1-1/4" additional finish deck
- No cut adjustable spout shank
- Test plug and spout shank tool included



Part #	Mfg #	Description	Handle(s)	Finish	Price
149604	4792	3-Hole 1/2"cc Connections. Adjustable Roman Tub Rough-In Valve			
152740	9792	4-Hole 1/2"cc Connections. Adjustable Roman Tub Rough-In Valve			

#### 2-Hdl Roman Tub Rough-In Valve

- 10" Centers
- 1/2" cc inlets
- 1-7/8" Deck thickness
- Includes brass test plug
- Flow rate: 16 gpm @ 45 psi
- 1248 Cartridge



Part #	Mfg #	Description	Handle(s)	Finish	Price
152179	4796	1/2"cc Connections, 2-Hdl 10"cc			

#### Roman Tub Rough-In Valve

- 10"-24"
- 2-5/8" Maximum deck thickness
- 24" Quick connect hoses
- Integral 1/2" PEX connections
- Includes (2) 1/2" CPVC adapters
- Includes brass test plug
- 140715 Kit available separately to connect to 1/2" cold expansion PEX
- Flow rate: 13 gpm @ 45 psi



Part #	Mfg #	Description	Handle(s)	Finish	Price
154444	4793	3-Hole, 10" - 24" center 1/2" CPVC Crimp Ring PEX			

\*Lifeshine® Anti-Tarnish Lifetime Finish

[www.plumbsupply.com](http://www.plumbsupply.com) • Serving our Customers Since 1946 • [www.waterconcepts.net](http://www.waterconcepts.net)

## Tub & Shower Valves

### Roman Tub Rough-In Valves (Continued)

#### Roman Tub Rough-In Valve

Part #	Mfg #	Description	Handle(s)	Finish	Price
152305	9793	4-Hole w/ Diverter, 10" - 24" center 1/2" CPVC Crimp Ring PEX			

#### Arris™ Single Riser Floor Mount Tub Filler

- 1/2" MNPT; CC
- Built in stops



Part #	Mfg #	Description	Handle(s)	Finish	Price
170174	TS50100	1/2" MNPT; CC Single-Hole Floor Mount			

#### Weymouth™ Double Riser Floor Mount Tub Filler

- 1/2" MNPT; CC
- Built in stops



Part #	Mfg #	Description	Handle(s)	Finish	Price
215023	TS50200	1/2"MNPT; CC Double Floor Mount			

\*Lifeshine® Anti-Tarnish Lifetime Finish

[www.waterconcepts.net](http://www.waterconcepts.net) • Serving our Customers Since 1946 • [www.plumbsupply.com](http://www.plumbsupply.com)

**Rough-In Valves**

**Tub & Shower Rough-In Valves**

**iBox Universal Plus Rough-In Valve**

- *With service stops*
- *3/4" Inlets and outlets*
- *Includes (3) 1/2" reducers and (1) 3/4" plug and seal*



Part #	Mfg #	Description	Price
133273	01850181	4-Port Universal Rough-In	

\*PVD Limited Lifetime Finish

[www.plumbsupply.com](http://www.plumbsupply.com) • **Serving our Customers Since 1946** • [www.waterconcepts.net](http://www.waterconcepts.net)

## Rough-In Valves

### Tub & Shower Rough-In Valves

#### Ceramic In-Wall Tub & Shower Rough-In Valve

- Flow rate: 10 gpm @ 45 psi
- Yoke with 8" centers
- Order trim separately



Part #	Mfg #	Description	Price
058278	K-302-K-NA	1/2" Ceramic In-Wall 2-Hdl Valve	

#### High-Flow Valve with Rigid Connections

- 1/2" Ceramic valve
- Time-tested and durable brass valve bodies
- For baths with finished deck- or rim-mount installations



Part #	Mfg #	Description	Price
066623	K-300-KR-NA	1/2" Ceramic High-Flow Valve	

#### Hi-Flow Valve System with Diverter Valve

- Finished deck-mount or rim-mount only
- High-flow valve
- Eliminates the need for a transfer valve and transfer valve trim on the bath deck
- Order trim separately



Part #	Mfg #	Description	Price
097845	K-438-K-NA	1/2" Ceramic High-Flow Valve System	

#### Hi-Flow Rite-Temp® Pressure Balancing Tub & Shower Rough-In Valve

- Wall-mount
- Superior resistance to aggressive or treated water
- Flow rate: 13 gpm
- Utilizes existing K-306-KS valve trim
- Provides anti-scald protection and temperature regulation at flow rates as low as 1.75 gpm
- Back-to-back installation is ideal for unique or high-volume jobs
- Order trim separately



Part #	Mfg #	Description	Price
133946	K-2971-KS-NA	3/4" NPT, Screwdriver Stops	

\* Vibrant Limited Lifetime Warranty

[www.waterconcepts.net](http://www.waterconcepts.net) • Serving our Customers Since 1946 • [www.plumbsupply.com](http://www.plumbsupply.com)



## Rough-In Valves

### Real Rain® Diverter Valve

- Forged brass body
- Flow rate: .5 gpm
- **Requires:**
  - K-76748 Diverter valve trim
  - K-76732 Overhead Panel Trim
  - K-76728 Overhead Panel



Part #	Mfg #	Description	Price
250650	K-76746-NA	1/2" NPT	

### Rite-Temp® Deep Rough-In Kit

- For K-8305/P8305 cartridges
- Increases depth by 3/4"



Part #	Mfg #	Description	Price
226715	K-10350-NA	For K-8305/P8305 Cartridge	

### Rite-Temp® Pressure-Balancing Valve Body and Cartridge Kit

- Includes:
  - Valve body
  - Pressure-Balance cartridge
  - Mud guard
  - Rough-in guide
- Once-piece cartridge design
- Flow rate: 5.0 gpm @ 45 psi
- Order trim separately
- (P) Prefix = Project Pack



Part #	Mfg #	Description	Price
227338	K-P8304-K-NA	Valve Body & Cartridge Kit, 1/2" NPT & Direct Swt Inlets & Outlets, P-Pk	
227339	K-P8304-KS-NA	Valve Body & Cartridge Kit, 1/2" NPT & Direct Swt Inlets & Outlets w/ Stops, P-Pk	
255062	K-P8304-US-NA	Valve Body & Cartridge Kit, 1/2" NPT & 1/2" PEX Expansion (F1960) & Direct Swt Outlets	
248478	K-P8304-UX-NA	Valve Body & Cartridge Kit, 1/2" NPT & 1/2" PEX Expansion (F1960) Inlets & Direct Swt Outlets	
226148	K-8304-K-NA	Valve Body & Cartridge Kit, 1/2" NPT & Direct Swt Inlets & Outlets	
229091	K-8304-KS-NA	Valve Body & Cartridge Kit, 1/2" NPT & Direct Swt Inlets & Outlets w/ Stops	
226216	K-8304-PX-NA	Valve Body & Cartridge Kit, 1/2" PEX Crimp (F1807) Inlets, 1/2" NPT & Direct Swt Outlets	
237018	K-8304-US-NA	Valve Body & Cartridge Kit, 1/2" PEX Inlets w/ Stops & 1/2" NPT and Swt Outlets	

\* Vibrant Limited Lifetime Warranty

[www.plumbsupply.com](http://www.plumbsupply.com) • Serving our Customers Since 1946 • [www.waterconcepts.net](http://www.waterconcepts.net)

## Rough-In Valves

### Rite-Temp® Valve Body Rough-In

- Includes:
  - Valve body
  - Rough-in guid
  - Test cap
- (P) Prefix = project pack-12 per case



Requires K-8305 Valve Cartridge to complete installation

Part #	Mfg #	Description	Price
227342	K-P8300-PX-NA	Valve Body, 1/2" PEX Crimp (F1807) Inlets, 1/2" NPT & Direct Swt Outlets, P-Pk	
226217	K-8300-K-NA	Valve Body, 1/2" NPT & Direct Swt Inlets & Outlets	
227340	K-P8300-K-NA	Valve Body, 1/2" NPT & Direct Swt Inlets & Outlets, P-Pk	
230988	K-P8300-UX-NA	Valve Body, 1/2" PEX Crimp (F1807) Inlets, 1/2" NPT & Direct Swt Outlets, P-Pk	
232104	P8300-US-NA	Valve Body, 1/2" PEX Expansion (F1960) Inlets w/ Stops, 1/2" NPT & Direct Swt Outlets, P-Pk	

### Rite-Temp® Pressure-Balance Cartridge

- Includes:
  - Pressure-Balance cartridge
  - Mud guard
- One-piece cartridge design
- Fits every Kohler® Rite-Temp® trim
- Flow rate: 5 gpm @ 45 psi
- (P) Prefix = Project Pack-12 per case
- Cartridge is reversible for installations where hot and cold supplies are reversed



Requires K-8300 Valve Body to complete installation

Part #	Mfg #	Description	Price
226716	K-8305-NA	Pressure-Balance Cartridge for Rite-Temp®, Requires K-8300 Valve Body	
229088	K-P8305-NA	Pressure-Balance Cartridge for Rite-Temp®, Requires K-8300 Valve Body	

### Rite-Temp® Pressure-Balancing Tub & Shower Rough-In with Push Button Diverter

- Brass valve body
- Rite-Temp® pressure-balancing diaphragm design
- Integral push button diverter mechanism actuates handshower/showerhead application or showerhead/bath spout application
- Flow rate: 5 gpm @ 45 psi
- Order trim separately



K-11748-K-NA

K-11748-KS-NA

Part #	Mfg #	Description	Price
139392	K-11748-K-NA	Universal Sweat/NPT Connections	
136578	K-11748-KS-NA	Universal Sweat/NPT Connections, Stops	
156569	K-1081410	Divert for K-11748-	

\* Vibrant Limited Lifetime Warranty

## Rough-In Valves

### MasterShower® Rough-In Valves

#### MasterShower® XVII Thermostatic Rough-In Valve

- Wall-mount, single-handle control
- Factory-calibrated comfort setting at 104°F
- Safety stop ensures temperature will not exceed 120°F
- Filter screens



Part #	Mfg #	Description	Price
147378	K-2972-KS-NA	1/2" NPT, Requires K-2974-K Volume Control Valve	
145875	K-2975-KS-NA	3/4" NPT, Requires K-2977-K Volume Control Valve	
145252	K-2976-KS-NA	3/4" NPT, Integral Stops & Volume Control	

#### MasterShower® Thermostatic Mixer

- Wall-mount
- High-temperature limit setting
- Temperature-balancing mechanism
- Scald hazard prevention
- Integral service stops
- Crossflow prevention
- Serviceable inlet filter screens
- Single outlet
- Independent temperature volume controls
- Flow rate: 7.2 gpm



Part #	Mfg #	Description	Price
178038	K-2973-KS-NA	1/2" NPT, Thermostatic Valve with Integrated Volume Control & Stops	

#### MasterShower® Volume Control Rough-In Valve

- Allows precise control of amount and intensity of water flow
- Forged brass construction
- Wall-mount
- Flow rate: 10.0 gpm
- 1/4-Turn washerless ceramic valve
- Designed for use with thermostatic mixer valves



Part #	Mfg #	Description	Price
147379	K-2974-K-NA	1/2" NPT	
147197	K-2977-K-NA	3/4" NPT	

\* Vibrant Limited Lifetime Warranty

[www.plumbsupply.com](http://www.plumbsupply.com) • Serving our Customers Since 1946 • [www.waterconcepts.net](http://www.waterconcepts.net)

## Rough-In Valves

### MasterShower® 3-Way/2-Way Transfer Rough-In Valve

- Wall-mount
- Brass valve body
- Permits three outlets to be interconnected
- Selection of one or combination of two outlets
- Can be converted from three outlets (360° handle rotation) to two outlets (120° handle rotation)



K-728-K Designed for use with Kohler Tub & Shower Supply Valves

Part #	Mfg #	Description	Price
132327	K-728-K-NA	3/4" Wall-mount 3-Way/2-Way Transfer Valve	

### MasterShower® 3-Way/2-Way Diverter Rough-In Valve

- Wall-mount
- Brass valve body
- Trickle flow from any two outlets to a variable flow from a single outlet
- One 3/4" NPT inlet connection
- Three 1/2" NPT outlet connection
- Can be converted from 3 outlets (360° handle rotation) to 2 outlets (120° handle rotation)



Part #	Mfg #	Description	Price
151075	K-737-K-NA	3/4" Wall-mount 3-Way/2-Way Diverter Valve	

## Roman Tub Rough-In Valves

### Ceramic High Flow Roman Tub Rough-In Valve

- Tub or deck-mount
- Order trim separately
- (P) Prefix = Project Pack



K-300-K

Part #	Mfg #	Description	Price
053703	K-300-K-NA	1/2" Washerless Ceramic	
121711	K-P300-K-NA	1/2" Washerless Ceramic, P-Pk	
053711	K-301-K-NA	3/4" Washerless Ceramic	

\* Vibrant Limited Lifetime Warranty

[www.waterconcepts.net](http://www.waterconcepts.net) • Serving our Customers Since 1946 • [www.plumbsupply.com](http://www.plumbsupply.com)

## Rough-In Valves

### Single Control Roman Tub Rough-In Valves

- Wall-mount
- Order trim separately



Part #	Mfg #	Description	Price
053935	K-307-K-NA	1-Piece Ceramic	

### Transfer Valve with Integral Check Valves

- Brass construction
- 2 or 3 Way configuration options
- Backflow prevention
- For use with non-diverter bath spouts



408-K-NA

Part #	Mfg #	Description	Price
058425	K-408-K-NA	13 to 15 gpm flow rate	
070360	K-409-K-NA	13 to 15 gpm flow rate	

### Mounting-Block/Valve for Bath Fillers

- Required for installation of Purist®, Stillness®, Margaux®, and Kelston® bath fillers



Part #	Mfg #	Description	Price
174982	K-97339-NA	1/2" Connections	

### Mounting-Block/Valve for Refinia® Bath Filler

- Brass and metal construction
- Test cap and mud guard included
- Required for installation of the K-T97334-4 Refinia® bath filler



Part #	Mfg #	Description	Price
185567	K-97342-NA	1/2" Connections	

### Mounting-Block/Valve for Loure® Bath Filler

- Brass and metal construction
- Test cap and mud guard included
- Required for installation of the K-T97330-4 Loure® bath filler



Part #	Mfg #	Description	Price
185645	K-97343-NA	1/2" Connections	

\* Vibrant Limited Lifetime Warranty

[www.plumbsupply.com](http://www.plumbsupply.com) • Serving our Customers Since 1946 • [www.waterconcepts.net](http://www.waterconcepts.net)



## Rough-In Valves

### Rough-In Valves

#### Roman Tub Handshower Deck Diverter Valve

- Deck mounted
- One 1/2" IPS outlet
- Two 3/4" IPS inlets
- One 3/4" IPS outlet
- Long thread allows for mounting in thick decks



Part #	Mfg #	Description	Price
241639	J-1209	Diverter Valve	



## Rough-In Valves

### Shower Rough-In Valves

#### Single Control Pressure Balancing Valve

- Universal 1/2" fittings
- Washerless cartridge
- Less stops



Part #	Mfg #	Description	Price
155190	P4SR-799	Sweat & IPS Connections, Less Stops	
243387	P4SR-799A	Type A PEX Connections (Cold Expansion) Less Stops	
235529	P4SR-799P	PEX Connection, Less Stops	

### Replacement Cartridges

#### Single Control Replacement Cartridge for Pressure Balance Valve



Part #	Mfg #	Description	Price
164024	P4SR-798WS	For Pressure Balancing Valve, With Stops	
164022	P4SR-798	For Pressure Balancing Valve, Less Stops	

## Rough-In Valves

### Tub & Shower Rough-In Valves Valve Pack PEX Fitting



Part #	Mfg #	Description	Price
233081	212-6235	Contractor Valve Pack PEX Fitting (Type A) Facing Up	
226648	212-5911	Contractor Valve Pack PEX Fitting (Type B) Facing Up	
226640	212-6096	Contractor Valve Pack PEX Fitting (Type B) Facing Down	

\* Vibrant Limited Lifetime Warranty

[www.waterconcepts.net](http://www.waterconcepts.net) • Serving our Customers Since 1946 • [www.plumbsupply.com](http://www.plumbsupply.com)

## Shower Heads, Arms & Flanges

### Rainheads

#### Contemporary Ceiling-Mount Rain Showerhead

- *Katalyst™ air-induction spray*
- (78) Nozzles
- *Optimized sprayface design creates a denser uniform spray*
- *MasterClean™ sprayface resists mineral buildup*
- *Flow rate: 2.5 gpm*
- *1/2" NPT Connection*
- *Showerarm and flange not included*



Part #	Mfg #	Description	Price
132990	K-13688-BN	8", *Brushed Nickel	
169050	K-13688-BV	8", *Brushed Bronze	
133222	K-13688-CP	8", Polished Chrome	
151105	K-13688-SN	8", *Polished Nickel	
252981	K-13688-TT	8", *Titanium	
258274	K-13689-BL	10", Matte Black	
133216	K-13689-BN	10", *Brushed Nickel	
183007	K-13689-BV	10", *Brushed Bronze	
133221	K-13689-CP	10", Polished Chrome	
141123	K-13689-SN	10", *Polished Nickel	
222085	K-13690-BGD	12", *Brushed Gold	
146039	K-13690-BN	12", *Brushed Nickel	
137164	K-13690-SN	12", *Polished Nickel	
142037	K-13691-CP	14", Polished Chrome	

#### Contemporary Ceiling-Mount Rain Showerhead

- *Katalyst™ air-induction spray*
- *Optimized sprayface*
- *MasterClean™ spray nozzles*
- *Flow rate: 2.5 gpm*
- *1/2" NPT Connection*
- *Showerarm and flange not included*



Part #	Mfg #	Finish	Price
140869	K-13695-BN	8", *Brushed Nickel	
138470	K-13695-CP	8", Polished Chrome	
149585	K-13696-BN	10", *Brushed Nickel	
155303	K-13696-BV	10", *Brushed Bronze	
153387	K-13696-CP	10", Polished Chrome	
160458	K-13696-SN	10", *Polished Nickel	

#### Contemporary 2.0 Square Rain Showerhead

- *Ceiling-mount*
- *Katalyst™ air-induction spray*
- *Optimized sprayface*
- *MasterClean™ spray nozzles*
- *Flow rate: 2.0 gpm*
- *1/2" NPT Connection*
- *Showerarm and flange not included*



Part #	Mfg #	Finish	Price
166633	K-45200-BN	8", *Brushed Nickel	
174985	K-45200-CP	8", Polished Chrome	

#### Traditional Round Rain Showerhead

- *Ceiling-mount*
- *Katalyst™ air-induction spray*
- *Optimized sprayface*
- *MasterClean™ spray nozzles*
- *1/2" - 14 NPT connection*
- *Showerarm and flange not included*
- *Flow rate: 2.5 gpm*



Part #	Mfg #	Finish	Price
133469	K-13692-BN	8", *Brushed Nickel	
134305	K-13692-BV	8", *Brushed Bronze	
139187	K-13692-CP	8", Polished Chrome	
183009	K-13692-SN	8", *Polished Nickel	
147027	K-13692-2BZ	8", Oil Rubbed Bronze	
138312	K-13693-AF	10", *French Gold	
135646	K-13693-BN	10", *Brushed Nickel	
186844	K-13693-BV	10", *Brushed Bronze	
148177	K-13693-CP	10", Polished Chrome	
160869	K-13693-SN	10", *Polished Nickel	
190152	K-13693-VNT	10", Vintage Nickel	
147028	K-13693-2BZ	10", Oil Rubbed Bronze	
239789	K-13694-AF	12", *French Gold	
159680	K-13694-BN	12", *Brushed Nickel	
189641	K-13694-BV	12", *Brushed Bronze	
148771	K-13694-CP	12", Polished Chrome	
159396	K-13694-SN	12", *Polished Nickel	
147029	K-13694-2BZ	12", Oil Rubbed Bronze	

\* Vibrant Limited Lifetime Finish

[www.plumbsupply.com](http://www.plumbsupply.com) • Serving our Customers Since 1946 • [www.waterconcepts.net](http://www.waterconcepts.net)

## Shower Heads, Arms & Flanges

### Traditional Round 2.0 Rain Showerhead

- Ceiling-mount
- *Katalyst™* air-induction spray
- Optimized sprayface
- *MasterClean™* spray nozzles
- 1/2" - 14 NPT connection
- Showerarm and flange not included
- Flow rate: 2.0 gpm



Part #	Mfg #	Finish	Price
177452	K-45202-CP	8", Polished Chrome	
177689	K-45202-2BZ	8", Oil Rubbed Bronze	

### WaterTile® Overhead Shower Panel 9-7/8" x 9-7/8"

- Integrated system for ceiling installation
- (4) 22-nozzle sprayheads
- Individually adjustable pivoting sprayheads simulate a gentle summer rain showering experience
- *MasterClean™* sprayface
- 1/2" NPT connections
- Max combined flow rate: 2.5 gpm



Part #	Mfg #	Finish	Price
157649	K-98740-BN	9-7/8"x9-7/8", *Br Nickel	
164091	K-98740-BV	9-7/8"x9-7/8", *Br Bronze	
158021	K-98740-CP	9-7/8"x9-7/8", Pol Chrome	
164094	K-98740-SN	9-7/8"x9-7/8", *Pol Nickel	
158308	K-98740-2BZ	9-7/8"x9-7/8", Oil-Rbd Brz	

## Showerheads

### Alteo® Single-Function Showerhead

- *Katalyst™* air-induction spray
- *MasterClean™* sprayface
- 1/2" NPT Connection
- Showerarm and flange not included



Part #	Mfg #	Finish	Price
147941	K-45123-BN	2.5 gpm, *Brushed Nickel	
157205	K-45123-CP	2.5 gpm, Polished Chrome	
153842	K-45123-2BZ	2.5 gpm, Oil Rubbed Bronze	

## Showerheads (Continued)

### Alteo® Single-Function Showerhead

Part #	Mfg #	Finish	Price
183576	K-5240-BN	2.0 gpm, *Brushed Nickel	

### Alteo® Multi-Function Showerhead

- *Katalyst™* air-induction spray
- *MasterClean™* spray nozzles
- Flow rate: 2.0 gpm
- 1/2" NPT Connection
- Showerarm and flange not included



Part #	Mfg #	Finish	Price
152390	K-45125-2BZ	Oil Rubbed Bronze	

### Artifacts® Single-Function Showerhead

- *Katalyst™* air-induction spray
- *MasterClean™* sprayface
- 6" Wide sprayface
- 1/2" NPT Connection
- Showerarm and flange not included



Part #	Mfg #	Finish	Price
162102	K-72773-BN	2.5gpm, *Brushed Nickel	
177299	K-72773-BV	2.5gpm, *Brushed Bronze	
165373	K-72773-CP	2.5gpm, Polished Chrome	
165043	K-72773-SN	2.5gpm, *Polished Nickel	
223898	K-72773-VNT	2.5 gpm, Vintage Nickel	
168456	K-72773-2BZ	2.5gpm, Oil Rubbed Bronze	
168023	K-72774-BN	2.0gpm, *Brushed Nickel	
246213	K-72774-BV	2.0gpm, *Brushed Bronze	
162832	K-72774-CP	2.0gpm, Polished Chrome	
223587	K-72774-SN	2.0 gpm, *Polished Nickel	
190150	K-72774-VNT	2.0 gpm, Vintage Nickel	

\* Vibrant Limited Lifetime Finish

## Shower Heads, Arms & Flanges

### Awaken® Multi-Function Showerhead

- Wide coverage, intense drenching, and targeted sprays
- Thumb tab for diverting sprays
- MasterClean™ sprayface
- 1/2" NPT connection
- Flow rate: 2.0 gpm
- Traditional design
- Showerarm and flange not included



Part #	Mfg #	Finish	Price
160470	K-72424-BN	3-3/4", *Br. Nickel, B90	
160261	K-72424-CP	3-3/4", Chrome, B90	
158911	K-72425-BN	4-5/16", *Br. Nickel, B110	
160255	K-72425-CP	4-5/16", Chrome, B110	

### Awaken® G110 Multi-Function Showerhead

- Wide coverage, intense drenching, and targeted sprays
- Thumb tab for diverting sprays
- MasterClean™ sprayface
- 1/2" NPT connection
- Flow rate: 2.0 gpm
- Contemporary design
- Showerarm and flange not included



Part #	Mfg #	Finish	Price
160468	K-72418-BN	3-9/16", *Br. Nickel, G90	
160258	K-72418-CP	3-9/16", Chrome, G90	
259566	K-72419-BL	4-5/16", Matte Black	
160426	K-72419-BN	4-5/16", *Brushed Nickel	
160259	K-72419-CP	4-5/16", Polished Chrome	
251597	K-72419-2BZ	4-5/16", Oil Rubbed Bronze	

### Awaken® G90 Single-Function Showerhead

- MasterClean™ spray nozzles
- 3-9/16" Diameter
- 1/2" - 14 NPT connection
- Flow rate: 1.75 gpm



Part #	Mfg #	Finish	Price
174436	K-72417-BN	3-9/16", *Brushed Nickel	
187831	K-72417-CP	3-6/16", Polished Chrome	

### Awaken™ Rainhead Showerhead

- MasterClean™ Spray nozzles
- Adjustable ball joint swivel
- 1/2-inch NPT connection
- Ceiling or wall mount installation
- Showerarm and flange sold separately
- WaterSense® certified: 2.0 gpm



Part #	Mfg #	Finish	Price
248274	K-76464-BN	8", *Brushed Nickel	
247689	K-76464-CP	8", Polished Chrome	
247167	K-76465-BN	10", *Brushed Nickel	
245965	K-76465-CP	10", Polished Chrome	

### Bancroft® Single-Function Showerhead

- Catalyst™ spray technology
- MasterClean™ spray nozzles
- Flow rate: 2.5 gpm
- 1/2" - 14 NPT connection
- Single function
- Showerarm and flange not included



Part #	Mfg #	Finish	Price
142299	K-10590-AK-BN	5-5/16", *Brushed Nickel	
251554	K-10590-AK-BV	5-5/16", *Brushed Bronze	
172789	K-10590-AK-SN	5-5/16", *Polished Nickel	
143014	K-10590-AK-CP	5-5/16", Polished Chrome	
154340	K-10590-AK-2BZ	5-5/16", Oil Rubbed Bronze	

### Bancroft® 2.5 gpm Multi-Function Showerhead

- Wide, full, aerated, and massage spray functions
- MasterClean™ sprayface
- 1/2" NPT connection
- Flow rate: 2.5 gpm
- Showerarm and flange not included



Part #	Mfg #	Finish	Price
148765	K-10591-2BZ	5-5/16", Oil Rubbed Bronze	

\* Vibrant Limited Lifetime Finish

[www.plumbsupply.com](http://www.plumbsupply.com) • Serving our Customers Since 1946 • [www.waterconcepts.net](http://www.waterconcepts.net)



## Shower Heads, Arms & Flanges

### Bancroft® Multi-Function Showerhead

- 6" spray face
- *Katalyst™* spray technology
- *MasterClean™* spray nozzles
- Flow rate: 2.5 gpm or 1.75 gpm
- 1/2" - 14 NPT connection
- Showerarm and flange not included



Part #	Mfg #	Finish	Price
255214	K-22167-BN	2.5 gpm, *Brushed Nickel	
258690	K-22167-G-BN	1.75 gpm, *Brushed Nickel	

### Converge® Integrated Showerhead & Handshower

- 3-Functions
  - Full coverage
  - Infinity spray
  - One combination spray
- 1/2" NPT connection
- 7-1/2" Showerarm
- *MasterClean™* sprayface
- Magnetic docking
- *MasterShower®* 60" Metal hose
- Flow rate: 2.5 gpm



Part #	Mfg #	Finish	Price
247592	K-30364-BN	2.5 gpm, *Brushed Nickel	

### Coralais® Single Function Showerhead

- Wall-mount
- 1/2" NPT connection
- Showerarm and flange not included
- Sprayface with flexible nozzles



Part #	Mfg #	Finish	Price
188239	K-11637-CP	2.5 gpm, Polished Chrome	

### Contemporary Rain Showerhead

- Ceiling mount
- 1/2" NPT connection
- *MasterClean™* sprayface
- *Katalyst®* air-induction spray
- Flow rate: 2.0 gpm
- Showerarm and flange not included



Part #	Mfg #	Finish	Price
238803	K-45201-BN	8", *Brushed Nickel	
243247	K-45201-CP	8", Polished Chrome	

### Devonshire® Single-Function Showerhead

- 5-15/16" Diameter
- *Katalyst™* spray technology
- 66 *MasterClean™* spray nozzles
- 1/2" NPT connection
- Single function
- Showerarm and flange not included



Part #	Mfg #	Finish	Price
164467	K-10391-AK-BN	2.5 gpm, *Brushed Nickel	
182984	K-10391-AK-BV	2.5 gpm, *Brushed Bronze	
161600	K-10391-AK-CP	2.5 gpm, Polished Chrome	
182985	K-10391-AK-PB	2.5 gpm, *Polished Brass	
183446	K-10391-AK-SN	2.5 gpm, *Polished Nickel	
146949	K-10391-AK-2BZ	2.5 gpm, Oil Rubbed Bronze	
173431	K-45413-BN	2.0 gpm, *Brushed Nickel	
146971	K-45413-2BZ	2.0 gpm, Oil Rubbed Bronze	

### Exhale™ Multi-function Showerhead

- *Katalyst™* spray technology with air induction ball joint
- Advanced spray engine provides for spray experiences
- 360° rotation of sprayface cycles
- Shower arm and flange not included



Part #	Mfg #	Finish	Price
189105	K-72597-CP	2.0 gpm, Polished Chrome	

\* Vibrant Limited Lifetime Finish

[www.waterconcepts.net](http://www.waterconcepts.net) • Serving our Customers Since 1946 • [www.plumbsupply.com](http://www.plumbsupply.com)



## Shower Heads, Arms & Flanges

### Fairfax® 2.5 gpm Single-Function Showerhead

- *Katalyst™ spray technology*
- *66 MasterClean™ spray nozzles*
- *5-1/2"*
- *1-2" NPT connection*
- *Showerarm and flange not included*



Part #	Mfg #	Finish	Price
225844	K-12008-AK-CP	2.5 gpm, Polished Chrome	

### Forté® Single-Function 5-1/2" Showerhead

- *Katalyst™ spray technology with air induction ball joint*
- *66 MasterClean™ spray nozzles*
- *1/2" - 14 NPT connection*
- *Showerarm and flange not included*



Part #	Mfg #	Finish	Price
226671	K-10282-AK-AF	2.5 gpm, *French Gold	
151903	K-10282-AK-BN	2.5 gpm, *Brushed Nickel	
247028	K-10282-AK-BV	2.5 gpm, *Brushed Bronze	
139248	K-10282-AK-CP	2.5 gpm, Polished Chrome	
224818	K-10282-AK-G	2.5 gpm, Brushed Chrome	
183168	K-10282-AK-PB	2.5 gpm, *Polished Brass	
148255	K-10327-CP	2.0 gpm, Polished Chrome	

### Forté® 2.5 gpm Multi-Function Showerhead

- *MasterClean® spray nozzles*
- *Full-coverage, therapeutic massage, soft-aerated spray, and water-saving eco spray options*
- *1/2" - 14 NPT connection*
- *Showerarm and flange not included*



Part #	Mfg #	Finish	Price
088479	K-10284-PB	5-15/16", *Polished Brass	
157860	K-10284-2BZ	5-15/16", Oil Rubbed Bronze	

### Flipside™ 2.5 gpm Multi-Function Showerhead

- *Flipstream Technology™*
- *Four unique, experiential spray patterns*  
—*Koverage™ (full)*,  
—*Kotton™ (downpour)*,  
—*Komotion™ (soft)*  
—*Kurrent™ (massage)*
- *Wall-mount*
- *Adjustable angle for various user heights*
- *Showerarm and flange not included*



Part #	Mfg #	Finish	Price
133052	K-15996-BN	2.5 gpm, *Brushed Nickel	
133007	K-15996-CP	2.5 gpm, Polished Chrome	
224246	K-15996-SN	2.5 gpm, *Polished Nickel	
171988	K-15996-2BZ	2.5 gpm, Oil Rubbed Bronze	

### Loure™ 2.5 gpm Single-Function Showerhead

- *Katalyst® air-induction spray*
- *(66) MasterClean™ spray nozzles*
- *1/2" - 14 NPT connection*
- *Single-function spray*
- *Showerarm and flange not included*



Part #	Mfg #	Finish	Price
151578	K-14786-BN	*Brushed Nickel	
171520	K-14786-CP	Polished Chrome	

### Margaux® Single-Function Wall-Mount Showerhead

- *MasterClean® spray nozzles prohibit mineral buildup for easy cleaning*
- *1/2" - 14 NPT connection*
- *Showerarm and flange not included*
- *(AK) represents Katalyst® air-induction spray*



Part #	Mfg #	Finish	Price
156077	K-45410-BN	2.0 gpm, *Brushed Nickel	
140673	K-16244-AK-AF	2.5 gpm, * French Gold	
165959	K-16244-AK-BN	2.5 gpm, *Brushed Nickel	
188545	K-16244-AK-BV	2.5 gpm, *Brushed Bronze	
146376	K-16244-AK-CP	2.5 gpm, Polished Chrome	

\* Vibrant Limited Lifetime Finish

[www.plumbsupply.com](http://www.plumbsupply.com) • Serving our Customers Since 1946 • [www.waterconcepts.net](http://www.waterconcepts.net)

## Shower Heads, Arms & Flanges

### MasterShower® Invigorating 2.5 gpm Multi-Function Showerhead

- Spray modes: wide strong spray, concentrated pulse and wide pulse
- Easy-grip for smooth switching between spray options
- MasterClean™ sprayface
- Showerarm and flange not included



Part #	Mfg #	Finish	Price
053749	K-8506-BN	*Brushed Nickel	
053746	K-8506-CP	Polished Chrome	

### MasterShower® Multi-Function Wall-Mount Relaxing 3-Way Showerhead

- Spray modes: wide soft, slow pulse and soft aerated
- Easy-grip for smooth switching between spray options
- Showerarm and flange not included



Part #	Mfg #	Finish	Price
053750	K-8507-BN	2.5 gpm, *Brushed Nickel	
057239	K-8507-CP	2.5 gpm, Polished Chrome	
105033	K-8544-CP	2.0 gpm, Polished Chrome	

### Memoirs® 2.5 gpm Single-Function Showerhead

- Katalyst® spray
- MasterClean™ sprayface with (66) nozzles
- 1/2" NPT connection
- Showerarm and flange not included



Part #	Mfg #	Finish	Price
162824	K-457-AK-BN	2.5 gpm, *Brushed Nickel	
144003	K-457-AK-CP	2.5 gpm, Polished Chrome	

### Memoirs® Single-Function Classic Showerhead

- Katalyst® air-induction spray
- MasterClean™ sprayface
- 5-1/2" Diameter sprayface
- 1/2" NPT connection
- Showerarm and flange not included
- Maximum flow rate: 2.0 gpm



Part #	Mfg #	Finish	Price
238910	K-45409-CP	2.0 gpm, Polished Chrome	
259289	K-45409-2BZ	2.0 gpm, Oil Rubbed Brz	

### Moxie® 2.5 gpm Single-Function Showerhead with Wireless Speaker

- Water-resistant, removable speaker
- USB charging table included
- Showerarm and flange not included
- Syncs with Bluetooth-enabled devices
- Lithium-ION battery provides 7 hours of runtime



Part #	Mfg #	Finish	Price
159709	K-9245-BN	5", *Brushed Nickel	
154131	K-9245-CP	5", Polished Chrome	
154132	K-9245-0	5", White	
159710	K-9245-2BZ	5", Oil Rubbed Bronze	

### Moxie™ 2.5 gpm Raincan Showerhead with Wireless Speaker

- Lithium-ION battery
- Syncs with Bluetooth enabled devices
- Water-resistant, removable speaker
- USB charging table included
- Showerarm and flange not included



Part #	Mfg #	Finish	Price
166461	K-99105-BN	8", *Brushed Nickel	
166460	K-99105-CP	8", Polished Chrome	
166462	K-99105-2BZ	8", Oil Rubbed Bronze	

\* Vibrant Limited Lifetime Finish

[www.waterconcepts.net](http://www.waterconcepts.net) • Serving our Customers Since 1946 • [www.plumbsupply.com](http://www.plumbsupply.com)

## Shower Heads, Arms & Flanges

### Moxie® Wireless Speaker

- Speaker insert only



Part #	Mfg #	Finish	Price
161727	K-9246-FBG	Retro Blue	
161725	K-9246-FGN	Chartreuse	
161726	K-9246-FNY	Navy Blue	
161728	K-9246-FRD	Cherry Red	

### Pinstripe® 2.5 gpm Single-Function Showerhead

- *Katalyst®* air induction technology
- *MasterClean™* spray nozzles
- 1/2" NPT connection
- Showerarm and flange not included



Part #	Mfg #	Finish	Price
189402	K-13137-AK-CP	5-9/16", Polished Chrome	
230450	K-13137-AK-SN	5-9/16", *Polished Nickel	

### Purist® 2.5 gpm Single-Function Showerhead

- *Katalyst™* spray technology with air induction ball joint
- *MasterClean™* spray nozzles
- 1/2" - 14 NPT connection
- Showerarm and flange not included



Part #	Mfg #	Finish	Price
140178	K-965-AK-BN	5-1/2", *Brushed Nickel	
152242	K-965-AK-CP	5-1/2", Polished Chrome	
158852	K-965-AK-SN	5-1/2", *Polished Nickel	

### Purist® 2.0 gpm Single-Function Showerhead

- *Katalyst™* spray technology with air induction ball joint
- *MasterClean™* spray nozzles
- 1/2" - 14 NPT connection
- Showerarm and flange not included



Part #	Mfg #	Finish	Price
257780	K-939-BL	5-1/2", Matte Black	
183163	K-939-BN	5-1/2", *Brushed Nickel	
230990	K-939-CP	5-1/2", Polished Chrome	

### Purist® 2.5 gpm Multi-Function Showerhead

- *MasterClean™* sprayface
- 1/2" NPT connection
- Flow rate: 2.5 gpm
- Showerarm and flange not included



Part #	Mfg #	Finish	Price
152201	K-966-BV	5-1/2", *Brushed Bronze	
086903	K-966-CP	5-1/2", Polished Chrome	

### Purist® 1.75 gpm Multifunction Showerhead

- *MasterClean™* sprayface
- 1/2-inch NPT connection
- Showerarm and flange not included



Part #	Mfg #	Finish	Price
140821	K-997-CP	5-1/2", Polished Chrome	
244779	K-997-BGD	5-1/2", *Moderne Br Gold	

### MasterShower™ Multi-Function 3-Way Showerhead with Relaxing Spray

- Spray modes: full coverage, aerated, and massage
- Showerarm and flange not included



Part #	Mfg #	Finish	Price
122908	K-GP85918-BN	*Brushed Nickel	
098345	K-GP85918-CP	Polished Chrome	

### Revival® Single-Function Showerhead

- *Katalyst®* air induction spray
- *MasterClean™* sprayface
- 48 Nozzles
- 1/2" NPT connections
- Showerarm and flange not included



Part #	Mfg #	Finish	Price
258971	K-45411-BN	2.0 GPM, Brushed Nickel	
183572	K-45411-CP	2.0 GPM, Pol Chrome	

\* Vibrant Limited Lifetime Finish

[www.plumbsupply.com](http://www.plumbsupply.com) • Serving our Customers Since 1946 • [www.waterconcepts.net](http://www.waterconcepts.net)

## Shower Heads, Arms & Flanges

### WaterTile® Wall-Mounted Square 54-Nozzle Showerhead with Soothing Spray

- Fully adjustable, pivoting MasterClean™ sprayface
- 1/2" NPT connections
- Flow rate: 2.2 gpm



Part #	Mfg #	Finish	Price
086871	K-8022-BN	*Brushed Nickel	
086263	K-8022-CP	Polished Chrome	
149151	K-8022-SN	*Polished Nickel	
174163	K-8022-2BZ	Oil Rubbed Bronze	

### WaterTile® Wall-Mounted Square 22-Nozzle Showerhead with Stimulating Spray

- Fully adjustable, pivoting MasterClean™ sprayface
- 1/2" NPT connections
- Flow rate: 2.2 gpm



Part #	Mfg #	Finish	Price
086264	K-8023-CP	Polished Chrome	
183153	K-8023-SN	*Polished Nickel	

## Showerarms

### Alteo® Showerarm & Flange

- Brass construction
- 1/2" NPT connection
- 5-3/8" Reach



Part #	Mfg #	Finish	Price
148791	K-45129-BN	*Brushed Nickel	
172067	K-45129-CP	Polished Chrome	
153841	K-45129-2BZ	Oil Rubbed Bronze	

### Artifacts® Showerarm and Flange

- Metal construction
- 1/2" NPT connection
- 10-11/16" Reach



Part #	Mfg #	Finish	Price
162139	K-72775-BN	*Brushed Nickel	
177298	K-72775-BV	*Brushed Bronze	
162833	K-72775-CP	Polished Chrome	
165040	K-72775-SN	*Polished Nickel	
190148	K-72775-VNT	Vintage Nickel	
168457	K-72775-2BZ	Oil Rubbed Bronze	

### 12" Ceiling Mount Showerarm & Flange

- Brass construction
- 1/2" NPT connection



Part #	Mfg #	Finish	Price
252946	K-7392-AF	*French Gold	
222084	K-7392-BGD	*Moderne Brushed Gold	
133215	K-7392-BN	*Brushed Nickel	
183146	K-7392-BV	*Brushed Bronze	
133224	K-7392-CP	Polished Chrome	
178253	K-7392-SN	*Polished Nickel	
244309	K-7392-VNT	Vintage Nickel	
147031	K-7392-2BZ	Oil Rubbed Bronze	

### Exhale® Showerarm & Flange

- Metal construction
- 1/2" NPT connection
- 7-5/16" Reach



Part #	Mfg #	Finish	Price
232038	K-98358-CP	Polished Chrome	

### Gooseneck Rainhead Showerarm and Flange

- Metal construction
- 1/2" NPT connection
- Includes 3-way diverter
- Diverter switches water between rainhead or handshower, or both on at one time



Part #	Mfg #	Finish	Price
238914	76336-CP	Polished Chrome	

### Loure® Showerarm & Flange

- 7-1/2" Reach
- 1/2" NPT connection



Part #	Mfg #	Finish	Price
145700	K-14679-BN	*Brushed Nickel	
170402	K-14679-CP	Polished Chrome	

\* Vibrant Limited Lifetime Finish



## Shower Heads, Arms & Flanges

### Loure® Square Showerarm and Flange

- 8-1/2" Reach
- 1/2" NPT Connection



Part #	Mfg #	Finish	Price
186199	K-99690-BN	*Brushed Nickel	
185643	K-99690-CP	Polished Chrome	
231451	K-99690-SN	*Polished Nickel	

### Margaux® Showerarm and Flange

- 10-5/8" reach
- 1/2" NPT connection



Part #	Mfg #	Finish	Price
239790	K-16280-AF	*French Gold	
141677	K-16280-BN	*Brushed Nickel	
114256	K-16280-BV	*Brushed Bronze	
130262	K-16280-CP	Polished Chrome	
145256	K-16280-SN	*Polished Nickel	

### MasterShower® Ceiling -Mount Showerarm & Flange

- 1/2" NPT connection



Part #	Mfg #	Finish	Price
138313	K-7394-AF	6", *French Gold	
133214	K-7394-BN	6", *Brushed Nickel	
140872	K-7394-BV	6", *Brushed Bronze	
133223	K-7394-CP	6", Polished Chrome	
141124	K-7394-SN	6", *Polished Nickel	
190151	K-7394-VNT	6", Vintage Nickel	
147032	K-7394-2BZ	6", Oil Rubbed Bronze	
256124	K-7396-AF	3", *French Gold	
258272	K-7396-BL	3", Matte Black	
059590	K-7396-BN	3", *Brushed Nickel	
075020	K-7396-BV	3", *Brushed Bronze	
053531	K-7396-CP	3", Polished Chrome	
151106	K-7396-SN	3", *Polished Nickel	

### Showerarms (Continued)

#### MasterShower® Ceiling -Mount Showerarm & Flange

Part #	Mfg #	Finish	Price
147033	K-7396-2BZ	3", Oil Rubbed Bronze	

#### MasterShower® Showerarm & Flange

- Brass construction
- 1/2" NPT Connection



Part #	Mfg #	Finish	Price
233721	K-7395-AF	5-3/8", *French Gold	
246652	K-7395-BV	5-3/8", *Brushed Bronze	
162820	K-7395-BN	5-3/8", *Brushed Nickel	
078842	K-7395-CP	5-3/8", Polished Chrome	
071988	K-7395-PB	5-3/8", *Polished Brass	
254542	K-7395-SN	5-3/8", *Polished Nickel	
170637	K-7395-2BZ	5-3/8", Oil Rubbed Bronze	
075058	K-7397-AF	7-1/2", *French Gold	
244777	K-7397-BGD	7-1/2", *Moderene Br Gold	
075037	K-7397-BN	7-1/2", *Brushed Nickel	
076971	K-7397-BV	7-1/2", *Brushed Bronze	
059781	K-7397-CP	7-1/2", Polished Chrome	
067423	K-7397-PB	7-1/2", Polished Brass	
086974	K-7397-SN	7-1/2", *Polished Nickel	
147034	K-7397-2BZ	7-1/2", Oil Rubbed Bronze	

#### Showerarm with 2-Way Diverter

- Includes flange
- Brass construction
- 1/2" NPT connection
- K-76334 traditional flange & K-76335 square flange available (sold separately)



Part #	Mfg #	Finish	Price
245496	K-76331-BN	8-1/16", *Brushed Nickel	
233815	K-76331-CP	8-1/16", Polished Chrome	

\* Vibrant Limited Lifetime Finish

[www.plumbsupply.com](http://www.plumbsupply.com) • Serving our Customers Since 1946 • [www.waterconcepts.net](http://www.waterconcepts.net)

## Shower Heads, Arms & Flanges

### Showerarm with 3-Way Diverter

- 8-1/16" Length
- Brass construction
- 1/2" NPT connection



Part #	Mfg #	Finish	Price
230250	K-76330-BN	8-1/16", Brushed Nickel	
237001	K-76330-CP	8-1/16", Polished Chrome	

### Rainhead Showerarm with 3-Way Diverter

- 18-1/16" Length
- Metal construction
- 1/2" NPT connection



Part #	Mfg #	Finish	Price
253056	K-76332-2BZ	18-1/16", Oil Rubbed Brz	

### Persona™ Two-Way Showerarm Diverter

- Brass construction
- 1/2" NPSM connection & thread



Part #	Mfg #	Finish	Price
054535	K-9662-VP	2-7/8", Polished Chrome	
066680	K-9662-PB	2-7/8", *Polished Brass	

### Pinstripe® Showerarm and Flange

- Brass construction
- 1/2" NPT connection



Part #	Mfg #	Finish	Price
237893	K-13136-BN	10-5/8", *Brushed Nickel	
086159	K-13136-CP	10-5/8", Polished Chrome	
084486	K-13136-SN	10-5/8", *Polished Nickel	

### Purist® 8-1/2" Showerarm and Flange

- Premium metal construction
- 1/2" NPT connection



Part #	Mfg #	Finish	Price
185181	K-933-BN	8-1/2" *Brushed Nickel	
181280	K-933-CP	8-1/2", Polished Chrome	

### Revival® 5-3/8" Showerarm

- 1/2" NPT connection



Part #	Mfg #	Finish	Price
080816	K-16133-AF	5-3/8", *French Gold	
073949	K-16133-BN	5-3/8", *Brushed Nickel	
096896	K-16133-BV	5-3/8", *Brushed Bronze	
073679	K-16133-CP	5-3/8", Polished Chrome	
080202	K-16133-PB	5-3/8", *Polished Brass	
157858	K-16133-2BZ	5-3/8", Oil Rubbed Bronze	

### Right Angle Showerarm and Flange

- Brass construction
- 1/2" NPT connection
- 14-5/8" Reach



Part #	Mfg #	Finish	Price
125722	K-10124-AF	14-5/8", *French Gold	
102528	K-10124-BN	14-5/8", *Brushed Nickel	
103948	K-10124-BV	14-5/8", *Brushed Bronze	
094715	K-10124-CP	14-5/8", Polished Chrome	
148320	K-10124-SN	14-5/8", *Polished Nickel	
252980	K-10124-TT	14-5/8", *Titanium	
147022	K-10124-2BZ	14-5/8", Oil Rubbed Bronze	

### Stillness® Showerarm and Flange

- 1/2" NPT connection
- 7-1/2" Reach



Part #	Mfg #	Finish	Price
181477	K-934-CP	7-1/2", Polished Chrome	

### Showerarm Trim Kit

- Metal construction
- Includes square flange & end caps
- For use with K-76330, K-76331, K-76332, K-76336, and K-76337 showerarm



Part #	Mfg #	Finish	Price
242114	K-76335-BN	2-1/2" x 2-1/2", *Br. Nickel	

\* Vibrant Limited Lifetime Finish



**Shower Heads, Arms & Flanges**

**Showerheads**

**Baliza® Raincan Showerhead**

- H2Okinetic® Technology
- Finished sprayface
- WaterSense® certified product:  
2.0 gpm @ 80 psi



Part #	Mfg #	Description	Price
209086	87305-BN	Brushed Nickel*	
171585	87305-PC	Chrome	
168306	87305-RB	Venetian Bronze®	

**Charlotte™ Raincan Showerhead**

- 8-1/4" Diameter
- H2Okinetic™ technology
- Maximum flow rate:  
2.5 gpm @ 80 psi



Part #	Mfg #	Description	Price
217256	81385-PN	8-1/4" Dia, Polished Nickel*	
156698	81385-PNCO	8-1/4" Diameter Cocoa Bronze™/Pol Nickel	
240654	87385-BN	5-13/16" Diameter, Br Nickel*	
252674	87385-PN	5-13/16" Dia, Pol Nickel*	
168147	87385-PNCO	5-13/16" Diameter Cocoa Bronze™/Pol Nickel	

**Hydrati™ 2-in-1 Euro Square Showerhead**

- H2Okinetic® technology
- MagneDock®
- 5-29/32" Diameter
- Integrated showerhead and handshower
- Four setting push button handshower
  - H2Okinetic® spray
  - H2Okinetic® spray w/ massage
  - Massage spray
  - Pause
- 60"-82" Stretchable metal hose
- Flow rate: 2.5 gpm @ 80 psi
- Showerarm & flange NOT included; use with RP74448



Part #	Mfg #	Description	Price
240692	86280-PC	Chrome	

**Hydrati™ 2-in-1 Transitional Square Showerhead**

- H2Okinetic® technology
- MagneDock®
- 6-1/8" Finished spray face
- Integrated showerhead and handshower
- Four setting push button handshower
  - H2Okinetic® spray
  - H2Okinetic® spray w/ massage
  - Massage spray
  - Pause
- 60"-82" Stretchable metal hose
- Flow rate: 2.5 gpm @ 80 psi
- Showerarm & flange NOT included; use with RP71649



Part #	Mfg #	Description	Price
254484	86201-PNCO	Cocoa Bronze/Pol Nickel	

**Hydrati® 2-in-1 Traditional Round Showerhead**

- H2Okinetic® technology
- MagneDock®
- 6" Diameter
- Integrated showerhead and handshower
- Four setting push button handshower
  - H2Okinetic® spray
  - H2Okinetic® spray w/ massage
  - Massage spray
  - Pause
- 60"-82" Stretchable metal hose
- Flow rate: 2.5 gpm @ 80 psi
- Showerarm & flange NOT included; use with RP74448



Part #	Mfg #	Description	Price
242180	86200-NK-2.5	Luxe Nickel*	
259572	86200-NKBL-2.5	Luxe Nickel/Matte Black	
171551	86200-PC-2.5	Chrome	
159402	86200-PN-2.5	Polished Nickel*	
168734	86200-RB-2.5	Venetian Bronze®	

\* Brilliance® Anti-Tarnish Lifetime Finishes

**Shower Heads, Arms & Flanges**

**Hydrati® 2-in-1 Euro Round Showerhead**

- H2Okinetic® technology
- MagneDock®
- 5-9/16" Diameter
- Integrated showerhead and handshower
- Four setting push button handshower
  - H2Okinetic® spray
  - H2Okinetic® spray w/ massage
  - Massage spray
  - Pause
- 60"-82" Stretchable metal hose
- Flow rate: 2.5 gpm @ 80 psi
- Showerarm & flange NOT included; use with RP74448



Part #	Mfg #	Description	Price
250983	86275-BL-2.5	Matte Black	
255705	86275-NK-2.5	Luxe Nickel	

**H2Okinetic® Raincan Showerhead**

- Touch-Clean® spray holes
- 7-3/4" Diameter
- 1/2" IPS connection
- Three-settings include:
  - Pause
  - Full body spray
  - H2Okinetic® spray
- WaterSense® certified: 2.0 gpm @ 80 psi



Part #	Mfg #	Description	Price
238808	52686-CZ	Champagne Bronze*	

**Levoir™ 10" Raincan Showerhead**

- Single function
- Finished sprayface
- 1/2"-14 NPSM
- WaterSense certified product:  
1.75 gpm or 2.5 gpm @ 80 psi



Part #	Mfg #	Description	Price
250599	81398-BN	Brushed Nickel*	
250562	81398-PN	Polished Nickel*	
252807	81398-SL-2.5	Luxe Steel, 2.5 gpm	

**Levoir™ H2Okinetic® Showerhead**

- Touch-Clean® nozzles
- Four-settings include
  - H2Okinetic® full body
  - Massaging spray
  - Full body spray
  - Pause
- Finished 6-7/8" sprayface
- 1/2"-14 NPSM
- WaterSense certified product: 1.75 gpm @ 80 psi



Part #	Mfg #	Description	Price
255367	87498-GL	Luxe Gold	
255721	87498-NK	Luxe Nickel*	
255115	87498-PN	Polished Nickel*	

**Litze™ Ceiling Mount Pendant Raincan Showerhead**

- Single function
- Flush-mounted
- Finished sprayface
- Four showerarm lengths (4", 6", 8" and 10")
- Maximum flow rate: 2.0 gpm @ 60 psi



Part #	Mfg #	Description	Price
237821	81335-PC	9", Chrome	

**Litze™ 8" Raincan Showerhead**

- H2Okinetic® technology spray
- Four-settings include
  - Pause
  - Massage spray
  - Invigorating H2Okinetic® spray
  - Full-body H2Okinetic® spray
- Finished sprayface
- Maximum flow rate: 2.0 gpm @ 80 psi



Part #	Mfg #	Description	Price
243459	87435-GL	Luxe Gold	
237820	87435-PC	Chrome	
257392	87435-PN	Polished Nickel*	
230171	87435-NK	Luxe Nickel	

\* Brilliance® Anti-Tarnish Lifetime Finishes

## Shower Heads, Arms & Flanges

### Odin Showerhead

- H2Okinetic® technology spray
- 5-3/8" Diameter
- Maximum flow rate:  
2.5 gpm @ 80 psi



Part #	Mfg #	Description	Price
212087	87375-BN	Brushed Nickel	
178516	87375-BL	Matte Black	
157995	87375-PC	Chrome	

### Odin™ Raincan Showerhead

- 8" Diameter
- Maximum flow rate:  
2.5 gpm @ 80 psi



Part #	Mfg #	Description	Price
240370	81375-BL	Matte Black	
162438	81375-BN	Brushed Nickel*	
243456	81375-GL	Luxe Gold	
246929	81375-NK	Luxe Nickel	
186177	81375-PC	Chrome	

### Rook™ Multi-Function Showerhead

- 8" Diameter
- H2Okinetic® technology
- Finished spray face
- Four spray settings  
Invigorating H2Okinetic spray  
Full body H2Okinetic spray  
Massage spray & pause
- Watersense® certified product: 2.0 gpm



Part #	Mfg #	Description	Price
223093	87461-NKBL	Luxe Nickel/Matte Black	
237296	87461-NK	Luxe Nickel	
250465	87461-PN	Polished Nickel*	

### RSVP® Two-Function Showerhead

- Full spray, and massage spray
- Flow rate: 2.5 gpm @ 80 psi



Part #	Mfg #	Description	Price
162290	RP48041BN	Brushed Nickel*	
127004	RP48041PC	Chrome	

### Siderna® Raincan Showerhead

- Single-function spray
- H2Okinetic® technology
- 5-3/8" Diameter
- WaterSense® certified product:  
2.0 gpm @ 80 psi



Part #	Mfg #	Description	Price
188611	87380-BL	Matte Black	
159083	87380-BN	Brushed Nickel*	
167704	87380-PC	Chrome	

### Siderna® Hydrati 2-in-1 Showerhead

- Integrated H2Okinetic® technology
- Four-setting push button handshower
- Flow rate: 2.5 gpm @ 80 psi



Part #	Mfg #	Description	Price
174212	86280-BN	Brushed Nickel*	

### Siderna® Ceiling-Mount Showerhead

- Single-function
- Finished spray face
- Touch-Clean® features
- 8-5/8" x 5-3/4" Rectangular  
raincan showerhead
- Flow rate: 2.5 gpm @ 80 psi



Part #	Mfg #	Description	Price
138958	81380-BN	Brushed Nickel	
222413	81380-BL	Matte Black	

### Sotria™ H2Okinetic® Raincan Showerhead

- 7" Diameter
- Five spray settings  
-Full spray  
-Full spray with massage  
-Massage spray  
-H2Okinetic® spray  
-Pause
- Finished spray face
- Touch-Clean® nozzles
- WaterSense® certified product: 2.0 gpm @ 80 psi



Part #	Mfg #	Description	Price
223971	87450-BL	Matte Black	

\* Brilliance® Anti-Tarnish Lifetime Finishes

[www.plumbsupply.com](http://www.plumbsupply.com) • Serving our Customers Since 1946 • [www.waterconcepts.net](http://www.waterconcepts.net)

**Shower Heads, Arms & Flanges**

**Sotria™ Raincan Showerhead**

- H2Okinetic® technology
- 10-3/8" Diameter
- Finished sprayface
- Flow rate: 2.5 gpm @ 80 psi



Part #	Mfg #	Description	Price
177378	81350-BL	Matte Black	

**Traditional 9" Touch-Clean® Rain Can Showerhead**

- Single-function
- Finished spray face
- Flow Rate: 2.5 gpm @ 80 psi



Part #	Mfg #	Finish	Price
129694	RP52090PC	Chrome	
124301	RP52090BN	Brushed Nickel*	
256113	RP52090NKB L	Luxe Nickel/Matte Black	
124215	RP52090RB	Venetian Bronze®	

**Traditional Raincan Showerhead**

- 11" Diameter
- Maximum flow rate:  
2.5 gpm @ 80 psi



Part #	Mfg #	Description	Price
165443	83310-BN	Brushed Nickel*	
223096	83310-NK	Luxe Nickel*	
145728	83310-PC	Chrome	
236862	83310-PN	Polished Nickel	
145234	83310-RB	Venetian Bronze®	

**Universal In2ition® Two-in-One Showerhead**

- H2Okinetic® technology
- MagnaTite® docking
- 4-Setting includes:
  - Pause feature
  - Massaging spray
  - H2Okinetic® spray
  - H2Okinetic® spray with massage
- Push button selection
- 60"-82" Stretchable metal hose
- 3-Way diverter for extra spray options
- Fixed showerhead & handshower all in one
- Flow rate: 2.5 gpm @ 80 psi



Part #	Mfg #	Description	Price
239788	58472-BL	Matte Black	

**Universal Single-Setting Raincan Showerhead**

- 6-9/16" Diameter
- 1/2" IPS connection
- Touch-clean® spray holes
- Soft rain spray setting
- WaterSense® certified: 2.0 gpm @ 80 psi



Part #	Mfg #	Description	Price
241286	52283-SS	Stainless*	

**Vettis™ Multi-Function Showerhead**

- 8" Diameter
- H2Okinetic® technology
- Touch-Clean® nozzles
- 4-Setting includes:
  - Pause feature
  - Full body spray
  - Massaging spray
  - H2Okinetic® spray
- 1/2"-14 NPSM female connection
- WaterSense® certified" 1.75 gpm @ 80 psi



Part #	Mfg #	Description	Price
252516	87488-BL	Matte Black	
249068	87488-PC	Chrome	
251062	87488-NK	Luxe Nickel*	

**Vesi® Raincan Showerhead**

- 8" Diameter
- Maximum flow rate:  
2.5 gpm @ 80 psi



Part #	Mfg #	Description	Price
131155	83341-BN	Brushed Nickel*	

\* Brilliance® Anti-Tarnish Lifetime Finishes



**Shower Heads, Arms & Flanges**

**Showerheads (Continued)**

**Vesi® Raincan Showerhead**

Part #	Mfg #	Description	Price
242228	83341-BL	Matte Black	
171182	83341-BZ	Brushed Bronze*	
131154	83341-PC	Chrome	
177301	83341-RB	Venetian Bronze®	

**Vesi® Single Function Raincan Showerhead**

- H2Okinetic® technology
- Finished sprayface matches shell finish
- 5-1/4" x 5-1/4" Square showerhead
- WaterSense® certified product: 2.0 gpm @ 80 psi



Part #	Mfg #	Description	Price
222653	87340-RB	Venetian Bronze	

**Vesi® Wall-Mount Showerhead**

- Multi-function
- Flow rate: 2.5 gpm @ 80 psi
- Showerarm and flange sold separately



Part #	Mfg #	Description	Price
143398	RP42431	Chrome	
090094	RP42431BN	Brushed Nickel*	
097361	RP42431BZ	Brushed Bronze*	
176455	RP42431RB	Venetian Bronze®	

**Vesi® Hydrati 2-in-1 Showerhead**

- Four-setting push button handshower
- H2Okinetic® spray
- H2Okinetic spray with massage
- Massage spray
- Pause
- H2Okinetic® technology
- MagneDock® technology
- Maximum flow rate: 2.5 gpm @ 80 psi



Part #	Mfg #	Description	Price
236585	86101-BN	Brushed Nickel	
224535	86201-BZ	Brushed Bronze*	

**Showerheads (Continued)**

**Vesi® Hydrati 2-in-1 Showerhead**

Part #	Mfg #	Description	Price
240344	86201-RB	Venetian Bronze	

**Virage® Raincan Showerhead**

- H2Okinetic® Technology
- Maximum flow rate: 2.5 gpm @ 80 psi



Part #	Mfg #	Description	Price
153335	81330-BN	8"x8", Brushed Nickel*	
176624	81330-BZ	8"x8", Brushed Bronze*	
143547	81330-PC	8"x8", Chrome	
153311	81330-RB	8"x8", Venetian Bronze®	
185740	87330-BN	6"x6", Brushed Nickel*	
163879	87330-PC	6"x6", Chrome	
170001	87330-PN	6"x6", Polished Nickel*	
164985	87330-RB	6"x6", Venetian Bronze®	

**Showerarms**

**Baliza® Shower Arm & Flange**

- 7" Reach



Part #	Mfg #	Description	Price
181112	RP62929BN	Brushed Nickel*	
242038	RP62929BZ	Brushed Bronze*	
242181	RP62929NK	Luxe Nickel*	
159460	RP62929PC	Chrome	
159401	RP62929PN	Polished Nickel*	
149365	RP62929RB	Venetian Bronze®	

**Vettis® Shower Arm & Flange**

- 1/2" NPT threads
- Intended for use with 87488 shower head



Part #	Mfg #	Description	Price
252515	RP90243BL	13", Matte Black	

\* Brilliance® Anti-Tarnish Lifetime Finishes

**Shower Heads, Arms & Flanges**

**Vesi® Ceiling-Mount Shower Arm & Flange**

- Shower arm with flange
- 1/2" IPS male threads



Part #	Mfg #	Description	Price
177377	RP48985BL	6", Matte Black	
105657	RP48985BN	6", Brushed Nickel*	
243458	RP48985GL	6", Luxe Gold	
223094	RP48985NK	6", Luxe Nickel*	
111314	RP48985PC	6", Chrome	
156697	RP48985PN	6", Polished Nickel*	
246267	RP48985RB	6", Venetian Bronze	
252806	RP48985SL	6", Luxe Steel	
248111	RP48986BL	10", Matte Black	
105658	RP48986BN	10", Brushed Nickel*	
260864	RP48986GL	10", Luxe Gold	
163825	RP48986PN	10", Polished Nickel*	

**Charlotte® Shower Arm Assembly**

- 8" Long shower arm with flange
- Use with 87385 or 81385



Part #	Mfg #	Description	Price
240653	RP70909BN	8", Brushed Nickel*	
189483	RP70909PC	8", Chrome	
168146	RP70909PN	8", Polished Nickel*	

**Brizo® Wall- Mount Showerarm & Flange**



Part #	Mfg #	Description	Price
178517	RP74751BL	Matte Black	
222155	RP74751BN	Brushed Nickel*	
180765	RP74751NK	Luxe Nickel*	
184778	RP74751PC	Chrome	
221311	RP74751PN	Polished Nickel*	
246266	RP74751RB	Venetian Bronze	

**Euro Shower Arm and Flange**



Part #	Mfg #	Description	Price
188719	RP71648BL	15", Matte Black	
174047	RP71648BN	15", Brushed Nickel*	
251607	RP71648NK	15", Luxe Nickel*	
237796	RP71650BL	16", Matte Black	
241752	RP71650BZ	16", Brushed Bronze*	

**Levoir™ Shower Arm and Flange**



Part #	Mfg #	Description	Price
255368	RP92044GL	Luxe Gold	
255707	RP92044NK	Luxe Nickel*	

**Litze™ Jointed Showerarm & Flange**

- 1/2" NPT threads
- 16" Total reach



Part #	Mfg #	Description	Price
232411	RP81434PC	16", Chrome	
246460	RP81434BN	16", Brushed Nickel*	
237157	RP81434BZ	16", Brushed Bronze*	
243460	RP81434GL	16", Luxe Gold	
230172	RP81434NK	16", Luxe Nickel	

**Rook™ Showerarm and Flange**



Part #	Mfg #	Description	Price
251333	RP78580GL	7", Luxe Gold	
223092	RP78580NK	7", Luxe Nickel*	
249967	RP78580PC	7", Chrome	
223520	RP78580PN	7", Polished Nickel*	

\* Brilliance® Anti-Tarnish Lifetime Finishes



## Shower Heads, Arms & Flanges

### RSVP® Showerarm



Part #	Mfg #	Description	Price
162289	RP48040BN	7", Brushed Nickel*	
127005	RP48040PC	7", Chrome	

### Siderna® Shower Arm & Flange



Part #	Mfg #	Description	Price
158702	RP71650BN	15", Brushed Nickel*	
188612	RP74448BL	7", Matte Black	
159082	RP74448BN	7", Brushed Nickel*	
251063	RP74448NK	7", Luxe Nickel*	
167705	RP74448PC	7", Chrome	

### Siderna® Ceiling-Mount Showerarm & Flange



Part #	Mfg #	Description	Price
153334	RP70764BN	6", Brushed Nickel*	
226387	RP70764BL	6", Matte Black	
176623	RP70764BZ	6", Brushed Bronze*	
163744	RP70764PC	6" Chrome	
153312	RP70764RB	6", Venetian Bronze®	
241130	RP70765BL	10", Matte Black	
158801	RP70765PC	10", Chrome	
206367	RP70765BN	10", Brushed Nickel*	

### Traditional Showerarm & Flange

- 16"



Part #	Mfg #	Description	Price
141944	RP54168BN	16", Brushed Nickel*	

### Showerarms (Continued)

#### Traditional Showerarm & Flange

Part #	Mfg #	Description	Price
128937	RP54168PC	16", Chrome	
251532	RP54168PN	16", Polished Nickel*	
118400	RP54168RB	16", Venetian Bronze®	

#### Vesi Channel® Showerarm & Flange



Part #	Mfg #	Description	Price
158294	RP71649BN	Brushed Nickel*	
189720	RP71649BZ	Brushed Bronze*	
177781	RP71649PC	Chrome	
190412	RP71649PN	Polished Nickel*	
222652	RP71649RB	Venetian Bronze	

### Virage® Showerarm



Part #	Mfg #	Description	Price
185739	RP62603BN	Brushed Nickel*	
163881	RP62603PC	Chrome	
170000	RP62603PN	Polished Nickel*	
164987	RP62603RB	Venetian Bronze®	

### Addison™ Showerarm Flange



Part #	Mfg #	Description	Price
134427	RP61266SS	*Stainless	

\* Brilliance® Anti-Tarnish Lifetime Finishes

[www.plumbsupply.com](http://www.plumbsupply.com) • Serving our Customers Since 1946 • [www.waterconcepts.net](http://www.waterconcepts.net)

## Shower Heads, Arms & Flanges

### Showerheads

#### Addison™ Raincan Single-Setting Showerhead

- H2Okinetic® spray
- Self-cleaning H2Okinetic® spray holes
- 6" Spray face diameter
- 2-3/4" Showerhead length
- WaterSense® certified: 2.0 gpm @ 80 psi



Part #	Mfg #	Finish	Price
139581	RP61265CZ	Champagne Bronze™	
134818	RP61265RB	Venetian Bronze®	
134811	RP61265SS	Stainless*	

#### H2Okinetic® Raincan Single-Setting Showerhead

- Self-cleaning H2Okinetic® spray holes
- 2-1/2" Showerhead length
- 8" spray face diameter
- Maximum flow: 2.5 gpm @ 80 psi



Part #	Mfg #	Finish	Price
138125	RP61274	Chrome	
130956	RP61274RB	Venetian Bronze®	
139972	RP61274SS	Stainless*	

#### Arzo® Touch-Clean® Single-Function Showerhead

- 2-1/2" Showerhead length
- 8" Square finished spray face
- Includes showerhead, showerarm and flange
- 16" long shower arm
- All metal
- Maximum flow: 2.5 gpm @ 80 psi



Part #	Mfg #	Finish	Price
127752	57740	Chrome	
125057	57740-SS	Stainless*	

#### Arzo® Touch-Clean® Raincan Showerhead

- Touch-Clean® spray holes
- 8" Square finished spray face
- 2-1/2" Showerhead length
- All metal
- 16" long shower arm
- Maximum flow: 2.5 gpm @ 80 psi



Part #	Mfg #	Finish	Price
138439	RP53496	Chrome	
136964	RP53496SS	Stainless*	

#### Arzo® 8" Touch-Clean® Raincan Showerhead

- Features Touch-Clean® spray holes
- Single-setting showerhead -Soft rain spray
- 8" Square spray face
- 2-1/2" Showerhead length
- Maximum flow: 2.5 gpm @ 80 psi



Part #	Mfg #	Finish	Price
119166	RP50841	Chrome	
152079	RP50841-SS	Stainless*	

#### Ashlyn® Touch-Clean® Raincan Showerhead

- Single-setting showerhead -Full body spray
- 5-1/4" Spray face diameter
- 2-11/16" Showerhead length
- WaterSense certified product: 2.0 gpm @ 80 psi



Part #	Mfg #	Description	Price
175767	RP64859	Chrome	
172453	RP64859-RB	Venetian Bronze®	
173663	RP64859-SS	Stainless*	

#### Classic Touch-Clean® Showerhead

- Single-setting showerhead Full body spray
- Features Touch-Clean® spray holes
- 2-5/8" Spray face diameter
- 2-1/2" Showerhead length
- Maximum flow: 2.0 gpm @ 80 psi



Part #	Mfg #	Finish	Price
067293	RP38357	Chrome	
146392	RP38357SS	Stainless*	

\* Brilliance® Anti-Tarnish Lifetime Finishes

www.waterconcepts.net • Serving our Customers Since 1946 • www.plumbsupply.com

## Shower Heads, Arms & Flanges

### Contemporary H2Okinetic® Modern Showerhead

- Touch-Clean® spray holes
- 5-13/16" Spray face diameter
- 3-15/16" Showerhead length
- Spray settings:
  - Full body spray
  - Full spray with massage
  - H2Okinetic® spray
  - Massaging spray
- WaterSense® certified: 1.75 gpm @ 80 psi



Part #	Mfg #	Description	Price
242224	52664	Chrome	
245675	52664-BL	Matte Black	
255534	52664-PN	Polished Nickel*	
244645	52664-RB	Venetian Bronze	
242476	52664-SS	Stainless*	

### Dryden™ Touch-Clean® Raincan Showerhead

- Single-setting showerhead
- Full body spray
- Features Touch-Clean® spray holes
- 6-1/2" Spray face across
- 3-1/8" Showerhead length
- Maximum flow: 2.5 gpm @ 80 psi



Part #	Mfg #	Finish	Price
129504	RP62283	Chrome	
254249	RP62283BL	Matte Black	
147192	RP62283CZ	Champagne Bronze™	
237779	RP62283PN	Polished Nickel*	
131412	RP62283RB	Venetian Bronze®	
135077	RP62283SS	Stainless*	

### Dryden™ H2Okinetic® Showerhead

- Single-setting showerhead
- H2Okinetic® spray
- Self-cleaning H2Okinetic® spray holes
- 6" Square spray face
- 5-1/8" Showerhead length
- WaterSense® certified: 1.75 gpm @ 80 psi
- (-15) 1.5 gpm @ 80 psi
- (-20) 2.0 gpm @ 80 psi



Part #	Mfg #	Description	Price
163619	RP70171	Chrome, 1.75 gpm	
250298	RP70171-BL	Matte Black, 1.75 gpm	

### Showerheads (Continued)

#### Dryden™ H2OKinetic® Showerhead

Part #	Mfg #	Description	Price
174558	RP70171-RB	Venetian Brz®, 1.75 gpm	
155716	RP70171-SS	Stainless*, 1.75 gpm	
257674	RP70171-SS20	Stainless*, 2.0 gpm	

#### Foundations® Single-Setting Showerhead

- 2" Spray face diameter
- 2-7/8" showerhead length
- WaterSense® certified: 2.0 gpm @ 80 psi



Part #	Mfg #	Description	Price
152088	RP44809	Chrome	
188670	RP44809BN	Brushed Nickel	

#### Lahara 5" Touch-Clean® Raincan Showerhead

- Single-setting showerhead
- Full body spray
- Touch-Clean® spray holes
- 5" Spray face across
- 2-3/4" Showerhead length
- Maximum flow: 2.5 gpm @ 80 psi



Part #	Mfg #	Finish	Price
114549	RP51305	Chrome	
160849	RP51305CZ	Champagne Bronze™	
112181	RP51305RB	Venetian Bronze®	
112023	RP51305SS	Stainless*	

#### Premium Touch-Clean® 3-Setting Showerhead

- Spray settings:
  - Full body
  - Massaging
  - Soft drench
- Touch-Clean® spray holes
- 4-7/8" Spray face diameter
- 4-3/4" Showerhead length
- WaterSense® certified: 2.0 gpm @ 80 psi



Part #	Mfg #	Description	Price
117717	RP43381	Chrome	
168994	RP43381PB	Polished Brass*	
158034	RP43381SS	Stainless*	

\* Brilliance® Anti-Tarnish Lifetime Finishes

[www.plumbsupply.com](http://www.plumbsupply.com) • Serving our Customers Since 1946 • [www.waterconcepts.net](http://www.waterconcepts.net)

## Shower Heads, Arms & Flanges

### Tesla™ Showerhead

- 3-Setting H2Okinetic® showerhead
- Full body
- H2Okinetic®
- Pause
- Self-cleaning H2Okinetic® spray holes
- 7-1/2" Spray face diameter
- 3-1/2" Showerhead length
- Watersense® certified: 2.0 gpm @ 80 psi



Part #	Mfg #	Description	Price
189179	52690	Chrome	
252003	52690-CZ	Champagne Bronze*	
188815	52690-RB	Venetian Bronze®	
181311	52690-SS	Stainless*	

### Universal HydroRain® 2-in-1 Showerhead

- Shower arm mount
- 5-Settings:
- Pause
- Massage
- Full body spray
- H2Okinetic® spray
- Full spray with massage
- 6" Raincan spray face diameter
- Raincan pivots 40°
- 4" Showerhead spray face diameter
- 14" Showerhead depth
- H2Okinetic® self-cleaning & Touch-Clean® spray holes
- Shower head lever changes spray setting and diverts water from shower head to raincan or both
- WaterSense® certified: 1.75 gpm



Part #	Mfg #	Description	Price
245629	58581-PK	Chrome	
257463	58581-RB-PK	Venetian Bronze	
256037	58581-SS-PK	Stainless*	

### Universal Showerhead

- Single-setting showerhead
- Full body spray
- 6" Spray face diameter
- 2-3/4" Showerhead length
- WaterSense® certified: 2.0 gpm @ 80 psi



Part #	Mfg #	Description	Price
160568	RP61181	Chrome	

### Showerheads (Continued)

#### Universal Showerhead

Part #	Mfg #	Description	Price
149683	RP61181BN	Brushed Nickel*	
170235	RP61181OB	Oil Rubbed Bronze	

#### Universal Water-Amplifying Showerhead

- Single-setting showerhead
- Adjustable H2Okinetic® spray
- 1/2" IPS connection
- 4-1/16" Spray face diameter
- 4-5/8" Showerhead length
- Maximum flow rate: 2.50 gpm @ 80 psi



Part #	Mfg #	Description	Price
242205	75152	Chrome	

#### Fundamentals™ 2-Setting Showerhead

- Spray settings:
- Pause
- Full body spray
- 3" Showerhead length
- 1-5/8" Spray face diameter
- Maximum flow: 2.0 gpm @ 80 psi



Part #	Mfg #	Finish	Price
108614	52650-PK	Chrome	

#### Fundamentals™ 2-Setting Showerhead 1"

- Spray settings:
- Pause
- Full body spray
- Brass construction
- 2-1/2" Showerhead length
- 1" Spray face diameter
- Maximum flow: 2.5 gpm @ 80 psi



Part #	Mfg #	Finish	Price
108613	52652-PK	Chrome	

\* Brilliance® Anti-Tarnish Lifetime Finishes



## Shower Heads, Arms & Flanges

### Fundamentals™ Single-Setting Showerhead

- Full body spray
- 1" Spray face diameter
- 2" Showerhead length
- Brass construction
- Maximum flow: 2.5 gpm @ 80 psi



Part #	Mfg #	Description	Price
159913	52654-PK	Chrome	

### Fundamentals™ Water-Efficient Showerhead

- Single-setting showerhead
- High efficiency spray
- 2-1/4" Spray face diameter
- 3-3/4" Showerhead length
- WaterSense® certified: 1.5 gpm @ 80 psi



Part #	Mfg #	Finish	Price
120563	52653-PK	Chrome	

### Fundamentals™ Touch-Clean® Showerhead

- Single-setting showerhead
- full spray
- 2-7/8" Spray face diameter
- 3-1/2" Showerhead length
- Features Touch-Clean® spray holes



Part #	Mfg #	Finish	Price
150654	52672-PK	2.5 gpm, Chrome	
147248	52672-WH-PK	2.5 gpm, White	
173545	52672-15-BG	1.5 gpm, Chrome	

### Fundamentals™ 3-Setting Showerhead

- (3) Spray settings
- Full body spray
- Massage spray
- Crossing full spray
- 3" Spray face diameter
- 3-5/8" Showerhead length
- Maximum flow rate: 2.5 gpm @ 80 psi



Part #	Mfg #	Description	Price
152108	52675-WH-PK	White/Chrome	

### Fundamentals™ 2-1/2" Showerhead

- Adjustable spray metal shower head
- 2-1/2" Spray face diameter
- 4-1/4" Showerhead length
- Six spray jets
- Maximum flow: 2.5 gpm @ 80 psi



Part #	Mfg #	Finish	Price
147523	52667-PK	Chrome	
155006	52667-SS-PK	Stainless*	

### Universal Contemporary Water-Efficient Showerhead

- Self-cleaning H2OKinetic® spray holes
- 4" Spray face diameter
- 4-1/2" Showerhead length
- H2OKinetic® spray



Part #	Mfg #	Finish	Price
145621	52655	Chrome, 2.0gpm	
163658	52657	Chrome, 2.5gpm	

### Fundamentals™ 4-Setting Showerhead

- Spray settings:
- Pause
- Full body spray
- Full spray w/ massage
- Fast massage
- Touch-Clean® spray holes
- MB = metal ball
- 3" Spray face diameter
- 3-3/4" Showerhead length
- 2.5gpm @ 80psi



Part #	Mfg #	Finish	Price
147349	52102-MB	Chrome	

\* Brilliance® Anti-Tarnish Lifetime Finishes

[www.plumbsupply.com](http://www.plumbsupply.com) • Serving our Customers Since 1946 • [www.waterconcepts.net](http://www.waterconcepts.net)

## Shower Heads, Arms & Flanges

### Fundamentals™ 3" Showerhead

- Four-setting showerhead:
  - Full body spray
  - Massage spray
  - Crossing full spray
  - Crossing full spray w/ massage
- 3" Spray face diameter
- 3-7/8" Showerhead length
- 2.5 gpm @ 80 psi
- (-20 Models 2.0 gpm @ 80 psi)



Part #	Mfg #	Finish	Price
001256	52665-PK	Chrome	

### Fundamentals™ 3" Touch-Clean® Showerhead

- Single-setting showerhead
  - Full body spa
- Features Touch-Clean® spray holes
- 3" Spray face diameter
- 2-13/4" Showerhead length
- WaterSense® certified: 2.0 gpm @ 80 psi



Part #	Mfg #	Finish	Price
117963	RP43164	Chrome	
114140	RP4316RB	Venetian Bronze®	
105055	RP43164SS	Stainless*	

### Universal 3-1/2" Touch-Clean® Showerhead (2)

- Five-setting showerhead
  - Pause
  - Full body spray
  - Full body spray w/ massage
  - Fast massage
  - Soft drench spray
- Features Touch-Clean® spray holes
- 3-3/4" Spray face diameter
- 4-1/4" Showerhead length
- Maximum flow: 2.5 gpm @ 80 psi



Part #	Mfg #	Finish	Price
166822	52678-PK	Chrome	
164046	52678-PB-PK	Polished Brass*	
147521	52678-RB-PK	Venetian Bronze®	
163079	52678-SS-PK	Stainless*	

### Premium 7-Setting Showerhead

- Settings include:
  - Full body
  - Fast massage
  - Full spray w/ massage
  - Shampoo rinsing
  - Soft drench
  - Soft drench w/ full
  - Pause
- 1/2" IPS connection
- Maximum flow: 1.75 gpm @ 80 psi



Part #	Mfg #	Description	Price
222779	52626-PB-PK	Polished Brass*	
229603	52626-RB-PK	Venetian Bronze®	
232009	52626-SS-PK	Stainless	

### Universal Touch-Clean® Showerhead

- Five-setting showerhead
  - Pause
  - Full body spray
  - Full spray w/ massage
  - H2Okinetic® spray
  - Massage spray
- 4-1/8" Spray face diameter
- 5-1/4" Showerhead length
- Self-cleaning H2Okinetic® spray holes
- WaterSense® certified: 2.0 gpm @ 80 psi



Part #	Mfg #	Description	Price
185819	52637-15-PK	Chrome, 1.5 gpm	
257020	52637-SS15-PK	Stainless*, 1.5 gpm	
251643	52637-PN18-PK	Polished Nickel, 1.75 gpm	
257981	52637-RB18-PK	Venetian Brnze, 1.75 gpm	
248974	52637-SS18-PK	Stainless*, 1.75 gpm	

### Universal 5-Setting Showerhead

- Five spray patterns
  - Full body spray
  - Full spray with massage
  - Massaging spray
  - Drenching spray
  - Soft drench with full spray
- WaterSense® certified: 2.0 gpm



Part #	Mfg #	Description	Price
228466	52636-SS-PK	Stainless*	

\* Brilliance® Anti-Tarnish Lifetime Finishes

www.waterconcepts.net • Serving our Customers Since 1946 • www.plumbsupply.com



## Shower Heads, Arms & Flanges

### Universal 5-Setting Contemporary Showerhead

- Five spray patterns
  - Pause
  - Full body spray
  - Full spray w/ massage
  - H2Okinetic® spray
  - Massage spray
- Touch-Clean® spray holes
- Self-cleaning H2Okinetic® spray holes
- H2Okinetic® showerhead
- 4-3/16" Spray face diameter
- 3-1/4" Showerhead length
- WaterSense® certified



Part #	Mfg #	Description	Price
174044	52638-15-PK	Chrome, 1.5 gpm	
238069	52638-20-PK	Chrome, 2.0 gpm	
236397	52638-BL20-PK	Matte Black, 2.0 gpm	
260922	52638-RB18-PK	Venetian Brnz, 1.75 gpm	
187829	52638-RB20-PK	Venetian Bronze, 2.0 gpm	

### 5-Setting Showerhead

- Touch-Clean® spray holes
- Flow rate: 2.0 gpm @ 80 psi



Part #	Mfg #	Description	Price
223737	RP78575	Chrome	
241177	RP78575CZ	Champagne Bronze	
221375	RP78575RB	Venetian Bronze®	
228076	RP78575SS	Stainless*	

### Fundamentals™ 3-5/16" Touch-Clean® Showerhead

- Single-setting showerhead
- Full body spray
- 3-5/16" Spray face diameter
- 2-13/16" Showerhead length
- Coordinates with Leland® and Lahara®
- WaterSense® certified: 2.5 gpm @ 80 psi



Part #	Mfg #	Finish	Price
084340	RP41589	Chrome	
100253	RP41589RB	Venetian Bronze®	

### Showerheads (Continued)

#### Fundamentals™ 3-5/16" Touch-Clean® Showerhead

Part #	Mfg #	Finish	Price
117475	RP41589SS	Stainless*	

#### Universal 4-1/2" Touch-Clean® 3-Function Showerhead

- Spray settings:
  - Full body spray
  - Massage spray
  - Soft drench spray
- Features Touch-Clean® spray holes
- 4-1/2" Spray face diameter
- 4" Showerhead length
- Maximum flow: 2.5 gpm @ 80 psi



Part #	Mfg #	Finish	Price
112551	RP48590	Chrome	
113409	RP48590SS	Stainless*	

#### Universal Raincan Showerhead

- Touch-Clean® spray holes
- 6-9/16" Spray face diameter
- 3-1/8" Showerhead length
- WaterSense® certified: 1.75 gpm @ 80 psi



Part #	Mfg #	Finish	Price
255636	52283	Chrome	

#### Universal Water-Efficient H2Okinetic® Showerhead

- Single-setting showerhead
- H2Okinetic® spray
- Self-cleaning H2Okinetic® spray holes
- 3-1/4" Spray face diameter
- 4-3/4" Showerhead length
- WaterSense® certified: 1.5 gpm @ 80 psi



Part #	Mfg #	Finish	Price
117776	RP46384	Chrome	
139671	RP46384SS	Stainless*	

\* Brilliance® Anti-Tarnish Lifetime Finishes

[www.plumbsupply.com](http://www.plumbsupply.com) • Serving our Customers Since 1946 • [www.waterconcepts.net](http://www.waterconcepts.net)

## Shower Heads, Arms & Flanges

### Universal Traditional Water-Efficient Showerhead

- Single-setting H2Okinetic® showerhead -H2Okinetic® spray
- Self-cleaning H2Okinetic® spray holes
- 3-7/8" Diameter spray face
- 4-1/2" Showerhead length
- WaterSense® certified: 1.5 gpm @ 80 psi



Part #	Mfg #	Finish	Price
128826	RP54752	Chrome	
130320	RP54752RB	Venetian Bronze®	
130319	RP54752SS	Stainless*	

### Universal Traditional Water-Efficient Showerhead

- Single-setting H2Okinetic® showerhead -H2Okinetic® spray
- Self-cleaning H2Okinetic® spray holes
- 3-7/8" Spray face diameter
- 4-1/2" Showerhead length
- WaterSense® certified



Part #	Mfg #	Description	Price
173544	52658-PK	Chrome, 1.5 gpm	
147737	52658-SS-PK	Stainless*, 1.5 gpm	
147736	52659-PK	Chrome, 2.0 gpm	
151946	52659-SS-PK	Stainless*, 2.0 gpm	
163114	52660-PK	Chrome, Adj 2.0 to 1.5 gpm	
147738	52660-RB-PK	Venetian Bronze®, Adj 2.0 to 1.5 gpm	
147559	52660-SS-PK	Stainless*, Adj 2.0 to 1.5 gpm	

### Universal Single-Setting Showerhead

- Full body spray
- 2.5 gpm @ 80 psi



Part #	Mfg #	Description	Price
125954	52140-VP-PK	Chrome, 2.5 gpm	

### Universal Round H2Okinetic® Showerhead

- Single-setting showerhead -H2Okinetic® spray
- Self-cleaning H2Okinetic® spray holes
- 5-1/2" Spray face diameter
- 2-5/8" Showerhead length
- WaterSense® certified: 2.0 gpm @ 80 psi



Part #	Mfg #	Description	Price
163621	RP70175	Chrome	
239639	RP70175-15	Chrome, 1.5 gpm	
255693	RP70175-20	Chrome, 2.0 gpm	
243016	RP70175-BL	Matte Black	
180015	RP70175-RB	Venetian Bronze®	
165425	RP70175-SS	Stainless*	

### Universal H2Okinetic® Contemporary Showerhead

- Touch-Clean® spray holes
- Push button diverter
- 5-setting raincan showerhead -Pause -Full body spray -Massaging spray -H2Okinetic® spray -Full spray with massage
- 6" Spray face diameter
- 3-15/16" Showerhead length
- WaterSense® certified: 1.75 gpm @ 80 psi



Part #	Mfg #	Description	Price
240537	52668	Chrome	
249801	52668-BL	Matte Black	
257140	52668-RB	Venetian Bronze	
240538	52668-SS	Stainless*	

\* Brilliance® Anti-Tarnish Lifetime Finishes

www.waterconcepts.net • Serving our Customers Since 1946 • www.plumbsupply.com

## Shower Heads, Arms & Flanges

### Universal H2Okinetic® Traditional Showerhead

- Touch-Clean® spray holes
- Push button diverter
- 5-setting raincan showerhead
  - Pause
  - Full body spray
  - Massaging spray
  - H2Okinetic® spray
  - Full spray with massage
- 6" Spray face diameter
- 4" Showerhead length
- WaterSense® certified: 1.75 gpm @ 80 psi



Part #	Mfg #	Description	Price
243783	52669	Chrome	
250765	52669-PN	Polished Nickel*	
243791	52669-RB	Venetian Bronze	
259755	52669-SS	Stainless*	

### Universal Contemporary Overhead Showerhead

- Single-setting showerhead
  - Soft rain spray
- 8-1/2" Spray face diameter
- 3-7/8" Showerhead length
- Brass construction
- Maximum flow: 2.5 gpm @ 80 psi



Part #	Mfg #	Finish	Price
146289	52682	Chrome	
145270	52682-RB	Venetian Bronze®	
145213	52682-SS	Stainless*	

### Universal Contemporary Overhead Raincan Showerhead

- Single-setting showerhead
  - Soft rain spray
- 6" Spray face across
- 3-1/2" Showerhead length
- Brass construction
- Maximum flow: 2.5 gpm @ 80 psi



Part #	Mfg #	Finish	Price
124312	52689	Chrome	
158652	52689-RB	Venetian Bronze®	
148076	52689-SS	Stainless*	

### Universal Contemporary Raincan Showerhead

- 3-Setting H2Okinetic® showerhead
  - Pause
  - Full body spray
  - H2Okinetic® spray
- Self-cleaning H2Okinetic® spray holes
- 7-5/8" Spray face diameter
- 3-1/2" showerhead length
- WaterSense® certified: 2.0 gpm @ 80 psi



Part #	Mfg #	Description	Price
181493	52684	Chrome	
234211	52684-BL	Matte Black	
188377	52684-CZ	Champagne Bronze™	
233771	52684-PN	Polished Nickel*	
169836	52684-RB	Venetian Bronze®	
171391	52684-SS	Stainless*	

### Universal Square Metal Raincan Showerhead

- Single-setting showerhead
  - Soft rain spray
- 11-3/4" x 11-3/4" Spray face
- Touch-Clean® spray holes
- Brass construction
- 1/2"-14 NPT pipe fitting
- Metal ball connector swivel angle is 36° (18 per side)
- Maximum flow: 2.5 gpm @ 80 psi



Part #	Mfg #	Finish	Price
258011	52159-BL25	Matte Black	
257482	52159-PN25	Polished Nickel*	
258749	52159-RB25	Venetian Bronze®	
257851	52159-SS25	Stainless*	

### Universal Round Metal Raincan Showerhead

- Single-setting showerhead
  - Soft rain spray
- 11-3/4" Spray face
- Touch-Clean® spray holes
- Brass construction
- 1/2"-14 NPT pipe fitting
- Metal ball connector swivel angle is 36° (18 per side)
- Maximum flow: 2.5 gpm @ 80 psi



Part #	Mfg #	Finish	Price
259541	52158-25	Chrome	
259579	52158-SS25	Stainless*	

\* Brilliance® Anti-Tarnish Lifetime Finishes

## Shower Heads, Arms & Flanges

### Universal Raincan Showerhead

- Three-setting showerhead
- Full body spray
- Full spray w/ massage
- Massaging spray
- Touch-Clean® spray holes
- 8" Spray face diameter
- Maximum flow: 2.5 gpm @ 80 psi



Part #	Mfg #	Description	Price
173180	75353	Chrome	

### Universal Raincan Showerhead

- Single-setting showerhead
- Soft rain spray
- Touch-Clean® spray holes
- 1/2" IPS connection
- 8" Spray face diameter
- 2-1/2" Showerhead length
- WaterSense® certified: 1.75 gpm @ 80 psi



Part #	Mfg #	Description	Price
246201	52841	Chrome	
234897	52841-SS	Stainless*	

### Universal Traditional Raincan Showerhead

- 3-Setting H2Okinetic® showerhead
- Pause
- Full body spray
- H2Okinetic® spray
- 8-1/4" Spray face diameter
- 3-7/8" Showerhead length
- Touch-Clean® spray holes
- Self-cleaning H2Okinetic® spray holes
- WaterSense® certified: 2.0 gpm @ 80 psi



Part #	Mfg #	Description	Price
170470	52687	Chrome	
178258	52687-PN	Polished Nickel*	
170017	52687-RB	Venetian Bronze®	
175919	52687-SS	Stainless*	

### Universal Transitional Raincan Showerhead Round

- 3-Setting H2Okinetic® showerhead
- Pause
- Full body spray
- H2Okinetic® spray
- 7-3/4" Spray face diameter
- 3-1/2" Showerhead length
- Touch-Clean® spray holes
- Self-cleaning H2Okinetic® spray holes
- WaterSense® certified: 2.0 gpm @ 80 psi



Part #	Mfg #	Description	Price
169876	52688	Chrome	
235178	52688-BL	Matte Black	
226889	52688-CZ	Champagne Bronze™	
184225	52688-RB	Venetian Bronze®	
172761	52688-SS	Stainless*	

### Universal Transitional Raincan Showerhead

- 5-Setting H2Okinetic® showerhead
- Pause
- Full body spray
- Massaging spray
- H2Okinetic® spray
- Full spray with massage
- Push button diverter
- 6" Spray face diameter
- 4" Showerhead length
- Touch-Clean® spray holes
- WaterSense® certified: 1.75 gpm @ 80 psi



Part #	Mfg #	Description	Price
251989	52666	Chrome	
245477	52666-SS	Stainless*	

### Universal Transitional Raincan Showerhead Square

- 3-Setting H2Okinetic® showerhead
- Pause
- Full body spray
- H2Okinetic® spray
- Touch-Clean® spray holes
- Self-cleaning H2Okinetic® spray holes
- 7-3/4" Spray face diameter
- 3-3/8" Showerhead length
- WaterSense® certified: 2.0 gpm @ 80 psi



Part #	Mfg #	Description	Price
175793	52686	Chrome	

\* Brilliance® Anti-Tarnish Lifetime Finishes



## Shower Heads, Arms & Flanges

### Showerheads (Continued)

#### Universal Transitional Raincan Showerhead Square

Part #	Mfg #	Description	Price
172582	52686-RB	Venetian Bronze®	
174315	52686-SS	Stainless*	

#### Universal Traditional Raincan Showerhead

- Single-setting showerhead  
-full body spray
- 9-3/8" Spray face diameter
- 4-1/2" Shower head length
- Touch-clean® spray holes
- Maximum flow: 2.5 gpm @ 80 psi



Part #	Mfg #	Description	Price
155251	RP72568	Chrome	
156707	RP72568-CZ	Champagne Bronze™	
172169	RP72568-PN	Polished Nickel*	
151100	RP72568-RB	Venetian Bronze®	
150789	RP72568-SS	Stainless*	

#### Universal 8-3/4" Touch-Clean® Raincan Showerhead

- Single-setting showerhead  
-Full body spray
- Touch-Clean® spray holes
- 8-3/4" Spray face diameter
- 2" Showerhead length
- Maximum flow: 2.5 gpm @ 80 psi



Part #	Mfg #	Finish	Price
121164	RP52382	Chrome	
140160	RP52382PB	Polished Brass*	
117370	RP52382RB	Venetian Bronze®	
117613	RP52382SS	Stainless*	

#### Universal 8" Touch-Clean® Raincan Showerhead

- 3-Setting showerhead  
-Full body spray  
-Full spray w/ massage  
-Massage spray
- Touch-Clean® spray holes
- 8" Spray face diameter
- 4-3/4" Showerhead length
- Maximum flow: 2.5 gpm @ 80 psi



Part #	Mfg #	Finish	Price
151177	52680	Chrome	
183589	52680-CZ	Champagne Bronze™	
148039	52680-RB	Venetian Bronze®	
147540	52680-SS	Stainless*	

#### Universal 7-1/2" Touch-Clean® Raincan Showerhead

- Single-setting showerhead  
-Full body spray
- 7-1/2" Spray face diameter
- 2-3/4" Showerhead length
- WaterSense® certified:  
2.5 gpm @ 80 psi



Part #	Mfg #	Finish	Price
109355	RP48686	Chrome	
154521	RP48686CZ	Champagne Bronze™	
107087	RP48686PB	Polished Brass*	
105330	RP48686RB	Venetian Bronze®	
109353	RP48686SS	Stainless*	

#### Universal 5-7/8" Touch-Clean® Raincan Showerhead

- Single-setting showerhead  
-Full body spray
- Touch-Clean® spray holes
- 5-7/8" Spray face diameter
- 2-1/2" Showerhead length
- Maximum flow: 2.5 gpm @ 80 psi



Part #	Mfg #	Finish	Price
089200	RP42578	Chrome	
088759	RP42578SS	Stainless*	

\* Brilliance® Anti-Tarnish Lifetime Finishes

## Shower Heads, Arms & Flanges

### Universal 5" Touch-Clean® 5-Setting Showerhead

- Spray settings
  - Pause
  - Full body spray
  - Full spray w/ massage
  - Massage spray
  - Soft-drench spray
- Touch-Clean® spray holes
- 5" Spray face diameter
- 3" Showerhead length
- Maximum flow: 2.5 gpm @ 80 psi



Part #	Mfg #	Finish	Price
146612	52683	Chrome	
148075	52683-SS	Stainless*	

### Universal Traditional Single-Setting Showerhead

- H2Okinetic® technology  
H2Okinetic® spray
- Self-cleaning H2Okinetic® spray holes
- 8" Spray face diameter
- 3-1/3" Showerhead length
- WaterSense® certified: 2.0gpm @80 psi



Part #	Mfg #	Description	Price
170650	RP70172	Chrome	
173184	RP70172-CZ	Champagne Bronze™	
154081	RP70172-RB	Venetian Bronze®	

### Universal Transitional Single-Setting Showerhead

- H2Okinetic® showerhead  
-H2Okinetic spray
- Self-cleaning H2Okinetic® spray holes
- 6-1/2" Spray face diameter
- 3" Showerhead length
- WaterSense® certified: 2.0 gpm @ 80 psi



Part #	Mfg #	Description	Price
148532	RP70173	Chrome	
145829	RP70173-CZ	Champagne Bronze™	
166960	RP70173-RB	Venetian Bronze®	
160299	RP70173-SS	Stainless*	

### Universal 5-Setting H2Okinetic® Showerhead

- Touch-Clean® spray holes
- 5-Setting showerhead
  - H2Okinetic® spray
  - Massaging spray
  - Full body spray
  - Pause
- 6" Spray face diameter
- 3-15/16" Showerhead length
- WaterSense® certified: 1.75 gpm @ 80 psi



Part #	Mfg #	Description	Price
260935	52663-BL	Matte Black	
256524	52663-SS	Stainless*	

### Universal Raincan Showerhead

- Single-setting showerhead  
-Full body spray
- 6" spray face diameter
- 12" adjustable shower arm
- Adjustable up and down 18"
- Showerhead swivels 180°
- Maximum flow: 2.5 gpm @ 80 psi



Part #	Mfg #	Description	Price
153412	52687-PK	Chrome	

### Vero™ 8-5/8" Touch-Clean® Raincan Showerhead

- Single-setting showerhead  
-Full body spray
- Touch-Clean® spray holes
- Showerhead is 8-5/8" across
- 5-11/16" Showerhead length
- Maximum flow: 2.5 gpm @ 80 psi



Part #	Mfg #	Finish	Price
136167	RP62955	Chrome	
170128	RP62955CZ	Champagne Bronze™	
256266	RP62955PN	Polished Nickel*	
145211	RP62955RB	Venetian Bronze®	
135608	RP62955SS	Stainless*	

\* Brilliance® Anti-Tarnish Lifetime Finishes



## Shower Heads, Arms & Flanges

### Victorian® Touch-Clean® 3-Function Showerhead

- Three-setting showerhead
  - Full body spray
  - Massage spray
  - Soft drench spray
- Touch-Clean® spray holes
- 5-1/2" Spray face diameter
- 4-5/16" Showerhead length
- Maximum flow: 2.5 gpm @ 80 psi



Part #	Mfg #	Finish	Price
058976	RP34355	Chrome	
144582	RP34355-CZ	Champagne Bronze™	
071162	RP34355-RB	Venetian Bronze®	
097715	RP34355-SS	Stainless*	

### Zura® Pendant Raincan Showerhead

- H2Oknetic® technology
- Single-setting showerhead
  - H2Oknetic spray
- 1/2" IPS connection
- For use with 9" ceiling
- Maximum flow: 2.0 gpm @ 80 psi



Part #	Mfg #	Description	Price
232101	57140	Chrome	
237952	57140-BL	Matte Black	

### Temp2O® Showerheads

LED digital temperature display, powered by (3) AAA batteries (included) with an estimated two-year battery life

#### Temp2O® Showerhead

- Six-setting showerhead:
  - Full Body spray
  - Full Spray w/ massage
  - Massaging
  - Shampoo Rinsing
  - Shampoo Rinsing w/ massage
  - Soft drench spray
- 4-3/4" Spray face diameter
- 5-1/4" Showerhead length
- Touch-Clean® spray holes
- WaterSense® certified: 2.0 gpm @ 80 psi



Part #	Mfg #	Description	Price
182498	52646-RB-PK	Venetian Bronze®	
177448	52646-SS-PK	Stainless*	

### Integrated Showers

#### ActivTouch Handshower/Showerhead Combo Pack

- Rubber spray holes
- Spray settings:
  - Full body
  - Fast massage
  - Full spray with massage
  - Shampoo rinsing
  - Shampoo rinsing with massage
  - Soft drench
  - Soft drench with massage
  - Soft full
  - Pause
- 60"-82" Hose
- Flow rate: 2.50 gpm @ 80 psi
- (58968) Flow rate: 2.0 gpm @ 80 psi



Part #	Mfg #	Description	Price
235713	58968-PK	Chrome	
223601	58968-SS-PK	Stainless*	

#### Classic In2ition® Two-In-One Showerhead (2)

- Integrated showerhead and handshower
- 2.5 gpm @ 80 psi
- (4) Spray settings
- 60" to 82" Stretchable metal hose
- Showerarm and flange NOT included



Part #	Mfg #	Finish	Price
146094	58467	Chrome	
122327	58467-SS	Stainless*	

#### HydroRain Raincan Showerhead

- Soft, rubber Touch-Clean® spray holes
- 7-7/8" Diameter
- Five-settings include:
  - Drenching spray
  - Pause spray
  - Shampoo Rinsing spray
  - Slow Massage spray
  - Soft Drench with full spray
- WaterSense® certified: 2.0 gpm @ 80 psi



Part #	Mfg #	Description	Price
235253	58580-PK	Chrome	
237704	58580-SS-PK	Stainless*	
241016	58580-RB-PK	Venetian Bronze®	

\* Brilliance® Anti-Tarnish Lifetime Finishes

[www.plumbsupply.com](http://www.plumbsupply.com) • Serving our Customers Since 1946 • [www.waterconcepts.net](http://www.waterconcepts.net)

## Shower Heads, Arms & Flanges

### In2ition® Two-In-One Showerhead

- Integrated handshower docks securely into showerhead when not in use
- (4) Spray settings and pause
- 6' Tangle-free hose
- 2.5 gpm @ 80 psi



Part #	Mfg #	Finish	Price
134022	58065	Chrome	
158691	58065-CZ	Champagne Bronze™	
135612	58065-RB	Venetian Bronze®	
134023	58065-SS	Stainless*	

### In2ition® Two-In-One Square Showerhead

- Integrated H2Okinetic® showerhead and handshower
- 60" to 82" Stretchable metal hose
- 2.5 gpm @ 80 psi
- 2.0 gpm (58473)
- Showerarm and flange not included
- 4-Setting handshower:
  - Pause
  - H2Okinetic® spray
  - Massage spray
  - H2Okinetic® with massage spray
- MagnaTite® docking



Part #	Mfg #	Description	Price
224660	58473	2.0gpm, Chrome	
227959	58473-RB	2.0gpm, Venetian Bronze	
224659	58473-SS	2.0gpm, Stainless*	

### In2ition® Contemporary Two-In-One Showerhead

- Integrated handshower
- 60" - 82" Stretchable metal hose
- Shower arm mount
- Shower arm and flange sold separately
- MagnaTite® docking
- 2.5 gpm @ 80 psi
- 4-Setting handshower:
  - Pause
  - H2Okinetic® spray
  - Massage spray
  - H2Okinetic® w/ massage spray



Part #	Mfg #	Description	Price
155321	58472	Chrome	
169568	58472-RB	Venetian Bronze®	
159008	58472-SS	Stainless*	

### In2ition® Traditional Two-In-One Showerhead

- Integrated handshower docks securely into showerhead when not in use
- 60" to 82" Stretchable metal hose
- 2.5 gpm @ 80 psi
- Showerarm and flange not included
- Change spray modes with push button
- 4-Setting handshower:
  - Pause
  - Massage spray
  - H2Okinetic™ spray
  - H2Okinetic™ spray w/ massage



Part #	Mfg #	Description	Price
153400	58471-PK	Chrome	
165488	58471-CZ-PK	Champagne Bronze™	
171598	58471-PN-PK	Polished Nickel*	
152495	58471-RB-PK	Venetian Bronze®	
151569	58471-SS-PK	Stainless*	

\* Brilliance® Anti-Tarnish Lifetime Finishes

www.waterconcepts.net • Serving our Customers Since 1946 • www.plumbsupply.com

## Shower Heads, Arms & Flanges

### In2ition® 4-Setting Two-In-One Showerhead

- Diverter lever sets:  
Shower head and hand shower  
Shower head only  
Hand shower only
- Pause feature
- Touch-Clean® spray holes
- Spray settings:  
-Full Body  
-Fast Massage  
-Full Spray with Massage
- Includes 72 in. hose
- WaterSense® certified: 2.0 gp, @ 80 psi



Part #	Mfg #	Description	Price
190444	58465-PK	Chrome	

### In2ition® Two-In-One 5-Setting Showerhead

- Five spray settings:  
-Full Body  
-Fast Massage  
-Full Spray with Massage  
-Slow Massage  
-Pause
- 82" Hose
- Touch-Clean® spray holes
- WaterSense® Certified: 2.0 gpm



Part #	Mfg #	Description	Price
189580	58569-PK	Chrome	
190357	58569-RB-PK	Venetian Bronze®	
190417	58569-CZ-PK	Champagne Bronze™	
190132	58569-SS-PK	Stainless*	

### In2ition® Two-In-One 5-Setting Showerhead

- Five spray settings:  
-Full Body  
-Fast Massage  
-Full Spray with Massage  
-Slow Massage  
-Pause
- 82" Hose
- Touch-Clean® spray holes
- WaterSense® Certified: 2.0 gpm



Part #	Mfg #	Description	Price
189934	58066	Chrome	
190473	58066-RB	Venetian Bronze®	
189679	58066-SS	Stainless*	

### H2Okinetic® In2ition® Two-in-One Showerhead

- Integrated handshower docks securely into showerhead when not in use
- Touch-Clean® nozzles
- 60" to 82" Stretchable metal hose
- 2.0 gpm @ 80 psi
- Showerarm and flange not included
- 5-Spray setting handshower



Part #	Mfg #	Description	Price
176161	58480-PK	Chrome	
237334	58480-BL-PK	Matte Black	
189132	58480-CZ-PK	Champagne Bronze™	
188927	58480-PN-PK	Polished Nickel*	
175914	58480-RB-PK	Venetian Bronze®	
175158	58480-SS-PK	Stainless*	

## Showerarms & Flanges

### Adjustable Showerarm



Part #	Mfg #	Description	Price
111132	UA902-PK	Chrome	

### 3" Ceiling-Mount Showerarm

- 1/2" IPS male threads
- 3" Long, 2-7/8" outside diameter
- Includes flange



Part #	Mfg #	Description	Price
149538	U4996	Chrome	
170129	U4996-CZ	Champagne Bronze™	
110274	U4996-RB	Venetian Bronze®	
145215	U4996-SS	Stainless*	

### 6" Ceiling Mount Showerarm and Flange

- 1/2" IPS Male threads
- 6" Long, 2-1/2" diameter
- Includes flange



Part #	Mfg #	Finish	Price
127429	RP61058	Chrome	
143043	RP61058CZ	Champagne Bronze™	

\* Brilliance® Anti-Tarnish Lifetime Finishes

## Shower Heads, Arms & Flanges

### Showerarms & Flanges (Continued)

#### 6" Ceiling Mount Showerarm and Flange

Part #	Mfg #	Finish	Price
172167	RP61058PN	Polished Nickel*	
126907	RP61058RB	Venetian Bronze®	
126996	RP61058SS	Stainless*	

#### 9" Ceiling-Mount Showerarm and Flange

- 1/2" IPS male threads
- 9" Long, 2-7/8" outside diameter
- Includes flange

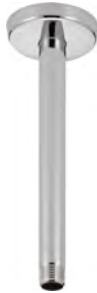

Part #	Mfg #	Description	Price
147351	U4999	Chrome	
172072	U4999-CZ	Champagne Bronze™	
091205	U4999-RB	Venetian Bronze®	
075690	U4999-SS	Stainless*	

#### 5-1/2" Showerarm

- 1/2" IPS male threads



Part #	Mfg #	Finish	Price
003668	RP6023	Chrome	
171602	RP6023PN	Polished Nickel	
086749	RP6023RB	Venetian Bronze®	
099955	RP6023SS	Stainless*	

#### 7" Showerarm

- 1/2" IPS male threads



Part #	Mfg #	Finish	Price
088072	RP40593	Chrome	
237336	RP40593BL	Matte Black	
144583	RP40593CZ	Champagne Bronze™	
172826	RP40593PN	Polished Nickel*	
117371	RP40593RB	Venetian Bronze®	
089812	RP40593SS	Stainless*	

#### 15" Curved Showerarm

- 1/2" IPS male threads



Part #	Mfg #	Finish	Price
131866	RP61273	Chrome	
137603	RP61273CZ	Champagne Bronze™	
178330	RP61273PN	Polished Nickel*	
127806	RP61273RB	Venetian Bronze®	
130467	RP61273SS	Stainless*	

#### 16" Showerarm

- 1/2" IPS Male threads



Part #	Mfg #	Finish	Price
115430	RP46870	Chrome	
147193	RP46870CZ	Champagne Bronze™	
144636	RP46870RB	Venetian Bronze®	
112142	RP46870SS	Stainless*	

#### 13" to 22" Extendable Showerarm

- Brass construction
- 1/2" IPS male threads
- Extends 13"-22" for overhead showering



Part #	Mfg #	Description	Price
155250	U6930	Chrome	
094365	U6930-RB	Venetian Bronze®	
147591	U6930-SS	Stainless*	

#### 6" Showerarm & Flange

- 1/2" IPS Male threads
- 6" Long, 2-3/8" outside diameter
- Includes flange



Part #	Mfg #	Finish	Price
022374	U4993-PK	Chrome	
175378	U4993-CZ	Champagne Bronze™	
168996	U4993-PB	Polished Brass*	
146054	U4993-RB	Venetian Bronze®	
113876	U4993-SS	Stainless*	

\* Brilliance® Anti-Tarnish Lifetime Finishes

www.waterconcepts.net • Serving our Customers Since 1946 • www.plumbsupply.com

## Shower Heads, Arms & Flanges

### 2-1/2" OD Showerarm and Flange

- 1/2" IPS Male threads
- 5-1/2" Long, 2-1/2" outside diameter
- Includes flange



Part #	Mfg #	Description	Price
067926	RP31554	Chrome	

### Cassidy™ Shower Flange

- 2-3/8" Outside diameter



Part #	Mfg #	Description	Price
216805	RP72562	Chrome	
168313	RP72562CZ	Champagne Bronze™	
172827	RP72562PN	Polished Nickel*	
154170	RP72562RB	Venetian Bronze®	
156482	RP72562SS	Stainless*	

### 2-1/2" Shower Flange

- 2-1/2" Outside diameter



Part #	Mfg #	Finish	Price
003670	RP6025	Chrome	
237335	RP6025BL	Matte Black	
144584	RP6025CZ	Champagne Bronze™	
145301	RP6025OB	Oil Rubbed Bronze	
113918	RP6025RB	Venetian Bronze®	
099957	RP6025SS	Stainless*	

### Shower Flange-Beveled Edge

- 2-1/2" Outside diameter



Part #	Mfg #	Description	Price
096659	RP38452	Chrome	
153502	RP38452RB	Venetian Bronze®	
088886	RP38452SS	Stainless*	

### Arzo® Shower Flange

- 2" Square



Part #	Mfg #	Description	Price
115429	RP46872	Chrome	
112143	RP46872SS	Stainless*	

### Dryden™ 2" Shower Flange

- 2" Outside diameter



Part #	Mfg #	Description	Price
129505	RP52144	Chrome	
165864	RP52144CZ	Champagne Bronze™	
121754	RP52144RB	Venetian Bronze®	
127034	RP52144SS	Stainless*	

### Vero® 2" Shower Flange

- 2" Outside diameter



Part #	Mfg #	Description	Price
138702	RP51034	Chrome	
179912	RP51034CZ	Champagne Bronze	
148040	RP51034RB	Venetian Bronze®	
159416	RP51034SS	Stainless*	

### Victorian® Shower Flange

- 3" Outside diameter



Part #	Mfg #	Description	Price
060355	RP34356	Chrome	
154520	RP34356CZ	Champagne Bronze™	
171601	RP34356PN	Polished Nickel*	
085173	RP34356RB	Venetian Bronze®	

\* Brilliance® Anti-Tarnish Lifetime Finishes

[www.plumbsupply.com](http://www.plumbsupply.com) • Serving our Customers Since 1946 • [www.waterconcepts.net](http://www.waterconcepts.net)





## Shower Heads, Arms & Flanges

### Showerarms & Flanges (Continued)

#### Victorian® Shower Flange

Part #	Mfg #	Description	Price
115147	RP34356SS	Stainless*	

#### 14S/17S/17T Shower Flange

Part #	Mfg #	Description	Price
260582	RP100370SS	Stainless*	

\* Brilliance® Anti-Tarnish Lifetime Finishes

[www.waterconcepts.net](http://www.waterconcepts.net) • Serving our Customers Since 1946 • [www.plumbsupply.com](http://www.plumbsupply.com)



## Shower Heads, Arms & Flanges

### Showerheads

#### Align™ Showerhead

- 3-1/2" Diameter
- Single-function full spray
- Flow rate: 2.5 gpm



Part #	Mfg #	Description	Price
253590	6399BL	Matte Black	

#### 90° Showerhead

- 6" Diameter
- Single-function full spray
- Flow rate: 2.5 gpm



Part #	Mfg #	Description	Price
174700	S6340	Chrome	
175138	S6340BN	Brushed Nickel	

#### Divine Showerhead

- 7" Diameter



Part #	Mfg #	Description	Price
219076	S156	Chrome	

#### Easy Clean® Single-Function Showerhead

- 3-3/8" Diameter
- Full spray
- Flow rate: 2.5 gpm



Part #	Mfg #	Description	Price
140197	6303	Chrome	
196579	6303BN	Brushed Nickel	
164885	6303ORB	Oil Rubbed Bronze	

### Eco-Performance Multi-Function Showerhead

- 3-1/4" Diameter
- 3-Function:
  - Full spray
  - Refreshing spray
  - Targeted massage
- 1/2" IPS connection
- Watersense® certified: 2.0 gpm



Part #	Mfg #	Description	Price
243058	20001	Chrome	

### Enthrall™ Five-Function Rainshower Head

- 9" diameter rainshower
- 5-function
  - Concentrated rinse
  - Deep massage
  - Full rainshower
  - Invigorating spray;
  - Relaxing massage
- 1/2" IPS connection
- Flow Rate: 2.5 gpm
- (EP Model): 1.75 gpm



Part #	Mfg #	Description	Price
250304	21532EP	Chrome	

### Envi Multi-Function Showerhead

- 4" Diameter
- 3-Function:
  - Concentrated rinse
  - Full spray
  - Combination
- Flow rate: 1.75 gpm



Part #	Mfg #	Description	Price
224125	3233EP	Chrome	
146348	3233EPBN	Brushed Nickel	

### ExactTemp Rainhead

- 7" Diameter
- Single-function spray
- Flow rate: 2.5 gpm (EP Model) 2.0 gpm



Part #	Mfg #	Description	Price
156054	S6310EP	2.0 gpm, Chrome	
099756	S6310	Chrome	
098847	S6310BN	Brushed Nickel	
096201	S6310ORB	Oil Rubbed Bronze	

\* Brilliance® Anti-Tarnish Lifetime Finishes

## Shower Heads, Arms & Flanges

### Fina™ Rainhead

- 7" Diameter
- Single-function spray
- Flow rate: 2.5 gpm



Part #	Mfg #	Description	Price
196018	S176	Chrome	
178097	S176BN	Brushed Nickel	

### Flat Rainhead

- 8" Diameter
- Single-function spray
- Immersion™ rainshower technology
- Flow rate: 2.5 gpm



Part #	Mfg #	Description	Price
179483	S6360	Chrome	
146511	S6360BN	Brushed Nickel	
165957	S6360ORB	Oil Rubbed Bronze	

### Icon Showerhead

- 5-7/8" Diameter
- Single-function spray
- Flow rate: 2.5 gpm



Part #	Mfg #	Description	Price
102070	S6312	Chrome	
167441	S6312BN	Brushed Nickel	
250883	S6312EPOB	Oil Rubbed Bronze	

### Isabel Rainhead

- 9" Diameter
- Two-function spray
- Immersion™ rainshower technology
- Flow rate: 2.5 gpm
- (-EP) Eco performance rainshower: 2.0 gpm



Part #	Mfg #	Description	Price
157423	S1311	Chrome	
102844	S1311BN	Brushed Nickel	
152847	S1311NL	Polished Nickel	
186120	S1311ORB	Oil Rubbed Bronze	

### Single Function Showerhead

- 4" Diameter
- Full spray
- Flow rate: 2.5 gpm



Part #	Mfg #	Description	Price
240345	6371BN	Brushed Nickel	
236909	6371ORB	Oil Rubbed Bronze	

### Method Showerhead

- 2-1/2" Diameter
- Full spray
- Flow rate: 2.5 gpm



Part #	Mfg #	Description	Price
099982	6300	Chrome	
152049	6300BN	Brushed Nickel	
122498	6300P	Polished Brass	

### Multi-Function Showerhead

- 4-3/8" Diameter spray head
- Spray functions:
  - Targeted massage
  - Invigorating spray
  - Full spray
  - Combo spray
- Flow rate: 2.5 gpm



Part #	Mfg #	Description	Price
211555	3638	Chrome	
176749	3638BN	Brushed Nickel	
164500	3638ORB	Oil Rubbed Bronze	

### Rainshower Showerhead

- 8" Diameter
- 1/2" IPS
- Flow rate: 2.0 gpm
- (-EP) Eco performance flow rate: 1.75 gpm



Part #	Mfg #	Description	Price
226196	6345	Chrome	
251689	6345EPBN	Brushed Nickel	
224750	6345BN	Brushed Nickel	
227727	6345ORB	Oil Rubbed Bronze	

\* Brilliance® Anti-Tarnish Lifetime Finishes

[www.waterconcepts.net](http://www.waterconcepts.net) • Serving our Customers Since 1946 • [www.plumbsupply.com](http://www.plumbsupply.com)

## Shower Heads, Arms & Flanges

### Rothbury Showerhead

- 1/2" IPS
- Single-Function
- 6-1/2" Diameter
- Flow rate: 2.5 gpm



Part #	Mfg #	Description	Price
093613	S6335	Chrome	
116606	S6335BN	Brushed Nickel	
119072	S6335ORB	Oil Rubbed Bronze	

### Five-Function Showerhead

- 4" Diameter
- 5-Setting:
  - Energizing Spray
  - Invigorating Spray
  - Refreshing Spray
  - Relaxing Spray
  - Targeted Massage
- Limited lifetime warranty



Part #	Mfg #	Description	Price
140696	3855	Chrome	

### Single-Function Showerhead

- 1/2" IPS connections
- 6" Diameter spray head
- Flow rate: 2.5 gpm



Part #	Mfg #	Description	Price
150544	S6365	Chrome	
207479	S6365BN	Brushed Nickel	
149726	S6365ORB	Oil Rubbed Bronze	

### Single-Function Eco-Performace Rainshower

- 1/2" IPS connections
- 10" Diameter spray head
- Eco-Performace WaterSense® certified Flow rate: 1.75 gpm



Part #	Mfg #	Description	Price
252365	S1001	Chrome	

### Single-Function Rainshower Showerhead

- 1/2" IPS connections
- 12" Diameter spray head
- Flow rate: 2.5 gpm



Part #	Mfg #	Description	Price
252917	S1004	Chrome	

### Standard Single-Function Showerhead

- 4-3/8" Diameter
- Single-function spray
- Flow rate: 2.5 gpm



Part #	Mfg #	Description	Price
108381	6302	Chrome	
087350	6302BN	Brushed Nickel	
087780	6302ORB	Oil Rubbed Bronze	
159009	6302P	Polished Brass	

### Velocity Square Showerhead

- 8-1/2" Diameter
- 2-Function spray
  - Concentrated rinse
  - Full rainshower
- Flow rate: 2.5 gpm



Part #	Mfg #	Description	Price
222864	S6345	Chrome	
227845	S6345BN	Brushed Nickel	

### Velocity Round Showerhead

- 8" Diameter
- 2-Function spray
  - Concentrated rinse
  - Full rainshower
- Flow rate: 2.5 gpm



Part #	Mfg #	Description	Price
095810	S6320	Chrome	
095813	S6320BN	Brushed Nickel	
101252	S6320ORB	Oil Rubbed Bronze	

\* Brilliance® Anti-Tarnish Lifetime Finishes

[www.plumbsupply.com](http://www.plumbsupply.com) • Serving our Customers Since 1946 • [www.waterconcepts.net](http://www.waterconcepts.net)

## Shower Heads, Arms & Flanges

### Voss™ Showerhead

- 4-1/16" Diameter
- Single-function spray
- Flow rate: 2.5 gpm



Part #	Mfg #	Description	Price
155227	6325BN	Brushed Nickel	
225074	6325ORB	Oil Rubbed Bronze	

### Waterhill® Showerhead

- 10" Diameter
- Single-function spray
- 1/2" IPS connections
- Flow rate: 2.5 gpm



Part #	Mfg #	Description	Price
119683	S112	Chrome	
094825	S112ORB	Oil Rubbed Bronze	
250884	S112EPORB	Oil Rubbed Bronze	
124906	S112BN	Brushed Nickel	
183894	S112NL	Polished Nickel	
116964	S112WR	Wrought Iron	

### Integrated Showers

#### Engage Handshower/Showerhead

- 3-1/2" Diameter
- Magnetix™ docking system
- 6-Function showerhead
- Flow rate: 2.5 gpm  
-EP models: 2.0 gpm



Part #	Mfg #	Description	Price
227174	26100	Chrome	
226430	26100SRN	Spot Resist Brushed Nickel	
189501	26100EP	2.0 gpm, Chrome	
225050	26100EPSRN	2.0 gpm, Spot Resist Brushed Nickel	

### Engage Handshower/Showerhead

- 5-1/2" Diameter
- Magnetix™ docking system
- 6-Function showerhead
- Flow rate: 2.0 gpm



Part #	Mfg #	Description	Price
189204	26112	Chrome	
232346	26112SRN	Spot Resist Stainless	

### Showerarms & Flanges

#### 90° Showerarm & Flange

- 1/2" IPS
- 8" Length



Part #	Mfg #	Description	Price
180461	S133BN	Brushed Nickel	

#### Arris™ Showerarm

- 1/2" IPS
- 14" Length
- 90° Elbow



Part #	Mfg #	Description	Price
170230	S110	Chrome	
176369	S110BN	Brushed Nickel	

#### Curved Showerarm & Flange

- 1/2" IPS
- 8" Length



Part #	Mfg #	Description	Price
207704	161951	Chrome	
216705	161951BN	Brushed Nickel	

\* Brilliance® Anti-Tarnish Lifetime Finishes

## Shower Heads, Arms & Flanges

### Moen 6" Showerarm

- 1/2" IPS
- 6" Length



Part #	Mfg #	Description	Price
061804	10154	Chrome	
087348	10154BN	Brushed Nickel	
077362	10154P	Polished Brass	
083246	10154ORB	Oil Rubbed Bronze	

### Moen 8" Showerarm

- 1/2" IPS
- 8" Length



Part #	Mfg #	Description	Price
118889	123815	Chrome	
119141	123815BN	Brushed Nickel	
109375	123815ORB	Oil Rubbed Bronze	

### Overhead Showerarm



Part #	Mfg #	Description	Price
185822	151380	Chrome	
133717	151380ORB	Oil Rubbed Bronze	

### Straight Showerarm

- 1/2" IPS
- (336651) 18" Length
- (226651) 12" Length
- (116651) 6" Length



Part #	Mfg #	Description	Price
118036	116651	Chrome	
084875	116651BN	Brushed Nickel	
098672	116651ORB	Oil Rubbed Bronze	
122741	226651	Chrome	
136890	226651BN	Brushed Nickel	
103911	226651ORB	Oil Rubbed Bronze	
248311	336651BN	Brushed Nickel	
248403	336651ORB	Oil Rubbed Bronze	

### Rothbury Showerarm & Flange

- 1/2" IPS
- 8" Length



Part #	Mfg #	Description	Price
141219	S122	Chrome	
148508	S122BN	Brushed Nickel	
149003	S122ORB	Oil Rubbed Bronze	

### Waterhill® 14" Showerarm



Part #	Mfg #	Description	Price
146582	S113	Chrome	
102843	S113BN	Brushed Nickel	
094823	S113ORB	Oil Rubbed Bronze	
195967	S113WR	Wrought Iron	

### Showerarm & Flange



Part #	Mfg #	Description	Price
217143	CL10154	6", Chrome	
217144	CL10154BN	6", Brushed Nickel	
217147	CL123815BN	8", Brushed Nickel	

### Showerarm Flange



Part #	Mfg #	Description	Price
038957	AT2199	Chrome	
083247	AT2199ORB	Oil Rubbed Bronze	
087349	AT2199BN	Brushed Nickel	

\* Brilliance® Anti-Tarnish Lifetime Finishes

[www.plumbsupply.com](http://www.plumbsupply.com) • Serving our Customers Since 1946 • [www.waterconcepts.net](http://www.waterconcepts.net)



---



---

## Shower Heads, Arms & Flanges

---



---

### Showerarm Flange



Part #	Mfg #	Description	Price
114410	137488BN	Brushed Nickel	

### Square Showerarm Flange



Part #	Mfg #	Description	Price
209398	147572	Chrome	

\* Brilliance® Anti-Tarnish Lifetime Finishes



---

---

## Shower Heads, Arms & Flanges

---

---

### Plumbing Specialties

#### Shower Arm

- Chrome plated brass
- 1/2" IPS - Heavy wall thickness



Part #	Mfg #	Size	Finish	Price
008029	1186	8"	Chrome	

#### Shower Arm Flange



Part #	Mfg #	Flange Style	Finish	Price
008030	1187	Set Screw	CP Die Cast	



## Shower Heads, Arms & Flanges

### Lav/Sink/Tub

#### S-Type Shower Arm

- Easier shower arm installations
- Wrench locks into shower arm for secure, no slip installation
- Allows shower arm installation with no external damage



Part #	Mfg #	Conn.	Rise	Finish	Price
052512	974-60315	1/2" MIP	10"	Chrome Plated	

## Shower Heads, Arms & Flanges

### Shower Supplies

#### "S" Showerarm

- Brass
- 1/2" Male IPS
- Raises height of showerhead by 8"
- 1/2" Escutcheons sold separately



Part #	Mfg #	Finish	Price
238257	8038-VB	Vintage Bronze	

#### 45° Shower Arms

- All Brass Full-wight
- 1/2" IPS x 10"



Part #	Mfg #	Finish	Price
169194	8033-ORB	Oil Rubbed Bronze	
124597	8033-PCH	Polished Chrome	
126024	8033-SN	Satin Nickel	

#### 8" 90° Shower Arms

- 2" Drop on 90° Bend
- Ideal for Rainheads



Part #	Mfg #	Finish	Price
140261	8040-PEW	Pewter	
166811	8040-SN	Satin Nickel	

#### 30" 90° Shower Arms

- 2" Drop on 90° Bend
- Ideal for Rainheads
- Long Sweep Pattern with Escutcheon



Part #	Mfg #	Finish	Price
173639	8048-PCH	Polished Chrome	

#### 12" Square Drop Ceiling Showerarm

- Brass construction
- 1/2" Male IPS x 1/2" male NPT
- 2 1/2" Sliding square escutcheon
- Ideal for square rainheads



Part #	Mfg #	Finish	Price
245500	8079-CB	Caramel Bronze	

### Shower Nipples

- Available in various lengths
- All Brass vertical drop
- 1/2" 801-12
- 3/4" 801-34



Part #	Mfg #	Finish	Price
153420	801-12.4-PB	1/2"x4" Polished Brass	
140813	801-12.4-ORB	1/2"x4" Oil Rubbed Bronze	
123368	801-12.4-SN	1/2"x4" Sain Nickel	
133151	801-12.6-ORB	1/2"x6" Oil Rubbed Bronze	
156841	801-12.6-SC	1/2"x6" Satin Chrome	
122350	801-12.6-SN	1/2"x6" Satin Nickel	
244889	801-12.12-MBK	1/2"x12" Matte Black	
145342	801-12.12-ORB	1/2"x12" Oil Rubbed Bronze	
154544	801-12.12-PCH	1/2"x12" Polished Chrome	
245402	801-12.12-PN	1/2"x12" Polished Nickel	
243426	801-12.12-SC	1/2"x12" Satin Chrome	
119810	801-12.12-SN	1/2"x12" Satin Nickel	
239280	801-12.12-VB	1/2" x 1/2" Vintage Bronze	
162160	801-12.18-ORB	1/2"x18" Oil Rubbed Bronze e	
114198	801-12.18-PCH	1/2"x18" Polished Chrome	
148516	801-12.24-ORB	1/2"x24" Oil Rubbed Bronze	
152476	801-12.24-PCH	1/2"x24" Polished Chrome	
171951	801-12.24-SN	1/2"x24" Satin Nickel	
155623	801-34.12-SN	3/4"x12" Satin Nickel	

### Support Rods

- Use with 7982 L-Bar with insert
- Can also be used to support long shower arms



Part #	Mfg #	Finish	Price
166889	4012-SN	12" Satin Nickel	
173640	4018-PCH	18" Polished Chrome	
151440	4024-SN	24" Satin Nickel	

## Shower Heads, Arms & Flanges

### Showerheads

#### Rain Machine® Rain Showerhead

- 8" Diameter
- 95 easy clean rubber jets
- Spray patterns: easy clean, full rain
- 1/2" IPS adjustable brass ball joint to adjust angle of showerhead
- Available flow rates: 2.5, 2.0, 1.75, & 1.5 gpm



Part #	Mfg #	Finish	Price
167612	S208SN	8" Satin Nickel	

#### Rain Machine® Rain Showerhead

- 16" Diameter
- 234 easy clean rubber jets
- Spray patterns: easy clean, full rain
- 1/2" Female IPS fixed—no ball joint design
- Available flow rates: 2.5 and 2.0gpm



Part #	Mfg #	Finish	Price
243425	S216-SC	16" Satin Chrome	

#### Rain Machine® Rain Showerhead

- 12" x 12"
- 121 easy clean rubber jets
- Spray patterns: easy clean, full rain
- 1/2" IPS adjustable brass ball joint
- Available flow rates: 2.5 and 2.0gpm



Part #	Mfg #	Finish	Price
245211	S213-ORB	Oil Rubbed Bronze	

#### Rain Machine® Rain Showerhead

- 16" x 16"
- 265 easy clean rubber jets
- Surface mount or flush mount
- Spray patterns: easy clean, full rain
- 1/2" Female IPS fixed, no ball joint design
- Available flow rates: 2.5 and 2.0gpm



Part #	Mfg #	Finish	Price
246364	S219-PCH	Polished Chrome	

### Rain Bar Body Spray

- Brass construction
- 1/2" IPS female connection
- Single connection design
- Bar rotates 360°
- Top & bottom rotate independently 180°
- Wall or ceiling installation
- Sliding 2-3/8" diameter escutcheon
- 42 easy clean rubber jets
- Flow rates: 2.5 & 2.0 gpm
- Can be used as outdoor shower



Part #	Mfg #	Finish	Price
240573	R028-PCH	Polished Chrome	

### QUADRATO Chromotherapy Dream Light

- 8" x 8"
- Surface or flush mount to ceiling
- Easy clean replaceable rubber jets
- Spray patterns: easy clean, full rain
- Low voltage color changing LED lights
- Input voltage 110V AC (transformer included)
- Wall-mounted control panel allows for fixed or color changing lights
- 1/2" Male IPS connection with flexible hose
- Requires minimum 5.5 gpm flow rate

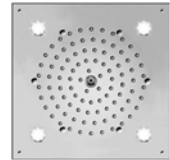

Part #	Mfg #	Finish	Price
242456	88-DLCT-PCH	Polished Chrome	

### QUADRATO Dream Light Raincan Showerhead

- 12" x 12"
- Single color-fixed lighting
- Surface or flush mount to ceiling
- Spray patterns: easy clean, full rain
- Input voltage 110V AC —transformer included
- 1/2" Male IPS connection with flexible hose
- Wall mounted control panel activates lights on/off
- Requires minimum flow rate of 5.5 gpm

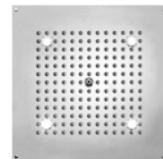

Part #	Mfg #	Finish	Price
242167	1212-DLRC-015	Blue	

## Shower Heads, Arms & Flanges

### Showerheads

#### Re-Vive™ Round Rain Showerhead

- Seamless stainless steel construction
- Ultra slim 2.4mm
- 1/2" IPS swivel
- 1.6 gpm (2.5 gpm restrictor included)



#### Flat Sure Grip Flange

- Brass
- Use with 1/2" IPS
- 13/16" I.D. X 2-1/2" O.D. X 13/32" HT



Part #	Mfg #	Finish	Price
102034	MT442X/BRN	Brushed Nickel	

Part #	Mfg #	Size	Finish	Price
242013	MT10-6/CPB	6"	Polished Chrome	
243667	MT10-8/BRN	8"	Brushed Nickel	
246510	MT10-8/CPB	8"	Polished Chrome	
244423	MT10-8/ORB	8"	Oil Rubbed Brz	
245323	MT10-8/PN	8"	Polished Nickel	
241837	MT10-10/BRN	10"	Brushed Nickel	
242675	MT10-12/BRN	12"	Brushed Nickel	

#### Re-Vive™ Square Rain Showerhead

- Seamless stainless steel construction
- Ultra slim 2.4mm
- 1/2" IPS swivel
- 1.6 gpm (2.5 gpm restrictor included)



Part #	Mfg #	Size	Finish	Price
243406	MT11-8/BRN	8"	Brushed Nickel	
246021	MT11-10/ORB	10"	Oil Rubbed Brz	
241873	MT11-12/MB	12"	Matte Black	

### Shower Arms

#### Re-Vive™ Round Shower Arm

- Solid brass construction
- Ceiling mount
- 1/2" NPT
- 2-7/16" Decorative brass escutcheon



Part #	Mfg #	Size	Finish	Price
242673	MT30-3/BRN	3"	Brushed Nickel	

#### Re-Vive™ Square Shower Arm

- Solid brass construction
- Ceiling mount
- 1/2" NPT
- 2" Decorative brass escutcheon



Part #	Mfg #	Size	Finish	Price
241874	MT31-8/MB	8"	Matte Black	

\*PVD Finish

**www.plumbsupply.com • Serving our Customers Since 1946 • www.waterconcepts.net**

## Shower Faucets

### Single-Handle Shower Trim

#### Archer® Rite-Temp® 1-Hdl Shower Trim

- Showerhead has MasterClean™ spray nozzles
- Wall-mount



**Requires:**

K-304/K-P304 Series Rite-Temp® Valves  
or

K-2971-KS 3/4" Pressure-balancing Valve

Part #	Mfg #	Description	Handle(s)	Finish	Price
225905	K-TS11078-4-CP	Shower Trim Only	Lever	Polished Chrome	
225906	K-TS11078-4-BN	Shower Trim Only	Lever	*Brushed Nickel	
225907	K-TS11078-4E-BN	Shower Trim Only, 2.0 gpm	Lever	*Brushed Nickel	

#### Archer® Rite-Temp® 1-Hdl Valve Trim



**Requires:**

K-304/K-P304 Series Rite-Temp® Valves  
or

K-2971-KS 3/4" Pressure-balancing Valve

Part #	Mfg #	Description	Handle(s)	Finish	Price
166902	K-TS98763-4-BN	Valve Trim Only	ADA Lever	*Brushed Nickel	
232814	K-TS98763-4-CP	Valve Trim Only	ADA Lever	Polished Chrome	

#### Alteo® Rite-Temp® 1-Hdl Shower Trim

- Premium construction
- MasterClean™ spray nozzles (-TLS) Less showerhead
- Intended for use with Rite-Temp® or HiFlow Rite-Temp® valves
- Heavy-duty slip-fit clamp design and NPT threaded spout



**Requires:**

K-304/K-P304 Series Rite-Temp® Valves  
or

K-2971-KS 3/4" Pressure-balancing Valve

Push-Button Diverter Trim Requires Valve: K-11748-K/KS

#### Without Push-Button Diverter

Part #	Mfg #	Description	Handle(s)	Finish	Price
225729	K-TS45106-4-BN	Shower Trim Only, 2.5 gpm	ADA Lever	*Brushed Nickel	
225727	K-TS45106-4-CP	Shower Trim Only 2.5 gpm	ADA Lever	Polished Chrome	
225730	K-TS45106-4-2BZ	Shower Trim Only 2.5 gpm	ADA Lever	Oil Rubbed Bronze	
238579	K-TLS45106-4-BN	Shower Trim Only, No Showerhead	ADA Lever	*Brushed Nickel	
236913	K-TLS45106-4-CP	Shower Trim Only, No Showerhead	ADA Lever	Polished Chrome	
242642	K-TLS45106-4-2BZ	Shower Trim Only, No Showerhead	ADA Lever	Oil Rubbed Bronze	

\* Vibrant Limited Lifetime Warranty

[www.waterconcepts.net](http://www.waterconcepts.net) • Serving our Customers Since 1946 • [www.plumbsupply.com](http://www.plumbsupply.com)



## Shower Faucets

### With Push-Button Diverter

Part #	Mfg #	Description	Handle(s)	Finish	Price
144678	K-T45108-4-BN	Shower Trim Only, 2.5 gpm, Pushbutton Diverter	ADA Lever	*Brushed Nickel	
147266	K-T45108-4-CP	Shower Trim Only, 2.5 gpm, Pushbutton Diverter	ADA Lever	Polished Chrome	
160692	K-T45108-4-2BZ	Shower Trim Only, 2.5 gpm, Pushbutton Diverter	ADA Lever	Oil Rubbed Bronze	

### Alteo® Rite-Temp® 1-Hdl Valve Trim

- Premium construction
- Intended for use with Rite-Temp® or HiFlow Rite-Temp® valves
- Heavy-duty slip-fit clamp design and NPT threaded spout

**Requires:**

**K-304/K-P304 Series Rite-Temp® Valves**  
or

**K-2971-KS 3/4" Pressure-balancing Valve**



**Push-Button Diverter Trim Requires Valve: K-11748-K/KS**

### Without Push-Button Diverter

Part #	Mfg #	Description	Handle(s)	Finish	Price
225733	K-TS45110-4-BN	Valve Trim Only	ADA Lever	*Brushed Nickel	
225732	K-TS45110-4-CP	Valve Trim Only	ADA Lever	Polished Chrome	
225734	K-TS45110-4-2BZ	Valve Trim Only	ADA Lever	Oil Rubbed Bronze	

### With Push-Button Diverter

Part #	Mfg #	Description	Handle(s)	Finish	Price
259496	K-T45112-4-BN	Valve Trim Only, Pushbutton Diverter	ADA Lever	*Brushed Nickel	
225329	K-T45112-4-CP	Valve Trim Only, Pushbutton Diverter	ADA Lever	Polished Chrome	

### Artifacts® Rite-Temp® 1-Hdl Valve Trim

- Metal construction
- Wall-mount



-4

-3

-3M

-9M

**Requires:**

**K-304/K-P304 Series Rite-Temp® Valves**  
or

**K-2971-KS 3/4" Pressure-balancing Valve**

Part #	Mfg #	Description	Handle(s)	Finish	Price
238992	K-TS72767-3-BN	Valve Trim Only	ADA Cross	*Brushed Nickel	
237543	K-TS72767-3-CP	Valve Trim Only	ADA Cross	Polished Chrome	
255736	K-TS72767-3-2BZ	Valve Trim Only	ADA Cross	Oil Rubbed Bronze	
229774	K-TS72767-3M-BN	Valve Trim Only	ADA Prong	*Brushed Nickel	
232915	K-TS72767-3M-BV	Valve Trim Only	ADA Prong	*Brushed Bronze	
167568	K-TS72767-3M-CP	Valve Trim Only	ADA Prong	Polished Chrome	
252837	K-TS72767-3M-SN	Valve Trim Only	ADA Prong	*Polished Nickel	
190146	K-TS72767-3M-VN	Valve Trim Only	ADA Prong	Vintage Nickel	

\* Vibrant Limited Lifetime Warranty

**www.plumbsupply.com • Serving our Customers Since 1946 • www.waterconcepts.net**

## Shower Faucets

### Single-Handle Shower Trim (Continued)

#### Artifacts® Rite-Temp® 1-Hdl Valve Trim

Part #	Mfg #	Description	Handle(s)	Finish	Price
240133	K-TS72767-3M-2B Z	Valve Trim Only	ADA Prong	Oil Rubbed Bronze	
232459	K-TS72767-4-BN	Valve Trim Only	ADA Lever	*Brushed Nickel	
181399	K-TS72767-4-BV	Valve Trim Only	ADA Lever	*Brushed Bronze	
171941	K-TS72767-4-CP	Valve Trim Only	ADA Lever	Polished Chrome	
174118	K-TS72767-4-SN	Valve Trim Only	ADA Lever	*Polished Nickel	
243422	K-TS72767-4-VNT	Valve Trim Only	ADA Lever	Vintage Nickel	
180272	K-TS72767-4-2BZ	Valve Trim Only	ADA Lever	Oil Rubbed Bronze	
165374	K-TS72767-9M-CP	Valve Trim Only	ADA Swing	Polished Chrome	
183090	K-TS72767-9M-BN	Valve Trim Only	ADA Swing	*Brushed Nickel	
165038	K-TS72767-9M-SN	Valve Trim Only	ADA Swing	*Polished Nickel	
247738	K-TS72767-9M-2B Z	Valve Trim Only	ADA Swing	Oil Rubbed Bronze	

#### Artifacts® Valve Trim with Push-Button Diverter

- Metal construction
- Front seal plate assembly



-3



-3M



-4



-9M

Requires valve:  
K-11748-K  
or  
K-11748-KS

Part #	Mfg #	Description	Handle(s)	Finish	Price
243715	K-T72768-3-CP	Valve Trim Only, Push-Button Diverter	ADA Cross	Polished Chrome	
162101	K-T72768-3M-BN	Valve Trim Only, Push-Button Diverter	ADA Prong	*Brushed Nickel	
162831	K-T72768-3M-CP	Valve Trim Only, Push-Button Diverter	ADA Prong	Polished Chrome	
223894	K-T72768-3M-VNT	Valve Trim Only, Push-Button Diverter	ADA Prong	Vintage Nickel	
183091	K-T72768-4-BN	Valve Trim Only, Push-Button Diverter	ADA Lever	*Brushed Nickel	
225931	K-T72768-4-BV	Valve Trim Only, Push-Button Diverter	ADA Lever	*Brushed Bronze	
166446	K-T72768-4-CP	Valve Trim Only, Push-Button Diverter	ADA Lever	Polished Chrome	
173103	K-T72768-4-SN	Valve Trim Only, Push-Button Diverter	ADA Lever	*Polished Nickel	
168459	K-T72768-4-2BZ	Valve Trim Only, Push-Button Diverter	ADA Lever	Oil Rubbed Bronze	
185564	K-T72768-9M-BN	Valve Trim Only, Push Button Diverter	ADA Lever	*Brushed Nickel	
176271	K-T72768-9M-CP	Valve Trim Only, Push-Button Diverter	ADA Swing Lever	Polished Chrome	
174462	K-T72768-9M-SN	Valve Trim Only, Push-Button Diverter	ADA Swing Lever	*Polished Nickel	
186474	K-T72768-9M-2BZ	Valve Trim Only, Push-Button Diverter	ADA Swing Lever	Oil Rubbed Bronze	

\* Vibrant Limited Lifetime Warranty

[www.waterconcepts.net](http://www.waterconcepts.net) • Serving our Customers Since 1946 • [www.plumbsupply.com](http://www.plumbsupply.com)

## Shower Faucets

### Bancroft® Rite-Temp® Pressure-Balancing Shower Trim

- MasterClean™ sprayface
- Includes showerarm with flange
- (-P) Ceramic lever handle
- (-TLS models do not include showerhead)



**Requires:**

**K-304/K-P304 Series Rite-Temp® Valves**

or

**K-2971-KS 3/4" Pressure-balancing Valve**

Part #	Mfg #	Description	Handle(s)	Finish	Price
227735	K-TS10583-4-BN	Shower Valve Trim, 2.5 gpm	ADA Lever	*Brushed Nickel	
120008	K-TS10583-4-BV	Shower Valve Trim, 2.5 gpm	ADA Lever	*Brushed Bronze	
232420	K-TS10583-4-CP	Shower Valve Trim, 2.5 gpm	ADA Lever	Polished Chrome	
151323	K-TS10583-4-2BZ	Shower Valve Trim, 2.5 gpm	ADA Lever	Oil Rubbed Bronze	
089589	K-TS10583-4P-CP	Shower Valve Trim, 2.5 gpm	ADA Ceramic Lever	Polished Chrome	
252059	K-TLS10583-4-BN	Shower Valve Trim, Less Showerhead	ADA Lever	*Brushed Nickel	
242064	K-TLS10583-4-CP	Shower Valve Trim, Less Showerhead	ADA Lever	Polished Chrome	

### Bancroft® Rite-Temp® Pressure-Balancing Valve Trim

- Intended for use with Rite-Temp® or HiFlow Rite-Temp® valves



**Requires:**

**K-304/K-P304 Series Rite-Temp® Valves**

or

**K-2971-KS 3/4" Pressure-balancing Valve**

Part #	Mfg #	Description	Handle(s)	Finish	Price
106164	K-TS10584-4-BN	Valve Trim Only	ADA Lever	*Brushed Nickel	
129027	K-TS10584-4-BV	Valve Trim Only	ADA Lever	*Brushed Bronze	
173349	K-TS10584-4-SN	Valve Trim Only	ADA Lever	*Polished Nickel	
163524	K-TS10584-4P-BN	Valve Trim Only	ADA Ceramic Lever	*Brushed Nickel	
093804	K-TS10584-4P-CP	Valve Trim Only	ADA Ceramic Lever	Polished Chrome	

\* Vibrant Limited Lifetime Warranty

[www.plumbsupply.com](http://www.plumbsupply.com) • Serving our Customers Since 1946 • [www.waterconcepts.net](http://www.waterconcepts.net)

## Shower Faucets

### Composed™ Rite-Temp® 1-Hdl Shower Trim

- Premium material construction with metal handles
- Includes face plate with handle
- Handle controls both on/off activation and temperature setting



(-4) Lever



(-3) Cross

**Requires:**

**K-304/K-P304 Series Rite-Temp® Valves**

or

**K-2971-KS 3/4" Pressure-balancing Valve**

**Push-Button Diverter Trim Requires Valve: K-11748-K/KS**

Part #	Mfg #	Description	Handle(s)	Finish	Price
231768	K-TS73115-3-CP	Valve Trim Only	ADA Cross	Polished Chrome	
242511	K-TS73115-3-TT	Valve Trim Only	ADA Cross	*Titanium	
225520	K-TS73115-4-CP	Valve Trim Only	ADA Lever	Polished Chrome	
231727	K-TS73115-4-TT	Valve Trim Only	ADA Lever	*Titanium	
224855	K-T73117-4-CP	Valve Trim Only, Push-Button Diverter	ADA Lever	Polished Chrome	
239034	K-T3117-3-TT	Valve Trim Only, Push-Button Diverter	ADA Cross	*Titanium	

### Coralais® Rite Temp® 2.5 gpm 1-Hdl Shower Trim

- Metal construction
- Adjustable spray showerhead, arm and flange
- High temperature limit stop
- 



**Requires:**

**K-304/K-P304 Series Rite-Temp® Valves**

or

**K-2971-KS 3/4" Pressure-balancing Valve**

Part #	Mfg #	Description	Handle(s)	Finish	Price
053771	K-PS15611-4-CP	Shower Trim Only, P-Pk, 2.5 gpm	ADA Lever	Polished Chrome	
225714	K-TS15611-4-CP	Shower Trim Only, 2.5 gpm	ADA Lever	Polished Chrome	
225715	K-TS15611-4-G	Shower Trim Only, 2.5 gpm	ADA Lever	Brushed Chrome	
225716	K-TS15611-4E-CP	Shower Trim Only, 2.0 gpm	ADA Lever	Polished Chrome	
234454	K-PLS15611-4-CP	Shower Trim, Less Showerhead, P-Pk	ADA Lever	Polished Chrome	

### Coralais® Rite Temp® 2.5 gpm 1-Hdl Valve Trim

- Metal construction
- High temperature limit stop



**Requires:**

**K-304/K-P304 Series Rite-Temp® Valves**

or

**K-2971-KS 3/4" Pressure-balancing Valve**

Part #	Mfg #	Description	Handle(s)	Finish	Price
225718	K-TS15621-4-CP	Valve Trim Only	ADA Lever	Polished Chrome	

\* Vibrant Limited Lifetime Warranty

[www.waterconcepts.net](http://www.waterconcepts.net) • Serving our Customers Since 1946 • [www.plumbsupply.com](http://www.plumbsupply.com)

## Shower Faucets

### Devonshire® Rite-Temp® 1-Hdl Shower Trim

- Metal construction
- Brass valve bodies
- Pressure-balancing mechanism of one-piece diaphragm cartridge
- Showerhead, arm and flange
- (-TLS Models do not include showerhead)



**Requires:**

**K-304/K-P304 Series Rite-Temp® Valves**

or

**K-2971-KS 3/4" Pressure-balancing Valve**

Part #	Mfg #	Description	Handle(s)	Finish	Price
225861	K-TS396-4-BN	Shower Trim Only, 2.5 gpm	ADA Lever	*Brushed Nickel	
225862	K-TS396-4-BV	Shower Trim Only, 2.5 gpm	ADA Lever	*Brushed Bronze	
225860	K-TS396-4-CP	Shower Trim Only, 2.5 gpm	ADA Lever	Polished Chrome	
225866	K-TS396-4-PB	Shower Trim Only, 2.5 gpm	ADA Lever	*Polished Brass	
225868	K-TS396-4-SN	Shower Trim Only, 2.5 gpm	ADA Lever	*Polished Nickel	
225865	K-TS396-4-2BZ	Shower Trim Only, 2.5 gpm	ADA Lever	Oil Rubbed Bronze	
254831	K-TLS396-4-PB	Shower Trim Only, Less Showerhead	ADA Lever	*Polished Brass	
255971	K-TLS396-4-2BZ	Shower Trim Only, Less Showerhead	ADA Lever	Oil Rubbed Bronze	
225869	K-TS396-4E-CP	Shower Trim Only, 2.0 gpm	ADA Lever	Polished Chrome	
225870	K-TS396-4E-2BZ	Shower Trim Only, 2.0 gpm	ADA Lever	Oil Rubbed Bronze	

### Devonshire® Rite-Temp® 1-Hdl Valve Trim

- Metal construction
- Brass valve bodies
- Pressure-balancing mechanism of one-piece diaphragm cartridge
- 



**Requires:**

**K-304/K-P304 Series Rite-Temp® Valves**

or

**K-2971-KS 3/4" Pressure-balancing Valve**

Part #	Mfg #	Description	Handle(s)	Finish	Price
225872	K-TS397-4-BN	Valve Trim Only	ADA Lever	*Brushed Nickel	
225873	K-TS397-4-BV	Valve Trim Only	ADA Lever	*Brushed Bronze	
225871	K-TS397-4-CP	Valve Trim Only	ADA Lever	Polished Chrome	
228503	K-TS397-4-PB	Valve Trim Only	ADA Lever	*Polished Brass	
225874	K-TS397-4-SN	Valve Trim Only	ADA Lever	*Polished Nickel	
146984	K-TS397-4-2BZ	Valve Trim Only	ADA Lever	Oil Rubbed Bronze	

\* Vibrant Limited Lifetime Warranty

[www.plumbsupply.com](http://www.plumbsupply.com) • Serving our Customers Since 1946 • [www.waterconcepts.net](http://www.waterconcepts.net)

## Shower Faucets

### Fairfax® Rite-Temp® 1-Hdl Shower Valve Trim

- Metal construction
- Showerhead, arm and flange



**Requires:**

K-304/K-P304 Series Rite-Temp® Valves

or

K-2971-KS 3/4" Pressure-balancing Valve

Part #	Mfg #	Description	Handle(s)	Finish	Price
225928	K-TS12014-4-BN	Shower Trim Only, 2.5 gpm	ADA Lever	*Brushed Nickel	
225925	K-TS12014-4-CP	Shower Trim Only, 2.5 gpm	ADA Lever	Polished Chrome	
225929	K-TS12014-4-2BZ	Shower Trim Only, 2.5 gpm	ADA Lever	Oil Rubbed Bronze	
225930	K-TS12014-4E-CP	Shower Trim Only, 2.0 gpm	ADA Lever	*Brushed Nickel	

### Fairfax® Rite-Temp® 1-Hdl Valve Trim

- Metal construction



**Requires:**

K-304/K-P304 Series Rite-Temp® Valves

or

K-2971-KS 3/4" Pressure-balancing Valve

Part #	Mfg #	Description	Handle(s)	Finish	Price
225933	K-TS12021-4-BN	Valve Trim Only	ADA Lever	*Brushed Nickel	
225932	K-TS12021-4-CP	Valve Trim Only	ADA Lever	Polished Chrome	
225934	K-TS12021-4-2BZ	Valve Trim Only	ADA Lever	Oil Rubbed Bronze	

### Finial® Rite-Temp® Pressure-Balancing 1-Hdl Shower Valve Trim

- Brass construction

**Requires:**

K-304/K-P304 Series Rite-Temp® Valves

or

K-2971-KS 3/4" Pressure-balancing Valve



Part #	Mfg #	Description	Handle(s)	Finish	Price
080076	K-TS313-4M-AF	Shower Trim Only, 2.5 gpm	ADA Lever	*French Gold	
060041	K-TS313-4M-BN	Shower Trim Only, 2.5 gpm	ADA Lever	*Brushed Nickel	
090329	K-TS313-4M-BV	Shower Trim Only, 2.5 gpm	ADA Lever	*Brushed Bronze	
060193	K-TS313-4M-CP	Shower Trim Only, 2.5 gpm	ADA Lever	Polished Chrome	
086147	K-TS313-4M-SN	Shower Trim Only, 2.5 gpm	ADA Lever	*Polished Nickel	
180593	K-TS313-4M-2BZ	Shower Trim Only, 2.5 gpm	ADA Lever	Oil Rubbed Bronze	

\* Vibrant Limited Lifetime Warranty

[www.waterconcepts.net](http://www.waterconcepts.net) • Serving our Customers Since 1946 • [www.plumbsupply.com](http://www.plumbsupply.com)



## Shower Faucets

### Forté® Rite-Temp® Pressure-Balancing 1-Hdl Shower Faucet Trim

- Metal construction
- Intended for use with Rite-Temp® or HiFlow Rite-Temp® valves
- Includes faceplate and handle
- (-TLS) Less showerhead



T10276-4



T10276-4A

**Requires:**

**K-304/K-P304 Series Rite-Temp® Valves**

or

**K-2971-KS 3/4" Pressure-balancing Valve**

Part #	Mfg #	Description	Handle(s)	Finish	Price
225884	K-TS10276-4-BN	Shower Trim Only, 2.5 gpm	ADA Sculpted Lever	*Brushed Nickel	
225882	K-TS10276-4-CP	Shower Trim Only, 2.5 gpm	ADA Sculpted Lever	Polished Chrome	
225883	K-TS10276-4-G	Shower Trim Only, 2.5 gpm	ADA Sculpted Lever	*Brushed Chrome	
225894	K-TS10276-4A-BN	Shower Trim Only, 2.5 gpm	ADA Traditional Lever	*Brushed Nickel	
225892	K-TS10276-4A-CP	Shower Trim Only, 2.5 gpm	ADA Traditional Lever	Polished Chrome	
225893	K-TS10276-4A-G	Shower Trim Only, 2.5 gpm	ADA Traditional Lever	*Brushed Chrome	
225896	K-TS10276-4AE-B N	Shower Trim Only, 2.0gpm	ADA Traditional Lever	*Brushed Nickel	
225952	K-TS10276-4E-BN	Shower Trim Only, 2.0gpm	ADA Sculpted Lever	*Brushed Nickel	
225951	K-TS10276-4E-CP	Shower Trim Only, 2.0gpm	ADA Sculpted Lever	Polished Chrome	
231876	K-TLS10276-4-CP	Shower Trim, Less Showerhead	ADA Sculpted Lever	Polished Chrome	
257692	K-TLS10276-4-G	Shower Trim, Less Showerhead	ADA Sculpted Lever	Brushed Chrome	

### Forté® Rite-Temp® Pressure-Balancing 1-Hdl Valve Trim

- Metal construction
- Intended for use with Rite-Temp® or HiFlow Rite-Temp® valves
- Includes faceplate and handle



**Requires:**

**K-304/K-P304 Series Rite-Temp® Valves**

or

**K-2971-KS 3/4" Pressure-balancing Valve**

Part #	Mfg #	Description	Handle(s)	Finish	Price
231843	K-TS10277-4-BN	Valve Trim Only	ADA Sculpted Lever	*Brushed Nickel	
226187	K-TS10277-4-CP	Valve Trim Only	ADA Sculpted Lever	Polished Chrome	

\* Vibrant Limited Lifetime Warranty

[www.plumbsupply.com](http://www.plumbsupply.com) • Serving our Customers Since 1946 • [www.waterconcepts.net](http://www.waterconcepts.net)

## Shower Faucets

### Honesty™ Rite-Temp® Pressure-Balancing 1-Hdl Shower Faucet Trim

- Premium metal construction
- Intended for use with Rite-Temp® or HiFlow Rite-Temp® valves
- (-TLS) Less showerhead



**Requires:**

K-304/K-P304 Series Rite-Temp® Valves

or

K-2971-KS 3/4" Pressure-balancing Valve

Push-Button Diverter Trim Requires Valve: K-11748-K/KS

Part #	Mfg #	Description	Handle(s)	Finish	Price
177482	K-TS99764-4-CP	Shower Trim Only, 2.0 gpm	ADA Lever	Polished Chrome	
250552	K-TLS99764-4-CP	Shower Trim Only, 2.0 gpm Less Head	ADA Lever	Polished Chrome	

### Honesty™ Rite-Temp® Pressure-Balancing 1-Hdl Valve Trim

- Premium metal construction
- Intended for use with Rite-Temp® or HiFlow Rite-Temp® valves



**Requires:**

K-304/K-P304 Series Rite-Temp® Valves

or

K-2971-KS 3/4" Pressure-balancing Valve

Push-Button Diverter Trim Requires Valve: K-11748-K/KS

Part #	Mfg #	Description	Handle(s)	Finish	Price
234927	K-TS99761-4-CP	Valve Trim Only,	ADA Lever	Polished Chrome	
178268	K-T99762-4-CP	Valve Trim Only, w/ Push-Button Diverter	ADA Lever	Polished Chrome	

### July™ Rite-Temp® Pressure-Balancing 1-Hdl Shower Valve Trim

- Premium construction
- Wall-mount



**Requires:**

K-304/K-P304 Series Rite-Temp® Valves

or

K-2971-KS 3/4" Pressure-balancing Valve

Part #	Mfg #	Description	Handle(s)	Finish	Price
223406	K-TS98008-4-CP	Shower Trim Only, 2.0 gpm	Lever	Polished Chrome	
223407	K-TS98008-4-G	Shower Trim Only, 2.0 gpm	Lever	*Brushed Chrome	
225523	K-TS98009-4-CP	Shower Trim Only, Less Showerhead	Lever	Polished Chrome	

\* Vibrant Limited Lifetime Warranty

[www.waterconcepts.net](http://www.waterconcepts.net) • Serving our Customers Since 1946 • [www.plumbsupply.com](http://www.plumbsupply.com)

## Shower Faucets

### July™ Rite-Temp® Pressure-Balancing 1-Hdl Valve Trim

- Premium construction
- Wall-mount



**Requires:**

**K-304/K-P304 Series Rite-Temp® Valves**

or

**K-2971-KS 3/4" Pressure-balancing Valve**

Part #	Mfg #	Description	Handle(s)	Finish	Price
223418	K-TS98147-4-CP	Valve Trim Only	Lever	Polished Chrome	
223419	K-TS98147-4-G	Valve Trim Only	Lever	*Brushed Chrome	

### Kelston®™ Rite-Temp® 1-Hdl Shower Valve Trim

- Metal construction, brass valve bodies
- High-temperature limit stop
- Mixing valve cycles from cold to hot
- For use with Rite-Temp® or HiFlow Rite-Temp® valves



**Requires:**

**K-304/K-P304 Series Rite-Temp® Valves**

or

**K-2971-KS 3/4" Pressure-balancing Valve**

Part #	Mfg #	Description	Handle(s)	Finish	Price
225914	K-TS13493-4-BN	Shower Trim Only, 2.5 gpm	ADA Lever	*Brushed Nickel	
225913	K-TS 13493-4-CP	Shower Trim Only, 2.5 gpm	ADA Lever	Polished Chrome	
225915	K-TS13493-4-2BZ	Shower Trim Only, 2.5 gpm	ADA Lever	Oil Rubbed Bronze	
225916	K-TS13493-4E-CP	Shower Trim Only, 2.0 gpm	ADA Lever	Polished Chrome	
225917	K-TS13493-4E-2B Z	Shower Trim Only, 2.0 gpm	ADA Lever	Oil Rubbed Bronze	
246310	K-TLS13493-4-BN	Shower Trim Only, Less Head	ADA Lever	*Brushed Nickel	
251800	K-TLS13493-4-2BZ	Shower Trim Only, Less Head	ADA Lever	Oil Rubbed Bronze	

### Kelston®™ Rite-Temp® 1-Hdl Valve Trim

- Metal construction, brass valve bodies
- High-temperature limit stop
- Mixing valve cycles from cold to hot
- For use with Rite-Temp® or HiFlow Rite-Temp® valves



**Requires:**

**K-304/K-P304 Series Rite-Temp® Valves**

or

**K-2971-KS 3/4" Pressure-balancing Valve**

Part #	Mfg #	Description	Handle(s)	Finish	Price
163601	K-TS98762-4-BN	Valve Trim Only	ADA Lever	*Brushed Nickel	
187728	K-TS98762-4-CP	Valve Trim Only	ADA Lever	Polished Chrome	
170253	K-TS98762-4-2BZ	Valve Trim Only	ADA Lever	Oil Rubbed Bronze	

\* Vibrant Limited Lifetime Warranty

**www.plumbsupply.com • Serving our Customers Since 1946 • www.waterconcepts.net**

## Shower Faucets

### Loure® Rite-Temp® 1-Hdl Shower Trim

- Brass construction
- MasterClean™ spray nozzles
- For use with Rite-Temp® or HiFlow Rite-Temp® valves



**Requires:**

**K-304/K-P304 Series Rite-Temp® Valves**

or

**K-2971-KS 3/4" Pressure-balancing Valve**

**Push-Button Diverter Trim Requires Valve: K-11748-K/KS**

Part #	Mfg #	Description	Handle(s)	Finish	Price
144349	K-TS14670-4-BN	Shower Trim Only, 2.5 gpm	Lever	*Brushed Nickel	
224852	K-TS14670-4-CP	Shower Trim Only, 2.5 gpm	Lever	Polished Chrome	
169473	K-TS14670-4-SN	Shower Trim Only, 2.5 gpm	Lever	Polished Nickel	

### Loure® Rite-Temp® 1-Hdl Valve Trim

- Brass construction
- For use with Rite-Temp® or HiFlow Rite-Temp® valves



**Requires:**

**K-304/K-P304 Series Rite-Temp® Valves**

or

**K-2971-KS 3/4" Pressure-balancing Valve**

**Push-Button Diverter Trim Requires Valve: K-11748-K/KS**

Part #	Mfg #	Description	Handle(s)	Finish	Price
145329	K-TS14671-4-BN	Valve Trim Only	Lever	*Brushed Nickel	
156034	K-TS146714-CP	Valve Trim Only	Lever	Polished Chrome	
231459	K-TS14671-4-SN	Valve Trim Only	Lever	Polished Nickel	
161713	K-T14668-4-BN	Valve Trim Only, with Push-Button Diverter	Lever	*Brushed Nickel	
181258	K-T14668-4-CP	Valve Trim Only, with Push-Button Diverter	Lever	Polished Chrome	

### Margaux® Rite-Temp® 1-Hdl Shower Trim

- Brass construction
- MasterClean™ sprayface
- For use with Rite-Temp® Valve



T16234-3

T16234-4

**Requires:**

**K-304/K-P304 Series Rite-Temp® Valves**

or

**K-2971-KS 3/4" Pressure-balancing Valve**

**Push-Button Diverter Trim Requires Valve: K-11748-K/KS**

Part #	Mfg #	Description	Handle(s)	Finish	Price
140272	K-TS16234-3-BN	Shower Trim Only, 2.5 gpm	Cross	*Brushed Nickel	
110490	K-TS16234-3-CP	Shower Trim Only, 2.5 gpm	Cross	Polished Chrome	
135701	K-TS16234-3-SN	Shower Trim Only, 2.5 gpm	Cross	*Polished Nickel	
182980	K-TS16234-4-AF	Shower Trim Only, 2.5 gpm	Cross	*French Gold	
227199	K-TS16234-4-BN	Shower Trim Only, 2.5 gpm	Lever	*Brushed Nickel	
177099	K-TS16234-4-BV	Shower Trim Only, 2.5 gpm	Lever	*Brushed Bronze	

\* Vibrant Limited Lifetime Warranty

## Shower Faucets

### Single-Handle Shower Trim (Continued)

#### Margaux® Rite-Temp® 1-Hdl Shower Trim

Part #	Mfg #	Description	Handle(s)	Finish	Price
107347	K-TS162344-CP	Shower Trim Only, 2.5 gpm	Lever	Polished Chrome	
142650	K-TS16234-4-SN	Shower Trim Only, 2.5 gpm	Lever	*Polished Nickel	

#### Margaux® Rite-Temp® 1-Hdl Valve Trim

- Brass construction
- For use with Rite-Temp® Valve

**Requires:**

**K-304/K-P304 Series Rite-Temp® Valves**

or

**K-2971-KS 3/4" Pressure-balancing Valve**

**Push-Button Diverter Trim Requires Valve: K-11748-K/KS**



Part #	Mfg #	Description	Handle(s)	Finish	Price
258939	K-TS16235-3-AF	Valve Trim Only	Cross	*French Gold	
229143	K-TS16235-3-BN	Valve Trim Only	Cross	*Brushed Nickel	
114354	K-TS16235-3-CP	Valve Trim Only	Cross	Polished Chrome	
135429	K-TS16235-4-AF	Valve Trim Only	Lever	*French Gold	
109779	K-TS16235-4-BN	Valve Trim Only	Lever	*Brushed Nickel	
188546	K-TS16235-4-BV	Valve Trim Only	Lever	*Brushed Bronze	
135068	K-TS16235-4-SN	Valve Trim Only	Lever	*Polished Nickel	
181324	K-T98759-4-CP	Valve Trim Only, Push-Button Diverter	Lever	Polished Chrome	
225581	K-T98759-4-SN	Valve Trim Only, Push-Button Diverter	Lever	*Polished Nickel	

#### Memoirs® Rite-Temp® 1-Hdl Shower Trim

- Metal construction
- Available with cross or lever handles
- For use with Rite-Temp® or HiFlow Rite-Temp® valves

**Requires:**

**K-304/K-P304 Series Rite-Temp® Valves**

or

**K-2971-KS 3/4" Pressure-balancing Valve**



Part #	Mfg #	Description	Handle(s)	Finish	Price
064750	K-TS462-4S-BN	Shower Trim Only, 2.5 gpm	Lever	*Brushed Nickel	
069909	K-TS462-4S-BV	Shower Trim Only, 2.5 gpm	Lever	*Brushed Bronze	
058777	K-TS462-4S-CP	Shower Trim Only, 2.5 gpm	Lever	Polished Chrome	
074956	K-TS462-4V-BN	Shower Trim Only, 2.5 gpm	Decor Lever	*Brushed Nickel	
076927	K-TS462-4V-BV	Shower Trim Only, 2.5 gpm	Decor Lever	*Brushed Bronze	
080341	K-TS4624V-CP	Shower Trim Only, 2.5 gpm	Decor Lever	Polished Chrome	
179421	K-TS462-4V-2BZ	Shower Trim Only, 2.5 gpm	Decor Lever	Oil Rubbed Bronze	

\* Vibrant Limited Lifetime Warranty

**www.plumbsupply.com • Serving our Customers Since 1946 • www.waterconcepts.net**

## Shower Faucets

### Memoirs® Rite-Temp® 1-Hdl Valve Trim

- Metal construction
- Available with cross or lever handles
- For use with Rite-Temp® or HiFlow Rite-Temp® valves



**Requires:**

**K-304/K-P304 Series Rite-Temp® Valves**

or

**K-2971-KS 3/4" Pressure-balancing Valve**

Part #	Mfg #	Description	Handle(s)	Finish	Price
069307	K-TS463-4S-BN	Valve Trim Only	Lever	*Brushed Nickel	
075916	K-TS463-4S-CP	Valve Trim Only	Lever	Polished Chrome	
082458	K-TS463-4V-BN	Valve Trim Only	Decor Lever	*Brushed Nickel	
228746	K-TS463-4V-BV	Valve Trim Only	Decor Lever	*Brushed Bronze	
079281	K-TS463-4V-CP	Valve Trim Only	Decor Lever	Polished Chrome	
165825	K-TS4634V-2BZ	Valve Trim Only	Decor Lever	Oil Rubbed Bronze	

### Pinstripe® Pure Rite-Temp® 1-Hdl Shower Trim

- Metal construction
- High-temperature limit stop



**Requires:**

**K-304/K-P304 Series Rite-Temp® Valves**

or

**K-2971-KS 3/4" Pressure-balancing Valve**

**Push-Button Diverter Trim Requires Valve: K-11748-K/KS**



Part #	Mfg #	Description	Handle(s)	Finish	Price
241604	K-TS13134-3A-BN	Shower Trim Only, 2.5 gpm	Cross	*Brushed Nickel	
092348	K-TS13134-3A-CP	Shower Trim Only, 2.5 gpm	Cross	Polished Chrome	
242130	K-TS13134-3A-SN	Shower Trim Only, 2.5 gpm	Cross	*Polished Nickel	
237887	K-TS13134-3B-BN	Shower Trim Only, 2.5 gpm	Cross	*Brushed Nickel	
255541	K-TS13134-3B-CP	Shower Trim Only, 2.5 gpm	Cross	Polished Chrome	
163780	K-TS13134-4A-BN	Shower Trim Only, 2.5 gpm	Lever	*Brushed Nickel	
104404	K-TS13134-4A-CP	Shower Trim Only, 2.5 gpm	Lever	Polished Chrome	
100192	K-TS13134-4A-SN	Shower Trim Only, 2.5 gpm	Lever	*Polished Nickel	

\* Vibrant Limited Lifetime Warranty

**www.waterconcepts.net • Serving our Customers Since 1946 • www.plumbsupply.com**



## Shower Faucets

### Pinstripe® Pure Rite-Temp® 1-Hdl Valve Trim

- Metal construction
- High-temperature limit stop



**Requires:**

**K-304/K-P304 Series Rite-Temp® Valves**

or

**K-2971-KS 3/4" Pressure-balancing Valve**

**Push-Button Diverter Trim Requires Valve: K-11748-K/KS**

Part #	Mfg #	Description	Handle(s)	Finish	Price
152771	K-TS13135-3A-BN	Valve Trim Only	Cross	*Brushed Nickel	
086158	K-TS13135-3A-CP	Valve Trim Only	Cross	Polished Chrome	
084484	K-TS13135-3A-SN	Valve Trim Only	Cross	*Polished Nickel	
167436	K-TS13135-4A-BN	Valve Trim Only	Lever	*Brushed Nickel	
231755	K-TS13135-4A-CP	Valve Trim Only	Lever	Polished Chrome	
162689	K-TS13135-4B-CP	Valve Trim Only, Etched Symmetrical Lines	Lever	Polished Chrome	
187377	K-T98757-4A-CP	Valve Trim Only, Push Button Diverter	Lever	Polished Chrome	
162688	K-T98757-4B-CP	Valve Trim Only, Push Button Diverter	Lever	Polished Chrome	

### Purist® Rite-Temp® 1-Hdl Shower Trim

- Brass construction
- Katalyst® Spray Technology
- (-TLS Models do not include showerhead)



**Requires:**

**K-304/K-P304 Series Rite-Temp® Valves**

or

**K-2971-KS 3/4" Pressure-balancing Valve**

**Push-Button Diverter Trim Requires Valve: K-11748-K/KS**

Part #	Mfg #	Description	Handle(s)	Finish	Price
238486	K-TS14422-3-BGD	Shower Trim Only, 2.5 gpm	Cross	*Moderne Brushed Gold	
065125	K-TS14422-3-CP	Shower Trim Only, 2.5 gpm	Cross	Polished Chrome	
257775	K-TS14422-3-SN	Shower Trim Only, 2.5 gpm	Cross	*Polished Nickel	
253505	K-TLS14422-3-CP	Shower Trim Only, Less Showerhead	Cross	Polished Chrome	
257785	K-TLS14422-4-BL	Shower Trim Only, Less Showerhead	Lever	Matte Black	
067952	K-TS14422-4-BN	Shower Trim Only, 2.5 gpm	Lever	*Brushed Nickel	
232140	K-TS14422-4-CP	Shower Trim Only, 2.5 gpm	Lever	Polished Chrome	
240888	K-TLS14422-4-CP	Shower Trim Only, Less Showerhead	Lever	Polished Chrome	

\* Vibrant Limited Lifetime Warranty

[www.plumbsupply.com](http://www.plumbsupply.com) • Serving our Customers Since 1946 • [www.waterconcepts.net](http://www.waterconcepts.net)

## Shower Faucets

### Purist® Rite-Temp® 1-Hdl Valve Trim

- Brass construction



**Requires:**

**K-304/K-P304 Series Rite-Temp® Valves**

or

**K-2971-KS 3/4" Pressure-balancing Valve**

**Push-Button Diverter Trim Requires Valve: K-11748-K/KS**

Part #	Mfg #	Description	Handle(s)	Finish	Price
243634	K-TS14423-3-BGD	Valve Trim Only	Cross	*Moderne Brushed Gold	
227810	K-TS14423-3-BV	Valve Trim Only	Cross	*Brushed Bronze	
087763	K-TS14423-3-CP	Valve Trim Only	Cross	Polished Chrome	
246625	TS14423-4-BGD	Valve Trim Only	Lever	*Moderne Brushed Gold	
076113	K-TS14423-4-BN	Valve Trim Only	Lever	*Brushed Nickel	
129624	K-TS14423-4-BV	Valve Trim Only	Lever	*Brushed Bronze	
074139	K-TS14423-4-CP	Valve Trim Only	Lever	Polished Chrome	
141121	K-TS14423-4-SN	Valve Trim Only	Lever	*Polished Nickel	
249034	K-T14501-3-BGD	Valve Trim Only, with Push-Button Diverter	Cross	*Moderne Brushed Gold	
244768	K-T14501-4-BGD	Valve Trim Only, with Push-Button Diverter	Lever	*Moderne Brushed Gold	
258271	K-T14501-4-BL	Valve Trim Only, with Push-Button Diverter	Lever	Matte Black	
157792	K-T14501-4-BN	Valve Trim Only, with Push-Button Diverter	Lever	*Brushed Nickel	
154954	K-T14501-4-CP	Valve Trim Only, with Push-Button Diverter	Lever	Polished Chrome	

### Refinia® Rite-Temp® 1-Hdl Shower Trim

- Premium construction
- MasterClean™ spray nozzles
- Heavy-duty slip-fit clamp design and NPT threaded spout
- (-TLS) Less showerhead



**Requires:**

**K-304/K-P304 Series Rite-Temp® Valves**

or

**K-2971-KS 3/4" Pressure-balancing Valve**

**Push-Button Diverter Trim Requires Valve: K-11748-K/KS**

Part #	Mfg #	Description	Handle(s)	Finish	Price
225799	K-TS5320-4-BN	Shower Trim Only, 2.5 gpm	ADA Lever	*Brushed Nickel	
225798	K-TS5320-4-CP	Shower Trim Only, 2.5 gpm	ADA Lever	Polished Chrome	
258182	K-TLS5320-4-CP	Shower Trim Only, Less Showehead	ADA Lever	Polished Chrome	
225800	K-TS5320-4E-BN	Shower Trim Only, 2.0 gpm	ADA Lever	*Brushed Nickel	
145068	K-T5319-4-BN	Shower Trim Only, 2.5 gpm Push Button Diverter	ADA Lever	*Brushed Nickel	
143236	K-T5319-4-CP	Shower Trim Only, 2.5 gpm Push Button Diverter	ADA Lever	Polished Chrome	

\* Vibrant Limited Lifetime Warranty

[www.waterconcepts.net](http://www.waterconcepts.net) • Serving our Customers Since 1946 • [www.plumbsupply.com](http://www.plumbsupply.com)

## Shower Faucets

### Refinia® Rite-Temp® 1-Hdl Valve Trim

- Premium construction
- Heavy-duty slip-fit clamp design and NPT threaded spout



**Requires:**

K-304/K-P304 Series Rite-Temp® Valves

or

K-2971-KS 3/4" Pressure-balancing Valve

Push-Button Diverter Trim Requires Valve: K-11748-K/KS

Part #	Mfg #	Description	Handle(s)	Finish	Price
142807	K-T5321-4-BN	Valve Trim Only, Push Button Diverter	ADA Lever	*Brushed Nickel	
172066	K-T5321-4-CP	Valve Trim Only, Push Button Diverter	ADA Lever	Polished Chrome	
225802	K-TS5322-4-BN	Valve Trim Only	ADA Lever	*Brushed Nickel	
225801	K-TS5322-4-CP	Valve Trim Only	ADA Lever	Polished Chrome	

### Revival® Rite-Temp® 1-Hdl Shower Trim

- Brass construction

**Requires:**

K-304/K-P304 Series Rite-Temp® Valves

or

K-2971-KS 3/4" Pressure-balancing Valve



Part #	Mfg #	Description	Handle(s)	Finish	Price
054681	K-TS16114-4A-CP	Shower Trim Only, 2.5 gpm	Traditional Lever	Polished Nickel	

### Revival® Rite-Temp® 1-Hdl Valve Trim

- Brass construction

**Requires:**

K-304/K-P304 Series Rite-Temp® Valves

or

K-2971-KS 3/4" Pressure-balancing Valve



Part #	Mfg #	Description	Handle(s)	Finish	Price
078303	K-TS16117-4A-BV	Valve Trim Only	ADA Traditional Lever	*Brushed Bronze	
064323	K-TS16117-4A-CP	Valve Trim Only	ADA Traditional Lever	Polished Chrome	

\* Vibrant Limited Lifetime Warranty

[www.plumbsupply.com](http://www.plumbsupply.com) • Serving our Customers Since 1946 • [www.waterconcepts.net](http://www.waterconcepts.net)

## Shower Faucets

### Stance® Rite-Temp 1-Hdl Shower Trim

- Brass construction
- MasterClean™ spray nozzles

**Requires:**

K-304/K-P304 Series Rite-Temp® Valves

or

K-2971-KS 3/4" Pressure-balancing Valve

Push-Button Diverter Trim Requires Valve: K-11748-K/KS



T-T14777-4

Part #	Mfg #	Description	Handle(s)	Finish	Price
233975	K-TS14778-4-BN	Shower Trim Only, 2.5 gpm	Lever	*Brushed Nickel	
138472	K-TS14778-4-CP	Shower Trim Only, 2.5 gpm	Lever	Polished Chrome	
156548	K-T14777-4-BN	Shower Trim Only, 2.5 gpm Push Button Diverter	Lever	*Brushed Nickel	

### Stance® Rite-Temp 1-Hdl Valve Trim

- Brass construction

**Requires:**

K-304/K-P304 Series Rite-Temp® Valves

or

K-2971-KS 3/4" Pressure-balancing Valve

Push-Button Diverter Trim Requires Valve: K-11748-K/KS



Part #	Mfg #	Description	Handle(s)	Finish	Price
138430	K-TS14780-4-CP	Valve Trim Only	Lever	Polished Chrome	
142074	K-T14779-4-BN	Valve Trim Only, Push Button Diverter	Lever	*Brushed Nickel	
150842	K-T14779-4-CP	Valve Trim Only, Push Button Diverter	Lever	Polished Chrome	

### Stillness® Rite-Temp 1-Hdl Shower Trim

- Premium metal construction

**Requires:**

K-304/K-P304 Series Rite-Temp® Valves

or

K-2971-KS 3/4" Pressure-balancing Valve

Push-Button Diverter Trim Requires Valve: K-11748-K/KS



Part #	Mfg #	Description	Handle(s)	Finish	Price
093775	K-TS949-4-BN	Shower Trim Only, 2.5 gpm	Lever	*Brushed Nickel	
234086	K-TS949-4-CP	Shower Trim Only, 2.5 gpm	Lever	Polished Chrome	

\* Vibrant Limited Lifetime Warranty

[www.waterconcepts.net](http://www.waterconcepts.net) • Serving our Customers Since 1946 • [www.plumbsupply.com](http://www.plumbsupply.com)

## Shower Faucets

### Stillness® Rite-Temp 1-Hdl Valve Trim

- Premium metal construction

**Requires:**

K-304/K-P304 Series Rite-Temp® Valves

or

K-2971-KS 3/4" Pressure-balancing Valve

Push-Button Diverter Trim Requires Valve: K-11748-K/KS



Part #	Mfg #	Description	Handle(s)	Finish	Price
087770	K-TS950-4-BN	Valve Trim Only	Lever	*Brushed Nickel	
061889	K-TS950-4-CP	Valve Trim Only	Lever	Polished Chrome	
226017	K-T1004-4-CP	Valve Trim Only, Push Button Diverter	Lever	Polished Chrome	

### Toobi™ Rite-Temp® 1-Hdl Shower Trim

- Metal construction
- Katalyst™ spray technology
- (48) MasterClean™ spray nozzles

**Requires:**

K-304/K-P304 Series Rite-Temp® Valves

or

K-2971-KS 3/4" Pressure-balancing Valve

Push-Button Diverter Trim Requires Valve: K-11748-K/KS



Part #	Mfg #	Description	Handle(s)	Finish	Price
149687	K-TS8978-4-BN	Shower Trim Only, 2.0 gpm	Lever	*Brushed Nickel	
152777	K-TS8978-4-CP	Shower Trim Only, 2.0 gpm	Lever	Polished Chrome	

### Toobi™ Rite-Temp® 1-Hdl Valve Trim

- Metal construction

**Requires:**

K-304/K-P304 Series Rite-Temp® Valves

or

K-2971-KS 3/4" Pressure-balancing Valve

Push-Button Diverter Trim Requires Valve: K-11748-K/KS



Part #	Mfg #	Description	Handle(s)	Finish	Price
143159	K-T8979-4-BN	Valve Trim Only, Push Button Diverter	Lever	*Brushed Nickel	
155215	K-T8979-4-CP	Valve Trim Only, Push Button Diverter	Lever	Polished Chrome	
143157	K-TS8981-4-BN	Valve Trim Only	Lever	*Brushed Nickel	
234924	K-TS8981-4-CP	Valve Trim Only	Lever	Polished Chrome	

\* Vibrant Limited Lifetime Warranty

**www.plumbsupply.com • Serving our Customers Since 1946 • www.waterconcepts.net**

## Shower Faucets

### Two-Handle Shower Trim

#### Coralais® 2-Hdl Shower Trim

- Metal construction
- Showerhead, arm and flange
- Reversible 1/2" 1/4-turn washerless ceramic disc valves



Requires valve K-302-K

Part #	Mfg #	Description	Handle(s)	Finish	Price
067315	K-T15211-4-CP	Shower Trim Only	ADA Lever	Polished Chrome	

#### Coralais® 2-Hdl Valve Trim

- Metal construction
- Reversible 1/2" 1/4-turn washerless ceramic disc valves



Requires valve K-302-K

Part #	Mfg #	Description	Handle(s)	Finish	Price
062715	K-T15225-4-CP	Valve Trim Only	ADA Lever	Polished Chrome	

### Performance Shower Valve Trim

- Vibrant finishes have a lifetime limited warranty

#### Alteo® Transfer Valve Trim

- Metal construction
- Front seal plate assembly



Requires: K-728-K 3/4" Transfer Valve

Part #	Mfg #	Description	Handle(s)	Finish	Price
142511	K-T45121-4-BN	Transfer Trim Only	ADA Metal Lever	*Brushed Nickel	
143973	K-T45121-4-CP	Transfer Trim Only	ADA Metal Lever	Polished Chrome	
153840	K-T45121-4-2BZ	Transfer Trim Only	ADA Metal Lever	Oil Rubbed Bronze	

#### Archer® Transfer Valve Trim

- Single lever handle allows control of up to 3 separate components to six different output options



Requires: K-728-K 3/4" in-wall 2- or 3-way Transfer Valve  
or  
K-737-K MasterShower® 2- or 3-way Diverter Valve

Part #	Mfg #	Description	Handle(s)	Finish	Price
173039	K-T45850-4-BN	Transfer Trim Only	ADA Metal Lever	*Brushed Nickel	
180694	K-T45850-4-CP	Transfer Trim Only	ADA Metal Lever	Polished Chrome	

\* Vibrant Limited Lifetime Warranty



## Shower Faucets

### Artifacts® Transfer Valve Trim

- Single lever handle allows control of up to 3 separate components to six different output options



Requires: K-728-K 3/4" in-wall 2- or 3-way Transfer Valve  
or  
K-737-K MasterShower® 2- or 3-way Diverter Valve



Part #	Mfg #	Description	Handle(s)	Finish	Price
256141	K-T72770-3-CP	Transfer Trim Only	ADA Cross	Polished Chrome	
252838	K-T72770-3-SN	Transfer Trim Only	ADA Cross	*Polished Nickel	
255738	K-T72770-3-2BZ	Transfer Trim Only	ADA Cross	Oil Rubbed Bronze	
232561	K-T72770-3M-CP	Transfer Trim Only	ADA Prong	Polished Chrome	
225784	K-T72770-3M-VNT	Transfer Trim Only	ADA Prong	Vintage Nickel	
240134	K-T72770-3M-2BZ	Transfer Trim Only	ADA Prong	Oil Rubbed Bronze	
166100	K-T72770-4-BN	Transfer Trim Only	ADA Lever	*Brushed Nickel	
169558	K-T72770-4-CP	Transfer Trim Only	ADA Lever	Polished Chrome	
181400	K-T72770-4-BV	Transfer Trim Only	ADA Lever	*Brushed Bronze	
174115	K-T72770-4-SN	Transfer Trim Only	ADA Lever	*Polished Nickel	
180273	K-T72770-4-2BZ	Transfer Trim Only	ADA Lever	Oil Rubbed Bronze	
188591	K-T72770-9M-BN	Transfer Trim Only	ADA Swing	*Brushed Nickel	
186424	K-T72770-9M-CP	Transfer Trim Only	ADA Swing	Polished Chrome	
165045	K-T72770-9M-SN	Transfer Trim Only	ADA Swing	Polished Nickel	
186118	K-T72770-9M-2BZ	Transfer Trim Only	ADA Swing	Oil Rubbed Bronze	

### Artifacts® Volume Control Valve Trim

- Metal construction
- Front seal plate assembly



Requires:  
K-2974-K 1/2" Volume Control Valve  
or  
K-2977-K 3/4" Volume Control Valve



Part #	Mfg #	Description	Handle(s)	Finish	Price
243475	K-T72771-3M-BN	Volume Trim Only	ADA Prong	*Brushed Nickel	
186412	K-T72771-3M-CP	Volume Trim Only	ADA Prong	Polished Chrome	
177053	K-T72771-3M-2BZ	Volume Trim Only	ADA Prong	Oil Rubbed Bronze	
177223	K-T72771-4-BN	Volume Trim Only	ADA Lever	*Brushed Nickel	
234101	K-T72771-4-BV	Volume Trim Only	ADA Lever	*Brushed Bronze	
183420	K-T72771-4-SN	Volume Trim Only	ADA Lever	*Polished Nickel	
173809	K-T72771-4-2BZ	Volume Trim Only	ADA Lever	Oil Rubbed Bronze	

\* Vibrant Limited Lifetime Warranty

[www.plumbsupply.com](http://www.plumbsupply.com) • Serving our Customers Since 1946 • [www.waterconcepts.net](http://www.waterconcepts.net)

## Shower Faucets

### Artifacts® Thermostatic Valve Trim

- Metal construction
- Front seal plate assembly

**Requires:**

**K-2972-KS 1/2" Thermostatic Valve**  
or  
**K-2975-KS 3/4" Thermostatic Valve**



-9



-3M



-9M

Part #	Mfg #	Description	Handle(s)	Finish	Price
243533	K-T72769-3M-BN	Thermostatic Trim Only	ADA Prong	*Brushed Nickel	
186411	K-T72769-3M-CP	Thermostatic Trim Only	ADA Prong	Polished Chrome	
177052	K-T72769-3M-2BZ	Thermostatic Trim Only	ADA Prong	Oil Rubbed Bronze	
177222	K-T72769-4-BN	Thermostatic Trim Only	ADA Lever	*Brushed Nickel	
234099	K-T72769-4-BV	Thermostatic Trim Only	ADA Lever	*Brushed Bronze	
247983	K-T72769-4-CP	Thermostatic Trim Only	ADA Lever	Polished Chrome	
183414	K-T72769-4-SN	Thermostatic Trim Only	ADA Lever	*Polished Nickel	
189247	K-T72769-4-2BZ	Thermostatic Trim Only	ADA Lever	Oil Rubbed Bronze	
183416	K-T72769-9M-2BZ	Thermostatic Valve Trim	ADA Swing	Oil Rubbed Bronze	

### Bancroft® Stacked Thermostatic Valve Trim

- Brass construction
- Front seal plate assembly



**Requires**

**K-2973-KS 1/2" Stacked Thermostatic Valve**  
or  
**K-2976-KS 3/4" Stacked Thermostatic Valve**

Part #	Mfg #	Description	Handle(s)	Finish	Price
103809	K-T10594-4-BN	Thermostatic Trim Only	ADA Metal Lever	*Brushed Nickel	
111084	K-T10594-4-BV	Thermostatic Trim Only	ADA Metal Lever	*Brushed Bronze	
099598	K-T10594-4-CP	Thermostatic Trim Only	ADA Metal Lever	Polished Chrome	
181997	K-T10594-4-SN	Thermostatic Trim Only	ADA Metal Lever	*Polished Nickel	
150240	K-T10594-4-2BZ	Thermostatic Trim Only	ADA Metal Lever	Oil Rubbed Bronze	
113176	K-T10594-4P-CP	Thermostatic Trim Only	ADA Wht Porcelain Lever	Polished Chrome	
179772	K-T10594-4P-BN	Thermostatic Trim Only	ADA Wht Porcelain Lever	*Brushed Nickel	

### Bancroft® MasterShower Thermostatic Valve Trim

- Patented K-joint installation
- Front seal plate assembly



**Requires:**

**K-2975-KS 3/4" Thermostatic Mixing Valve**  
or  
**K-2972-KS 1/2" Thermostatic Mixing Valve**

Part #	Mfg #	Description	Handle(s)	Finish	Price
110899	K-T10593-4-BN	Thermostatic Valve Trim Only	ADA Lever	*Brushed Nickel	

\* Vibrant Limited Lifetime Warranty

[www.waterconcepts.net](http://www.waterconcepts.net) • Serving our Customers Since 1946 • [www.plumbsupply.com](http://www.plumbsupply.com)

## Shower Faucets

### Performance Shower Valve Trim (Continued)

#### Bancroft® MasterShower Thermostatic Valve Trim

Part #	Mfg #	Description	Handle(s)	Finish	Price
115779	K-T10593-4-CP	Thermostatic Valve Trim Only	ADA Lever	Polished Chrome	
138304	K-T10593-4-2BZ	Thermostatic Valve Trim Only	ADA Lever	*Brushed Nickel	

#### Bancroft® Transfer Valve Trim

- Brass construction
- Front seal plate assembly



Requires: K-728-K 3/4" in-wall 2- or 3-way Transfer Valve  
or  
K-737-K 3/4" 2- or 3-way Diverter Valve

Part #	Mfg #	Description	Handle(s)	Finish	Price
103810	K-T10595-4-BN	Transfer Trim Only	ADA Metal Lever	*Brushed Nickel	
111081	K-T10595-4-BV	Transfer Trim Only	ADA Metal Lever	*Brushed Bronze	
104051	K-T10595-4-CP	Transfer Trim Only	ADA Metal Lever	Polished Chrome	
173350	K-T10595-4-SN	Transfer Trim Only	ADA Metal Lever	*Polished Nickel	
150241	K-T10595-4-2BZ	Transfer Trim Only	ADA Metal Lever	Oil Rubbed Bronze	

#### Bancroft® Volume Control Valve Trim

- Brass construction
- Front seal plate assembly



Requires:  
K-2974-K 1/2" Volume Control Valve  
or  
K-2977-K 3/4" Volume Control Valve

Part #	Mfg #	Description	Handle(s)	Finish	Price
110911	K-T10596-4-BN	Volume Control Trim Only	ADA Metal Lever	*Brushed Nickel	
102626	K-T10596-4-CP	Volume Control Trim Only	ADA Metal Lever	Polished Chrome	
146019	K-T10596-4-SN	Volume Control Trim Only	ADA Metal Lever	*Polished Nickel	
138305	K-T10596-4-2BZ	Volume Control Trim Only	ADA Metal Lever	Oil Rubbed Bronze	
105157	K-T10596-4P-CP	Volume Control Trim Only	ADA Porcelain Lever	Polished Chrome	

#### Composed™ MasterShower® Thermostatic Valve Trim

- K-Joint installation
- Front seal plate assembly



Requires:  
K-2975-KS 3/4" Thermostatic Mixing Valve  
or  
K-2972-KS 1/2" Thermostatic Mixing Valve

Part #	Mfg #	Description	Handle(s)	Finish	Price
253364	K-T73133-3-CP	Thermostatic Valve Trim Only	ADA Cross	Polished Chrome	

\* Vibrant Limited Lifetime Warranty

[www.plumbsupply.com](http://www.plumbsupply.com) • Serving our Customers Since 1946 • [www.waterconcepts.net](http://www.waterconcepts.net)

## Shower Faucets

### Performance Shower Valve Trim (Continued) Composed™ MasterShower® Thermostatic Valve Trim

Part #	Mfg #	Description	Handle(s)	Finish	Price
250808	K-T73133-3-TT	Thermostatic Valve Trim Only	ADA Cross	*Titanium	
257856	K-T73133-4-TT	Thermostatic Valve Trim Only	ADA Lever	*Titanium	

### Composed™ Transfer Valve Trim

- Metal construction
- Front seal plate assembly



(-4) Lever



(-3) Cross Handle

Requires: K-728-K 3/4" in-wall 2- or 3-way Transfer Valve  
or  
K-737-K 3/4" 2- or 3-way Diverter Valve

Part #	Mfg #	Description	Handle(s)	Finish	Price
231769	K-T73140-3-CP	Transfer Trim Only	ADA Cross	Polished Chrome	
252979	K-T73140-3-TT	Transfer Trim Only	ADA Cross	*Titanium	
224854	K-T73140-4-CP	Transfer Trim Only	ADA Lever	Polished Chrome	

### Composed™ Volume Control Valve Trim

- K-Joint installation
- Front seal plate assembly



Requires:  
K-2974-K 1/2" Volume Control Valve  
or  
K-2977-K 3/4" Volume Control Valve

Part #	Mfg #	Description	Handle(s)	Finish	Price
253365	K-T73135-3-CP	Volume Control Trim Only	ADA Cross	Polished Chrome	
250809	K-T73135-3-TT	Volume Control Trim Only	ADA Cross	*Titanium	
257858	K-T73135-4-TT	Volume Control Trim Only	ADA Lever	*Titanium	

### Coralais® Transfer Valve Trim

- K-Joint installation
- Front seal plate assembly



Requires: K-728-K 3/4" 2- or 3-Way Transfer Valve  
or  
K-737-K 3/4" 2- or 3-Way Diverter Valve

Part #	Mfg #	Description	Handle(s)	Finish	Price
255258	K-T97831-4-G	Transfer Trim Only	ADA Lever	Brushed Chrome	

\* Vibrant Limited Lifetime Warranty

[www.waterconcepts.net](http://www.waterconcepts.net) • Serving our Customers Since 1946 • [www.plumbsupply.com](http://www.plumbsupply.com)

## Shower Faucets

### Devonshire® Transfer Valve Trim

- Brass construction
- Front seal plate assembly



Requires: K-728-K 3/4" in-wall 2- or 3-way Transfer Valve  
or  
K-737-K 3/4" 2- or 3-way Diverter Valve

Part #	Mfg #	Description	Handle(s)	Finish	Price
091165	K-T376-4-BN	Transfer Trim Only	ADA Lever	*Brushed Nickel	
090304	K-T376-4-BV	Transfer Trim Only	ADA Lever	*Brushed Bronze	
094950	K-T376-4-CP	Transfer Trim Only	ADA Lever	Polished Chrome	
104043	K-T376-4-PB	Transfer Trim Only	ADA Lever	*Polished Brass	
172079	K-T376-4-SN	Transfer Trim Only	ADA Lever	*Polished Nickel	
146974	K-T376-4-2BZ	Transfer Trim Only	ADA Lever	Oil Rubbed Bronze	

### Devonshire® Thermostatic Valve Trim

- Metal construction
- Front seal plate assembly



Requires:  
K-2972-KS 1/2" Thermostatic Valve  
or  
K-2975-KS 3/4" Thermostatic Valve

Part #	Mfg #	Description	Handle(s)	Finish	Price
117653	K-T10357-4-BN	Thermostatic Valve Trim	ADA Lever	*Brushed Nickel	
120681	K-T10357-4-BV	Thermostatic Valve Trim	ADA Lever	*Brushed Bronze	
121709	K-T10357-4-CP	Thermostatic Valve Trim	ADA Lever	Polished Chrome	
146197	K-T10357-4-PB	Thermostatic Valve Trim	ADA Lever	*Polished Brass	
184419	K-T10357-4-SN	Thermostatic Valve Trim	ADA Lever	*Polished Nickel	
146972	K-T10357-4-2BZ	Thermostatic Valve Trim	ADA Lever	Oil Rubbed Bronze	

### Devonshire® Volume Control Valve Trim

- Brass construction
- Front seal plate assembly



Requires:  
K-2974-K 1/2" Volume Control Valve  
or  
K-2977-K 3/4" Volume Control Valve

Part #	Mfg #	Description	Handle(s)	Finish	Price
117655	K-T10358-4-BN	Volume Control Trim Only	ADA Lever	*Brushed Nickel	
120682	K-T10358-4-BV	Volume Control Trim Only	ADA Lever	*Brushed Bronze	
121708	K-T10358-4-CP	Volume Control Trim Only	ADA Lever	Polished Chrome	
146198	K-T10358-4-PB	Volume Control Trim Only	ADA Lever	*Polished Brass	
184420	K-T10358-4-SN	Volume Control Trim Only	ADA Lever	*Polished Nickel	
146973	K-T10358-4-2BZ	Volume Control Trim Only	ADA Lever	Oil Rubbed Bronze	

\* Vibrant Limited Lifetime Warranty

[www.plumbsupply.com](http://www.plumbsupply.com) • Serving our Customers Since 1946 • [www.waterconcepts.net](http://www.waterconcepts.net)

## Shower Faucets

### Fairfax® Transfer or Diverter Valve Trim

- Patented K-joint installation
- When used with K-728 Series MasterShower diverter valves, handle controls flow to two or three outlets individually or any two outlets at a time
- When used with K-737 Series MasterShower diverter valves, handle controls flow to two or three outlets individually (only one outlet at a time)
- Valve (not supplied) can be configured on site for two or three outlet operation
- 360° handle rotation with three outlet operation
- 120° handle rotation with two outlet operation



**Requires:**

**K-728-K 3/4" 2- or 3-way Transfer Valve**  
or  
**K-737-K 3/4" 2- or 3-way Diverter Valve**

Part #	Mfg #	Description	Handle(s)	Finish	Price
095172	K-T12189-4-CP	Transfer Trim Only	ADA Lever	Polished Chrome	
133314	K-T12189-4-2BZ	Transfer Trim Only	ADA Lever	Oil Rubbed Bronze	

### Finial® Traditional Transfer Valve Trim

- Brass construction
- Front seal plate assembly



**Requires: K-728-K 3/4" in-wall 2- or 3-way Transfer Valve**  
or  
**K-737-K 3/4" 2- or 3-way Diverter Valve**

Part #	Mfg #	Description	Handle(s)	Finish	Price
098147	K-T10304-4M-AF	Transfer Trim Only	ADA Lever	*French Gold	
100291	K-T10304-4M-BN	Transfer Trim Only	ADA Lever	*Brushed Nickel	

### Finial® Traditional Thermostatic Valve Trim

- Metal construction
- Front seal plate assembly



**Requires:**

**K-2972-KS 1/2" Thermostatic Valve**  
or  
**K-2975-KS 3/4" Thermostatic Valve**

Part #	Mfg #	Description	Handle(s)	Finish	Price
252944	K-T10301-4M-AF	Thermostatic Valve Trim	ADA Lever	*French Gold	
096600	K-T10301-4M-BN	Thermostatic Valve Trim	ADA Lever	*Brushed Nickel	
091561	K-T10301-4M-BV	Thermostatic Valve Trim	ADA Lever	*Brushed Bronze	
091338	K-T10301-4M-CP	Thermostatic Valve Trim	ADA Lever	Polished Chrome	
182954	K-T10301-4M-SN	Thermostatic Valve Trim	ADA Lever	*Polished Nickel	
242009	K-T10301-4M-2BZ	Thermostatic Valve Trim	ADA Lever	Oil Rubbed Bronze	

\* Vibrant Limited Lifetime Warranty

**www.waterconcepts.net • Serving our Customers Since 1946 • www.plumbsupply.com**



## Shower Faucets

### Finial® Traditional Volume Control Valve Trim

- Brass construction
- Front seal plate assembly



**Requires:**

K-2974-K 1/2" Volume Control Valve  
or  
K-2977-K 3/4" Volume Control Valve

Part #	Mfg #	Description	Handle(s)	Finish	Price
252945	K-T10303-4M-AF	Volume Control Trim	ADA Lever	*French Gold	
096601	K-T10303-4M-BN	Volume Control Trim	ADA Lever	*Brushed Nickel	
091562	K-T10303-4M-BV	Volume Control Trim	ADA Lever	*Brushed Bronze	
108910	K-T10303-4M-CP	Volume Control Trim	ADA Lever	Polished Chrome	
182956	K-T10303-4M-SN	Volume Control Trim	ADA Lever	*Polished Nickel	
242010	K-T10303-4M-2BZ	Volume Control Trim	ADA Lever	Oil Rubbed Bronze	

### Finial® Traditional Stacked Thermostatic Valve Trim

- Brass construction
- Front seal plate assembly



**Requires:**

K-2973-KS 1/2" Stacked Thermostatic Valve  
or  
K-2976-KS 3/4" Stacked Thermostatic Valve

Part #	Mfg #	Description	Handle(s)	Finish	Price
182955	K-T10302-4M-AF	Stacked Thermostatic Valve Trim	ADA Lever	*French Gold	
100292	K- T10302-4M-BN	Stacked Thermostatic Valve Trim	ADA Lever	*Brushed Nickel	
099694	K- T10302-4M-BV	Stacked Thermostatic Valve Trim	ADA Lever	*Brushed Bronze	
121788	K- T10302-4M-CP	Stacked Thermostatic Valve Trim	ADA Lever	Polished Chrome	
137985	K- T10302-4M-SN	Stacked Thermostatic Valve Trim	ADA Lever	*Polished Nickel	

### Forté® Thermostatic Valve Trim

- Metal construction
- Front seal plate assembly



**Requires:**

K-2972-KS 1/2" Thermostatic Valve  
or  
K-2975-KS 3/4" Thermostatic Valve

Part #	Mfg #	Description	Handle(s)	Finish	Price
116800	K-T10359-4-BN	Thermostatic Trim Only	ADA Sculpted Lever	*Brushed Nickel	
121306	K-T10359-4-CP	Thermostatic Trim Only	ADA Sculpted Lever	Polished Chrome	
167079	K-T10359-4-G	Thermostatic Trim Only	ADA Sculpted Lever	Brushed Chrome	

\* Vibrant Limited Lifetime Warranty

[www.plumbsupply.com](http://www.plumbsupply.com) • Serving our Customers Since 1946 • [www.waterconcepts.net](http://www.waterconcepts.net)

## Shower Faucets

### Forté® Volume Control Valve Trim

- Brass construction
- Front seal plate assembly



**Requires:**

K-2974-K 1/2" Volume Control Valve  
or  
K-2977-K 3/4" Volume Control Valve

Part #	Mfg #	Description	Handle(s)	Finish	Price
119281	K-T10360-4-BN	Volume Control Trim Only	ADA Sculpted Lever	*Brushed Nickel	
116531	K-T10360-4-CP	Volume Control Trim Only	ADA Sculpted Lever	Polished Chrome	
167080	K-T10360-4-G	Volume Control Trim Only	ADA Sculpted Lever	Brushed Chrome	

### Forté® Transfer Valve Trim

- Brass construction
- Front seal plate assembly



**Requires: K-728-K 3/4" in-wall 2- or 3-way Transfer Valve**

or  
K-737-K 3/4" 2- or 3-way Diverter Valve

Part #	Mfg #	Description	Handle(s)	Finish	Price
090303	K-T10290-4-BN	Transfer Trim Only	ADA Sculpted Lever	*Brushed Nickel	
090704	K-T10290-4-CP	Transfer Trim Only	ADA Sculpted Lever	Polished Chrome	
096556	K-T10290-4-G	Transfer Trim Only	ADA Sculpted Lever	Brushed Chrome	

### Kelston® Transfer Valve Trim

- Metal construction
- Front seal plate assembly



**Requires:**

K-728-K 3/4" in-wall 2- or 3-way Transfer Valve  
or  
K-737-K 3/4" 2- or 3-way Diverter Valve

Part #	Mfg #	Description	Handle(s)	Finish	Price
147110	K-T13661-4-BN	Transfer Trim Only	ADA Lever	*Brushed Nickel	
147109	K-T13661-4-CP	Transfer Trim Only	ADA Lever	Polished Chrome	
147003	K-T13661-4-2BZ	Transfer Trim Only	ADA Lever	Oil Rubbed Bronze	

\* Vibrant Limited Lifetime Warranty

[www.waterconcepts.net](http://www.waterconcepts.net) • Serving our Customers Since 1946 • [www.plumbsupply.com](http://www.plumbsupply.com)

## Shower Faucets

### Loure® Thermostatic Valve Trim

- Brass construction
- Front seal plate assembly



**Requires:**

**K-2972-KS 1/2" Thermostatic Valve**  
or  
**K-2975-KS 3/4" Thermostatic Valve**

Part #	Mfg #	Description	Handle(s)	Finish	Price
145696	K-T14672-4-BN	Thermostatic Trim Only	ADA Lever	*Brushed Nickel	
156032	K-T14672-4-CP	Thermostatic Trim Only	ADA Lever	Polished Chrome	

### Loure® Volume Control Valve Trim

- Brass construction
- Front seal plate assembly



**Requires:**

**K-2974-K 1/2" Volume Control Valve**  
or  
**K-2977-K 3/4" Volume Control Valve**

Part #	Mfg #	Description	Handle(s)	Finish	Price
145697	K-T14674-4-BN	Volume Control Trim Only	ADA Lever	*Brushed Nickel	
156033	K-T14674-4-CP	Volume Control Trim Only	ADA Lever	Polished Chrome	

### Loure® Transfer Valve Trim

**Requires:**

**K-728-K 3/4" in-wall 2- or 3-way Transfer Valve**  
or  
**K-737-K 3/4" 2- or 3-way Diverter Valve**



Part #	Mfg #	Description	Handle(s)	Finish	Price
145330	K-T14673-4-BN	Transfer Trim Only	ADA Lever	*Brushed Nickel	
139114	K-T14673-4-CP	Transfer Trim Only	ADA Lever	Polished Chrome	
231449	K-T14673-4-SN	Transfer Trim Only	ADA Lever	*Polished Nickel	

### MasterShower® Rite-Temp® Valve Trim

- Cylinder handle
- Includes trim adapter kit for:
  - K-8304 Series valve
  - Rite-Temp® K-304/K-2971 HiFlow



Part #	Mfg #	Description	Handle(s)	Finish	Price
246056	K-TS9492-7-CP	Transfer Trim Only	ADA Knob	Polished Chrome	

\* Vibrant Limited Lifetime Warranty

[www.plumbsupply.com](http://www.plumbsupply.com) • Serving our Customers Since 1946 • [www.waterconcepts.net](http://www.waterconcepts.net)

## Shower Faucets

### MasterShower® Transfer Valve Trim

- Brass construction
- Front seal plate assembly



**Requires:**

K-728-K 3/4" in-wall 2- or 3-way Transfer Valve  
or  
K-737-K 3/4" 2- or 3-way Diverter Valve

Part #	Mfg #	Description	Handle(s)	Finish	Price
156637	K-T10185-7-CP	Transfer Valve Trim Only	Knob	Polished Chrome	

### MasterShower® Thermostatic Valve Trim

- Brass construction
- Front seal plate assembly



**Requires:**

K-2972-KS 1/2" Thermostatic Valve  
or  
K-2975-KS 3/4" Thermostatic Valve

Part #	Mfg #	Description	Handle(s)	Finish	Price
182952	K-T10182-7-BN	Thermostatic Trim Only	Knob	*Brushed Nickel	
141590	K-T10182-7-CP	Thermostatic Trim Only	Knob	Polished Chrome	

### MasterShower® Volume Control Valve

- Brass construction
- Front seal plate assembly



**Requires:**

K-2974-K 1/2" Volume Control Valve  
or  
K-2977-K 3/4" Volume Control Valve

Part #	Mfg #	Description	Handle(s)	Finish	Price
182953	K-T10184-7-BN	Volume Control Trim	Knob	*Brushed Nickel	
141591	K-T10184-7-CP	Volume Control Trim	Knob	Polished Chrome	

### Margaux® Thermostatic Valve Trim

- Brass construction
- Front seal plate assembly



**Requires:**

K-2972-KS 1/2" Thermostatic Valve  
or  
K-2975-KS 3/4" Thermostatic Valve

Part #	Mfg #	Description	Handle(s)	Finish	Price
239792	K-T16239-3-AF	Thermostatic Trim Only	ADA Cross	*French Gold	
114258	K-T16239-3-BV	Thermostatic Trim Only	ADA Cross	*Brushed Bronze	
117695	K-T16239-3-CP	Thermostatic Trim Only	ADA Cross	Polished Chrome	
152152	K-T16239-3-SN	Thermostatic Trim Only	ADA Cross	*Polished Nickel	

\* Vibrant Limited Lifetime Warranty

## Shower Faucets

### Performance Shower Valve Trim (Continued)

#### Margaux® Thermostatic Valve Trim

Part #	Mfg #	Description	Handle(s)	Finish	Price
120554	K-T16239-4-BN	Thermostatic Trim Only	ADA Lever	*Brushed Nickel	
241806	K-T16239-4-BV	Thermostatic Trim Only	ADA Lever	*Brushed Bronze	
115701	K-T16239-4-CP	Thermostatic Trim Only	ADA Lever	Polished Chrome	
160871	K-T16239-4-SN	Thermostatic Trim Only	ADA Lever	*Polished Nickel	

#### Margaux® Volume Control Valve Trim

- Brass construction
- Front seal plate assembly



**Requires:**

**K-2974-K 1/2" Volume Control Valve**

or

**K-2977-K 3/4" Volume Control Valve**

Part #	Mfg #	Description	Handle(s)	Finish	Price
239793	K-T16241-3-AF	Volume Control Trim Only	ADA Cross	*French Gold	
114259	K-T16241-3-BV	Volume Control Trim Only	ADA Cross	*Brushed Bronze	
117696	K-T16241-3-CP	Volume Control Trim Only	ADA Cross	Polished Chrome	
152155	K-T16241-3-SN	Volume Control Trim Only	ADA Cross	*Polished Nickel	
120555	K-T16241-4-BN	Volume Control Trim Only	ADA Lever	*Brushed Nickel	
241805	K-T16241-4-BV	Volume Control Trim Only	ADA Lever	*Brushed Bronze	
127387	K-T16241-4-CP	Volume Control Trim Only	ADA Lever	Polished Chrome	
160872	K-T16241-4-SN	Volume Control Trim Only	ADA Lever	*Polished Nickel	

#### Margaux® Transfer Valve Trim

- Brass construction
- Front seal plate assembly



**Requires:**

**K-728-K 3/4" in-wall 2- or 3-way Transfer Valve**

or

**K-737-K 3/4" 2- or 3-way Diverter Valve**

Part #	Mfg #	Description	Handle(s)	Finish	Price
176333	K-T16242-3-BN	Transfer Valve Trim Only	Cross	*Brushed Nickel	
184124	K-T16242-4-AF	Transfer Valve Trim Only	ADA Lever	*French Gold	
108760	K-T16242-4-BN	Transfer Valve Trim Only	ADA Lever	*Brushed Nickel	
188547	K-T16242-4-BV	Transfer Valve Trim Only	ADA Lever	*Brushed Bronze	
107352	K-T16242-4-CP	Transfer Valve Trim Only	ADA Lever	Polished Chrome	
135074	K-T16242-4-SN	Transfer Valve Trim Only	ADA Lever	*Polished Nickel	

\* Vibrant Limited Lifetime Warranty

**www.plumbsupply.com • Serving our Customers Since 1946 • www.waterconcepts.net**

## Shower Faucets

### Memoirs® Stately Transfer Valve Trim

- Brass construction
- Front seal plate assembly



**Requires:**

K-728-K 3/4" in-wall 2- or 3-way Transfer Valve  
or  
K-737-K 3/4" 2- or 3-way Diverter Valve

Part #	Mfg #	Description	Handle(s)	Finish	Price
094310	K-T10424-4S-BN	Transfer Valve Trim Only	ADA Lever	*Brushed Nickel	
090053	K-T10424-4V-BN	Transfer Valve Trim Only	ADA Decor Lever	*Brushed Nickel	
095146	K-T10424-4V-BV	Transfer Valve Trim Only	ADA Decor Lever	*Brushed Bronze	
093508	K-T10424-4V-CP	Transfer Valve Trim Only	ADA Decor Lever	Polished Chrome	
165826	K-T10424-4V-2BZ	Transfer Valve Trim Only	ADA Decor Lever	Oil Rubbed Bronze	

### Memoirs® Stately Thermostatic Valve Trim

- Brass construction
- Front seal plate assembly



**Requires:**

K-2972-KS 1/2" Thermostatic Valve  
or  
K-2975-KS 3/4" Thermostatic Valve

Part #	Mfg #	Description	Handle(s)	Finish	Price
182957	K-T10421-4S-BN	Valve Trim Only	ADA Faceted Lever	*Brushed Nickel	
103893	K-T10421-4V-BN	Valve Trim Only	ADA Decor Lever	*Brushed Nickel	
089143	K-T10421-4V-CP	Valve Trim Only	ADA Deco Lever	Polished Chrome	

### Memoirs® Stately Stacked Thermostatic Valve Trim

- Patented K-joint installation
- Ergonomic handle is ADA-compliant
- Trim requires valve to complete



**Requires**

K-2973-KS 1/2" Stacked Thermostatic Valve  
or  
K-2976-KS 3/4" Stacked Thermostatic Valve

Part #	Mfg #	Description	Handle(s)	Finish	Price
182958	K-T10422-4S-CP	Stacked Thermostatic Valve Trim	ADA Lever	Polished Chrome	
186591	K-T10422-4V-2BZ	Stacked Thermostatic Valve Trim	ADA Decor Lever	Oil Rubbed Bronze	

\* Vibrant Limited Lifetime Warranty

[www.waterconcepts.net](http://www.waterconcepts.net) • Serving our Customers Since 1946 • [www.plumbsupply.com](http://www.plumbsupply.com)



## Shower Faucets

### Memoirs® Volume Control Trim

- Brass construction
- Front seal plate assembly

**Requires:**

**K-2974-K 1/2" Volume Control Valve**  
or  
**K-2977-K 3/4" Volume Control Valve**



Part #	Mfg #	Description	Handle(s)	Finish	Price
182959	K-T10423-4S-BN	Volume Control Trim	ADA Faceted Lever	*Brushed Nickel	
142324	K-T10423-4S-BV	Volume Control Trim	ADA Faceted Lever	*Brushed Bronze	
102090	K-T10423-4V-BN	Volume Control Trim	ADA Decor Lever	*Brushed Nickel	
100874	K-T10423-4V-BV	Volume Control Trim	ADA Decor Lever	*Brushed Bronze	
089147	K-T10423-4V-CP	Volume Control Trim	ADA Decor Lever	Polished Chrome	

### Pinstripe® Thermostatic Valve trim

- Brass construction
- Front seal plate assembly
- Model **(K-T13173-4A-BN)** comes with pure design

**Requires:**

**K-2972-KS 1/2" Thermostatic Valve**  
or  
**K-2975-KS 3/4" Thermostatic Valve**



Part #	Mfg #	Description	Handle(s)	Finish	Price
237891	K-T13173-3B-BN	Valve Trim Only	Cross	*Brushed Nickel	
230265	K-T13173-3B-SN	Valve Trim Only	Cross	*Polished Nickel	
182969	K-T13173-4A-BN	Valve Trim Only, Pure Design	ADA Lever	*Brushed Nickel	
138583	K-T13173-4A-CP	Valve Trim Only, Pure Design	ADA Lever	Polished Chrome	
180917	K-T13173-4B-CP	Valve Trim Only	ADA Lever	Polished Chrome	

### Pinstripe® Volume Control Trim

- Brass construction
- Front seal plate assembly

**Requires:**

**K-2974-K 1/2" Volume Control Valve**  
or  
**K-2977-K 3/4" Volume Control Valve**



Part #	Mfg #	Description	Handle(s)	Finish	Price
237892	K-T13174-3B-BN	Valve Trim Only	ADA Cross	*Brushed Nickel	
182970	K-T13174-3B-SN	Valve Trim Only	ADA Cross	*Polished Nickel	
187257	K-T13174-4A-CP	Valve Trim Only	ADA Lever	Polished Chrome	
180918	K-T13174-4B-CP	Valve Trim Only	ADA Lever	Polished Chrome	

\* Vibrant Limited Lifetime Warranty

[www.plumbsupply.com](http://www.plumbsupply.com) • Serving our Customers Since 1946 • [www.waterconcepts.net](http://www.waterconcepts.net)

## Shower Faucets

### Pinstripe® Transfer Valve Trim with Pure Design

- Brass construction
- Front seal plate assembly
- Model (K-T13175-3B-CP) includes etched symmetrical lines



**Requires:**

K-728-K 3/4" in-wall 2- or 3-way Transfer Valve

or

K-737-K 3/4" 2- or 3-way Diverter Valve

Part #	Mfg #	Description	Handle(s)	Finish	Price
152772	K-T13175-3A-BN	Transfer Trim Only	Cross	*Brushed Nickel	
237890	K-T13175-3B-BN	Transfer Trim Only, Etched Symmetrical Lines	Cross	*Brushed Nickel	
162236	K-T13175-3B-CP	Transfer Trim Only, Etched Symmetrical Lines	Cross	Polished Chrome	
163781	K-T13175-4A-BN	Transfer Trim Only	Lever	*Brushed Nickel	
110256	K-T13175-4A-CP	Transfer Trim Only	Lever	Polished Chrome	
182971	K-T13175-4B-SN	Transfer Trim Only	Lever	*Polished Nickel	

### Purist® Transfer Valve Trim

- Brass construction
- Front seal plate assembly



K-T14491-3



K-T14491-4

**Requires:**

K-728-K 3/4" in-wall 2- or 3-way Transfer Valve

or

K-737-K 3/4" 2- or 3-way Diverter Valve

Part #	Mfg #	Description	Handle(s)	Finish	Price
162442	K-T14491-3-BN	Transfer Trim Only	Cross	*Brushed Nickel	
144443	K-T14491-3-CP	Transfer Trim Only	Cross	Polished Chrome	
148315	K-T14491-3-SN	Transfer Trim Only	Cross	*Polished Nickel	
091680	K-T14491-4-BN	Transfer Trim Only	ADA Lever	*Brushed Nickel	
153093	K-T14491-4-BV	Transfer Trim Only	ADA Lever	*Brushed Bronze	
094455	K-T14491-4-CP	Transfer Trim Only	ADA Lever	Polished Chrome	
131003	K-T14491-4-SN	Transfer Trim Only	ADA Lever	*Polished Nickel	

### Purist® Thermostatic Valve Trim

- Brass construction
- Front seal plate assembly



**Requires:**

K-2972-KS 1/2" Thermostatic Valve

or

K-2975-KS 3/4" Thermostatic Valve

Part #	Mfg #	Description	Handle(s)	Finish	Price
239519	K-T14488-3-SN	Thermostatic Trim Only	ADA Cross	*Polished Nickel	
091679	K-T14488-4-BN	Thermostatic Trim Only	ADA Lever	*Brushed Nickel	
092815	K-T14488-4-CP	Thermostatic Trim Only	ADA Lever	Polished Chrome	
182972	K-T14488-4-SN	Thermostatic Trim Only	ADA Lever	*Polished Nickel	

\* Vibrant Limited Lifetime Warranty

## Shower Faucets

### Purist® Volume Control Valve Trim

- Brass construction
- Front seal plate assembly



**Requires:**

**K-2974-K 1/2" Volume Control Valve**

or

**K-2977-K 3/4" Volume Control Valve**

Part #	Mfg #	Description	Handle(s)	Finish	Price
239534	K-T14490-3-SN	Volume Control Trim	ADA Cross	*Polished Nickel	
099336	K-T14490-3-CP	Volume Control Trim	ADA Cross	Polished Chrome	
098371	K-T14490-4-BN	Volume Control Trim	ADA Lever	*Brushed Nickel	
092816	K-T14490-4-CP	Volume Control Trim	ADA Lever	Polished Chrome	
182973	K-T14490-4-SN	Volume Control Trim	ADA Lever	*Polished Nickel	

### Purist® Thermostatic Stacked Valve Trim

- Patented K-joint
- Wall-Mount installation
- Trim requires valve to be complete



**Requires**

**K-2973-KS 1/2" Stacked Thermostatic Valve**

or

**K-2976-KS 3/4" Stacked Thermostatic Valve**

Part #	Mfg #	Description	Handle(s)	Finish	Price
097865	K-T14489-4-CP	Stacked Thermostatic Trim	ADA Lever	Polished Chrome	
188577	K-T14489-4-BV	Stacked Thermostatic Trim	ADA Lever	*Brushed Bronze	

### Real Rain® Diverter Valve Trim

- Includes round and square escutcheon options



**Requires:**

**K-76746 Diverter Valve**

**K-76728 Overhead Panel**

**K-76732 Overhead Panel Trim**

Part #	Mfg #	Description	Handle(s)	Finish	Price
253736	76748-BL	Diverter Trim Only	ADA Push Button	Matte Black	
258185	76748-BN	Diverter Trim Only	ADA Push Button	*Brushed Nickel	
250651	76748-CP	Diverter Trim Only	ADA Push Button	Polished Chrome	

\* Vibrant Limited Lifetime Warranty

[www.plumbsupply.com](http://www.plumbsupply.com) • Serving our Customers Since 1946 • [www.waterconcepts.net](http://www.waterconcepts.net)

## Shower Faucets

### Refinia® Transfer Valve Trim

- Brass construction
- Front seal plate assembly



**Requires:**

K-728-K 3/4" in-wall 2- or 3-way Transfer Valve  
or  
K-737-K 3/4" 2- or 3-way Diverter Valve

Part #	Mfg #	Description	Handle(s)	Finish	Price
141711	K-T5326-4-BN	Transfer Trim Only	ADA Lever	*Brushed Nickel	
141712	K-T5326-4-CP	Transfer Trim Only	ADA Lever	Polished Chrome	

### Stance® Thermostatic Valve Trim

- Brass construction
- Front seal plate assembly



**Requires:**

K-2972-KS 1/2" Thermostatic Valve  
or  
K-2975-KS 3/4" Thermostatic Valve

Part #	Mfg #	Description	Handle(s)	Finish	Price
134407	K-T14781-4-BN	Thermostatic Trim Only	ADA Lever	*Brushed Nickel	
156015	K-T14781-4-CP	Thermostatic Trim Only	ADA Lever	Polished Chrome	

### Stance® Volume Control Valve Trim

- Brass construction
- Front seal plate assembly



**Requires:**

K-2974-K 1/2" Volume Control Valve  
or  
K-2977-K 3/4" Volume Control Valve

Part #	Mfg #	Description	Handle(s)	Finish	Price
134410	K-T14782-4-BN	Volume Control Trim	ADA Lever	*Brushed Nickel	
156014	K-T14782-4-CP	Volume Control Trim	ADA Lever	Polished Chrome	

### Stance® 3-Way Transfer Valve Trim

- Brass construction
- Front seal plate assembly



**Requires:**

K-728-K 3/4" in-wall 2- or 3-way Transfer Valve  
or  
K-737-K 3/4" 2- or 3-way Diverter Valve

Part #	Mfg #	Description	Handle(s)	Finish	Price
168293	K-T14783-4-BN	Transfer Trim Only	ADA Lever	*Brushed Nickel	
138431	K-T14783-4-CP	Transfer Trim Only	ADA Lever	Polished Chrome	

\* Vibrant Limited Lifetime Warranty

[www.waterconcepts.net](http://www.waterconcepts.net) • Serving our Customers Since 1946 • [www.plumbsupply.com](http://www.plumbsupply.com)

## Shower Faucets

### Stillness® MasterShower Thermostatic Valve Trim

- Patented K-joint installation



**Requires:**

K-2975-KS 3/4" Thermostatic Mixing Valve  
or  
K-2972-KS 1/2" Thermostatic Mixing Valve

Part #	Mfg #	Description	Handle(s)	Finish	Price
090623	K-T10940-4-BN	Valve Trim Only	ADA Lever	*Brushed Nickel	

### Stillness® Thermostatic Stacked Valve Trim

- Patented K-joint
- Wall-Mount installation
- Trim requires valve to be complete



**Requires**

K-2976-KS 3/4" Thermostatic Mixer  
or  
K-2973-KS 1/2" Thermostatic Mixing Valve

Part #	Mfg #	Description	Handle(s)	Finish	Price
091098	K-T10941-4-CP	Valve Trim Only	ADA Lever	Polished Chrome	

### Stillness® Transfer Valve Trim

- Brass construction
- Front seal plate assembly



**Requires:**

K-728-K 3/4" in-wall 2- or 3-way Transfer Valve  
or  
K-737-K 3/4" 2- or 3-way Diverter Valve

Part #	Mfg #	Description	Handle(s)	Finish	Price
090240	K-T10944-4-BN	Transfer Trim Only	ADA Lever	*Brushed Nickel	
091099	K-T10944-4-CP	Transfer Trim Only	ADA Lever	Polished Chrome	

### Toobi™ MasterShower Thermostatic Valve Trim

- Brass construction
- Patented K-joint installation



**Requires:**

K-2975-KS 3/4" Thermostatic Mixing Valve  
or  
K-2975-KS 1/2" Thermostatic Mixing Valve

Part #	Mfg #	Description	Handle(s)	Finish	Price
248289	K-T8982-4-CP	Valve Trim Only	ADA Lever	Polished Chrome	

\* Vibrant Limited Lifetime Warranty

[www.plumbsupply.com](http://www.plumbsupply.com) • Serving our Customers Since 1946 • [www.waterconcepts.net](http://www.waterconcepts.net)

## Shower Faucets

### Toobi™ Transfer Valve Trim

- Brass construction
- Front seal plate assembly



**Requires:**

K-728-K 3/4" in-wall 2- or 3-way Transfer Valve  
or  
K-737-K 3/4" 2- or 3-way Diverter Valve

Part #	Mfg #	Description	Handle(s)	Finish	Price
159776	K-T8984-4-BN	Transfer Trim Only	ADA Lever	*Brushed Nickel	
148624	K-T8984-4-CP	Transfer Trim Only	ADA Lever	Polished Chrome	

### Toobi™ Volume Control Valve Trim

- Brass construction
- Patented K-joint installation



**Requires:**

K-2977-K 3/4" Volume Control Valve  
or  
K-2974-K 1/2" Volume Control Valve

Part #	Mfg #	Description	Handle(s)	Finish	Price
248290	K-T8983-4-CP	Valve Trim Only	ADA Lever	Polished Chrome	

## Shower Packages

### Bancroft® Essentials Performance Shower Package

- Multi-Function showerhead and handheld shower
- Includes:
  - Handshower
  - Showerhead
  - Showerarm with diverter
  - Shower hose
  - Slidebar kit
  - RiteTemp® valve trim

Requires Valve: K-304-K/KS



Part #	Mfg #	Description	Handle(s)	Finish	Price
159682	K-10828-4-BN	Shower Package	ADA Lever	*Brushed Nickel	
103996	K-10828-4-CP	Shower Package	ADA Lever	Polished Chrome	

\* Vibrant Limited Lifetime Warranty



## Shower Faucets

### Monitor® 13 Series Shower & Valve Trim

#### Classic Monitor® 13 Series 1-Hdl Shower Trim

- Fits MultiChoice™ universal valve
- Includes cartridge
- Handle adjusts temperature
- Touch-Clean® showerhead
- Sweat onto 1/2" CWT or thread onto 1/2" IPS



H2O

Part #	Mfg #	Description	Handle(s)	Finish	Price
092585	T13220	Shower Trim Only, 2.0 gpm	ADA Lever	Chrome	
134430	T13220-SS	Shower Trim Only, 2.0 gpm	ADA Lever	Stainless*	
092587	T13220-SHC	Shower Trim Only, 3-Function, 1.75 gpm	ADA Lever	Chrome	
092590	T13220-PBSHC	Shower Trim Only, 3-Function, 1.75 gpm	ADA Lever	Polished Brass*	
174001	T13220-SSSHC	Shower Trim Only, 3-Function, 1.75 gpm	ADA Lever	Stainless*	
092630	T13222	Shower Trim Only, 1.75 gpm	Clear Knob	Chrome	
124988	T13220-H2OT	Shower Trim Only, H2O Showerhead, 1.5 gpm	ADA Lever	Chrome	
135315	T13220-SSH2OT	Shower Trim Only, H2O Showerhead, 1.5 gpm	ADA Lever	Stainless*	

#### Classic Monitor® 13 Series 1-Hdl Valve Trim

- Fits MultiChoice™ universal valve
- Includes cartridge
- Handle adjusts temperature
- Sweat onto 1/2" CWT or thread onto 1/2" IPS



Part #	Mfg #	Description	Handle(s)	Finish	Price
092580	T13020	Valve Trim Only	ADA Lever	Chrome	
135846	T13020-SS	Valve Trim Only	ADA Lever	Stainless*	
164345	T13020-SSDPE	Valve Trim Only, 1" Deeper Escutcheon	ADA Lever	Stainless*	

#### Foundations® Core-B Monitor® 13 Series 1-Hdl Shower Trim

- Fits MultiChoice® universal valve
- Single-function pressure balance cartridge
- Handle adjusts temperature
- Full body spray showerhead



Part #	Mfg #	Description	Handle(s)	Finish	Price
133788	BT13210	Shower Trim Only, 1.75 gpm	ADA Lever	Chrome	
139319	BT13210-SS	Shower Trim Only, 1.75 gpm	ADA Lever	Stainless*	

\* Brilliance® Anti-Tarnish Lifetime Finishes

## Shower Faucets

### Foundations® Core-B Monitor® 13 Series 1-Hdl Valve Trim

- Fits MultiChoice® universal valve
- Single-function pressure balance cartridge
- Handle adjusts temperature
- Full body spray showerhead



Part #	Mfg #	Description	Handle(s)	Finish	Price
135543	BT13010	Valve Trim Only	ADA Lever	Chrome	
139743	BT13010-SS	Valve Trim Only	ADA Lever	Stainless	

### Monitor® 13 Series Commercial 1-Hdl Shower Trim

- Fits MultiChoice® universal valve
- Single-function pressure balance cartridge
- Handle adjusts temperature
- Red/blue indicator
- Touch-Clean® showerhead (-LHD models - less showerhead)



Part #	Mfg #	Description	Handle(s)	Finish	Price
123152	T13291	Shower Trim Only, 1.75 gpm	ADA Lever	Chrome	
161746	T13291-LHD	Shower Trim Only, Less Showerhead	ADA Lever	Chrome	
188227	T13291-SSLHD	Shower Trim Only, Less Showerhead	ADA Lever	Stainless*	

### Monitor® 13 Series Commercial 1-Hdl Valve Trim

- Fits MultiChoice® universal valve
- Single-function pressure balance cartridge
- Handle adjusts temperature
- Red/blue indicator



Part #	Mfg #	Description	Handle(s)	Finish	Price
107820	T13091	Valve Trim Only	ADA Lever	Chrome	

### Monitor® 14 Series Shower and Valve Trim

#### Addison™ Monitor® 14 Series 1-Hdl Shower Trim

- Fits MultiChoice® universal valve
- Single-function pressure balance cartridge
- Handle adjusts temperature
- H2Okinetic® 6" showerhead (-LHD models - less showerhead)
- Self-cleaning H2Okinetic® spray holes



Part #	Mfg #	Description	Handle(s)	Finish	Price
129077	T14292	Shower Trim Only, 1.75 gpm	ADA Lever	Chrome	
137747	T14292-CZ	Shower Trim Only, 1.75 gpm	ADA Lever	Champagne Bronze™	
125981	T14292-RB	Shower Trim Only, 1.75 gpm	ADA Lever	Venetian Bronze®	
128708	T14292-SS	Shower Trim Only, 1.75 gpm	ADA Lever	Stainless*	

\* Brilliance® Anti-Tarnish Lifetime Finishes

## Shower Faucets

### Monitor® 14 Series Shower and Valve Trim (Continued)

#### Addison™ Monitor® 14 Series 1-Hdl Shower Trim

Part #	Mfg #	Description	Handle(s)	Finish	Price
174473	T14292-LHD	Shower Trim Only, Less Showerhead	ADA Lever	Chrome	

#### Addison™ Monitor® 14 Series 1-Hdl Valve Trim

- Fits MultiChoice® universal valve
- Single-function pressure balance cartridge
- Handle adjusts temperature



Part #	Mfg #	Description	Handle(s)	Finish	Price
131864	T14092	Valve Trim Only	ADA Lever	Chrome	
137944	T14092-CZ	Valve Trim Only	ADA Lever	Champagne Bronze™	
125982	T14092-RB	Valve Trim Only	ADA Lever	Venetian Bronze®	
127961	T14092-SS	Valve Trim Only	ADA Lever	Stainless*	

#### Angular Modern Monitor® 14 Series Valve Trim with Integrated Diverter

- 2-Handle trim with separate temperature dial
- Single-function pressure balance cartridge
- Control volume and water temperature independently with two separate handles for more refined control of your shower experience
- Monitor® pressure balance valve keeps water temperature within a safe  $\pm 3^{\circ} F (\pm 1.6^{\circ} C)$ , helping to protect you from sudden changes in hot or cold water pressure



Requires Valve: MultiChoice® universal valve (R22000 series)

Part #	Mfg #	Description	Handle(s)	Finish	Price
229945	T24867	3-Setting, 2-Port Diverter Only Trim	ADA Lever	Chrome	
237747	T24867-RB	3-Setting, 2-Port Diverter Only Trim	ADA Lever	Venetian Bronze	
230294	T24867-SS	3-Setting, 2-Port Diverter Only Trim	ADA Lever	Stainless*	
250611	T24967-RB	6-Setting, 2-Port Diverter Only Trim	ADA Lever	Venetian Bronze	
259333	T24967-SS	6-Setting, 2-Port Diverter Only Trim	ADA Lever	Stainless	

#### Ara™ Monitor® 14 Series 1-Hdl Shower Trim

- Fits MultiChoice® universal valve
- Single-function pressure balance cartridge
- Handle adjusts temperature
- H2Okinetic™ 6" showerhead (-LHD models - less showerhead)
- Self-cleaning H2Okinetic® spray holes



Part #	Mfg #	Description	Handle(s)	Finish	Price
166432	T14267	Shower Trim Only, 1.75 gpm	ADA Lever	Chrome	
233360	T14267-BL	Shower Trim Only, 1.75 gpm	ADA Lever	Matte Black	

\* Brilliance® Anti-Tarnish Lifetime Finishes

[www.plumbsupply.com](http://www.plumbsupply.com) • Serving our Customers Since 1946 • [www.waterconcepts.net](http://www.waterconcepts.net)

## Shower Faucets

### Monitor® 14 Series Shower and Valve Trim (Continued)

#### Ara™ Monitor® 14 Series 1-Hdl Shower Trim

Part #	Mfg #	Description	Handle(s)	Finish	Price
168011	T14267-SS	Shower Trim Only, 1.75 gpm	ADA Lever	Stainless*	
177014	T14267-LHD	Shower Trim Only, Less Showerhead	ADA lever	Chrome	
236395	T14267-BLLHD	Shower Trim Only, Less Showerhead	ADA lever	Matte Black	
176237	T14267-SSLHD	Shower Trim Only, Less Showerhead	ADA lever	Stainless*	

#### Ara™ Monitor® 14 Series 1-Hdl Valve Trim

- Fits MultiChoice® universal valve
- Single-function pressure balance cartridge
- Handle adjusts temperature



Part #	Mfg #	Description	Handle(s)	Finish	Price
164422	T14067	Valve Trim Only	ADA Lever	Chrome	
234210	T14067-BL	Valve Trim Only	ADA Lever	Matte Black	
168012	T14067-SS	Valve Trim Only	ADA Lever	Stainless*	

#### Ashlyn® Monitor® 14 Series 1-Hdl Shower Trim

- Fits MultiChoice® universal valve
- Single-function pressure balance cartridge
- Red/blue pad print indicators on handle
- Handle adjusts temperature
- Touch-Clean® 5-1/4" raincan showerhead (-LHD models - less showerhead)



Part #	Mfg #	Description	Handle(s)	Finish	Price
172336	T14264	Shower Trim Only, 1.75 gpm	ADA Lever	Chrome	
172037	T14264-RB	Shower Trim Only, 1.75 gpm	ADA Lever	Venetian Bronze®	
171218	T14264-SS	Shower Trim Only, 1.75 gpm	ADA Lever	Stainless*	
188131	T14264-LHD	Shower Trim Only, Less Showerhead	ADA Lever	Chrome	
189847	T14264-RBLHD	Shower Trim Only, Less Showerhead	ADA Lever	Venetian Bronze®	
173742	T14264-SSLHD	Shower Trim Only, Less Showerhead	ADA Lever	Stainless*	

#### Ashlyn® Monitor® 14 Series 1-Hdl Valve Trim

- Fits MultiChoice® universal valve
- Single-function pressure balance cartridge
- Red/blue pad print indicators on handle
- Handle adjusts temperature



Part #	Mfg #	Description	Handle(s)	Finish	Price
173181	T14064	Valve Trim Only	ADA Lever	Chrome	
170994	T14064-RB	Valve Trim Only	ADA Lever	Venetian Bronze®	

\* Brilliance® Anti-Tarnish Lifetime Finishes

## Shower Faucets

### Monitor® 14 Series Shower and Valve Trim (Continued)

#### Ashlyn® Monitor® 14 Series 1-Hdl Valve Trim

Part #	Mfg #	Description	Handle(s)	Finish	Price
170947	T14064-SS	Valve Trim Only	ADA Lever	Stainless*	

#### Cassidy™ Monitor® 14 Series Shower Trim

- Fits MultiChoice® universal valve
- Single-function pressure balance cartridge
- H2Okinetic® technology 8" showerhead (-LHP models - less showerhead)
- Self-cleaning H2Okinetic® spray holes
- Handle adjusts temperature



Handle Not Included

Part #	Mfg #	Description	Handle(s)	Finish	Price
165487	T14297-CZLHP	Shower Trim Only, 1.75 gpm	Less Handle	Champagne Bronze™	
151993	T14297-LHP	Shower Trim Only, 1.75 gpm	Less Handle	Chrome	
159383	T14297-PNLHP	Shower Trim Only, 1.75 gpm	Less Handle	Polished Nickel*	
152945	T14297-RBLHP	Shower Trim Only, 1.75 gpm	Less Handle	Venetian Bronze®	
153496	T14297-SSLHP	Shower Trim Only, 1.75 gpm	Less Handle	Stainless*	
172022	T14297-LHP-LHD	Shower Trim Only, Less Showerhead	Less Handle	Chrome	
168815	T14297-SSLHP-LHD	Shower Trim Only, Less Showerhead	Less Handle	Stainless*	

#### Cassidy™ Monitor® 14 Series Valve Trim

- Fits MultiChoice® universal valve
- Single-function pressure balance cartridge
- Handle adjusts temperature



Handle Not Included

Part #	Mfg #	Description	Handle(s)	Finish	Price
156283	T14097-CZLHP	Valve Trim Only	Less Handle	Champagne Bronze™	
151513	T14097-LHP	Valve Trim Only	Less Handle	Chrome	
171600	T14097-PNLHP	Valve Trim Only	Less Handle	Polished Nickel*	
156726	T14097-RBLHP	Valve Trim Only	Less Handle	Venetian Bronze®	
152713	T14097-SSLHP	Valve Trim Only	Less Handle	Stainless*	

\* Brilliance® Anti-Tarnish Lifetime Finishes



## Shower Faucets

### Compel® Monitor® 14 Series 1-Hdl Shower Trim

- Fits MultiChoice® universal valve
- Single-function pressure balance cartridge
- Red/blue pad print escutcheon
- H2Okinetic® 5-1/2" raincan showerhead (-LHD models - less showerhead)
- Self-cleaning H2Okinetic® spray holes
- Handle adjusts temperature



Part #	Mfg #	Description	Handle(s)	Finish	Price
150798	T14261	Shower Trim Only	ADA Lever	Chrome	
156713	T14261-SS	Shower Trim Only	ADA Lever	Stainless*	
161015	T14261-LHD	Shower Trim Only, Less Showerhead	ADA Lever	Chrome	
168470	T14261-SSLHD	Shower Trim Only, Less Showerhead	ADA Lever	Stainless*	

### Compel® Monitor® 14 Series 1-Hdl Valve Trim

- Fits MultiChoice® universal valve
- Single-function pressure balance cartridge
- Red/blue pad print escutcheon
- Handle adjusts temperature



Part #	Mfg #	Description	Handle(s)	Finish	Price
156842	T14061	Valve Trim Only	ADA Lever	Chrome	
156905	T14061-SS	Valve Trim Only	ADA Lever	Stainless*	

### Dryden™ Monitor® 14 Series 1-Hdl Shower Trim

- Fits MultiChoice® universal valve
- Single-function pressure balance cartridge
- Handle adjusts temperature
- Touch-Clean® showerhead (-LHP models - less showerhead)



H2O Showerhead

Part #	Mfg #	Description	Handle(s)	Finish	Price
116295	T14251	Shower Trim Only, 2.5 gpm	ADA Lever	Chrome	
143553	T14251-CZ	Shower Trim Only, 2.5 gpm	ADA Lever	Champagne Bronze™	
217775	T14251-PN	Shower Trim Only, 2.5 gpm	ADA Lever	Polished Nickel*	
233893	T14251-SP	Shower Trim Only, 2.5 gpm	ADA Lever	SpotShield Stainless*	
116298	T14251-SS	Shower Trim Only, 2.5 gpm	ADA Lever	Stainless*	
116297	T14251-RB	Shower Trim Only, 2.5 gpm	ADA Lever	Venetian Bronze®	
152868	T14251-H2O	Shower Trim Only, 1.75 gpm , H2Okinetic®	ADA Lever	Chrome	
166103	T14251-RBH2O	Shower Trim Only, 1.75 gpm , H2Okinetic®	ADA Lever	Venetian Bronze®	
155827	T14251-SSH2O	Shower Trim Only, 1.75 gpm , H2Okinetic®	ADA Lever	Stainless*	
175350	T14251-LHD	Shower Trim Only, Less Showerhead	ADA Lever	Chrome	

\* Brilliance® Anti-Tarnish Lifetime Finishes



## Shower Faucets

### Dryden™ Monitor® 14 Series 1-Hdl Valve Trim

- Fits MultiChoice® universal valve
- Single-function pressure balance cartridge
- Handle adjusts temperature



Part #	Mfg #	Description	Handle(s)	Finish	Price
116638	T14051	Valve Trim Only	ADA Lever	Chrome	
179988	T14051-CZ	Valve Trim Only	ADA Lever	Champagne Bronze™	
245443	T14051-PN	Valve Trim Only	ADA Lever	Polished Nickel*	
117059	T14051-RB	Valve Trim Only	ADA Lever	Venetian Bronze®	
245754	T14051-SP	Valve Trim Only	ADA Lever	SpotShield Stainless*	
117060	T14051-SS	Valve Trim Only	ADA Lever	Stainless*	

### Lahara® Monitor® 14 Series 1-Hdl Shower Trim

- Fits MultiChoice® universal valve
- Single-function pressure balance cartridge
- Handle adjusts temperature
- Touch-Clean® full body showerhead (-LHD models - less showerhead)
- 120° Maximum handle rotation



Part #	Mfg #	Description	Handle(s)	Finish	Price
110980	T14238	Shower Trim Only, 1.75 gpm	ADA Lever	Chrome	
145764	T14238-CZ	Shower Trim Only, 1.75 gpm	ADA Lever	Champagne Bronze™	
110982	T14238-RB	Shower Trim Only, 1.75 gpm	ADA Lever	Venetian Bronze®	
110984	T14238-SS	Shower Trim Only, 1.75 gpm	ADA Lever	Stainless*	
132446	T14238-RBH2O	Shower Trim Only, 1.75 gpm H2Okinetic®	ADA Lever	Venetian Bronze®	
128933	T14238-SSH2O	Shower Trim Only, 1.75 gpm H2Okinetic®	ADA Lever	Stainless*	
171222	T14238-LHD	Shower Trim Only, Less Showerhead	ADA Lever	Chrome	
170049	T14238-SSLHD	Shower Trim Only, Less Showerhead	ADA Lever	Stainless*	

### Lahara® Monitor® 14 Series 1-Hdl Valve Trim

- Fits MultiChoice® universal valve
- Single-function pressure balance cartridge
- Handle adjusts temperature
- 120° Maximum handle rotation



Part #	Mfg #	Description	Handle(s)	Finish	Price
119196	T14038	Valve Trim Only	ADA Lever	Chrome	
112180	T14038-RB	Valve Trim Only	ADA Lever	Venetian Bronze®	
113294	T14038-SS	Valve Trim Only	ADA Lever	Stainless*	

\* Brilliance® Anti-Tarnish Lifetime Finishes

[www.plumbsupply.com](http://www.plumbsupply.com) • Serving our Customers Since 1946 • [www.waterconcepts.net](http://www.waterconcepts.net)

## Shower Faucets

### Leland® Monitor® 14 Series 1-Hdl Shower Trim

- Fits MultiChoice® universal valve
- Single function pressure balance cartridge
- Handle adjusts temperature
- Hot/cold indicator
- Touch-Clean 3-setting showerhead



Part #	Mfg #	Description	Handle(s)	Finish	Price
181158	T14278RBSHCER	Shower Trim Only, 1.75 gpm	ADA Lever	Venetian Bronze®	

### Linden™ Monitor® 14 Series Scald-Guard® 1-Hdl Shower Trim

- Fits MultiChoice® universal valve
- Single-function pressure balance cartridge
- Handle adjusts temperature
- Hot/cold indicators
- Red/blue pad print escutcheon (LHD model)
- Touch-Clean® showerhead (-LHD models - less showerhead)



T14294



H2O



T14293

Part #	Mfg #	Description	Handle(s)	Finish	Price
190196	T14293	Shower Trim Only, 1.75 gpm	ADA Lever	Chrome	
222401	T14293-RB	Shower Trim Only, 1.75 gpm	ADA Lever	Venetian Bronze®	
223872	T14293-SS	Shower Trim Only, 1.75 gpm	ADA Lever	Stainless*	
144715	T14294	Shower Trim Only, 1.75 gpm	ADA Lever	Chrome	
145524	T14294-CZ	Shower Trim Only, 1.75 gpm	ADA Lever	Champagne Bronze™	
143566	T14294-RB	Shower Trim Only, 1.75 gpm	ADA Lever	Venetian Bronze®	
143754	T14294-SS	Shower Trim Only, 1.75 gpm	ADA Lever	Stainless*	
154143	T14294-H2O	Shower Trim Only, H2Okinetic®, 1.5 gpm	ADA Lever	Chrome	
147541	T14294-RBH2O	Shower Trim Only, H2Okinetic®, 1.5 gpm	ADA Lever	Stainless*	
186870	T14294-LHD	Shower Trim Only, Less Showerhead	ADA Lever	Chrome	

### Linden™ Monitor® 14 Series Scald-Guard® 1-Hdl Valve Trim

- Fits MultiChoice® universal valve
- Single-function pressure balance cartridge
- Handle adjusts temperature
- Hot/cold indicators
- Red/blue pad print escutcheon



T14094



T14093

Part #	Mfg #	Description	Handle(s)	Finish	Price
144225	T14094	Valve Trim Only	ADA Lever	Chrome	
156704	T14094-CZ	Valve Trim Only	ADA Lever	Champagne Bronze™	
144328	T14094-RB	Valve Trim Only	ADA Lever	Venetian Bronze®	
144144	T14094-SS	Valve Trim Only	ADA Lever	Stainless*	

\* Brilliance® Anti-Tarnish Lifetime Finishes

## Shower Faucets

### Monitor® 14 Series Shower and Valve Trim (Continued)

#### Linden™ Monitor® 14 Series Scald-Guard® 1-Hdl Valve Trim

Part #	Mfg #	Description	Handle(s)	Finish	Price
233210	T14093	Valve Trim Only	ADA Lever	Chrome	
228005	T14093-RB	Valve Trim Only	ADA Lever	Venetian Bronze®	
229184	T14093-SS	Valve Trim Only	ADA Lever	Stainless*	

#### Pivotal™ Monitor® 14 Series 1-Hdl Shower Trim

- Fits MultiChoice® universal valve (R10000 Series)
- H2Okinetic® technology
- Five-setting showerhead
  - Pause
  - Massage spray
  - Full body spray
  - H2Okinetic® spray
  - Full spray with massage
- Single-function pressure balance cartridge



Part #	Mfg #	Description	Handle(s)	Finish	Price
242141	T14299	Shower Trim Only, 1.75 gpm	ADA Lever	Chrome	
250841	T14299-BL	Shower Trim Only, 1.75 gpm	ADA Lever	Matte Black	
244082	T14299-SS	Shower Trim Only, 1.75 gpm	ADA Lever	Stainless*	

#### Pivotal™ Monitor® 14 Series 1-Hdl Valve Trim

- Fits MultiChoice® universal valve (R10000 Series)
- Single-function pressure balance cartridge



Part #	Mfg #	Description	Handle(s)	Finish	Price
252742	T14099	Valve Trim Only	ADA Lever	Chrome	
245672	T14099-BL	Valve Trim Only	ADA Lever	Matte Black	

#### Stryke™ Monitor 14 Series 1-Hdl Shower Trim

- Fits MultiChoice® universal valve (R10000)
- Single-function pressure balance cartridge
- Red/blue pad print escutcheon
- Handle adjusts temperature
- 5-Setting H2Okinetic® 6" showerhead (-LHD models - less showerhead)
- WaterSense certified: 1.75 gpm @ 80 psi



Part #	Mfg #	Description	Handle(s)	Finish	Price
260039	T14276	Shower Trim Only, 1.75 gpm	ADA Lever	Chrome	
259910	T14276-LHD	Shower Trim Only, Less Showerhead	ADA Lever	Chrome	
259438	T14276-BL	Shower Trim Only, 1.75 gpm	ADA Lever	Matte Black	
258760	T142766-BL	Shower Trim Only, 1.75 gpm	ADA Cross	Matte Black	

\* Brilliance® Anti-Tarnish Lifetime Finishes

[www.plumbsupply.com](http://www.plumbsupply.com) • Serving our Customers Since 1946 • [www.waterconcepts.net](http://www.waterconcepts.net)

## Shower Faucets

### Stryke™ Monitor® 14 Series 1-Hdl Valve Trim

- Fits MultiChoice® universal valve (R10000 Series)
- Single-function pressure balance cartridge



Part #	Mfg #	Description	Handle(s)	Finish	Price
259436	T14076-BL	Valve Trim Only	ADA Lever	Matte Black	

### Trinsic® Monitor 14 Series 1-Hdl Shower Trim

- Fits MultiChoice® universal valve
- Single-function pressure balance cartridge
- Red/blue pad print escutcheon
- Handle adjusts temperature
- H2Okinetic® water-efficient 5-1/2" showerhead (-LHD models - less showerhead)
- Self-cleaning H2Okinetic® spray holes



Part #	Mfg #	Description	Handle(s)	Finish	Price
153081	T14259	Shower Trim Only, 1.75 gpm	ADA Lever	Chrome	
233027	T14259-BL	Shower Trim Only, 1.75 gpm	ADA Lever	Matte Black	
153082	T14259-CZ	Shower Trim Only, 1.75 gpm	ADA Lever	Champagne Bronze™	
153083	T14259-RB	Shower Trim Only, 1.75 gpm	ADA Lever	Venetian Bronze®	
153084	T14259-SS	Shower Trim Only, 1.75 gpm	ADA Lever	Stainless*	
235686	T14259-BLLHD	Shower Trim Only, Less Showerhead	ADA Lever	Matte Black	
174516	T14259-SSLHD	Shower Trim Only, Less Showerhead	ADA Lever	Stainless*	

### Trinsic® Monitor 14 Series 1-Hdl Valve Trim

- Fits MultiChoice® universal valve
- Single-function pressure balance cartridge
- Red/blue pad print escutcheon
- Handle adjusts temperature



Part #	Mfg #	Description	Handle(s)	Finish	Price
153077	T14059	Valve Trim Only	ADA Lever	Chrome	
235685	T14059-BL	Valve Trim Only	ADA Lever	Matte Black	
153078	T14059-CZ	Valve Trim Only	ADA Lever	Champagne Bronze™	
153079	T14059-RB	Valve Trim Only	ADA Lever	Venetian Bronze®	
153080	T14059-SS	Valve Trim Only	ADA Lever	Stainless*	

\* Brilliance® Anti-Tarnish Lifetime Finishes

## Shower Faucets

### Tesla® Monitor 14 Series Shower Trim

- Fits MultiChoice® universal valve
- Single-function pressure balance cartridge
- Handle adjusts temperature
- Red/blue indicators
- H2OKinetic® 3-setting showerhead (-LHD models - less showerhead)
- Self-cleaning H2OKinetic® spray holes



Part #	Mfg #	Description	Handle(s)	Finish	Price
189240	T14252	Shower Trim Only, 1.75 gpm	ADA Lever	Chrome	
183780	T14252-SS	Shower Trim Only, 1.75 gpm	ADA Lever	Stainless*	
245455	T14252-LHD	Shower Trim Only, Less Showerhead	ADA Lever	Chrome	
189163	T14252-SSLHD	Shower Trim Only, Less Showerhead	ADA Lever	Stainless*	

### Tesla® Monitor 14 Series Valve Trim

- Fits MultiChoice® universal valve
- Single-function pressure balance cartridge
- Handle adjusts temperature
- Red/blue indicators



Part #	Mfg #	Description	Handle(s)	Finish	Price
237120	T14052	Valve Trim Only	ADA Lever	Chrome	
189289	T14052-SS	Valve Trim Only	ADA Lever	Stainless*	

### Vero Monitor® 14 Series 1-Hdl Shower Trim

- For use with MultiChoice® universal rough valve body
- Single-function pressure balance cartridge
- Handle adjusts temperature
- Touch-Clean® 8-5/8" showerhead (-LHD models - less showerhead)
- H2OKinetic® 6" showerhead (with H2O model)



Part #	Mfg #	Description	Handle(s)	Finish	Price
134777	T14253	Shower Trim Only, 2.5 gpm	ADA Lever	Chrome	
173121	T14253-CZ	Shower Trim Only , 2.5 gpm	ADA Lever	Champagne Bronze™	
158653	T14253-RB	Shower Trim Only , 2.5 gpm	ADA Lever	Venetian Bronze®	
134778	T14253-SS	Shower Trim Only , 2.5 gpm	ADA Lever	Stainless*	
141895	T14253-H2O	Shower Trim Only , H2OKinetic® 1.75 gpm	ADA Lever	Chrome	
256570	T14253-CZH2O	Shower Trim Only, H2OKinetic® 1.75 gpm	ADA Lever	Champagne Bronze™	
150722	T14253-RBH2O	Shower Trim Only, H2OKinetic® 1.75 gpm	ADA Lever	Venetian Bronze®	
144346	T14253-SSH2O	Shower Trim Only, H2OKinetic® 1.75 gpm	ADA Lever	Stainless*	
173348	T14253-LHD	Shower Trim Only, Less Showerhead	ADA Lever	Chrome	

\* Brilliance® Anti-Tarnish Lifetime Finishes

[www.plumbsupply.com](http://www.plumbsupply.com) • Serving our Customers Since 1946 • [www.waterconcepts.net](http://www.waterconcepts.net)



## Shower Faucets

### Vero Monitor® 14 Series 1-Hdl Valve Trim

- For use with MultiChoice® universal rough valve body
- Single-function pressure balance cartridge
- Handle adjusts temperature



Part #	Mfg #	Description	Handle(s)	Finish	Price
134775	T14053	Valve Trim Only	ADA Lever	Chrome	
179911	T14053-CZ	Valve Trim Only	ADA Lever	Champagne Bronze™	
134776	T14053-SS	Valve Trim Only	ADA Lever	Stainless*	
151387	T14053-RB	Valve Trim Only	ADA Lever	Venetian Bronze®	

### Victorian Monitor® 14 Series 1-Hdl Shower Trim

- Fits MultiChoice® universal valve
- Single-function pressure balance cartridge
- Handle adjusts temperature (sold separately)
- Touch-Clean® 3-setting showerhead (-LHD models - less showerhead)



Part #	Mfg #	Description	Handle(s)	Finish	Price
092737	T14255-LHP	Shower Trim Only, 2.5 gpm	Less Handle	Chrome	
092743	T14255-RBLHP	Shower Trim Only , 2.5 gpm	Less Handle	Venetian Bronze®	
092744	T14255-SSLHP	Shower Trim Only , 2.5 gpm	Less Handle	Stainless*	
152757	T14255-H2OLHP	Shower Trim Only, H2Oknetic® 1.75 gpm	Less Handle	Chrome	

### Victorian Monitor® 14 Series 1-Hdl Valve Trim

- Fits MultiChoice® universal valve
- Single-function pressure balance cartridge
- Handle adjusts temperature (sold separately)



Part #	Mfg #	Description	Handle(s)	Finish	Price
112082	T14055-RBLHP	Valve Trim Only	Less Handle	Venetian Bronze®	
111600	T14055-SSLHP	Valve Trim Only	Less Handle	Stainless*	

\* Brilliance® Anti-Tarnish Lifetime Finishes



## Shower Faucets

### Windemere® Monitor® 14 Series 1-Hdl Shower Trim

- Fits MultiChoice® universal valve
- Single-function pressure balance cartridge
- Handle adjusts temperature
- Full body 6" showerhead



Part #	Mfg #	Description	Handle(s)	Finish	Price
135569	BT14296	Shower Trim Only, 1.75 gpm	ADA Lever	Chrome	
131931	BT14296-OB	Shower Trim Only, 1.75 gpm	ADA Lever	Oil Rubbed Bronze	
135495	BT14296-SS	Shower Trim Only, 1.75 gpm	ADA Lever	Stainless*	

### Windemere® Monitor® 14 Series 1-Hdl Valve Trim

- Fits MultiChoice® universal valve
- Single-function pressure balance cartridge
- Handle adjusts temperature



Part #	Mfg #	Description	Handle(s)	Finish	Price
157497	BT14096	Valve Trim Only	ADA Lever	Chrome	
143873	BT14096-OB	Valve Trim Only	ADA Lever	Oil Rubbed Bronze	
136144	BT14096-SS	Valve Trim Only	ADA Lever	Stainless*	

### Woodhurst™ Monitor® 14 Series 1-Hdl Shower Trim

- Fits MultiChoice® universal valve
- Single-function pressure balance cartridge
- Handle adjusts temperature
- Full body 5-7/8" raincan showerhead
- Touch-Clean® spray holes



Part #	Mfg #	Description	Handle(s)	Finish	Price
251169	T14232	Shower Trim Only, 1.75 gpm	ADA Lever	Chrome	
251180	T14232-RB	Shower Trim Only, 1.75 gpm	ADA Lever	Venetian Bronze®	
251194	T14232-SS	Shower Trim Only, 1.75 gpm	ADA Lever	Stainless*	

\* Brilliance® Anti-Tarnish Lifetime Finishes

[www.plumbsupply.com](http://www.plumbsupply.com) • Serving our Customers Since 1946 • [www.waterconcepts.net](http://www.waterconcepts.net)

## Shower Faucets

### Woodhurst™ Monitor® 14 Series 1-Hdl Valve Trim

- Fits MultiChoice® universal valve
- Single-function pressure balance cartridge
- Handle adjusts temperature



Part #	Mfg #	Description	Handle(s)	Finish	Price
252962	T14032	Valve Only	ADA Lever	Chrome	
259375	T14032-RB	Valve Only	ADA Lever	Venetian Bronze	
257180	T14032-SS	Valve Only	ADA Lever	Stainless*	

### Zura® Monitor® 14 Series 1-Hdl Shower Trim

- Fits MultiChoice® universal valve
- Touch-Clean® spray holes
- H2Okynamic® 7-5/8" showerhead (-LHD models - less showerhead)
- Single-function pressure balance cartridge
- Spray settings include: H2Okynamic® spray, full body spray, and pause



Part #	Mfg #	Description	Handle(s)	Finish	Price
230343	T14274	Shower Trim Only, 1.75 gpm	ADA Lever	Chrome	
229146	T14274-SS	Shower Trim Only, 1.75 gpm	ADA Lever	Stainless*	
232573	T14274-LHD	Shower Trim Only, Less Showerhead	ADA Lever	Chrome	

### Zura® Monitor® 14 Series 1-Hdl Shower Trim

- Fits MultiChoice® universal valve
- Single-function pressure balance cartridge



Part #	Mfg #	Description	Handle(s)	Finish	Price
249687	T14074-SS	Valve Only	ADA Lever	Stainless*	

\* Brilliance® Anti-Tarnish Lifetime Finishes

## Shower Faucets

### Angular Modern 14 Series Temp2O® Shower Trim

- Fits MultiChoice® universal valve
- Single-function pressure balance cartridge
- Temp2O® technology
- Digital temperature display with color indication
- Battery operated 3 (AAA) included
- Fahrenheit and Celsius options at install
- **Order handle separately (LHP)**
- Handle adjusts temperature



Part #	Mfg #	Description	Handle(s)	Finish	Price
227380	T14001-T20-LHP	Valve Only	Less Handle	Chrome	
173914	T14001-SST20-LHP	Valve Only	Less Handle	Stainless*	

### Traditional 14 Series Temp2O® Shower Trim

- Fits MultiChoice® universal valve
- Single-function pressure balance cartridge
- Temp2O® technology
- Digital temperature display with color indication
- Battery operated 3 (AAA) included
- Fahrenheit and Celsius options at install
- **Order handle separately (LHP)**
- Handle adjusts temperature



Part #	Mfg #	Description	Handle(s)	Finish	Price
258381	T1400-T20-LHP	Valve Only	Less Handle	Chrome	
168735	T1400-RBT20-LHP	Valve Only	Less Handle	Venetian Bronze®	

### Transitional 14 Series Temp2O® Shower Trim

- Fits MultiChoice® universal rough valve
- Single-function pressure balance cartridge
- Temp2O® technology
- Digital temperature display with color indication
- Battery operated, (3 AAA) included
- Fahrenheit and Celsius options at install
- **Order handle separately (LHP)**
- Handle adjusts temperature



Part #	Mfg #	Description	Handle(s)	Finish	Price
242017	T14003-T20-LHP	Valve Trim Only	Less Handle	Chrome	
252250	T14003-RBT20-LHP	Valve Trim Only	Less Handle	Venetian Bronze	
177446	T14003-SST20-LHP	Valve Trim Only	Less Handle	Stainless*	

\* Brilliance® Anti-Tarnish Lifetime Finishes

## Shower Faucets

### Contemporary Monitor® 14 Series 2-Hdl Diverter Valve Trim

- 6-5/8" Diameter
- Three or six function integrated diverter
- Single-function pressure balance cartridge
- For use with MultiChoice® universal rough valve body —R22000 series



Part #	Mfg #	Description	Handle(s)	Finish	Price
235911	T24859	3-Setting 2-Port Diverter Only Trim	ADA Lever	Chrome	
243257	T24859-RB	3-Setting 2-Port Diverter Only Trim	ADA Lever	Venetian Bronze	
237972	T24859-SS	3-Setting 2-Port Diverter Only Trim	ADA Lever	Stainless*	
248697	T24959-RB	6-Setting 3-Port Diverter Only Trim	ADA Lever	Venetian Bronze	
241486	T24959-SS	6-Setting 3-Port Diverter Only Trim	ADA Lever	Stainless*	

### Traditional Monitor® 14 Series Valve Trim with 3-Setting Integrated Diverter

- 3-Setting diverter has (2) individual positions, (1) shared position
- 2-Handle trim
- Monitor® pressure balance valve keeps water temperature within a safe  $\pm 3^{\circ} F$  ( $\pm 1.6^{\circ} C$ ), helping to protect you from sudden changes in hot or cold water pressure



Requires Valve R22000

Part #	Mfg #	Description	Handle(s)	Finish	Price
232778	T24897	3-Setting Integrated Diverter	ADA Lever	Chrome	
229164	T24897-RB	3-Setting Integrated Diverter	ADA Lever	Venetian Bronze®	
228598	T24897-SS	3-Setting Integrated Diverter	ADA Lever	Stainless*	
243414	T24997-RB	6-Setting 3-Port Diverter Only Trim	ADA Lever	Venetian Bronze	
235503	T24997-SS	6-Setting 3-Port Diverter Only Trim	ADA Lever	Stainless	

### Monitor® 17 Series Shower Trim

#### Addison™ Monitor® 17 Series Shower Trim

- Fits MultiChoice® universal valve
- Dual function pressure balance cartridge
- Dial adjusts temperature, handle adjusts volume
- H2OKinetic® 6" showerhead (-LHD models - less showerhead)
- Self-cleaning H2OKinetic® spray holes



Part #	Mfg #	Description	Handle(s)	Finish	Price
128353	T17292	Shower Trim Only, 1.75 gpm	ADA Lever	Chrome	
126708	T17292-RB	Shower Trim Only , 1.75 gpm	ADA Lever	Venetian Bronze®	
128434	T17292-SS	Shower Trim Only , 1.75 gpm	ADA Lever	Stainless*	

\* Brilliance® Anti-Tarnish Lifetime Finishes

## Shower Faucets

### Addison™ Monitor® 17 Series Valve Trim

- Fits MultiChoice® universal valve
- Dual function pressure balance cartridge
- Dial adjusts temperature, handle adjusts volume



Part #	Mfg #	Description	Handle(s)	Finish	Price
132428	T17092	Valve Trim Only	ADA Lever	Chrome	
137601	T17092-CZ	Valve Trim Only	ADA Lever	Champagne Bronze™	
130313	T17092-RB	Valve Trim Only	ADA Lever	Venetian Bronze®	
132985	T17092-SS	Valve Trim Only	ADA Lever	Stainless*	

### Angular Modern Monitor® 17 Series Integrated Diverter Valve Trim

- 3-Setting diverters have (2) individual positions, (1) shared position
- 6-Setting diverters have (3) individual positions, (3) shared positions
- 2-Handle trim with separate temperature dial
- Cartridge included



**Requires Valve: R22000**

Part #	Mfg #	Description	Handle(s)	Finish	Price
229899	T27867	3-Setting, Diverter Only Trim	ADA Lever	Chrome	
229917	T27867-SS	3-Setting, Diverter Only Trim	ADA Lever	Stainless*	
242729	T27967	6-Setting, Diverter Only Trim	ADA Lever	Chrome	

### Ara™ Monitor® 17 Series Shower Trim

- Fits MultiChoice® universal valve
- Dual-function pressure balance cartridge
- Red/blue indicator
- Handle adjusts volume, dial adjusts temperature
- H2Okinetic® 6" showerhead (-LHD models - less showerhead)
- Self-cleaning H2Okinetic® spray holes



Part #	Mfg #	Description	Handle(s)	Finish	Price
171860	T17267	Shower Trim Only, 1.75 gpm	ADA Lever	Chrome	
235031	T17267-BL	Shower Trim Only, 1.75 gpm	ADA Lever	Matte Black	
162249	T17267-SS	Shower Trim Only, 1.75 gpm	ADA Lever	Stainless*	

\* Brilliance® Anti-Tarnish Lifetime Finishes

**www.plumbsupply.com • Serving our Customers Since 1946 • www.waterconcepts.net**

## Shower Faucets

### Ara™ Monitor® 17 Series Valve Trim

- Fits MultiChoice® universal valve
- Dual-function pressure balance cartridge
- Red/blue indicator
- Handle adjusts volume, dial adjusts temperature



Part #	Mfg #	Description	Handle(s)	Finish	Price
165656	T17067	Valve Trim Only	ADA Lever	Chrome	
242636	T17067-BL	Valve Trim Only	ADA Lever	Matte Black	
162243	T17067-SS	Valve Trim Only	ADA Lever	Stainless*	

### Ashlyn™ Monitor® 17 Series Shower Trim

- Fits MulticChoice® universal valve
- Dual-function pressure balance cartridge
- Red/blue pad print indicators
- Handle adjusts temperature, dial adjusts volume
- Touch-Clean® 5-1/4" showerhead (-LHD models - less showerhead)



Part #	Mfg #	Description	Handle(s)	Finish	Price
174058	T17264	Shower Trim Only, 1.75 gpm	ADA Lever	Chrome	
170921	T17264-SS	Shower Trim Only, 1.75 gpm	ADA Lever	Stainless*	
178390	T17264-RB	Shower Trim Only, 1.75 gpm	ADA Lever	Venetian Bronze®	

### Ashlyn™ Monitor® 17 Series Valve Trim

- Fits MulticChoice® universal valve
- Dual-function pressure balance cartridge
- Red/blue pad print indicators
- Handle adjusts temperature, dial adjusts volume



Part #	Mfg #	Description	Handle(s)	Finish	Price
177023	T17064	Valve Trim Only	ADA Lever	Chrome	
222400	T17064-RB	Valve Trim Only	ADA Lever	Venetian Bronze®	
174314	T17064-SS	Valve Trim Only	ADA Lever	Stainless*	

\* Brilliance® Anti-Tarnish Lifetime Finishes



## Shower Faucets

### Ashlyn™ Monitor 17 Series Shower Trim with In2ition Showerhead

- Fits MultiChoice® universal valve
- Dual-function pressure balance cartridge
- In2ition integrated showerhead and handshower
- Handle adjusts temperature, dial adjusts volume
- Features Touch-Clean® spray holes
- 5-Setting handshower
- Soft-Touch® grip
- 69" Long UltraFlex® hose



Part #	Mfg #	Description	Handle(s)	Finish	Price
173063	T17264-I	Shower Trim Only, In2ition Showerhead 1.75 gpm	ADA Lever	Chrome	
171775	T17264-RB-I	Shower Trim Only, In2ition Showerhead 1.75 gpm	ADA Lever	Venetian Bronze®	
172466	T17264-SS-I	Shower Trim Only, In2ition Showerhead 1.75 gpm	ADA Lever	Stainless*	

### Cassidy™ Monitor® 17 Series Shower Trim

- Fits MultiChoice® universal valve
- Dual-function pressure balance cartridge
- Handle adjusts volume, dial adjusts temperature
- H2Okinetic 8" showerhead
- Self-cleaning H2Okinetic® spray holes



Part #	Mfg #	Description	Handle(s)	Finish	Price
151997	T17297	Shower Trim Only, 1.75 gpm	ADA Lever	Chrome	
156180	T17297-CZ	Shower Trim Only, 1.75 gpm	ADA Lever	Champagne Bronze™	
153326	T17297-PN	Shower Trim Only, 1.75 gpm	ADA Lever	Polished Nickel	
150950	T17297-RB	Shower Trim Only, 1.75 gpm	ADA Lever	Venetian Bronze®	
151767	T17297-SS	Shower Trim Only, 1.75 gpm	ADA Lever	Stainless*	

### Cassidy™ Monitor® 17 Series Valve Trim

- Fits MultiChoice® universal valve
- Dual-function pressure balance cartridge
- Handle adjusts volume, dial adjusts temperature



Part #	Mfg #	Description	Handle(s)	Finish	Price
151516	T17097	Valve Trim Only	ADA Lever	Chrome	
168312	T17097-CZ	Valve Trim Only	ADA Lever	Champagne Bronze™	
176412	T17097-PN	Valve Trim Only	ADA Lever	Polished Nickel*	
151960	T17097-RB	Valve Trim Only	ADA Lever	Venetian Bronze®	
153889	T17097-SS	Valve Trim Only	ADA Lever	Stainless*	

\* Brilliance® Anti-Tarnish Lifetime Finishes

[www.plumbsupply.com](http://www.plumbsupply.com) • Serving our Customers Since 1946 • [www.waterconcepts.net](http://www.waterconcepts.net)

## Shower Faucets

### Classic Monitor® 17 Series Shower Trim

- Fits MultiChoice® universal valve
- Dual-function pressure balance cartridge
- Red/blue indicator
- Handle adjusts volume, dial adjusts temperature
- Touch-Clean® 3-setting showerhead
- H2Okinetic® 6" showerhead with self-cleaning spray holes



Part #	Mfg #	Description	Handle(s)	Finish	Price
092708	T17230	Shower Trim Only, 1.75 gpm	ADA Lever	Chrome	
155275	T17230-SS	Shower Trim Only, 1.75 gpm	ADA Lever	Stainless*	
153773	T17230-H2O	Shower Trim Only, H2O Showerhead, 1.75 gpm	ADA Lever	Chrome	
171300	T17230-SSH2O	Shower Trim Only, H2O Showerhead, 1.75 gpm	ADA Lever	Stainless*	

### Compel™ Monitor 17 Series Shower Trim

- Fits MultiChoice® universal valve
- Dual-function pressure balance cartridge
- Red/blue indicator
- Handle adjusts volume, dial adjusts temperature
- H2Okinetic® 5-1/2" showerhead with self-cleaning spray holes



Part #	Mfg #	Description	Handle(s)	Finish	Price
153741	T17261	Shower Trim Only, 1.75 gpm	ADA Lever	Chrome	
158118	T17261-SS	Shower Trim Only, 1.75 gpm	ADA Lever	Stainless*	

### Compel™ Monitor 17 Series Valve Trim

- Fits MultiChoice® universal valve
- Dual-function pressure balance cartridge
- Red/blue indicator
- Handle adjusts volume, dial adjusts temperature



Part #	Mfg #	Description	Handle(s)	Finish	Price
162531	T17061	Valve Trim Only	ADA Lever	Chrome	
156708	T17061-SS	Valve Trim Only	ADA Lever	Stainless*	

\* Brilliance® Anti-Tarnish Lifetime Finishes

## Shower Faucets

### Dryden™ Monitor® 17 Series Shower Trim

- Fits MultiChoice® universal valve
- Handle adjusts volume, dial adjusts temperature
- Touch-Clean® 6-9/16" showerhead
- H2Okinetic® 6" showerhead and self-cleaning spray holes (H2O model)



H2O

Part #	Mfg #	Description	Handle(s)	Finish	Price
116303	T17251	Shower Trim Only, 2.5 gpm	ADA Lever	Chrome	
159269	T17251-CZ	Shower Trim Only , 2.5 gpm	ADA Lever	Champagne Bronze™	
175029	T17251-PN	Shower Trim Only , 2.5 gpm	ADA Lever	Polished Nickel*	
116305	T17251-RB	Shower Trim Only, 2.5 gpm	ADA Lever	Venetian Bronze®	
232321	T17251-SP	Shower Trim Only , 2.5 gpm	ADA Lever	SpotShield Stainless	
116306	T17251-SS	Shower Trim Only, 2.5 gpm	ADA Lever	Stainless*	
167373	T17251-H2O	Shower Trim Only, H2Okinetic® 1.75 gpm	ADA Lever	Chrome	
166665	T17251-CZH2O	Shower Trim Only, H2Okinetic® 1.75 gpm	ADA Lever	Champagne Bronze™	
226636	T17251-PNH2O	Shower Trim Only, H2Okinetic® 1.75 gpm	ADA Lever	Polished Nickel*	
139209	T17251-RBH2O	Shower Trim Only, H2Okinetic® 1.75 gpm	ADA Lever	Venetian Bronze®	
154022	T17251-SSH2O	Shower Trim Only, H2Okinetic® 1.75 gpm	ADA Lever	Stainless*	

### Dryden™ Monitor® 17 Series Valve Trim

- Fits MultiChoice® universal valve
- Handle adjusts volume, dial adjusts temperature



Part #	Mfg #	Description	Handle(s)	Finish	Price
117061	T17051	Valve Trim Only	ADA Lever	Chrome	
143503	T17051-CZ	Valve Trim Only	ADA Lever	Champagne Bronze™	
224891	T17051-PN	Valve Trim Only	ADA Lever	Polished Nickel*	
117197	T17051-RB	Valve Trim Only	ADA Lever	Venetian Bronze®	
117198	T17051-SS	Valve Trim Only	ADA Lever	Stainless*	

\* Brilliance® Anti-Tarnish Lifetime Finishes

[www.plumbsupply.com](http://www.plumbsupply.com) • Serving our Customers Since 1946 • [www.waterconcepts.net](http://www.waterconcepts.net)

## Shower Faucets

### Lahara™ Monitor® 17 Series Shower Trim with Volume Control

- Fits MultiChoice® universal valve
- Dual-function pressure balance cartridge
- Handle adjusts temperature, dial adjusts temperature
- Touch-Clean® 5" showerhead (-LHD models - less showerhead)
- H2Okinetic® 6-1/2" showerhead with self-cleaning spray holes (H2O model)



Part #	Mfg #	Description	Handle(s)	Finish	Price
110997	T17238	Shower Trim Only, 1.75 gpm	ADA Lever	Chrome	
154977	T17238-CZ	Shower Trim Only, 1.75 gpm	ADA Lever	Champagne Bronze™	
110999	T17238-RB	Shower Trim Only, 1.75 gpm	ADA Lever	Venetian Bronze®	
111001	T17238-SS	Shower Trim Only, 1.75 gpm	ADA Lever	Stainless*	
154842	T17238-H2O	Shower Trim Only, H2Okinetic® 1.75 gpm	ADA Lever	Chrome	
168070	T17238-RBH2O	Shower Trim Only, H2Okinetic® 1.75 gpm	ADA Lever	Venetian Bronze®	
153667	T17238-SSH2O	Shower Trim Only, H2Okinetic® 1.75 gpm	ADA Lever	Stainless*	

### Lahara™ Monitor® 17 Series Valve Trim with Volume Control

- Fits MultiChoice® universal valve
- Dual-function pressure balance cartridge
- Handle adjusts temperature, dial adjusts temperature



Part #	Mfg #	Description	Handle(s)	Finish	Price
110990	T17038	Valve Trim Only	ADA Lever	Chrome	
155805	T17038-CZ	Valve Trim Only	ADA Lever	Champagne Bronze™	
110994	T17038-RB	Valve Trim Only	ADA Lever	Venetian Bronze®	
110996	T17038-SS	Valve Trim Only	ADA Lever	Stainless*	

### Linden™ Monitor® 17 Series Shower Trim

- Fits MultiChoice® universal valve
- Dual-function pressure balance cartridge
- Handle adjusts volume, dial adjusts temperature
- H2Okinetic® 6-1/2" showerhead (-LHD models - less showerhead)
- Self-cleaning H2Okinetic® spray holes



Part #	Mfg #	Description	Handle(s)	Finish	Price
225564	T17293	Shower Trim Only, 1.75 gpm	ADA Lever	Chrome	
226552	T17293-RB	Shower Trim Only, 1.75 gpm	ADA Lever	Venetian Bronze®	
227849	T17293-SS	Shower Trim Only, 1.75 gpm	ADA Lever	Stainless*	

\* Brilliance® Anti-Tarnish Lifetime Finishes

## Shower Faucets

### Monitor® 17 Series Shower Trim (Continued)

#### Linden™ Monitor® 17 Series Shower Trim

Part #	Mfg #	Description	Handle(s)	Finish	Price
146278	T17294	Shower Trim Only, 1.75 gpm	ADA Lever	Chrome	
144730	T17294-CZ	Shower Trim Only, 1.75 gpm	ADA Lever	Champagne Bronze™	
143330	T17294-RB	Shower Trim Only, 1.75 gpm	ADA Lever	Venetian Bronze®	
143886	T17294-SS	Shower Trim Only, 1.75 gpm	ADA Lever	Stainless*	

#### Linden™ Monitor® 17 Series Valve Trim

- Fits MultiChoice® universal valve
- Dual-function pressure balance cartridge
- Handle adjusts volume, dial adjusts temperature



Part #	Mfg #	Description	Handle(s)	Finish	Price
225780	T17093	Valve Trim Only	ADA Lever	Chrome	
234306	T17093-RB	Valve Trim Only	ADA Lever	Venetian Bronze®	
226461	T17093-SS	Valve Trim Only	ADA Lever	Stainless*	
144338	T17094	Valve Trim Only	ADA Lever	Chrome	
144581	T17094-CZ	Valve Trim Only	ADA Lever	Champagne Bronze™	
143323	T17094-RB	Valve Trim Only	ADA Lever	Venetian Bronze®	
143642	T17094-SS	Valve Trim Only	ADA Lever	Stainless*	

#### Linden™ Monitor® 17 Series Shower Trim with In2ition® Two-in-One Shower

- Fits MultiChoice® universal valve
- Dual function pressure balance control
- Handle adjusts volume; dial adjusts temperature
- 4-Setting, In2ition® integrated showerhead and handshower
- Features Touch-Clean® spray holes
- 69" Long UltraFlex® hose



Part #	Mfg #	Description	Handle(s)	Finish	Price
227569	T17293-I	Shower Trim Only, In2ition Showerhead, 1.75 gpm	ADA lever	Chrome	
228007	T17293-RB-I	Shower Trim Only, In2ition Showerhead, 1.75 gpm	ADA lever	Venetian Bronze®	
227986	T17293-SS-I	Shower Trim Only, In2ition Showerhead, 1.75 gpm	ADA lever	Stainless*	
143815	T17294-I	Shower Trim Only, In2ition Showerhead, 1.75 gpm	ADA Lever	Chrome	
147449	T17294-CZ-I	Shower Trim Only, In2ition Showerhead, 1.75 gpm	ADA Lever	Champagne Bronze™	
143310	T17294-RB-I	Shower Trim Only, In2ition Showerhead, 1.75 gpm	ADA Lever	Venetian Bronze®	
143530	T17294-SS-I	Shower Trim Only, In2ition Showerhead, 1.75 gpm	ADA Lever	Stainless*	

\* Brilliance® Anti-Tarnish Lifetime Finishes

[www.plumbsupply.com](http://www.plumbsupply.com) • Serving our Customers Since 1946 • [www.waterconcepts.net](http://www.waterconcepts.net)



## Shower Faucets

### Pivotal™ Monitor® 17 Series 1-Hdl Shower Trim

- Fits MultiChoice® universal valve (R10000 Series)
- H2Okinetic® technology
- Five-setting showerhead
  - Pause
  - Massage spray
  - Full body spray
  - H2Okinetic® spray
  - Full spray with massage
- Dual-function pressure balance cartridge



Part #	Mfg #	Description	Handle(s)	Finish	Price
244514	T17299	Shower Trim Only, 1.75 gpm	ADA Lever	Chrome	
251012	T17299-BL	Shower Trim Only, 1.75 gpm	ADA Lever	Matte Black	
243543	T17299-SS	Shower Trim Only, 1.75 gpm	ADA Lever	Stainless*	

### Pivotal™ Monitor® 17 Series 1-Hdl Valve Trim

- Fits MultiChoice® universal valve (R10000 Series)
- Dual-function pressure balance cartridge



Part #	Mfg #	Description	Handle(s)	Finish	Price
244790	T17099	Valve Trim Only	ADA Lever	Chrome	
251678	T17099-BL	Valve Trim Only	ADA Lever	Matte Black	
258226	T17099-PN	Valve Trim Only	ADA Lever	Polished Nickel*	
245355	T17099-SS	Valve Trim Only	ADA Lever	Stainless*	

### Stryke™ Monitor® 17 Series Valve Trim

- Fits MultiChoice® universal valve
- Dual-function pressure balance cartridge
- Red/blue indicators
- Handle adjust volume, dial adjusts temperature



Part #	Mfg #	Description	Handle(s)	Finish	Price
258866	T17076	Valve Trim Only	ADA Lever	Chrome	
259865	T17076-BL	Valve Trim Only	ADA Lever	Matte Black	
260029	T17076-SS	Valve Trim Only	ADA Lever	Stainless*	

\* Brilliance® Anti-Tarnish Lifetime Finishes



## Shower Faucets

### Tesla® Monitor 17 Series H2Okinetic® Shower Trim

- Fits MultiChoice® universal valve
- Dual-function pressure balance cartridge
- Red/blue indicators
- Handle adjust volume, dial adjusts temperature
- H2Okinetic® 3-Setting 7-1/2" showerhead (-LHD models - less showerhead)
- Self-cleaning H2Okinetic® spray holes



Part #	Mfg #	Description	Handle(s)	Finish	Price
185037	T17252	Shower Trim Only, 1.75 gpm	ADA Lever	Chrome	
182299	T17252-PN	Shower Trim Only, 1.75 gpm	ADA Lever	Polished Nickel*	
181116	T17252-SS	Shower Trim Only, 1.75 gpm	ADA Lever	Stainless*	

### Tesla® Monitor 17 Series H2Okinetic® Valve Trim

- Fits MultiChoice® universal valve
- Dual-function pressure balance cartridge
- Red/blue indicators
- Handle adjust volume, dial adjusts temperature



Part #	Mfg #	Description	Handle(s)	Finish	Price
184955	T17052	Valve Trim Only	ADA Lever	Chrome	
229491	T17052-PN	Valve Trim Only	ADA Lever	Polished Nickel	

### Trinsic® Monitor® 17 Series Shower Trim

- Fits MultiChoice® universal valve
- Dual-function pressure balance cartridge
- Red/blue indicator
- Handle adjusts volume, dial adjusts temperature
- H2Okinetic® 5-1/2" showerhead (-LHD models - less showerhead)
- Self-cleaning H2Okinetic® spray holes



Part #	Mfg #	Description	Handle(s)	Finish	Price
151410	T17259	Shower Trim Only, 1.75 gpm	ADA Lever	Chrome	
235621	T17259-BL	Shower Trim Only, 1.75 gpm	ADA Lever	Matte Black	
181860	T17259-CZ	Shower Trim Only, 1.75 gpm	ADA Lever	Champagne Bronze™	
173511	T17259-RB	Shower Trim Only, 1.75 gpm	ADA Lever	Venetian Bronze®	
156457	T17259-SS	Shower Trim Only, 1.75 gpm	ADA Lever	Stainless*	
159917	T17259-LHD	Shower Trim Only, Less Showerhead	ADA Lever	Chrome	
187858	T17259-SSLHD	Shower Trim Only, Less Showerhead	ADA Lever	Stainless*	

\* Brilliance® Anti-Tarnish Lifetime Finishes

[www.plumbsupply.com](http://www.plumbsupply.com) • Serving our Customers Since 1946 • [www.waterconcepts.net](http://www.waterconcepts.net)

## Shower Faucets

### Trinsic® Monitor® 17 Series Valve Trim

- Fits MultiChoice® universal valve
- Dual-function pressure balance cartridge
- Red/blue indicator
- Handle adjusts volume, dial adjusts temperature



Part #	Mfg #	Description	Handle(s)	Finish	Price
155074	T17059	Valve Trim Only	ADA Lever	Chrome	
237951	T17059-BL	Valve Trim Only	ADA Lever	Matte Black	
181859	T17059-CZ	Valve Trim Only	ADA Lever	Champagne Bronze™	
166174	T17059-RB	Valve Trim Only	ADA Lever	Venetian Bronze®	
160095	T17059-SS	Valve Trim Only	ADA Lever	Stainless*	

### Vero Monitor® 17 Series Shower Trim

- Fits MultiChoice® universal valve
- Dual-function pressure balance cartridge
- Hot/cold indicator(s)
- Handle adjusts volume, dial adjusts temperature
- Touch-Clean® 8-5/8" showerhead (-LHD models - less showerhead)
- H2Okinetic® 6" showerhead and self-cleaning spray holes (H2O model)



-H2O

Part #	Mfg #	Description	Handle(s)	Finish	Price
137210	T17253	Shower Trim Only, 2.5 gpm Full Body Spray	ADA Lever	Chrome	
171284	T17253-CZ	Shower Trim Only, 2.5 gpm Full Body Spray	ADA Lever	Champagne Bronze™	
146666	T17253-RB	Shower Trim Only, 2.5 gpm Full Body Spray	ADA Lever	Venetian Bronze®	
137153	T17253-SS	Shower Trim Only, 2.5 gpm Full Body Spray	ADA Lever	Stainless*	
137234	T17253-H2O	Shower Trim Only, 1.75 gpm H2Okinetic Spray	ADA Lever	Chrome	
143243	T17253-CZH2O	Shower Trim Only, 1.75 gpm H2Okinetic Spray	ADA Lever	Champagne Bronze™	
153196	T17253-RBH2O	Shower Trim Only, 1.75 gpm H2Okinetic Spray	ADA Lever	Venetian Bronze®	
140802	T17253-SSH2O	Shower Trim Only, 1.75 gpm H2Okinetic Spray	ADA Lever	Stainless*	

### Vero Monitor® 17 Series Valve Trim

- Fits MultiChoice® universal valve
- Dual-function pressure balance cartridge
- Hot/cold indicator(s)
- Handle adjusts volume, dial adjusts temperature



Part #	Mfg #	Description	Handle(s)	Finish	Price
137211	T17053	Valve Trim Only, 2.5 gpm Full Body Spray	ADA Lever	Chrome	
146148	T17053-RB	Valve Trim Only, 2.5 gpm Full Body Spray	ADA Lever	Venetian Bronze®	
137152	T17053-SS	Valve Trim Only, 2.5 gpm Full Body Spray	ADA Lever	Stainless*	

\* Brilliance® Anti-Tarnish Lifetime Finishes

## Shower Faucets

### Victorian® Monitor® 17 Series Shower Trim with Volume Control

- Fits MultiChoice™ universal valve
- Dual-function pressure balance cartridge
- Handle adjusts volume, dial adjusts temperature
- Hot/cold indicator
- Touch-Clean® 3-setting showerhead
- H2Okinetic® 8" showerhead and self-cleaning spray holes (H2O model)



H2O

Part #	Mfg #	Description	Handle(s)	Finish	Price
092841	T17255	Shower Trim Only, 2.5 gpm	ADA Lever	Chrome	
150528	T17255-CZ	Shower Trim Only , 2.5 gpm	ADA Lever	Champagne Bronze™	
092845	T17255-PB	Shower Trim Only , 2.5 gpm	ADA Lever	Polished Brass	
092847	T17255-RB	Shower Trim Only, 2.5 gpm	ADA Lever	Venetian Bronze®	
092848	T17255-SS	Shower Trim Only, 2.5 gpm	ADA Lever	Stainless*	
154563	T17255-H2O	Shower Trim Only, H2O Showerhead 1.75 gpm	ADA Lever	Chrome	
173150	T17255-RBH2O	Shower Trim Only, H2O Showerhead 1.75 gpm	ADA Lever	Venetian Bronze®	

### Zura® Monitor® 17 Series 2-Hdl Shower Trim

- Fits MultiChoice® universal valve
- Touch-Clean® spray holes
- H2Okinetic® 7-5/8" showerhead
- Dual-function pressure balance cartridge
- Spray settings include: H2Okinetic® spray, full body spray, and pause



Part #	Mfg #	Description	Handle(s)	Finish	Price
229317	T17274-SS	Shower Trim Only, 1.75 gpm	ADA Lever	Stainless*	

### Zura® Monitor® 17 Series 2-Hdl Valve Trim

- Fits MultiChoice® universal valve
- Dual-function pressure balance cartridge



Part #	Mfg #	Description	Handle(s)	Finish	Price
228204	T17074	Valve Trim Only	ADA Lever	Chrome	
229373	T17074-SS	Valve Trim Only	ADA Lever	Stainless*	

\* Brilliance® Anti-Tarnish Lifetime Finishes

## Shower Faucets

### Contemporary Monitor® 17 Series 2-Hdl Diverter Valve Trim

- 6-5/8" Diameter
- 3-Setting diverters have (2) individual positions, (1) shared position
- 6-Setting diverters have (3) individual positions, (3) shared positions
- Dual-function pressure balance cartridge
- For use with MultiChoice® universal rough valve body  
—R22000 series



Part #	Mfg #	Description	Handle(s)	Finish	Price
233269	T27859	3-Setting Integrated Diverter Trim	ADA Lever	Chrome	
231083	T27859-SS	3-Setting Integrated Diverter Trim	ADA Lever	Stainless*	
233016	T27859-RB	3-Setting Integrated Diverter Trim	ADA Lever	Venetian Bronze	
255268	T27959-RB	6-Setting Integrated Diverter Trim	ADA Lever	Venetian Bronze	

### Traditional Monitor® 17 Series 2-Hdl Integrated Diverter Valve Trim

- 3-Setting diverters have (2) individual positions, (1) shared position
- 6-Setting diverters have (3) individual positions, (3) shared positions
- 2-Handle trim with separate temperature dial
- Dual-function pressure balance cartridge included



**Requires Valve: R22000**

Part #	Mfg #	Description	Handle(s)	Finish	Price
230859	T27897	3-Setting 2 Port Diverter Only Trim	ADA Lever	Chrome	
230670	T27897-RB	3-Setting 2 Port Diverter Only Trim	ADA Lever	Venetian Bronze®	
232008	T27897-SS	3-Setting 2 Port Diverter Only Trim	ADA Lever	Stainless	
256756	T27997	6-Setting 3-Port Diverter Only Trim	ADA Lever	Chrome	
242877	T27997-SS	6-Setting 3-Port Diverter Only Trim	ADA Lever	Stainless*	

### TempAssure® 17T Series Shower Trim

#### Addison® TempAssure® 17T Series Shower Trim

- Fits MultiChoice® universal valve
- Dual-function thermostatic cartridge
- Handle adjusts volume, dial adjusts temperature
- H2Okinetic® 8" showerhead
- Self-cleaning H2Okinetic® spray holes
- Requires R10000-UNBX rough-in valve, order separately



Part #	Mfg #	Description	Handle(s)	Finish	Price
128480	T17T292	Shower Trim Only, 2.5 gpm	ADA Lever	Chrome	
140634	T17T292-CZ	Shower Trim Only, 2.5 gpm	ADA Lever	Champagne Bronze™	
130664	T17T292-RB	Shower Trim Only, 2.5 gpm	ADA Lever	Venetian Bronze®	
128782	T17T292-SS	Shower Trim Only, 2.5 gpm	ADA Lever	Stainless*	

\* Brilliance® Anti-Tarnish Lifetime Finishes

## Shower Faucets

### Addison® TempAssure® 17T Series Valve Trim

- Fits MultiChoice® universal valve
- Dual-function thermostatic cartridge
- Handle adjusts volume, dial adjusts temperature
- Requires R10000-UNBX rough-in valve, order separately



Part #	Mfg #	Description	Handle(s)	Finish	Price
127658	T17T092	Valve Trim Only	ADA Lever	Chrome	
139580	T17T092-CZ	Valve Trim Only	ADA Lever	Champagne Bronze™	
128750	T17T092-RB	Valve Trim Only	ADA Lever	Venetian Bronze®	
129782	T17T092-SS	Valve Trim Only	ADA Lever	Stainless*	

### Ara® TempAssure® 17T Series Shower Trim

- Fits MultiChoice® universal valve
- Dual-function thermostatic cartridge
- Red/blue indicator
- Handle adjusts volume, dial adjusts temperature
- H2Okinetic® 6" showerhead
- Self-cleaning H2Okinetic® spray holes



Part #	Mfg #	Description	Handle(s)	Finish	Price
166359	T17T267	Shower Trim Only, 1.75 gpm	ADA Lever	Chrome	
177472	T17T267-SS	Shower Trim Only, 1.75 gpm	ADA Lever	Stainless*	

### Ara® TempAssure® 17T Series Valve Trim

- Fits MultiChoice® universal valve
- Dual-function thermostatic cartridge
- Red/blue indicator
- Handle adjusts volume, dial adjusts temperature



Part #	Mfg #	Description	Handle(s)	Finish	Price
237805	T17T067	Valve Trim Only	ADA Lever	Chrome	
254649	T17T067-BL	Valve Trim Only	ADA Lever	Matte Black	
186420	T17T067-SS	Valve Trim Only	ADA Lever	Stainless*	

### Cassidy™ TempAssure® 17T Series Valve Trim

- Fits MultiChoice® universal valve
- Dual-function thermostatic valve cartridge
- Hot/cold indicator
- Handle adjusts volume, dial adjusts temperature



Part #	Mfg #	Description	Handle(s)	Finish	Price
170886	T17T097	Valve Trim Only	ADA Lever	Chrome	
159730	T17T097-RB	Valve Trim Only	ADA Lever	Venetian Bronze®	
166399	T17T097-SS	Valve Trim Only	ADA Lever	Stainless*	

\* Brilliance® Anti-Tarnish Lifetime Finishes

[www.plumbsupply.com](http://www.plumbsupply.com) • Serving our Customers Since 1946 • [www.waterconcepts.net](http://www.waterconcepts.net)



## Shower Faucets

### Cassidy™ TempAssure® 17T Series Shower Trim

- Fits MultiChoice® universal valve
- Dual-function thermostatic valve cartridge
- Hot/cold indicator
- Handle adjusts volume, dial adjusts temperature
- Touch-Clean® 9-3/8" full body showerhead



Part #	Mfg #	Description	Handle(s)	Finish	Price
164875	T17T297	Shower Trim Only, 2.5 gpm	ADA Lever	Chrome	
180466	T17T297-CZ	Shower Trim Only, 2.5 gpm	ADA Lever	Champagne Bronze™	
164759	T17T297-PN	Shower Trim Only, 2.5 gpm	ADA Lever	Polished Nickel*	
151568	T17T297-RB	Shower Trim Only, 2.5 gpm	ADA Lever	Venetian Bronze®	
151699	T17T297-SS	Shower Trim Only, 2.5 gpm	ADA Lever	Stainless*	
254376	T17T297-WE	Shower Trim Only, 1.75 gpm	ADA Lever	Chrome	

### Compel® TempAssure® 17T Series Shower Trim

- Fits MultiChoice® universal valve
- Dual-function thermostatic cartridge
- Red/blue indicator
- Handle adjusts volume, dial adjusts temperature
- H2Okinetic® 7-3/4" 3-setting showerhead
- Self-cleaning H2Okinetic® spray holes



Part #	Mfg #	Description	Handle(s)	Finish	Price
186507	T17T261-H2O	Shower Trim Only, 1.75 gpm	ADA Lever	Chrome	
180260	T17T261-SSH2O	Shower Trim Only, 1.75 gpm	ADA Lever	Stainless*	

### Dryden™ TempAssure® 17T Series Shower Trim

- Fits MultiChoice® universal valve
- Dual-function thermostatic cartridge
- Handle adjusts volume, dial adjusts temperature
- Hot/cold indicator(s)
- Touch-Clean® 6-9/16" full body showerhead



Part #	Mfg #	Description	Handle(s)	Finish	Price
117029	T17T251	Shower Trim Only, 2.5 gpm	ADA Lever	Chrome	
152695	T17T251-CZ	Shower Trim Only, 2.5 gpm	ADA Lever	Champagne Bronze™	
117027	T17T251-RB	Shower Trim Only, 2.5 gpm	ADA Lever	Venetian Bronze®	
257638	T17T251-SP	Shower Trim Only, 2.5 gpm	ADA Lever	SpotShield Stainless®	
117026	T17T251-SS	Shower Trim Only, 2.5 gpm	ADA Lever	Stainless*	

\* Brilliance® Anti-Tarnish Lifetime Finishes



## Shower Faucets

### Dryden™ TempAssure® 17T Series Shower Trim

- Fits MultiChoice® universal valve
- Dual-function thermostatic cartridge
- Handle adjusts volume, dial adjusts temperature
- Hot/cold indicator(s)



Part #	Mfg #	Description	Handle(s)	Finish	Price
117199	T17T051	Valve Trim Only	ADA Lever	Chrome	
230139	T17T051-PN	Valve Trim Only	ADA Lever	Polished Nickel	
117201	T17T051-RB	Valve Trim Only	ADA Lever	Venetian Bronze®	
117202	T17T051-SS	Valve Trim Only	ADA Lever	Stainless*	

### Lahara® TempAssure® 17T Series Valve Trim

- Fits MultiChoice® universal valve
- Dual-function thermostatic cartridge
- Handle adjusts volume, dial adjusts temperature
- Hot/cold indicator(s)



Part #	Mfg #	Description	Handle(s)	Finish	Price
111006	T17T038	Valve Trim Only	ADA Lever	Chrome	
111008	T17T038-RB	Valve Trim Only	ADA Lever	Venetian Bronze®	
111009	T17T038-SS	Valve Trim Only	ADA Lever	Stainless*	

### Lahara® TempAssure® 17T Series Shower Trim

- Fits MultiChoice® universal valve
- Dual-function thermostatic cartridge
- Handle adjusts volume, dial adjusts temperature
- Hot/cold indicator(s)
- Touch-Clean® 5" full body showerhead



Part #	Mfg #	Description	Handle(s)	Finish	Price
111010	T17T238	Shower Trim Only, 2.5 gpm	ADA Lever	Chrome	
111014	T17T238-SS	Shower Trim Only, 2.5 gpm	ADA Lever	Stainless*	

### Pivotal™ TempAssure® 17T Series Shower Trim

- Fits MultiChoice® universal valve
- Dual-function thermostatic cartridge
- Handle adjusts volume, dial adjusts temperature
- Hot/cold indicator(s)
- Touch-Clean® H2OKinetic® 8-21-32" showerhead



Part #	Mfg #	Description	Handle(s)	Finish	Price
252634	T17T299-BL	Shower Trim Only, 2.5 gpm	ADA Lever	Matte Black	
259130	T17T299-SS	Shower Trim Only, 2.5 gpm	ADA Lever	Stainless*	

\* Brilliance® Anti-Tarnish Lifetime Finishes

[www.plumbsupply.com](http://www.plumbsupply.com) • Serving our Customers Since 1946 • [www.waterconcepts.net](http://www.waterconcepts.net)

## Shower Faucets

### Zura® TempAssure® 17T Series Shower Trim

- Fits MultiChoice® universal valve
- Dual-function thermostatic cartridge
- Handle adjusts volume, dial adjusts temperature
- Hot/cold indicator(s)
- 3-Setting H2OKinetic® showerhead



Part #	Mfg #	Description	Handle(s)	Finish	Price
237171	T17T274	Shower Trim Only, 1.75 gpm	ADA Lever	Chrome	

### Tesla® TempAssure® 17T Series Shower Trim

- Fits MultiChoice® universal valve
- Dual-function thermostatic cartridge
- Handle adjusts volume, dial adjusts temperature
- Hot/cold indicator (s)
- H2OKinetic® 7-5/8" three-setting showerhead
- Self-cleaning H2OKinetic® spray holes
- Touch-Clean® spray holes



Part #	Mfg #	Description	Handle(s)	Finish	Price
250827	T17T252-PN	Shower Trim Only, 1.75 gpm	ADA Lever	Polished Nickel*	

### Tesla® TempAssure® 17T Series Shower Trim

- Fits MultiChoice® universal valve
- Dual-function thermostatic cartridge
- Handle adjusts volume, dial adjusts temperature
- Hot/cold indicator (s)



Part #	Mfg #	Description	Handle(s)	Finish	Price
238275	T17T052-SS	Valve Trim Only	ADA Lever	Stainless*	

### Trinsic® TempAssure® 17T Series Shower Trim

- Fits MultiChoice® universal valve
- Dual-function thermostatic cartridge
- Handle adjusts volume, dial adjusts temperature
- Hot/cold indicator (s)
- H2OKinetic® 7-3/4" three-setting showerhead
- Self-cleaning H2OKinetic® spray holes
- Touch-Clean® spray holes



Part #	Mfg #	Description	Handle(s)	Finish	Price
182829	T17T259-H2O	Shower Trim Only, 1.75 gpm	ADA Lever	Chrome	
187383	T17T259-CZH2O	Shower Trim Only, 1.75 gpm	ADA Lever	Champagne Bronze™	
228810	T17T259-RBH2O	Shower Trim Only, 1.75 gpm	ADA Lever	Venetian Bronze®	
187860	T17T259-SSH2O	Shower Trim Only, 1.75 gpm	ADA Lever	Stainless*	

\* Brilliance® Anti-Tarnish Lifetime Finishes

## Shower Faucets

### Trinsic® TempAssure® 17T Series Valve Trim

- Fits MultiChoice® universal valve
- Dual-function thermostatic cartridge
- Handle adjusts volume, dial adjusts temperature
- Hot/cold indicator (s)



Part #	Mfg #	Description	Handle(s)	Finish	Price
233439	T17T059	Valve Trim Only	ADA Lever	Chrome	
180014	T17T059-RB	Valve Trim Only	ADA Lever	Venetian Bronze®	
182809	T17T059-SS	Valve Trim Only	ADA Lever	Stainless*	

### Vero® TempAssure® 17T Series Valve Trim

- Fits MultiChoice® universal valve
- Dual-function thermostatic cartridge
- Handle adjusts volume, dial adjusts temperature
- Hot/cold indicator



Part #	Mfg #	Description	Handle(s)	Finish	Price
135645	T17T053	Valve Trim Only	ADA Lever	Chrome	
173609	T17T053-RB	Valve Trim Only	ADA Lever	Venetian Bronze®	
137128	T17T053-SS	Valve Trim Only	ADA Lever	Stainless*	

### Vero® TempAssure® 17T Series Shower Trim

- Fits MultiChoice® universal valve
- Dual-function thermostatic cartridge
- Handle adjusts volume, dial adjusts temperature
- Hot/cold indicator
- Touch-Clean® 8-5/8" full body showerhead



Part #	Mfg #	Description	Handle(s)	Finish	Price
135493	T17T253	Shower Trim Only, 2.5 gpm	ADA Lever	Chrome	
152031	T17T253-RB	Shower Trim Only , 2.5 gpm	ADA Lever	Venetian Bronze®	
139460	T17T253-SS	Shower Trim Only, 2.5 gpm	ADA Lever	Stainless*	

### Victorian® TempAssure® 17T Series Shower Trim

- Fits MultiChoice® universal valve
- Dual-function thermostatic cartridge
- Hot/cold indicator
- Handle adjusts volume, dial adjusts temperature
- Touch-Clean® 3-function showerhead



Part #	Mfg #	Description	Handle(s)	Finish	Price
112665	T17T255	Shower Trim Only, 2.5 gpm	ADA Lever	Chrome	
103631	T17T255-RB	Shower Trim Only, 2.5 gpm	ADA Lever	Venetian Bronze®	

\* Brilliance® Anti-Tarnish Lifetime Finishes

**www.plumbsupply.com • Serving our Customers Since 1946 • www.waterconcepts.net**

## Shower Faucets

### TempAssure® 17T Series Shower Trim (Continued)

#### Victorian® TempAssure® 17T Series Shower Trim

Part #	Mfg #	Description	Handle(s)	Finish	Price
103033	T17T255-SS	Shower Trim Only, 2.5 gpm	ADA Lever	Stainless*	

#### Victorian® TempAssure® 17T Series Valve Trim

- Fits MultiChoice® universal valve
- Dual-function thermostatic cartridge
- Hot/cold indicator
- Handle adjusts volume, dial adjusts temperature



Part #	Mfg #	Description	Handle(s)	Finish	Price
161032	T17T055	Valve Trim Only	ADA Lever	Chrome	
145825	T17T055-CZ	Valve Trim Only	ADA Lever	Champagne Bronze™	
107863	T17T055-RB	Valve Trim Only	ADA Lever	Venetian Bronze®	
108537	T17T055-SS	Valve Trim Only	ADA Lever	Stainless*	

#### Pivotal™ TempAssure® 17T Series Valve Trim

- Dual function pressure balance cartridge valve
- For use with MultiChoice® universal rough-in  
—(R10000 Series) ordered separately



Part #	Mfg #	Description	Handle(s)	Finish	Price
244867	T17T099	3-Setting 2-Port Diverter Only Trim	ADA Lever	Chrome	

#### Compel® TempAssure® 17T Series Valve Trim

- Dual function thermostatic cartridge valve
- For use with MultiChoice® universal rough-in  
—(R10000 Series) ordered separately



Part #	Mfg #	Description	Handle(s)	Finish	Price
240695	T17T061	17T TempAssure Valve Only Trim	ADA Lever	Chrome	

\* Brilliance® Anti-Tarnish Lifetime Finishes

## Shower Faucets

### Contemporary TempAssure® 17T Series Valve Trim with Integrated Diverter

- 3-Setting diverter has (2) individual positions, (1) shared position
- 6-Setting diverter has (3) individual positions, (3) shared position
- 2-handle trim with separate temperature dial
- Control volume and water temperature independently with two separate handles for more refined control of your shower experience



**Requires Valve: MultiChoice® R22000 series**

Part #	Mfg #	Description	Handle(s)	Finish	Price
253886	T27T859	3-Setting 2-Port Diverter Only Trim	ADA Lever	Chrome	

### Traditional TempAssure® 17T Series Valve Trim Integrated Diverter

- 3-Setting diverter has (2) individual positions, (1) shared position
- 6-Setting diverter has (3) individual positions, (3) shared position
- 2-handle trim with separate temperature dial
- Control volume and water temperature independently with two separate handles for more refined control of your shower experience



**Requires Valve: R22000**

Part #	Mfg #	Description	Handle(s)	Finish	Price
226548	T27T897-SS	17T TempAssure w/ 3-Setting Diverter	ADA Lever	Stainless*	
242015	T27T997-RB	17T TempAssure w/ 6-Setting Diverter	ADA Lever	Venetian Bronze	
248969	T27T997-SS	17T TempAssure w/ 6-Setting Diverter	ADA Lever	Stainless*	

## Custom Shower System Trim

### Addison™ 1-Hdl Diverter Trim

- 3-Setting diverters have (2) individual positions, (1) shared position
- 6-Setting diverters have (3) individual positions, (3) shared positions
- Requires R11000 rough-in (sold separately)
- Includes cartridge



Part #	Mfg #	Description	Handle(s)	Finish	Price
140585	T11892	3-Setting 2-Port Diverter Only Trim	ADA Lever	Chrome	
143525	T11892-CZ	3-Setting 2-Port Diverter Only Trim	ADA Lever	Champagne Bronze™	
135362	T11892-RB	3-Setting 2-Port Diverter Only Trim	ADA Lever	Venetian Bronze®	
135399	T11892-SS	3-Setting 2-Port Diverter Only Trim	ADA Lever	Stainless*	
135017	T11992	6-Setting 3-Port Diverter Only Trim	ADA Lever	Chrome	
135018	T11992-CZ	6-Setting 2-Port Diverter Only Trim	ADA Lever	Champagne Bronze™	
135020	T11992-RB	6-Setting 3-Port Diverter Only Trim	ADA Lever	Venetian Bronze®	
135021	T11992-SS	6-Setting 3-Port Diverter Only Trim	ADA Lever	Stainless*	

\* Brilliance® Anti-Tarnish Lifetime Finishes

**www.plumbsupply.com • Serving our Customers Since 1946 • www.waterconcepts.net**



## Shower Faucets

### Ara® 1-Hdl Diverter Trim

- 3-Setting diverters have (2) individual positions, (1) shared position
- 6-Setting diverters have (3) individual positions, (3) shared positions
- Requires R11000 rough-in (sold separately)
- Includes cartridge



Part #	Mfg #	Description	Handle(s)	Finish	Price
170070	T11867	3-Setting 2-Port Diverter Only Trim	ADA Lever	Chrome	
241128	T11867-BL	3-Setting 2-Port Diverter Only Trim	ADA Lever	Black	
162250	T11867-SS	3-Setting 2-Port Diverter Only Trim	ADA Lever	Stainless*	
176786	T11967	6-Setting 3-Port Diverter Only Trim	ADA Lever	Chrome	
233359	T11967-BL	6-Setting 3-Port Diverter Only Trim	ADA Lever	Matte Black	
162244	T11967-SS	6-Setting 3-Port Diverter Only Trim	ADA Lever	Stainless*	

### Ashlyn™ 1-Hdl Diverter Trim

- 3-Setting diverters have (2) individual positions, (1) shared position
- 6-Setting diverters have (3) individual positions, (3) shared positions
- Requires R11000 rough-in (sold separately)
- Includes cartridge



Part #	Mfg #	Description	Handle(s)	Finish	Price
174456	T11864	3-Setting 2-Port Diverter Only Trim	ADA Lever	Chrome	
172342	T11864-RB	3-Setting 2-Port Diverter Only Trim	ADA Lever	Venetian Bronze®	
170527	T11864-SS	3-Setting 2-Port Diverter Only Trim	ADA Lever	Stainless*	
179974	T11964	6-Setting 3-Port Diverter Only Trim	ADA Lever	Chrome	
180610	T11964-RB	6-Setting 3-Port Diverter Only Trim	ADA Lever	Venetian Bronze®	
182917	T11964-SS	6-Setting 3-Port Diverter Only Trim	ADA Lever	Stainless*	

### Cassidy™ 1-Hdl Diverter Trim

- **-LHP Less Handle Package**
- 1/2" Rough-in
- 3-Setting diverters have (2) individual positions, (1) shared positions
- 6-Setting diverters have (3) individual positions, (3) shared positions
- Diverter valve **R11000** required
- Includes cartridge



Part #	Mfg #	Description	Handle(s)	Finish	Price
168310	T11897-CZLHP	3-Setting 2-Port Diverter Only Trim	Less Handle	Champagne Bronze™	
152237	T11897-LHP	3-Setting 2-Port Diverter Only Trim	Less Handle	Chrome	
158845	T11897-PNLHP	3-Setting 2-Port Diverter Only Trim	Less Handle	Polished Nickel*	
150951	T11897-RBLHP	3-Setting 2-Port Diverter Only Trim	Less Handle	Venetian Bronze®	
151986	T11897-SSLHP	3-Setting 2-Port Diverter Only Trim	Less Handle	Stainless*	
185318	T11997-CZLHP	6-Setting 3-Port Diverter Only Trim	Less Handle	Champagne Bronze™	
163799	T11997-LHP	6-Setting 3-Port Diverter Only Trim	Less Handle	Chrome	

\* Brilliance® Anti-Tarnish Lifetime Finishes



## Shower Faucets

### Custom Shower System Trim (Continued)

#### Cassidy™ 1-Hdl Diverter Trim

Part #	Mfg #	Description	Handle(s)	Finish	Price
161954	T11997-PNLHP	6-Setting 3-Port Diverter Only Trim	Less Handle	Polished Nickel*	
156996	T11997-RBLHP	6-Setting 3-Port Diverter Only Trim	Less Handle	Venetian Bronze®	
151700	T11997-SSLHP	6-Setting 3-Port Diverter Only Trim	Less Handle	Stainless*	

#### Compel® 1-Hdl Diverter Trim

- **-LHP Less Handle Package**
- 1/2" Rough-in
- 3-Setting diverters have (2) individual positions, (1) shared positions
- 6-Setting diverters have (3) individual positions, (3) shared positions
- Diverter valve **R11000** required
- Includes cartridge



Part #	Mfg #	Description	Handle(s)	Finish	Price
159271	T11861	3-Setting 2-Port Diverter Only Trim	ADA Lever	Chrome	
164427	T11861-SS	3-Setting 2-Port Diverter Only Trim	ADA Lever	Stainless*	
153742	T11961	6-Setting 3-Port Diverter Only Trim	ADA Lever	Chrome	
161981	T11961-SS	6-Setting 3-Port Diverter Only Trim	ADA Lever	Stainless*	

#### Dryden™ Collection 1-Hdl Multi-Function Diverter Trim

- Coordinates with all Delta Dryden™ bath suites
- 1/2" Rough-in
- 3-Setting diverters have (2) individual positions, (1) shared position
- 6-Setting diverters have (3) individual positions, (3) shared positions
- Requires R11000 rough-in (sold separately)
- Includes valve cartridge



Part #	Mfg #	Description	Handle(s)	Finish	Price
134758	T11851	3-Setting 2-Port Diverter Only Trim	ADA Lever	Chrome	
155249	T11851-CZ	3-Setting 2-Port Diverter Only Trim	ADA Lever	Champagne Bronze™	
175034	T11851-PN	3-Setting 2-Port Diverter Only Trim	ADA Lever	Polished Nickel*	
134759	T11851-RB	3-Setting 2-Port Diverter Only Trim	ADA Lever	Venetian Bronze®	
134760	T11851-SS	3-Setting 2-Port Diverter Only Trim	ADA Lever	Stainless*	
232320	T11851-SP	3-Setting 2-Port Diverter Only Trim	ADA Lever	SpotShield Stainless	
134762	T11951	6-Setting 3-Port Diverter Only Trim	ADA Lever	Chrome	
160832	T11951-CZ	6-Setting 3-Port Diverter Only Trim	ADA Lever	Champagne Bronze®	
175030	T11951-PN	6-Setting 3-Port Diverter Only Trim	ADA Lever	Polished Nickel*	
134763	T11951-RB	6-Setting 3-Port Diverter Only Trim	ADA Lever	Venetian Bronze®	
243316	T11951-SP	6-Setting 3-Port Diverter Only Trim	ADA Lever	SpotShield Stainless*	
134764	T11951-SS	6-Setting 3-Port Diverter Only Trim	ADA Lever	Stainless*	

\* Brilliance® Anti-Tarnish Lifetime Finishes

**www.plumbsupply.com • Serving our Customers Since 1946 • www.waterconcepts.net**

## Shower Faucets

### Innovations® Collection 1-Hdl Multi-Function Diverter Trim

- 3-Setting diverters have (2) individual positions, (1) shared position
- 6-Setting diverters have (3) individual positions, (3) shared positions
- Requires R11000 rough-in
- 1/2" Rough-in
- Includes cartridge



Part #	Mfg #	Description	Handle(s)	Finish	Price
134196	T11800	3-Setting 2-Port Diverter Only Trim	ADA Lever	Chrome	
154978	T11800-CZ	3-Setting 2-Port Diverter Only Trim	ADA Lever	Champagne Bronze™	
181893	T11800-PB	3-Setting 2-Port Diverter Only Trim	ADA Lever	Polished Brass*	
134548	T11800-RB	3-Setting 2-Port Diverter Only Trim	ADA Lever	Venetian Bronze®	
134024	T11800-SS	3-Setting 2-Port Diverter Only Trim	ADA Lever	Stainless*	
134674	T11900	6-Setting 3-Port Diverter Only Trim	ADA Lever	Chrome	
134309	T11900-RB	6-Setting 3-Port Diverter Only Trim	ADA Lever	Venetian Bronze®	
134673	T11900-SS	6-Setting 3-Port Diverter Only Trim	ADA Lever	Stainless*	

### Linden™ 1-Hdl Diverter Trim

- 3-Setting diverters have (2) individual positions, (1) shared position
- 6-Setting diverters have (3) individual positions, (3) shared positions
- Requires R11000 rough-in (sold separately)
- Includes cartridge



Part #	Mfg #	Description	Handle(s)	Finish	Price
147744	T11894	3-Setting 2-Port Diverter Only Trim	ADA Lever	Chrome	
156705	T11894-CZ	3-Setting 2-Port Diverter Only Trim	ADA Lever	Champagne Bronze®	
143311	T11894-RB	3-Setting 2-Port Diverter Only Trim	ADA Lever	Venetian Bronze®	
143641	T11894-SS	3-Setting 2-Port Diverter Only Trim	ADA Lever	Stainless*	
144743	T11994	6-Setting 3-Port Diverter Only Trim	ADA Lever	Chrome	
154519	T11994-CZ	6-Setting 3-Port Diverter Only Trim	ADA Lever	Champagne Bronze™	
150877	T11994-SS	6-Setting 3-Port Diverter Only Trim	ADA Lever	Stainless*	
144744	T11994-RB	6-Setting 3-Port Diverter Only Trim	ADA Lever	Venetian Bronze®	

### Litze™ 1-Hdl Diverter Trim — Less Handle

- 3-Setting diverters have (2) individual positions, (1) shared position
- 6-Setting diverters have (3) individual positions, (3) shared position
- Requires R60700 rough-in valve
- 1/2" Universal inlets/outlets
- Cartridge ships with the trim



Part #	Mfg #	Description	Handle(s)	Finish	Price
242292	T60835-GLLHP	3-Setting 2-Port Diverter Only Trim	Less Handle	Luxe Gold	

\* Brilliance® Anti-Tarnish Lifetime Finishes

www.waterconcepts.net • Serving our Customers Since 1946 • www.plumbsupply.com

## Shower Faucets

### Pivotal™ 1-Hdl Diverter Trim

- 3-Setting diverters have (2) individual positions, (1) shared position
- 6-Setting diverters have (3) individual positions, (3) shared positions
- Requires R11000 rough-in (sold separately)



Part #	Mfg #	Description	Handle(s)	Finish	Price
244517	T11899	3-Setting 2-Port Diverter Only Trim	ADA Lever	Chrome	
251679	T11899-BL	3-Setting 2-Port Diverter Only Trim	ADA Lever	Matte Black	
241828	T11899-SS	3-Setting 2-Port Diverter Only Trim	ADA Lever	Stainless*	
255171	T11999-BL	6-Setting 3-Port Diverter Only Trim	ADA Lever	Matte Black	
246035	T11999-SS	6-Setting 3-Port Diverter Only Trim	ADA Lever	Stainless*	

### Pivotal™ Monitor® 14 Series 2-Hdl Integrated Diverter Trim

- 3-Setting diverters have (2) individual positions, (1) shared position
- 6-Setting diverters have (3) individual positions, (3) shared positions
- Requires R22000 rough-in (sold separately)



Part #	Mfg #	Description	Handle(s)	Finish	Price
252298	T24899	3-Setting 2-Port Diverter Only Trim	ADA Lever	Chrome	

### Pivotal™ Monitor® 17 Series 1-Hdl Integrated Diverter Trim

- 3-Setting diverters have (2) individual positions, (1) shared position
- 6-Setting diverters have (3) individual positions, (3) shared positions
- Requires R22000 rough-in (sold separately)
- Includes cartridge



Part #	Mfg #	Description	Handle(s)	Finish	Price
249287	T27899-SS	3-Setting 2-Port Diverter Only Trim	ADA Lever	Stainless*	
256300	T27999-SS	6-Setting 3-Port Diverter Only Trim	ADA Lever	Stainless*	

\* Brilliance® Anti-Tarnish Lifetime Finishes

## Shower Faucets

### Stryke™ Monitor® 14 Series Integrated Diverter Valve Trim

- 3-Setting diverters have (2) individual positions, (1) shared position
- 6-Setting diverters have (3) individual positions, (3) shared positions
- Requires R22000 rough-in (sold separately)
- Cartridges included
- (-LHP) Less handle package



Part #	Mfg #	Description	Handle(s)	Finish	Price
260569	T24876-LHP	3-Setting 2-Port Diverter Only Trim	ADA Lever	Chrome	
260584	T24876-SSLHP	3-Setting 2-Port Diverter Only Trim	ADA Lever	Stainless*	

### Stryke™ Monitor® 17 Series Integrated Diverter Valve Trim

- 3-Setting diverters have (2) individual positions, (1) shared position
- 6-Setting diverters have (3) individual positions, (3) shared positions
- Requires R22000 rough-in (sold separately)
- Includes cartridge
- (-LHP) Less handle package



Part #	Mfg #	Description	Handle(s)	Finish	Price
260933	T27876-BLLHP	3-Setting 2-Port Diverter Only Trim	Less Handles	Matte Black	
259077	T27876-SSLHP	3-Setting 2-Port Diverter Only Trim	Less Handles	Stainless*	
260228	T27976-SSLHP	6-Setting 3-Port Diverter Only Trim	Less Handles	Stainless*	

### Stryke™ 1-Hdl Diverter Trim

- 3-Setting diverters have (2) individual positions, (1) shared position
- 6-Setting diverters have (3) individual positions, (3) shared positions
- Requires R11000 rough-in (sold separately)
- Includes cartridge



Part #	Mfg #	Description	Handle(s)	Finish	Price
259866	T11876-BL	3-Setting 2-Port Diverter Only Trim	ADA Lever	Matte Black	
260099	T11876-SS	3-Setting 2-Port Diverter Only Trim	ADA Lever	Stainless*	

### Tesla® 1-Hdl Diverter Trim

- 3-Setting diverters have (2) individual positions, (1) shared position
- 6-Setting diverters have (3) individual positions, (3) shared positions
- Requires R11000 rough-in (sold separately)
- Includes cartridge



Part #	Mfg #	Description	Handle(s)	Finish	Price
185039	T11852	3-Setting 2-Port Diverter Only Trim	ADA Lever	Chrome	

\* Brilliance® Anti-Tarnish Lifetime Finishes

[www.waterconcepts.net](http://www.waterconcepts.net) • Serving our Customers Since 1946 • [www.plumbsupply.com](http://www.plumbsupply.com)

## Shower Faucets

### Custom Shower System Trim (Continued)

#### Tesla® 1-Hdl Diverter Trim

Part #	Mfg #	Description	Handle(s)	Finish	Price
182336	T11852-PN	3-Setting 2-Port Diverter Only Trim	ADA Lever	Polished Nickel*	
182334	T11852-SS	3-Setting 2-Port Diverter Only Trim	ADA Lever	Stainless*	
188240	T11952	6-Setting 3-Port Diverter Only Trim	ADA Lever	Chrome	
224766	T11952-SS	6-Setting 3-Port Diverter Only Trim	ADA Lever	Stainless*	

#### Trinsic® 1-Hdl Diverter Trim

- 3-Setting diverters have (2) individual positions, (1) shared position
- 6-Setting diverters have (3) individual positions, (3) shared positions
- Requires R11000 rough-in (sold separately)
- RP75137 adds 1" to max installation thickness
- Includes cartridge



Part #	Mfg #	Description	Handle(s)	Finish	Price
153351	T11859	3-Setting 2-Port Diverter Only Trim	ADA Lever	Chrome	
235181	T11859-BL	3-Setting 2-Port Diverter Only Trim	ADA Lever	Matte Black	
226888	T11859-CZ	3-Setting 2-Port Diverter Only Trim	ADA Lever	Champagne Bronze™	
158184	T11859-RB	3-Setting 2-Port Diverter Only Trim	ADA Lever	Venetian Bronze®	
160744	T11859-SS	3-Setting 2-Port Diverter Only Trim	ADA Lever	Stainless*	
166065	T11959	6-Setting 3-Port Diverter Only Trim	ADA Lever	Chrome	
249100	T11959-BL	6-Setting 3-Port Diverter Only Trim	ADA Lever	Matte Black	
173970	T11959-RB	6-Setting 3-Port Diverter Only Trim	ADA Lever	Venetian Bronze®	
167669	T11959-SS	6-Setting 3-Port Diverter Only Trim	ADA Lever	Stainless*	

#### Vero® 1-Handle Diverter Trim

- Coordinates with all Delta Vero® styled bath suites
- 1/2" Rough-in
- 3-Setting diverters have (2) individual positions, (1) shared position
- 6-Setting diverters have (3) individual positions, (3) shared positions
- Includes valve cartridge
- For use with R11000 diverter rough-in (sold separately)



Part #	Mfg #	Description	Handle(s)	Finish	Price
135494	T11853	3-Setting 2-Port Diverter Only Trim	ADA Lever	Chrome	
171286	T11853-CZ	3-Setting 2-Port Diverter Only Trim	ADA Lever	Champagne Bronze™	
146150	T11853-RB	3-Setting 2-Port Diverter Only Trim	ADA Lever	Venetian Bronze®	
135821	T11853-SS	3-Setting 2-Port Diverter Only Trim	ADA Lever	Stainless*	
138700	T11953	6-Setting 3-Port Diverter Only Trim	ADA Lever	Chrome	
236748	T11953-CZ	6-Setting 3-Port Diverter Only Trim	ADA Lever	Champagne Bronze™	
147408	T11953-RB	6-Setting 3-Port Diverter Only Trim	ADA Lever	Venetian Bronze®	
137130	T11953-SS	6-Setting 3-Port Diverter Only Trim	ADA Lever	Stainless*	

\* Brilliance® Anti-Tarnish Lifetime Finishes



## Shower Faucets

### Victorian® 1-Hdl Multi-Function Diverter Trim

- Coordinates with all Delta Victorian® bath suites
- 1/2" Rough-in
- 3-Setting diverters have (2) individual positions, (1) shared position
- 6-Setting diverters have (3) individual positions, (3) shared positions
- Requires R11000 rough-in (sold separately)



Part #	Mfg #	Description	Handle(s)	Finish	Price
134752	T11855-RB	3-Setting 2-Port Diverter Only Trim	ADA Lever	Venetian Bronze®	
146408	T11855-CZ	3-Setting 2-Port Diverter Only Trim	ADA Lever	Champagne Bronze™	
134753	T11855-SS	3-Setting 2-Port Diverter Only Trim	ADA Lever	Stainless*	
134755	T11955	3-Setting 2-Port Diverter Only Trim	ADA Lever	Chrome	
134756	T11955-RB	6-Setting 3-Port Diverter Only Trim	ADA Lever	Venetian Bronze®	

### XO Jetted Module Diverter Trim

- Must order R18000-XO rough valve separately
- MultiChoice® rough valve and R1827-XO
- H2Okinetic™ jets rotate 30°
- (3) individual positions, (3) shared positions
- Each jet flows at .75 gpm @ 60 psi
- Total unit flows at 2.5 gpm @ 80 psi



Part #	Mfg #	Description	Handle(s)	Finish	Price
153144	T18017-XO	2 H2Okinetic™ Body Sprays	Lever	Chrome	
156558	T18017-RBXO	2 H2Okinetic™ Body Sprays	Lever	Venetian Bronze®	
153665	T18017-SSXO	2 H2Okinetic™ Body Sprays	Lever	Stainless*	
142737	T18037-XO	2 H2Okinetic™ Body Sprays	Lever	Chrome	
137185	T18037-SSXO	2 H2Okinetic™ Body Sprays	Lever	Stainless*	

### Zura® 1-Hdl Multi-Function Diverter Trim

- 1/2" Rough-in
- Monitor® pressure balance valve
- 3-Setting diverter: (2) individual positions, (1) shared position
- 6-Setting diverters have (3) individual positions, (3) shared positions
- Requires R11000 rough-in (sold separately)



Part #	Mfg #	Description	Handle(s)	Finish	Price
234055	T11874	3-Setting 2-Port Diverter Only Trim	ADA Lever	Chrome	
239501	T11874-SS	3-Setting 2-Port Diverter Only Trim	ADA Lever	Stainless*	
232760	T11974	6-Setting 3-Port Diverter Only Trim	ADA Lever	Chrome	
234869	T11974-SS	6-Setting 3-Port Diverter Only Trim	ADA Lever	Stainless*	

\* Brilliance® Anti-Tarnish Lifetime Finishes



## Shower Faucets

### Shower Trim

#### Baliza® Tempassure Thermostatic Shower Trim

- Fits MultiChoice® universal rough-in valve
- Independent temperature and volume control
- H2Okinetic® spray technology
- 7- 1/8" Raincan showerhead
- 7" Showerarm



Part #	Mfg #	Description	Handle(s)	Finish	Price
175329	T60205-BN	Shower Trim Only, 2.0 gpm	ADA Lever	Brushed Nickel*	
171318	T60205-BZ	Shower Trim Only, 2.0 gpm	ADA Lever	Brushed Bronze*	
184104	T60205-PC	Shower Trim Only, 2.0 gpm	ADA Lever	Chrome	
175472	T60205-PN	Shower Trim Only, 2.0 gpm	ADA Lever	Polished Nickel*	
170960	T60205-RB	Shower Trim Only, 2.0 gpm	ADA Lever	Venetian Bronze®	

#### Baliza® Tempassure Thermostatic Valve Trim

- Fits MultiChoice® universal rough-in valve
- Independent temperature and volume control



Part #	Mfg #	Description	Handle(s)	Finish	Price
141938	T60005-BN	Valve Trim Only	ADA Lever	Brushed Nickel*	
229566	T60005-BZ	Valve Trim Only	ADA Lever	Brushed Bronze*	
158927	T60005-PC	Valve Trim Only	ADA Lever	Chrome	
159400	T60005-PN	Valve Trim Only	ADA Lever	Polished Nickel*	
170978	T60005-RB	Valve Trim Only	ADA Lever	Venetian Bronze®	

#### Charlotte™ Tempassure® Thermostatic Shower Trim

- Fits MultiChoice® universal rough-in valve
- Independent temperature and volume control
- H2Okinetic® spray technology
- 5-13/16" Raincan showerhead
- 8" Shower arm and flange



Part #	Mfg #	Description	Handle(s)	Finish	Price
180676	T60285-BN	Shower Trim Only, 2.0 gpm	ADA Lever	Brushed Nickel*	
222919	T60285-PC	Shower Trim Only, 2.0 gpm	ADA Lever	Chrome	
222841	T60285-PN	Shower Trim Only, 2.0 gpm	ADA Lever	Polished Nickel*	
144793	T60285-PNCO	Shower Trim Only, 2.0 gpm	ADA Lever	Cocoa Bronze™/Pol Nickel	

\* Brilliance® Anti-Tarnish Lifetime Finishes

[www.plumbsupply.com](http://www.plumbsupply.com) • Serving our Customers Since 1946 • [www.waterconcepts.net](http://www.waterconcepts.net)

**Shower Faucets**

**Charlotte™ Tempassure® Thermostatic Valve Trim**

- Fits MultiChoice® universal rough-in valve
- Independent temperature and volume control



Part #	Mfg #	Description	Handle(s)	Finish	Price
168173	T60085-PC	Valve Trim Only	ADA Lever	Chrome	
147476	T60085-PNCO	Valve Trim Only	ADA Lever	Cocoa Bronze™/Pol Nickel	

**Litze™ TempAssure® Thermostatic Shower Trim**

- Fits MultiChoice® universal valve (R60000 Series)
- H2Okinetic® technology
- 8" Multi-function raincan showerhead
- Four functions include
  - Massaging spray
  - Pause
  - H2Okinetic® full body spray
  - H2Okinetic® invigorating spray
- Independent temperature and volume control
- Jointed solid brass shower arm with two locking hinges for positioning
- MUST ORDER HANDLES SEPARATELY



Part #	Mfg #	Description	Handle(s)	Finish	Price
242290	T60235-GLLHP	Shower Trim Only, 2.0 gpm	Less Handles	Luxe Gold	
257379	T60235-PNLHP	Shower Trim Only, 2.0 gpm	Less Handles	Polished Nickel*	

**Loki™ Pressure Balance Shower Trim**

- Fits MultiChoice® universal rough-in valve (R60000 Series)
- Temperature only controlled with handle
- 120° Maximum handle rotation
- Single function H2Okinetic® showerhead



Part #	Mfg #	Description	Handle(s)	Finish	Price
180745	T60P220-BN	Shower Trim Only, 2.0 gpm	ADA Lever	Brushed Nickel*	
185543	T60P220-PC	Shower Trim Only, 2.0 gpm	ADA Lever	Chrome	

\* Brilliance® Anti-Tarnish Lifetime Finishes

## Shower Faucets

### Odin™ Tempassure® Thermostatic Shower Trim

- Fits MultiChoice® universal rough-in valve
- Independent temperature and volume control
- H2Okinetic® spray technology
- 5-3/8" Raincan showerhead
- 16" Shower arm and flange
- (-P) pressure balance shower valve



Part #	Mfg #	Description	Handle(s)	Finish	Price
176991	T60275-BL	Shower Trim Only, 2.0 gpm	ADA Lever	Matte Black	
160587	T60275-BN	Shower Trim Only, 2.0 gpm	ADA Lever	Brushed Nickel*	
160051	T60275-PC	Shower Trim Only, 2.0 gpm	ADA Lever	Chrome	

### Odin™ Tempassure® Thermostatic Valve Trim

- Fits MultiChoice® universal rough-in valve
- Independent temperature and volume control
- (-P) pressure balance shower valve



Part #	Mfg #	Description	Handle(s)	Finish	Price
178515	T60075-BL	Valve Trim Only	ADA Lever	Matte Black	
240367	T60P075-BL	Valve Trim Only, Pressure balance	ADA Lever	Matte Black	
160591	T60075-BN	Valve Trim Only	ADA Lever	Brushed Nickel*	
156844	T60075-PC	Valve Trim Only	ADA Lever	Chrome	

### Providence™ Belle Pressure Balance Shower Trim

- Fits MultiChoice® universal rough-in valve
- H2Okinetic® spray technology
- Handle adjusts temperature
- 7-1/8" Raincan showerhead
- 7" Shower arm



Part #	Mfg #	Description	Handle(s)	Finish	Price
160644	T60P210-BN	Shower Trim Only, 2.0 gpm	ADA Lever	Brushed Nickel*	
157988	T60P210-PC	Shower Trim Only, 2.0 gpm	ADA Lever	Chrome	
175144	T60P210-PN	Shower Trim Only, 2.0 gpm	ADA Lever	Polished Nickel*	
177603	T60P210-RB	Shower Trim Only, 2.0 gpm	ADA Lever	Venetian Bronze®	

\* Brilliance® Anti-Tarnish Lifetime Finishes

[www.plumbsupply.com](http://www.plumbsupply.com) • Serving our Customers Since 1946 • [www.waterconcepts.net](http://www.waterconcepts.net)

## Shower Faucets

### Rook™ Tempassure® Thermostatic Shower Trim

- Fits Multichoice® universal rough-in valve
- H2Okinetic® spray technology
- Handle adjusts temperature
- 8" Raincan showerhead
- 7" Shower arm



Part #	Mfg #	Description	Handle(s)	Finish	Price
237563	T60261-PC	Shower Trim Only, 2.0 gpm	ADA Lever	Chrome	
185779	T60261-NK	Shower Trim Only, 2.0 gpm	ADA Lever	Luxe Nickel*	
188717	T60261-NKBL	Shower Trim Only, 2.0 gpm	ADA Lever	Luxe Nickel /Matte Black*	
224444	T60261-PN	Shower Trim Only, 2.0 gpm	ADA Lever	Polished Nickel*	
186084	T60261-RB	Shower Trim Only, 2.0 gpm	ADA Lever	Venetian Bronze*	

### Rook™ Tempassure® Thermostatic Valve Trim

- Fits Multichoice® universal rough-in valve
- Handle adjusts temperature



Part #	Mfg #	Description	Handle(s)	Finish	Price
188967	T60061-PC	Valve Trim Only	ADA Lever	Chrome	
189245	T60061-RB	Valve Trim Only	ADA Lever	Venetian Bronze®	
227071	T60061-NK	Valve Trim Only	ADA Lever	Luxe Nickel*	

### RSVP® Tempassure® Thermostatic Shower Trim

- Fits Multichoice® universal rough-in valve
- Independent temperature and volume control
- 2-Function 5-7/8" x 3-7/8" raincan showerhead
- 6-3/4" Shower arm
- Flow rate: 2.5 gpm @ 80 psi



Part #	Mfg #	Description	Handle(s)	Finish	Price
119119	T60290-PC	Shower Trim Only	ADA Lever	Chrome	

\* Brilliance® Anti-Tarnish Lifetime Finishes

[www.waterconcepts.net](http://www.waterconcepts.net) • Serving our Customers Since 1946 • [www.plumbsupply.com](http://www.plumbsupply.com)

## Shower Faucets

### RSVP® Pressure Balance Shower Trim

- Fits Multichoice® universal rough-in valve
- 6-3/4" Shower arm
- Single function 5-1/4" showerhead
- Flow rate: 2.0 gpm @ 60 psi



Part #	Mfg #	Description	Handle(s)	Finish	Price
211429	T60P290-BN	Shower Trim Only	ADA Lever	Brushed Nickel*	
215387	T60P290-PC	Shower Trim Only	ADA Lever	Chrome	

### Siderna® Tempassure® Thermostatic Shower Trim

- Fits MultiChoice® universal rough-in valve
- Independent temperature and volume control
- 8-5/8" (T60280) or 5-3/8" (T60281) Raincan showerhead
- 16" (T60280) or 7" (T60281) Shower arm and flange



T6028

T6028

Part #	Mfg #	Description	Handle(s)	Finish	Price
162478	T60280-BL	Shower Trim Only, 2.5 gpm	ADA Lever	Matte Black	
162592	T60280-BN	Shower Trim Only, 2.5 gpm	ADA Lever	Brushed Nickel*	
143847	T60280-PC	Shower Trim Only, 2.5 gpm	ADA Lever	Chrome	

### Siderna® Tempassure® Thermostatic Valve Trim

- Fits MultiChoice® universal rough-in valve
- Independent temperature and volume control



Part #	Mfg #	Description	Handle(s)	Finish	Price
162476	T60080-BL	Valve Trim Only	ADA Lever	Matte Black	
159079	T60080-BN	Valve Trim Only	ADA Lever	Brushed Nickel*	
141646	T60080-PC	Valve Trim Only	ADA Lever	Chrome	

### Siderna® Pressure Balance Trim

- Fits MultiChoice® universal rough-in valve (R60000 series)
- Single-function pressure-balance cartridge
- Handle adjusts temperature



Part #	Mfg #	Description	Handle(s)	Finish	Price
242331	T60P080-BL	Valve Trim Only	ADA Lever	Matte Black	
242982	T60P080-BN	Valve Trim Only	ADA Lever	Brushed Nickel*	
230151	T60P080-PC	Valve Trim Only	ADA Lever	Chrome	

\* Brilliance® Anti-Tarnish Lifetime Finishes

[www.plumbsupply.com](http://www.plumbsupply.com) • Serving our Customers Since 1946 • [www.waterconcepts.net](http://www.waterconcepts.net)

## Shower Faucets

### Sotria® Tempassure® Thermostatic Shower Trim

- Fits MultiChoice® universal rough-in valve
- H2Okinetic® spray technology
- Handle adjusts temperature



Part #	Mfg #	Description	Handle(s)	Finish	Price
177373	T60250-BL	Shower Trim Only, 2.0 gpm	ADA Lever	Matte Black	
181331	T60250-NK	Shower Trim Only, 2.0 gpm	ADA Lever	Luxe Nickel*	
184214	T60250-PC	Shower Trim Only, 2.0 gpm	ADA Lever	Chrome	
179427	T60250-PN	Shower Trim Only, 2.0 gpm	ADA Lever	Polished Nickel*	

### Sotria® Tempassure® Thermostatic Valve Trim

- Fits MultiChoice® universal rough-in valve
- Handle adjusts temperature



Part #	Mfg #	Description	Handle(s)	Finish	Price
177374	T60050-BL	Valve Trim Only	ADA Lever	Matte Black	
179626	T60050-NK	Valve Trim Only	ADA Lever	Luxe Nickel*	

### Sotria® Pressure Balance Trim

- Fits MultiChoice® universal rough-in valve (R60000 series)
- Single-function pressure-balance cartridge
- Handle adjusts temperature



Part #	Mfg #	Description	Handle(s)	Finish	Price
242328	T60P050-BL	Valve Trim Only	ADA Lever	Matte Black	
242959	T60P050-NK	Valve Trim Only	ADA Lever	Luxe Nickel	

### Traditional Tempassure® Thermostatic Shower Trim

- Fits MultiChoice® universal rough-in valve
- Handle adjusts temperature



Part #	Mfg #	Description	Handle(s)	Finish	Price
126549	T60210-BN	Shower Trim Only, 2.5 gpm	ADA Lever	Brushed Nickel*	
136997	T60210-PC	Shower Trim Only, 2.5 gpm	ADA Lever	Chrome	
115185	T60210-PN	Shower Trim Only, 2.5 gpm	ADA Lever	Polished Nickel*	

\* Brilliance® Anti-Tarnish Lifetime Finishes



## Shower Faucets

### Shower Trim (Continued)

#### Traditional Tempassure® Thermostatic Shower Trim

Part #	Mfg #	Description	Handle(s)	Finish	Price
103912	T60210-RB	Shower Trim Only, 2.5 gpm	ADA Lever	Venetian Bronze®	

#### Traditional Tempassure® Thermostatic Shower Trim

- Fits MultiChoice® universal rough-in valve
- Handle adjusts temperature



Part #	Mfg #	Description	Handle(s)	Finish	Price
112067	T60010-RB	Valve Trim Only	ADA Lever	Venetian Bronze®	

#### Virage™ Tempassure® Thermostatic Shower Trim

- Single-function
- H2OKinetic® technology
- Lever volume control handle, temperature adjustment dial
- Requires R60000-UNBX rough-in valve (sold separately)



Part #	Mfg #	Description	Handle(s)	Finish	Price
134891	T60230-BN	Shower Trim Only , 2.0 gpm	ADA Lever	Brushed Nickel*	
132569	T60230-BZ	Shower Trim Only, 2.0 gpm	ADA Lever	Brushed Bronze*	
129975	T60230-PC	Shower Trim Only, 2.0 gpm	ADA Lever	Chrome	
165830	T60230-PN	Shower Trim Only, 2.0 gpm	ADA Lever	Polished Nickel*	
147684	T60230-RB	Shower Trim Only, 2.0 gpm	ADA Lever	Venetian Bronze®	

#### Virage™ Tempassure® Thermostatic Valve Trim

- Single-function
- Lever volume control handle, temperature adjustment dial
- Requires R60000-UNBX rough-in valve (sold separately)



Part #	Mfg #	Description	Handle(s)	Finish	Price
143198	T60030-BN	Valve Trim Only	ADA Lever	Brushed Nickel*	
149262	T60030-PC	Valve Trim Only	ADA Lever	Chrome	
248238	T60030-PN	Valve Trim Only	ADA Lever	Polished Nickel*	
137492	T60030-RB	Valve Trim Only	ADA Lever	Venetian Bronze®	

\* Brilliance® Anti-Tarnish Lifetime Finishes

[www.plumbsupply.com](http://www.plumbsupply.com) • Serving our Customers Since 1946 • [www.waterconcepts.net](http://www.waterconcepts.net)

**Shower Faucets**

**Vettis™ Tempassure® Thermostatic Shower Trim**

- H2Okinetic® technology with self-cleaning spray holes
- TempAssure® thermostatic medium flow valving
- Fits MultiChoice® universal rough-in valve
- Independent temperature and volume control
- Red/blue temperature markings
- 13" decorative, solid brass shower arm
- 8" x 8-1/2" H2Okinetic® multi-function showerhead



Part #	Mfg #	Description	Handle(s)	Finish	Price
243771	T60288-PC	Shower Trim Only, 2.0 gpm	ADA Lever	Chrome	

**Vesi® Tempassure® Thermostatic Shower Trim**

- Fits MultiChoice® universal rough-in valve
- Lever volume control handle, temperature adjustment dial
- 3-Function shower head
- Requires R60000-UNBX rough-in valve (sold separately)



Part #	Mfg #	Description	Handle(s)	Finish	Price
104149	T60240-BN	Shower Trim Only, 2.5 gpm	ADA Lever	Brushed Nickel*	

**Vesi® Tempassure® Thermostatic Valve Trim**

- Fits MultiChoice® universal rough-in valve
- Lever volume control handle, temperature adjustment dial
- Requires R60000-UNBX rough-in valve (sold separately)



Part #	Mfg #	Description	Handle(s)	Finish	Price
104198	T60040-BN	Valve Trim Only	ADA Lever	Brushed Nickel*	
222654	T60040-RB	Valve Trim Only	ADA Lever	Venetian Bronze	

**Vesi Channel Pressure Balance Shower Trim**

- Fits MultiChoice® universal rough-in valve
- Handle adjusts temperature



Part #	Mfg #	Description	Handle(s)	Finish	Price
183271	T60P240-BN	Shower Trim Only, 2.0 gpm	ADA Lever	Brushed Nickel*	
189725	T60P240-BZ	Shower Trim Only, 2.0 gpm	ADA Lever	Brushed Bronze*	

\* Brilliance® Anti-Tarnish Lifetime Finishes

## Shower Faucets

### Diverter Shower Trim

#### Baliza Diverter Trim

- 2 Individual positions, 1 shared position
- 1/2" Universal inlets/outlets
- Cartridge ships with trim
- Requires rough-in valve R60700



Part #	Mfg #	Description	Handle(s)	Finish	Price
175330	T60805-BN	Diverter Trim, 3-Setting	ADA Lever	Brushed Nickel*	
171319	T60805-BZ	Diverter Trim, 3-Setting	ADA Lever	Brushed Bronze*	
173268	T60805-PC	Diverter Trim, 3-Setting	ADA Lever	Chrome	
186749	T60805-PN	Diverter Trim, 3-Setting	ADA Lever	Polished Nickel*	
217401	T60805-RB	Diverter Trim, 3-Setting	ADA Lever	Venetian Bronze®	

#### Charlotte™ Diverter Trim

- 2 Individual positions, 1 shared position (T60885)
- 3 Individual positions, 3 shared positions (T60985)
- 1/2" Universal inlets/outlets
- Cartridge ships with trim
- Requires rough-in valve R60700



Part #	Mfg #	Description	Handle(s)	Finish	Price
206960	T60885-BN	Diverter Trim, 3-Setting	ADA Lever	Brushed Nickel*	
171232	T60885-PC	Diverter Trim, 3-Setting	ADA Lever	Chrome	
222842	T60885-PN	Diverter Trim, 3-Setting	ADA Lever	Polished Nickel*	
147475	T60885-PNCO	Diverter Trim, 3-Setting	ADA Lever	Cocoa Bronze™/Pol Nickel	
210825	T60985-PN	Diverter Trim, 6-Setting	ADA Lever	Polished Nickel*	
148741	T60985-PNCO	Diverter Trim, 6-Setting	ADA Lever	Cocoa Bronze™/Pol Nickel	

#### Litze™ Diverter Trim

- 2 individual positions, 1 shared position (T60835)
- 3 individual positions, 3 shared positions (T60935)
- 1/2" universal inlets/outlets
- Cartridge ships with the trim
- Requires rough-in valve R60700
- (-LHP) Less handle package



Part #	Mfg #	Description	Handle(s)	Finish	Price
246927	T60935-NKLHP	Diverter Trim, 6-Setting	ADA Lever	Luxe Nickel	

\* Brilliance® Anti-Tarnish Lifetime Finishes

[www.plumbsupply.com](http://www.plumbsupply.com) • Serving our Customers Since 1946 • [www.waterconcepts.net](http://www.waterconcepts.net)

## Shower Faucets

### Odin™ Jason Wu Diverter Trim

- 3 Individual positions, 3 shared positions
- Cartridge ships with trim
- Requires rough-in valve R60700



Part #	Mfg #	Description	Handle(s)	Finish	Price
240368	T60975-BL	Diverter Trim, 6-Setting	ADA Lever	Matte Black	

### Odin™ Diverter Trim

- 2 Individual positions, 1 shared position (T60875)
- 3 Individual positions, 3 shared positions (T60975)
- 1/2" Universal inlets/outlets
- Cartridge ships with trim
- Requires rough-in valve R60700



Part #	Mfg #	Description	Handle(s)	Finish	Price
160589	T60875-BN	Diverter Trim, 3-Setting	ADA Lever	Brushed Nickel*	
157189	T60875-PC	Diverter Trim, 3-Setting	ADA Lever	Chrome	
166503	T60975-BN	Diverter Trim, 6-Setting	ADA Lever	Brushed Nickel*	
157994	T60975-PC	Diverter Trim, 6-Setting	ADA Lever	Chrome	

### Rook™ Diverter Trim

- 2 individual positions, 1 shared position
- 1/2" Universal inlets/outlets
- Cartridge ships with trim
- Requires rough-in valve R60700



Part #	Mfg #	Description	Handle(s)	Finish	Price
185780	T60861-NK	Diverter Trim, 3-Setting	ADA Lever	Luxe Nickel*	
188968	T60861-PC	Diverter Trim, 3-Setting	ADA Lever	Chrome	
250561	T60861-PN	Diverter Trim, 3-Setting	ADA Lever	Polished Nickel*	
240669	T60861-RB	Diverter Trim, 3-Setting	ADA Lever	Venetian Bronze	
227116	T60961-NK	Diverter Trim, 6-Setting	ADA Lever	Luxe Nickel*	
238885	T60961-RB	Diverter Trim, 6-Setting	ADA Lever	Venetian Bronze	

### RSVP Diverter Trim

- 2 Individual positions, 1 shared position (T60890)
- 3 Individual positions, 3 shared positions (T60990)
- 1/2" Universal inlets/outlets
- Cartridge ships with trim
- Requires rough-in valve R60700



Part #	Mfg #	Description	Handle(s)	Finish	Price
170276	T60890-BN	Diverter Trim, 3-Setting	ADA Lever	Brushed Nickel*	
141156	T60890-PC	Diverter Trim, 3-Setting	ADA Lever	Chrome	

\* Brilliance® Anti-Tarnish Lifetime Finishes

[www.waterconcepts.net](http://www.waterconcepts.net) • Serving our Customers Since 1946 • [www.plumbsupply.com](http://www.plumbsupply.com)

## Shower Faucets

### Diverter Shower Trim (Continued)

#### RSVP Diverter Trim

Part #	Mfg #	Description	Handle(s)	Finish	Price
177207	T60990-PC	Diverter Trim, 6-Setting	ADA Lever	Chrome	

#### Siderna® Diverter Trim

- 2 Individual positions, 1 shared position (T60880)
- 3 Individual positions, 3 shared positions (T60980)
- 1/2" Universal inlets/outlets
- Cartridge ships with trim
- Requires rough-in valve R60700



Part #	Mfg #	Description	Handle(s)	Finish	Price
188615	T60880-BL	Diverter Trim, 3-Setting	ADA Lever	Matte Black	
159080	T60880-BN	Diverter Trim, 3-Setting	ADA Lever	Brushed Nickel*	
141647	T60880-PC	Diverter Trim, 3-Setting	ADA Lever	Chrome	
162477	T60980-BL	Diverter Trim, 6-Setting	ADA Lever	Matte Black	
161830	T60980-BN	Diverter Trim, 6-Setting	ADA Lever	Brushed Nickel*	
143848	T60980-PC	Diverter Trim, 6-Setting	ADA Lever	Chrome	

#### Sotria Diverter Trim

- 3-Setting: 2 Individual positions, 1 shared position (T60850)
- 6-Setting: 3 Individual positions, 3 shared positions (T60950)
- 1/2" Universal inlets/outlets
- Cartridge ships with trim
- Requires rough-in valve R60700



Part #	Mfg #	Description	Handle(s)	Finish	Price
177379	T60850-BL	Diverter Trim, 3-Setting	ADA Lever	Matte Black	
181332	T60850-NK	Diverter Trim, 3-Setting	ADA Lever	Luxe Nickel*	
184216	T60850-PC	Diverter Trim, 3-Setting	ADA Lever	Chrome	
254651	T60950-NK	Diverter Trim, 6-Setting	ADA Lever	Luxe Nickel*	

#### Traditional Diverter Trim

- 2 Individual positions, 1 shared position (T60810)
- 3 Individual positions, 3 shared positions (T60910)
- 1/2" Universal inlets/outlets
- Cartridge ships with trim
- Requires rough-in valve R60700



Part #	Mfg #	Description	Handle(s)	Finish	Price
144967	T60810-BN	Diverter Trim, 3-Setting	ADA Lever	Brushed Nickel*	
155232	T60810-PC	Diverter Trim, 3-Setting	ADA Lever	Chrome	
175145	T60810-PN	Diverter Trim, 3-Setting	ADA Lever	Polished Nickel*	
147343	T60810-RB	Diverter Trim, 3-Setting	ADA Lever	Venetian Bronze®	
144968	T60910-BN	Diverter Trim, 6-Setting	ADA Lever	Brushed Nickel*	

\* Brilliance® Anti-Tarnish Lifetime Finishes

**www.plumbsupply.com • Serving our Customers Since 1946 • www.waterconcepts.net**

## Shower Faucets

### Diverter Shower Trim (Continued)

#### Traditional Diverter Trim

Part #	Mfg #	Description	Handle(s)	Finish	Price
155690	T60910-PC	Diverter Trim, 6-Setting	ADA Lever	Chrome	
150705	T60910-RB	Diverter Trim, 6-Setting	ADA Lever	Venetian Bronze®	

#### Vesi® Diverter Trim

- 2 Individual positions, 1 shared position (T60840)
- 3 Individual positions, 3 shared positions (T60940)
- 1/2" Universal inlets/outlets
- Cartridge ships with trim
- Requires rough-in valve R60700



Part #	Mfg #	Description	Handle(s)	Finish	Price
162436	T60840-BN	Diverter Trim, 3-Setting	ADA Lever	Brushed Nickel*	
162659	T60840-BZ	Diverter Trim, 3-Setting	ADA Lever	Brushed Bronze*	
164349	T60840-PC	Diverter Trim, 3-Setting	ADA Lever	Chrome	
222655	T60840-RB	Diverter Trim, 3-Setting	ADA Lever	Venetian Bronze	
159862	T60940-BN	Diverter Trim, 6-Setting	ADA Lever	Brushed Nickel*	
197750	T60940-BZ	Diverter Trim, 6-Setting	ADA Lever	Brushed Bronze*	

#### Virage Diverter Trim

- 2 Individual positions, 1 shared position (T60830)
- 3 Individual positions, 3 shared positions (T60930)
- 1/2" Universal inlets/outlets
- Cartridge ships with trim
- Requires rough-in valve R60700



Part #	Mfg #	Description	Handle(s)	Finish	Price
149845	T60830-BN	Diverter Trim, 3-Setting	ADA Lever	Brushed Nickel*	
158217	T60830-BZ	Diverter Trim, 3-Setting	ADA Lever	Brushed Bronze*	
149263	T60830-PC	Diverter Trim, 3-Setting	ADA Lever	Chrome	
165831	T60830-PN	Diverter Trim, 3-Setting	ADA Lever	Polished Nickel*	
173286	T60830-RB	Diverter Trim, 3-Setting	ADA Lever	Venetian Bronze®	
153333	T60930-BN	Diverter Trim, 6-Setting	ADA Lever	Brushed Nickel*	
163743	T60930-PC	Diverter Trim, 6-Setting	ADA Lever	Chrome	
159770	T60930-RB	Diverter Trim, 6-Setting	ADA Lever	Venetian Bronze®	

\* Brilliance® Anti-Tarnish Lifetime Finishes



## Shower Faucets

### Pressure Balance Shower Trim

#### Baliza® Pressure Balance Shower Trim

- Fits MultiChoice® universal rough-in valve (R60000 Series)
- Temperature only controlled with handle
- 120° Maximum handle rotation



Part #	Mfg #	Description	Handle(s)	Finish	Price
259526	T60P005-PN	Pressure Balance Trim	ADA Lever	Brushed Nickel*	
252362	T60P005-PC	Pressure Balance Trim	ADA Lever	Chrome	

#### Charlotte® Pressure Balance Shower Trim

- Fits MultiChoice® universal rough-in valve (R60000 Series)
- Temperature only controlled with handle
- 120° Maximum handle rotation



Part #	Mfg #	Description	Handle(s)	Finish	Price
248744	T60P085-BN	Pressure Balance Trim	ADA Lever	Brushed Nickel*	

#### Levoir™ Pressure Balance Shower Trim

- Fits MultiChoice® universal rough-in valve (R60000 Series)
- Temperature only controlled with handle
- 1/2" universal inlets/outlets
- 120° Maximum handle rotation
- Handles sold separately



Part #	Mfg #	Description	Handle(s)	Finish	Price
255365	T60P098-GLLHP	Pressure Balance Trim	ADA Lever	Luxe Gold	
255116	T60P098-PNLHP	Pressure Balance Trim	ADA Lever	Polished Nickel*	

#### Levoir™ Pressure Balance Shower Trim with Integrated Diverter

- Fits MultiChoice® universal rough-in valve (R60000 Series)
- Temperature only controlled with handle
- 1/2" universal inlets/outlets
- (3-Function) 2 individual positions and 1 shared position
- 2 individual positions, no shared positions order RP72123
- Cartridges ship with trim
- Handles sold separately



Part #	Mfg #	Description	Handle(s)	Finish	Price
253992	T75P598-PNLHP	Pressure Balance Trim, 3-Way Diverter	Less Handles	Polished Nickel*	
252810	T75P598-SLLHP	Pressure Balance Trim, 3-Way Diverter	Less Handles	Luxe Steel	

\* Brilliance® Anti-Tarnish Lifetime Finishes

[www.plumbsupply.com](http://www.plumbsupply.com) • Serving our Customers Since 1946 • [www.waterconcepts.net](http://www.waterconcepts.net)

## Shower Faucets

### Rook™ Pressure Balance Shower Trim

- Fits MultiChoice® universal rough-in valve (R60000 Series)
- Temperature only controlled with handle
- 120° Maximum handle rotation



Part #	Mfg #	Description	Handle(s)	Finish	Price
252780	T60P060-NKBL	Pressure Balance Trim	ADA Lever	Luxe Nickel/Matte Black	
250749	T60P060-RB	Pressure Balance Trim	ADA Lever	Venetian Bronze	
250560	T60P061-PN	Pressure Balance Trim	ADA Cross	Polished Nickel*	

### Vettis™ Pressure Balance Shower Trim

- Fits MultiChoice® universal rough-in valve (R60000 Series)
- Temperature only controlled with handle
- 120° Maximum handle rotation
- Red/Blue temperature markings
- RP91024 extension kit extends rough installation up to 1-3/4"



Part #	Mfg #	Description	Handle(s)	Finish	Price
251936	T60P088-NK	Pressure Balance Trim	ADA Lever	Luxe Nickel*	

### Vettis™ Pressure Balance Shower Trim with Integrated Diverter

- Fits MultiChoice® universal rough-in valve (R75000 Series)
- Valve handle adjusts temperature
- 1/2" universal inlets/outlets
- 3-Setting: 2 individual positions and 1 shared position
- 6-Setting: 3 individual positions and 3 shared position
- Cartridges ship with trim



Part #	Mfg #	Description	Handle(s)	Finish	Price
258957	T75P588-BL	Pressure Balance Trim, 3-Way Diverter	ADA Lever	Matte Black	

### Virage® Pressure Balance Shower Trim

- Fits MultiChoice® universal rough-in valve (R60000 Series)
- Temperature only controlled with handle
- 120° Maximum handle rotation
- Red/Blue temperature markings
- RP81665 extension kit extends rough installation up to 1-3/4"



Part #	Mfg #	Description	Handle(s)	Finish	Price
250044	T60P030-BN	Pressure Balance Trim	Lever	Brushed Nickel*	
256299	T60P030-BZ	Pressure Balance Trim	Lever	Brushed Bronze*	
256302	T60P030-RB	Pressure Balance Trim	Lever	Venetian Bronze	

\* Brilliance® Anti-Tarnish Lifetime Finishes

## Shower Faucets

### Thermostatic Valve Trim

#### Baliza® Sensori® Thermostatic Valve Trim

- Thermostatic cartridge ships with trim
- High temperature limit stop - 120°
- Requires rough-in valve R6600-WS



Part #	Mfg #	Description	Handle(s)	Finish	Price
246261	T66T005-BZ	Thermostatic Trim	ADA Lever	Brushed Bronze*	
246496	T66T005-PC	Thermostatic Trim	ADA Lever	Chrome	

#### Charlotte™ Sensori® Thermostatic Valve Trim

- Thermostatic cartridge ships with trim
- High temperature limit stop - 120°
- Requires rough-in valve R6600-WS



Part #	Mfg #	Description	Handle(s)	Finish	Price
155369	T66T085-BN	Thermostatic Trim	ADA Lever	Brushed Nickel*	
168177	T66T085-PC	Thermostatic Trim	ADA Lever	Chrome	
205687	T66T085-PNCO	Thermostatic Trim	ADA Lever	Polished Nickel/Cocoa Bronze	

#### Levoir® Tempassure® Thermostatic Shower Trim

- Fits MultiChoice® universal rough-in valve
- H2Okinetic® spray technology
- Independent temperature and volume control
- 6-7/8" Multi-function showerhead: 1.75 gpm @ 80 psi
- 7-1/2" Decorative solid brass shower arm



Part #	Mfg #	Description	Handle(s)	Finish	Price
255719	T60298-NK	Thermostatic Trim	ADA Lever	Luxe Nickel	

#### Levoir™ Tempassure® Thermostatic Valve Trim

- For use with MultiChoice® universal rough-in
- Thermostatic cartridge ships with trim
- RP74785 extension kit extends rough installation up to 1-3/4"
- Requires rough-in valve (R60000 series)



Part #	Mfg #	Description	Handle(s)	Finish	Price
255702	T60098-NK	Thermostatic Trim	ADA Lever	Luxe Nickel	
254002	T60098-PN	Thermostatic Trim	ADA Lever	Polished Nickel*	

\* Brilliance® Anti-Tarnish Lifetime Finishes

www.plumbsupply.com • Serving our Customers Since 1946 • www.waterconcepts.net

## Shower Faucets

### Levoir™ Tempassure® Thermostatic Diverter Valve Trim

- 1/2" Universal inlets/outlets
- For use with MultiChoice® universal rough-in
- Thermostatic cartridge ships with trim
- 3-Function: 2 individual positions and 1 shared position
- 6-Function: 3 individual positions and 3 shared position
- RP90545 extension kit extends rough installation up to 1"
- Requires rough-in valve (R75000 series)



Part #	Mfg #	Description	Handle(s)	Finish	Price
253989	T75598-PN	Thermostatic Trim, 3-Setting	ADA Lever	Polished Nickel*	
259627	T75698-PC	Thermostatic Trim, 6-Setting	ADA Lever	Chrome	
255720	T75698-NK	Thermostatic Trim, 6-Setting	ADA Lever	Luxe Nickel	

### Litze™ Tempassure® Thermostatic Valve Trim—Less Handles

- Thermostatic cartridge ships with trim
- RP74785 extension kit extends rough installation up to 1-3/4"
- Requires rough-in valve (R60000 series)



Part #	Mfg #	Description	Handle(s)	Finish	Price
243461	T60035-GLLHP	Thermostatic Trim	Less Handles	Luxe Gold	
243662	T60035-NKLHP	Thermostatic Trim	Less Handles	Luxe Nickel	
243243	T60035-PCLHP	Thermostatic Trim	Less Handles	Chrome	

### Litze™ Tempassure® Thermostatic 3-Function Diverter Valve Trim—Less Handles

- 1/2" Universal inlets/outlets
- Thermostatic cartridge ships with trim
- Diverter has 2 individual positions and 1 shared position
- For 2 individual positions, no shared position, order (RP72123)
- Requires rough-in valve (R65700)



Part #	Mfg #	Description	Handle(s)	Finish	Price
254945	T75535-GLLHP	Thermostatic Diverter Trim, 3-Setting	Less Handles	Luxe Gold	
237818	T75535-PCLHP	Thermostatic Diverter Trim, 3-Setting	Less Handles	Chrome	
240678	T75535-PNLHP	Thermostatic Diverter Trim, 3-Setting	Less Handles	Polished Nickel	

\* Brilliance® Anti-Tarnish Lifetime Finishes

[www.waterconcepts.net](http://www.waterconcepts.net) • Serving our Customers Since 1946 • [www.plumbsupply.com](http://www.plumbsupply.com)

## Shower Faucets

### Litze™ Sensori® Thermostatic Valve Trim—Less Handles

- Thermostatic cartridge ships with trim
- High temperature limit stop — 120°F
- Requires rough-in valve (R66000-WS)
- (RP72604) Available 1-3/4" extension kit



Part #	Mfg #	Description	Handle(s)	Finish	Price
243451	T66T035-GLLHP	Thermostatic Trim	ADA Lever	Luxe Gold	

### Odin™ Sensori® Thermostatic Valve Trim

- Thermostatic cartridge ships with trim
- High temperature limit stop - 120°
- Requires rough-in valve R66000-WS



Part #	Mfg #	Description	Handle(s)	Finish	Price
223387	T66T075-BL	Thermostatic Trim	ADA Lever	Matte Black	
157192	T66T075-PC	Thermostatic Trim	ADA Lever	Chrome	

### Rook™ Sensori® Thermostatic Valve Trim

- Thermostatic cartridge ships with trim
- High temperature limit stop - 120°
- Requires rough-in valve R66000-WS



Part #	Mfg #	Description	Handle(s)	Finish	Price
223091	T66T060-NKBL	Thermostatic Trim	ADA Lever	Luxe Nickel/Matte Black*	
230918	T66T060-PC	Thermostatic Trim	ADA Lever	Chrome	
185521	T66T060-RB	Thermostatic Trim	ADA Lever	Venetian Bronze®	
248928	T66T061-NKBL	Thermostatic Trim	ADA Cross	Luxe Nickel/Matte Black*	
250462	T66T061-PN	Thermostatic Trim	ADA Cross	Polished Nickel*	

### Rook™ Tempassure® Thermostatic Valve with 3-Function Diverter Trim

- TempAssure® thermostatic medium flow valving
- Independent temperature, volume and diverter control
- 3-Way diverter: 2 individual positions and 1 shared position
- 6-Way diverter: 3 individual positions and 3 shared positions
- For 2 individual positions, no shared positions, order RP72123
- For 3 individual positions, no shared positions, order RP72124
- 1/2" universal inlets/outlets
- Cartridges ship with the trim
- Requires rough-in valve R75000



Part #	Mfg #	Description	Handle(s)	Finish	Price
250056	T75561-PC	Thermostatic Trim w/ 3-Way Diverter	ADA Lever	Chrome	
248276	T75561-PN	Thermostatic Trim w/ 3-Way Diverter	ADA Lever	Polished Nickel*	

\* Brilliance® Anti-Tarnish Lifetime Finishes

[www.plumbsupply.com](http://www.plumbsupply.com) • Serving our Customers Since 1946 • [www.waterconcepts.net](http://www.waterconcepts.net)



## Shower Faucets

### Thermostatic Valve Trim (Continued)

#### Rook™ Tempassure® Thermostatic Valve with 3-Function Diverter Trim

Part #	Mfg #	Description	Handle(s)	Finish	Price
237295	T75561-NK	Thermostatic Trim w/ 3-Way Diverter	ADA Lever	Luxe Nickel	
251608	T75661-NKBL	Thermostatic Trim w/ 6-Way Diverter	ADA Lever	Luxe Nickel/Matte Black	

#### Siderna® Thermostatic Valve Trim

- Thermostatic cartridge ships with trim
- High temperature limit stop - 120°
- Requires rough-in valve R66000-WS



Part #	Mfg #	Description	Handle(s)	Finish	Price
138961	T66T080-BN	Thermostatic Trim	ADA Lever	Brushed Nickel*	
242221	T66T080-BL	Thermostatic Trim	ADA Lever	Matte Black	
158800	T66T080-PC	Thermostatic Trim	ADA Lever	Chrome	

#### Sotria™ Sensori® Thermostatic Valve Trim

- Thermostatic cartridge ships with trim
- High temperature limit stop - 120°
- Requires rough-in valve R6600-WS



Part #	Mfg #	Description	Handle(s)	Finish	Price
179653	T66T050-NK	Thermostatic Trim	ADA Lever	Luxe Nickel*	

#### Traditional Sensori® Thermostatic Valve Trim

- Thermostatic cartridge ships with trim
- High temperature limit stop - 120°
- Requires rough-in valve R66000-WS



Part #	Mfg #	Description	Handle(s)	Finish	Price
181110	T66T036-BN	Thermostatic Trim	ADA Lever	Brushed Nickel*	
145726	T66T036-PC	Thermostatic Trim	ADA Lever	Chrome	
128361	T66T036-RB	Thermostatic Trim	ADA Lever	Venetian Bronze®	
148360	T66T038-BN	Thermostatic Trim	ADA Cross	Brushed Nickel*	
165675	T66T038-PC	Thermostatic Trim	ADA Cross	Chrome	

\* Brilliance® Anti-Tarnish Lifetime Finishes



## Shower Faucets

### Vesi Sensori® Thermostatic Valve Trim

- Thermostatic cartridge ships with trim
- High temperature limit stop - 120°
- Requires rough-in valve R66000-WS



Part #	Mfg #	Description	Handle(s)	Finish	Price
189721	T66T040-BZ	Thermostatic Trim	ADA Lever	Brushed Bronze*	

### Vettis™ Sensori® Thermostatic Valve Trim

- Thermostatic cartridge ships with trim
- High temperature limit stop - 120° F
- Requires rough-in valve R66000-WS



Part #	Mfg #	Description	Handle(s)	Finish	Price
245887	T66T088-PC	Thermostatic Trim	ADA Lever	Chrome	

### Vettis™ Tempassure® Thermostatic Valve Trim with Integrated Diverter

- For use with MultiChoice® rough-in
- Thermostatic cartridge ships with trim
- Independent temperature, volume and diverter control
- 1/2" Universal inlets/outlets
- (3-Function) 2 individual positions and 1 shared position
- (6-Function) 3 individual positions and 3 shared positions
- 2 individual positions, no shared positions, order RP72123
- 3 individual positions, no shared positions, order RP72124
- Requires rough-in valve R75000



Part #	Mfg #	Description	Handle(s)	Finish	Price
252514	T75588-BL	Thermostatic Trim w/ 3-Way Diverter	ADA Lever	Matte Black	
251060	T75688-NK	Thermostatic Trim w/ 6-Way Diverter	ADA Lever	Luxe Nickel*	

### Virage Sensori® Thermostatic Valve Trim

- Thermostatic cartridge ships with trim
- High temperature limit stop - 120°
- Requires rough-in valve R66000-WS



Part #	Mfg #	Description	Handle(s)	Finish	Price
148047	T66T030-BN	Thermostatic Trim	ADA Lever	Brushed Nickel*	
146531	T66T030-PC	Thermostatic Trim	ADA Lever	Chrome	
170002	T66T030-PN	Thermostatic Trim	ADA Lever	Polished Nickel*	
148035	T66T030-RB	Thermostatic Trim	ADA Lever	Venetian Bronze®	

\* Brilliance® Anti-Tarnish Lifetime Finishes

[www.plumbsupply.com](http://www.plumbsupply.com) • Serving our Customers Since 1946 • [www.waterconcepts.net](http://www.waterconcepts.net)

## Shower Faucets

### Volume Control Trim

#### Baliza® Sensori® Volume Control Trim

- Recommended working pressure 45-80 psi
- Requires rough-in valve R36500



Part #	Mfg #	Description	Handle(s)	Finish	Price
246263	T66605-BZ	Volume Control Trim	ADA Lever	Brushed Bronze*	
246497	T66605-PC	Volume Control Trim	ADA Lever	Chrome	

#### Charlotte™ Volume Control Trim

- Recommended working pressure 45-60 psi
- Requires rough-in valve R66600



Part #	Mfg #	Description	Handle(s)	Finish	Price
155370	T66685-BN	Volume Control Trim	ADA Lever	Brushed Nickel*	
168175	T66685-PC	Volume Control Trim	ADA Lever	Chrome	
233018	T66685-PNCO	Volume Control Trim	ADA Lever	Cocoa Bronze/Polished Nickel	

#### Odin™ Sensori® Volume Control Trim

- Recommended working pressure 45-60 psi
- Requires rough-in valve R66600



Part #	Mfg #	Description	Handle(s)	Finish	Price
223388	T66675-BL	Volume Control Trim	ADA Lever	Matte Black	
157193	T66675-PC	Volume Control Trim	ADA Lever	Chrome	

#### Rook™ Sensori® Volume Control Trim

- Recommended working pressure 45-80 psi
- Requires rough-in valve R66600



Part #	Mfg #	Description	Handle(s)	Finish	Price
223098	T66660-NKBL	Volume Control Trim	ADA Lever	Luxe Nkl/Matte Blk	
230919	T66660-PC	Volume Control Trim	ADA Lever	Chrome	
185522	T66660-RB	Volume Control Trim	ADA Lever	Venetian Bronze®	
232226	T66661-PC	Volume Control Trim	ADA Chrome	Chrome	
250463	T66661-PN	Volume Control Trim	ADA Cross	Polished Nickel*	

#### Siderna® Sensori® Volume Control Trim

- Recommended working pressure 45-60 psi
- Requires rough-in valve R66000
- Flush mount installation



Part #	Mfg #	Description	Handle(s)	Finish	Price
242225	T66680-BL	Volume Control Trim	ADA Lever	Matte Black	
138962	T66680-BN	Volume Control Trim	ADA Lever	Brushed Nickel*	
166851	T66680-PC	Volume Control Trim	ADA Lever	Chrome	

\* Brilliance® Anti-Tarnish Lifetime Finishes

## Shower Faucets

### Traditional Sensori® Volume Control Trim

- Recommended working pressure of 45-80 psi
- Requires rough-in valve R66600



Part #	Mfg #	Description	Handle(s)	Finish	Price
181111	T66636-BN	Volume Control Trim	ADA Lever	Brushed Nickel*	
145727	T66636-PC	Volume Control Trim	ADA Lever	Chrome	
128362	T66636-RB	Volume Control Trim	ADA Lever	Venetian Bronze®	
148362	T66638-BN	Volume Control Trim	ADA Cross	Brushed Nickel*	
146429	T66638-BZ	Volume Control Trim	ADA Cross	Brushed Bronze*	
165676	T66638-PC	Volume Control Trim	ADA Cross	Chrome	
145233	T66638-RB	Volume Control Trim	ADA Cross	Venetian Bronze®	

### Tresa® Sensori® Volume Control Trim

- Recommended working pressure of 45-80 psi
- Requires rough-in valve R35600



Part #	Mfg #	Description	Handle(s)	Finish	Price
245898	T66638-PN	Volume Control Trim	ADA Cross	Polished Nickel*	

### Vesi Sensori® Volume Control Trim

- Recommended working pressure of 45-80 psi
- Requires rough-in valve R66600



Part #	Mfg #	Description	Handle(s)	Finish	Price
189722	T66640-BZ	Volume Control Trim	ADA Lever	Brushed Bronze*	

### Vettis™ Sensori Volume Control Trim

- Recommended working pressure of 45-80 psi
- Requires rough-in valve R35600



Part #	Mfg #	Description	Handle(s)	Finish	Price
245888	T66688-PC	Volume Control Trim	ADA Lever	Chrome	

### Virage Sensori® Volume Control Trim

- Recommended working pressure of 45-80 psi
- Requires rough-in valve R66600



Part #	Mfg #	Description	Handle(s)	Finish	Price
148046	T66630-BN	Volume Control Trim	ADA Lever	Brushed Nickel*	
146532	T66630-PC	Volume Control Trim	ADA Lever	Chrome	
170003	T66630-PN	Volume Control Trim	ADA Lever	Polished Nickel*	
148036	T66630-RB	Volume Control Trim	ADA Lever	Venetian Bronze®	

\* Brilliance® Anti-Tarnish Lifetime Finishes

[www.plumbsupply.com](http://www.plumbsupply.com) • Serving our Customers Since 1946 • [www.waterconcepts.net](http://www.waterconcepts.net)



## Shower Faucets

### Shower Trim

#### Hardwater® 2-Hdl Shower Trim

- 8"cc
- Body cast of high copper content brass
- Ceramaflow ceramic disc cartridge
- Regular showerhead with black spray plate
- Maximum showerhead 2.5 gpm @ 80 psi
- Pressure-compensating flow control
- Slip-fit diverter spout
- Ejector tee



Part #	Mfg #	Description	Handle(s)	Finish	Price
029694	58-460	Shower Only Trim, IPS/Sweat, Slide Escutcheon	ADA Hardwater®	Chrome	

#### Gerber® Classics™ 2-Hdl Shower Trim

- 8"cc
- Compression cartridges and stems
- Body cast of high copper content brass
- By-Pass valve body complete with integral stops available
- Single function showerhead 2.0 gpm @ 80 psi
- Easy-Clean, soft touch nozzles
- Air injection technology
- Pressure manifold technology
- 1/2" IPS or sweat water inlet connections
- Brass plug for tub filler outlet



Part #	Mfg #	Description	Handle(s)	Finish	Price
049343	48-220-83	Shower Only Trim, IPS/Sweat, Slide Escutcheon	ADA Wing	Chrome	

### Shower Valves

#### Gerber® Classics™ Corner Pattern Shower Valve

- Compression cartridges and stems
- Body cast of high copper content brass
- Exposed parts have heavy chrome plate finish
- 1/2" I.P.S. or 1/2" nominal copper sweat connections
- Comes in pairs – One hot & one cold
- Threaded escutcheons



Part #	Mfg #	Description	Handle(s)	Finish	Price
004712	47-150	Chrome			

\*Physical Vapor Deposition (PVD) Limited Lifetime Finish

[www.waterconcepts.net](http://www.waterconcepts.net) • Serving our Customers Since 1946 • [www.plumbsupply.com](http://www.plumbsupply.com)

## Shower Faucets

### Single-Handle Shower Trim

#### P4B Builders Series 1-Hdl Shower Trim

- Washerless pressure balance valve
- CC and IP
- Less stops
- Maximum flow rate: 2.5 gpm @ 80 psi



-D Models

-D models have decorative showerhead

Part #	Mfg #	Description	Handle(s)	Finish	Price
141379	P4B-720C	Shower Trim w/ Pressure Balance Valve	ADA Lever	Chrome	
142986	P4B-720BN	Shower Trim w/ Pressure Balance Valve	ADA Lever	Brushed Nickel	
141382	P4B-720ORB	Shower Trim w/ Pressure Balance Valve	ADA Lever	Oil Rubbed Bronze	
153958	P4B-700C	Valve Trim Only w/ Pressure Balance Valve	ADA Lever	Chrome	

#### Job Pack Models

**Less Valve - Must order pressure balancing valve separate**

Part #	Mfg #	Description	Handle(s)	Finish	Price
155192	P4B-720CJP	Shower Trim Only, Less Valve	ADA Lever	Chrome	
235537	P4B-720CDJP	Shower Trim Only w/Decortive Showerhead, Less Valve	ADA Lever	Chrome	
235534	P4B-720BNDJP	Shower Trim Only w/Decortive Showerhead, Less Valve	ADA Lever	Brushed Nickel	

### P4C Classic Series 1-Hdl Shower Trim

- Washerless pressure balance valve
- CC and IP
- Less stops
- Max flow rate: 2.5 gpm @ 80 psi



Part #	Mfg #	Description	Handle(s)	Finish	Price
141395	P4C-720C	Shower Trim Only	ADA Lever	Chrome	



## Shower Faucets

### Two-Handle Shower Trim

#### P4V Value Series 2-Hdl Shower Trim

- *Non-pressure balance*
- *Washerless cartridges*
- *Acrylic round handles*
- *Max flow rate: 2.0 gpm @ 80 psi*



Part #	Mfg #	Description	Handle(s)	Finish	Price
153267	P4V-822C	Shower Trim Only	Acrylic Round	Chrome	

### Handshower Sets

#### P4HS 3-Setting Handshower

- *24" Metal slide bar*
- *Non-positive shutoff*
- *72" Flexible stainless steel hose*
- *Includes solid brass wall mount drop elbow*
- *Wall-mount hose connector with check valve*
- *WaterSense® certified: 2.0 gpm @ 80 psi*



Part #	Mfg #	Description	Price
242775	P4HS-600C	Chrome	



## Shower Faucets

### Posi-Temp Shower Trim

#### 90° Posi-Temp® 1-Hdl Shower Trim

- Fits M•PACT® system
- 6" Diameter spray head (-NH) Less showerhead
- Full spray



Requires Valve: 2520

Part #	Mfg #	Description	Handle(s)	Finish	Price
157732	TS2712EP	Shower Trim Only, 1.75 gpm	ADA Lever	Chrome	
130739	TS2712	Shower Trim Only, 2.5 gpm	ADA Lever	Chrome	
249572	TS2712NHBN	Shower Trim Only, 2.5 gpm, Less Head	ADA Lever	Brushed Nickel	
143954	TS2712BN	Shower Trim Only, 2.5 gpm	ADA Lever	Brushed Nickel	

#### 90° Posi-Temp® 1-Hdl Valve Trim

- Fits M•PACT® system



Requires Valve: 2520

Part #	Mfg #	Description	Handle(s)	Finish	Price
143558	TS2711	Valve Trim Only, 2.5 gpm	ADA Lever	Chrome	
147964	TS2711BN	Valve Trim Only, 2.5 gpm	ADA Lever	Brushed Nickel	

### Align™ Posi-Temp® 1-Hdl Shower Trim

- Fits M•PACT® system
- 3-5/8" Diameter spray head (-NH) Less showerhead
- Full spray



Requires Valve: 2520

Part #	Mfg #	Description	Handle(s)	Finish	Price
186493	T2192	Shower Trim Only, 2.5 gpm	ADA Lever	Chrome	
178158	T2192BN	Shower Trim Only, 2.5 gpm	ADA Lever	Brushed Nickel	
170260	T2192EP	Shower Trim Only, 1.75 gpm	ADA Lever	Chrome	
171857	T2192EPBN	Shower Trim Only, 1.75 gpm	ADA Lever	Brushed Nickel	
226105	T2192NHBN	Shower Trim Only, Less Showerhead	ADA Lever	Brushed Nickel	

\*Lifeshine® Anti-Tarnish Lifetime Finish

[www.plumbsupply.com](http://www.plumbsupply.com) • Serving our Customers Since 1946 • [www.waterconcepts.net](http://www.waterconcepts.net)

## Shower Faucets

### Align™ Posi-Temp® 1-Hdl Valve Trim

- Fits M•PACT® system



Requires Valve: 2520

Part #	Mfg #	Description	Handle(s)	Finish	Price
179861	T2191	Valve Trim Only	ADA Lever	Chrome	
178093	T2191BN	Valve Trim Only	ADA Lever	Brushed Nickel	

### Arris® Posi-Temp® 1-Hdl Shower Trim

- Fits M•PACT® system
- 10" Diameter spray head (-NH) Less showerhead
- Full spray



Requires Valve: 2520

Part #	Mfg #	Description	Handle(s)	Finish	Price
228103	TS22002EP	Shower Trim Only, 2.0 gpm	ADA Lever	Chrome	

### Boardwalk® Posi-Temp® 1-Hdl Shower Trim

- Fits M•PACT® system
- 6" Diameter single function showerhead (-NH) Less showerhead



Requires Valve: 2520

Part #	Mfg #	Description	Handle(s)	Finish	Price
237057	T2162EPSRN	Shower Trim Only, 1.75 gpm	ADA Lever	SpotResist Brushed Nickel	

### Belfield™ Posi-Temp® 1-Hdl Shower Trim

- Fits M•PACT® system
- 7" Diameter single function showerhead
- (-NH) Less showerhead



Part #	Mfg #	Description	Handle(s)	Finish	Price
251959	T2312BN	Shower Trim Only, 2.5 gpm	ADA Lever	Brushed Nickel	
239253	T2312ORB	Shower Trim Only, 2.5 gpm	ADA Lever	Oil Rubbed Bronze	
247110	T2312NHBN	Shower Trim Only, Less Head	ADA Lever	Brushed Nickel	

\*Lifeshine® Anti-Tarnish Lifetime Finish

[www.waterconcepts.net](http://www.waterconcepts.net) • Serving our Customers Since 1946 • [www.plumbsupply.com](http://www.plumbsupply.com)

## Shower Faucets

### Belfield™ Posi-Temp® 1-Hdl Valve Trim

- Fits M•PACT® system



Requires Valve: 2520

Part #	Mfg #	Description	Handle(s)	Finish	Price
251492	T2311	Valve Trim Only	ADA Lever	Chrome	
248255	T2311ORB	Valve Trim Only	ADA Lever	Oil Rubbed Bronze	

### Brantford™ Posi-Temp® 1-Hdl Shower Trim

- Fits M•PACT® system
- Easy Clean® XLT single-function showerhead, arm and flange (-NH) Less showerhead
- EP Suffix - indicates eco-performance



Requires Valve: 2520

Part #	Mfg #	Description	Handle(s)	Finish	Price
106867	T2152	Shower Trim Only, 2.5 gpm	ADA Lever	Chrome	
102297	T2152BN	Shower Trim Only, 2.5 gpm	ADA Lever	Brushed Nickel	
102292	T2152ORB	Shower Trim Only, 2.5 gpm	ADA Lever	Oil Rubbed Bronze	
183267	T2152EPORB	Shower Trim Only, 1.75 gpm	ADA Lever	Oil Rubbed Bronze	
225048	T2252EP	Shower Trim Only, 8" 1.75 gpm Showerhead	ADA Lever	Chrome	
225364	T2252EPBN	Shower Trim Only, 8" 1.75 gpm Showerhead	ADA Lever	Brushed Nickel	
134885	T2152NHBN	Shower Trim Only, Less Showerhead	ADA Lever	Brushed Nickel	
141584	T2152NHORB	Shower Trim Only, Less Showerhead	ADA Lever	Oil Rubbed Bronze	

### Brantford™ Posi-Temp® 1-Hdl Valve Trim

- Fits M•PACT® system



Requires Valve: 2520

Part #	Mfg #	Description	Handle(s)	Finish	Price
148208	T2151	Valve Trim Only	ADA Lever	Chrome	
111024	T2151BN	Valve Trim Only	ADA Lever	Brushed Nickel	
102291	T2151ORB	Valve Trim Only	ADA Lever	Oil Rubbed Bronze	

\*Lifeshine® Anti-Tarnish Lifetime Finish

[www.plumbsupply.com](http://www.plumbsupply.com) • Serving our Customers Since 1946 • [www.waterconcepts.net](http://www.waterconcepts.net)

## Shower Faucets

### Caldwell Posi-Temp® 1-Hdl Shower Trim

- Fits M•PACT® system
- 4" Diameter spray head, full spray
- 1/2" IPS connections
- 1222 Cartridge
- WaterSense® Certified: 2.0 gpm



Part #	Mfg #	Description	Handle(s)	Finish	Price
229158	82495C	Shower Trim Only, 2.0 gpm	ADA Lever	Chrome	

### Chateau® Posi-Temp® 1-Hdl Shower Trim

- Fits M•PACT® system
- Adjustable temperature limit stop
- Easy-Clean® XL single-function showerhead, arm and flange



Requires Valve: 2520

Part #	Mfg #	Description	Handle(s)	Finish	Price
191628	T182	Shower Trim Only (Bulk 12/Pk)	Acrylic Knob	Chrome	
037060	TL182	Shower Trim Only (Bulk 12/Pk)	ADA Lever	Chrome	
152042	TL182EP	Shower Trim Only, 1.75 gpm	ADA Lever	Chrome	
019892	L2352	Shower Trim Only	ADA Lever	Chrome	

### Chateau® Posi-Temp® 1-Hdl Valve Trim

- Fits M•PACT® system
- Adjustable temperature limit stop



Requires Valve: 2520

Part #	Mfg #	Description	Handle(s)	Finish	Price
157585	TL181	Valve Trim Only	ADA Lever	Chrome	

### Chateau® Standard 1-Hdl Shower Trim

- Metal construction
- Built on M-PACT common valve system
- Adjustable temperature limit stop
- Easy Clean® XL single-function showerhead, arm and flange
- Valve sold separately



Part #	Mfg #	Description	Handle(s)	Finish	Price
193158	TL473	Shower Trim Only (Bulk 12/Pk) 2.5 gpm	ADA Lever	Chrome	
191630	T473	Shower Trim Only, 2.5 gpm	Acrylic Knob	Chrome	

\*Lifeshine® Anti-Tarnish Lifetime Finish

## Shower Faucets

### Dartmoor™ Posi-Temp® 1-Hdl Shower Trim

- Fits M•PACT® system
- 4" Diameter showerhead (T2182)
- 8" Diameter rainhead (T2282)  
(-NH) Less showerhead
- Full spray



Requires Valve: 2520

Part #	Mfg #	Description	Handle(s)	Finish	Price
189424	T2182	Shower Trim Only, 2.5 gpm	ADA Lever	Chrome	
227432	T2182BN	Shower Trim Only, 2.5 gpm	ADA Lever	Brushed Nickel	
222889	T2182ORB	Shower Trim Only, 2.5 gpm	ADA Lever	Oil Rubbed Bronze	
236997	T2282EP	Shower Trim Only, 2.0 gpm w/ 8" Rainhead	ADA Lever	Chrome	

### Dartmoor™ Posi-Temp® 1-Hdl Valve Trim

- Fits M•PACT® system



Requires Valve: 2520

Part #	Mfg #	Description	Handle(s)	Finish	Price
224239	T2181	Valve Trim Only	ADA Lever	Chrome	
225166	T2181BN	Valve Trim Only	ADA Lever	Brushed Nickel	
240953	T2181ORB	Valve Trim Only	ADA Lever	Oil Rubbed Bronze	

### Eva™ Posi-Temp® 1-Hdl Shower Trim

- Fits M•PACT® system
- Easy Clean® XLT single-function showerhead, arm and flange  
(-NH) Less showerhead



Requires Valve: 2520

Part #	Mfg #	Description	Handle(s)	Finish	Price
094490	T2132	Shower Trim Only, 2.5 gpm	ADA Lever	Chrome	
095676	T2132BN	Shower Trim Only, 2.5 gpm	ADA Lever	Brushed Nickel	
096054	T2132ORB	Shower Trim Only, 2.5 gpm	ADA Lever	Oil Rubbed Bronze	
226512	T2232EP	Shower Trim Only, 8" 1.75gpm Showerhead	ADA Lever	Chrome	
224746	T2232EPBN	Shower Trim Only, 8" 1.75gpm Showerhead	ADA Lever	Brushed Nickel	
137062	T2132NHBN	Shower Trim Only, Less Showerhead	ADA Lever	Brushed Nickel	
132963	T2132NHORB	Shower Trim Only, Less Showerhead	ADA Lever	Oil Rubbed Bronze	
214368	T62132NH	Shower Trim Only, Less Showerhead	ADA Lever	Chrome	

\*Lifeshine® Anti-Tarnish Lifetime Finish

[www.plumbsupply.com](http://www.plumbsupply.com) • Serving our Customers Since 1946 • [www.waterconcepts.net](http://www.waterconcepts.net)

## Shower Faucets

### Eva™ Posi-Temp® 1-Hdl Valve Trim

- Fits M•PACT® system



Requires Valve: 2520

Part #	Mfg #	Description	Handle(s)	Finish	Price
103009	T2131	Valve Trim Only	ADA Lever	Chrome	
104567	T2131BN	Valve Trim Only	ADA Lever	Brushed Nickel	
099683	T2131ORB	Valve Trim Only	ADA Lever	Oil Rubbed Bronze	

### Genta™ Posi-Temp® 1-Hdl Shower Trim

- Fits M•PACT system
- 3-3/4" Diameter spray head
- 3-Setting showerhead: full, wide, & massage
- (-EP) Eco-performance showerhead



Part #	Mfg #	Description	Handle(s)	Finish	Price
243605	T2472EP	Shower Trim Only, 2.0 gpm	ADA Lever	Chrome	

### Gibson™ Posi-Temp® 1-Hdl Shower Trim

- Fits M•PACT system
- 8" Diameter spray head
- Single function showerhead
- Red/blue markings
- (-EP) Eco-performance showerhead



Part #	Mfg #	Description	Handle(s)	Finish	Price
247439	T3002EP	Shower Trim Only, 1.75 gpm	ADA Lever	Chrome	

\*Lifeshine® Anti-Tarnish Lifetime Finish



## Shower Faucets

### Gibson™ Chrome Posi-Temp® Shower Trim

- Fits M•PACT system
- 3.6" diameter spray head
- Single function showerhead
- Red/blue markings
- (-EP) Eco-performance showerhead



Part #	Mfg #	Description	Handle(s)	Finish	Price
250306	T2902EP	Shower Trim Only, 1.75 gpm	ADA Lever	Chrome	

### Glyde™ Posi-Temp® 1-Hdl Shower Trim

- 8" Diameter spray head
- Single function showerhead
- Adjustable temperature limit stop
- 1222 Cartridge design
- (-EP) Eco-performance showerhead



Part #	Mfg #	Description	Handle(s)	Finish	Price
249772	T2842EPBN	Shower Trim Only, 2.0 gpm	ADA Lever	Brushed Nickel	

### Icon™ Posi-Temp® 1-Hdl Shower Trim

- Fits M•PACT® system
- 5-7/8" Diameter showerhead
- Full spray



Requires Valve: 2520

Part #	Mfg #	Description	Handle(s)	Finish	Price
096176	TS2142BN	Shower Trim Only, 2.5 gpm	ADA Lever	Brushed Nickel	

### Kingsley™ Posi-Temp® 1-Hdl Shower Trim

- Fits M•PACT® system
- Moenflo® XL single-function showerhead, arm and flange (-NH) Less showerhead



Requires Valve: 2520

Part #	Mfg #	Description	Handle(s)	Finish	Price
070914	T2112	Shower Trim Only, 2.5 gpm	ADA Lever	Chrome	

\*Lifeshine® Anti-Tarnish Lifetime Finish

[www.plumbsupply.com](http://www.plumbsupply.com) • Serving our Customers Since 1946 • [www.waterconcepts.net](http://www.waterconcepts.net)

## Shower Faucets

### Posi-Temp Shower Trim (Continued)

#### Kingsley™ Posi-Temp® 1-Hdl Shower Trim

Part #	Mfg #	Description	Handle(s)	Finish	Price
083601	T2112BN	Shower Trim Only, 2.5 gpm	ADA Lever	Brushed Nickel	
077215	T2112ORB	Shower Trim Only, 2.5 gpm	ADA Lever	Oil Rubbed Bronze	
161362	T2112P	Shower Trim Only, 2.5 gpm	ADA Lever	Polished Brass	
073944	T2112WR	Shower Trim Only	ADA Lever	Wrought Iron	
239533	T2112NH	Shower Trim Only, Less Showerhead	ADA Lever	Chrome	
180569	T2112NHBN	Shower Trim Only, Less Showerhead	ADA Lever	Brushed Nickel	

#### Kingsley™ Posi-Temp® 1-Hdl Valve Trim

- Fits M•PACT® system



Requires Valve: 2520

Part #	Mfg #	Description	Handle(s)	Finish	Price
077652	T2111	Valve Trim Only	ADA Lever	Chrome	
088715	T2111BN	Valve Trim Only	ADA Lever	Brushed Nickel	
083243	T2111ORB	Valve Trim Only	ADA Lever	Oil Rubbed Bronze	
161364	T2111P	Valve Trim Only	ADA Lever	Polished Brass	
235661	T2111WR	Valve Trim Only	ADA Lever	Wrought Iron	

#### Rizon™ Posi-Temp® 1-Hdl Shower Trim

- Fits M•PACT® system
- 3-3/4" Diameter spray head
- Single function, full spray (-NH) Less showerhead
- 1/2" CC connections



Requires Valve: 2520

Part #	Mfg #	Description	Handle(s)	Finish	Price
236530	T2812NH	Shower Trim Only, Less Showerhead	ADA Lever	Chrome	

#### Rizon™ Posi-Temp® 1-Hdl Valve Trim

- Fits M•PACT® system
- 1/2" CC connections



Requires Valve: 2520

Part #	Mfg #	Description	Handle(s)	Finish	Price
248231	T2811BN	Valve Trim Only	ADA Lever	Brushed Nickel	

\*Lifeshine® Anti-Tarnish Lifetime Finish

[www.waterconcepts.net](http://www.waterconcepts.net) • Serving our Customers Since 1946 • [www.plumbsupply.com](http://www.plumbsupply.com)

## Shower Faucets

### Rothbury™ Posi-Temp® 1-Hdl Shower Trim

- Fits M•PACT® system
- 6-1/2" Diameter spray head (-NH) Less showerhead
- Single function, full spray
- 1/2" CC connections



Requires Valve: 2520

Part #	Mfg #	Description	Handle(s)	Finish	Price
122028	TS2212	Shower Trim Only, 2.5 gpm	ADA Lever	Chrome	
198370	TS2212BN	Shower Trim Only, 2.5 gpm	ADA Lever	Brushed Nickel	
112108	TS2212ORB	Shower Trim Only, 2.5 gpm	ADA Lever	Oil Rubbed Bronze	

### Rothbury™ Posi-Temp® 1-Hdl Valve Trim

- Fits M•PACT® system
- 1/2" CC connections



Requires Valve: 2520

Part #	Mfg #	Description	Handle(s)	Finish	Price
203410	TS2211	Valve Trim Only	ADA Lever	Chrome	
147537	TS2211BN	Valve Trim Only	ADA Lever	Brushed Nickel	
122078	TS2211ORB	Valve Trim Only	ADA Lever	Oil Rubbed Bronze	

### Via™ Posi-Temp® 1-Hdl Shower Trim

- Fits M•PACT® system
- 6" Diameter spray head
- Single function, full spray
- Red/blue markings
- Immersion™ rainshower technology



Requires Valve: 62300, 2500 Series

Part #	Mfg #	Description	Handle(s)	Finish	Price
247540	TS8712	Shower Trim Only, 2.5 gpm	ADA Lever	Chrome	

\*Lifeshine® Anti-Tarnish Lifetime Finish

[www.plumbsupply.com](http://www.plumbsupply.com) • Serving our Customers Since 1946 • [www.waterconcepts.net](http://www.waterconcepts.net)

## Shower Faucets

### Voss™ Posi-Temp® 1-Hdl Shower Trim

- Fits M•PACT® system
- 4-1/16" Diameter spray head (-NH) Less showerhead
- Single function, full spray



Requires Valve: 2520

Part #	Mfg #	Description	Handle(s)	Finish	Price
150273	T2692	Shower Trim Only, 2.5 gpm	ADA Lever	Chrome	
253342	T2692BG	Shower Trim Only, 2.5 gpm	ADA Lever	Brushed Gold	
150369	T2692BN	Shower Trim Only, 2.5 gpm	ADA Lever	Brushed Nickel	
239248	T2692EP	Shower Trim Only, 1.75 gpm	ADA Lever	Chrome	
160098	T2692ORB	Shower Trim Only, 2.5 gpm	ADA Lever	Oil Rubbed Bronze	
212882	T2692NH	Shower Trim Only, Less Showerhead	ADA Lever	Chrome	
176963	T2692NHBN	Shower Trim Only, Less Showerhead	ADA Lever	Brushed Nickel	
212482	T2692NHORB	Shower Trim Only, Less Showerhead	ADA Lever	Oil Rubbed Bronze	

### Voss™ Posi-Temp® 1-Hdl Valve Trim

- Fits M•PACT® system



Requires Valve: 2520

Part #	Mfg #	Description	Handle(s)	Finish	Price
150543	T2691	Valve Trim Only	ADA Lever	Chrome	
160292	T2691BN	Valve Trim Only	ADA Lever	Brushed Nickel	
152281	T2691ORB	Valve Trim Only	ADA Lever	Oil Rubbed Bronze	

### Waterhill™ Posi-Temp® 1-Hdl Shower Trim

- Fits M•PACT® system
- 10" Diameter spray head
- Single-function, full spray
- Flow rate: 2.5 gpm



Requires Valve: 2520

Part #	Mfg #	Description	Handle(s)	Finish	Price
154266	TS312	Shower Trim Only	ADA Lever	Chrome	
112232	TS312ORB	Shower Trim Only	ADA Lever	Oil Rubbed Bronze	

\*Lifeshine® Anti-Tarnish Lifetime Finish

[www.waterconcepts.net](http://www.waterconcepts.net) • Serving our Customers Since 1946 • [www.plumbsupply.com](http://www.plumbsupply.com)

## Shower Faucets

### Weymouth™ Posi-Temp® 1-Hdl Shower Trim

- Fits M•PACT® system
- 9" Diameter Immersion™ rain shower head (-NH) Less showerhead



Requires Valve: 2520

Part #	Mfg #	Description	Handle(s)	Finish	Price
181597	TS32102NL	Shower Trim Only, 2.5 gpm	ADA Lever	Polished Nickel	
159815	TS32102EP	Shower Trim Only, 2.0 gpm	ADA Lever	Chrome	
250940	TS33102NHNL	Shower Trim Only, Less Head	ADA Lever	Polished Nickel	

### Weymouth™ Posi-Temp® 1-Hdl Valve Trim

- Fits M•PACT® system



Requires Valve: 2520

Part #	Mfg #	Description	Handle(s)	Finish	Price
156109	TS3210	Valve Trim Only	ADA Lever	Chrome	
183892	TS3210NL	Valve Trim Only	ADA Lever	Polished Nickel	

### Wynford™ Posi-Temp® 1-Hdl Shower Trim

- Fits M•PACT® system
- 5-7/8" Diameter spray head (-NH) Less showerhead
- Single function, full spray



Requires Valve: 2520

Part #	Mfg #	Description	Handle(s)	Finish	Price
188034	T4502	Shower Trim Only, 1.75 gpm	ADA Lever	Chrome	
178607	T4502BN	Shower Trim Only, 1.75 gpm	ADA Lever	Brushed Nickel	
181590	T4502ORB	Shower Trim Only, 1.75 gpm	ADA Lever	Oil Rubbed Bronze	
235115	T4502NH	Shower Trim Only, Less Head	ADA Lever	Chrome	

### Wynford™ Posi-Temp® 1-Hdl Valve Trim

- Fits M•PACT® system



Requires Valve: 2520

Part #	Mfg #	Description	Handle(s)	Finish	Price
218916	T4501	Valve Trim Only	ADA Lever	Chrome	

\*Lifeshine® Anti-Tarnish Lifetime Finish

[www.plumbsupply.com](http://www.plumbsupply.com) • Serving our Customers Since 1946 • [www.waterconcepts.net](http://www.waterconcepts.net)

## Shower Faucets

### Posi-Temp Shower Trim (Continued)

#### Wynford™ Posi-Temp® 1-Hdl Valve Trim

Part #	Mfg #	Description	Handle(s)	Finish	Price
216437	T4501BN	Valve Trim Only	ADA Lever	Brushed Nickel	
228306	T4501ORB	Valve Trim Only	ADA Lever	Oil Rubbed Bronze	

### Moentrol® Shower Trim

#### 90° Moentrol® 1-Hdl Shower Trim

- Fits M•PACT® system
- 6" Diameter spray head (-NH) Less showerhead
- Single function, full spray



Requires Valve: 3510

Part #	Mfg #	Description	Handle(s)	Finish	Price
139926	TS3715	Shower Trim Only, 2.5 gpm	ADA Lever	Chrome	
151185	TS3715BN	Shower Trim Only, 2.5 gpm	ADA Lever	Brushed Nickel	

#### 90° Moentrol® 1-Hdl Valve Trim

- Fits M•PACT® system



Requires Valve: 3510

Part #	Mfg #	Description	Handle(s)	Finish	Price
139135	TS3711	Valve Trim Only	ADA Lever	Chrome	

### Align® Moentrol® 1-Hdl Shower Trim

- Fits M•PACT® system
- 6" Diameter spray head (-NH) Less showerhead
- Single function, full spray



Requires Valve: 3510

Part #	Mfg #	Description	Handle(s)	Finish	Price
177550	T3292	Shower Trim Only, 2.5 gpm	ADA Lever	Chrome	
176385	T3292BN	Shower Trim Only, 2.5 gpm	ADA Lever	Brushed Nickel	
247429	T3292NHBN	Shower Trim Only, Less Head	ADA Lever	Brushed Nickel	

\*Lifeshine® Anti-Tarnish Lifetime Finish

[www.waterconcepts.net](http://www.waterconcepts.net) • Serving our Customers Since 1946 • [www.plumbsupply.com](http://www.plumbsupply.com)



## Shower Faucets

### Align® Moentrol® 1-Hdl Valve Trim

- Fits M•PACT® system



Requires Valve: 3510

Part #	Mfg #	Description	Handle(s)	Finish	Price
177265	T3291	Valve Trim Only	ADA Lever	Chrome	

### Belfield® Moentrol® 1-Hdl Shower Trim Only — Less Showerhead

- Fits M•PACT® system
- (-NH) Less head



Requires Valve: 3510



Part #	Mfg #	Description	Handle(s)	Finish	Price
250045	T3312NH	Shower Trim Only, Less Head	ADA Lever	Chrome	

### Icon™ Moentrol® 1-Hdl Shower Trim

- Fits M•PACT® system
- 5-7/8" Diameter spray head (-NH) Less showerhead
- Single function, full spray
- 1225 Cartridge design



Requires Valve: 3510

Part #	Mfg #	Description	Handle(s)	Finish	Price
197620	TS2155	Shower Trim Only, 2.5 gpm	ADA Lever	Chrome	
150164	TS2155BN	Shower Trim Only, 2.5 gpm	ADA Lever	Brushed Nickel	

### Icon™ Moentrol® 1-Hdl Valve Trim

- Fits M•PACT® system
- 1225 Cartridge design



Requires Valve: 3510

Part #	Mfg #	Description	Handle(s)	Finish	Price
127095	TS2154	Valve Trim Only	ADA Lever	Chrome	
150866	TS2154BN	Valve Trim Only	ADA Lever	Brushed Nickel	

\*Lifeshine® Anti-Tarnish Lifetime Finish

[www.plumbsupply.com](http://www.plumbsupply.com) • Serving our Customers Since 1946 • [www.waterconcepts.net](http://www.waterconcepts.net)

## Shower Faucets

### Kingsley® Moentrol® 1-Hdl Shower Trim

- Fits M•PACT® system
- 4-3/8" Diameter spray head (-NH) Less showerhead
- Single function, full spray



Requires Valve: 3510

Part #	Mfg #	Description	Handle(s)	Finish	Price
070932	T3112	Shower Trim Only, 2.5 gpm	ADA Lever	Chrome	
095635	T3112BN	Shower Trim Only, 2.5 gpm	ADA Lever	Brushed Nickel	
094822	T3112ORB	Shower Trim Only, 2.5 gpm	ADA Lever	Oil Rubbed Bronze	
214713	T3112P	Shower Trim Only, 2.5 gpm	ADA Lever	Polished Brass	
248382	T3112NH	Shower Trim Only, Less Showerhead	ADA Lever	Chrome	

### Kingsley® Moentrol® 1-Hdl Valve Trim

- Fits M•PACT® system



Requires Valve: 3510

Part #	Mfg #	Description	Handle(s)	Finish	Price
136827	T3111	Valve Trim Only	ADA Lever	Chrome	
074528	T3111BN	Valve Trim Only	ADA Lever	Brushed Nickel	
169364	T3111P	Valve Trim Only	ADA Lever	Polished Brass	

### Legend® Moentrol® 1-Hdl Shower Trim

- Fits M•PACT® system
- Single function showerhead



Requires Valve: 3510

Part #	Mfg #	Description	Handle(s)	Finish	Price
193104	TL171	Shower Trim Only, 2.5 gpm	ADA Lever	Chrome	

\*Lifeshine® Anti-Tarnish Lifetime Finish

[www.waterconcepts.net](http://www.waterconcepts.net) • Serving our Customers Since 1946 • [www.plumbsupply.com](http://www.plumbsupply.com)

## Shower Faucets

### Voss™ Moentrol® 1-Hdl Shower Trim

- Fits M•PACT® system
- 6" Diameter spray head (-NH) Less showerhead
- Single function, full spray



Requires Valve: 3510

Part #	Mfg #	Description	Handle(s)	Finish	Price
153510	T3692	Shower Trim Only, 2.5 gpm	ADA Lever	Chrome	
155031	T3692BN	Shower Trim Only, 2.5 gpm	ADA Lever	Brushed Nickel	
152810	T3692ORB	Shower Trim Only, 2.5 gpm	ADA Lever	Oil Rubbed Bronze	
244308	T3692NH	Shower Trim Only, Less Head	ADA Lever	Chrome	
246123	T3692NHBN	Shower Trim Only, Less Head	ADA Lever	Brushed Nickel	

### Voss™ Moentrol® 1-Hdl Valve Trim

- Fits M•PACT® system



Requires Valve: 3510

Part #	Mfg #	Description	Handle(s)	Finish	Price
207703	T3691	Valve Trim Only	ADA Lever	Chrome	
188937	T3691BN	Valve Trim Only	ADA Lever	Brushed Nickel	
175496	T3691ORB	Valve Trim Only	ADA Lever	Oil Rubbed Bronze	

### Wynford™ Moentrol® 1-Hdl Shower Trim

- Fits M•PACT® system
- 7" Diameter spray head (-NH) Less showerhead
- Single function, full spray



Requires Valve: 3510

Part #	Mfg #	Description	Handle(s)	Finish	Price
187258	T5502	Shower Trim Only, 2.5 gpm	ADA Lever	Chrome	
189836	T5502BN	Shower Trim Only, 2.5 gpm	ADA Lever	Brushed Nickel	
187015	T5502NL	Shower Trim Only, 2.5 gpm	ADA Lever	Polished Nickel	
181283	T5502ORB	Shower Trim Only, 2.5 gpm	ADA Lever	Oil Rubbed Bronze	
244526	T5502NH	Shower Trim Only, Less Head	ADA Lever	Chrome	

\*Lifeshine® Anti-Tarnish Lifetime Finish

[www.plumbsupply.com](http://www.plumbsupply.com) • Serving our Customers Since 1946 • [www.waterconcepts.net](http://www.waterconcepts.net)

## Shower Faucets

### Wynford™ Moentrol® 1-Hdl Valve Trim

- Fits M•PACT® system



Requires Valve: 3510

Part #	Mfg #	Description	Handle(s)	Finish	Price
218841	T5501	Valve Trim Only	ADA Lever	Chrome	
185270	T5501BN	Valve Trim Only	ADA Lever	Brushed Nickel	

### Icon™ Moentrol® with Transfer Valve

- Fits M•PACT® system
- Two independent, one shared position
- 1/2" cc connection
- Not recommended for tub spout application
- Showerhead sold separately



Requires Valve: 3330

Part #	Mfg #	Description	Handle(s)	Finish	Price
197521	TS4112	Valve Trim Only, Moentrol w/ Transfer	ADA Lever	Chrome	
197242	TS4112BN	Valve Trim Only, Moentrol w/ Transfer	ADA Lever	Brushed Nickel	

### Kingsley® Moentrol® with Transfer Valve

- Fits M•PACT® system
- Two independent, one shared position
- 1/2" cc connection
- Not recommended for tub spout application
- Showerhead sold separately



Requires Valve: 3330

Part #	Mfg #	Description	Handle(s)	Finish	Price
176135	T4111	Valve Trim Only, Moentrol w/ Transfer	ADA Lever	Chrome	
146510	T4111BN	Valve Trim Only, Moentrol w/ Transfer	ADA Lever	Brushed Nickel	
083244	T4111ORB	Valve Trim Only, Moentrol w/ Transfer	ADA Lever	Oil Rubbed Bronze	
216047	T4111P	Valve Trim Only, Moentrol w/ Transfer	ADA Lever	Polished Brass	

\*Lifeshine® Anti-Tarnish Lifetime Finish

## Shower Faucets

### Rothbury™ Moentrol® with Transfer

- Fits M•PACT® system
- Two independent, one shared position
- 1/2" cc connection
- Not recommended for tub spout application
- Showerhead sold separately



Requires Valve: 3330

Part #	Mfg #	Description	Handle(s)	Finish	Price
198497	TS4211	Valve Trim Only, Moentrol w/ Transfer	ADA Lever	Chrome	
167438	TS4211BN	Valve Trim Only, Moentrol w/ Transfer	ADA Lever	Brushed Nickel	
119070	TS4211ORB	Valve Trim Only, Moentrol w/ Transfer	ADA Lever	Oil Rubbed Bronze	

### ExactTemp Shower Trim

#### Moen ExactTemp® Thermostatic Shower Trim

- Fits M•PACT® system
- Allows you to dial in and maintain your idea temperature for more precise temperature control; 3/4" volume control valve allows optimum water flow in homes with 1/2" or 3/4" plumbing
- 7" Immersion™ spray head with full spray



For use with S3371, 3/4" Thermostatic Valve and S3600, Volume Control Valve

Part #	Mfg #	Description	Handle(s)	Finish	Price
157840	TS3400	Shower Trim Only, Thermostatic, 2.5 gpm	ADA Lever	Chrome	
095816	TS3400BN	Shower Trim Only, Thermostatic, 2.5 gpm	ADA Lever	Brushed Nickel	
103407	TS3400ORB	Shower Trim Only, Thermostatic, 2.5 gpm	ADA Lever	Oil Rubbed Bronze	
144398	TS3411BN	Valve Trim Only, Thermostatic	ADA Lever	Brushed Nickel	
108132	TS3411ORB	Valve Trim Only, Thermostatic	ADA Lever	Oil Rubbed Bronze	

### Weymouth® ExactTemp® Thermostatic Valve Trim

- Fits M•PACT® system
- Showerhead sold separately
- Separate volume control valve required



Requires Valve: S 3371, 3/4" Thermostatic Valve

Part #	Mfg #	Description	Handle(s)	Finish	Price
225628	TS32110BN	Valve Trim Only, Thermostatic	ADA Lever	Brushed Nickel	

\*Lifeshine® Anti-Tarnish Lifetime Finish

[www.plumbsupply.com](http://www.plumbsupply.com) • Serving our Customers Since 1946 • [www.waterconcepts.net](http://www.waterconcepts.net)

## Shower Faucets

### Volume Control Trim

#### 90° Volume Control Trim

- Single function



**Requires Thermostatic Valve: S3371**  
**Volume Control Valve: S3600**

Part #	Mfg #	Description	Handle(s)	Finish	Price
190026	TS300	Volume Control Trim Only	ADA Lever	Chrome	
141008	TS3300BN	Volume Control Trim Only	ADA Lever	Brushed Nickel	

### Arris™ Volume Control Trim

- Single function



**Requires Thermostatic Valve: S3371**  
**Volume Control Valve: S3600**

Part #	Mfg #	Description	Handle(s)	Finish	Price
175133	TS33003	Volume Control Trim Only	ADA Lever	Chrome	
169031	TS33003BN	Volume Control Trim Only	ADA Lever	Brushed Nickel	

### Icon™ Volume Control Trim

- Single function



**Requires Thermostatic Valve: S3371**  
**Volume Control Valve: S3600**

Part #	Mfg #	Description	Handle(s)	Finish	Price
209763	TS3200	Volume Control Trim Only	ADA Lever	Chrome	
156157	TS3200BN	Volume Control Trim Only	ADA Lever	Brushed Nickel	

### Moen Volume Control Trim

- Single function



**Requires Thermostatic Valve: S3371**  
**Volume Control Valve: S3600**

Part #	Mfg #	Description	Handle(s)	Finish	Price
110475	TS3600	Volume Control Trim Only	ADA Lever	Chrome	
095820	TS3600BN	Volume Control Trim Only	ADA Lever	Brushed Nickel	
096199	TS3600ORB	Volume Control Trim Only	ADA Lever	Oil Rubbed Bronze	

\*Lifeshine® Anti-Tarnish Lifetime Finish



## Shower Faucets

### Rothbury™ Volume Control Trim

- *Single function*



Requires Thermostatic Valve: S3371  
Volume Control Valve: S3600

Part #	Mfg #	Description	Handle(s)	Finish	Price
180826	TS3820	Volume Control Trim Only	ADA Lever	Chrome	
207945	TS820BN	Volume Control Trim Only	ADA Lever	Brushed Nickel	
182222	TS3820ORB	Volume Control Trim Only	ADA Lever	Oil Rubbed Bronze	

### Waterhill™ Volume Control Trim

- *Single function*



Requires Thermostatic Valve: S3371  
Volume Control Valve: S3600

Part #	Mfg #	Description	Handle(s)	Finish	Price
196957	TS514BN	Volume Control Trim Only	ADA Lever	Brushed Nickel	

### Weymouth™ Volume Control Trim

- *Single function*
- *3/4" IPS connections*



Requires Thermostatic Valve: S3371  
Volume Control Valve: S3600

Part #	Mfg #	Description	Handle(s)	Finish	Price
205897	TS52104	Volume Control Trim Only	ADA Lever	Chrome	
216685	TS52104BN	Volume Control Trim Only	ADA Lever	Brushed Nickel	
210300	TS52104NL	Volume Control Trim Only	ADA Lever	Polished Nickel	
144164	TS52104ORB	Volume Control Trim Only	ADA Lever	Oil Rubbed Bronze	

\*Lifeshine® Anti-Tarnish Lifetime Finish

[www.plumbsupply.com](http://www.plumbsupply.com) • Serving our Customers Since 1946 • [www.waterconcepts.net](http://www.waterconcepts.net)

## Shower Faucets

### Posi-Temp® Valve Trim

#### Gibson Posi-Temp® Valve Trim

- Fits M-PACT System
- install with Posi-Temp® pressure balancing control valve to maintain water temperature control in the shower
- Red/blue markings



Part #	Mfg #	Description	Handle(s)	Finish	Price
250615	T2901	Posi-Temp Trim Only	ADA Lever	Chrome	

### Glyde™ Posi-Temp® 1-Hdl Valve Trim

- Fits M•PACT system
- 1222 Cartridge design
- 3-3/4" Diameter spray head



Part #	Mfg #	Description	Handle(s)	Finish	Price
245859	T2741	Posi-Temp Trim Only	ADA Lever	Chrome	

### Via Posi-Temp® Valve Trim

- M-PACT valve system
- Red/blue markings



Part #	Mfg #	Description	Handle(s)	Finish	Price
240891	TS8711	Posi-Temp Trim Only	ADA Lever	Chrome	

### Thermostatic Valve Trim

#### 90° ExactTemp® Thermostatic Valve Trim

- ExactTemp® thermostatic valve allows you to dial in and maintain your ideal temperature for more precise temperature control
- Built on the Moen M•PACT common valve system
- 3/4" IPS connections



Requires Thermostatic Valve: S3371  
Volume Control Valve: S3600

Part #	Mfg #	Description	Handle(s)	Finish	Price
190027	TS3100	Thermostatic Trim Only	ADA Lever	Chrome	
180460	TS3100BN	Thermostatic Trim Only	ADA Lever	Brushed Nickel	

\*Lifeshine® Anti-Tarnish Lifetime Finish

www.waterconcepts.net • Serving our Customers Since 1946 • www.plumbsupply.com

## Shower Faucets

### Arris™ ExactTemp® Thermostatic Valve Trim

- *ExactTemp® thermostatic valve allows you to dial in and maintain your ideal temperature for more precise temperature control*
- *Built on M•PACT® common valve system*
- *3/4" IPS connections*



**Requires Thermostatic Valve: S3371**  
**Volume Control Valve: S3600**

Part #	Mfg #	Description	Handle(s)	Finish	Price
179487	TS33002	Thermostatic Trim Only	ADA Lever	Chrome	
181325	TS33002BN	Thermostatic Trim Only	ADA Lever	Brushed Nickel	

### Rothbury™ ExactTemp® Thermostatic Valve Trim

- *ExactTemp® thermostatic valve allows you to dial in and maintain your ideal temperature for more precise temperature control*
- *Built on M•PACT® common valve system*
- *3/4" IPS connections*



**Requires Thermostatic Valve: S3371**  
**Volume Control Valve: S3600**

Part #	Mfg #	Description	Handle(s)	Finish	Price
182221	TS760ORB	Thermostatic Trim Only	ADA Lever	Oil Rubbed Bronze	

### Weymouth™ ExactTemp® Thermostatic Valve Trim

- *ExactTemp® thermostatic valve allows you to dial in and maintain your ideal temperature for more precise temperature control*
- *Built on M•PACT® common valve system*
- *3/4" IPS connections*



**Requires Thermostatic Valve: S3371**  
**Volume Control Valve: S3600**

Part #	Mfg #	Description	Handle(s)	Finish	Price
176305	TS32110ORB	Thermostatic Trim Only	ADA Lever	Oil Rubbed Bronze	

\*Lifeshine® Anti-Tarnish Lifetime Finish

## Shower Faucets

### Vertical Spa Digital Control

- 4 Outlets
- Precise flow rate and temperature control
- 3/4" CC, CPVC inlet connectors; outlet push-fit crimp ring PEX
- Includes: 30 ft Data cable



Requires IoDIGITAL® S3384 Valve

Part #	Mfg #	Description	Handle(s)	Finish	Price
180904	TS420ORB	Digital Valve Control	N/A	Oil Rubbed Bronze	

### Moentrol® Valve Trim

#### Belfield® Moentrol® Valve Trim

- Fits M•PACT system
- 1/2" IPS connection
- Pressure balancing volume control



Part #	Mfg #	Description	Handle(s)	Finish	Price
239761	T3311ORB	Moentrol Valve Trim	ADA Lever	Oil Rubbed Bronze	

### Transfer Valve Trim

#### 90° Transfer Valve Trim

- Fits M•PACT® system
- Two independent, one shared position
- 1/2" CC



Requires Valve: 3372 or 3375

Part #	Mfg #	Description	Handle(s)	Finish	Price
159212	TS4172	Transfer Valve Trim Only	ADA Lever	Chrome	
149931	TS4172BN	Transfer Valve Trim Only	ADA Lever	Brushed Nickel	

### Align™ Transfer Valve Trim

- Fits M•PACT® system
- Two independent, one shared position
- 1/2" CC



Requires Valve: 3372 or 3375

Part #	Mfg #	Description	Handle(s)	Finish	Price
177267	T4191	Transfer Valve Trim Only	ADA Lever	Chrome	
176386	T4191BN	Transfer Valve Trim Only	ADA Lever	Brushed Nickel	

\*Lifeshine® Anti-Tarnish Lifetime Finish

## Shower Faucets

### Belfield™ Multi-Function Transfer Valve Trim

- Fits M•PACT® system
- Ceramic disc cartridge
- 180° rotation with stops



Requires Valve: 3372 or 3375

Part #	Mfg #	Description	Handle(s)	Finish	Price
247418	T4301ORB	Transfer Valve Trim Only	ADA Lever	Oil Rubbed Bronze	

### Brantford™ Transfer Valve Trim

- Fits M•PACT® system
- Ceramic disc cartridge
- Two/three function
- Detent's at each flow position
- Pair with 3360, 3 function transfer rough-in valve



Requires Valve: 3372 or 3375

Part #	Mfg #	Description	Handle(s)	Finish	Price
251009	T2021	Transfer Valve Trim Only	ADA Lever	Chrome	
247151	T2021BN	Transfer Valve Trim Only	ADA Lever	Brushed Nickel	
246479	T2021ORB	Transfer Valve Trim Only	ADA Lever	Oil Rubbed Bronze	

### Dartmoor™ Transfer Valve Trim

- Fits M•PACT® system
- Ceramic disc cartridge
- Detent's at each flow position
- Pair with 3360, 3 function transfer rough-in valve



Requires Valve: 3372 or 3375

Part #	Mfg #	Description	Handle(s)	Finish	Price
248591	T2031BN	Transfer Valve Trim Only	ADA Lever	Brushed Nickel	

### Eva™ Transfer Valve Trim

- Fits M•PACT® system
- Ceramic disc cartridge
- Detent's at each flow position
- Pair with 3360, 3 function transfer rough-in valve



Requires Valve: 3372 or 3375

Part #	Mfg #	Description	Handle(s)	Finish	Price
246573	T2011	Transfer Valve Trim Only	ADA Lever	Chrome	
246533	T2011BN	Transfer Valve Trim Only	ADA Lever	Brushed Nickel	
247461	T2011ORB	Transfer Valve Trim Only	ADA Lever	Oil Rubbed Bronze	

\*Lifeshine® Anti-Tarnish Lifetime Finish

[www.plumbsupply.com](http://www.plumbsupply.com) • Serving our Customers Since 1946 • [www.waterconcepts.net](http://www.waterconcepts.net)

## Shower Faucets

### Kingsley™ Transfer Valve Trim

- Fits M•PACT® system
- Two independent, one shared position
- 1/2" CC



Requires Valve: 3372 or 3375

Part #	Mfg #	Description	Handle(s)	Finish	Price
218901	T4311	Transfer Valve Trim Only	ADA Lever	Chrome	
171115	T4311BN	Transfer Valve Trim Only	ADA Lever	Brushed Nickel	
172898	T4311ORB	Transfer Valve Trim Only	ADA Lever	Oil Rubbed Bronze	

### Moen Transfer Valve Trim

- Metal construction
- Two independent, one shared position
- 1/2" CC



Requires Valve: 3372

Part #	Mfg #	Description	Handle(s)	Finish	Price
131045	T4171	Transfer Valve Trim Only	ADA Lever	Chrome	
133034	T4171BN	Transfer Valve Trim Only	ADA Lever	Brushed Nickel	
138866	T4171ORB	Transfer Valve Trim Only	ADA Lever	Oil Rubbed Bronze	

### Voss™ Transfer Valve Trim

- Fits M•PACT® valve system
- Two independent, one shared position
- 1/2" CC



Requires Valve: 3372 or 3375

Part #	Mfg #	Description	Handle(s)	Finish	Price
150274	T4611	Transfer Valve Trim Only	ADA Lever	Chrome	
152229	T4611BN	Transfer Valve Trim Only	ADA Lever	Brushed Nickel	
152811	T4611ORB	Transfer Valve Trim Only	ADA Lever	Oil Rubbed Bronze	

### Waterhill® Transfer Valve Trim

- Fits M•PACT® valve system
- Two independent, one shared position
- 1/2" CC



Requires Valve: 3372 or 3375

Part #	Mfg #	Description	Handle(s)	Finish	Price
237667	TS325	Transfer Valve Trim Only	ADA Lever	Chrome	
215286	TS325BN	Transfer Valve Trim Only	ADA Lever	Brushed Nickel	
184585	TS325ORB	Transfer Valve Trim Only	ADA Lever	Oil Rubbed Bronze	

\*Lifeshine® Anti-Tarnish Lifetime Finish

[www.waterconcepts.net](http://www.waterconcepts.net) • Serving our Customers Since 1946 • [www.plumbsupply.com](http://www.plumbsupply.com)



## Shower Faucets

### Weymouth™ Transfer Valve Trim

- Fits M•PACT® system
- Two independent, one shared position
- 1/2" CC



Requires Valve: 3372 or 3375

Part #	Mfg #	Description	Handle(s)	Finish	Price
184232	TS32205NL	Transfer Valve Trim Only	ADA Lever	Polished Nickel	

### Wynford™ Transfer Valve Trim

- Fits M•PACT® system
- Two independent, one shared position
- 1/2" CC



Requires Valve: 3372 or 3375

Part #	Mfg #	Description	Handle(s)	Finish	Price
188037	T4511	Transfer Valve Trim Only	ADA Lever	Chrome	
218545	T4511BN	Transfer Valve Trim Only	ADA Lever	Brushed Nickel	

\*Lifeshine® Anti-Tarnish Lifetime Finish

**Shower Faucets**

**Shower Faucets**

**Shower Trim**

- Single function operation
- Touch-Clean showerhead
- Flow rate: 1.5 gpm

Requires R10000 Rough-In Valve



Part #	Mfg #	Description	Handle(s)	Finish	Price
171148	PTT188763	Shower Trim Only	Lever	Chrome	
186603	PTT188763-BN	Shower Trim Only	Lever	Brushed Nickel	

**Showerheads**

**A+ Type Showerhead**

- 1.5 GPM



Part #	Item #	Description	Price
226344	RP75572	1.5 GPM Showerhead	

**Handshowers**

**5-Setting Handshower**

- Touch-Clean® nozzles
- 60" Ultra flex hose
- Spray settings include:
  - Aerated spray
  - Massage spray
  - Full body spray
  - Full spray with aerated
  - Full spray with massage
- Adjustable shower arm mount
- WaterSense® certified: 2.0 gpm @ 80 psi



Part #	Mfg #	Description	Spout Height	Finish	Price
242669	76516	2.0 GPM Handshower	10"	Chrome	

\* Brilliance® Anti-Tarnish Lifetime Finishes

## Shower Faucets

### Shower Trim Basement Shower Fitting

- Renew valves & seats
- Cast brass body
- Chrome-plated body & fittings
- C-N-I fits all unions
- Flow rated @ 2.5 gpm



Part #	Mfg #	Description	Price
010495	38	Cast Brass Shower Fitting with Soap Dish, Showerhead & Arm	

## Shower Faucets

### Single-Handle Shower Trim

#### Noble Three-Function Single-Handle Shower Trim

- 1-Piece pressure balanced ceramic cartridge with balancing spool
- Back-to-back installation capability
- 3-7/8" 3-Function shower head
- Metal shower arm with flange
- Metal escutcheon with screws
- Zinc handle
- 1.5 gpm @ 80 psi shower head



Part #	Mfg #	Description	Handles	Finish	Price
230831	212-5904	Shower Trim	ADA Lever	Chrome	
229706	212-5905	Shower Trim	ADA Lever	Brushed Nickel	
231177	212-5906	Shower Trim	ADA Lever	Oil Rubbed Bronze	

#### Majestic Three-Function Single-Handle Shower Trim

- 1-Piece pressure balanced ceramic cartridge with balancing spool
- Back-to-back installation capability
- 3-7/8" 3-Function shower head
- Metal shower arm with flange
- Metal escutcheon with screws
- Zinc handle
- 1.5 gpm @ 80 psi shower head



Part #	Mfg #	Description	Handles	Finish	Price
226872	192-6213	Shower Trim	ADA Lever	Chrome	
226638	192-6215	Shower Trim	ADA Lever	Brushed Nickel	
229588	192-6217	Shower Trim	ADA Lever	Oil Rubbed Bronze	

## Steam Generator Components

### Invigoration™ Series Steam Generators

- *Fast-Response® technology produces steam in just one minute instead of waiting four minutes*
- *Power Clean™ technology automatic cleaning feature at the touch of a button*
- *Compatible with the KOHLER DTV+ showering system*



Requires K-5557 Control Kit or K-5548-K1 Adapter Kit

Part #	Mfg #	Description	Price
184917	K-5525-NA	5kW, Fast-Response® 84 Cubic Feet	
184918	K-5526-NA	7kW Fast-Response® 112 Cubic Feet	
184919	K-5529-NA	9kW Fast-Response® 240 Cubic Feet	
184920	K-5531-NA	11kW, Fast-Response® 317 Cubic Feet	
184921	K-5533-NA	13kW Fast-Response® 447 Cubic Feet	
184922	K-5535-NA	15kW Fast-Response® 500 Cubic Feet	
184924	K-5539-NA	18kW Fast-Response® 480 Cubic Feet	
184925	K-5543-NA	22kW, Fast-Response® 634 Cubic Feet	
184926	K-5546-NA	26kW, Fast-Response® 894 Cubic Feet	
184927	K-5547-NA	30kW, Fast Response® 1000 Cubic Feet	

### Control Kits

#### Invigoration™ Series Steam Generator Control Kit

- *For use with Invigoration™ Series 5kW - 15kW steam generators*
- *Circular steam head protracts from finished wall, allowing steam to evenly dispense throughout shower*
- *Easily adjustable control panel allows user to set temperature (90 - 125°F range) and steam session duration*
- *20-Minute safety shutoff*
- *Steam head features an integral aromatherapy well for adding scents*
- *Fast-Response® technology produces a luxurious steam shower in 60 seconds*
- *Power Clean™ technology offers one-touch automatic cleaning and safe maintenance*



Part #	Mfg #	Description	Price
184928	K-5557-BN	*Brushed Nickel	
184932	K-5557-BV	*Brushed Bronze	
184929	K-5557-CP	Polished Chrome	
184930	K-5557-SN	*Polished Nickel	
184931	K-5557-2BZ	Oil Rubbed Bronze	

## Steam Generator Components

### Invigoration™ Series Tandem Steam Generator Kit

- For use with Invigoration™ Series 18kW - 30kW Steam Generators
- Fast-Response® technology produces a luxurious steam shower in 60 seconds
- Quick-connect RJ-12 cord and connector
- Mounting arm and gasket
- Digital clock
- Two thermostatic steam heads with aromatherapy reservoirs
- Adjustable time and temperature settings between 90 and 125°F
- Controls the Power Clean feature.
- 20-minute safety shutoff



Part #	Mfg #	Description	Color	Price
184826	K-5558-CP	Polished Chrome		

### DTV+™ Steam Adapter Kit

- For use with steam generators between 5 and 15 kilowatts.
- Allows steam generator to be controlled with DTV+ controller.
- Adjustable time and temperature settings between 90 and 125°F
- Includes steam head, temperature sensor, and adapter.
- 20-minute safety shutoff.
- Aromatherapy reservoir on steam head.



Requires DTV+ shower components (sold separately)

Part #	Mfg #	Description	Color	Price
184934	K-5548-K1-BN	*Brushed Nickel		
184937	K-5548-K1-BV	*Brushed Bronze		
184933	K-5548-K1-CP	Polished Chrome		
184935	K-5548-K1-SN	*Polished Nickel		

## Steam Shower Accessories

### Invigoration® Series Large Drain Pan

- 3/4" NPT Outlet for drain connection
- Stainless steel construction is corrosion resistant
- Recommended for Kohler Steam Generators 13, 15, 26, 30 kW
- For use with K-5533, K-5535, K-5546, and K-5547 steam generators  
—K-5546 and K-5547 require two drain pans



Part #	Mfg #	Description	Color	Price
185321	5562-NA	19-3/8"L x 14"W x 2"H		



## Steam Generator Components

### Invigoration® Series Small Drain Pan

- 3/4" NPT Outlet for drain connection
- Stainless steel construction is corrosion resistant
- For use with K-5525, K-5526, K-5529, K-5531, K-5539, and K-5543 steam generators  
—K-5539 and K-5543 require two drain pans
- Recommended for Invigoration™ Series Steam Generators sizes 5kW, 7kW, 9kW, 11kW, 18kW, and 22kW



Part #	Mfg #	Description	Color	Price
185320	5559-NA	19-1/8"L x 8-3/8"W x 2"H		

## Tub & Shower Faucets

### Single-Handle Tub & Shower Trim

#### Alteo® Rite-Temp® 1-Hdl Tub & Shower Trim with Diverter

- Premium construction
- MasterClean™ spray nozzles
- 2.5 gpm Showerhead
- Intended for use with Rite-Temp® or HiFlow Rite-Temp® valves
- Heavy-duty slip-fit clamp design and NPT threaded spout



**Requires:**

**K-304/K-P304 Series Rite-Temp® Valves**  
or

**K-2971-KS 3/4" Pressure-balancing Valve**

Part #	Mfg #	Description	Handle(s)	Finish	Price
225725	K-TS45104-4-BN	Tub & Shower Trim, Pushbutton Diverter	ADA Lever	*Brushed Nickel	
251296	K-TLS45104-4-BN	Tub & Shower Trim, Pushbutton Diverter, Less Head	ADA Lever	*Brushed Nickel	
225724	K-TS45104-4-CP	Tub & Shower Trim, Pushbutton Diverter	ADA Lever	Polished Chrome	
225726	K-TS45104-4-2BZ	Tub & Shower Trim, Pushbutton Diverter Bronze	ADA Lever	Oil Rubbed	

#### Archer™ Rite-Temp® 1-Hdl Tub & Shower Trim

- Metal construction
- Intended for use with Rite-Temp or Hi Flow Rite-Temp valves
- High-temperature limit setting
- Mixing valve cycles from "cold" to "hot"
- 6-1/2" Diverter spout, 1/2" IPS connection
- Flow rate: 2.5 gpm



**Requires:**

**K-304/K-P304 Series Rite-Temp® Valves**  
or

**K-2971-KS 3/4" Pressure-balancing Valve**

Part #	Mfg #	Description	Handle(s)	Finish	Price
225900	K-TS11077-4-CP	Tub & Shower Trim, 2.5 GPM	ADA Lever	Polished Chrome	
224670	K-T11077-4E-BN	Tub & Shower Trim, 2.0 GPM	ADA Lever	*Brushed Nickel	

#### Bancroft® Rite-Temp® 1-Hdl Tub & Shower Trim

- Metal construction
- 5-3/4" Diverter spout, NPT or Slip-fit connection
- (-P) ADA porcelain handle lever
- (K-TS10582) includes slip fit spout
- (-TLS) Does not include showerhead



**Requires:**

**K-304/K-P304 Series Rite-Temp® Valves**  
or

**K-2971-KS 3/4" Pressure-balancing Valve**

Part #	Mfg #	Description	Handle(s)	Finish	Price
226203	K-TS10581-4-BN	Tub & Shower Trim	ADA Lever	*Brushed Nickel	

\* Vibrant Limited Lifetime Warranty

**www.waterconcepts.net • Serving our Customers Since 1946 • www.plumbsupply.com**

## Tub & Shower Faucets

### Single-Handle Tub & Shower Trim (Continued)

#### Bancroft® Rite-Temp® 1-Hdl Tub & Shower Trim

Part #	Mfg #	Description	Handle(s)	Finish	Price
114250	K-TS10581-4-BV	Tub & Shower Trim	ADA Lever	*Brushed Bronze	
231236	K-TS10581-4-CP	Tub & Shower Trim	ADA Lever	Polished Chrome	
104658	K-TS10581-4P-BN	Tub & Shower Trim	ADA Porcelain Lever	*Brushed Nickel	
094944	K-TS10581-4P-CP	Tub & Shower Trim	ADA Porcelain Lever	Polished Chrome	
243536	K-TLS10582-4-BN	Tub & Shower Trim, Less Head	ADA Lever	*Brushed Nickel	
247724	K-TS10582-4-BN	Tub & Shower Trim, Slip Fit Spout	ADA Lever	*Brushed Nickel	
247727	K-TS10582-4-CP	Tub & Shower Trim, Slip Fit Spout	ADA Lever	Polished Chrome	
255457	K-TLS10582-4-CP	Tub & Shower Trim, Slip Fit Spout, Less head	ADA Lever	Polished Chrome	
182960	K-TS10582-4-SN	Tub & Shower Trim, Slip Fit Spout	ADA Lever	*Polished Nickel	
183392	K-TS10582-4-2BZ	Tub & Shower Trim, Slip Fit Spout Bronze	ADA Lever	Oil Rubbed	

#### Coralais® Mixing Valve 1-Hdl Tub & Shower Trim

- Metal construction
- Adjustable spray showerhead, arm and flange
- High temperature limit stop
- 4-7/8" Diverter spout with NPT or slip-fit connection
- (-S) Slip-fit spout
- (-P) Project pack - 12 per case

Requires valve K-304-KI-KP/KS



K-TS15601-4

K-T15601-7

K-T15603-4

Part #	Mfg #	Description	Handle(s)	Finish	Price
226201	K-TS15601-4-CP	Tub & Shower Trim	ADA Lever	Polished Chrome	
225710	K-TS15601-4-G	Tub & Shower Trim	ADA Lever	Brushed Chrome	
226202	K-TS15601-4S-CP	Tub & Shower Trim, Slip Diverter	ADA Lever	Polished Chrome	
225712	K-TS15601-4S-G	Tub & Shower Trim, Slip Diverter	ADA Lever	Brushed Chrome	
238476	K-PLS15601-4-CP	Tub & Shower Trim, Less Showerhead, P-Pk	ADA Lever	Polished Chrome	
225711	K-PS15601-4-CP	Tub & Shower Trim, P-Pk	ADA Lever	Polished Chrome	
225713	K-PS15601-4S-CP	Tub & Shower Trim, Slip Diverter, P-Pk	ADA Lever	Polished Chrome	
255256	K-PS15601-4S-G	Tub & Shower Trim, Slip Diverter, P-Pk	ADA Lever	Brushed Chrome	

\* Vibrant Limited Lifetime Warranty

[www.plumbsupply.com](http://www.plumbsupply.com) • Serving our Customers Since 1946 • [www.waterconcepts.net](http://www.waterconcepts.net)

## Tub & Shower Faucets

### Devonshire® Rite-Temp® 1-Hdl Tub & Shower Trim

- Metal construction
- Brass valve bodies
- Pressure-balancing mechanism of one-piece diaphragm cartridge
- 2.5 gpm showerhead, arm and flange
- 5-1/4" Diverter spout
- (-S) Slip-fit spout
- (E) 2.0 gpm



K-TS395-4

**Requires:**

**K-304/K-P304 Series Rite-Temp® Valves**  
or

**K-2971-KS 3/4" Pressure-balancing Valve**

Part #	Mfg #	Description	Handle(s)	Finish	Price
249106	K-TLS395-4S-2BZ	Tub & Shower Trim, No Showerhead Bronze	ADA Lever	Oil Rubbed	
225809	K-TS395-4-BN	Tub & Shower Trim	ADA Lever	*Brushed Nickel	
225810	K-TS395-4-BV	Tub & Shower Trim	ADA Lever	*Brushed Bronze	
225808	K-TS395-4-CP	Tub & Shower Trim	ADA Lever	Polished Chrome	
094402	K-TS395-4-PB	Tub & Shower Trim	ADA Lever	*Polished Brass	
181952	K-TS395-4-SN	Tub & Shower Trim	ADA Lever	*Polished Nickel	
225811	K-TS395-4-2BZ	Tub & Shower Trim Bronze	ADA Lever	Oil Rubbed	
225814	K-TS395-4E-2BZ	Tub & Shower Trim, 2.0 GPM Bronze	ADA Lever	Oil Rubbed	
225816	K-TS395-4S-BN	Tub & Shower Trim, Slip-Fit Diverter Spout	ADA Lever	*Brushed Nickel	
225815	K-TS395-4S-CP	Tub & Shower Trim, Slip-Fit Diverter Spout	ADA Lever	Polished Chrome	
225817	K-TS395-4S-2BZ	Tub & Shower Trim, Slip-Fit Diverter Spout Bronze	ADA Lever	Oil Rubbed	
225859	K-TS395-4SE-2BZ	Tub & Shower Trim, Slip-Fit Diverter Spout, 2.0 GPM Bronze	ADA Lever	Oil Rubbed	

### Fairfax® Rite-Temp® 1-Hdl Tub & Shower Trim

- Metal construction
- Showerhead, arm and flange
- 4-7/8" Diverter spout, 1/2" IPS connection



**Requires:**

**K-304/K-P304 Series Rite-Temp® Valves**  
or

**K-2971-KS 3/4" Pressure-balancing Valve**

Part #	Mfg #	Description	Handle(s)	Finish	Price
225918	K-TS12007-4-CP	Tub & Shower Trim, Diverter Spout	ADA Lever	Polished Chrome	
225919	K-TS12007-4-BN	Tub & Shower Trim, Diverter Spout	ADA Lever	*Brushed Nickel	

\* Vibrant Limited Lifetime Warranty

**www.waterconcepts.net • Serving our Customers Since 1946 • www.plumbsupply.com**

## Tub & Shower Faucets

### Single-Handle Tub & Shower Trim (Continued)

#### Fairfax® Rite-Temp® 1-Hdl Tub & Shower Trim

Part #	Mfg #	Description	Handle(s)	Finish	Price
225920	K-TS12007-4-2BZ	Tub & Shower Trim, Diverter Spout Bronze	ADA Lever	Oil Rubbed	

#### Finial® Rite-Temp® 1-Hdl Tub & Shower Trim

- Brass construction
- Push-button diverter
- 5-3/4" spout with NPT connection

Requires Valve: K-305-K/-KS Rite-Temp® with push-button diverter



Part #	Mfg #	Description	Handle(s)	Finish	Price
107933	K-T312-4M-AF	Tub & Shower Trim, Push-Button Diverter	Traditional Lever	*French Gold	
059246	K-T312-4M-BN	Tub & Shower Trim, Push-Button Diverter	Traditional Lever	*Brushed Nickel	
253504	K-T312-4M-BV	Tub & Shower Trim, Push-Button Diverter	Traditional Lever	*Brushed Bronze	
139370	K-T312-4M-CP	Tub & Shower Trim, Push-Button Diverter	Traditional Lever	Polished Chrome	
082821	K-T312-4M-SN	Tub & Shower Trim, Push-Button Diverter	Traditional Lever	*Polished Nickel	
180604	K-T312-4M-2BZ	Tub & Shower Trim, Push-Button Diverter Bronze	Traditional Lever	Oil Rubbed	

#### Forté® Rite-Temp® Pressure-Balancing 1-Hdl Tub & Shower Trim

- Metal construction
- Intended for use with Rite-Temp® or HiFlow Rite-Temp® valves
- Includes faceplate and handle
- Flow rate: 2.5 gpm
- 5-1/4" NPT Diverter spout  
—(K-TS10275) Slip-fit spout
- (-TLS) Less showerhead
- (-4E Models are WaterSense® certified: 2.0 gpm)



K-T10274-4

K-T10274-4A

Requires:

K-304/K-P304 Series Rite-Temp® Valves  
or

K-2971-KS 3/4" Pressure-balancing Valve

Part #	Mfg #	Description	Handle(s)	Finish	Price
225877	K-TS10274-4-BN	Tub & Shower Trim	ADA Sculpted Lever	*Brushed Nickel	
225875	K-TS10274-4-CP	Tub & Shower Trim	ADA Sculpted Lever	Polished Chrome	
225876	K-TS10274-4-G	Tub & Shower Trim	ADA Sculpted Lever	Brushed Chrome	
225888	K-TS10274-4A-BN	Tub & Shower Trim	ADA Traditional Lever	*Brushed Nickel	
225885	K-TS10274-4A-CP	Tub & Shower Trim	ADA Traditional Lever	Polished Chrome	
225887	K-TS10274-4A-G	Tub & Shower Trim	ADA Traditional Lever	Brushed Chrome	

\* Vibrant Limited Lifetime Warranty

[www.plumbsupply.com](http://www.plumbsupply.com) • Serving our Customers Since 1946 • [www.waterconcepts.net](http://www.waterconcepts.net)

## Tub & Shower Faucets

### Single-Handle Tub & Shower Trim (Continued)

#### Forté® Rite-Temp® Pressure-Balancing 1-Hdl Tub & Shower Trim

Part #	Mfg #	Description	Handle(s)	Finish	Price
225881	K-TS10275-4-BN	Tub & Shower Trim with Slip-Fit Spout	ADA Sculpted Lever	*Brushed Nickel	
225879	K-TS10275-4-CP	Tub & Shower Trim with Slip-Fit Spout	ADA Sculpted Lever	Polished Chrome	
260551	K-TS10275-4E-BN	Tub & Shower Trim with Slip-Fit Spout, 2.0 gpm	ADA Sculpted Lever	*Brushed Nickel	
257691	K-TLS10275-4-G	Tub & Shower Trim with Slip-Fit Spout, Less Head	ADA Sculpted Lever	Brushed Chrome	

#### Honesty™ Rite-Temp® Pressure-Balancing 1-Hdl Tub & Shower Trim

- Premium construction
- Single function showerhead
- WaterSense® certified product: 2.0 gpm

Requires Valve: K-11748-K or K-11748-KS



Part #	Mfg #	Description	Handle(s)	Finish	Price
178232	K-T99763-4-CP	Tub & Shower Trim with Push-Button Diverter	ADA Lever	Polished Chrome	

#### July™ Rite-Temp® Pressure-Balancing 1-Hdl Tub & Shower Trim

- Premium construction
- Single function showerhead
- WaterSense® certified product: 2.0 gpm

Requires:  
K-304/K-P304 Series Rite-Temp® Valves  
or  
K-2971-KS 3/4" Pressure-balancing Valve



Part #	Mfg #	Description	Handle(s)	Finish	Price
223403	K-TS98006-4-CP	Tub & Shower Trim, Slip-fit Diverter Spout	ADA Lever	Polished Chrome	
223404	K-TS98006-4-G	Tub & Shower Trim, Slip-fit Diverter Spout	ADA Lever	Brushed Chrome	

\* Vibrant Limited Lifetime Warranty

[www.waterconcepts.net](http://www.waterconcepts.net) • Serving our Customers Since 1946 • [www.plumbsupply.com](http://www.plumbsupply.com)



## Tub & Shower Faucets

### Kelston®™ Rite-Temp® 1-Hdl Tub & Shower Trim

- Metal construction, brass valve bodies
- High-temperature limit stop
- Mixing valve cycles from cold to hot
- Diverter spout with 1/2" NPT or slip-fit connection
- For use with Rite-Temp® or HiFlow Rite-Temp® valves
- Heavy-duty slip-fit clamp design
- Flow rate: 2.5 gpm
- (-4E Models are WaterSense® certified: 2.0 gpm)
- (-LS) Less showerhead



**Requires:**

**K-304/K-P304 Series Rite-Temp® Valves**

or

**K-2971-KS 3/4" Pressure-balancing Valve**

Part #	Mfg #	Description	Handles	Finish	Price
251802	K-TLS 13492-4-2BZ	Tub & Shower Trim, 2.5 gpm, Less Head Bronze	ADA Lever	Oil Rubbed	
225909	K-TS13492-4-BN	Tub & Shower Trim, 2.5 gpm	ADA Lever	*Brushed Nickel	
225908	K-TS13492-4-CP	Tub & Shower Trim, 2.5 gpm	ADA Lever	Polished Chrome	
225910	K-TS 13492-4-2BZ	Tub & Shower Trim, 2.5 gpm Bronze	ADA Lever	Oil Rubbed	
251491	K-TS13492-4E-BN	Tub & Shower Trim, 2.0 gpm	ADA Lever	*Brushed Nickel	

### Loure® Rite-Temp® 1-Hdl Tub & Shower Trim

- Brass construction
- Push-button diverter
- MasterClean® spray nozzles prohibit mineral build-up

**Requires Valve:**

**K-11748-K**

or

**K-11748-KS**



Part #	Mfg #	Description	Handle(s)	Finish	Price
170481	K-T14664-4-BN	Tub & Shower Trim, Push Button Diverter	Lever	*Brushed Nickel	
156037	K-T14664-4-CP	Tub & Shower Trim, Push Button Diverter	Lever	Polished Chrome	
182974	K-T14664-4-SN	Tub & Shower Trim, Push Button Diverter	Lever	*Polished Nickel	

\* Vibrant Limited Lifetime Warranty

**www.plumbsupply.com • Serving our Customers Since 1946 • www.waterconcepts.net**

## Tub & Shower Faucets

### Margaux® Rite-Temp® 1-Hdl Tub & Shower Trim

- Brass construction
- MasterClean® sprayface
- Model (K-T16233) includes push-button diverter
- (-L) Less showerhead



Requires Valve: **K-304-K** or **K-304-KS**

Push-Button Diverter Trim Requires Valve: **K-11748-K/KS**

Part #	Mfg #	Description	Handle(s)	Finish	Price
134193	K-TS16225-3-BN	Tub & Shower Trim	Cross	*Brushed Nickel	
115419	K-TS16225-3-CP	Tub & Shower Trim	Cross	Polished Chrome	
182977	K-TS16225-4-AF	Tub & Shower Trim	Lever	*French Gold	
167737	K-TS16225-4-BN	Tub & Shower Trim	Lever	*Brushed Nickel	
233790	K-TS16225-4-CP	Tub & Shower Trim	Lever	Polished Chrome	
145255	K-TS16225-4-SN	Tub & Shower Trim	Lever	*Polished Nickel	
182978	K-T16233-3-CP	Tub & Shower Trim, Push-Button Diverter	Cross	Polished Chrome	
182979	K-T16233-3-SN	Tub & Shower Trim, Push-Button Diverter	Cross	*Polished Nickel	
109273	K-T16233-4-CP	Tub & Shower Trim, Push-Button Diverter	Lever	Polished Chrome	
256516	K-T16233-4L-CP	Tub & Shower Trim, Push-Button Diverter, Less Head	Lever	Polished Chrome	

### Memoirs® Stately Rite-Temp® Tub and Shower Valve Trim

- Premium material construction
- Pressure-balancing diaphragm technology
- Includes single function 2.5 gpm showerhead
- Showerhead features MasterClean™ sprayface
- Includes diverter bath spout with 1/2" NPT connection
- Includes face plate with metal handle and shower arm with flange
- (-TLS models do not include showerhead)



Requires Valve:

**K-304/K-P304 Series Rite-Temp® Valves**

or

**K-2971-KS 3/4" pressure-balancing valve**

Part #	Mfg #	Description	Handle(s)	Finish	Price
251575	K-TLS461-4S-CP	Tub & Shower Trim, Less Showerhead	ADA Lever	Polished Chrome	
077036	K-TS461-4V-BN	Tub & Shower Trim	ADA Deco Lever	*Brushed Nickel	
089325	K-TS461-4V-CP	Tub & Shower Trim	ADA Deco Lever	Polished Chrome	

\* Vibrant Limited Lifetime Warranty

[www.waterconcepts.net](http://www.waterconcepts.net) • Serving our Customers Since 1946 • [www.plumbsupply.com](http://www.plumbsupply.com)

## Tub & Shower Faucets

### Pinstripe® Pure Rite-Temp® Pressure-Balancing 1-Hdl Tub & Shower Trim

- Push-button diverter
- For use with valves with diverters



Requires Valve:  
K-11748-K  
or  
K-11748-KS

Part #	Mfg #	Description	Handle(s)	Finish	Price
091482	K-T13133-3A-BN	Tub & Shower Trim, Push Button Diverter	Cross	*Brushed Nickel	
188988	K-T13133-3A-CP	Tub & Shower Trim, Push Button Diverter	Cross	Polished Chrome	
111913	K-T13133-3A-SN	Tub & Shower Trim, Push Button Diverter	Cross	*Polished Nickel	
237888	K-T13133-3B-BN	Tub & Shower Trim, Push Button Diverter & Pinstripe	Cross	*Brushed Nickel	
084110	K-T13133-3B-CP	Tub & Shower Trim, Push Button Diverter & Pinstripe	Cross	Polished Chrome	
109568	K-T13133-4A-BN	Tub & Shower Trim, Push Button Diverter	Lever	*Brushed Nickel	
129747	K-T13133-4A-CP	Tub & Shower Trim, Push Button Diverter	Lever	Polished Chrome	
173480	K-T13133-4A-SN	Tub & Shower Trim, Push Button Diverter	Lever	*Polished Nickel	

### Purist® Rite-Temp® Pressure Balancing 1-Hdl Tub & Shower Trim

- Push-button diverter
- Premium metal construction
- For use with valves with diverters
- (-L) Less showerhead



Requires Valve:  
K-11748-K  
or  
K-11748-KS

Part #	Mfg #	Description	Handle(s)	Finish	Price
243637	K-T14420-3-BGD	Tub & Shower Trim, Push Button Diverter Gold	Cross	*Moderne Br.	
257346	K-T14420-3-SN	Tub & Shower Trim, Push Button Diverter	Cross	*Polished Nickel	
183680	K-T14420-4-SN	Tub & Shower Trim, Push Button Diverter	Lever	*Polished Nickel	
247729	K-T14420-4-RGD	Tub & Shower Trim, Push Button Diverter	Cross	*Rose Gold	
167358	K-T14421-3-CP	Tub & Shower Trim, Push Button Diverter	Cross	Polished Chrome	
105986	K-T14421-4-BN	Tub & Shower Trim, Push Button Diverter	Lever	*Brushed Nickel	
257778	K-T14421-4L-BL	Tub & Shower Trim, Push Button Diverter, Less Head	Lever	Matte Black	
239598	K-T14421-4-BV	Tub & Shower Trim, Push Button Diverter	Lever	*Brushed Bronze	
071158	K-T14421-4-CP	Tub & Shower Trim, Push Button Diverter	Lever	Polished Chrome	
178255	K-T14421-4-SN	Tub & Shower Trim, Push Button Diverter	Lever	*Polished Nickel	
171806	K-T14421-4E-CP	Tub & Shower Trim, Push Button Diverter, 2.0 GPM	Lever	Polished Chrome	

\* Vibrant Limited Lifetime Warranty

[www.plumbsupply.com](http://www.plumbsupply.com) • Serving our Customers Since 1946 • [www.waterconcepts.net](http://www.waterconcepts.net)

## Tub & Shower Faucets

### Refinia® Rite-Temp® 1-Hdl Tub & Shower Trim

- Premium construction
- MasterClean™ spray nozzles
- Intended for use with Rite-Temp® or HiFlow Rite-Temp® valves
- Heavy-duty slip-fit clamp design and NPT threaded spout
- (-TLS) Less showerhead



**Requires:**

**K-304/K-P304 Series Rite-Temp® Valves**

or

**K-2971-KS 3/4" Pressure-balancing Valve**

Part #	Mfg #	Description	Handle(s)	Finish	Price
244303	K-TLS5318-4-BN	Tub & Shower Trim, Less Head	Lever	*Brushed Nickel	
225737	K-TS5318-4-BN	Tub & Shower Trim	Lever	*Brushed Nickel	
225738	K-TS5318-4E-BN	Tub & Shower Trim, 2.0 GPM	Lever	*Brushed Nickel	
225736	K-TS5318-4-CP	Tub & Shower Trim	Lever	Polished Chrome	

### Revival® Rite-Temp® 1-Hdl Tub & Shower Trim

- Premium construction
- Single function showerhead with showerarm



**Requires:**

**K-304/K-P304 Series Rite-Temp® Valves**

or

**K-2971-KS 3/4" Pressure-balancing Valve**

Part #	Mfg #	Description	Handle(s)	Finish	Price
129050	K-T16115-4A-BN	Tub & Shower Trim, Pushbutton Diverter	Traditional Lever	*Brushed Nickel	
075516	K-T16115-4A-CP	Tub & Shower Trim, Pushbutton Diverter	Traditional Lever	Polished Chrome	

### Stillness® Rite-Temp® 1-Hdl Tub & Shower Trim

- Requires valve: K-11748-NA (sold separately)



Part #	Mfg #	Description	Handle(s)	Finish	Price
073647	K-T948-4-BN	Tub & Shower Trim, Pushbutton Diverter	Lever	*Brushed Nickel	

\* Vibrant Limited Lifetime Warranty

[www.waterconcepts.net](http://www.waterconcepts.net) • Serving our Customers Since 1946 • [www.plumbsupply.com](http://www.plumbsupply.com)

## Tub & Shower Faucets

### Toobi® Rite-Temp® 1-Hdl Tub & Shower Trim

- Metal construction
- (48) MasterClean™ spray nozzles with Katalyst™ spray technology
- (3) Color options included for the bath spout outlet and showerhead trim ring - white, green, or black
- Push-button diverter
- Flow rate: 2.0 gpm

Requires Valve:  
K-11748-K  
or  
K-11748-KS



Part #	Mfg #	Description	Handle(s)	Finish	Price
159803	K-T8975-4-BN	Tub & Shower Trim, Pushbutton Diverter	Lever	*Brushed Nickel	
154963	K-T8975-4-CP	Tub & Shower Trim, Pushbutton Diverter	Lever	Polished Chrome	

### Two-Handle Tub & Shower Trim

#### Coralais® 2-Hdl Tub & Shower Trim

- Metal construction
- Showerhead, arm and flange
- Reversible 1/2" 1/4-turn washerless ceramic disc valves
- 4-7/8" Diverter spout



Requires valve K-302-K

Part #	Mfg #	Description	Handle(s)	Finish	Price
061694	K-T15201-4-CP	Tub & Shower, NPT Diverter Spout	ADA Lever	Polished Chrome	
061696	K-T15201-4S-CP	Tub & Shower, Slip Fit Diverter Spout			

### Revival® 2-Hdl Tub & Shower Trim

- Brass construction, brass valve bodies
- 1/2" quarter-turn washerless ceramic disc valves
- Available with scroll or traditional lever handles
- Diverter spout
- For 8" centers
- Valve included



Part #	Mfg #	Description	Handle(s)	Finish	Price
092983	K-16213-4A-BN	Tub & Shower, Diverter Spout	Traditional Lever	*Brushed Nickel	
163760	K-16213-4A-PB	Tub & Shower, Diverter Spout	Traditional Lever	*Polished Brass	
092984	K-16214-4A-BN	Tub & Shower, Less Spout	Traditional Lever	*Brushed Nickel	

\* Vibrant Limited Lifetime Warranty

[www.plumbsupply.com](http://www.plumbsupply.com) • Serving our Customers Since 1946 • [www.waterconcepts.net](http://www.waterconcepts.net)

## Tub & Shower Faucets

### Tub & Shower Trim

#### Baliza Tempassure® Thermostatic Tub & Shower Trim

- Features H2Okinetic® technology
- TempAssure® thermostatic medium flow valving
- Fits MultiChoice® universal valve
- Independent temperature and volume control
- 7-1/8" Round raincan showerhead
- WaterSense® certified product: 2.0 gpm @ 80 psi



Part #	Mfg #	Description	Handle(s)	Finish	Price
143803	T60405-BN	7-1/8" Pull-up Diverter Spout	ADA Lever	Brushed Nickel*	
144000	T60405-PC	7-1/8" Pull-up Diverter Spout	ADA Lever	Chrome	
170005	T60405-PN	7-1/8" Pull-up Diverter Spout	ADA Lever	Polished Nickel*	
170959	T60405-RB	7-1/8" Pull-up Diverter Spout Bronze®	ADA Lever	Venetian	

#### Charlotte™ Tempassure® Thermostatic Tub & Shower Trim

- Features H2Okinetic® technology
- TempAssure® thermostatic medium flow valving
- Fits MultiChoice® universal valve
- Independent temperature and volume control
- 5-13/16" Round raincan showerhead
- 8" Shower arm
- WaterSense® certified product: 2.0 gpm @ 80 psi



Part #	Mfg #	Description	Handle(s)	Finish	Price
170568	T60485-BN	8-3/8" Pull-Down Diverter Spout	ADA Lever	Brushed Nickel*	
170569	T60485-PC	8-3/8" Pull-Down Diverter Spout	ADA Lever	Chrome	
156583	T60485-PNCO	8-3/8" Pull-Down Diverter Spout Nkl	ADA Lever	Cocoa Brz™/Pol	

\* Brilliance® Anti-Tarnish Lifetime Finishes

[www.waterconcepts.net](http://www.waterconcepts.net) • Serving our Customers Since 1946 • [www.plumbsupply.com](http://www.plumbsupply.com)



## Tub & Shower Faucets

### Lahara® Monitor® 17 Series Tub & Shower Trim

- H2Okinetic® Technology
- 5-1/2" Spout reach, 6-13/32" showerhead
- Fits MultiChoice® universal valve
- Monitor® pressure balance valve
- H2Okinetic spray setting
- Dual-function pressure balance cartridge
- WaterSense® certified product: 2.0 gpm @ 80 psi



Part #	Mfg #	Description	Handle(s)	Finish	Price
211833	T17438-RBH2O	5-1/2" Pull-Up Diverter Spout	ADA Lever	Venetian Bronze	

### Loki® Pressure Balance Tub & Shower Trim

- Features H2Okinetic® technology
- Fits MultiChoice® universal valve
- Handle adjusts temperature
- 5-3/8" Showerhead
- WaterSense® certified product: 2.0 gpm @ 80 psi



Part #	Mfg #	Description	Handle(s)	Finish	Price
161617	T60P420-PC	5-1/2" Pull-Down Diverter Spout	ADA Lever	Chrome	

### Odin™ Tempassure® Thermostatic Tub & Shower Trim

- Features H2Okinetic® technology
- TempAssure® thermostatic medium flow valving
- Fits MultiChoice® universal valve
- Independent temperature and volume control
- 5-3/8" Showerhead
- 16" Shower arm and flange
- WaterSense® certified product: 2.0 gpm @ 80 psi



Part #	Mfg #	Description	Handle(s)	Finish	Price
176994	T60475-BL	5-1/2" Pull-Down Diverter Spout	ADA Lever	Matte Black	
165338	T60475-BN	5-1/2" Pull-Down Diverter Spout	ADA Lever	Brushed Nickel*	
177505	T60475-PC	5-1/2" Pull-Down Diverter Spout	ADA Lever	Chrome	

\* Brilliance® Anti-Tarnish Lifetime Finishes

[www.plumbsupply.com](http://www.plumbsupply.com) • Serving our Customers Since 1946 • [www.waterconcepts.net](http://www.waterconcepts.net)

## Tub & Shower Faucets

### Siderna Tempassure® Thermostatic Tub & Shower Trim

- TempAssure® thermostatic medium flow valving
- Fits MultiChoice® universal valve
- Independent temperature and volume control
- 8-5/8" x 5-3/4" Rectangle single-function raincan showerhead
- 16" Shower arm
- Maximum flow rate: 2.5 gpm @ 80 psi



Part #	Mfg #	Description	Handle(s)	Finish	Price
177334	T60480-BL	7" Pull-Down Diverter Spout	ADA Lever	Matte Black	
175340	T60480-BN	7" Pull-Down Diverter Spout	ADA Lever	Brushed Nickel*	
151872	T60480-PC	7" Pull-Down Diverter Spout	ADA Lever	Chrome	

### Sotria™ Tempassure® Thermostatic Tub & Shower Trim

- Fits MultiChoice® universal valve
- Multi-Function H2OKinetic® showerhead
- Independent temperature and volume control
- WaterSense® certified product: 2.0 gpm @ 80 psi



Part #	Mfg #	Description	Handle(s)	Finish	Price
222411	T60450-BL	9" Pull-Up Diverter Spout	ADA Lever	Matte Black	
178248	T60450-PC	9" Pull-Up Diverter Spout	ADA Lever	Chrome	

### Tresa® Pressure Balance Tub & Shower Trim

- Features H2OKinetic® technology
- Single-function pressure balance cartridge
- Fits MultiChoice® universal valve
- Handle adjusts temperature
- 7-1/8" Raincan showerhead
- 7" Shower arm
- WaterSense certified product: 2.0 gpm @ 80 psi



Part #	Mfg #	Description	Handle(s)	Finish	Price
176453	T60P410-BN	7" Pull-Up Diverter Spout	ADA Lever	Brushed Nickel*	
171586	T60P410-PC	7" Pull-Up Diverter Spout	ADA Lever	Chrome	

\* Brilliance® Anti-Tarnish Lifetime Finishes

www.waterconcepts.net • Serving our Customers Since 1946 • www.plumbsupply.com

## Tub & Shower Faucets

### Vesi® Channel Pressure Balance Tub & Shower Trim

- Features H2Okinetic® technology
- Single-function pressure balance cartridge
- Fits MultiChoice® universal valve
- Handle adjusts temperature
- 5-1/4" Showerhead
- WaterSense® certified product: 2 gpm @ 80 psi



Part #	Mfg #	Description	Handle(s)	Finish	Price
165257	T60P440-BN	6-1/2" Pull-Up Diverter Spout	ADA Lever	Brushed Nickel*	

### Vesi Tempassure® Thermostatic Tub & Shower Trim

- TempAssure® thermostatic medium flow valving
- Fits MultiChoice® universal rough valve
- Independent temperature and column control
- 5" Showerhead with three spray functions



Part #	Mfg #	Description	Handle(s)	Finish	Price
188602	T60440-RB	6-1/2" Pull-Up Diverter Spout Bronze®	ADA Lever	Venetian	

### Virage Tempassure® Thermostatic Tub & Shower Trim

- Features H2Okinetic® technology
- TempAssure® thermostatic medium flow valving
- Fits MultiChoice® universal valve
- Independent temperature and volume control
- 6" Square raincan showerhead
- WaterSense® certified product: 2.0 gpm @ 80 psi



Part #	Mfg #	Description	Handle(s)	Finish	Price
135417	T60430-BN	7-3/4" Pull-down Diverter Spout	ADA Lever	Brushed Nickel*	
169193	T60430-PC	7-3/4" Pull-down Diverter Spout	ADA Lever	Chrome	
173283	T60430-RB	7-3/4" Pull-down Diverter Spout Bronze®	ADA Lever	Venetian	

\* Brilliance® Anti-Tarnish Lifetime Finishes

[www.plumbsupply.com](http://www.plumbsupply.com) • Serving our Customers Since 1946 • [www.waterconcepts.net](http://www.waterconcepts.net)

## Tub & Shower Faucets

### Monitor® 13 Series Tub & Shower Trim

#### Classic Monitor® 13 Series 1-Hdl Tub & Shower Trim

- Fits MultiChoice™ universal valve
- Includes cartridge
- Handle adjusts temperature
- Touch-Clean® showerhead
- Sweat onto 1/2" CWT or thread onto 1/2" IPS
- "-LHD" & "-SLHD" models have pad printed red/blue temperature indication less showerhead
- WaterSense® certified product: 1.75 gpm @ 80 psi
- H2O Model: 1.5 gpm @ 80 psi



Part #	Mfg #	Description	Handle(s)	Finish	Price
092591	T13420	Tub & Shower Trim, 5-1/2" Pull-Up Diverter Spout	ADA Lever	Chrome	
134431	T13420-SS	Tub & Shower Trim, 5-1/2" Pull-Up Diverter Spout	ADA Lever	Stainless*	
114939	T13420-H2O	T&S Trim, 5-1/2" DivSpout, H2OKinetic® Showerhead	ADA Lever	Chrome	
128425	T13420-H2OT	T&S Complete, 5-1/2" Div Spout, H2OKinetic® Showerhead	ADA Lever	Chrome	
135314	T13420-SSH2OT	T&S Complete, 5-1/2" Div Spout, H2OKinetic® Showerhead	ADA Lever	Stainless*	
092594	T13420-PD	Tub & Shower Trim, 6" Pull-Down Diverter Spout	ADA Lever	Chrome	
136066	T13420-SSPD	Tub & Shower Trim, 6" Pull-Down Diverter Spout	ADA Lever	Stainless*	
092633	T13422	Tub & Shower Trim, 5-1/2" Pull-Up Diverter Spout	Clear Knob	Chrome	
092636	T13422-PDSOS	T&S Trim, 6" Div Spout, Slip-On Spout for 1/2" C.W.T.	Clear Knob	Chrome	
130188	T13491-LHD	T&S Trim, Less Showerhead 4-3/4" Diverter Spout	ADA Lever	Chrome	

#### Classic Monitor® 13 Series 1-Hdl Tub & Shower Trim

- Fits MultiChoice™ universal valve
- Handle adjusts temperature
- TouchClean®
- 3-Setting showerhead:
  - Full Body
  - Massaging
  - Soft drench
- Sweat onto 1/2" C.W.T or thread onto 1/2" IPS
- (T13420-SHCCER) Slip-on spout for 1/2" C.W.T.
- WaterSense® certified product: 1.75 gpm, @ 80 psi



Part #	Mfg #	Description	Handle(s)	Finish	Price
092596	T13420-SHC	Tub & Shower Trim, 5-1/2" Pull-Up Diverter Spout	ADA lever	Chrome	
174002	T13420-SSHC	Tub & Shower Trim, 5-1/2" Pull-Up Diverter Spout	ADA lever	Stainless*	
166690	T13420-SHCCER	T&S Trim, 7" Slip-On Div Spout, MultiChoice® Ceramic Cartridge Chrome		ADA Lever	
157014	T13420-PBSHCCE R	T&S Trim, 7" Slip-On Div Spout, MultiChoice® Ceramic Cartridge Polished Brass*		ADA Lever	
092598	T13420-PBSHCPD	Tub & Shower Trim, 6" Pull-Down Div Spt	ADA Lever	Polished Brass*	

\* Brilliance® Anti-Tarnish Lifetime Finishes

## Tub & Shower Faucets

### Foundations® Monitor® 13 Series 1-Hdl Tub & Shower Trim

- Fits MultiChoice® universal valve
- Handle adjusts temperature
- Full body 2" showerhead
- Slip onto 1/2" CWT
- Removable threaded adapter for 1/2" IPS
- WaterSense® certified product
- 1.75 gpm @ 80 psi



Part #	Mfg #	Description	Handle(s)	Finish	Price
133789	BT13410	Tub & Shower Trim, 5-3/8" Pull-Up Tub Spout	ADA Lever	Chrome	
139320	BT13410-SS	Tub & Shower Trim, 5-3/8" Pull-Up Tub Spout	ADA Lever	Stainless*	

### Monitor® 14 Series Tub & Shower Trim

#### Addison™ Monitor® 14 Series 1-Hdl Tub & Shower Trim

- Fits MultiChoice™ universal valve
- Handle adjusts temperature
- Sweat onto 1/2" C.W.T or thread onto 1/2" IPS
- H2Okinetic technology® 6" rain can showerhead
- Self-cleaning H2Okinetic® spray holes
- WaterSense® certified product
- 1.75 gpm @ 80 psi



Part #	Mfg #	Description	Handle(s)	Finish	Price
128169	T14492	Tub & Shower Trim, 7-1/2" Pull-Up Diverter Spout	ADA Lever	Chrome	
137913	T14492-CZ	Tub & Shower Trim, 7-1/2" Pull-Up Diverter Spout Bronze™	ADA Lever	Champagne	
129835	T14492-RB	Tub & Shower Trim, 7-1/2" Pull-Up Diverter Spout	ADA Lever	Venetian Bronze®	
130260	T14492-SS	Tub & Shower Trim, 7-1/2" Pull-Up Diverter Spout	ADA Lever	Stainless*	
231758	T14492-LHD	Tub & Shower Trim, 7-1/2" Pull-Up Div Spout, Less Head	ADA Lever	Chrome	

### Ara™ Monitor® 14 Series 1-Hdl Tub & Shower Trim

- Fits MultiChoice™ universal valve
- Single-function pressure balance cartridge
- Handle adjusts temperature
- 6-1/4" Pull-up diverter spout
- Sweat onto 1/2" CWT or thread onto 1/2" IPS
- (T14467, T14467-SS) WaterSense® certified product: 1.75 gpm @ 80 psi



Part #	Mfg #	Description	Handle(s)	Finish	Price
165653	T14467	Tub & Shower Trim, 6-1/4" Div Spout, H2O Showerhead	ADA Lever	Chrome	
240268	T14467-BL	Tub & Shower Trim, 6-1/4" Div Spout, H2O Showerhead	ADA Lever	Matte Black	
162251	T14467-SS	Tub & Shower Trim, 6-1/4" Div Spout, H2O Showerhead	ADA Lever	Stainless*	
180995	T14467-LHD	Tub & Shower Trim, 6-1/4" Div Spout, Less Head	ADA Lever	Chrome	

\* Brilliance® Anti-Tarnish Lifetime Finishes

[www.plumbsupply.com](http://www.plumbsupply.com) • Serving our Customers Since 1946 • [www.waterconcepts.net](http://www.waterconcepts.net)



## Tub & Shower Faucets

### Monitor® 14 Series Tub & Shower Trim (Continued)

#### Ara™ Monitor® 14 Series 1-Hdl Tub & Shower Trim

Part #	Mfg #	Description	Handle(s)	Finish	Price
177469	T14467-SSLHD	Tub & Shower Trim, 6-1/4" Div Spt Less Head	ADA Lever	Stainless*	

#### Ara™ Monitor 14 Series 1-Hdl Tub & Shower Trim with H2Okinetic®

- Fits MultiChoice™ universal valve
- Handle adjusts temperature
- H2Okinetic® 4" raincan showerhead
- Self-Cleaning H2Okinetic® spray holes
- Sweat onto 1/2" C.W.T. or thread onto 1/2" IPS
- WaterSense® certified product: 1.5 gpm @ 80 psi



Part #	Mfg #	Description	Handle(s)	Finish	Price
174340	T14467-H2O	Tub & Shower Trim, 7-1/8" Diverter Spout	ADA Lever	Chrome	
175937	T14467-SSH2O	Tub & Shower Trim, 7-1/8" Diverter Spout	ADA Lever	Stainless*	

#### Ara™ Temp2O® Angular Modern 1-Hdl Tub & Shower Trim

- Fits MultiChoice™ universal valve
- Touch-Clean® spray holes
- Temp2O® Technology
- Self-cleaning H2Okinetic® spray holes
- Digital temperature display with color indication
- Handle adjusts temperature
- Sweat onto 1/2" CWT or thread onto 1/2" IPS
- 3-Setting H2Okinetic® 8" raincan showerhead
- WaterSense® certified product: 2.0 gpm @ 80 psi



Part #	Mfg #	Description	Handle(s)	Finish	Price
173079	T14401-T2O	Tub & Shower Trim, 7-1/8" Pull-Up Div Spout	ADA Lever	Chrome	
176971	T14401-SST2O	Tub & Shower Trim, 7-1/8" Pull-Up Div Spout	ADA Lever	Stainless*	

\* Brilliance® Anti-Tarnish Lifetime Finishes



## Tub & Shower Faucets

### Ashlyn™ Monitor® 14 Series 1-Hdl Tub & Shower Trim

- Fits MultiChoice™ universal valve
- Sweat onto 1/2" CWT or thread onto 1/2" IPS
- Handle adjusts temperature
- Touch-Clean® 5-1/4" raincan showerhead
- WaterSense® certified product: 1.75 gpm @ 80 psi
- **(-LHD) Showerhead Sold Separately**



Part #	Mfg #	Description	Handle(s)	Finish	Price
173154	T14464	Tub & Shower Trim, 7-15/16" Pull-Up Diverter Spout	ADA Lever	Chrome	
173156	T14464-RB	Tub & Shower Trim, 7-15/16 " Pull-Up Diverter Spout	ADA Lever	Venetian Bronze®	
170526	T14464-SS	Tub & Shower Trim, 7-15/16 " Pull-Up Diverter Spout	ADA Lever	Stainless*	
222505	T14464-LHD	Tub & Shower Trim, 7-15/16" Pull-Up Divr Spt Less Head	ADA Lever	Chrome	
228394	T14464-RBLHD	Tub & Shower Trim, 7-15/16" Pull-Up Divr Spt Less Head	ADA Lever	Venetian Bronze®	
185951	T14464-SSLHD	Tub & Shower Trim, 7-15/16" Diverter Spout Less Head	ADA Lever	Stainless*	

### Cassidy™ Monitor 14 Series 1-Hdl Tub & Shower Trim

- Fits MultiChoice™ universal valve
- Handle adjusts temperature
- Sweat onto 1/2" CWT or thread onto 1/2" IPS
- H2Okinetic® 8" raincan showerhead with self-cleaning spray holes
- WaterSense® certified product: 1.75 gpm @ 80 psi
- **(-LHP) Handle sold separately**



Part #	Mfg #	Description	Handle(s)	Finish	Price
151996	T14497-LHP	Tub & Shower Trim, 7-2/3" Div Spt	Less Handles	Chrome	
182756	T14497-CZLHP	Tub & Shower Trim, 7-2/3" Div Spt Bronze™	Less Handles	Champagne	
153341	T14497-PNLHP	Tub & Shower Trim, 7-2/3" Div Spt	Less Handles	Polished Nickel*	
152960	T14497-RBLHP	Tub & Shower Trim, 7-2/3" Div Spt	Less Handles	Venetian Bronze®	
153498	T14497-SSLHP	Tub & Shower Trim, 7-2/3" Div Spt	Less Handles	Stainless*	
174088	T14497-LHP-LHD	Tub & Shower Trim, 7-2/3" Div Spt, Less Showerhead	Less Handles	Chrome	
171306	T14497-SSLHP-LHD	Tub & Shower Trim, 7-2/3" Div Spt, Less Showerhead	Less Handles	Stainless*	

\* Brilliance® Anti-Tarnish Lifetime Finishes

[www.plumbsupply.com](http://www.plumbsupply.com) • Serving our Customers Since 1946 • [www.waterconcepts.net](http://www.waterconcepts.net)

## Tub & Shower Faucets

### Compel™ Monitor 14 Series 1-Hdl Tub & Shower Trim

- Fits MultiChoice™ universal valve
- Handle adjusts temperature
- H2Okinetic® 5-1/2" raincan showerhead
- Self-cleaning H2Okinetic® spray holes
- Sweat onto 1/2" CWT or thread onto 1/2" IPS
- WaterSense® certified product: 1.75 gpm @ 80 psi



Part #	Mfg #	Description	Handle(s)	Finish	Price
157512	T14461	Tub & Shower Trim, 7" Pull-Down Spout	ADA Lever	Chrome	
161007	T14461-LHD	Tub & Shower Trim, 7" Pull-Down Spout, Less Head	ADA Lever	Chrome	
156779	T14461-SS	Tub & Shower Trim, 7" Pull-Down Spout	ADA Lever	Stainless*	
230520	T14461-SSLHD	Tub & Shower Trim, 7" Pull-Down Spout, Less Head	ADA Lever	Stainless*	

### Dryden™ Monitor® 14 Series 1-Hdl Tub & Shower Trim

- Fits MultiChoice® universal valve
- Handle adjusts temperature
- Touch-Clean® rain can showerhead
- Sweat onto 1/2" CWT or thread onto 1/2" IPS
- 2.5 gpm @ 80 psi for standard models
- -H2O & -WE models: WaterSense® certified 1.75 gpm @ 80 psi



Part #	Mfg #	Description	Handle(s)	Finish	Price
116299	T14451	Tub & Shower Trim, 6-1/4" Pull-Up Diverter Spout	ADA Lever	Chrome	
158508	T14451-CZ	Tub & Shower Trim, 6-1/4" Pull-Up Diverter Spout Bronze™	ADA Lever	Champagne	
214819	T14451-PN	Tub & Shower Trim, 6-1/4" Pull-Up Diverter Spout	ADA Lever	Polished Nickel*	
244039	T14451-PN-WE	Tub & Shower Trim, 6-1/4" Pull-Up Diverter Spout	ADA Lever	Polished Nickel*	
116301	T14451-RB	Tub & Shower Trim, 6-1/4" Pull-Up Diverter Spout	ADA Lever	Venetian Bronze®	
116302	T14451-SS	Tub & Shower Trim, 6-1/4" Pull-Up Diverter Spout	ADA Lever	Stainless*	
247416	T14451-SP	Tub & Shower Trim, 6-1/4" Pull-Up Diverter Spout	ADA Lever	Spotshield Stainless*	
162272	T14451-H2O	Tub & Shower Trim, 6-1/4" Pull-Up Diverter Spout	ADA Lever	Chrome	
226544	T14451-PNH2O	Tub & Shower Trim, 6-1/4" Pull-Up Diverter Spout	ADA Lever	Polished Nickel*	
168325	T14451-RBH2O	Tub & Shower Trim, 6-1/4" Pull-Up Diverter Spout	ADA Lever	Venetian Bronze®	
171798	T14451-SSH2O	Tub & Shower Trim, 6-1/4" Pull-Up Diverter Spout	ADA Lever	Stainless*	
174474	T14451-LHD	Tub & Shower Trim, 6-1/4" Pull-Up Diverter Spout	ADA Lever	Chrome	

\* Brilliance® Anti-Tarnish Lifetime Finishes

## Tub & Shower Faucets

### Lahara™ Monitor® 14 Series 1-Hdl Tub & Shower Trim

- Fits MultiChoice™ universal valve
- Handle adjusts temperature
- Sweat onto 1/2" C.W.T. or thread onto 1/2" IPS
- Touch-Clean® full body showerhead
- WaterSense® certified product
- 1.75 gpm @ 80 psi
- H2O models - 1.5 gpm



Part #	Mfg #	Description	Handle(s)	Finish	Price
110985	T14438	Tub & Shower Trim, 6-3/4" Pull-Up Spout	ADA Lever	Chrome	
156450	T14438-CZ	Tub & Shower Trim, 6-3/4" Pull-Up Spout Bronze™	ADA Lever	Champagne	
110987	T14438-RB	Tub & Shower Trim, 6-3/4" Pull-Up Spout	ADA Lever	Venetian Bronze®	
110988	T14438-SS	Tub & Shower Trim, 6-3/4" Pull-Up Spout	ADA Lever	Stainless*	
132447	T14438-RBH2O	Tub & Shower Trim, 5-1/2" Spout, H2OKinetic Showerhead	ADA Lever	Venetian Bronze®	
180448	T14438-LHD	Tub & Shower Trim, 6-3/4" Pull-Up Spout Less Showerhead	ADA Lever	Chrome	
170039	T14438-SSLHD	Tub & Shower Trim, 6-3/4" Pull-Up Spout Less Showerhead	ADA Lever	Stainless*	

### Leland® Monitor® 14 Series Tub & Shower Trim

- Fits MultiChoice™ universal valve
- Handle adjusts temperature
- Sweat onto 1/2" CWT or thread onto 1/2" IPS
- Touch-Clean™ 4-setting showerhead
- WaterSense® certified product: 1.75 gpm @ 80 psi



Part #	Mfg #	Description	Handle(s)	Finish	Price
169503	T14478-RBSHCCE R	Tub & Shower Trim, 5-1/2" Pull-Up Diverter Spout	ADA Lever	Venetian Bronze®	
164706	T14478-SSSHCCE R	Tub & Shower Trim, 5-1/2" Pull-Up Diverter Spout	ADA Lever	Stainless*	

\* Brilliance® Anti-Tarnish Lifetime Finishes

## Tub & Shower Faucets

### Linden™ Monitor® 14 Series 1-Hdl Tub & Shower Trim

- Fits MultiChoice™ universal valve
- Handle adjusts temperature
- Sweat onto 1/2" CWT or thread onto 1/2" IPS
- Touch-Clean® showerhead
- 1.75 gpm @ 80 psi
- WaterSense® certified (H2O) 1.5 gpm @ 80 psi



T14494

H2O

T14493

Part #	Mfg #	Description	Handle(s)	Finish	Price
225483	T14493	Tub & Shower Trim, 6-1/2" Tub Spout	ADA Lever	Chrome	
222402	T14493-RB	Tub & Shower Trim, 6-1/2" Tub Spout	ADA Lever	Venetian Bronze®	
223249	T14493-SS	Tub & Shower Trim, 6-1/2" Tub Spout	ADA Lever	Stainless*	
144713	T14494	Tub & Shower Trim, 6-1/2" Tub Spout	ADA Lever	Chrome	
145171	T14494-CZ	Tub & Shower Trim, 6-1/2" Tub Spout Bronze™	ADA Lever	Champagne	
143316	T14494-RB	Tub & Shower Trim, 6-1/2" Tub Spout	ADA Lever	Venetian Bronze®	
143399	T14494-SS	Tub & Shower Trim, 6-1/2" Tub Spout	ADA Lever	Stainless*	
252824	T14494-RBSOS	Tub & Shower Trim, 6-1/2" Tub Spout	ADA Lever	Venetian Bronze	
154145	T14494-H2O	Tub & Shower Trim, 6-1/2" Tub Spout, H2Okynamic®	ADA Lever	Chrome	
172877	T14494-RBH2O	Tub & Shower Trim, 6-1/2" Tub Spout, H2Okynamic®	ADA Lever	Venetian Bronze®	
163981	T14494-SSH2O	Tub & Shower Trim, 6-1/2" Tub Spout, H2Okynamic®	ADA Lever	Stainless*	

### Pivotal® Monitor® 14 Series 1-Hdl Tub & Shower Trim

- Fits MultiChoice® universal valve
- Handle adjusts temperature
- H2Okynamic® 5-3/4" 5-setting showerhead
- Single function pressure balance cartridge
- WaterSense® certified: 1.75 gpm @ 80 psi



Part #	Mfg #	Description	Handle(s)	Finish	Price
251344	T14499	Tub & Shower Trim, 9" Tub Spout	ADA Lever	Chrome	
257305	T14499-BL	Tub & Shower Trim, 9" Tub Spout	ADA Lever	Matte Black	
253170	T14499-SS	Tub & Shower Trim, 9" Tub Spout	ADA Lever	Stainless*	

\* Brilliance® Anti-Tarnish Lifetime Finishes

## Tub & Shower Faucets

### Stryke™ Monitor® 14 Series 1-Hdl Tub & Shower Trim

- Fits MultiChoice® universal valve
- 120° Maximum handle rotation
- 1/2"-14 NPT
- Five-setting H2Okinetic® 6" showerhead
- WaterSense® certified: 1.75 gpm @ 80 psi
- (-LHD) Less shower head



Part #	Mfg #	Description	Handle(s)	Finish	Price
259906	T14476-LHD	Tub & Shower Trim, 8-5/16" Pull-Up Div Spout, Less Head	ADA Lever	Chrome	
257613	T14476-BL	Tub & Shower Trim, 8-5/16" Pull-Up Div Spout	ADA Lever	Matte Black	
257873	T14476-CZ	Tub & Shower Trim, 8-5/16" Pull-Up Div Spout Bronze™	ADA Lever	Champagne	
257144	T14476-SS	Tub & Shower Trim, 8-5/16" Pull-Up Div Spout	ADA Lever	Stainless*	
259222	T144766-BL	Tub & Shower Trim, 8-5/16" Pull-Up Div Spout	ADA Cross	Matte Black	

### Tesla® Monitor® 14 Series 1-Hdl Tub & Shower Trim

- Fits MultiChoice® universal valve
- Handle adjusts temperature
- Sweat onto 1/2" C.W.T. or thread onto 1/2" IPS
- H2Okinetic® 7-1/2" showerhead
- WaterSense® certified: 1.75 gpm @ 80 psi



Part #	Mfg #	Description	Handle(s)	Finish	Price
233664	T14452	Tub & Shower Trim, 5-1/2" Pull-Up Div Spout	ADA Lever	Chrome	
184440	T14452-SS	Tub & Shower Trim, 5-1/2" Pull-Up Div Spout	ADA Lever	Stainless*	
186917	T14452-LHD	Tub & Shower Trim, 5-1/2" Pull-Up Div Spout, LESS Head	ADA Lever	Chrome	

### Trinsic™ Monitor® 14 Series 1-Hdl Tub & Shower Trim

- Fits MultiChoice® universal valve
- Handle adjusts temperature
- 6-1/8" Diverter spout
- H2Okinetic® 5-1/2" showerhead
- Sweat onto 1/2" C.W.T. or thread onto 1/2" IPS
- WaterSense® certified product: 1.75 gpm @ 80 psi



Part #	Mfg #	Description	Handle(s)	Finish	Price
153086	T14459	Tub & Shower Trim, 6-1/8" Diverter Spout	ADA Lever	Chrome	
233974	T14459-BL	Tub & Shower Trim, 6-1/8" Diverter Spout	ADA Lever	Matte Black	
153087	T14459-CZ	Tub & Shower Trim, 6-1/8" Diverter Spout Bronze™	ADA Lever	Champagne	

\* Brilliance® Anti-Tarnish Lifetime Finishes

[www.plumbsupply.com](http://www.plumbsupply.com) • Serving our Customers Since 1946 • [www.waterconcepts.net](http://www.waterconcepts.net)



## Tub & Shower Faucets

### Monitor® 14 Series Tub & Shower Trim (Continued)

#### Trinsic™ Monitor® 14 Series 1-Hdl Tub & Shower Trim

Part #	Mfg #	Description	Handle(s)	Finish	Price
153088	T14459-RB	Tub & Shower Trim, 6-1/8" Diverter Spout	ADA Lever	Venetian Bronze®	
153089	T14459-SS	Tub & Shower Trim, 6-1/8" Diverter Spout	ADA Lever	Stainless*	
160461	T14459-LHD	Tub & Shower Trim, 6-1/8" Div Spout, Less Head	ADA Lever	Chrome	
242603	T14459-BLLHD	Tub & Shower Trim, 6-1/8" Diverter Spout, Less Head	ADA Lever	Matte Black	
178605	T14459-SSLHD	Tub & Shower Trim, 6-1/8" Div Spout, Less Head	ADA Lever	Stainless*	

#### Temp2O® Traditional 14 Series 1-Hdl Tub & Shower Trim

- Fits MultiChoice™ universal valve
- Temp2O™ technology
- 3-Setting 8" H2Okinetic® raincan showerhead
- Handle adjusts temperature
- Sweat onto 1/2" CWT or thread onto 1/2" IPS
- Touch-Clean® spray holes
- Self-cleaning H2Okinetic® spray holes
- WaterSense® certified product: 2.0 gpm @ 80 psi



Part #	Mfg #	Description	Handle(s)	Finish	Price
168076	T14400-T2O	Tub & Shower Trim, 6-1/2" Pull-Up Tub Spout	ADA Lever	Chrome	
172017	T14400-SST2O	Tub & Shower Trim, 6-1/2" Pull-Up Tub Spout	ADA Lever	Stainless*	

#### Transitional 14 Series Temp2O® 1-Hdl Tub & Shower Trim

- Fits MultiChoice™ universal valve
- Temp2O™ Technology
- H2Okinetic® Three-setting showerhead
- Handle adjusts temperature
- Self-cleaning H2Okinetic® spray holes
- Touch-Clean® spray holes
- Sweat onto 1/2" CWT or thread onto 1/2" IPS
- WaterSense® certified product: 2.0 gpm @ 80 psi



Part #	Mfg #	Description	Handle(s)	Finish	Price
174950	T14403-PNT2O	Tub & Shower Trim, 6-3/4" Pull-Up Div Spout	ADA Lever	Polished Nickel*	
185338	T14403-SST2O	Tub & Shower Trim, 6-3/4" Pull-Up Div Spout	ADA Lever	Stainless*	

\* Brilliance® Anti-Tarnish Lifetime Finishes



## Tub & Shower Faucets

### Vero™ Monitor® 14 Series 1-Hdl Tub & Shower Trim

- Fits MultiChoice™ universal valve
- Handle adjusts temperature
- Sweat onto 1/2" CWT or thread onto 1/2" IPS
- WaterSense® certified: 1.75 gpm @ 80 psi



Part #	Mfg #	Description	Handle(s)	Finish	Price
134783	T14453	T&S Trim, 7-1/8" Div Spout, Touch-Clean® Head	ADA Lever	Chrome	
159333	T14453-RB	T&S Trim, 7-1/8" Div Spout, Touch-Clean® Head	ADA Lever	Venetian Bronze®	
134784	T14453-SS	T&S Trim, 7-1/8" Div Spout, Touch-Clean® Head	ADA Lever	Stainless*	
188279	T14453-LHD	T&S Trim, 7-1/8" Div Spout, Less Showerhead	ADA Lever	Chrome	
155691	T14453-H2O	T&S Trim, 7-1/8" Div Spout, H2Okynamic® Head	ADA Lever	Chrome	
256569	T14453-CZH2O	T&S Trim, 7-1/8" Div Spout, H2Okynamic® Head Bronze™	ADA Lever	Champagne	
150724	T14453-RBH2O	T&S Trim, 7-1/8" Div Spout, H2Okynamic® Head	ADA Lever	Venetian Bronze®	
150516	T14453-SSH2O	T&S Trim, 7-1/8" Div Spout, H2Okynamic® Head	ADA Lever	Stainless*	

### Victorian® Monitor® 14 Series 1-Hdl Tub & Shower Trim

- Fits MultiChoice™ universal valve
- Handle adjusts temperature
- Sweat onto 1/2" CWT or thread onto 1/2" IPS
- 2.5 gpm @ 80 psi
- H2O model-WaterSense® certified: 1.75 gpm @ 80 psi



Part #	Mfg #	Description	Handle(s)	Finish	Price
092745	T14455-LHP	T&S Trim, 6-1/2" Div Spout, Touch-Clean® Head	Less Handle	Chrome	
092751	T14455-RBLHP	T&S Trim, 6-1/2" Div Spout, Touch-Clean® Head	Less Handle	Venetian Bronze®	
092752	T14455-SSLHP	T&S Trim, 6-1/2" Div Spout, Touch-Clean® Head	Less Handle	Stainless*	
240963	T14455-RBH2OLH P	T & S Trim, 7-1/2" Div Spout, H2Okynamic® Head	Less Handle	Venetian Bronze®	
169764	T14455-SSH2OLH P	T&S Trim, 6-1/2" Div Spout, H2Okynamic® Head	Less Handle	Stainless*	

\* Brilliance® Anti-Tarnish Lifetime Finishes

## Tub & Shower Faucets

### Windemere® Monitor® 14 Series 1-Hdl Tub & Shower Trim

- Fits MultiChoice™ universal valve
- Handle adjusts temperature
- Slip onto 1/2" C.W.T.
- Removable threaded adapter for 1/2" IPS
- Full body 6" raincan showerhead
- WaterSense® certified product
- 1.75 gpm @ 80 psi



Part #	Mfg #	Description	Handle(s)	Finish	Price
132753	BT14496	Tub & Shower Trim, 5-3/8" Pull-Up Div Spout	ADA Lever	Chrome	
133543	BT14496-OB	Tub & Shower Trim, 5-3/8" Pull-Up Div Spout	ADA Lever	Oil Rubbed Bronze	
135987	BT14496-SS	Tub & Shower Trim, 5-3/8" Pull-Up Div Spout	ADA Lever	Stainless*	

### Woodhurst™ Monitor® 14 Series 1-Hdl Tub & Shower Trim

- Fits MultiChoice™ universal valve
- Handle adjusts temperature
- Tri-Universal adapter for thread 1/2 IPS, Sweat 1/2" C.W.T., or slip onto 1/2" C.W.T
- Single-function pressure balance cartridge valve
- Full body 5-7/8" TouchClean® raincan showerhead
- WaterSense® certified product: 1.75 gpm @ 80 psi



Part #	Mfg #	Description	Handle(s)	Finish	Price
252353	T14432	Tub & Shower Trim, 6-1/2" Pull-Up Div Spout	ADA Lever	Chrome	
251181	T14432-RB	Tub & Shower Trim, 6-1/2" Pull-Up Div Spout	ADA Lever	Venetian Bronze	
249520	T14432-SS	Tub & Shower Trim, 6-1/2" Pull-Up Div Spout	ADA Lever	Stainless*	

### Zura® Monitor® 14 Series Tub & Shower Trim

- Features H2OKinetic® technology
- Soft, rubber Touch-Clean® spray holes
- Single-function pressure balance cartridge valve
- WaterSense® certified product: 1.75 gpm @ 80 psi
- 7-5/8" Shower head with three spray functions
- Spray settings: H2OKinetic spray and full body spray, and pause
- Trim kit only, must order MultiChoice® Universal Valve separately to complete the unit



Part #	Mfg #	Description	Handle(s)	Finish	Price
230344	T14474	6" Pull-Up Diverter Spout	ADA Lever	Chrome	
237624	T14474-SS	6" Pull-Up Diverter Spout	ADA Lever	Stainless*	

\* Brilliance® Anti-Tarnish Lifetime Finishes

## Tub & Shower Faucets

### Monitor® 17 Series Tub & Shower Trim

#### Addison™ Monitor® 17 Series Tub & Shower Trim

- Fits MultiChoice™ universal valve
- Handle adjusts volume
- Dial adjusts temperature
- Sweat onto 1/2" C.W.T. or thread into 1/2" IPS
- H2Okinetic® technology® 6" showerhead
- Self-cleaning H2Okinetic® spray holes
- WaterSense® certified product: 1.75 gpm @ 80 psi



Part #	Mfg #	Description	Handle(s)	Finish	Price
128424	T17492	Tub & Shower Trim, 7-1/2" Pull-Up Diverter Spout	ADA Lever	Chrome	
139329	T17492-CZ	Tub & Shower Trim, 7-1/2" Pull-Up Diverter Spout Bronze™	ADA Lever	Champagne	
129202	T17492-RB	Tub & Shower Trim, 7-1/2" Pull-Up Diverter Spout	ADA Lever	Venetian Bronze®	
128428	T17492-SS	Tub & Shower Trim, 7-1/2" Pull-Up Diverter Spout	ADA Lever	Stainless*	

#### Ara™ Monitor® 17 Series Tub & Shower Trim

- Fits MultiChoice™ universal valve
- H2Okinetic® 6" showerhead
- Handle adjusts volume, dial adjusts temperature
- Sweat onto 1/2" C.W.T. or thread onto 1/2" IPS
- Self-cleaning H2Okinetic® spray holes
- WaterSense® certified product: 1.75 gpm @ 80 psi



Part #	Mfg #	Description	Handle(s)	Finish	Price
170071	T17467	Tub & Shower Trim, 7-1/8" Pull-Up Div Spout	ADA Lever	Chrome	
256523	T17467-BL	Tub & Shower Trim, 7-1/8" Pull-Up Div Spout	ADA Lever	Matte Black	
180017	T17467-SS	Tub & Shower Trim, 7-1/8" Pull-Up Div Spout	ADA Lever	Stainless*	

#### Ashlyn® Monitor® 17 Series Tub & Shower Trim

- Fits MultiChoice® universal valve
- Handle adjusts volume, dial adjusts temperature
- Sweat onto 1/2" CWT or thread onto 1/2" IPS
- Touch-Clean® 5-1/4" raincan showerhead
- WaterSense® certified product: 1.75 gpm @ 80 psi



Part #	Mfg #	Description	Handle(s)	Finish	Price
174262	T17464	Tub & Shower Trim, 7-15/16" Pull-Up Div Spt	ADA Lever	Chrome	
185273	T17464-RB	Tub & Shower Trim, 7-15/16" Pull-Up Div Spt	ADA Lever	Venetian Bronze®	

\* Brilliance® Anti-Tarnish Lifetime Finishes

[www.plumbsupply.com](http://www.plumbsupply.com) • Serving our Customers Since 1946 • [www.waterconcepts.net](http://www.waterconcepts.net)

## Tub & Shower Faucets

### Monitor® 17 Series Tub & Shower Trim (Continued)

#### Ashlyn® Monitor® 17 Series Tub & Shower Trim

Part #	Mfg #	Description	Handle(s)	Finish	Price
176649	T17464-SS	Tub & Shower Trim, 7-15/16" Pull-Up Div Spt	ADA Lever	Stainless*	

#### Ashlyn® Monitor® 17 Series Tub & Shower Trim with In2ition®

- Fits MultiChoice™ universal valve
- In2ition® integrated showerhead and hand shower
- Touch-Clean® spray holes
- Handle adjusts volume, dial adjusts temperature
- Sweat onto 1/2" CWT or thread onto 1/2" IPS
- In2ition integrated showerhead and handshower
- 5-Setting handshower with Soft-Touch® grip
- 69" long UltraFlex® hose
- Plated spray face
- Maximum flow rate: 1.75 gpm @ 80 psi



Part #	Mfg #	Description	Handle(s)	Finish	Price
174455	T17464-I	Tub & Shower Trim, 7-15/16" Pull-Up Div Spt	ADA Lever	Chrome	
171776	T17464-RB-I	Tub & Shower Trim, 7-15/16" Pull-Up Div Spt	ADA Lever	Venetian Bronze®	
172467	T17464-SS-I	Tub & Shower Trim, 7-15/16" Pull-Up Div Spt	ADA Lever	Stainless*	

#### Cassidy™ Monitor 17 Series Tub & Shower Trim

- Fits MultiChoice™ universal valve
- H2Okinetic® 8" raincan showerhead
- Handle adjusts volume, dial adjusts temperature
- Sweat onto 1/2" CWT or thread onto 1/2" IPS
- Self-cleaning H2Okinetic® spray holes
- WaterSense® certified product: 1.75 gpm @ 80 psi



Part #	Mfg #	Description	Handle(s)	Finish	Price
152236	T17497	Tub & Shower Trim, 7-2/3" Pull-Up Div Spout	ADA Lever	Chrome	
188608	T17497-CZ	Tub & Shower Trim, 7-2/3" Pull-Up Div Spout Bronze™	ADA Lever	Champagne	
172788	T17497-PN	Tub & Shower Trim, 7-2/3" Pull-Up Div Spout	ADA Lever	Polished Nickel*	
151959	T17497-RB	Tub & Shower Trim, 7-2/3" Pull-Up Div Spout	ADA Lever	Venetian Bronze®	
151983	T17497-SS	Tub & Shower Trim, 7-2/3" Pull-Up Div Spout	ADA Lever	Stainless*	

\* Brilliance® Anti-Tarnish Lifetime Finishes

## Tub & Shower Faucets

### Classic Monitor® 17 Series Tub & Shower Trim

- Fits MultiChoice™ universal valve
- Handle adjusts volume, dial adjusts temperature
- Sweat onto 1/2" CWT or thread onto 1/2" IPS
- Touch-Clean® 3-setting showerhead
- WaterSense certified product: 1.75 gpm @ 80 psi



SOS=Slip-on spout for 1/2"



Part #	Mfg #	Description	Handle(s)	Finish	Price
092714	T17430	Tub & Shower Trim, 6-1/8" Div Spout	ADA Lever	Chrome	
153925	T17430-SS	Tub & Shower Trim, 6-1/8" Div Spout	ADA Lever	Stainless*	
155193	T17430-SSSOS	Tub & Shower Trim, 6-1/8" Div Spout w/ SOS	ADA Lever	Stainless*	

### Compel™ Monitor® 17 Series Tub & Shower Trim

- Fits MultiChoice™ universal valve
- Handle adjusts volume, dial adjusts temperature
- H2Okinetic® 5-1/2" raincan showerhead
- Self-cleaning H2Okinetic® spray holes
- Sweat onto 1/2" CWT or thread onto 1/2" IPS
- WaterSense® certified: 1.75 gpm @ 80 psi



Part #	Mfg #	Description	Handle(s)	Finish	Price
151179	T1746	Tub & Shower Trim, 7" Pull-Up Tub Spout	ADA Lever	Chrome	
161484	T17461-SS	Tub & Shower Trim, 7" Pull-Up Tub Spout	ADA Lever	Stainless*	

### Dryden™ Monitor® 17 Series Tub & Shower Trim

- Fits MultiChoice™ universal valve
- Handle adjusts volume, dial adjusts temperature
- Sweat onto 1/2" CWT or thread onto 1/2" IPS
- 2.5 gpm @ 80 psi
- H2O model-WaterSense® certified: 1.75 gpm @ 80 psi



Part #	Mfg #	Description	Handle(s)	Finish	Price
116307	T17451	T&S Trim, 6-1/4" Div Spout, Touch-Clean® Head	ADA Lever	Chrome	
146210	T17451-CZ	T&S Trim, 6-1/4" Div Spout, Touch-Clean® Head Bronze™	ADA Lever	Champagne	
178257	T17451-PN	T&S Trim, 6-1/4" Div Spout, Touch-Clean® Head	ADA Lever	Polished Nickel*	
116309	T17451-RB	T&S Trim, 6-1/4" Div Spout, Touch-Clean® Head	ADA Lever	Venetian Bronze®	
235226	T17451-SP	T&S Trim, 6-1/4" Div Spout, Touch-Clean® Head	ADA Lever	SpotShield Stainless	
116310	T17451-SS	T&S Trim, 6-1/4" Div Spout, Touch-Clean® Head	ADA Lever	Stainless*	
167372	T17451-H2O	T&S Trim, 6-1/4" Div Spout, H2Okinetic® Head	ADA Lever	Chrome	

\* Brilliance® Anti-Tarnish Lifetime Finishes

[www.plumbsupply.com](http://www.plumbsupply.com) • Serving our Customers Since 1946 • [www.waterconcepts.net](http://www.waterconcepts.net)



## Tub & Shower Faucets

### Monitor® 17 Series Tub & Shower Trim (Continued)

#### Dryden™ Monitor® 17 Series Tub & Shower Trim

Part #	Mfg #	Description	Handle(s)	Finish	Price
244078	T17451-CZH2O	T&S Trim, 6-1/4" Div Spout, H2Okinetic® Head Bronze™	ADA Lever	Champagne	
132424	T17451-SSH2O	T&S Trim, 6-1/4" Div Spout, H2Okinetic® Head	ADA Lever	Stainless*	

#### Lahara™ Monitor® 17 Series Tub & Shower Trim

- Fits MultiChoice™ universal valve
- Handle adjusts temperature, dial adjusts temperature
- Sweat onto 1/2" C.W.T or thread onto 1/2" IPS
- 1.75 gpm @ 80 psi



Part #	Mfg #	Description	Handle(s)	Finish	Price
111002	T17438	T&S Trim, 6-3/4" Div Spout, Touch-Clean® Head	ADA Lever	Chrome	
190192	T17438-CZ	T&S Trim, 6-3/4" Div Spout, Touch-Clean® Head Bronze™	ADA Lever	Champagne	
111004	T17438-RB	T&S Trim, 6-3/4" Div Spout, Touch-Clean® Head	ADA Lever	Venetian Bronze®	
111005	T17438-SS	T&S Trim, 6-3/4" Div Spout, Touch-Clean® Head	ADA Lever	Stainless*	
172474	T17438-H2O	T&S Trim, 6-3/4" Div Spout, H2Okinetic® Head	ADA Lever	Chrome	
160802	T17438-SSH2O	T&S Trim, 6-3/4" Div Spout, H2Okinetic® Head	ADA Lever	Stainless*	

#### Linden™ Monitor® 17 Series Tub & Shower Trim

- Fits MultiChoice™ universal valve
- Handle adjusts volume, dial adjusts temperature
- Sweat onto 1/2" CWT or thread onto 1/2" IPS
- H2Okinetic® 6-1/2" raincan showerhead
- Self-cleaning H2Okinetic® spray holes
- WaterSense® certified product, 1.75 gpm @ 80 psi



T17494

T17493



Part #	Mfg #	Description	Handle(s)	Finish	Price
190199	T17493	Tub & Shower Trim, 6-1/2" Pull-Up Div Spout	ADA Lever	Chrome	
227835	T17493-SS	Tub & Shower Trim, 6-1/2" Pull-Up Div Spout	ADA Lever	Stainless	
144786	T17494	Tub & Shower Trim, 6-1/2" Pull-Up Div Spout	ADA Lever	Chrome	
144071	T17494-RB	Tub & Shower Trim, 6-1/2" Pull-Up Div Spout	ADA Lever	Venetian Bronze®	
143647	T17494-SS	Tub & Shower Trim, 6-1/2" Pull-Up Div Spout	ADA Lever	Stainless*	

\* Brilliance® Anti-Tarnish Lifetime Finishes



## Tub & Shower Faucets

### Linden™ Monitor® 17 Series Shower Trim with In2ition®

- Fits MultiChoice™ universal valve
- In2ition® integrated showerhead and handshower
- Touch-Clean® spray holes
- Four-setting handshower
- 69" Long UltraFlex® hose
- Handle adjusts volume; dial adjusts temperature
- Sweat into 1/2" CWT or thread onto 1/2" IPS
- 1.75 gpm @ 80 psi



Part #	Mfg #	Description	Handle(s)	Finish	Price
230795	T17493-I	Tub & Shower Trim, 6-1/2" Div Spout w/ Handshower	ADA Lever	Chrome	
233414	T17493-RB-I	Tub & Shower Trim, 6-1/2" Div Spout w/ Handshower	ADA Lever	Venetian Bronze®	
236592	T17493-SS-I	Tub & Shower Trim, 6-1/2" Div Spout w/ Handshower	ADA Lever	Stainless*	
143817	T17494-I	Tub & Shower Trim, 6-1/2" Div Spout w/ Handshower	ADA Lever	Chrome	
144075	T17494-CZ-I	Tub & Shower Trim, 6-1/2" Div Spout w/ Handshower	ADA Lever	Champagne Brz™	
144263	T17494-RB-I	Tub & Shower Trim, 6-1/2" Div Spout w/ Handshower	ADA Lever	Venetian Bronze®	
143643	T17494-SS-I	Tub & Shower Trim, 6-1/2" Div Spout w/ Handshower	ADA Lever	Stainless*	

### Pivotal™ Monitor® 17 Series H2Okinetic® Tub & Shower Trim

- Fits MultiChoice™ universal valve
- Self-cleaning H2Okinetic® spray holes
- 9" Metal pull-up tub spout
- 5-Setting 6" raincan showerhead
  - Pause
  - Massage
  - Full body spray
  - H2Okinetic spray
  - Full spray with Massage
- Dual-function pressure balance cartridge
- Sweat spout onto 1/2" C.W.T or thread onto 1/2" IPS
- WaterSense® certified: 1.75 gpm @ 80 psi



Part #	Mfg #	Description	Handle(s)	Finish	Price
244513	T17499	Tub & Shower Trim, 9" Pull-Up Tub Spout	ADA Lever	Chrome	
251694	T17499-BL	Tub & Shower Trim, 9" Pull-Up Tub Spout	ADA Lever	Matte Black	
241825	T17499-SS	Tub & Shower Trim, 9" Pull-Up Tub Spout	ADA Lever	Stainless*	

\* Brilliance® Anti-Tarnish Lifetime Finishes

[www.plumbsupply.com](http://www.plumbsupply.com) • Serving our Customers Since 1946 • [www.waterconcepts.net](http://www.waterconcepts.net)

## Tub & Shower Faucets

### Stryke™ Monitor® 17 Series Tub & Shower Trim

- Fits MultiChoice™ universal valve
- Handle adjusts volume, dial adjusts temperature
- Universal fittings
- H2Okinetic® 5-Setting 6" raincan showerhead
- Self-cleaning H2Okinetic® spray holes
- WaterSense® certified product: 1.75 gpm @ 80 psi



Part #	Mfg #	Description	Handle(s)	Finish	Price
259784	T17476-BL	Tub & Shower Trim, 8-5/16" Pull-Up Diverter Spout	ADA Lever	Matte Black	

### Tesla® Monitor® 17 Series Tub & Shower Trim

- Fits MultiChoice™ universal valve
- Handle adjusts volume, dial adjusts temperature
- Sweat onto 1/2" C.W.T or thread onto 1/2" IPS
- H2Okinetic® 3-Setting 7-1/2" raincan showerhead
- Self-cleaning H2Okinetic® spray holes
- WaterSense® certified product: 1.75 gpm @ 80 psi



Part #	Mfg #	Description	Handle(s)	Finish	Price
188062	T17452	Tub & Shower Trim, 5-1/2" Pull-Up Diverter Spout	ADA Lever	Chrome	
181217	T17452-SS	Tub & Shower Trim, 5-1/2" Pull-Up Diverter Spout	ADA Lever	Stainless*	

### Trinsic® Monitor 17 Series Tub & Shower Trim

- Fits MultiChoice™ universal valve
- Handle adjusts volume, dial adjusts temperature
- Sweat onto 1/2" C.W.T or thread onto 1/2" IPS
- H2Okinetic® 5-1/2" raincan showerhead
- Self-cleaning H2Okinetic® spray holes
- WaterSense® certified product: 1.75 gpm @ 80 psi



Part #	Mfg #	Description	Handle(s)	Finish	Price
153350	T17459	Tub & Shower Trim, 6-1/8" Pull-Up Diverter Spout	ADA Lever	Chrome	
245628	T17459-BL	Tub & Shower Trim, 6-1/8" Pull-Up Diverter Spout	ADA Lever	Matte Black	
179562	T17459-CZ	Tub & Shower Trim, 6-1/8" Pull-Up Diverter Spout Bronze™	ADA Lever	Champagne	
172057	T17459-RB	Tub & Shower Trim, 6-1/8" Pull-Up Diverter Spout	ADA Lever	Venetian Bronze®	
156458	T17459-SS	Tub & Shower Trim, 6-1/8" Pull-Up Diverter Spout	ADA Lever	Stainless*	
231174	T17459-SSLHD	Tub & Shower Trim, 6-1/8" Pull-Up Div Spout, Less Head	ADA Lever	Stainless*	

\* Brilliance® Anti-Tarnish Lifetime Finishes

## Tub & Shower Faucets

### Vero™ Monitor® 17 Series Tub & Shower Trim

- Fits MultiChoice® universal valve
- Handle adjusts temperature, dial adjusts volume
- Sweat onto 1/2" CWT or thread onto 1/2" IPS
- Maximum flow rate: 2.5 gpm @ 80 psi
- Standard models: 2.5 gpm @ 80 psi
- 1.75 gpm @ 80 psi for models with -H2O & -WE suffix



Part #	Mfg #	Description	Handle(s)	Finish	Price
147589	T17453	T&S Trim, 6-1/2" Div Spout, Touch-Clean® Head	ADA Lever	Chrome	
146149	T17453-CZ	T&S Trim, 6-1/2" Div Spout, Touch-Clean® Head Bronze™	ADA Lever	Champagne	
154169	T17453-RB	T&S Trim, 6-1/2" Div Spout, Touch-Clean® Head	ADA Lever	Venetian Bronze®	
135685	T17453-SS	T&S Trim, 6-1/2" Div Spout, Touch-Clean® Head	ADA Lever	Stainless*	
137220	T17453-H2O	T&S Trim, 6-1/2" Div Spout, H2Okinetic® Head	ADA Lever	Chrome	
137219	T17453-SSH2O	T&S Trim, 6-1/2" Div Spout, H2Okinetic® Head	ADA Lever	Stainless*	
253695	T17453-SS-WE	T&S Trim, 6-1/2" Div Spout, Touch-Clean® Head	ADA Lever	Stainless*	

### Victorian™ Monitor® 17 Series Tub & Shower Trim

- Fits MultiChoice™ universal valve
- Handle adjusts volume, dial adjusts temperature
- Sweat onto 1/2" CWT or thread onto 1/2" IPS
- 2.5 gpm @ 80 psi
- H2O Model-WaterSense® certified: 1.75 gpm @ 80 psi



Part #	Mfg #	Description	Handle(s)	Finish	Price
092849	T17455	T&S Trim, 6-1/2" Div Spout, Touch-Clean® Head	ADA Lever	Chrome	
170224	T17455-CZ	T&S Trim, 6-1/2" Div Spout, Touch-Clean® Head	ADA Lever	Champagne Bronze™	
092855	T17455-RB	T&S Trim, 6-1/2" Div Spout, Touch-Clean® Head	ADA Lever	Venetian Bronze®	
092856	T17455-SS	T&S Trim, 6-1/2" Div Spout, Touch-Clean® Head	ADA Lever	Stainless*	
162314	T17455-RBH2O	T&S Trim, 6-1/2" Div Spout, H2Okinetic® Head	ADA Lever	Venetian Bronze®	
163294	T17455-SSH2O	T&S Trim, 6-1/2" Div Spout, H2Okinetic® Head	ADA Lever	Stainless*	

\* Brilliance® Anti-Tarnish Lifetime Finishes

## Tub & Shower Faucets

### Zura® Monitor 17 Series Tub & Shower Trim

- Fits MultiChoice® universal valve
- Touch-Clean® spray holes
- H2Okinetic® technology
- Three spray settings
  - Full body spray
  - Pause spray
  - H2Okinetic® spray
- Dual-function pressure balance cartridge valve
- WaterSense® certified product: 1.75 gpm @ 80 psi



Part #	Mfg #	Description	Handle(s)	Finish	Price
238474	T17474	T&S Trim, 7-1/4" Pull-Up Div Spout	ADA Lever	Chrome	
229316	T17474-SS	T&S Trim, 7-1/4" Pull-Up Div Spout	ADA Lever	Stainless*	

### TempAssure® 17T Series Tub & Shower Trim

#### Addison® TempAssure® 17T Series Tub & Shower Trim

- Fits MultiChoice™ universal valve
- Handle adjusts volume, dial adjusts temperature
- Sweat onto 1/2" CWT or thread onto 1/2" IPS
- H2Okinetic 8" raincan showerhead
- Self-cleaning H2Okinetic® spray holes
- 2.5 gpm @ 80 psi



Part #	Mfg #	Description	Handle(s)	Finish	Price
184873	T17T492	Tub & Shower Trim, 7-1/2" Pull-Up Div Spout	ADA Lever	Chrome	

### Ara® TempAssure® 17T Series Tub & Shower Trim

- Fits MultiChoice® universal valve
- Handle adjusts volume, dial adjusts temperature
- Sweat onto 1/2" CWT or thread onto 1/2" IPS
- H2Okinetic® 6" raincan showerhead
- Self-cleaning H2Okinetic® spray holes
- WaterSense® certified product: 1.75 gpm



Part #	Mfg #	Description	Handle(s)	Finish	Price
177474	T17T467	Tub & Shower Trim, 7-1/8" Pull-Up Div Spout	ADA Lever	Chrome	
177475	T17T467-SS	Tub & Shower Trim, 7-7/8" Pull-Up Div Spout	ADA Lever	Stainless*	

\* Brilliance® Anti-Tarnish Lifetime Finishes

## Tub & Shower Faucets

### Cassidy™ TempAssure® 17T Series Tub & Shower Trim

- Fits MultiChoice® universal valve
- Handle adjusts volume, dial adjusts temperature
- Sweat into 1/2" C.W.T. or thread into 1/2" IPS
- Touch-Clean® 9-3/8" raincan showerhead
- Flow rate: 2.5 gpm @ 80 psi
- WaterSense certified product: 1.75 @ 80 psi



Part #	Mfg #	Description	Handle(s)	Finish	Price
212109	T17T497	Tub & Shower Trim, 6-1/2" Pull-Up Diverter Spout	ADA Lever	Chrome	
251049	T17T497-PN	Tub & Shower Trim, 6-1/2" Pull-Up Diverter Spout	ADA Lever	Polished Nickel*	
173984	T17T497-RB	Tub & Shower Trim, 6-1/2" Pull-Up Diverter Spout	ADA Lever	Venetian Bronze®	
155377	T17T497-SS	Tub & Shower Trim, 6-1/2" Pull-Up Diverter Spout	ADA Lever	Stainless*	
254377	T17T497-WE	Tub & Shower Trim, 6-1/2" Pull-Up Diverter Spout	ADA Lever	Chrome	

### Compel® TempAssure® 17T Series Tub & Shower Trim

- Fits MultiChoice™ universal valve
- Handle adjusts volume, dial adjusts temperature
- Sweat onto 1/2" CWT or thread onto 1/2" IPS
- H2Okinetic 7-3/4" raincan showerhead
- Self-cleaning H2Okinetic® spray holes
- Touch-Clean® spray holes
- WaterSense® certified product: 1.75 gpm @ 80 psi



Part #	Mfg #	Description	Handle(s)	Finish	Price
182289	T17T461-SSH2O	Tub & Shower Trim, 7" Pull-Up Diverter Spout	ADA Lever	Stainless*	

### Dryden™ TempAssure® 17T Series Tub & Shower Trim

- Fits MultiChoice® universal valve
- Handle adjusts volume, dial adjusts temperature
- Sweat onto 1/2" CWT or thread onto 1/2" IPS
- Touch-Clean® 6-9/16" raincan showerhead
- Flow rate: 2.5 gpm @ 80 psi



Part #	Mfg #	Description	Handle(s)	Finish	Price
240960	T17T451-PN	Tub & Shower Trim, 6-1/4" Pull-Up Diverter Spout	ADA Lever	Polished Nickel	
237807	T17T451-SP	Tub & Shower Trim, 6-1/4" Pull-Up Diverter Spout	ADA Lever	SpotShield Stainless	
117207	T17T451-SS	Tub & Shower Trim, 6-1/4" Pull-Up Diverter Spout	ADA Lever	Stainless*	

\* Brilliance® Anti-Tarnish Lifetime Finishes

[www.plumbsupply.com](http://www.plumbsupply.com) • Serving our Customers Since 1946 • [www.waterconcepts.net](http://www.waterconcepts.net)



## Tub & Shower Faucets

### Lahara® TempAssure® 17T Series Tub & Shower Trim

- Fits MultiChoice® universal valve
- Handle adjusts volume, dial adjusts temperature
- Sweat onto 1/2" C.W.T or thread onto 1/2" IPS
- Touch-Clean® 5" raincan showerhead
- Flow rate: 2.5 gpm @ 80 psi



Part #	Mfg #	Description	Handle(s)	Finish	Price
111015	T17T438	Tub & Shower Trim, 7" Pull-Up Diverter Spout	ADA Lever	Chrome	
111019	T17T438-SS	Tub & Shower Trim, 7" Pull-Up Diverter Spout	ADA Lever	Stainless*	
111018	T17T438-RB	Tub & Shower Trim, 7" Pull-Up Diverter Spout	ADA Lever	Venetian Bronze®	

### Pivotal™ TempAssure® 17T Series H2Okinetic® Tub & Shower Trim

- Fits MultiChoice® universal valve (R10000-UNBX series) sold separately
- Handle adjusts volume, dial adjusts temperature
- Pull-up diverter spout
- Touch-Clean® raincan showerhead
- Dual-function thermostatic cartridge
- Flow rate: 2.5 gpm @ 80 psi



Part #	Mfg #	Description	Handle(s)	Finish	Price
260217	T17T499-BL	Tub & Shower Trim, 7-1/2" Pull-Up Diverter Spout	ADA Lever	Matte Black	

### Tesla™ TempAssure® 17T Series Tub & Shower Trim

- Fits MultiChoice® universal valve
- Handle adjusts volume, dial adjusts temperature
- Pull-up diverter spout
- 3-Setting H2Okinetic® showerhead
- WaterSense® certified product: 1.75 gpm @ 80 psi



Part #	Mfg #	Description	Handle(s)	Finish	Price
224765	T17T452-SS	Tub & Shower Trim, 5-1/2" Pull-Up Diverter Spout	ADA Lever	Stainless*	

\* Brilliance® Anti-Tarnish Lifetime Finishes



## Tub & Shower Faucets

### Trinsic® TempAssure® 17T Series Tub & Shower Trim

- Fits MultiChoice® universal valve
- Handle adjusts volume, dial adjusts temperature
- Slip-on spout for 1/2" C.W.T.
- H2Okinetic® 7-3/4" raincan showerhead
- Touch-Clean® spray holes
- Self-cleaning H2Okinetic® spray holes
- WaterSense® certified product: 1.75 gpm @ 80 PSI



Part #	Mfg #	Description	Handle(s)	Finish	Price
246890	T17T459-CZH2O	Tub & Shower Trim, 6-3/16" Pull-Up Div Spout	ADA Lever	Champagne Bronze	
180253	T17T459-H2O	Tub & Shower Trim, 6-3/16" Pull-Up Div Spout	ADA Lever	Chrome	
180946	T17T459-SSH2O	Tub & Shower Trim, 6-3/16" Pull-Up Div Spout	ADA Lever	Stainless*	
186754	T17T459-RBH2O	Tub & Shower Trim, 6-3/16" Pull-Up Div Spout	ADA Lever	Venetian Bronze®	

### Vero™ TempAssure® 17T Series Tub & Shower Trim

- Fits MultiChoice™ universal valve
- Handle adjusts temperature, dial adjusts volume
- Sweat onto 1/2" CWT or thread onto 1/2" IPS
- Touch-Clean® 8-5/8" raincan showerhead
- Maximum flow rate: 2.5 gpm @ 80 psi



Part #	Mfg #	Description	Handle(s)	Finish	Price
172634	T17T453	Tub & Shower Trim, 7-1/8" Diverter Spout	ADA Lever	Chrome	

\* Brilliance® Anti-Tarnish Lifetime Finishes

[www.plumbsupply.com](http://www.plumbsupply.com) • Serving our Customers Since 1946 • [www.waterconcepts.net](http://www.waterconcepts.net)

## Tub & Shower Faucets

### Two-Handle Tub & Shower Trim

#### Chateau 2-Hdl Tub & Shower Trim

- Metal construction
- 1/2" connections: IPS-exterior, CC-Interior
- Dual control
- 1224 Cartridge design
- Max flow: 2.5 gpm or EP 1.75 gpm



Part #	Mfg #	Description	Handle(s)	Finish	Price
242842	2995EP	Tub & Shower Trim, Knob Handle Diverter, 1.75 gpm	Acrylic Knob	Chrome	
231341	2919EP	Tub & Shower Trim, 5-1/2" Diverter Spout, 1.75 gpm	Acrylic Knob	Chrome	

### Single-Handle Tub & Shower Trim

#### 90°™ Posi-Temp® 1-Hdl Tub & Shower Trim

- Fits M•PACT® system
- 1/2" CC connections
- Adjustable temperature limit stop
- 7-1/4" Diverter tub spout
- Max flow: 2.5 gpm or EP 1.75 gpm



Requires Valve: 2520

Part #	Mfg #	Description	Handle(s)	Finish	Price
139946	TS2713	Tub & Shower Trim	ADA Lever	Chrome	
141002	TS2713BN	Tub & Shower Trim	ADA Lever	Brushed Nickel	

#### Align™ Posi-Temp® 1-Hdl Tub & Shower Trim

- Fits M•PACT® system
- Adjustable Temperature limit stop
- 7-3/8" Tub spout length
- Max flow: 2.5 gpm or EP 1.75 gpm
- -EP Modes eco-performance showerhead
- -NH Models less showerhead



Requires Valve: 2520

Part #	Mfg #	Description	Handle(s)	Finish	Price
174196	T2193	Tub & Shower Trim	ADA Lever	Chrome	
186109	T2193BN	Tub & Shower Trim	ADA Lever	Brushed Nickel	
170257	T2193EP	Tub & Shower Trim	ADA Lever	Chrome	
246227	T2193EPBL	Tub & Shower Trim	ADA Lever	Matte Black	
180636	T2193NH	Tub & Shower Trim, Less Showerhead	ADA Lever	Chrome	

\*Lifeshine® Anti-Tarnish Lifetime Finish

[www.waterconcepts.net](http://www.waterconcepts.net) • Serving our Customers Since 1946 • [www.plumbsupply.com](http://www.plumbsupply.com)

## Tub & Shower Faucets

### Single-Handle Tub & Shower Trim (Continued)

#### Align™ Posi-Temp® 1-Hdl Tub & Shower Trim

Part #	Mfg #	Description	Handle(s)	Finish	Price
236946	T2193NHBN	Tub & Shower Trim, Less Showerhead	ADA Lever	Brushed Nickel	
179496	T3293	Tub & Shower Trim	ADA Lever	Chrome	
251487	T3293NH	Tub & Shower Trim, Less Showerhead	ADA Lever	Chrome	

#### Arris™ Posi-Temp® 1-Hdl Tub & Shower Trim

- Fits M•PACT® system
- 10" Immersion™ rainhead
- 6-3/4" Tub spout
- EP Suffix - indicates eco-performance
- Max flow: 2.5 gpm or EP 1.75 gpm



Requires Valve: 2520

Part #	Mfg #	Description	Handle(s)	Finish	Price
175357	TS22003EP	Tub & Shower Trim	ADA Lever	Chrome	
253201	TS2203BL	Tub & Shower Trim	ADA Lever	Matte Black	
190292	TS2203BN	Tub & Shower Trim	ADA Lever	Brushed Nickel	

#### Belfield™ Posi-Temp® Tub & Shower Trim

- Fits M•PACT® system
- 7" Diameter single function showerhead
- 7-3/4" Tub spout
- EP Suffix - indicates eco-performance
- Max flow: 2.5 gpm or EP 1.75 gpm



Part #	Mfg #	Description	Handle(s)	Finish	Price
243062	T2313EP	Tub & Shower Trim, 1.75 gpm	ADA Lever	Chrome	
249633	T2313BN	Tub & Shower Trim	ADA Lever	Brushed Nickel	
239249	T2313ORB	Tub & Shower Trim	ADA Lever	Oil Rubbed Bronze	

\*Lifeshine® Anti-Tarnish Lifetime Finish

[www.plumbsupply.com](http://www.plumbsupply.com) • Serving our Customers Since 1946 • [www.waterconcepts.net](http://www.waterconcepts.net)

## Tub & Shower Faucets

### Boardwalk™ Posi-Temp® 1-Hdl Tub & Shower Trim

- Fits M•PACT® system
- 6" Diameter single function showerhead
- 6-1/2" IPS diverter spout
- EP Suffix - indicates eco-performance
- Max flow: 2.5 gpm or EP 1.75 gpm



Requires Valve: 2520

Part #	Mfg #	Description	Handle(s)	Finish	Price
237058	T2163EPSRN	Tub & Shower Trim, 1.75 gpm	ADA Lever	SpotResist Brushed Nickel	

### Brantford™ Posi-Temp® 1-Hdl Tub & Shower Trim

- Fits M•PACT® system
- Easy Clean® XLT single-function showerhead, arm and flange
- 6-1/2" Slip fit diverter spout
- EP Suffix - indicates eco-performance
- Max flow: 2.5 gpm or EP 1.75 gpm



2153

Requires Valve: 2520

Part #	Mfg #	Description	Handle(s)	Finish	Price
108178	T2153	Tub & Shower Trim	ADA Lever	Chrome	
102298	T2153BN	Tub & Shower Trim	ADA Lever	Brushed Nickel	
102293	T2153ORB	Tub & Shower Trim	ADA Lever	Oil Rubbed Bronze	
202527	T2153NHBN	Tub & Shower Trim, Less Showerhead	ADA Lever	Brushed Nickel	
188382	T2153EPBN	Tub & Shower Trim, 1.75gpm	ADA Lever	Brushed Nickel	
183266	T2153EPORB	Tub & Shower Trim, 1.75gpm	ADA Lever	Oil Rubbed Bronze	
227874	T2253EPBN	Tub & Shower Trim, 8" 1.75gpm Showerhead	ADA Lever	Brushed Nickel	
226285	T2253EPORB	Tub & Shower Trim, 8" 1.75gpm Showerhead	ADA Lever	Oil Rubbed Bronze	

### Chateau® Posi-Temp® 1-Hdl Tub & Shower Trim

- Fits M•PACT® system
- Adjustable temperature limit stop
- Easy-Clean® XL single-function showerhead, arm and flange
- 5-1/2" Slip fit diverter tub spout
- Flow rate: 2.5 gpm



TL471

Requires Valve: 2520

Part #	Mfg #	Description	Handle(s)	Finish	Price
037059	TL183	Tub & Shower Trim (Bulk 12/Pk)	ADA Lever	Chrome	
089635	TL183BC	Tub & Shower Trim (Bulk 12/Pk)	ADA Lever	Brushed Chrome	
193674	TL471	Tub & Shower Trim (Bulk 12/Pk)	ADA Lever	Chrome	

\*Lifeshine® Anti-Tarnish Lifetime Finish

[www.waterconcepts.net](http://www.waterconcepts.net) • Serving our Customers Since 1946 • [www.plumbsupply.com](http://www.plumbsupply.com)

## Tub & Shower Faucets

### Chateau® Posi-Temp® 1-Hdl Tub & Shower Trim

- 4-Port pressure balancing cycling valve design without volume control
- Adjustable temperature limit stop
- Easy Clean® XL single-function showerhead, arm and flange
- Valve sold separately
- Flow rate: 2.5 gpm



Part #	Mfg #	Description	Handle(s)	Finish	Price
020308	L2353	Tub & Shower Trim, 5-1/2" Tub Spout	Clear Knob	Chrome	
191629	T183	Tub & Shower Trim, H&C Indicators, 5-1/2" Tub Spout	Clear Knob	Chrome	
191632	T471	Tub & Shower Trim, 5-1/2" Tub Spout	Clear Knob	Chrome	

### Chateau Posi-Temp® Tub & Shower Trim w/ Wide Plate

- EPA WaterSense® criteria to conserve water without sacrificing performance
- Fits M•PACT® system
- Adjustable temperature limit stop
- Easy-Clean® XL single-function showerhead, arm and flange
- 5-1/2" Slip fit diverter tub spout
- Flow rate: 1.75 gpm



Requires Valve: 2510

Part #	Mfg #	Description	Handle(s)	Finish	Price
250430	TL2369EP	Tub & Shower Trim, 5-1/2" Tub Spout	ADA Lever	Chrome	

### Dartmoor™ Posi-Temp® 1-Hdl Tub & Shower Trim

- Fits M•PACT® system
- Adjustable temperature limit stop
- 1222 cartridge design
- Includes showerhead, arm, flange, and tub spout
- 7-3/8" diverter tub spout
- Flow rate: 2.5 gpm or EP 1.75 gpm



Requires Valve: 2520

Part #	Mfg #	Description	Handle(s)	Finish	Price
228792	T2183	Tub & Shower Trim	ADA Lever	Chrome	
238485	T2183BN	Tub & Shower Trim	ADA Lever	*Brushed Nickel	
222894	T2183ORB	Tub & Shower Trim	ADA Lever	Oil Rubbed Bronze	

\*Lifeshine® Anti-Tarnish Lifetime Finish

[www.plumbsupply.com](http://www.plumbsupply.com) • Serving our Customers Since 1946 • [www.waterconcepts.net](http://www.waterconcepts.net)

## Tub & Shower Faucets

### Dartmoor™ Posi-Temp® 1-Hdl Tub & Shower Trim

- Fits M•PACT® system
- LifeShine® finish
- Adjustable temperature limit stop
- 1222 cartridge design
- Includes eco-performance showerhead, arm, flange, and tub spout
- 8" Diameter sprayhead
- 7" diverter tub spout length
- WaterSense® certified: 2.0 gpm @ 80 psi



Requires Valve: 2520

Part #	Mfg #	Description	Handle(s)	Finish	Price
244395	T2283EP	Tub & Shower Trim	ADA Lever	Chrome	
240202	T2283EPBN	Tub & Shower Trim	ADA Lever	Brushed Nickel	

### Eva™ Posi-Temp® 1-Hdl Tub & Shower Trim

- Fits M•PACT® system
- LifeShine® non-tarnish finish
- Single-function showerhead, arm and flange  
—(-EP) Eco-performance showerhead
- 7" Slip fit diverter tub spout
- Flow rate: 2.5 gpm or (EP) 1.75 gpm
- (-NH) Models: Showerhead sold separately



Requires Valve: 2520

Part #	Mfg #	Description	Handle(s)	Finish	Price
094489	T2133	Tub & Shower Trim, 2.5 gpm	ADA Lever	Chrome	
095677	T2133BN	Tub & Shower Trim, 2.5 gpm	ADA Lever	Brushed Nickel	
098474	T2133ORB	Tub & Shower Trim	ADA Lever	Oil Rubbed Bronze	
214366	T62133NH	Tub & Shower Trim, Less Showerhead	ADA Lever	Chrome	
167391	T2133NHBN	Tub & Shower Trim, Less Showerhead	ADA Lever	Brushed Nickel	
202854	T2133NHORB	Tub & Shower Trim, Less Showerhead	ADA Lever	Oil Rubbed Bronze	
226511	T2233EP	Tub & Shower Trim, 1.75 gpm 8" Showerhead	ADA Lever	Chrome	
243352	T2233EPORB	Tub & Shower Trim, 1.75 gpm 8" Showerhead	ADA Lever	Oil Rubbed Bronze	
176810	T2133EPBN	Tub & Shower Trim, 1.75 gpm	ADA Lever	*Brushed Nickel	
178593	T2133EPORB	Tub & Shower Trim, 1.75 gpm	ADA Lever	Oil Rubbed Bronze	
244769	T2137EPBN	Tub & Shower Trim, 1.75 gpm	ADA Lever	Brushed Nickel	

\*Lifeshine® Anti-Tarnish Lifetime Finish



## Tub & Shower Faucets

### Genta™ Posi-Temp® 1-Hdl Tub & Shower Trim

- Fits M•PACT® system
- 3-3/4" Diameter multi-function showerhead
- 7" diverter tub spout
- Flow rate: 2.5 gpm (EP) 2.0 gpm
- -NH Models: Showerhead sold separately



Requires Valve: 2520

Part #	Mfg #	Description	Handle(s)	Finish	Price
237020	T2473EP	Tub & Shower Trim, 2.0 gpm	ADA Lever	Chrome	
236516	T2473NH	Tub & Shower Trim, 2.5 gpm, No Showerhead	ADA Lever	Chrome	

### Glyde™ Posi-Temp® 1-Hdl Tub & Shower Trim with Rainshower

- Fits M•PACT® system
- 8" Diameter eco performance showerhead
- 7" Diverter tub spout length
- (-EP) Eco performance
- Flow rate: 2.0 gpm



Part #	Mfg #	Description	Handle(s)	Finish	Price
240557	T2843EP	Tub & Shower Trim	ADA Lever	Chrome	
248654	T2843EPBN	Tub & Shower Trim	ADA Lever	Brushed Nickel	

### Glyde™ Posi-Temp® 1-Hdl Tub & Shower Trim

- Fits M•PACT® system
- 3-3/4" Diameter sprayhead
- 7" Diverter tub spout length
- Slip-fit spout connection
- Flow rate: 2.5 gpm



Part #	Mfg #	Description	Handle(s)	Finish	Price
241466	T2743	Tub & Shower Trim	ADA Lever	Chrome	

\*Lifeshine® Anti-Tarnish Lifetime Finish

[www.plumbsupply.com](http://www.plumbsupply.com) • Serving our Customers Since 1946 • [www.waterconcepts.net](http://www.waterconcepts.net)

## Tub & Shower Faucets

### Gibson™ T2903 Series Posi-Temp® 1-Hdl Tub & Shower

- Fits M•PACT® system
- 3-3/4" Diameter
- 6-1/2" Diverter tub spout
- 1222 Cartridge design
- (-NH) Less showerhead



Part #	Mfg #	Description	Handle(s)	Finish	Price
243060	T2903NH	Tub & Shower Trim, Less Head	ADA Lever	Chrome	

### Gibson™ T2903EP Series Posi-Temp® 1-Hdl Tub & Shower Trim

- Fits M•PACT® system
- 3.6" diameter spray head
- 6-1/2" Diverter tub spout
- 1222 Cartridge design
- (-EP) Eco Performance
- WaterSense® certified



Part #	Mfg #	Description	Handle(s)	Finish	Price
250305	T2903EP	Tub & Shower Trim	ADA Lever	Chrome	

### Gibson™ T3003EP Series Posi-Temp® 1-Hdl Tub & Shower Trim

- Fits M•PACT® system
- 7" Diameter
- 6-1/2" Diverter tub spout
- 1222 Cartridge design
- (-EP) Eco Performance
- WaterSense® certified: 2.0 gpm



Part #	Mfg #	Description	Handle(s)	Finish	Price
247441	T3003EP	Tub & Shower Trim	ADA Lever	Chrome	

\*Lifeshine® Anti-Tarnish Lifetime Finish

[www.waterconcepts.net](http://www.waterconcepts.net) • Serving our Customers Since 1946 • [www.plumbsupply.com](http://www.plumbsupply.com)

## Tub & Shower Faucets

### Kingsley™ Posi-Temp® 1-Hdl Tub & Shower Trim

- Fits M•PACT® system
- Moenflo® XL single-function showerhead, arm and flange
- 6" Slip fit diverter tub spout



Requires Valve: 2520

Part #	Mfg #	Description	Handle(s)	Finish	Price
070915	T2113	Tub & Shower Trim	ADA Lever	Chrome	
078571	T2113BN	Tub & Shower Trim	ADA Lever	*Brushed Nickel	
077213	T2113ORB	Tub & Shower Trim	ADA Lever	Oil Rubbed Bronze	
245075	T2113P	Tub & Shower Trim	ADA Lever	Polished Brass	
079639	T2113WR	Tub & Shower Trim	ADA Lever	Wrought Iron	

### Method™ Posi-Temp® 1-Hdl Tub & Shower Trim

- Fits M•PACT® system
- 5-7/8" Diverter tub spout
- 1222 Cartridge design
- Flow rate: 2.5 gpm



Requires Valve: 2520

Part #	Mfg #	Description	Handle(s)	Finish	Price
137868	T2803	Tub & Shower Trim	ADA Lever	Chrome	
134862	T2803BN	Tub & Shower Trim	ADA Lever	*Brushed Nickel	

### Rothbury™ Posi-Temp® 1-Hdl Tub & Shower Trim

- Fits M•PACT® system
- 6-1/2" Diameter spray head, full spray
- 7-5/8" Slip fit diverter tub spout
- Flow rate: 2.5 gpm



Requires Valve: 2520

Part #	Mfg #	Description	Handle(s)	Finish	Price
180824	TS2213	Tub & Shower Trim, 2.5 gpm	ADA Lever	Chrome	
124661	TS2231BN	Tub & Shower Trim, 2.5 gpm	ADA Lever	Brushed Nickel	
122079	TS2213ORB	Tub & Shower Trim, 2.5 gpm	ADA Lever	Oil Rubbed Bronze	

\*Lifeshine® Anti-Tarnish Lifetime Finish

[www.plumbsupply.com](http://www.plumbsupply.com) • Serving our Customers Since 1946 • [www.waterconcepts.net](http://www.waterconcepts.net)

## Tub & Shower Faucets

### Voss™ Posi-Temp® 1-Hdl Tub & Shower Trim

- Fits M•Pact® system
- 7-3/4" Tub spout length
- Flow rate: 2.5 gpm or 1.75 gpm



Requires Valve: 2520

Part #	Mfg #	Description	Handle(s)	Finish	Price
152101	T2693	Tub & Shower Trim	ADA Lever	Chrome	
253356	T2693BG	Tub & Shower Trim	ADA Lever	Brushed Gold	
151294	T2693BN	Tub & Shower Trim	ADA Lever	Brushed Nickel	
153396	T2693ORB	Tub & Shower Trim	ADA Lever	Oil Rubbed Bronze	
150546	T2693EP	Tub & Shower Trim, 1.75 gpm	ADA Lever	Chrome	
212353	T2693NH	Tub & Shower Trim, Less Showerhead	ADA Lever	Chrome	
152715	T2693NHBN	Tub & Shower Trim, Less Showerhead	ADA Lever	Brushed Nickel	
210192	T2693NHORB	Tub & Shower Trim, Less Showerhead	ADA Lever	Oil Rubbed Bronze	

### Waterhill® Posi-Temp® 1-Hdl Tub & Shower Trim

- Fits M•PACT® system
- 10" Diameter rain shower head
- 6-3/4" Slip fit diverter tub spout
- Flow rate: 2.5 gpm or EP 1.75 gpm



Requires Valve: 2520

Part #	Mfg #	Description	Handle(s)	Finish	Price
200052	TS314	Tub & Shower Trim	ADA Lever	Chrome	
208181	TS314BN	Tub & Shower Trim	ADA Lever	Brushed Nickel	
187910	TS314ORB	Tub & Shower Trim	ADA Lever	Oil Rubbed Bronze	

### Weymouth™ Posi-Temp® 1-Hdl Tub & Shower Trim

- Fits M•PACT® system
- 9" Diameter rain shower head
- 6-3/4" Slip fit diverter tub spout
- Flow rate: 2.5 gpm



Requires Valve: 2520

Part #	Mfg #	Description	Handle(s)	Finish	Price
172109	TS32104	Tub & Shower Trim	ADA Lever	Chrome	
181749	TS32104BN	Tub & Shower Trim	ADA Lever	Brushed Nickel	

\*Lifeshine® Anti-Tarnish Lifetime Finish

[www.waterconcepts.net](http://www.waterconcepts.net) • Serving our Customers Since 1946 • [www.plumbsupply.com](http://www.plumbsupply.com)

## Tub & Shower Faucets

### Wynford™ Posi-Temp® 1-Hdl Tub & Shower Trim

- Fits M•PACT® system
- 5-7/8" Diameter
- 6-1/2" Slip fit diverter tub spout
- Flow rate: 2.5 gpm



Requires Valve: 2520

Part #	Mfg #	Description	Handle(s)	Finish	Price
187216	T4503	Tub & Shower Trim	ADA Lever	Chrome	
217680	T4503BN	Tub & Shower Trim	ADA Lever	Brushed Nickel	
184815	T4503NL	Tub & Shower Trim	ADA Lever	Polished Nickel	
189589	T4503ORB	Tub & Shower Trim	ADA Lever	Oil Rubbed Bronze	
224186	T4503NHBN	Tub & Shower Trim, Less Showerhead	ADA Lever	Brushed Nickel	
187259	T5503	Tub & Shower Trim, 2.5gpm 7" Showerhead	ADA Lever	Chrome	
187014	T5503NL	Tub & Shower Trim, 2.5gpm 7" Showerhead	ADA Lever	Polished Nickel	
250383	T5503NHBN	Tub & Shower Trim, Less Showerhead	ADA Lever	Brushed Nickel	

### Moentrol Tub & Shower Trim

#### 90° Moentrol® 1-Hdl Tub & Shower Trim

- Fits M•PACT® system
- Equipped with Moentrol® pressure-balancing control valve: control allows you to adjust both water volume and temperature
- Immersion™ 6" spray head
- Full spray
- 7-1/4" Tub spout length
- Flow rate: 2.5 gpm



Requires Valve: 3510

Part #	Mfg #	Description	Handle(s)	Finish	Price
171263	TS3713	Tub & Shower Trim	ADA Lever	Chrome	

\*Lifeshine® Anti-Tarnish Lifetime Finish

[www.plumbsupply.com](http://www.plumbsupply.com) • Serving our Customers Since 1946 • [www.waterconcepts.net](http://www.waterconcepts.net)

## Tub & Shower Faucets

### Belfield® Moentrol® 1-Hdl Tub & Shower Trim

- Fits M•PACT® system
- Moentrol® pressure-balancing control valve
- 1225® Cartridge design
- 7-3/4" Slip fit diverter spout
- Showerhead sold separately



Part #	Mfg #	Description	Handle(s)	Finish	Price
252704	T3313NHBN	Tub & Shower Trim	ADA Lever	Brushed Nickel	

### Legend® Moentrol® 1-Hdl Tub & Shower Trim

- Fits M•PACT® system
- Moentrol® pressure-balancing control valve
- 2-1/2" Spray head
- 5-1/2" Slip fit diverter spout
- Flow rate: 2.5 gpm



Requires Valve: 3510

Part #	Mfg #	Description	Handle(s)	Finish	Price
193105	TL172	Tub & Shower Trim	ADA Lever	Chrome	

### Kingsley® Moentrol® 1-Hdl Tub & Shower Trim

- Fits M•PACT® system
- Moentrol® pressure-balancing control valve
- 4-3/8" Showerhead
- 5-1/2" Tub spout length
- Flow rate: 2.5 gpm
- (-NH) Less showerhead



Requires Valve: 63100, 3500 series

Part #	Mfg #	Description	Handle(s)	Finish	Price
070933	T3113	Tube & Shower Trim	ADA Lever	Chrome	
087883	T3113BN	Tube & Shower Trim	ADA Lever	Brushed Nickel	
094826	T3113ORB	Tube & Shower Trim	ADA Lever	Oil Rubbed Bronze	
249566	T3113NHBN	Tub & Shower Trim, Less Head	ADA Lever	Brushed Nickel	

\*Lifeshine® Anti-Tarnish Lifetime Finish

[www.waterconcepts.net](http://www.waterconcepts.net) • Serving our Customers Since 1946 • [www.plumbsupply.com](http://www.plumbsupply.com)



## Tub & Shower Faucets

### Voss™ Moentrol® 1-Hdl Tub & Shower Trim

- Fits M•PACT® system
- Moentrol® pressure-balancing control valve
- 6" Immersion™ rain shower, full spray
- 7-15/16" Tub spout length
- Flow rate: 2.5 gpm



Requires Valve: 63100, 3500 series

Part #	Mfg #	Description	Handle(s)	Finish	Price
153258	T3693BN	Tub & Shower Trim	ADA Lever	Brushed Nickel	

\*Lifeshine® Anti-Tarnish Lifetime Finish



## Tub & Shower Faucets

### Tub & Shower Trim

#### Hardwater® 2-Hdl Tub & Shower Trim

- Body cast of high copper content brass
- Ceramaflow ceramic disc cartridge
- Regular showerhead with black spray plate
- Maximum showerhead 2.5 gpm @ 80 psi
- Pressure-compensating flow control
- Slip-fit diverter spout
- Ejector tee



58-400

Part #	Mfg #	Description	Handle(s)	Finish	Price
106635	58-400	8"cc T&S Trim, IPS/Sweat, Thread Escutcheon	ADA Hardwater®	Chrome	
029695	58-420	8"cc T&S Trim, IPS/Sweat, Slide Escutcheon	ADA Hardwater®	Chrome	

#### Hardwater® 3-Hdl Tub & Shower Trim

- Body cast of high copper content brass
- Ceramaflow ceramic disc cartridge
- Exposed parts have heavy chrome plated finish
- Single function showerhead 2.0 gpm @ 80 psi
- Easy-Clean, soft touch nozzles
- Air injection technology
- Pressure manifold technology
- 1/2" IPS or sweat water inlet connections
- Three valve with center diverter
- Zinc die cast tub spout



Part #	Mfg #	Description	Handle(s)	Finish	Price
048965	58-520	8"cc T&S Trim IPS/Sweat, Slide Escutcheon	ADA Hardwater®	Chrome	

#### Gerber Classics™ 2-Hdl Tub & Shower Trim

- Compression cartridges and stems
- Body cast of high copper content brass
- Exposed parts have heavy chrome plate finish
- Working parts can easily be replaced
- Single function showerhead: 2.0 gpm @ 80 psi
- Easy-Clean, Soft touch nozzles
- Air injection technology
- Pressure manifold technology
- 1/2" IPS connections
- Brass plug for tub filler outlet



Part #	Mfg #	Description	Handle(s)	Finish	Price
004713	47-920	3-3/8"cc T&S Trim, IPS	ADA Wing	Chrome	

\*Physical Vapor Deposition (PVD) Limited Lifetime Finish

[www.waterconcepts.net](http://www.waterconcepts.net) • Serving our Customers Since 1946 • [www.plumbsupply.com](http://www.plumbsupply.com)



## Tub & Shower Faucets

### Gerber Classics™ 2-Hdl Tub & Shower Trim

- Compression stems
- Body cast of high copper content brass
- Exposed parts have heavy chrome plated finish
- Working parts can be easily replaced
- Single function showerhead
- 1/2" IPS or Sweat water inlet connections
- 8" centers with threaded escutcheon's
- Zinc die cast spout with internal diverter (ejector tee)
- Flow rate: 2.0 gpm



Part #	Mfg #	Description	Handle(s)	Finish	Price
197447	48-720	8"cc, T&S Trim, IPS/Sweat, Thread Escutcheons	ADA Wing	Chrome	

### Gerber Classics™ 3-Hdl Tub & Shower Trim

- Cast brass body
- Single function showerhead : 2.5 gpm @ 80 psi
- Easy-Clean, soft-touch nozzles
- Air injection technology
- Pressure manifold technology
- Compression stems
- Zinc die cast tub spout
- Three valve with center diverter
- 1/2" IPS/Sweat connections



Part #	Mfg #	Description	Handle(s)	Finish	Price
004714	48-030	8"cc T&S Trim, Thread Escutcheons	ADA Wing	Chrome	
022337	47-130-83	11"cc T&S Trim, Sliding Sleeve Escutcheons	ADA Wing	Chrome	

## Tub Trim

### Gerber Classics™ 2-Hdl Tub Filler Trim

- Compression cartridges and stems
- Body cast of high copper content brass
- Exposed parts have heavy chrome plate finish
- Working parts can easily be replaced
- 6" centers with sliding sleeve escutcheons
- 1/2" IPS connections or 1/2" nominal copper sweat connections
- Zinc die cast tub spout



Part #	Mfg #	Description	Handle(s)	Finish	Price
040410	46-610-83	6"cc Tub Trim, Sleeve Escutcheons	ADA Wing	Chrome	

\*Physical Vapor Deposition (PVD) Limited Lifetime Finish

**www.plumbsupply.com • Serving our Customers Since 1946 • www.waterconcepts.net**



## Tub & Shower Faucets

### Gerber Classics™ 2-Hdl Tub Filler Trim

- Compression cartridges and stems
- Body cast of high copper content brass
- Exposed parts have heavy chrome plate finish
- Working parts can easily be replaced
- 8" centers with threaded escutcheons
- 1/2" IPS connections or 1/2" nominal copper sweat connections
- Zinc die cast tub spout
- Brass plug for shower outlet



Part #	Mfg #	Description	Handle(s)	Finish	Price
004715	48-810	8"cc Tub Only Trim, IPS/Sweat, Thread Escutcheon	ADA Wing	Chrome	

\*Physical Vapor Deposition (PVD) Limited Lifetime Finish

[www.waterconcepts.net](http://www.waterconcepts.net) • Serving our Customers Since 1946 • [www.plumbsupply.com](http://www.plumbsupply.com)

## Tub & Shower Faucets

### Single-Handle Tub & Shower Trim

#### P4B Builders Series 1-Hdl Tub & Shower Faucet

- Washerless pressure balance valve
- Slip fit diverter spout
- CC and IP
- Less stops
- Maximum flow rate: 2.0 gpm @ 80 psi
- -JP Models: Trim Only



Part #	Mfg #	Description	Handle(s)	Finish	Price
234718	P4B-730C	Tub & Shower, Slip-Fit Diverter Spout	ADA Lever Blade	Chrome	
141380	P4B-730BN	Tub & Shower, Slip-Fit Diverter Spout	ADA Lever Blade	Brushed Nickel	
174011	P4B-730BNJP	Tub & Shower Trim Kit, Slip-Fit Diverter Spout	ADA Lever Blade	Brushed Nickel	
141381	P4B-730ORB	Tub & Shower, Slip-Fit Diverter Spout	ADA Lever Blade	Oil Rubbed Bronze	
151680	P4B-730CJP	Tub & Shower, Slip-Fit Diverter Spout	ADA Lever Blade	Chrome	
235536	P4B-730CDJP	Tub & Shower, Slip-Fit DivSpt w/Decorative Shwrhd	ADA Lever Blade	Chrome	
235532	P4B-730BNDJP	Tub & Shower, Slip-Fit DivSpt w/Decorative Shwrhd	ADA Lever Blade	Brushed Nickel	

#### P4C Classic Series 1-Hdl Tub & Shower Trim

- Washerless pressure balance valve
- Slip fit diverter spout
- CC and IP
- Less stops
- Maximum flow rate: 2.5 gpm @ 80 psi
- -JP Models: Trim Only



Part #	Mfg #	Description	Handle(s)	Finish	Price
141394	P4C-730C	Tub & Shower, Slip-Fit Diverter	ADA Lever Blade	Chrome	
155990	P4C-730CJP	Tub & Shower, Slip-Fit Diverter	ADA Lever Blade	Chrome	
151472	P4C-732C	Tub & Shower, Slip-Fit Diverter	Crystal Ball Handle	Chrome	

### Two-Handle Tub & Shower Trim

#### P4V Value Series 2-Hdl Tub & Shower Trim

- Non-pressure balanced
- Slip fit diverter spout
- IP Rough
- Maximum flow rate: 2.5 gpm @ 80 psi



Part #	Mfg #	Description	Handle(s)	Finish	Price
141397	P4V-830C	Tub & Shower, Slip-Fit Diverter	Round Metal	Chrome	



## Tub & Shower Faucets

### Two-Handle Tub & Shower Trim (Continued)

#### P4V Value Series 2-Hdl Tub & Shower Trim

Part #	Mfg #	Description	Handle(s)	Finish	Price
158739	P4V-832C	Tub & Shower, Slip-Fit Diverter	Crystal Ball	Chrome	

### Three-Handle Tub & Shower Trim

#### P4V Value Series 3-Hdl Tub & Shower Trim

- *Non-pressure balanced*
- *Washerless cartridges*
- *Metal round handles*
- *Non-diverter spout*
- *Max flow rate: 2.0 gpm @ 80 psi*



Part #	Mfg #	Description	Handle(s)	Finish	Price
234715	P4V-870C	Tub & Shower, Slip-Fit Non-Diverter Spout	Round Metal	Chrome	



**Tub & Shower Faucets**

**Tub & Shower Faucets**

**Tub & Shower Trim**

- Single function operation
- Touch-Clean showerhead
- Flow rate: 1.5 gpm



Part #	Mfg #	Description	Handle(s)	Finish	Price
171147	PTT188773	Tub & Shower Trim Only	Lever	Chrome	
186606	PTT188773-BN	Tub & Shower Trim Only	Lever	Brushed Nickel	

\* Brilliance® Anti-Tarnish Lifetime Finishes

## Tub & Shower Faucets

### Single-Handle Tub & Shower Trim

#### Noble Three-Function Single-Handle Tub & Shower Trim Pack

- 1-Piece pressure balanced ceramic cartridge w/ balancing spool
- Back-to-back installation capability
- 3-7/8" 3-Function shower head
- Metal shower arm with flange
- Metal escutcheon with screws
- Zinc handle
- 1.5 gpm @ 80 psi showerhead
- 7.0 gpm @ 80 psi diverter tub spout with easy 'Snap-In' design



Part #	Mfg #	Description	Handles	Finish	Price
226877	212-5901	Tub & Shower Trim	ADA Lever	Chrome	
226645	212-5902	Tub & Shower Trim	ADA Lever	Brushed Nickel	
229591	212-5903	Tub & Shower Trim	ADA Lever	Oil Rubbed Bronze	

## Tub Faucets

### Two-Handle Roman Tub Trim

#### Alteo™ 2-Hdl Deck-Mount Tub Trim

- Bath- or deck-mount installation
- Metal construction
- 7-5/8" Spout



T45115-4 Requires valve K-300-K/KR or K-301-K

T45117-4 Requires valve K-438-K

#### Non-Diverter Spout

Part #	Mfg #	Description	Handle(s)	Finish	Price
141715	K-T45115-4-BN	High-Arch Non-Diverter Spout	ADA Lever	*Brushed Nickel	
141716	K-T45115-4-CP	High-Arch Non-Diverter Spout	ADA Lever	Polished Chrome	
149754	K-T45115-4-2BZ	High-Arch Non-Diverter Spout Bronze	ADA Lever	Oil Rubbed	

#### Diverter Spout

Part #	Mfg #	Description	Handle(s)	Finish	Price
141724	K-T45117-4-BN	High-Arch, Diverter Spout	ADA Lever	*Brushed Nickel	
141723	K-T45117-4-CP	High-Arch, Diverter Spout	ADA Lever	Polished Chrome	
166497	K-T451174-2BZ	High-Arch, Diverter Spout Bronze	ADA Lever	Oil Rubbed	

### Antique™ Bath Faucet Wall-Mount Adapter Kit



Part #	Mfg #	Description	Handle(s)	Finish	Price
077968	K-101-BN	Wall-Mount	-	*Brushed Nickel	
077123	K-101-CP	Wall-Mount	-	Polished Chrome	
165628	K-101-2BZ	Wall-Mount Bronze	-	Oil Rubbed	

### Archer® 2-Hdl Deck-Mount Tub Trim with Non-Diverter Spout

- Bath- or deck-mount installation
- Metal construction
- High-arch non-diverter spout



Requires Valve: K-300-K/KR or K-301-K

Part #	Mfg #	Description	Handle(s)	Finish	Price
183398	K-T45849-4-BN	High-Arch Non-Diverter Spout	ADA Lever	*Brushed Nickel	
182043	K-T45849-4-CP	High-Arch Non-Diverter Spout	ADA Lever	Polished Chrome	

\* Vibrant Limited Lifetime Warranty

www.plumbsupply.com • Serving our Customers Since 1946 • www.waterconcepts.net

## Tub Faucets

### Bancroft® 2-Hdl Deck-Mount Tub Trim with 7" Spout

- Bath- or deck-mount installation
- Slip-fit spout



T10592-4 Requires Valve K-438-K

T10585-4 Requires Valve K-300-K/KR or K-301-K

#### Non-Diverter Spout

Part #	Mfg #	Description	Handle(s)	Finish	Price
099266	K-T10585-4-BN	7" Non-Diverter Spout	ADA Lever	* Brushed Nickel	
120009	K-T10585-4-BV	7" Non-Diverter Spout	ADA Lever	* Brushed Bronze	
088081	K-T10585-4-CP	7" Non-Diverter Spout	ADA Lever	Polished Chrome	
243906	K-T10585-4-SN	7" Non-Diverter Spout	ADA Lever	*Polished Nickel	
134420	K-T10585-4-2BZ	7" Non-Diverter Spout Bronze	ADA Lever	Oil Rubbed	

#### Diverter Spout

Part #	Mfg #	Description	Handle(s)	Finish	Price
100090	K-T10592-4-BN	7" Diverter Spout	ADA Lever	* Brushed Nickel	
141443	K-T10592-4-BV	7" Diverter Spout	ADA Lever	* Brushed Bronze	
103939	K-T10592-4-CP	7" Diverter Spout	ADA Lever	Polished Chrome	
116734	K-T10592-4-SN	7" Diverter Spout	ADA Lever	* Polished Nickel	
153388	K-T10592-4-2BZ	7" Diverter Spout Bronze	ADA Lever	Oil Rubbed	
120383	K-T10592-4P-BN	7" Diverter Spout	ADA White Ceramic Lever	* Brushed Nickel	
105019	K-T10592-4P-CP	7" Diverter Spout	ADA White Ceramic Lever	Polished Chrome	

### Composed® 2-Hdl Deck-Mount Tub Trim

- 8-1/4" Reach, 6-7/16" high spout
- Deck-mount installation
- 3" Maximum deck thickness
- Maximum flow rate: 12 gpm



Part #	Mfg #	Description	Handle(s)	Finish	Price
257860	K-73081-3-TT	8-1/4" Non-Diverter Spout	ADA Cross	*Titanium	
229557	K-73081-4-CP	8-1/4" Non-Diverter Spout	ADA Lever	Chrome	

### Coralais® 2-Hdl Deck-Mount Tub Trim with 8" Non-Diverter Slip-Fit Spout

- Bath- or deck-mount installation
- 1/2" Ceramic valves



Requires valve K-300-K/KR or K-301-K

Part #	Mfg #	Description	Handle(s)	Finish	Price
062910	K-T15290-4-CP	8" Spout	ADA Lever	Polished Chrome	
067371	K-T15290-4-G	8" Spout	ADA Lever	* Brushed Chrome	

\* Vibrant Limited Lifetime Warranty

## Tub Faucets

### Coralais® 2-Hdl Rim-Mount Tub Trim with 5-1/2" Non-Diverter Slip-Fit Spout

- Bath- or deck-mount.
- 1/2" Ceramic valves



Requires valve K-300-KI-KR or K-301-K

Part #	Mfg #	Description	Handle(s)	Finish	Price
064057	K-T15294-4-CP	5-1/2" Spout	ADA Lever	Polished Chrome	
069512	K-T15294-4-G	5-1/2" Spout	ADA Lever	Brushed Chrome	

### Devonshire® 2-Hdl Deck-/Rim-Mount Tub Trim for High-Flow Valve with Spout

- Brass construction
- Flexible connections



K-T387-4

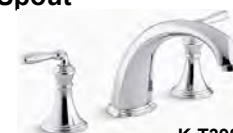

K-T398-4

K-T387 Requires valve K-438-K

K-T398 Requires valve K-300-KI-KR or K-301-K

#### 8-15/16" Diverter Spout

Part #	Mfg #	Description	Handle(s)	Finish	Price
100791	K-T387-4-BN	Diverter Spout	ADA Lever	* Brushed Nickel	
107375	K-T387-4-BV	Diverter Spout	ADA Lever	* Brushed Bronze	
116516	K-T387-4-CP	Diverter Spout	ADA Lever	Polished Chrome	
253476	K-T387-4-SN	Diverter Spout	ADA Lever	*Polished Nickel	
146975	K-T387-4-2BZ	Diverter Spout Bronze	ADA Lever	Oil Rubbed	

#### 9" Non-Diverter Spout

Part #	Mfg #	Description	Handle(s)	Finish	Price
068219	K-T398-4-BN	Non-Diverter Spout	ADA Lever	*Brushed Nickel	
087676	K-T398-4-BV	Non-Diverter Spout	ADA Lever	*Brushed Bronze	
068218	K-T398-4-CP	Non-Diverter Spout	ADA Lever	Polished Chrome	
070746	K-T398-4-PB	Non-Diverter Spout	ADA Lever	*Polished Brass	
172076	K-T398-4-SN	Non-Diverter Spout	ADA Lever	*Polished Nickel	
146985	K-T398-4-2BZ	Non-Diverter Spout Bronze	ADA Lever	Oil Rubbed	

### Fairfax® 2-Hdl Deck-Mount Tub Trim

- Bath- or deck-mount installation
- 8-7/8" High-arch non-diverter spout with slip-fit connection



Requires valve K-300-KI/KR or K-301-K

Part #	Mfg #	Description	Handle(s)	Finish	Price
057321	K-T12885-4-BN	8-7/8" Spout Reach	ADA Lever	* Brushed Nickel	
056050	K-T12885-4-CP	8-7/8" Spout Reach	ADA Lever	Polished Chrome	
129496	K-T12885-4-2BZ	8-7/8" Spout Reach Bronze	ADA Lever	Oil Rubbed	

\* Vibrant Limited Lifetime Warranty

**www.plumbsupply.com • Serving our Customers Since 1946 • www.waterconcepts.net**

## Tub Faucets

### Finial® Traditional 2-Hdl Dual Control Wall-Mounted Lavatory Sink Faucet Trim

- Brass construction
- Less drain
- Stationary spout
- 9-3/4" Spout reach
- Quarter-turn washerless ceramic disc valves
- 1.2 gpf flow rate



Requires two-handle ceramic valve K-410-K

Part #	Mfg #	Description	Handle(s)	Finish	Price
142138	K-T343-4M-BN	9-3/4" Spout Reach	ADA Lever	*Brushed Nickel	
152065	K-T343-4M-BV	9-3/4" Spout Reach	ADA Lever	*Brushed Bronze	
142139	K-T343-4M-CP	9-3/4" Spout Reach	ADA Lever	Polished Chrome	

### Forté® 2-Hdl Sculpted Deck-Mount Tub Trim for High-Flow Valve with 7" Spout

- Brass construction
- Fluid design lines



K-T10278-



K-T10278-4A

T10278-4/4A Requires valve K-300-K/-KR or K-301-K

T10292-4/4A Requires valve K-438-K

#### Non-Diverter Spout

Part #	Mfg #	Description	Handle(s)	Finish	Price
074193	K-T10278-4-BN	7" Non-Diverter Spout	ADA Sculpted Lever	* Brushed Nickel	
071119	K-T10278-4-CP	7" Non-Diverter Spout	ADA Sculpted Lever	Polished Chrome	
072248	K-T10278-4-G	7" Non-Diverter Spout	ADA Sculpted Lever	Brushed Chrome	
076641	K-T10278-4A-BN	7" Non-Diverter Spout	ADA Traditional Lever	*Brushed Nickel	
074925	K-T10278-4A-CP	7" Non-Diverter Spout	ADA Traditional Lever	Polished Chrome	
072795	K-T10278-4A-G	7" Non-Diverter Spout	ADA Traditional Lever	Brushed Chrome	

#### Diverter Spout

Part #	Mfg #	Description	Handle(s)	Finish	Price
101737	K-T10292-4-BN	7" Diverter Spout	ADA Sculpted Lever	* Brushed Nickel	
103190	K-T10292-4-CP	7" Diverter Spout	ADA Sculpted Lever	Polished Chrome	
107086	K-T10292-4-G	7" Diverter Spout	ADA Sculpted Lever	Brushed Chrome	
108121	K-T10292-4A-BN	7" Diverter Spout	ADA Traditional Lever	* Brushed Nickel	
123190	K-T10292-4A-CP	7" Diverter Spout	ADA Traditional Lever	Polished Chrome	

\* Vibrant Limited Lifetime Warranty

[www.waterconcepts.net](http://www.waterconcepts.net) • Serving our Customers Since 1946 • [www.plumbsupply.com](http://www.plumbsupply.com)



## Tub Faucets

### Finial® Traditional 2-Hdl Deck-Mount Tub Faucet Trim for High-Flow Valve with 7-1/2" Non-Diverter Spout

- Deck-mount installation
- Slip-fit, high-arch spout



Requires Valve K-300-K/KR or K-301-K

Part #	Mfg #	Description	Handle(s)	Finish	Price
075052	K-T314-4M-AF	7-1/2" Non-Diverter Spout	ADA Lever Handles	* French Gold	
059245	K-T314-4M-BN	7-1/2" Non-Diverter Spout	ADA Lever Handle	* Brushed Nickel	
090328	K-T314-4M-BV	7-1/2" Non-Diverter Spout	ADA Lever Handles	* Brushed Bronze	
060194	K-T314-4M-CP	7-1/2" Non-Diverter Spout	ADA Lever Handles	Polished Chrome	
061725	K-T314-4M-SN	7-1/2" Non-Diverter Spout	ADA Lever Handles	* Polished Nickel	
180596	K-T314-4M-2BZ	7-1/2" Non-Diverter Spout Bronze	ADA Lever Handles	Oil Rubbed	

### Kelston™ 2-Hdl Deck-Mount Tub Trim

- Bath- or deck-mount installation
- High-arch non-diverter spout with slip-fit connection
- 6-1/2" Stationary spout
- 9-1/4" Inlet to outlet



T13494-4 Requires valve K-300-K/KR or K-301-K

Part #	Mfg #	Description	Handle(s)	Finish	Price
124523	K-T13494-4-BN	6-1/2" Spout Reach	ADA Lever	* Brushed Nickel	
156464	K-T13494-4-CP	6-1/2" Spout Reach	ADA Lever	Polished Chrome	
147002	K-T13494-4-2BZ	6-1/2" Spout Reach Bronze	ADA Lever	Oil Rubbed	

### Loure® 2-Hdl Deck-Mount Tub Faucet with 6-1/2" Non-Diverter Spout

- Deck-mount installation
- 12.0 Gpm flow rate

Valve Included



Part #	Mfg #	Description	Handle(s)	Finish	Price
159658	K-15285-4-BN	6-1/2" Non-Diverter Spout	Lever Handles	* Brushed Nickel	
183471	K-15285-4-CP	6-1/2" Non-Diverter Spout	Lever Handles	Polished Chrome	

\* Vibrant Limited Lifetime Warranty

[www.plumbsupply.com](http://www.plumbsupply.com) • Serving our Customers Since 1946 • [www.waterconcepts.net](http://www.waterconcepts.net)

## Tub Faucets

### Margaux® 2-Hdl Deck-Mount Tub Faucet for High-Flow Valve with 7" Spout

- Bath- or deck-mount installation
- Ceramic disc valves
- Slip-fit spout



**T16236-3/-4** Requires valve **K-438-K**

**T16237** Requires valve **K-300K/KR** or **K-301-K**

#### Diverter Spout

Part #	Mfg #	Description	Handle(s)	Finish	Price
239797	K-T16236-3-AF	Diverter Spout	Cross Handles	* French Gold	
140270	K-T16236-3-BN	Diverter Spout	Cross Handles	* Brushed Nickel	
114260	K-T16236-3-BV	Diverter Spout	Cross Handles	* Brushed Bronze	
118149	K-T16236-3-CP	Diverter Spout	Cross Handles	Polished Chrome	
127744	K-T16236-4-BN	Diverter Spout	ADA Lever Handles	* Brushed Nickel	
182981	K-T16236-4-BV	Diverter Spout	ADA Lever Handles	* Brushed Bronze	
112654	K-T16236-4-CP	Diverter Spout	ADA Lever Handles	Polished Chrome	
135065	K-T16236-4-SN	Diverter Spout	ADA Lever Handles	* Polished Nickel	

#### Non-Diverter Spout

Part #	Mfg #	Description	Handle(s)	Finish	Price
176332	K-T16237-3-BN	Non-Diverter Spout	Cross Handles	*Brushed Nickel	
110492	K-T16237-3-CP	Non-Diverter Spout	Cross Handles	Polished Chrome	
135431	K-T16237-4-AF	Non-Diverter Spout	ADA Lever Handles	* French Gold	
106168	K-T16237-4-BN	Non-Diverter Spout	ADA Lever Handles	* Brushed Nickel	
141182	K-T16237-4-BV	Non-Diverter Spout	ADA Lever Handles	* Brushed Bronze	
107353	K-T16237-4-CP	Non-Diverter Spout	ADA Lever Handles	Polished Chrome	
135974	K-T16237-4-SN	Non-Diverter Spout	ADA Lever Handles	* Polished Nickel	

### Memoirs® Stately 2-Hdl Deck-Mount Tub Trim

- Bath- or deck-mount installation
- Diverter spout with 6-5/16" reach
- 3 Handle styles available
- (K-T469-4V-2BZ) non-diverter model



**K-T428** Requires high flow valve: **K-438-K**

**K-T469** Requires high flow valve **K-301-K-NA**

Part #	Mfg #	Description	Handle(s)	Finish	Price
182982	K-T428-4S-BN	6-5/16" Spout Reach, W/Diverter	ADA Lever	* Brushed Nickel	
097846	K-T428-4S-CP	6-5/16" Spout Reach, W/Diverter	ADA Lever	Polished Chrome	
104446	K-T428-4V-BN	6-5/16" Spout Reach, W/Diverter	ADA Deco Lever	* Brushed Nickel	
114829	K-T428-4V-BV	6-5/16" Spout Reach, W/Diverter	ADA Deco Lever	* Brushed Bronze	
109784	K-T428-4V-CP	6-5/16" Spout Reach, W/Diverter	ADA Deco Lever	* Polished Nickel	

\* Vibrant Limited Lifetime Warranty

[www.waterconcepts.net](http://www.waterconcepts.net) • Serving our Customers Since 1946 • [www.plumbsupply.com](http://www.plumbsupply.com)

## Tub Faucets

### Two-Handle Roman Tub Trim (Continued)

#### Memoirs® Stately 2-Hdl Deck-Mount Tub Trim

Part #	Mfg #	Description	Handle(s)	Finish	Price
242858	K-T428-4V-2BZ	6-5/16" Spout Reach, W/Diverter Bronze	ADA Deco Lever	Oil Rubbed	
078465	K-T469-4V-CP	6-5/16" Spout Reach, Non-diverter	ADA Deco Lever	Polished Chrome	
187059	K-T469-4V-2BZ	6-5/16" Spout Reach, Non-diverter Bronze	ADA Deco Lever	Oil Rubbed	

#### Pinstripe® 2-Hdl Deck-Mount Tub Faucet with 7-1/16" Non-Diverter Slip-Fit Spout

- Available with lever or cross handles
- Etched detailing on spout and handles on -3B and -4B models



Part #	Mfg #	Description	Handle(s)	Finish	Price
140849	K-T13140-3A-CP	Non-Diverter Spout	Cross Handles	Polished Chrome	
182967	K-T13140-3B-CP	Non-Diverter Spout with Etched Design	Cross Handles	Polished Chrome	
089947	K-T13140-3B-SN	Non-Diverter Spout with Etched Design	Cross Handles	* Polished Nickel	
163779	K-T13140-4A-BN	Non-Diverter Spout	ADA Widespread Lever Handles	* Brushed Nickel	
127031	K-T13140-4A-CP	Non-Diverter Spout	ADA Widespread Lever Handles	Polished Chrome	
112663	K-T13140-4A-SN	Non-Diverter Spout	ADA Lever Handles	* Polished Nickel	
095171	K-T13140-4B-CP	Non-Diverter Spout with Etched Design	ADA Lever Handles	Polished Chrome	

#### Purist® 2-Hdl Deck-Mount Tub Faucet with 7-1/2" Non-Diverter Slip-Fit Spout

- Bath- or deck-mount installation

Requires valve K-300-K/KR or K-301-K



Part #	Mfg #	Description	Handle(s)	Finish	Price
182810	K-14430-CP	Spout Only, 7-1/2" reach	Less Handles	Polished Chrome	
093123	K-T14428-3-BN	7- 1/2" Spout Reach	Cross Handles	* Brushed Nickel	
105653	K-T14428-3-BV	7-1/2" Spout Reach	Cross Handles	* Brushed Bronze	
067402	K-T14428-3-CP	7-1/2" Spout Reach	Cross Handles	Polished Chrome	
090737	K-T14428-3-SN	7-1/2" Spout Reach	Cross Handles	* Polished Nickel	
226952	K-T14428-4-BGD	7-1/2" Spout Reach	ADA Lever Handles	* Brushed Gold	
083829	K-T14428-4-BN	7-1/2" Spout Reach	ADA Lever Handles	* Brushed Nickel	
093381	K-T14428-4-BV	7-1/2" Spout Reach	ADA Lever Handles	* Brushed Bronze	
081204	K-T14428-4-CP	7-1/2" Spout Reach	ADA Lever Handles	Polished Chrome	
170480	K-T14428-4-SN	7-1/2" Spout Reach	ADA Lever Handles	* Polished Nickel	

\* Vibrant Limited Lifetime Warranty

[www.plumbsupply.com](http://www.plumbsupply.com) • Serving our Customers Since 1946 • [www.waterconcepts.net](http://www.waterconcepts.net)

## Tub Faucets

### Refinia® 2-Hdl Deck-Mount Tub Faucet Trim for High-Flow Valve with High-Arc Stationary Spout

- Bath- or deck-mount installation
- Metal construction



T5323-4 Requires valve K-300-K/KR or K-301-K

T5324-4 Requires valve K-438-K

#### Non-Diverter Spout

Part #	Mfg #	Description	Handle(s)	Finish	Price
141705	K-T5323-4-BN	7-7/16" Non-Diverter Spout	ADA Lever	*Brushed Nickel	
141706	K-T5323-4-CP	7-7/16" Non-Diverter Spout	ADA Lever	Polished Chrome	

#### Diverter Spout

Part #	Mfg #	Description	Handle(s)	Finish	Price
141707	K-T5324-4-BN	7-7/16" Diverter Spout	ADA Lever	*Brushed Nickel	
141708	K-T5324-4-CP	7-7/16" Diverter Spout	ADA Lever	Polished Chrome	

### Revival® 2-Hdl Deck-Mount Tub Faucet for High-Flow Valve

- Deck-mount installation  
—(K-T16119) 9-5/8" spout reach
- Bath-mount installation  
—(K-T16122) 6-5/8" spout reach
- 6-1/4" spout height



-4, Scroll Lever Handles



-4A, Traditional Lever

Requires valve K-300-K/KR or K-301-K

Part #	Mfg #	Description	Handle(s)	Finish	Price
065916	K-T16119-4A-BN	9-5/8" Spout Reach	Traditional Lever Handles	* Brushed Nickel	
078302	K-T16119-4A-BV	9-5/8" Spout Reach	Traditional Lever Handles	* Brushed Bronze	
053994	K-T16119-4A-CP	9-5/8" Spout Reach	Traditional Lever Handles	Polished Chrome	
066677	K-T16119-4A-PB	9-5/8" Spout Reach	Traditional Lever Handles	* Polished Brass	
078403	K-T16122-4A-BN	6-5/8" Spout Reach	Traditional Lever Handles	* Brushed Nickel	
189431	K-T16122-4A-PB	6-5/8" Spout Reach	Traditional Lever Handles	* Polished Brass	

### Stillness® 2-Hdl Deck-Mount Tub Faucet with 6-7/8" Non-Diverter Slip-Fit High-Arc Spout

- Bath- or deck-mount installation



Requires high-flow valve K-300-K/KR or K-301-K

Part #	Mfg #	Description	Handle(s)	Finish	Price
074806	K-T954-4-BN	6-7/8" Non-Diverter Spout	ADA Lever Handles	*Brushed Nickel	
060612	K-T954-4-CP	6-7/8" Non-Diverter Spout	ADA Lever Handles	Polished Chrome	

\* Vibrant Limited Lifetime Warranty

[www.waterconcepts.net](http://www.waterconcepts.net) • Serving our Customers Since 1946 • [www.plumbsupply.com](http://www.plumbsupply.com)

## Tub Faucets

### One-Handle Tub Faucets

#### Composed® 1-Hdl Deck-Mount Tub Faucet with 8-1/4" Diverter Spout

- Temperature memory
- High-temperature limit setting
- MasterClean™ sprayface
- Single-function handshower with 60" metal hose
- Maximum flow rate: 8 gpm
- Handshower flow rate: 2 gpm



Part #	Mfg #	Description	Handle(s)	Finish	Price
244545	K-73078-4-CP	8-1/4" Diverter Spout	Single Lever Handle	Polished Chrome	

#### Loure® 1-Hdl Deck-Mount Tub Faucet with 6-1/2" Non-Diverter Spout

- Single control ceramic remote valve

Valve Included



Part #	Mfg #	Description	Handle(s)	Finish	Price
163690	K-14675-4-BN	6-1/2" Non-Diverter Spout	Single Lever Handle	* Brushed Nickel	
139934	K-14675-4-CP	6-1/2" Non-Diverter Spout	Single Lever Handle	Polished Chrome	

#### Toobi™ 1-Hdl Deck-Mount Tub Faucet with Handshower

- Spout with pull diverter, 8-13/16" reach
- Single-control cylinder handle
- Escutcheon plates
- Includes white, green and black spout insert color options
- Handshower includes adjustable sprayface with 60" length hose



For Floor Mount Installation, use riser tubes K-18492

Part #	Mfg #	Description	Handle(s)	Finish	Price
143158	K-8973-7-BN	8-13/16" Spout	Single Handle Knob	* Brushed Nickel	
167291	K-8973-7-CP	8-13/16" Spout	Single Handle Knob	Polished Chrome	

#### Stance® 1-Hdl Deck-Mount High-Flow Tub Faucet with Single-Control Remote Valve and 9" Spout



Diverter Spout

Part #	Mfg #	Description	Handle(s)	Finish	Price
134411	K-14774-4-BN	8-1/4" Diverter Spout	Single Lever Handle	* Brushed Nickel	

\* Vibrant Limited Lifetime Warranty

[www.plumbsupply.com](http://www.plumbsupply.com) • Serving our Customers Since 1946 • [www.waterconcepts.net](http://www.waterconcepts.net)

## Tub Faucets

### One-Handle Tub Faucets (Continued)

#### Stance® 1-Hdl Deck-Mount High-Flow Tub Faucet with Single-Control Remote Valve and 9" Spout Diverter Spout

Part #	Mfg #	Description	Handle(s)	Finish	Price
145688	K-14774-4-CP	8-1/4" Diverter Spout	Single Lever Handle	Polished Chrome	

#### Non-Diverter Spout

Part #	Mfg #	Description	Handle(s)	Finish	Price
139155	K-14775-4-BN	8-1/4" Non-Diverter Spout	Single Lever Handle	* Brushed Nickel	
139347	K-14775-4-CP	8-1/4" Non-Diverter Spout	Single Lever Handle	Polished Chrome	

#### Symbol® 1-Hdl Tub Faucet with 8" Diverter Spout Handshower

- Bath- or deck-mount installation
- Push-button diverter
- Handshower included with 60" hose
- Optional riser-mount installation when used with K-18492 riser tubs



Part #	Mfg #	Description	Handle(s)	Finish	Price
104159	K-18486-4-CP	8" Spout Reach	Lever	Polished Chrome	

### Floor Mount Tub Faucets

#### Artifacts® 1-Hdl Floor-Mount Tub Faucet with 8-7/16" Spout Reach & Handshower

- Metal construction
- Ceramic disc valves
- Handshower with 60" hose
- WaterSense® certified: 8 gpm
- Handshower flow rate: 1.75 gpm



Requires K-97339 Mounting-Block

Part #	Mfg #	Description	Handle(s)	Finish	Price
254654	K-T72790-9M-CP	8-7/16" Spout Reach	Lever	Polished Chrome	

\* Vibrant Limited Lifetime Warranty

[www.waterconcepts.net](http://www.waterconcepts.net) • Serving our Customers Since 1946 • [www.plumbsupply.com](http://www.plumbsupply.com)



## Tub Faucets

### Composed® 1-Hdl Floor-Mount Tub Faucet with 8-1/4" Spout Reach & Handshower

- Metal construction
- 8-1/4" Diverter spout
- Ceramic disc valves
- MasterClean™ sprayface
- Multifunction handshower with 60" hose
- WaterSense® certified: 8 gpm
- Handshower flow rate: 2 gpm



Requires K-97339 Mounting-Block

Part #	Mfg #	Description	Handle(s)	Finish	Price
247629	K-T73087-4-CP	8-1/4" Spout Reach	Lever	Polished Chrome	
251666	K-T73087-4-TT	8-1/4" Spout Reach	Lever	*Titanium	

### Finial® Traditional Floor-or Wall-Mount Faucet with Lever Handles, 9-5/8" Diverter Spout, & Handshower

- Solid brass construction
- Brass valve bodies
- Polished finish accents
- One-piece ceramic valve
- Traditional handshower with 69" hose



Part #	Mfg #	Description	Handle(s)	Finish	Price
079382	K-331-4M-BN	9-5/8" Spout Reach	Lever	*Brushed Nickel	
076966	K-331-4M-BV	9-5/8" Spout Reach	Lever	*Brushed Bronze	
133269	K-331-4M-CP	9-5/8" Spout Reach	Lever	Polished Chrome	
161881	K-331-4M-2BZ	9-5/8" Spout Reach Bronze	Lever	Oil Rubbed	

### Kelston® 1-Hdl Floor-Mount Tub Faucet with 8-3/4" Spout Reach

- Includes K-72776 handshower and hose
- Flow rate: 6 gpm



Requires K-97339 Mounting-Block

Part #	Mfg #	Description	Handle(s)	Finish	Price
226439	K-T97332-4-BN	8-3/4" Spout Reach	Lever	Brushed Nickel	
183293	K-T97332-4-CP	8-3/4" Spout Reach	Lever	Polished Chrome	
185339	K-T97332-4-2BZ	8-3/4" Spout Reach Bronze	Lever	Oil Rubbed	

\* Vibrant Limited Lifetime Warranty

[www.plumbsupply.com](http://www.plumbsupply.com) • Serving our Customers Since 1946 • [www.waterconcepts.net](http://www.waterconcepts.net)

## Tub Faucets

### Loure® 1-Hdl Floor Mount Bath Filler with 6-9/16" Spout Reach

- Includes K-45203 handshower and hose
- Flow Rate: 6 gpm @ 45 psi
- Requires K-97343-NA mounting-block



Part #	Mfg #	Description	Handle(s)	Finish	Price
184143	K-T97330-4-CP	6-9/16" Spout Reach	Lever	Polished Chrome	

### Margaux® 1-Hdl Floor-Mount Tub Faucet with 4-5/16" Spout Reach

- Includes K-45203 handshower and hose
- Flow rate: 6 gpm

Requires K-97339 Mounting-Block



Part #	Mfg #	Description	Handle(s)	Finish	Price
224471	K-T97331-4-BN	4-5/16" Spout Reach	Lever	*Brushed Nickel	
181191	K-T97331-4-CP	4-5/16" Spout Reach	Lever	Polished Chrome	

### Purist® 1-Hdl Floor-Mount Tub Filler

- 12-1/16" Spout reach
- Includes K-10257 handshower and hose
- Flow rate: 6 gpm

Requires K-97339 Mounting-Block



Part #	Mfg #	Description	Handle(s)	Finish	Price
174981	K-T97328-4-BN	12-1/16" Spout Reach	Lever	* Brushed Nickel	
179749	K-T97328-4-CP	12-1/16" Spout Reach	Lever	Polished Chrome	
257776	K-T97328-4-SN	12-1/16" Spout Reach	Lever	*Polished Nickel	

\* Vibrant Limited Lifetime Warranty

[www.waterconcepts.net](http://www.waterconcepts.net) • Serving our Customers Since 1946 • [www.plumbsupply.com](http://www.plumbsupply.com)

## Tub Faucets

### Refinia® 1-Hdl Floor-Mount Tub Filler

- 8-1/2" Spout reach
- Includes K-72420 Awaken B90 2.0 gpm handshower and 60" shower hose
- Flow rate: 7 gpm
- Requires K-97342-NA mounting-block



Part #	Mfg #	Description	Handle(s)	Finish	Price
185566	K-T97334-4-BN	8-1/2" Spout Reach	Lever	*Brushed Nickel	
223678	K-T97334-4-CP	8-1/2" Spout Reach	Lever	Polished Chrome	

### Stillness® 1-Hdl Floor-Mount Tub Faucet

- 8-1/2" Spout reach
- Includes K-10257 handshower and hose
- Flow rate: 6 gpm

Requires K-97339 Mounting-Block



Part #	Mfg #	Description	Handle(s)	Finish	Price
176947	K-T97344-4-CP	8-1/2" Spout Reach	Lever	Polished Chrome	

## Tub Faucet Components (Spouts and Handles)

### Alteo® Valve Trim Handles

- Two-handle bat- or deck- or wall-mount installation
- Metal construction



Requires Valve: K-300-K/KR, K-301-K, or K-302-K

Part #	Mfg #	Description	Handle(s)	Finish	Price
141722	K-T45119-4-BN	Handle Trim Only	ADA Lever	*Brushed Nickel	
141721	K-T45119-4-CP	Handle Trim Only	ADA Lever	Polished Chrome	
154100	K-T45119-4-2BZ	Handle Trim Only Bronze	ADA Lever	Oil Rubbed	

\* Vibrant Limited Lifetime Warranty

[www.plumbsupply.com](http://www.plumbsupply.com) • Serving our Customers Since 1946 • [www.waterconcepts.net](http://www.waterconcepts.net)

## Tub Faucets

### Antique™ Riser Tubes

- Brass construction
- Floor-mount installation



Part #	Mfg #	Mount	Length	Height	Finish	Price
070939	K-126-CP	Floor	26"	27-7/8"	Polished Chrome	
245786	K-126-PB	Floor	26"	27-7/8"	*Polished Brass	

### Antique™ Riser Tubes and Cross Connection

- 8" Width
- Brass construction
- Floor-mount installation



Part #	Mfg #	Mount	Length	Height	Finish	Price
183462	K-127-2BZ	Floor	26"	27-7/8"	Oil Rubbed Bronze	
057708	K-128-CP	Floor	29-5/8"	31-1/2"	Polished Chrome	
182406	K-128-SN	Floor	29-5/8"	31-1/2"	*Polished Nickel	

### Artifacts® Deck-Mount Bath Spout with Arc Design

- 9" Reach, 5-1/4" high spout
- Brass construction
- Ceramic disc valves
- Flow rate: 15 gpm
- Handle trim sold separately



Part #	Mfg #	Description	Handle(s)	Finish	Price
174430	K-72778-BN	9" Non-Diverter Spout	Less Handle Trim	*Brushed Nickel	
181402	K-72778-BV	9" Non-Diverter Spout	Less Handle Trim	* Brushed Bronze	
173102	K-72778-SN	9" Non-Diverter Spout	Less Handle Trim	* Polished Nickel	
180274	K-72778-2BZ	9" Non-Diverter Spout Bronze	Less Handle Trim	Oil Rubbed	

\* Vibrant Limited Lifetime Warranty

[www.waterconcepts.net](http://www.waterconcepts.net) • Serving our Customers Since 1946 • [www.plumbsupply.com](http://www.plumbsupply.com)

## Tub Faucets

### Artifacts® Deck-Mount Bath Spout with Flare Design

- 9" Reach, 4-3/4" high spout
- Brass construction
- Ceramic disc valves
- Flow rate: 15 gpm
- Handle trim sold separately



Part #	Mfg #	Description	Handle(s)	Finish	Price
177220	K-72777-BN	9" Non-Diverter Spout	Less Handle Trim	*Brushed Nickel	
222669	K-72777-BV	9" Non-Diverter Spout	Less Handle Trim	*Brushed Bronze	
167566	K-72777-CP	9" Non-Diverter Spout	Less Handle Trim	Polished Chrome	
181719	K-72777-SN	9" Non-Diverter Spout	Less Handle Trim	* Polished Nickel	
184807	K-72777-VNT	9" Non-Diverter Spout	Less Handle Trim	Vintage Nickel	
168451	K-72777-2BZ	9" Non-Diverter Spout Bronze	Less Handle Trim	Oil Rubbed	

### Artifacts® Deck-Mount Bath Handle Trim

- Premium metal construction
- Deck-mount
- Bath spout sold separately



Lever

Prong

Swing

Part #	Mfg #	Description	Handle(s)	Finish	Price
183421	K-T98071-3M-BN	Less Spout	ADA Prong	*Brushed Nickel	
183423	K-T98071-3M-BV	Less Spout	ADA Prong	*Brushed Bronze	
167567	K-T98071-3M-CP	Less Spout	ADA Prong	Polished Chrome	
183424	K-T98071-3M-SN	Less Spout	ADA Prong	*Polished Nickel	
184808	K-T-98071-3M-VN T	Less Spout	ADA Prong	Vintage Nickel	
168452	K-T98071-3M-2BZ	Less Spout Bronze	ADA Prong	Oil Rubbed	
174431	K-T98071-4-BN	Less Spout	ADA Lever	*Brushed Nickel	
181404	K-T98071-4-BV	Less Spout	ADA Lever	*Brushed Bronze	
171944	K-T98071-4-CP	Less Spout	ADA Lever	Polished Chrome	
173100	K-T98071-4-SN	Less Spout	ADA Lever	* Polished Nickel	
173811	K-T98071-4-2BZ	Less Spout Bronze	ADA Lever	Oil Rubbed	
183089	K-T98071-9M-BN	Less Spout	Swing Lever	*Brushed Nickel	
183426	K-T98071-9M-CP	Less Spout	Swing Lever	Polished Chrome	
183427	K-T98071-9M-SN	Less Spout	Swing Lever	*Polished Nickel	
183429	K-T98071-9M-2BZ	Less Spout Bronze	Swing Lever	Oil Rubbed	

\* Vibrant Limited Lifetime Warranty

**www.plumbsupply.com • Serving our Customers Since 1946 • www.waterconcepts.net**

## Tub Faucets

### Bancroft® Deck-Mount Valve Trim with Metal Lever Handles

- Bath- or deck-mount installation
- High-flow valve trim
- Spout sold separately



Requires Valve K-300-K/KR or K-301-K

Part #	Mfg #	Description	Handle(s)	Finish	Price
151324	K-T10587-4-2BZ	Handle Trim Only Bronze	ADA Lever	Oil Rubbed	

### Composed® Non-Diverter Bath Spout

- Brass construction
- Wall-mount
- 7-3/8" Spout reach



Part #	Mfg #	Description	Handle(s)	Finish	Price
239032	K-73120-TT	7-3/8" Spout Reach, Non Diverter	-	Titanium	

### Fairfax® Deck or Wall-Mount Tub Trim Handles

- Brass construction
- Less spout
- Handles only sold as pair
- Lifetime limited



Part #	Mfg #	Description	Handle(s)	Finish	Price
183393	K-T12887-4-2BZ	- Bronze	ADA Lever	Oil Rubbed	

### Laminar Deck-Mount Bath Filler Spout

- Solid brass construction



Part #	Mfg #	Description	Handle(s)	Finish	Price
111512	K-8360-BN	13" Spout Reach, Non Diverter	-	*Brushed Nickel	
118108	K-8360-CP	13" Spout Reach, Non Diverter	-	Polished Chrome	

\* Vibrant Limited Lifetime Warranty

[www.waterconcepts.net](http://www.waterconcepts.net) • Serving our Customers Since 1946 • [www.plumbsupply.com](http://www.plumbsupply.com)



## Tub Faucets

### Laminar Wall-or-Ceiling Mount Bath Filler

- Solid brass construction
- Easy-to-access cartridge
- Pressure-compensating flow control
- Complements the Purist® collection



Part #	Mfg #	Description	Handle(s)	Finish	Price
058224	K-922-CP	0.8" Orifice	-	Polished Chrome	
062436	K-923-CP	0.95" Orifice	-	Polished Chrome	

### Memoirs® Stately Deck-Mount High-Flow Bath Valve Trim and Deco Lever Handles

- Brass construction

Requires Valve: K-300-K or K-301-K



Part #	Mfg #	Description	Handle(s)	Finish	Price
094147	K-T467-4V-BN	Deck-Mount, High-Flow	Deco Lever	*Brushed Nickel	
097100	K-T467-4V-BV	Deck-Mount, High-Flow	Deco Lever	*Brushed Bronze	
181030	K-T467-4V-CP	Deck-Mount, High-Flow	Deco Lever	Polished Chrome	

### Pinstripe® Pure Deck-Mount Valve Trim Handles

- Metal construction
- Bath- or deck-mount
- Available with cross or lever handles



Requires Valve: K-300-K/Kr or K-301-K

Part #	Mfg #	Description	Handle(s)	Finish	Price
182968	K-T13141-4A-BN	Handles Only	ADA Lever	*Brushed Nickel	

### Purist® Deck-or Wall-Mount High-Flow Tub Valve Trim

- Brass construction, brass valve bodies
- Cross or lever handles only
- Bath- or deck-mount

Requires: K-300-K/KR 1/2" high-flow valve  
or  
K-301-K 3/4" high-flow valve  
or  
K-302-K 2-Hdl 1/2" valve



Part #	Mfg #	Description	Handle(s)	Finish	Price
222086	K-T14429-3-BGD	Deck-Mount	Cross	*Moderne Brushed Gold	
254557	K-T14429-3-SN	Deck-or Wall-Mount	Cross	*Polished Nickel	
074796	K-T14429-4-CP	Deck-or Wall-Mount	Lever	Polished Chrome	
253464	K-T14429-4-SN	Deck-or Wall-Mount	Lever	*Polished Nickel	

\* Vibrant Limited Lifetime Warranty

[www.plumbsupply.com](http://www.plumbsupply.com) • Serving our Customers Since 1946 • [www.waterconcepts.net](http://www.waterconcepts.net)

## Tub Faucets

### Refinia® Deck-or Wall-Mount Valve Trim Handles

- Metal construction



Requires: K-300-K high-flow valve  
or  
K-300-KR high-flow valve with rigid connections  
or  
K-301-K 3/4" high flow bath valve  
or  
K-302-K 2-Hdl 1/2" ceramic in-wall valve system

Part #	Mfg #	Description	Handle(s)	Finish	Price
141709	K-T5325-4-BN	Deck-or Wall-Mount	ADA Lever	*Brushed Nickel	
141710	K-T5325-4-CP	Deck-or Wall-Mount	ADA Lever	Polished Chrome	

### Symbol® Riser Tubes

- Premium metal construction
- Floor-mount installation
- 2-5/8"L x 24-7/8"H x 5-7/8"W



Part #	Mfg #	Description	Handle(s)	Finish	Price
107492	K-18492-CP	Floor-Mount	-	Polished Chrome	

\* Vibrant Limited Lifetime Warranty

[www.waterconcepts.net](http://www.waterconcepts.net) • Serving our Customers Since 1946 • [www.plumbsupply.com](http://www.plumbsupply.com)

## Tub Faucets

### MultiChoice™ Universal Wall-Mount Tub Trim

#### Ashlyn™ Monitor® 14 Series 1-Hdl Tub Only Trim

- Fits MultiChoice™ universal valve
- Handle adjusts temperature
- Sweat onto 1/2" C.W.T. or thread onto 1/2" IPS



Part #	Mfg #	Description	Handle(s)	Finish	Price
178458	T14164	Tub Trim Only, 7-15/16" Non-Diverter Spout	ADA Lever	Chrome	
170525	T14164-SS	Tub Trim Only, 7-15/16" Non-Diverter Spout	ADA Lever	Stainless*	

#### Classic Monitor® 13 Series 1-Hdl Tub Trim

- Fits MultiChoice™ universal valve
- Handle adjusts temperature
- Thread onto 1/2" IPS



Part #	Mfg #	Description	Handle(s)	Finish	Price
092581	T13120	Tub Trim Only, 5-1/4" Non-Diverter Spout	ADA Lever	Chrome	
092582	T13120-LTS	Tub Trim Only, 7" Non-Diverter Spout	ADA Lever	Chrome	

#### Compel® Monitor® 14 Series 1-Hdl Tub Trim

- Fits MultiChoice™ universal valve
- Handle adjusts temperature
- 7-3/4" Non-diverter tub spout



Part #	Mfg #	Description	Handle(s)	Finish	Price
239099	T14161	Tub Trim Only, 7-3/4" Non-Diverter Spout	ADA Lever	Chrome	
249328	T14161-SS	Tub Trim Only, 7-3/4" Non-Diverter Spout	ADA Lever	Stainless*	

\* Brilliance® Anti-Tarnish Lifetime Finishes

## Tub Faucets

### Linden™ Monitor 14 Series Tub Trim

- Fits MultiChoice™ universal valve
- Handle adjusts temperature
- 6-1/2" Non-diverter tub spout



T14193-SS

T14194-SS

Part #	Mfg #	Description	Handle(s)	Finish	Price
253381	T14193	Tub Trim Only, 6-1/2" Non-Diverter Spout	ADA Lever	Chrome	
246799	T14193-RB	Tub Trim Only, 6-1/2" Non-Diverter Spout	ADA Lever	Venetian Bronze®	
226839	T14193-SS	Tub Trim Only, 6-1/2" Non-Diverter Spout	ADA Lever	Stainless*	
144841	T14194-RB	Tub Trim Only, 6-1/2" Non-Diverter Spout	ADA Lever	Venetian Bronze®	
145250	T14194-SS	Tub Trim Only, 6-1/2" Non-Diverter Spout	ADA Lever	Stainless*	

### Trinsic® Monitor 14 Series 1-Hdl Tub Trim

- Fits MultiChoice™ universal valve
- Handle adjusts temperature
- Single-function pressure balance cartridge
- 7-15/16" Non-diverter tub spout



Part #	Mfg #	Description	Handle(s)	Finish	Price
240369	T14159	Tub Trim Only, 7-15/16" Non-Diverter Spout	ADA Lever	Chrome	
258554	T14159-CZ	Tub Trim Only, 7-15/16" Non-Diverter Spout Bronze™	ADA Lever	Champagne	

## Free Standing Tub Fillers

### Ara® Floor Mount Tub Filler Trim

- 8-3/16" Reach, 40-7/16" high spout
- 39-1/4" From deck to outlet
- 60"-82" stretchable metal hose
- Auto resetting diverter
- Pivot handshower holder
- Dual integral check valve on handshower
- Handshower flow rate: 2.0 gpm @ 80 psi



Part #	Mfg #	Description	Handle(s)	Finish	Price
230324	T4767-FL	1-Hole, with Handshower	ADA Lever	Chrome	
254359	T4767-BL FL	1-Hole, with Handshower	ADA Lever	Matte Black	
228154	T4767-SSFL	1-Hole, with Handshower	ADA Lever	Stainless*	

\* Brilliance® Anti-Tarnish Lifetime Finishes

## Tub Faucets

### Cassidy™ Floor Mount Tub Filler Trim

- 8-1/2" Reach, 42-1/2" high swivel spout
- 40" From deck to outlet
- Handle adjusts temperature
- Pivoting handshower arm
- 60"-82" Stretchable hose
- H2Okinetic® 3-Setting handshower includes double check valves
- Self-cleaning H2Okinetic® spray holes
- Flow rate: 10.0 gpm @ 60 psi
- Handshower flow rate: 2.0 gpm @ 80 psi



Order handle separately (LHP)

Part #	Mfg #	Description	Handle(s)	Finish	Price
178716	T4797-FL-LHP	1-Hole, with Handshower	Less Handle	Chrome	
222136	T4797-CZFL-LHP	1-Hole, with Handshower Bronze™	Less Handle	Champagne	
225204	T4797-PNFL-LHP	1-Hole, with Handshower	Less Handle	Polished Nickel	
168551	T4797-RBFL-LHP	1-Hole, with Handshower	Less Handle	Venetian Bronze®	
174148	T4797-SSFL-LHP	1-Hole, with Handshower	Less Handle	Stainless*	

### Contemporary Floor Mount Tub Filler Trim

- 8" Reach, 41" high swivel spout
- 37" From deck to outlet
- Swivel spout
- Handle adjusts temperature, pivoting handshower arm
- Touch-Clean® handshower includes double check valves
- 60"-82" stretchable metal hose
- Flow rate: 6.0 gpm @ 60 psi
- Handshower flow rate: 2.0 gpm @ 80 psi



Part #	Mfg #	Description	Handle(s)	Finish	Price
163782	T4759-FL	1-Hole, with Handshower	ADA Lever	Chrome	
246655	T4759-BLFL	1-Hole, with Handshower	ADA Lever	Matte Black	
175699	T4759-CZFL	1-Hole, with Handshower Bronze™	ADA Lever	Champagne	
167049	T4759-RBFL	1-Hole, with Handshower	ADA Lever	Venetian Bronze®	
162182	T4759-SSFL	1-Hole, with Handshower	ADA Lever	Stainless*	

\* Brilliance® Anti-Tarnish Lifetime Finishes

[www.plumbsupply.com](http://www.plumbsupply.com) • Serving our Customers Since 1946 • [www.waterconcepts.net](http://www.waterconcepts.net)

## Tub Faucets

### Stryke™ Floor Mount Tub Filler Trim

- 9-23/32" Reach, 42-29/32" high spout
- 3" Maximum deck thickness
- Handle adjusts temperature
- Pivot handshower arm
- H2Okinetic® single-setting handshower includes double check valves for backflow prevention
- 60"-82" Stretchable hose
- Flow rate: 10.0 gpm @ 60 psi
- Handshower flow rate: 1.75 gpm @ 80 psi



Rough-in R4700-FL or R4700-FLWS required, sold separately

Part #	Mfg #	Description	Handle(s)	Finish	Price
255546	T4776-SSFL	1-Hole with Handshower	ADA Lever	Stainless*	

### Tesla® Floor Mount Tub Filler Trim

- 9" Reach, 41-1/2" high spout
- 40-1/8" From deck to outlet
- Handle adjusts temperature
- Pivot handshower arm
- H2Okinetic® 4-setting handshower includes double check valves for backflow prevention
- Self-cleaning H2Okinetic® spray holes
- 60"-82" Stretchable hose
- Flow rate: 10.0 gpm @ 60 psi
- Handshower flow rate: 2.0 gpm @ 80 psi



Part #	Mfg #	Description	Handle(s)	Finish	Price
187265	T4752-FL	1-Hole, with Handshower	ADA Lever	Chrome	
229500	T4752-PNFL	1-Hole, with Handshower	ADA Lever	Polished Nickel	
189164	T4752-SSFL	1-Hole, with Handshower	ADA Lever	Stainless*	

\* Brilliance® Anti-Tarnish Lifetime Finishes



## Tub Faucets

### Zura® Floor Mount Tub Filler Trim

- 9-3/6" Reach, 40-5/8" high spout
- 39-3/16" From floor to outlet
- Handle adjusts temperature
- Pivot handshower arm
- 60"-82" Stretchable hose with metal fittings
- Handshower flow rate: 1.75 gpm @ 80 psi
- Dual integral check valves on handshower
- Auto resetting diverter



Valve is not included, must purchase separately  
Rough-in R4700-FL or R4700-FLWS

Part #	Mfg #	Description	Handle(s)	Finish	Price
228395	T4774-FL	1-Hole, with Handshower	ADA Lever	Chrome	
234865	T4774-SSFL	1-Hole, with Handshower	ADA Lever	Stainless*	

### Two-Handle Roman Tub Trim Packs

#### Addison™ 2-Hdl Roman Tub Trim

- Requires rough-in kit
- 8-7/8" Reach, 8-1/8" high rigid slip-on spout
- 5-3/4" From deck to aerator
- 2-3/4" Diameter scalloped handle bases



T2792



T4792

(T4792 Model)

- Touch-Clean® full body handshower includes double check valves for backflow prevention
- Handshower flow rate: 2.0 gpm @ 60 psi

Part #	Mfg #	Description	Handle(s)	Finish	Price
128423	T2792	3-Hole 8"-16"cc	ADA Lever	Chrome	
125980	T2792-RB	3-Hole 8"-16"cc	ADA Lever	Venetian Bronze®	
128427	T2792-SS	3-Hole 8"-16"cc	ADA Lever	Stainless*	
131446	T4792	4-Hole 8"-16"cc, Handshower	ADA Lever	Chrome	
137746	T4792-CZ	4-Hole 8"-16"cc, Handshower Bronze™	ADA Lever	Champagne	
126445	T4792-RB	4-Hole 8"-16"cc, Handshower	ADA Lever	Venetian Bronze®	
132290	T4792-SS	4-Hole 8"-16"cc, Handshower	ADA Lever	Stainless*	

\* Brilliance® Anti-Tarnish Lifetime Finishes

[www.plumbsupply.com](http://www.plumbsupply.com) • Serving our Customers Since 1946 • [www.waterconcepts.net](http://www.waterconcepts.net)

## Tub Faucets

### Ara™ 2-Hdl Roman Tub Trim

- Requires rough-in kit
- 8-3/16" Reach, 6-11/16" high rigid spout
- 5-11/16" From deck to aerator
- 2-1/2" Square handle bases



T2767



T4767

#### (T4768) Model with Channel Spout

- H2Okinetic® handshower includes double check valves
- Self-cleaning H2Okinetic® spray holes
- Handshower flow rate: 2.0 gpm @ 80 psi

Part #	Mfg #	Description	Handle(s)	Finish	Price
166550	T2767	3-Hole 8"-16"cc	ADA Lever	Chrome	
254357	T2767-BL	3-Hole 8"-16"cc	ADA Lever	Matte Black	
162245	T2767-SS	3-Hole 8"-16"cc	ADA Lever	Stainless*	
180887	T4767	4-Hole 8"-16"cc, 2.0 gpm Handshower	ADA Lever	Chrome	
258959	T4767-BL	4-Hole 8"-16"cc, 2.0 gpm Handshower	ADA Lever	Matte Black	
182277	T4767-SS	4-Hole 8"-16"cc, 2.0 gpm Handshower	ADA Lever	Stainless*	
254485	T4768-BL	4-Hole 8"-16"cc, 2.0 gpm Handshower	ADA Lever	Matte Black	

### Ara™ 2-Hdl Roman Tub Trim with Channel Spout

- Requires rough-in kit
- 9" Reach, 6-11/16" high rigid spout
- 5-3/8" From deck to aerator
- 2-1/2" Square handle bases



Part #	Mfg #	Description	Handle(s)	Finish	Price
173563	T2768	3-Hole 8"-16"cc, Channel Spout	ADA Lever	Chrome	
160231	T2768-SS	3-Hole 8"-16"cc, Channel Spout	ADA Lever	Stainless*	
189892	T4768	4-Hole 8"-16"cc, 2.0 gpm Handshower & Channel Spout	ADA Lever	Chrome	
165749	T4768-SS	4-Hole 8"-16"cc, 2.0 gpm Handshower & Channel Spout	ADA Lever	Stainless*	

\* Brilliance® Anti-Tarnish Lifetime Finishes

## Tub Faucets

### Ashlyn™ 2-Hdl Roman Tub Trim

- Requires rough-in kit
- 8-3/8" Reach, 6-5/8" high rigid spout
- 5-1/2" From deck to aerator
- Red/blue indicators
- 2-5/8" Diameter handle bases



**(T4764 Model)**

- 5-Setting handshower includes double check valves for backflow prevention
- Touch-Clean® spray holes
- Handshower flow rate: 2.0 gpm @ 80 psi

Part #	Mfg #	Description	Handle(s)	Finish	Price
173153	T2764	3-Hole 8"-16"cc	ADA Lever	Chrome	
172038	T2764-RB	3-Hole 8"-16"cc	ADA Lever	Venetian Bronze®	
173095	T2764-SS	3-Hole 8"-16"cc	ADA Lever	Stainless*	
180170	T4764	4-Hole 8"-16"cc, w/ Handshower	ADA Lever	Chrome	
171539	T4764-RB	4-Hole 8"-16"cc, w/ Handshower	ADA Lever	Venetian Bronze®	
173518	T4764-SS	4-Hole 8"-16"cc, w/ Handshower	ADA Lever	Stainless*	

### Cassidy™ 2-Hdl Roman Tub Tri

- Requires rough-in kit
- 10-3/32" Reach, 9-11/32" high rigid slip-on spout
- 6-19/32" From deck to aerator
- Handles sold separately
- Three-setting H2Okinetic™ handshower -H2Okinetic™ spray, massage spray, and pause
- Self-cleaning H2Okinetic® spray holes
- Handshower includes double check valves for backflow prevention
- Handshower flow rate: 2.0 gpm @ 80 psi



**(-LHP) Less handle package**

Part #	Mfg #	Description	Handle(s)	Finish	Price
152933	T2797-CZLHP	3-Hole, 8"-16"cc Bronze™	Less Handles	Champagne	
151502	T2797-LHP	3-Hole, 8"-16"cc	Less Handles	Chrome	
152935	T2797-PNLHP	3-Hole, 8"-16"cc	Less Handles	Polished Nickel*	
152936	T2797-RBLHP	3-Hole, 8"-16"cc	Less Handles	Venetian Bronze®	
152937	T2797-SSLHP	3-Hole, 8"-16"cc	Less Handles	Stainless*	
152950	T4797-CZLHP	4-Hole, 8"-16"cc with Handshower Bronze™	Less Handles	Champagne	
152944	T4797-LHP	4-Hole, 8"-16"cc with Handshower	Less Handles	Chrome	
152951	T4797-PNLHP	4-Hole, 8"-16"cc with Handshower	Less Handles	Polished Nickel*	
151694	T4797-RBLHP	4-Hole, 8"-16"cc with Handshower	Less Handles	Venetian Bronze®	
151697	T4797-SSLHP	4-Hole, 8"-16"cc with Handshower	Less Handles	Stainless*	

\* Brilliance® Anti-Tarnish Lifetime Finishes

[www.plumbsupply.com](http://www.plumbsupply.com) • Serving our Customers Since 1946 • [www.waterconcepts.net](http://www.waterconcepts.net)

## Tub Faucets

### Cassidy™ 2-Hdl Low Arc Spout Tub Trim

- Requires rough-in kit
- 10-3/32" Reach, 6-11/16" high rigid slip-on spout
- 4-11/32" From deck to aerator
- Handles sold separately
- 2-3/4" Diameter handle bases
- H2Okinetic™ handshower includes double check valve for backflow prevention
- 3-Setting handshower
- Self-cleaning H2Okinetic® spray holes
- Handshower flow rate: 2.0 gpm @ 80 psi



(-LHP) Less handle package

Part #	Mfg #	Description	Handle(s)	Finish	Price
152835	T2795-CZLHP	3-Hole, 8"-16"cc Bronze™	Less Handles	Champagne	
152834	T2795-LHP	3-Hole, 8"-16"cc	Less Handles	Chrome	
152930	T2795-PNLHP	3-Hole, 8"-16"cc	Less Handles	Polished Nickel*	
152931	T2795-RBLHP	3-Hole, 8"-16"cc	Less Handles	Venetian Bronze®	
152932	T2795-SSLHP	3-Hole, 8"-16"cc	Less Handles	Stainless*	
152938	T4795-LHP	4-Hole, 8"-16"cc with Handshower	Less Handles	Chrome	
152939	T4795-CZLHP	4-Hole, 8"-16"cc with Handshower Bronze™	Less Handles	Champagne	
152940	T4795-PNLHP	4-Hole, 8"-16"cc with Handshower	Less Handles	Polished Nickel*	
152369	T4795-RBLHP	4-Hole, 8"-16"cc with Handshower	Less Handles	Venetian Bronze™	
152941	T4795-SSLHP	4-Hole, 8"-16"cc with Handshower	Less Handles	Stainless*	

### Cassidy™ Roman Tub Handshower with Transfer Valve

- Ledge or wall-mount transfer valve for maximum 1-3/4" deck thickness
- 69" long UltraFlex® hose
- Handle mounts on deck only
- 2-3/4" diameter handle base
- H2Okinetic® handshower includes double check valves for backflow prevention
- Self-cleaning H2Okinetic® spray holes
- Flow rate: 2.0 gpm @ 80 psi



Order handles separately (LHP)

Handle Options Include: H595, H597, or H598

Part #	Mfg #	Description	Handle(s)	Finish	Price
152982	RP72767LHP	2-Hole, 4"-18cc"	Less Handles	Chrome	
152983	RP72767CZLHP	2-Hole, 4"-18cc" Bronze™	Less Handles	Champagne	
152984	RP72767PNLHP	2-Hole, 4"-18cc"	Less Handles	Polished Nickel*	
152985	RP72767RBLHP	2-Hole, 4"-18cc"	Less Handles	Venetian Bronze®	

\* Brilliance® Anti-Tarnish Lifetime Finishes

www.waterconcepts.net • Serving our Customers Since 1946 • www.plumbsupply.com

## Tub Faucets

### Two-Handle Roman Tub Trim Packs (Continued)

#### Cassidy™ Roman Tub Handshower with Transfer Valve

Part #	Mfg #	Description	Handle(s)	Finish	Price
152986	RP72767SSLHP	2-Hole, 4"-18cc"	Less Handles	Stainless*	

#### Traditional Roman Tub Handshower with Transfer Valve

- Ledge or wall-mount transfer valve for maximum 1-3/4" deck thickness
- 69" Long UltraFlex® hose
- Touch-Clean® handshower includes double check valves for backflow prevention
- Handle mounts on deck only
- 2-5/8" diameter handle base
- WaterSense® certified: 2.0 gpm @ 80 psi



Order handles separately (LHP)

Part #	Mfg #	Description	Handle(s)	Finish	Price
162206	RP33791CZLHP	2-Hole, 4"-18"cc Bronze™	Less Handles	Champagne	

#### Roman Tub Handshower Wand

- 7 1/2" long
- 2 1/2" diameter spray face
- Hand Shower includes double check valves for backflow prevention
- WaterSense® certified: 2.0 gpm @ 80 psi

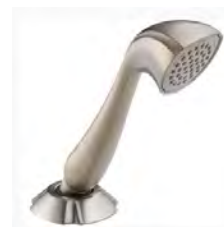

Part #	Mfg #	Description	Handle(s)	Finish	Price
155100	RP61283SS	Stainless*			

#### Classic Roman Tub Handshower with Transfer Valve

- Ledge or wall-mount transfer valve for maximum 1-3/4" deck thickness
- 69" Long UltraFlex® hose
- 2-19/32" Diameter handle base
- Handle mounts on deck only
- Handshower includes double check valves for backflow prevention
- Touch-Clean® spray holes
- Soft-Touch® handle
- WaterSense certified: 2.0 gpm @ 80 psi



Part #	Mfg #	Description	Handle(s)	Finish	Price
003477	RP14979	2-Hole, 4"-18"cc	Less Handles	Chrome	

\* Brilliance® Anti-Tarnish Lifetime Finishes

[www.plumbsupply.com](http://www.plumbsupply.com) • Serving our Customers Since 1946 • [www.waterconcepts.net](http://www.waterconcepts.net)

## Tub Faucets

### Two-Handle Roman Tub Trim Packs (Continued)

#### Classic Roman Tub Handshower with Transfer Valve

Part #	Mfg #	Description	Handle(s)	Finish	Price
137196	RP14979SS	2-Hole, 4"-18"cc	Less Handles	Stainless*	

#### Classic 2-Hdl Roman Tub Trim

- Requires rough-in kit
- 8-1/8" Reach, 7-1/2" High
- 6-1/2" Reach, 7" High (T5722)
- 4-4/5" From deck to outlet
- 2-19/32" Diameter handle bases



#### (T4705 Model)

- 7-1/2" Reach, 5-3/16" high rigid slip-on spout
- 3-1/4" From deck to aerator
- Touch-Clean® handshower includes double check valves for backflow prevention
- Handshower flow rate: 2.0 gpm @ 60 psi

Part #	Mfg #	Description	Handle(s)	Finish	Price
134645	T2705	3-Hole, 8"-16"cc	ADA Lever	Chrome	
134562	T2705-SS	3-Hole, 8"-16"cc	ADA Lever	Stainless*	
106910	T4705	4-Hole, 8"-16"cc	ADA Lever	Chrome	
137332	T4705-SS	4-Hole, 8"-16"cc	ADA Lever	Stainless*	
093055	T2710	3-Hole, 8"-16"cc Low Spout	Acrylic Knob	Chrome	
136041	T5722	3-Hole, 10"-16"cc, 6-1/2" Spout Reach	ADA Lever	Chrome	

#### Contemporary™ 2-Hdl Wall Mount Tub Filler

- Requires rough-in kit (R3500-WL)
- 11-2/5" Spout length
- 1/2" IPS connection
- Ceramic valve
- Cartridges ship with rough
- 1/2"-14 NPT threaded female inlets



Part #	Mfg #	Description	Handle(s)	Finish	Price
255143	T5759-BLWL	3-Hole, 8-16"cc	ADA Lever	Matte Black	
258376	T5759-SSWL	3-Hole, 8-16"cc	ADA Lever	Stainless*	
256035	T5759-WL	3-Hole, 8-16"cc	ADA Lever	Chrome	

\* Brilliance® Anti-Tarnish Lifetime Finishes

[www.waterconcepts.net](http://www.waterconcepts.net) • Serving our Customers Since 1946 • [www.plumbsupply.com](http://www.plumbsupply.com)



## Tub Faucets

### Compel® 2-Hdl Roman Tub Trim

- Requires rough-in kit
- 8-3/4" reach, 8-1/4" high rigid slip-on spout
- 4-3/4" From deck to aerator
- 2-1/2" Diameter handle bases



**(T4761 Model)**

- Touch-Clean® handshower includes double check valves for backflow prevention
- Handshower flow rate: 2.0 gpm @ 80 psi

Part #	Mfg #	Description	Handle(s)	Finish	Price
157503	T2761	3-Hole, 8"-16"cc	ADA Lever	Chrome	
157480	T2761-SS	3-Hole, 8"-16"cc	ADA Lever	Stainless*	
154547	T4761	4-Hole, 8"-16"cc w/ Handshower	ADA Lever	Chrome	
164973	T4761-SS	4-Hole, 8"-16"cc w/ Handshower	ADA Lever	Stainless*	

### Dryden® 2-Hdl Roman Tub Trim

- Requires rough-in kit
- 9" Reach, 7-3/4" high rigid slip-on spout
- 4" From deck to aerator



**(T4751-LHP Model)**

- Touch-Clean® full body handshower includes double check valves for backflow prevention
- Handshower flow rate: 2.0 gpm @ 80 psi

Part #	Mfg #	Description	Handle(s)	Finish	Price
116254	T2751	3-Hole, 8"-16"cc	ADA Lever	Chrome	
160600	T2751-CZ	3-Hole, 8"-16"cc	ADA Lever	Champagne Bronze™	
187681	T2751-PN	3-Hole, 8"-16"cc	ADA Lever	Polished Nickel*	
116289	T2751-RB	3-Hole, 8"-16"cc	ADA Lever	Venetian Bronze®	
238976	T2751-SP	3-Hole, 8"-16"cc	ADA Lever	SpotShield® Stainless*	
116290	T2751-SS	3-Hole, 8"-16"cc	ADA Lever	Stainless*	
116291	T4751	4-Hole, 8"-16"cc w/ Handshower	ADA Lever	Chrome	
168433	T4751-CZ	4-Hole, 8"-16"cc w/ Handshower	ADA Lever	Champagne Bronze™	
175054	T4751-PN	4-Hole, 8"-16"cc w/ Handshower	ADA Lever	Polished Nickel*	
116293	T4751-RB	4-Hole, 8"-16"cc w/ Handshower	ADA Lever	Venetian Bronze®	
116294	T4751-SS	4-Hole, 8"-16"cc w/ Handshower	ADA Lever	Stainless*	

\* Brilliance® Anti-Tarnish Lifetime Finishes

## Tub Faucets

### Foundations® Roman Tub Trim

- Requires rough-in kit
- 6-7/8" Reach, 4-1/2" high rigid slip-on spout
- 3" From deck to aerator
- 2-7/16" Diameter handle bases



Part #	Mfg #	Description	Handle(s)	Finish	Price
136068	BT2710	3-Hole, 8"-16"cc	ADA Lever	Chrome	
140289	BT2710SS	3-Hole, 8"-16"cc	ADA Lever	Stainless*	

### Windemere® 2-Hdl Roman Tub Trim

- Requires rough-in kit
- 7-11/16" Reach, 7-5/16" high rigid slip-on spout
- 5-11/32" From deck to aerator
- 2-3/8" Diameter handle bases



Part #	Mfg #	Description	Handle(s)	Finish	Price
138413	BT2796	3-Hole, 8"-16"cc	ADA Lever	Chrome	
135262	BT2796-OB	3-Hole, 8"-16"cc	ADA Lever	Oil Rubbed Bronze	
137029	BT2796-SS	3-Hole, 8"-16"cc	ADA Lever	Stainless*	

### Lahara® 2-Hdl Roman Tub Trim

- Requires rough-in kit
- 8-3/4" Reach, 8-1/2" high rigid slip-on spout
- 5-3/8" From deck to aerator
- 2-5/8" Diameter scalloped handle bases



**(T4738 Model)**

- Touch-Clean® full body handshower includes double check valves for backflow prevention
- Handshower flow rate: 2.0 gpm @ 80 psi

Part #	Mfg #	Description	Handle(s)	Finish	Price
110777	T2738	3-Hole, 8"-16"cc	ADA Lever	Chrome	
155122	T2738-CZ	3-Hole, 8"-16"cc Bronze™	ADA Lever	Champagne	
110971	T2738-RB	3-Hole, 8"-16"cc	ADA Lever	Venetian Bronze®	
110972	T2738-SS	3-Hole, 8"-16"cc	ADA Lever	Stainless*	
110973	T4738	4-Hole, 8"-16"cc, Handshower	ADA Lever	Chrome	
189997	T4738-CZ	4-Hole, 8"-16"cc, Handshower Bronze™	ADA Lever	Champagne	
110976	T4738-RB	4-Hole, 8"-16"cc, Handshower	ADA Lever	Venetian Bronze®	
110977	T4738-SS	4-Hole, 8"-16"cc, Handshower	ADA Lever	Stainless*	

\* Brilliance® Anti-Tarnish Lifetime Finishes

## Tub Faucets

### Linden™ 2-Hdl Roman Tub Trim

- Requires rough-in kit
- 8-3/8" Reach, 7-7/8" high rigid slip-on spout
- 5-1/2" From deck to aerator
- 2-3/8" Diameter handle bases



T2794

T4794

(T4794-LHP Model)

Handshower includes double check valves for backflow prevention  
Touch-Clean® Handshower

Handshower flow rate: 2.0 gpm @ 60 psi

Part #	Mfg #	Description	Handle(s)	Finish	Price
147204	T2794	3-Hole 8"-16"cc	ADA Lever	Chrome	
145522	T2794-CZ	3-Hole 8"-16"cc Bronze™	ADA Lever	Champagne	
143315	T2794-RB	3-Hole 8"-16"cc	ADA Lever	Venetian Bronze®	
144339	T2794-SS	3-Hole 8"-16"cc	ADA Lever	Stainless*	
144638	T4794	4-Hole 8"-16"cc, Handshower	ADA Lever	Chrome	
156773	T4794-CZ	4-Hole 8"-16"cc, Handshower Bronze™	ADA Lever	Champagne	
143376	T4794-SS	4-Hole 8"-16"cc, Handshower	ADA Lever	Stainless*	
143615	T4794-RB	4-Hole 8"-16"cc, Handshower	ADA Lever	Venetian Bronze®	

### Linden™ 2-Hdl Roman Tub Trim

- Requires rough-in kit
- 8-3/8" Reach, 7-7/8" high rigid slip-on spout
- 5-1/2" From deck to aerator
- 2-3/8" Diameter handle bases



T2793

T4793

(T4793-LHP Model)

Handshower includes double check valves for backflow prevention  
Touch-Clean® Handshower

Handshower flow rate: 2.0 gpm @ 60 psi

Part #	Mfg #	Description	Handle(s)	Finish	Price
190198	T2793	3-Hole 8"-16"cc	ADA Lever	Chrome	
227876	T2793-RB	3-Hole 8"-16"cc	ADA Lever	Venetian Bronze	
225097	T2793-SS	3-Hole 8"-16"cc	ADA Lever	Stainless*	
259431	T4793	4-Hole 8"-16"cc	ADA Lever	Chrome	
238118	T4793-RB	4-Hole 8"-16"cc	ADA Lever	Venetian Bronze	
235288	T4793-SS	4-Hole 8"-16"cc	ADA Lever	Stainless*	

\* Brilliance® Anti-Tarnish Lifetime Finishes

## Tub Faucets

### Pivotal™ 2-Hdl Roman Tub Trim

- Requires rough-in kit
- Ceramic valves
- 11-3/4" Reach, 7-1/8" high rigid slip-on diverter spout
- Spray settings: Massaging spray, H2OKinetic® spray, Pause
- Includes double check valves for backflow protection
- WaterSense certified product: 2.0 gpm @ 80 psi



T4799-SS

Part #	Mfg #	Description	Handle(s)	Finish	Price
244510	T2799	3-Hole 8"-16"cc	ADA Lever	Chrome	
250678	T2799-BL	3-Hole 8"-16"cc	ADA Lever	Matte Black	
244522	T2799-SS	3-Hole 8"-16"cc, Handshower	ADA Lever	Stainless*	
244511	T4799	4-Hole 8"-16"cc, Handshower	ADA Lever	Chrome	
258227	T4799-PN	4-Hole 8"-16"cc, Handshower	ADA Lever	Polished Nickel*	
240255	T4799-SS	4-Hole 8"-16"cc, Handshower	ADA Lever	Stainless*	

### Pivotal™ 2-Hdl Wall Mount Tub Filler

- Requires rough-in kit (R3500-WL)
- Extends 11-1/2" from wall
- 1/2" IPS connection
- Ceramic valve
- Cartridges ship with rough
- 1/2"-14 NPT threaded female inlets



Part #	Mfg #	Description	Handle(s)	Finish	Price
251677	T5799-BLWL	3-Hole 8"cc	ADA Lever	Matte Black	
243413	T5799-SSWL	3-Hole 8"cc	ADA Lever	Stainless*	
252088	T5799-WL	3-Hole 8"cc	ADA Lever	Chrome	

### Rook™ 2-Hdl Roman Tub Trim with Channel Spout—Less Handles

- Requires rough-in kit (R62707)
- 10-3/4" Reach, 7" high
- 2-1/2" Maximum deck thickness
- 4-9/16" Deck to aerator
- Ceramic cartridge
- Must order handles separately



Part #	Mfg #	Description	Handle(s)	Finish	Price
251559	T67361-NKLHP	3-Hole 10"-16"cc	Less Handles	Polished Nickel*	

### Stryke™ 2-Hdl Roman Tub Trim

- Requires rough-in kit (R2707)
- 9-23/32" Reach, 9-1/4" high
- 2-1/2" Maximum deck thickness
- Red/blue indicators



Part #	Mfg #	Description	Handle(s)	Finish	Price
258865	T2776	3-Hole 8"-16"cc	ADA Lever	Chrome	

\* Brilliance® Anti-Tarnish Lifetime Finishes

## Tub Faucets

### Stryke™ 2-Hdl Wall Mount Tub Filler

- Requires rough-in kit (R3500-WL)
- Extends 12-3/4" from wall
- 1/4 Turn stops
- Accommodates wall thicknesses from 1/8 in. to 3-3/4 in
- 1/2"-14 NPT threaded female inlets
- Cartridges ship with rough
- Flow rate: 8.0 gpm @ 60 psi



Part #	Mfg #	Description	Handle(s)	Finish	Price
259360	T57766-BLWL	3-Hole 8"-16"cc	ADA Lever	Matte Black	

### Tesla® 2-Hdl Roman Tub Trim

- Requires rough-in kit
- 8-1/16" reach, 7-1/2" high slip-on rigid spout
- 6-1/4" From deck to aerator
- 2" x 2-1/2" diameter handle bases



T2752

T4752

(T4752 Model)

H2Okinetic® Handshower has four settings

Includes double check valves for backflow prevention

Self-cleaning H2Okinetic® spray holes

Handshower flow rate: 2.0 gpm @ 60 psi

Part #	Mfg #	Description	Handle(s)	Finish	Price
185042	T2752	3-Hole 8"-16"cc	ADA Lever	Chrome	
223739	T2752-SS	3-Hole 8"-16"cc	ADA Lever	Stainless*	
189283	T4752	4-Hole 8"-16"cc, Handshower	ADA Lever	Chrome	
222195	T4752-PN	4-Hole 8"-16"cc, Handshower	ADA Lever	Polished Nickel	
181162	T4752-SS	4-Hole 8"-16"cc, Handshower	ADA Lever	Stainless*	

### Traditional™ 2-Hdl Wall Mount Tub Filler

- Requires rough-in kit (R3500-WL)
- 12" Spout length
- 1/2" IPS connection
- Ceramic valve
- Cartridges ship with rough
- 1/2"-14 NPT threaded female inlets



Part #	Mfg #	Description	Handle(s)	Finish	Price
256341	T5797-RBWL	3-Hole 8-16"	ADA Lever	Venetian Bronze	
255290	T5797-SSWL	3-Hole 8-16"	ADA Lever	Stainless*	
256036	T5797-WL	3-Hole 8-16"	ADA Lever	Chrome	

\* Brilliance® Anti-Tarnish Lifetime Finishes

[www.plumbsupply.com](http://www.plumbsupply.com) • Serving our Customers Since 1946 • [www.waterconcepts.net](http://www.waterconcepts.net)

## Tub Faucets

### Trinsic™ 2-Hdl Roman Tub Trim

- Requires rough-in kit
- 10" Reach, 10" high rigid slip-on spout
- 5-7/8" From deck to aerator
- 2-1/2" Diameter handle bases



T2759



T4759

**(T4795-LHP Model)**

- Touch-Clean® full body handshower includes double check valves for backflow prevention
- Handshower flow rate: 2.0 gpm @ 80 psi

Part #	Mfg #	Description	Handle(s)	Finish	Price
153059	T2759	3-Hole 8"-16"cc	ADA Lever	Chrome	
240928	T2759-BL	3-Hole 8"-16"cc	ADA Lever	Matte Black	
153060	T2759-CZ	3-Hole 8"-16"cc Bronze™	ADA Lever	Champagne	
153061	T2759-RB	3-Hole 8"-16"cc	ADA Lever	Venetian Bronze®	
153062	T2759-SS	3-Hole 8"-16"cc	ADA Lever	Stainless*	
153063	T4759	4-Hole 8"-16"cc, Handshower	ADA Lever	Chrome	
256614	T4759-BL	4-Hole 8"-16"cc, Handshower	ADA Lever	Matte Black	
153064	T4759-CZ	4-Hole 8"-16"cc, Handshower Bronze™	ADA Lever	Champagne	
153066	T4759-RB	4-Hole 8"-16"cc, Handshower	ADA Lever	Venetian Bronze®	
153067	T4759-SS	4-Hole 8"-16"cc, Handshower	ADA Lever	Stainless*	

### Vero™ 2-Hdl Roman Tub Trim

- Requires rough-in kit
- 8-3/4" Reach, 9-15/16" high rigid slip-on spout
- 5-31/32" From deck to spout
- 2-7/16" Handle bases
- Minimum 2-1/2" clearance to backsplash recommended



T2753



T4753

**(T4753-LHP Model)**

- Handshower includes double check valves for backflow prevention
- Touch-Clean® full body handshower
- Handshower flow rate: 2.5 gpm @ 80 psi

Part #	Mfg #	Description	Handle(s)	Finish	Price
134771	T2753	3-Hole 8"-16"cc	ADA Lever	Chrome	
170131	T2753-CZ	3-Hole 8"-16"cc Bronze™	ADA Lever	Champagne	
156626	T2753-RB	3-Hole 8"-16"cc	ADA Lever	Venetian Bronze®	
134772	T2753-SS	3-Hole 8"-16"cc	ADA Lever	Stainless*	
134773	T4753	4-Hole 8"-16"cc, Handshower, Diverter Spout	ADA Lever	Chrome	
154742	T4753-CZ	4-Hole 8"-16"cc, Handshower, Diverter Spout Bronze™	ADA Lever	Champagne	
150364	T4753-RB	4-Hole 8"-16"cc, Handshower, Diverter Spout	ADA Lever	Venetian Bronze	

\* Brilliance® Anti-Tarnish Lifetime Finishes



## Tub Faucets

### Two-Handle Roman Tub Trim Packs (Continued)

#### Vero™ 2-Hdl Roman Tub Trim

Part #	Mfg #	Description	Handle(s)	Finish	Price
134774	T4753-SS	4-Hole 8"-16"cc, Handshower, Diverter Spout	ADA Lever	Stainless*	

#### Victorian® 2-Hdl Roman Tub Trim

- Requires rough-in kit
- 8-3/4" Reach, 7-1/2" high rigid slip-on spout
- 2-5/8" Diameter handle bases
- Handles sold separately



**Touch-Clean® full body handshower**  
**Includes double check valves for backflow prevention**  
**Handshower flow rate: 2.0 gpm @ 80 psi**  
**(-LHP) Less Handle Package**

Part #	Mfg #	Description	Handle(s)	Finish	Price
093087	T2755-LHP	3-Hole 8"-16"cc	Less Handles	Chrome	
145818	T2755-CZLHP	3-Hole 8"-16"cc Bronze™	Less Handles	Champagne	
093093	T2755-RBLHP	3-Hole 8"-16"cc	Less Handles	Venetian Bronze®	
093094	T2755-SSLHP	3-Hole 8"-16"cc	Less Handles	Stainless*	
093095	T4755-LHP	4-Hole 8"-16"cc, Handshower	Less Handles	Chrome	
153937	T4755-CZLHP	4-Hole 8"-16"cc, Handshower Bronze™	Less Handles	Champagne	
093096	T4755-RBLHP	4-Hole 8"-16"cc, Handshower	Less Handles	Venetian Bronze®	
093097	T4755-SSLHP	4-Hole 8"-16"cc, Handshower	Less Handles	Stainless*	

#### Woodhurst™ 2-Hdl Roman Tub

- 11-1/8" Reach, 9-3/8" high
- Ceramic valve type
- Touch-Clean® spray holes
- Rigid slip-on diverter spout
- Handshower includes double check valves
- WaterSense Certified: 2.0 gpm @ 80 psi



T4732 with

Requires R4707 rough-in

Part #	Mfg #	Description	Handle(s)	Finish	Price
252969	T2732	4-Hole 8"-16"cc	ADA Lever	Chrome	
258377	T2732-RB	4-Hole 8"-16"cc	ADA Lever	Venetian Bronze	
251522	T2732-SS	4-Hole 8"-16"cc	ADA Lever	Stainless*	
253748	T4732	4-Hole 8"-16"cc, Handshower	ADA Lever	Chrome	
251179	T4732-RB	4-Hole 8"-16"cc, Handshower	ADA Lever	Venetian Bronze	
251196	T4732-SS	4-Hole 8"-16"cc, Handshower	ADA Lever	Stainless*	

\* Brilliance® Anti-Tarnish Lifetime Finishes

**www.plumbsupply.com • Serving our Customers Since 1946 • www.waterconcepts.net**

## Tub Faucets

### Zura® 2-Hdl Roman Tub

- 9-13/16" Reach, 8-1/2" high
- H2Okinetic® spray
- Ceramic valve type
- Touch-Clean® spray holes
- Rigid slip-on diverter spout
- Flow rate: 2.0 gpm @ 80 psi



Requires R4707 rough-in

Part #	Mfg #	Description	Handle(s)	Finish	Price
235028	T2774	3-Hole 8"-16"cc	ADA Lever	Chrome	
246909	T2774-SS	3-Hole 8"-16"cc	ADA Lever	Stainless	
240956	T4774	4-Hole 8"-16"cc, Handshower	ADA Lever	Chrome	
249105	T4774-SS	4-Hole 8"-16"cc, Handshower	ADA Lever	Stainless*	

\* Brilliance® Anti-Tarnish Lifetime Finishes

## Tub Faucets

### Roman Tub Trim

#### Baliza® 2-Hdl Roman Tub Trim

- 8-15/16" Reach, 7-25/64" high
- 5-7/8" From deck to aerator
- 2-1/2" Maximum deck thickness
- Requires rough-in valve R62707 (T67305)
- Requires rough-in valve R64707 (T67405)
- HANDLES SOLD SEPARATELY (HL605, HX605)



T64705-PCLHP w/ HX605 Handles

Part #	Mfg #	Description	Handle(s)	Finish	Price
242037	T67305-BZLHP	3-Hole, Slip-on Spout	Less Handles	Brushed Bronze*	
250460	T67305-PNLHP	3-Hole, Slip-on Spout	Less Handles	Polished Nickel*	
141936	T67405-BNLHP	4-Hole 1.75 gpm Handshower, Slip-on Spout	Less Handles	Brushed Nickel*	
171310	T67405-BZLHP	4-Hole 1.75 gpm Handshower, Slip-on Spout	Less Handles	Brushed Bronze*	
173814	T67405-PCLHP	4-Hole 1.75 gpm Handshower, Slip-on Spout	Less Handles	Chrome	
134671	T67405-PNLHP	4-Hole 1.75 gpm Handshower, Slip-on Spout	Less Handles	Polished Nickel*	

#### Charlotte™ 2-Hdl Roman Tub Trim

- 9" Reach, 9-1/8" high spout
- 6" From deck to aerator
- 2-1/2" Maximum deck thickness
- Requires rough-in valve R62707 (T67385)
- Requires rough-in valve R64707 (T67485)
- HANDLES SOLD SEPARATELY (HL685)



T67485-PCLHP w/ HL685-PC Handles

Part #	Mfg #	Description	Handle(s)	Finish	Price
150766	T67385-PNCOLH P	3-Hole, Slip-On Spout	Less Handles	Cocoa Bronze™/Pol Nickel	
167645	T67385-PNLHP	3-Hole, Slip-On Spout	Less Handles	Polished Nickel*	
171230	T67485-PCLHP	4-Hole 2.0 gpm Handshower, Slip-On Spout	Less Handles	Chrome	
144791	T67485-PNCOLH P	4-Hole 2.0 gpm Handshower, Slip-On Spout	Less Handles	Cocoa Bronze™/Pol Nickel	

#### Levoir™ 2-Hdl Roman Tub Trim

- 9-11/16" Reach, 6-13/16" high
- 4-15/16" From deck to aerator
- 2-1/2" Maximum deck thickness
- Requires rough-in valve (R62707)
- HANDLES SOLD SEPARATELY



Part #	Mfg #	Description	Handle(s)	Finish	Price
254000	T67398-PNLHP	3-Hole	Less Handles	Polished Nickel*	
255114	T67498-PNLHP	4-Hole, 1.75 gpm Handshower	Less Handles	Polished Nickel*	

\* Brilliance® Anti-Tarnish Lifetime Finishes

[www.plumbsupply.com](http://www.plumbsupply.com) • Serving our Customers Since 1946 • [www.waterconcepts.net](http://www.waterconcepts.net)

## Tub Faucets

### Litze™ 2-Hdl Roman Tub Trim

- 9-11/16" Reach, 9-3/8" high
- 6-1/2" From deck to aerator
- 2-1/2" Maximum deck thickness
- Requires rough-in valve (R62707)
- HANDLES SOLD SEPARATELY



Part #	Mfg #	Description	Handle(s)	Finish	Price
243664	T67335-NKLHP	3-Hole	Less Handles	Luxe Nickel	
243249	T67335-PCLHP	3-Hole	Less Handles	Chrome	
254942	T67435-GLLHP	4-Hole, 1.75 gpm Handshower	Less Handles	Luxe Gold	

### Odin™ Roman Tub Trim

- 9" Reach, 11-1/2" high spout
- 6-1/2" From deck to aerator
- 2-3/4" Maximum deck thickness
- Requires rough-in valve R62707 (T67375)
- Requires rough-in valve R64707 (T67475)



Part #	Mfg #	Description	Handle(s)	Finish	Price
178520	T67375-BL	3-Hole, Slip-on Spout	ADA Lever	Matte Black	
254606	T67375-BN	3-Hole, Slip-on Spout	ADA Lever	Brushed Nickel*	
157993	T67375-PC	3-Hole, Slip-on Spout	ADA Lever	Chrome	
248109	T67475-BL	4-Hole 2.0 gpm Handshower, Slip-on Spout	ADA Lever	Matte Black	
185562	T67475-BN	4-Hole 2.0 gpm Handshower, Slip-on Spout	ADA Lever	Brushed Nickel*	
168707	T67475-PC	4-Hole 2.0 gpm Handshower, Slip-on Spout	ADA Lever	Chrome	

### Quiessence® 1-Hdl Roman Tub Trim

- 8-3/4" Reach, 7" high spout
- 5-1/4" From deck to aerator
- 3" Maximum deck thickness
- Wedge and maple wood accents included
- Rough and trim included
- 12.28 gpm @ 60 psi
- Handshower: 2.0 gpm @ 80 psi



Part #	Mfg #	Description	Handle(s)	Finish	Price
142904	67214-BN	3-Hole	ADA Lever	Brushed Nickel*	
159916	67214-PC	3-Hole	ADA Lever	Chrome	

\* Brilliance® Anti-Tarnish Lifetime Finishes

## Tub Faucets

### RSVP® 2-Hdl Roman Tub Trim

- 9-3/4" Reach, 8" high spout
- 4" From deck to aerator
- 3" Maximum deck thickness
- Decorative finials available (RP48904, and RP47959)
- Requires rough-in valve R62707 (T67390)
- Requires rough-in valve R64707 (T67490)
- 18.5 gpm @ 60 psi
- HANDLES SOLD SEPARATELY (HL790, or HX790)



T67490-PC w/ HL790-PC Handles

Part #	Mfg #	Description	Handle(s)	Finish	Price
248093	T67390-BNLHP	3-Hole	Less Handles	Brushed Nickel*	
160247	T67490-BN	4-Hole	Less Handles	Brushed Nickel*	
141154	T67490-PC	4-Hole	Less Handles	Chrome	

### Rook™ Roman Tub Trim

- 10-3/4" Reach, 7" high spout
- 4-9/16" From deck to aerator
- 2-1/2" Maximum deck thickness
- Available in channel and closed spout
- Requires rough-in valve for four hole R64707
- Requires rough-in valve for three hole R62707
- HANDLES SOLD SEPARATELY (HL660, HX660)



T67460-PCLHP Closed



T67461-PCLHP Channel Spout

Part #	Mfg #	Description	Handle(s)	Finish	Price
234247	T67361-NKBLLHP	3-Hole, Channel Spout Blk	Less Handles	Luxe Nkl/Matte	
252779	T67460-NKBLLHP	4-Hole 2.0 gpm Handshower, Closed Spout Blk	Less Handles	Luxe Nkl/Matte	
223101	T67461-NKBLLHP	4-Hole 2.0 gpm Handshower, Channel Spout Blk	Less Handles	Luxe Nkl/Matte	
230916	T67461-PC LHP	4-Hole 2.0 gpm Handshower, Channel Spout	Less Handles	Chrome	
185519	T67461-RBLHP	4-Hole 2.0 gpm Handshower, Channel Spout Bronze®	Less Handles	Venetian	

### Siderna® 2-Hdl Roman Tub Trim

- 10-15/16" Reach, 9-3/4" high spout
- 5-7/16" From deck to aerator
- 2-1/2" Maximum deck thickness
- 18 gpm @ 60 psi
- Requires rough-in valve R62707
- HANDLES SOLD SEPARATELY (HL680, HL681, or HL682)



T67380-PCLHP w/ HL680-PC Handles

Part #	Mfg #	Description	Handle(s)	Finish	Price
155289	T67380-BNLHP	3-Hole	Less Handles	Brushed Nickel*	
231644	T67380-BLLHP	3-Hole	Less Handles	Matte Black	

\* Brilliance® Anti-Tarnish Lifetime Finishes

[www.plumbsupply.com](http://www.plumbsupply.com) • Serving our Customers Since 1946 • [www.waterconcepts.net](http://www.waterconcepts.net)

## Tub Faucets

### Roman Tub Trim (Continued)

#### Siderna® 2-Hdl Roman Tub Trim

Part #	Mfg #	Description	Handle(s)	Finish	Price
181626	T67380-PCLHP	3-Hole	Less Handles	Chrome	
162484	T67480-BLLHP	4-Hole, Matching Handshower	Less Handles	Matte Black	
176450	T67480-BNLHP	4-Hole, Matching Handshower	Less Handles	Brushed Nickel*	
168303	T67480-PCLHP	4-Hole, Matching Handshower	Less Handles	Chrome	

#### Sotria™ 2-Hdl Roman Tub Trim

- 9-3/8" Reach, 7-1/2" high spout
- 5-7/8" From deck to aerator
- Requires rough-in valve R62707 (T67350)
- Requires rough-in valve R64707 (T67450)



Part #	Mfg #	Description	Handle(s)	Finish	Price
222676	T67350-PC	3-Hole	ADA Lever	Chrome	
225071	T67450-BL	4-Hole, 2.0 gpm Handshower	ADA Lever	Matte Black	
177247	T67450-NK	4-Hole, 2.0 gpm Handshower	ADA Lever	Luxe Nickel*	

#### Tresa® 2-Hdl Roman Tub Trim

- 9" Reach, 8-1/2" high spout
- 5" From deck to aerator
- 2-1/2" Maximum deck thickness
- Requires rough-in valve R64707 (T67436)
- Requires rough-in valve R62707 (T67336)
- 20 gpm @ 60 psi
- T67436 Includes 2.0gpm matching handshower



Part #	Mfg #	Description	Handle(s)	Finish	Price
172781	T67336-PN	3-Hole	ADA Lever	Polished Nickel*	
147261	T67336-RB	3-Hole Bronze®	ADA Lever	Venetian	
236618	T67436-PN	4-Hole, 2.0 gpm Handshower	ADA Lever	Polished Nickel*	

#### Tresa® 2-Hdl Roman Tub Trim with Cross Handles

- 9" Reach, 8-1/2" high spout
- 5" From deck to aerator
- 2-1/2" Maximum deck thickness
- Requires rough-in valve R64707 (T67438)
- Requires rough-in valve R2707 (T67338)
- 18.5 gpm @ 60 psi
- T67438 Includes 2.0gpm matching handshower



Part #	Mfg #	Description	Handle(s)	Finish	Price
185901	T67338-PC	3-Hole	ADA Cross	Chrome	
175141	T67338-PN	3-Hole	ADA Cross	Polished Nickel*	

\* Brilliance® Anti-Tarnish Lifetime Finishes

[www.waterconcepts.net](http://www.waterconcepts.net) • Serving our Customers Since 1946 • [www.plumbsupply.com](http://www.plumbsupply.com)



## Tub Faucets

### Roman Tub Trim (Continued)

#### Tresa® 2-Hdl Roman Tub Trim with Cross Handles

Part #	Mfg #	Description	Handle(s)	Finish	Price
137925	T67438-BN	4-Hole, 2.0 gpm Handshower	Cross Handles	Brushed Nickel*	
171916	T67438-PC	4-Hole, 2.0 gpm Handshower	Cross Handles	Chrome	
171917	T67438-PN	4-Hole, 2.0 gpm Handshower	Cross Handles	Polished Nickel*	
125587	T67438-RB	4-Hole, 2.0 gpm Handshower Bronze®	Cross Handles	Venetian	

#### Vettis™ 2-Hdl Wall Mount Roman Tub Filler

- Requires rough-in kit (R70400)
- High flow ceramic control valves
- (RP92777) Extension kit available
- 11 gpm @ 60 psi



Part #	Mfg #	Description	Handle(s)	Finish	Price
246626	T70488-PC	3-Hole	ADA Lever	Chrome	

#### Vesi® Channel 2-Hdl Roman Tub Trim

- 9" Reach, 6-1/4" high
- 3-1/4" From deck to aerator
- 2-1/2" Maximum deck thickness
- 18 gpm @ 60 psi
- Requires rough-in valve R62707 (T6745)
- Requires rough-in valve R64707 (T67745)



Part #	Mfg #	Description	Handle(s)	Finish	Price
130805	T6745-BN	3-Hole	Lever Handles	Brushed Nickel*	
135231	T6745-BZ	3-Hole	Lever Handles	Brushed Bronze*	
096069	T67745-BN	4-Hole, 2.0 gpm Handshower	Lever Handles	Brushed Nickel*	
159675	T67745-BZ	4-Hole, 2.0 gpm Handshower	Lever Handles	Brushed Bronze*	
246644	T67745-RB	4-Hole, 2.0 gpm Handshower	Lever Handles	Venetian Bronze	

#### Vesi® Curve 2-Hdl Roman Tub Trim

- 9" Reach, 6-3/4" high spout
- 4" From deck to aerator
- 2-1/2" Maximum deck thickness
- 18 gpm @ 60 psi
- Requires rough-in valve R62707



Part #	Mfg #	Description	Handle(s)	Finish	Price
159861	T6740-BN	3-Hole	ADA Lever	Brushed Nickel*	
117635	T6740-PC	3-Hole	ADA Lever	Chrome	
160276	T67740-BN	4-Hole, 2.0 gpm Handshower	ADA Lever	Brushed Nickel*	

\* Brilliance® Anti-Tarnish Lifetime Finishes

[www.plumbsupply.com](http://www.plumbsupply.com) • Serving our Customers Since 1946 • [www.waterconcepts.net](http://www.waterconcepts.net)

## Tub Faucets

### Virage® 2-Hdl Roman Tub Trim

- 9-5/16" Reach, 8-5/16" high spout
- 5-11/16" From deck to aerator
- 2-1/2" Maximum deck thickness
- Requires rough-in valve R62707 (T67330)
- Requires rough-in valve R64707 (T67430)
- Maximum flow rate: 20 gpm @ 60 psi



Part #	Mfg #	Description	Handle(s)	Finish	Price
165444	T67330-BN	3-Hole, Slip-On Spout	ADA Lever	Brushed Nickel*	
181852	T67330-BZ	3-Hole, Slip-On Spout	ADA Lever	Brushed Bronze*	
129979	T67330-PC	3-Hole, Slip-On Spout	ADA Lever	Chrome	
169998	T67330-PN	3-Hole, Slip-On Spout	ADA Lever	Polished Nickel*	
133557	T67430-BN	4-Hole, 2.0 gpm Handshower Slip-On Spout	ADA Lever	Brushed Nickel*	
146530	T67430-PC	4-Hole, 2.0 gpm Handshower Slip-On Spout	ADA Lever	Chrome	
139476	T67430-RB	4-Hole, 2.0 gpm Handshower Slip-On Spout Bronze®	ADA Lever	Venetian	

### 1-Hdl Freestanding Tub Fillers

#### Contemporary Single Handle Freestanding Tub Filler

- Floor mounted
- 8" Reach, 41" high
- Auto resetting diverter
- Pivot handshower holder
- Dual integral check valves
- 60"-82" stretchable hose with metal fittings
- Handshower flow rate: 1.75 gpm @ 80 psi
- Optional high flow cartridge (RP73598) available
- Must order R4700-FL or R4700-FLWS



Part #	Mfg #	Description	Handle(s)	Finish	Price
246655	T4759-BLFL	1-Hole, 1.75 gpm Handshower High Arc Spout	ADA Lever	Matte Black	

\* Brilliance® Anti-Tarnish Lifetime Finishes

[www.waterconcepts.net](http://www.waterconcepts.net) • Serving our Customers Since 1946 • [www.plumbsupply.com](http://www.plumbsupply.com)

## Tub Faucets

### Litze™ Single Handle Freestanding Tub Filler—Less Handle

- Floor mounted
- Solid brass construction
- 9-1/4" Reach, 29-15/16" high
- 36-5/16" From floor to spout outlet
- Auto resetting diverter
- Indexing handshower holder
- High flow ceramic mixing cartridge
- Handshower flow rate: 2.0 gpm @ 80 psi
- 60" - 82" Stretchable, finished metal hose
- Includes multi-function H2Okinetic® handshower
- Drain and rough-in valves sold separately



Part #	Mfg #	Description	Handle(s)	Finish	Price
243464	T70135-GLLHP	1-Hole, H2Okinetic® Handshower	T-Lever	Luxe Gold	
237823	T70135-PCLHP	1-Hole, H2Okinetic® Handshower	T-Lever	Chrome	

### Odin™ Single Handle Freestanding Tub Filler

- Floor mounted
- Solid brass construction
- 8-7/8" Reach, 40-1/2" high
- 35-7/16" From floor to spout outlet
- High flow ceramic mixing cartridge
- Indexing handshower holder
- Handshower flow rate: 2.0 gpm @ 80 psi
- 60" - 82" Stretchable metal hose
- 14.5 gpm @ 60 psi With R70100
- 12 gpm @ 60 psi With R70100-WS
- Drain and rough-in valves sold separately



Part #	Mfg #	Description	Handle(s)	Finish	Price
240365	T70175-BL	1-Hole, H2Okinetic® Handshower	ADA Lever	Matte Black	
235833	T70175-BN	1-Hole, H2Okinetic® Handshower	ADA Lever	Brushed Nickel*	
171028	T70175-PC	1-Hole, H2Okinetic® Handshower	ADA Lever	Chrome	

\* Brilliance® Anti-Tarnish Lifetime Finishes

[www.plumbsupply.com](http://www.plumbsupply.com) • Serving our Customers Since 1946 • [www.waterconcepts.net](http://www.waterconcepts.net)

## Tub Faucets

### Rook™ Single Handle Freestanding Tub Filler

- Floor mounted
- Solid brass construction
- 9-13/16" Reach, 38-5/16" high
- 34-7/8" From floor to spout outlet
- High flow ceramic mixing cartridge
- Auto resetting diverter
- Certified dual check valves in handshower
- Drain no included
- Includes single-function handshower - 2.0 GPM  
60"-82" stretchable finished metal hose



**Requires Rough-In:**

**R701 00-WS with integrated stops**

or

**R70100 without stops, provides maximum flow**

Part #	Mfg #	Description	Handle(s)	Finish	Price
227070	T70161-NK	1-Hole, 2.0 GPM Handshower	ADA Lever	Luxe Nickel	
249469	T70161-PC	1-Hole, 2.0 GPM Handshower	ADA Lever	Chrome	

### Siderna® Single-Handle Freestanding Tub Filler

- Floor mounted
- Solid brass construction
- 9-5/16" Reach, 40-1/2" high
- 35-13/32" From floor to spout outlet
- High flow ceramic mixing cartridge
- Indexing handshower holder
- Handshower flow rate: 2.0 gpm @ 80 psi
- 60" - 82" Stretchable metal hose
- 14.5 gpm @ 60 psi With R70100
- 12 gpm @ 60 psi With R70100-WS
- Drain and rough-in valves sold separately



Part #	Mfg #	Description	Handle(s)	Finish	Price
175599	T70180-BN	1-Hole, Touch-Clean® Handshower	ADA Lever	Brushed Nickel*	
226385	T70180-BL	1-Hole, Touch-Clean® Handshower	ADA Lever	Matte Black	
169310	T70180-PC	1-Hole, Touch-Clean® Handshower	ADA Lever	Chrome	

\* Brilliance® Anti-Tarnish Lifetime Finishes

[www.waterconcepts.net](http://www.waterconcepts.net) • Serving our Customers Since 1946 • [www.plumbsupply.com](http://www.plumbsupply.com)

## Tub Faucets

### Sotria™ Single-Handle Freestanding Tub Filler

- Floor mounted
- Solid brass construction
- 11-11/16" Reach, 39" high
- 35-5/16" From floor to spout outlet
- High flow ceramic mixing cartridge
- Indexing handshower holder
- Handshower flow rate: 2.0 gpm @ 80 psi
- 60" - 82" Stretchable metal hose
- 14.5 gpm @ 60 psi With R70100
- 12 gpm @ 60 psi With R70100-WS
- Drain and rough-in valves sold separately



Part #	Mfg #	Description	Handle(s)	Finish	Price
174107	T70150-NK	1-Hole, H2Okinetic® Handshower	ADA Lever	Luxe Nickel*	
179426	T70150-PN	1-Hole, H2Okinetic® Handshower	ADA Lever	Polished Nickel*	

### Vettis™ Single-Handle Freestanding Tub Filler

- Floor mounted
- Solid brass construction
- 8-15/16" Reach, 36-11/16" high
- 35-9/16" Deck to aerator
- High flow ceramic mixing cartridge
- Indexing handshower holder
- Auto resetting diverter
- 3-Function handshower flow rate: 2.0 gpm @ 80 psi
- 60" - 82" Stretchable metal hose
- 14.5 gpm @ 60 psi with R70100
- 12 gpm @ 60 psi with R70100-WS
- Flush-mounted rectangular laminar stream straightner
- Drain and rough-in valves sold separately



Part #	Mfg #	Description	Handle(s)	Finish	Price
252513	T70188-BL	1-Hole, H2Okinetic® Handshower	ADA Lever	Matte Black	

\* Brilliance® Anti-Tarnish Lifetime Finishes

[www.plumbsupply.com](http://www.plumbsupply.com) • Serving our Customers Since 1946 • [www.waterconcepts.net](http://www.waterconcepts.net)

## Tub Faucets

### Virage® Single-Handle Freestanding Tub Filler

- Floor mounted
- Solid brass construction
- 9-5/16" Reach, 40-1/2" high
- 35-13/32" From floor to spout outlet
- High flow ceramic mixing cartridge
- Indexing handshower holder
- Handshower flow rate: 2.0 gpm @ 80 psi
- 60" - 82" Stretchable metal hose
- 14.5 gpm @ 60 psi With R70100
- 12 gpm @ 60 psi With R70100-WS
- Drain and rough-in valves sold separately



Part #	Mfg #	Description	Handle(s)	Finish	Price
165271	T70130-BN	1-Hole, H2Okinetic® Handshower	ADA Lever	Brushed Nickel*	
165909	T70130-PC	1-Hole, H2Okinetic® Handshower	ADA Lever	Chrome	
248715	T70130-PN	1-Hole, H2Okinetic® Handshower	ADA Lever	Polished Nickel*	
187887	T70130-RB	1-Hole, H2Okinetic® Handshower Bronze®	ADA Lever	Venetian	

### 2-Hdl Freestanding Tub Fillers

**Body Assembly + Trim Kit + Floor, Deck, or Wall Mount Components + Rough (Floor Mount Only) = Completed Set**

#### Baliza® Two-Handle Freestanding Tub Filler Trim Kit

- 8-1/4" Reach (deck & floor mount)
- 10-1/2" Reach (wall mount)
- Bi-directional diverter handle
- 60"-82" stretchable, finished metal hose
- Dual check valves in handshower
- Handshower flow rate: 2.0 gpm @ 80 psi
- Requires mounting hardware
- Tub drain not included



Part #	Mfg #	Description	Handle(s)	Finish	Price
245037	T70305-PC	2.0 gpm Handshower	ADA Lever	Chrome	

#### Charlotte™ Tub Filler Trim

- 8-1/4" Reach (deck & floor mount)
- 10-5/8" Reach (wall mount)
- Bi-directional diverter lever handle
- Handshower includes dual check valves for backflow prevention
- 60" - 82" Stretchable metal hose



Part #	Mfg #	Description	Handle(s)	Finish	Price
173485	T70385-BN	2.0 gpm Handshower	Lever Handles	Brushed Nickel*	

\* Brilliance® Anti-Tarnish Lifetime Finishes

**www.waterconcepts.net • Serving our Customers Since 1946 • www.plumbsupply.com**



## Tub Faucets

### 2-Hdl Freestanding Tub Fillers (Continued)

#### Charlotte™ Tub Filler Trim

Part #	Mfg #	Description	Handle(s)	Finish	Price
173660	T70385-PC	2.0 gpm Handshower	Lever Handles	Chrome	
172171	T70385-PN	2.0 gpm Handshower	Lever Handles	Polished Nickel*	
242410	T70385-PNCO	2.0 gpm Handshower	Lever Handles	Cocoa Brz/Pol Nkl	

#### Rook™ Two-Handle Freestanding Tub Filler Trim Kit

- 8-1/4" Reach (deck & floor mount)
- 10-5/8" Reach (wall mount)
- Bi-directional diverter handle
- 60"-82" stretchable, finished metal hose
- Dual check valves in handshower
- Flow rate: 2.0 gpm @ 80 psi
- Requires mounting hardware
- Drain not included



Part #	Mfg #	Description	Handle(s)	Finish	Price
243907	T70361-PC	2.0 gpm Handshower	Cross Handles	Chrome	

#### Traditional Two-Handle Freestanding Tub Filler Body Assembly

- Solid brass construction
- High flow ceramic control valves
- Handshower cradle rotates 90° in either direction
- 12 gpm @ 60 psi With R70200
- 10 gpm @ 60 psi With R70200-WS



Part #	Mfg #	Description	Handle(s)	Finish	Price
173484	T70210-BNLHP	2-Hole Floor, Deck, or Wall Mounted Installation	-	Brushed Nickel*	
165672	T70210-PCLHP	2-Hole Floor, Deck, or Wall Mounted Installation	-	Chrome	
172170	T70210-PNLHP	2-Hole Floor, Deck, or Wall Mounted Installation	-	Polished Nickel*	
172604	T70210-RBLHP	2-Hole Floor, Deck, or Wall Mounted Installation Bronze®	-	Venetian	

#### Traditional Tub Filler Trim Kit

- 8-1/4" Reach (deck & floor mount)
- 10-1/2" Reach (wall mount)
- Bi-directional diverter lever handle
- Handshower includes dual check valves for backflow prevention
- 60" - 82" Stretchable metal hose



Part #	Mfg #	Description	Handle(s)	Finish	Price
182499	T70336-BN	2.0 gpm Handshower	Lever Handles	*Brushed Nickel	
165671	T70336-PC	2.0 gpm Handshower	Lever Handles	Chrome	

\* Brilliance® Anti-Tarnish Lifetime Finishes

[www.plumbsupply.com](http://www.plumbsupply.com) • Serving our Customers Since 1946 • [www.waterconcepts.net](http://www.waterconcepts.net)

## Tub Faucets

### 2-Hdl Freestanding Tub Fillers (Continued)

#### Traditional Tub Filler Trim Kit

Part #	Mfg #	Description	Handle(s)	Finish	Price
172603	T70336-RB	2.0 gpm Handshower Bronze®	Lever Handles	Venetian	

#### Tresa® Two-Handle Freestanding Tub Filler Trim

- 8-1/4" Reach (deck & floor mount)
- 10-1/2" Reach (wall mount)
- Bi-directional diverter lever handle
- 60"-82" Stretchable, finished metal hose
- Handshower flow rate: 2.0 gpm @ 80 psi
- Tub drain not included



Part #	Mfg #	Description	Handle(s)	Finish	Price
238991	T70338-BN	2.0 Handshower	Lever Handles	Brushed Nickel*	
236424	T70338-PC	2.0 Handshower	Lever Handles	Chrome	
245904	T70338-PN	2.0 Handshower	Lever Handles	Polished Nickel*	
238519	T70338-RB	2.0 Handshower	Lever Handles	Venetian Bronze	

### Tub Filler Accessories

#### Tub Filler Risers



Part #	Mfg #	Description	Handle(s)	Finish	Price
182500	RP73764-BN	Dual Column Design, Wall Mount	-	Brushed Nickel*	
242408	RP73764-PN	Dual Column Design, Wall Mount	-	Polished Nickel*	
181906	RP73765-BN	Dual Column Design, Deck-Mount	-	Brushed Nickel*	
258912	RP73765-PC	Dual Column Design, Deck-Mount	-	Chrome	
173326	RP73765-RB	Dual Column Design, Deck-Mount	-	Venetian Bronze*	

#### Baliza® Tub Filler Spout Reach Extensions

- Solid brass construction
- 8" center to center; insulated to control surface condensation and heat
- Provides 2" of additional spout reach for the wall, deck & floor mount configurations
- Must order in conjunction with wall mount unions, floor mount risers, or deck mount risers



Part #	Mfg #	Description	Handle(s)	Finish	Price
222865	RP80157PC	8" center-to-center	-	Chrome	
242409	RP80157PN	8" center-to-center	-	Polished Nickel*	

\* Brilliance® Anti-Tarnish Lifetime Finishes

[www.waterconcepts.net](http://www.waterconcepts.net) • Serving our Customers Since 1946 • [www.plumbsupply.com](http://www.plumbsupply.com)

---



---

## Tub Faucets

---



---

### Traditional Floor Mount Tub Filler Risers

- Solid brass construction
- 38" Overall height (risers only)
- 31-3/4" - 32-11/16" From floor to spout outlet depending on tub filler trim kit
- Optional riser extension set (RP73767) provides 2" of additional spout height
- Insulated to control surface condensation and heat
- Rough-in valve sold separately



Part #	Mfg #	Description	Handle(s)	Finish	Price
173487	RP73766BN	Dual column design, 8" center-to-center	-	Brushed Nickel*	
165673	RP73766PC	Dual column design, 8" center-to-center	-	Chrome	
172172	RP73766PN	Dual column design, 8" center-to-center	-	Polished Nickel*	
172602	RP73766RB	Dual column design, 8" center-to-center Bronze®	-	Venetian	

\* Brilliance® Anti-Tarnish Lifetime Finishes

[www.plumbsupply.com](http://www.plumbsupply.com) • Serving our Customers Since 1946 • [www.waterconcepts.net](http://www.waterconcepts.net)

## Tub Faucets

### Two-Handle Roman Tub Trim

#### 90° 2-Hdl Roman Tub Trim

- Fits M•PACT® system
- 9" Reach, 4-3/4" high spout
- 4-1/4" From deck to aerator



Requires Valve: 4793

w/ Handshower Requires: 9793

Part #	Mfg #	Description	Handle(s)	Finish	Price
132633	TS903	3-Hole, 10" - 24" Centers	ADA Lever	Chrome	

### Align® 2-Hdl Roman Tub Trim

- Fits M•PACT® system
- 7.90" Spout reach



Requires Valve: 4793

w/ Handshower Requires: 9793

Part #	Mfg #	Description	Handle(s)	Finish	Price
146176	TS903BN	3-Hole, 10" - 24" Centers	ADA Lever	Brushed Nickel	
202157	TS904	4-Hole, 10" - 24" Centers, 2.0 gpm Handshower	ADA Lever	Chrome	
147963	TS904BN	4-Hole, 10" - 24" Centers, 2.0 gpm Handshower	ADA Lever	Brushed Nickel	
177263	T393	3-Hole	ADA Lever	Chrome	
219182	T393BN	3-Hole	ADA Lever	Brushed Nickel	
223516	T394	4-Hole, 2.0 gpm Handshower	ADA Lever	Chrome	

### Arris™ 2-Hdl Roman Tub Trim

- Fits M•PACT® system
- 8.08" Spout reach



Requires Valve: 4793

w/ Handshower Requires Valve: 9793

Part #	Mfg #	Description	Handle(s)	Finish	Price
160880	TS93003	3-Hole, 10" - 24" Centers	ADA Lever	Chrome	
184652	TS93003BN	3-Hole, 10" - 24" Centers	ADA Lever	Brushed Nickel	
178069	TS93004	4-Hole, 10" - 24" Centers, 2.0 gpm Handshower	ADA Lever	Chrome	

\*Lifeshine® Anti-Tarnish Lifetime Finish

[www.waterconcepts.net](http://www.waterconcepts.net) • Serving our Customers Since 1946 • [www.plumbsupply.com](http://www.plumbsupply.com)

## Tub Faucets

### Belfield™ 2-Hdl Roman Tub Trim

- Fits M•PACT® system
- Built in diverter valve
- 7-1/2" Spout reach
- Includes double check valves
- Handshower flow rate: 2.0 gpm



Valves: 9792

Handshower Valve: 9793

Part #	Mfg #	Description	Handle(s)	Finish	Price
249913	T9024BN	4-Hole, 10"-24" Centers, 2.0 gpm Handshower	ADA Lever	Brushed Nickel	
247530	T9024ORB	4-Hole, 10"-24" Centers, 2.0 gpm Handshower	ADA Lever	Oil Rubbed Bronze	

### Brantford™ 2-Hdl Roman Tub Trim

- Fits M•PACT® system
- 7-1/4" Spout reach
- 7-1/4" From deck to aerator



Requires Valve: 4793

w/ Handshower Requires Valve: 9793

Part #	Mfg #	Description	Handle(s)	Finish	Price
126008	T933	3-Hole, 10" - 24" Centers	ADA Lever	Chrome	
102296	T933BN	3-Hole, 10" - 24" Centers	ADA Lever	Brushed Nickel	
102289	T933ORB	3-Hole, 10" - 24" Centers	ADA Lever	Oil Rubbed Bronze	
111593	T924	4-Hole, 10" - 24" Centers, 2.0 gpm Handshower	ADA Lever	Chrome	
108122	T924BN	4-Hole, 10" - 24" Centers, 2.0 gpm Handshower	ADA Lever	Brushed Nickel	
108188	T924ORB	4-Hole, 10" - 24" Centers, 2.0 gpm Handshower	ADA Lever	Oil Rubbed Bronze	

### Brantford 2-Hdl Garden Tub Trim

- Fits M•PACT® system
- 6-3/8" Spout reach, 6" spout height
- 4-1/2" From deck to aerator



Requires Valve: 4793

Part #	Mfg #	Description	Handle(s)	Finish	Price
138741	T4943	3-Hole, 10"-24" Centers	ADA Lever	Chrome	
110181	T4943BN	3-Hole, 10"-24" Centers	ADA Lever	Brushed Nickel	
105275	T4943ORB	3-Hole, 10"-24" Centers	ADA Lever	Oil Rubbed Bronze	

\*Lifeshine® Anti-Tarnish Lifetime Finish

[www.plumbsupply.com](http://www.plumbsupply.com) • Serving our Customers Since 1946 • [www.waterconcepts.net](http://www.waterconcepts.net)

## Tub Faucets

### Chateau® 2-Hdl Roman Tub Trim

- Fits M•PACT® system
- 9" Spout reach



Requires Valve: 4793

w/ Handshower Requires Valve: 9793

Part #	Mfg #	Description	Handle(s)	Finish	Price
087523	T990	3-Hole, 10" - 24" Centers	ADA Lever	Chrome	
031379	T999	3-Hole, 10" - 24" Centers	Acrylic Knob	Chrome	

### Dartmoor™ 2-Hdl Roman Tub Trim

- Fits M•PACT® system
- 8-7/16" Reach, 7" high spout
- 4-5/8" From deck to aerator



Requires Valve: 4793

w/ Handshower Requires Valve: 9793

Part #	Mfg #	Description	Handle(s)	Finish	Price
225803	T683	3-Hole, 10" - 24" Centers	ADA Lever	Chrome	
249635	T683BN	3-Hole, 10" - 24" Centers	ADA Lever	Brushed Nickel	

### Eva™ 2-Hdl Roman Tub Trim

- Fits M•PACT® system
- 7.67" Spout reach



Requires Valve: 4793

w/ Handshower Requires Valve: 9793

Part #	Mfg #	Description	Handle(s)	Finish	Price
094491	T943	3-Hole, 10" - 24" Centers	ADA Lever	Chrome	
097631	T943BN	3-Hole, 10" - 24" Centers	ADA Lever	Brushed Nickel	
096184	T943ORB	3-Hole, 10" - 24" Centers	ADA Lever	Oil Rubbed Bronze	
095679	T944BN	4-Hole, 10" - 24" Centers w/ 2.0 gpm Handshower	ADA Lever	Brushed Nickel	
099675	T944ORB	4-Hole, 10" - 24" Centers w/ 2.0 gpm Handshower	ADA Lever	Oil Rubbed Bronze	

### Glyde™ 2-Hdl Roman Tub Trim

- Fits M•PACT® system
- 8-7/16" Reach, 7" high arc spout



Part #	Mfg #	Description	Handle(s)	Finish	Price
245858	T373	3-Hole, 10" - 24" Centers	ADA Lever	Chrome	

\*Lifeshine® Anti-Tarnish Lifetime Finish

[www.waterconcepts.net](http://www.waterconcepts.net) • Serving our Customers Since 1946 • [www.plumbsupply.com](http://www.plumbsupply.com)



## Tub Faucets

### Kingsley® 2-Hdl Roman Tub Trim

- Fits M•PACT® system
- 9" Spout reach
- 7" From deck to aerator



**Requires Valve: 4793**

**w/ Handshower Requires Valve: 9793**

Part #	Mfg #	Description	Handle(s)	Finish	Price
195208	T920	3-Hole, 10" - 24" Centers	ADA Lever	Chrome	
079237	T920BN	3-Hole, 10" - 24" Centers	ADA Lever	Brushed Nickel	
077214	T920ORB	3-Hole, 10" - 24" Centers	ADA Lever	Oil Rubbed Bronze	
187402	T920P	3-Hole, 10" - 24" Centers	ADA Lever	Polished Brass	
084794	T920WR	3-Hole, 10" - 24" Centers	ADA Lever	Wrought Iron	
083853	T922BN	4-Hole, 10" - 24" Centers	ADA Lever	Brushed Nickel	
081258	T922ORB	4-Hole, 10" - 24" Centers	ADA Lever	Oil Rubbed Bronze	

### Method™ 2-Hdl Roman Tub Trim

- Fits M•PACT® system
- 7-1/2" Spout reach
- 1/8" to 2-5/8" Deck thickness



**Requires Valve: 9793**

**w/ Handshower Requires Valve: 9793**

Part #	Mfg #	Description	Handle(s)	Finish	Price
153348	T987	4-Hole, 10" - 24" Centers, 2.0 gpm Handshower	ADA Lever	Chrome	

### Rothbury™ 2-Hdl Roman Tub Trim

- Fits M•PACT® system
- 8" Spout reach
- 1/8" to 2-5/8" Deck thickness



**Requires Valve: 4793**

**w/ Handshower Requires Valve: 9793**

Part #	Mfg #	Description	Handle(s)	Finish	Price
164543	TS923	3-Hole, 10" - 24" Centers	ADA Lever	Chrome	
180827	TS925	4-Hole, 10" - 24" Centers w/ 2.0 gpm Handshower	ADA Lever	Chrome	

\*Lifeshine® Anti-Tarnish Lifetime Finish

[www.plumbsupply.com](http://www.plumbsupply.com) • Serving our Customers Since 1946 • [www.waterconcepts.net](http://www.waterconcepts.net)

## Tub Faucets

### Voss™ 2-Hdl Roman Tub Trim

- Fits M•PACT® system
- 7.50" Spout reach
- 1/8" to 2-3/4" Deck thickness



Requires Valve: 4793

w/ Handshower Requires Valve: 9793

Part #	Mfg #	Description	Handle(s)	Finish	Price
150272	T693	3-Hole, 10" - 24" Centers	ADA Lever	Chrome	
152227	T693BN	3-Hole, 10" - 24" Centers	ADA Lever	Brushed Nickel	
153394	T693ORB	3-Hole, 10" - 24" Centers	ADA Lever	Oil Rubbed Bronze	
160291	T694BN	4-Hole, 10" - 24" Centers, 2.0 gpm Handshower	ADA Lever	Brushed Nickel	
152279	T694ORB	4-Hole, 10" - 24" Centers, 2.0 gpm Handshower	ADA Lever	Oil Rubbed Bronze	

### Waterhill® 2-Hdl Roman Tub Trim

- Fits M•PACT® system
- 8-7/8" Spout reach
- 4-13/16" From deck to aerator



Requires Valve: 4793

w/ Handshower Requires Valve: 9793

Part #	Mfg #	Description	Handle(s)	Finish	Price
106413	TS214ORB	3-Hole, 10" - 24" Centers	ADA Lever	Oil Rubbed Bronze	

### Weymouth™ 2-Hdl Roman Tub Trim

- Fits M•PACT® system
- 8.10" Spout reach
- 1/8" to 2-5/8" Deck thickness



Pictured w/ Cross Handles

Requires Valve: 4793

w / Handshower Requires Valve: 9793

Part #	Mfg #	Description	Handle(s)	Finish	Price
176301	TS22103ORB	3-Hole, 10" - 24" Centers	ADA Lever	Oil Rubbed Bronze	
165868	TS21102BN	4-Hole, 10" - 24" Centers, 2.0 gpm Handshower	Cross	Brushed Nickel	
181595	TS21104ORB	4-Hole, 10" - 24" Centers, 2.0 gpm Handshower	ADA Lever	Oil Rubbed Bronze	

\*Lifeshine® Anti-Tarnish Lifetime Finish

[www.waterconcepts.net](http://www.waterconcepts.net) • Serving our Customers Since 1946 • [www.plumbsupply.com](http://www.plumbsupply.com)

## Tub Faucets

### Wynford™ 2-Hdl Roman Tub Trim

- Fits M•PACT® system
- 7.1/2" Spout reach



Requires Valve: 4793

w/ Handshower Requires Valve: 9793

Part #	Mfg #	Description	Handle(s)	Finish	Price
220058	T653BN	3-Hole, 10" - 24" Centers	ADA Lever	Brushed Nickel	
184809	T653NL	3-Hole, 10" - 24" Centers	ADA Lever	Polished Nickel	
181282	T653ORB	3-Hole, 10" - 24" Centers	ADA Lever	Oil Rubbed Bronze	
187213	T657	3-Hole, 10" - 24" Centers	ADA Cross	Chrome	
187214	T658	4-Hole, 10" - 24" Centers w/ Handshower	ADA Cross	Chrome	
219769	T658BN	4-Hole, 10" - 24" Centers w/ Handshower	ADA Cross	Brushed Nickel	

### Freestanding Tub Fillers

#### Arris™ 1-Hdl Freestanding Tub Filler

- Fits M•PACT® valve system
- Single-function handshower and shower
- 11" Spout reach
- Floor mount
- Handshower flow rate: 2.0 gpm



Requires Valve: TS50100

Part #	Mfg #	Description	Handle(s)	Finish	Price
170175	S93005	11" Spout Reach, 2.0gpm Handshower	ADA Lever	Chrome	

#### Voss™ 1-Hdl Freestanding Tub Filler

- Fits M•PACT® valve system
- Single-function handshower and shower
- 9-3/4" Spout reach
- 59" Double interlock spiral metal hose
- Floor mount
- Integral dual check valves included
- WaterSense® certified handshower flow rate: 1.75 gpm



Requires rough-in kit:  
 —TS50100 Joist  
 —TS50110 Concrete

Part #	Mfg #	Description	Handle(s)	Finish	Price
253535	695BN	9-3/4" Spout Reach, 1.75gpm Handshower	ADA Lever	Brushed Nickel	
251493	695	9-3/4" Spout Reach, 1.75gpm Handshower	ADA Lever	Chrome	

\*Lifeshine® Anti-Tarnish Lifetime Finish

[www.plumbsupply.com](http://www.plumbsupply.com) • Serving our Customers Since 1946 • [www.waterconcepts.net](http://www.waterconcepts.net)

## Tub Faucets

### Weymouth® 2-Hdl Freestanding Tub Filler

- Fits M•PACT® valve system
- Single-function handshower and shower
- 9" Spout reach
- 3/4" MNPT connections
- 59" Double interlock spiral metal hose
- Floor mount
- Handshower flow rate: 2.0 gpm



Requires: TS25105 Risers  
TS50200 Rough-In Kit

Part #	Mfg #	Description	Handle(s)	Finish	Price
225631	S22110BN	9" Spout Reach, 2.0 gpm Handshower	ADA Lever	Brushed Nickel	

\*Lifeshine® Anti-Tarnish Lifetime Finish

[www.waterconcepts.net](http://www.waterconcepts.net) • Serving our Customers Since 1946 • [www.plumbsupply.com](http://www.plumbsupply.com)



## Tub Faucets

### Two-Handle Tub Trim

#### P4B Builder Series 2-Hdl Roman Tub Faucet

- Ceramic cartridges
- High flow loose rough-in
- Maximum flow rate: 4.0 gpm @ 60 psi



Part #	Mfg #	Description	Handle(s)	Finish	Price
141383	P4B-900C	3-Hole	ADA Metal Lever	Chrome	
141384	P4B-900BN	3-Hole	ADA Metal Lever	Brushed Nickel	
141385	P4B-900ORB	3-Hole	ADA Metal Lever	Oil Rubbed Bronze	

## Tub Faucets

### Tub Spouts

#### Standard Tub Spout with Front Diverter

- Tapered threads
- Slip connects to 5/8" O.D. with 1-3/8" adjustment

Part #	Mfg #	Length	Material	Price
184085	972-35	5-1/4"	Chrome-Plated Zinc	

#### SmartSpout™ Shower Diverter & Repair Adapter Kit

- For 1/2" copper tube
- Installs directly onto 1/2" copper stub out with #2 Phillips screwdriver
- Slip-fit convenience; secure, clean, tight to finished wall eliminating the need to caulk
- 5-1/4" overall length in three finish options
- Free dry seal pipe collar included with every SmartSpout™
- Optional copper extension adapter available
- Reduced end fits inside type M or type L copper to extend the length of the stub out



Part #	Mfg #	Finish	Clamshell	Price
184086	972-361PK2	Chrome	Yes	



## Tub Faucets

### Two-Handle Roman Tub Trim

#### Grand Two-Handle Roman Tub Trim

- 5-1/4" High, 7-1/8" Reach spout
- Solid brass waterway construction with 1/2"-14 NPSM connection
- 1/4 Turn premium grade high flow rate ceramic cartridges (Type K)
- Brass tub spout, zinc handle
- Flow rate: 4.0 gpm
- 100% Pressure system tested



Part #	Mfg #	Description	Handles	Finish	Price
226643	211-6603	8"cc, 3-Hole	ADA Levers	Brushed Nickel	
229589	211-6604	8"cc, 3-Hole	ADA Levers	Oil Rubbed Bronze	

## Tub Spouts

### Tub Spouts

#### Alteo® Non-Diverter Tub Spout



Part #	Mfg #	Description	Finish	Price
144679	K-45133-BN	7-1/2" Reach	*Brushed Nickel	
153487	K-45133-CP	7-1/2" Reach	Polished Chrome	
170274	K-45133-2BZ	7-1/2" Reach	Oil Rubbed Bronze	

#### Alteo® Diverter Tub Spout



Part #	Mfg #	Description	Finish	Price
147969	K-45131-BN	6-1/2" Reach	*Brushed Nickel	
152420	K-45131-CP	6-1/2" Reach	Polished Chrome	
182292	K-45131-2BZ	6-1/2" Reach	Oil Rubbed Bronze	

#### Artifacts® Wall-Mount Spout with Flare Design

- Metal construction



Part #	Mfg #	Description	Finish	Price
162100	K-72791-BN	8" Reach	*Brushed Nickel	
166449	K-72791-CP	8" Reach	Polished Chrome	
174116	K-72791-SN	8" Reach	*Polished Nickel	
223896	K-72791-VNT	8" Reach	Vintage Nickel	
170523	K-72791-2BZ	8" Reach	Oil Rubbed Bronze	

#### Artifacts® Non-Diverter Tub Spout with Turned Design

- Metal construction



Part #	Mfg #	Description	Finish	Price
168022	K-72792-BN	8-7/16" Reach	*Brushed Nickel	
225935	K-72792-BV	8-7/16" Reach	*Brushed Bronze	
162834	K-72792-CP	8-7/16" Reach	Polished Chrome	
174461	K-72792-SN	8-7/16" Reach	*Polished Nickel	
218311	K-72792-2BZ	8-7/16" Reach	Oil Rubbed Bronze	

\* Vibrant Limited Lifetime Warranty

[www.waterconcepts.net](http://www.waterconcepts.net) • Serving our Customers Since 1946 • [www.plumbsupply.com](http://www.plumbsupply.com)

## Tub Spouts

### Bancroft® Wall-Mount Diverter Bath Spout

- Metal construction
- (K-10589) includes slip-fit connection



Part #	Mfg #	Description	Finish	Price
130194	K-10588-BN	5-3/4" Reach	*Brushed Nickel	
189640	K-10588-BV	5-3/4" Reach	*Brushed Bronze	
097866	K-10588-CP	5-3/4" Reach	Polished Chrome	
173110	K-10588-SN	5-3/4" Reach	*Polished Nickel	
166280	K-10589-BN	5-3/4" Reach with Slip-fit Connection	*Brushed Nickel	
221947	K-10589-BV	5-3/4" Reach with Slip-fit Connection	*Brushed Bronze	
121493	K-10589-CP	5-3/4" Reach with Slip-fit Connection	Polished Chrome	
182988	K-10589-SN	5-3/4" Reach with Slip-fit Connection	*Polished Nickel	

### Components™ Wall-Mount Non-Diverter Tub Spout

- Metal construction
- NPT connection
- 1-1/2" Max hole diameter



Part #	Mfg #	Description	Finish	Price
259380	K-77999-BL	9-7/16" Reach, NPT Connection	Matte Black	

### Composed® Wall-Mount Non-Diverter Tub Spout

- Solid brass construction
- Vibrant® titanium finish



Part #	Mfg #	Description	Finish	Price
243642	K-73120-CP	7-3/8" Reach	Polished chrome	

### Coralais® Non-Diverter Tub Spout with NPT Connection



Part #	Mfg #	Description	Finish	Price
095975	K-15135-CP	4-7/8" Reach, NPT Connection	Polished Chrome	
153619	K-15135-G	4-7/8" Reach, NPT Connection	Brushed Chrome	

\* Vibrant Limited Lifetime Warranty

[www.plumbsupply.com](http://www.plumbsupply.com) • Serving our Customers Since 1946 • [www.waterconcepts.net](http://www.waterconcepts.net)

## Tub Spouts

### Coralais® Diverter Tub Spout



#### NPT Connection

Part #	Mfg #	Description	Finish	Price
105547	K-15136-BN	4-7/8" Reach	*Brushed Nickel	
067310	K-15136-CP	4-7/8" Reach	Polished Chrome	
073896	K-15136-G	4-7/8" Reach	Brushed Chrome	
129500	K-15136-PB	4-7/8" Reach	*Polished Brass	
058480	K-15138-CP	8" Reach, NPT Connection	Polished Chrome	

#### Slip-Fit Connection

Part #	Mfg #	Description	Finish	Price
074785	K-15136-S-BN	4-7/8" Reach, Slip-Fit Connection	*Brushed Nickel	
060794	K-15136-S-CP	4-7/8" Reach, Slip-Fit Connection	Polished Chrome	
135660	K-15136-S-G	4-7/8" Reach, Slip-Fit Connection	Brushed Chrome	
060717	K-15136-S-PB	4-7/8" Reach, Slip-Fit Connection	*Polished Brass	

### Devonshire Non-Diverter Tub Spout with NPT Connection



Part #	Mfg #	Description	Finish	Price
085076	K-373-BN	4-7/16" Reach, NPT Connection	*Brushed Nickel	
108388	K-373-CP	4-7/16" Reach, NPT Connection	Polished Chrome	
158579	K-373-PB	4-7/16" Reach, NPT Connection	*Polished Brass	
146964	K-373-2BZ	4-7/16" Reach, NPT Connection	Oil Rubbed Bronze	

### Devonshire Diverter Tub Spout



#### NPT Connection

Part #	Mfg #	Description	Finish	Price
109303	K-389-BN	4-7/16" Reach Diverter NPT Connection	*Brushed Nickel	

#### Slip-Fit Connection

Part #	Mfg #	Description	Finish	Price
182858	K-389-S-CP	4-7/16" Reach, Diverter Slip Fit Connection	Polished Chrome	

\* Vibrant Limited Lifetime Warranty

## Tub Spouts

### Tub Spouts (Continued)

#### Devonshire Diverter Tub Spout Slip-Fit Connection

Part #	Mfg #	Description	Finish	Price
080750	K-389-S-BN	4-7/16" Reach, Diverter Slip Fit Connection	*Brushed Nickel	
117124	K-389-S-BV	4-7/16" Reach, Diverter Slip Fit Connection	*Brushed Bronze	
182859	K-389-S-PB	4-7/16" Reach, Diverter Slip Fit Connection	*Polished Brass	
146967	K-389-S-2BZ	4-7/16" Reach, Diverter Slip Fit Connection	Oil Rubbed Bronze	

#### Forté® Diverter Tub Spout with Sculpted Lift Rod

- 1/2" Npt connection (K-10280 models)
- Slip-fit connection (K-10281 models)



Part #	Mfg #	Description	Finish	Price
087527	K-10280-4-BN	5-1/4" Reach, 1/2" NPT Connection	*Brushed Nickel	
072075	K-10280-4-CP	5-1/4" Reach, 1/2" NPT Connection	Polished Chrome	
127682	K-10280-4-G	5-1/4" Reach, 1/2" NPT Connection	Brushed Chrome	
077228	K-10281-4-BN	5-1/4" Reach, Slip-Fit Connection	*Brushed Nickel	

#### Loure® Non-Diverter Tub Spout



Part #	Mfg #	Description	Finish	Price
145890	K-14676-BN	9-3/4" Reach	*Brushed Nickel	
159671	K-14676-CP	9-3/4" Reach	Polished Chrome	

#### Margaux® Non-Diverter Bath Spout

- Brass construction
- 1/2" NPT connection



Part #	Mfg #	Description	Finish	Price
114356	K-16246-CP	6-13/16" Reach	Polished Chrome	
230468	K-16246-SN	6-13/16" Reach	*Polished Nickel	

\* Vibrant Limited Lifetime Warranty

[www.plumbsupply.com](http://www.plumbsupply.com) • Serving our Customers Since 1946 • [www.waterconcepts.net](http://www.waterconcepts.net)

## Tub Spouts

### Memoirs® Stately Diverter Tub Spout with NPT Connection

- (-V) Deco lift rod



Part #	Mfg #	Description	Finish	Price
079180	K-496-CP	6" Reach, NPT Connection	Polished Chrome	
088893	K-496-V-BN	6" Reach, NPT Connection	*Brushed Nickel	
154455	K-496-V-BV	6" Reach, NPT Connection	*Brushed Bronze	
088776	K-496-V-CP	6" Reach, NPT Connection	Polished Chrome	
173099	K-496-2BZ	6" Reach, NPT Connection	Oil Rubbed Bronze	

### Purist® Non-Diverter Bath Spout

- Brass construction
- Wall-Mount



Part #	Mfg #	Description	Finish	Price
076333	K-14426-CP	7-3/4" Reach, 35° Arc	Polished Chrome	
253698	K-14426-SN	7-3/4" Reach, 35° Arc	*Polished Nickel	
085530	K-14427-BN	7-3/4" Reach, 90° Arc	*Brushed Nickel	
074138	K-14427-CP	7-3/4" Reach, 90° Arc	Polished Chrome	
178254	K-14427-SN	7-3/4" Reach, 90° Arc	*Polished Nickel	

### Toobi™ Non-Diverter Bath Spout with 1/2" NPT Connection



Part #	Mfg #	Description	Finish	Price
156152	K-3962-BN	6-3/4" Reach, 1/2" NPT Connection	*Brushed Nickel	
154693	K-3962-CP	6-3/4" Reach, 1/2" NPT Connection	Polished Chrome	

### Refinia® Diverter Tub Spout

- 5/8" O.D. slip-fit or 1/2" NPT connection



Part #	Mfg #	Description	Finish	Price
145407	K-5327-BN	6-3/4" Reach, 5/8" OD Slip-Fit or 1/2" NPT Connection	*Brushed Nickel	
160899	K-5327-CP	6-3/4" Reach, 5/8" OD Slip-Fit or 1/2" NPT Connection	Polished Chrome	

\* Vibrant Limited Lifetime Warranty

[www.waterconcepts.net](http://www.waterconcepts.net) • Serving our Customers Since 1946 • [www.plumbsupply.com](http://www.plumbsupply.com)



## Tub Spouts

### Refinia® Non-Diverter Tub Spout

- 5/8" O.D. slip-fit or 1/2" NPT connection



Part #	Mfg #	Description	Finish	Price
149467	K-5328-BN	6-1/2" Reach, 5/8" OD Slip-Fit or 1/2" NPT Connection	*Brushed Nickel	
145520	K-5328-CP	6-1/2" Reach, 5/8" OD Slip-Fit or 1/2" NPT Connection	Polished Chrome	

### Souris® Sheetflow Non-Diverter Tub Spout with 1/2" NPT Connection

- Requires minimum 6 gpm flow rate from supply valve
- 6-5/8"W x 4-7/8"H



Part #	Mfg #	Description	Finish	Price
156292	K-6946-BN	5-5/16" Reach, 1/2" Slip-Fit Connection	*Brushed Nickel	
114684	K-6946-CP	5-5/16" Reach, 1/2" Slip-Fit Connection	Polished Chrome	

### Stance® Wall-Mount Tub Spout with 1/2" NPT Connection

- Brass construction



Part #	Mfg #	Description	Finish	Price
139622	K-14795-CP	7-7/8" Reach, 1/2" Slip-Fit Connection	Polished Chrome	

### Standard Diverter Tub Spout

- Solid brass construction



Part #	Mfg #	Description	Finish	Price
183622	K-6855-2BZ	IPS Connection	Oil Rubbed Bronze	
152170	K-85555-2BZ	IPS Connection	Oil Rubbed Bronze	
081693	GP85555-BN	IPS Connection	*Brushed Nickel	
103917	GP85555-CP	IPS Connection	Polished Chrome	
115373	GP85556-CP	Slip-Fit Connection	Polished Chrome	

\* Vibrant Limited Lifetime Warranty

[www.plumbsupply.com](http://www.plumbsupply.com) • Serving our Customers Since 1946 • [www.waterconcepts.net](http://www.waterconcepts.net)

## Tub Spouts

### Diverter Tub Spouts

#### Ara® Pull-Up Diverter Tub-Spout

- 7-1/10" Length
- Thread onto 1/2" IPS nipple



Part #	Mfg #	Description	Price
187193	RP75435	Chrome	
241657	RP75435BL	Matte Black	
171153	RP75435SS	Stainless*	

#### Addison™ Pull-Up Diverter Tub Spout

- 7-1/2" Long
- Thread onto 1/2" IPS nipple



Part #	Mfg #	Description	Price
137425	RP61269SS	Stainless*	

#### Ashlyn™ Diverter Tub Spout

- 7-15/16" Length
- Thread onto 1/2" IPS



Part #	Mfg #	Description	Price
187894	RP77091	Chrome	
179607	RP77091SS	Stainless*	
175219	RP770091RB	Venetian Bronze®	

#### Carlisle™ Pull-Up Diverter Spout

- 6-1/2" Length
- Thread onto 1/2" IPS nipple



Part #	Mfg #	Description	Price
223423	RP52153CZ	Champagne Bronze™	
175385	RP52153RB	Venetian Bronze®	
155378	RP52153SS	Stainless*	

#### Cassidy™ Pull-Up Diverter Spout

- 7-2/3" Length
- Thread onto 1/2" IPS nipple



Part #	Mfg #	Description	Price
163967	RP72565	Chrome	
170688	RP72565CZ	Champagne Bronze™	
162209	RP72565PN	Polished Nickel*	
163175	RP72565RB	Venetian Bronze®	
172165	RP72565SS	Stainless*	

#### Compel® Diverter Tub Spout

- 7" Length
- Thread onto 1/2" IPS nipple



Part #	Mfg #	Description	Price
156843	RP73372	Chrome	
156906	RP73372SS	Stainless*	

#### Dryden™ Pull-Up Diverter Tub Spout

- 7-1/2" Length
- Thread onto 1/2" IPS nipple



Part #	Mfg #	Description	Price
143219	RP52148	Chrome	
180119	RP52148PN	Polished Nickel*	
118525	RP52148SS	Stainless*	
117907	RP52148RB	Venetian Bronze®	

#### Foundations® Pull-Up Diverter Tub Spout

- 7" Length
- Removable threaded adapter for 1/2" IPS



Part #	Mfg #	Description	Price
147568	RP64721	Chrome	
173461	RP64721OB	Oil Rubbed Bronze	
162666	RP64721SS	Stainless*	

\* Brilliance® Anti-Tarnish Lifetime Finishes

## Tub Spouts

### Lahara® Pull-Up Diverter Tub Spout

- 6-3/4" Length
- Thread onto 1/2" IPS nipple



Part #	Mfg #	Finish	Price
122471	RP51303	Chrome	
155806	RP51303CZ	Champagne Bronze™	
117832	RP51303RB	Venetian Bronze®	
113295	RP51303SS	Stainless*	

### Lahara® Pull-Up Diverter Tub Spout

- 6-3/4" Length



Part #	Mfg #	Finish	Price
242347	RP83677RB	Venetian Bronze	

### Leland® Diverter Tub Spout

- 6-1/2" Length
- Thread onto 1/2" IPS nipple



Part #	Mfg #	Finish	Price
109404	RP42915RB	Venetian Bronze®	
109599	RP42915SS	Stainless*	

### Linden™ Diverter Tub Spout



Part #	Mfg #	Description	Price
231520	RP83676SS	Stainless*	

### Pivotal™ Pull-Up Diverter Tub Spout

- Extends 9" from wall



Part #	Mfg #	Finish	Price
242226	RP90158	Chrome	
257611	RP90158SS	Stainless*	

### Stryke™ Diverter Tub Spout

- 8.3" Length
- Thread onto 1/2" IPS
- Sweat onto 1/2" C.W.T.



Part #	Mfg #	Description	Price
259437	RP93376BL	Matte Black	

### Trinsic® Diverter Tub Spout

- 6-1/8" Length
- Thread onto 1/2" IPS nipple



Part #	Mfg #	Description	Price
159281	RP73371	Chrome	
164424	RP73371SS	Stainless*	

### Universal Handshower Diverter Tub Spout

- Thread onto 1/2" or 3/4" IPS



U1072-PK

U1010PK

Part #	Mfg #	Description	Price
001158	U1072-PK	5-1/4", 1/2" CWT Slip Fit, Chrome	
001154	U1010-PK	6-1/2", Threads onto 1/2" or 3/4" IPS, Chrome	
149133	U1010-SS-PK	6-1/2", Threads onto 1/2" or 3/4" IPS, Stainless	
003627	RP3914	4-7/8" Diverter, Threads onto 1/2" or 3/4" IPS	

### Vero® Diverter Tub Spout

- 7-1/8" Length
- Thread onto 1/2" IPS nipple



Part #	Mfg #	Description	Price
136539	RP53419	Chrome	
151394	RP53419RB	Venetian Bronze®	
135444	RP53419SS	Stainless*	

\* Brilliance® Anti-Tarnish Lifetime Finishes

[www.plumbsupply.com](http://www.plumbsupply.com) • Serving our Customers Since 1946 • [www.waterconcepts.net](http://www.waterconcepts.net)

## Tub Spouts

### Victorian® Pull-Up Diverter Spout

- 7-1/2" Length
- Thread onto 1/2" IPS nipple



Part #	Mfg #	Description	Price
169275	RP34357CZ	Champagne Bronze™	
074878	RP34357SS	Stainless*	

### RP19820 Diverter Tub Spout

- 5-1/2" Length
- Slip onto 1/2" CST



Part #	Mfg #	Finish	Price
003581	RP19820	Chrome	
159831	RP19820SS	Stainless*	

### Windemere® Pull-Up Diverter Tub Spout

- Slip-On



Part #	Mfg #	Description	Price
227895	RP81273SS	Stainless	

### RP4909 Diverter Tub Spout

- 7" Long
- Thread onto 1/2" IPS nipple



Part #	Mfg #	Finish	Price
154205	RP49094BN	Brushed Nickel*	

### RP61357 Diverter Tub Spout

- 5-3/8" Length
- Thread onto 1/2" IPS nipple



Part #	Mfg #	Description	Price
163620	RP61357	Chrome	
186372	RP61357OB	Oil Rubbed Bronze	

### RP5834 Diverter Tub Spout

- 5-1/2" Long
- Thread onto 1/2" IPS nipple



Part #	Mfg #	Finish	Price
003651	RP5834	Chrome	

### RP17453 Pull-Down Diverter Tub Spout

- 6" Long
- Thread onto 1/2" IPS nipple



Part #	Mfg #	Finish	Price
003523	RP17453	Chrome	
096806	RP17453SS	Stainless*	

### RP19895 Diverter Tub Spout

- 5-1/2" Long
- Thread onto 1/2" IPS nipple



Part #	Mfg #	Finish	Price
047170	RP19895	Chrome	

### RP5836 Pull-Down Diverter Tub Spout

- 6-1/8" Length
- Slip onto 1/2" CWT



Part #	Mfg #	Finish	Price
003653	RP5836	Chrome	

\* Brilliance® Anti-Tarnish Lifetime Finishes

## Tub Spouts

### RP93273 Modern Push-Button Diverter Tub Spout

- 6-1/2" Long
- Auto-reset
- Universal adapter included



Part #	Mfg #	Finish	Price
260541	RP93273BL	Matte Black	

### U1075-PK Pull-Down Diverter Tub Spout

- 5-1/4" Length
- Thread onto 1/2" or 3/4" IPS nipple



Part #	Mfg #	Description	Price
154662	U1075-PK	Chrome	
174510	U1075-PB-PK	Polished Brass*	

### Non-Diverter Tub Spouts

#### Addison™ Non-Diverter Tub Spout



Part #	Mfg #	Description	Price
223420	RP54863CZ	Champagne Bronze™	
135400	RP54863SS	Stainless	

#### Ara® Enclosed Tub Filler Spout Assembly

Part #	Mfg #	Description	Price
244045	RP84077SS	Enclosed Stainless*	

#### Ashlyn® Non-Diverter Tub Spout



Part #	Mfg #	Description	Price
185332	RP77092SS	Stainless*	

### Compel® Non-Diverter Tub Spout



Part #	Mfg #	Description	Price
189293	RP80132SS	Stainless	

### Dryden™ Non-Diverter Tub Spout

- 7-1/2" Length
- Thread onto 1/2" IPS nipple



Part #	Mfg #	Description	Price
129020	RP54323SS	Stainless*	

### Foundations® Non-Diverter Tub Spout

- 7" Length
- Removable threaded adapter for 1/2" IPS
- Coordinates with Windemere®



Part #	Mfg #	Description	Price
156695	RP64722	Chrome	
159725	RP64722OB	Oil Rubbed Bronze	
159503	RP64722SS	Stainless*	

### Lahara® Non-Diverter Tub Spout

- 6-3/4" Length
- Sweat onto 1/2" C.W.T. or thread onto 1/2" IPS



Part #	Mfg #	Description	Price
125098	RP53237	Chrome	
149439	RP53237CZ	Champagne Bronze™	
119644	RP53237RB	Venetian Bronze®	
121140	RP53237SS	Stainless*	

### Stryke™ Non-Diverter Tub Spout

- 10.31" Length
- Thread onto 1/2" IPS
- Sweat onto 1/2" C.W.T.



Part #	Mfg #	Description	Price
258333	RP93377SS	Stainless*	

\* Brilliance® Anti-Tarnish Lifetime Finishes

[www.plumbsupply.com](http://www.plumbsupply.com) • Serving our Customers Since 1946 • [www.waterconcepts.net](http://www.waterconcepts.net)

## Tub Spouts

### Tesla® Non-Diverter Tub Spout



Part #	Mfg #	Description	Price
251186	RP78736	Chrome	

### RP43165 Non-Diverter Tub Spout

- 6-1/2" Length
- Sweat onto 1/2" C.W.T
- Thread onto 1/2" IPS nipple



Part #	Mfg #	Description	Price
109485	RP43165	Chrome	
095154	RP43165SS	Stainless*	

### Trinsic® Non-Diverter Tub Spout

- 7" Length
- 1/2" IPS connection
- RP12307 adapter assembly included



Part #	Mfg #	Description	Price
245680	RP77350BL	Matte Black	

### RP43028 Non-Diverter Tub Spout

- 7-1/2" Length
- Thread onto 1/2" IPS nipple
- Coordinates with Victorian®, Cassidy™, and Linden™



Part #	Mfg #	Description	Price
084517	RP43028	Chrome	
156282	RP43028CZ	Champagne Bronze™	
088992	RP43028SS	Stainless*	

### Vero™ Non-Diverter Tub Spout

- 7" Length
- Threads into nose of spout



Part #	Mfg #	Finish	Price
123317	RP48333	Chrome	
239435	RP48333RB	Venetian Bronze	
123898	RP48333SS	Stainless*	

### RP5833 Non-Diverter Tub Spout

- 4-3/4" Length
- Thread onto 1/2" IPS nipple -



Part #	Mfg #	Finish	Price
003650	RP5833	Chrome	

### Windemere® Non-Diverter Tub Spout

- 5-3/8" Length
- Coordinates with Foundations® and Windemere®



Part #	Mfg #	Description	Price
161987	RP62149	Chrome	

### Zura Non-Diverter Tub Spout

- 1/2" IPS connection



Part #	Mfg #	Description	Price
236703	RP8725	Chrome	

\* Brilliance® Anti-Tarnish Lifetime Finishes

www.waterconcepts.net • Serving our Customers Since 1946 • www.plumbsupply.com



## Tub Spouts

### Tub Spouts

#### Baliza® Tub Spout

- Solid brass construction
- Pull-up diverter tub spout
- 7" Long



		Description	Finish
160851	RP49094	7" Length, Diverter	Chrome

#### Brizo® Non Diverter Tub Spout



		Description	Finish
093908	RP37762	6-7/8" Length, Non-Diverter	Chrome
144916	RP37762-BN	6-7/8" Length, Non-Diverter	Brushed Nickel*
156700	RP37762-PN	6-7/8" Length, Non-Diverter	Polished Nickel*
165010	RP37762-RB	6-7/8" Length, Non-Diverter	Venetian Bronze®

#### Charlotte® Tub Spout Assembly

- Solid brass construction
- Pull-down diverter tub spout
- 8 3/8" long



		Description	Finish
157365	RP70908PNCO	8-3/8" Length, Diverter	Cocoa Bronze™/Polished Nickel

#### Levoir™ Diverter Tub Spout

- Solid brass construction
- 9-3/4" Long
- Thread onto 1/2" NPT
- Sweat or slip onto 1/2" CWT
- RP90472 universal adapter ships with tub spout



		Description	Finish
255703	RP92042-NK	9-3/4" Length, Diverter	Luxe Nickel

#### Levoir™ Non-Diverter Tub Spout

- Solid brass construction
- 7-9/16" Long
- Thread onto 1/2" NPT
- Sweat or slip onto 1/2" CWT



		Description	Finish
253982	RP92041PN	7-9/16" Length, Non-Diverter	Polished Nickel*

\* Brilliance® Anti-Tarnish Lifetime Finishes

[www.plumbsupply.com](http://www.plumbsupply.com) • Serving our Customers Since 1946 • [www.waterconcepts.net](http://www.waterconcepts.net)

## Tub Spouts

### Litze™ Diverter Tub Spout

- Solid brass construction
- Textural knurling detail
- 7-1/2" Long



		Description	Finish
243245	RP81437PC	7-1/2" Length, Diverter	Chrome

### Litze™ Non-Diverter Tub Spout

- Solid brass construction
- 7-1/2" Long



		Description	Finish
241635	RP81435PC	7-1/2" Length, Non-Diverter	Chrome

### Modern Tub Spout Assembly

- Solid brass construction
- Pull-down diverter tub spout
- 5-1/2" long



		Description	Finish
160594	RP54873BN	5-1/2" Length, Non-Diverter	Brushed Nickel*
161848	RP54874BN	5-1/2" Length, Diverter	Brushed Nickel*
156845	RP54874PC	5-1/2" Length, Diverter	Chrome

### Rook™ Non-Diverter Tub Spout

- Solid brass construction
- 9" Long



		Description	Finish
259507	RP78582PC	9" Length, Non-Diverter	Chrome

### Rook™ Channel Non-Diverter Tub Spout

- Solid brass construction
- 9-1/2" Long



		Description	Finish
185632	RP78583NK	9-1/2" Length, Non-Diverter	Luxe Nickel*
256115	RP78583NKBL	9-1/2" Length, Non-Diverter	Luxe Nickel/Matte Black
240670	RP78583RB	9-1/2" Length, Non-Diverter	Venetian Bronze

\* Brilliance® Anti-Tarnish Lifetime Finishes

---



---

**Tub Spouts**

---



---

**Rook™ Pull-Up Diverter Tub Spout**

- Solid brass construction
- 9" Long



		Description	Finish
242179	RP78581NK	9" Length, Pull-Up Diverter	Luxe Nickel*
259573	RP78581NKBL	9" Length, Pull-Up Diverter	Luxe Nickel/Matte Black

**Sotria™ Non Diverter Tub Spout**

- Solid brass construction
- Non-diverter tub spout
- 9" Long



		Description	Finish
237806	RP74646PC	9" Length, Non-Diverter	Chrome
179652	RP74646NK	9" Length, Non-Diverter	Luxe Nickel*

**Sotria™ Pull-Up Diverter Tub Spout**

- Solid brass construction
- 9" Long



		Description	Finish
242329	RP74644BL	9" Length, Pull-Up Diverter	Matte Black
242964	RP74644NK	9" Length, Pull-Up Diverter	Luxe Nickel

\* Brilliance® Anti-Tarnish Lifetime Finishes

## Tub Spouts

### Diverter Tub Spouts

#### Arris® Diverter Tub Spouts

- 7-1/8" Spout Length
- 1/2" slip fit



Part #	Mfg #	Description	Finish	Price
251488	165914	7-1/8" Diverter Spout Only	Chrome	

#### Belfield® Diverter Tub Spout

- 7-3/4" Length
- 1/2" Slip fit



Part #	Mfg #	Description	Finish	Price
252910	185820ORB	7-3/4" Diverter Spout Only	Oil Rubbed Bronze	

#### Brantford® Diverter Tub Spout

- 7-1/4" Length
- 1/2" IPS connections



Part #	Mfg #	Description	Finish	Price
189243	3814	7-1/4" Diverter Spout Only	Chrome	
219791	3814BN	7-1/4" Diverter Spout Only	Brushed Nickel	
189333	3814ORB	7-1/4" Diverter Spout Only	Oil Rubbed Bronze	

#### Rothbury™ Diverter Tub Spout

- 7-5/8" Length
- 1/2" Slip fit



Part #	Mfg #	Description	Finish	Price
147554	S3859BN	7-5/8" Diverter Spout Only	Brushed Nickel	

#### Waterhill® Diverter Tub Spout

- 6-3/4" Length
- 1/2" Slip fit



Part #	Mfg #	Description	Finish	Price
113874	S114ORB	6-3/4" Diverter Tub Spout	Oil Rubbed Bronze	

\*Lifeshine® Anti-Tarnish Lifetime Finish

[www.waterconcepts.net](http://www.waterconcepts.net) • Serving our Customers Since 1946 • [www.plumbsupply.com](http://www.plumbsupply.com)

## Tub Spouts

### Weymouth™ Diverter Tub Spout

- 1/2" Slip fit



Part #	Mfg #	Description	Finish	Price
176394	S12104	Tub Spout Only, 6-3/4"	Chrome	
240131	S12104BN	Tub Spout Only, 6-3/4"	Brushed Nickel	

### Diverter Spout

- 7-1/4" Reach



Part #	Mfg #	Description	Finish	Price
150239	3857	Tub Spout Only, 7-1/4"	Chrome	
118661	3857BN	Tub Spout Only, 7-1/4"	Brushed Nickel	
136832	3857ORB	Tub Spout Only, 7-1/4"	Oil Rubbed Bronze	

### Diverter Spout

- 7-1/8" Reach



Part #	Mfg #	Description	Finish	Price
244653	172656	Tub Spout Only 7-1/8"	Chrome	

### Method™ Diverter Tub Spout

- 5-7/8" Spout length
- 1/2" Slip fit

Part #	Mfg #	Description	Finish	Price
238166	152027BN	Tub Spout Only, 5-7/8"	Brushed Nickel	

### Moen Diverter Spout

- 5-1/2" Spout length



Part #	Mfg #	Description	Finish	Price
113173	3801	Tub Spout Only, 5-1/2"	Chrome	

\*Lifeshine® Anti-Tarnish Lifetime Finish

## Tub Spouts

### Diverter Tub Spout

- 5-1/2" Spout Length
- 1/2" Slip Fit



Part #	Mfg #	Description	Finish	Price
195701	3808	Tub Spout Only, 5-1/2"	Chrome	
249509	3808P	tub Spout Only, 5-1/2"	Polished Brass	

### Diverter Tub Spout

- 5-1/2" Spout Length
- 1/2" Slip fit



Part #	Mfg #	Description	Finish	Price
007268	3931	Tub Spout Only, 5-1/2"	Chrome	

### Diverter Tub Spout



Part #	Mfg #	Description	Finish	Price
007262	3911	Tub Spout Only, 5-1/2"	Chrome	

### Non-Diverter Tub Spouts

#### Arris™ Non-Diverter Tub Spout

- 7-1/8" Length
- 1/2" Slip fit



Part #	Mfg #	Description	Finish	Price
252963	S16900	Tub Spout Only, 7-1/8"	Brushed Nickel	

#### Brantford® Non-Diverter Tub Spout

- 1/2" Slip fit



Part #	Mfg #	Description	Finish	Price
153680	3858BN	Tub Spout Only, 7-1/4"	Brushed Nickel	

\*Lifeshine® Anti-Tarnish Lifetime Finish



## Tub Spouts

### Dartmoor® Non-Diverter Tub Spout

- 7-1/8" Length
- LifeShine

Part #	Mfg #	Description	Finish	Price
247850	3737BN	Tub Spout Only, 7-1/8"	Brushed Nickel	

### Rothbury™ Non-Diverter Tub Spout

- 7-5/8" Length
- 1/2" Slip fit connections



Part #	Mfg #	Description	Finish	Price
221020	S3860	7-5/8" Non-Diverter Spout Only	Chrome	
198915	S3860BN	7-5/8" Non-Diverter Spout Only	Brushed Nickel	
222607	S3860ORB	7-5/8" Non-Diverter Spout Only	Oil Rubbed Bronze	

### Level Non-Diverter Tub Spout

- 6-1/2" Length



Part #	Mfg #	Description	Finish	Price
243262	3892	6-1/2" Non-Diverter Spout Only	Chrome	

### Moen Non-Diverter Tub Spout

- 7" Length
- 1/2" IPS



Part #	Mfg #	Description	Finish	Price
097118	3828	Tub Spout Only, 7"	Chrome	

### Moen Non-Diverter Tub Spouts

- 7" Length
- 1/2" Slip fit



Part #	Mfg #	Description	Finish	Price
087586	3829	Tub Spout Only, 7"	Chrome	
088716	3829BN	Tub Spout Only, 7"	Brushed Nickel	

\*Lifeshine® Anti-Tarnish Lifetime Finish

[www.plumbsupply.com](http://www.plumbsupply.com) • Serving our Customers Since 1946 • [www.waterconcepts.net](http://www.waterconcepts.net)

## Tub Spouts

### Moen Non-Diverter Tub Spouts

- 7-15/16" Length
- 1/2" Slip fit



Part #	Mfg #	Description	Finish	Price
247284	195386BN	Tub Spout Only, 7-15/16"	Brushed Nickel	
253593	195386ORB	Tub Spout Only, 7-15/16"	Oil Rubbed Bronze	

\*Lifeshine® Anti-Tarnish Lifetime Finish

[www.waterconcepts.net](http://www.waterconcepts.net) • Serving our Customers Since 1946 • [www.plumbsupply.com](http://www.plumbsupply.com)

## Tub Spouts

### Tub Trim

#### 39 Cast Brass 2-Hdl Bath Faucet

- Renew valves & seats
- Cast brass body on 3-3/8" centers
- Chrome finish
- Chrome metal dome type handles



39



39C

Part #	Mfg #	Description	Price
010496	39	Bath Faucet with Nozzle	
026950	39C	Bath Faucet with Code Spout	



---

---

**Tub Spouts**

---

---

**Tub Spouts**

**Front Lift Diverter Spout**

- 5-5/8" Length
- 1/2" FPT

Part #	Mfg #	Finish	Price
252961	1128	Chrome	

**Adjustable Non-Diverter Spout**

- 5-5/8" Length
- 2-1/4" Adjust
- 1/2" CWT

Part #	Mfg #	Finish	Price
252923	1136	Chrome	

## Tub Spouts

### Tub Spouts

#### Overrim Non-Diverter Tub Spout

- 1/2" FIP



Part #	Mfg #	Finish	Length	Price
190778	0620002	Chrome	5"	

#### Slip-On Diverter Tub Spout

- Fits 1/2" copper with set screw and O-Ring seal



Part #	Mfg #	Finish	Length	Price
194626	0620003	Chrome		

#### Diverter Tub Spout

- Furnished with 1/2" - 3/4" face bushing (back mount)



Part #	Mfg #	Finish	Length	Price
048373	0620005	Chrome		

#### Front Connection Diverter Tub Spout

- 1/2"



Part #	Mfg #	Description	Length	Price
052690	0620008	Chrome	5"	

## Wall Hydrants

### Wall Faucets

#### Model 14 Freezeless Wall Faucet

- 3/4" Male hose thread nozzle
- Permanent stainless steel seat will not wire draw
- EPDM Packing to prevent leaking
- Full circle threads on valve body
- Metal Handle and retainer
- No lead solder
- Standard "O" size seat washer
- Powder-coated, die cast aluminum handle standard
- Adjustable polycarbonate flange
- Maximum pressure: 125 psi
- Maximum temperature: 120°F



#### 1/2" MIP x 1/2" Female Swt Inlet

Part #	Mfg #	Thickness	Handle	Price
011670	14CP-6-MH	6"	Metal	
011674	14CP-8-MH	8"	Metal	
011665	14CP-10-MH	10"	Metal	
011666	14CP-12-MH	12"	Metal	
011667	14CP-14-MH	14"	Metal	
011668	14CP-18-MH	18"	Metal	

#### 1/4" MIP x 3/4" Female Swt Inlet

Part #	Mfg #	Thickness	Handle	Price
233236	14CP3-10-MH	10"	Metal	

#### 1/2" FIP x 3/4" MIP

Part #	Mfg #	Thickness	Handle	Price
104400	14P-12-MH	12"	Metal	

#### Model 17 Anti-Siphon Freezeless Wall Faucet

- 3/4" Male hose thread nozzle
- Permanent stainless steel seat will not wire draw
- EPDM Packing to prevent leaking
- Full circle threads on valve body and retainer
- No lead solder
- Standard "O" size seat washer
- Power-coated, die cast aluminum handle
- Vacuum breaker cap and body and adjustable polycarbonate flange
- Maximum pressure: 125 psi
- Maximum temperature: 120°F



#### Copper Swt Inlet

- 1/2" K, L or M inside and 3/4" M only outside

Part #	Mfg #	Thickness	Handle	Price
011690	17C-12-MH	12"	Metal	

#### 1/2" MIP x 1/2" Female Swt Inlet

Part #	Mfg #	Thickness	Handle	Price
059484	17CP-4-MH	4"	Metal	
011687	17CP-6-MH	6"	Metal	
011688	17CP-8-MH	8"	Metal	
011683	17CP-10-MH	10"	Metal	
011684	17CP-12-MH	12"	Metal	
011685	17CP-14-MH	14"	Metal	
011686	17CP-18-MH	18"	Metal	
052677	17CP-24-MH	24"	Metal	

#### 1/2" Wirsbo/Uponor Inlet

Part #	Mfg #	Thickness	Handle	Price
126713	17W-8	8"	-	
126714	17W-10	10"	-	
110108	17W-12	12"	-	
126715	17W-14	14"	-	

#### 1/2" FIP x 3/4" MIP

Part #	Mfg #	Thickness	Handle	Price
235541	17P-8-MH	8"	Metal	

#### 1/2" PEX Tube Inlet

Part #	Mfg #	Thickness	Handle	Price
132238	17PX-8	8"	-	



## Wall Hydrants

### Wall Faucets (Continued)

#### 1/2" Wirsbo/Uponor Inlet

##### 1/2" PEX Tube Inlet

Part #	Mfg #	Thickness	Handle	Price
106270	17PX-10-MH	10"	Metal	
076406	17PX-12-MH	12"	Metal	
100654	17PX-14	14"	-	

##### 3/4" PEX Tube Inlet

Part #	Mfg #	Thickness	Handle	Price
206158	17PX3-10-MH	10"	Metal	
105970	17PX3-18-MH	18"	Metal	
157206	17PX3	12"	Metal	

#### Model 19 Anti-Siphon Freezeless Wall Faucet

- 3/4" Male hose thread nozzle
- Permanent stainless steel seat will not wire draw
- EPDM Packing to prevent leaking
- No lead solder
- Standard "O" size seat washer
- Power-coated, die cast aluminum handle
- Adjustable wall flange
- Maximum pressure: 125 psi
- Maximum temperature: 120°F



##### 1/2" MIP x 1/2" Female Swt Inlet

Part #	Mfg #	Thickness	Handle	Price
084038	19CP-8	8"	-	
082384	19CP-10	10"	-	
082385	19CP-12	12"	-	
085823	19CP-14	14"	-	

##### 1/2" PEX Inlet

Part #	Mfg #	Thickness	Handle	Price
148048	19PX-1212	1/2"	-	

### Models 22/V22 Freezeless Hot & Cold Wall Faucet

- 3/4" Male hose thread nozzle
- Permanent stainless steel seat will not wire draw
- EPDM Packing to prevent leaking
- No lead solder
- Standard "O" seat washer
- Power-coated die cast aluminum oval handle
- Maximum pressure: 125 psi
- Maximum temperature: 120°F
- Full circle threads on valve body and retainer
- Internal, resetting pressure relief valves prevents casing tube from bursting in freezing conditions even if a hose is unintentionally left on
- Built-in vent float style vacuum breaker
- Faucet drains automatically when hose is removed



##### 1/2" MIP x 1/2" Female Copper Swt Inlet

Part #	Mfg #	Thickness	Handle	Price
041207	22CP-8-MH	8"	Metal	
041208	22CP-10-MH	10"	Metal	
041209	22CP-12-MH	12"	Metal	

##### 1/2" MIP x 1/2" Swt Inlet Vertical-Mounted

- Rough brass
- For slab construction



Part #	Mfg #	Thickness	Handle	Price
204928	V22CP-8	8"		
079604	V22CP-10-MH	10"	Metal	
057074	V22CP-12-MH	12"	Metal	

## Wall Hydrants

### 3/4" MIP x 3/4" Swt Inlet Vertical-Mounted



Part #	Mfg #	Thickness	Handle	Price
149599	V22CP3-12	12"	-	

### Model 25 Anti-Siphon Automatic Draining Freezeless Wall Faucet

- Brass finish
- Molded nitrile valve suitable for hot water
- No lead solder
- Hemispherical cushion
- type plunger
- Delrin Stem screw
- Brass head nut
- Metal handle
- Maximum pressure: 125 psi
- Maximum temperature: 120°F



#### 1/2" MIP x 1/2" Female Swt Inlet

Part #	Mfg #	Thickness	Handle	Price
011699	25CP10	10"	Metal	
011700	25CP12	12"	Metal	
011701	25CP14	14"	Metal	

### Model 27 Backflow Protected Automatic Draining Freezeless Wall Faucet

- Brass finish
- Molded nitrile valve suitable for hot water
- No lead solder
- Hemispherical cushion type plunger
- Delrin stem screw
- Brass head nut
- Maximum pressure: 125 psi
- Maximum temperature: 120°F



#### C Inlet

#### 1/2" K, L, or M Inside x M Only Outside

Part #	Mfg #	Thickness	Handle	Price
238232	27C-12-TK	12" w/Tee Key	Metal	

### Non-Freeze Area Wall Faucets

#### Model 24/B24 Anti-Siphon Commercial Wall Faucet

- Designed for mild climate areas
- EPDM Packing prevents leaking
- Adjustable brass nut with deep stem guard
- Standard "O" size washer
- Furnished with polycarbonate wheel handle and loose tee key
- Maximum pressure: 125 psi
- Maximum temperature: 120°F



#### 1/2" FIP Inlet with Vacuum Breaker Anti-Siphon Wall Faucet

Part #	Mfg #	Size	Finish	Handle	Price
017531	24P1/2-PC-MH	1/2"	Pol Chr	Metal	
011694	24P1/2-BR	1/2"	Rgh Brs	Poly	

#### 3/4" FIP Inlet with Vacuum Breaker Anti-Siphon Wall Faucet

Part #	Mfg #	Size	Finish	Handle	Price
011697	24P3/4-MH	3/4"	Chrome	Metal	
011696	24P3/4-PCMH	3/4"	Pol Chr	Metal	
011695	24P3/4-BRMH	3/4"	Rgh Brs	Metal	

#### 1/2" Copper Tube x 1/2" MIP Inlet

Part #	Mfg #	Size	Finish	Handle	Price
022638	24CP-MH	1/2"	Chrome	Metal	

## Wall Hydrants

### Wall Hydrants

#### Model 67/B67 Backflow Protected Freezeless Wall Hydrant

- Permanent type brass valve body with hemispherical seating surface
- 1-Piece valve plunger accurately controls both flow and drainage with a minimum number of turns and without need for adjustment
- Drain is under nozzle away from hands of operator and with a lip to divert water away from building
- Copper tube casing
- No lead solder
- Hardened stainless steel stem resists damage
- Loose key operates hydrant
- 3/8" Solid brass operating rod
- Maximum pressure: 125 psi
- Maximum temperature: 120°F



#### 3/4" Copper Water Tube

Part #	Mfg #	Size	Finish	Handle	Price
011739	67C-8	8"	Chrome	Tee Key	
011734	67C-10	10"	Chrome	Tee Key	
011735	67C-12	12"	Chrome	Tee Key	
011736	67C-14	14"	Chrome	Tee Key	
049800	67C-16	16"	Chrome	Tee Key	
011737	67C-18	18"	Chrome	Tee Key	

#### Model 67 Box Assembly

Part #	Mfg #	Description	Price
089253	67BX	For Converting 65 and 67 to Box Type	

#### B67 Series Freezless Wall Hydrant

- 8" x 7" x 19"
- Automatic draining
- 3/4" Femal copper inlet
- Concealed in a wall box
- Two independant check valves
- Includes 50HA backflow preventer
- 14" Rough-in or 21" mounting depth



Part #	Mfg #	Size	Inlet	Handle	Price
151774	B67C-14	Small	3/4" Fml	Tee Key	
151773	B67C-3412	Combo	3/4" x 12		

#### Model 14 Freezeless Wall Hydrant

- No-lead solder
- 3/4" Male hose thread nozzle
- Standard "O" size seat washer
- Maximum pressure: 125 psi
- Maximum temperature: 120° F
- Powder-coated, die cast aluminum handle
- Adjustable polycarbonate wall flange
- Optional tee key available



Part #	Mfg #	Size	Inlet	Handle	Price
204806	14PX-10-MH	10"	1/2" Pex	Spg	

### Parts & Accessories

Part #	Mfg #	Thickness	Price
150249	WHDMP	Drywall Mounting Plate fpr (V)22	

## Wall Hydrants

### Commercial Hydrants

#### Non-Freeze Wall Hydrant

- *Chrome face*
- *Integral vacuum breaker*
- *3/4" Hose connection, 3/4" x 1" male pipe connection*
- *All bronze head, seat casing and internal working parts*
- *Bronze wall casing & loose key*



Part #	Mfg #	Wall Thickness	Price
062532	HY-420-12	12"	

**Wall Hydrants**

**Sillcocks**

**T-550 CPVC 1/4-Turn Frostproof Sillcock (CTS)**

- *Soft Touch Handle™*
- *Brass cap*
- *Anti-siphon and automatic*
- *Integrated CPVC connection*
- *Fits 1/2" CTS CPVC tubing without adapter*



Part #	Mfg #	Size	Price
083590	108-153	1/2" x 8"	
083591	108-154	1/2" x 10"	
083592	108-155	1/2" x 12"	
083593	108-156	1/2" x 14"	



## Wall Hydrants

### Wall Hydrants

#### Freezeless Wall Hydrant



Part #	Mfg #	Size	Price
191488	C-134D08	1/2" MIP x 1/2" Swt x 8"	
191489	C-134D10	1/2" MIP x 1/2" Swt x 10"	
191490	C-134D12	1/2" MIP x 1/2" Swt x 12"	
196085	C-134W12	1/2" PEX x 1/2" PEX x 12"	

#### Freezeless Anti-Siphon Wall Hydrant



Part #	Mfg #	Size	Price
196895	C-144S10	1/2" Swt x 1/2" Swt x 10"	



## Yard Hydrants

### Yard Hydrants

#### Model SRH Sanitary Freezeless Roof Hydrant

- No drain line required
- Variable flow plunger
- 3/4" NPT fml inlet connection
- 1/2" galvanized pipe
- Maximum pressure: 100 psi
- Maximum temperature: 120° F
- Dual check backflow preventer —3/4" Hose connection
- Adjustable link provides easy and positive adjustment of the lever lock tension
- All hydrant repairs can be made from top without removing hydrant
- (-MS) Mounting system included



Part #	Mfg #	Thickness	Price
170436	SRH	Hydrant Assy w/Well Seal&Boot	
241765	SRH-MS	Complete w/ Mounting System	

#### Model Y34 & Y1 Freezeless Iowa® Yard Hydrant

- Adjustable link provides easy and positive adjustment of the lever lock tension
- Rod guide eliminates side pull on rod, reduces wear on packing, packing nut and stem
- Simple cam can be set to automatically obtain the same flow each time or lock against accidental opening
- Graphite packing for lubricity and long life
- 1-Piece variable flow plunger
- 3/8" Galvanized steel operating rod
- Tapped 1/8" NPT drain hole
- 3/4" Brass male hose nozzle
- Maximum pressure: 125 psi
- Maximum temperature: 120°F



#### 3/4" FIP Inlet

Part #	Mfg #	Bury Depth	Price
192221	Y34-2	2'	
011641	Y34-3	3'	
011642	Y34-4	4'	
011643	Y34-5	5'	
011644	Y34-6	6'	

#### 1" FIP Inlet

Part #	Mfg #	Bury Depth	Price
011639	Y1-5	5'	

### Yard Hydrants (Continued)

#### Model Y34 & Y1 Freezeless Iowa® Yard Hydrant

#### 1" FIP Inlet

Part #	Mfg #	Bury Depth	Price
011640	Y1-6	6'	

#### Model U150/U200 Freezeless Utility Yard Hydrant

- 2" FPT Inlet, 2" FPT Galv Tee Outlet (U200)
- 1-1/2" FPT Inlet, 1-1/2" Galv Tee Outlet (U150)

Part#	Mfg#	Thickness	Max Pressure
236773	U200M-3	3"	100 PSI

#### Model Y2 Automatic Draining Freezeless Yard Hydrant

- Drains when shut off even with hose attached
- Backflow protected with 50HF
- For filling field spray equipment, cleaning tools, lawn and garden, watering livestock
- Immediate water flow even in sub-zero
- Adjustable link, rod guide
- Flow finder with lock
- Graphite packing for lubricity and long life
- 1-Piece variable flow plunger
- 3/8" Galvanized steel operating rod
- 1" NPT Female inlet
- 1-1/4" Galvanized steel pipe casing
- Tapped 1/8" NPT drain hole
- 3/4" Male hose thread nozzle
- Maximum pressure: 125 psi
- Maximum temperature: 120°F



Part #	Mfg #	Bury Depth	Price
107908	Y2-5	5'	



## Yard Hydrants

### Commercial Roof Hydrants

#### Model RHY2 Freezeless Roof Hydrant

- Rod guide
- Adjustable link
- 1-Piece variable flow plunger
- Automatic drain feature
- All repairs can be made from top of unit without removing hydrant
- 1" NPT Female inlet
- 1-1/4" Galvanized pipe
- Double check valve
- Maximum pressure: 125 psi
- Maximum temperature: 120°F



Part #	Mfg #	Description	Price
108847	RHY2	Hydrant with Boot and Well Seal	
128265	RHY2MS	RHY2 and RH-MS Mounting System	

### Thermaline® Sanitary Water Connectors

#### Thermaline Freezeless Sanitary Water Connector

- Designed to provide water service to mobile homes
- Also ideal for livestock waterers
- Brass casting head with 3/4"NPT outlet



Part #	Mfg #	Bury Depth	Price
011636	THERM-4	4'	
011637	THERM-5	5'	

## Yard Hydrants

### Frost Proof Yard Hydrants

#### Standard 3/4" Anyflow Frost Proof

- 3/4" NPT Inlet in heavy casting
- 3/4" Brass hose thread outlet
- Stainless steel operating rod
- Teflon packing
- Automatic self-adjusting plunger
- 1" Galvanized stand pipe and 7/16" galvanized operating rod



Part #	Mfg #	Size & Length	Price
042251	AF7504	3/4" x 4' Bury	
006542	AF7505	3/4" x 5' Bury	

**Fire Safety**

**AQUASAFE® Looped Fire Safety Systems**

**ProPEX® LF Brass Fire Sprinkler Adapter  
(PEX x PEX x FNPT)**

- Connects residential fire sprinklers to AQUAPEX tubing
- NSF and UL Approved for combining plumbing and fire sprinkler systems



Part #	Mfg #	Description	Price
132198	WILF7707575	Adapter Tee, 3/4"x3/4"x1/2"	
134020	WILF7701010	Adapter Tee, 1"x1"x1/2"	

**Parts & Accessories**

**Fire Sprinkler Adapter Mounting Bracket**

Part #	Mfg #	Description	Price
132271	WIA7750700	3/4" and 1"	

**Fire Sprinkler Adapter Push-On Nut**

- 25/Pk

Part #	Mfg #	Description	Price
133923	WIF7000005	Adapter Push-On Nut	

## Fire Safety

### Fire Safety Fittings

#### Viega PEX Press Tee (P x P x FPT)

- Smart connect feature
- Suitable for ViegaPEX Ultra tubing Model V5009.5, V5009.1, V5009.51
- Polymer



Part #	Mfg #	Size	Price
233376	1112VPTFS	1" x 1" x 1/2"	

#### Viega PEX Press 90° Elbow (P x FPT)

- Smart connect feature
- Suitable for ViegaPEX Ultra tubing Model V5009.5, V5009.1, V5009.51
- Polymer



Part #	Mfg #	Size	Price
233375	112VPPR90FS	1" x 1/2"	

### Fire Safety Accessories

#### J-Clamp Tubing Fasteners

- For use with ViegaPEX Ultra, Viega FostaPEX, or ViegaPEX Barrier
- Plastic



Part #	Mfg #	Size	Price
233377	12VPJCLAMP	1/2"	
233379	1VPJCLAMP	1"	

## Screwdrivers & Bits

### Screwdrivers & Bits

#### 9 in 1 Multi-Tool

- Slip-resistant grip
- Thick-walled shaft
- Included:
  - Bits
  - Valve core remover
  - Square #2
  - 1/2" Hex
  - 5/16" Hex
  - 3/8" Hex
  - Phillips #1 & #2
  - 3/16" and 1/4" slotted



Part #	Mfg #	Description	Price
165766	1839053	9-in-1 Multi-Tool	

#### 3" Shaft Magnetic Nut Drivers

- Secure hold
- Color-coded for quick identification
- Slip-resistant grip
- Hollowed shaft allows for use on long bolts
- Chrome-vanadium steel construction



Part #	Mfg #	Description	Price
171359	1839059	Red, 1/4" x 3"	
171360	1839060	Yellow, 5/16" x 3"	

#### 6" Shaft Magnetic Nut Drivers

- Secure hold
- Color-coded for quick identification
- Slip-resistant grip
- Hollowed shaft allows for use on long bolts
- Chrome-vanadium steel construction



Part #	Mfg #	Description	Price
171362	1839068	Red, 1/4" x 6"	
171363	1839069	Yellow, 5/16" x 6"	
171364	1839074	Set of 2, 1/4" & 5/16"	

### Precision Screwdriver Set

- Comfortable grips
- Maximum precision
  - Rotating head allows for precise adjustments
- Quick identification with easy-to-read tips
- Pouch included for storage
- Includes:
  - #0x3" Phillips, 1/16"x2", 3/32"x3", 1/8"x4", 1/8"x6" Slotted



Part #	Mfg #	Description	Price
174627	1891089	5-Pc Set	



## Sheet Metal Tools

### Sheet Metal Tools

#### Aviation Snips

- Comfortable grip
- High-carbon steel blades with reinforce chrome silicon spring
- Color-coded handle inserts and splines



Part #	Mfg #	Description	Price
177210	1891133	Aviation Snips Left Cut	
177211	1891134	Aviation Snip Right Cut	

#### Hand Seamers

- Comfortable grip
- High-carbon steel blades with reinforced chrome silicon spring
- Quick notification with 1/4" depth marks on blades



Part #	Mfg #	Description	Price
174605	1891183	3" Offset Hand Seamer	
174604	1891185	3" Hand Seamer	

#### Folding Tools

- Built for both 3/8" (10mm) and 1" (25mm) folds
- Equipped with sight holes for proper depth alignment



Part #	Mfg #	Description	Price
174607	1891146	12" Folding Tool	
174608	1890985	18" Folding Tool	
174610	1890986	24" Folding Tool	

#### Hole Cutters

- Lightweight aluminum frame, with a milled bit
- Inch and metric scales
- Fits into any corded or cordless drill with a 1/4" or larger chuck



Part #	Mfg #	Description	Price
175060	1891191	2" to 12" Hole Cutter	

## Soldering & Brazing

### MAPP Gas & Tanks



Part #	Mfg #	Description	Price
112728	MAPPRO	14.1 oz MAPP, Throwing Gas Cylinder	

### Torches

#### Self-Igniting Hand Torch



330544 &  
330545

Part #	Mfg #	Description	Price
080597	LX331785	Self-Igniting w/Adj Swirl Flame	
080624	330545	Self-Igniting Adj Swirl Flame Replacement Assembly	
080598	330546	Self-Igniting Adj Ultra Swirl Flame	
084220	330554	Replacement Tip for LT92	
086360	330555	Replacement Tip for LT90 & LT91	

### Mobile Torch System



Part #	Mfg #	Description	Price
107079	10883	LX300PS Mobile Torch System with LP300 3/8" Tip Included	
132787	330533	LX400FB Mobile Torch System Kit	

### Self-Igniting Swirl Flame



Part #	Mfg #	Size	Price
113302	330590	1/2"	

### "B" Air Acetylene Kit

- Includes:
  - Air acetylene piston regulator with TANKTOTE handle, GAUGE GUARD and 2" gauge
  - AA Torch handle
  - AA Hose
  - TANKTOTE sleeve
  - "B" Tank key
- Tank sold separately



TANK NOT INCLUDED

Part #	Mfg #	Description	Price
089164	21839LX800B	LX800B Kit with AA800 5/16" Self-Igniting Swirl Flame Tip	

### "MC" Air Acetylene Kit

- Includes:
  - Air acetylene piston regulator with TANKTOTE handle, GAUGE GUARD and 2" gauge
  - AA Torch handle
  - AA Hose
  - TANKTOTE sleeve
  - "MC" Tank key
- Tank sold separately



TANK NOT INCLUDED

Part #	Mfg #	Description	Price
089165	21843LX800MC	LX800MC Kit with AA800 3/8" Self-Igniting Swirl Flame Tip	

## Aqua-PEX Fittings

### EP Manifolds

#### EP Branch Manifold Tee

- Features 3/4" inlet with 1/2" ProPEX® branch outlets
- Made of engineered plastic, which is proven in demanding hot-water applications



Part #	Mfg #	Size	# Outlets	Price
108571	34APPBMF312	3/4"	3	
068482	34APPBMF412	3/4"	4	
125989	34APPBMF612	3/4"	6	
126734	WIQ2277550	3/4"	7	
137844	34APPM812	3/4"	8	
075385	Q2261050	1"	6	
163870	1APPM812	1"	8	
126735	1APPM1012	1"	10	
137846	1APPM1212	1"	12	

#### EP Flow-Through Manifold

- Made of EP, suitable for hot-water applications
- 1/2" ProPEX® branch outlets
- ProPEX® tool is required
- ProPEX® Rings required, sold separately



Part #	Mfg #	Inlet x Outlet	# Outlets	Price
068480	34APPMF212	3/4" x 3/4"	2	
068481	34APPMF312	3/4" x 3/4"	3	
073319	34APPMF412	3/4" x 3/4"	4	
108574	34APPMF612FT	3/4" x 3/4"	6	
227359	1APPM412	1" x 1/2"	4	
075386	Q2241057	1" x 3/4"	4	
095903	Q2261057	1" x 3/4"	6	
223087	WIQ2241051	1" x 1"	4	

### EP Opposing-Port Multi-Port Tee

- Designed for all residential, commercial or multi-family applications
- Ideal for a zone plumbing application
- Does not require an access panel

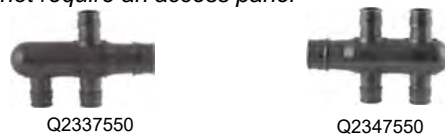

Part #	Mfg #	Size	# Outlets	Price
122571	WIQ2337550	3/4"	3	
122572	WIQ2347550	3/4"	4	

### EP Flow-Through Opposing-Port Multi-Port Tee

- Made of EP, suitable for hot-water applications
- 3/4" ProPEX® branch outlets
- ProPEX® tool required
- ProPEX® Rings required, sold separately



Part #	Mfg #	Description	Price
151153	WIQ2337557	3/4" 3	

### ProPEX® EP Fittings

#### ProPEX® EP Coupling (PEX x PEX)

- Engineer plastic coupling makes PEX to PEX connections for hePEX plus and AQUAPEX tubing
- ProPEX® tool and ProPEX® rings required (sold separately)



Part #	Mfg #	Size	Price
033959	38APPCP	3/8" x 3/8"	
033958	12APPCP	1/2" x 1/2"	
115454	1234APPCP	1/2" x 3/4"	
123915	58APPCP	5/8" x 5/8"	
033957	34APPCP	3/4" x 3/4"	
114394	341APPCP	3/4" x 1"	
033956	1APPCP	1" x 1"	
147256	11434APPCP	1-1/4" x 3/4"	
137672	1141APPCP	1-1/4" x 1"	
136963	114APPCP	1-1/4" x 1-1/4"	
136983	11234APPCP	1-1/2" x 3/4"	
130444	1121APPCP	1-1/2" x 1"	
134221	112114APPCP	1-1/2" x 1-1/4"	
134219	112APPCP	1-1/2" x 1-1/2"	
130691	2112APPCP	2" x 1-1/2"	

**Aqua-PEX Fittings**

**ProPEX® EP Fittings (Continued)**

**ProPEX® EP Coupling (PEX x PEX)**

Part #	Mfg #	Size	Price
118971	2APPCP	2" x 2"	
244678	212114APPCP	2-1/2" x 1-1/4"	
185093	212112APPCP	2-1/2" x 1-1/2"	
185094	2122APPCP	2-1/2" x 2"	
185088	212APPCP	2-1/2" x 2-1/2"	
185095	32APPCP	3" x 2"	
185096	3212APPCP	3" x 2-1/2"	
185089	3APPCP	3" x 3"	

**ProPEX® EP Elbow (PEX x PEX)**

- ProPEX® tool and ProPEX® rings required (sold separately)



Part #	Mfg #	Size	Price
033960	12APP90	1/2" x 1/2"	
033961	34APP90	3/4" x 3/4"	
033962	1APP90	1" x 1"	
110318	114APP90	1-1/4" x 1-1/4"	
099642	112APP90	1-1/2" x 1-1/2"	
118977	2APP90	2" x 2"	
185091	212APP90	2-1/2" x 2-1/2"	
185092	3APP90	3" x 3"	

**ProPEX® EP 45° Elbow (PEX x PEX)**

- Engineer plastic elbow makes PEX to PEX connections for Uponor PEX tubing supply in return mains
- ProPEX tool require, rings sold separately



Part #	Mfg #	Description	Price
161798	112APP45	1-1/2" x 1-1/2"	
163626	2APP45	2" x 2"	
222661	212APP45	2-1/2" x 2-1/2"	
185289	3APP45	3" x 3"	

**ProPEX® EP Tee (PEX x PEX x PEX)**

- ProPEX® tool and ProPEX® rings required (sold separately)



Part #	Mfg #	Size	Price
033991	12APPT	1/2" x 1/2" x 1/2"	
034000	34APPT	3/4" x 3/4" x 3/4"	
033999	1APPT	1" x 1" x 1"	
113322	114APPT	1-1/4" x 1-1/4" x 1-1/4"	
108731	112APPT	1-1/2" x 1-1/2" x 1-1/2"	
118972	2APPT	2" x 2" x 2"	
185097	212APPT	2-1/2" x 2-1/2" x 2-1/2"	
185098	3APPT	3" x 3" x 3"	

**ProPEX® EP Reducing Tee (PEX x PEX x PEX)**

- ProPEX® tool and ProPEX® rings required (sold separately)



Part #	Mfg #	Size	Price
108098	121234APPT	1/2" x 1/2" x 3/4"	
033997	341212APPT	3/4" x 1/2" x 1/2"	
033996	341234APPT	3/4" x 1/2" x 3/4"	
033998	343412APPT	3/4" x 3/4" x 1/2"	
114590	34341APPT	3/4" x 3/4" x 1"	
033994	13434APPT	1" x 3/4" x 3/4"	
033995	1341APPT	1" x 3/4" x 1"	
033993	1112APPT	1" x 1" x 1/2"	
033992	1134APPT	1" x 1" x 3/4"	
108736	114134APPT	1-1/4" x 1" x 3/4"	
110317	11411APPT	1-1/4" x 1" x 1"	
161794	11411412APPT	1-1/4" x 1-1/4" x 1/2"	
108737	11411434APPT	1-1/4" x 1-1/4" x 3/4"	
108735	1141141APPT	1-1/4" x 1-1/4" x 1"	
101210	11211APPT	1-1/2" x 1" x 1"	
161795	1121112APPT	1-1/2" x 1" x 1-1/2"	
150436	11211434APPT	1-1/2" x 1-1/4" x 3/4"	
132742	112114114APP T	1-1/2"x1-1/4"x1-1/4"	
161796	11211212APPT	1-1/2" x 1-1/2" x 1/2"	
136984	11211234APPT	1-1/2" x 1-1/2" x 3/4"	
087320	1121121APPT	1-1/2" x 1-1/2" x 1"	

## Aqua-PEX Fittings

### ProPEX® EP Fittings (Continued)

#### ProPEX® EP Reducing Tee (PEX x PEX x PEX)

Part #	Mfg #	Size	Price
108729	112112114APP T	1-1/2" x 1-1/2" x 1-1/4"	
111038	211234APPT	2" x 1-1/2" x 3/4"	
118973	21121APPT	2" x 1-1/2" x 1"	
111040	2112114APPT	2" x 1-1/2" x 1-1/4"	
171250	2112112APPT	2" x 1-1/2" x 1-1/2"	
162295	21122APPT	2" x 1-1/2" x 2"	
161797	2212APPT	2" x 2" x 1/2"	
118974	2234APPT	2" x 2" x 3/4"	
118975	221APPT	2" x 2" x 1"	
111044	22114APPT	2" x 2" x 1-1/4"	
118976	22112APPT	2" x 2" x 1-1/2"	
224174	2122112APPT	2-1/2" x 2" x 1-1/2"	
245826	21222APPT	2-1/2" x 2" x 2"	
185099	21221234APPT	2-1/2" x 2-1/2" x 3/4"	
185100	2122121APPT	2-1/2" x 2-1/2" x 1"	
244197	212212114APP T	2-1/2" x 2-1/2" x 1-1/4"	
185101	212212112APP T	2-1/2" x 2-1/2" x 1-1/2"	
185103	2122122APPT	2-1/2" x 2-1/2" x 2"	
185287	322APPT	3" x 2" x 2"	
226329	3212112APPT	3" x 2-1/2" x 1-1/2"	
185104	3334APPT	3" x 3" x 3/4"	
185288	331APPT	3" x 3" x 1"	
228646	33114APPT	3" x 3" x 1-1/4"	
185106	33112APPT	3" x 3" x 1-1/2"	
185105	332APPT	3" x 3" x 2"	
243973	33212APPT	3" x 3" x 2-1/2"	

#### ProPEX® EP Plug (PEX)

- For pressure testing and permanent plug installations
- ProPEX® tool and ProPEX® rings required (sold separately)



Part #	Mfg #	Size	Price
027963	12APPPL	1/2"	
034229	34APPPL	3/4"	
034230	1APPPL	1"	
114947	114APPPL	1-1/4"	
114948	112APPPL	1-1/2"	
154868	2APPPL	2"	

#### ProPEX® EP Swivel Faucet Adapter

- Use to connect 1/2" AQUAPEX® tubing to male NPSM faucet connections
- ProPEX® tool and ProPEX® rings required (sold separately)



Part #	Mfg #	Size	Price
044746	12APPFCTA	1/2"	

### ProPEX® Lead-Free Branch Manifolds

#### ProPEX® LF 1" Copper Valved Manifold with ProPEX® Ball Valves

- Type "L" copper features 1/2" ProPEX® outlets
- A soldered valve connection allows for simple and easy isolation of individual loops
- Sections can sweat together to extend the number of outlets using a standard 1" copper coupling
- Do not exceed accepted flow rates for 1" nominal copper
- Both 1" ends are copper pipe size and require a copper end cap, coupling or transition fitting to make the proper system connection
- ProPEX® tool and ProPEX® rings required (sold separately)



Part #	Mfg #	Outlet Size	No of Outlets	Price
049243	1APVMF412	1/2"	4	
048401	1APVMF612	1/2"	6	
048403	1APVMF812	1/2"	8	
048404	1APVMF1012	1/2"	10	
048405	1APVMF1212	1/2"	12	

#### ProPEX® LF 1" Copper Branch Manifold (PEX)

- Type "L" copper features 1/2" ProPEX® outlets
- Sections can sweat together to extend the number of outlets using a standard 1" copper coupling
- Do not exceed accepted flow rates for 1" nominal copper
- ProPEX® tool and ProPEX® rings required (sold separately)



Part #	Mfg #	Outlet Size	No of Outlets	Price
025310	1APMF412	1/2"	4	
025311	1APMF612	1/2"	6	
025312	1APMF812	1/2"	8	
027981	1APMF1012	1/2"	10	
027982	1APMF1212	1/2"	12	



**Aqua-PEX Fittings**

**ProPEX® Brass Fittings**

**ProPEX® Brass Coupling (PEX x PEX)**

- Use to make PEX to PEX connections
- Suitable with AQUAPEX® and hePEX™ plus tubing
- ProPEX® tool and ProPEX® rings required, sold separately



Part #	Mfg #	Size	Price
043563	WI58CP	5/8" x 5/8"	

**ProPEX® Brass Sweat Adapter (PEX x CU)**

- Use to transition AQUAPEX® and hePEX™ plus tubing to copper pipe
- ProPEX® tool and ProPEX® rings required, sold separately



Part #	Mfg #	Size	Price
042797	WI58PEX34SWT	5/8" x 3/4"	
104096	2APCSA	2" x 2"	

**ProPEX® Brass Fitting Adapter (PEX x CU)**

- Use to transition AQUAPEX® tubing to copper fittings
- ProPEX® tool and ProPEX® rings required (sold separately)



Part #	Mfg #	Size	Price
085652	Q4506350	5/8" x 1/2"	
042956	WI58PEX34FTG	5/8" x 3/4"	
034035	3412APCFA	3/4" x 1/2"	

**ProPEX® Brass Male Threaded Adapter (PEX x MIP)**

- Use to connect Uponor™ AQUAPEX® and hePEX™ plus tubing to male NPT threads
- ProPEX® tool and ProPEX® rings required (sold separately)



Part #	Mfg #	Size	Price
041164	341APMA	3/4" x 1"	

**ProPEX® Brass Female Threaded Adapter (PEX x FIP)**

- Use to connect Uponor™ AQUAPEX® and hePEX™ plus tubing to female NPT threads
- ProPEX® tool and ProPEX® rings required (sold separately)



Part #	Mfg #	Size	Price
041167	341APFA	3/4" x 1"	

**ProPEX® 90° Brass Elbow (PEX x PEX)**

- ProPEX® tool and ProPEX® rings required (sold separately)



Part #	Mfg #	Size	Price
107571	58AP90	5/8" x 5/8"	
024836	1AP90	1" x 1"	
104098	2AP90	2" x 2"	

**ProPEX® Brass Reducing Tee (PEX x PEX x PEX)**

- ProPEX® tool and ProPEX® rings required (sold separately)



Part #	Mfg #	Size	Price
096228	34341APFST	3/4" x 3/4" x 1"	
024839	13434APT	1" x 3/4" x 3/4"	
080819	1341APT	1" x 3/4" x 1"	

**ProPEX® Brass Ball Valve (PEX x PEX)**

Part #	Mfg #	Size	Price
248537	WIA3201010	1" x 1"	
248538	WIA3201313	1-1/4" x 1-1/4"	
248539	WIA3201515	1-1/2" x 1-1/2"	
248540	WIA3202020	2" x 2"	
248534	WIA3205050	1/2" x 1/2"	
248536	WIA3207575	3/4" x 3/4"	



## Aqua-PEX Fittings

### ProPEX® Lead-Free Brass Fittings

#### ProPEX® LF Brass 90° Elbow (PEX x PEX)



Part #	Mfg #	Size	Price
022601	34AP90	3/4" x 3/4"	

#### ProPEX® LF Brass 90° Elbow (PEX x MIP)



Part #	Mfg #	Size	Price
062421	12APM90	1/2" x 1/2" MIP	

#### ProPEX® LF Drop Ear Brass Elbow (PEX x FIP)



Part #	Mfg #	Size	Price
084295	1238APPFDE90	1/2" x 3/8"	
127137	12APPFDE90	1/2" x 1/2"	
147535	34APPFDE90	3/4" x 3/4"	
159479	1APFDE90LF	1" x 1"	

#### ProPEX® LF Brass Coupling (PEX x PEX)



Part #	Mfg #	Size	Price
024837	1APCP	1" x 1"	
022611	12APCP	1/2" x 1/2"	
026475	1234APCP	1/2" x 3/4"	
022612	34APCP	3/4" x 3/4"	
055085	134APCP	1" x 3/4"	

### ProPEX® LF Brass Tee (PEX)



Part #	Mfg #	Size	Price
029336	1APT	1" x 1" x 1"	
022613	12APT	1/2" x 1/2" x 1/2"	
022035	34APT	3/4" x 3/4" x 3/4"	

### ProPEX® LF Brass Reducing Tee (PEX)



Part #	Mfg #	Size	Price
043682	1112APT	1" x 1" x 1/2"	
024838	1134APT	1" x 1" x 3/4"	
022616	343412APT	3/4" x 3/4" x 1/2"	

### ProPEX® LF Brass Female Adapter (PEX x NPT)



Part #	Mfg #	Size	Price
022606	12APFA	1/2" x 1/2"	
034032	1234APFA	1/2" x 3/4"	
022607	34APFA	3/4" x 3/4"	
029337	1APFA	1" x 1"	
229885	114APFA	1-1/4" x 1-1/4"	
161473	112APFA	1-1/2" x 1-1/2"	
111037	2APFA	2" x 2"	

### ProPEX® LF Brass Male Adapter (PEX x NPT)



Part #	Mfg #	Size	Price
022605	12APMA	1/2" x 1/2"	
022037	1234APMA	1/2" x 3/4"	
022040	34APMA	3/4" x 3/4"	
041166	134APMA	1" x 3/4"	
029338	1APMA	1" x 1"	
084140	114APMA	1-1/4" x 1-1/4"	

**Aqua-PEX Fittings**

**ProPEX® Lead-Free Brass Fittings  
(Continued)**

**ProPEX® LF Brass Female Adapter (PEX x NPT)**

**ProPEX® LF Brass Male Adapter (PEX x NPT)**

Part #	Mfg #	Size	Price
070887	112APMA	1-1/2" x 1-1/2"	
111034	2APMA	2" x 2"	
222764	212APMA	2-1/2" x 2-1/2"	
185292	3APMA	3" x 3"	

**ProPEX® LF Brass Sweat Adapter (PEX x CU)**



Part #	Mfg #	Size	Price
022603	12APCSA	1/2" x 1/2"	
022604	1234APCSA	1/2" x 3/4"	
034031	3412APCSA	3/4" x 1/2"	
022036	34APCSA	3/4" x 3/4"	
025313	341APCSA	3/4" x 1"	
024840	1APCSA	1" x 1"	
079466	114APCSA	1-1/4" x 1-1/4"	
112506	112APCSALF	1-1/2" x 1-1/2"	
222662	212APCSA	2-1/2" x 2-1/2"	
185291	3APCSA	3" x 3"	

**ProPEX® LF Brass Fitting Adapter (PEX x CU)**



Part #	Mfg #	Size	Price
022608	12APCFA	1/2" x 1/2"	
034036	1234APCSFA	1/2" x 3/4"	
022609	34APCFA	3/4" x 3/4"	
160607	341APCFALF	3/4" x 1"	
034034	1APCFA	1" x 1"	
152504	112APCFA	1-1/2" x 1-1/2"	
111032	2APCFA	2" x 2"	

**ProPEX® LF Brass Press Fml Adapter (PEX x CU)**



Part #	Mfg #	Size	Price
239045	1APPFA	1" x 1"	
239046	114APPFA	1-1/4" x 1-1/4"	
239047	112APPFA	1-1/2" x 1-1/2"	
239048	2APPFA	2" x 2"	
239049	212APPFA	2-1/2" x 2-1/2"	
239050	3APPFA	3" x 3"	
239051	12APPFA	1/2" x 1/2"	
239052	34APPFA	3/4" x 3/4"	

**ProPEX® LF Brass Press Male Adapter (PEX x CU)**



Part #	Mfg #	Size	Price
239053	1APPA	1" x 1"	
239055	114APPA	1-1/4" x 1-1/4"	
239056	112APPA	1-1/2" x 1-1/2"	
239057	2APPA	2" x 2"	
239058	212APPA	2-1/2" x 2-1/2"	
239059	3APPA	3" x 3"	
239060	12APPA	1/2" x 1/2"	
239061	34APPA	3/4" x 3/4"	

**ProPEX® LF Brass Press to PE Couplings  
(PEX x PE)**



- ProPEX LF brass to PE couplings transition black PE tubing (per ASTM D2737) to Uponor PEX tubing
- Product does not include hose clamps for the PE side of the coupling

Part #	Mfg #	Size	Price
053642	1APPEXADPT	1"	

## Aqua-PEX Fittings

### ProPEX® LF Brass Stub Elbow (PEX x CU)



Part #	Mfg #	Conn	Leg Size(s)	Price
024514	12APCS903128	1/2"	3-1/2" x 8"	
026616	12APCS90813	1/2"	8" x 13"	

### ProPEX® LF Copper Tub Elbow (PEX x CU)



Part #	Mfg #	Size	Price
022599	12APCT90	3" x 4"	

### ProPEX® LF Copper Straight Stub (PEX x CU)



Part #	Mfg #	Size	Price
038781	12APSO8	1/2" x 1/2"	8"
032616	12APSO	1/2" x 1/2"	15"
185290	3APSO	3" x 3"	

### ProPex® Stainless Steel Fittings

#### ProPEX® Stainless Steel Male Threaded Adapter (PEX x NPT)



- 316 SS
- ProPEX® tool is required, rings sold separately

Part #	Mfg #	Description	Price
132157	12APSSMA	1/2" x 1/2"	
131351	1APSSMA	1" x 1"	

#### Compression Insert



- AQUAPEX® stainless steel inserts
- Must be used with compression straight and angle stops
- Do not substitute similar inserts

Part #	Mfg #	Size	Price
031702	14APSSI	1/4"	
024086	12APSSI	1/2"	

### ProPEX® Outlet Boxes and Accessories

#### ProPEX® Washing Machine Outlet Box

- Includes (2) 1/2" lead-free color-coded hot and cold valves
- Box can be mounted with the valves either on the top or bottom
- Snap-on cover plate accommodates up to 1" drywall



Part #	Mfg #	Description	Price
117268	12APWMBWSB	1/2" Lead-Free Brass Valve	

#### Ice Maker Box with Support Brackets (LF Brass)

- High-impact polystyrene box, frame and support brackets
- Snap-in frame includes a 1/2" lead-free brass valve with 1/4" OD compression connection



Part #	Mfg #	Description	Price
116666	12APIMBWSB	1/2" Lead-Free Brass Valve	

#### ProPEX® LF In-Line Ice Maker Tee & Valve

- In-line tee with valve, ProPEX® tool and ProPEX® rings required (sold separately)



Part #	Mfg #	Size	Price
041170	12APICEMAKER TEE	1/2"PEX x 1/2"PEX x 1/4" O.D.	
164490	12APIMVLF	1/2" PEX x 1/4" O.D.	

#### ProPEX® Brass Plugs (PEX)

- Terminates the end of PEX tubing
- Installed for temporary or permanent usage
- ProPEX® tool and ProPEX® rings required (sold separately)



Part #	Mfg #	Description	Price
045202	WI58PL	5/8"	

## Aqua-PEX Fittings

### ProPEX® Rings

- A ProPEX® ring is required to make a proper ProPEX® connection
- Red and blue print on the rings distinguishes hot and cold lines



Part #	Mfg #	Description	Price
025842	12APRBWS	1/2" Blue w/Stop	
042798	WI58PEXRING	5/8" Black	
123524	34APRBWS	3/4" Blue w/Stop	
139817	1APRWS	1" Black w/Stop	
112440	114APRWS	1-1/4" Black w/Stop	
060530	112APR	1-1/2" Black w/Stop	
111047	2APR	2" Black w/Stop	
185108	212APR	2-1/2" Black w/Stop	
185107	3APR	3" Black w/Stop	

### Installation Fittings & Tools

#### Finish Sleeve - Chrome (PEX)

- Slides over 3/8" and 1/2" AQUAPEX® connected to point-of-use valve
- Provides protection and improves appearance



Part #	Mfg #	Size	Price
031783	12APCS12	1/2"	

#### Plastic Bend Support

- Glass reinforced nylon
- Provides rigid 90° bend and sleeve for Uponor™ ProPEX™plus and AQUAPEX® tubing



Part #	Mfg #	Size	Price
036591	12APPBS	1/2"	
041393	34APPBS	3/4"	

#### Plastic Drop Ear Bend Support

- Glass reinforced nylon
- Provides rigid 90° bend and connection free stub-out from a stud wall or floor



Part #	Mfg #	Size	Price
038158	12APPDEBS	1/2"	

### Metal Straight-Thru Support

- Zinc-plated
- Provides rigid straight-thru support for 1/2" AQUAPEX® tubing as it exits a floor



Part #	Mfg #	Size	Price
031525	12APSS12	1/2"	

### Metal Drop Ear Bend Support

- Zinc-plated
- Provides rigid 90° bend and connection free stub-out for 3/8" or 1/2" PEX tubing products



Part #	Mfg #	Size	Price
022598	12APDEBS	1/2"	

### PEX Wall Support Bracket

- Provides rigid, straight-through support for AQUAPEX® tubing and copper stubs



Part #	Mfg #	Description	Price
116226	A5750500	1/2" & 3/4" PEX Support Bracket	

### PEX Rail - Plastic (PEX)

- Use to secure Uponor™ PEX tubing products to concrete floors and wood subfloors
- Tube spacing on rail is every 2"
- Suitable floor fastening hardware required (sold separately)
- Do not use PEX rails in joist heating applications



Part #	Mfg #	Size	Price
030779	12APTR65	1/2" x 6-1/2'	
019017	WITR5865	5/8" x 61-1/2'	

### ProPEX® LF Water Heater Adapter (PEX x FIP)

- Lead free



Part #	Mfg #	Description	Price
077934	WILF2957575	3/4" x 3/4" x 18"	

## Aqua-PEX Fittings

### ProPEX® Copper Tub Elbow (1/2" PEX x 1/2" CU)

- Provides a 90° transition from tub and shower valve to AQUAPEX®
- ProPEX® tool and ProPEX® rings required (sold separately)



Part #	Mfg #	Size	Price
035474	12APPSTELL	3" x 6"	

### ProPEX® Copper Stub Elbow (PEX x CU)

- Provides a 90° transition from AQUAPEX® to copper
- ProPEX® tool and ProPEX® rings required (sold separately)



Part #	Mfg #	Size	Leg Lengths	Price
048180	34APSTUBELL	3/4" x 3/4"	4" x 8"	

**Aqua-Pex Stop Valves**

**ProPEX® Stop Valves**

**ProPEX® LF Brass Stop Valve - Full Port  
(PEX x OD)**

- Used for point-of-use shut-off at the fixture
- Connect 1/2" Uponor AQUAPEX® tubing to 3/8" OD risers



Part #	Mfg #	Size	Type	Price
029671	1238APAS	1/2" x 3/8"	Angle	
029670	1238APSS	1/2" x 3/8"	Straight	

**ProPEX® LF Brass Compression Stop Valve  
(PEX x OD)**

Part #	Mfg #	Size	Type	Price
022602	1238APCA S	1/2" x 3/8"	Angle	



## Aqua-PEX Fittings

### Floor Sleeves

#### Straight Floor Sleeve

- Rigid support for flexible 1/2" CTS tubing
- Use to support tube up through sub-floor going directly to the fixture



Part #	Mfg #	Floor Support	Price
119235	550-FP2	1/2" CTS	
148303	550-FP2S	1/2" CTS w/ Tube Protector	

### PEX Brackets & Hangers

#### Sidewinder™ Metal Bend Supports

- Forms tight 90° bends in flexible CTS tube without kinking
- Nail plate models have unique open corner allowing tube to be inserted after bracket is installed and tubing end has been plugged
- Pre-drilled hole for 3/8" rebar —Allows installer to use a ground stake for flexible CTS tube
- Mount several Sidewinders™ to PowerBar™ to organize pipes underground before the pour



Part #	Mfg #	Flexible CTS/PEX Tube Size	Price
076211	550-M2	1/2"	
119234	550-MP2	1/2" With Nail Plate	
183489	550-MP3	3/4" With Nail Plate	
076212	550-M3	3/4"	

#### PEX Simple Bend Support

- 90° Bend radius
- 40% Glass-filled nylon



Part #	Mfg #	Size	Price
183490	550-PB2	1/2"	

### PowerPEX® Systems

#### PowerPEX® BranchMaster™ F1807 Valved Manifold

- 1/2" F1807 PEX ball valve branches
- 1" Female sweat x spin closed trunk
- 1" Type L copper trunk
- Branches are 2" on-center
- Valved branches are perfect for centrally located water supply manifolds



Part #	Mfg #	Branches	Inlet	Price
183790	672XV0810	8	Right Inlet	
183791	672XV0810L	8	Left Inlet	
183792	672XV1010L	10	Left Inlet	
183793	672XV1810L	18	Left Inlet	

#### PowerPEX® BranchMaster™ F1807 Male Manifold

- 1/2" F1807 PEX branches
- 1" Male sweat x spin closed trunk
- 1" Type L copper trunk can be easily converted to most any connection
- Branches are 2" on-center
- 1" Male sweat inlet is press-fitting compatible
- No lead



Part #	Mfg #	Branches	Price
183782	672X0640	6	
183789	672X1240	12	

#### PowerPEX® BranchMaster™ F1807 PEX Manifold

- 1/2" F1807 PEX branches
- 3/4" F1807 PEX x spin closed trunk
- 1" Type L copper trunk
- Branches are 2" on-center
- Great as a secondary manifold
- No lead



Part #	Mfg #	Size	Quantify	Price
183779	672X0390PK	1/2"	3	
066140	672X0490	1/2"	4	
183781	672X0490PK	1/2"	4	
128513	672X0690	1/2"	6	
183783	672X0690PK	1/2"	6	
183786	672X0790	1/2"	7	
128514	672X0890	1/2"	8	
183787	672X0990	1/2"	9	

## Aqua-PEX Fittings

### PowerPEX® Systems (Continued)

#### PowerPEX® BranchMaster™ F1807 PEX Manifold

Part #	Mfg #	Size	Quantify	Price
147130	672X1090	1/2"	10	
147139	672X1290	1/2"	12	

#### PowerPEX® BranchMaster™ F1807 Manifold

- 1/2" F1807 PEX branches
- 3/4" Male sweat x spin closed trunk
- 1" Type L copper trunk
- Branches are 2" on-center
- 3/4" Male sweat connection provides flexibility
- No lead



672X083

Part #	Mfg #	Size	Quantify	Price
068035	672X0430	1/2"	4	
076700	672X0630	1/2"	6	
076701	672X0830	1/2"	8	
076702	672X1230	1/2"	12	

#### PowerPEX® BranchMaster™ 1" Male Swt x Spin Closed Trunk

- 1" Type L copper trunk can be easily converted to most any connection
- Branches are 2" on-center
- 1" male sweat inlet is press-fitting compatible

Part #	Mfg #	Description	Price
254909	672X0440	1/2"	4
254910	672X0840	1/2"	8

#### PowerPEX® BranchMaster™ Female Swt Manifold

- 3/4" Female sweat branches
- 1-1/4" Male sweat x 1-1/4" male sw
- 1-1/4" Type L copper trunk
- Branches are 4" on-center
- Press-fitting compatible



67445L-0833

Part #	Mfg #	Size	Quantify	Price
166528	67745L-08334	3/4"	8	

#### PowerPEX® BranchMaster™ Male Sweat Manifold

- 3/4" Male sweat branches
- 1-1/2" Male sweat x 1-1/2" male sw
- 1-1/2" Type L copper trunk
- Branches are 3" on-center
- Press-fitting compatible



6796L-1233

Part #	Mfg #	Size	Quantify	Price
186421	6796L-12333	3/4"	12	

#### PowerPEX® BranchMaster™ PEX Valved Manifold

- 1/2" F1807 PEX branches
- 1" Male swt x 1" female swt trunk
- 1" Type L copper trunk
- Brazed branches
- Branches are 2" on-center (unless noted)
- No lead



Part #	Mfg #	Size	Quantify	Price
174287	672XV0442	1/2"	4	
254913	672XV0342	1/2"	3	
254914	672XV4L1131	1/2" x 3" O.C	11	

#### PowerPEX® BranchMaster™ F1960 PEX Manifolds

##### (3/4" MSwt x Spin Closed Tr

- 1/2" F1960 PEX ball valve branches
- 1" Type L copper trunk
- Branches are 2" on-center



672WV063

Part #	Mfg #	Size	Quantity	Price
178244	672WV0430	1/2"	4	
178245	672WV0630	1/2"	6	
178246	672WV0830	1/2"	8	

#### PowerPEX® BranchMaster™ F1960 PEX Manifolds

##### (1" MSwt x 1" MSwt Trunks)

- 1/2" F1960 ball valve branches
- Branches are 1-1/2" on-center
- 1" Type L copper trunk

Part #	Mfg #	Size	Quantity	Price
222275	672WV0644	1/2"	6	
243330	672WV1444	1/2"	14	

## Aqua-PEX Fittings

### PowerPex® No Lead Brass Ball Valve

- Chrome-plated ball, blowout-proof stem



Part #	Mfg #	Size	Price
225349	648WG2FP	1/2"	
225340	648WG3FP	3/4"	
225339	648WG6FP	1-1/2"	
225338	648WG7FP	2"	
189973	648WG2FPPK 1	1/2"	
189974	648WG3FPPK 1	3/4"	
189975	648WG4FPPK 1	1"	

### PowerPEX® Lead Free Brass Elbow

- Full flow—no restriction
- One-piece no lead brass



Part #	Mfg #	F1960 PEX x F1960 PEX	Price
160778	642WG2	1/2" x 1/2"	

### PowerPEX® Lead Free Brass Straight Adapters

- FIP x PEX
- One-piece no lead brass



Part #	Mfg #	FIP x F1960 PEX	Price
187548	647WG2	1/2" x 1/2"	
187547	647WG3	3/4" x 3/4"	
183763	647WG4	1" x 1"	

## Black Steel Fittings

### Threaded Black Malleable Iron Fittings

#### 150# Black MI Hex Bushing



Mfg #	Size	Price
1418BBU	1/4" x 1/8"	
3818BBU	3/8" x 1/8"	
3814BBU	3/8" x 1/4"	
1218BBU	1/2" x 1/8"	
1214BBU	1/2" x 1/4"	
1238BBU	1/2" x 3/8"	
3418BBU	3/4" x 1/8"	
3414BBU	3/4" x 1/4"	
3438BBU	3/4" x 3/8"	
3412BBU	3/4" x 1/2"	
118BBU	1" x 1/8"	
114BBU	1" x 1/4"	
138BBU	1" x 3/8"	
112BBU	1" x 1/2"	
134BBU	1" x 3/4"	
11414BBU	1-1/4" x 1/4"	
11438BBU	1-1/4" x 3/8"	
11412BBU	1-1/4" x 1/2"	
11434BBU	1-1/4" x 3/4"	
1141BBU	1-1/4" x 1"	
11212BBU	1-1/2" x 1/2"	
11234BBU	1-1/2" x 3/4"	
1121BBU	1-1/2" x 1"	
112114BBU	1-1/2" x 1-1/4"	
212BBU	2" x 1/2"	
234BBU	2" x 3/4"	
21BBU	2" x 1"	
2114BBU	2" x 1-1/4"	
2112BBU	2" x 1-1/2"	
21234BBU	2-1/2" x 3/4"	
2121BBU	2-1/2" x 1"	
212114BBU	2-1/2" x 1-1/4"	
212112BBU	2-1/2" x 1-1/2"	
2122BBU	2-1/2" x 2"	
312BBU	3" x 1/2"	
31BBU	3" x 1"	

### Threaded Black Malleable Iron Fittings (Continued)

#### 150# Black MI Hex Bushing

Mfg #	Size	Price
3112BBU	3" x 1-1/2"	
32BBU	3" x 2"	
3212BBU	3" x 2-1/2"	
3123BBU	3-1/2" x 3"	
4114BBU	4" x 1-1/4"	
42BBU	4" x 2"	
4212BBU	4" x 2-1/2"	
43BBU	4" x 3"	
54BBU	5" x 4"	
64BBU	6" x 4"	

#### 150# Black MI Cap



Mfg #	Size	Price
18BCA	1/8"	
14BCA	1/4"	
38BCA	3/8"	
12BCA	1/2"	
34BCA	3/4"	
1BCA	1"	
114BCA	1-1/4"	
112BCA	1-1/2"	
2BCA	2"	
212BCA	2-1/2"	
3BCA	3"	
4BCA	4"	

#### 150# Black MI Cross



Mfg #	Size	Price
14BCR	1/4"	
12BCR	1/2"	
34BCR	3/4"	
1BCR	1"	

### Threaded Black Malleable Iron Fittings (Continued)

#### 150# Black MI Cross

Mfg #	Size	Price
114BCR	1-1/4"	
112BCR	1-1/2"	
2BCR	2"	

#### 150# Black MI Half Coupling

Mfg #	Size	Price
34BHCP	3/4"	

#### 150# Black MI Coupling

Mfg #	Size	Price
38BMCP	3/8"	
12BMCP	1/2"	
34BMCP	3/4"	
1BMCP	1"	
114BMCP	1-1/4"	
112BMCP	1-1/2"	
2BMCP	2"	

### Black Steel Merchant Coupling



Mfg #	Size	Price
18BCP	1/8"	
14BCP	1/4"	
38BCP	3/8"	
12BCP	1/2"	
34BCP	3/4"	
1BCP	1"	
114BCP	1-1/4"	
112BCP	1-1/2"	
2BCP	2"	
212BCP	2-1/2"	
3BCP	3"	
4BCP	4"	
6BCP	6"	
3418BCP	3/4" x 1/8"	

**Black Steel Fittings**

**150# Black MI 45° Elbow**



Mfg #	Size	Price
18B45	1/8"	
14B45	1/4"	
38B45	3/8"	
12B45	1/2"	
34B45	3/4"	
1B45	1"	
114B45	1-1/4"	
112B45	1-1/2"	
2B45	2"	
212B45	2-1/2"	
3B45	3"	
4B45	4"	

**150# Black MI 45° Street Elbow**



Mfg #	Size	Price
18BS45	1/8"	
14BS45	1/4"	
38BS45	3/8"	
12BS45	1/2"	
34BS45	3/4"	
1BS45	1"	
114BS45	1-1/4"	
112BS45	1-1/2"	
2BS45	2"	

**150# Black MI 90° Elbow**



Mfg #	Size	Price
18B90	1/8"	
14B90	1/4"	
38B90	3/8"	
12B90	1/2"	

**Threaded Black Malleable Iron Fittings (Continued)**

**150# Black MI 90° Elbow**

Mfg #	Size	Price
34B90	3/4"	
1B90	1"	
114B90	1-1/4"	
112B90	1-1/2"	
2B90	2"	
212B90	2-1/2"	
3B90	3"	
4B90	4"	

**150# Black MI 90° Street Elbow**



Mfg #	Size	Price
18BS90	1/8"	
14BS90	1/4"	
38BS90	3/8"	
12BS90	1/2"	
34BS90	3/4"	
1BS90	1"	
114BS90	1-1/4"	
112BS90	1-1/2"	
2BS90	2"	
3BS90	3"	

**150# Black MI 90° Street Reducing Elbow**



Mfg #	Size	Price
3412BS90	3/4" x 1/2"	
1121BS90	1-1/2" x 1"	

**150# Black MI 90° Reducing Elbow**



Mfg #	Size	Price
1214B90	1/2" x 1/4"	
1238B90	1/2" x 3/8"	
3414B90	3/4" x 1/4"	
3412B90	3/4" x 1/2"	
112B90R	1" x 1/2"	
134B90	1" x 3/4"	
11412B90	1-1/4" x 1/2"	
11434B90	1-1/4" x 3/4"	
1141B90	1-1/4" x 1"	
11234B90	1-1/2" x 3/4"	
1121B90	1-1/2" x 1"	
112114B90	1-1/2" x 1-1/4"	
234B90	2" x 3/4"	
21B90	2" x 1"	
2114B90	2" x 1-1/4"	
2112B90	2" x 1-1/2"	
2122B90	2-1/2" x 2"	

**150# Black MI Reducing Coupling**



Mfg #	Size	Price
1418BCP	1/4" x 1/8"	
3818BCP	3/8" x 1/8"	
3814BCP	3/8" x 1/4"	
1218BCP	1/2" x 1/8"	
1214BCP	1/2" x 1/4"	
1238BCP	1/2" x 3/8"	
3414BCP	3/4" x 1/4"	
3438BCP	3/4" x 3/8"	
3412BCP	3/4" x 1/2"	
138BCP	1" x 3/8"	
114BCPR	1" x 1/4"	
112BCPR	1" x 1/2"	
134BCP	1" x 3/4"	



## Black Steel Fittings

### Threaded Black Malleable Iron Fittings (Continued)

#### 150# Black MI Reducing Coupling

Mfg #	Size	Price
11412BCP	1-1/4" x 1/2"	
11434BCP	1-1/4" x 3/4"	
1141BCP	1-1/4" x 1"	
11212BCP	1-1/2" x 1/2"	
11234BCP	1-1/2" x 3/4"	
1121BCP	1-1/2" x 1"	
112114BCP	1-1/2" x 1-1/4"	
212BCPR	2" x 1/2"	
234BCP	2" x 3/4"	
21BCP	2" x 1"	
2114BCP	2" x 1-1/4"	
2112BCP	2" x 1-1/2"	
212114BCP	2-1/2" x 1-1/4"	
212112BCP	2-1/2" x 1-1/2"	
2122BCP	2-1/2" x 2"	
3112BCP	3" x 1-1/2"	
32BCP	3" x 2"	
3212BCP	3" x 2-1/2"	
42BCP	4" x 2-1/2"	
43BCP	4" x 3"	

#### 150# Black MI Tee



Mfg #	Size	Price
18BT	1/8"	
14BT	1/4"	
38BT	3/8"	
12BT	1/2"	
34BT	3/4"	
1BT	1"	
114BT	1-1/4"	
112BT	1-1/2"	
2BT	2"	
212BT	2-1/2"	
3BT	3"	
4BT	4"	

### 150# Black MI Reducing Run/Outlet Tee



Mfg #	Size	Price
12121BT	1/2" x 1/2" x 1"	
341212BT	3/4" x 1/2" x 1/2"	
11212BT	1" x 1/2" x 1/2"	
11234BT	1" x 1/2" x 3/4"	
13412BT	1" x 3/4" x 1/2"	
13434BT	1" x 3/4" x 3/4"	
11112BT	1" x 1" x 1-1/2"	
1143434BT	1-1/4" x 3/4" x 3/4"	
114341BT	1-1/4" x 3/4" x 1"	
114112BT	1-1/4" x 1" x 1/2"	
114134BT	1-1/4" x 1" x 3/4"	
11411BT	1-1/4" x 1" x 1"	
11211BT	1-1/2" x 1" x 1"	
1121114BT	1-1/2" x 1" x 1-1/4"	
11211412B T	1-1/2" x 1-1/4" x 1/2"	
11211434B T	1-1/2" x 1-1/4" x 3/4"	
1121141BT	1-1/2" x 1-1/4" x 1"	
112114114B T	1-1/2" x 1-1/4" x 1-1/4"	
2114114BT	2" x 1-1/4" x 1-1/4"	
21121BT	2" x 1-1/2" x 1"	
2112114BT	2" x 1-1/2" x 1-1/4"	
2112112BT	2" x 1-1/2" x 1-1/2"	
212212114B T	2-1/2" x 2-1/2" x 1-1/4"	
2122122BT	2-1/2" x 2-1/2" x 2"	

#### 150# Black MI Reducing Run Tee



Mfg #	Size	Price
121412BT	1/2" x 1/4" x 1/2"	

### Threaded Black Malleable Iron Fittings (Continued)

#### 150# Black MI Reducing Run Tee

Mfg #	Size	Price
123812BT	1/2" x 3/8" x 1/2"	
341234BT	3/4" x 1/2" x 3/4"	
1121BT	1" x 1/2" x 1"	
1341BT	1" x 3/4" x 1"	
11434114B T	1-1/4" x 3/4" x 1-1/4"	
1141114BT	1-1/4" x 1" x 1-1/4"	
11212112B T	1-1/2" x 1/2" x 1-1/2"	
11234112B T	1-1/2" x 3/4" x 1-1/2"	
1121112BT	1-1/2" x 1" x 1-1/2"	
212BRT	2" x 1" x 2"	
21122BT	2" x 1-1/2" x 2"	
323BT	3" x 2" x 3"	

#### 150# Black MI Reducing Outlet Tee



Mfg #	Size	Price
383812BT	3/8" x 3/8" x 1/2"	
121214BT	1/2" x 1/2" x 1/4"	
121238BT	1/2" x 1/2" x 3/8"	
343414BT	3/4" x 3/4" x 1/4"	
343412BT	3/4" x 3/4" x 1/2"	
1114BT	1" x 1" x 1/4"	
1112BT	1" x 1" x 1/2"	
1134BT	1" x 1" x 3/4"	
11411412B T	1-1/4" x 1-1/4" x 1/2"	
11411434B T	1-1/4" x 1-1/4" x 3/4"	
1141141BT	1-1/4" x 1-1/4" x 1"	
11211212B T	1-1/2" x 1-1/2" x 1/2"	
11211234B T	1-1/2" x 1-1/2" x 3/4"	
1121121BT	1-1/2" x 1-1/2" x 1"	





## Black Steel Fittings

### Threaded Black Malleable Iron Fittings (Continued)

#### 150# Black MI Reducing Outlet Tee

Mfg #	Size	Price
112112114B T	1-1/2" x 1-1/2" x 1-1/4"	
2212BT	2" x 2" x 1/2"	
2234BT	2" x 2" x 3/4"	
221BT	2" x 2" x 1"	
22114BT	2" x 2" x 1-1/4"	
22112BT	2" x 2" x 1-1/2"	
21221234B T	2-1/2" x 2-1/2" x 3/4"	
332BT	3" x 3" x 2"	

#### 150# Black MI Bull Tee



Mfg #	Size	Price
121234BT	1/2" x 1/2" x 3/4"	
34341BT	3/4" x 3/4" x 1"	
11114BT	1" x 1" x 1-1/4"	

#### Black MI 150# Square Head Plug - Solid



Mfg #	Size	Price
18BPL	1/8"	
14BPL	1/4"	
38BPL	3/8"	
12BPL	1/2"	
34BPL	3/4"	
1BPL	1"	
114BPL	1-1/4"	
112BPL	1-1/2"	
2BPL	2"	
212BPL	2-1/2"	
3BPL	3"	
4BPL	4"	

#### 150# Black MI Floor Flange



Mfg #	Size	Price
12BFF	1/2"	
38BFF	3/8"	
34BFF	3/4"	
1BFF	1"	
114BFF	1-1/4"	
112BFF	1-1/2"	
2BFF	2"	

### Black Malleable Iron Unions

#### 150# Black MI All Iron Union



Mfg #	Size	Price
18BU	1/8"	
14BU	1/4"	
38BU	3/8"	
12BU	1/2"	
34BU	3/4"	
1BU	1"	
114BU	1-1/4"	
112BU	1-1/2"	
2BU	2"	
212BU	2-1/2"	
3BU	3"	
4BU	4"	

### Black Steel Nipples



#### Standard Weight Black Steel Nipples



#### 1/8" Std Wt Black Steel Nipple

Mfg #	Size	Price
18CLBN	1/8" x Close	
18112BN	1/8" x 1-1/2"	
182BN	1/8" x 2"	
18212BN	1/8" x 2-1/2"	
183BN	1/8" x 3"	
18312BN	1/8" x 3-1/2"	
184BN	1/8" x 4"	
18412BN	1/8" x 4-1/2"	
185BN	1/8" x 5"	
18512BN	1/8" x 5-1/2"	
186BN	1/8" x 6"	

#### 1/4" Std Wt Black Steel Nipple

Mfg #	Size	Price
14CLBN	1/4" x Close	
14112BN	1/4" x 1-1/2"	
142BN	1/4" x 2"	
14212BN	1/4" x 2-1/2"	
143BN	1/4" x 3"	
14312BN	1/4" x 3-1/2"	
144BN	1/4" x 4"	
14412BN	1/4" x 4-1/2"	
145BN	1/4" x 5"	
14512BN	1/4" x 5-1/2"	
146BN	1/4" x 6"	
141FTBN	1/4" x 12"	

#### 3/8" Std Wt Black Steel Nipple

Mfg #	Size	Price
38CLBN	3/8" x Close	
38112BN	3/8" x 1-1/2"	



## Black Steel Fittings

### Standard Weight Black Steel Nipples (Continued)

#### 3/8" Std Wt Black Steel Nipple

Mfg #	Size	Price
382BN	3/8" x 2"	
38212BN	3/8" x 2-1/2"	
383BN	3/8" x 3"	
38312BN	3/8" x 3-1/2"	
384BN	3/8" x 4"	
38412BN	3/8" x 4-1/2"	
385BN	3/8" x 5"	
38512BN	3/8" x 5-1/2"	
386BN	3/8" x 6"	

#### 1/2" Std Wt Black Steel Nipple

Mfg #	Size	Price
12CLBN	1/2" x Close	
12112BN	1/2" x 1-1/2"	
122BN	1/2" x 2"	
12212BN	1/2" x 2-1/2"	
123BN	1/2" x 3"	
12312BN	1/2" x 3-1/2"	
124BN	1/2" x 4"	
12412BN	1/2" x 4-1/2"	
125BN	1/2" x 5"	
12512BN	1/2" x 5-1/2"	
126BN	1/2" x 6"	
12612BN	1/2" x 6-1/2"	
127BN	1/2" x 7"	
12712BN	1/2" x 7-1/2"	
128BN	1/2" x 8"	
12812BN	1/2" x 8-1/2"	
129BN	1/2" x 9"	
1210BN	1/2" x 10"	
121012BN	1/2" x 10-1/2"	
1211BN	1/2" x 11"	
121FTBN	1/2" x 12"	
1214BN	1/2" x 14"	
1216BN	1/2" x 16"	
1218BN	1/2" x 18"	
1224BN	1/2" x 24"	
1230BN	1/2" x 30"	
1236BN	1/2" x 36"	

### Standard Weight Black Steel Nipples (Continued)

#### 1/2" Std Wt Black Steel Nipple

Mfg #	Size	Price
1248BN	1/2" x 48"	
1260BN	1/2" x 60"	

#### 3/4" Std Wt Black Steel Nipple

Mfg #	Size	Price
34CLBN	3/4" x Close	
34112BN	3/4" x 1-1/2"	
342BN	3/4" x 2"	
34212BN	3/4" x 2-1/2"	
343BN	3/4" x 3"	
34312BN	3/4" x 3-1/2"	
344BN	3/4" x 4"	
34412BN	3/4" x 4-1/2"	
345BN	3/4" x 5"	
34512BN	3/4" x 5-1/2"	
346BN	3/4" x 6"	
347BN	3/4" x 7"	
348BN	3/4" x 8"	
349BN	3/4" x 9"	
3410BN	3/4" x 10"	
3411BN	3/4" x 11"	
341FTBN	3/4" x 12"	
3418BN	3/4" x 18"	
3424BN	3/4" x 24"	
3430BN	3/4" x 30"	
3436BN	3/4" x 36"	
3448BN	3/4" x 48"	
3460BN	3/4" x 60"	

#### 1" Std Wt Black Steel Nipple

Mfg #	Size	Price
1CLBN	1" x Close	
12BN	1" x 2"	
1212BN	1" x 2-1/2"	
13BN	1" x 3"	
1312BN	1" x 3-1/2"	
14BN	1" x 4"	
1412BN	1" x 4-1/2"	
15BN	1" x 5"	

### Standard Weight Black Steel Nipples (Continued)

#### 1" Std Wt Black Steel Nipple

Mfg #	Size	Price
1512BN	1" x 5-1/2"	
16BN	1" x 6"	
17BN	1" x 7"	
18BN	1" x 8"	
19BN	1" x 9"	
110BN	1" x 10"	
111BN	1" x 11"	
11FTBN	1" x 12"	
118BN	1" x 18"	
12FTBN	1" x 24"	
130BN	1" x 30"	
136BN	1" x 36"	
14FTBN	1" x 48"	
160BN	1" x 60"	

#### 1-1/4" Std Wt Black Steel Nipple

Mfg #	Size	Price
114CLBN	1-1/4" x Close	
1142BN	1-1/4" x 2"	
114212BN	1-1/4" x 2-1/2"	
1143BN	1-1/4" x 3"	
114312BN	1-1/4" x 3-1/2"	
1144BN	1-1/4" x 4"	
114412BN	1-1/4" x 4-1/2"	
1145BN	1-1/4" x 5"	
114512BN	1-1/4" x 5-1/2"	
1146BN	1-1/4" x 6"	
1148BN	1-1/4" x 8"	
11410BN	1-1/4" x 10"	
1141FTBN	1-1/4" x 12"	

#### 1-1/2" Std Wt Black Steel Nipple

Mfg #	Size	Price
112CLBN	1-1/2" x Close	
1122BN	1-1/2" x 2"	
112212BN	1-1/2" x 2-1/2"	
1123BN	1-1/2" x 3"	



**Black Steel Fittings**

**Standard Weight Black  
Steel Nipples (Continued)**

**1-1/2" Std Wt Black Steel  
Nipple**

Mfg #	Size	Price
112312BN	1-1/2" x 3-1/2"	
1124BN	1-1/2" x 4"	
112412BN	1-1/2" x 4-1/2"	
1125BN	1-1/2" x 5"	
112512BN	1-1/2" x 5-1/2"	
1126BN	1-1/2" x 6"	
1127BN	1-1/2" x 7"	
1128BN	1-1/2" x 8"	
11210BN	1-1/2" x 10"	
1121FTBN	1-1/2" x 12"	

**2" Std Wt Black Steel Nipple**

Mfg #	Size	Price
2CLBN	2" x Close	
2212BN	2" x 2-1/2"	
23BN	2" x 3"	
2312BN	2" x 3-1/2"	
24BN	2" x 4"	
2412BN	2" x 4-1/2"	
25BN	2" x 5"	
2512BN	2" x 5-1/2"	
26BN	2" x 6"	
27BN	2" x 7"	
28BN	2" x 8"	
29BN	2" x 9"	
210BN	2" x 10"	
21FTBN	2" x 12"	

**2-1/2" Std Wt Black Steel  
Nipple**

Mfg #	Size	Price
212CLBN	2-1/2" x Close	
2123BN	2-1/2" x 3"	
212312BN	2-1/2" x 3-1/2"	
2124BN	2-1/2" x 4"	
212412BN	2-1/2" x 4-1/2"	
2125BN	2-1/2" x 5"	
212512BN	2-1/2" x 5-1/2"	

**Standard Weight Black  
Steel Nipples (Continued)**

**2-1/2" Std Wt Black Steel  
Nipple**

Mfg #	Size	Price
2126BN	2-1/2" x 6"	
2127BN	2-1/2" x 7"	
2128BN	2-1/2" x 8"	
21210BN	2-1/2" x 10"	
2121FTBN	2-1/2" x 12"	

**3" Std Wt Black Steel Nipple**

Mfg #	Size	Price
3CLBN	3" x Close	
33BN	3" x 3"	
3312BN	3" x 3-1/2"	
34BN	3" x 4"	
3412BN	3" x 4-1/2"	
35BN	3" x 5"	
3512BN	3" x 5-1/2"	
36BN	3" x 6"	
37BN	3" x 7"	
38BN	3" x 8"	
310BN	3" x 10"	
31FTBN	3" x 12"	

**4" Std Wt Black Steel Nipple**

Mfg #	Size	Price
4CLBN	4" x Close	
4312BN	4" x 3-1/2"	
44BN	4" x 4"	
4412BN	4" x 4-1/2"	
45BN	4" x 5"	
4512BN	4" x 5-1/2"	
46BN	4" x 6"	
47BN	4" x 7"	
48BN	4" x 8"	
410BN	4" x 10"	
41FTBN	4" x 12"	

**Black Steel Nipple Sets**

**25 Pack Black Steel Nipple  
Assortment**

Mfg #	Size	Price
12BN25PAC	1/2"	
34BN25PAC	3/4"	

**54 Pack Black Steel Nipple  
Assortment**

Mfg #	Size	Price
2BN54PAC	2" Special-6	

**60 Pack Black Steel Nipple  
Assortment**

Mfg #	Size	Price
1BN60PAC	1"	
114BN60PAC	1-1/4"	

**66 Pack Black Steel Nipple  
Assortment**

Mfg #	Size	Price
12BN66PAC	1/2"	
34BN66PAC	3/4"	



**Xtra-Heavy Black Malleable Fit**

**300# Black MI XH 90° Elbow**

Part #	Mfg #	Size
013057	12XH90	1/2"
014636	34XH90	3/4"
012195	1XH90	1"
027550	114XH90	1-1/4"
012394	112XH90	1-1/2"
013765	2XH90	2"
099660	3412XH90	3/4" x 1/2"



**Black Steel Nipples**



**Extra-Heavy Black Steel Fittings**

**300# Black MI XH Coupling**



Part #	Mfg #	Size	Price
013054	12XHCP	1/2"	
014633	34XHCP	3/4"	
012752	114XHCP	1-1/4"	
012192	1XHCP	1"	
012391	112XHCP	1-1/2"	
013763	2XHCP	2"	

**300# Black MI XH Tee**



Part #	Mfg #	Size	Price
013055	12XHT	1/2"	
014635	34XHT	3/4"	
012193	1XHT	1"	

**Xtra-Heavy Black Malleable Unions**

**300# Black MI XH Ground Joint Union**



Part #	Mfg #	Size	Price
013056	12XHU	1/2"	
014631	34XHU	3/4"	
012194	1XHU	1"	
012772	114XHU	1-1/4"	
012393	112XHU	1-1/2"	
013764	2XHU	2"	

**Black Steel Nipples**



**Xtra-Heavy Sch 80 Black Steel Nipples**



**1/8" XH Sch 80 Black Steel Nipple**

Part #	Mfg #	Size	Price
032493	18CLXHN	1/8" x Close	
034052	18112XHN	1/8" x 1-1/2"	
175258	182XHN	1/8" x 2"	
175259	18212XHN	1/8" x 2-1/2"	
175260	183XHN	1/8" x 3"	
175261	18312XHN	1/8" x 3-1/2"	
175262	184XHN	1/8" x 4"	
175263	18412XHN	1/8" x 4-1/2"	
175264	185XHN	1/8" x 5"	
013718	18512XHN	1/8" x 5-1/2"	
013722	186XHN	1/8" x 6"	

**1/4" XH Sch 80 Black Steel Nipple**

Part #	Mfg #	Size	Price
013486	14CLXHN	1/4" x Close	
013546	14112XHN	1/4" x 1-1/2"	
013580	142XHN	1/4" x 2"	
013584	14212XHN	1/4" x 2-1/2"	
013589	143XHN	1/4" x 3"	
013592	14312XHN	1/4" x 3-1/2"	
034053	144XHN	1/4" x 4"	
013604	14412XHN	1/4" x 4-1/2"	
013608	145XHN	1/4" x 5"	
175265	14512XHN	1/4" x 5-1/2"	
013617	146XHN	1/4" x 6"	

**3/8" XH Sch 80 Black Steel Nipple**

Part #	Mfg #	Size	Price
015062	38CLXHN	3/8" x Close	
017022	38112XHN	3/8" x 1-1/2"	
031014	382XHN	3/8" x 2"	
015118	38212XHN	3/8" x 2-1/2"	



**Extra-Heavy Black Steel Fittings**

**Xtra-Heavy Sch 80 Black Steel Nipples  
(Continued)**

**3/8" XH Sch 80 Black Steel Nipple**

Part #	Mfg #	Size	Price
028995	383XHN	3/8" x 3"	
027578	38312XHN	3/8" x 3-1/2"	
015151	384XHN	3/8" x 4"	
175266	38412XHN	3/8" x 4-1/2"	
015160	385XHN	3/8" x 5"	
028996	38512XHN	3/8" x 5-1/2"	
080370	386XHN	3/8" x 6"	

**1/2" XH Sch 80 Black Steel Nipple**

Part #	Mfg #	Size	Price
013087	12CLXHN	1/2" x Close	
013232	12112XHN	1/2" x 1-1/2"	
013295	122XHN	1/2" x 2"	
013300	12212XHN	1/2" x 2-1/2"	
013308	123XHN	1/2" x 3"	
013314	12312XHN	1/2" x 3-1/2"	
013365	124XHN	1/2" x 4"	
013370	12412XHN	1/2" x 4-1/2"	
013376	125XHN	1/2" x 5"	
013381	12512XHN	1/2" x 5-1/2"	
013386	126XHN	1/2" x 6"	

**3/4" XH Sch 80 Black Steel Nipple**

Part #	Mfg #	Size	Price
014662	34CLXHN	3/4" x Close	
014797	34112XHN	3/4" x 1-1/2"	
014864	342XHN	3/4" x 2"	
014869	34212XHN	3/4" x 2-1/2"	
014877	343XHN	3/4" x 3"	
014881	34312XHN	3/4" x 3-1/2"	
014918	344XHN	3/4" x 4"	
014923	34412XHN	3/4" x 4-1/2"	
014928	345XHN	3/4" x 5"	
014932	34512XHN	3/4" x 5-1/2"	
014940	346XHN	3/4" x 6"	
182023	34612XHBN	3/4" x 6-1/2"	

**1" XH Sch 80 Black Steel Nipple**

Part #	Mfg #	Size	Price
012214	1CLXHN	1" x Close	
013216	12XHN	1" x 2"	
013246	1212XHN	1" x 2-1/2"	
013400	13XHN	1" x 3"	
013404	1312XHN	1" x 3-1/2"	
013541	14XHN	1" x 4"	
013556	1412XHN	1" x 4-1/2"	
013622	15XHN	1" x 5"	
013628	1512XHN	1" x 5-1/2"	
013640	16XHN	1" x 6"	

**1-1/4" XH Sch 80 Black Steel Nipple**

Part #	Mfg #	Size	Price
012804	114CLXHN	1-1/4" x Close	
012957	1142XHN	1-1/4" x 2"	
012961	114212XHN	1-1/4" x 2-1/2"	
012965	1143XHN	1-1/4" x 3"	
012968	114312XHN	1-1/4" x 3-1/2"	
012995	1144XHN	1-1/4" x 4"	
020017	114412XHN	1-1/4" x 4-1/2"	
017023	1145XHN	1-1/4" x 5"	
032032	114512XHN	1-1/4" x 5-1/2"	
013008	1146XHN	1-1/4" x 6"	

**1-1/2" Black Steel XH Sch 80 Nipple**

Part #	Mfg #	Size	Price
012433	112CLXHN	1/2" x Close	
012684	1122XHN	1-1/2" x 2"	
012691	112212XHN	1-1/2" x 2-1/2"	
012695	1123XHN	1-1/2" x 3"	
012698	112312XHN	1-1/2" x 3-1/2"	
019140	1124XHN	1-1/2" x 4"	
026781	112412XHN	1-1/2" x 4-1/2"	
030137	1125XHN	1-1/2" x 5"	
012732	112512XHN	1-1/2" x 5-1/2"	
012737	1126XHN	1-1/2" x 6"	

**2" XH Sch 80 Black Steel Nipple**

Part #	Mfg #	Size	Price
013808	2CLXHN	2" x Close	
014232	2212XHN	2" x 2-1/2"	



**Extra-Heavy Black Steel Fittings**

**Extra-Heavy Black Steel Nipples  
(Continued)**

**1/4" XH Sch 80 Black Steel Nipple**

Mfg #	Size	Price	Price
0422680SN23XHN	1/4" x CL	2" x 3"	
04422680SN312XHN	1/4" x 2-1/2"	2" x 3-1/2"	
04222680SN4XHN	1/4" x 2-1/2"	2" x 4"	
0308680SN	2412XHN	1/4" x 3"	2" x 4-1/2"
02719880SN5XHN	1/4" x 3-1/2"	2" x 5"	
0326380SN	2512XHN	1/4" x 4"	2" x 5-1/2"
04422680SN6XHN	1/4" x 4-1/2"	2" x 6"	
145S80SN	1/4" x 5"		

**2-1/2" XH Sch 80 Black Steel Nipple**

Part #	Mfg #	Size	Price
159331	212CLXHN	2-1/2" x CL	
175267	2123XHN	2-1/2" x 3"	
1862680SN12512XHN		2-1/2" x 5-1/2"	4"
02142680SN126XHN		2-1/2" x 6"	
182S80SN		1/8" x 2"	

**3" XH Sch 80 Black Steel Nipple**

Part #	Mfg #	Size	Price
18312S80SN	31CLXHN	1/8" x 3-1/2"	3" x Close
184S80SN	33XHN	1/8" x 4"	3" x 3"
18412S80SN	312XHN	1/8" x 4-1/2"	3" x 3-1/2"
185S80SN	34XHN	1/8" x 5"	3" x 4"
18512S80SN	3412XHN	1/8" x 5-1/2"	3" x 4-1/2"
186S80SN	35XHN	1/8" x 6"	3" x 5"
175271	3512XHN	1/8" x 5-1/2"	
175272	36XHN	1/8" x 6"	

**3/8" XH Black Steep Nipple**

Mfg #	Size	Price
38CLS80SN	3/8" x CL	
38112S80SN	3/8" x 1-1/2"	
382S80SN	3/8" x 2"	
38212S80SN	3/8" x 2-1/2"	
383S80SN	3/8" x 3"	
38312S80SN	3/8" x 3-1/2"	
384S80SN	3/8" x 4-1/2"	
38412S80SN	3/8" x 4-1/2"	
385S80SN	3/8" x 5"	
38512S80SN	3/8" x 5-1/2"	
386S80SN	3/8" x 6"	
142S80SN	1/4" x 2"	

**Extra Heavy Black Steel Nipples**

**1/4" XH Black Steep Nipple**



## Black Steel Fittings

### 1/2" XH Black Steep Nipple

Mfg #	Size	Price
12CLS80SN	1/2" x CL	
12112S80SN	1/2" x 1-1/2"	
122S80SN	1/2" x 2"	
12212S80SN	1/2" x 2-1/2"	
123S80SN	1/2" x 3"	
12312S80SN	1/2" x 3-1/2"	
124S80SN	1/2" x 4"	
125S80SN	1/2" x 5"	
12512S80SN	1/2" x 5-1/2"	
126S80SN	1/2" x 6"	

### 3/4" XH Black Steep Nipple

Mfg #	Size	Price
34CLS80SN	3/4" x CL	
34112S80SN	3/4" x 1-1/2"	
342S80SN	3/4" x 2"	
34212S80SN	3/4" x 2-1/2"	
343S80SN	3/4" x 3"	
34312S80SN	3/4" x 3-1/2"	
344S80SN	3/4" x 4"	
34412S80SN	3/4" x 4-1/2"	
345S80SN	3/4" x 5"	
34512S80SN	3/4" x 5-1/2"	
346S80SN	3/4" x 6"	

### 1" XH Black Steep Nipple

Mfg #	Size	Price
1CLS80SN	1" x CL	
12S80SN	1" x 2"	
1212S80SN	1" x 2-1/2"	
13S80SN	1" x 3"	
1312S80SN	1" x 3-1/2"	
14S80SN	1" x 4"	
1412S80SN	1" x 4-1/2"	
15S80SN	1" x 5"	
1512S80SN	1" x 5-1/2"	
16S80SN	1" x 6"	

### 1-1/4" XH Black Steep Nipple

Mfg #	Size	Price
114CLS80SN	1-1/4" x CL	

### Extra Heavy Black Steel Nipples (Continued)

#### 1-1/4" XH Black Steep Nipple

Mfg #	Size	Price
1142S80SN	1-1/4" x 2"	
114212S80SN	1-1/4" x 2-1/2"	
1143S80SN	1-1/4" x 3"	
114312S80SN	1-1/4" x 3-1/2"	
114412S80SN	1-1/4" x 4-1/2"	
1145S80SN	1-1/4" x 5"	
114512S80SN	1-1/4" x 5-1/2"	
1146S80SN	1-1/4" x 6"	

#### 1-1/2" XH Black Steep Nipple

Mfg #	Size	Price
112CLS80SN	1-1/2" x CL	
1122S80SN	1-1/2" x 2"	
112212S80SN	1-1/2" x 2-1/2"	
1123S80SN	1-1/2" x 3"	
112312S80SN	1-1/2" x 3-1/2"	
1124S80SN	1-1/2" x 4"	
112412S80SN	1-1/2" x 4-1/2"	
1125S80SN	1-1/2" x 5"	
112512S80SN	1-1/2" x 5-1/2"	
1126S80SN	1-1/2" x 6"	

#### 2" XH Black Steep Nipple

Mfg #	Size	Price
2CLS80SN	2" x CL	
2212S80SN	2" x 2-1/2"	
23S80SN	2" x 3"	
2312S80SN	2" x 3-1/2"	
24S80SN	2" x 4"	
2412S80SN	2" x 4-1/2"	
25S80SN	2" x 5"	
2512S80SN	2" x 5-1/2"	
26S80SN	2" x 6"	

### 2-1/2" XH Black Steep Nipple

Mfg #	Size	Price
212CLS80SN	2-1/2" x CL	
2123S80SN	2-1/2" x 3"	
212312S80SN	2-1/2" x 3-1/2"	
2124S80SN	2-1/2" x 4"	
212412S80SN	2-1/2" x 4-1/2"	
2125S80SN	2-1/2" x 5"	
212512S80SN	2-1/2" x 5-1/2"	
2126S80SN	2-1/2" x 6"	

### 3" XH Black Steep Nipple

Mfg #	Size	Price
3CLS80SN	3" x CL	
33S80SN	3" x 3"	
3312S80SN	3" x 3-1/2"	
34S80SN	3" x 4"	
3412S80SN	3" x 4-1/2"	
35S80SN	3" x 5"	
3512S80SN	3" x 5-1/2"	
36S80SN	3" x 6"	

### 4" XH Black Steep Nipple

Mfg #	Size	Price
4CLS80SN	4" x CL	
44S80SN	4" x 4"	
4412S80SN	4" x 4-1/2"	
45S80SN	4" x 5"	
4512S80SN	4" x 5-1/2"	
46S80SN	4" x 6"	

## Black Steel Nipples



## Black Steel Nipples



---

---

## Black Steel Fittings

---

---

### Standard Weight Black Steel Nipples



#### 3/4" Std Wt Black Steel Nipple

Part #	Size	Price
014941	3/4" x 6-1/2"	

### Black Steel Fittings

#### 23CH Countersunk Hex Plug

- Merchant black steel



Part #	Size	Price
184193	1/8"	

## Brass Fittings

### Standard Brass Fittings

#### Brass Hex Bushing - Threaded



Part #	Mfg #	Size	Price
013566	1418BRBU	1/4" x 1/8"	
015081	3814BRBU	3/8" x 1/4"	
013285	1218BRBU	1/2" x 1/8"	
013265	1214BRBU	1/2" x 1/4"	
013328	1238BRBU	1/2" x 3/8"	
014854	3418BRBU	3/4" x 1/8"	
014846	3414BRBU	3/4" x 1/4"	
014906	3438BRBU	3/4" x 3/8"	
014803	3412BRBU	3/4" x 1/2"	
012377	112BRBU	1" x 1/2"	
013410	134BRBU	1" x 3/4"	
012934	11412BRBU	1-1/4" x 1/2"	
012971	11434BRBU	1-1/4" x 3/4"	
012659	11212BRBU	1-1/2" x 1/2"	
012701	11234BRBU	1-1/2" x 3/4"	
012561	1121BRBU	1-1/2" x 1"	
012613	112114BRBU	1-1/2" x 1-1/4"	
133706	212BRBU	2" x 1/2"	
087906	234BRBU	2" x 3/4"	
025419	21BRBU	2" x 1"	
014037	2114BRBU	2" x 1-1/4"	
013984	2112BRBU	2" x 1-1/2"	
052436	2122BRBU	2-1/2" x 2"	

#### Brass Cap - Threaded



Part #	Mfg #	Size	Price
013462	14BRCA	1/4"	
014974	38BRCA	3/8"	
013039	12BRCA	1/2"	
014616	34BRCA	3/4"	
012176	1BRCA	1"	
012760	114BRCA	1-1/4"	
012378	112BRCA	1-1/2"	
013752	2BRCA	2"	

### Brass Coupling - Threaded



Part #	Mfg #	Size	Price
013653	18BRCP	1/8"	
014975	38BRCP	3/8"	
013040	12BRCP	1/2"	
014617	34BRCP	3/4"	
012177	1BRCP	1"	
012761	114BRCP	1-1/4"	
012379	112BRCP	1-1/2"	
064494	2BRCP	2"	

### Brass Reducing Coupling - Threaded



Part #	Mfg #	Size	Price
027581	1418BRCP	1/4" x 1/8"	
015082	3814BRCP	3/8" x 1/4"	
013329	1238BRCP	1/2" x 3/8"	
036471	3438BRCP	3/4" x 3/8"	
014804	3412BRCP	3/4" x 1/2"	
013411	134BRCP	1" x 3/4"	
012884	1141BRCP	1-1/4" x 1"	
104881	1121BRCP	1-1/2" x 1"	
012614	112114BRCP	1-1/2" x 1-1/4"	
050014	2112BRCP	2" x 1-1/2"	

### Brass 45° Elbow - Threaded



Part #	Mfg #	Size	Price
013046	12BR45	1/2"	
014624	34BR45	3/4"	
012182	1BR45	1"	
012383	112BR45	1-1/2"	

## Brass Fittings

### Brass 45° Street Elbow - Threaded



Part #	Mfg #	Size	Price
026780	12BRS45	1/2"	
138393	34BRS45	3/4"	
158700	1BRS45	1"	

### Brass 90° Elbow - Threaded



Part #	Mfg #	Size	Price
013468	14BR90	1/4"	
014980	38BR90	3/8"	
013047	12BR90	1/2"	
014625	34BR90	3/4"	
012183	1BR90	1"	
012765	114BR90	1-1/4"	
012384	112BR90	1-1/2"	
013755	2BR90	2"	

### Brass 90° Reducing Elbow - Threaded

Part #	Mfg #	Size	Price
020519	1418BR90	1/4" x 1/8"	
077706	3412BR90	3/4" x 1/2"	
013413	134BR90	1" x 3/4"	

### Brass 90° Street Elbow - Threaded



Part #	Mfg #	Size	Price
013656	18BRS90	1/8"	
013466	14BRS90	1/4"	
013043	12BRS90	1/2"	
014621	34BRS90	3/4"	
012179	1BRS90	1"	

### Brass Square Head Solid Plug - Threaded



Part #	Mfg #	Size	Price
013655	18BRPL	1/8"	
013465	14BRPL	1/4"	
014976	38BRPL	3/8"	
013042	12BRPL	1/2"	
012178	1BRPL	1"	
012762	114BRPL	1-1/4"	
012380	112BRPL	1-1/2"	
013753	2BRPL	2"	

### Brass Tee - Threaded



Part #	Mfg #	Size	Price
013467	14BRT	1/4"	
014977	38BRT	3/8"	
013044	12BRT	1/2"	
014622	34BRT	3/4"	
012180	1BRT	1"	
012763	114BRT	1-1/4"	
012381	112BRT	1-1/2"	
013754	2BRT	2"	

### Brass Reducing Tee - Threaded



Part #	Mfg #	Size	Price
014898	343412BRT	3/4" x 3/4" x 1/2"	
013412	1134BRT	1" x 1" x 3/4"	

### Brass Union - Threaded



Part #	Mfg #	Size	Price
031701	14BRU	1/4"	
014978	38BRU	3/8"	
013045	12BRU	1/2"	

**Brass Fittings**

**Standard Brass Fittings (Continued)**

**Brass Union - Threaded**

Part #	Mfg #	Size	Price
014623	34BRU	3/4"	
012181	1BRU	1"	
012764	114BRU	1-1/4"	
012382	112BRU	1-1/2"	
019574	2BRU	2"	

**Lead Free GH Swivel**



Part #	Mfg #	Size	Price
162036	3412FGHFIPSWLF	3/4"FGHX1 x 1/2"FIP	
045374	34FGHFIPSWLF	3/4" FGH x 3/4" FIP	

**Red Brass Nipples**



**1/8" Red Brass Nipple**

Part #	Mfg #	Size	Price
013667	18CLBRN	1/8" x Close	
030821	18112BRN	1/8" x 1-1/2"	
013690	182BRN	1/8" x 2"	
013693	18212BRN	1/8" x 2-1/2"	
013700	183BRN	1/8" x 3"	
013721	186BRN	1/8" x 6"	

**1/4" Red Brass Nipple**

Part #	Mfg #	Size	Price
013544	14112BRN	1/4" x 1-1/2"	
013600	144BRN	1/4" x 4"	
013615	146BRN	1/4" x 6"	

**3/8" Red Brass Nipple**

Part #	Mfg #	Size	Price
014998	38CLBRN	3/8" x Close	
015065	38112BRN	3/8" x 1-1/2"	
015111	382BRN	3/8" x 2"	
015115	38212BRN	3/8" x 2-1/2"	
015120	383BRN	3/8" x 3"	

**Red Brass Nipples (Continued)**

**3/8" Red Brass Nipple**

Part #	Mfg #	Size	Price
015124	38312BRN	3/8" x 3-1/2"	
015148	384BRN	3/8" x 4"	
015153	38412BRN	3/8" x 4-1/2"	
015157	385BRN	3/8" x 5"	
015162	38512BRN	3/8" x 5-1/2"	
015168	386BRN	3/8" x 6"	

**1/2" Red Brass Nipple**

Part #	Mfg #	Size	Price
013080	12CLBRN	1/2" x Close	
013229	12112BRN	1/2" x 1-1/2"	
013292	122BRN	1/2" x 2"	
013297	12212BRN	1/2" x 2-1/2"	
013304	123BRN	1/2" x 3"	
013311	12312BRN	1/2" x 3-1/2"	
013361	124BRN	1/2" x 4"	
013367	12412BRN	1/2" x 4-1/2"	
013372	125BRN	1/2" x 5"	
013378	12512BRN	1/2" x 5-1/2"	
013383	126BRN	1/2" x 6"	

**3/4" Red Brass Nipple**

Part #	Mfg #	Size	Price
014657	34CLBRN	3/4" x Close	
014793	34112BRN	3/4" x 1-1/2"	
014861	342BRN	3/4" x 2"	
014867	34212BRN	3/4" x 2-1/2"	
014874	343BRN	3/4" x 3"	
014879	34312BRN	3/4" x 3-1/2"	
014915	344BRN	3/4" x 4"	
014920	34412BRN	3/4" x 4-1/2"	
014926	345BRN	3/4" x 5"	
014930	34512BRN	3/4" x 5-1/2"	
014937	346BRN	3/4" x 6"	
048185	348BRN	3/4" x 8"	
048184	341FTBRN	3/4" x 12"	

**1" Red Brass Nipple**

Part #	Mfg #	Size	Price
012209	1CLBRN	1" x Close	

## Brass Fittings

### Red Brass Nipples (Continued)

#### 1" Red Brass Nipple

Part #	Mfg #	Size	Price
013041	12BRN	1" x 2"	
013236	1212BRN	1" x 2-1/2"	
013397	13BRN	1" x 3"	
013402	1312BRN	1" x 3-1/2"	
013464	14BRN	1" x 4"	
013548	1412BRN	1" x 4-1/2"	
013619	15BRN	1" x 5"	
013625	1512BRN	1" x 5-1/2"	
013635	16BRN	1" x 6"	
048183	11FTBRN	1" x 12"	

#### 1-1/4" Red Brass Nipple

Part #	Mfg #	Size	Price
012799	114CLBRN	1-1/4" x Close	
012955	1142BRN	1-1/4" x 2"	
012959	114212BRN	1-1/4" x 2-1/2"	
012963	1143BRN	1-1/4" x 3"	
012993	1144BRN	1-1/4" x 4"	
012997	114412BRN	1-1/4" x 4-1/2"	
013000	1145BRN	1-1/4" x 5"	
013003	114512BRN	1-1/4" x 5-1/2"	
013006	1146BRN	1-1/4" x 6"	

#### 1-1/2" Red Brass Nipple

Part #	Mfg #	Size	Price
012428	112CLBRN	1-1/2" x Close	
012678	1122BRN	1-1/2" x 2"	
012688	112212BRN	1-1/2" x 2-1/2"	
012693	1123BRN	1-1/2" x 3"	
025894	112312BRN	1-1/2" x 3-1/2"	
012723	1124BRN	1-1/2" x 4"	
051927	112412BRN	1-1/2" x 4-1/2"	
051925	1125BRN	1-1/2" x 5"	
051924	112512BRN	1-1/2" x 5-1/2"	
012734	1126BRN	1-1/2" x 6"	

#### 2" Red Brass Nipple

Part #	Mfg #	Size	Price
013803	2CLBRN	2" x Close	
014230	2212BRN	2" x 2-1/2"	

### Red Brass Nipples (Continued)

#### 2" Red Brass Nipple

Part #	Mfg #	Size	Price
014241	23BRN	2" x 3"	
032231	2312BRN	2" x 3-1/2"	
014261	24BRN	2" x 4"	
054282	25BRN	2" x 5"	
014281	26BRN	2" x 6"	

### Brass Hex Nipples (MIP x MIP)



Part #	Mfg #	Size	Price
013654	18BRHEN	1/8"	



### Test Plugs

#### TP Series Test Plug

- Temperature and pressure probe inserts into the test plug for test readings
- Economical means of balancing heating and air conditioning systems
- Pressure gauge adapter has 0.076" dia probe of stainless steel with brass union nut



#### TP-N - Test Plug for Natural Gas and Petroleum Products

- Temperature range: -40° - 200°F

Part #	Mfg #	Model	Type/Color	Size	Price
156597	WTLFTPN	TPN	Neoprene/Blue	1/4"	
		14			
156598	WTLFTPN	TPN	Neoprene/Blue	1/2"	
		12			
157248	WTLFTPG	LFTP-GA1		1/4"	
		A1			



## Brass Fittings

### LFDPTG-1 Combination Pressure and Temperature Gauges, Bottom-

- Black enamel steel case
- Kostil polymer window
- Tin alloy welding
- 1/2" Lead Free\* Brass NPT
- Pressure gauge ASME Type "B" accuracy
- Copper alloy Bourdon pressure element
- Bimetal spiral spring temperature element



Part #	Mfg #	Model	Size	Price
156942	WTLFDPT	LFDPTG-1 G13	-	3"



### Brass Flare Fittings

#### Brass Flare Seal Cap



Part #	Mfg #	Size	Price
013505	14FLCA	1/4"	
015024	38FLCA	3/8"	
013119	12FLCA	1/2"	
015571	58FLC	5/8"	

#### Brass Flare Coupling (Fir x FIP)



Part #	Mfg #	Size	Price
013561	1414FLC	1/4" x 1/4"	
015137	3838FLC	3/8" x 3/8"	
015075	3812FLC	3/8" x 1/2"	
013345	1238FLC	1/2" x 3/8"	
013241	1212FLC	1/2" x 1/2"	
013320	1234FLC	1/2" x 3/4"	
015593	5812FLC	5/8" x 1/2"	
015601	5834FLC	5/8" x 3/4"	
014824	3412FLC	3/4" x 1/2"	

#### Brass Flare 90° Elbow (Fir x FIP)



Part #	Mfg #	Size	Price
015138	3838FLF90	3/8" x 3/8"	
015602	5834FLF90	5/8" x 3/4"	

#### Brass Flare 90° Elbow (Fir x MIP)



Part #	Mfg #	Size	Price
028993	1414FLM90	1/4" x 1/4"	
015095	3814FLM90	3/8" x 1/4"	
015140	3838FLM90	3/8" x 3/8"	
015130	3834FLM90	3/8" x 3/4"	
013244	1212FLM90	1/2" x 1/2"	
013323	1234FLM90	1/2" x 3/4"	
015596	5812FLM90	5/8" x 1/2"	
015604	5834FLM90	5/8" x 3/4"	

#### Brass Flare Short Nut



Part #	Mfg #	Size	Price
013506	14FLN	1/4"	
015026	38FLN	3/8"	
013121	12FLN	1/2"	
015573	58FLN	5/8"	
014692	34FLN	3/4"	

#### Brass Flare Short Forged Nut



Part #	Mfg #	Size	Price
013511	14FLNUTS	1/4"	
015027	38FLNUTS	3/8"	
013122	12FLNUTS	1/2"	
015574	58FLNUTS	5/8"	

## Brass Flare Fittings

### Brass Flare Fittings (Continued)

#### Brass Flare Short Forged Nut

Part #	Mfg #	Size	Price
170971	34FLNUTLF	3/4", Lead Free	

#### Brass Flare Plug



Part #	Mfg #	Size	Price
013507	14FLP	1/4"	
015028	38FLP	3/8"	
013123	12FLP	1/2"	

#### Brass Flare Swivel Connector



Part #	Mfg #	Size	Price
031005	14FLFSC	1/4"	
013120	12FLFSC	1/2"	
015572	58FLFSC	5/8"	

#### Brass Flare Tee (Flr x Flr x Flr)



Part #	Mfg #	Size	Price
013508	14FLT	1/4"	
015029	38FLT	3/8"	
013124	12FLT	1/2"	
015576	58FLT	5/8"	

#### Brass Flare Union (Flr x Flr)



Part #	Mfg #	Size	Price
013509	14FLU	1/4"	
015030	38FLU	3/8"	
013125	12FLU	1/2"	
015577	58FLU	5/8"	
014694	34FLU	3/4"	

#### Brass Flare Reducing Union (Flr x Flr)

Part #	Mfg #	Size	Price
013350	1238FLU	1/2" x 3/8"	

#### Brass Flare Half-Union (Flr x MIP)



Part #	Mfg #	Size	Price
013562	1414FLMA	1/4" x 1/4"	
013598	1438FLMA	1/4" x 3/8"	
013552	1412FLMA	1/4" x 1/2"	
015094	3814FLMA	3/8" x 1/4"	
015139	3838FLMA	3/8" x 3/8"	
015077	3812FLMA	3/8" x 1/2"	
015129	3834FLMA	3/8" x 3/4"	
013347	1238FLMA	1/2" x 3/8"	
013243	1212FLMA	1/2" x 1/2"	
013322	1234FLMA	1/2" x 3/4"	
015595	5812FLMA	5/8" x 1/2"	
015603	5834FLMA	5/8" x 3/4"	
014825	3412FLMA	3/4" x 1/2"	

#### Brass Lavatory Nut

- Temperature range: -65°F to +250°F



Part #	Mfg #	Size	Price
195131	AB902	1/2"	

### Brass Hose Fittings

#### Garden Hose Adaptor



(MHT x MIP)

Part #	Mfg #	Size	Price
122418	3412BRMHMASWT	3/4" x 1/2"	

**Brass Fittings**

**Brass Hose Fittings (Continued)**

**Garden Hose Adaptor  
(MHT x MIP)**

Part #	Mfg #	Size	Price
014809	3412BRMHMA	3/4" x 1/2"	

**(MHT x MIP)  
Tapped 1/2" FIP**

Part #	Mfg #	Size	Price
014891	343412BRMHMAFA	3/4" x 3/4"	

**(MHT x MHT)**

Part #	Mfg #	Size	Price
014885	3434BRMHMH	3/4" x 3/4"	

**(MHT x FIP)**

Part #	Mfg #	Size	Price
014808	3412BRMHFA	3/4" x 1/2"	
014884	3434BRMHFA	3/4" x 3/4"	

**(FHT x MIP)**

Part #	Mfg #	Size	Price
014807	3412BRFHMA	3/4" x 1/2"	
014883	3434BRFHMA	3/4" x 3/4"	

**(FHT x FIP)**

Part #	Mfg #	Size	Price
014806	3412BRFHFA	3/4" x 1/2"	
014882	3434BRFHFA	3/4" x 3/4"	



**No Lead Bronze Fittings**

**Hex Bushing**



Part #	Mfg #	Size	Price
012883	1141BRBU	1-1/4" x 1"	

**No Lead Bronze Fittings (Continued)**

**Hex Bushing**

Part #	Mfg #	Size	Price
015103	3818BRBU	3/8" x 1/8"	

**Bronze Square Head Plug**



Part #	Mfg #	Size	Price
014620	34BRPL	3/4"	

**Bronze Coupling**



Part #	Mfg #	Size	Price
013463	14BRCP	1/4"	

**Bronze 45° Elbow**



Part #	Mfg #	Size	Price
121486	14BR45	1/4"	

**Bronze 90° Elbow**



Part #	Mfg #	Size	Price
052595	18BR90	1/8"	

## Brass OD Compression Fittings

### Brass Compression Fittings

#### Brass Coupling (Comp x FIP)



Part #	Mfg #	Size	Price
013557	1414COMFC	1/4"	
013569	1418COMFC	1/4" x 1/8"	
015133	3838COMFC	3/8"	
015105	3818COMFC	3/8" x 1/8"	
015088	3814COMFC	3/8" x 1/4"	
015072	3812COMFC	3/8" x 1/2"	
013237	1212COMFC	1/2"	
013338	1238COMFC	1/2" x 3/8"	
034709	7834COMFC	7/8" x 3/4"	

#### Brass Connector (Comp x MIP)



Part #	Mfg #	Size	Price
013558	1414COMMC	1/4"	
013570	1418COMMC	1/4" x 1/8"	
013596	1438COMMC	1/4" x 3/8"	
013551	1412COMMC	1/4" x 1/2"	
054620	51614COMMC	5/16" x 1/4"	
015134	3838COMMC	3/8"	
015104	3818COMMC	3/8" x 1/8"	
015089	3814COMMC	3/8" x 1/4"	
015073	3812COMMC	3/8" x 1/2"	
013238	1212COMMC	1/2"	
013339	1238COMMC	1/2" x 3/8"	
015605	5838COMMC	5/8" x 3/8"	
015590	5812COMMC	5/8" x 1/2"	
015600	5834COMMC	5/8" x 3/4"	
015781	7834COMMC	7/8" x 3/4"	

#### Brass Compression Cap



Part #	Mfg #	Size	Price
022300	38COMC	3/8"	

### Brass 90° Elbow (Comp x Comp)



Part #	Mfg #	Size	Price
013560	1414COM90	1/4"	
015136	3838COM90	3/8"	
013240	1212COM90	1/2"	
015611	5858COM90	5/8"	

### Brass 90° Elbow (Comp x MIP)



Part #	Mfg #	Size	Price
013559	1414COMM90	1/4"	
013571	1418COMM90	1/4" x 1/8"	
013597	1438COMM90	1/4" x 3/8"	
015135	3838COMM90	3/8"	
015090	3814COMM90	3/8" x 1/4"	
015074	3812COMM90	3/8" x 1/2"	
013239	1212COMM90	1/2"	
013340	1238COMM90	1/2" x 3/8"	
015591	5812COMM90	5/8" x 1/2"	

### Brass Insert



Part #	Mfg #	Size ID	Hose	Price
013490	14COMI	1/4"	0.17	
015007	38COMI	3/8"	0.25	

### Brass Compression Nut



Part #	Mfg #	Size	Price
013492	14COMN	1/4"	
015008	38COMN	3/8"	
013091	12COMN	1/2"	
015563	58COMN	5/8"	
015769	78COMN	7/8"	

## Brass OD Compression Fittings

### Brass Compression Sleeve



Part #	Mfg #	Size	Price
013670	18COMSL	1/8"	
013493	14COMSL	1/4"	
015009	38COMSL	3/8"	
013092	12COMSL	1/2"	
015564	58COMSL	5/8"	

### Brass Compression Plug

Part #	Mfg #	Size	Price
026028	38COMPL	3/8"	

### Delrin Plastic Compression Sleeve



Part #	Mfg #	Size	Price
013489	14COMDSL	1/4"	
015006	38COMDSL	3/8"	

### Brass Compression Tee



Part #	Mfg #	Size	Price
013494	14COMT	1/4"	
015010	38COMT	3/8"	
013093	12COMT	1/2"	
015565	58COMT	5/8"	

### Brass Compression Union



Part #	Mfg #	Size	Price
013671	18COMU	1/8"	
013495	14COMU	1/4"	
015011	38COMU	3/8"	
015091	3814COMU	3/8" x 1/4"	
013094	12COMU	1/2"	
013341	1238COMU	1/2" x 3/8"	
015566	58COMU	5/8"	

### Brass Compression Fittings (Continued)

#### Brass Compression Union

Part #	Mfg #	Size	Price
015606	5838COMU	5/8" x 3/8"	
015592	5812COMU	5/8" x 1/2"	
014669	34COMU	3/4"	
015771	78COMU	7/8"	

#### Brass Compression Adapter



Part #	Mfg #	Size	Price
214576	750097-0604	1/4" x 3/8"	

### Brass Needle Valves

#### Brass 90° Needle Valve (Comp x MIP)

Part #	Mfg #	Size	Price
013491	14COMMAAV	1/4"	

### Brass EZ Connect Fittings

#### EZ Connect Adapter Tee (MIP x Comp)



Part #	Mfg #	Size	Price
128437	BK993015R P	3/8" x 1/4"	
129189	BK993016R P	3/8" x 3/8"	



---



---

## Brass OD Compression Fittings

---



---

### Threaded Sleeve Fittings

- 2-Piece construction - nut & body
- Use with copper, brass, aluminum & plastic tubing
- Temperature range: -65° - +250°F

#### Nut with Break-Away Sleeve

Part #	Mfg #	Size	Price
020264	18COMB N	1/8"	
013488	14COMB N	1/4"	



## Cast Iron Fittings

### Threaded Black Cast Iron Fittings

#### 125# Black CI 90° Elbow

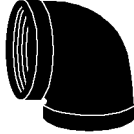

Part #	Mfg #	Size	Price
01307 7	12CI90	1/2"	
01465 5	34CI90	3/4"	
01220 7	1CI90	1"	
01279 7	114CI90	1-1/4"	
01242 6	112CI90	1-1/2"	
01380 1	2CI90	2"	
01407 7	212CI90	2-1/2"	
01434 1	3CI90	3"	

#### 125# Black CI Concentric Reducer



Part #	Mfg #	Size	Price
01481 6	3412CICR	3/4" x 1/2"	
01341 9	134CICR	1" x 3/4"	
01242 0	112CICR	1" x 1/2"	
01262 5	112114CIC R	1-1/2"x1-1/4"	
01270 5	11234CICR	1-1/2"x3/4"	
01399 1	2112CICR	2"x1-1/2"	

#### 125# Black CI Tee

Part #	Mfg #	Size	Price
01307 4	12CIT	1/2"	

### Threaded Black Cast Iron Fittings (Continued)

#### 125# Black CI Tee

Part #	Mfg #	Size	Price
01465 2	34CIT	3/4"	
01279 4	114CIT	1-1/4"	
01242 3	112CIT	1-1/2"	
01379 7	2CIT	2"	
01407 5	212CIT	2-1/2"	

#### 125# Black CI Reducing Tee

Part #	Mfg #	Size	Price
01292 4	11411412CIT	1-1/4x1-1/4x 1/2	
01260 4	11211234CIT	1-1/2x1-1/2x 3/4	

#### 125# 45° Elbow



Part #	Mfg #	Size	Price
01307 6	12CI45	1/2"	
01242 5	112CI45	1-1/2"	

#### 125# Eccentric Reducer



Part #	Mfg #	Size	Price
01481 7	3412CIER	3/4" x 1/2"	
01289 1	1141CIER	1-1/4" x 1"	
01266 2	11212CIER	1-1/2" x 1/2"	

### Threaded Black Cast Iron Fittings (Continued)

#### 125# Eccentric Reducer

Part #	Mfg #	Size	Price
01262 6	112114CIE R	1-1/2"x1-1/4"	
01399 2	2112CIER	2" x 1-1/2"	

### Flanged Black Cast Iron Fittings

#### 125# Black CI Companion Flange

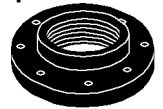

Part #	Mfg #	Size	Price
012728 F	1125CIC	1-1/2" x 5"	
014282	26CICF	2" x 6"	
014193 F	2127CIC	2-1/2" x 7"	
014960 F	3712CIC	3" x 7-1/2"	
015503	49CICF	4" x 9"	

## Chrome-Plated Fittings

### Chrome-Plated Brass Nipples



#### 3/8" Chrome-Plated Brass Nipple

Part #	Mfg #	Size	Price
014999	38CLCPN	3/8" x Close	
015066	38112CPN	3/8" x 1-1/2"	
015112	382CPN	3/8" x 2"	
015116	38212CPN	3/8" x 2-1/2"	
015121	383CPN	3/8" x 3"	
015125	38312CPN	3/8" x 3-1/2"	
015149	384CPN	3/8" x 4"	
015154	38412CPN	3/8" x 4-1/2"	
015158	385CPN	3/8" x 5"	
015163	38512CPN	3/8" x 5-1/2"	
015169	386CPN	3/8" x 6"	

#### 1/2" Chrome-Plated Brass Nipple

Part #	Mfg #	Size	Price
013230	12112CPN	1/2" x 1-1/2"	
013293	122CPN	1/2" x 2"	
013298	12212CPN	1/2" x 2-1/2"	
013305	123CPN	1/2" x 3"	
013312	12312CPN	1/2" x 3-1/2"	
013362	124CPN	1/2" x 4"	
013368	12412CPN	1/2" x 4-1/2"	
013373	125CPN	1/2" x 5"	
013379	12512CPN	1/2" x 5-1/2"	
013384	126CPN	1/2" x 6"	

### Chrome-Plated Brass Fittings

#### Chrome-Plated 125# Brass Coupling - Threaded



Part #	Mfg #	Size	Price
015012	38CPCP	3/8"	
013095	12CPCP	1/2"	

### Chrome-Plated 125# Brass 90° Elbow - Threaded



Part #	Mfg #	Size	Price
015014	38CP90	3/8"	
013108	12CP90	1/2"	

## Copper Grooved CTS Fittings

### Gruvlok® CTS Couplings for Grooved End Pipe

#### 6400 CTS Rigid Coupling



Part #	Mfg #	Size	Price
121575	GL64002	2"	
121577	GL6400212	2-1/2"	
121578	GL64003	3"	
121579	GL64004	4"	

### Grooved End Pipe CTS Fittings

#### 6050 CTS 90° Elbow



Part #	Mfg #	Size	Price
121583	GL60502	2"	
121584	GL6050212	2-1/2"	
121585	GL60503	3"	
121586	GL60504	4"	
121588	GL60506	6"	

#### 6051 CTS 45° Elbow



Part #	Mfg #	Size	Price
121595	GL60512	2"	
121596	GL6051212	2-1/2"	
121597	GL60513	3"	
121598	GL60514	4"	
121600	GL60516	6"	

### 6060 CTS Tee



Part #	Mfg #	Size	Price
121602	GL60602	2"	
121604	GL6060212	2-1/2"	
121603	GL60603	3"	
121605	GL60604	4"	
121606	GL60605	5"	
121607	GL60606	6"	

### 6061 CTS Reducing Tee (Grv x Grv x Grv)



Part #	Mfg #	Size	Price
121609	GL60612122	2-1/2" " x 2"	
121610	GL606132	3" x 2"	
121611	GL60613212	3" x 2-1/2"	
121612	GL606142	4" x 2"	
121613	GL60614212	4" x 2-1/2"	
121614	GL606143	4" x 3"	
121617	GL60616212	6" x 2-1/2"	
121618	GL606163	6" x 3"	

### 6072 CTS Concentric Reducer (Grv x Grv)



Part #	Mfg #	Size	Price
121622	GL60722122	2-1/2" " x 2"	

### Grooved End Pipe CTS Fittings (Continued)

#### 6072 CTS Concentric Reducer (Grv x Grv)

Part #	Mfg #	Size	Price
121623	GL607232	3" x 2"	
121624	GL60723212	3" x 2-1/2"	
121626	GL60724212	4" x 2-1/2"	
121627	GL607243	4" x 3"	
121631	GL607264	6" x 4"	
121633	GL607286	8" x 6"	

#### 6084 CTS Flange Adapter



Part #	Mfg #	Size	Price
124669	GL60843	3"	
121994	GL60844	4"	

## Copper Pressure Fittings

### Cast Copper Pressure Fittings

#### Female Adapter (C x FIP)

- *Leaded brass*



Part #	Mfg #	Size	Price
064111	4CFA	4"	

#### Copper Cross (C x C x C x C)

- *Lead-free brass*



Part #	Mfg #	Size	Price
013064	12CCR	1/2"	
014643	34CCR	3/4"	

#### Copper 90° Drop Ear Elbow (C x C)

- *Lead-free brass*



Part #	Mfg #	Size	Price
013067	12CCDE90	1/2"	
014645	34CCDE90	3/4"	

#### Copper 90° Drop Ear Elbow (C x FIP)

- *Lead-free brass*



Part #	Mfg #	Size	Price
013066	12CFDE90	1/2"	
014644	34CFDE90	3/4"	
005587	1CFDE90	1"	

#### Copper 90° Reducing Drop Ear Elbow (C x FIP)

- *Lead-free brass*



Part #	Mfg #	Size	Price
013331	1238CDEF90	1/2" x 3/8"	

### Cast Copper Pressure Fittings (Continued)

#### Copper 90° Reducing Drop Ear Elbow (C x FIP)

Part #	Mfg #	Size	Price
014811	3412CFDE90	3/4" x 1/2"	

#### Copper 90° Adapter Elbow (C x FIP)

- *Lead-free brass*



Part #	Mfg #	Size	Price
013071	12CF90	1/2"	
014647	34CF90	3/4"	
012202	1CF90	1"	
012414	112CF90	1-1/2"	

#### Copper 90° Reducing Adapter Elbow (C x FIP)

- *Lead-free brass*



Part #	Mfg #	Size	Price
013333	1238CF90	1/2" x 3/8"	
013416	134CF90	1" x 3/4"	
013317	1234CF90	1/2" x 3/4"	
014813	3412CF90	3/4" x 1/2"	

#### Copper 90° Elbow (C x MIP)

- *Lead-free brass*



Part #	Mfg #	Size	Price
014664	34CM90	3/4"	
013089	12CM90	1/2"	
012217	1CM90	1"	

## Copper Pressure Fittings

### Copper 90° Flanged Sink Elbow (C x FIP)

- Lead-free brass



Part #	Mfg #	Size	Price
013070	12CFLL90	1/2"	

### 125# Copper Companion Flange (C)

- Lead-free brass



Part #	Mfg #	Size	Price
166262	2CFLNL	2"	
166263	212CFLNL	2-1/2"	
166264	3CFLNL	3"	
166266	4CFLNL	4"	
166267	5CFLNL	5"	
166268	6CFLNL	6"	

### Copper Baseboard Tee (C x FIP x C)

- Lead-free brass



Part #	Mfg #	Size	Price
013290	121812CFCBB T	1/2" x 1/8" x 1/2"	
014859	341834CFCBB T	3/4" x 1/8" x 3/4"	
013021	1181CFCBBT	1" x 1/8" x 1"	

### Copper Tee (C x C x FIP)

- Lead-free brass



Part #	Mfg #	Size	Price
013247	121212CFT	1/2"	
014651	34CFT	3/4"	

### Copper Reducing Tee (C x C x FIP)

- Lead-free brass



Part #	Mfg #	Size	Price
013249	121214CFT	1/2" x 1/2" x 1/4"	
014893	343412CFT	3/4" x 3/4" x 1/2"	
013253	121234CFT	1/2" x 1/2" x 3/4"	

### Copper Drop Ear Tee (C x C x C)

- Lead-free brass



Part #	Mfg #	Size	Price
114095	12CFDETEE	1/2"	

### Copper Drop Ear Tee (C x C x FIP)

- Lead-free brass



Part #	Mfg #	Size	Price
013072	12CFDET	1/2"	

### Copper Union (C x C)

- Lead-free brass



Part #	Mfg #	Size	OD Size	Price
014352	3CU	3"		
014090	212CU	2-1/2"		

### Copper Union (C x M)

- Leaded brass



Part #	Mfg #	Size	Price
069274	12CMU	1/2"	
035531	34CMU	3/4"	

## Copper Pressure Fittings

### (Cast Copper Pressure Fittings)

#### Copper Flush Male Adapter (C x M)



Part #	Mfg #	Size	Price
024626	12CMFA	1/2"	

#### Tee (C x C x F)



Part #	Mfg #	Size	Price
013249	121214CFT	1/2" x 1/2" x 1/4"	
013253	121234CFT	1/2" x 1/2" x 3/4"	
014893	343412CFT	3/4" x 3/4" x 1/2"	

#### Union (C x F)



Part #	Mfg #	Size	Price
070566	12CFU	1/2"	
052604	34CFU	3/4"	

#### Union (C x M)



Part #	Mfg #	Size	Price
069274	12CMU	1/2"	
035531	34CMU	3/4"	

#### Union (C x C)



Part #	Mfg #	Size	Price
012818	114CU	1-1/4"	
012449	112CU	1-1/2"	

### (Cast Copper Pressure Fittings) (Continued)

#### Union (C x C)

Part #	Mfg #	Size	Price
013819	2CU	2"	
014090	212CU	2-1/2"	
014352	3CU	3"	

#### 90° Elbow (C x F)



Part #	Mfg #	Size	Price
013071	12CF90	1/2"	
014647	34CF90	3/4"	
012202	1CF90	1"	
012414	112CF90	1-1/2"	
013333	1238CF90	1/2" x 3/8"	
013317	1234CF90	1/2" x 3/4"	
014813	3412CF90	3/4"x1/2"	

#### 90° Elbow (C x M)



Part #	Mfg #	Size	Price
013089	12CM90	1/2"	
014664	34CM90	3/4"	
012217	1CM90	1"	

#### Drop Adapter (Ftg x M)



Part #	Mfg #	Size	Price
028509	212CMSA	2-1/2"	



**Copper Pressure Fittings**

**90° Drop Elbow (C x F)**



Part #	Mfg #	Size	Price
014644	34CFDE90	3/4"	
005587	1CFDE90	1"	
013331	1238CDEF90	1/2" x 3/8"	
014811	3412CFDE90	3/4" x 1/2"	

**90° Drop Elbow (C x C)**



Part #	Mfg #	Size	Price
013067	12CCDE90	1/2"	
014645	34CCDE90	3/4"	

**Special Drop Adapter (C x F)**



Part #	Mfg #	Size	Price
035678	34CFDA	3/4"	

**Drop Tee (C x C x F)**



Part #	Mfg #	Size	Price
013072	12CFDET	1/2"	

**90° Flanged Sink Elbow (C x F)**



Part #	Mfg #	Size	Price
013070	12CFFL90	1/2"	

**150# Companion Flange (C)**

• Sweat



Part #	Mfg #	Size	Price
173362	2CFL2P	2"	
173364	212CFL2P	2-1/2"	
173365	3CFL2P	3"	
173366	4CFL2P	4"	
173367	5CFL2P	5"	
173368	6CFL2P	6"	



**Cast Copper Pressure Fittings**

**Cast Copper Union  
(Sweat x Sweat)**



Part #	Mfg #	Size	Price
204580	12CCU	1/2"	
204581	34CCU	3/4"	
205690	1CCU	1"	
213494	114CCU	1-1/4"	
213495	112CCU	1-1/2"	
222472	2CCU	2"	



**Wrot Copper Pressure Fittings**

**Adapter (C x FIP)**



Part #	Nom Size	OD Size	Price
013665	1/8"	1/4" OD x 1/8"	
013481	1/4"	3/8" OD x 1/4"	
014994	3/8"	1/2" OD x 3/8"	

**Copper Pressure Fittings**

**Wrot Copper Pressure Fittings (Continued)**

**Adapter (C x FIP)**

Part #	Nom Size	OD Size	Price
013069	1/2"	5/8" OD x 1/2"	
014646	3/4"	7/8" OD x 3/4"	
012201	1"	1-1/8" OD x 1"	
012792	1-1/4"	1-3/8" OD x 1-1/4"	
012413	1-1/2"	1-5/8" OD x 1-1/2"	
013789	2"	2-1/8" OD x 2"	
014070	2-1/2"	2-5/8" OD x 2-1/2"	

**Female Reducing Adapter (C x FIP)**



Part #	Size	Price
013549	1/8" x 1/2"	1/4" OD x 1/2"
015084	3/8" x 1/4"	1/2" OD x 1/4"
015069	3/8" x 1/2"	1/2" OD x 1/2"
013267	1/2" x 1/4"	5/8" OD x 1/4"
013332	1/2" x 3/8"	5/8" OD x 3/8"
013316	1/2" x 3/4"	5/8" OD x 3/4"
014812	3/4" x 1/2"	7/8" OD x 1/2"
014783	3/4" x 1"	7/8" OD x 1"
013415	1" x 3/4"	1-1/8" OD x 3/4"
012348	1" x 1-1/4"	1-1/8" OD x 1-1/4"

**Adapter (Ftg x FIP)**



Part #	Nom Size	OD Size	Price
013073	1/2"	5/8" OD x 1/2"	
014650	3/4"	7/8" OD x 3/4"	
012813	1"	1-1/8" OD x 1"	
012808	1-1/4"	1-3/8" OD x 1-1/4"	
012418	1-1/2"	1-5/8" OD x 1-1/2"	
013792	2"	2-1/8" OD x 2"	

**Adapter (C x MIP)**



Part #	Nom Size	OD Size	Price
013487	1/4"	3/8" OD x 1/4"	
015003	3/8"	1/2" OD x 3/8"	
013088	1/2"	5/8" OD x 1/2"	
014663	3/4"	7/8" OD x 3/4"	
012215	1"	1-1/8" OD x 1"	
012805	1-1/4"	1-3/8" OD x 1-1/4"	
012434	1-1/2"	1-5/8" OD x 1-1/2"	
013809	2"	2-1/8" OD x 2"	
014081	2-1/2"	2-5/8" OD x 2-1/2"	
014345	3"	3-1/8" OD x 3"	
015221	4"	4-1/8" OD x 4"	

**Copper Male Reducing Adapter  
(C x MIP)**



Part #	Size	Price
012681	1-1/2" x 2"	
013993	2" x 1-1/2"	
015087	3/8" x 1/4"	1/2" OD x 1/4"
013550	1/4" x 1/2"	3/8" OD x 1/2"
015071	3/8" x 1/2"	1/2" OD x 1/2"
013271	1/2" x 1/4"	5/8" OD x 1/4"
123271	1/2" x 1"	5/8" OD x 1"
013336	1/2" x 3/8"	5/8" OD x 3/8"
013318	1/2" x 3/4"	5/8" OD x 3/4"
014818	3/4" x 1/2"	7/8" OD x 1/2"
014784	3/4" x 1"	7/8" OD x 1"
013421	1" x 3/4"	1-1/8" OD x 3/4"
012349	1" x 1-1/4"	1-1/8" OD x 1-1/4"
012893	1-1/4" x 1"	1-3/8" OD x 1"
012913	1-1/4" x 1-1/2"	1-3/8" OD x 1-1/2"
012628	1-1/2" x 1-1/4"	1-5/8" OD x 1-1/4"

## Copper Pressure Fittings

### Adapter (Ftg x MIP)

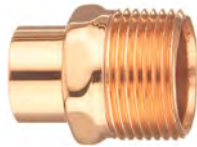

Part #	Nom Size	OD Size	Price
013090	1/2"	5/8" OD x 1/2"	
014667	3/4"	7/8" OD x 3/4"	
012216	1"	1-1/8" OD x 1"	
012806	1-1/4"		
012436	1-1/2"		
013791	2"		

### Tube Cap (C)



Part #	Nom Size	OD Size	Price
013479	1/4"	3/8" OD	
014990	3/8"	1/2" OD	
013060	1/2"	5/8" OD	
014639	3/4"	7/8" OD	
012198	1"	1-1/8" OD	
012778	1-1/4"	1-3/8" OD	
012398	1-1/2"	1-5/8" OD	
013768	2"	2-1/8" OD	
014067	2-1/2"	2-5/8" OD	
014317	3"	3-1/8" OD	
015202	4"	4-1/8" OD	

### Flush Bushing (Ftg x C)



Part #	Nom Size	OD Size	Price
015085	3/8" x 1/8"	1/2" x 1/4"	
013268	1/2" x 1/4"	5/8" x 3/8"	
013334	1/2" x 3/8"	5/8" x 1/2"	
015588	5/8" x 1/2"	3/4" x 5/8"	
014814	3/4" x 1/2"	7/8" x 5/8"	
054329	3/4" x 5/8"	7/8" x 3/4"	
012415	1" x 1/2"	1-1/8" x 5/8"	
013417	1" x 3/4"	1-1/8" x 7/8"	
012888	1-1/4" x 1"	1-3/8" x 1-1/8"	
012622	1-1/2" x 1-1/4"	1-5/8" x 1-3/8"	

### Coupling with Roll Stops (C x C)



Part #	Nom Size	OD Size	Price
013664	1/8"	1/4" OD	
014200	3/16"	5/16" OD	

### Coupling with Dimpled Stops (C x C)



Part #	Nom Size	OD Size	Price
013480	1/4"	3/8" OD	
014992	3/8"	1/2" OD	
013062	1/2"	5/8" OD	
015561	5/8"	3/4" OD	
014641	3/4"	7/8" OD	
012200	1"	1-1/8" OD	
012780	1-1/4"	1-3/8" OD	
012400	1-1/2"	1-5/8" OD	
013770	2"	2-1/8" OD	
014069	2-1/2"	2-5/8" OD	
014319	3"	3-1/8" OD	
015204	4"	4-1/8" OD	

### Flush Bushing (Ftg x FIP)



Part #	Nom Size	OD Size	Price
013287	1/2" x 1/8"	5/8" OD x 1/8"	
013269	1/2" x 1/4"	5/8" OD x 1/4"	

## Copper Pressure Fittings

### Slip Coupling (C x C)



Part #	Nom Size	OD Size	Price
013496	1/4"	3/8" OD	
013109	1/2"	5/8" OD	
014682	3/4"	7/8" OD	
012219	1"	1-1/8" OD	
012807	1-1/4"	1-3/8" OD	
012439	1-1/2"	1-5/8" OD	
013810	2"	2-1/8" OD	
014084	2-1/2"	2-5/8" OD	
014347	3"	3-1/8" OD	

### Reducing Coupling (C x C)



Part #	Nom Size	OD Size	Price
013572	1/4" x 1/8"	3/8" x 1/4"	
015106	3/8" x 1/8"	1/2" x 1/4"	
015092	3/8" x 1/4"	1/2" x 3/8"	
023351	3/8" x 5/16" OD	1/2" x 5/16"	
027548	1/2" x 1/8"	5/8" x 1/4"	
013272	1/2" x 1/4"	5/8" x 3/8"	
013343	1/2" x 3/8"	5/8" x 1/2"	
014291	5/8" x 1/2"	3/4" x 5/8"	
014909	3/4" x 3/8"	7/8" x 1/2"	
014848	3/4" x 1/4"	7/8" x 3/8"	
014822	3/4" x 1/2"	7/8" x 5/8"	
014934	3/4" x 5/8"	7/8" x 3/4"	
012437	1" x 1/2"	1-1/8" x 5/8"	
013422	1" x 3/4"	1-1/8" x 7/8"	
012938	1-1/4" x 1/2"	1-3/8" x 5/8"	
012977	1-1/4" x 3/4"	1-3/8" x 7/8"	
012894	1-1/4" x 1"	1-3/8" x 1-1/8"	
012664	1-1/2" x 1/2"	1-5/8" x 5/8"	
012707	1-1/2" x 3/4"	1-5/8" x 7/8"	
012567	1-1/2" x 1"	1-5/8" x 1-1/8"	
012629	1-1/2" x 1-1/4"	1-5/8" x 1-3/8"	
014082	2" x 1/2"	2-1/8" x 5/8"	
014253	2" x 3/4"	2-1/8" x 7/8"	
013963	2" x 1"	2-1/8" x 1-1/8"	

### Wrot Copper Pressure Fittings (Continued)

#### Reducing Coupling (C x C)

Part #	Nom Size	OD Size	Price
014041	2" x 1-1/4"	2-1/8" x 1-3/8"	
013994	2" x 1-1/2"	2-1/8" x 1-5/8"	
030948	2-1/2" x 1"	2-5/8" x 1-1/8"	
014133	2-1/2" x 1-1/2"	2-5/8" x 1-5/8"	
014152	2-1/2" x 2"	2-5/8" x 2-1/8"	
014483	3" x 1-1/2"	3-1/8" x 1-5/8"	
014521	3" x 2"	3-1/8" x 2-1/8"	
014557	3" x 2-1/2"	3-1/8" x 2-5/8"	
015387	4" x 2"	4-1/8" x 2-1/8"	
015430	4" x 3"	4-1/8" x 3-1/8"	
054576	6" x 3"	6-1/8" x 3-1/8"	

#### 45° Elbow (C x C)



Part #	Nom Size	OD Size	Price
013502	1/4"	3/8" OD	
015022	3/8"	1/2" OD	
013117	1/2"	5/8" OD	
015570	5/8"	3/4" OD	
014690	3/4"	7/8" OD	
012228	1"	1-1/8" OD	
012820	1-1/4"	1-3/8" OD	
012450	1-1/2"	1-5/8" OD	
013820	2"	2-1/8" OD	
014091	2-1/2"	2-5/8" OD	
014353	3"	3-1/8" OD	
015227	4"	4-1/8" OD	

#### 45° Elbow (Ftg x C)



Part #	Nom Size	OD Size	Price
013497	1/4"	3/8" OD	
015017	3/8"	1/2" OD	
013112	1/2"	5/8" OD	
015567	5/8"	3/4" OD	
014685	3/4"	7/8" OD	

## Copper Pressure Fittings

### Wrot Copper Pressure Fittings (Continued)

#### 45° Elbow (Ftg x C)

Part #	Nom Size	OD Size	Price
012223	1"	1-1/8" OD	
012814	1-1/4"	1-3/8" OD	
012444	1-1/2"	1-5/8" OD	
013815	2"	2-1/8" OD	
014087	2-1/2"	2-5/8" OD	
014349	3"	3-1/8" OD	
032446	4"	4-1/8" OD	

#### 90° Close Rough Elbow (C x C)



Part #	Nom Size	OD Size	Price
013672	1/8"	1/4" OD	
013503	1/4"	3/8" OD	
015023	3/8"	1/2" OD	
013118	1/2"	5/8" OD	
020819	5/8"	3/4" OD	
014691	3/4"	7/8" OD	
012229	1"	1-1/8" OD	
012821	1-1/4"	1-3/8" OD	
012451	1-1/2"	1-5/8" OD	
013821	2"	2-1/8" OD	
014092	2-1/2"	2-5/8" OD	
014354	3"	3-1/8" OD	
015228	4"	4-1/8" OD	

#### 90° Close Rough Reducing Elbow (C x C)



Part #	Nom Size	OD Size	Price
013273	1/2" x 1/4"	5/8" OD x 3/8" OD	
014823	3/4" x 1/2"	7/8" OD x 5/8" OD	
012438	1" x 1/2"	1-1/8" OD x 5/8" OD	
013423	1" x 3/4"	1-1/8" OD x 7/8" OD	
012631	1-1/2" x 1-1/4"	1-5/8" OD x 1-3/8" OD	

### 90° Close Rough Street Elbow (Ftg x C)



Part #	Nom Size	OD Size	Price
013498	1/4"	3/8" OD	
015018	3/8"	1/2" OD	
013113	1/2"	5/8" OD	
015568	5/8"	3/4" OD	
014686	3/4"	7/8" OD	
012224	1"	1-1/8" OD	
012815	1-1/4"	1-3/8" OD	
012445	1-1/2"	1-5/8" OD	
013816	2"	2-1/8" OD	
014195	2-1/2"	2-5/8" OD	
014350	3"	3-1/8" OD	
015225	4"	4-1/8" OD	

### 90° Long Radius Elbow (C x C)



Part #	Nom Size	OD Size	Price
013485	1/4"	3/8" OD	
015002	3/8"	1/2" OD	
013086	1/2"	5/8" OD	
015562	5/8"	3/4" OD	
014661	3/4"	7/8" OD	
015768	7/8"	1" OD	
012213	1"	1-1/8" OD	
012803	1-1/4"	1-3/8" OD	
012432	1-1/2"	1-5/8" OD	
013807	2"	2-1/8" OD	
026335	2-1/2"	2-5/8" OD	



## Copper Pressure Fittings

### 90° Long Radius Street Elbow (Ftg x C)



Part #	Nom Size	OD Size	Price
038358	1/4"	3/8" OD	
015001	3/8"	1/2" OD	
013085	1/2"	5/8" OD	
014290	5/8"	3/4" OD	
014660	3/4"	7/8" OD	
012212	1"	1-1/8" OD	
012802	1-1/4"	1-3/8" OD	
012431	1-1/2"	1-5/8" OD	
013806	2"	2-1/8" OD	
029652	2-1/2"	2-5/8" OD	

### Return Bend (C x C)



Part #	Size	Price
014681	3/4" x 2-1/2"	

### Fitting Reducer (Ftg x C)



Part #	Nom Size	OD Size	Price
013568	1/4" x 1/8"	3/8" x 1/4"	
015086	3/8" x 1/4"	1/2" x 3/8"	
013270	1/2" x 1/4"	5/8" x 3/8"	
013335	1/2" x 3/8"	5/8" x 1/2"	
023361	5/8" x 1/2"	3/4" x 5/8"	
014815	3/4" x 1/2"	7/8" x 5/8"	
014933	3/4" x 5/8"	7/8" x 3/4"	
012417	1" x 1/2"	1-1/8" x 5/8"	
013418	1" x 3/4"	1-1/8" x 7/8"	
012936	1-1/4" x 1/2"	1-3/8" x 5/8"	
012974	1-1/4" x 3/4"	1-3/8" x 7/8"	
012889	1-1/4" x 1"	1-3/8" x 1-1/8"	
012661	1-1/2" x 1/2"	1-5/8" x 5/8"	

### Wrot Copper Pressure Fittings (Continued)

#### Fitting Reducer (Ftg x C)

Part #	Nom Size	OD Size	Price
012704	1-1/2" x 3/4"	1-5/8" x 7/8"	
012564	1-1/2" x 1"	1-5/8" x 1-1/8"	
012623	1-1/2" x 1-1/4"	1-5/8" x 1-3/8"	
014072	2" x 1/2"	2-1/8" x 5/8"	
014250	2" x 3/4"	2-1/8" x 7/8"	
013960	2" x 1"	2-1/8" x 1-1/8"	
014040	2" x 1-1/4"	2-1/8" x 1-3/8"	
013990	2" x 1-1/2"	2-1/8" x 1-5/8"	
014142	2-1/2" x 1-1/4"	2-5/8" x 1-3/8"	
014132	2-1/2" x 1-1/2"	2-5/8" x 1-5/8"	
014150	2-1/2" x 2"	2-5/8" x 2-1/8"	
014482	3" x 1-1/2"	3-1/8" x 1-5/8"	
014520	3" x 2"	3-1/8" x 2-1/8"	
014556	3" x 2-1/2"	3-1/8" x 2-5/8"	
015385	4" x 2"	4-1/8" x 2-1/8"	
015428	4" x 3"	4-1/8" x 3-1/8"	
015465	4" x 3-1/2"	4-1/8" x 3-5/8"	

#### Tube Strap - Two-Hole



Part #	Size	Price
013500	1/4" OD	
015020	3/8" OD	
013115	1/2" OD	
014688	3/4" OD	
012226	1" OD	
012810	1-1/4" OD	
012448	1-1/2" OD	
013818	2" OD	

#### Tee (C x C x C)



Part #	Nom Size	OD Size	Price
013499	1/4"	3/8" OD	
015019	3/8"	1/2" OD	
013114	1/2"	5/8" OD	



## Copper Pressure Fittings

### Wrot Copper Pressure Fittings (Continued)

#### Tee (C x C x C)

Part #	Nom Size	OD Size	Price
015569	5/8"	3/4" OD	
014687	3/4"	7/8" OD	
012225	1"	1-1/8" OD	
012817	1-1/4"	1-3/8" OD	
012447	1-1/2"	1-5/8" OD	
014089	2-1/2"	2-5/8" OD	
014351	3"	3-1/8" OD	
015226	4"	4-1/8" OD	

#### Bullhead Tee (C x C x C)



Part #	Nom Size	OD Size	Price
015142	3/8" x 1/2"	1/2" x 5/8"	
013254	1/2" x 3/4"	5/8" x 7/8"	
014889	3/4" x 1"	7/8" x 1-1/8"	
012341	1" x 1-1/4"	1-1/8" x 1-3/8"	
012339	1" x 1-1/2"	1-1/8" x 1-5/8"	
012602	1-1/2" x 2"	1-5/8" x 2-1/8"	

#### Reducing Tee (C x C x C)

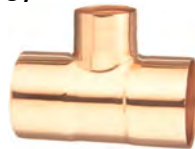

Part #	Nom Size	OD Size	Price
013358	1/2" x 3/8" x 3/8"	5/8" x 1/2" x 1/2"	
013250	1/2" x 1/4"	5/8" x 3/8"	
013257	1/2" x 3/8"	5/8" x 1/2"	
014837	3/4" x 1/2" x 1/2"	7/8" x 5/8" x 5/8"	
014841	3/4" x 1/2" x 3/4"	7/8" x 5/8" x 7/8"	
014902	3/4" x 3/8"	7/8" x 1/2"	
014895	3/4" x 1/2"	7/8" x 5/8"	
012665	1" x 1/2" x 1/2"	1-1/8" x 5/8" x 5/8"	
012708	1" x 1/2" x 3/4"	1-1/8" x 5/8" x 7/8"	
012568	1" x 1/2" x 1"	1-1/8" x 5/8" x 1-1/8"	
013438	1" x 3/4" x 1/2"	1-1/8" x 7/8" x 5/8"	
013442	1" x 3/4" x 3/4"	1-1/8" x 7/8" x 7/8"	
013434	1" x 3/4" x 1"	1-1/8" x 7/8" x 1-1/8"	

### Wrot Copper Pressure Fittings (Continued)

#### Reducing Tee (C x C x C)

Part #	Nom Size	OD Size	Price
012345	1" x 1/2"	1-1/8" x 5/8"	
012744	1" x 3/4"	1-1/8" x 7/8"	
043373	1-1/4" x 1-1/2"	1-3/8" x 1-5/8"	
014053	1-1/4" x 1/2" x 1-1/4"	1-3/8" x 5/8" x 1-3/8"	
012986	1-1/4" x 3/4" x 1/2"	1-3/8" x 7/8" x 5/8"	
012989	1-1/4" x 3/4" x 3/4"	1-3/8" x 7/8" x 7/8"	
012984	1-1/4" x 3/4" x 1"	1-3/8" x 7/8" x 1-1/8"	
020820	1-1/4" x 3/4" x 1-1/4"	1-3/8" x 7/8" x 1-3/8"	
012914	1-1/4" x 1" x 1/2"	1-3/8" x 1-1/8" x 5/8"	
012949	1-1/4" x 1" x 3/4"	1-3/8" x 1-1/8" x 7/8"	
012907	1-1/4" x 1" x 1"	1-3/8" x 1-1/8" x 1-1/8"	
012910	1-1/4" x 1" x 1-1/4"	1-3/8" x 1-1/8" x 1-3/8"	
012925	1-1/4" x 1/2"	1-3/8" x 5/8"	
012930	1-1/4" x 3/4"	1-3/8" x 7/8"	
012920	1-1/4" x 1"	1-3/8" x 1-1/8"	
012673	1-1/2" x 1/2" x 1-1/2"	1-5/8" x 5/8" x 1-5/8"	
012720	1-1/2" x 3/4" x 3/4"	1-5/8" x 7/8" x 7/8"	
012716	1-1/2" x 3/4" x 1"	1-5/8" x 7/8" x 1-1/8"	
012719	1-1/2" x 3/4" x 1-1/4"	1-5/8" x 7/8" x 1-3/8"	
012718	1-1/2" x 3/4" x 1-1/2"	1-5/8" x 7/8" x 1-5/8"	
012588	1-1/2" x 1" x 1/2"	1-5/8" x 1-1/8" x 5/8"	
012675	1-1/2" x 1" x 3/4"	1-5/8" x 1-1/8" x 7/8"	
012583	1-1/2" x 1" x 1"	1-5/8" x 1-1/8" x 1-1/8"	
012585	1-1/2" x 1" x 1-1/2"	1-5/8" x 1-1/8" x 1-5/8"	
012655	1-1/2" x 1-1/4" x 3/4"	1-5/8" x 1-3/8" x 7/8"	
012644	1-1/2" x 1-1/4" x 1"	1-5/8" x 1-3/8" x 1-1/8"	
012649	1-1/2" x 1-1/4" x 1-1/4"	1-5/8" x 1-3/8" x 1-3/8"	
026358	1-1/2" x 1-1/4" x 1-1/2"	1-5/8" x 1-3/8" x 1-5/8"	
012599	1-1/2" x 1/2"	1-5/8" x 5/8"	
012605	1-1/2" x 3/4"	1-5/8" x 7/8"	
012591	1-1/2" x 1"	1-5/8" x 1-1/8"	
012595	1-1/2" x 1-1/4"	1-5/8" x 1-3/8"	
014153	2" x 1/2" x 2"	2-1/8" x 5/8" x 2-1/8"	
014258	2" x 3/4" x 2"	2-1/8" x 7/8" x 2-1/8"	
013978	2" x 1" x 1"	2-1/8" x 1-1/8" x 1-1/8"	
014088	2" x 1" x 2"	2-1/8" x 1-1/8" x 2-1/8"	
014049	2" x 1-1/4" x 1"	2-1/8" x 1-3/8" x 1-1/8"	
014051	2" x 1-1/4" x 1-1/4"	2-1/8" x 1-3/8" x 1-3/8"	
014054	2" x 1-1/4" x 2"	2-1/8" x 1-3/8" x 2-1/8"	
014052	2" x 1-1/2" x 1/2"	2-1/8" x 1-5/8" x 5/8"	

## Copper Pressure Fittings

### Wrot Copper Pressure Fittings (Continued)

#### Reducing Tee (C x C x C)

Part #	Nom Size	OD Size	Price
014034	2" x 1-1/2" x 3/4"	2-1/8" x 1-5/8" x 7/8"	
014015	2" x 1-1/2" x 1"	2-1/8" x 1-5/8" x 1-1/8"	
014026	2" x 1-1/2" x 1-1/4"	2-1/8" x 1-5/8" x 1-3/8"	
014020	2" x 1-1/2" x 1-1/2"	2-1/8" x 1-5/8" x 1-5/8"	
014031	2" x 1-1/2" x 2"	2-1/8" x 1-5/8" x 2-1/8"	
014233	2" x 1/2"	2-1/8" x 5/8"	
014238	2" x 3/4"	2-1/8" x 7/8"	
014213	2" x 1"	2-1/8" x 1-1/8"	
014227	2" x 1-1/4"	2-1/8" x 1-3/8"	
014221	2" x 1-1/2"	2-1/8" x 1-5/8"	
013817	2"	2-1/8" OD	
014139	2-1/2" x 1-1/2" x 2"	2-5/8" x 1-5/8" x 2-1/8"	
064485	2-1/2" x 2" x 3/4"	2-5/8" x 2-1/8" x 7/8"	
014161	2-1/2" x 2" x 1"	2-5/8" x 2-1/8" x 1-1/8"	
014162	2-1/2" x 2" x 1-1/4"	2-5/8" x 2-1/8" x 1-3/8"	
021097	2-1/2" x 2" x 1-1/2"	2-5/8" x 2-1/8" x 1-5/8"	
014175	2-1/2" x 2" x 2"	2-5/8" x 2-1/8" x 2-1/8"	
014170	2-1/2" x 1/2"	2-5/8" x 5/8"	
014174	2-1/2" x 3/4"	2-5/8" x 7/8"	
014165	2-1/2" x 1"	2-5/8" x 1-1/8"	
014169	2-1/2" x 1-1/4"	2-5/8" x 1-3/8"	
014167	2-1/2" x 1-1/2"	2-5/8" x 1-5/8"	
014172	2-1/2" x 2"	2-5/8" x 2-1/8"	
014566	3" x 2" x 2"	3-1/8" x 2-1/8" x 2-1/8"	
057309	3" x 2" x 3"	3-1/8" x 2-1/8" x 2-1/8"	
064483	3" x 2-1/2" x 2"	3-1/8" x 2-5/8" x 2-1/8"	
014586	3" x 1/2"	3-1/8" x 5/8"	
014599	3" x 3/4"	3-1/8" x 7/8"	
014575	3" x 1"	3-1/8" x 1-1/8"	
014579	3" x 1-1/2"	3-1/8" x 1-5/8"	
014593	3" x 2"	3-1/8" x 2-1/8"	
014598	3" x 2-1/2"	3-1/8" x 2-5/8"	
021514	4" x 1-1/4"	4-1/8" x 1-3/8"	
026854	4" x 3"	4-1/8" x 3-1/8"	

### Copper Union (C x C)



Part #	Size	Price
013116	1/2"	
014689	3/4"	
012227	1"	
012818	1-1/4"	1-3/8"OD
012449	1-1/2"	1-5/8"OD
013819	2"	2-1/8"OD



### Preformed Copper for Sweat

#### Sweat Bullet™ No Lead Spin Closed Stub-Out

- *Stub Out – Turn your variable job site costs into fixed job costs*
- *Stub Out – Reduce job site and shop costs such as measuring, cutting, cleaning, fluxing, assembling and soldering*
- *Stub Out – 1-1/4" – 2" CTS Bullets available for quote*
- *Stub Out – accepts sweat, push-fitting and compression valves*
- *Polished Nickel-Plated (N) – Eliminates the need for sleeving or tinning and solders with standard flux*
- *Bracketed Stub Out – Perfect for stubbing up through the floor for closets or lavs*
- *Bracketed Stub Out – Square O Strap is crimped to tube 12" from each end*



Part #	Mfg #	Copper Type	CTS	Length	Price
032467	622-L08	L	1/2"	8"	
108531	622-L12	L	1/2"	12"	
183718	622-M08	M	1/2"	8"	
183719	622-M12	M	1/2"	12"	
183720	622-M15	M	1/2"	15"	
183721	623-L06	L	3/4"	6"	
253696	623-L24	L	3/4"	24"	
135659	624-L24	L	1"	24"	

## Copper Pressure Fittings

### No Lead Offset Riser Fitting

- Saves three slider joints
- Made from type L copper tube



Part #	Mfg #	MSwt x FSwt	Price
226820	616-15	1/2" x 1/2"	

### No Lead Stub-Out Elbow

- L copper
- A stub-out, cap and elbow in one full flow fitting—even better time saver than straight stub outs
- Full flow—no restrictions
- Accepts sweat, push-fitting and compression valves
- Square O Strap is crimped onto tube for solid attachment to bracket or stub



#### Female Swt with Square O Strap™

Part #	Mfg #	Conn.	Size	Radius	Price
140267	609-L246E	1/2" CTS	3-1/2" x 6"	1-1/4"	

#### Female Sweat

Part #	Mfg #	Conn.	Size	Radius	Price
183526	609-L246	1/2" CTS	3-1/2" x 6"	1-1/4"	
252752	609-L4612	1" CTS	6" x 12"	2"	

### Tub Spout Elbow

- 1-1/4" Radius fits all valve rough-ins
- 1/2" CTS Connection
- **Male sweat** with square o strap or with wall block plate  
—Connect tub valve to spout nipple in one easy step  
—Square o strap & wall block are crimped to tube
- **MIP Swivel:**  
—No soldering with easy swivel thread installation
- **Fixed MIP:** with or without wall block plate  
—No soldering with male thread connection
- **FIP Swivel:**  
—No soldering with easy swivel thread installation  
—Do **NOT** use pipe dope or Teflon tape on FIP threads



#### Male Sweat (MSwt x 1/2" CTS)

Part #	Mfg #	Size	Price
020710	613-57	5" x 7"	
181707	613-67	6" x 7"	
089057	613-87	8" x 7"	
253366	613-107	10" x 7"	
032471	613-137	13" x 7"	

### Male Sweat with Wall Block (MSwt x 1/2" CTS)

Part #	Mfg #	Size	Price
116056	612-57	5" x 7"	
163610	612-87	8" x 7"	

### FIP Swivel (FIP x 1/2" CTS)

Part #	Mfg #	Size	Price
183528	613-57Y	5" x 7"	

### Copper Star™ Tube Locking Nut

- 20 Gauge solid copper
- Slides over and locks copper tube into place
- Prevents tube from sliding backward



Part #	Mfg #	I.D. x O.D.	Price
064577	612-2	1/2" CTS x 2" Tube Nut	

### Shower WallNut™ Showerarm Adapter

- Bagged
- Stub out to shower arm connection is made outside the finished wall.
- No hidden leaks behind the wall that promote mold growth
- Stub out with copper tube, just like other fixtures
- No pipe seal tape or pipe joint compound needed on shower arm threads



Part #	Mfg #	Escutcheon	Price
064892	616-02C	Chrome-Plated Steel	
168816	616-02RB	Oil Rubbed Bronze	
183716	616-02SN	Satin Nickel	

### Shower-Lock Tub/Shower Elbow

- Locknut threads can be trimmed after installation
- Internal 1/2" FIP thread for shower arm or tub nipple
- For use on shower risers, tub spouts and non-pressure fitting applications



Part #	Mfg #	FSwt x FIP	Price
067264	616-2	1/2" x 1/2"	

### F1380 Polybutylene Crimp Ring

- For use with SDR-11 tubing only
- Not for use with PEX tube
- Pure, annealed copper rings



Part #	Mfg #	Description	Price
137032	649-2	1/2"	

## Copper Pressure Fittings

### Full-Slip Sweat Repair Couplings with Sweat Connection

- Perfect for repair of cold hot water lines

600-21



Part #	Mfg #	Slips Over	Length	Price
064578	600-212	1/2" CTS	12"	
183521	600-212PK	1/2" CTS	12"	
064580	600-312	3/4" CTS	12"	
183522	600-312PK	3/4" CTS	12"	

### WalLet™ Wall Termination Fitting

- One-piece, forged brass fitting with rigid mounting plate
- Secure loose or fragile wall penetrations reduce the risk of leaks
- Ideal for back mounted faucets, sillcocks, threaded stops, shower rain heads, body-spray systems, and pot fillers



Part #	Mfg #	MIP x FSwt	Price
169164	615-214	1/2" x 1/2"	

### Copper PEX Fittings

#### PowerPEX® F1807 PEX Crimp Ring

- Pure, annealed copper rings
- For use with PEX SDR-9 piping only
- Do not use with PB pipe



649X

Part #	Mfg #	Size	Price
168712	649X1	3/8" PEX	
069180	649X2	1/2" PEX	
069181	649X3	3/4" PEX	
095776	649X4	1" PEX	

#### PowerPEX® F1380 X F1807 Straight Adapter

- One-piece solid copper
- F1380 No lead polybutylene x F1807 copper coupling with crimp rings
- Great for adapting PB lines to new PEX lines
- Each adapter is bagged with one natural copper PB crimp ring and one black copper PEX crimp ring



645X2

Part #	Mfg #	PB x PEX	Price
180443	645X2GPK2	1/2" x 1/2"	

#### PowerPEX® F1807 Copper Straight Adapter

- One piece solid copper
- PEX x male swt or PEX x female swt



644X2

Part #	Mfg #	Connection	Price
147608	643X2	(1/2") PEX x MSwt	

### Copper PEX Fittings (Continued)

#### PowerPEX® F1807 Copper Straight Adapter

Part #	Mfg #	Connection	Price
153540	643X3	(3/4") PEX x MSwt	
153538	643X4	(1") PEX x MSwt	
153539	643X43	3/4" PEX x 1" MSwt	
072010	644X2	(1/2") PEX x FSwt	
153537	644X3	(3/4") PEX x FSwt	
153535	644X4	(1") PEX x FSwt	
153536	644X43	3/4" PEX x 1" FSwt	

#### PowerPEX® ASTM F1807 Straight Adapter

- Female sweat
- One-piece lead-free brass



Part #	Mfg #	Description	Price
231393	644XG4	1"PEX x 1" Fswt	

#### PEX Adapter PEX x Male Sweat



Part #	Mfg #	Description	Price
153540	643X3	3/4" PEX x 3/4" Mswt	

#### PowerPEX® F1807 V-Sleeve™ Compression System

- V-Sleeves are to be used with ASTM F1807 and F2159 PEX fittings in conjunction with any SDR 9 PEX tubing manufactured to the ASTM F876 or ASTM F876-2
- Visibility of tube fully inserted in sleeve and to tube stop on fitting
- 360° Visibility of crimped sleeve
- Sleeve can be pre-loaded onto fitting
- 360° Compression on all sealing surface areas
- V-Sleeve must be installed using a Sioux Chief 305-8\_TX compression tool
- Third-party tested to ASTM F877



Part #	Mfg #	Size	Material	Price
149259	649TX2	1/2"	Stainless Steel	
149260	649TX3	3/4"	Stainless Steel	
166407	649TX4	1"	Stainless Steel	



## Copper Pressure Fittings

### PowerPEX® ASTM F1807 Stub-Out Elbow

- Accepts sweat and compression valves
- Combines easy adapting of copper stub-outs with easy installation of PEX systems
- (-N) Polished nickel-plated



Part #	Mfg #	Connection	CTS	Length	Price
091662	630X246	1/2" PEX	1/2"	6"	
085711	630X248	1/2" PEX	1/2"	8"	
180658	630X348	3/4" PEX	1/2"	8"	
237850	630X248N	1/2" PEX	1/2"	8"	

### Square O Strap™ Stub-Out Elbow (F1807 PEX)

- Accepts sweat and compression valves
- Combines easy adapting of copper stub-outs with easy installation of PEX systems
- Affix easily to edge bracket or any backing board to provide solid installations



Part #	Mfg #	Connection	CTS	Length	Price
117979	630X2412E	1/2" PEX	1/2"	12"	
085262	630X248E	1/2" PEX	1/2"	8"	
224229	630X348E	3/4" PEX	3/4"	8"	

### PowerPEX F1807 Bullet™ Lead Free Stub-Out (F1807 x CTS)

- **Spin closed stub out**  
—Type L copper
- **Bracketed stub out**  
—Perfect for stubbing through floor for closets or lavs  
— Square O Strap is crimped to tube 8" from spin closed end on 638X212E  
— Type L copper
- **Open ended stub out**  
—Type L copper



Part #	Mfg #	PEX	CTS	Stub Out	Price
085263	638X208	1/2"	1/2"	Spin Closed	
178326	638X212E	1/2"	1/2"	Bracketed	
111542	638X212	1/2"	1/2"	Spin Closed	
183740	638X312	3/4"	3/4"	Spin Closed	

### PowerPEX® F1807 Tub/Shower Pressure Connector

- Perfect for sweat connection to standard tub and shower valves
- MIP & FIP Swivel connections means no torch at the tub and shower valve
- Made from Type L copper tube
- Elongated tailpiece allows for rigid bracket attachment



Part #	Mfg #	Connection	Price
085461	632X243	1/2" F1807 PEX x 1/2" MSwt	

### PowerPEX® F1807 Elbow Adapter

- Great multipurpose sweat x PEX elbow
- One-piece solid copper



Part #	Mfg #	Connection	Price
169181	632X122	3/8" F1807 PEX x 1/2" MSwt	
080419	632X222	1/2" F1807 PEX x 1/2" MSwt	
093142	SC632X225	1/2" F1807 PEX x 1/2" FSwt	

### PowerPEX® F1960 Standard Stub-Out Elbow

- No lead
- Accepts sweat, push-fitting and compression valves
- Combines easy adapting of copper stub-outs with easy installation of F1960 PEX system



Part #	Mfg #	PEX	CTS	Size	Radius	Price
168028	630WG248	1/2"	1/2"	4" x 8"	1-1/4"	
168039	630WG348	3/4"	3/4"	6" x 8"	1-3/4"	
185555	630WG4612	1"	1"	6" x 12"	2"	

### PowerPEX® F1960 Standard Stub-Out Elbow (Square O Strap—No Lead)

- Accepts sweat, push-fitting and compression valves
- Combines easy adapting of copper stub-outs with easy installation of F1960 PEX system
- Square O Straps affix easily to the Edge bracket or any backing board to provide solid installations  
—Straps are identical to radius size
- Multiple mounting holes allow for installations on sides, bottom, or top



Part #	Mfg #	PEX	CTS	Size	Radius	Price
135504	630WG248E	1/2"	1/2"	4" x 8"	1-1/4"	
164830	630WG348E	3/4"	3/4"	6" x 8"	1-3/4"	
164828	630WG4612E	1"	1"	6" x 12"	2"	

## Copper Pressure Fittings

### PowerPEX® F1960 No Lead Bullet™ Stub-Out

- Standard spin closed
- Type L copper
- Accepts sweat, push-fitting and compression valves



638WG215

Part #	Mfg #	F1960 PEX	CTS	Length	Price
173519	638WG208	1/2"	1/2"	8"	
173858	638WG215	1/2"	1/2"	15"	

### PowerPEX® F1960 No Lead Bullet™ Stub-Out with Square O Strap

- Standard spin closed
- Type L copper
- Accepts sweat, push-fitting and compression valves
- Square O Strap is crimped to tube from 8" from spin closed end



Part #	Mfg #	F1960 PEX	CTS	Length	Price
246381	638WG212E	1/2"	1/2"	12"	

### PowerPEX® F1807 Stub-Out Elbow—No Lead

- **Standard**
  - Accepts sweat, push-fitting and compression valves
  - Combines easy adapting of copper stub-outs with easy installation of PEX system
  - One piece Type L Copper
  - Tube stops formed into each fitting
- **Polish Nickel-Plated**
  - Push-fitting systems are not compatible with nickel-plated stub out elbows

#### Standard

Part #	Mfg #	PEX/CTS	Size	Radius	Price
183724	630X146	3/8"/1/2"	3-1/2"x6"	1-1/4"	
183727	630x468	1"/1"	6"x12"	2"	

### PowerPEX® F1807 Square O Strap Stub-Out Elbow

- Accepts sweat, push-fitting and compression valves w/ Type L Copper
- Combines easy adapting of copper stub-outs with easy installation of PEX system
- Square O Straps affix easily to the edge bracket or any backing board to provide solid installations
- Rad. = radius



630X246E

Part #	Mfg #	PEX CTS	Size	Rad.	Strap	Price
183726	630X246E	(1/2")	4" x 12"	1-1/4"	1-3/4"	

### Copper PEX Fittings (Continued)

#### PowerPEX® F1807 Square O Strap Stub-Out Elbow

Part #	Mfg #	PEX CTS	Size	Rad.	Strap	Price
224229	630X348E	(3/4")	4-1/2"x8"	1-3/4"	2"	

#### PowerPEX F1960 Tub/Shower Pressure Connector

- Perfect for sweat connection to standard tub/shower valves
- MIP and FIP swivel connections no torch at the tub/shower valve
- Type L Copper / 1-1/4" radius
- Elongated tailpiece allows for rigid bracket attachment



632WG263

Part #	Mfg #	Connection	Size	Price
183728	632WG263	(1/2") PEX x MSwt	6" x 2-1/4"	



### Copper Wrot Pressure Stub-Outs

#### Air Chamber or Stub-Out



Part #	Mfg #	Size	Price
013390	128CSO	1/2" x 8"	

### Copper Wrot Fittings

#### 45° Elbow (C x C)



Part #	Mfg #	Size	Price
032033	18C45	1/8"	
026847	6C45	6"	



## Copper Pressure Fittings

**90° Elbow Close Rough**  
(C x C)



Part #	Mfg #	Size	Price
026848	6C90	6"	

**90° Elbow Long Radius**  
(C x C)



Part #	Mfg #	Size	Price
162191	18CLT90	1/8"	

**Reducing Coupling**  
(C x C)



Part #	Mfg #	Size	Price
075910	5838CRC	5/8" x 3/8"	
026850	64CRC	6" x 4"	

**Tee**  
(C x C x C)



Part #	Mfg #	Size	Price
033622	1141142CT	1-1/4" x 1-1/4" x 2"	
054575	6CT	6"	

**Tube Cap**  
(C x C)



Part #	Mfg #	Size	Price
089592	58CCA	5/8"	



## Copper Fittings - Cleaned & Bagged

### Copper Kleen-Fit™ Pressure Fittings

#### 101-R Copper Reducing Coupling with Stop (C x C)



Part #	Mfg #	Size	OD Size	Price
115470	1238CRCCB	1/2" x 3/8"	5/8" x 1/2"	
127002	3438CRCCB	3/4" x 3/8"	7/8" x 1/2"	

#### 104 Copper Male Adapter (C x M)



Part #	Mfg #	Size	OD Size	Price
130414	12CMACB	1/2"	5/8" x 1/2"	

#### 107-C Copper 90° Close Rough Elbow (C x C)



Part #	Mfg #	Size	OD Size	Price
084695	34C90CB	3/4"	7/8"	

#### 118 Copper Reducer Fitting (Ftg x C)



Part #	Mfg #	Size	OD Size	Price
100335	3412CFRCB	3/4" x 1/2"	7/8" x 5/8"	



### Wrot Copper Pressure Fittings

#### Tube Cap (C) - Cleaned/Bagged



Part #	Nom Size	OD Size	Price
091183	1/2"	5/8" OD	
093869	3/4"	7/8" OD	

### Wrot Copper Pressure Fittings (Continued)

#### Tube Cap (C) - Cleaned/Bagged

Part #	Nom Size	OD Size	Price
100329	1"	1-1/8" OD	

#### Coupling with Dimpled Stops (C x C) - Cleaned/Bagged



Part #	Nom Size	OD Size	Price
084721	1/2"	5/8" OD	
084698	3/4"	7/8" OD	
084621	1"	1-1/8" OD	

#### Reducing Coupling (C x C) - Cleaned/Bagged (1)



Part #	Nom Size	OD Size	Price
106355	1" x 1/2"	1-1/8" x 5/8"	

#### Reducing Coupling (C x C) - Cleaned/Bagged



Part #	Nom Size	OD Size	Price
106376	3/4" x 1/2"	7/8" x 5/8"	
106377	1" x 1/2"	1-1/8" x 5/8"	
106380	1" x 3/4"	1-1/8" x 7/8"	

#### 45° Elbow (C x C) - Cleaned/Bagged



Part #	Nom Size	OD Size	Price
102458	1/2"	5/8" OD	
102455	3/4"	7/8" OD	
084624	1"	1-1/8" OD	

**Copper Fittings - Cleaned & Bagged**

**45° Elbow (Ftg x C) - Cleaned/Bagged**



Part #	Nom Size	OD Size	Price
106450	1/2"	5/8" OD	
104396	3/4"	7/8" OD	
106451	1"	1-1/8" OD	

**Tee (C x C x C) - Cleaned/Bagged**



Part #	Nom Size	OD Size	Price
084757	1/2"	5/8" OD	
084701	3/4"	7/8" OD	
084714	3/4" x 1/2"	7/8" x 5/8"	
084715	3/4" x 1/2" x 1/2"	7/8" x 5/8" x 5/8"	
084758	3/4" x 1/2" x 3/4"	7/8" x 5/8" x 7/8"	
084710	1"	1-1/8" OD	
106469	1" x 1/2" x 3/4"	1-1/8" x 5/8" x 7/8"	
100339	1" x 1/2" x 1"	1-1/8" x 5/8" x 1-1/8"	
084731	1" x 3/4" x 1/2"	1-1/8" x 7/8" x 5/8"	
084716	1" x 1/2"	1-1/8" x 5/8"	
106466	1-1/2"	1-5/8" OD	
106500	2" x 1" x 2"	2-1/8" x 1-1/8" x 2-1/8"	
100343	2" x 1"	2-1/8" x 1-1/8"	

**90° Elbow (C x C) - Cleaned/Bagged**



Part #	Nom Size	OD Size	Price
084705	1/2"	5/8" OD	
084617	1"	1-1/8" OD	

**90° Close Rough Elbow (Ftg x C) -  
Cleaned/Bagged**



Part #	Nom Size	OD Size	Price
106455	1/2"	5/8" OD	
104395	3/4"	7/8" OD	
106456	1"	1-1/8" OD	

**90° Long Radius Elbow (C x C) -  
Cleaned/Bagged**



Part #	Nom Size	OD Size	Price
097945	1"	1-1/8" OD	

## Copper DWV Fittings

### Cast Brass DWV Fittings

#### Cast Brass Marvel Threaded Adapter (C x SJ)



Part #	Mfg #	Size	Price
012435	112CMARVEL	1-1/2"	

#### Cast Brass Cleanout with Plug (Ftg x Cleanout)



Part #	Mfg #	Size	Price
012455	112CDFCOWPL	1-1/2"	
013774	2CDFCOWPL	2"	

#### Cast Brass Test Tee with Plug (C x C x Cleanout)



Part #	Mfg #	Size	Price
012409	112CDTT	1-1/2"	
013784	2CDTT	2"	

#### Cast Brass P-Trap (C x C)



Part #	Mfg #	Size	Price
012404	112CDPT	1-1/2"	
013776	2CDPT	2"	

### Cast Copper Return Bend (C x C)



Part #	Mfg #	Size	Price
013777	2CDRB	2"	

### Wrot DWV Copper Fittings

#### Wrot Copper Trap Adapter (Ftg x SJ)



Part #	Mfg #	Size	Price
012419	112CFSJA	1-1/2" x 1-1/2" OD	

#### Wrot Copper Trap Adapter (C x SJ)



Part #	Mfg #	Size	Price
012809	114CDSJA	1-1/4" x 1-1/4" OD	
012630	112114CDSJA	1-1/2" x 1-1/4" OD	
012441	112CDSJA	1-1/2" x 1-1/2" OD	

#### Wrot Copper Threaded Adapter (C x FIP)



Part #	Mfg #	Size	Price
012783	114CDFA	1-1/4"	
012403	112CDFA	1-1/2"	
013773	2CDFA	2"	

#### Wrot Copper Threaded Adapter (C x MIP)



Part #	Mfg #	Size	Price
012784	114CDMA	1-1/4"	

## Copper DWV Fittings

### Wrot DWV Copper Fittings (Continued)

#### Wrot Copper Threaded Adapter (C x MIP)

Part #	Mfg #	Size	Price
013775	2CDMA	2"	

#### Wrot Copper Coupling (C x C)



Part #	Mfg #	Size	Price
012782	114CDCP	1-1/4"	
012617	112114CDCP	1-1/2" x 1-1/4"	
012402	112CDCP	1-1/2"	
013986	2112CDCP	2" x 1-1/2"	
013772	2CDCP	2"	
014320	3CDCP	3"	

#### Wrot Copper Reducing Coupling (Ftg x C)



Part #	Mfg #	Size	Price
012618	112114CDFR	1-1/2" x 1-1/4"	
013987	2112CDFR	2" x 1-1/2"	
014519	32CDFR	3" x 2"	

#### Wrot Copper Repair Coupling (C x C)



Part #	Mfg #	Size	Price
013068	112CDSCP	1-1/2"	
013779	2CDSCP	2"	

### Wrot Copper 22-1/2° Elbow (C x C)

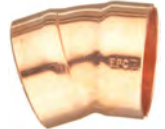

Part #	Mfg #	Size	Price
012689	112CD22	1-1/2"	
013786	2CD22	2"	

### Wrot Copper 45° Elbow (C x C)



Part #	Mfg #	Size	Price
012790	114CD45	1-1/4"	
012411	112CD45	1-1/2"	
013787	2CD45	2"	
014331	3CD45	3"	

### Wrot Copper 45° Elbow (Ftg x C)



Part #	Mfg #	Size	Price
012785	114CDS45	1-1/4"	
012405	112CDS45	1-1/2"	
013780	2CDS45	2"	
014325	3CDS45	3"	

### Wrot Copper 90° Elbow (C x C)



Part #	Mfg #	Size	Price
012791	114CD90	1-1/4"	
012412	112CD90	1-1/2"	
013788	2CD90	2"	
014333	3CD90	3"	

## Copper DWV Fittings

### Wrot Copper 90° Elbow (Ftg x C)



Part #	Mfg #	Size	Price
012786	114CDS90	1-1/4"	
012406	112CDS90	1-1/2"	
013781	2CDS90	2"	

### Wrot Copper 45° Wye (C x C x C)



Part #	Mfg #	Size	Price
012410	112CDY	1-1/2"	
014219	22112CDY	2" x 1-1/2"	
013785	2CDY	2"	

### Wrot Copper Sanitary Tee (C x C x C)



Part #	Mfg #	Size	Price
012787	114CDT	1-1/4"	
012619	112114CDT	1-1/2" x 1-1/4"	
012407	112CDT	1-1/2"	
014018	2112112CDT	2" x 1-1/2" x 1-1/2"	
014029	21122CDT	2" x 1-1/2" x 2"	
014039	2114CDT	2" x 1-1/4"	
014218	22112CDT	2" x 1-1/2"	
013782	2CDT	2"	
014327	3CDT	3"	

### Wrot Copper Test Cap (C)



Part #	Mfg #	Size	Price
012788	114CDTC	1-1/4"	
012408	112CDTC	1-1/2"	
013783	2CDTC	2"	



### Wrot DWV Copper Fittings

#### Wrot Copper Test Cap (C)



Part #	Mfg #	Size	Price
027855	12CDTC	1/2"	
027856	34CDTC	3/4"	

### Wrot Copper Trap Adapter (Ftg x SJ)



Part #	Mfg #	Size	Price
012624	112114CFS JA	1-1/2" x 1-1/4" OD	

### Wrot Copper Trap Adapter (FIP x SJ)



Part #	Mfg #	Size	Price
029419	112114CDF A	1-1/2" x 1-1/4" OD	
044826	112CDFSJA	1-1/2" x 1-1/2" OD	



## Copper DWV Fittings

### Wrot Copper Trap Adapter (MIP x SJ)

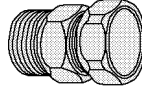

Part #	Mfg #	Size	Price
035755	114CDMSJ A	1-1/4" x 1-1/4" OD	
029421	112CDMSJ A	1-1/2" x 1-1/2" OD	

### Wrot Copper Threaded Adapter (C x MIP)



Part #	Mfg #	Size	Price
012679	112CDMA	1-1/2"	
019463	112114CDM A	1-1/2" x 1-1/4"	

### Cast Copper DWV Fittings

#### Cast Copper Threaded Piece Adapter (C x MIP)



Part #	Mfg #	Size	Price
023821	114CMARV EL	1-1/4"	
020249	2CMARVEL	2"	

#### Cast Copper Threaded Adapter (C x MIP)



Part #	Mfg #	Size	Price
108622	112CDMAB	1-1/2"	
108608	2CDMAB	2"	

### Cast Copper Double Tee (C x C x C x C)



Part #	Mfg #	Size	Price
029192	2112CDDST	2" x 2" x 1-1/2" x 1-1/2"	
065471	2CDCR	2"	

### Cast Copper 45° Wye (C x C x C)



Part #	Mfg #	Size	Price
104417	114CDY	1-1/4"	



### DWV Fittings

#### DWV Slip Joint Adapter

- Brass marvel thread
- Sweat on to copper DWV pipe to make slip joint connections



274-6

Part #	FSwt x Slip Joint Thread	Price
183382	1-1/4" x 1-1/4"	
183383	1-1/2" x 1-1/2"	
183384	2" x 2"	



## CPVC Schedule 80 Fittings

### CPVC Sch 80 Fittings

#### CPVC Sch 80 Special Reinforced Female Adapter (Soc x SR FIPT)



Part #	Mfg #	Size	Price
118045	34CPVCP8FASR	3/4"	
118046	1CPVCP8FASR	1"	
112906	114CPVCP8FASR	1-1/4"	
112907	112CPVCP8FASR	1-1/2"	
104189	2CPVCP8FASR	2"	
112908	3CPVCP8FASR	3"	
077816	4CPVCP8FASR	4"	

#### CPVC Sch 80 Special Reinforced 90° Elbow (Soc x SR FIPT)



Part #	Mfg #	Size	Price
143596	12CPVCP8SF90SR	1/2"	

#### CPVC Sch 80 Male Adapter (Soc x MIPT)



Part #	Mfg #	Size	Price
056489	12CPVCP8MA	1/2"	
139732	34CPVCP8MA	3/4"	
086755	1CPVCP8MA	1"	
112918	114CPVCP8MA	1-1/4"	
088827	112CPVCP8MA	1-1/2"	
103244	2CPVCP8MA	2"	
104323	212CPVCP8MA	2-1/2"	
072194	3CPVCP8MA	3"	
108152	4CPVCP8MA	4"	
112919	6CPVCP8MA	6"	

### CPVC Sch 80 Female Adapter (Soc x FIPT)



Part #	Mfg #	Size	Price
056490	12CPVCP8FA	1/2"	
094813	34CPVCP8FA	3/4"	
135670	1CPVCP8FA	1"	
180266	114CPVCP8FA	1-1/4"	
180267	112CPVCP8FA	1-1/2"	
109349	2CPVCP8FA	2"	
072193	3CPVCP8FA	3"	

### CPVC Sch 80 Reducer Bushing Flush Style (Soc x Spgt)



Part #	Mfg #	Size	Price
137626	3412CPVCP8BU	3/4" x 1/2"	
086754	112CPVCP8RBU	1" x 1/2"	
135600	134CPVCP8BU	1" x 3/4"	
112922	11412CPVCP8BU	1-1/4" x 1/2"	
112923	11434CPVCP8BU	1-1/4" x 3/4"	
112924	1141CPVCP8BU	1-1/4" x 1"	
112925	11212CPVCP8BU	1-1/2" x 1/2"	
112926	11234CPVCP8BU	1-1/2" x 3/4"	
112927	1121CPVCP8BU	1-1/2" x 1"	
112928	112114CPVCP8BU	1-1/2" x 1-1/4"	
112930	234CPVCP8BU	2" x 3/4"	
112931	21CPVCP8BU	2" x 1"	
112932	2114CPVCP8BU	2" x 1-1/4"	
112933	2112CPVCP8BU	2" x 1-1/2"	
112934	2121CPVCP8BU	2-1/2" x 1"	
112935	212114CPVCP8BU	2-1/2" x 1-1/4"	
112936	212112CPVCP8BU	2-1/2" x 1-1/2"	
112940	3114CPVCP8BU	3" x 1-1/4"	
112941	3112CPVCP8BU	3" x 1-1/2"	
112942	32CPVCP8BU	3" x 2"	
112943	3212CPVCP8BU	3" x 2-1/2"	
108160	42CPVCP8BU	4" x 2"	
075111	43CPVCP8BU	4" x 3"	
112944	62CPVCP8BU	6" x 2"	



## CPVC Schedule 80 Fittings

### CPVC Sch 80 Fittings (Continued)

#### CPVC Sch 80 Reducer Bushing Flush Style (Soc x Spgt)

Part #	Mfg #	Size	Price
112945	6212CPVCP8BU	6" x 2-1/2"	
112946	63CPVCP8BU	6" x 3"	
112947	64CPVCP8BU	6" x 4"	
112948	82CPVCP8BU	8" x 2"	
104186	83CPVCP8BU	8" x 3"	
112949	84CPVCP8BU	8" x 4"	
112950	86CPVCP8BU	8" x 6"	

#### CPVC Sch 80 Reducer Bushing Flush Style (Spgt x FIPT)



Part #	Mfg #	Size	Price
129459	1214CPVCP8FBU	1/2" x 1/4"	
143621	11234CPVCP8FBU	1-1/2" x 3/4"	
166739	1121CPVCP8FBU	1-1/2" x 1"	
128307	112CPVCP8FBU	1" x 1/2"	
136542	21CPVCP8FBU	2" x 1"	

#### CPVC Sch 80 Reducer Bushing Flush Style (MIPT x FIPT)



Part #	Mfg #	Size	Price
186980	134CPVCP8TBU	1" x 3/4"	
233897	1141CPVCP8TBU	1-1/4" x 1"	

#### CPVC Sch 80 Coupling (Soc)



Part #	Mfg #	Size	Price
138815	12CPVCP8CP	1/2"	
094811	34CPVCP8CP	3/4"	
100544	1CPVCP8CP	1"	
112874	114CPVCP8CP	1-1/4"	
088825	112CPVCP8CP	1-1/2"	

### CPVC Sch 80 Fittings (Continued)

#### CPVC Sch 80 Coupling (Soc)

Part #	Mfg #	Size	Price
075102	2CPVCP8CP	2"	
087750	212CPVCP8CP	2-1/2"	
072191	3CPVCP8CP	3"	
075117	4CPVCP8CP	4"	
112876	6CPVCP8CP	6"	
112877	8CPVCP8CP	8"	

#### CPVC Sch 80 Reducing Coupling (Soc)



Part #	Mfg #	Size	Price
138813	3412CPVCP8RCP	3/4" x 1/2"	
056486	112CPVCP8RCP	1" x 1/2"	
118044	134CPVCP8RCP	1" x 3/4"	
112880	11234CPVCP8RCP	1-1/2" x 3/4"	
112881	1121CPVCP8RCP	1-1/2" x 1"	
112884	234CPVCP8RCP	2" x 3/4"	
112886	2112CPVCP8RCP	2" x 1-1/2"	
112887	212112CPVCP8RCP	2-1/2" x 1-1/2"	
077783	32CPVCP8RCP	3" x 2"	
104191	3212CPVCP8RCP	3" x 2-1/2"	
112895	42CPVCP8RCP	4" x 2"	
112896	4212CPVCP8RCP	4" x 2-1/2"	
112898	62CPVCP8RCP	6" x 2"	
112899	6212CPVCP8RCP	6" x 2-1/2"	
112900	63CPVCP8RCP	6" x 3"	
112904	86CPVCP8RCP	8" x 6"	
077775	43CPVCP8RCP	4" x 3"	
100541	3112CPVCP8RCP	3" x 1-1/2"	
112879	11212CPVCP8RCP	1-1/2" x 1/2"	
112882	112114CPVCP8RCP	1-1/2" x 1-1/4"	
112888	2122CPVCP8RCP	2-1/2" x 2"	



## CPVC Schedule 80 Fittings

**CPVC Sch 80 90° Elbow  
(Soc)**



Part #	Mfg #	Size	Price
056488	12CPVCP890	1/2"	
064988	34CPVCP890	3/4"	
100543	1CPVCP890	1"	
064987	114CPVCP890	1-1/4"	
088826	112CPVCP890	1-1/2"	
077777	2CPVCP890	2"	
087751	212CPVCP890	2-1/2"	
072190	3CPVCP890	3"	
075103	4CPVCP890	4"	
079688	6CPVCP890	6"	
079686	8CPVCP890	8"	

**CPVC Sch 80 Long Sweep 90° Elbow  
(Soc)**



Part #	Mfg #	Size	Price
189756	2CPVCP8LS90	2"	
189758	3CPVCP8LS90	3"	
238147	4CPVCP8LS90	4"	

**CPVC Sch 80 90° Street Elbow  
(Soc)**



Part #	Mfg #	Size	Price
100540	112CPVCP8S90	1-1/2"	
112847	2CPVCP8S90	2"	
112848	3CPVCP8S90	3"	
077781	4CPVCP8S90	4"	
112853	6CPVCP8S90	6"	
112854	8CPVCP8S90	8"	

**CPVC Sch 80 90° Elbow  
(FIP x FIP)**



Part #	Mfg #	Size	Price
186975	1CPVCP8T90	1"	

**CPVC Sch 80 45° Elbow  
(Soc)**



Part #	Mfg #	Size	Price
086757	12CPVCP845	1/2"	
094810	34CPVCP845	3/4"	
118042	1CPVCP845	1"	
112855	114CPVCP845	1-1/4"	
100539	112CPVCP845	1-1/2"	
075101	2CPVCP845	2"	
112856	212CPVCP845	2-1/2"	
072195	3CPVCP845	3"	
075105	4CPVCP845	4"	
112864	8CPVCP845	8"	

**CPVC Sch 80 45° Street Elbow  
(Soc)**



Part #	Mfg #	Size	Price
112870	2CPVCP8S45	2"	
112871	212CPVCP8S45	2-1/2"	
077780	4CPVCP8S45	4"	
112873	8CPVCP8S45	8"	
077779	3CPVCP8S45	3"	
112863	6CPVCP845	6"	
112869	112CPVCP8S45	1-1/2"	



## CPVC Schedule 80 Fittings

### CPVC Sch 80 22-1/2° Elbow (Soc)



Part #	Mfg #	Size	Price
127468	2CPVCP822	2"	

### CPVC Sch 80 Tee (Soc)



Part #	Mfg #	Size	Price
138547	12CPVCP8T	1/2"	
128626	34CPVCP8T	3/4"	
128306	1CPVCP8T	1"	
112803	114CPVCP8T	1-1/4"	
112804	112CPVCP8T	1-1/2"	
083376	2CPVCP8T	2"	
072192	3CPVCP8T	3"	
075106	4CPVCP8T	4"	
112805	212CPVCP8T	2-1/2"	
079685	6CPVCP8T	6"	

### CPVC Sch 80 Reducing Tee (Soc)



Part #	Mfg #	Size	Price
138548	343412CPVCP8T	3/4" x 3/4" x 1/2"	
086753	1112CPVCP8T	1" x 1" x 1/2"	
135671	1134CPVCP8T	1" x 1" x 3/4"	
112810	11411412CPVCP8T	1-1/4" x 1-1/4" x 1/2"	
112812	1141141CPVCP8T	1-1/4" x 1-1/4" x 1"	
112814	11211212CPVCP8T	1-1/2" x 1-1/2" x 1/2"	
112815	11211234CPVCP8T	1-1/2" x 1-1/2" x 3/4"	
112816	1121121CPVCP8T	1-1/2" x 1-1/2" x 1"	
112817	112112114CPVCP8	1-1/2" x 1-1/2" x 1-1/4"	
112818	2212CPVCP8T	2" x 2" x 1/2"	
112819	2234CPVCP8T	2" x 2" x 3/4"	
112820	221CPVCP8T	2" x 2" x 1"	
112822	22112CPVCP8T	2" x 2" x 1-1/2"	
112824	21221234CPVCP8T	2-1/2" x 2-1/2" x 3/4"	

### CPVC Sch 80 Fittings (Continued)

#### CPVC Sch 80 Reducing Tee (Soc)

Part #	Mfg #	Size	Price
091653	2122121CPVCP8T	2-1/2" x 2-1/2" x 1"	
112827	2122122CPVCP8T	2-1/2" x 2-1/2" x 2"	
112832	33112CPVCP8T	3" x 3" x 1-1/2"	
112833	332CPVCP8T	3" x 3" x 2"	
108159	442CPVCP8T	4" x 4" x 2"	
112838	443CPVCP8T	4" x 4" x 3"	
112839	662CPVCP8T	6" x 6" x 2"	
112840	66212CPVCP8T	6" x 6" x 2-1/2"	
112841	663CPVCP8T	6" x 6" x 3"	
112842	664CPVCP8T	6" x 6" x 4"	
112843	884CPVCP8T	8" x 8" x 4"	
112844	886CPVCP8T	8" x 8" x 6"	

### CPVC Sch 80 Cap (Soc)



Part #	Mfg #	Size	Price
139292	12CPVCP8CA	1/2"	
144076	34CPVCP8CA	3/4"	
083389	1CPVCP8CA	1"	
112951	114CPVCP8CA	1-1/4"	
112952	112CPVCP8CA	1-1/2"	
083388	2CPVCP8CA	2"	
112953	212CPVCP8CA	2-1/2"	
078210	4CPVCP8CA	4"	
112954	3CPVCP8CA	3"	
112955	6CPVCP8CA	6"	

### CPVC Sch 80 Flange Van Stone Style w/ Plastic Ring (Soc)



Part #	Mfg #	Size	Price
167684	1CPVCP8VSSOF	1"	
112968	212CPVCP8VSSOF	2-1/2"	
112969	3CPVCP8VSSOF	3"	



## CPVC Schedule 80 Fittings

### CPVC Sch 80 Fittings (Continued)

#### CPVC Sch 80 Flange Van Stone Style w/ Plastic Ring (Soc)

Part #	Mfg #	Size	Price
112970	4CPVCP8VSSOF	4"	
112973	8CPVCP8VSSOF	8"	
112972	6CPVCP8VSSOF	6"	
141977	2CPVCP8VSSOF	2"	
167685	112CPVCP8VSSOF	1-1/2"	

#### CPVC Sch 80 Flange Van Stone Style w/ Plastic Ring (FIPT)



Part #	Mfg #	Size	Price
112975	212CPVCP8VSFFL G	2-1/2"	
112977	3CPVCP8VSFFLG	3"	
112978	4CPVCP8VSFFLG	4"	

#### CPVC Sch 80 Flange Van Stone Style w/ Plastic Ring (Spgt)



Part #	Mfg #	Size	Price
078213	4CPVCP8VSSFLG	4"	

#### CPVC Sch 80 Flange (Soc)

- One-Piece



Part #	Mfg #	Size	Price
091654	212CPVCP8F	2-1/2"	

### CPVC Sch 80 Union with Viton O-Rings (Soc)



Part #	Mfg #	Size	Price
101671	12CPVCP8U2000	1/2"	
144009	34CPVCP8U2000	3/4"	
101673	1CPVCP8U2000	1"	
112957	114CPVCP8U2000	1-1/4"	
112959	112CPVCP8U2000	1-1/2"	
112960	2CPVCP8U2000	2"	
112962	212CPVCP8U2000	2-1/2"	
112963	3CPVCP8U2000	3"	
112965	4CPVCP8U2000	4"	
112967	6CPVCP8U2000	6"	

### CPVC Sch 80 Union with EPDM O-Ring Seal (Soc)



Part #	Mfg #	Size	Price
149657	1CPVCP8UE	1"	

### CPVC Sch 80 Standard Wye (Soc x Soc x Soc)

- 235 psi
- Molded gray



Part #	Mfg #	Size	Price
075109	4CPVCP8Y	4"	
075118	42CPVCP8Y	4" x 2"	
077782	3CPVCP8Y	3"	
238145	2CPVCP8Y	2"	

### CPVC Sch 80 Nipples



#### 1" Sch 80 CPVC Nipples

Part #	Mfg #	Size	Price
065394	1CLCPVCP8N	1" x Close	





---

---

## CPVC Schedule 80 Fittings

---

---

### 2" Sch 80 CPVC Nipples

Part #	Mfg #	Size	Price
083384	28CPVCP8N	2" x 8"	

**CPVC (CTS) Fittings**

**CPVC/CTS Fittings**

**CPVC Ball Valve  
(Slip x Slip)**



Part #	Mfg #	Size	Price
013168	12CPVCSV	1/2"	
014676	34CPVCSV	3/4"	

**HC24 CPVC Transition Coupling  
(SPIGOT X COMP)**

Part #	Mfg #	Size	Price
191845	12CPVCTC	1/2"	



**CPVC/CTS Fittings**

**CPVC Coupling  
(Slip x Slip)**



Part #	Mfg #	Size	Price
014820	3412CPVCCP	3/4" x 1/2"	
014673	34CPVCIPSCTSB	3/4" IPS x 3/4" CTS	

**CPVC 90° Elbow  
(Slip x Slip)**



Part #	Mfg #	Size	Price
013107	12CPVC90	1/2"	
014680	34CPVC90	3/4"	

**CPVC 90° Street Elbow  
(Spgt x Slip)**



Part #	Mfg #	Size	Price
013104	12CPVCS90	1/2"	
014677	34CPVCS90	3/4"	

**CPVC 90° Drop Ear Elbow  
(Slip x Slip)**



Part #	Mfg #	Size	Price
013100	12CPVCDE90	1/2"	

**CPVC 90° Drop Ear Elbow  
(Slip x FIP)**

• Includes washer



Part #	Mfg #	Size	Price
013099	12CPVCDEF90	1/2"	

**CPVC 45° Street Elbow (Spgt x Slip)**

Part #	Mfg #	Size	Price
031009	12CPVCS45	1/2"	

**CPVC Tee  
(Slip x Slip x Slip)**



Part #	Mfg #	Size	Price
013105	12CPVCT	1/2"	
014678	34CPVCT	3/4"	
014821	3412CPVCT	3/4" x 1/2"	

**CPVC Reducer Bushing  
(Spgt x Slip)**



Part #	Mfg #	Size	Price
014819	3412CPVCBU	3/4" x 1/2"	
017745	134CPVCBU	1" x 3/4"	

**Pipe Straps for CPVC**

Part #	Mfg #	Size	Price
014675	34CPVCSTRAP	3/4"	

**CPVC Sch 40 Fittings**

**CPVC Sch 40 Coupling  
(Soc)**



Part #	Mfg #	Size	Price
013098	12CPVCCP	1/2"	

## CPVC (CTS) Fittings

### CPVC Sch 40 Fittings (Continued)

#### CPVC Sch 40 Coupling (Soc)

Part #	Mfg #	Size	Price
014671	34CPVCCP	3/4"	

#### CPVC Sch 40 45° Elbow (Soc)



Part #	Mfg #	Size	Price
013106	12CPVC45	1/2"	
014679	34CPVC45	3/4"	

#### CPVC Sch 40 Female Adapter (Soc x FIP)



Part #	Mfg #	Size	Price
013101	12CPVCFA	1/2"	
014672	34CPVCFA	3/4"	

#### CPVC Sch 40 Male Adapter (Soc x MIP)



Part #	Mfg #	Size	Price
013102	12CPVCMA	1/2"	
014674	34CPVCMA	3/4"	

#### CPVC Sch 40 Cap (Soc)



Part #	Mfg #	Size	Price
013097	12CPVCCA	1/2"	
014670	34CPVCCA	3/4"	
216987	1CPVCCA	1"	

### Snap-On Strap Polypropylen - CPVC-CTS 4724



Part #	Mfg #	Size	Price
013103	12CPVCSTRAP	1/2"	



### CPVC/CTS Fittings

#### CPVC CTS Union (Soc w/EPDM O-Ring Seal)

- Maximum internal pressure: 100 psi @ 180°F



Part #	Mfg #	Size	Price
074831	12CPVCU	1/2"	

#### CPVC CTS Drop Ear Elbow (Soc x SS FIPT)

- Stainless steel thread
- NSF® Certified Lead Free



Part #	Mfg #	Size	Price
191844	12CPVCDE90SS	1/2"	

#### CPVC CTS Male Adapter (Soc x SS MIP)

- Stainless steel thread transition
- NSF® Certified Lead Free



Part #	Mfg #	Size	Price
191839	12CPVCMAS	1/2"	
191840	34CPVCMAS	3/4"	



## CPVC (CTS) Fittings

### CPVC CTS Female Adapter (Soc x SS FIP)

- Stainless steel thread transition
- NSF® Certified Lead Free



Part #	Mfg #	Size	Price
191831	12CPVCFASS	1/2"	
191832	34CPVCFASS	3/4"	

### CPVC/CTS Valves

#### CPVC CTS Ball Valve (Soc)

- EPDM O-Ring



Part #	Mfg #	Size	Price
039563	34CPVCBV	3/4"	



### CPVC Adapters

#### Metal Head™ Straight Adapter Male Swt x CPVC

- Perfect for connecting sillcocks, laundry boxes, water service connections, etc.
- All fittings are production tested to ensure maximum quality and a leak-free connection
- Use caution when soldering whenever possible, solder with CPVC socket facing downward. If CPVC joint is above solder joint, plug temporarily with nipple and cap to prevent chimney effect. Always apply torch to female fitting, not to the adapter. Perform all solder joints a minimum of: 10" from 1/2" and 3/4" CPVC sockets 18" from 1" and 1 1/4" CPVC sockets 20" from 1 1/2" CPVC socket 22" from 2" CPVC socket. Use a commercial heat blocking agent between solder joint and CPVC joint.



Part #	Mfg #	Connection	Price
183745	643-C311	(3/4") CPVC x M SWT	

### PowerPEX® F1807 PEX Crimp x Metal Head™ CPVC Straight Adapter

- No lead, & quick and easy transition
- Perfect for hooking up PEX underground water service lines to CPVC in-house piping systems

Part #	Mfg #	Connection	Price
183757	645XC3	(3/4") CPVC x PEX	
183759	645XC4	(1") CPVC x PEX	
183758	645XC34	1" CPVC x 3/4" PEX	

### Fire/Flameguard

#### PowerPEX® ASTM F2159 Elbow



Part #	Mfg #	Connection	Price
217028	642PX3	3/4" F2159 x 3/4" F2159	

## Dielectric Unions

### Dielectric Unions

#### 3000 Series Dielectric Union/Fitting

- Protects against destructive effect of galvanic and stray current corrosion
- For residential, commercial and industrial

#### LF3001A Dielectric Union FIP Thread to Solder



Part #	Mfg #	Model	Size	Price
210742	34DIUFLFHD	LF3001A	1-1/2"	

#### LF3002 Dielectric Union FIP Thread to Solder



Part #	Mfg #	Model	Size	Price
210743	3412DIUFLFHD	LF3002	3/4" x 1/2"	
158092	341DIUFLF	LF3002	1"	

#### LF3004 Dielectric Unions FIP thread to FIP Thread

Part #	Mfg #	Model	Size	Price
158093	112DIUFFLF	LF3004	1-1/2"	

#### Dielectric Union (MIP x Swt)



Part #	Mfg #	Model	Size	Price
158083	12DIUMLF	LF3005A	1/2"	
158084	34DIUMLF	LF3005A	3/4"	

#### Flanged Iron Pipe Thread to Copper Solder Joint Dielectric Union



Part #	Mfg #	Model	Size	Price
158094	212DIUFLF	LF3100	2-1/2"	
158095	3DIUFLF	LF3100	3"	

#### 301 Series Dielectric Union/Fitting

- Protects against destructive effect of galvanic and stray current corrosion
- For residential, commercial and industrial

#### Dielectric Union (FIP x Swt)



Part #	Mfg #	Model	Size	Price
158085	12DIUFLF	LF301	1/2" FIP	
158086	34DIUFLF	LF301	3/4" FIP	
158087	1DIUFLF	LF301	1" FIP	
158088	114DIUFLF	LF301	1-1/4" FIP	
158089	112DIUFLF	LF301	1-1/2" FIP	
158090	2DIUFLF	LF301	2" FIP	
158091	3412DIUFLF	LF301	3/4" x 1/2"	

#### Dielectric Union (MIP x Swt)

Part #	Mfg #	Model	Size	Price
191039	1234DIUMLF	301-205NL	1/2" x 3/4"	

### Accessories and Parts

#### Accessories

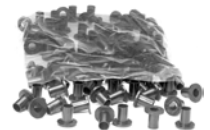

Part #	Mfg #	Description	Price
164513	WT0889142	1/2" Bolt Insulator	
002556	WT0889144	5/8" Bolt Insulator	
164514	WT0889148	7/8" Bolt Insulator	
030597	WT0889146	3/4" Bolt Insulator	



## Flexible Couplings

### Band-Seal® Specialty Couplings

- Shielded transition couplings join similar and dissimilar pipe sizes and pipe materials
- Resists shear forces while maintaining alignment
- Corrosion-resistant 300 Series stainless steel components
- Internal rubber sleeve reduces noise and vibration
- Neoprene rubber sleeve conforms to ASTM C 564



#### C Series

- CI= Cast Iron
- PL= Schedule 40 Plastic
- ST= Steel

### 300 Series Stainless Steel Worm Drive Clamping Mechanisms are standard on all Couplings

Part #	Mfg #	Description	Price
135775	C 320	3" CI to 2" CI, PL or ST	

#### CP Series

- CI= Cast Iron
- PL= Schedule 40 Plastic
- ST= Steel
- XH CI= Extra Heavy Cast Iron

Part #	Mfg #	Description	Price
007139	CP 150	1-1/2" CI, PL or ST to 1-1/2" CI, PL or ST	
007140	CP 200	2" CI, PL or ST to 2" CI, PL or ST	
007141	CP 215	2" CI, PL or ST to 1-1/2" CI, PL or ST	
007142	CP 33	3" CI to 3" PL, ST or XH CI	
007143	CP 43	4" CI to 3" PL, ST or XH CI	
007144	CP 44	4" CI to 4" PL, ST or XH CI	
063377	CP 55	5" CI to 5" PL, ST or XH CI	
063379	CP 66	6" CI to 6" PL, ST or XH CI	
055439	CP 88	8" CI to 8" PL, ST or XH CI	

### CK Series

- CI= Cast Iron
- K= Copper
- PL= Schedule 40 Plastic
- ST= Steel

Part #	Mfg #	Description	Price
007131		1-1/2" CI, PL or ST to 1-1/4" K or 1" PL or ST	
007132	CK1125	1-1/2" CI, PL or ST to 1-1/2" K or 1-1/4" PL or ST	
007133	CK115	2" CI, PL or ST to 1-1/4" K or 1" PL or ST	
007134	CK 215	2" CI, PL or ST to 1-1/2" K or 1-1/4" PL or ST	
007135	CK 22	2" CI, PL or ST to 2" K	
138807	CK 315	3" CI to 1-1/2" K or 1-1/4" PL or ST	
076967	CK 32	3" CI to 2" K	
007136	CK33	3" CI to 3" K	
007137	CK 43	4" CI to 3" K	
007138	CK 44	4" CI to 4" K	

### K Series

- K= Copper
- PL= Schedule 40 Plastic
- ST= Steel

Part #	Mfg #	Description	Price
170794	K 075	3/4" K to 3/4" K (O.D. 0.0875")	
110461	K 1125	1-1/2" K or 1-1/4" PL, ST to 1-1/4" K or 1" PL, ST	
007145	K 150	1-1/2" K or 1-1/4" PL, ST to 1-1/2" K or 1-1/4" PL, ST	
007146	K 200	2" K to 2" K	
069234	K 300	3" K to 3" K	

### KC Series

- CI= Cast Iron
- K= Copper
- PL= Schedule 40 Plastic
- ST= Steel
- T= Tubular

Part #	Mfg #	Description	Price
054046	KC 43	4" K to 3" CI, PL or ST	





## Flexible Couplings

### P Series

- *CI= Cast Iron*
- *K= Copper*
- *PL= Schedule 40 Plastic*
- *ST= Steel*
- *XH CI= Extra Heavy Cast Iron*

Part #	Mfg #	Description	Price
170795	P 075	3/4" PL, ST or 1" K to 3/4" PL, ST or 1" K	
162701	P 100	1" PL, ST or 1-1/4" K to 1" PL, ST or 1-1/4" K	
170796	P 175	3/4" PL, ST or 1" K to 1" PL, ST or 1-1/4" K	
079865	P 250	2-1/2" PL or ST to 2-1/2" PL or ST	
078996	P 300	3" PL, ST or XH CI to 3" PL, ST or XH CI	
075318	P 400	4" PL, ST or XH CI to 4" PL, ST or XH CI	
160474	P 430	4" PL, ST or XH CI to 3" PL, ST or XH CI	

### PK Series

- *CI= Cast Iron*
- *K= Copper*
- *PL= Schedule 40 Plastic*
- *ST= Steel*
- *XH CI= Extra heavy Cast Iron*

Part #	Mfg #	Description	Price
007147	PK 33	3" PI, ST or XH CI to 3" K	

### T Series

- *CI= Cast Iron*
- *PL= Schedule 40 Plastic*
- *ST= Steel*
- *T= Tubular*

Part #	Mfg #	Description	Price
021665	T 150	1-1/2" T to 1-1/2" CI, PL or ST	
115022	T 215	1-1/2" T to 2" CI, PL or ST	

### TWC & TWP Series

- *CI= Cast Iron*
- *TWP= Thin wall Plastic*
- *PL= Schedule 40 Plastic*
- *ST= Steel*
- *XH CI= Extra Heavy Cast Iron*

Part #	Mfg #	Description	Price
044261	TWC 44	4" TWP to 3" CI	
044263	TWP 44	4" TWP to 4" PL, ST or XH CI	

### Flex-Seal® Couplings

- *Flexible rubber couplings connect any 2 pipes without use of bushing's*
- *Sleeve manufactured of molded natural and synthetic rubber*
- *Leak proof seal*
- *(2) 300 Series SS worm drive clamping bands*
- *Conforms to ASTM C 425, ASTM C 1173 and ISO 9002*



### MR56 Series - CI/PL to CI/PL

- *Cast iron or plastic to cast iron or plastic*

Part #	Mfg #	Description	Price
003037	CPLG56125	1-1/2" Tbg/Cpr or 1-1/4" PL to 1-1/2" Tbg/Cpr or 1-1/4" PL	
003038	CPLG56150	1-1/2" CI/PL to 1-1/2" CI/PL	
003039	CPLG56150125	1-1/4" CI/PL to 1-1/2" Tbg/Cpr or 1-1/4" PL	
003040	CPLG56215	2" CI/PL to 1-1/2" CI/PL	
003041	CPLG5622	2" CI/PL to 2" CI/PL	
003025	CPLG5632	3" CI/PL to 2" CI/PL	
003042	CPLG5633	3" CI/PL to 3" CI/PL	
003043	CPLG5642	4" CI/PL to 2" CI/PL	
003044	CPLG5643	4" CI/PL to 3" CI/PL	
003045	CPLG5644	4" CI/PL to 4" CI/PL	
052674	CPLG5654	5" CI/PL to 4" CI/PL	
036055	CPLG5655	5" CI/PL to 5" CI/PL	
003046	CPLG5664	6" CI/PL to 4" CI/PL	
003047	CPLG5666	6" CI/PL to 6" CI/PL	
095771	CPLG5686	8" CI/PL to 6" CI/PL	
003048	CPLG5688	8" CI/PL to 8" CI/PL	
003035	CPLG561010	10" CI/PL to 10" CI/PL	

### MR01 Series - Clay to Clay

Part #	Mfg #	Description	Price
003027	CPLG144	4" CL to 4" CL	



## Flexible Couplings

### Flex-Seal® Couplings (Continued)

#### MR01 Series - Clay to Clay

Part #	Mfg #	Description	Price
003029	CPLG166	6" CL to 6" CL	
003030	CPLG188	8" CL to 8" CL	

#### MR02 Series - Clay to CI/PL

- Clay to cast iron or plastic

Part #	Mfg #	Description	Price
003031	CPLG244	4" CL to 4" CI/PL	
003032	CPLG264	6" CL to 4" CI/PL	
003033	CPLG266	6" CL to 6" CI/PL	
003034	CPLG288	8" CL to 8" CI/PL	
019029	CPLG21212	12" CL to 12" CI/PL	

### Flex-Seal® Adjustable Repair Couplings

- Flexible rubber couplings connect any two pipes without use of bushing's
- Sleeve manufactured of molded natural and synthetic rubber
- Sealing o-rings under each sealing clamp band
- (2) Surgical grade 316 stainless steel nut and bolt clamping bands



#### MR02 Series - Clay to CI/PL (2)

- Clay to cast iron or plastic

Part #	Mfg #	Description	Price
043362	CPLG0244SR	4" CL to 4" CI/PL	
043364	CPLG0264SR	6" CL to 4" CI/PL	
043363	CPLG0266SR	6" CL to 6" CI/PL	

#### MR56 Series - CI/PL to CI/PL

- Cast iron or plastic to cast iron or plastic

Part #	Mfg #	Description	Price
084837	CPLG5622SR	2" CI/PL to 2" CI/PL	
031825	CPLG5633SR	3" CI/PL to 3" CI/PL	
031826	CPLG5644SR	4" CI/PL to 4" CI/PL	
049769	CPLG5664SR	6" CI/PL to 4" CI/PL	
031827	CPLG5666SR	6" CI/PL to 6" CI/PL	
106437	CPLG5688SR	8" CI/PL to 8" CI/PL	

### Flex-Seal®

#### Compression Joint Sealer

- Joins bell and spigot pipe



Part #	Mfg #	Description	Price
005671	DONUT215	2" CI SV Hub to 1-1/2" Sch 40 PL, ST	
005672	DONUT225	2" CI SV Hub to 2" Sch 40 PL, ST, CI XH	
005674	DONUT325	3" CI SV Hub to 2" Sch 40 PL, ST, CI XH	
005675	DONUT335	3" CI SV Hub to 3" Sch 40 PL, ST, CI XH	
005676	DONUT425	4" CI SV Hub to 2" Sch 40 PL, ST, CI XH	
005677	DONUT435	4" CI SV Hub to 3" Sch 40 PL, ST, CI XH	
086488	MNMR44UX305	4" CI XH Hub to 3" Sch 40 PL, ST, CI XH	
005678	DONUT445	4" CI SV Hub to 4" Sch 40 PL, ST, CI XH	

#### Compression O-Ring

- Used in joining 6" inside diameter pipe to 4" outside diameter CI/Sch 40 PL/ST pipe

Part #	Mfg #	Description	Price
095777	MR64	Compression O Ring	

#### Drain Piping to Tubular Trap



Part #	Mfg #	Description	Price
114882	CPLGDTC150D S	1-1/4" or 1-1/2" x 1-1/4" or 1-1/2"	

#### Coupling Shear Ring

Part #	Mfg #	Size	Price
125562	CPLGSHEARRI NG3	3"	
124757	CPLGSHEARRI NG4	4"	



## Flexible Couplings

### Flex-Seal® (Continued)

#### Coupling Shear Ring

Part #	Mfg #	Size	Price
124758	CPLGSHEARRI NG6	6"	

### Band-Seal® End Caps

#### End Cap

- Reusable
- Strong-molded "x" braces against head pressures and axially tapered design distributes and dissipates internal stress
- Needs no plastic liner
- Made of high quality rubber
- Resists water and ozone
- Tight fitting, molded internal cone is integral part of end cap
- For use with cast iron, steel, PVC, and ABS piping materials



Part #	Mfg #	Size	Price
002738	CAPC150	1-1/2"	
002739	CAPC200	2"	
002740	CAPC300	3"	
002741	CAPC400	4"	
046504	CAPC600	6"	
090251	CAPC800	8"	



### Couplings Hi-Torq 125 Coupling



Part #	Mfg #	Size	Price
002742	10015	1-1/2"	
002743	10020	2"	
002744	10030	3"	
002745	10040	4"	
002746	10060	6"	



### Flexible Couplings

#### One-Piece Eccentric Couplings

- Aligns the inside wall of the two pipes
- Provides an obstruction free flow
- Meets ASTM C 1173 and D 5936
- 300 Series stainless steel clamp



Part #	Mfg #	Description	Price
139647	CPLG100264E C	6" Clay to 4" CI or PL	

#### Tubular Drain Pipe Connector

- Alter or repairs any combination of brass or plastic drain pipe



TC-150



DTC-150

Part #	Mfg #	Description	Price
192847	FETC150	Tubular Drain Pipe Connector	
192838	FEDTC150	Drain & Trap Connector	

#### Condensate Pipe Connector

- Connects 3/4" plastic or 3/4" and 1" copper condensate pipe
- Maximum test pressure: 4.3 PSI
- Maximum operating temp: 140°F
- Stainless steel clamps are corrosion-resistant and rust-proof



Part #	Mfg #	Description	Price
194776	CPLG56075	3/4"	
194777	CPLG56100	1"	

## Flexible Couplings

### DFW Flexible Sewer Saddles

#### Plastic Sewer Saddle Tee with Clamps



Part #	Mfg #	Pipe Size	Price
018217	DFW-4T/C	4"	



### Flexible Saddles

- *Elastomeric construction provides maximum strength and flexibility*



Part #	Mfg #	Description	Price
062129	DFW-4Y/C	4" Wye with Clamps	
120005	33S248	Full Serrated Clamps for Saddle Skirts	

### Flexible Couplings

Part #	Mfg #	Description	Price
122376	81020	2 Clamp-All Coupling	
165061	81040	4 Clamp-All Coupling	

## Flexible Gas Fittings

### AutoSnap® Fittings & Accessories

#### AutoSnap® Straight Fitting

- Brass



Part #	Mfg #	Size	Price
164302	TP38ASF	3/8"	
164303	TP12ASF	1/2"	
164304	TP34ASF	3/4"	
164305	TP1ASF	1"	

#### AutoSnap® Reducing Tee

- CounterStrike/ All Outlets



Part #	Mfg #	Size	Price
163466	TP343412T	3/4" x 3/4" x 1/2"	
163469	TP1134T	1" x 1" x 3/4"	

#### AutoSnap® Coupling

- Brass



Part #	Mfg #	Size	Price
183274	TP38ASCP	3/8"	
183275	TP12ASCP	1/2"	
183276	TP34ASCP	3/4"	
183279	TP1ASCP	1"	

#### AutoSnap® Flange Fittings

- Brass and Stainless Steel plate



Part #	Mfg #	Size	Price
183282	TP38ASFF	3/8"	
183284	TP12ASFF	1/2"	
183286	TP34ASFF	3/4"	

### AutoSnap® Fittings & Accessories (Continued)

#### AutoSnap® Flange Fittings

Part #	Mfg #	Size	Price
183287	TP1ASFF	1"	

#### AutoSnap® Wallbox with Valve



Part #	Mfg #	Size	Price
183281	TP12ASMWV	1/2"	

### AutoFlare® Fittings & Accessories

#### AutoFlare® PS-II MNPT Adapter



Part #	Mfg #	Size	Price
119635	TP12UGMA	1/2"	
119636	TP34UGMA	3/4"	
124302	TP1UGMA	1"	

#### AutoFlare® Straight Mechanical Fitting



FGP-FS      FGP-FST

Part #	Mfg #	Size	Price
107504	TP12SA	1/2"	
112498	TP34SA	3/4"	
112497	TP1SA	1"	
119556	TP114SA	1-1/4"	
124677	TP112SA	1-1/2"	

#### AutoFlare® Spare Split Ring



Part #	Mfg #	Size	Price
107505	TP12SR	1/2"	

**Flexible Gas Fittings**

**AutoFlare® Fittings & Accessories  
(Continued)**

**AutoFlare® Spare Split Ring**

Part #	Mfg #	Size	Price
119609	TP34SR	3/4"	
119610	TP1SR	1"	

**AutoFlare® Meter Termination**



Part #	Mfg #	Size	Termination	Price
115086	TP12MT6	1/2"	6"	
115087	TP34MT6	3/4"	6"	
115088	TP1MT6	1"	6"	

**AutoFlare® Termination Mount Fitting**



Part #	Mfg #	Size	Price
118993	TP12TM	1/2"	

**AutoFlare® Bracket & Stub-Out**



FGP-FPT-500

Part #	Mfg #	Description	Price
118481	TP12FPSO	1/2" Fireplace Stub-Out	
119613	TP12ASO	1/2" x 2-1/2" Appliance Stub-Out	

**AutoFlare® Outlet Tee**



Part #	Mfg #	Size	Price
122482	TP12T	1/2"	
122483	TP34T	3/4"	

**AutoFlare® Coupling**



Part #	Mfg #	Size	Price
117345	TP12CP	1/2"	
120386	TP34CP	3/4"	
120387	TP1CP	1"	

**AutoFlare® Flange Fitting**



BFF-50



BFF-750

Part #	Mfg #	Size	Material	Price
112496	TP12BFF	1/2"	Brass	
112495	TP34BFF	3/4"	Brass	
112494	TP1BFF	1"	Brass	

**AutoFlare® 90° Elbow Flange Fitting**



Part #	Mfg #	Size	Material	Price
130582	TP12FF90	1/2"	Brass	



## Flexible Gas Fittings

### AutoFlare® 90° Elbow Flange Valve



Part #	Mfg #	Size	Material	Price
119611	TP12BF90V	1/2"	Brass	

### Floppy Steel Conduit



Part #	Mfg #	Fits	Size	Length	Price
119625	TP12FSC	1/2"	1"	1'	
119626	TP34FSC	3/4"	1-1/4"	1'	
119627	TP1FSC	1"	1-1/2"	1'	

### TracPipe® Accessories & Tools

#### Manifold

- (4) Ports 1/2" female



FGP-MI-PC



FGP-MB2

Part #	Mfg #	Description	Price
119617	TP341212CM4	4" x 1/2" Coated	
119618	TPFGPMB2	Bracket for Use with FGP-MI-PC Only	

### Silicon Tape

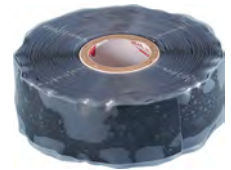

Part #	Mfg #	Size	Color	Price
119628	TPTAPEOS	1" x 12 yds	Yellow	
119629	TPTAPEBLK	1" x 12 yds	Black	

### Pressure Regulator

- Cast housing suitable for outdoor use
- Includes an approved vent limiter



Part #	Mfg #	Regulator	Size	Price
119631	TP12REG2PSI	2 psi, 8"wc	1/2"	

### Leak Check

- Non-corrosive solution

Part #	Mfg #	Description	Price
119630	TPLCS	1 Quart	

### Bonding Clamp

Part #	Mfg #	Description	Price
119619	TP381234BC	For 3/8" - 3/4" TracPipe	
119620	TP1114BC	For 1" - 1-1/4" TracPipe	

### TracPipe® Protection Devices

#### Striker Plate

- Hardened carbon steel



Quarter



Half



Full

Part #	Mfg #	Size	Material	Price
119621	TPQSP	3" x 2"	Quarter	
119622	TPHSP	3" x 7"	Half	
119623	TPTQSP	3" x 8"	Half	
119624	TPFSP	3" x 12"	Full	

### Wall Outlet Boxes



Part #	Mfg #	Description	Price
112493	TP12MWB	Metal Box with 1/2" Valve, Fire Rated	
121236	TP34MWB	Metal Box with 3/4" Valve, Fire Rated	

## Flexible Gas Fittings

### Wardflex Fittings

#### Wardflex Male Mechanical Joint

- Approved for concealed use
- One corrugation crush seal
- Reusable
- 3/8" through 1-1/4" patented STEPSAVER fittings
- 1-1/2" and 2" fittings - Reliable gasket seal



Part #	Mfg #	Size	Price
190546	WF201	3/8" x 1/2"	
190547	WF202	1/2"	
190548	WF203	3/4"	
193108	WF204	1" x 3/4"	
194253	WF205	1" x 1"	
196153	WF206	1-1/4"	
196871	WF207	1-1/2"	

#### Wardflex Female Mechanical Joint

- Approved for concealed use
- One corrugation crush seal
- Reusable
- 3/8" through 1-1/4" patented STEPSAVER fitting
- 1-1/2" and 2" fittings - Reliable gasket seal



Part #	Mfg #	Size	Price
193911	WF251	1/2"	
193912	WF252	3/4"	
193914	WF254	1"	

#### Wardflex Mechanical Coupling

- Approved for concealed use
- One corrugation crush seal
- Reusable
- 3/8" through 1-1/4" patented STEPSAVER fittings
- 1-1/2" and 2" fittings - Reliable gasket seal



Part #	Mfg #	Size	Price
193915	WF261	1/2"	
193916	WF262	3/4"	
193917	WF263	1"	

#### Wardflex Male Termination Fitting

- Provides fixed point termination on wall or floor
- One corrugation crush seal
- Reusable
- 3/8" through 1-1/4" patented STEPSAVER fittings
- Base Plate Steel



Part #	Mfg #	Size	Price
190550	WF271	1/2"	
193954	WF272	3/4"	
201548	WF274	1"	

#### Wardflex Male Outdoor Termination Fitting

- Provides fixed point termination on wall or floor
- One corrugation crush seal
- Reusable
- 3/8" through 1-1/4" patented STEPSAVER fittings
- Base Plate Steel
- Outdoor fittings are supplied w/o-rings



Part #	Mfg #	Size	Price
190558	WF281	1/2"	
190559	WF282	3/4"	
195777	WF284	1"	

#### Wardflex Mechanical Tees

- Approved for concealed use
- One corrugation crush seal
- Reusable
- 3/8" through 1-1/4" patented STEPSAVER fittings
- 1-1/2" and 2" fittings - Reliable gasket seal



Part #	Mfg #	Size	Price
193918	WF351	1/2"	
193919	WF365	3/4" x 3/4" x 1/2"	
199212	WF366	3/4" x 1/2" x 1/2"	
193920	WF352	3/4"	
199622	WF353	1"	
199924	WF358	1" x 1" x 1/2"	
199969	WF357	1" x 1" x 3/4"	

## Flexible Gas Fittings

### Appliance Stub Out

- Fixed termination point with male NPT connections
- Stub Out Pipe - schedule 40 steel pipe
- Plate - 14 Gauge Steel
- Coating - Black Paint, except threads



Part #	Mfg #	Size	Price
193941	WF381	1/2"	
193940	WF382	3/4"	

### Meter Stub Out

- Fixed termination point with male NPT connections
- Stub Out Pipe - schedule 40 steel pipe
- Plate - 14 Gauge Steel
- Coating - Black Paint, except threads



Part #	Mfg #	Size	Price
195148	WF3992	1/2" x 6"	

### Cross Manifolds

- Multiple sizes and configurations
- Female NPT connections
- Central distribution center
- Malleable Iron



Part #	Mfg #	Size	Price
209839	WF606	1" x 3/4"	

### Striker Plates

- Provides protection from puncture threats where tubing is concealed and restricted
- Striker plate - 16 gauge 1050 steel
- Hardness - Rockwell 30-40c



Part #	Mfg #	Size	Price
190554	WF610	1.50" x 3.25"	

### Wardflex Fittings (Continued)

#### Striker Plates

Part #	Mfg #	Size	Price
190553	WF611	6.50" x 3.25"	
190552	WF612	11.50" x 3.25"	

#### Stripwound Conduit



Part #	Mfg #	Size	Price
196305	WF623	1/2" x 12"	
196306	WF625	3/4" x 12"	

#### Tubing Cutters



Part #	Mfg #	Size	Price
190555	WF662	3/8" to 3/4"	
200734	WF664	3/4" to 1-1/4"	

#### Flush Mount Gas Valve Kit

- Provides flush mount termination for appliance connections
- White Box



Part #	Mfg #	Size	Price
195149	WF701	1/2"	
209097	WF702	3/4"	

#### Bounding Clamps



Part #	Mfg #	Size	Price
198634	WF800	3/8-1"	

---

---

## Flexible Gas Fittings

---

---

### Gas Fittings

#### SnapFast® Deluxe Quick-Disconnect

- Includes nipple and coupling

Part #	Mfg #	Size	Price
138022	A75	3/4"	
138023	A100	1"	

**Flo Control PVC Fittings**

**Compression Fittings**  
**PVC IPS Comp Coupling**



Part #	Mfg #	IPS Size	Body Length	Price
229181	CPC-0500	1/2"	4"	
229182	CPC-0500	3/4"	4-1/4"	
229183	CPC-1000	1"	4-1/2"	
229185	CPC-1250	1-1/4"	5"	
229190	CPC-1500	1-1/2"	5-1/2"	
229191	CPC-2000	2"	6"	
229192	CPC-2500	2-1/2"	8"	
229198	CPC-4000	4"	10"	

**Expansion Repair Couplings**

**PVC Pro-Span™ PVC Repair Coupling**

- *Non-union*



Part #	Mfg #	IPS Size	Price
004412	118-25	2-1/2"	
018078	118-30	3"	
004413	118-40	4"	

**Galvanized Steel Fittings**

**Galvanized Malleable Iron Fittings**

**Threaded 150# Galv MI 45° Elbow**



Mfg #	Size	Price
18G45	1/8"	
14G45	1/4"	
38G45	3/8"	
12G45	1/2"	
34G45	3/4"	
1G45	1"	
114G45	1-1/4"	
112G45	1-1/2"	
2G45	2"	
212G45	2-1/2"	
3G45	3"	

**Threaded 150# Galv MI 45° Street Elbow**



Mfg #	Size	Price
18GS45	1/8"	
14GS45	1/4"	
38GS45	3/8"	
12GS45	1/2"	
34GS45	3/4"	
1GS45	1"	
114GS45	1-1/4"	
112GS45	1-1/2"	
2GS45	2"	

**Threaded 150# Galv MI 90° Elbow**



Mfg #	Size	Price
18G90	1/8"	
14G90	1/4"	
38G90	3/8"	

**Galvanized Malleable Iron Fittings (Continued)**

**Threaded 150# Galv MI 90° Elbow**

Mfg #	Size	Price
12G90	1/2"	
34G90	3/4"	
1G90	1"	
114G90	1-1/4"	
112G90	1-1/2"	
2G90	2"	
212G90	2-1/2"	
3G90	3"	
4G90	4"	

**Threaded 150# Galv MI 90° Street Elbow**



Mfg #	Size	Price
18GS90	1/8"	
14GS90	1/4"	
38GS90	3/8"	
12GS90	1/2"	
34GS90	3/4"	
1GS90	1"	
114GS90	1-1/4"	
112GS90	1-1/2"	
2GS90	2"	

**Threaded 150# Galv MI 90° Reducing Elbow**



Mfg #	Size	Price
1238G90	1/2" x 3/8"	
1214G90	1/2" x 1/4"	
3438G90	3/4" x 3/8"	
3412G90	3/4" x 1/2"	

**Galvanized Malleable Iron Fittings (Continued)**

**Threaded 150# Galv MI 90° Reducing Elbow**

Mfg #	Size	Price
112G90R	1" x 1/2"	
134G90	1" x 3/4"	
11412G90	1-1/4" x 1/2"	
1141G90	1-1/4" x 1"	
1121G90	1-1/2" x 1"	
112114G90	1-1/2" x 1-1/4"	
2112G90	2" x 1-1/2"	

**Threaded 150# Galv MI Half Coupling**

Mfg #	Size	Price
12GMCP	1/2"	
34GMCP	3/4"	
1GMCP	1"	
114GMCP	1-1/4"	
112GMCP	1-1/2"	
2GMCP	2"	

**Galv MI Merchant Coupling**



Mfg #	Size	Price
18GCP	1/8"	
14GCP	1/4"	
38GCP	3/8"	
12GCP	1/2"	
34GCP	3/4"	
1GCP	1"	
114GCP	1-1/4"	
112GCP	1-1/2"	
2GCP	2"	
212GCP	2-1/2"	
3GCP	3"	
4GCP	4"	



**Galvanized Steel Fittings**

**Threaded 150# Galv MI  
Reducer**



Mfg #	Size	Price
1418GCP	1/4" x 1/8"	
3814GCP	3/8" x 1/4"	
1218GCP	1/2" x 1/8"	
1214GCP	1/2" x 1/4"	
1238GCP	1/2" x 3/8"	
3418GCP	3/4" x 1/8"	
3414GCP	3/4" x 1/4"	
3438GCP	3/4" x 3/8"	
3412GCP	3/4" x 1/2"	
112GCP	1" x 1/2"	
134GCP	1" x 3/4"	
11412GCP	1-1/4" x 1/2"	
11434GCP	1-1/4" x 3/4"	
1141GCP	1-1/4" x 1"	
11212GCP	1-1/2" x 1/2"	
11234GCP	1-1/2" x 3/4"	
1121GCP	1-1/2" x 1"	
112114GCP	1-1/2" x 1-1/4"	
234GCP	2" x 3/4"	
21GCP	2" x 1"	
2114GCP	2" x 1-1/4"	
2112GCP	2" x 1-1/2"	
212112GCP	2-1/2" x 1-1/2"	
2122GCP	2-1/2" x 2"	
32GCP	3" x 2"	
3212GCP	3" x 2-1/2"	

**Threaded 150# Galv MI Tee**



Mfg #	Size	Price
18GT	1/8"	
14GT	1/4"	
38GT	3/8"	
12GT	1/2"	
34GT	3/4"	

**Galvanized Malleable Iron  
Fittings (Continued)**

**Threaded 150# Galv MI Tee**

Mfg #	Size	Price
1GT	1"	
114GT	1-1/4"	
112GT	1-1/2"	
2GT	2"	
212GT	2-1/2"	
3GT	3"	
4GT	4"	

**Threaded 150# Galv MI  
Reducing Run/Outlet Tee**



Mfg #	Size	Price
123838GT	1/2" x 3/8" x 3/8"	
121214GT	1/2" x 1/2" x 1/4"	
341212GT	3/4" x 1/2" x 1/2"	
11212GT	1" x 1/2" x 1/2"	
13412GT	1" x 3/4" x 1/2"	
13434GT	1" x 3/4" x 3/4"	
114112GT	1-1/4" x 1" x 1/2"	
114134GT	1-1/4" x 1" x 3/4"	
1121141GT	1-1/2" x 1-1/4" x 1"	
11211212G	1-1/2" x 1-1/2" x 1/2"	
T	1/2"	
112112114	1-1/2"x1-1/2"x1-1/4"	
GT	1/4"	

**Threaded 150# Galv MI  
Reducing Run Tee**



Mfg #	Size	Price
341234GT	3/4" x 1/2" x 3/4"	
1341GT	1" x 3/4" x 1"	

**Threaded 150# Galv MI  
Reducing Outlet Tee**



Mfg #	Size	Price
121238GT	1/2" x 1/2" x 3/8"	
343412GT	3/4" x 3/4" x 1/2"	
1112GT	1" x 1" x 1/2"	
1134GT	1" x 1" x 3/4"	
11411434G	1-1/4" x 1-1/4" x 3/4"	
T	3/4"	
1141141GT	1-1/4" x 1-1/4" x 1"	
11211234G	1-1/2" x 1-1/2" x 3/4"	
T	3/4"	
1121121GT	1-1/2" x 1-1/2" x 1"	
2234GT	2" x 2" x 3/4"	
221GT	2" x 2" x 1"	
22112GT	2" x 2" x 1-1/2"	

**Threaded 150# Galv MI Cross**



Mfg #	Size	Price
12GCR	1/2"	
34GCR	3/4"	
1GCR	1"	

**Threaded 150# Galv MI Hex  
Bushing**



Mfg #	Size	Price
1418GBU	1/4" x 1/8"	
3818GBU	3/8" x 1/8"	
3814GBU	3/8" x 1/4"	
1218GBU	1/2" x 1/8"	
1214GBU	1/2" x 1/4"	
1238GBU	1/2" x 3/8"	
3418GBU	3/4" x 1/8"	

**Galvanized Steel Fittings**

**Galvanized Malleable Iron  
Fittings (Continued)**

**Threaded 150# Galv MI Hex  
Bushing**

Mfg #	Size	Price
3414GBU	3/4" x 1/4"	
3438GBU	3/4" x 3/8"	
3412GBU	3/4" x 1/2"	
118GBU	1" x 1/8"	
114GBU	1" x 1/4"	
138GBU	1" x 3/8"	
112GBU	1" x 1/2"	
134GBU	1" x 3/4"	
11414GBU	1-1/4" x 1/4"	
11412GBU	1-1/4" x 1/2"	
11434GBU	1-1/4" x 3/4"	
1141GBU	1-1/4" x 1"	
11214GBU	1-1/2" x 1/4"	
11212GBU	1-1/2" x 1/2"	
11234GBU	1-1/2" x 3/4"	
1121GBU	1-1/2" x 1"	
112114GBU	1-1/2" x 1-1/4"	
212GBU	2" x 1/2"	
234GBU	2" x 3/4"	
21GBU	2" x 1"	
2114GBU	2" x 1-1/4"	
2112GBU	2" x 1-1/2"	
212112GBU	2-1/2" x 1-1/2"	
2122GBU	2-1/2" x 2"	
3112GBU	3" x 1-1/2"	
32GBU	3" x 2"	
3212GBU	3" x 2-1/2"	
42GBU	4" x 2"	
43GBU	4" x 3"	
64GBU	6" x 4"	

**Threaded 150# Galv MI Cap**



Mfg #	Size	Price
18GCA	1/8"	
14GCA	1/4"	
38GCA	3/8"	

**Galvanized Malleable Iron  
Fittings (Continued)**

**Threaded 150# Galv MI Cap**

Mfg #	Size	Price
12GCA	1/2"	
34GCA	3/4"	
1GCA	1"	
114GCA	1-1/4"	
112GCA	1-1/2"	
2GCA	2"	
212GCA	2-1/2"	
3GCA	3"	
4GCA	4"	

**Hex Caps**

Mfg #	Size	Price
12GHEXCA	1/2"	

**Threaded 150# Galv MI Floor  
Flange**



Mfg #	Size	Price
12GFF	1/2"	
34GFF	3/4"	
1GFF	1"	
114GFF	1-1/4"	
112GFF	1-1/2"	
2GFF	2"	

**Threaded 150# Galv MI  
Locknut**



Mfg #	Size	Price
12GLN	1/2"	
34GLN	3/4"	
1GLN	1"	
114GLN	1-1/4"	

**Threaded 150# Galv MI  
Square Headed Plug Cored**



Mfg #	Size	Price
18GPL	1/8"	
14GPL	1/4"	
38GPL	3/8"	
12GPL	1/2"	
34GPL	3/4"	
1GPL	1"	
114GPL	1-1/4"	
112GPL	1-1/2"	
2GPL	2"	
212GPL	2-1/2"	
3GPL	3"	

**Galvanized Malleable Iron  
Unions**

**Threaded 150# Galv MI  
Ground Joint All Iron Union**



Mfg #	Size	Price
38GU	3/8"	
14GU	1/4"	
12GU	1/2"	
34GU	3/4"	
1GU	1"	
114GU	1-1/4"	
112GU	1-1/2"	
2GU	2"	
212GU	2-1/2"	
3GU	3"	



**Galvanized Steel Fittings**

**Standard Galvanized Steel  
Nipples**



**1/8" Std Wt Galv Steel Nipple**

Mfg #	Size	Price
18CLGN	1/8" x Close	
18112GN	1/8" x 1-1/2"	
182GN	1/8" x 2"	
18212GN	1/8" x 2-1/2"	
183GN	1/8" x 3"	
18312GN	1/8" x 3-1/2"	
184GN	1/8" x 4"	
18412GN	1/8" x 4-1/2"	
185GN	1/8" x 5"	
18512GN	1/8" x 5-1/2"	
186GN	1/8" x 6"	

**1/4" Std Wt Galv Steel Nipple**

Mfg #	Size	Price
14CLGN	1/4" x Close	
14112GN	1/4" x 1-1/2"	
142GN	1/4" x 2"	
14212GN	1/4" x 2-1/2"	
143GN	1/4" x 3"	
144GN	1/4" x 4"	
14312GN	1/4" x 3-1/2"	
14412GN	1/4" x 4-1/2"	
145GN	1/4" x 5"	
14512GN	1/4" x 5-1/2"	
146GN	1/4" x 6"	

**3/8" Std Wt Galv Steel Nipple**

Mfg #	Size	Price
38CLGN	3/8" x Close	
38112GN	3/8" x 1-1/2"	
382GN	3/8" x 2"	
38212GN	3/8" x 2-1/2"	
383GN	3/8" x 3"	
38312GN	3/8" x 3-1/2"	
384GN	3/8" x 4"	

**Standard Galvanized Steel  
Nipples (Continued)**

**3/8" Std Wt Galv Steel Nipple**

Mfg #	Size	Price
38412GN	3/8" x 4-1/2"	
385GN	3/8" x 5"	
38512GN	3/8" x 5-1/2"	
386GN	3/8" x 6"	

**1/2" Std Wt Galv Steel Nipple**

Mfg #	Size	Price
12CLGN	1/2" x Close	
12112GN	1/2" x 1-1/2"	
122GN	1/2" x 2"	
12212GN	1/2" x 2-1/2"	
123GN	1/2" x 3"	
12312GN	1/2" x 3-1/2"	
124GN	1/2" x 4"	
12412GN	1/2" x 4-1/2"	
125GN	1/2" x 5"	
12512GN	1/2" x 5-1/2"	
126GN	1/2" x 6"	
127GN	1/2" x 7"	
128GN	1/2" x 8"	
1210GN	1/2" x 10"	
1211GN	1/2" x 11"	
121FTGN	1/2" x 12"	
1236GN	1/2" x 36"	

**3/4" Std Wt Galv Steel Nipple**

Mfg #	Size	Price
34CLGN	3/4" x Close	
34112GN	3/4" x 1-1/2"	
342GN	3/4" x 2"	
34212GN	3/4" x 2-1/2"	
343GN	3/4" x 3"	
34312GN	3/4" x 3-1/2"	
344GN	3/4" x 4"	
34412GN	3/4" x 4-1/2"	
345GN	3/4" x 5"	
34512GN	3/4" x 5-1/2"	
346GN	3/4" x 6"	
347GN	3/4" x 7"	

**Standard Galvanized Steel  
Nipples (Continued)**

**3/4" Std Wt Galv Steel Nipple**

Mfg #	Size	Price
348GN	3/4" x 8"	
349GN	3/4" x 9"	
3410GN	3/4" x 10"	
341FTGN	3/4" x 12"	

**1" Std Wt Galv Steel Nipple**

Mfg #	Size	Price
1CLGN	1" x Close	
12GN	1" x 2"	
1212GN	1" x 2-1/2"	
13GN	1" x 3"	
1312GN	1" x 3-1/2"	
14GN	1" x 4"	
1412GN	1" x 4-1/2"	
15GN	1" x 5"	
1512GN	1" x 5-1/2"	
16GN	1" x 6"	
17GN	1" x 7"	
18GN	1" x 8"	
19GN	1" x 9"	
110GN	1" x 10"	
111GN	1" x 11"	
11FTGN	1" x 12"	
118GN	1" x 18"	
1GN24	1" x 24"	

**1-1/4" Std Wt Galv Steel  
Nipple**

Mfg #	Size	Price
114CLGN	1-1/4" x Close	
1142GN	1-1/4" x 2"	
114212GN	1-1/4" x 2-1/2"	
1143GN	1-1/4" x 3"	
114312GN	1-1/4" x 3-1/2"	
1144GN	1-1/4" x 4"	
114412GN	1-1/4" x 4-1/2"	
1145GN	1-1/4" x 5"	
114512GN	1-1/4" x 5-1/2"	
1146GN	1-1/4" x 6"	

**Galvanized Steel Fittings**

**Standard Galvanized Steel  
Nipples (Continued)**

**1-1/4" Std Wt Galv Steel  
Nipple**

Mfg #	Size	Price
1148GN	1-1/4" x 8"	
1149GN	1-1/4" x 9"	
11410GN	1-1/4" x 10"	
1141FTGN	1-1/4" x 12"	

**1-1/2" Std Wt Galv Steel  
Nipple**

Mfg #	Size	Price
112CLGN	1-1/2" x Close	
1122GN	1-1/2" x 2"	
112212GN	1-1/2" x 2-1/2"	
1123GN	1-1/2" x 3"	
112312GN	1-1/2" x 3-1/2"	
1124GN	1-1/2" x 4"	
112412GN	1-1/2" x 4-1/2"	
1125GN	1-1/2" x 5"	
112512GN	1-1/2" x 5-1/2"	
1126GN	1-1/2" x 6"	
11210GN	1-1/2" x 10"	
1121FTGN	1-1/2" x 12"	

**2" Std Wt Galv Steel Nipple**

Mfg #	Size	Price
2CLGN	2" x Close	
2212GN	2" x 2-1/2"	
23GN	2" x 3"	
2312GN	2" x 3-1/2"	
24GN	2" x 4"	
2412GN	2" x 4-1/2"	
25GN	2" x 5"	
2512GN	2" x 5-1/2"	
26GN	2" x 6"	
28GN	2" x 8"	
21FTGN	2" x 12"	
218GN	2" x 18"	

**2-1/2" Std Wt Galv Steel  
Nipple**

Mfg #	Size	Price
212CLGN	2-1/2" x Close	
2123GN	2-1/2" x 3"	
212312GN	2-1/2" x 3-1/2"	
2124GN	2-1/2" x 4"	
2125GN	2-1/2" x 5"	
212512GN	2-1/2" x 5-1/2"	
2126GN	2-1/2" x 6"	

**3" Std Wt Galv Steel Nipple**

Mfg #	Size	Price
3CLGN	3" x Close	
33GN	3" x 3"	
34GN	3" x 4"	
3412GN	3" x 4-1/2"	
35GN	3" x 5"	
36GN	3" x 6"	
31FTGN	3" x 12"	

**4" Std Wt Galv Steel Nipple**

Mfg #	Size	Price
4CLGN	4" x CL	
4312GN	4" x 3-1/2"	
44GN	4" x 4"	
4412GN	4" x 4-1/2"	
46GN	4" x 6"	
41FTGN	4" x 12"	

**Galvanized Steel Nipple  
Sets**

**60 Pack Galv Steel Nipple  
Assortment**

Mfg #	Size	Price
1GN60PAC	1" Special-6	
114GN60PA C	1-1/4"	

**66 Pack Galv Steel Nipple  
Assortment**

Mfg #	Size	Price
12GN66PAC	1/2" Special-6	
34GN66PAC	3/4" Special-6	

## Geothermal Fittings

### Headers & Manifolds

#### Parallel Header

• Sold individually



Part #	Mfg #	Description	Price
055101	114334SFHEADER P	1-1/4" Inlet x (3) 3/4" Outlets	
055102	114434SFHEADER P	1-1/4" Inlet x (4) 3/4" Outlets	
054876	114434SFHEADER	1-1/4" Inlet x (4) 3/4" Outlet Alternated	
055103	114534SFHEADER P	1-1/4" Inlet x (5) 3/4" Outlets	
054877	114534SFHEADER	1-1/4" Inlet x (5) 3/4" Outlet Alternated	
055104	114634SFHEADER P	1-1/4" Inlet x (6) 3/4" Outlets	

### Socket Fusion Fittings

#### Socket Fusion Coupling



Part #	Mfg #	Size	Price
026588	34SFCP	3/4" X 3/4"	
026584	11434SFRCP	1-1/4" x 3/4"	
026585	1141SFRCP	1-1/4" x 1"	
026590	114SFCP	1-1/4" x 1-1/4"	
026587	2114SFRCP	2" x 1-1/4"	
054712	2SFCP	2" x 2"	

#### Socket Fusion 90° Elbow



Part #	Mfg #	Size	Price
054837	34SF90	3/4" x 3/4"	
054838	1SF90	1" x 1"	
054844	11434SF90	1-1/4" x 3/4"	
054839	114SF90	1-1/4" x 1-1/4"	
054840	112SF90	1-1/2" x 1-1/2"	
054841	2SF90	2" x 2"	

### Socket Fusion 45° Elbow



Part #	Mfg #	Size	Price
054848	114SF45	1-1/4" x 1-1/4"	
134037	2SF45	2" x 2"	

### Socket Fusion End Cap



Part #	Mfg #	Size	Price
026626	34SFCA	3/4"	

### Socket Fusion Tee



Part #	Mfg #	Size	Price
026579	34SFT	3/4" x 3/4" x 3/4"	
054728	1143434SFT	1-1/4" x 3/4" x 3/4"	
054729	11411434SFT	1-1/4" x 1-1/4" x 3/4"	
054731	1141141SFT	1-1/4" x 1-1/4" x 1"	
026581	114SFT	1-1/4" x 1-1/4" x 1-1/4"	
054732	2234SFT	2" x 2" x 3/4"	
092936	22114SFT	2" x 2" x 1-1/4"	
054734	2SFT	2" x 2" x 2"	

### PE Fusion Fittings

#### Fusion Male Adapter



Part #	Mfg #	Description	Price
026592	34SFMA	3/4" Fusion x 3/4" MPT	
092935	1141SFMA	1-1/4" Fusion x 1" MPT Nupi	
026594	114SFMA	1-1/4" Fusion x 1-1/4" MPT Nupi	
026595	112SFMA	1-1/2" Fusion x 1-1/2" MPT	
092938	2SFMA	2" Fusion x 2" MPT Nupi	



---

---

## Geothermal Fittings

---

---

### Fusion Ball Valve

Part #	Mfg #	Description	Price
117033	114SFBV	1-1/4" Valve Assembly with PE Pipe	



## Grooved Fittings

### Grooved Fittings

#### No. 11 45° Elbow



Part #	Mfg #	Size	Price
260615	34VIC45	3/4"	
260616	1VIC45	1"	
260617	114VIC45	1-1/4"	
260618	112VIC45	1-1/2"	
260619	2VIC45	2"	
260620	212VIC45	2-1/2"	
260621	3VIC45	3"	
260622	312VIC45	3-1/2"	
258520	4VIC45	4"	
260623	5VIC45	5"	
260624	6VIC45	6"	
260625	8VIC45	8"	
260626	10VIC45	10"	
260627	12VIC45	12"	

#### No. 10 90° Elbow



Part #	Mfg #	Size	Price
260600	34VIC90	3/4"	
260601	1VIC90	1"	
260602	114VIC90	1-1/4"	
260603	112VIC90	1-1/2"	
260604	2VIC90	2"	
260605	212VIC90	2-1/2"	
258515	3VIC90	3"	
260607	312VIC90	3-1/2"	
258517	4VIC90	4"	
260608	5VIC90	5"	
258518	6VIC90	6"	
260609	8VIC90	8"	
260611	10VIC90	10"	
260612	12VIC90	12"	

### No. 611 45° Copper Elbow



Part #	Mfg #	Size	Price
262317	2VICC45	2"	
262318	212VICC45	2-1/2"	
262320	3VICC45	3"	
262320	4VICC45	4"	

### No. 20 Tees



Part #	Mfg #	Size	Price
260667	34VICT	3/4"	
260668	1VICT	1"	
260669	114VICT	1-1/4"	
260670	112VICT	1-1/2"	
230746	2VICT	2"	
258522	212VICT	2-1/2"	
258523	3VICT	3"	
260671	312VICT	3-1/2"	
258524	4VICT	4"	
260672	5VICT	5"	
258525	6VICT	6"	
260673	8VICT	8"	
260674	10VICT	10"	
260675	12VICT	12"	

### No. 25 Reducing Tees



Part #	Mfg #	Size	Price
260676	1134VICT	1" x 1" x 3/4"	
260677	114114VICT	1-1/4" x 1-1/4" x 1"	
260678	11211234VICT	1-1/2" x 1-1/2" x 3/4"	
260679	1121121VICT	1-1/2" x 1-1/2" x 1"	
260680	112112114VICT	1-1/2" x 1-1/2" x 1-1/4"	
260681	2234VICT	2" x 2" x 3/4"	



## Grooved Fittings

### Grooved Fittings (Continued)

#### No. 25 Reducing Tees

Part #	Mfg #	Size	Price
260682	221VICT	2" x 2" x 1"	
260683	22114VICT	2" x 2" x 1-1/4"	
260684	22112VICT	2" x 2" x 1-1/2"	
260685	21221234VICT	2-1/2" x 2-1/2" x 3/4"	
260686	2122121VICT	2-1/2" x 2-1/2" x 1"	
260687	212212114VICT	2-1/2" x 2-1/2" x 1-1/4"	
260688	212212112VICT	2-1/2" x 2-1/2" x 1-1/2"	
260689	2122122VICT	2-1/2" x 2-1/2" x 2"	
260690	3334VICT	3" x 3" x 3/4"	
260691	331VICT	3" x 3" x 1"	
260692	33114VICT	3" x 3" x 1-1/4"	
260693	33112VICT	3" x 3" x 1-1/2"	
260694	332VICT	3" x 3" x 2"	
260695	33212VICT	3" x 3" x 2-1/2"	
260696	4434VICT	4" x 4" x 3/4"	
260697	441VICT	4" x 4" x 1"	
260698	44114VICT	4" x 4" x 1-1/4"	
260699	44112VICT	4" x 4" x 1-1/2"	
260700	442VICT	4" x 4" x 2"	
260701	44212VICT	4" x 4" x 2-1/2"	
260702	443VICT	4" x 4" x 3"	
260703	551VICT	5" x 5" x 1"	
260704	55112VICT	5" x 5" x 1-1/2"	
260705	552VICT	5" x 5" x 2"	
260706	55212VICT	5" x 5" x 2-1/2"	
260707	553VICT	5" x 5" x 3"	
260708	554VICT	5" x 5" x 4"	
260709	661VICT	6" x 6" x 1"	
260710	66112VICT	6" x 6" x 1-1/2"	
260711	662VICT	6" x 6" x 2"	
260712	66212VICT	6" x 6" x 2-1/2"	
260713	663VICT	6" x 6" x 3"	
260714	664VICT	6" x 6" x 4"	
260715	665VICT	6" x 6" x 5"	
260716	88112VICT	8" x 8" x 1-1/2"	
260717	882VICT	8" x 8" x 2"	
260718	88212VICT	8" x 8" x 2-1/2"	
260719	883VICT	8" x 8" x 3"	
260720	884VICT	8" x 8" x 4"	
260721	885VICT	8" x 8" x 5"	

### Grooved Fittings (Continued)

#### No. 25 Reducing Tees

Part #	Mfg #	Size	Price
260722	886VICT	8" x 8" x 6"	
260891	1010112VICT	10" x 10" x 1-1/2"	
260892	10102VICT	10" x 10" x 2"	
260894	1010212VICT	10" x 10" x 2-1/2"	
260895	10103VICT	10" x 10" x 3"	
260896	10104VICT	10" x 10" x 4"	
260897	10105VICT	10" x 10" x 5"	
260898	10106VICT	10" x 10" x 6"	
260899	10108VICT	10" x 10" x 8"	
260900	12121VICT	12" x 12" x 1"	
260903	12122VICT	12" x 12" x 2"	
260904	1212212VICT	12" x 12" x 2-1/2"	
260905	12123VICT	12" x 12" x 3"	
260906	12124VICT	12" x 12" x 4"	
260907	12125VICT	12" x 12" x 5"	
260908	12126VICT	12" x 12" x 6"	
260909	12128VICT	12" x 12" x 8"	
260910	121210VICT	12" x 12" x 10"	

#### No. 60 Caps



Part #	Mfg #	Size	Price
260862	34VICCA	3/4"	
260863	1VICCA	1"	
260865	114VICCA	1-1/4"	
260866	112VICCA	1-1/2"	
260867	2VICCA	2"	
260868	212VICCA	2-1/2"	
260869	3VICCA	3"	
260870	312VICCA	3-1/2"	
260871	4VICCA	4"	
260872	5VICCA	5"	
260873	6VICCA	6"	
260874	8VICCA	8"	
260875	10VICCA	10"	
260876	12VICCA	12"	

## Grooved Fittings

### No. 50 Concentric Reducers



Part #	Mfg #	Size	Price
260789	6112VICCONC	6" x 1-1/2"	
260758	11434VICCONC	1-1/4" x 3/4"	
260759	1141VICCONC	1-1/4" x 1"	
260760	11234VICCONC	1-1/2" x 3/4"	
260761	1121VICCONC	1-1/2" x 1"	
260762	112114VICCONC	1-1/2" x 1-1/4"	
260763	234VICCONC	2" x 3/4"	
260764	21VICCONC	2" x 1"	
260765	2114VICCONC	2" x 1-1/4"	
260766	2112VICCONC	2" x 1-1/2"	
260768	2121VICCONC	2-1/2" x 1"	
260769	212114VICCONC	2-1/2" x 1-1/4"	
260770	212112VICCONC	2-1/2" x 1-1/2"	
260771	2122VICCONC	2-1/2" x 2"	
260773	31VICCONC	3" x 1"	
260774	3114VICCONC	3" x 1-1/4"	
260775	3112VICCONC	3" x 1-1/2"	
258540	32VICCONC	3" x 2"	
260776	3212VICCONC	3" x 2-1/2"	
260777	3123VICCONC	3-1/2" x 3"	
258539	41VICCONC	4" x 1"	
260778	4114VICCONC	4" x 1-1/4"	
260780	4112VICCONC	4" x 1-1/2"	
258537	42VICCONC	4" x 2"	
260782	4212VICCONC	4" x 2-1/2"	
258536	43VICCONC	4" x 3"	
260783	4312VICCONC	4" x 3-1/2"	
260784	52VICCONC	5" x 2"	
260785	5212VICCONC	5" x 2-1/2"	
260786	53VICCONC	5" x 3"	
260787	54VICCONC	5" x 4"	
260788	61VICCONC	6" x 1"	
260790	62VICCONC	6" x 2"	
260791	6212VICCONC	6" x 2-1/2"	
260792	63VICCONC	6" x 3"	
260793	64VICCONC	6" x 4"	
260794	65VICCONC	6" x 5"	

### Grooved Fittings (Continued)

#### No. 50 Concentric Reducers

Part #	Mfg #	Size	Price
260795	83VICCONC	8" x 3"	
260796	84VICCONC	8" x 4"	
260798	85VICCONC	8" x 5"	
260799	86VICCONC	8" x 6"	
260800	104VICCONC	10" x 4"	
260802	105VICCONC	10" x 5"	
260803	106VICCONC	10" x 6"	
260804	108VICCONC	10" x 8"	
260805	124VICCONC	12" x 4"	
260806	126VICCONC	12" x 6"	
260807	128VICCONC	12" x 8"	
260808	1210VICCONC	12" x 10"	
260767	21234VICCONC	2-1/2" x 3/4"	
260772	334VICCONC	3" x 3/4"	

#### No. 51 Eccentric Reducers



Part #	Mfg #	Size	Price
260811	1141VICECC	1-1/4" x 1"	
260812	11234VICECC	1-1/2" x 3/4"	
260824	334VICECC	3" x 3/4"	
260844	6112VICECC	6" x 1-1/2"	
260832	4114VICECC	4" x 1-1/4"	
260810	11434VICECC	1-1/4" x 3/4"	
260813	1121VICECC	1-1/2" x 1"	
260814	112114VICECC	1-1/2" x 1-1/4"	
260815	234VICECC	2" x 3/4"	
260816	21VICECC	2" x 1"	
260817	2114VICECC	2" x 1-1/4"	
260818	2112VICECC	2" x 1-1/2"	
260819	21234VICECC	2-1/2" x 3/4"	
260820	2121VICECC	2-1/2" x 1"	
260821	212114VICECC	2-1/2" x 1-1/4"	
260822	212112VICECC	2-1/2" x 1-1/2"	
260823	2122VICECC	2-1/2" x 2"	
260825	31VICECC	3" x 1"	
260826	3114VICECC	3" x 1-1/4"	
260827	3112VICECC	3" x 1-1/2"	

## Grooved Fittings

### Grooved Fittings (Continued)

#### No. 51 Eccentric Reducers

Part #	Mfg #	Size	Price
260828	32VICECC	3" x 2"	
260829	3212VICECC	3" x 2-1/2"	
260830	3123VICECC	3-1/2" x 3"	
260831	41VICECC	4" x 1"	
260833	4112VICECC	4" x 1-1/2"	
260835	42VICECC	4" x 2"	
260836	4212VICECC	4" x 2-1/2"	
260837	43VICECC	4" x 3"	
260838	4312VICECC	4" x 3-1/2"	
260839	52VICECC	5" x 2"	
260840	5212VICECC	5" x 2-1/2"	
260841	53VICECC	5" x 3"	
260842	54VICECC	5" x 4"	
260843	61VICECC	6" x 1"	
260845	62VICECC	6" x 2"	
260846	6212VICECC	6" x 2-1/2"	
260847	63VICECC	6" x 3"	
260848	64VICECC	6" x 4"	
260849	65VICECC	6" x 5"	
260850	83VICECC	8" x 3"	
260851	84VICECC	8" x 4"	
260852	85VICECC	8" x 5"	
260853	86VICECC	8" x 6"	
260854	104VICECC	10" x 4"	
260855	105VICECC	10" x 5"	
260856	106VICECC	10" x 6"	
260857	108VICECC	10" x 8"	
260858	124VICECC	12" x 4"	
260859	126VICECC	12" x 6"	
260860	128VICECC	12" x 8"	
260861	1210VICECC	12" x 10"	

#### No. 107N QuickVic™ Couplings



Part #	Mfg #	Size	Price
260628	2VICCP107N	2"	
260629	212VICCP107N	2-1/2"	

### Grooved Fittings (Continued)

#### No. 107N QuickVic™ Couplings

Part #	Mfg #	Size	Price
258510	3VICCP107N	3"	
258512	4VICCP107N	4"	
260630	5VICCP107N	5"	
258513	6VICCP107N	6"	
260631	8VICCP107N	8"	
260632	10VICCP107N	10"	
260633	12VICCP107N	12"	

#### No. 177N QuickVic™ Flexible Couplings



Part #	Mfg #	Size	Price
261591	2VICCP177N	2"	
261592	212VICCP177N	2-1/2"	
261593	3VICCP177N	3"	
261595	4VICCP177N	4"	
261597	5VICCP177N	5"	
261598	6VICCP177N	6"	
261599	8VICCP177N	8"	

#### No. 750 Reducing Couplings



Part #	Mfg #	Size	Price
230747	21VICCP	2" x 1"	
260634	2112VICCP	2" x 1-1/2"	
260635	2122VICCP	2-1/2" x 2"	
260636	32VICCP	3" x 2"	
260637	3212VICCP	3" x 2-1/2"	
260638	42VICCP	4" x 2"	
260639	4212VICCP	4" x 2-1/2"	
260640	43VICCP	4" x 3"	
260641	54VICCP	5" x 4"	
260642	64VICCP	6" x 4"	

## Grooved Fittings

### Grooved Fittings (Continued)

#### No. 750 Reducing Couplings

Part #	Mfg #	Size	Price
260643	65VICCP	6" x 5"	
260644	86VICCP	8" x 6"	
260645	108VICCP	10" x 8"	

#### No. 741 "E" Flange Adapters



Part #	Mfg #	Size	Price
260646	2VICFLGAE	2"	
260647	212VICFLGAE	2-1/2"	
188899	3VICFLGAE	3"	
258526	4VICFLGAE	4"	
260648	5VICFLGAE	5"	
258527	6VICFLGAE	6"	
260649	8VICFLGAE	8"	
260650	10VICFLGAE	10"	
260651	12VICFLGAE	12"	

#### No. 40 Adapter Nipples (Grooved x Threaded)



Part #	Mfg #	Size	Price
261071	343VICANGT40	3/4" x 3"	
261072	344VICANGT40	3/4" x 4"	
261074	13VICANGT40	1" x 3"	
261075	14VICANGT40	1" x 4"	
261076	16VICANGT40	1" x 6"	
261081	1144VICANGT40	1-1/4" x 4"	
261082	1146VICANGT40	1-1/4" x 6"	
261064	1124VICANGT40	1-1/2" x 4"	
261084	1126VICANGT40	1-1/2" x 6"	
261085	1128VICANGT40	1-1/2" x 8"	
261087	11210VICANGT40	1-1/2" x 10"	
261088	11212VICANGT40	1-1/2" x 12"	
261089	23VICANGT40	2" x 3"	
261066	24VICANGT40	2" x 4"	
261090	26VICANGT40	2" x 6"	

### Grooved Fittings (Continued)

#### No. 40 Adapter Nipples (Grooved x Threaded)

Part #	Mfg #	Size	Price
261091	28VICANGT40	2" x 8"	
261092	210VICANGT40	2" x 10"	
261093	212VICANGT40	2" x 12"	
261094	2124VICANGT40	2-1/2" x 4"	
261095	2126VICANGT40	2-1/2" x 6"	
261096	2128VICANGT40	2-1/2" x 8"	
261097	21210VICANGT40	2-1/2" x 10"	
261098	21212VICANGT40	2-1/2" x 12"	
261099	34VICANGT40	3" x 4"	
261100	36VICANGT40	3" x 6"	
261101	38VICANGT40	3" x 8"	
261102	310VICANGT40	3" x 10"	
261103	312VICANGT40	3" x 12"	
261114	43VICANGT40	4" x 3"	
261115	46VICANGT40	4" x 6"	
261116	48VICANGT40	4" x 8"	
261117	410VICANGT40	4" x 10"	
261118	412VICANGT40	4" x 12"	
261119	63VICANGT40	6" x 3"	
261120	68VICANGT40	6" x 8"	
261121	610VICANGT40	6" x 10"	
261123	612VICANGT40	6" x 12"	
261083	1123VICANGT40	1-1/2" x 3"	
261079	1143VICANGT40	1-1/4" x 3"	

#### No. 43 Adapter Nipples (Grooved x Grooved)



Part #	Mfg #	Size	Price
261135	343VICANGG43	3/4" x 3"	
261136	344VICANGG43	3/4" x 4"	
261137	13VICANGG43	1" x 3"	
261138	14VICANGG43	1" x 4"	
261140	16VICANGG43	1" x 6"	
261142	1146VICANGG43	1-1/4" x 6"	
261144	1124VICANGG43	1-1/2" x 4"	
261146	1126VICANGG43	1-1/2" x 6"	
261147	1128VICANGG43	1-1/2" x 8"	
261149	11210VICANGG43	1-1/2" x 10"	

## Grooved Fittings

### Grooved Fittings (Continued)

#### No. 43 Adapter Nipples (Grooved x Grooved)

Part #	Mfg #	Size	Price
261150	11212VICANGG43	1-1/2" x 12"	
261158	23VICANGG43	2" x 3"	
261159	24VICANGG43	2" x 4"	
261160	26VICANGG43	2" x 6"	
261161	28VICANGG43	2" x 8"	
261162	210VICANGG43	2" x 10"	
261163	212VICANGG43	2" x 12"	
261164	2123VICANGG43	2-1/2" x 3"	
261166	2124VICANGG43	2-1/2" x 4"	
261167	2126VICANGG43	2-1/2" x 6"	
261168	2128VICANGG43	2-1/2" x 8"	
261169	21210VICANGG43	2-1/2" x 10"	
261170	21212VICANGG43	2-1/2" x 12"	
261171	33VICANGG43	3" x 3"	
261173	34VICANGG43	3" x 4"	
261174	36VICANGG43	3" x 6"	
261175	38VICANGG43	3" x 8"	
261176	310VICANGG43	3" x 10"	
261177	312VICANGG43	3" x 12"	
261179	43VICANGG43	4" x 3"	
261180	44VICANGG43	4" x 4"	
261181	46VICANGG43	4" x 6"	
261182	48VICANGG43	4" x 8"	
261183	410VICANGG43	4" x 10"	
261184	412VICANGG43	4" x 12"	
261185	53VICANGG43	5" x 3"	
261188	54VICANGG43	5" x 4"	
261190	56VICANGG43	5" x 6"	
261191	58VICANGG43	5" x 8"	
261193	510VICANGG43	5" x 10"	
261194	512VICANGG43	5" x 12"	
261196	63VICANGG43	6" x 3"	
261198	64VICANGG43	6" x 4"	
261199	66VICANGG43	6" x 6"	
261201	68VICANGG43	6" x 8"	
261203	610VICANGG43	6" x 10"	
261204	612VICANGG43	6" x 12"	
261143	1123VICANGG43	1-1/2" x 3"	
261141	1143VICANGG43	1-1/4" x 3"	

### No. 730 "E" Tee-Type Strainer



Part #	Mfg #	Size	Price
261224	112VICTS	1-1/2"	
261226	2VICTS	2"	
261227	212VICTS	2-1/2"	
261228	3VICTS	3"	
261229	4VICTS	4"	
261230	5VICTS	5"	
261231	6VICTS	6"	
261232	8VICTS	8"	
261234	10VICTS	10"	
261235	12VICTS	12"	

### Miscellaneous Fittings

#### No. 920N Mechanical Tees

• Threaded

Part #	Mfg #	Size	Price
260746	6114VICMECT	6" x 1-1/4"	
260723	212VICMECT	2" x 1/2"	
260724	234VICMECT	2" x 3/4"	
260725	21VICMECT	2" x 1"	
260726	2114VICMECT	2" x 1-1/4"	
260727	2112VICMECT	2" x 1-1/2"	
260728	21212VICMECT	2-1/2" x 1/2"	
258547	21234VICMECT	2-1/2" x 3/4"	
260729	2121VICMECT	2-1/2" x 1"	
260730	212114VICMECT	2-1/2" x 1-1/4"	
260732	312VICMECT	3" x 1/2"	
258546	334VICMECT	3" x 3/4"	
260733	31VICMECT	3" x 1"	
260734	3114VICMECT	3" x 1-1/4"	
260735	3112VICMECT	3" x 1-1/2"	
242553	32VICMECT	3" x 2"	
260736	412VICMECT	4" x 1/2"	
258545	434VICMECT	4" x 3/4"	
258544	41VICMECT	4" x 1"	
260737	4114VICMECT	4" x 1-1/4"	



## Grooved Fittings

### Miscellaneous Fittings (Continued)

#### No. 920N Mechanical Tees

Part #	Mfg #	Size	Price
258542	4112VICMECT	4" x 1-1/2"	
260738	42VICMECT	4" x 2"	
260739	4212VICMECT	4" x 2-1/2"	
260740	43VICMECT	4" x 3"	
260741	5112VICMECT	5" x 1-1/2"	
260742	52VICMECT	5" x 2"	
260743	5212VICMECT	5" x 2-1/2"	
260744	53VICMECT	5" x 3"	
260747	6112VICMECT	6" x 1-1/2"	
258541	62VICMECT	6" x 2"	
260748	6212VICMECT	6" x 2-1/2"	
260749	63VICMECT	6" x 3"	
260750	64VICMECT	6" x 4"	
260751	82VICMECT	8" x 2"	
260752	8212VICMECT	8" x 2-1/2"	
260753	83VICMECT	8" x 3"	
260754	84VICMECT	8" x 4"	

#### No. 99 Roust-A-Bout Couplings



Part #	Mfg #	Size	Price
260652	1VICCP99	1"	
260653	112VICCP99	1-1/2"	
260654	2VICCP99	2"	
260655	212VICCP99	2-1/2"	
260656	3VICCP99	3"	
260657	312VICCP99	3-1/2"	
260658	4VICCP99	4"	
260659	5VICCP99	5"	
260660	6VICCP99	6"	
260661	8VICCP99	8"	
260662	10VICCP99	10"	
260663	12VICCP99	12"	
260664	14VICCP99	14"	
260665	16VICCP99	16"	
260666	18VICCP99	18"	

### Grooved Valves

#### No. 712 "E" Check Valve

• 300 psi



Part #	Mfg #	Size	Price
261280	2VICCVE712	2"	
261281	212VICCVE712	2-1/2"	
261282	3VICCVE712	3"	
261283	4VICCVE712	4"	

#### No. 779 "E" Venturi Check Valve



Part #	Mfg #	Size	Price
261290	4VICCVE7792	4"	
261291	5VICCVE7792	5"	
261292	6VICCVE7792	6"	
261293	8VICCVE7792	8"	
261294	10VICCVE7792	10"	
261295	12VICCVE7792	12"	

#### No. 761 "E" 300 MasterSeal™ Butterfly Valve



Part #	Mfg #	Size	Handle	Price
260878	2VICBFVE2	2"	10-POS	
246004	212VICBFVE2	2-1/2"	10-POS	
252747	3VICBFVE2	3"	10-POS	
260879	4VICBFVE2	4"	10-POS	
260881	5VICBFVE2	5"	10-POS	
258531	6VICBFVE2	6"	10-POS	
260882	6VICBFVE5	6"	Gear Operator	
237172	8VICBFVE2	8"	10-POS	
260883	8VICBFVE5	8"	Gear Operator	
260884	10VICBFVE2	10"	10-POS	
260885	10VICBFVE5	10"	Gear Operator	



## Grooved Fittings

### Grooved Valves (Continued)

#### No. 761 "E" 300 MasterSeal™ Butterfly Valve

Part #	Mfg #	Size	Handle	Price
260886	12VICBFVE2	12"	10-POS	
260887	12VICBFVE5	12"	Gear Operator	

### Parts & Accessories

#### Repair Parts

Part #	Mfg #	Size	Price
261506	2VICE107N177N	2" E Gskt 107N/177N	
261508	212VICE107N177N	2-1/2" E Gskt 107N/177N	
261275	3VICEGSK77	3" Gskt 77 FS-E	
261509	3VICE107N177N	3" E Gskt 107N/177N	
261511	4VICE107N177N	4" E Gskt 107N/177N	
261513	5VICE107N177N	5" E Gskt 107N/177N	
261514	6VICE107N177N	6" E Gskt 107N/177N	
261516	8VICE107N177N	8" E Gskt 107N/177N	
261517	10VICE107N	10" E Gskt 107N	
261518	12VICE107N	12" E Gskt 107N	
261284	2VICEDK712	2" "E" 712 Disc Kit	
261287	212VICEDK712	2-1/2" "E" 712 Disc Kit	
261288	3VICEDK712	3" "E" 712 Disc Kit	
261289	4VICEDK712	4" "E" 712 Disc Kit	
240882	VICTAPE	Tape Measure	

#### Victaulic Lube

Part #	Mfg #	Size	Price
188900	P00000000P	4.5 oz	
260599	P00000000Q	1 Quart	



### Gruvlok® CTS Couplings for Grooved End Pipe

#### 7001 Standard Coupling with E Gasket

- Designed for a wide range of applications
- Housing design allows for optimum strength without excessive casting weight
- Maximum working pressure: 1,000 psi

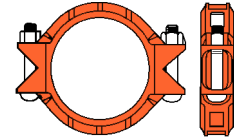

Part #	Mfg #	Size	Price
232765	GLGR70011	1"	
063039	GLGR70012	2"	
047680	GLGR7001212	2-1/2"	
047681	GLGR70013	3"	
047682	GLGR70014	4"	
047683	GLGR70015	5"	
047684	GLGR70016	6"	
047685	GLGR70018	8"	

#### 7401 Rigidlok™ Coupling with E Gasket

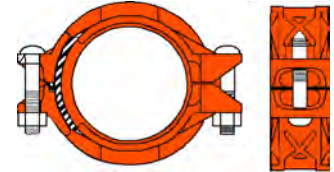

Part #	Mfg #	Size	Price
052980	GLGR7401112	1-1/2"	
056293	GLGR74012	2"	
047503	GLGR7401212	2-1/2"	
047506	GLGR74013	3"	
047507	GLGR74014	4"	
047508	GLGR74015	5"	
047509	GLGR74016	6"	
047511	GLGR74018	8"	
070798	GLGR740110	10"	
076146	GLGR740112	12"	

## Grooved Fittings

### 7401 Galvanized Rigidlok™ Coupling with E Gasket

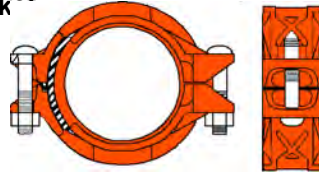

Part #	Mfg #	Size	Price
093229	GLGR7401212G	2-1/2"	
093220	GLGR74013G	3"	
076143	GLGR74014G	4"	
077197	GLGR74016G	6"	
077198	GLGR74018G	8"	

### 7042F Female IPS Outlet Coupling

Part #	Mfg #	Size	Price
093728	GLGRI7042F21234	2-1/2" x 3/4"	
093727	GLGRI7042F2121	2-1/2" x 1"	

### 7012 Flange with E Gasket

- Direct connection of Class 125 or 150 components

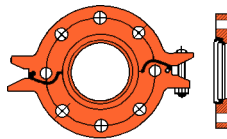

Part #	Mfg #	Size	Price
062835	GLGR70122	2"	
047633	GLGR7012212	2-1/2"	
047634	GLGR70123	3"	
047635	GLGR70124	4"	
074507	GLGR70125	5"	
047636	GLGR70126	6"	
047637	GLGR70128	8"	
074504	GLGR701210	10"	

### 7012 Flange Seal Ring

- Recommended for use between wafer/lug type valves and Gruvlok flanges

Part #	Mfg #	Size	Price
047646	GLGR212GRVLKFSR	2-1/2"	
047647	GLGR3GRVLKFSR	3"	
047648	GLGR4GRVLKFSR	4"	
103361	GLGR5GRVLKFSR	5"	
047650	GLGR8GRVLKFSR	8"	

### 7010 Reducing Coupling with E Gasket

- Maximum working pressure: 350 psi



Part #	Mfg #	Size	Price
130097	GLGR701032	3" x 2"	
052463	GLGR70103212	3" x 2-1/2"	
085736	GLGR701064	6" x 4"	

### 7087 Female Threaded Adapter (FPT x Grv)

Part #	Mfg #	Size	Price
087090	GLGR7087212	2-1/2"	
102694	GLGR70873	3"	

### Fig. 74 SlideLOK® Coupling

- Use with:
  - Gruvlok® fittings
  - Gruvlok® valves
  - Grooved light wall pipe
  - roll groove or cut groove steel pipe
- Maximum working pressure: 750 psi



Part #	Mfg #	Size	Price
222274	GLGR742	2"	
222276	GLGR74212	2-1/2"	
222277	GLGR743	3"	
222278	GLGR744	4"	
222279	GLGR745	5"	
222281	GLGR746	6"	
222282	GLGR748	8"	

### 64 CTS SlideLOK® Coupling

Part #	Mfg #	Size	Price
246384	GL642	2"	
246385	GL64212	2-1/2"	
246386	GL643	3"	
246387	GL644	4"	
246388	GL645	5"	
246389	GL646	6"	
246390	GL648	8"	

## Grooved Fittings

**Fig. 7402 SlideLOK® Coupling**

- Use with:
  - Gruvlok® grooved-end fittings
  - Gruvlok® grooved-end valves
  - Grooved light wall pipe
  - roll groove or cut groove steel pipe
- Maximum working pressure: 750 psi



Part #	Mfg #	Size	Price
152572	GLGR74022	2"	
152573	GLGR7402212	2-1/2"	
152574	GLGR74023	3"	
152575	GLGR74024	4"	
152577	GLGR74026	6"	
161299	GLGR74028	8"	

**Fig. 64 SlideLOK® Coupling**

- Ready for installation
- CTS SlideLOK to be used with copper tube sizes 2" - 8"



Part #	Mfg #	Size	Price
246384	GL642	2"	
246386	GL643	3"	

### Branch Outlet Systems

#### 7045 Female Threaded Branch Clamp-T

- Rated working pressure: 500 psi



Part #	Mfg #	Size	Price
105789	GLGR7045212	2" x 1/2"	
086646	GLGR7045234	2" x 3/4"	
078244	GLGR704521212	2-1/2" x 1/2"	
052051	GLGR704521234	2-1/2" x 3/4"	
052055	GLGR70452121	2-1/2" x 1"	
052056	GLGR7045212114	2-1/2" x 1-1/4"	
085342	GLGR7045212112	2-1/2" x 1-1/2"	
074238	GLGR7045312	3" x 1/2"	
052049	GLGR7045334	3" x 3/4"	
052054	GLGR704531	3" x 1"	
052053	GLGR70453114	3" x 1-1/4"	
078243	GLGR70453112	3" x 1-1/2"	
104154	GLGR704532	3" x 2"	

### Branch Outlet Systems (Continued)

#### 7045 Female Threaded Branch Clamp-T

Part #	Mfg #	Size	Price
080423	GLGR7045412	4" x 1/2"	
078646	GLGR7045434	4" x 3/4"	
085741	GLGR704541	4" x 1"	
078241	GLGR70454114	4" x 1-1/4"	
093896	GLGR70454112	4" x 1-1/2"	
081180	GLGR704542	4" x 2"	
085344	GLGR70455114	5" x 1-1/4"	
082280	GLGR70456114	6" x 1-1/4"	
078648	GLGR70456112	6" x 1-1/2"	
071800	GLGR704562	6" x 2"	
104129	GLGR704582	8" x 2"	

#### 7045 Galvanized Female Threaded Branch Clamp-T

- Rated working pressure

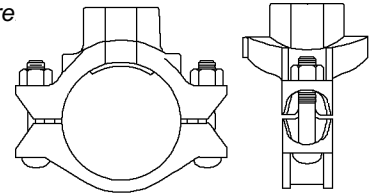

Part #	Mfg #	Size	Price
093226	GLGR704521234G	2-1/2" x 3/4"	
093241	GLGR70452121G	2-1/2" x 1"	
093940	GLGR7045212114G	2-1/2" x 1-1/4"	

### Grooved End Pipe Fittings

#### 7055 90° Adapter Elbow

- Gr x MPT



Part #	Mfg #	Size	Price
182715	GLGR70552	2"	

## Grooved Fittings

### 7050 90° Elbow



Part #	Mfg #	Size	Price
063038	GLGR70502	2"	
047617	GLGR7050212	2-1/2"	
047618	GLGR70503	3"	
167698	GLGR7050312	3-1/2"	
047619	GLGR70504	4"	
047643	GLGR70505	5"	
047620	GLGR70506	6"	
047621	GLGR70508	8"	
077186	GLGR705012	12"	

### 7050 Galvanized 90° Elbow

Part #	Mfg #	Size	Price
094094	GLGR7050212G	2-1/2"	
072763	GLGR70503G	3"	
076150	GLGR70504G	4"	
093918	GLGR70506G	6"	

### 7051 45° Elbow



Part #	Mfg #	Size	Price
063036	GLGR70512	2"	
047622	GLGR7051212	2-1/2"	
047623	GLGR70513	3"	
047624	GLGR70514	4"	
047625	GLGR70516	6"	
047626	GLGR70518	8"	
070793	GLGR705110	10"	
077185	GLGR705112	12"	

### 7051 Galvanized 45° Elbow

Part #	Mfg #	Size	Price
093935	GLGR70513G	3"	
093957	GLGR70514G	4"	

### 7052 22-1/2° Elbow

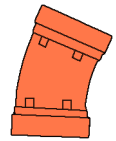

Part #	Mfg #	Size	Price
062803	GLGR7052212	2-1/2"	
104130	GLGR70523	3"	
104131	GLGR70524	4"	
076257	GLGR70526	6"	

### 7060 Tee



Part #	Mfg #	Size	Price
063040	GLGR70602	2"	
047627	GLGR7060212	2-1/2"	
047628	GLGR70603	3"	
047629	GLGR70604	4"	
047645	GLGR70605	5"	
047630	GLGR70606	6"	
047631	GLGR70608	8"	

### 7060 Galvanized Tee

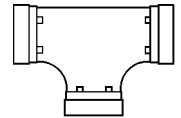

Part #	Mfg #	Size	Price
094093	GLGR7060212G	2-1/2"	
076147	GLGR70604G	4"	

### 7061 Standard Reducing Tee (Grv x Grv x Grv)



Part #	Mfg #	Size	Price
052465	GLGR7061212112	2-1/2" x 1-1/2"	
060008	GLGR70612122	2-1/2" x 2"	
052064	GLGR706132	3" x 2"	
060009	GLGR70613212	3" x 2-1/2"	
082290	GLGR706142	4" x 2"	
060179	GLGR70614212	4" x 2-1/2"	
052067	GLGR706143	4" x 3"	



## Grooved Fittings

### Grooved End Pipe Fittings (Continued)

#### 7061 Standard Reducing Tee (Grv x Grv x Grv)

Part #	Mfg #	Size	Price
085331	GLGR70615212	5" x 2-1/2"	
078848	GLGR706153	5" x 3"	
076139	GLGR706154	5" x 4"	
078664	GLGR706162	6" x 2"	
060180	GLGR70616212	6" x 2-1/2"	
074777	GLGR706163	6" x 3"	
070796	GLGR706164	6" x 4"	
082289	GLGR706165	6" x 5"	
076138	GLGR706184	8" x 4"	
093983	GLGR706186	8" x 6"	

#### 7061 Standard Reducing Galvanized Tee (Grv x Grv x Grv)

Part #	Mfg #	Size	Price
093926	GLGR706164G	6" x 4"	

#### 7064 Branch Reducing Tee (Thrd)

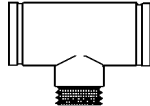

Part #	Mfg #	Size	Price
060178	GLGR7064	2-1/2" x 1"	
094960	GLGR7064212112	2-1/2" x 1-1/2"	
078699	GLGR70642122	2-1/2" x 2"	
076768	GLGR7064334	3" x 3/4"	
060175	GLGR706432	3" x 2"	
111245	GLGR70644114	4" x 1-1/4"	
060174	GLGR70644112	4" x 1-1/2"	
104138	GLGR706442	4" x 2"	

#### 7260 Tee Strainer

- Strainer basket made of stainless steel type 304 bar and woven wire screen
- Maximum working pressure: 750 psi

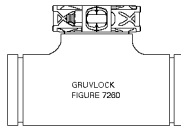

Part #	Mfg #	Size	Price
079056	GLGR72604	4"	
082284	GLGR72606	6"	

### 7072 Concentric Reducer (Grv x Grv)



Part #	Mfg #	Size	Price
052979	GLGR7072212112	2-1/2" x 1-1/2"	
052959	GLGR70722122	2-1/2" x 2"	
052955	GLGR707232	3" x 2"	
052978	GLGR70723212	3" x 2-1/2"	
056294	GLGR707242	4" x 2"	
052977	GLGR70724212	4" x 2-1/2"	
047675	GLGR707243	4" x 3"	
167421	GLGR70724312	4" x 3-1/2"	
047676	GLGR707254	5" x 4"	
063083	GLGR70726212	6" x 2-1/2"	
060181	GLGR707263	6" x 3"	
047677	GLGR707264	6" x 4"	
063085	GLGR707265	6" x 5"	
098606	GLGR707284	8" x 4"	
047678	GLGR707286	8" x 6"	
070797	GLGR7072106	10" x 6"	
078645	GLGR7072128	12" x 8"	
094001	GLGR70721210	12" x 10"	

### 7072 Galvanized Concentric Reducer (Grv x Grv)



Part #	Mfg #	Size	Price
076173	GLGR707264G	6" x 4"	
076149	GLGR707243G	4" x 3"	

### 7076 Concentric Reducer (Grv x MIP)



Part #	Mfg #	Size	Price
102695	GLGR70762112	2" x 1-1/2"	
062981	GLGR70762121	2-1/2" x 1"	
099291	GLGR7076212114	2-1/2" x 1-1/4"	
080422	GLGR7076212112	2-1/2" x 1-1/2"	
052046	GLGR70762122	2-1/2" x 2"	
074778	GLGR707631	3" x 1"	
076769	GLGR70763112	3" x 1-1/2"	
076141	GLGR707632	3" x 2"	



## Grooved Fittings

### Grooved End Pipe Fittings (Continued)

#### 7076 Concentric Reducer (Grv x MIP)

Part #	Mfg #	Size	Price
077191	GLGR70763212	3" x 2-1/2"	
076140	GLGR707642	4" x 2"	

#### 7076 Galvanized Concentric Reducer (Grv x MIP)



Part #	Mfg #	Size	Price
093223	GLGR7076212112G	2-1/2" x 1-1/2"	
093939	GLGR707632G	3" x 2"	

#### 7073 Eccentric Reducer (Grv x Grv)

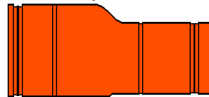

Part #	Mfg #	Size	Price
082293	GLGR707332	3" x 2"	
081541	GLGR70733212	3" x 2-1/2"	
062990	GLGR707343	4" x 3"	
082287	GLGR707364	6" x 4"	

#### 7097 Eccentric Reducer (Grv x Thrd)

Part #	Mfg #	Size	Price
085329	GLGR70972122	2-1/2" x 2"	

#### 7074 Cap



Part #	Mfg #	Size	Price
063041	GLGR70742	2"	
047638	GLGR7074212	2-1/2"	
047639	GLGR70743	3"	
047640	GLGR70744	4"	
047641	GLGR70746	6"	
047642	GLGR70748	8"	

#### 6074 CTS Cap



Part #	Mfg #	Size	Price
121634	GL60742	2"	
121635	GL6074212	2-1/2"	
121636	GL60743	3"	
121637	GL60744	4"	

#### 7080 Adapter Nipples (GR x GR)

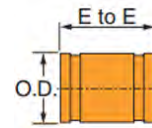

Part #	Mfg #	Size	Price
183256	GLGR708026	2" x 4"	
183257	GLGR708028	2" x 8"	
183258	GLGR7080212	2" x 12"	

#### 7081 Adapter Nipples (Gr x MPT)

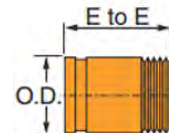

Part #	Mfg #	Size	Price
183259	GLGR708126	2" x 4"	
183260	GLGR708128	2" x 8"	
183261	GLGR7081212	2" x 12"	

#### 7081F Adapter Nipple (Grv x MIP)



Part #	Mfg #	Size	Price
047775	GLGR708124	2" x 4"	
047776	GLGR70812124	2-1/2" x 4"	
047777	GLGR708134	3" x 4"	

#### 7084 Flange Nipples ( Flange x Grv )

Part #	Mfg #	Size	Price
118067	GLGR7084212	2-1/2"	
125652	GLGR70843	3"	
125649	GLGR70844	4"	

## Grooved Fittings

### Flange Adapter



Part #	Mfg #	Size	Price
171563	GLGR77882	2"	
171564	GLGR7788212	2-1/2"	
171565	GLGR77883	3"	
171566	GLGR77884	4"	
171567	GLGR77885	5"	
171568	GLGR77886	6"	
171569	GLGR77888	8"	

### Gruvlok® Copper Method

#### 7400 Rigidlite™ Coupling



Part #	Mfg #	Size	Price
069868	GLGR74002	2"	
069869	GLGR7400212	2-1/2"	
069870	GLGR74003	3"	
069871	GLGR74004	4"	
069873	GLGR74006	6"	
069874	GLGR74008	8"	

### Gruvlok® Di-Lok® Nipples

#### 7088 Di-Electric Pipe Connection (Grv x MIP)



Part #	Mfg #	Size	Price
078242	GLGR70882	2" x 4"	
075544	GLGR7088212	2-1/2" x 6"	

#### 7090 Di-Electric Pipe Connection (Thrd x Thrd)



Part #	Mfg #	Size	Price
137391	GLGR7090123	1/2" x 3"	
110497	GLGR7090343	3/4" x 3"	
110498	GLGR709014	1" x 4"	

### Gruvlok® Di-Lok® Nipples (Continued)

#### 7090 Di-Electric Pipe Connection (Thrd x Thrd)

Part #	Mfg #	Size	Price
125776	GLGR70901144	1-1/4" x 4"	
127254	GLGR70901124	1-1/2" x 4"	
127712	GLGR709024	2" x 4"	
125371	GLGR709036	3" x 6"	

### Grooved Fittings for Plain End Pipe

#### 7005 Roughneck™ Coupling

- Gripper action provides positive pipe joint
- Maximum working pressure: 750 psi



Part #	Mfg #	Size	Price
047780	GLGR70052	2"	
047781	GLGR7005212	2-1/2"	
047782	GLGR70053	3"	
047783	GLGR70054	4"	
104146	GLGR70058	8"	

### Gruvlok® Valves

#### 7721 Lever/Lock Butterfly Valve

- 10-Position
- EPDM Disc coating



Part #	Mfg #	Size	Price
063046	GLGN772132	2"	
047687	GLGN77213212	2-1/2"	
047771	GLGN772133	3"	
047772	GLGN772134	4"	
069881	GLGN772135	5"	
047773	GLGN772136	6"	
047774	GLGN772138	8"	

## Grooved Fittings

### 6700 Lever Bronze Body Butterfly Valve

- Designed for use with grooved copper tubing (CTS), fittings & couplings
- 10-Position lever handle
- EPDM rubber encapsulated disc
- For use in potable water systems, 300 PSI



Part #	Mfg #	Size	Price
121641	GL67003	3"	

### 7700 Ductile Iron Body Grooved CTS BFV with Gear Operating Mechanism

- Upper and lower shaft are type 416 stainless steel
- Spherical bore of the disc seat area for constant disc-to-seat loading
- Rated to 300 psi dead-end service
- EPDM (Grade E) disc coating
- One-piece casting with integral mounting base
- Nylon body coating



Part #	Mfg #	Size	Price
074509	GLGN772238	8"	

### 7800 Check Valve

- Maximum working pressure: 300 psi



Part #	Mfg #	Size	Price
085347	GLGR7811212	2-1/2"	
085349	GLGR78113	3"	
104143	GLGR78114	4"	
104144	GLGR78116	6"	

### GBV-G Grooved End Straight Balancing Valve

- Pressure differential ports on both sides of valve
- Positive shut-off for equipment servicing
- Multi-turn adjustment
- Maximum working temperature: 300°F
- Maximum working pressure: 300 psi

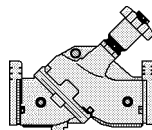

Part #	Mfg #	Size	Price
122590	GLGBVG3	3"	

 SMITH-COOPER  
 INTERNATIONAL

### Cooplok™ Orange Painted Grooved Fittings

#### Concentric Reducer

- Ductile iron
- Orange painted coating



Part #	Size	Price
164275	2-1/2" x 2"	
164276	3" x 2"	
164277	3" x 2-1/2"	
164278	4" x 2"	
164280	4" x 2-1/2"	
164281	4" x 3"	
164282	6" x 2-1/2"	
164283	6" x 3"	
164284	6" x 4"	

#### Cap

- Ductile iron
- Orange painted coating



Part #	Size	Price
164251	2"	
164252	2-1/2"	
164253	3"	
164254	4"	
164255	5"	
164256	6"	
164257	8"	

#### 90° Elbow

- Ductile iron
- Orange painted coating



Part #	Size	Price
164223	2"	
164224	2-1/2"	
164225	3"	

## Grooved Fittings

### Cooplok™ Orange Painted Grooved Fittings (Continued)

#### 90° Elbow

Part #	Size	Price
164226	4"	
164227	5"	
164228	6"	
164229	8"	

#### Grooved x Flange Adapter

- Ductile iron
- Orange painted coating



Part #	Size	Price
164258	2"	
164259	2-1/2"	
164260	3"	
164261	4"	
164262	6"	
164263	8"	

#### Hinged Flange Adapter

- Ductile iron
- Orange painted coating



Part #	Size	Price
164214	2"	
164215	2-1/2"	
164216	3"	
164217	4"	
164218	5"	
164219	6"	
164220	8"	

#### 45° Elbow

- Ductile iron
- Orange painted coating



Part #	Size	Price
164230	2"	
164231	2-1/2"	
164232	3"	
164233	4"	
164234	5"	
164235	6"	
164236	8"	

#### 22-1/2° Elbow

- Ductile iron -full flow
- Orange painted coating



Part #	Size	Price
164237	2"	
164238	2-1/2"	
164239	3"	
164240	4"	
164241	5"	
164242	6"	
164243	8"	

#### Tee

- Ductile iron
- Orange painted coating



Part #	Size	Price
164244	2"	
164245	2-1/2"	
164246	3"	
164247	4"	
164248	5"	
164249	6"	
164250	8"	

#### Reducing Tee

- Ductile iron
- Orange painted coating



Part #	Size	Price
164286	4" x 4" x 2-1/2"	
164287	4" x 4" x 3"	

#### Rigid Coupling

- Ductile iron
- Orange painted coating
- EPDM "C" gasket



Part #	Size	Price
164201	2"	
164204	2-1/2"	
164205	3"	
164206	4"	
164208	5"	
164209	6"	

#### Mechanical Tee

- Ductile iron
- Threaded outlet
- Orange painted coating



Part #	Size	Price
167122	2" x 1/2"	
167123	2" x 3/4"	
167124	2" x 1"	
167125	2" x 1-1/4"	
164265	2" x 1-1/2"	
167126	2-1/2" x 1/2"	
167127	2-1/2" x 3/4"	
167128	2-1/2" x 1"	
167129	2-1/2" x 1-1/4"	
164266	2-1/2" x 1-1/2"	
167130	3" x 1"	
167131	3" x 1-1/4"	
167132	3" x 1-1/2"	
164268	3" x 2"	
167133	4" x 1"	
167134	4" x 1-1/4"	
167135	4" x 1-1/2"	

---



---

## Grooved Fittings

---



---

### Cooplok™ Orange Painted Grooved Fittings (Continued) Mechanical Tee

Part #	Size	Price
167136	4" x 2"	
167137	4" x 2-1/2"	
164269	4" x 3"	
167138	5" x 1-1/4"	
167139	5" x 1-1/2"	
167140	5" x 2"	
167141	5" x 2-1/2"	
164270	5" x 3"	
167142	6" x 1-1/4"	
167143	6" x 1-1/2"	
167144	6" x 2"	
167145	6" x 2-1/2"	
167146	6" x 3"	
164271	6" x 4"	
167147	8" x 2"	
167148	8" x 2-1/2"	
167149	8" x 3"	
164272	8" x 4"	

### Cooplok™ Grooved Valves Lever Handle Butterfly

- Series 67BFV



Part #	Size	Price
164289	2"	
164291	2-1/2"	
164292	3"	
164293	4"	
164294	5"	
164295	6"	
164296	8"	

## Insert Fittings

### Nylon Barbed Fittings

#### MIPT Adapter

- 2/Pack
- (701-002-5) model sold as each



Part #	Mfg #	Description	Price
169848	701-001B	1/2" Barb x 1/2" MIPT	
244895	701-002-5	1/2" Barb x 3/4" MIPT	
169853	701-012B	3/8" Barb x 1/2" MIPT	
169854	701-013B	3/8" Barb x 3/8" MIPT	
169855	701-014B	5/8" Barb x 3/4" MIPT	
197228	701-043	3/8" Barb x 3/4" MIPT	

#### FPT 90° Elbow

- 2/Pack unless marked bulk



Barb x MPT

Part #	Mfg #	Description	Price
141559	701-019	1/2" Barb x 3/4" FPT	

#### Elbow (Barb x Barb)

- 2/Pack



Part #	Mfg #	Description	Price
169856	701-018B	1/2" Barb x Barb	
169858	701-023B	3/4" Barb x Barb	
169866	701-040B	5/8" Barb x Barb	

#### Male Adapter Elbow (Barb x MIPT)

- 2/Pack



Part #	Mfg #	Description	Price
169859	701-025B	3/4" Barb x 3/4" MIPT	
169862	701-028B	5/8" Barb x 3/4" MIPT	

### Hose Mender (Barb x Barb)

- 2/Pack



Part #	Mfg #	Description	Price
197229	701-032	3/8" Barb x Barb	
186721	701-033	5/8" Barb x Barb	

### Tee (Barb x Barb x Barb)

- 2/Pack



Part #	Mfg #	Description	Price
169863	701-034B	1/2" Barb x Barb x Barb	
169864	701-038B	3/8" Barb x Barb x Barb	
210309	701-037B	3/4" Barb x Barb x Barb	

## Insert Fittings For PE

### Nylon Insert Fittings for Polyethylene Pipe

#### Nylon Bushing

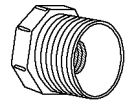

Part #	Mfg #	Size	Price
007791	3412NBU	3/4" x 1/2"	
007789	134NBU	1" x 3/4"	
007788	1141NBU	1-1/4" x 1"	
007787	112114NBU	1-1/2" x 1-1/4"	
007790	2112NBU	2" x 1-1/2"	



**Insert Fittings**

**Packaged Nylon Fittings**

- For vinyl, supertube and other plastic tubing

**Packaged Nylon 90° Elbow**



MIP x Barb

Part #	Mfg #	Size	Qty	Price
002275	0623	5/8" Barb x 3/4" FIP	4/Pkg	

**Nylon Hose Mender  
Barb x Barb**



Part #	Mfg #	Size	Price
133840	TMA-1212	3/8" x 3/8"	

**Nylon Flat Seat  
Barb x Barb**



Part #	Mfg #	Size	Price
024912	TLW-16	1/2"	



**Plastic Insert Fittings**

- For flexible (polyethylene) plastic pipe

**Poly Male Adapter**

- Plastic pipe to male iron pipe (MIP)



Part #	Mfg #	Size	Price
006646	12IPMA	1/2" x 1/2" MIP	
006648	34IPMA	3/4" x 3/4" MIP	
006641	341IPMA	3/4" x 1" MIP	
006639	1IPMA	1" x 1" MIP	
006643	1114IPMA	1" x 1-1/4" MIP	
006642	114IPMA	1-1/4" x 1-1/4" MIP	
006644	112IPMA	1-1/2" x 1-1/2" MIP	
006645	2IPMA	2" x 2" MIP	

**Nylon Male Adapter**

- Plastic pipe to male iron pipe (MIP)

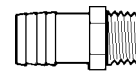

Part #	Mfg #	Size	Price
006607	34INMA	3/4" x 3/4" MIP	
006605	1INMA	1" x 1" MIP	

**PVC Male Adapter**

- Plastic pipe to male iron pipe (MIP)

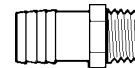

Part #	Mfg #	Size	Price
006638	1234IPMA	1/2" x 3/4" MIP	
006647	3412IPMA	3/4" x 1/2" MIP	
006649	134IPMA	1" x 3/4" MIP	

**PVC Female Adapter**

- Plastic pipe to female iron pipe (FIP)

Part #	Mfg #	Size	Price
006632	12IPFA	1/2" x 1/2" FIP	
006633	34IPFA	3/4" x 3/4" FIP	
006630	1IPFA	1" x 1" FIP	
006631	114IPFA	1-1/4" x 1-1/4" FIP	

**Poly Coupling**

- Plastic pipe to plastic pipe



Part #	Mfg #	Size	Price
006616	12IPCP2	1/2" x 1/2"	
006617	34IPCP2	3/4" x 3/4"	
006608	1IPCP2	1" x 1"	
006610	114IPCP2	1-1/4" x 1-1/4"	
006614	112IPCP2	1-1/2" x 1-1/2"	
006615	2IPCP2	2" x 2"	

**Poly Reducing Coupling**

- Plastic pipe to plastic pipe



Part #	Mfg #	Size	Price
006609	134IPCP2	1" x 3/4"	

## Insert Fittings

### Poly Insert Plugs

- Plastic pipe

Part #	Mfg #	Size	Price
006651	114IPPL	1-1/4"	

### PVC Insert Plugs

- Plastic pipe

Part #	Mfg #	Size	Price
006653	34IPPL	3/4"	
006650	1IPPL	1"	

### Poly Insert Tee

- Plastic pipe to plastic pipe



Part #	Mfg #	Size	Price
006667	12IPTIII	1/2" x 1/2" x 1/2"	
006668	34IPTIII	3/4" x 3/4" x 3/4"	
006661	1IPTIII	1" x 1" x 1"	

### PVC Combination Insert Tee

- Plastic pipe to female iron pipe (FIP)

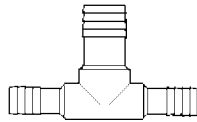

Part #	Mfg #	Size	Price
006659	34IPTIIF	3/4" x 3/4" x 3/4" FIP	
006657	1134IPTIIF	1" x 1" x 3/4" FIP	

### Poly Elbow

- Plastic pipe to plastic pipe



Part #	Mfg #	Size	Price
006628	12IP90II	1/2"x 1/2"	
006629	34IP90II	3/4"x 3/4"	
006624	1IP90II	1" x 1"	
006625	114IP90II	1-1/4" x 1-1/4"	

### Nylon Elbow

- Plastic pipe to plastic pipe

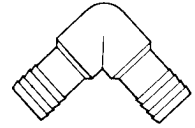

Part #	Mfg #	Size	Price
006603	11N90II	1" x 1"	

### Poly Combination Elbow

- Plastic pipe to male iron pipe (MIP)



Part #	Mfg #	Size	Price
060414	12IP90IM	1/2" x 1/2" MIP	
006636	34IP90IM	3/4" x 3/4" MIP	
006635	1IP90IM	1" x 1" MIP	

### PVC Combination Elbow

- Plastic pipe to female iron pipe (FIP)

Part #	Mfg #	Size	Price
006623	34IP90IF	3/4" x 3/4" FIP	

### Yellow Brass Insert Fittings

- For flexible (polyethylene) plastic pipe

#### Yellow Brass Solder Adaptor

- Plastic pipe to copper tube (Swt)



Part #	Mfg #	Size	Price
006595	1IYSA	1" x 1"	
006596	114IYSA	1-1/4" x 1-1/4"	

### Red & Yellow Brass Hydrant Elbow

- Plastic pipe to male iron pipe (MIP)

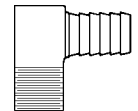

Part #	Mfg #	Size	Price
006689	34IR90IM	3/4" x 3/4" MIP	

### Red & Yellow Brass Tee

- Plastic pipe to plastic pipe

Part #	Mfg #	Size	Price
018821	1134IRTIII	1" x 1" x 3/4"	

## Insert Fittings

### Red Brass Insert Fittings

- For flexible (polyethylene) plastic pipe

#### Red Brass Male Adapter

- Plastic pipe to male iron pipe (MIP)



Part #	Mfg #	Size	Price
006697	12IRMA	1/2" x 1/2" MIP	
006698	34IRMA	3/4" x 3/4" MIP	
006693	134IRMA	1" x 3/4" MIP	
006692	1IRMA	1" x 1" MIP	
057635	1141IRMA	1" x 1-1/4" MIP	
124175	1114IRMA	1-1/4" x 1" MIP	
006694	114IRMA	1-1/4" x 1-1/4" MIP	
006695	112IRMA	1-1/2" x 1-1/2" MIP	
006696	2IRMA	2" x 2" MIP	

#### Red Brass Female Adapter

- Plastic pipe to female iron pipe (FIP)



Part #	Mfg #	Size	Price
006685	12IRFA	1/2" x 1/2" FIP	
006686	34IRFA	3/4" x 3/4" FIP	
006682	1IRFA	1" x 1" FIP	
006683	114IRFA	1-1/4" x 1-1/4" FIP	
006684	112IRFA	1-1/2" x 1-1/2" FIP	

#### Red Brass Coupling

- Plastic pipe to plastic pipe with hex



Part #	Mfg #	Size	Price
006675	34IRCPII	3/4" x 3/4"	

### Red Brass Insert Fittings (Continued)

#### Red Brass Coupling

Part #	Mfg #	Size	Price
086542	341IRCPII	3/4" x 1"	
006670	1IRCPII	1" x 1"	
050019	1141IRCII	1" x 1-1/4"	
006671	114IRCPII	1-1/4" x 1-1/4"	
006672	112IRCPII	1-1/2" x 1-1/2"	
006673	2IRCPII	2" x 2"	

#### Red Brass Elbow

- Plastic pipe to plastic pipe



Part #	Mfg #	Size	Price
006678	34IR90II	3/4" x 3/4"	
006676	1IR90II	1" x 1"	
006677	114IR90II	1-1/4" x 1-1/4"	
114147	112IR90II	1-1/2" x 1-1/2"	

#### Red Brass Combination Elbow

- Plastic pipe to male iron pipe (MIP)



Part #	Mfg #	Size	Price
006687	134IR90IM	1" x 1" MIP	
006688	1IR90IM	1" x 1" MIP	

#### Red Brass Tee

- Plastic pipe to plastic pipe



Part #	Mfg #	Size	Price
006681	34IRTIII	3/4"	
006690	34IRTIIM	3/4"	
006691	1134IRTIIM	1" x 3/4" x 1"	
006679	1IRTIII	1"	
006680	114IRTIII	1-1/4"	

## Iron & Carbon Steel Fittings & Nipples

### Merchant Steel Fittings

#### Recessed API5L Coupling

- Threaded
- Merchant Steel



Part #	Size	Price
176314	1/4"	
176315	3/8"	
176316	1/2"	
176317	3/4"	
176318	1"	
176319	1-1/4"	
176320	1-1/2"	
176321	2"	
176322	2-1/2"	
176323	3"	

### Malleable Iron Fittings

#### Black Cap

- 300# Threaded
- Malleable iron



Part #	Size	Price
176210	1/4"	
176211	3/8"	
064805	1/2"	
064806	3/4"	
025149	1"	
176212	1-1/4"	
176213	1-1/2"	
176214	2"	
176215	2-1/2"	
176216	3"	

#### Black 90° Elbow

- 300# Threaded
- Malleable iron



Part #	Size	Price
013478	1/4"	
076779	3/8"	

### Malleable Iron Fittings (Continued)

#### Black 90° Elbow

Part #	Size	Price
013057	1/2"	
014636	3/4"	
012195	1"	
027550	1-1/4"	
012394	1-1/2"	
013765	2"	
096077	2-1/2"	
176218	3"	

#### Black 45° Elbow

- 300# Threaded
- Malleable iron



Part #	Size	Price
176219	1/4"	
176220	3/8"	
027551	1/2"	
026082	3/4"	
027552	1"	
012775	1-1/4"	
027553	1-1/2"	
027554	2"	
176221	2-1/2"	
176222	3"	

#### Black 90° Street Elbow

- 300# Threaded
- Malleable iron



Part #	Size	Price
013471	1/4"	
176286	3/8"	
051781	1/2"	
014634	3/4"	
012187	1"	
034546	1-1/4"	
176287	1-1/2"	

### Malleable Iron Fittings (Continued)

#### Black 90° Street Elbow

Part #	Size	Price
132514	2"	
176288	3"	

#### Black Reducing Coupling

- 300# Threaded
- Malleable iron



Part #	Size	Price
176258	3/8" x 1/4"	
019102	1/2" x 1/4"	
027176	1/2" x 3/8"	
176259	3/4" x 3/8"	
021421	3/4" x 1/2"	
176260	1" x 1/2"	
064808	1" x 3/4"	
144739	1-1/4" x 1/2"	
132509	1-1/4" x 3/4"	
064809	1-1/4" x 1"	
155112	1-1/2" x 1/2"	
132510	1-1/2" x 3/4"	
076778	1-1/2" x 1"	
021422	1-1/2" x 1-1/4"	
176262	2" x 1/2"	
076775	2" x 3/4"	
132088	2" x 1"	
132087	2" x 1-1/4"	
055659	2" x 1-1/2"	
176263	2-1/2" x 1-1/2"	
132512	2-1/2" x 2"	
176264	3" x 2"	

## Iron & Carbon Steel Fittings & Nipples

### Black Coupling

- 300# Threaded
- Malleable iron



Part #	Size	Price
013054	1/2"	
014633	3/4"	
012192	1"	
012752	1-1/4"	
012391	1-1/2"	
013763	2"	

### Black Tee

- 300# Threaded
- Malleable iron



Part #	Size	Price
176289	1/4"	
176290	3/8"	
013055	1/2"	
014635	3/4"	
012193	1"	
027555	1-1/4"	
027556	1-1/2"	
027557	2"	
129478	2-1/2"	
176291	3"	

### Black Union with Brass Seat

- 300# Threaded
- Malleable iron



Part #	Size	Price
176292	1/4"	
176293	3/8"	
013056	1/2"	
014631	3/4"	
012194	1"	
012772	1-1/4"	
012393	1-1/2"	
013764	2"	

### Malleable Iron Fittings (Continued)

#### Black Union with Brass Seat

Part #	Size	Price
095254	2-1/2"	
176294	3"	

#### Black Reducing Tee

- 300# Threaded
- Malleable iron



Part #	Size	Price
075661	3/4" x 3/4" x 1/2"	
154334	1" x 1" x 1/2"	
165081	1" x 1" x 3/4"	
176279	1-1/4" x 1-1/4" x 1/2"	
144681	1-1/4" x 1-1/4" x 3/4"	
104415	1-1/4" x 1-1/4" x 1"	
155125	1-1/2" x 1-1/2" x 1/2"	
094249	1-1/2" x 1-1/2" x 3/4"	
094248	1-1/2" x 1-1/2" x 1"	
094250	1-1/2" x 1-1/2" x 1-1/4"	
132089	2" x 2" x 1/2"	
094269	2" x 2" x 3/4"	
055656	2" x 2" x 1"	
132511	2" x 2" x 1-1/4"	
155126	2" x 2" x 1-1/2"	
176280	2-1/2" x 2-1/2" x 2"	
176281	3" x 3" x 2"	



## John Guest Fittings

### Mur-lok® Polypropylene Quick-Connect Fittings & Valves

- All polypropylene construction
- Dual EPDM Chloramine-resistant o-ring technology
- Designed for use with polyethylene, polypropylene, nylon, polyurethane, and soft metal tubing
- The use of hose stems and clamps is required when using braided plastic hose

#### Mur-lok® Male NPTF Connector

Part #	Mfg #	Thread	Mur-lok	Price
052027	JGMALE14	1/4" Male NPTF	1/4"	
052028	JGMALE1438	3/8" Male NPTF	1/4"	
052029	JGMALE38	3/8" Male NPTF	3/8"	
052030	JGMALE3812	1/2" Male NPTF	3/8"	

#### Mur-lok® Union Connector

Part #	Mfg #	Mur-lok	Mur-lok	Price
052031	JGUNION14	1/4"	1/4"	
178668	JGUNION51614	5/16"	1/4"	
052032	JGUNION3814	3/8"	1/4"	
052033	JGUNION38	3/8"	3/8"	

#### Mur-lok® Faucet/Refrigerator Connectors

Part #	Mfg #	Thread	Mur-lok	Price
052034	JGFAUCETCONN14	7/16" - 24 UNS	1/4"	
052035	JGFAUCETCONN38	7/16" - 24 UNS	3/8"	

#### Mur-lok® Union Tees

Part #	Mfg #	Mur-lok	Price
052036	JGUNIONT14	1/4"	
052038	JGUNIONT383814	3/8" x 3/8" x 1/4"	
052037	JGUNIONT38	3/8"	

#### Mur-lok® End Stops

Part #	Mfg #	Mur-lok	Price
052040	JGENDSTOP38	3/8"	



### John Guest® Super Speedfit® Fittings

#### Speedfit® 90° Union Elbow

Part #	Mfg #	Size	Price
104607	JG90UE38	3/8" JG x 3/8" JG	

### Speedfit® 90° Union Tee

Part #	Mfg #	Size	Price
150353	JGUNIONT12	1/2" JG x 1/2" JG	

### Speedfit® Union Connectors

Part #	Mfg #	Size	Price
150354	JGUNION1238	1/2" JG x 3/8" JG	

### Speedfit® Female Connectors

Part #	Mfg #	Size	Price
090453	JGFEMALE3814	3/8" JG x 1/4" Female NPTF	



### John Guest® Polypropylene Shut-Off Valves

#### Inline Shut-Off Valve

Part #	Mfg #	Size	Price
051651	JG14BV	1/4" JG x 1/4" JG	
051654	JG38BV	3/8" JG x 3/8" JG	

### Self-Piercing Saddle Valves

Part #	Mfg #	Description	Price
094414	JGSADDLEVALVE14	1/4" Brass Compression	





## Lab Waste Fittings

### LabWaste™ CPVC Corrosive Waste Drainage System Fittings

CPVC Cap (Socket)



Part #	Mfg #	Size	Price
096975	2CPLWCA	2"	
123993	4CPLWCA	4"	
123994	6CPLWCA	6"	
242357	8CPLWCA	8"	

CPVC Coupling (H x H)



Part #	Mfg #	Size	Price
098138	112CPLWCP	1-1/2"	
085949	2CPLWCP	2"	
085951	3CPLWCP	3"	
089664	4CPLWCP	4"	
123995	6CPLWCP	6"	
242318	8CPLWCP	8"	

CPVC Female Adapter (FPT x H)



Part #	Mfg #	Size	Price
132478	112CPLWFA	1-1/2"	

CPVC Female Trap Adapter



Part #	Mfg #	Size	Price
085953	112CPLWSJA	1-1/2"	

CPVC Female Trap Adapter

• H x Slip w/ Chrome nut & washer



Part #	Mfg #	Size	Price
120226	112CPLWTA	1-1/2"	

CPVC Pipe Increaser - Reducer (H x H)



Part #	Mfg #	Size	Price
089673	2112CPLWCP	2" x 1-1/2"	
089676	32CPLWCP	3" x 2"	
089677	43CPLWCP	4" x 3"	

\* Fabricated

CPVC Flush Bushing Cleanout Adapter (S x FPT)



Part #	Mfg #	Size	Price
125386	2112CPLWBU	2" x 1-1/2"	
085952	32CPLWBU	3" x 2"	
116234	42CPLWBU	4" x 2"	
089678	43CPLWBU	4" x 3"	
123992	64CPLWBU	6" x 4"	
242421	84CPLWBU	8" x 4"	
242420	86CPLWBU	8" x 6"	

CPVC Male Adapter (MPT x H)

• Will not accept tail piece



Part #	Mfg #	Size	Price
087918	112CPLWMA	1-1/2"	
082201	2CPLWMA	2"	



## Lab Waste Fittings

**CPVC 90° Elbow  
(H x H)**



Part #	Mfg #	Size	Price
089859	112CPLW90	1-1/2"	
085954	2CPLW90	2"	
116658	3CPLW90	3"	
095523	4CPLW90	4"	
123991	6CPLW90	6"	
242352	8CPLW90	8"	

**CPVC 22-1/2° Street Elbow  
(H x S)**



Part #	Mfg #	Size	Price
242530	4CPLWS22	4"	
242529	6CPLWS22	6"	

**CPVC 90° Street Elbow  
(S x H)**



Part #	Mfg #	Size	Price
116783	112CPLWS90	1-1/2"	
113828	2CPLWS90	2"	
134658	3CPLWS90	3"	
089868	4CPLWS90	4"	

**CPVC 90° Long Bend Elbow  
(H x H)**



Part #	Mfg #	Size	Price
120228	112CPLWLS90	1-1/2"	

## LabWaste™ CPVC Corrosive Waste Drainage System Fittings (Continued)

**CPVC 90° Long Bend Elbow  
(H x H)**

Part #	Mfg #	Size	Price
108607	2CPLWLS90	2"	
113831	3CPLWLS90	3"	
116233	4CPLWLS90	4"	
242528	6CPLWLS90	6"	

**CPVC 90° Long Sweep Bend Street Elbow**



Part #	Mfg #	Size	Price
113825	2CPLWLSS90	2"	

**CPVC 45° Elbow  
(H x H)**



Part #	Mfg #	Size	Price
085955	112CPLW45	1-1/2"	
085956	2CPLW45	2"	
085957	3CPLW45	3"	
089665	4CPLW45	4"	
124809	6CPLW45	6"	
242353	8CPLW45	8"	

**CPVC 45° Street Elbow  
(H x S)**



Part #	Mfg #	Size	Price
085958	112CPLWS45	1-1/2"	
085960	2CPLWS45	2"	
085961	3CPLWS45	3"	
089666	4CPLWS45	4"	
123990	6CPLWS45	6"	



## Lab Waste Fittings

### LabWaste™ CPVC Corrosive Waste Drainage System Fittings (Continued)

#### CPVC 45° Street Elbow (H x S)

Part #	Mfg #	Size	Price
242524	8CPLWS45	8"	

#### CPVC 22° Elbow (H x H)



Part #	Mfg #	Size	Price
139086	2CPLW22	2"	
163709	4CPLW22	4"	

#### CPVC Sanitary Tee (H x H x H)



Part #	Mfg #	Size	Price
108601	112CPLWT	1-1/2"	
085962	2CPLWT	2"	
113833	3CPLWT	3"	
090068	4CPLWT	4"	

#### CPVC Reducing Sanitary Tee (H x H x H)



Part #	Mfg #	Size	Price
085963	22112CPLWT	2" x 2" x 1-1/2"	
118876	332CPLWT	3" x 3" x 2"	
122224	2112112CPLWT	2" x 1-1/2" x 1-1/2"	
095525	442CPLWT	4" x 4" x 2"	

### CPVC Reducing Double Sanitary Tee (All Hub)



Part #	Mfg #	Size	Price
121027	2112CPLWDT	2" x 2" x 1-1/2" x 1-1/2"	

### CPVC Cleanout Tee with Cleanout Plug (H x H)



Part #	Mfg #	Size	Price
095524	2CPLWCOTWPL	2"	
089679	4CPLWCOTWP	4"	
242359	6CPLWCOTWP	6"	
242360	8CPLWCOTWP	8"	

### CPVC Cleanout Adapter with Square Head Plug (Spig)



Part #	Mfg #	Size	Price
090229	3CPLWCOAWP	3"	

### CPVC Wye (All Hub)



Part #	Mfg #	Size	Price
098599	112CPLWY	1-1/2"	
085964	2CPLWY	2"	
085965	3CPLWY	3"	
089668	4CPLWY	4"	
123989	6CPLWY	6"	
242525	8CPLWY	8"	



## Lab Waste Fittings

### CPVC Reducing Wye (All Hub)



Part #	Mfg #	Size	Price
139224	22112CPLWY	2" x 2" x 1-1/2"	
149872	33112CPLWY	3" x 3" x 1-1/2"	
085966	332CPLWY	3" x 3" x 2"	
089858	442CPLWY	4" x 4" x 2"	
089669	443CPLWY	4" x 4" x 3"	
123986	664CPLWY	6" x 6" x 4"	
242354	884CPLWY	8" x 8" x 4"	
242356	886CPLWY	8" x 8" x 6"	

### CPVC Tail Piece with Nut



Part #	Mfg #	Size	Price
120225	112CPLW6TPN	1-1/2" x 6"	
092655	112CPLW12TP	1-1/2" x 12"	

### Jar Trap w/ Tail Piece Adapter (Slip x H)



Part #	Mfg #	Size	Price
217707	112CPLWJTWTP	1-1/2"	

### CPVC P-Trap (H x H)



Part #	Mfg #	Size	Price
085967	2CPLWPT	2"	
089671	3CPLWPT	3"	
095528	4CPLWPT	4"	

### CPVC Adjustable P-Trap with Plastic Nut (H x H)



Part #	Mfg #	Size	Price
085969	112CPLWUPT	1-1/2"	
122907	2CPLWUPT	2"	

### CPVC L.A. Pattern P-Trap (Slip x H) with Plastic Nut & Washer



Part #	Mfg #	Size	Price
116785	112CPLWLAPT	1-1/2"	



## Low Extractable Fittings

### Low Extractable Pipe Ultra-Pure Water Systems

#### Low Extractable PVC Sch 80 Pipe - 15' Lengths

- Pure Pipe
- Plain end
- For Ultra-Pure water systems
- Not for compressed air or gas



Part #	Mfg #	Size	Price
108599	1215LXTP	1/2" x 15'	
095530	3415LXTP	3/4" x 15'	
095531	115LXTP	1" x 15'	
103577	11415LXTP	1-1/4" x 15'	
145236	11215LXTP	1-1/2" x 15'	

### Low Extractable Fittings Ultra-Pure Water Systems

#### LXT Male Adapter (Mipt x Socket)



Part #	Mfg #	Size	Price
101475	12LXTMA	1/2"	
095536	34LXTMA	3/4"	
237835	1LXTMA	1"	
237815	112LXTMA	1-1/2"	

#### LXT 90° Elbow (Socket x Socket)



Part #	Mfg #	Size	Price
101478	12LXT90	1/2"	
095532	34LXT90	3/4"	
095533	1LXT90	1"	
103575	114LXT90	1-1/4"	

#### LXT 45° Elbow (Socket x Socket)



Part #	Mfg #	Size	Price
110520	12LXT45	1/2"	

#### LXT Tee (Socket x Socket)



Part #	Mfg #	Size	Price
108598	12LXTT	1/2"	
120615	34LXTT	3/4"	

#### LXT Reducing Tee (Socket x Socket)



Part #	Mfg #	Size	Price
095542	1134LXTT	1" x 1" x 3/4"	
145237	1121121LXT T	1-1/2" x 1-1/2" x 1"	

#### LXT Coupling (Socket x Socket)

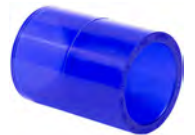

Part #	Mfg #	Size	Price
101480	12LXTCP	1/2"	
095534	34LXTCP	3/4"	
095535	1LXTCP	1"	

#### LXT Reducer Coupling (Socket x Socket)



Part #	Mfg #	Size	Price
120616	3412LXTCP	3/4" x 1/2"	
129419	134LXTCP	1" x 3/4"	
129417	1121LXTCP	1-1/2" x 1"	



## Low Extractable Fittings

### Low Extractable Fittings Ultra-Pure Water Systems (Continued)

#### LXT Reducer Coupling (Socket x Socket)

Part #	Mfg #	Size	Price
237814	112114LXTC P	1-1/2" x 1-1/4"	

#### LXT Cap (Socket x Socket)



Part #	Mfg #	Size	Price
109391	12LXTCA	1/2"	
096977	34LXTCA	3/4"	

#### LXT Reducer Bushing Flush Style (Spigot x Socket)



Part #	Mfg #	Size	Price
108595	3412LXTBU	3/4" x 1/2"	
171213	112LXTBU	1" x 1/2"	
095543	134LXTBU	1" x 3/4"	

#### True Union 2000 Industrial Ball Valve

- EPDM O-Ring
- With handle lockout & safe T-Block™ design



Part #	Mfg #	Size	Price
101476	12LXTBVTUE	1/2"	
095537	34LXTBVTUE	3/4"	
095538	1LXTBVTUE	1"	
145235	112LXTBVTU E	1-1/2"	

#### Diaphragm Valve

- EPDM O-Ring
- EPDM Backed PTFE diaphragm



Part #	Mfg #	Size	Price
237836	112LXTDPVL V	1-1/2"	

#### Special Reinforced Female Adapter (Socket x SR Fipt)



Part #	Mfg #	Size	Price
109390	12LXTFASR	1/2"	
108593	34LXTFASR	3/4"	





## MegaPress Gas Fittings

### Viega MegaPress® Gas Fittings

- HNBR sealing element

#### Viega MegaPressG 45° Street Elbow (P x Ftg)

- For use with carbon steel piping system
- Carbon steel
- Press connection, street
- HNBR sealing element



Part #	Mfg #	Size	Price
180623	12MPGS45	1/2"	
180624	34MPGS45	3/4"	
180625	1MPGS45	1"	
180626	114MPGS45	1-1/4"	
180627	112MPGS45	1-1/2"	
180628	2MPGS45	2"	

#### Viega MegaPressG 45° Elbow (P x P)

- For use with carbon steel piping systems
- Carbon steel
- Press connection
- HNBR sealing element



Part #	Mfg #	Size	Price
151369	12MPG45	1/2"	
151370	34MPG45	3/4"	
151371	1MPG45	1"	
151372	114MPG45	1-1/4"	
151373	112MPG45	1-1/2"	
151374	2MPG45	2"	

#### Viega MegaPressG® 90° Street Elbow (P x Ftg)

- For use with carbon steel piping system
- Carbon steel
- Press connection, street
- HNBR sealing element



Part #	Mfg #	Size	Price
180616	12MPGS90	1/2"	
180617	34MPGS90	3/4"	
180618	1MPGS90	1"	
180619	114MPGS90	1-1/4"	
180621	112MPGS90	1-1/2"	

### Viega MegaPress® Gas Fittings (Continued)

#### Viega MegaPressG® 90° Street Elbow (P x Ftg)

Part #	Mfg #	Size	Price
180622	2MPGS90	2"	

#### Viega MegaPressG 90° Elbow (P x P)

- For use with carbon steel piping system
- Carbon steel
- Press connection, street
- HNBR sealing element



Part #	Mfg #	Size	Price
151363	12MPG90	1/2"	
151364	34MPG90	3/4"	
151365	1MPG90	1"	
151366	114MPG90	1-1/4"	
151367	112MPG90	1-1/2"	
151368	2MPG90	2"	

#### Viega MegaPressG Coupling (P x P)

- For use with carbon steel piping system
- Carbon steel
- Press connection
- HNBR sealing element



Part #	Mfg #	Size	Price
151345	12MPGCP	1/2"	
151346	34MPGCP	3/4"	
151347	1MPGCP	1"	
151348	114MPGCP	1-1/4"	
151349	112MPGCP	1-1/2"	
151350	2MPGCP	2"	



## MegaPress Gas Fittings

### Viega MegaPressG Coupling (No Stop) (P x P)

- For use with carbon steel piping system
- Carbon steel
- Press connection
- HNBR sealing element



Part #	Mfg #	Size	Price
151493	12MPGRCP	1/2"	
151494	34MPGRCP	3/4"	
151495	1MPGRCP	1"	
151496	114MPGRCP	1-1/4"	
151497	112MPGRCP	1-1/2"	
151498	2MPGRCP	2"	

### Viega MegaPressG Union (P x P)

- For use with carbon steel piping system
- Carbon steel
- Press connection
- HNBR sealing element



Part #	Mfg #	Size	Price
151487	12MPGU	1/2"	
151488	34MPGU	3/4"	
151489	1MPGU	1"	
151490	114MPGU	1-1/4"	
151491	112MPGU	1-1/2"	
151492	2MPGU	2"	

### Viega MegaPressG Reducer (Ftg x P)

- For use with carbon steel piping system
- Carbon steel
- Street, press connection
- HNBR sealing element



Part #	Mfg #	Size	Price
151503	3412MPGFTGR	3/4" x 1/2"	
151504	112MPGFTGR	1" x 1/2"	
151505	134MPGFTGR	1" x 3/4"	
151507	1141MPGFTGR	1-1/4" x 1"	
151508	11234MPGFTGR	1-1/2" x 3/4"	
151510	1121MPGFTGR	1-1/2" x 1"	

### Viega MegaPress® Gas Fittings (Continued)

#### Viega MegaPressG Reducer (Ftg x P)

Part #	Mfg #	Size	Price
151509	112114MPGFTGR	1-1/2" x 1-1/4"	
151511	21MPGFTGR	2" x 1"	
151512	2114MPGFTGR	2" x 1-1/4"	
151514	2112MPGFTGR	2" x 1-1/2"	

#### Viega MegaPressG Tee (P x P x P)

- For use with carbon steel piping system
- Carbon steel
- Press connection
- HNBR sealing element



Part #	Mfg #	Size	Price
151375	12MPGT	1/2" x 1/2" x 1/2"	
151376	34MPGT	3/4" x 3/4" x 3/4"	
151377	1MPGT	1" x 1" x 1"	
231918	11411412MPGT	1-1/4" x 1-1/4" x 1/2"	
231917	11411434MPGT	1-1/4" x 1-1/4" x 3/4"	
151378	114MPGT	1-1/4" x 1-1/4" x 1-1/4"	
151379	112MPGT	1-1/2" x 1-1/2" x 1-1/2"	
151380	2MPGT	2" x 2" x 2"	
151381	343412MPGT	3/4" x 3/4" x 1/2"	
151382	1112MPGT	1" x 1" x 1/2"	
151383	1134MPGT	1" x 1" x 3/4"	
182162	1141141MPGT	1-1/4" x 1-1/4" x 1"	
151384	11211212MPGT	1-1/2" x 1-1/2" x 1/2"	
151385	11211234MPGT	1-1/2" x 1-1/2" x 3/4"	
151386	1121121MPGT	1-1/2" x 1-1/2" x 1"	
151388	112112114MPGT	1-1/2" x 1-1/2" x 1-1/4"	
151389	2212MPGT	2" x 2" x 1/2"	
151390	2234MPGT	2" x 2" x 3/4"	
151391	221MPGT	2" x 2" x 1"	
151392	22114MPGT	2" x 2" x 1-1/4"	
151393	22112MPGT	2" x 2" x 1-1/2"	



## MegaPress Gas Fittings

### Viega MegaPressG Tee (P x P x FPT)

- For use with carbon steel piping system
- Carbon steel
- Press connection, female pipe thread
- HNBR sealing element



Part #	Mfg #	Size	Price
151474	343412MPGTRF	3/4" x 3/4" x 1/2"	
151475	1112MPGTRF	1" x 1" x 1/2"	
151476	1134MPGTRF	1" x 1" x 3/4"	
151478	11211234MPGTR F	1-1/2" x 1-1/2" x 3/4"	
151480	2212MPGTRF	2" x 2" x 1/2"	
151481	2234MPGTRF	2" x 2" x 3/4"	

### Viega MegaPressG Female Adapter (P x FPT)

- For use with carbon steel piping system
- Carbon steel
- Press connection, female pipe thread
- HNBR sealing element



Part #	Mfg #	Size	Price
151482	3412MPGFR	3/4" x 1/2"	
151483	134MPGFR	1" x 3/4"	
151484	1141MPGFR	1-1/4" x 1"	
151485	112114MPGFR	1-1/2" x 1-1/4"	
151486	2112MPGFR	2" x 1-1/2"	
151357	12MPGFA	1/2" x 1/2"	
151358	34MPGFA	3/4" x 3/4"	
151359	1MPGFA	1" x 1"	
151360	114MPGFA	1-1/4" x 1-1/4"	
151361	112MPGFA	1-1/2" x 1-1/2"	
151362	2MPGFA	2" x 2"	

### Viega MegaPressG Male Adapter (P x MPT)

- For use with carbon steel piping systems
- Carbon steel
- Press connection, male pipe thread
- HNBR sealing element



Part #	Mfg #	Size	Price
151351	12MPGMA	1/2" x 1/2"	

### Viega MegaPress® Gas Fittings (Continued)

#### Viega MegaPressG Male Adapter (P x MPT)

Part #	Mfg #	Size	Price
151352	34MPGMA	3/4" x 3/4"	
151353	1MPGMA	1" x 1"	
151354	114MPGMA	1-1/4" x 1-1/4"	
151355	112MPGMA	1-1/2" x 1-1/2"	
151356	2MPGMA	2" x 2"	

### Viega MegaPress® Fittings

- EPDM sealing elements

#### MegaPress Coupling (P x P)

- No stop
- Smart Connect technology
- For use with Sch.5 to Sch.40 carbon steel pipe
- Carbon steel
- Press connection
- EPDM sealing elements



Part #	Mfg #	Size	Price
151305	2MPRCP	2" x 2"	
151302	1MPRCP	1" x 1"	
151303	114MPRCP	1-1/4" x 1-1/4"	
151304	112MPRCP	1-1/2" x 1-1/2"	

#### MegaPress Coupling (P x P)

- With stop
- Smart Connect technology
- For use with Sch.5 to Sch.40 carbon steel pipe
- Carbon steel
- Press connection
- EPDM sealing elements



Part #	Mfg #	Size	Price
151259	12MPCP	1/2" x 1/2"	
151260	34MPCP	3/4" x 3/4"	
151261	1MPCP	1" x 1"	
151262	114MPCP	1-1/4" x 1-1/4"	
151264	2MPCP	2" x 2"	



## MegaPress Gas Fittings

### MegaPress Male Adapter (P x MPT)

- Smart Connect technology
- For use with Sch.5 to Sch.40 carbon steel pipe
- Carbon steel
- Press connection, male pipe thread
- EPDM sealing elements



Part #	Mfg #	Size	Price
151242	34MPMA	3/4" x 3/4"	
151243	1MPMA	1" x 1"	
151244	114MPMA	1-1/4" x 1-1/4"	
151245	112MPMA	1-1/2" x 1-1/2"	
151246	2MPMA	2" x 2"	

### MegaPress Female Adapter (P x FPT)

- Smart Connect technology
- For use with Sch.5 to Sch.40 carbon steel pipe
- Carbon steel
- Press connection, female pipe thread
- EPDM sealing elements



Part #	Mfg #	Size	Price
151249	1MPFA	1" x 1"	
151251	112MPFA	1-1/2" x 1-1/2"	

### MegaPress 90° Elbow (P x P)

- Smart Connect technology
- For use with Sch.5 to Sch.40 carbon steel pipe
- Carbon steel
- Press connection
- EPDM sealing elements



Part #	Mfg #	Size	Price
151198	12MP90	1/2" x 1/2"	
151199	34MP90	3/4" x 3/4"	
151200	1MP90	1" x 1"	
151201	114MP90	1-1/4" x 1-1/4"	
151202	112MP90	1-1/2" x 1-1/2"	

### MegaPress 45° Elbow (P x P)

- Smart Connect technology
- For use with Sch.5 to Sch.40 carbon steel pipe
- Carbon steel
- Press connection
- EPDM sealing elements



Part #	Mfg #	Size	Price
151205	34MP45	3/4" x 3/4"	
151206	1MP45	1" x 1"	
151207	114MP45	1-1/4" x 1-1/4"	
151208	112MP45	1-1/2" x 1-1/2"	

### MegaPress Tee (P x P)

- Smart Connect technology
- For use with Sch.5 to Sch.40 carbon steel pipe
- Carbon steel
- Press connection
- EPDM sealing elements



Part #	Mfg #	Size	Price
151210	12MPT	1/2" x 1/2" x 1/2"	
151212	1MPT	1" x 1" x 1"	
151217	1112MPT	1" x 1" x 1/2"	
151218	1134MPT	1" x 1" x 3/4"	
151213	114MPT	1-1/4" x 1-1/4" x 1-1/4"	

### MegaPress Union (P x P)

- Smart Connect technology
- For use with Sch.5 to Sch.40 carbon steel pipe
- Carbon steel
- Press connection
- EPDM sealing elements



Part #	Mfg #	Size	Price
151309	1MPU	1" x 1"	



## MegaPress Gas Fittings

### MegaPress Reducer (FTG x P)

- Smart Connect technology
- For use with Sch.5 to Sch.40 carbon steel pipe
- Carbon steel
- Street, press connection
- EPDM sealing elements



Part #	Mfg #	Size	Price
151327	112MPFR	1" x 1/2"	

### Viega® MegaPress® 45° Elbow P x P

- Smart connect feature
- 304 Stainless steel
- Press connection
- FKM Sealing elements



Part #	Mfg #	Size	Price
236124	12MPSS45	1/2"	
236125	34MPSS45	3/4"	
236127	1MPSS45	1"	
236128	112MPSS45	1-1/2"	
236130	2MPSS45	2"	

### Viega MegaPress® 304 Stainless Fittings

#### Viega® MegaPress® 90° Elbow P x P

- Smart connect feature
- 304 Stainless steel
- Press connection
- FKM Sealing elements



Part #	Mfg #	Size	Price
236112	12MPSS90	1/2"	
236114	34MPSS90	3/4"	
236115	1MPSS90	1"	
236117	112MPSS90	1-1/2"	
236118	2MPSS90	2"	

#### Viega® MegaPress® 45° Street Elbow P x FTG)

- Smart connect feature
- 304 Stainless steel
- Press connection
- FKM Sealing elements



Part #	Mfg #	Size	Price
236131	12MPSSS45	1/2"	
236132	34MPSSS45	3/4"	
236133	1MPSSS45	1"	
236135	112MPSSS45	1-1/2"	
236136	2MPSSS45	2"	

#### Viega® MegaPress® 90° Street Elbow P x FTG)

- Smart connect feature
- 304 Stainless steel
- Press connection
- FKM Sealing elements



Part #	Mfg #	Size	Price
236119	12MPSSS90	1/2"	
236120	34MPSSS90	3/4"	
236121	1MPSSS90	1"	
236122	112MPSSS90	1-1/2"	
236123	2MPSSS90	2"	

#### Viega® MegaPress® Tee P x P x P

- Smart connect feature
- 304 Stainless steel
- Press connection
- FKM Sealing elements



Part #	Mfg #	Size	Price
236137	12MPSSST	1/2"	
236142	343412MPSSST	3/4" x 3/4" x 1/2"	
236138	34MPSSST	3/4"	
236143	1112MPSSST	1" x 1" x 1/2"	
236144	1134MPSSST	1" x 1" x 3/4"	
236139	1MPSSST	1"	
236145	11211212MPSSST	1-1/2" x 1-1/2" x 1/2"	
236146	11211234MPSSST	1-1/2" x 1-1/2" x 3/4"	
236147	1121121MPSSST	1-1/2" x 1-1/2" x 1"	
236140	112MPSSST	1-1/2"	
236148	2212MPSSST	2" x 2" x 1/2"	



## MegaPress Stainless Fittings

### Viega MegaPress® 304 Stainless Fittings (Continued)

#### Viega® MegaPress® Tee P x P x P

Part #	Mfg #	Size	Price
236149	2234MPSST	2" x 2" x 3/4"	
236150	221MPSST	2" x 2" x 1"	
236151	22112MPSST	2" x 2" x 1-1/2"	
236141	2MPSST	2"	

### Viega® MegaPress® Tee P x P x FPT

- Smart connect feature
- 304 Stainless steel
- Press connection
- FKM Sealing elements



Part #	Mfg #	Size	Price
236152	343412MPSSTF	3/4" x 3/4" x 1/2"	
236153	34MPSSTF	3/4"	
236154	1112MPSSTF	1" x 1" x 1/2"	
236156	1134MPSSTF	1" x 1" x 3/4"	
236157	11211212MPSST F	1-1/2" x 1-1/2" x 1/2"	
236159	11211234MPSST F	1-1/2" x 1-1/2" x 3/4"	
236160	1121121MPSSTF	1-1/2" x 1-1/2" x 1"	
236162	2212MPSSTF	2" x 2" x 1/2"	
236163	2234MPSSTF	2" x 2" x 3/4"	
236164	221MPSSTF	2" x 2" x 1"	

### Viega® MegaPress® Male Adapter P x MPT

- Smart connect feature
- 304 Stainless steel
- Press connection
- FKM Sealing elements



Part #	Mfg #	Size	Price
236166	12MPSSMA	1/2"	
236167	3412MPSSMA	3/4" x 1/2"	
236168	34MPSSMA	3/4"	
236169	1MPSSMA	1"	
236170	112MPSSMA	1-1/2"	
236171	2MPSSMA	2"	

### Viega® MegaPress® Female Adapter P x FPT

- Smart connect feature
- 304 Stainless steel
- Press connection
- FKM Sealing elements



Part #	Mfg #	Size	Price
236172	12MPSSFA	1/2"	
236173	34MPSSFA	3/4"	
236174	1MPSSFA	1"	
236175	112MPSSFA	1-1/2"	





## MegaPress Stainless Fittings

### Viega MegaPress® 304 Stainless Fittings (Continued)

#### Viega® MegaPress® Female Adapter P x FPT

Part #	Mfg #	Size	Price
236176	2MPSSFA	2"	

### Viega MegaPress® 304 Stainless Fittings (Continued)

#### Viega® MegaPress® Reducer P x P

Part #	Mfg #	Size	Price
236190	2112MPSSRC	2" x 1-1/2"	

#### Viega® MegaPress® Coupling With Stop P x P

- Smart connect feature
- 304 Stainless steel
- Press connection
- FKM Sealing elements



Part #	Mfg #	Size	Price
236177	12MPSSCPWS	1/2"	
236178	34MPSSCPWS	3/4"	
236179	1MPSSCPWS	1"	
236180	112MPSSCPWS	1-1/2"	
236181	2MPSSCPWS	2"	

#### Viega® MegaPress® Coupling P x P

- Smart connect feature
- 304 Stainless steel
- Press connection
- FKM Sealing elements



Part #	Mfg #	Size	Price
236182	12MPSSCP	1/2"	
236183	34MPSSCP	3/4"	
236184	1MPSSCP	1"	
236185	112MPSSCP	1-1/2"	
236186	2MPSSCP	2"	

#### Viega® MegaPress® Reducer P x P

- Smart connect feature
- 304 Stainless steel
- Press connection
- FKM Sealing elements



Part #	Mfg #	Size	Price
236187	3412MPSSRC	3/4" x 1/2"	
236188	134MPSSRC	1" x 3/4"	
236189	1121MPSSRC	1-1/2" x 1"	



## MegaPress Stainless Fittings

### Viega® MegaPress® Reducer FTG x P

- Smart connect feature
- 304 Stainless steel
- Press connection
- FKM Sealing elements



Part #	Mfg #	Size	Price
236191	3412MPSSFTGR	3/4" x 1/2"	
236192	112MPSSFTGR	1" x 1/2"	
236193	134MPSSFTGR	1" x 3/4"	
236194	11234MPSSFTGR	1-1/2" x 3/4"	
236195	1121MPSSFTGR	1-1/2" x 1"	
236196	2112MPSSFTGR	2" x 1-1/2"	

### Viega® MegaPress® Flange (P x BP)

- Smart connect feature
- 304 Stainless steel
- Press connection
- FKM Sealing elements

Part #	Mfg #	Size	Price
237240	12MPSSFL	1/2"	
237242	34MPSSFL	3/4"	
237243	1MPSSFL	1"	
237244	112MPSSFL	1-1/2"	
237245	2MPSSFL	2"	

### Viega® MegaPress® Cap

- Smart connect feature
- 304 Stainless steel
- Press connection
- FKM Sealing elements



Part #	Mfg #	Size	Price
236197	12MPSSCAP	1/2"	
236198	34MPSSCAP	3/4"	
236199	1MPSSCAP	1"	
236200	112MPSSCAP	1-1/2"	
236201	2MPSSCAP	2"	

### Viega® MegaPress® Union

- Smart connect feature
- 304 Stainless steel
- Press connection
- FKM Sealing elements



Part #	Mfg #	Size	Price
236202	12MPSSU	1/2"	
236203	34MPSSU	3/4"	
236204	1MPSSU	1"	
236205	112MPSSU	1-1/2"	
236207	2MPSSU	2"	



## MegaPress Stainless Fittings

### Viega MegaPress® 316 Stainless Fittings

#### Viega® MegaPress® 90° Elbow P x P

- Smart connect feature
- 316 Stainless steel
- Press connection



Part #	Mfg #	Size	Price
236208	12MPSS390	1/2"	
236209	34MPSS390	3/4"	
236210	1MPSS390	1"	
236211	112MPSS390	1-1/2"	
236212	2MPSS390	2"	

#### Viega® MegaPress® 90° Street Elbow P x FTG

- Smart connect feature
- 316 Stainless steel
- Press connection
- EPDM Sealing elements



Part #	Mfg #	Size	Price
236213	12MPSS3S90	1/2"	
236215	34MPSS3S90	3/4"	
236216	1MPSS3S90	1"	
236217	112MPSS3S90	1-1/2"	
236218	2MPSS3S90	2"	

#### Viega® MegaPress® 45° Elbow P x P

- Smart connect feature
- 316 Stainless steel
- Press connection
- EPDM Sealing elements



Part #	Mfg #	Size	Price
236219	12MPSS345	1/2"	
236220	34MPSS345	3/4"	
236221	1MPSS345	1"	
236222	112MPSS345	1-1/2"	
236223	2MPSS345	2"	

### Viega® MegaPress® 45° Street Elbow P x FTG

- Smart connect feature
- 316 Stainless steel
- Press connection
- EPDM Sealing elements



Part #	Mfg #	Size	Price
236224	12MPSS3S45	1/2"	
236225	34MPSS3S45	3/4"	
236226	1MPSS3S45	1"	
236227	112MPSS3S45	1-1/2"	
236228	2MPSS3S45	2"	

### Viega® MegaPress® Tee P x P x P

- Smart connect feature
- 316 Stainless steel
- Press connection
- EPDM Sealing elements



Part #	Mfg #	Size	Price
236229	12MPSS3T	1/2"	
236230	34MPSS3T	3/4"	
236231	1MPSS3T	1"	
236232	112MPSS3T	1-1/2"	
236233	2MPSS3T	2"	
236234	343412MPSS3T	3/4" x 3/4" x 1/2"	
236235	1112MPSS3T	1" x 1" x 1/2"	
236236	1134MPSS3T	1" x 1" x 3/4"	
236237	11211212MPSS3 T	1-1/2" x 1-1/2" x 1/2"	
236238	11211234MPSS3 T	1-1/2" x 1-1/2" x 3/4"	
236239	1121121MPSS3T	1-1/2" x 1-1/2" x 1"	
236240	2212MPSS3T	2" x 2" x 1/2"	
236241	2234MPSS3T	2" x 2" x 3/4"	
236242	221MPSS3T	2" x 2" x 1"	
236243	22112MPSS3T	2" x 2" x 1-1/2"	



## MegaPress Stainless Fittings

### Viega® MegaPress® Tee P x P x FPT

- Smart connect feature
- 316 Stainless steel
- Press connection
- EPDM Sealing elements



Part #	Mfg #	Size	Price
236244	343412MPSS3TF	3/4" x 3/4" x 1/2"	
236251	34MPSS3TF	3/4"	
236252	1112MPSS3TF	1" x 1" x 1/2"	
236253	1134MPSS3TF	1" x 1" x 3/4"	
236254	11211212MPSS3TF	1-1/2" x 1-1/2" x 1/2"	
236255	11211234MPSS3TF	1-1/2" x 1-1/2" x 3/4"	
236257	1121121MPSS3TF	1-1/2" x 1-1/2" x 1"	
236258	2212MPSS3TF	2" x 2" x 1/2"	
236259	2234MPSS3TF	2" x 2" x 3/4"	
236261	221MPSS3TF	2" x 2" x 1"	

### Viega® MegaPress® Male Adapter P x MPT

- Smart connect feature
- 316 Stainless steel
- Press connection
- EPDM Sealing elements



Part #	Mfg #	Size	Price
236262	12MPSS3MA	1/2"	
236264	3412MPSS3MA	3/4" x 1/2"	
236265	34MPSS3MA	3/4"	
236266	1MPSS3MA	1"	
236267	112MPSS3MA	1-1/2"	
236268	2MPSS3MA	2"	

### Viega® MegaPress® Female Adapter P x FPT

- Smart connect feature
- 316 Stainless steel
- Press connection
- EPDM Sealing elements



Part #	Mfg #	Size	Price
236269	12MPSS3FA	1/2"	
236270	34MPSS3FA	3/4"	
236271	1MPSS3FA	1"	

### Viega MegaPress® 316 Stainless Fittings (Continued)

#### Viega® MegaPress® Female Adapter P x FPT

Part #	Mfg #	Size	Price
236272	112MPSS3FA	1-1/2"	
236273	2MPSS3FA	2"	

#### Viega® MegaPress® Coupling with Stop P x P

- Smart connect feature
- 316 Stainless steel
- Press connection
- EPDM Sealing elements



Part #	Mfg #	Size	Price
236274	12MPSS3CPWS	1/2"	
236275	34MPSS3CPWS	3/4"	
236276	1MPSS3CPWS	1"	
236277	112MPSS3CPWS	1-1/2"	
236279	2MPSS3CPWS	2"	

#### Viega® MegaPress® Coupling P x P

- Smart connect feature
- 316 Stainless steel
- Press connection
- EPDM Sealing elements



Part #	Mfg #	Size	Price
236280	12MPSS3CP	1/2"	
236281	34MPSS3CP	3/4"	
236282	1MPSS3CP	1"	
236283	112MPSS3CP	1-1/2"	
236284	2MPSS3CP	2"	

#### Viega® MegaPress® Reducer P x P

- Smart connect feature
- 316 Stainless steel
- Press connection
- EPDM Sealing elements



Part #	Mfg #	Size	Price
236286	3412MPSS3RC	3/4" x 1/2"	
236288	134MPSS3RC	1" x 3/4"	



## MegaPress Stainless Fittings

### Viega MegaPress® 316 Stainless Fittings (Continued)

#### Viega® MegaPress® Reducer P x P

Part #	Mfg #	Size	Price
236289	1121MPSS3RC	1-1/2" x 1"	
236290	2112MPSS3RC	2" x 1-1/2"	

### Viega® MegaPress® Reducer FTG x P

- Smart connect feature
- 316 Stainless steel
- Press connection
- EPDM Sealing elements



Part #	Mfg #	Size	Price
236291	3412MPSS3FTGR	3/4" x 1/2"	
236292	112MPSS3FTGR	1" x 1/2"	
236293	134MPSS3FTGR	1" x 3/4"	
236294	11234MPSS3FTGR	1-1/2" x 3/4"	
236295	1121MPSS3FTGR	1-1/2" x 1"	
236296	21MPSS3FTGR	2" x 1"	
236297	2112MPSS3FTGR	2" x 1-1/2"	

### Viega® MegaPress® Cap P

- Smart connect feature
- 316 Stainless steel
- Press connection
- EPDM Sealing elements



Part #	Mfg #	Size	Price
236298	12MPSS3CAP	1/2"	
236299	34MPSS3CAP	3/4"	
236300	1MPSS3CAP	1"	
236301	112MPSS3CAP	1-1/2"	
236302	2MPSS3CAP	2"	

### Viega® MegaPress® Union P x P

- Smart connect feature
- 316 Stainless steel
- Press connection
- EPDM Sealing elements



Part #	Mfg #	Size	Price
236303	12MPSS3U	1/2"	
236304	34MPSS3U	3/4"	
236305	1MPSS3U	1"	
236306	112MPSS3U	1-1/2"	
236307	2MPSS3U	2"	

## Orion Rionfuse Fittings

### Rionfuse® Acid Waste Fittings

#### Rionfuse® 45° Wye

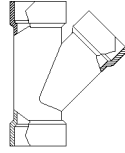

Part #	Mfg #	Size	Price
120783	ORION3Y	3"	

#### Rionfuse® Sanitary Tee

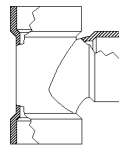

Part #	Mfg #	Size	Price
148615	ORION3T	3"	

#### Rionfuse® Coupling

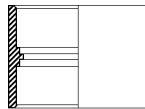

Part #	Mfg #	Size	Price
096876	ORION112CP	1-1/2"	
096424	ORION2CP	2"	
151713	ORION4MJCP	4"	
121696	ORION2MJCP	2"	

#### Rionfuse® Clean Out Adapter with Plug

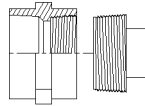

Part #	Mfg #	Size	Price
148609	ORION112COA	1-1/2"	
148610	ORION2COA	2"	

#### Rionfuse® Female Adapter

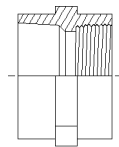

Part #	Mfg #	Size	Price
148611	ORION112MA	1-1/2"	
148612	ORION2MA	2"	

### Rionfuse® Male Adapter

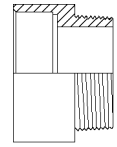

Part #	Mfg #	Size	Price
100196	ORION112FA	1-1/2"	

### Rionfuse® Reducing Bushing

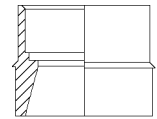

Part #	Mfg #	Size	Price
148614	ORION32RBU	3" x 2"	

### Rionfuse® P-Trap with Unions

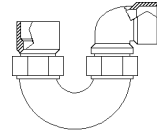

Part #	Mfg #	Size	Price
147924	ORION112PTUTP	1-1/2"	

### Rionfuse® P-Trap

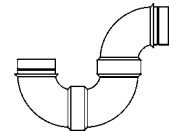

Part #	Mfg #	Size	Price
148725	ORION2RBP	2"	

### Rionfuse® Sink Tail Piece Extension - 12" Long

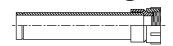

Part #	Mfg #	Size	Price
148616	ORION2TPRLNS	2"	





## Polysulfone Push-Fittings

### Polysulfone Push-Fit Valves & Fittings

#### 2100A Polysulfone Coupling - Push-Fit

- CTS x CTS



Part #	Mfg #	Size	Price
141730	12PFCP	1/2"	
141731	34PFCP	3/4"	
141732	3412PFCP	3/4" x 1/2"	

#### 2103A Polysulfone End Cap - Push-Fit

- CTS x CTS



Part #	Mfg #	Size	Price
141734	34PFCA	3/4"	

#### 2130A Polysulfone Tee - Push-Fit



Part #	Mfg #	Size	Price
141735	12PFT	1/2"	
141736	34PFT	3/4"	
141737	3412PFT	3/4" x 1/2"	

#### 2190A Polysulfone Elbow - Push-Fit

- CTS x CTS



Part #	Mfg #	Size	Price
141738	12PF90	1/2"	
141739	34PF90	3/4"	



## ProPress

### Viega ProPress® Fittings

#### ProPress® Adapter - Female (P x FPT)

- Bronze
- Smart Connect® feature
- Press connection, female pipe thread



Part #	Mfg #	Size	Price
049054	12PPFA	1/2" x 1/2"	
049053	1238PPFA	1/2" x 3/8"	
049055	1234PPFA	1/2" x 3/4"	
049057	3412PPFA	3/4" x 1/2"	
049058	34PPFA	3/4" x 3/4"	
049060	134PPFA	1" x 3/4"	
049061	1PPFA	1" x 1"	
049062	1114PPFA	1" x 1-1/4"	
049063	1141PPFA	1-1/4" x 1"	
049064	114PPFA	1-1/4" x 1-1/4"	
049065	114112PPFA	1-1/4" x 1-1/2"	
049066	112114PPFA	1-1/2" x 1-1/4"	
049067	112PPFA	1-1/2" x 1-1/2"	
049068	2PPFA	2" x 2"	

#### ProPress® Adapter - Male (P x MPT)

- Bronze
- Smart Connect® feature
- Press connection, male pipe thread



Part #	Mfg #	Size	Price
049017	1238PPMA	1/2" x 3/8"	
160289	12PPMA	1/2" x 1/2"	
049021	34PPMA	3/4" x 3/4"	
231294	341PPMA	3/4" x 1"	
049022	134PPMA	1" x 3/4"	
160499	1PPMA	1" x 1"	
049024	1114PPMA	1" x 1-1/4"	
049025	1141PPMA	1-1/4" x 1"	
049026	114PPMA	1-1/4" x 1-1/4"	
049027	114112PPMA	1-1/4" x 1-1/2"	
049029	112114PPMA	1-1/2" x 1-1/4"	
049031	112PPMA	1-1/2" x 1-1/2"	
141776	2PPMA	2" x 2"	
049019	1234PPMA	1/2" x 3/4"	
049020	3412PPMA	3/4" x 1/2"	

### Viega ProPress Adapter Flange - 2 Pc

- Smart Connect technology, Zero Lead
- For use with ASTM B88 tubing
- Bronze
- Press connection



Part #	Mfg #	Size	Price
116533	PP79680	1"	
116535	112PPFL	1-1/2"	
116536	2PPFL	2"	

### Viega ProPress 90° Elbow (P x FPT)

- Smart Connect technology, Zero Lead
- For use with ASTM B88 tubing
- Bronze
- Press connection, female pipe thread



Part #	Mfg #	Size	Price
249914	PP79545	1" x 1/2"	
249915	PP79550	1" x 1"	
249916	PP79560	1-1/4" x 1-1/4"	
249917	PP79565	1-1/2" x 1-1/2"	
249918	PP79570	2" x 2"	

### ProPress® Elbow - Female - 90° (P x FPT)

- Bronze
- Drop ear
- Smart Connect® feature
- Press connection, female pipe thread



Part #	Mfg #	Size	Price
049163	12PPCFDE90	1/2" x 1/2"	
049164	34PPCFDE90	3/4" x 3/4"	

### ProPress® Elbow - Female - 90° (P x FPT)

- Bronze
- Smart Connect® feature
- Press connection, female pipe thread



Part #	Mfg #	Size	Price
049154	12PPCF90	1/2" x 1/2"	
153184	3412PPCF90	3/4" x 1/2"	



## ProPress

### ProPress® Tee (P x P x FNPT)

- Bronze
- Smart Connect® feature
- Press connection, female pipe thread



Part #	Mfg #	Size	Price
049204	12PPTF	1/2" x 1/2" x 1/2"	
226340	34PPTF	3/4" x 3/4" x 3/4"	
159689	112PPTF	1-1/2" x 1-1/2" x 1/2"	

### ProPress® Vent Elbow (P x P x FPT)

- Bronze
- Press connection, female pipe thread



Part #	Mfg #	Size	Price
173437	PP79640	3/4" x 3/4" x 1/8"	

### Viega ProPress® Di-Electric Union (P x FPT)

- For use with ASTM B88 tubing
- Bronze
- Press connection, female pipe thread



Part #	Mfg #	Size	Price
167933	34PPDIUF	3/4"	
167934	1PPDIUF	1"	
167935	114PPDIUF	1-1/4"	
167936	2PPDIUF	2"	

### ProPress® Test Plug

- For Viega ProPress fittings
- Bronze



Part #	Mfg #	Size	Price
116525	PP78207	3/4"	

### ProPress® Union (P x P)

- Bronze
- Ground joint
- Smart Connect® feature
- Press connection



Part #	Mfg #	Size	Price
049210	12PPU	1/2"	
049211	34PPU	3/4"	
049212	1PPU	1"	

### Viega ProPress® Fittings (Continued)

#### ProPress® Union (P x P)

Part #	Mfg #	Size	Price
049213	114PPU	1-1/4"	
049214	112PPU	1-1/2"	
049215	2PPU	2"	

#### ProPress® Union (P x FPT)

- Bronze
- Ground joint
- Smart Connect® feature
- Press connection, female pipe thread



Part #	Mfg #	Size	Price
049216	12PPCFU	1/2" x 1/2"	
049217	34PPCFU	3/4" x 3/4"	
049218	1PPCFU	1" x 1"	
049219	114PPCFU	1-1/4" x 1-1/4"	
049220	112PPCFU	1-1/2" x 1-1/2"	
049221	2PPCFU	2" x 2"	

#### ProPress® Union - Male (P x MPT)

- Bronze
- Ground joint
- Smart Connect® feature
- Press connection, male pipe thread



Part #	Mfg #	Size	Price
149110	34PPCMU	3/4" x 3/4"	
149111	1PPMU	1" x 1"	
158953	112PPCMU	1-1/2" x 1-1/2"	
049227	2PPCMU	2" x 2"	

#### ProPress® Adapter - Female (Ftg x FPT)

- Bronze
- Street, female pipe thread



Part #	Mfg #	Size	Price
049082	1238PPSFA	1/2" x 3/8"	
159750	12PPSFA	1/2" x 1/2"	
049086	3412PPSFA	3/4" x 1/2"	
049087	34PPSFA	3/4" x 3/4"	
049088	1PPSFA	1" x 1"	
049089	114PPSFA	1-1/4" x 1-1/4"	
049091	2PPSFA	2" x 2"	



## ProPress

### ProPress® Adapter - Male (Ftg x MPT)

- Bronze
- Street, male pipe thread



Part #	Mfg #	Size	Price
049071	1238PPSMA	1/2" x 3/8"	
049074	12PPSMA	1/2" x 1/2"	
049075	1234PPSMA	1/2" x 3/4"	
049076	3412PPSMA	3/4" x 1/2"	
049077	34PPSMA	3/4" x 3/4"	
049078	1PPSMA	1" x 1"	
049079	114PPSMA	1-1/4" x 1-1/4"	
049080	112PPSMA	1-1/2" x 1-1/2"	
049081	2PPSMA	2" x 2"	

### ProPress® Cap (P)

- Copper
- Smart Connect® feature
- Press connection



Part #	Mfg #	Size	Price
049092	12PPCCA	1/2"	
049093	34PPCCA	3/4"	
049094	1PPCCA	1"	
049095	114PPCCA	1-1/4"	
049096	112PPCCA	1-1/2"	
049097	2PPCCA	2"	

### ProPress® Coupling - with Stop (P x P)

- Copper
- Smart Connect® feature
- Press connection



Part #	Mfg #	Size	Price
049098	12PPCCP	1/2"	
049099	34PPCCP	3/4"	
049132	1PPCCP	1"	
049133	114PPCCP	1-1/4"	
049134	112PPCCP	1-1/2"	
049135	2PPCCP	2"	

### ProPress® Coupling - No Stop (P x P)

- Copper
- Smart Connect® feature
- Press connection



Part #	Mfg #	Size	Price
049136	12PPCSCP	1/2"	

### Viega ProPress® Fittings (Continued)

#### ProPress® Coupling - No Stop (P x P)

Part #	Mfg #	Size	Price
049137	34PPCSCP	3/4"	
049138	1PPCSCP	1"	
049139	114PPCSCP	1-1/4"	
049140	112PPCSCP	1-1/2"	
049141	2PPCSCP	2"	

#### ProPress® Crossover (P x P)

- Copper
- Smart Connect® feature
- Press connection



Part #	Mfg #	Size	Price
049142	12PPCROSSOVER	1/2"	
049143	34PPCROSSOVER	3/4"	

#### ProPress® Elbow - 90° (P x P)

- Copper
- Smart Connect® feature
- Press connection



Part #	Mfg #	Size	Price
048980	12PP90	1/2"	
048981	34PP90	3/4"	
048982	1PP90	1"	
048983	114PP90	1-1/4"	
048984	112PP90	1-1/2"	
048985	2PP90	2"	

#### ProPress® Elbow - 90° (Ftg x P)

- Copper
- Smart Connect® feature
- Press connection, street



Part #	Mfg #	Size	Price
048986	12PPS90	1/2"	
048987	34PPS90	3/4"	
048989	1PPS90	1"	
048991	114PPS90	1-1/4"	
048992	112PPS90	1-1/2"	
048993	2PPS90	2"	



## ProPress

### ProPress® Elbow - 45° (P x P)

- Copper
- Smart Connect® feature
- Press connection



Part #	Mfg #	Size	Price
048994	12PP45	1/2"	
048995	34PP45	3/4"	
048996	1PP45	1"	
048997	114PP45	1-1/4"	
048998	112PP45	1-1/2"	
048999	2PP45	2"	

### ProPress® Elbow - 45° (Ftg x P)

- Copper
- Smart Connect® feature
- Press connection, street



Part #	Mfg #	Size	Price
049000	12PPS45	1/2"	
049001	34PPS45	3/4"	
049002	1PPS45	1"	
049003	114PPS45	1-1/4"	
049004	112PPS45	1-1/2"	
049005	2PPS45	2"	

### ProPress® Reducer (P x P)

- Copper
- Smart Connect® feature
- Press connection



Part #	Mfg #	Size	Price
089722	112PPCRC	1" x 1/2"	
089724	11434PPCRC	1-1/4" x 3/4"	
049166	3412PPCRC	3/4" x 1/2"	
049167	134PPCRC	1" x 3/4"	
049168	1141PPCRC	1-1/4" x 1"	
089725	11234PPCRC	1-1/2" x 3/4"	
089726	1121PPCRC	1-1/2" x 1"	
049169	112114PPCRC	1-1/2" x 1-1/4"	
089727	234PPCRC	2" x 3/4"	
089728	21PPCRC	2" x 1"	
108995	2114PPCRC	2" x 1-1/4"	
049170	2112PPCRC	2" x 1-1/2"	

### ProPress® Reducer (Ftg x P)

- Copper
- Smart Connect® feature
- Street, press connection



Part #	Mfg #	Size	Price
049171	3412PPCFR	3/4" x 1/2"	
049172	112PPCFR	1" x 1/2"	
049173	134PPCFR	1" x 3/4"	
168073	PP22333	1-1/4" x 1/2"	
049174	11434PPCFR	1-1/4" x 3/4"	
049175	1141PPCFR	1-1/4" x 1"	
159119	11212PPCFR	1-1/2" x 1/2"	
089730	11234PPCFR	1-1/2" x 3/4"	
049176	1121PPCFR	1-1/2" x 1"	
049177	112114PPCFR	1-1/2" x 1-1/4"	
089731	212PPCFR	2" x 1/2"	
089732	234PPCFR	2" x 3/4"	
049178	21PPCFR	2" x 1"	
049179	2114PPCFR	2" x 1-1/4"	
049180	2112PPCFR	2" x 1-1/2"	

### ProPress® Tee (P x P x P)

- Copper
- Smart Connect® feature
- Press connection



Part #	Mfg #	Size	Price
049181	12PPT	1/2" x 1/2"	
049187	1234PPT	1/2" x 3/4"	
049188	341212PPT	3/4" x 1/2" x 1/2"	
049189	341234PPT	3/4" x 1/2" x 3/4"	
049190	343412PPT	3/4" x 1/2"	
049182	34PPT	3/4" x 3/4"	
049191	34341PPT	3/4" x 1"	
072291	1121PPT	1" x 1/2" x 1"	
049192	13412PPT	1" x 3/4" x 1/2"	
049193	13434PPT	1" x 3/4" x 3/4"	
049194	1341PPT	1" x 3/4" x 1"	
049195	1112PPT	1" x 1/2"	
049196	1134PPT	1" x 3/4"	
049183	1PPT	1" x 1"	
089736	11114PPT	1" x 1" x 1-1/4"	
114364	11412114PPT	1-1/4" x 1/2" x 1-1/4"	
123641	11434114PPT	1-1/4" x 3/4" x 1-1/4"	
081055	11411PPT	1-1/4" x 1" x 1"	



## ProPress

### Viega ProPress® Fittings (Continued)

#### ProPress® Tee (P x P x P)

Part #	Mfg #	Size	Price
049198	11411434PPT	1-1/4" x 3/4"	
049197	1141141PPT	1-1/4" x 1"	
049184	114PPT	1-1/4" x 1-1/4"	
072289	11411412PPT	1-1/4" x 1/2"	
072290	114134PPT	1-1/4" x 1" x 3/4"	
185198	112134PPT	1-1/2" x 1" x 3/4"	
084669	11211PPT	1-1/2" x 1" x 1"	
089741	1121112PPT	1-1/2" x 1" x 1-1/2"	
089742	1121141PPT	1-1/2" x 1-1/4" x 1"	
089706	112114114PPT	1-1/2" x 1-1/4" x 1-1/4"	
089743	11211212PPT	1-1/2" x 1-1/2" x 1/2"	
049199	11211234PPT	1-1/2" x 1-1/2" x 3/4"	
049200	1121121PPT	1-1/2" x 1-1/2" x 1"	
049201	112112114PPT	1-1/2" x 1-1/2" x 1-1/4"	
049185	112PPT	1-1/2" x 1-1/2" x 1-1/2"	
089746	PP15528	2" x 1" x 2"	
089747	2114114PPT	2" x 1-1/4" x 1-1/4"	
084668	211234PPT	2" x 1-1/2" x 3/4"	
089749	21121PPT	2" x 1-1/2" x 1"	
089750	PP15508	2" x 1-1/2" x 1-1/4"	
089751	2112112PPT	2" x 1-1/2" x 1-1/2"	
085805	2212PPT	2" x 2" x 1/2"	
072293	2234PPT	2" x 2" x 3/4"	
072292	221PPT	2" x 2" x 1"	
049203	22114PPT	2" x 2" x 1-1/4"	
049202	22112PPT	2" x 2" x 1-1/2"	
049186	2PPT	2" x 2" x 2"	

### Viega ProPress® XL® Fittings

#### ProPress® XL® Tee (P x P x P)

- Bronze



Part #	Mfg #	Size	Price
180269	PP20784	4" x 3" x 3"	

### Viega ProPress® XL-C® Fittings

#### ProPress® XL-C® Adapter - Male (P x MPT)

- Copper
- Smart Connect® feature
- Press connection



Part #	Mfg #	Size	Price
115625	212PPXLCMA	2-1/2" x 2-1/2"	
115626	3PPXLCMA	3" x 3"	
115627	4PPXLCMA	4" x 4"	

#### ProPress® XL-C® Adapter Flange (Flange x P)

- Copper
- Smart Connect® feature
- Press connection



Part #	Mfg #	Size	Price
116543	212PPXLCFL	2-1/2"	
113280	3PPXLCFL	3"	
116544	4PPXLCFL	4"	

#### ProPress® XL-C® Coupling - No Stop (P x P)

- Copper
- Smart Connect® feature
- Press connection



Part #	Mfg #	Size	Price
115634	212PPXLCSCP	2-1/2"	
115635	3PPXLCSCP	3"	
115636	4PPXLCSCP	4"	

#### ProPress® XL-C® Cap (P x P)

- Copper
- Smart Connect® feature
- Press connection



Part #	Mfg #	Size	Price
115629	212PPXLCCAP	2-1/2"	
113281	3PPXLCCAP	3"	
115630	4PPXLCCAP	4"	





## ProPress

### ProPress® XL-C® Coupling - with Stop (P x P)

- Copper
- Smart Connect® feature
- Press connection



Part #	Mfg #	Size	Price
115631	212PPXLCCP	2-1/2"	
115632	3PPXLCCP	3"	
115633	4PPXLCCP	4"	

### ProPress® XL-C® Elbow - 90° (P x P)

- Zero Lead™ copper
- Smart Connect® feature
- Press connection



Part #	Mfg #	Size	Price
115637	212PPXLC90	2-1/2"	
115638	3PPXLC90	3"	
115639	4PPXLC90	4"	

### ProPress® XL-C® Elbow - 90° (Ftg x P)

- Copper
- Smart Connect® feature
- Press connection, street



Part #	Mfg #	Size	Price
115640	212PPXLCST90	2-1/2"	
115641	3PPXLCST90	3"	
115642	4PPXLCST90	4"	

### ProPress® XL-C® Elbow - 45° (P x P)

- Copper
- Smart Connect® feature
- Press connection



Part #	Mfg #	Size	Price
115643	212PPXLC45	2-1/2"	
115644	3PPXLC45	3"	
115645	4PPXLC45	4"	

### ProPress® XL-C® Elbow - 45° (Ftg x P)

- Copper
- Smart Connect® feature
- Press connection, street



Part #	Mfg #	Size	Price
115646	212PPXLCST45	2-1/2"	
115647	3PPXLCST45	3"	
115648	4PPXLCST45	4"	

### ProPress® XL-C® Reducer (P x P)

- Copper
- Smart Connect® feature
- Press connection



Part #	Mfg #	Size	Price
127702	2121PPXLCRC	2-1/2" x 1"	
127703	212114PPXLCRC	2-1/2" x 1-1/4"	
127704	212112PPXLCRC	2-1/2" x 1-1/2"	
127705	2122PPXLCRC	2-1/2" x 2"	
127706	3112PPXLCRC	3" x 1-1/2"	
127707	32PPXLCRC	3" x 2"	
127708	3212PPXLCRC	3" x 2-1/2"	
127709	42PPXLCRC	4" x 2"	
127710	4212PPXLCRC	4" x 2-1/2"	
127711	43PPXLCRC	4" x 3"	

### ProPress® XL-C® Reducer (Ftg x P)

- Copper
- Smart Connect® feature
- Street, press connection



Part #	Mfg #	Size	Price
124723	2121PPXLCFR	2-1/2" x 1"	
115649	212112PPXLCFR	2-1/2" x 1-1/2"	
115650	2122PPXLCFR	2-1/2" x 2"	
115651	3112PPXLCFR	3" x 1-1/2"	
113282	32PPXLCFR	3" x 2"	
115652	3212PPXLCFR	3" x 2-1/2"	
115653	42PPXLCFR	4" x 2"	
115654	4212PPXLCFR	4" x 2-1/2"	
115656	43PPXLCFR	4" x 3"	



## ProPress

### ProPress® XL-C® Tee (P x P x P)

- Copper
- Smart Connect® feature
- Press connection



Part #	Mfg #	Size	Price
158952		2-1/2" x 2" x 1"	
124732	21221212PPXLCT	2-1/2" x 2-1/2" x 1/2"	
111195	21221234PPXLCT	2-1/2" x 2-1/2" x 3/4"	
115667	2122121PPXLCT	2-1/2" x 2-1/2" x 1"	
115666	21222PPXLCT	2-1/2" x 2" x 2"	
111334	212212114PPXLC T	2-1/2" x 2-1/2" x 1-1/4"	
115668	212212112PPXLC T	2-1/2" x 2-1/2" x 1-1/2"	
115669	2122122PPXLCT	2-1/2" x 2-1/2" x 2"	
115665	212PPXLCT	2-1/2" x 2-1/2" x 2-1/2"	
124719	3334PPTXLC	3" x 3" x 3/4"	
115671	33114PPXLCT	3" x 3" x 1-1/4"	
115672	33112PPTXLC	3" x 3" x 1-1/2"	
117707	331PPXLCT	3" x 3" x 1"	
115673	332PPXLCT	3" x 3" x 2"	
115674	33212PPXLCT	3" x 3" x 2-1/2"	
115670	3PPXLCT	3" x 3" x 3"	
124721	441PPXLCT	4" x 4" x 1"	
115676	442PPXLCT	4" x 4" x 2"	
115677	44212PPXLCT	4" x 4" x 2-1/2"	
115678	443PPXLCT	4" x 4" x 3"	
115675	4PPXLCT	4" x 4" x 4"	

### ProPress® XL-C® Tee (P x P x FNPT)

- Copper
- Smart Connect® feature
- Press connection, female pipe thread



Part #	Mfg #	Size	Price
115662	2122122PPLXCTF	2-1/2" x 2-1/2" x 2"	
115663	332PPXLCTF	3" x 3" x 2"	
115664	442PPXLCTF	4" x 4" x 2"	
111194	21221234PPXLCT F	2-1/2" x 2-1/2" x 3/4"	

## ProPress System

### M12™ Lithium-Ion Cordless Press Tools

#### M12™ Cordless ProPEX® Expansion Tool Kit

- Speed: 60 SPM
- Head rotation: built-in auto-rotator
- Head compatibility: 3/8" to 1" M12™/Uponor®
- LED Light
- 5-Year warranty
- Includes:
  - (1) M12™ Cordless ProPEX® Expansion Tool (Bare Tool) (2432-20)
  - (2) M12™ XC High Capacity REDLITHIUM™ Battery (48-11-2402)
  - (1) M18™ & M12™ Multi-Voltage Charger (48-59-1812)
  - (1) ProPEX Expander Cone Grease (49-08-2400)
  - (1) 1/2" ProPEX® Expansion Head (49-16-2404)
  - (1) 3/4" ProPEX® Expansion Head (49-16-2406)
  - (1) 1" ProPEX® Expansion Head (49-16-2408)
  - (1) Carrying Case



Part #	Mfg #	Description	Price
135837	2432-22	Kit	
173179	2432-22XC	Kit	
135835	2432-20	Bare Tool	

#### M12™ Force Logic™ Press Tool Kit

- Interchangeable jaw for quick adjustment from 1/2" to 1-1/4"
- Suitable for one-hand use
- 5-Second cycle time
- Press force: 5,400 lbs
- 32,000 Cycles between calibrations
- Includes:
  - M12™ Force Logic™ press tool (2473-20)
  - (2) M12™ REDLITHIUM™ batteries
  - 30-Minute charger
  - Hard carrying case
- 5-Year warranty on tool
- 2-Year warranty on jaws



Part #	Mfg #	Description	Price
150846	2473-20	Press Tool Kit	
150847	2473-22	Press Tool Kit with Jaws	

### M18™ Lithium-Ion Cordless Press Tools

#### M18™ Force Logic™ Press Tool Kit

- Interchangeable jaw for quick adjustment from 1/2" to 2"
- Suitable for 1-hand use
- 5-Second cycle time
- Press force: 7,200 lbs
- 40,000 Cycles between calibrations
- Kit includes:
  - M18™ Force Logic™ press tool (2673-20)
  - (2) M18™ REDLITHIUM™ batteries
  - (6) Jaws - 1/2", 3/4", 1", 1-1/4", 1-1/2" and 2"
  - 30-Minute charger
  - Hard carrying case
- 5-Year warranty on tool
- 2-Year warranty on jaws



Part #	Mfg #	Description	Price
150849	2673-22	Press Tool Kit	

#### M18™ Force Logic™ 2"-3" ProPEX® Expansion Tool Kit

- Expands 2", 2-1/2" and 3" Uponor® large diameter PEX pipe
- LED light
- Auto-rotate mechanism expands
- Auto-cycle: Rotates, expands
- Overhead connections
- Flips over for extended use on table-top
- Includes:
  - (1) 2-1/2" ProPEX® Expansion head (49-16-2616)
  - (1) 2" ProPEX® Expansion head (49-16-2614)
  - (3) 3" ProPEX® Expansion head (49-16-2618)
  - (2) M18™ REDLITHIUM™ XC 4.0 extended capacity Battery Pack (48-11-1840)
  - (1) M18™ & M12™ Multi-voltage charger (48-59-1812)
  - (1) 150g ProPEX® Expander cone grease (49-08-2401)
  - (1) Carrying case
  - (1) Side handle



Part #	Mfg #	Size	Price
182828	2633-22	2"-3"	



## ProPress System

### M18™ Short Throw Press Tool Kit PureFlow™

#### Jaws

- Designed for one handed use
- Auto cycle ensures full press every time
- 40% Faster press
- No calibration interval
- Optimized for residential installs
- Kit Includes
  - (2) M18™ REDLITHIUM™ 2.0 Compact battery pack (48-11-1820)
  - (1) M18™ & M12™ Multi-voltage charger (48-59-1812)
  - (1) M18™ 1/2" Viega PureFlow™ jaw for M18™ short throw press tool (49-16-2631P)
  - (1) M18™ 3/4" Viega PureFlow™ jaw for M18™ short throw press tool (49-16-2633P)
  - (1) M18™ 1" Viega PureFlow™ jaw for M18™ short throw press tool (49-16-2634P)
  - (1) Carrying case



### Press Jaws and Rings

### M18™ Force Logic™ Press Tool Kit with 1/2"-2"

#### Jaws

- Auto-cycle
- Brushless press tool
- One-handed presses
- In-line design for unrivaled access
- Longest calibration-50,000 cycles
- Includes:
  - (1) M18™ FORCE LOGIC™ Press Tool (2773-20)
  - (2) M18™ REDLITHIUM™ 2.0 battery (48-11-1820)
  - (1) M18™ & M12™ Multi-voltage charger (48-59-1812)
  - (1) M18™ 1/2" Jaw (49-16-2650)
  - (1) M18™ 3/4" Jaw (49-16-2651)
  - (1) M18™ 1" Jaw (49-16-2652)
  - (1) M18™ 1 1/4" Jaw (49-16-2653)
  - (1) M18™ 1 1/2" Jaw (49-16-2654)
  - (1) M18™ 2" Jaw (49-16-2655)



Part #	Mfg #	Description	Price
250894	2674-20C	PEX Crimp Jaws - Tool Only	
231181	2674-22C	PEX Crimp Jaws - Kit	
228433	2674-22P	Viega Jaws - Kit	

Part #	Mfg #	Description	Price
229336	2773-20	Tool Only	
226110	2773-22	Tool Kit	

### M18™ ProPEX™ Expansion Tool Kit

- Built-in Auto Rotate Head
- LED Work Light
- Quick Cam Mechanism
- For 3/8"-1-1/2" ProPEX™
- D-Handle Design
- Integrated Magnesium Frame
- Includes:
  - (1) M18™ Cordless LITHIUM-ION ProPEX® Expansion Tool (2632-20)
  - (2) M18™ REDLITHIUM™ Battery (48-11-1828)
  - (1) M18™ & M12™ Charger (48-59-1812)
  - (1) ProPEX Expander Cone Grease (49-08-2400)
  - (1) 1" M18™ ProPEX® Expansion Head
  - (1) 1-1/4" M18™ ProPEX® Expansion Head
  - (1) 1-1/2" M18™ ProPEX® Expansion Head



### Black Iron Press Kit 1/2" - 2"

- (1) M18™ 1/2" Black Iron Press Jaw —(49-16-2650B)
- (1) M18™ 3/4" Black Iron Press Jaw —(49-16-2651B)
- (1) M18™ 1" Black Iron Press Jaw —(49-16-2652B)
- (1) M18™ 1-1/4" Black Iron Press Ring —(49-16-2653B)
- (1) M18™ 1-1/2" Black Iron Press Ring (49-16-2654B)
- (1) M18™ 2" Black Iron Press Ring (49-16-2655B)
- (1) Ring Jaw 1 (49-16-2659)



Part #	Mfg #	Description	Price
173693	2632-22XC	Expansion Tool Kit	

Part #	Mfg #	Size	Price
171199	49-16-2697	1/2" - 2"	

### Black Iron Press Kit 1/2" - 1"

- Includes:
  - (1) M18™ 1/2" Black Iron Press Jaw (49-16-2650B)
  - (1) M18™ 3/4" Black Iron Press Jaw (49-16-2651B)
  - (1) M18™ 1" Black Iron Press Jaw (49-16-2652B)



Part #	Mfg #	Size	Price
171197	49-16-2696	1/2" - 1"	

## ProPress System

### M18™ Force Logic Press Rings Kit

- (1) M18™ 2 - 1/2" Ring (49-16-2656)
- (1) M18™ 3" Ring (49-16-2657)
- (1) M18™ 4" Ring (49-16-2658)
- (1) Ring Jaw 1 (49-16-2659)
- (1) Plastic Carrying Case



Part #	Mfg #	Size	Price
150850	49-16-2652B	2-1/2" - 4"	

### Ring Jaw 1

- For use with M18™ Force Logic™ standard rings



Part #	Mfg #	Description	Price
150862	49-16-2659	Ring Jaw 1	

### M12™ Force Logic™ Press Tool Jaw

- One-handed pressing solution for up to 1-1/4" pipe



Part #	Mfg #	Jaw Size	Price
150863	49-16-2450	1/2"	
150864	49-16-2451	3/4"	
150865	49-16-2452	1"	
150867	49-16-2453	1-1/4"	

### M18™ Force Logic™ Press Tool Jaw



Part #	Mfg #	Jaw Size	Price
242795	49-16-2631C	1/2"	
150851	49-16-2650	1/2"	
150852	49-16-2651	3/4"	
150853	49-16-2652	1"	
150854	49-16-2653	1-1/4"	
150855	49-16-2654	1-1/2"	
150857	49-16-2655	2"	
150859	49-16-2656	2-1/2"	

### M18™ Force Logic Press Tool Ring

- Presses 2-1/2" to 4" pipes



Part #	Mfg #	Ring Size	Price
150860	49-16-2657	3"	
150861	49-16-2658	4"	

### M18™ Black Iron Press Ring

- Dual pivot design
- For use on Viega® MegaPress® fittings
- Works with M18™ force logic™ press tool  
—Use with ring jaw 1



Part #	Mfg #	Ring Size	Price
253708	49-16-2653B	1-1/4"	
253709	49-16-2654B	1/1/2"	
226139	49-16-2655B	2"	

## Parts & Accessories

### ProPEX® Expander Heads



Part #	Mfg #	Size	For:	Price
135839	49-16-2404	1/2"	Most Uponor	
153044	49-16-2405	5/8"	Most Uponor	
135840	49-16-2406	3/4"	Most Uponor	
135841	49-16-2408	1"	Most Uponor	
135928	49-16-2612	1-1/2"	Most Uponor	





## ProPress System

### Parts & Accessories (Continued)

#### ProPEX® Expander Heads

Part #	Mfg #	Size	For:	Price
135927	49-16-2610	1-1/4"	Most Uponor	

#### ProPEX Expander Cone Grease

- Used to protect the surface between the ProPEX® tools and ProPEX® expansion heads



Part #	Mfg #	Description	Price
148865	49-08-2400	1.75 oz	



### Pressing Tools

- Completes a reliable, watertight connection in seconds, cutting installation time in half versus soldering

#### RP 340 Model Corded Press Tool

- 180° Barrel/jaw swivel
- 7,200 lbs
- 4-5 Seconds cycle time
- More than 400 presses per charge using Advanced Lithium 4 Battery
- Ultimate flexibility with the ability to switch between battery and AC power on the same tool
- LED-light for continued operations in no or low-light environments
- Standard kit includes:
  - RP 340 Press Tool
  - AC Power adapter
  - Carrying case



Part #	Mfg #	Model	Description	Price
162369	43373	RP 340	½" to 4" for Copper and Stainless Steel, ½" to 2" for PEX	



## ProPress System

### MegaPress® Jaws And Rings

- Joins 1/2" to 2" commercially available Sch 5-40 black iron pipe when used with RIDGID® Standard Press Tools and Viega® MegaPress fittings
- Press connections can be made on a "wet" system
- Flameless system eliminates the need for hot work permits



Part #	Mfg #	Model	Description	Price
151678	37953	1/2" to 2" MegaPress Kit for Standard Press Tools		
178616	48558	Kit, 1/2" to 2" commercially available sch 5-40 black iron pipe		

### MegaPress Jaws

Part #	Mfg #	Model	Description	Price
151585	37963	3/4" MegaPress Jaw for Standard RIDGID Press Tools		
151586	37968	1" MegaPress Jaw for Standard RIDGID Press Tools		

### MegaPress Rings

Part #	Mfg #	Model	Description	Price
151587	37973	1-1/4" MegaPress Ring for Standard RIDGID Press Tools		
151588	37978	1-1/2" MegaPress Ring for Standard RIDGID Press Tools		
151589	37983	2" MegaPress Ring for Standard RIDGID Press Tools		

### Accessories

Part #	Mfg #	Model	Description	Price
151590	37993	1/2" to 1" MegaPress End Prep Tool		
151591	37988	1-1/4" to 2" MegaPress End Prep Tool		
151592	38008	Abrasive Strips, 1/2" to 1"		
151593	38003	Abrasive Strips, 1-1/4" to 2"		

### ProPress® Rings

- Designed in conjunction with the ProPress system fittings, ensuring total system compatibility
- V1 and V2 Kits are designed for use with RIDGID Standard Press Tools (CT-400, 320-E, RP 330-B, RP 330-C, or RP 340)
- C1 Compact Kits are designed for RIDGID Compact press tools (100-B, RP 200-B, RP 210-B)
- Standard Kit includes: Press rings, actuator and carrying case



Part #	Mfg #	Model	Description	Price
151600	21878	1/2" to 2" copper and stainless steel tubing		

## PVC - DWV Fittings

### PVC DWV Fittings

#### PVC DWV Female Adapter (FPT x H)



Part #	Mfg #	Size	Price
012499	112PDFA	1-1/2"	
013874	2PDFA	2"	
014393	3PDFA	3"	
015267	4PDFA	4"	
015642	6PDFA	6"	
144468	8PDFA	8"	

#### PVC DWV Male Trap Adapter with Plastic Nut & Washer (S x Slip)

- Includes 1-1/2" plastic nut and washer and 1-1/2" x 1-1/4" washer



Part #	Mfg #	Size	Price
093429	112PDMTAP103F	1-1/2"	

#### PVC Male Trap Adapter with Plastic Nut (S x Slip)



Part #	Mfg #	Size	Price
012854	114PDMTA	1-1/4"	
012505	112PDMTA	1-1/2"	
012637	112114PDMTA	1-1/2" x 1-1/4"	

#### PVC DWV Female Trap Adapter (H x Slip) with Plastic Nut & Washer

- Includes 1-1/2" plastic nut and washer and 1-1/2" x 1-1/4" washer



Part #	Mfg #	Size	Price
093430	112PDFTAP103F	1-1/2"	

#### PVC Slip Joint Trap Adapter with Plastic Nut (H x Slip)



Part #	Mfg #	Size	Price
012853	114PDFTA	1-1/4"	
012501	112PDFTA	1-1/2"	
012635	112114PDFTA	1-1/2" x 1-1/4"	

#### PVC Female Fitting Adapter (S x FIP)



Part #	Mfg #	Size	Price
026570	112PDFCOLP	1-1/2"	
209450	8PDFCOLP	8"	

#### PVC Male Adapter (MIP x H)

- Will not accept tail piece



Part #	Mfg #	Size	Price
012503	112PDMA	1-1/2"	
012636	112114PDMA	1-1/2" x 1-1/4"	
013879	2PDMA	2"	
014398	3PDMA	3"	
015273	4PDMA	4"	

#### PVC Male Fitting Adapter (S x MIP)



Part #	Mfg #	Size	Price
012504	112PDMFA	1-1/2"	
013880	2PDMFA	2"	

## PVC - DWV Fittings

### PVC Hub Adapter, Cast Iron, Increaser (H x S)

- Plain end: Joint can be made with compression gasket or plastic lead & seal rope



Part #	Mfg #	Size	Price
012683	1122PDHA	1-1/2" x 2"	
014739	34PDHA	3" x 4"	

### PVC Hub Adapter, Cast Iron (H x S)

- Plain end: Joint can be made with compression gasket or plastic lead & seal rope



Part #	Mfg #	Size	Price
013877	2PDHA	2"	
014396	3PDHA	3"	

### PVC DWV Flush Bushing Cleanout Adapter (S x H)



Part #	Mfg #	Size	Price
014004	2112PDBU	2" x 1-1/2"	
014487	3112PDBU	3" x 1-1/2"	
014532	32PDBU	3" x 2"	
015398	42PDBU	4" x 2"	
015440	43PDBU	4" x 3"	
015729	64PDBU	6" x 4"	
015859	86PDBU	8" x 6"	
058525	84PDBU	8" x 4"	
089934	106PDBU	10" x 6"	
036502	108PDBU	10" x 8"	
207960	123PDBU	12" x 3"	
055955	1210PDBU	12" x 10"	

### Fitting Cleanout Adapter (S x FIP)



Part #	Mfg #	Size	Price
014394	3PDFCO	3"	

### PVC Cleanout with Plug (S x FIP)



Part #	Mfg #	Size	Price
012500	112PDFCOWPL	1-1/2"	
013876	2PDFCOWPL	2"	
014395	3PDFCOWPL	3"	
015269	4PDFCOWPL	4"	
015644	6PDFCOWPL	6"	

### PVC DWV No-Hub Adapter (S x H)



Part #	Mfg #	Size	Price
095916	112PDNHADPT	1-1/2"	
060347	2PDNHADPT	2"	
065821	3PDNHADPT	3"	
065822	4PDNHADPT	4"	
167741	6PDNHADPT	6"	

### PVC Fitting Adapter Bushing (S x H)

Part #	Mfg #	Size	Price
019748	3PDSDBU	3"	

### PVC DWV Cap (Soc)



Part #	Mfg #	Size	Price
192757	112PDCA	1-1/2"	
144796	6PDCA	6"	
192774	8PDCA	8"	
074323	10PDCA	10"	

## PVC - DWV Fittings

### PVC DWV Coupling (H x H)



Part #	Mfg #	Size	Price
012496	112PDCP	1-1/2"	
013871	2PDCP	2"	
014390	3PDCP	3"	
015264	4PDCP	4"	
015641	6PDCP	6"	
015794	8PDCP	8"	
020159	10PDCP	10"	
057116	12PDCP	12"	

### PVC Pipe Increaser - Reducer (H x H)



Part #	Mfg #	Size	Price
014005	2112PDCP	2" x 1-1/2"	
014488	3112PDCP	3" x 1-1/2"	
014533	32PDCP	3" x 2"	
015399	42PDCP	4" x 2"	
015441	43PDCP	4" x 3"	
038995	64PDCP	6" x 4"	
064620	84PDCP	8" x 4"	
073255	86PDCP	8" x 6"	
064621	104PDCP	10" x 4"	
041465	108PDCP	10" x 8"	
064622	1210PDCP	12" x 10"	
064623	1612PDCP	16" x 12"	

### PVC Repair Coupling (H x H)



Part #	Mfg #	Size	Price
012511	112PDRCP	1-1/2"	
013883	2PDRCP	2"	
014401	3PDRCP	3"	
015277	4PDRCP	4"	

### PVC DWV Fittings (Continued)

#### PVC Repair Coupling (H x H)

Part #	Mfg #	Size	Price
038526	6PDRCP	6"	

#### PVC DWV Double 1/4 Bend Elbow (H x H x H)



Part #	Mfg #	Size	Price
131693	112PDD90	1-1/2"	
097890	2PDD90	2"	
131691	3PDD90	3"	

#### PVC DWV 90° Elbow (H x H)

- 1/4 Bend



Part #	Mfg #	Size	Price
012522	112PD90	1-1/2"	
013895	2PD90	2"	
014411	3PD90	3"	
015287	4PD90	4"	
015651	6PD90	6"	
015798	8PD90	8"	
024746	10PD90	10"	
058097	12PD90	12"	

#### PVC DWV 90° Elbow, Reducing (H x H)

- 1/4 Bend



Part #	Mfg #	Size	Price
045719	43PD90	4" x 3"	

## PVC - DWV Fittings

### PVC DWV 90° Street Elbow (S x H)

- 1/4 Bend



Part #	Mfg #	Size	Price
012514	112PDS90	1-1/2"	
013886	2PDS90	2"	
014404	3PDS90	3"	
015281	4PDS90	4"	
015646	6PDS90	6"	
073568	8PDS90	8"	

### PVC 90° Reducing Street Elbow (S x H)

Part #	Mfg #	Size	Price
102562	43PDCB	4" x 3" less Cap	

### PVC DWV 90° Long Bend Elbow (H x H)

- Long sweep 1/4 bend



Part #	Mfg #	Size	Price
012502	112PDLS90	1-1/2"	
013878	2PDLS90	2"	
014397	3PDLS90	3"	
020113	4PDLS90	4"	
064614	6PDLS90	6"	
247403	8PDLS90	8"	

### PVC DWV 90° Long Bend Street Elbow (H x S)

- Long sweep 1/4 bend, street



Part #	Mfg #	Size	Price
054652	112PDSLS90	1-1/2"	
054654	2PDSLS90	2"	
054656	3PDSLS90	3"	

### PVC DWV Fittings (Continued)

#### PVC DWV 90° Long Bend Street Elbow (H x S)

Part #	Mfg #	Size	Price
114901	4PDSLS90	4"	

#### PVC 90° Side Inlet Elbow (Hub)

- 1/4 Bend with side inlet



Part #	Mfg #	Size	Price
014581	33112PDSI90	3" x 1-1/2"	
014595	332PDSI90	3" x 2"	

#### PVC 60° Elbow (H x H)



Part #	Mfg #	Size	Price
012521	112PD60	1-1/2"	
013894	2PD60	2"	
014410	3PD60	3"	
015286	4PD60	4"	

#### PVC 60° Street Elbow (H x S)

- 1/6 Bend, street



Part #	Mfg #	Size	Price
077784	2PDS60	2"	
039441	3PDS60	3"	

#### PVC DWV 45° Elbow (H x H)

- 1/8 Bend



Part #	Mfg #	Size	Price
012520	112PD45	1-1/2"	
013893	2PD45	2"	

## PVC - DWV Fittings

### PVC DWV Fittings (Continued)

#### PVC DWV 45° Elbow (H x H)

Part #	Mfg #	Size	Price
014409	3PD45	3"	
015285	4PD45	4"	
015650	6PD45	6"	
015797	8PD45	8"	
020114	10PD45	10"	
057237	12PD45	12"	

#### Sch 40 PVC DWV 45° Street Elbow (H x S)



Part #	Mfg #	Size	Price
012513	112PDS45	1-1/2"	
013885	2PDS45	2"	
014403	3PDS45	3"	
015280	4PDS45	4"	
015645	6PDS45	6"	
043038	8PDS45	8"	
073429	10PDS45	10"	
073442	12PDS45	12"	

#### PVC 22-1/2° Elbow (H x H)

• 1/16 Bend



Part #	Mfg #	Size	Price
012519	112PD22	1-1/2"	
013892	2PD22	2"	
014408	3PD22	3"	
015284	4PD22	4"	
015649	6PD22	6"	
030571	8PD22	8"	
207969	10PD22	10"	

#### PVC DWV 22° Street Elbow (H x S)

• 1/16 Bend, street



Part #	Mfg #	Size	Price
012512	112PDS22	1-1/2"	
013884	2PDS22	2"	
014402	3PDS22	3"	
015279	4PDS22	4"	
049505	6PDS22	6"	
187608	8PDS22	8"	

#### PVC DWV Vent Elbow (H x H)



Part #	Mfg #	Size	Price
012517	112PDV90	1-1/2"	
013890	2PDV90	2"	
014406	3PDV90	3"	
109810	4PDV90	4"	

#### PVC DWV Vent Street Elbow (H x S)



Part #	Mfg #	Size	Price
109812	112PDVS90	1-1/2"	
072935	2PDVS90	2"	
109811	3PDVS90	3"	
109746	4PDVS90	4"	

#### PVC Cleanout Plug (MIP)



Part #	Mfg #	Size	Price
012493	112PDCOP	1-1/2"	
013868	2PDCOP	2"	
014388	3PDCOP	3"	



## PVC - DWV Fittings

### PVC DWV Fittings (Continued)

#### PVC Cleanout Plug (MIP)

Part #	Mfg #	Size	Price
015262	4PDCOP	4"	
015638	6PDCOP	6"	
073426	8PDCOP	8"	

#### PVC DWV Flush Cleanout Plug (MIP)



Part #	Mfg #	Size	Price
090644	6PDFCOPL	6"	

#### PVC DWV Sanitary Street Tee (S x H x H)



Part #	Mfg #	Size	Price
025639	112PDST	1-1/2"	
023480	2PDST	2"	
084035	3PDST	3"	
084036	4PDST	4"	

#### PVC Street Tee (S x H x H)

- Sanitary tee, street, reducing



Part #	Mfg #	Size	Price
021326	2112112PDST	2" x 1-1/2" x 1-1/2"	
025013	22112PDST	2" x 2" x 1-1/2"	
073826	33112PDST	3" x 3" x 1-1/2"	
056475	332PDST	3" x 3" x 2"	

#### PVC DWV Reducing Tee (H x H x H)



Part #	Mfg #	Size	Price
014022	2112112PDT	2" x 1-1/2" x 1-1/2"	
014032	21122PDT	2" x 1-1/2" x 2"	
014223	22112PDT	2" x 1-1/2"	
014582	33112PDT	3" x 1-1/2"	
014596	332PDT	3" x 2"	
088648	44112PDT	4" x 1-1/2"	
015481	442PDT	4" x 2"	
015486	443PDT	4" x 3"	
015749	664PDT	6" x 4"	
035771	886PDT	8" x 6"	
096943	104PDT	10" x 10" x 4"	

#### PVC DWV Sanitary Tee (H x H x H)



Part #	Mfg #	Size	Price
012515	112PDT	1-1/2"	
013888	2PDT	2"	
014405	3PDT	3"	
015282	4PDT	4"	
015647	6PDT	6"	
015796	8PDT	8"	
073444	P400-120	12"	

#### PVC Flush Cleanout Tee with Cleanout Plug (H x H x FIP)



Part #	Mfg #	Size	Price
012494	112PDCOT	1-1/2"	
013869	2PDCOT	2"	
014389	3PDCOT	3"	
015263	4PDCOT	4"	

## PVC - DWV Fittings

### PVC DWV Fittings (Continued)

#### PVC Flush Cleanout Tee with Cleanout Plug (H x H x FIP)

Part #	Mfg #	Size	Price
015640	6PDCOTWPL	6"	
073450	10PDCOT	10" x 10" x 8"	

#### Test Tee with Plug (Soc x FIP)



Part #	Mfg #	Size	Price
059713	8PDCOTWPL	8"	

#### PVC Horizontal Twin Tee (H x H x H x H)



Part #	Mfg #	Size	Price
014491	3112PDHTT	3" x 3" x 1-1/2" x 1-1/2"	

#### PVC 2-Way Cleanout Tee (H x H x H)



Part #	Mfg #	Size	Price
192767	3PDTWCO	3"	
024174	4PDTWCO	4"	

#### PVC Test Tee (H x H x FIPT)



Part #	Mfg #	Size	Price
012495	112PDCOTNP	1-1/2"	
054901	2PDCOTNP	2"	
054900	3PDCOTNP	3"	
192745	4PDCOTNP	4"	

#### PVC Double Fixture Tee (H x H x H x H)



Part #	Mfg #	Size	Price
045720	2PDDFF	2"	
123815	3PDDFF	3"	
014024	2112112112PDFDFF	2"x1-1/2"x1-1/2"x1-1/2"	
014225	22112112PDDFF	2" x 2" x 1-1/2" x 1-1/2"	

#### PVC Double Sanitary Tee (H x H x H x H)



Part #	Mfg #	Size	Price
012497	112PDDT	1-1/2"	
013872	2PDDT	2"	
014391	3PDDT	3"	
015265	4PDDT	4"	

#### PVC Double Sanitary Tee, Reducing (H x H x H x H)



Part #	Mfg #	Size	Price
014006	2112PDDT	2" x 2" x 1-1/2" x 1-1/2"	
014489	3112PDDT	3" x 3" x 1-1/2" x 1-1/2"	
014534	32PDDT	3" x 3" x 2" x 2"	
015400	42PDDT	4" x 4" x 2" x 2"	
015442	43PDDT	4" x 4" x 3" x 3"	

#### PVC DWV Reducing Combination Wye and 45° Bend (H x H x H)

- One piece, 1/8 bend



Part #	Mfg #	Size	Price
192768	112PDCY	1-1/2"	
040638	2PDCY	2"	

## PVC - DWV Fittings

### PVC DWV Fittings (Continued)

#### PVC DWV Reducing Combination Wye and 45° Bend (H x H x H)

Part #	Mfg #	Size	Price
057470	3PDCY	3"	
024821	4PDCY	4"	
152330	6PDCY	6"	
073455	8PDCY	8"	

#### PVC DWV Reducing Combination Wye and 45° Bend Reducing (H x H x H)

- One piece, 1/8 bend



Part #	Mfg #	Size	Price
061909	32PDCY	3" x 3" x 2"	
024820	42PDCY	4" x 4" x 2"	
024819	43PDCY	4" x 4" x 3"	
119656	662PDCY	6" x 2"	
101955	664PDCY	6" x 4"	

#### PVC DWV Reducing Combination Wye and 45° Bend Reducing (H x H x H)

- Two piece, 1/8 bend



Part #	Mfg #	Size	Price
119655	663PDCY	6" x 3"	
069096	884PDCY	8" x 4"	
096932	10106PDCY	10" x 10" x 6"	

#### PVC DWV Reducing Wye (H x H x H)



Part #	Mfg #	Size	Price
012518	112PDY	1-1/2"	
013891	2PDY	2"	
014407	3PDY	3"	
015283	4PDY	4"	

### PVC DWV Fittings (Continued)

#### PVC DWV Reducing Wye (H x H x H)

Part #	Mfg #	Size	Price
015648	6PDY	6"	
040871	8PDY	8"	
064615	10PDY	10"	
058920	12PDY	12"	

#### PVC DWV Reducing Wye, Reducing (H x H x H)



Part #	Mfg #	Size	Price
014023	2112112PDY	2" x 1-1/2" x 1-1/2"	
014224	22112PDY	2" x 1-1/2"	
230573	21122PDY	2" x 1-1/2" x 2"	
014583	33112PDY	3" x 1-1/2"	
014597	332PDY	3" x 2"	
088647	44112PDY	4" x 1-1/2"	
015482	442PDY	4" x 2"	
015487	443PDY	4" x 3"	
015750	664PDY	6" x 4"	
015868	886PDY	8" x 6"	
123984	662PDY	6" x 6" x 2"	
050454	663PDY	6" x 6" x 3"	
050370	884PDY	8" x 8" x 4"	
099078	10104PDY	10" x 10" x 4"	
024785	10106PDY	10" x 10" x 6"	
055952	121210PDY	12" x 12" x 10"	
024784	10108PDY	10" x 10" x 8"	
064616	12124PDY	12" x 12" x 4"	
055954	12126PDY	12" x 12" x 6"	
064617	12128PDY	12" x 12" x 8"	

## PVC - DWV Fittings

### PVC DWV Street Wye (S x H x H)



Part #	Mfg #	Size	Price
109809	112PDSY	1-1/2"	
109808	2PDSY	2"	
109807	3PDSY	3"	
109813	4PDSY	4"	

### PVC DWV Street Wye Reducing (S x H x H)



Part #	Mfg #	Size	Price
060952	332PDSY	3" x 2"	
113113	442PDSY	4" x 2"	
113112	443PDSY	4" x 3"	

### PVC 45° Double Wye (H x H x H x H)



Part #	Mfg #	Size	Price
012498	112PDDY	1-1/2"	
013873	2PDDY	2"	
014392	3PDDY	3"	
015266	4PDDY	4"	

### PVC 45° Double Wye, Reducing (H x H x H x H)



Part #	Mfg #	Size	Price
014007	2112PDDY	2" x 2" x 1-1/2" x 1-1/2"	
014490	3112PDDY	3" x 3" x 1-1/2" x 1-1/2"	
014536	32PDDY	3" x 3" x 2" x 2"	
015401	42PDDY	4" x 4" x 2" x 2"	
015443	43PDDY	4" x 4" x 3" x 3"	

### PVC DWV Fittings (Continued)

#### PVC 45° Double Wye, Reducing (H x H x H x H)

Part #	Mfg #	Size	Price
037291	64PDDY	6" x 6" x 4" x 4"	

#### PVC Double Combo Wye 1/8 Bend (H x H x H)

Part #	Mfg #	Size	Price
040637	4PDDCY	4"	

#### PVC 90° Low Heel Inlet Elbow (H x H x H)

- 1/4 Bend



Part #	Mfg #	Size	Price
014580	33112PDLHI90	3" x 3" x 1-1/2"	
014594	332PDLHI90	3" x 3" x 2"	
139838	442PDLHI90	4" x 4" x 2"	

#### PVC Double Tee with Right & Left Inlets (All Hub)



Part #	Mfg #	Size	Price
014535	32PDDTRL	3" x 3" x 3" x 3" x 2" x 2"	

#### PVC Sanitary Tee with 90° Right/Left Side Inlets (H x H x H x H x H)



Part #	Mfg #	Size	Price
014494	3112PDTRL	3"x3"x3"x1-1/2"x1-1/2"	
014540	32PDTRL	3" x 3" x 3" x 2" x 2"	

## PVC - DWV Fittings

**PVC Sanitary Tee with 90° Left Inlet**  
(H x H x H x H)



Part #	Mfg #	Size	Price
014492	3112PDLHT	3" x 3" x 3" x 1-1/2"	
014537	32PDLHT	3" x 3" x 3" x 2"	
192748	42PDLHT	4" x 4" x 4" x 2"	

**PVC P-Trap with Plug**  
(H x H x CO)



Part #	Mfg #	Size	Price
012507	112PDPTCO	1-1/2"	
013881	2PDPTCO	2"	

**PVC Sanitary Tee with 90° Right Inlet**  
(H x H x H x H)



Part #	Mfg #	Size	Price
014493	3112PDRHT	3" x 3" x 3" x 1-1/2"	
014539	32PDRHT	3" x 3" x 3" x 2"	

**PVC DWV Adjustable P-Trap w/ Plastic Nut**  
(H x H)



Part #	Mfg #	Size	Price
012516	112PDUPT	1-1/2"	
013889	2PDUPT	2"	

**PVC DWV Return Bend**  
(H x H)



Part #	Mfg #	Size	Price
012509	112PDRB	1-1/2"	
013882	2PDRB	2"	
014400	3PDRB	3"	
015276	4PDRB	4"	

**PVC DWV Flush Closet Flange with Knockout**

- Fits over 3" pipe or inside 4" pipe



Part #	Mfg #	Size	Price
104204	43815SPEARS	4" x 3" 1/4" x 3"	

**PVC DWV Closet Flange, Reducing (Spigot)**



Part #	Mfg #	Size	Price
015448	43PDSCF	4" x 3"	

**PVC DWV P-Trap (H x H)**



Part #	Mfg #	Size	Price
012506	112PDPT	1-1/2"	
015795	2PDPT	2"	
014399	3PDPT	3"	
015275	4PDPTLCO	4"	
064613	6PDPT	6"	

**PVC DWV Closet Flange (Hub)**



Part #	Mfg #	Size	Price
015261	4PD CFHSP		

## PVC - DWV Fittings

### PVC DWV Closet Flange (Spigot)

- Adjustable metal ring



Part #	Mfg #	Size	Price
015449	43PDSCFMR	4" x 3"	

*Genova*  
PRODUCTS

### Sch 40 PVC DWV Fittings

#### Female Adapter (Hub x FIP)



Part #	Mfg #	Size	Price
114693	70311	1-1/2" x 1-1/4"	

**Oatey**<sup>®</sup>

### Saddle Tee Kits

- For tapping into a 3" or 4" Sch 40 DWV line
- Saddle is solvent welded to the existing line and secured with metal V-bolts, washers and nuts provided in kit
- The tee accepts the incoming line inside the socket or joins with a Sch 40 DWV fitting



Part #	Mfg #	Description	Price
041350	43789	3" x 2" PVC	
041351	43791	4" x 2" PVC	
041358	43793	4" x 3" PVC	
041352	43795	4" x 4" PVC	

### Gasket for Tappig into Cast Iron Soil Pipe

Part #	Mfg #	Size	Price
194975	43796	6-3/4" x 5-3/4"	

### PVC Sewer Fittings

#### Mystic™ Rainwater Collection System Adapter

- Two-piece design
- UV-resistant material
- Includes 4 ft hi-flo hose
- Fits standard 2"x3" residential downspouts
- Designed to direct rainwater from downspouts into collection barrels for re-use in lawn/garden watering



Part #	Mfg #	Size	Price
245760	14209	2" x 3" PVC	

**Sioux Chief**

### Cleanout Plugs

#### Slotted Polypropylene Flush Plug

- With or without threaded brass insert
- Combine with FIP adapters to make a cleanout
- Glass-filled polypropylene plugs:
  - Will not seize up on ABS or PVC
  - Acid resistant and chemically inert
  - More durable than traditional plugs

#### Without Threaded Brass Insert



Part #	Mfg #	Size	Price
139754	878-015	1-1/2"	
044644	878-020	2"	
045442	878-030	3"	
045441	878-040	4"	

#### With Threaded Brass Insert



Part #	Mfg #	Size	Price
058669	878-15	1-1/2"	
184063	878-20	2"	
184064	878-30	3"	
184065	878-35	3-1/2"	
184066	878-40	4"	
115732	878-60	6"	



## PVC - DWV Fittings

### Commercial PVC Spanner Flush plug

- Schedule 40 thread
- Machined from solid PVC
- Load limit 6,000+ lbs.

Part #	Mfg #	Size	Price
184067	878-980	8"	

### Closeout Flanges

#### FullFlush™ Offset Closet Flange with Knockout

- Full-flow, 3" I.D. throat — no restriction
- Allows for 1½ offset in any direction for closet bowl setting
- Corrosion-resistant 430 stainless steel swivel ring is engineered for maximum strength



Part #	Mfg #	Hub/Inside	Flush to Floor	Price
151863	889-POTM	3"	4"	

### Tees

#### SmartSaddle™ Residential DWV Saddle Tee Fitting

- Compact design is perfect when DWV stacks are close to walls or other obstructions
- Corrosion resistant
- Information about bands
  - Stainless steel
  - Provide even torque—Eliminate stress points
  - Take up less room than v-bolts or u-bolts

Part #	Mfg #	Trunk	Inlet Branch	Price
098101	891-033P	3" Sch. 40	1-1/2"Hub x 3"Spigot	
184073	891-0412P	4" Sch. 40	1-1/2"Hub x 2"Spigot	

## PVC Schedule 40 Fittings

### PVC Sch 40

**PVC Adapter  
(Soc x FIP)**



Part #	Mfg #	Size	Price
013178	12P4FA	1/2"	
014745	34P4FA	3/4"	
012268	1P4FA	1"	
012859	114P4FA	1-1/4"	
012530	112P4FA	1-1/2"	
013904	2P4FA	2"	
095129	212P4FA	2-1/2"	
021261	4P4FA	4"	

**PVC Reducing Adapter  
(Soc x FIP)**



Part #	Mfg #	Size	Price
013324	1234P4FASF	1/2" x 3/4"	
113165	3412P40FASF	3/4" x 1/2"	
013430	134P40FASF	1" x 3/4"	

**PVC Adapter  
(Spgt x FIP)**



Part #	Mfg #	Size	Price
112490	12P4SFA	1/2"	
112489	34P4SFA	3/4"	

**PVC Adapter  
(MIP x Soc)**



Part #	Mfg #	Size	Price
013181	12P4MA	1/2"	
014748	34P4MA	3/4"	
012271	1P4MA	1"	
012860	114P4MA	1-1/4"	
012532	112P4MA	1-1/2"	
013905	2P4MA	2"	
014110	212P4MA	2-1/2"	

### PVC Sch 40 (Continued)

**PVC Adapter  
(MIP x Soc)**

Part #	Mfg #	Size	Price
014417	3P4MA	3"	
015291	4P4MA	4"	
015660	6P4MA	6"	
068653	8P4MA	8"	

**PVC Reducing Adapter  
(MIP x Soc)**



Part #	Mfg #	Size	Price
028975	3412P4MA	1/2" x 3/4"	
057799	1234P4MA	3/4" x 1/2"	
062208	341P4MA	3/4" x 1"	
040897	134P4MA	1" x 3/4"	
112378	1141P4MA	1" x 1-1/4"	
191400	114112P4MA	1-1/4" x 1-1/2"	
047439	1122P4MA	1-1/2" x 2"	
200859	2112P4MA	2" x 1-1/2"	

**PVC Flush Style Reducer Bushing  
(Spgt x Soc)**



Part #	Mfg #	Size	Price
014833	3412P4BU	3/4" x 1/2"	
012525	112P4BU	1" x 1/2"	
013427	134P4BU	1" x 3/4"	
019973	11412P4BU	1-1/4" x 1/2"	
012981	11434P4BU	1-1/4" x 3/4"	
012900	1141P4BU	1-1/4" x 1"	
012670	11212P4BU	1-1/2" x 1/2"	
012713	11234P4BU	1-1/2" x 3/4"	
012574	1121P4BU	1-1/2" x 1"	
012638	112114P4BU	1-1/2" x 1-1/4"	
014107	212P4BU	2" x 1/2"	
014256	234P4BU	2" x 3/4"	
013970	21P4BU	2" x 1"	
014046	2114P4BU	2" x 1-1/4"	

## PVC Schedule 40 Fittings

### PVC Sch 40 (Continued)

#### PVC Flush Style Reducer Bushing (Spgt x Soc)

Part #	Mfg #	Size	Price
014008	2112P4BU	2" x 1-1/2"	
014136	212112P4BU	2-1/2" x 1-1/2"	
014157	2122P4BU	2-1/2" x 2"	
086353	31P4BU	3" x 1"	
088748	1214P4BU	1/2" x 1/4"	
080209	3114P4BU	3" x 1-1/4"	
014495	3112P4BU	3" x 1-1/2"	
014541	32P4BU	3" x 2"	
014560	3212P4BU	3" x 2-1/2"	
015402	42P4BU	4" x 2"	
015450	43P4BU	4" x 3"	
142948	54P4BU	5" x 4"	
035956	86P4BU	8" x 6"	

#### PVC Flush Style Reducer Bushing (Spgt x FIP)



Part #	Mfg #	Size	Price
013279	1214P4FBU	1/2" x 1/4"	
021368	1238P4FBU	1/2" x 3/8"	
039068	3414P4FBU	3/4" x 1/4"	
014832	3412P4FBU	3/4" x 1/2"	
012531	112P4FBU	1" x 1/2"	
013428	134P4FBU	1" x 3/4"	
012943	11412P4FBU	1-1/4" x 1/2"	
012982	11434P4FBU	1-1/4" x 3/4"	
012901	1141P4FBU	1-1/4" x 1"	
024445	11212P4FBU	1-1/2" x 1/2"	
012714	11234P4FBU	1-1/2" x 3/4"	
012575	1121P4FBU	1-1/2" x 1"	
012639	112114P4FBU	1-1/2" x 1-1/4"	
013969	212P4FBU	2" x 1/2"	
014257	234P4FBU	2" x 3/4"	
013968	21P4FBU	2" x 1"	
054604	2114P4FBU	2" x 1-1/4"	
077022	2112P4FBU	2" x 1-1/2"	
014469	31P4FBU	3" x 1"	

### PVC Sch 40 (Continued)

#### PVC Flush Style Reducer Bushing (Spgt x FIP)

Part #	Mfg #	Size	Price
191404	3112P4FBU	3" x 1-1/2"	
072876	32P4FBU	3" x 2"	

#### PVC Reducer Bushing (MIP x FIP)



Part #	Mfg #	Size	Price
013176	12P4CA	1/2"	
014743	34P4CA	3/4"	
012265	1P4CA	1"	
012857	114P4CA	1-1/4"	
012527	112P4CA	1-1/2"	
013901	2P4CA	2"	
014108	212P4CA	2-1/2"	
014414	3P4CA	3"	
015289	4P4CA	4"	
015658	6P4CA	6"	
015804	8P4CA	8"	
032697	10P4CA	10"	
106599	12P4CA	12"	

#### Reducer Bushing (MIP x FIP)



Part #	Mfg #	Size	Price
041022	1214P4MFBU	1/2" x 1/4"	
014831	3412P4MFBU	3/4" x 1/2"	
077972	112P4MFBU	1" x 1/2"	
013429	134P4MFBU	1" x 3/4"	
012851	1141P4MFBU	1-1/4" x 1"	
012671	11212P4MFBU	1-1/2" x 1/2"	
012640	112114P4MFBU	1-1/2" x 1-1/4"	

## PVC Schedule 40 Fittings

### PVC Cap (FIP)



Part #	Mfg #	Size	Price
051068	12P4TCA	1/2"	
051069	34P4TCA	3/4"	
051070	1P4TCA	1"	
051071	114P4TCA	1-1/4"	
036229	112P4TCA	1-1/2"	
036138	2P4TCA	2"	

### PVC Coupling (FIP)



Part #	Mfg #	Size	Price
042835	12P4TCP	1/2"	
102274	34P4TCP	3/4"	
098882	430131	1" x 3/4"	

### PVC Coupling (Soc)



Part #	Mfg #	Size	Price
013177	12P4CP	1/2"	
014744	34P4CP	3/4"	
012266	1P4CP	1"	
012858	114P4CP	1-1/4"	
012528	112P4CP	1-1/2"	
013902	2P4CP	2"	
014109	212P4CP	2-1/2"	
014415	3P4CP	3"	
015290	4P4CP	4"	
015659	6P4CP	6"	
063458	5P4CP	5"	
015806	8P4CP	8"	

### PVC Schedule 40 Reducing Coupling (Soc x Soc)

• Molded



Part #	Mfg #	Size	Price
087474	3412P4CP	3/4" x 1/2"	
074996	134P4CP	1" x 3/4"	
125702	1121P4CP	1-1/2" x 1"	
143136	21P4CP	2" x 1"	
047441	2112P4CP	2" x 1-1/2"	
047440	2122P4CP	2-1/2" x 2"	
039748	32P4CP	3" x 2"	
024644	64P4RC	6" x 4"	
051140	84P4CP	8" x 4"	

### PVC Schedule 40 Reducing Eccentric Coupling (Soc x Soc)



Part #	Mfg #	Size	Price
088643	43P4ECP	4" x 3"	

### PVC Schedule 40 Coupling (Soc x Soc)

• Deep Socket



Part #	Mfg #	Size	Price
064558	112P4DSCP	1-1/2"	
094633	2P4DSCP	2"	

### PVC Cross (Soc)



Part #	Mfg #	Size	Price
040769	34P4CR	3/4"	
012267	1P4CR	1"	
071416	114P4CR	1-1/4"	
012529	112P4CR	1-1/2"	
013903	2P4CR	2"	

## PVC Schedule 40 Fittings

### PVC Sch 40 (Continued)

#### PVC Cross (Soc)

Part #	Mfg #	Size	Price
085594	3P4CR	3"	

#### PVC 90° Elbow (Soc)



Part #	Mfg #	Size	Price
013187	12P490	1/2"	
014755	34P490	3/4"	
012276	1P490	1"	
012864	114P490	1-1/4"	
012538	112P490	1-1/2"	
013909	2P490	2"	
014113	212P490	2-1/2"	
014421	3P490	3"	
015294	4P490	4"	
015662	6P490	6"	
015805	8P490	8"	

#### PVC 90° Elbow (FIP)



Part #	Mfg #	Size	Price
032758	34P4FF90	3/4"	

#### PVC Reducing 90° Elbow (Soc)



Part #	Mfg #	Size	Price
087473	3412P490	3/4" x 1/2"	
132414	2112P490	2" x 1-1/2"	

#### PVC 90° Elbow (Soc x FIP)



Part #	Mfg #	Size	Price
013180	12P4F90	1/2"	
014747	34P4F90	3/4"	
049671	1P4F90	1"	
036808	2P4F90	2"	

#### 90° Reducing Elbow (Soc x FIP)



Part #	Mfg #	Size	Price
044983	3412P4F90	3/4" x 1/2"	
102273	134P4F90	1" x 3/4"	

#### PVC 90° Street Elbow (Spgt x Soc)



Part #	Mfg #	Size	Price
013188	12P4S90	1/2"	
014752	34P4S90	3/4"	
012273	1P4S90	1"	
012861	114P4S90	1-1/4"	
012534	112P4S90	1-1/2"	
013906	2P4S90	2"	

#### PVC 90° Street Elbow (MIP x Soc)



Part #	Mfg #	Size	Price
013182	12P4MS90	1/2"	
014749	34P4SM90	3/4"	

## PVC Schedule 40 Fittings

### PVC 90° Street Elbow (MIP x FIP)



Part #	Mfg #	Size	Price
024184	34P4MFS90	3/4"	
191396	1P4S90T	1"	

### Side Outlet Elbow (Soc x Soc x Soc)



Part #	Mfg #	Size	Price
118356	34P4SO90	3/4"	

### PVC 45° Elbow (Soc)



Part #	Mfg #	Size	Price
013186	12P445	1/2"	
014754	34P445	3/4"	
012275	1P445	1"	
012863	114P445	1-1/4"	
012537	112P445	1-1/2"	
013908	2P445	2"	
014112	212P445	2-1/2"	
014420	3P445	3"	
015293	4P445	4"	
128300	5P445	5"	
015661	6P445	6"	
035963	8P445	8"	

### PVC 45° Street Elbow (Spgt x Soc)



Part #	Mfg #	Size	Price
069584	12P4S45	1/2"	
055971	34P4S45	3/4"	

### PVC Sch 40 (Continued)

#### PVC 45° Street Elbow (Spgt x Soc)

Part #	Mfg #	Size	Price
116550	1P4S45	1"	
061658	114P4S45	1-1/4"	
096206	112P4S45	1-1/2"	
134669	2P4S45	2"	
128301	5P4S45	5"	

#### PVC 22-1/2° Elbow (Soc x Soc)



Part #	Mfg #	Size	Price
238021	12P422	1/2"	
244924	1P422	1"	
066784	2P422	2"	
118273	3P422	3"	
099937	4P422	4"	

#### PVC 11-1/4° Elbow (Soc)



Part #	Mfg #	Size	Price
091281	2P41114	2"	
143133	3P41114	3"	
043021	4P41114	4"	

#### Riser Extension (FIP x MIP)



Part #	Mfg #	Size	Price
040391	34P4RE	3/4"	



## PVC Schedule 40 Fittings

**PVC Plug  
(Spgt)**



Part #	Mfg #	Size	Price
012272	1P4SPL	1"	
012533	112P4SPL	1-1/2"	
019858	2P4SPL	2"	

**PVC Plug  
(MIP)**



Part #	Mfg #	Size	Price
064560	12P4TPL	1/2"	
019070	34P4TPL	3/4"	
019071	1P4TPL	1"	
019072	114P4TPL	1-1/4"	
012536	112P4TPL	1-1/2"	
047442	2P4TPL	2"	
112010	212P4TPL	2-1/2"	

**PVC Tee  
(Soc)**



Part #	Mfg #	Size	Price
013185	12P4T	1/2"	
014753	34P4T	3/4"	
012274	1P4T	1"	
012862	114P4T	1-1/4"	
012535	112P4T	1-1/2"	
013907	2P4T	2"	
014111	212P4T	2-1/2"	
014419	3P4T	3"	
015292	4P4T	4"	

**PVC Reducing Tee  
(Soc)**



Part #	Mfg #	Size	Price
014897	343412P4T	3/4" x 1/2"	
030374	1112P4T	1" x 1/2"	
012747	1134P4T	1" x 3/4"	
088599	11411434P4T	1-1/4" x 3/4"	
088600	1141141P4T	1-1/4" x 1"	
012601	11211212P4T	1-1/2" x 1/2"	
048263	11211234P4T	1-1/2" x 3/4"	
068828	1121121P4T	1-1/2" x 1"	
066124	2112112P4T	2" x 1-1/2" x 1-1/2"	
034592	2234P4T	2" x 3/4"	
036756	221P4T	2" x 1"	
073453	22112P4T	2" x 1-1/2"	
076514	33114P4T	3" x 1-1/4"	
088639	332P4T	3" x 2"	
094061	441P4T	4" x 1"	
088606	442P4T	4" x 2"	

**PVC Sanitary Tee  
(Soc x FIP)**



Part #	Mfg #	Size	Price
131254	11411412P4SRF PT	1-1/4" x 1/2"	

**PVC Tee  
(Soc x FIP)**



Part #	Mfg #	Size	Price
013179	12P4FT	1/2"	
014746	34P4FT	3/4"	
012270	1P4FT	1"	

## PVC Schedule 40 Fittings

### PVC Schedule 40 Tee (Soc x Soc x FIP)



Part #	Mfg #	Size	Price
021099	343412P4FT	3/4" x 1/2"	
030373	1112P4FT	1" x 1/2"	
012746	1134P4FT	1" x 3/4"	
012927	11411412P4FT	1-1/4" x 1/2"	
127585	2234P4FT	2" x 3/4"	

### PVC Schedule 40 Tee (FIP x FIP x FIP)



Part #	Mfg #	Size	Price
060411	12P4FIPT	1/2"	
102262	34P4FIPT	3/4"	
236576	114P4FIPT	1-1/4"	

### PVC Schedule 40 Hose Swivel Adapter Swivel with Washer (FIP x FHT)



Part #	Mfg #	Size	Price
076436	34P4FIPFHT	3/4"	

### PVC Schedule 40 Hose Swivel Adapter Swivel with Washer (MIP x FHT)



Part #	Mfg #	Size	Price
076435	34P4MIPFHT	3/4"	

### Sch 40 Pipe Extender (Pipe O.D. Spigot x Pipe I.D. Spigot)

- Allows difficult broken pipe repair to be made easily
- Fabricated, non-pressure rated



Part #	Mfg #	Size	Price
198784	112P4PIPEEXT	1-1/2"	
198785	2P4PIPEEXT	2"	
153207	3P4PEXT	3"	
198786	4P4PIPEEXT	4"	

### Sch 40 Pipe Extender (Spigot (Socket) x Socket O.D.)



Part #	Mfg #	Size	Price
198787	112P4FPIPEEXT	1-1/2"	
198788	2P4FPIPEEXT	2"	

### PVC Union with Buna-N O-Ring Seal (Soc)

- 150 psi @ 73°F



Part #	Mfg #	Size	Price
092060	12P4U	1/2"	
033396	34P4U	3/4"	
193423	1P4UBUNA	1"	
050025	114P4U	1-1/4"	
046205	112P4U	1-1/2"	
053023	2P4U	2"	
080210	3P4U	3"	

### PVC Union with EDPM O-Ring Seal (Soc)

- 150 psi @ 73°F



Part #	Mfg #	Size	Price
039750	1P4U	1"	

## PVC Schedule 40 Fittings

### PVC Union with Buna O-Ring Seal (FIP)



Part #	Mfg #	Size	Price
194615	112P4TUBUNA	1-1/2"	
107255	2P4TU	2"	

### Stainless Steel Reinforced Fittings

#### PVC Adapter (Soc x SR FIP)



Part #	Mfg #	Size	Price
055694	12P4FASR	1/2"	
055696	34P4FASR	3/4"	
055698	1P4FASR	1"	
055699	114P4FASR	1-1/4"	
055700	112P4FASR	1-1/2"	
055701	2P4FASR	2"	
108099	212P4SRFA	2-1/2"	
055702	3P4FASR	3"	
055703	4P4FASR	4"	

#### PVC Wye (Soc x Soc x Soc)



Part #	Mfg #	Size	Price
118185	3P4Y	3"	
125920	1P4Y	1"	

### PVC Insert Fittings

#### Transition Tees (Soc x Insert)



Part #	Mfg #	Size	Price
034942	34P4SSBT	3/4"	

#### PVC Insert Adapter (Insert x IPS Spgt)

• ASTM D 2609



Part #	Mfg #	Size	Price
171000	34P4INSXSPG	3/4"	
100348	1P4INSXSPG	1"	
100349	114P4INSXSPG	1-1/4"	
087377	2P4INSIPSSPIG OT	2"	

#### PVC Insert Adapter (Soc x Insert)



Part #	Mfg #	Size	Price
048262	34P4SXINSERT	3/4"	
072342	1P4SXINSERT	1"	
100350	114P4SXINSERT	1-1/4"	

#### PVC Insert Female Adapter (FIP x Insert)



Part #	Mfg #	Size	Price
190657	112IPFA	1-1/2"	

## PVC Schedule 40 Fittings

### PVC Sch 40 Fittings

#### PowerPEX® Copper PVC Straight Adapter

- Perfect for water service transitions
- Lead-Free solder joint
- Made from Type L copper tub



Part #	Mfg #	Connection	Price
183755	645X3P	(3/4") PEX x PVC	
183756	645X4P	(1") PVC x PEX	

#### PVC MetalHead™ Straight Adapter

- Perfect fitting to transition from a PVC service line to a threaded adapter for CPVC, copper or PEX piping system
- Great transition for irrigation systems
- Lead-Free solder joint



Part #	Mfg #	Connection	Price
183761	646-PG5	(1-1/4") PVC x MIP	
183762	646-PG7	(2") PVC x MIP	

## PVC Schedule 80 Fittings

### PVC Sch 80 Fittings

#### Male Adapter - PVC Lined Brass Transition (Brass Mipt x Socket)

- NSF® certified lead free



Part #	Mfg #	Size	Price
231935	1P8MABR	1"	
231936	114P8MABR	1-1/4"	
231937	2P8MABR	2"	

#### PVC Female Adapter (Soc x FIP)



Part #	Mfg #	Size	Price
053074	12P8FA	1/2"	
051959	34P8FA	3/4"	
012281	1P8FA	1"	
029225	114P8FA	1-1/4"	
055074	112P8FA	1-1/2"	
024103	2P8FA	2"	
188105	212P8FA	2-1/2"	
022715	3P8FA	3"	
045223	4P8FA	4"	

#### PVC Male Adapter (Soc x MIP)



Part #	Mfg #	Size	Price
032237	12P8MA	1/2"	
014757	34P8MA	3/4"	
012282	1P8MA	1"	
012867	114P8MA	1-1/4"	
012541	112P8MA	1-1/2"	
013911	2P8MA	2"	
082903	212P8MA	2-1/2"	
014422	3P8MA	3"	
045222	4P8MA	4"	
114840	6P8MA	6"	

### PVC Flush Style Reducer Bushing (Spgt x Soc)



Part #	Mfg #	Size	Price
014834	3412P8BU	3/4" x 1/2"	
019409	112P8BU	1" x 1/2"	
013431	134P8BU	1" x 3/4"	
037395	11434P8BU	1-1/4" x 3/4"	
012902	1141P8BU	1-1/4" x 1"	
012715	11234P8BU	1-1/2" x 3/4"	
062555	1121P8BU	1-1/2" x 1"	
064774	112114P8BU	1-1/2" x 1-1/4"	
090250	212P8BU	2" x 1/2"	
053477	234P8BU	2" x 3/4"	
019410	21P8BU	2" x 1"	
117469	2114P8BU	2" x 1-1/4"	
065705	2112P8BU	2" x 1-1/2"	
065702	212112P8BU	2-1/2" x 1-1/2"	
014158	2122P8BU	2-1/2" x 2"	
104603	3112P8BU	3" x 1-1/2"	
065706	32P8BU	3" x 2"	
065703	3212P8BU	3" x 2-1/2"	
057151	42P8BU	4" x 2"	
078171	4212P8BU	4" x 2-1/2"	
065704	43P8BU	4" x 3"	
053486	62P8BU	6" x 2"	
104196	63P8BU	6" x 3"	
053487	64P8BU	6" x 4"	
082026	86P8BU	8" x 6"	
101906	108P8BU	10" x 8"	

### PVC Flush Style Reducer Bushing (Spgt x FIP)



Part #	Mfg #	Size	Price
119439	1214P8FBU	1/2" x 1/4"	
082562	3414P8FBU	3/4" x 1/4"	

## PVC Schedule 80 Fittings

### PVC Sch 80 Fittings (Continued)

#### PVC Flush Style Reducer Bushing (Spgt x FIP)

Part #	Mfg #	Size	Price
033400	3412P8FBU	3/4" x 1/2"	
052491	112P8FBU	1" x 1/2"	
115802	134P8FBU	1" x 3/4"	
042760	11434P8FBU	1-1/4" x 3/4"	
133396	11234P8FBU	1-1/2" x 3/4"	
135618	1121P8FBU	1-1/2" x 1"	
012641	112114P8FBU	1-1/2" x 1-1/4"	
053542	21P8FBU	2" x 1"	
014009	2112P8FBU	2" x 1-1/2"	
045486	32P8FBU	3" x 2"	
050024	11412P8FBU	1-1/4" x 1/2"	
112012	1141P8FBU	1-1/4" x 1"	
080185	212P8FBU	2" x 1/2"	

#### Reducer Bushing (T.T.) Flush Style (MIP x FIP)



Part #	Mfg #	Size	Price
069422	3412P8MFB	3/4" x 1/2"	
069424	112114P8MFB U	1-1/2" x 1-1/4"	
132061	234P8MFB	2" x 3/4"	
069425	2112P8MFB	2" x 1-1/2"	

#### PVC Cap (Soc)



Part #	Mfg #	Size	Price
032508	12P8CA	1/2"	
064767	34P8CA	3/4"	
065388	1P8CA	1"	
042759	114P8CA	1-1/4"	
064768	112P8CA	1-1/2"	
063200	2P8CA	2"	
065709	212P8CA	2-1/2"	
053481	3P8CA	3"	

### PVC Sch 80 Fittings (Continued)

#### PVC Cap (Soc)

Part #	Mfg #	Size	Price
078272	4P8CA	4"	
105383	6P8CA	6"	

#### PVC Cap (FIP)



Part #	Mfg #	Size	Price
106044	2P8TCA	2"	
191384	1P8TCA	1"	
191385	114P8TCA	1-1/4"	

#### PVC Coupling (Soc)



Part #	Mfg #	Size	Price
013190	12P8CP	1/2"	
014756	34P8CP	3/4"	
012278	1P8CP	1"	
053250	114P8CP	1-1/4"	
012540	112P8CP	1-1/2"	
013910	2P8CP	2"	
065710	212P8CP	2-1/2"	
025989	3P8CP	3"	
015295	4P8CP	4"	
053485	6P8CP	6"	
077836	8P8CP	8"	
101907	10P8CP	10"	
106593	12INP8CP	12"	

#### Reducer Coupling (Soc x Soc)



Part #	Mfg #	Size	Price
064769	3412P8RCP	3/4" x 1/2"	
064771	134P8RCP	1" x 3/4"	
064772	1141P8RCP	1-1/4" x 1"	



## PVC Schedule 80 Fittings

### PVC Sch 80 Fittings (Continued)

#### Reducer Coupling (Soc x Soc)

Part #	Mfg #	Size	Price
149836	1121P8RCP	1-1/2" x 1"	
029226	112114P8RCP	1-1/2" x 1-1/4"	
062501	21P8RCP	2" x 1"	
080182	2112P8RCP	2" x 1-1/2"	
082899	212112P8RCP	2-1/2" x 1-1/2"	
082902	2122P8RCP	2-1/2" x 2"	
025990	32P8RCP	3" x 2"	
126808	42P8RCP	4" x 2"	
078161	43P8RCP	4" x 3"	
058967	64P8RCP	6" x 4"	
085578	86P8RCP	8" x 6"	

#### PVC Coupling (Fipt x Fipt)



Part #	Mfg #	Size	Price
027150	34P8TCP	3/4"	
191381	112P8TCP	1-1/2"	
020309	2P8TCP	2"	

#### PVC Cross (Soc x Soc x Soc x Soc)



Part #	Mfg #	Size	Price
084194	112P8CR	1-1/2"	

#### PVC 90° Elbow (Soc)



Part #	Mfg #	Size	Price
013194	12P890	1/2"	
014762	34P890	3/4"	
012286	1P890	1"	
012870	114P890	1-1/4"	

### PVC Sch 80 Fittings (Continued)

#### PVC 90° Elbow (Soc)

Part #	Mfg #	Size	Price
012545	112P890	1-1/2"	
013915	2P890	2"	
042583	212P890	2-1/2"	
014427	3P890	3"	
015299	4P890	4"	
053483	6P890	6"	
077835	8P890	8"	
101911	10P890	10"	
106597	12INP890	12"	
123099	14INP890	14", Fabricated	

#### PVC 90° Elbow (Soc x FIP)



Part #	Mfg #	Size	Price
126890	34P8F90	3/4"	

#### PVC 90° Elbow (FIP)



Part #	Mfg #	Size	Price
121026	12P8T90	1/2"	
125406	34P8T90	3/4"	
112013	1P8T90	1"	

#### PVC 90° Street Elbow (Spgt x Soc)



Part #	Mfg #	Size	Price
116654	12P8S90	1/2"	
093292	34P8S90	3/4"	
112060	1P8S90	1"	

## PVC Schedule 80 Fittings

### PVC Sch 80 Fittings (Continued)

#### PVC 90° Street Elbow (Spgt x Soc)

Part #	Mfg #	Size	Price
116655	114P8S90	1-1/4"	
114762	112P8S90	1-1/2"	
112151	2P8S90	2"	
116656	3P8S90	3"	
116657	4P8S90	4"	

#### PVC 45° Elbow (Soc)



Part #	Mfg #	Size	Price
032236	12P845	1/2"	
014761	34P845	3/4"	
012285	1P845	1"	
057125	114P845	1-1/4"	
012544	112P845	1-1/2"	
013914	2P845	2"	
042584	212P845	2-1/2"	
033514	3P845	3"	
045225	4P845	4"	
060072	6P845	6"	
085576	8P845	8"	
101910	10P845	10"	
106596	12INP845	12"	

#### PVC 45° Street Elbow (Spgt x Soc)



Part #	Mfg #	Size	Price
131324	12P8S45	1/2"	
093293	34P8S45	3/4"	
117632	112P8S45	1-1/2"	
077647	2P8S45	2"	
078160	4P8S45	4"	
126365	6P8S45	6"	

#### PVC 22-1/2° Elbow (Soc)



Part #	Mfg #	Size	Price
104683	112P822	1-1/2"	
101916	4P822	4"	
101915	6P822	6"	
101912	10P822	10"	

#### PVC One-Piece Flange (Soc)



Part #	Mfg #	Size	Price
062888	1P8SOF	1"	
053478	2P8SOF	2"	
014424	3P8SOF	3"	
015297	4P8SOF	4"	
015664	6P8SOF	6"	

#### PVC Flange - Van Stone Style with Glass Filled PVC Ring (Soc)

- Max internal pressure: 150 psi @ 73°F

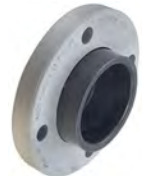

Part #	Mfg #	Size	Price
019418	3P8VSSOF	3"	
015298	4P8VSSOF	4"	
054409	5P8VSSOF	5"	
037949	6P8VSSOF	6"	
015807	8P8VSSOF	8"	
101905	10P8VSSOF	10"	

## PVC Schedule 80 Fittings

### PVC Flange - Van Stone Style with Plastic Ring (Soc)

- Max internal pressure: 150 psi @ 73°F



Part #	Mfg #	Size	Price
080179	1P8VSSOF	1"	
080180	112P8VSSOF	1-1/2"	
062201	2P8VSSOF	2"	
065708	212P8VSSOF	2-1/2"	
085679	12INP8VSSOF	12"	

### PVC Flange - Van Stone Style with Plastic Ring (Spgt)

- Maximum internal pressure: 150 psi @ 73°F



Part #	Mfg #	Size	Price
131273	212P8VSSSOF	2-1/2"	
101904	3P8VSSSOF	3"	
101902	4P8VSSSOF	4"	
101901	6P8VSSSOF	6"	
101900	8P8VSSSOF	8"	
101898	10P8VSSSOF	10"	

### PVC Flange - Blind



Part #	Mfg #	Size	Price
078157	4P8BF	4"	
086920	6P8BF	6"	

### Plug (Mipt)



Part #	Mfg #	Size	Price
184370	34P8TPL	3/4"	
191386	114P8TP	1-1/4"	

### PVC Sch 80 Fittings (Continued)

#### Plug (Mipt)

Part #	Mfg #	Size	Price
127011	112P8TPL	1-1/2"	
140206	1P8TPL	1"	
130019	2P8TPL	2"	
126513	3P8TPL	3"	

#### PVC Tee (Soc)



Part #	Mfg #	Size	Price
013192	12P8T	1/2"	
014759	34P8T	3/4"	
012283	1P8T	1"	
037392	114P8T	1-1/4"	
012542	112P8T	1-1/2"	
013913	2P8T	2"	
065707	212P8T	2-1/2"	
014425	3P8T	3"	
028874	4P8T	4"	
078209	6P8T	6"	
085579	8P8T	8"	
118037	12INP8T	12"	

#### Tee - Reducing (Soc x Soc x Soc)



Part #	Mfg #	Size	Price
124455	343412P8T	3/4" x 1/2"	
118261	1112P8T	1" x 1/2"	
051945	134P8T	1" x 3/4"	
117733	11411434P8T	1-1/4" x 3/4"	
121907	11211234P8T	1-1/2" x 3/4"	
118011	1121121P8T	1-1/2" x 1"	
121025	2212P8T	2" x 1/2"	
153571	2234P8T	2" x 3/4"	
115800	221P8T	2" x 1"	
111874	22112P8T	2" x 1-1/2"	
126901	212212112P8T	2-1/2" x 1-1/2"	

## PVC Schedule 80 Fittings

### PVC Sch 80 Fittings (Continued)

**Tee - Reducing  
(Soc x Soc x Soc)**

Part #	Mfg #	Size	Price
135663	33112P8T	3" x 1-1/2"	
053482	332P8T	3" x 2"	
089964	44112P8T	4" x 1-1/2"	
089963	442P8T	4" x 2"	
069486	443P8T	4" x 3"	
108429	66112P8T	6" x 1-1/2"	
085580	662P8T	6" x 2"	
085581	663P8T	6" x 3"	
105476	664P8T	6" x 4"	
108428	884P8T	8" x 4"	
118040	10108P8T	10" x 8"	

**PVC Tee  
(Soc x Soc x FIP)**



Part #	Mfg #	Size	Price
112061	1P8FT	1"	

**PVC Tee - Reducing  
(Soc x Soc x FIP)**



Part #	Mfg #	Size	Price
110013	2234P8FT	2" x 3/4"	

**PVC Tee  
(FIP x FIP x FIP)**



Part #	Mfg #	Size	Price
013191	12P8TT	1/2"	
126345	34P8TT	3/4"	
191389	1P8TT	1"	
182783	2P8TT	2"	

**PVC 2000 Union  
with Viton® O-Ring Seal  
(Soc)**



*• Maximum internal pressure: 235 psi @ 73°F*

Part #	Mfg #	Size	Price
013193	12P8U	1/2"	
014760	34P8U	3/4"	
012284	1P8U	1"	
012869	114P8U	1-1/4"	
012543	112P8U	1-1/2"	
018203	2P8U	2"	
014426	3P8U	3"	

**PVC 2000 Union  
with EPDM O-Ring Seal  
(Soc x Soc)**



Part #	Mfg #	Size	Price
200745	212P8U	2-1/2"	

**PVC 2000 Union  
with EPDM O-Ring Seal  
(FIP x FIP)**



Part #	Mfg #	Size	Price
039747	34P8TU	3/4"	
191394	1P8TUEPDM	1"	
021160	112P8TU	1-1/2"	

**PVC Union (Old Style)  
with FKM O-Ring Seal  
(Soc x Soc)**



Part #	Mfg #	Size	Price
094323	4P8U	4"	

**PVC Union (Old Style)  
with EPDM O-Ring Seal  
(Soc x FIP)**



Part #	Mfg #	Size	Price
109376	2P8FUE	2"	

**PVC Schedule 80 Fittings**

**PVC Wye**  
(Soc x Soc x Soc)



Part #	Mfg #	Size	Price
033513	3P8Y	3"	
126362	4P8Y	4"	
126366	6P8Y	6"	

**Stainless Steel Reinforced Fittings**

**PVC Female Adapter**  
(Soc x SR FIP)



Part #	Mfg #	Size	Price
065711	12P8FASR	1/2"	
065712	34P8FASR	3/4"	
065713	1P8FASR	1"	
111654	114P8FASR	1-1/4"	
065714	112P8FASR	1-1/2"	
065715	2P8FASR	2"	

**PVC Reducing Female Adapter**  
(Soc x SR FIP)



Part #	Mfg #	Size	Price
140959	112P8FARSR	1" x 1/2"	

**PVC Sch 80 Reducing Bushing**  
(Spigot SR x FIPT)

- Molded
- Stainless steel collar



Part #	Mfg #	Size	Price
174017	114P8BUSR	1" x 1/4"	



## PVC Schedule 80 Fittings

### PVC Sch 80 Nipples



### 1/4" Sch 80 PVC Nipples

Part#	Mfg#	Size	Price
121116	142P8N	1/4" x 2"	
119437	143P8N	1/4" x 3"	

### 1/2" Sch 80 PVC Nipples

Part#	Mfg#	Size	Price
047074	12CLP8N	1/2" x Close	
142716	12112P8N	1/2" x 1-1/2"	
041017	122P8N	1/2" x 2"	
196059	12212P8N	1/2" x 2-1/2"	
013307	123P8N	1/2" x 3"	
094453	124P8N	1/2" x 4"	
196062	125P8N	1/2" x 5"	
087472	126P8N	1/2" x 6"	
141664	121FTP8N	1/2" x 12"	
105871	1236P8N	1/2" x 36"	
034778	1242P8N	1/2" x 42"	

### 3/4" Sch 80 PVC Nipples

Part#	Mfg#	Size	Price
026183	34CLP8N	3/4" x Close	
107250	34112P8N	3/4" x 1-1/2"	
071398	342P8N	3/4" x 2"	
071399	343P8N	3/4" x 3"	
071401	344P8N	3/4" x 4"	
121353	346P8N	3/4" x 6"	

### 1" Sch 80 PVC Nipples

Part#	Mfg#	Size	Price
108454	1212P8N	1" x 2-1/2"	
088644	13P8N	1" x 3"	
081056	16P8N	1" x 6"	
023575	18P8N	1" x 8"	
076513	110P8N	1" x 10"	

### 1-1/4" Sch 80 PVC Nipples

Part#	Mfg#	Size	Price
142385	114CLP8N	1-1/4" x Close	
142393	1146P8N	1-1/4" x 6"	

### 1-1/2" Sch 80 PVC Nipples

Part#	Mfg#	Size	Price
047075	112CLP8N	1-1/2" x Close	

### 2" Sch 80 PVC Nipples

Part#	Mfg#	Size	Price
029467	2CLP8N	2" x Close	
094450	23P8N	2" x 3"	
094449	24P8N	2" x 4"	
094448	26P8N	2" x 6"	

### 3" Sch 80 PVC Nipples

Part#	Mfg#	Size	Price
135662	34P8N	3" x 4"	



## PVC Sewer Fittings

### PVC Solvent Weld SDR 35 (ASTM D-3034)

**PVC SDR 35 Straight Tee SW**  
(H x H x H)

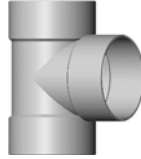

Part #	Mfg #	Size	Type	Price
024581	4SDTND	4"	Molded Fitting	
192177	6SDTND	6"	Molded Fitting	

**PVC SDR 35 Sanitary Tee (TY) SW**  
(H x H x H)

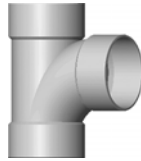

Part #	Mfg #	Size	Type	Price
015310	4SDT	4"	Molded Fitting	
015671	6SDT	6"	Molded Fitting	
015814	8SDT	8"	Molded Fitting	

**PVC SDR 35 Tee Cross SW**  
(H x H x H)

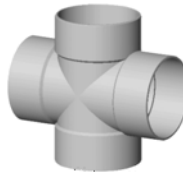

Part #	Mfg #	Size	Type	Price
015304	4SDCR	4"	Molded Fitting	

**PVC SDR 35 1/4 Bend (90°) SW**  
(H x H)

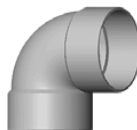

Part #	Mfg #	Size	Type	Price
024582	4SDSS90	4"	Molded Fitting	
015674	6SD90	6"	Molded Fitting	
015818	8SD90	8"	Molded Fitting	

**PVC SDR 35 Long Turn 1/4 (90°) Bend SW**  
(H x H)



Part #	Mfg #	Size	Type	Price
015314	4SD90	4"	Molded Fitting	

**PVC SDR 35 Long Turn 1/4 (90°) Bend SW**  
(H x S)



Part #	Mfg #	Size	Type	Price
015309	4SDS90	4"	Molded Fitting	

**PVC SDR 35 45° Wye SW**  
(H x H x H)

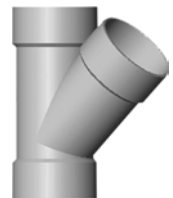

Part #	Mfg #	Size	Type	Price
015313	4SDY	4"	Molded Fitting	
015731	664SDY	6" x 4"	Molded Fitting	
015672	6SDY	6"	Molded Fitting	

**PVC SDR 35 2-Way Cleanout**  
(H x H x H)



Part #	Mfg #	Size	Type	Price
192169	4SDTWCO	4"	Molded Fitting	

**PVC SDR 35 1/8 Bend (45°) SW**  
(H x H)



Part #	Mfg #	Size	Type	Price
015312	4SD45	4"	Molded Fitting	
015673	6SD45	6"	Molded Fitting	
015817	8SD45	8"	Molded Fitting	

## PVC Sewer Fittings

### PVC SDR 90° Elbow (H x S)

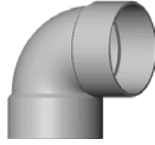

Part #	Mfg #	Size	Type	Price
039444	6SDS90	6"	Molded Fittings	

### PVC SDR 35 1/8 Bend (45°) SW (H x S)



Part #	Mfg #	Size	Type	Price
015308	4SDS45	4"	Molded Fitting	
192176	6SDS45	6"	Molded Fitting	

### PVC SDR 35 1/16 Bend (22-1/2°) SW (H x S)



Part #	Mfg #	Size	Type	Price
015311	4SD22	4"	Molded Fitting	
046503	6SD22	6"	Molded Fitting	
015816	8SD22	8"	Molded Fitting	

### PVC SDR 35 (22-1/2°) Street Elbow (S x H)



Part #	Mfg #	Size	Type	Price
192173	4SDS22	4"	Molded Fitting	
192180	6SDS22	6"	Molded Fitting	

### PVC SDR 35 Coupling SW (H x H)

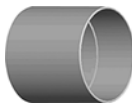

Part #	Mfg #	Size	Type	Price
015303	4SDCP	4"	Molded Fitting	
015668	6SDCP	6"	Molded Fitting	
015810	8SDCP	8"	Molded Fitting	

### PVC SDR 35 Reducer Coupling SW (H x H)

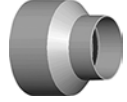

Part #	Mfg #	Size	Type	Price
059488	43SDICP	4" x 3"	Molded Fitting	
015730	64SDCP	6" x 4"	Molded Fitting	
194862	108SDCP	10" x 8"	Molded Fitting	

### PVC SDR 35 DWV Coupling SW (Sewer H x DWV H)



Part #	Mfg #	Size	Type	Price
015439	43PDACP	4" x 3"	Molded Fitting	
015260	4PDACP	4"	Molded Fitting	
015747	6SDPDCP	6"	Molded Fitting	

### PVC SDR 35 Drain Grate SW



Part #	Mfg #	Size	Type	Price
015305	4SDDG	4"	Molded Fitting	

### PVC SDR 35 Threaded Plug SW



Part #	Mfg #	Size	Type	Price
015307	4SDPL	4"	Molded Fitting	
015670	6SDPL	6"	Molded Fitting	
015813	8SDPL	8"	Molded Fitting	

### PVC SDR 35 DWV Bushing SW (Sewer Spgt x DWV H)

• D3034

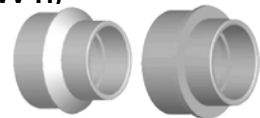

Part #	Mfg #	Size	Type	Price
077448	4PDABU	4"	Molded Fitting	
192170	PVS43BUS H	4"x3"	Molded Fitting	

## PVC Sewer Fittings

### PVC SDR 35 Reducer Bushing SW (S x H)

• D3034

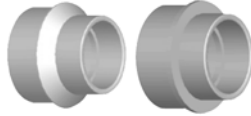

Part #	Mfg #	Size	Type	Price
192183	64SDBU	6" x 4"	Molded Fitting	
015861	86SDBU	8" x 6"	Molded Fitting	

### PVC SDR 35 Adapter SW (DWV Spgt x Sewer H)

• D3034



Part #	Mfg #	Size	Type	Price
027831	4SDABU	4"	Molded Fitting	

### PVC SDR 35 Female Adapter SW (H x FIP)

• D3034

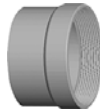

Part #	Mfg #	Size	Type	Price
063151	4SDFA	4"	Molded Fitting	
015669	6SDFA	6"	Molded Fitting	

### Flushmount Downspout Adapter (Flushmount Downspout x Solvent Sewer Hub)

Part #	Mfg #	Size	Type	Price
192174	PVS23419	2" x 3" x 4"		
	2			
192182	PVS46619	4" x 6" x 6"		
	4			

### Corrugated Pipe Adapter (S x H)

Part #	Mfg #	Size	Type	Price
192171	4SDCORA	4" x 4"		

### PVC SDR 35 Fitting Cleanout SW (Spgt x FIP)

• D3034

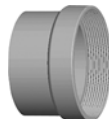

Part #	Mfg #	Size	Type	Price
015306	4SDCO	4"	Molded Fitting	
015667	6SDCO	6"	Molded Fitting	

### PVC SDR 35 Cap SW



Part #	Mfg #	Size	Type	Price
015301	4SDCA	4"	Molded Fitting	
015666	6SDCA	6"	Molded Fitting	
015809	8SDCA	8"	Molded Fitting	
013196	12SDCA	12"	Molded Fitting	

### PVC Heavy Wall Gasketed SDR 26 (ASTM D-3034)

#### PVC SDR 26 Stop Coupling (G x G)



Part #	Mfg #	Size	Type	Price
029317	4SDGJCP	4"	Molded Fitting	

#### PVC SDR 26 45° Wye Gasketed (G x G x G)



Part #	Mfg #	Size	Type	Price
029310	4SDGJY	4"	Molded Fitting	
029311	6SDGJY	6"	Molded Fitting	
029312	64SDGJY	6" x 4"	Molded Fitting	

#### PVC SDR 26 1/4 Bend (90°) Long Sweep Gasketed (G x G)

Part #	Mfg #	Size	Type	Price
029308	4SDGJLT9	4"	Molded Fitting	
	0			

#### PVC SDR 26 1/8 Bend (45°) Gasketed (G x G)



Part #	Mfg #	Size	Type	Price
029315	4SDGJ45	4"	Molded Fitting	

## PVC Sewer Fittings

### PVC SDR 26 1/8 Bend (45°) Gasketed (S x G)



Part #	Mfg #	Size	Type	Price
029313	4SDGJS45	4"	Molded Fitting	
029314	6SDGJS45	6"	Molded Fitting	

### PVC SDR 26 1/16 Bend (22-1/2°) Gasketed (H x H)



Part #	Mfg #	Size	Type	Price
029323	4SDGJ22	4"	Molded Fitting	

### PVC SDR 26 1/16 Bend (22-1/2°) Gasketed (S x G)



Part #	Mfg #	Size	Type	Price
077445	4SDGJS22	4"	Molded Fitting	

### PVC SDR 26 Concentric Increaser Coupling Gasketed (G x G)



Part #	Mfg #	Size	Type	Price
029319	64SDGJCP	6" x 4"	Molded Fitting	

## PVC Sewer Fittings

### Sewer Fittings

#### Solid Snap End Cap

- Easily snaps into place
- For use in joining polyethylene drainage pipes



Part #	Mfg #	Size	Price
196777	HAN4CAP	4"	
192978	HAN10CAP	10"	

#### Arc Style End Cap

Part #	Mfg #	Size	Price
199005	HANARC18EC	ARC-18	
199006	HANARC24EC	ARC-24	

#### Coupling



Part #	Mfg #	Size	Price
192977	HAN10COUP	10"	

#### Slip Coupling

- Easily snaps into place
- For use in joining polyethylene drainage pipes



Part #	Mfg #	Size	Price
194827	HAN4C	4"	
202798	HAN6C	6"	

#### Slip Internal Coupling

- Easily snaps into place
- For use in joining polyethylene drainage pipes



Part #	Mfg #	Size	Price
205147	HAN4IC	4"	

#### Slip Snap Reducer Coupling

- Easily snaps into place
- For use in joining polyethylene drainage pipes



Part #	Mfg #	Size	Price
197847	HAN64R	6" x 4"	
192976	HAN104	10" x 4"	

#### 90° Elbow

- Easily snaps into place
- For use in joining polyethylene drainage pipes



Part #	Mfg #	Size	Price
194883	HAN490	4"	

#### Snap Tee

- Easily snaps into place
- For use in joining polyethylene drainage pipes



Part #	Mfg #	Size	Price
194884	HAN4TEE	4"	

#### HDPE Snap Wye Coupling

- Easily snaps into place
- For use in joining polyethylene drainage pipes



Part #	Mfg #	Size	Price
194885	HAN4WYE	4"	

#### Downspout Adapter

- Easily snaps into place
- For use in joining polyethylene drainage pipes



Part #	Mfg #	Size	Price
194828	HAN234	2" x 3" x 4"	
194829	HAN344	3" x 4" x 4"	

#### Leach Chamber

- Easily snaps into place
- For use in joining polyethylene drainage pipes



Part #	Mfg #	Size	Price
199003	HANARC18	12"H x 67"L x 16"W	
199004	HANARC24	12"H x 67"L x 22-1/2"W	

#### Meter Pits

- Dual-wall design
- Corrugated HDPE
- Corrugations lock into soil



Part #	Mfg #	Size	Price
191015	MW1830	18" x 30"	
191016	MW1836	18" x 36"	



---

---

## PVC Sewer Fittings

---

---

### Sewer Fittings (Continued)

#### Meter Pits

Part #	Mfg #	Size	Price
194622	MW2130	21" x 30"	
194886	MW2136	21" x 36"	



## Rigid Couplings & Repair Clamps

### Clampette Products

#### Malleable Compression Coupling - Galvanized

- Malleable Compression Coupling
- Hot Dipped Galvanized
- ASTM 197
- BUNA-N Gaskets
- Zinc Plated Friction Washer
- 125 PSI WOG
- 180° F



Part #	Mfg #	Size	Type	Price
002981	GALCOMCP34	3/4"	Short	
002993	GALCOMCPL12	1/2"	Long	
002994	GALCOMCPL34	3/4"	Long	
002995	GALCOMCPL1	1"	Long	
002996	GALCOMCPL114	1-1/4"	Long	
002997	GALCOMCPL112	1-1/2"	Long	
002998	GALCOMCPL2	2"	Long	

### Galvanized Pipe Repair Clamps

#### Clampette No Lead Pipe Patch Clamp - IPS

- #304 Stainless steel band
- Temperature rating: -40° - 212°F
- Pressure rating: 150 psi



Part #	Mfg #	Size	Bolts	Price
002990	CL123	1/2" x 3"	1	
003000	CL343	3/4" x 3"	1	
002991	CL13	1" x 3"	1	
002986	CL1143	1-1/4" x 3"	1	
002983	CL1123	1-1/2" x 3"	1	
002999	CL23	2" x 3"	1	
003001	CL346	3/4" x 6"	2	
002992	CL16	1" x 6"	2	



## Sharkbite Fittings

### Push-To-Connect (PTC) Valves

- Instant push-fit connection for increased ease-of-use: No soldering, clamps, unions, or glue required
- Fittings certified to 200 PSI and 200°F (93°C): Proven durability and quality
- Fits copper tubing, and CTS CPVC and PEX: Connects all three types in any combination

#### Straight Stops

- 1/4 Turn



Part #	Mfg #	Size	Price
170531	SB1238SSLF	1/2" x 3/8" Compression	

#### Angle Stops

- 1/4 Turn



Part #	Mfg #	Size	Price
170529	SB1238ASLF	1/2" x 3/8" Compression	
201690	SB23336LF	1/2" x 1/4" Compression	

#### Dual Outlet Angle Stop

- 1/4 Turn



Part #	Mfg #	Size	Price
245996	25558LF	1/2"x3/8"Comp x 3/8"Comp	

#### Tee Stop

- 1/4" Compression line and 1/4 turn valve



Part #	Mfg #	Size	Price
181125	SB121214SST	1/2"x1/2"x1/4" Compression	

### Large Diameter Push-To-Connect Ball Valves

- Lead free



Part #	Mfg #	Size	Price
206786	SVBV35	1-1/4"	
206787	SBBV41	1-1/2"	

### Push-To-Connect Ball Valves

- Lead free



Part #	Mfg #	Size	Price
161196	SB12BVLF	1/2"	
196592	SB34BVLF	3/4"	
161198	SB1BVLF	1"	

### EB25-DUPE Pressure Regulating Valve

- Double union PEX ends
- Valve adjusts between 20-90 psi -Factory set at 45 psi
- Integral by-pass feature
- Full cartridge with pressure indicator



Part #	Mfg #	Size	Price
246330	SB239570045	3/4"	

### EB45-DUPE Pressure Regulating Valve

- Double union PEX ends
- Valve adjusts between 10-70 psi -Factory set at 45 psi
- Integral by-pass feature

Part #	Mfg #	Size	Price
246132	CA238910045	3/4"	

### EB45-DSB Pressure Regulating Valve

- Direct sharkbite connection
- Valve adjusts between 10-70 psi -Factory set at 45 psi
- Equipped with a 1/2 cartridge design



Part #	Mfg #	Size	Price
199419	SB238080045	3/4"	



## Sharkbite Fittings

### EB45 Pressure Regulating Valve

- Threaded NPT connection
- Valve adjusts between 10-70 psi  
-Factory set at 45 psi
- Equipped with a 1/2 cartridge design



Part #	Mfg #	Size	Price
245445	SB238810045	3/4" FIP x FIP	

### In-Line Thermostatic Mixing Valve

- Lead free
- (HG145) Compression connections w/  
mounting clamp and inlet strainer screens
- ASSE 1070 & CSA B 125.3

Part #	Mfg #	Size	Price
214815	HG145LF	3/4" Compression	

### Push-To-Connect Large Diameter Fittings

- Instant push-fit connection for increased ease-of-use:  
No soldering, clamps, unions, or glue required
- Fittings certified to 200 PSI and 200°F (93°C):  
Proven durability and quality
- Fits copper tubing, and CTS CPVC and PEX:  
Connects all three types in any combination

#### Large Diameter Couplings

- Lead free DZR brass body



Part #	Mfg #	Size	Price
204085	SB0135	1-1/4" x 1-1/4"	
204087	SB0141	1-1/2" x 1-1/2"	
206716	SB0154	2" x 2"	

### Large Diameter Reducing Couplings

- Lead free DZR brass body



Part #	Mfg #	Size	Price
206720	SB013528	1-1/4" x 1"	
206721	SB014135	1-1/2" x 1-1/4"	

### Large Diameter End Caps

- Lead free DZR brass body



Part #	Mfg #	Size	Price
206783	SB0435	1-1/4"	
206784	SB0441	1-1/2"	

### Push-To-Connect Large Diameter 90° Elbows

- Lead free DZR brass body



Part #	Mfg #	Size	Price
216800	SB0235	1-1/4"	

### Large Diameter PEX Stiffeners

- Inserts that go inside large diameter  
sharkbite fittings
- Required to connect SharkBite fitting  
to PEX tubing



Part #	Mfg #	Size	Price
206792	SBTL35	1-1/4"	
206793	SBTL41	1-1/2"	

### Push-To-Connect (PTC) Fittings

- Instant push-fit connection for increased ease-of-use:  
No soldering, clamps, unions, or glue required
- Fittings certified to 200 PSI and 200°F (93°C):  
Proven durability and quality
- Fits copper tubing, and CTS CPVC and PEX:  
Connects all three types in any combination

#### Male Adapters / Connectors

- Push-To-Connect design combined  
with standard MNPT adapter on  
opposite end



Part #	Mfg #	Size	Price
161154	SB3812MALF	3/8" x 1/2" MNPT	
161155	SB12MALF	1/2" PTC x 1/2" MNPT	
133981	SB1234MALF	1/2" x 3/4" MNPT	
161157	SB3412MALF	3/4" x 1/2" MNPT	
161156	SB34MALF	3/4" PTC x 3/4" MNPT	
161158	SB341MALF	3/4" x 1" MNPT	
196073	SB134MALF	1" x 3/4" MNPT	
161159	SB1MALF	1" PTC x 1" MNPT	



## Sharkbite Fittings

### Female Adapters / Connectors

- Push-To-Connect design combined with standard MNPT adapter on opposite end



Part #	Mfg #	Size	Price
161148	SB3812FALF	3/8" PTC x 1/2" FNPT	
161149	SB12FALF	1/2" PTC x 1/2" FNPT	
133980	SB1234FALF	1/2" PTC x 3/4" FNPT	
161150	SB34FALF	3/4" PTC x 3/4" FNPT	
161152	SB1FALF	1" PTC x 1" FNPT	
161151	SB3412FALF	3/4" PTC x 1/2" FNPT	

### Push-To-Connect Couplings

- Lead free DZR brass body



Part #	Mfg #	Size	Price
161136	SB14CPLF	1/4"	
139932	SB38CPLF	3/8"	
161138	SB12CPLF	1/2"	
133979	SB1238CPLF	1/2" x 3/8"	
161139	SB34CPLF	3/4"	
161140	SB1CPLF	1"	
161142	SB3412CPLF	3/4" x 1/2"	
161143	SB134CPLF	1" x 3/4"	
161141	SB1412CPLF	1/4" x 1/2"	

### Transition Couplings (Polybutylene x SB Polybutylene)

- Lead free DZR brass body



Part #	Mfg #	Size	Price
202032	SBU4008LF	1/2"	
202033	SBU4016LF	3/4"	

### Fitting Reducers (CTS x SB)

- Lead free DZR brass body



Part #	Mfg #	Size	Price
161195	SB341FRLF	3/4" x 1"	

### Slip Couplings

- APPROVALS:  
-ASSE 1061  
CSA B125.3  
NSF 372  
NSF/ANSI 61



Part #	Mfg #	Size	Price
161144	SB12RCPLF	1/2"	
161145	SB34RCPLF	3/4"	
161146	SB1RCPLF	1"	

### Push-To-Connect End Caps

- Lead free DZR brass body



Part #	Mfg #	Size	Price
161189	SB12CALF	1/2"	
161190	SB34CALF	3/4"	
161191	SB1CALF	1"	

### Push-To-Connect 90° Elbows

- Lead free DZR brass body



Part #	Mfg #	Size	Price
161162	SB3890LF	3/8"	
161163	SB1290LF	1/2"	
161164	SB3490LF	3/4"	
161165	SB190LF	1"	

### Push-To-Connect Reducing 90° Elbows

- Lead free DZR brass body



Part #	Mfg #	Size	Price
161170	SB3412R90LF	3/4" x 1/2"	

### Male Elbow

- Lead free DZR brass body



Part #	Mfg #	Size	Price
161167	SB12M90LF	1/2" x 1/2"	
161168	SB34M90LF	3/4" x 3/4"	



## Sharkbite Fittings

### Female Elbow

- Lead free DZR brass body



Part #	Mfg #	Size	Price
134201	SB12F90LF	1/2" x 1/2"	

### Push-To-Connect Female Drop-Ear Elbows (FNPT)

- Lead free DZR brass body



Part #	Mfg #	Size	Price
161175	SB12FDE90LF	1/2" x 1/2"	

### Push-To-Connect Drop-Ear Elbows

- Lead free DZR brass body



Part #	Mfg #	Size	Price
161174	SB12DE90LF	1/2" x 1/2"	

### Push-To-Connect Tees

- Lead free DZR brass body



Part #	Mfg #	Size	Price
161178	SB38TLF	3/8"	
161179	SB12TLF	1/2"	
161180	SB34TLF	3/4"	
161181	SB1TLF	1"	

### Push-To-Connect Reducing Tees

- Lead free DZR brass body



Part #	Mfg #	Size	Price
161187	SB341212TLF	3/4" x 1/2" x 1/2"	
161185	SB343412TLF	3/4" x 3/4" x 1/2"	
161186	SB341234TLF	3/4" x 1/2" x 3/4"	

### Push-To-Connect (PTC) Fittings (Continued)

#### Push-To-Connect Reducing Tees

Part #	Mfg #	Size	Price
161188	SB1134TLF	1" x 1" x 3/4"	

#### Slip Tees

- Lead free DZR brass body



Part #	Mfg #	Size	Price
199998	SBU3362LF	1/2" x 1/2" x 1/2"	

#### Water Softener Fittings



Part #	Mfg #	Size	Price
221161	SB1412CPLF	3/4"SB x 1" FIP	

### Parts & Accessories

#### Disconnect Clips



Part #	Mfg #	Size	Price
161202	U710	1/2"	
161203	U712	3/4"	
161204	U714	1"	

#### De-Mount Clips



Part #	Mfg #	Size	Price
206789	SBDC35	1-1/4"	
206790	SBDC41	1-1/2"	
206791	SBDC54	2"	





## Sharkbite Fittings

### PEX Tubing Cutters

- Use w/ 1/4", 3/8", 1/2", 3/4", and 1" SharkBite PEX Tubing



Part#	Mfg#	Description	Price
236761	SBU701	1/4", 3/8", 1/2", 3/4" & 1"	

### PEX Clamp/Crimp Tools



Part#	Mfg#	Description	Price
236760	SB23081	Clamp, 3/8" up to 1"	
236759	SB23251	Crimp, 1/2" to 3/4"	

### Deburr & Gauge Tool

- Use for 1/4", 3/8", 1/2", 5/8", 3/4" and 1" Copper and CPVC Pipe



Part #	Mfg #	Size	Price
161205	DEBURRINGTOOL	1/4" up to 1"	

### Silicone Wrap

- Self-adhesive tape
- Stretches up to 300%
- Creates watertight seal within minutes
- Working temperature: -65°F to 500°F
- Protects brass fittings from contaminants that can be found in ground conditions



Part #	Mfg #	Size	Price
227051	SB25406	For Fitting Burial	

### Flexible Coupling Hoses

- Braided hose
- NSF 372
- ASME A112.18.6-2009/CSA B125.6-200



Part #	Mfg #	Size	Price
205412	SBU3016FLEX18L	3/4" x 3/4" x 18"L	
	F		

### Flexible Water Heater Connectors

- Braided hose
- NSF 372
- NSF/ANSI 61
- ASME A112.18.6-2009/CSA B125.6-200



Part #	Mfg #	Size	Price
204912	SBU3068FLEX24L	3/4"SB x 1/2"FIP x 24"L	
	F		
199318	SBU3088FLEX12L	3/4"SB x 3/4"FIP x 12"L	
	F		
158715	SB34FLEX18LF	3/4"SB x 3/4"FIP x 18"L	
199319	SBU3088FLEX24L	3/4"SB x 3/4"FIP x 24"L	
	F		
165862	SBU3068FLEX18L	1/2"SB x 3/4"FIP x 18"L	
	F		
204911	SBU3068FLEX12L	1/2"Sb x 3/4"FIP x 12"L	
	F		

### With Ball Valve



Part #	Mfg #	Size	Price
134794	SB34FLEX18BVLF	3/8"SB x 3/4"FIP x 18"L	
202079	SBU3068FLEX18B	1/2"SB x 3/4"FIP x 18"L	
	V		

### Flexible Water Softener Hose



Part #	Mfg #	Size	Price
212546	SBU3086FLEX24L	3/4" x 1"F x 24"L	
	F		



## Soil No-Hub Fittings

### Cast Iron No-Hub Soil Fittings

#### Cast Iron No-Hub Soil 1/16 Bend

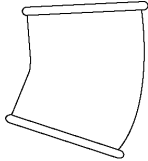

Part #	Size	Price
012489	1-1/2"	
013861	2"	
014383	3"	
015254	4"	
015635	6"	
059068	8"	

#### Cast Iron No-Hub Soil 1/8 Bend

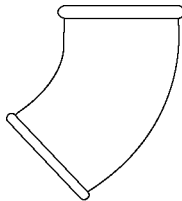

Part #	Size	Price
012491	1-1/2"	
013864	2"	
014386	3"	
015257	4"	
015518	5"	
015637	6"	
015793	8"	
041695	10"	
055789	12"	
078347	15"	

#### Cast Iron No-Hub Soil 1/6 Bend

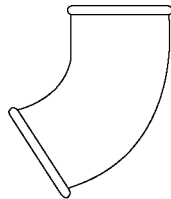

Part #	Size	Price
013863	2"	
014385	3"	

### Cast Iron No-Hub Soil Fittings (Continued)

#### Cast Iron No-Hub Soil 1/6 Bend

Part #	Size	Price
015256	4"	

#### Cast Iron No-Hub Soil 1/4 Bend

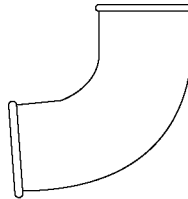

Part #	Size	Price
012490	1-1/2"	
013862	2"	
014384	3"	
015255	4"	
015517	5"	
015636	6"	
015792	8"	

#### Cast Iron No-Hub Soil Short Sweep 1/4 Bend

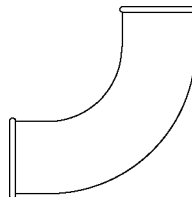

Part #	Size	Price
077149	2"	
077150	3"	
077151	4"	
105252	6"	
082045	8"	
041696	10"	
073167	12"	
078468	15"	

### Cast Iron No-Hub Soil Long Sweep 1/4 Bend

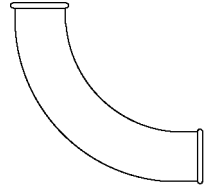

Part #	Size	Price
012483	1-1/2"	
013855	2"	
014377	3"	
015435	4" x 3"	
015248	4"	
019253	5"	
015629	6"	

### Cast Iron No-Hub Soil Double 1/4 Bend

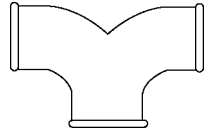

Part #	Size	Price
122211	2"	

### Cast Iron No-Hub Soil Sanitary Tee

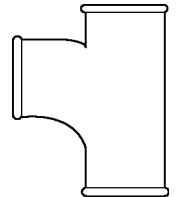

Part #	Size	Price
012486	1-1/2"	
014001	2" x 1-1/2"	
013858	2"	
014485	3" x 1-1/2"	
014529	3" x 2"	
014380	3"	
015395	4" x 2"	
015437	4" x 3"	
015251	4"	
015514	5"	
059066	6" x 3"	

## Soil No-Hub Fittings

### Cast Iron No-Hub Soil Fittings (Continued)

#### Cast Iron No-Hub Soil Sanitary Tee

Part #	Size	Price
015727	6" x 4"	
015632	6"	
105251	8" x 4"	
089630	8"	

#### Cast Iron No-Hub Soil Sanitary Tapped Tee

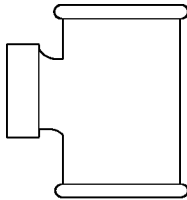

Part #	Size	Price
024764	1-1/2" x 1-1/4"	
012487	1-1/2" x 1-1/2"	
014045	2" x 1-1/4"	
014003	2" x 1-1/2"	
014208	2" x 2"	
014486	3" x 1-1/2"	
014530	3" x 2"	
015367	4" x 1-1/2"	

#### Cast Iron No-Hub Soil Wye

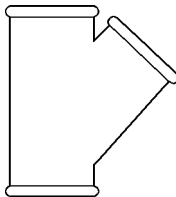

Part #	Size	Price
012488	1-1/2"	
013860	2"	
014531	3" x 2"	
014382	3"	
015397	4" x 2"	
015438	4" x 3"	
015253	4"	
015547	5" x 4"	
015516	5"	

### Cast Iron No-Hub Soil Fittings (Continued)

#### Cast Iron No-Hub Soil Wye

Part #	Size	Price
015717	6" x 3"	
015728	6" x 4"	
043550	6" x 5"	
015634	6"	
082087	8" x 3"	
015849	8" x 4"	
036189	8" x 5"	
015858	8" x 6"	
015791	8"	
057640	10" x 4"	
041599	10" x 6"	
046771	10" x 8"	
012301	10"	
060519	12"	
080847	15"	

#### Cast Iron No-Hub Soil Double Wye

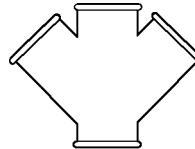

Part #	Size	Price
013853	2"	
014375	3"	
015393	4" x 2"	
069698	4" x 3"	
015246	4"	

#### Cast Iron No-Hub Soil Combination Wye & 45° Elbow

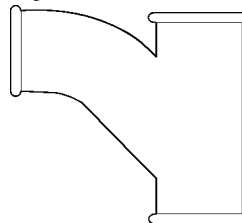

Part #	Size	Price
046775	2" x 1-1/2"	

### Cast Iron No-Hub Soil Fittings (Continued)

#### Cast Iron No-Hub Soil Combination Wye & 45° Elbow

Part #	Size	Price
013852	2"	
014526	3" x 2"	
014374	3"	
015391	4" x 2"	
015433	4" x 3"	
015245	4"	
015716	6" x 3"	
046777	6" x 4"	

#### Cast Iron No-Hub Soil Double Combination Wye & 45° Elbow

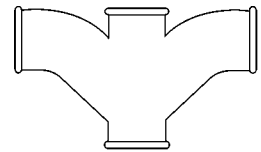

Part #	Size	Price
051139	2"	
110029	3"	
015392	4" x 2"	
057639	4"	

#### Cast Iron No-Hub Tapped Double Wye

Part #	Size	Price
102027	2" x 1-1/2"	

#### Cast Iron No-Hub Soil Sanitary Cross

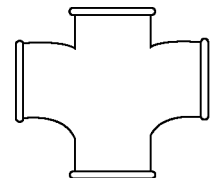

Part #	Size	Price
090971	1-1/2"	
013851	2"	
014525	3" x 2"	
075602	3"	

## Soil No-Hub Fittings

### Cast Iron No-Hub Soil Fittings (Continued)

#### Cast Iron No-Hub Soil Sanitary Cross

Part #	Size	Price
015390	4" x 2"	
082088	4" x 3"	
030652	4"	
082044	6" x 4"	
082042	8" x 4"	

#### Cast Iron No-Hub Soil Sanitary Tap Cross

Part #	Size	Price
069699	2" x 1-1/4"	
014002	2" x 1-1/2"	

#### Cast Iron No-Hub Soil Test Tee with Type A Brass Plug

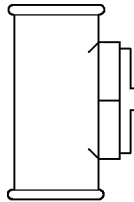

Part #	Size	Price
013859	2" - 2"	
014381	3" - 3"	
015252	4" - 4"	
015515	5" - 5"	
015633	6" - 6"	
031673	8" - 8"	

#### Cast Iron No-Hub Soil Test Tee Less Plug

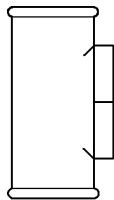

Part #	Size	Price
052546	10" - 10"	

### Cast Iron No-Hub Soil Short Reducer

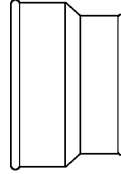

Part #	Size	Price
014000	2" x 1-1/2"	
071374	3" x 1-1/2"	
014528	3" x 2"	
015394	4" x 2"	
015436	4" x 3"	
015546	5" x 4"	
041601	6" x 2"	
040267	6" x 3"	
015726	6" x 4"	
015741	6" x 5"	
015848	8" x 4"	
033726	8" x 5"	
015857	8" x 6"	
041603	10" x 6"	
036568	10" x 8"	
060521	12" x 6"	
068555	12" x 10"	
105522	15" x 8"	
078471	15" x 10"	
080846	15" x 12"	

### Cast Iron No-Hub Soil Cleanout Ferrule with Type A Brass Plug

Part #	Size	Price
013854	2" - 1-1/2"	
014376	3" - 2-1/2"	
015247	4" - 3-1/2"	
052548	5" - 4"	
015628	6" - 5"	
068545	8" - 6"	

### Cast Iron No-Hub Soil Blind Plug

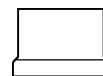

Part #	Size	Price
012481	1-1/2"	
013849	2"	

### Cast Iron No-Hub Soil Fittings (Continued)

#### Cast Iron No-Hub Soil Blind Plug

Part #	Size	Price
014372	3"	
015242	4"	
027135	6"	
102463	12"	

### Cast Iron No-Hub Soil P-Trap

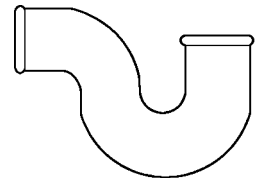

Part #	Size	Price
012484	1-1/2"	
013856	2"	
014378	3"	
015249	4"	

### Cast Iron No-Hub Soil Closet Flange (Slot & Notch)

Part #	Size	Price
015468	4" x 3" x 3-1/2"	
015488	4" x 4" x 4"	



## Soil No-Hub Fittings

### No-Hub Pipe Couplings

- *Lightweight*
- *Cast iron soil pipe*
- *Easy to install with standard 60"lbs torque wrenches*
- *Longer slots on clamping band provide greater adaptability to varying cast iron pipe diameters*
- *Conforms to ASTM C 564-91 and ASTM A 167-91*



### No-Hub Pipe Couplings (Continued)

#### Heavyweight No-Hub Coupling

Part #	Mfg #	Size	Price
130620	10NHCPHW	10"	
054923	12NHCPHW	12"	
054924	15NHCPHW	15"	

Part #	Mfg #	Size	Price
012482	112NHCP	1-1/2"	
013850	2NHCP	2"	
013999	2112NHCP	2" - 1-1/2"	
014373	3NHCP	3"	
014524	32NHCP	3" - 2"	
015244	4NHCP	4"	
015389	42NHCP	4" - 2"	
015432	43NHCP	4" - 3"	
015512	5NHCP	5"	
015627	6NHCP	6"	
015789	8NHCP	8"	
012300	10NHCP	10"	
054923	12NHCPHW	12"	

### Heavyweight No-Hub Coupling

- *Multiple bands attached to a heavy duty corrugated stainless steel shield over a molded 1-piece elastomer sealing sleeve*
- *12.5% Thicker stainless steel strap bands*
- *Extra-positive seal*
- *Greater surface load bearing contact of 304 stainless steel shields accommodates additional sealing clamp and provides for greater load bearing contact between coupling and pipe surface*
- *(4) Additional protection sealing rings are incorporated as an integral circumferential continuous sealing register gasket - restraining joint movement*



Part #	Mfg #	Size	Price
130613	112NHCPHW	1-1/2"	
130614	2NHCPHW	2"	
130615	3NHCPHW	3"	
130616	4NHCPHW	4"	
130617	5NHCPHW	5"	
130618	6NHCPHW	6"	
130619	8NHCPHW	8"	

## Soil No-Hub Fittings

### Super Duty No-Hub Pipe Couplings

#### Husky SD 4000 Super Duty No-Hub Couplings

- *Stainless steel coupling*
- *Extra width*
- *Shield color coated orange*

**HUSKY**



Part #	Mfg #	Size	Price
112671	112NHCPHUSKY	1-1/2"	
112672	2NHCPHUSKY	2"	
112673	3NHCPHUSKY	3"	
112682	43NHCPHUSKY	4" x 3"	
112674	4NHCPHUSKY	4"	
112675	5NHCPHUSKY	5"	
112676	6NHCPHUSKY	6"	
112677	8NHCPHUSKY	8"	

#### Husky HD 2000 Heavy Duty No-Hub Couplings

- *Stainless steel coupling*
- *Extra width*
- *304SS Heavy duty*
- *Shield color coated white*
- *Additional sealing clamps for better seal*



Part #	Mfg #	Size	Price
220326	112NHCP2002	1-1/2"	
220321	2NHCP2006	2"	
220322	3NHCP2008	3"	
220323	4NHCP2010	4"	
224254	5NHCP2014	5"	
220324	6NHCP2016	6"	
220325	8NHCP2016	8"	

#### Husky 4200 Series Super Duty Transition Couplings

- *A Super-Duty stainless steel coupling for No-Hub cast iron soil pipe to plastic*
- *Extra width for lateral support*
- *Additional sealing clamps for better load distribution and a more positive seal*
- *304 stainless steel heavy duty construction*
- *Shield color coated orange*
- *Meets ASTM C-1460 standard specification for Heavy Duty shielded couplings*



Part #	Mfg #	Size	Price
249713	2CIPLHUSKY	2"	

### Super Duty No-Hub Pipe Couplings (Continued)

#### Husky 4200 Series Super Duty Transition Couplings

Part #	Mfg #	Size	Price
244095	3CIPLHUSKY	3"	
243580	4CIPLHUSKY	4"	



## Soil No-Hub Fittings

### No-Hub Couplings

#### Classic No-Hub Couplings

- A quality line of standard-duty, import couplings fully manufactured and backed by Ideal Clamp Products
- Manufactured utilizing the same tools and equipment for our full line
- Couplings are subjected to the same quality systems and measurements
- A lower price point without sacrifices in quality, reliability, logistical convenience and peace of mind
- In full compliance to ASTM C564, CISPI 310 and ASTM C1277, and also carries IAPMO, Canadian Std. Association, and NSF Certifications



### No-Hub Couplings (Continued)

#### Heavy-Duty MD No-Hub Couplings

Part #	Mfg #	Size	Price
247063	6223Y8G	8" No-Hub Coupling	
247064	6230Y8G	10" No-Hub Coupling	

Part #	Mfg #	Size	Price
247046	621708G	1-1/2" No-Hub Coupling	
247047	621808G	2" No-Hub Coupling	
247048	621908G	3" No-Hub Coupling	
247049	622008G	4" No-Hub Coupling	
247050	622108G	5" No-Hub Coupling	
247051	622208G	6" No-Hub Coupling	
247052	622308G	8" No-Hub Coupling	
247053	623008G	10" No-Hub Coupling	
247054	62R218G	2 x 1-1/2" No-Hub Coupling	
247055	62R328G	3 x 2" No-Hub Coupling	
247056	62R438G	4 x 3" No-Hub Coupling	

### Heavy-Duty MD No-Hub Couplings

- Same as Heavy-Duty HD, but with a 5/16" inch drive
- Value-engineered alternative to the HD Green Shield
- No-risk, lower cost choice when performance criteria can't be altered
- In full compliance to ASTM C564, ASTM C1540, FM 1680
- (Class 1 and 2), and carries IAPMO, and Canadian Std. Association certification



Part #	Mfg #	Size	Price
247057	6217Y8G	1-1/2" No-Hub Coupling	
247058	6218Y8G	2" No-Hub Coupling	
247059	6219Y8G	3" No-Hub Coupling	
247060	6220Y8G	4" No-Hub Coupling	
247061	6221Y8G	5" No-Hub Coupling	
247062	6222Y8G	6" No-Hub Coupling	



## Refrigeration Press Fittings

### Refrigeration Press Fittings

- Suitable for air-conditioning and refrigeration applications up to 48 bar
- Flame-free installation avoids the need for a fire permit and the risk of fire on site
- Mechanical joint, eliminates the need for nitrogen purge during the jointing process
- UL Certified Recognized Component

#### 45° Obtuse Elbow



Part #	Mfg #	Size	Price
245371	38RP45	3/8" O.D.	
245373	58RP45	5/8" O.D.	
245370	14RP45	1/4" O.D.	
245375	78RP45	7/8" O.D.	
245374	34RP45	3/4" O.D.	
245372	12RP45	1/2" O.D.	
245376	1RP45	1" O.D.	
245377	118RP45	1-1/8" O.D.	

#### 90° Elbow



Part #	Mfg #	Size	Price
245369	118RP90	1-1/8" O.D.	
245364	12RP90	1/2" O.D.	
245361	14RP90	1/4" O.D.	
245368	1RP90	1" O.D.	
245366	34RP90	3/4" O.D.	
245363	38RP90	3/8" O.D.	
245365	58RP90	5/8" O.D.	
245367	78RP90	7/8" O.D.	

#### 90° Street Elbow



Part #	Mfg #	Size	Price
245360	118RPS90	1-1/8" O.D.	
245354	12RPS90	1/2" O.D.	
245359	1RPS90	1" O.D.	
245357	34RPS90	3/4" O.D.	
245353	38RPS90	3/8" O.D.	

### Refrigeration Press Fittings (Continued)

#### 90° Street Elbow

Part #	Mfg #	Size	Price
245356	58RPS90	5/8" O.D.	
245358	78RPS90	7/8" O.D.	

#### Straight Coupler



Part #	Mfg #	Size	Price
245424	118RPCP	1-1/8" O.D.	
245419	12RPCP	1/2" O.D.	
245416	14RPCP	1/4" O.D.	
245423	1RPCP	1" O.D.	
245421	34RPCP	3/4" O.D.	
245417	38RPCP	3/8" O.D.	
245420	58RPCP	5/8" O.D.	
245422	78RPCP	7/8" O.D.	

#### Reducing Coupler



Part #	Mfg #	Size	Price
245390	11834RPRCP	1-1/8" O.D. x 3/4" O.D.	
245389	11858RPRCP	1-1/8" O.D. x 5/8" O.D.	
245391	11878RPRCP	1-1/8" O.D. x 7/8" O.D.	
245378	1238RPRCP	1/2" O.D. x 3/8" O.D.	
245382	3412RPRCP	3/4" O.D. x 1/2" O.D.	
245381	3438RPRCP	3/4" O.D. x 3/8" O.D.	
245383	3458RPRCP	3/4" O.D. x 5/8" O.D.	
245380	5812RPRCP	5/8" O.D. x 1/2" O.D.	
245379	5838RPRCP	5/8" O.D. x 3/8" O.D.	
245385	7812RPRCP	7/8" O.D. x 1/2" O.D.	
245388	7834RPRCP	7/8" O.D. x 3/4" O.D.	
245387	7858RPRCP	7/8" O.D. x 5/8" O.D.	

## Refrigeration Press Fittings

### Equal Tee



Part #	Mfg #	Size	Price
245441	118RPT	1-1/8" O.D.	
245436	12RPT	1/2" O.D.	
245434	14RPT	1/4" O.D.	
245440	1RPT	1" O.D.	
245438	34RPT	3/4" O.D.	
245435	38RPT	3/8" O.D.	
245437	58RPT	5/8" O.D.	
245439	78RPT	7/8" O.D.	

### Fitting Reducer



Part #	Mfg #	Size	Price
245412	11812RPFR	1-1/8" O.D. x 1/2" O.D.	
245414	11834RPFR	1-1/8" O.D. x 3/4" O.D.	
245413	11858RPFR	1-1/8" O.D. x 5/8" O.D.	
245415	11878RPFR	1-1/8" O.D. x 7/8" O.D.	
245404	1238RPFR	1/2" O.D. x 3/8" O.D.	
245407	3412RPFR	3/4" O.D. x 1/2" O.D.	
245408	3458RPFR	3/4" O.D. x 5/8" O.D.	
245403	3814RPFR	3/8" O.D. x 1/4" O.D.	
245406	5812RPFR	5/8" O.D. x 1/2" O.D.	
245405	5838RPFR	5/8" O.D. x 3/8" O.D.	
245409	7812RPFR	7/8" O.D. x 1/2" O.D.	
245411	7834RPFR	7/8" O.D. x 3/4" O.D.	
245410	7858RPFR	7/8" O.D. x 5/8" O.D.	

### Stop End Cap



Part #	Mfg #	Size	Price
245433	118RPCAP	1-1/8" O.D.	
245427	12RPCAP	1/2" O.D.	
245425	14RPCAP	1/4" O.D.	
245432	1RPCAP	1" O.D.	
245429	34RPCAP	3/4" O.D.	

### Refrigeration Press Fittings (Continued)

#### Stop End Cap

Part #	Mfg #	Size	Price
245426	38RPCAP	3/8" O.D.	
245428	58RPCAP	5/8" O.D.	
245430	78RPCAP	7/8" O.D.	

#### Simple Flare Fitting



Part #	Mfg #	Size	Price
256125	14RPSF	1/4" O.D.	
256126	38RPSF	3/8" O.D.	
256127	12RPSF	1/2" O.D.	
256128	58RPSF	5/8" O.D.	
256129	34RPSF	3/4" O.D.	

### Parts & Accessories

#### Refrigeration Press Jaw

Part #	Mfg #	Size	Price
245612	118RPJAW	1-1/8"	
245607	12RPJAW	1/2"	
245605	14RPJAW	1/4"	
245611	1RPJAW	1"	
245609	34RPJAW	3/4"	
245606	38RPJAW	3/8"	
245608	58RPJAW	5/8"	
245610	78RPJAW	7/8"	
245602	RPJAWSET	1/4" - 1-1/8"	

#### Compact Size Press Jaw Set

- #1000002602 Conex and hand tools
- Also fits: Milwaukee M12 Rigid RP241/RP240?RP210-B/RP200-B

Part #	Mfg #	Size	Price
260089	RPJAWSETCOMPAC	1/4", 3/8", 1/2", 5/8", 3/4", 7/8"	

## Soil SV Fittings

### Cast Iron Service-Weight Soil Fittings

#### Cast Iron Single-Hub Service-Weight Soil 1/16 Bend

Part #	Size	Price
013937	2"	
014448	3"	
015335	4"	
015688	6"	
015827	8"	

#### Cast Iron Single-Hub Service-Weight Soil 1/8 Bend

Part #	Size	Price
013940	2"	
014451	3"	
015338	4"	
015527	5"	
015690	6"	
015829	8"	
012318	10"	
013207	12"	
023108	15"	

#### Cast Iron Single-Hub Service-Weight Soil 1/6 Bend

Part #	Size	Price
013939	2"	
014450	3"	
015337	4"	

#### Cast Iron Single-Hub Service-Weight Soil 1/4 Bend

Part #	Size	Price
013938	2"	
014449	3"	
015336	4"	
043549	5"	
015689	6"	
015828	8"	
012317	10"	
059067	12"	

#### Cast Iron Single-Hub Service-Weight Soil Long 1/4 Bend

Part #	Size	Price
120468	4" - 12"	
120476	4" - 18"	

#### Cast Iron Single-Hub Service-Weight Soil Short Sweep Bend

Part #	Size	Price
089347	3"	
089348	4"	
110025	12"	

#### Cast Iron Single-Hub Service-Weight Soil Long Sweep Bend

Part #	Size	Price
013931	2"	
014543	3" x 2"	
014442	3"	
015455	4" x 3"	
015328	4"	
015525	5"	
015684	6"	
015825	8"	
032842	12"	

#### Cast Iron Service-Weight Single-Hub Soil Wye

Part #	Size	Price
013936	2"	
014547	3" x 2"	
014447	3"	
015409	4" x 2"	
015460	4" x 3"	
015334	4"	
015540	5" x 2"	
015526	5"	
015710	6" x 2"	
015721	6" x 3"	
015736	6" x 4"	

### Cast Iron Service-Weight Soil Fittings (Continued)

#### Cast Iron Service-Weight Single-Hub Soil Wye

Part #	Size	Price
015687	6"	
015853	8" x 4"	
015855	8" x 5"	
015864	8" x 6"	
015826	8"	
032688	10" x 4"	
012330	10" x 6"	
031677	10" x 8"	
031678	10"	
013364	12" x 4"	
032845	12" x 6"	
032167	12" x 8"	
013206	12"	
032844	15"	

#### Cast Iron Service-Weight Soil Double Wye

Part #	Size	Price
019500	3" x 2"	
014440	3"	
027136	4" x 2"	
015454	4" x 3"	
015326	4"	

#### Cast Iron Service-Weight Soil Combination Wye & 45° Elbow (Long Turn Pattern)

Part #	Size	Price
013929	2"	
014542	3" x 2"	
014438	3"	
015403	4" x 2"	
015452	4" x 3"	
015323	4"	
015719	6" x 3"	
015732	6" x 4"	
024902	6"	
033320	8"	

**Soil SV Fittings**

**Cast Iron Service-Weight Soil Double Combination Wye & 45° Elbow (Long Turn Pattern)**

Part #	Size	Price
014439	3"	
015404	4" x 2"	
015453	4" x 3"	
015324	4"	

**Cast Iron Service-Weight Soil Sanitary Tee**

Part #	Size	Price
013934	2"	
014546	3" x 2"	
014445	3"	
015408	4" x 2"	
015459	4" x 3"	
015332	4"	
043551	6" x 2"	
015735	6" x 4"	
023086	8"	
018847	10" x 6"	

**Cast Iron Service-Weight Soil Sanitary Cross**

Part #	Size	Price
043553	4" x 3"	

**Cast Iron Service-Weight Closet Bend Plain - Less Collar**

Part #	Size	Price
015466	3" x 4" x 16" x 16"	
015477	4" x 4" x 16"	
015499	4" x 6" x 16"	
015377	4" x 16" x 16"	
015476	4" x 16"	

**Cast Iron Service-Weight Soil P-Trap**

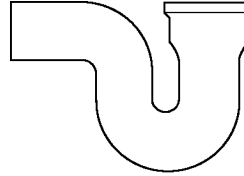

Part #	Size	Price
013932	2"	
014443	3"	
015329	4"	
015685	6"	
032765	8"	

**Cast Iron Service-Weight Washington Test Tee with Southern Raised Head Brass Plug Installed**

Part #	Size	Price
035296	8" - 8"	

**Cast Iron Service-Weight Miami Test Tee with Southern Raised Head Brass Plug Installed**

Part #	Size	Price
013935	2" - 2"	
014446	3" - 3"	
015333	4" - 4"	
015686	6" - 6"	

**Cast Iron Service-Weight Double Two-Way Cleanout**

Part #	Size	Price
025202	4"	

**Cast Iron Service-Weight Cleanout Ferrules with Southern Raised Head Brass Plug Installed**

Part #	Size	Price
013928	2" - 1-1/2"	
014437	3" - 2-1/2"	
015682	6" - 5"	

**Cast Iron Service-Weight Soil Fittings (Continued)**

**Cast Iron Service-Weight Cleanout Ferrules with Southern Raised Head Brass Plug Installed**

Part #	Size	Price
023087	8" - 6"	
015371	4" x 12" - 3-1/2"	

**Cast Iron Service-Weight Bar Grate with Legs**

Part #	Size	Price
013925	2"	

**Cast Iron Service-Weight Reducer**

Part #	Size	Price
014544	3" x 2"	
015405	4" x 2"	
015456	4" x 3"	
021259	5" x 4"	
015720	6" x 3"	
015734	6" x 4"	
015743	6" x 5"	
031676	8" x 4"	
015863	8" x 6"	
018846	10" x 4"	
033319	10" x 6"	
012332	10" x 8"	
089350	12" x 4"	
013393	12" x 8"	
013225	12" x 10"	
032843	15" x 8"	
013627	15" x 12"	

**Cast Iron Service-Weight Double-Hub Fitting**

Part #	Size	Price
015325	4"	

## Soil SV Fittings

### Cast Iron Service-Weight Pipe Plug

Part #	Size	Price
013926	2"	
014435	3"	
015320	4"	
015681	6"	
023088	8"	

### Specialty Cast Iron Soil Fittings

#### Specialty Cast Iron Notched and Slotted Closet Flange

- Fits over 4" pipe for caulk joints

Part #	Size	Price
015365	4" x 1-1/2"	
015386	4" x 2"	
015429	4" x 3"	
015212	4" x 4"	
015497	4" x 6"	
015467	4" x 3" x 3"	

## Soil SV Fittings

### Cast Iron Service-Weight Soil Fittings

#### Cast Iron Service-Weight Short Sweep Bend

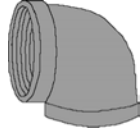

Part #	Mfg #	Size	Price
089346	2SVSS14	2"	

#### Double Wye

Part #	Mfg #	Size	Price
243841	86SVDY	8" x 6"	

### No-Hub Fittings

#### Ironbody Cleanout (Ferrule)

- Tapped



Part #	Mfg #	Size	Price
207937	2NHFERRULEL P	2"	
207939	4NHFERRULEL P	4"	





## Soil SV Fittings

### Mission Tite® Gaskets

#### Mission Tite® Service-Weight Gasket

- For connecting bell and spigot cast iron pipe
- Meets ASTM C 564



Part #	Mfg #	Size	Price
069464	2SVGAG	2"	
069465	3SVGAG	3"	
069466	4SVGAG	4"	
069467	5SVGAG	5"	
069468	6SVGAG	6"	
069469	8SVGAG	8"	
069470	10SVGAG	10"	
069471	12SVGAG	12"	
069472	15SVGAG	15"	

#### Mission Tite® Extra Heavy Weight Gasket

- For connecting bell and spigot cast iron pipe
- Meets ASTM C 564



Part #	Mfg #	Size	Price
124425	2SVGAXH	2"	
124426	3SVGAXH	3"	
124427	4SVGAXH	4"	

**Soil SV Fittings**

**Anaco® Service-Weight  
Gaskets**

**EZ Tight SV Gasket**



Part #	Mfg #	Size	Price
013930	2SVGA	2"	
014441	3SVGA	3"	
015327	4SVGA	4"	
015524	5SVGA	5"	
015683	6SVGA	6"	
015824	8SVGA	8"	
012316	10SVGA	10"	
013205	12SVGA	12"	
013621	15SVGA	15"	

## Soil SV Fittings

### Cleanout Plugs

#### Commercial Brass Flush Plug

- Combine with FIP adapters to make cleanouts or flush plug assemblies
- Square head models are Southern code
- Brass construction for heavy duty applications

Part #	Mfg #	Style	Size	Price
184061	877-935	Slotted	3-1/2"	

#### Residential Cast Iron Closet Flange

- Fits over 4" cast iron DWV pipe
- Perfect for retrofit or remodel applications
- Easy compression installation with neoprene gasket
- Integral neoprene cover/cap removes with utility knife after test



Part #	Mfg #	Connection	Price
184072	890-142	4" Compression	

## Forged Carbon Steel Fittings

### 2000# Carbon Steel Fittings

#### 90° Elbow

- 2000# Forged carbon steel
- Threaded



Part #	Size	Price
046813	1/2"	
047472	3/4"	
163363	1"	
175479	1-1/4"	
175480	1-1/2"	
175481	2"	

#### 45° Elbow

- 2000# Forged carbon steel
- Threaded



Part #	Size	Price
048848	1/2"	
014695	3/4"	
175482	1"	
175483	1-1/4"	
175484	1-1/2"	
175485	2"	

#### Tee

- 2000# Forged carbon steel
- Threaded



Part #	Size	Price
046815	1/2"	
047473	3/4"	
099077	1"	
175486	1-1/4"	
175487	1-1/2"	
175488	2"	

#### Cross

- 2000# Forged carbon steel
- Threaded



Part #	Size	Price
175489	1/2"	
175490	3/4"	
175491	1"	
175492	1-1/4"	
175493	1-1/2"	
175494	2"	

### 3000# Carbon Steel Fittings

#### Cap

- 3000# Forged carbon steel
- Threaded



Part #	Size	Price
176845	1/8"	
172314	1/4"	
172315	3/8"	
053499	1/2"	
156470	3/4"	
156471	1"	
149560	1-1/4"	
132774	1-1/2"	
018788	2"	
172316	2-1/2"	
172317	3"	
172318	4"	

#### Half Coupling

- 3000# Forged carbon steel
- Threaded



Part #	Size	Price
172296	1/8"	
172297	1/4"	
168977	3/8"	
146216	1/2"	

### 3000# Carbon Steel Fittings (Continued)

#### Half Coupling

Part #	Size	Price
146217	3/4"	
158810	1"	
158811	1-1/4"	
158812	1-1/2"	
158813	2"	
169842	2-1/2"	
169843	3"	
169844	4"	

#### Coupling

- 3000# Forged carbon steel
- Threaded



Part #	Size	Price
176843	1/8"	
172294	1/4"	
172295	3/8"	
013127	1/2"	
014696	3/4"	
012230	1"	
012823	1-1/4"	
012453	1-1/2"	
013823	2"	
020655	2-1/2"	
020799	3"	
158328	4"	

#### 90° Street Elbow

- 3000# Forged carbon steel
- Threaded



Part #	Size	Price
176836	1/8"	
168766	1/4"	
172289	3/8"	
172290	1/2"	
158908	3/4"	
158907	1"	

## Forged Carbon Steel Fittings

### 3000# Carbon Steel Fittings (Continued)

#### 90° Street Elbow

Part #	Size	Price
172291	1-1/4"	
172292	1-1/2"	
172293	2"	

#### 90° Elbow

- 3000# Forged carbon steel
- Threaded



Part #	Size	Price
176834	1/8"	
161950	1/4"	
172270	3/8"	
047174	1/2"	
117942	3/4"	
132749	1"	
149557	1-1/4"	
012454	1-1/2"	
018276	2"	
108751	2-1/2"	
172271	3"	
172272	4"	

#### 45° Elbow

- 3000# Forged carbon steel
- Threaded



Part #	Size	Price
176838	1/8"	
172273	1/4"	
172274	3/8"	
163540	1/2"	
158910	3/4"	
157576	1"	
157577	1-1/4"	
161951	1-1/2"	
156375	2"	
172275	3"	

### 3000# Carbon Steel Fittings (Continued)

#### 45° Elbow

Part #	Size	Price
172276	4"	

#### Hex Bushing

- 3000# Forged carbon steel
- Threaded



Part #	Size	Price
172319	1/4" x 1/8"	
176861	3/8" x 1/8"	
172320	3/8" x 1/4"	
163542	1/2" x 1/8"	
161811	1/2" x 1/4"	
176862	1/2" x 3/8"	
176863	3/4" x 1/8"	
107881	3/4" x 1/4"	
163545	3/4" x 3/8"	
155053	3/4" x 1/2"	
163546	1" x 1/8"	
163547	1" x 1/4"	
163548	1" x 3/8"	
155055	1" x 1/2"	
027180	1" x 3/4"	
163549	1-1/4" x 1/4"	
163550	1-1/4" x 3/8"	
176864	1-1/4" x 1/2"	
163552	1-1/4" x 3/4"	
160935	1-1/4" x 1"	
155056	1-1/2" x 1/2"	
155050	1-1/2" x 3/4"	
171782	1-1/2" x 1"	
023948	1-1/2" x 1-1/4"	
163553	2" x 1/4"	
163554	2" x 3/8"	
163555	2" x 1/2"	
155051	2" x 3/4"	
160928	2" x 1"	
156184	2" x 1-1/4"	
155048	2" x 1-1/2"	

### 3000# Carbon Steel Fittings (Continued)

#### Hex Bushing

Part #	Size	Price
172321	2-1/2" x 1"	
172322	2-1/2" x 1-1/2"	
172323	2-1/2" x 2"	
172324	3" x 1"	
172325	3" x 2"	
172326	3" x 2-1/2"	
172327	4" x 1"	
172328	4" x 2"	
172329	4" x 3"	

#### Reducing Coupling

- 3000# Forged carbon steel
- Threaded



Part #	Size	Price
172298	1/4" x 1/8"	
172299	3/8" x 1/8"	
172300	3/8" x 1/4"	
172301	1/2" x 1/8"	
172302	1/2" x 1/4"	
117945	1/2" x 3/8"	
172303	3/4" x 1/8"	
172304	3/4" x 1/4"	
172305	3/4" x 3/8"	
047474	3/4" x 1/2"	
172306	1" x 1/8"	
172307	1" x 1/4"	
172308	1" x 3/8"	
163407	1" x 1/2"	
149567	1" x 3/4"	
172309	1-1/4" x 1/4"	
172310	1-1/4" x 3/8"	
172311	1-1/4" x 1/2"	
149568	1-1/4" x 3/4"	
149570	1-1/4" x 1"	
172312	1-1/2" x 3/8"	
170934	1-1/2" x 1/2"	
156472	1-1/2" x 3/4"	
012569	1-1/2" x 1"	

## Forged Carbon Steel Fittings

### 3000# Carbon Steel Fittings (Continued)

#### Reducing Coupling

Part #	Size	Price
149572	1-1/2" x 1-1/4"	
016377	2" x 1/2"	
156473	2" x 3/4"	
156474	2" x 1"	
172313	2" x 1-1/4"	
149573	2" x 1-1/2"	
107982	2-1/2" x 2"	

#### Reducing Tee

- 3000# Forged carbon steel
- Threaded



Part #	Size	Price
055582	3/4" x 3/4" x 1/2"	
160656	1" x 1" x 1/2"	
160657	1" x 1" x 3/4"	
157777	1-1/4" x 1-1/4" x 1"	
159536	1-1/2" x 1-1/2" x 3/4"	
159405	2" x 2" x 3/4"	
157800	2" x 2" x 1"	
160727	2" x 2" x 1-1/4"	
168607	2" x 2" x 1-1/2"	

#### Square Head Plug

- 3000# Forged carbon steel
- Threaded



Part #	Size	Price
172330	1/8"	
168377	3/8"	
168378	1/2"	
168379	3/4"	
168380	1"	
168381	1-1/4"	
168382	1-1/2"	
159406	2"	

### 3000# Carbon Steel Fittings (Continued)

#### Square Head Plug

Part #	Size	Price
168383	2-1/2"	
168384	3"	
172331	4"	

#### Tee

- 3000# Forged carbon steel
- Threaded



Part #	Size	Price
176839	1/8"	
172277	1/4"	
172278	3/8"	
013128	1/2"	
150078	3/4"	
150079	1"	
150080	1-1/4"	
132735	1-1/2"	
132734	2"	
107981	2-1/2"	
172279	3"	
172280	4"	

#### Union

- 3000# Forged carbon steel
- Threaded



Part #	Size	Price
176842	1/8"	
172332	1/4"	
172333	3/8"	
013129	1/2"	
044156	3/4"	
044157	1"	
012824	1-1/4"	
132736	1-1/2"	
013825	2"	
172334	2-1/2"	
172335	3"	

### Cross

- 3000# Forged carbon steel
- Threaded



Part #	Size	Price
176840	1/4"	
176841	3/8"	
058311	1/2"	
172281	3/4"	
172282	1"	
172283	1-1/4"	
172284	1-1/2"	
172285	2"	
172286	2-1/2"	
172287	3"	
172288	4"	

### Outlet

- 3000# Forged carbon steel
- Threaded



Part #	Size	Price
176876	1-1/4" x 2"-3-1/2"	
176877	1-1/2" x 3"-5"	
176878	2"x4"-6"	

### 3000# Carbon Steel Fittings

#### Socket Weld

#### Cap

- 3000# Forged carbon steel
- Socket Weld



Part #	Size	Price
172422	1/4"	
172423	3/8"	
168498	1/2"	
168501	3/4"	
120202	1"	
172424	1-1/4"	
151861	1-1/2"	
072547	2"	



## Forged Carbon Steel Fittings

### 3000# Carbon Steel Fittings (Continued)

#### Cap

Part #	Size	Price
172425	2-1/2"	
172426	3"	
172427	4"	

#### Coupling

- 3000# Forged carbon steel
- Socket Weld



Part #	Size	Price
172385	1/4"	
149211	3/8"	
161471	1/2"	
074559	3/4"	
012231	1"	
149214	1-1/4"	
106712	1-1/2"	
013824	2"	
112542	2-1/2"	
172386	3"	
172387	4"	

#### Half Coupling

- 3000# Forged carbon steel
- Socket Weld



Part #	Size	Price
172388	1/4"	
172389	3/8"	
172390	1/2"	
172391	3/4"	
153224	1"	
172392	1-1/4"	
172393	1-1/2"	
172394	2"	
172395	2-1/2"	
172396	3"	
172397	4"	

#### Reducing Coupling

- 3000# Forged carbon steel
- Socket Weld



Part #	Size	Price
172398	1/4" x 1/8"	
172399	3/8" x 1/8"	
172400	3/8" x 1/4"	
172401	1/2" x 1/8"	
172402	1/2" x 1/4"	
172403	1/2" x 3/8"	
172404	3/4" x 1/8"	
172405	3/4" x 1/4"	
172406	3/4" x 3/8"	
112537	3/4" x 1/2"	
172407	1" x 1/8"	
172408	1" x 1/4"	
172409	1" x 3/8"	
164417	1" x 1/2"	
112538	1" x 3/4"	
172410	1-1/4" x 1/4"	
172411	1-1/4" x 3/8"	
172412	1-1/4" x 1/2"	
172413	1-1/4" x 3/4"	
172414	1-1/4" x 1"	
172415	1-1/2" x 3/8"	
172416	1-1/2" x 1/2"	
172417	1-1/2" x 3/4"	
172418	1-1/2" x 1"	
172462	1-1/2" x 1-1/4"	
172419	2" x 1/2"	
172420	2" x 3/4"	
167815	2" x 1"	
172421	2" x 1-1/4"	
112540	2" x 1-1/2"	

#### 90° Elbow

- 3000# Forged carbon steel
- Socket Weld



Part #	Size	Price
172365	1/4"	
172366	3/8"	
161463	1/2"	
112536	3/4"	
057184	1"	
022226	1-1/4"	
079881	1-1/2"	
019750	2"	
022225	2-1/2"	
167683	3"	
172367	4"	

#### 45° Elbow

- 3000# Forged carbon steel
- Socket weld



Part #	Size	Price
172368	1/4"	
172369	3/8"	
161468	1/2"	
161469	3/4"	
120203	1"	
161470	1-1/4"	
106711	1-1/2"	
156560	2"	
172370	2-1/2"	
168545	3"	
172371	4"	

#### Insert

- 3000# Forged carbon steel
- Socket weld



Part #	Size	Price
172428	1/2" x 1/8"	

## Forged Carbon Steel Fittings

### 3000# Carbon Steel Fittings (Continued)

#### Insert

Part #	Size	Price
172429	1/2" x 1/4"	
166722	1/2" x 3/8"	
172430	3/4" x 1/8"	
172431	3/4" x 1/4"	
172432	3/4" x 3/8"	
168833	3/4" x 1/2"	
172434	1" x 1/8"	
172435	1" x 1/4"	
172436	1" x 3/8"	
168832	1" x 1/2"	
160766	1" x 3/4"	
172437	1-1/4" x 1/4"	
172438	1-1/4" x 3/8"	
168831	1-1/4" x 1/2"	
160767	1-1/4" x 3/4"	
160769	1-1/4" x 1"	
172439	1-1/2" x 3/8"	
168830	1-1/2" x 1/2"	
160771	1-1/2" x 3/4"	
160772	1-1/2" x 1"	
160773	1-1/2" x 1-1/4"	
168828	2" x 1/2"	
163511	2" x 3/4"	
168836	2" x 1"	
162942	2" x 1-1/4"	
162941	2" x 1-1/2"	
172440	2-1/2" x 3/4"	
172441	2-1/2" x 1"	
172442	2-1/2" x 1-1/4"	
114238	2-1/2" x 1-1/2"	
112541	2-1/2" x 2"	
172443	3" x 1"	
172444	3" x 1-1/4"	
167681	3" x 1-1/2"	
167680	3" x 2"	
172445	3" x 2-1/2"	

#### Tee

- 3000# Forged carbon steel
- Socket Weld



Part #	Size	Price
172372	1/4"	
172373	3/8"	
161465	1/2"	
074556	3/4"	
057185	1"	
072544	1-1/4"	
074563	1-1/2"	
019751	2"	
114237	2-1/2"	
168547	3"	
172374	4"	

#### Union

- 3000# Forged carbon steel
- Socket Weld



Part #	Size	Price
172446	1/4"	
172447	3/8"	
014697	3/4"	
012232	1"	
133075	1-1/4"	
161467	1-1/2"	
056880	2"	
172448	2-1/2"	
168548	3"	

#### Cross

- 3000# Forged carbon steel
- Socket Weld



Part #	Size	Price
172375	1/4"	
172376	3/8"	
172377	1/2"	
172378	3/4"	

### 3000# Carbon Steel Fittings (Continued)

#### Cross

Part #	Size	Price
172379	1"	
172380	1-1/4"	
172381	1-1/2"	
172382	2"	
172383	2-1/2"	
172384	3"	

#### Outlet

- 3000# Forged carbon steel
- Socket weld



Part #	Size	Price
176879	1/2" x 3/4" - 36"	
176880	3/4" x 1-1/2" - 36"	
176881	1" x 3" - 36"	
176882	1-1/4" x 4" - 36"	
176883	1-1/2" x 6" - 36"	
176884	2" x 4" - 6"	
176885	2" x 8" - 36"	

## 304/316 Stainless Steel 150# Nipples

### 304 Stainless Steel Nipples

#### Schedule 40 Welded Nipple

- 304/304L SS



#### 1/8" Diameter

Part #	Size	Price
175637	1/8" x CL	
175638	1/8" x 1-1/2"	
175639	1/8" x 2"	
175640	1/8" x 2-1/2"	
175641	1/8" x 3"	
175642	1/8" x 3-1/2"	
175643	1/8" x 4"	
175644	1/8" x 4-1/2"	
175645	1/8" x 5"	
175646	1/8" x 5-1/2"	
175647	1/8" x 6"	

#### 1/4" Diameter

Part #	Size	Price
164567	1/4" x CL	
164568	1/4" x 1-1/2"	
065108	1/4" x 2"	
164570	1/4" x 2-1/2"	
164571	1/4" x 3"	
164573	1/4" x 3-1/2"	
164574	1/4" x 4"	
164575	1/4" x 4-1/2"	
164576	1/4" x 5"	
164577	1/4" x 5-1/2"	
065112	1/4" x 6"	

#### 3/8" Diameter

Part #	Size	Price
069938	3/8" x CL	
164580	3/8" X 1-1/2"	
069939	3/8" x 2"	
164581	3/8" X 2-1/2"	
069940	3/8" x 3"	
164582	3/8" X 3-1/2"	
069941	3/8" x 4"	
164583	3/8" X 4-1/2"	
069942	3/8" x 5"	

### 304 Stainless Steel Nipples (Continued)

#### Schedule 40 Welded Nipple

#### 3/8" Diameter

Part #	Size	Price
164584	3/8" X 5-1/2"	
069943	3/8" x 6"	

#### 1/2" Diameter

Part #	Size	Price
065114	1/2" x CL	
144747	1/2" x 1-1/2"	
065115	1/2" x 2"	
144748	1/2" x 2-1/2"	
065116	1/2" x 3"	
144749	1/2" x 3-1/2"	
065117	1/2" x 4"	
164585	1/2" x 4-1/2"	
065118	1/2" x 5"	
164586	1/2" x 5-1/2"	
131533	1/2" x 6"	
204448	1/2" x 12"	

#### 3/4" Diameter

Part #	Size	Price
065126	3/4" x CL	
164587	3/4" x 1-1/2"	
065127	3/4" x 2"	
163616	3/4" x 2-1/2"	
065128	3/4" x 3"	
164588	3/4" x 3-1/2"	
065129	3/4" x 4"	
164589	3/4" x 4-1/2"	
164590	3/4" x 5"	
164591	3/4" x 5-1/2"	
065131	3/4" x 6"	

#### 1" Diameter

Part #	Size	Price
065133	1" x CL	
065134	1" x 2"	
175648	1" x 2-1/2"	
065135	1" x 3"	

### 304 Stainless Steel Nipples (Continued)

#### Schedule 40 Welded Nipple

#### 1" Diameter

Part #	Size	Price
175649	1" x 3-1/2"	
065136	1" x 4"	
175650	1" x 4-1/2"	
065137	1" x 5"	
175651	1" x 5-1/2"	
065138	1" x 6"	

#### 1-1/4" Diameter

Part #	Size	Price
065140	1-1/4" x CL	
065141	1-1/4" x 2"	
175652	1-1/4" x 2-1/2"	
065142	1-1/4" x 3"	
175653	1-1/4" x 3-1/2"	
065143	1-1/4" x 4"	
175654	1-1/4" x 4-1/2"	
065145	1-1/4" x 5"	
175655	1-1/4" x 5-1/2"	
065146	1-1/4" x 6"	

#### 1-1/2" Diameter

Part #	Size	Price
065148	1-1/2" x CL	
065149	1-1/2" x 2"	
175656	1-1/2" x 2-1/2"	
065150	1-1/2" x 3"	
175658	1-1/2" x 3-1/2"	
065151	1-1/2" x 4"	
175659	1-1/2" x 4-1/2"	
065152	1-1/2" x 5"	
175660	1-1/2" x 5-1/2"	
065153	1-1/2" x 6"	

#### 2" Diameter

Part #	Size	Price
065155	2" x CL	
065157	2" x 2-1/2"	
065158	2" x 3"	

## 304/316 Stainless Steel 150# Nipples

### 304 Stainless Steel Nipples (Continued)

Schedule 40 Welded Nipple  
2" Diameter

Part #	Size	Price
175662	2" x 3-1/2"	
065159	2" x 4"	
175663	2" x 4-1/2"	
065160	2" x 5"	
175664	2" x 5-1/2"	
065194	2" x 6"	
182552	2" x 8"	

### 316 Stainless Steel Nipples

Schedule 40 Welded Nipple

- 316\316L SS



1/8" Diameter

Part #	Size	Price
167592	1/8" x CL	
167593	1/8" x 1-1/2"	
167594	1/8" x 2"	
167595	1/8" x 2-1/2"	
167596	1/8" x 3"	
167597	1/8" x 3-1/2"	
167598	1/8" x 4"	
167599	1/8" x 4-1/2"	
167600	1/8" x 5"	
167601	1/8" x 5-1/2"	
167602	1/8" x 6"	

1/4" Diameter

Part #	Size	Price
164593	1/4" x CL	
164594	1/4" x 1-1/2"	
164595	1/4" x 2"	
164596	1/4" x 2-1/2"	
164597	1/4" x 3"	
164598	1/4" x 3-1/2"	
164599	1/4" x 4"	
164600	1/4" x 4-1/2"	
164601	1/4" x 5"	

### 316 Stainless Steel Nipples (Continued)

Schedule 40 Welded Nipple  
1/4" Diameter

Part #	Size	Price
164602	1/4" x 5-1/2"	
164603	1/4" x 6"	

3/8" Diameter

Part #	Size	Price
164604	3/8" x CL	
164605	3/8" x 1-1/2"	
164606	3/8" x 2"	
164607	3/8" x 2-1/2"	
164608	3/8" x 3"	
164609	3/8" x 3-1/2"	
164611	3/8" x 4"	
164612	3/8" x 4-1/2"	
164613	3/8" x 5"	
164615	3/8" x 5-1/2"	
164616	3/8" x 6"	

1/2" Diameter

Part #	Size	Price
164618	1/2" x CL	
164619	1/2" x 1-1/2"	
164620	1/2" x 2"	
164621	1/2" x 2-1/2"	
164622	1/2" x 3"	
164623	1/2" x 3-1/2"	
164624	1/2" x 4"	
164625	1/2" x 4-1/2"	
164626	1/2" x 5"	
164627	1/2" x 5-1/2"	
163478	1/2" x 6"	

3/4" Diameter

Part #	Size	Price
164629	3/4" x CL	
164630	3/4" x 1-1/2"	
164631	3/4" x 2"	
164632	3/4" x 2-1/2"	
163936	3/4" x 3"	

### 316 Stainless Steel Nipples (Continued)

Schedule 40 Welded Nipple  
3/4" Diameter

Part #	Size	Price
164633	3/4" x 3-1/2"	
164634	3/4" x 4"	
164635	3/4" x 4-1/2"	
164636	3/4" x 5"	
164637	3/4" x 5-1/2"	
164638	3/4" x 6"	

1" Diameter

Part #	Size	Price
164644	1" x CL	
164645	1" x 2"	
164647	1" x 2-1/2"	
164648	1" x 3"	
164649	1" x 3-1/2"	
164650	1" x 4"	
164651	1" x 4-1/2"	
164652	1" x 5"	
164653	1" x 5-1/2"	
164654	1" x 6"	

1-1/4" Diameter

Part #	Size	Price
164655	1-1/4" x CL	
164656	1-1/4" x 2"	
164657	1-1/4" x 2-1/2"	
164658	1-1/4" x 3"	
164659	1-1/4" x 3-1/2"	
164660	1-1/4" x 4"	
164661	1-1/4" x 4-1/2"	
164662	1-1/4" x 5"	
164663	1-1/4" x 5-1/2"	
164664	1-1/4" x 6"	

1-1/2" Diameter

Part #	Size	Price
163935	1-1/2" x CL	
163934	1-1/2" x 2"	
163933	1-1/2" x 2-1/2"	

## 304/316 Stainless Steel 150# Nipples

### 316 Stainless Steel Nipples (Continued)

#### Schedule 40 Welded Nipple

#### 1-1/2" Diameter

Part #	Size	Price
163932	1-1/2" x 3"	
163931	1-1/2" x 3-1/2"	
163929	1-1/2" x 4"	
163928	1-1/2" x 4-1/2"	
163926	1-1/2" x 5"	
163925	1-1/2" x 5-1/2"	
163924	1-1/2" x 6"	

#### 2" Diameter

Part #	Size	Price
164665	2" x CL	
164666	2" x 2-1/2"	
164667	2" x 3"	
164668	2" x 3-1/2"	
164669	2" x 4"	
164670	2" x 4-1/2"	
164671	2" x 5"	
164672	2" x 5-1/2"	
163037	2" x 6"	

### Hex Nipple



Part #	Size	Price
165479	1/4"	
165480	3/8"	
165481	1/2"	
165482	3/4"	
165483	1"	

### King Nipples



Part #	Size	Price
167546	1/2"	
167548	1"	

### 316 Stainless Steel Nipples (Continued)

#### King Nipples

Part #	Size	Price
167551	2"	



## SS 304/316 150# Nipples

### 304 Stainless Steel Nipples

#### Schedule 40 Welded Nipples

Part #	Mfg #	Size	Price
076133	11210SS304N	1-1/2" x 10"	
167974	3414SS304N	3/4" x 14"	
167975	349SS304N	3/4" x 9"	

#### Schedule 40 Toe Nipples

Part #	Mfg #	Size	Price
180725	1123SS304TOEN	1-1/2" x 3"	
180718	342SS304TOEN	3/4" x 2"	
180719	1142SS304TOEN	1-1/4" x 2"	



## Socket Weld 304SS/316SS/L 3000# FTGS

### 3000# 304 Stainless Steel

#### Full Coupling

- 3000# Forged socket weld
- 304 Stainless steel



Part #	Size	Price
181779	1/2"	
181780	3/4"	
181781	1"	
181782	1-1/4"	
181783	1-1/2"	
181784	2"	

#### 90° Elbow

- 3000# Forged socket weld
- 304 Stainless steel



Part #	Size	Price
181761	1/2"	
181762	3/4"	
181763	1"	
181764	1-1/4"	
181765	1-1/2"	
181766	2"	

#### 45° Elbow

- 3000# Forged socket weld
- 304 Stainless steel



Part #	Size	Price
181767	1/2"	
181768	3/4"	
181769	1"	
181770	1-1/4"	
181771	1-1/2"	
181772	2"	

#### Cap

- 3000# Forged socket weld
- 304 Stainless steel



Part #	Size	Price
181785	1/2"	
181786	3/4"	
181787	1"	
181788	1-1/4"	
181789	1-1/2"	
181790	2"	

#### Tee

- 3000# Forged socket weld
- 304 Stainless steel



Part #	Size	Price
181773	1/2"	
181774	3/4"	
181775	1"	
181776	1-1/4"	
181777	1-1/2"	
181778	2"	

#### Union

- 3000# Forged socket weld
- 304 Stainless steel



Part #	Size	Price
181791	1/2"	
181792	3/4"	
181793	1"	
181794	1-1/4"	
181795	1-1/2"	
181796	2"	

### 3000# 316/L Stainless Steel

#### Insert

- 3000# Forged socket weld
- 316/L Stainless steel



Part #	Size	Price
162990	3/4" x 1/2"	

### 3000# 316/L Stainless Steel (Continued)

#### Insert

Part #	Size	Price
162991	1" x 1/2"	
162992	1" x 3/4"	
162993	1-1/2" x 1/2"	
162994	1-1/2" x 3/4"	
162995	1-1/2" x 1"	
162996	2" x 1/2"	
162997	2" x 3/4"	
162998	2" x 1"	
162999	2" x 1-1/2"	

#### Full Coupling

- 3000# Forged socket weld
- 316/L Stainless steel



Part #	Size	Price
162961	1/2"	
162962	3/4"	
162963	1"	
162964	1-1/4"	
162965	1-1/2"	
162966	2"	

#### Half Coupling

- 3000# Forged socket weld
- 316/L Stainless steel



Part #	Size	Price
162980	1/2"	
162981	3/4"	
162982	1"	
162983	1-1/4"	
162984	1-1/2"	
162985	2"	

## Socket Weld 304SS/316SS/L 3000# FTGS

### Reducing Coupling

- 3000# Forged socket weld
- 316/L Stainless steel



Part #	Size	Price
163000	3/4" x 1/2"	
163001	1" x 1/2"	
163002	1" x 3/4"	
163003	1-1/2" x 1/2"	
163004	1-1/2" x 3/4"	
163005	2" x 1-1/4"	
163006	2" x 1-1/2"	

### 90° Elbow

- 3000# Forged socket weld
- 316/L Stainless steel



Part #	Size	Price
162967	1/2"	
162968	3/4"	
162970	1"	
162971	1-1/4"	
162972	1-1/2"	
162973	2"	

### 45° Elbow

- 3000# Forged socket weld
- 316/L Stainless steel



Part #	Size	Price
162974	1/2"	
162975	3/4"	
162976	1"	
162977	1-1/4"	
162978	1-1/2"	
162979	2"	

### Cap

- 3000# Forged socket weld
- 316/L Stainless steel



Part #	Size	Price
162953	1/2"	

### 3000# 316/L Stainless Steel (Continued)

#### Cap

Part #	Size	Price
162954	3/4"	
162956	1"	
162957	1-1/4"	
162959	1-1/2"	
162960	2"	

#### Tee

- 3000# Forged socket weld
- 316/L Stainless steel



Part #	Size	Price
163007	1/2"	
163008	3/4"	
163009	1"	
163010	1-1/4"	
163011	1-1/2"	
163012	2"	

#### Union

- 3000# Forged socket weld
- 316/L Stainless steel



Part #	Size	Price
163015	1/2"	
163016	3/4"	
163017	1"	
163018	1-1/4"	
163019	1-1/2"	
163020	2"	

## 316SS Compression Fittings

### 316SS Compression Fittings

#### Female Adapter

- Tube OD x NPT



Part #	Size	Price
176063	1/4" x 1/4"	
176064	1/4" x 3/8"	
176066	1/4" x 1/2"	
176067	3/8" x 1/4"	
176068	3/8" x 3/8"	
176069	3/8" x 1/2"	
176070	1/2" x 1/4"	
176071	1/2" x 3/8"	
176072	1/2" x 1/2"	

#### Male Adapter

- Tube OD x NPT



Part #	Size	Price
176073	1/4" x 1/4"	
176074	1/4" x 3/8"	
176075	1/4" x 1/2"	
176076	3/8" x 1/4"	
176077	3/8" x 3/8"	
176078	3/8" x 1/2"	
176079	1/2" x 1/4"	
176080	1/2" x 3/8"	
176081	1/2" x 1/2"	

#### Male 90° Elbow

- Tube OD x NPT



Part #	Size	Price
176082	1/4" x 1/4"	
176083	1/4" x 3/8"	
176084	1/4" x 1/2"	
176085	3/8" x 1/4"	
176086	3/8" x 3/8"	
176087	3/8" x 1/2"	

### 316SS Compression Fittings (Continued)

#### Male 90° Elbow

Part #	Size	Price
176088	1/2" x 1/4"	
176089	1/2" x 3/8"	
176090	1/2" x 1/2"	

#### Straight Union



Part #	Size	Price
176091	1/4"	
176092	3/8"	
176093	1/2"	

#### Union 90° Elbow



Part #	Size	Price
176094	1/4"	
176095	3/8"	
176096	1/2"	

#### Union Tee



Part #	Size	Price
176097	1/4"	
176098	3/8"	
176099	1/2"	

## 304SS/316SS 150# Fittings

### 304 Stainless Steel Fittings

#### Hex Bushing

- 150# Cast
- 304 Stainless Steel



Part #	Size	Price
175802	1/4" x 1/8"	
167977	3/8" x 1/8"	
175803	3/8" x 1/4"	
159639	3/4" x 1/4"	
167976	3/4" x 3/8"	
063710	3/4" x 1/2"	
175804	1/2" x 1/8"	
065093	1/2" x 1/4"	
069936	1/2" x 3/8"	
131104	1" x 1/2"	
175805	1" x 3/4"	
175806	1-1/4" x 3/4"	
175807	1-1/4" x 1/2"	
065094	1-1/4" x 1"	
175810	1-1/2" x 1/2"	
175809	1-1/2" x 3/4"	
175808	1-1/2" x 1"	
065097	1-1/2" x 1-1/4"	
175814	2" x 1/2"	
175813	2" x 3/4"	
175812	2" x 1"	
175811	2" x 1-1/4"	
065098	2" x 1-1/2"	

#### Cap

- 150# Cast
- 304 Stainless Steel



Part #	Size	Price
175818	1/8"	
065054	1/4"	
069934	3/8"	
065055	1/2"	
065056	3/4"	
065057	1"	
065058	1-1/4"	

### 304 Stainless Steel Fittings (Continued)

#### Cap

Part #	Size	Price
065059	1-1/2"	
065060	2"	

#### Coupling

- 150# Cast
- 304 Stainless Steel



Part #	Size	Price
175753	1/8"	
065009	1/4"	
069928	3/8"	
065010	1/2"	
065012	3/4"	
065013	1"	
065014	1-1/4"	
065015	1-1/2"	
065016	2"	

#### Half Coupling

- 150# Cast
- 304 Stainless Steel



Part #	Size	Price
175755	1/8"	
175756	1/4"	
175757	3/8"	
175758	1/2"	
175759	3/4"	
175760	1"	
175761	1-1/4"	
175762	1-1/2"	
175763	2"	

### Reducing Coupling

- 150# Cast
- 304 Stainless Steel



Part #	Size	Price
175770	1/4" x 1/8"	
175771	3/8" x 1/8"	
175772	3/8" x 1/4"	
175773	1/2" x 1/8"	
065087	1/2" x 1/4"	
069935	1/2" x 3/8"	
175774	3/4" x 1/8"	
175775	3/4" x 1/4"	
131106	3/4" x 3/8"	
065088	3/4" x 1/2"	
175779	1" x 1/4"	
175776	1" x 1/2"	
175778	1" x 3/8"	
065089	1" x 3/4"	
175781	1-1/4" x 1/2"	
175780	1-1/4" x 3/4"	
158281	1-1/4" x 1"	
175785	1-1/2" x 1/2"	
175784	1-1/2" x 3/4"	
175783	1-1/2" x 1"	
175782	1-1/2" x 1-1/4"	
175789	2" x 1/2"	
175788	2" x 3/4"	
175787	2" x 1"	
175786	2" x 1-1/4"	
065092	2" x 1-1/2"	

### 90° Elbow

- 150# Cast
- 304 Stainless Steel



Part #	Size	Price
175670	1/8"	
065032	1/4"	
167978	3/8"	
175671	1/2"	
065034	3/4"	

## 304SS/316SS 150# Fittings

### 304 Stainless Steel Fittings (Continued)

#### 90° Elbow

Part #	Size	Price
065035	1"	
065036	1-1/4"	
065037	1-1/2"	
076086	2"	

#### 45° Elbow

- 150# Cast
- 304 Stainless Steel



Part #	Size	Price
175714	1/8"	
065048	1/4"	
069933	3/8"	
131535	1/2"	
065050	3/4"	
065051	1"	
065052	1-1/4"	
065053	1-1/2"	
175715	2"	

#### 90° Street Elbow

- 150# Cast
- 304 Stainless Steel



Part #	Size	Price
175672	1/8"	
175685	1/4"	
175686	3/8"	
065042	1/2"	
065043	3/4"	
175687	1"	
175688	1-1/4"	
065046	1-1/2"	
065047	2"	

### Square Head Plug

- 150# Cast
- 304 Stainless Steel



Part #	Size	Price
175815	1/8"	
175816	1/4"	
150708	3/8"	
066403	1/2"	
066404	3/4"	
066405	1"	
175817	1-1/4"	
066407	1-1/2"	
066408	2"	

### Tee

- 150# Cast
- 304 Stainless steel



Part #	Size	Price
175722	1/8"	
065025	1/4"	
069930	3/8"	
065026	1/2"	
065027	3/4"	
065029	1"	
175723	1-1/4"	
175724	1-1/2"	
175725	2"	

### Union

- 150# Cast
- 304 Stainless Steel



Part #	Size	Price
175735	1/8"	
065018	1/4"	
069929	3/8"	
065019	1/2"	
065020	3/4"	
065021	1"	
175736	1-1/4"	
065023	1-1/2"	

### 304 Stainless Steel Fittings (Continued)

#### Union

Part #	Size	Price
065024	2"	

#### Cross

- 150# Cast
- 304 Stainless Steel



Part #	Size	Price
175727	1/4"	
175728	3/8"	
175729	1/2"	
175730	3/4"	
175731	1"	
175732	1-1/4"	
175733	1-1/2"	
175734	2"	

### 316 Stainless Steel Fittings

#### Hex Bushing

- 150# Cast
- 316 Stainless Steel



Part #	Size	Price
162859	3/8" x 1/4"	
162860	1/2" x 1/4"	
162861	1/2" x 3/8"	
162862	3/4" x 1/4"	
162863	3/4" x 3/8"	
162864	3/4" x 1/2"	
162865	1" x 1/4"	
162866	1" x 3/8"	
162867	1" x 1/2"	
162868	1" x 3/4"	
162869	1-1/4" x 1/4"	
162870	1-1/4" x 3/8"	
162871	1-1/4" x 1/2"	
162872	1-1/4" x 3/4"	
162873	1-1/4" x 1"	
162874	1-1/2" x 1/4"	

## 304SS/316SS 150# Fittings

### 316 Stainless Steel Fittings (Continued)

#### Hex Bushing

Part #	Size	Price
162875	1-1/2" x 3/8"	
162876	1-1/2" x 1/2"	
162877	1-1/2" x 3/4"	
162878	1-1/2" x 1"	
162879	1-1/2" x 1-1/4"	
162880	2" x 1/4"	
162881	2" x 3/8"	
162882	2" x 1/2"	
162883	2" x 3/4"	
162884	2" x 1"	
162885	2" x 1-1/4"	
162886	2" x 1-1/2"	

#### Coupling

- 150# Cast
- 316 Stainless Steel



Part #	Size	Price
167585	1/8"	
097937	1/4"	
162790	3/8"	
097938	1/2"	
162791	3/4"	
162792	1"	
162793	1-1/4"	
162794	1-1/2"	
162795	2"	

#### Half Coupling

- 150# Cast
- 316 Stainless Steel



Part #	Size	Price
167590	1/8"	
162888	1/4"	
162889	3/8"	
162890	1/2"	
162891	3/4"	

### 316 Stainless Steel Fittings (Continued)

#### Half Coupling

Part #	Size	Price
076079	1"	
162892	1-1/4"	
162893	1-1/2"	
162894	2"	

#### Reducing Coupling

- 150# Cast
- 316 Stainless Steel



Part #	Size	Price
164695	3/4" x 1/2"	
164696	1" x 3/4"	
164697	1-1/4" x 1"	
167609	1" x 1/2"	
173405	2" x 1-1/2"	
173406	1-1/2" x 1"	
173408	1-1/2" x 1-1/4"	
173409	2" x 1-1/4"	
173410	2" x 1"	

#### Cap

- 150# Cast
- 316 Stainless Steel



Part #	Size	Price
162805	1/4"	
162806	3/8"	
162807	1/2"	
162808	3/4"	
162809	1"	
162810	1-1/4"	
162811	1-1/2"	
162812	2"	

### 90° Elbow

- 150# Cast
- 316 Stainless Steel



Part #	Size	Price
167584	1/8"	
097929	1/4"	
162797	3/8"	
027174	1/2"	
162798	3/4"	
162799	1"	
162800	1-1/4"	
162801	1-1/2"	
162802	2"	

### 45° Elbow

- 150# Cast
- 316 Stainless Steel



Part #	Size	Price
097930	1/4"	
162853	3/8"	
097932	1/2"	
162854	3/4"	
162855	1"	
162856	1-1/4"	
162857	1-1/2"	
162858	2"	

### 90° Street Elbow

- 150# Cast
- 316 Stainless Steel



Part #	Size	Price
167586	1/8"	
167591	1/4"	
069932	3/8"	
164698	1/2"	
164699	3/4"	
166559	1"	
167876	1-1/2"	
167877	2"	



## 304SS/316SS 150# Fittings

### Square Head Plug

- 150# Cast
- 316 Stainless Steel



Part #	Size	Price
167588	1/8"	
162895	1/4"	
162896	3/8"	
162897	1/2"	
162898	3/4"	
162899	1"	
162900	1-1/4"	
162901	1-1/2"	
162902	2"	

### 316 Stainless Steel Fittings (Continued)

#### Union

Part #	Size	Price
162919	2"	

### Tee

- 150# Cast
- 316 Stainless Steel



Part #	Size	Price
167587	1/8"	
162903	1/4"	
162904	3/8"	
162905	1/2"	
162906	3/4"	
162907	1"	
162908	1-1/4"	
162909	1-1/2"	
162910	2"	

### Union

- 150# Cast
- 316 Stainless Steel



Part #	Size	Price
162912	1/4"	
162913	3/8"	
162914	1/2"	
162915	3/4"	
162916	1"	
162917	1-1/4"	
162918	1-1/2"	



## SS 304/316 150# FTGS

### 304SS 150# FTGS

#### RF Blind Flange

Part #	Mfg #	Size	Price
176705	1SS304BFRF	1"	
176707	112SS04BFRF	1-1/2"	
176708	2SS304BFRF	2"	
176709	4SS304BFRF	4"	
176710	6SS304BFRF	6"	
225494	8SS04BFRF	8"	

#### RF Slip-On Flange

Part #	Mfg #	Size	Price
176695	1SS304SOFRF	1"	
176696	114SS304SOFRF	1-1/4"	
161944	112SS304SOFRF	1-1/2"	
170898	3SS304SOFRF	3"	
176697	4SS304SOFRF	4"	
176698	6SS304SOFRF	6"	
177350	8SS304SOFRF	8"	

#### RF Threaded Flange

Part #	Mfg #	Size	Price
176681	1SS304TFRF	1"	
176682	114SS304TFRF	1-1/4"	
176683	112SS304TFRF	1-1/2"	
176684	2SS304TFRF	2"	
176685	3SS304TFRF	3"	
176686	4SS304TFRF	4"	

#### RF W/N Flange

Part #	Mfg #	Size	Price
176692	3SS304WNFRF	3"	
176693	4SS304WNFRF	4"	
176694	6SS304WNFRF	6"	

#### RF S/W Flange

Part #	Mfg #	Size	Price
176699	1SS304SWFRF	1"	
176701	112SS304SWFRF	1-1/2"	
131597	2SS304SWFRF	2"	
176702	3SS304SWFRF	3"	

### Ductile Iron Blackup Flange

Part #	Mfg #	Size	Price
176673	112DIBUF	1-1/2"	
176674	2DIBUF	2"	
176675	3DIBUF	3"	
176676	4DIBUF	4"	
176677	6DIBUF	6"	
177909	8DIBUF	8"	



## SS 304 Weld FTGS

### 304SS Sch10 Weld Fittings

#### 304SS Sch10 Stub Ends

- A403/ASME
- SA403

Part #	Mfg #	Size	Price
176659	112SS30410ASE	1-1/2"	
176660	2SS30410ASE	2"	
176661	3SS30410ASE	3"	
176662	4SS30410ASE	4"	
176663	6SS30410ASE	6"	
177908	8SS30410ASE	8"	

#### 304SS Sch10 Weld Caps

- A403/ASME
- SA403

Part #	Mfg #	Size	Price
177891	2SS30410WCA	2"	
166381	3SS30410WCA	3"	
177892	4SS30410WCA	4"	
177893	6SS30410WCA	6"	
177894	8SS30410WCA	8"	

#### 304SS Sch10 Concentric Reducers

- A403/ASME
- SA403

Part #	Mfg #	Size	Price
177900	112SS30410WCR	1" x 1/2"	
177902	1121SS30410WCR	1-1/2" x 1"	
177903	21SS30410WCR	2" x 1"	
176640	2112SS30410WCR	2" x 1-1/2"	
176641	32SS30410WCR	3" x 2"	
176642	42SS30410WCR	4" x 2"	
176643	43SS30410WCR	4" x 3"	
176645	63SS30410WCR	6" x 3"	
176647	64SS30410WCR	6" x 4"	
177428	84SS30410WCR	8" x 4"	
177904	86SS30410WCR	8" x 6"	

#### 304SS Sch10 Tees

- A403/ASME
- SA403

Part #	Mfg #	Size	Price
177911	1SS30410WT	1"	

### 304SS Sch10 Weld Fittings (Continued)

#### 304SS Sch10 Tees

Part #	Mfg #	Size	Price
176635	112SS30410WT	1-1/2"	
176636	2SS30410WT	2"	
176637	3SS30410WT	3"	
176638	4SS30410WT	4"	
176639	6SS30410WT	6"	
177907	8SS30410WT	8"	

#### 304SS Sch10 90° LR Elbows

- A403/ASME
- SA403

Part #	Mfg #	Size	Price
177910	1SS30410WLR90	1"	
176627	112SS30410WLR90	1-1/2"	
176628	2SS30410WLR90	2"	
165275	3SS30410WLR90	3"	
165276	4SS30410WLR90	4"	
176629	6SS30410WLR90	6"	
177905	8SS30410WLR90	8"	

#### 304SS Sch10 45° Elbows

- A403/ASME
- SA403

Part #	Mfg #	Size	Price
176631	2SS30410W45	2"	
176632	3SS30410W45	3"	
176633	4SS30410W45	4"	
176634	6SS30410W45	6"	
177906	8SS30410WLR45	8"	

### 304SS SCH10 Weld Fittings

#### 304SS Sch40 Weld Caps

Part #	Mfg #	Size	Price
177895	112SS304WCA	1-1/2"	
177896	2SS304WCA	2"	
177897	3SS304WCA	3"	
177899	6SS304WCA	6"	



## SS 304 Weld FTGS

### 304SS Sch40 Concentric Reducers

Part #	Mfg #	Size	Price
176618	64SS304WCR	6" x 4"	
176614	2112SS304WCR	2" x 1-1/2"	
176615	2114SS304WCR	2" x 1-1/4"	
176542	112114SS304WCR	1-1/2" x 1-1/4"	
175690	32SS304WCR	3" x 2"	
176617	43SS304WCR	4" x 3"	

### 304SS Sch40 Tees

Part #	Mfg #	Size	Price
176524	114SS304WT	1-1/4"	
176526	2SS304WT	2"	
176527	3SS304WT	3"	
176529	6SS304WT	6"	

### 304SS Sch40 90° Elbows

Part #	Mfg #	Size	Price
176507	1SS304W90	1"	
176509	114SS304W90	1-1/4"	
176511	112SS304W90	1-1/2"	
176512	2SS304W90	2"	
176513	3SS304W90	3"	
176516	6SS304W90	6"	

### 304SS Sch40 45° Elbows

Part #	Mfg #	Size	Price
176520	3SS304W45	3"	
176522	6SS304W45	6"	



## SS Sanitary Clamp Fittings

### Clamp Adapters

#### Clamp x MNPT Adapter



Part #	Mfg #	Tube OD Size	SS	Price
181435	1SSSANCLMA	1" x 1"	304	
179621	112SSSANCLMA	1-1/2" x 1-1/2"	304	

#### 316 Stainless Steel

Part #	Mfg #	Tube OD Size	SS	Price
177757	1SSSANCL316MA	1" x 1"	316	
177758	112SSSANCL316MA	1-1/2" x 1-1/2"	316	
177759	2SSSANCL316MA	2" x 2"	316	

#### Rubber Hose Barb Clamp Adapter



Part #	Mfg #	Tube OD Size	SS	Price
182019	11212SSSANCLRHB	1-1/2" x 1/2"	316	

### Clamps

#### Heavy Duty Single Pin Clamp



Part #	Mfg #	Tube OD Size	SS	Price
167970	2SSSANHDCLAMP	2"	304	
177692	212SSSANHDCLAMP	2-1/2"	304	
167969	3SSSANHDCLAMP	3"	304	
167922	4SSSANHDCLAMP	4"	304	
239915	12INSSSANHDCLMP	12"	304	

### Clamp Caps

#### Solid End Clamp Cap



Part #	Mfg #	Tube OD Size	SS	Price
177644	1SSSANCLCA	1"-1-1/2"	304	
177645	2SSSANCLCA	2"	304	

### Clamp Caps (Continued)

#### Solid End Clamp Cap

Part #	Mfg #	Tube OD Size	SS	Price
177647	3SSSANCLCA	3"	304	
177648	4SSSANCLCA	4"	304	

#### 316 Stainless Steel

Part #	Mfg #	Tube OD Size	SS	Price
177714	1SSSANCL316CA	1"-1-1/2"	316	

### Clamp Elbows

#### 45° Clamp Elbows



Part #	Mfg #	Tube OD Size	SS	Price
177612	2SSSANCL45	2"	304	
177614	3SSSANCL45	3"	304	

#### 316 Stainless Steel

Part #	Mfg #	Tube OD Size	SS	Price
177699	112SSSANCL31645	1-1/2"	316	

#### 90° Clamp Elbows



Part #	Mfg #	Tube OD Size	SS	Price
177604	1SSSANCL90	1"	304	
177605	112SSSANCL90	1-1/2"	304	
177606	2SSSANCL90	2"	304	
177607	212SSSANCL90	2-1/2"	304	
177608	3SSSANCL90	3"	304	

#### 316 Stainless Steel

Part #	Mfg #	Tube OD Size	SS	Price
177693	1SSSANCL31690	1"	316	
177694	112SSSANCL31690	1-1/2"	316	
177695	2SSSANCL31690	2"	316	



## SS Sanitary Clamp Fittings

### Clamp Gaskets

#### BUNA-N Clamp Gasket

- Type 1
- Black



Part #	Mfg #	Tube OD Size	Price
177813	1SSSANCLBG	1"	

#### EPDM Clamp Gasket

- Type 1
- Black or white



Part #	Mfg #	Tube OD Size	Price
177820	1SSSANCLEG	1"	
177821	112SSSANCLEG	1-1/2"	
177822	2SSSANCLEG	2"	
177824	3SSSANCLEG	3"	
177825	4SSSANCLEG	4"	

#### Teflon® Bevel Seat Gasket

- DHR



Part #	Mfg #	Tube OD Size	Price
222592	2SSSANBVLGTREG	2"	

#### Teflon® Clamp Gasket

- Type 1



Part #	Mfg #	Tube OD Size	Price
177807	1SSSANCLTG	1"	
177808	112SSSANCLTG	1-1/2"	
177809	2SSSANCLTG	2"	
177810	212SSSANCLTG	2-1/2"	
177811	3SSSANCLTG	3"	
177812	4SSSANCLTG	4"	

### Ferrules

#### Heavy Wall Tank Weld Ferrule



Part #	Mfg #	Tube OD Size	SS	Price
167913	112SSSANCLHTF	1-1/2"	316	
167899	2SSSANCLHTF	2"	316	
167910		3"	316	

#### Light Wall Tank Ferrule



Part #	Mfg #	Tube OD Size	SS	Price
180869	1SSSANCLLTF	1"	304	
180870	112SSSANCLLTF	1-1/2"	304	
180871	2SSSANCLLTF	2"	304	
180873	4SSSANCLLTF	4"	304	

#### 316 Stainless Steel

Part #	Mfg #	Tube OD Size	SS	Price
180174	112SSSAN6CLLWF	1-1/2"	316	
180175	2SSSAN6CLLWF	2"	316	
177722	2SSSANCL316LTF	2"	316	
177723	3SSSANCL316LTF	3"	316	

#### Long Buttweld Ferrule



Part #	Mfg #	Tube OD Size	SS	Price
177631	1SSSANCLLWF	1"	304	
177632	112SSSANCLLWF	1-1/2"	304	
177633	2SSSANCLLWF	2"	304	
177634	212SSSANCLLWF	2-1/2"	304	
177635	3SSSANCLLWF	3"	304	
177636	4SSSANCLLWF	4"	304	





## SS Sanitary Clamp Fittings

### Short Threaded Bevel Seat Ferrule



Part #	Mfg #	Tube OD Size	SS	Price
222591	2SSSANBVLSTHSF	2"	304	

### Short Welding Ferrule



Part #	Mfg #	Tube OD Size	SS	Price
177637	1SSSANCLSWF	1"	304	
177638	112SSSANCLSWF	1-1/2"	304	
177639	2SSSANCLSWF	2"	304	
177642	3SSSANCLSWF	3"	304	
177643	4SSSANCLSWF	4"	304	

### Clamp Tees

#### Tee

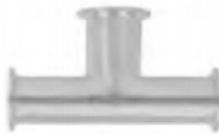

Part #	Mfg #	Tube OD Size	SS	Price
177617	1SSSANCLT	1"	304	
177619	2SSSANCLT	2"	304	
177621	3SSSANCLT	3"	304	

#### 316 Stainless Steel

Part #	Mfg #	Tube OD Size	SS	Price
177704	112SSSANCL316T	1-1/2"	316	
177705	2SSSANCL316T	2"	316	

### Nuts

#### John Perry Union Hex Nut



Part #	Mfg #	Tube OD Size	SS	Price
222590	2SSSANBVLHXNUT	2"	304	

### Reducers

#### Concentric Reducer (Clamp x Clamp)

- 7" Length



Part #	Mfg #	Tube OD Size	SS	Price
177626	2112SSSANCLCR	2" x 1-1/2"	304	
177627	32SSSANCLCR	3" x 2"	304	

#### 316 Stainless Steel

Part #	Mfg #	Tube OD Size	SS	Price
177708	1121SSSANCL3CR	3" x 1-1/2"	316	
177709	21SSSANCL316CR	2" x 1"	316	
177711	2122SSSANCL3CR	2-1/2" x 2"	316	

#### Buttweld Concentric Reducer

- Polish ID/OD



Part #	Mfg #	Tube OD Size	SS	Price
167912	3SSSANCLHTF	1-1/2" x 1"	304	
181991	2112SSSANBWCR	2" x 1-1/2"	304	

### Tank Vents

#### Tank Pressure Vacuum Relief Valve

- 304 Stainless steel



Part #	Mfg #	Tube OD Size	SS	Price
181339	112SSSANCLVRV	1-1/2"	304	



## SS Sanitary Clamp Fittings

### Tube Hangers

#### Tube Hanger with Rubber Grommets

- 304 Stainless steel



Part #	Mfg #	Tube OD Size	Price
181428	1SSSANCLTHG	1" HEX	
181447	112SSSANCLTHG	1-1/2" HEX	

#### Tube Hanger with PolyPropylene Sleeve

- 304 Stainless steel



Part #	Mfg #	Tube OD Size	Price
180792	112SSSANCLTH	1-1/2" HEX	
177798	2SSSANCLTH	2" HEX	
177799	3SSSANCLTH	3" HEX	

### Miscellaneous

#### In Line Sight Glass

- Acrylic
- White buna seals



Part #	Mfg #	Tube OD Size	SS	Price
181470	112SSSANCLILSG	1-1/2"	316	

#### Rotating Spray Ball

- 360° Spray pattern
- OD mirror finish
- Used to clean tanks or vessels



Part #	Mfg #	Tube OD Size	SS	Price
184165	112SSSANCLRSB	1-1/2"	304	

### Butt Weld Crosses

#### Polished ID/OD Butt Weld Cross

- .065 Nominal wall size



Part #	Mfg #	Size	SS	Price
243655	1SSSANBWCR	1"	304	
236841	2SSSANBWCR	2"	316L	

### Butt Weld Elbows

#### 45° Butt Weld Elbow

- Less tangent
- Polished ID/OD



Part #	Mfg #	Size	Nominal Wall	Price
167971	1SSSANBW45	1"	.065	
167924	112SSSANBW45	1-1/2"	.065	
167945	3SSSANBW45	3"	.065	

#### 90° Butt Weld Elbow

- Less tangent or (1.5 x CLR)
- Polished ID/OD



Part #	Mfg #	Size	Nominal Wall	Price
167925	1SSSANBW90	1"	.065	
167909	112SSSANBW90	1-1/2"	.065	
181442	2SSSANBW90	2"	.065	
181445	3SSSANBW90	3"	.065	

### Butt Weld Tees

#### Reducing Butt Weld Tee

- Polished ID/OD



Part #	Mfg #	Size	Price
167962	32SSSANBWT	3" x 2"	



## SS Sanitary BW Fittings

### Short Buttweld Tee

- Polished ID/OD



Part #	Mfg #	Size	Nominal Wall	Price
181341	1SSSANBWT	1"	.065	
180790	112SSSANBWT	1-1/2"	.065	
181444	2SSSANBWT	2"	.065	

### Long Buttweld Tee

- Polished ID/OD



Part #	Mfg #	Size	Nominal Wall	Price
242577	1SSSANLBWT	1"	.065	



## TecTite Fittings

### TecTite™ Fittings

#### 200 TecTite™ Coupling with Stop (C x C)



Part #	Mfg #	Size	Price
142376	38TTCCP	3/8"	
098073	12TTCCP	1/2"	
098075	34TTCCP	3/4"	
110136	1TTCCP	1"	
114714	114TTCCP	1-1/4"	
113216	112TTCCP	1-1/2"	
114715	2TTCCP	2"	

\* Low lead

#### 201 TecTite™ Slip Coupling (C x C)



Part #	Mfg #	Size	Price
110147	12TTCSCP	1/2"	
110148	34TTCSCP	3/4"	
110149	1TTCSCP	1"	

#### 201-R TecTite™ Reducer Coupling (C x C)



Part #	Mfg #	Size	Price
142374	1238TTCCP	1/2" x 3/8"	
098076	3412TTCCP	3/4" x 1/2"	
110137	134TTCCP	1" x 3/4"	

#### 203 TecTite™ Female Adapter (C x F)



Part #	Mfg #	Size	Price
098077	12TTCFA	1/2"	
098079	34TTCFA	3/4"	
110138	1TTCFA	1"	
114716	114TTCFA	1-1/4"	
142378	38TTCCA	1-1/4"	

### TecTite™ Fittings (Continued)

#### 203 TecTite™ Female Adapter (C x F)

Part #	Mfg #	Size	Price
114718	2TTCFA	2"	

#### 203-R TecTite™ Low Lead Reducing Female Adapter (C x F)



Part #	Mfg #	Size	Price
142372	1234TTCFA	1/2" x 3/4"	

#### 204 TecTite™ Male Adapter (C x M)



Part #	Mfg #	Size	Price
098080	12TTCMA	1/2"	
098081	34TTCMA	3/4"	
110139	1TTCMA	1"	
114719	114TTCMA	1-1/4"	
114720	112TTCMA	1-1/2"	
114721	2TTCMA	2"	

#### 204-R TecTite™ Reducing Male Adapter (C x M)



Part #	Mfg #	Size	Price
142370	1234TTCMA	1/2" x 3/4"	
110140	134TTCMA	1" x 3/4"	

\* Low lead



## TecTite Fittings

### 207 TecTite™ 90° Elbow (C x C)



Part #	Mfg #	Size	Price
144181	38TTC90	3/8"	
098082	12TTC90	1/2"	
098083	34TTC90	3/4"	
110141	1TTC90	1"	
114728	2TTC90	2"	

### 2707-3-5 TecTite™ 90° Drop Ear Elbow (C x F)



Part #	Mfg #	Size	Price
098084	12TTCDE90	1/2"	

### 207-4 Low Lead 90° Male Elbow (C x M)



Part #	Mfg #	Size	Price
142377	12TTCF90	1/2"	

### 208 Water Heater Hose - Low Lead

- C x 20" Hose x FMPT



Part #	Mfg #	Nom Size	Price
126932	34TTCWHH	3/4"	
156416	1234TTCWHH	1/2" x 3/4"	

### 210 TecTite™ Ball Valve



Part #	Mfg #	Size	Price
110150	12TTCBV	1/2"	
110151	34TTCBV	3/4"	
110152	1TTCBV	1"	

### 210-8 TecTite™ Water Heater Connector

- C x FIP
- Lead-free brass
- Ball valve included
- Braided stainless steel hose



Part #	Mfg #	Size	Price
152876	34TTWHC	3/4" x 3/4"	
152875	1234TTWHC	1/2" x 3/4"	

### 211 TecTite™ Tee (C x C x C)



Part #	Mfg #	Size	Price
144178	38TTCT	3/8"	
144179	383812TTCT	3/8" x 3/8" x 1/2"	
144180	121238TTCT	1/2" x 1/2" x 3/8"	
098085	12TTCT	1/2"	
098087	343412TTCT	3/4" x 1/2"	
098086	34TTCT	3/4"	
110145	1134TTCT	1" x 3/4"	
110144	1TTCT	1"	

### 211-R Reducer Tee (C x C x C)



Part #	Mfg #	Size	Price
110143	341234TTCT	3/4" x 1/2" x 3/4"	
110142	341212TTCT	3/4" x 1/2" x 1/2"	



## TecTite Fittings

### 217 TecTite™ Tube Cap



Part #	Mfg #	Size	Price
097652	12TTCCA	1/2"	
097653	34TTCCA	3/4"	
110154	1TTCCA	1"	

### Demounting Clip - Removal Key



Part #	Mfg #	Size	Price
098088	12TTRT	1/2"	
098089	34TTRT	3/4"	
110146	1TTRT	1"	





## Viega-PEX Fittings

### Viega ProPress® Manifold Valves

#### ProPress® Copper Manifold Valve (P x Copper)

- Zero Lead™ brass
- 1/2" ProPress tool required
- Sleeve not included



Part #	Mfg #	Size	Price
110376	12VPMFBV	1/2" x 1/2"	

### Viega PureFlow® PEX Press Fittings

#### Viega PEX Press Angle Stop Valve (Press x CTS)

- or use with ViegaPEX Ultra, Viega FostaPEX, or ViegaPEX Barrier
- Chrome-plated brass
- Press connection, compression
- ¼ turn



Part #	Mfg #	Size	Price
157515	3838VPASLF	3/8" x 1/4"	
137259	1238VPASLF	1/2" x 1/4"	

#### Viega PEX Press Coupling (Press x Press)

- Radel R
- Smart Connect® feature
- Zero Lead™



Part #	Mfg #	Size	Price
147121	1234VPPPCP	1/2" x 3/4"	
147118	12VPPPCP	1/2" x 1/2"	
147119	34VPPPCP	3/4" x 3/4"	
147122	341VPPPCP	3/4" x 1"	
147123	1VPPPCP	1" x 1"	

#### Viega PEX Press Elbow (Press)

- Radel R
- Smart Connect® feature
- Zero Lead™



Part #	Mfg #	Size	Price
147124	12VPPP90	1/2"	
147125	34VPPP90	3/4"	
147126	1VPPP90	1"	

### Viega PEX Press Elbow - Drop Ear (Press x FNPT)

- Bronze



Part #	Mfg #	Size	Price
126478	12VPDE90WSL	1/2" x 1/2"	
140025	34VPDE90WSL	3/4" x 3/4"	

### Viega PEX Press Tee (Press x Press x Press)

- Radel R
- Smart Connect® feature
- Zero Lead™



Part #	Mfg #	Size	Price
147127	12VPPPT	1/2"	
147128	121234VPPPT	1/2" x 1/2" x 3/4"	
147129	34VPPPT	3/4"	
147131	341212VPPPT	3/4" x 1/2" x 1/2"	
147132	341234VPPPT	3/4" x 1/2" x 3/4"	
147133	343412VPPPT	3/4" x 3/4" x 1/2"	
147134	1VPPPT	1"	
147135	11212VPPPT	1" x 1/2" x 1/2"	
147136	1121VPPPT	1" x 1/2" x 1"	
147137	13412VPPPT	1" x 3/4" x 1/2"	
147138	13434VPPPT	1" x 3/4" x 3/4"	
147140	1341VPPPT	1" x 3/4" x 1"	
147141	1112VPPPT	1" x 1" x 1/2"	
147142	1134VPPPT	1" x 1" x 3/4"	

### Viega PEX Press Test Plug (Press)

- Radel R
- Smart Connect® feature
- Zero Lead™



Part #	Mfg #	Size	Price
147143	12VPPPPL	1/2"	
147144	34VPPPPL	3/4"	
147145	1VPPPPL	1"	



## Viega-PEX Fittings

### Viega PEX Press Lav Adapter (Press x Lav)

- Bronze
- Metal nut
- Sleeve not included



Part #	Mfg #	Size	Price
108376	12VPLA	1/2" x 1/2"	

### Viega PEX Press Copper Stub-Out - Straight (Press x Copper x Length)

- Copper
- Sleeve not included



Part #	Mfg #	Size	Price
099872	12VPSOS8	1/2" x 1/2" x 8"	
099873	12VPSOS15	1/2" x 1/2" x 15"	

### Viega PEX Press Stub-Out - Elbow (Press x Copper x Length)

- Copper
- Sleeve not included



Part #	Mfg #	Size	Price
099871	12VPSO8	1/2" x 1/2" (3-1/2" x 8")	

### Viega PEX Press Tub Elbow(Press x Copper x Length)

- Copper
- Sleeve not included



Part #	Mfg #	Size	Price
099870	12VPCTE	1/2" x 1/2" (3" x 6")	

### Viega PEX Press 90° Stub-Out

- Copper
- Press connection, street
- Wall plate



Part #	Mfg #	Size	Price
163985	12VPSO90	1/2" x 1/2" (3-1/2" x 8")	

### Viega PEX Press Ball Valve (Press x Press)

- Zero Lead™ brass
- Sleeve not included



Part #	Mfg #	Size	Price
099874	12VPBVLV	1/2" x 1/2"	
099875	34VPBVLV	3/4" x 3/4"	

### Viega PEX Straight Stop Valve (Press x CTS)

- Chrome-plated Zero Lead™ brass
- 1/4-Turn
- Sleeve not included



Part #	Mfg #	Size	Price
099876	1238VPSSLF	1/2" x 3/8"	

### PureFlow® PEX Crimp Fittings

#### Viega PEX Crimp Ring

- Copper
- For use with Viega PEX crimp fittings and tools only



Part #	Mfg #	Size	Price
099796	12VGCRB	1/2"	
099797	34VGCRB	3/4"	
099798	1VGCRB	1"	

### Viega PureFlow Crimp Closet Adapter

- Zero Lead
- For use with Viega PureFlow PEX
- Brass
- Crimp connection, closet connection



Part #	Mfg #	Size	Price
204707	VG46234	1/2" x 1/2"	

### Viega PureFlow Crimp 90° Elbow

- Zero Lead
- For use with Viega PureFlow PEX
- Brass
- Crimp connection



Part #	Mfg #	Size	Price
099854	34VP90LF	3/4" x 3/4"	



## Viega-PEX Fittings

### Viega PEX Crimp Copper Adapter - Tubing (Crimp x Copper Female)

- Zero Lead™ brass



Part #	Mfg #	Size	Price
105078	12VGFFA	1/2" x 1/2"	

### Viega PEX Crimp Copper Adapter - Fitting (Crimp x Copper Male)

- Zero Lead™ brass



Part #	Mfg #	Size	Price
105079	12VGMFA	1/2" x 1/2"	

### Viega PureFlow Crimp Adapter



Part #	Mfg #	Size	Price
153991	341VPFA	3/4" x 1"	

### Viega PureFlow Press Adapter

- Bronze
- Press connection, flare connection



Part #	Mfg #	Size	Price
250530	1VPFAFLWSL	1" x 1"	

### Viega PureFlow Crimp Lav Adapter

- For use with Viega PureFlow PEX
- Equipped with Viega PureFlow Crimp ring Model V5019.9, ferrule Part No 53005
- Brass
- Crimp connection, compression



Part #	Mfg #	Size	Price
206382	VG46331	1/2" x 1/4"	

### Viega PureFlow Crimp Tee

- Zero Lead
- For use with Viega PureFlow PEX
- Brass
- Crimp connection



Part #	Mfg #	Size	Price
105115	1341VGT	1" x 3/4" x 1"	

### Viega PEX Crimp Test Plug (Crimp)

- Zero Lead™ poly



Part #	Mfg #	Size	Price
105124	12VGPPL	1/2"	
105125	34VGPPL	3/4"	
105126	1VGPPL	1"	

## PureFlow® PEX Press Outlet Boxes

### PEX Press Washing Machine Outlet Box

- Wall-mount
- 1/4-Turn valves with color coded handles
- Sleeves not included
- Zero Lead™



Part #	Mfg #	Size (Press Vlv)	Price
106744	12VPWMOB	1/2"	

### PEX Press Ice Maker Outlet Box

- Wall-mount
- Zero Lead™ brass valve



Part #	Mfg #	Size (Press Vlv)	Price
166334	12VPIMOBFL	1/2"	

## PureFlow® Plumbing Accessories

### Economy PEX Tubing Clamp



Part #	Mfg #	Size	Price
115196	VP52120	1/2"	



## Viega-PEX Fittings

### Snap-In Bend Support

- Bend supports snap in on 2" centers
- Not for use with FostaPEX®



Part #	Mfg #	Size	Price
110768	12VPSBS	1/2"	

### Viega PEX Press Fittings

#### Viega PEX Press Adapter - Copper Tubing (Press x Copper Female)

- Bronze



Part #	Mfg #	Size	Price
125874	12VPCFSAWSL	1/2" x 1/2"	
125875	1234VPCFSAWSL	1/2" x 3/4"	
125876	3412VPCFSAWSL	3/4" x 1/2"	
125878	34VPCFSAWSL	3/4" x 3/4"	
125879	1VPCFSAWSL	1" x 1"	

#### Viega PEX Press Adapter - Copper Fitting (Press x Copper Male)

- Bronze



Part #	Mfg #	Size	Price
125844	12VPCFAWSL	1/2" x 1/2"	
125845	1234VPCFAWSL	1/2" x 3/4"	
169329	3412VPCFAWSLL F	3/4" x 1/2"	
125846	34VPCFAWSL	3/4" x 3/4"	
125848	1VPCFAWSL	1" x 1"	

#### Viega PEX Press Adapter (P x P)

- Bronze
- Press connection



Part #	Mfg #	Size	Price
159712	12VPAPP	1/2" x 1/2"	
105047	34VPAPP	3/4" x 3/4"	
144956	1VPAPP	1" x 1"	

### Viega PureFlow Press Adapter (PEX x P)

- For transitioning between Viega PureFlow Press and Viega ProPress
- Bronze
- Press connection



Part #	Mfg #	Size	Price
153417	PP69627	5/8" PEX x 1/2" ProPress	

### Viega PEX Press Adapter - Male (Press x MPT)

- Bronze



Part #	Mfg #	Size	Price
160420	12VPMASLLF	1/2" x 1/2"	
160115	1234VPMALF	1/2" x 3/4"	
160320	34VPMASLLF	3/4" x 3/4"	
238134	134VPMMA	1" x 3/4"	
125790	1VPMASL	1" x 1"	
187733	114VPMASL	1-1/4" x 1-1/4"	
187734	112VPMASL	1-1/2" x 1-1/2"	
187735	2VPMASL	2" x 2"	

### Viega PEX Press Adapter - Female (Press x FNPT)

- Bronze



Part #	Mfg #	Size	Price
160321	12VPFASLLF	1/2" x 1/2"	
125786	1234VPFAWSL	1/2" x 3/4"	
125166	34VPFAWSL	3/4" x 3/4"	
125787	1VPFAWSL	1" x 1"	
230692	2VPFAWSL	2"	

### Viega PEX Press Coupling (Press x Press)

- Bronze



Part #	Mfg #	Size	Price
125832	12VPCPWSL	1/2"	
125834	1234VPCPWSL	1/2" x 3/4"	
125833	34VPCPWSL	3/4"	
125835	341VPCPWSL	3/4" x 1"	
125836	1VPCPWSL	1"	



## Viega-PEX Fittings

### Viega PEX Press Elbow (Press x Press)

- Bronze



Part #	Mfg #	Size	Price
124857	12VP90WSL	1/2"	
124858	34VP90WSL	3/4"	
124859	1VP90WSL	1"	

### Viega PEX Press Adapter (Press x C)

- Bronze
- Press connection, female copper tube size



Part #	Mfg #	Size	Price
187704	112VPCFSAWSL	1-1/2" x 1-1/2"	
187705	2VPCFSAWSL	2" x 2"	

### Viega PEX Press Elbow (Press x Copper)

- Bronze



Part #	Mfg #	Size	Price
109711	1234VPCFS90	1/2" x 3/4"F	
109712	34VPCFS90WSL	3/4" x 3/4"F	
109713	12VPCSM90	1/2" x 1/2"M	

### Polymer PEX Press Fittings

#### Viega PEX Press 90° Elbow

- Polymer
- Press connection



Part #	Mfg #	Size	Price
187651	114VPP90	1-1/4"	
187652	112VPP90	1-1/2"	
187653	2VPP90	2"	

### Viega PEX Press Elbow - Male (Press x MNPT)

- Bronze



Part #	Mfg #	Size	Price
125880	12VP90MAWSL	1/2" x 1/2"	

### Viega PEX Press Coupling

- Polymer
- Press connection



Part #	Mfg #	Size	Price
187802	1121VPPCP	1-1/2" x 1"	
187800	2112VPPCP	2" x 1-1/2"	
187661	114VPPCP	1-1/4" x 1-1/4"	
187662	112VPPCP	1-1/2" x 1-1/2"	
187663	2VPPCP	2" x 2"	

### Viega PEX Press Tee (Press x Press x Press)

- Bronze



Part #	Mfg #	Size	Price
124860	12VPTWSL	1/2"	
124861	121234VPTWSL	1/2" x 3/4"	
124862	34VPTWSL	3/4"	
124863	341212VPTWSL	3/4" x 1/2" x 1/2"	
124864	341234VPTWSL	3/4" x 1/2" x 3/4"	
124865	343412VPTWSL	3/4" x 1/2"	
124866	1VPTWSL	1"	
124867	11212VPTWSL	1" x 1/2" x 1/2"	
124869	13434VPTWSL	1" x 3/4" x 3/4"	
124871	1112VPTWSL	1" x 1/2"	
124872	1134VPTWSL	1" x 3/4"	

### Viega PEX Press Tee

- Polymer
- Press connection



Part #	Mfg #	Size	Price
187736	114VPPT	1-1/4" x 1-1/4" x 1-1/4"	
187737	112VPPT	1-1/2" x 1-1/2" x 1-1/2"	
187738	2VPPT	2" x 2" x 2"	
187665	11411VPPT	1-1/4" x 1" x 1"	
187664	11411434VPPT	1-1/4" x 1-1/4" x 3/4"	
187656	11211VPPT	1-1/2" x 1" x 1"	
187657	11211434VPPT	1-1/2" x 1-1/4" x 3/4"	
187658	1121141VPPT	1-1/2" x 1-1/4" x 1"	



---



---

## Viega-PEX Fittings

---



---

### Polymer PEX Press Fittings (Continued)

#### Viega PEX Press Tee

Part #	Mfg #	Size	Price
187654	11211234VPPT	1-1/2" x 1-1/2" x 3/4"	
187655	1121121VPPT	1-1/2" x 1-1/2" x 1"	
187660	21121VPPT	2" x 1-1/2" x 1"	
187797	2234VPPT	2" x 2" x 3/4"	
187804	221VPPT	2" x 2" x 1"	
187799	22112VPPT	2" x 2" x 1-1/2"	





## Viega PEX Tools

### Tools

#### PEX Press Tool

- Ratcheting design
- Color coded handles



Part#	Mfg#	Size	Color	Price
099878	12VPPRESSTOOL	1/2"	Yellow	
099879	34VPPRESSTOOL	3/4"	Blue	
099880	1VPPRESSTOOL	1"	Orange	

#### PEX Crimp Tool

- For use with Viega PEX Crimp fittings
- Soft touch



Part#	Mfg#	Size	Color	Price
187789	12VPPJAW	1/2"		
234975	1VPCRIMPTOOL	1"		

#### PureFlow Crimp Hand Tool

- For use with Viega PureFlow Crimp Fittings
- Compact angled, color coded handles



Part#	Mfg#	Size	Color	Price
099780	12VPCRIMPTOOL	1/2"	Yellow	
099781	34VPCRIMPTOOL	3/4"	Blue	

#### PEX Press Tool Set

- Starter set includes:
  - 1/2" and 3/4" PEX Press tools
  - and basic tubing cutter
  - with three additional slots



Part#	Mfg#	Description	Price
099881	VPPRESSTOOLKIT	Starter PEX Tool Set	

### PEX Press Jaw

- For Rigid standard tools, PEX tubing
- Steel



Part #	Mfg #	Size	Price
187790	34VPPJAW	3/4"	
187791	1VPPJAW	1"	
187792	114VPPJAW	1-1/4"	
187793	112VPPJAW	1-1/2"	
187794	2VPPJAW	2"	

### PEX Press Jaw - Compact

- For Rigid standard tools, PEX tubing
- Steel



Part #	Mfg #	Size	Price
232833	12VPPJAWCOMPACT	1/2"	
232834	34VPPJAWCOMPACT	3/4"	
232835	1VPPJAWCOMPACT	1"	



## Viega Manifolds

### Viega PEX Press Manifolds

#### Viega PEX Press Manifold

- Smart connect feature
- For use with ViegaPEX™ Ultra, Viega FostaPEX™, or ViegaPEX™
- Only use with lock clip #58075
- Press connection
- Flow through
- Does not include mounting hardware



Part #	Mfg #	Size	Outlets	Price
160497	34VPPMF412	3/4" x 3/4" x 1/2"	4	
160488	34VPPMF212	3/4" x 3/4" x 1/2"	2	
160496	34VPPMF312	3/4" x 3/4" x 1/2"	3	
160498	134VPPMF412	1" x 3/4" x 1/2"	4	
160501	1VPPMF612	1" x 1" x 1/2"	6	
160502	1VPPMF812	1" x 1" x 1/2"	8	

### Viega MANABLOC® Manifolds

#### MANABLOC® - Compression

- Compression port adapters
- Home run distribution manifold
- Factory assembled with valves
- Color coded ports for hot and cold water
- Zero Lead™
- Supply connections sold separately



Part #	Mfg #	Size	Hot/Cold	Price
086011	VGMXBD183	18 Ports: 1/2"	8/10	

#### MANABLOC® PEX Crimp

- Zero Lead® brass port adapters
- Home run distribution manifold
- Factory assembled with valves
- Color coded ports for hot and cold water
- Supply connections sold separately

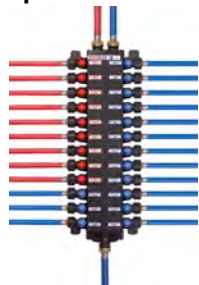

Part #	Mfg #	Size	Hot/Cold	Price
126790	VP41303	30 Ports: 1/2"	12/18	
126792	VP41363	36 Ports: 1/2"	14/22	

### MANABLOC® Smart Connect

- Press connection
- Zero Lead™
- 1/4 Turn valves
- T-handle valve key
- Color coded ports for hot and cold water
- Supply connections sold separately

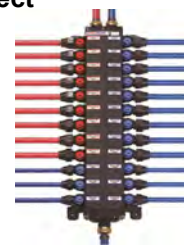

Part#	Mfg#	Size	Hot/Cold	Price
244679	VP49243	24 Ports: 1/2"	9/15	

### MANABLOC® V5030.5 Distribution Manifold

- For use with Viega PureFlow PEX
- Suitable for port cap Model V5087
- Use with prep tool Model 2858
- Crimp connection
- Color coded ports for hot&cold water
- 1/4 Turn valves, T-handle valve key
- Does not include supply connections

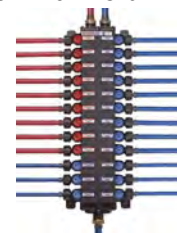

Part#	Mfg#	Size	Hot/Cold	Price
247533	VG50303	30 Ports: 1/2"	12/18	
245952	VG50363	36 Ports: 1/2"	14/22	
126789	VP50250	18 Ports: 1/2"	8/10	

### MANABLOC® V5630 Distribution Manifold

- For use with Viega PureFlow PEX, Viega FostaPEX, or ViegaPEX Barrier
- Use with bracket Model 2850.4US
- Press connection
- Color coded ports for hot&cold water
- 1/4 Turn valves, T-handle valve key
- Does not include supply connections

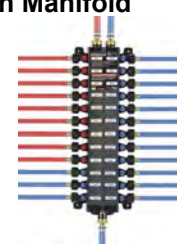

Part#	Mfg#	Size	Hot/Cold	Price
244679	VP49243	24 Ports: 1/2"	9/15	

### MANABLOC®/MiniBloc™ Accessories

#### MANABLOC® Wrench

- Use with compression MANABLOC® or MiniBloc™ only



Part #	Mfg #	Size	Price
094674	VGMW1	3/8" & 1/2"	



## Viega Manifolds

### Viega PEX Press Port Adapter (Press x MANABLOC Port)

- Zero Lead™ bronze
- Connects distribution lines to MANABLOC® and MiniBloc™



Part #	Mfg #	Size	Price
110815	12VPPALF	1/2" x 1/2"	

### PEX Crimp Supply Adapter (Crimp x MANABLOC Supply)

- Zero Lead™ brass
- Connects PEX supply lines to MANABLOC® and MiniBloc™



Part #	Mfg #	Size	Price
117862	VGMXSC4	3/4" x 1"	
121064	VGMXSC5	1" x 1"	

### ViegaPEX™ Press Supply Adapter (Press x MANABLOC Supply)

- Bronze
- Connects PEX supply lines to MANABLOC® and MiniBloc™



Part #	Mfg #	Size	Price
132173	341VPMS	3/4" x 1"	

### MANABLOC® Supply Adapter - Male (MNPT x MANABLOC Supply)

- Zero Lead™ brass
- Connects FNPT supply lines to MANABLOC® and MiniBloc™



Part #	Mfg #	Size	Price
121704	34VGMSA	3/4" x 1"	
117863	VGMSC5	1" x 1"	

### MANABLOC® Cap

- Zero Lead™



Part #	Mfg #	Size	Price
100136	12VGSCA	1/2" Port	
086005	VGECAP1	1" Supply	

### MANABLOC®/MiniBloc™ - Compression Accessory

- For use with MANABLOC® compression fittings
- Zero Lead™

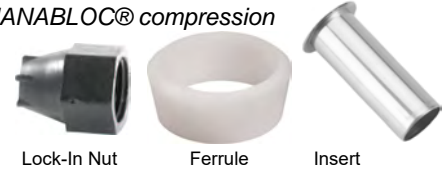

Part #	Mfg #	Size	Price
147224	12VPLOCKINNUT	1/2" Lock-in Nut	
112781	12VPLIINSERT	1/2" Lock-in Insert	
112780	12VPFERRULE	1/2" Ferrule	
112779	12VPINSERT	1/2" SS Insert Stiffener	

### MANABLOC® Valve Stem Replacement Kit

- Red valve, blue valve, valve removal tool, T-handle valve key



Part #	Mfg #	Description	Price
204706	VG51602	For ManaBloc & MiniBloc valve stems, ports 1/2" or 3/8"	

### ProRadiant™ Manifold Accessories

#### Viega PEX Press Sleeve (Press)

- Stainless steel
- For use with Viega PEX Press fittings and tools only



Part #	Mfg #	Size	Price
099867	34VPCS	3/4"	

## Watts-PEX Fittings

### Copper Manifolds

#### Closed End x 1" Swaged End Manifold

- 1" Diameter manifold trunks are closed at one end and swaged to accept 1" copper at the other
- 3/8" x 1/2" Brass CrimpRing™ fittings, with or without 1/4-turn brass mini ball valves (MBV)
- Branches are 2" O.C.
- Manifolds are sold individually
- Order one for hot and one for cold

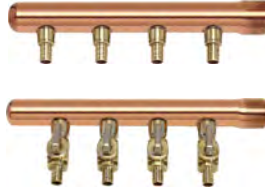

Part #	Mfg#	Description	Price
161078	1WPMF412LF	4 Port x 1/2" CF	
159387	1WPMF412MBVLF	4 Port x 1/2" CF/MBV	
160795	1WPMF612LF	6 Port x 1/2" CF	
159388	1WPMF612MBVLF	6 Port x 1/2" CF/MBV	
161028	1WPMF812LF	8 Port x 1/2" CF	
159389	1WPMF812MBVLF	8 Port x 1/2" CF/MBV	
160794	1WPMF1012LF	10 Port x 1/2" CF	
159390	1WPMF1012MBVLF	10 Port x 1/2" CF/MBV	
160945	1WPMF1212LF	12 Port x 1/2" CF	
159391	1WPMF1212MBVLF	0121108 12 Port x 1/2" CF/MBV	

### PEX Manifold Bracket



Part #	Mfg#	Description	Price
075788	WPMANBRACKET	2-Pack	

### Ball Valves

#### Full Port Ball Valves

- 600# PSI In-Line Crimp x Crimp
- Lead Free



Part #	Mfg#	Size	Price
158445	12WPBVLF	1/2" PEX	
158433	34WPBVLF	3/4" PEX	
158446	1WPBVLF	1" PEX	

### Brass PEX Fittings

#### CrimpRing™ x Threaded Adapter



WP12B



WP13B

Part #	Mfg#	Size	Price
075755	3812WPMA	3/8" CF x 1/2" MPT	
075608	12WPMA	1/2" CF x 1/2" MPT	
075609	1234WPMA	1/2" CF x 3/4" MPT	
075610	3412WPMA	3/4" CF x 1/2" MPT	
085989	34WPMA	3/4" CF x 3/4" MPT	
081708	341WPMA	3/4" CF x 1" MPT	
084978	134WPMA	1" CF x 3/4" MPT	
084980	1WPMA	1" CF x 1" MPT	
169767	1141WPMALF	1-1/4" CF x 1" MPT	
075611	12WPFA	1/2" CF x 1/2" FIP	
110680	1234WPFA	1/2" CF x 3/4" FIP	
075612	34WPFA	3/4" CF x 3/4" FIP	
169771	114WPFALF	1-1/4" CF x 1-1/4" C	
101029	1WPFA	1" CF x 1" FIP	

#### CrimpRing™ Sweat Adapter



Part #	Mfg#	Size	Price
075754	3812WPCMSA	1/2" M SWT x 3/8" CF	
075587	12WPCMSALF	1/2" M SWT x 1/2" CF	
075605	34WPCMSA	3/4" M SWT x 3/4" CF	
079969	1WPCMSA	1" M SWT x 1" CF	
169758	1114WPMSALF	1" M SWT x 1-1/4" CR	
169759	114WPMSALF	1-1/4" M SWT x 1-1/4" CF	
075606	12WPCFSA	1/2" F SWT x 1/2" CF	
075607	34WPCFSA	3/4" F SWT x 3/4" CF	
077558	1WPCFSA	1" F SWT x 1" CF	
169754	1114WPFSA	1" F SWT x 1-1/4" CF	
169755	114WPFSA	1-1/4" F SWT x 1-1/4" CF	



## Watts-PEX Fittings

### Close Ear CinchClamp



Part#	Mfg#	Size	Price
152384	12WPCINCHCLCE	1/2"	
152387	34WPCINCHCLCE	3/4"	
152388	34WPCINCL100CE	3/4"	

### Stainless Steel CinchClamps™

- Perfect for connecting PEX to crimp-style fittings in hard-to-reach spaces
- Pinch tab closed with CinchTool™
- Do not use with wrought copper PEX fittings



Part#	Mfg#	Size	Price
079227	38WPCINCHCLAMP	3/8"	
128288	12WPCINCHCL100	1/2"	
079229	12WPCINCHCLAMP	1/2"	
128287	34WPCINCHCL100	3/4"	
079230	34WPCINCHCLAMP	3/4"	
079231	1WPCINCHCLAMP	1"	

### Copper PEX CrimpRing™



Part#	Mfg#	Size	Price
075756	38WPCRIMPRING	3/8"	
075613	12WPCRIMPRING	1/2"	
075614	34WPCRIMPRING	3/4"	
077557	1WPCRIMPRING	1"	
169777	114WPCRIMPRING	1-1/4"	
169778	112WPCRIMPRING	1-1/2"	

### CrimpRing™ Coupling



Part#	Mfg#	Size	Price
075615	12WPCP	1/2" CF x 1/2" CF	
161107	1238WPCP	1/2" CF x 3/8" CF	

### Brass PEX Fittings (Continued)

#### CrimpRing™ Coupling

Part#	Mfg#	Size	Price
081709	3412WPCP	3/4" CF x 1/2" CF	
075616	34WPCP	3/4" CF x 3/4" CF	
084977	134WPCP	1" CF x 3/4" CF	
077556	1WPCP	1" CF x 1" CF	
169747	114WPCPLF	1-1/4"CF x 1-1/4"CF	

#### CrimpRing™ Tee



Part #	Mfg#	Size	Price
075617	12WPT	1/2" x 1/2" x 1/2"	
075618	121234WPT	1/2" x 1/2" x 3/4"	
075622	34WPT	3/4" x 3/4" x 3/4"	
075619	341212WPT	3/4" x 1/2" x 1/2"	
075620	341234WPT	3/4" x 1/2" x 3/4"	
075621	343412WPT	3/4" x 3/4" x 1/2"	
084979	13434WPT	1" x 3/4" x 3/4"	
077553	1112WPT	1" x 1" x 1/2"	
077554	1134WPT	1" x 1" x 3/4"	
077555	1WPT	1" x 1" x 1"	
169735	1141141WPTLF	1-1/4" x 1-1/4" x 1"	
169737	114WPTLF	1-1/4" x 1-1/4" x 1-1/4"	

#### CrimpRing™ Elbow - Crimp x Crimp



Part#	Mfg#	Size	Price
075759	38WP90	3/8" x 3/8"	
075623	12WP90	1/2" x 1/2"	
100581	1234WP90	3/4" x 1/2"	
075624	34WP90	3/4" x 3/4"	
081151	1WP90	1" x 1"	
169743	114WP90LF	1-1/4"	

## Watts-PEX Fittings

### CrimpRing™ Elbow - Crimp x MIP



Part#	Mfg#	Size	Price
100585	12WPCM90	1/2" CF x 1/2" MIP	

### Drop Ear Elbow



Part#	Mfg#	Size	Price
075789	3812WPDE90	3/8" CF x 1/2" FIP	
104527	34WPDE90	3/4" CF x 3/4" FIP	
075790	12WPDE90	1/2" CF x 1/2" FIP	

### CrimpRing™ Test Plug



Part#	Mfg#	Size	Price
075625	12WPPLUG	1/2" CF	
075626	34WPPLUG	3/4" CF	
084981	1WPPLUG	1" CF	

### Poly-Alloy Fittings

#### Poly-Alloy CrimpRing™ x MIP Adapter



Part #	Mfg#	Size	Price
137432	12WPPMABAG10	1/2" CF x 1/2" MIP	
137433	34WPPMABAG10	3/4" CF x 3/4" MIP	

### Poly-Alloy CrimpRing™ Coupling



Part #	Mfg#	Size	Price
128207	12WPPCPBAG10	1/2" CF x 1/2" CF	
122547	3412WPPCPBAG10	3/4" CF x 1/2" CF	
128209	34WPPCPBAG10	3/4" CF x 3/4" CF	
137430	134WPPCPBAG10	1" CF x 3/4" CF	
137429	1WPPCPBAG10	1" CF x 1" CF	

### Poly-Alloy CrimpRing™ Elbow



Part #	Mfg#	Size	Price
128212	12WPP90BAG10	1/2" CF x 1/2" CF	
128213	34WPP90BAG10	3/4" CF x 3/4" CF	
137428	1WPP90BAG10	1" CF x 1" CF	

### Poly-Alloy CrimpRing™ Tee



Part #	Mfg#	Size	Price
128214	12WPPTBAG10	1/2" x 1/2" x 1/2"	
137435	121234WPPTBAG10	1/2" x 1/2" x 3/4"	
122682	341212WPPT	3/4" x 1/2" x 1/2"	
128218	341212WPPTBAG10	3/4" x 1/2" x 1/2"	
122681	341234WPPT	3/4" x 1/2" x 3/4"	
128217	341234WPPTBAG10	3/4" x 1/2" x 3/4"	
122683	343412WPPT	3/4" x 3/4" x 1/2"	
128216	343412WPPTBAG10	3/4" x 3/4" x 1/2"	
128215	34WPPTBAG10	3/4" x 3/4" x 3/4"	
137436	34341WPPTBAG10	3/4" x 3/4" x 1"	
137438	13434WPPTBAG10	1" x 3/4" x 3/4"	
137437	1112WPPTBAG10	1" x 1" x 1/2"	
137439	1134WPPTBAG10	1" x 1" x 3/4"	
137434	1WPPTBAG5	1" x 1" x 1"	



## Watts-PEX Fittings

### Poly Alloy Angle Swivel Coupling



Part #	Mfg#	Size	Price
130466	12WPPFEMSWIV90	1/2" CF x 1/2" FIP	

### Poly Alloy Test Plug



Part #	Mfg#	Size	Price
128586	12WPPPL	1/2" CF	
128587	34WPPPL	3/4" CF	
085994	1WPPPL	1" CF	

### Fasteners

#### Stub-Out Elbow - Copper



Part #	Mfg#	Size	Price
075628	12WPSO8	1/2" x 8"	
082944	12WPSOE8	1/2"CFx1/2"Nom 8" Eared Strap	

### SnapClip™ for WaterPEX® Tubing

- Can be used with or without ClipRails™
- Can be interlocked for a very tight arrangement
- Anchor them with a single screw through base (screws not included)



Part #	Mfg#	Size	Price
101851	12WPSC	1/2"	
101853	34WPSC	3/4"	

### Supply Lines & Fittings

#### Washing Machine Valve & Box

- Comes complete with two individual 1/4-turn brass valves and white protective enclosure with faceplate
- Valves are fitted for standard washing machine hose and 1/2" WaterPEX® CrimpRing™ fittings
- Design allows for left, center or right valve and waste mounting
- 6-1/2" x 7-5/8" x 3" Enclosure
- Comes complete with brackets for nailing to house framing
- Hoses sold separately



Part #	Mfg#	Description	Price
075634	12WPWMB	Valve And Enclosure	

#### Ice Maker Valve & Box

- Comes complete with one 1/4-turn brass valve and white protective enclosure with faceplate
- Valves are fitted for standard 1/4" compression ice maker and 1/2" WaterPEX® CrimpRing™ fitting
- The 5-3/16" x 5-3/16" x 2-1/2" enclosure nails directly to house framing



Part #	Mfg#	Description	Price
157731	12WPIMBLF	Valve and Enclosure	
156549	12WPIMVANGLF	Valve Only	

### Tools

#### CinchClamp™ Tool



WPCCT-2



WPCCT-6

Part #	Mfg#	Description	Price
079232	WPCINCHTOOL	Tool w/Holster & Gauge	
109528	WTWPCCT6	Ratcheting, 1/2" - 1"	

**Watts-PEX Fittings**

**CrimpMaster™ Crimp Tool**



WPCMT-08PB and

Part #	Mfg#	Size	Price
075631	12WPCRIMPTOOL	1/2"	
075632	34WPCRIMPTOOL	3/4"	

**CrimpRing™ Removal Tool**



Part #	Mfg#	Description	Price
101723	WTWPCRT1	Crimp Ring Remover	

## Watts-PEX Fittings

### PEX Fittings

#### Copper Coupling

- Tube stops formed into each fitting
- 1-Piece solid copper



Part #	Mfg #	PEX x PEX	Price
099284	645X12PK2	3/8" x 1/2"	

### PowerPEX®—ASTM F1807

#### PowerPEX® F1807 Brass Straight Adapter

Part #	Mfg #	PEX x MSwt	Price
141348	643XB2	1/2" x 1/2"	

#### PowerPEX® F1807 Copper Straight Adapter

- PEX x Male Sweat
- One-piece solid copper



643X20

Part #	Mfg #	PEX x MSwt	Price
230871	643X23	3/4" x 1/2"	

#### PowerPEX® F1807 No Lead Copper Elbow Adapter

- Tube stops formed into each fitting
- Longer radius bend for increased flow characteristics



Part #	Mfg #	PEX x PEX	Price
089534	642X2	1/2" x 1/2"	
096271	642X3	3/4" x 3/4"	

#### PowerPEX® F1807 No Lead Faucet Straight Adapter

- Easily connects PEX to faucet thread
- Copper component is available individually
- High impact FIP swivel nut includes nose cone gasket



637X1

Part #	Mfg #	PEX x FIP Swivel	Price
183733	637X10	3/8" x 1/2"	
183734	637X20	1/2" x 1/2"	

#### PowerPEX® F1807 Ballcock Straight Adapter

- No lead
- Easily connects PEX to ball cock thread
- Ballcock swivel nut includes nose cone gasket

Part #	Mfg #	PEX x Swivel Ballcock	Price
183735	637X420	1/2"	

#### PowerPEX® F1807 Ballcock Elbow Adapter

- No lead
- Easily connects PEX to ball cock thread
- Swivel ball cock nut includes nose cone gasket
- Long radius elbow fitting for smoother flow

Part #	Mfg #	PEX x Swivel Ballcock	Price
183738	637X423PK	1/2"	

#### PowerPEX® F1807 Tub/Shower Elbow Adapter (Drop-Ear Model)

- Lead-free solder joint
- Internal 1/2" FIP thread for shower arm or tub nipple
- For use on shower risers, tub spouts and non-pressure fitting applications

Part #	Mfg #	F1807 PEX x FIP	Price
183764	647X23E	3/4" x 1/2"	
165006	642XG23	3/4" x 1/2", No Lead	

#### PowerPEX® F1807 Brass Elbow



Part #	Mfg #	PEX x PEX	Price
146099	642XB2	1/2" x 1/2"	
145167	642XB3	3/4" x 1/2"	

### PowerPEX®—ASTM F1960

#### PowerPEX® F1960 Male Swt Brass Straight Adapter

- Male sweat x PEX
- Full flow—no restriction
- One-piece no lead brass

Part #	Mfg #	F1960 PEX x MSwt	Price
227461	643WG32	1/2" x 3/4"	

### F2159 AccuCrimp™ Fittings

#### PowerPEX® AccuCrimp™ F2159 Tee—Lead Free

- Wide selection of tee configurations
- Tabs perfectly position crimp ring or sleeve over sealing barbs every time



F2159

Part #	Mfg #	Description	Price
226722	641PX222	1/2" x 1/2" x 1/2"	
230196	641PX332	3/4" x 3/4" x 1/2"	

## Watts-PEX Fittings

### F2159 AccuCrimp™ Fittings (Continued)

**PowerPEX® AccuCrimp™ F2159 Tee—Lead Free F2159**

Part #	Mfg #	Description	Price
231386	641PX433	1" x 3/4" x 3/4"	

#### AccuCrimp

Part #	Mfg #	Description	Price
231042	641XP322	3/4" x 1/2" x 1/2"	
226724	641XP333	3/4" x 3/4" x 3/4"	
226726	641XP442	1" x 1" x 1/2"	
226728	641XP443	1" x 1" x 3/4"	
226725	641XP444	1" x 1" x 1"	

### PowerPEX® F2159 AccuCrimp™ Elbow Directional



- No lead
- Tabs perfectly position crimping or sleeve over sealing barbs every time
- Use elbows when a tight radius 90° turn is needed

Part #	Mfg #	PEX x PEX	Price
226718	642XP2	1/2" x 1/2"	
183742	642XP4	1" x 1"	

### PowerPEX® AccuCrimp™ F2159 Coupling

- Tabs perfectly position crimp ring or sleeve over sealing barbs every time
- No lead

645PX3



Part #	Mfg #	Connection	Price
230197	645PX2	1/2" x 1/2" F2159	
226758	645PX3	3/4" x 3/4" F2159	
226721	645XP32	3/4" x 1/2" AccuCrimp	
183760	645XP43	1" x 3/4" AccuCrimp	
229467	645PX42	1" x 1/2" F2159	

### PowerPEX® AccuCrimp™ F2159 Plug

- Tabs perfectly position crimp ring or sleeve over sealing barbs every time
- No lead



Part #	Mfg #	Connection	Price
231392	640PX12	1/2" F2159	
231391	640PX13	3/4" F2159	
231390	640PX14	1" F2159	

## Watts Quick Connect Fittings

### KwikStop Stop Valves

#### KwikStop Angle 1/4-Turn Water Supply Stop

- Quick-connect technology
- For use on copper, CPVC or PEX
- NSF, UPC and CSA Approved



Part #	Mfg #	Model	Size	Price
123687	1238QCASV	QC894A	1/2" x 3/8"	

#### KwikStop Straight 1/4-Turn Water Supply Stop

- Quick-connect technology
- For use on copper, CPVC or PEX
- NSF, UPC and CSA Approved



Part #	Mfg #	Model	Size	Price
123688	1238QCSSV	QC894S	1/2" x 3/8"	

### Quick - Connect Polysulfone Fittings

#### Valve Tee

- Poly sulfone



Part #	Mfg #	Model	Size	Price
172087	1214QCPTV	LF3550B	1/2" CTS x 1/4" OD	

#### End Stop

- Polysulfone
- Lead-free



Part #	Mfg #	Model	Size	Price
052039	JGENDSTOP14	1045B04	1/4" OD	

## Weld Fittings

### Standard Weight Weld Fittings

#### 90° Long Radius Elbow

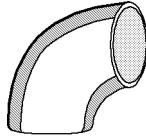

Part #	Mfg.#	Size	Price
013214	12WLR90	1/2"	
014779	34WLR90	3/4"	
012293	1WLR90	1"	
012877	114WLR90	1-1/4"	
012554	112WLR90	1-1/2"	
013944	2WLR90	2"	
014120	212WLR90	2-1/2"	
014456	3WLR90	3"	
015344	4WLR90	4"	
015695	6WLR90	6"	
015832	8WLR90	8"	

#### 90° Short Radius Elbow

Part #	Mfg.#	Size	Price
168978	112WSR90	1-1/2"	
072525	2WSR90	2"	
168561	212WSR90	2-1/2"	
168562	3WSR90	3"	
168563	4WSR90	4"	
068379	6WSR90	6"	
068380	8WSR90	8"	
025307	10WSR90	10"	

#### 45° Long Radius Elbow

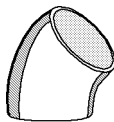

Part #	Mfg.#	Size	Price
174866	12WLR45	1/2"	
012556	112WLR45	1-1/2"	
013943	2WLR45	2"	
014119	212W45	2-1/2"	
014455	3WLR45	3"	
015343	4WLR45	4"	
015529	5WLR45	5"	
015694	6WLR45	6"	
015831	8WLR45	8"	

### Tee

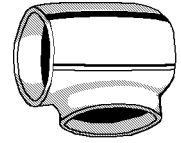

Part #	Mfg.#	Size	Price
014780	34WT	3/4"	
012294	1WT	1"	
012878	114WT	1-1/4"	
012555	112WT	1-1/2"	
013948	2WT	2"	
014123	212WT	2-1/2"	
014460	3WT	3"	
015348	4WT	4"	
015698	6WT	6"	
015835	8WT	8"	
029629	10WT	10"	

### Reducing Tee

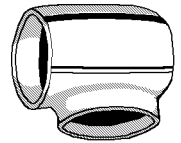

Part #	Mfg.#	Size	Price
024273	2121WT	2-1/2" x 2-1/2" x 1"	
020177	2122WT	2-1/2" x 2-1/2" x 2"	
014550	32WT	3" x 3" x 2"	
032915	4212WT	4" x 4" x 2-1/2"	
015463	43WT	4" x 4" x 3"	
029624	53WT	5" x 5" x 3"	
029625	63WT	6" x 6" x 3"	
015739	64WT	6" x 6" x 4"	
029626	65WT	6" x 6" x 5"	
029628	86WT	8" x 8" x 6"	

### Concentric Reducer

Part #	Mfg.#	Size	Price
020178	11234WCR	1-1/2" x 3/4"	
012576	1121WCR	1-1/2" x 1"	
013971	21WCR	2" x 1"	
014047	2114WCR	2" x 1-1/4"	
014011	2112WCR	2" x 1-1/2"	
029612	212114WCR	2-1/2" x 1-1/4"	
014137	212112WCR	2-1/2" x 1-1/2"	
014159	2122WCR	2-1/2" x 2"	
014496	3112WCR	3" x 1-1/2"	



## Weld Fittings

### Standard Weight Weld Fittings (Continued)

#### Concentric Reducer

Part #	Mfg.#	Size	Price
014548	32WCR	3" x 2"	
014561	3212WCR	3" x 2-1/2"	
015368	4112WCR	4" x 1-1/2"	
015410	42WCR	4" x 2"	
015417	4212WCR	4" x 2-1/2"	
015461	43WCR	4" x 3"	
015549	54WCR	5" x 4"	
015737	64WCR	6" x 4"	
015744	65WCR	6" x 5"	
029621	84WCR	8" x 4"	

#### Eccentric Reducer

Part #	Mfg.#	Size	Price
012642	112114WER	1-1/2" x 1-1/4"	
014012	2112WER	2" x 1-1/2"	
014143	212114WER	2-1/2" x 1-1/4"	
014138	212112WER	2-1/2" x 1-1/2"	
014160	2122WER	2-1/2" x 2"	
014497	3112WER	3" x 1-1/2"	
014549	32WER	3" x 2"	
014562	3212WER	3" x 2-1/2"	
015411	42WER	4" x 2"	
015418	4212WER	4" x 2-1/2"	
015462	43WER	4" x 3"	

#### Cap

Part #	Mfg.#	Size	Price
012876	114WCA	1-1/4"	
012553	112WCA	1-1/2"	
013942	2WCA	2"	
014118	212WCA	2-1/2"	
014454	3WCA	3"	
015342	4WCA	4"	
015693	6WCA	6"	
015830	8WCA	8"	
025163	12WCA	12"	

### #150 Raised Face Flanges

#### Slip-On

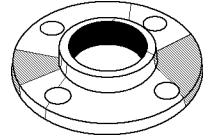

Part #	Mfg.#	Size	Price
013946	2WSOFRF	2"	
014122	212WSOFRF	2-1/2"	
014459	3WSOFRF	3"	
015346	4WSOFRF	4"	
015531	5WSOFRF	5"	
015697	6WSOFRF	6"	
015833	8WSOFRF	8"	
018778	10WSOFRF	10"	

#### Blind

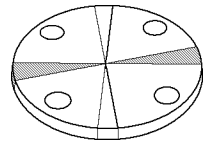

Part #	Mfg.#	Size	Price
028206	212WBFRF	2-1/2"	
014453	3WBFRF	3"	
015341	4WBFRF	4"	
020187	5WBFRF	5"	
015692	6WBFRF	6"	
029622	8WBFRF	8"	

#### Weldneck

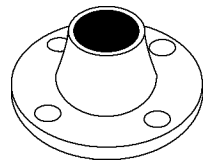

Part #	Mfg.#	Size	Price
013945	2WNFRF	2"	
014121	212WNFRF	2-1/2"	
014457	3WNFRF	3"	
015345	4WNFRF	4"	
015696	6WNFRF	6"	
012319	10WNFRF	10"	

#### Threaded

Part #	Mfg.#	Size	Price
154570	2WTFR	2"	
162550	3WTFRF	3"	



---

---

## Weld Fittings

---

---

### #150 Raised Face Flanges (Continued)

Threaded

Part #	Mfg.#	Size	Price
162551	4WTFRF	4"	

---



---

**Weld Fittings**

---



---

**Forged Steel O-Lets**

**Class 3000 Forged Steel Thread-O-Let**

Part #	Mfg #	Outlet Size	Nom Run Pipe Size	Price
070470	TOL12UNIVERSAL	1/2"	1/2"	
055925	TOL34UNIVERSAL	3/4"	3/4"	
055927	TOL1UNIVERSAL	1"	1"	
055940	TOL114UNIVERSA L	1-1/4"	1-1/4"	
055945	TOL112UNIVERSA L	1-1/2"	1-1/2"	
055944	TOL1123124	1-1/2"	4 - 3-1/2"	
055951	TOL2UNIVERSAL	2"	2"	

## Zurn-PEX Fittings

### Poly PEX Fittings

#### Qick Sert CR® Polymer Swivel Adapter

- Molded from highly engineered polymers
- Used in hot and cold potable water applications
- Low-Lead Compliant



Part #	Mfg #	Size	Price
197272	QQPSFC33X	1/2" Barb x 1/2" FPT	
197273	QQPSFC44X	3/4" Barb x 3/4" FPT	

#### Qick Sert CR® Polymer Swivel Elbow

- Molded from highly engineered polymers
- Used in hot and cold potable water applications
- Low-Lead Compliant



Part #	Mfg #	Size	Price
197274	QQPE33BSX	1/2" Barb x 1/2" FPT	
197275	QQPE44BSX	3/4" Barb x 3/4" FPT	

#### QickTite® Assembled Elbow

- For use with PEX, copper, CPVC, and polybutylene
- Used in potable water systems only.



Part #	Mfg #	Size	Price
193030	QAE33	1/2" CTS	
193031	QAE44	3/4" CTS	

#### Qick Sert CR® Polymer Male Adapter

- Molded from highly engineered polymers
- Used in hot and cold potable water applications
- Low-Lead Compliant



Part #	Mfg #	Size	Price
197253	QQPMC33X	1/2" Barb x 1/2" MPT	
197254	QQPMC34X	1/2" Barb x 3/4" MPT	
197255	QQPMC44X	3/4" Barb x 3/4" MPT	

### Qick Sert CR® Polymer Coupling

- Molded from highly engineered polymers
- Low-lead compliant



Part #	Mfg #	Size	Price
197248	QQPC33X	1/2" Barb	
197250	QQPC44X	3/4" Barb	
197249	QQPC43X	3/4" Barb x 1/2" Barb	
197251	QQPC54X	1" Barb x 3/4" Barb	
197252	QQPC55X	1" Barb	
235431	QQPC75X	1-1/2" Barb x 1" Barb	
235434	QQPC77X	1-1/2" Barb	
235429	QQPC87X	2" Barb x 1-1/2" Barb	
235433	QQPC88X	2" Barb	

#### Qick Sert CR® Polymer 90° Elbow

- Molded from highly engineered polymers
- Low-lead compliant



Part #	Mfg #	Size	Price
197258	QQPE33X	1/2" Barb	
197260	QQPE44X	3/4" Barb	
197259	QQPE43X	3/4" Barb x 1/2" Barb	
197261	QQPE55X	1" Barb	
235432	QQPE77X	1-1/2" Barb	
235427	QQPE88X	2" Barb	

#### Qick Sert CR® Polymer Adapter 90° Elbow

- Molded from highly engineered polymers
- Used in hot and cold potable water applications
- Low-Lead Compliant



Part #	Mfg #	Size	Price
197256	QQPE33BTX	1/2" Barb x 1/2" MPT	
197257	QQPE44BTX	3/4" Barb x 3/4" MPT	

## Zurn-PEX Fittings

### Quick Sert CR® Polymer Tee

- Molded from highly engineered polymers
- Low-lead compliant



Part #	Mfg #	Size	Price
197262	QQPT333X	1/2" Barb x 1/2" Barb x 1/2" Barb	
197263	QQPT334X	1/2" Barb x 1/2" Barb x 3/4" Barb	
197264	QQPT433X	3/4" Barb x 1/2" Barb x 1/2" Barb	
197265	QQPT434X	3/4" Barb x 1/2" Barb x 3/4" Barb	
197266	QQPT443X	3/4" Barb x 3/4" Barb x 1/2" Barb	
197267	QQPT444X	3/4" Barb x 3/4" Barb x 3/4" Barb	
240754	QQPT445X	3/4" Barb x 3/4" Barb x 1" Barb	
197268	QQPT553X	1" Barb x 1" Barb x 1/2" Barb	
197270	QQPT554X	1" Barb x 1" Barb x 3/4" Barb	
197271	QQPT555X	1" Barb x 1" Barb x 1" Barb	
197269	QQPT544X	1" Barb x 3/4" Barb x 3/4" Barb	
235430	QQPT775X	1-1/2" Barbx1-1/2" Barbx1" Barb	
235428	QQPT885X	2" Barb x 2" Barb x 1" Barb	
248134	QQPT888X	2" Barb x 2" Barb x 2" Barb	

### QuickTite® Assembled Coupling

- For use with PEX, copper, CPVC, and polybutylene
- Use in potable water systems only.



Part #	Mfg #	Size	Price
193037	QAC21	3/8" CTS x 1/4" CTS	
193038	QAC22	3/8" CTS	
193035	QAC32	1/2" CTS x 3/8" CTS	
193039	QAC33	1/2" CTS	
193040	QAC43	3/4" CTS x 1/2" CTS	
193041	QAC44	3/4" CTS	

### QuickTite® Assembled Tee

- For use with PEX, copper, CPVC, and polybutylene
- Used in potable water systems only.



Part #	Mfg #	Size	Price
193021	QAT222	3/8" CTS	
193026	QAT333	1/2" CTS x 1/2" CTS x 3/8" CTS	
193027	QAT433	3/4" CTS x 1/2" CTS x 1/2" CTS	
193028	QAT443	3/4" CTS x 3/4" CTS x 1/2" CTS	
193029	QAT444	3/4" CTS	

### Copper PEX Fittings

#### Copper Female Sweat Adapter

- For use with PEX hot and cold water plumbing applications
- Low-lead compliant



Part #	Mfg #	Size	Price
201345	QQ750CX	1/2" Swt x 1/2" Barb	
201401	QQ775CX	3/4" Swt x 3/4" Barb	
201346	QQ800CX	1" Swt x 1" Barb	

#### Copper Male Sweat Adapter

- Low-lead compliant



Part #	Mfg #	Size	Price
201344	QQ700CX	1" Swt x 1" Barb	

#### Copper Sweat Adapter

- Low-lead compliant



Part #	Mfg #	Size	Price
201399	QQ650CX	1/2" Male Swt x 1/2" Barb	
201400	QQ675CX	3/4" Male Swt x 3/4" Barb	

## Zurn-PEX Fittings

### Brass PEX Fittings

#### XL Brass Drop Ear 90° Elbow

- Low-lead compliant



Part #	Mfg #	Size	Price
201371	QQDE33BFG X	1/2" FNPT x 1/2" Barb	
201373	QQDE44BFG X	3/4" FNPT x 3/4" Barb	

#### XL Brass 90° Elbow

- Low-lead compliant



Part #	Mfg #	Size	Price
201264	QQE33GX	1/2" Barb	
201266	QQE44GX	3/4" Barb	
201265	QQE43GX	3/4" Barb x 1/2" Barb	
201267	QQE55GX	1" Barb	
234518	QQE66GX	1-1/4" Barb	
233983	QQE88GX	2" Barb	

#### XL Brass Male 90° Elbow

- Used in PEX hot and cold water plumbing applications
- Easy installation
- Low-lead compliant



Part #	Mfg #	Size	Price
201263	QQE33BTGX	1/2" Barb x 1/2" MPT	

#### XL Brass Tee

- Low-lead compliant



Part #	Mfg #	Size	Price
201278	QQT333GX	1/2" Barb x 1/2" Barb x 1/2" Barb	
201398	QQT334GX	1/2 Barb x 1/2" Barb x 3/4" Barb	

### Brass PEX Fittings (Continued)

#### XL Brass Tee

Part #	Mfg #	Size	Price
201273	QQT433GX	3/4" Barb x 1/2" Barb x 1/2" Barb	
201358	QQT434GX	3/4" Barb x 1/2" Barb x 3/4" Barb	
201279	QQT443GX	3/4" Barb x 3/4" Barb x 1/2" Barb	
201282	QQT444GX	3/4" Barb x 3/4" Barb x 3/4" Barb	
201367	QQT553GX	1" Barb x 1" Barb x 1/2" Barb	
201364	QQT554GX	1" Barb x 1" Barb x 3/4" Barb	
201365	QQT555GX	1" Barb x 1" Barb x 1" Barb	
234513	QQT663GX	1-1/4"Barbx1-1/4"Barbx1/2"Barb	
234512	QQT664GX	1-1/4"Barbx1-1/4"Barbx3/4"Barb	
234511	QQT665GX	1-1/4"Barbx1-1/4"Barbx1"Barb	
234510	QQT666GX	1-1/4" Barb	
234507	QQT773GX	1-1/2"Barbx1-1/2"Barbx1/2"Barb	
234508	QQT774GX	1-1/2"Barbx1-1/2"Barbx3/4"Barb	
234506	QQT777GX	1-1/2" Barb	
233988	QQT883GX	2" Barb x 2" Barb x 1/2" Barb	
233985	QQT884GX	2" Barb x 2" Barb x 3/4" Barb	

#### XL Brass Test Plug



Part #	Mfg #	Size	Price
201276	QQP3GX	1/2" Barb	
201277	QQP4GX	3/4" Barb	
201355	QQP5GX	1" Barb	

#### XL Brass Sweat Adapter

- Used in PEX hot and cold water plumbing applications
- Easy to install
- Low-lead compliant



Part #	Mfg #	Size	Price
234509	QQ900GX	1-1/2" Male Swt x 1-1/2" Barb	



## Zurn-PEX Fittings

### XL Brass Male Adapter

- Used in PEX hot and cold water plumbing applications
- Easy to install
- Low-lead compliant



Part #	Mfg #	Size	Price
201268	QQMC33GX	1/2" Barb x 1/2" MPT	
201269	QQMC34GX	1/2" Barb x 3/4" MPT	
201270	QQMC43GX	3/4" Barb x 1/2" MPT	
201271	QQMC44GX	3/4" Barb x 3/4" MPT	
201369	QQMC54GX	1" Barb x 3/4" MPT	
201370	QQMC55GX	1" Barb x 1" MPT	
234516	QQMC66GX	1-1/4" Barb x 1-1/4" MPT	

### XL Brass Female Adapter



Part #	Mfg #	Size	Price
201274	QQUFC33GX	1/2" Barb x 1/2" FPT	
201368	QQUFC34GX	1/2" Barb x 3/4" FPT	
201275	QQUFC44GX	3/4" Barb x 3/4" FPT	
201374	QQUFC55GX	1" Barb x 1" FPT	
234517	QQUFC66GX	1-1/4" Barb x 1-1/4" FPT	
233987	QQUFC88GX	2" Barb x 2" FPT	

### XL Brass Coupling

- Used in PEX hot and cold water plumbing applications
- Easy installation
- Low-lead compliant



Part #	Mfg #	Size	Price
201262	QQC33GX	1/2" Barb	
201359	QQC43GX	3/4" Barb x 1/2" Barb	
201356	QQC44GX	3/4" Barb	
201363	QQC54GX	1" Barb x 3/4" Barb	
201362	QQC55GX	1" Barb	
234525	QQC65GX	1-1/4" Barb x 1" Barb	
234535	QQC66GX	1-1/4" Barb	
234536	QQC74GX	1-1/2" Barb x 3/4" Barb	
234537	QQC75GX	1-1/2" Barb x 1/2" Barb	
234538	QQC76GX	1-1/2" Barb x 1-1/4" Barb	

### Brass PEX Fittings (Continued)

#### XL Brass Coupling

Part #	Mfg #	Size	Price
234540	QQC85GX	2" Barb x 1" Barb	
234542	QQC86GX	2" Barb x 1-1/4" Barb	
234544	QQC88GX	2" Barb	

#### Brass Swivel Elbow

- Used in PEX hot and cold water plumbing applications
- Easy installation
- Low-lead compliant



Part #	Mfg #	Size	Price
192999	QQE33BSGX	1/2" x 1/2" Barb	

#### XL Brass Non-Swivel Large Diameter Female Adapter

- Used in PEX hot and cold water plumbing applications
- Easy to Install
- Low-Lead Compliant
- Dezincification resistant



Part #	Mfg #	Size	Price
212602	QQUFC77GX	1-1/2" Barb x 1-1/2" FPT	

#### QuickTite Male Assembled Adapter Coupling

- For use with PEX, copper, CPVC, and polybutylene
- Use in potable water systems only.



Part #	Mfg #	Size	Price
201353	QACA33MG	1/2" CTS x 1/2" MIP	
201354	QACA34MG	1/2" CTS x 3/4" MIP	
193042	QACA44MG	3/4" CTS x 3/4" MIP	

#### XL Brass Swivel Adapter



Part #	Mfg #	Size	Price
201375	QQSFC44GX	3/4" Barb x 3/4" Female Swivel	
201376	QQSFC45GX	3/4" Barb x 1" Female Swivel	

## Zurn-PEX Fittings

### Brass PEX Fittings (Continued)

#### XL Brass Swivel Adapter

Part #	Mfg #	Size	Price
201377	QQSFC55GX	1" Barb x 1" Female Swivel	

#### XL Brass Swivel Cone

- Used in PEX hot and cold water plumbing applications
- Easy to Install
- Low-Lead Compliant



Part #	Mfg #	Size	Price
192998	QQSFC33GX P	1/2" Barb x 1/2" FPT	

#### Transition Coupling

- Brass PEX to PB
- Used in PEX hot and cold water plumbing applications
- Easy to install
- Dezincification resistant



Part #	Mfg #	Size	Price
201342	QQC33CCXN PK1	1/2" Barb	
201343	QQC44CCXN PK1	3/4" Barb	

#### XL Brass Stop Angle Valve

- Used in PEX hot and cold water plumbing applications
- Quarter turn
- Quarter turn valve
- Low-Lead Compliant



Part #	Mfg #	Size	Price
205650	QQTV40GX	1/2" Barb x 1/4" OD	
201272	QQTV60GX	1/2" Barb x 3/8" OD	

#### XL Brass Compression Straight Stop Valve

- Used in PEX hot and cold water plumbing applications
- Quarter turn
- Easy turn tee handle
- Low-Lead Compliant



Part #	Mfg #	Size	Price
201711	QQTV60SGX	1/2" Barb x 3/8" OD	

### Manifolds

#### PEX Manifold

- Complete with supply and return isolation ball valves and automatic air vents
- Includes fill/drain valves and supply and return thermometers
- Rated for 150psi at a maximum temperature of 230°F
- Mounting brackets included

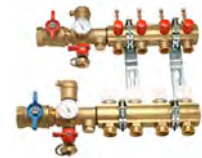

Part #	Mfg #	Size	Price
200489	QHPM10	10 Port	

#### QickPort Manifold Cap

- Add-A-Port manifold component
- Manufactured using highly engineered polymer
- Low-lead compliant



Part #	Mfg #	Size	Price
197692	QTC3FQP	1/2"	

#### QickPort® Female Assembled Adapter

- Add-A-Port manifold component
- Manufactured using highly engineered polymer
- Low-lead compliant



Part #	Mfg #	Size	Price
193036	QAFA33F	1/2" CTS x 1/2" FPT	
193034	QAFA44F	3/4" CTS x 3/4" FPT	

## Zurn-PEX Fittings

### Tools & Misc.

#### Test Plug

- Plastic Test Plug 1/2"
- Temporary use only



Part #	Mfg #	Size	Price
195961	QXP3XP	1/2" Barb	
197485	QXP4XP	3/4" Barb	
197486	QXP5XP	1" Barb	

#### Compression Plastic Ferrule

- Ferrules Compression Ring for Supply tube



Part #	Mfg #	Size	Price
191977	QBF0	1/4" OD	
191978	QBF1	3/8" OD	
193193	QBF2	1/2" OD	

#### QickCap® Crimp Ring

- Accurately positions crimp ring on tubing to ensure proper installation
- Quick and easy installation



Part #	Mfg #	Size	Price
228191	QCR3XPC	1/2"	
228194	QCR4XPC	3/4"	
228195	QCR5XPC	1"	

#### Qickclamp® Crimp Ring

- Patent-pending stainless steel technology
- One-tool system
- Indicator positioning site hole
- Used in PEX hot and cold water plumbing applications
- Easy installation



Part #	Mfg #	Size	Price
196361	QCLP3X	1/2"	
196362	QCLP4X	3/4"	

### Tools & Misc. (Continued)

#### Qickclamp® Crimp Ring

Part #	Mfg #	Size	Price
196363	QCLP5X	1"	

#### Stainless Steel Crimp Ring

- Stainless Steel Crimp Ring
- Utilizes one tool
- Used in hot and cold water plumbing applications



Part #	Mfg #	Size	Price
211083	QSOET3X	1/2"	
211084	QSOET4X	3/4"	
216018	QSOET5X	1"	

#### Copper Crimp Ring

- Annealed copper crimp ring
- For use with SDR9 tubing



Part #	Mfg #	Size	Price
193003	QCR2X	3/8"	
193004	QCR3X	1/2"	
193005	QCR4X	3/4"	
193006	QCR5X	1"	
212566	QCR7X	1-1/2"	
212601	QCR8X	2"	

#### QickTite® Nut/Ring/Cone Set

- For use with PEX, Copper, CPVC, and Polybutylene
- Use in potable water systems only.



Part #	Mfg #	Size	Price
193044	QBFNCR4	1" Thread - 3/4" Nominal CTS	

## Zurn-PEX Fittings

### Repair Kit QCRT\_CM Copper Crimp Ring Tool

- Compatible with QCRT2CM, QCRT3CM, QCRTJCM, QCRT4CM



Part #	Mfg #	Size	Price
227294	QCRTCMRK		

### Repair Kit for Medium QickClamp® Crimp Tool

- Compatible with QCRTQCM



Part #	Mfg #	Size	Price
230720	QCRTQCMRK	For Medium QickClamp® Tool IT	

### Lavatory Supply Tube

- Flexible
- Easy to install
- Low-lead compliant



Part #	Mfg #	Size	Price
191973	QBA12X	3/8" OD x 12"	
191974	QBA20X	3/8" OD x 20"	
191975	QBA30X	3/8" OD x 30"	
191976	QBA36X	3/8" OD x 36"	

### Closet Supply Tube

- Flexible
- Easy to install
- Low-lead compliant



Part #	Mfg #	Size	Price
191980	QCL12X	3/8" OD x 12"	
191981	QCL20X	3/8" OD x 20"	

### Bend Support

- Bend Support for 1/2" PEX tubing
- Comes with integral mounting bracket
- Used in hot and cold water plumbing applications
- Used in radiant heating applications



Part #	Mfg #	Size	Price
194612	QHPBS3	1/2"	

### Stainless Steel Crimp Ring Tool

- Crimps multiple stainless crimp sizes
- Easy to use



Part #	Mfg #	Description	Price
216019	QSECRT	Tool Only	

### Crimp Ring Remover

- Durable Crimp Ring Remover Tool
- Allows easy removal of crimp ring



Part #	Mfg #	Description	Price
194717	QCRRT		

### Large Crimp Tool

- Large Crimp Tool for 1" copper crimp ring
- Includes Go/No-Go gauge



Part #	Mfg #	Description	Price
195069	QCRT5T	1"	

### Medium Crimp Tool

- Medium crimp tool for 1/2" copper crimp ring
- Includes Go/No-Go gauge



Part #	Mfg #	Description	Price
193122	QCRT3CM	1/2"	
193123	QCRT4CM	3/4"	

## Zurn-PEX Fittings

### QickClamp Crimp Tool

- Easy to use with one hand
- Crimps multiple size QickClamp rings



Part #	Mfg #	Description	Price
196694	QCRTQCM		

### QickClamp Ratcheting Tool

- QickClamp ratcheting tool
- Indicator lights illuminates when crimp is complete
- Comes with canvas holder



Part #	Mfg #	Description	Price
201554	QCRTQCRM	Tool Only	

### Crimp Gauge

- For Checking 3/8", 1/2", 3/4" Crimps



Part #	Mfg #	Description	Price
193124	QGA234P	3/8", 1/2", 3/4"	
212915	QGA5N	1"	

### QickClamp Crimp Gauge

- For Checking 3/8", 1/2", 3/4" and 1" QickClamp Crimps



Part #	Mfg #	Description	Price
207185	QGNQC	3/8", 1/2", 3/4", 1"	

### Tube Cutter

- Durable PEX tubing cutter
- Cuts up to 2" tubing



Part #	Mfg #	Description	Price
234353	QLRCUT	Cuts up to 2" Tubing	

### Ratchet Tube Cutter

- Durable PEX tubing cutter



Part #	Mfg #	Description	Price
193025	QPC752	Tool Only	



## Pedestal Lavatories

### Fireclay Pedestal Lavatories

#### Kathryn® Pedestal Lavatory

- Overflow drain
- Fireclay
- Rectangular Basin



**K-2322 Combination: K-2323 Basin and K-2324 Pedestal**

Part #	Mfg #	Description	Dimensions	Color	Price
104526	K-2322-1-0	1-Hole Complete	27" x 20" x 35"	White	
072574	K-2322-8-0	8"cc Complete	27" x 20" x 35"	White	
074593	K-2322-8-96	8"cc Complete	27" x 20" x 35"	Biscuit	
182822	K-2322-8-K4	8"cc Complete	27" x 20" x 35"	Cashmere	

#### Memoirs® Classic Pedestal Lavatory

- Overflow drain
- Fireclay
- Available in 24" or 27" widths



K-2258



K-2238

24"

**K-2238 Combination: K-2239 Basin, K-2267 Pedestal**

24" x 19-3/4" x 34-3/8"

Part #	Mfg #	Description	Dimensions	Color	Price
071261	K-2238-1-0	1-Hole Complete	24" x 19-3/4" x 34-3/8"	White	
110556	K-2238-1-47	1-Hole Complete	24" x 19-3/4" x 34-3/8"	Almond	
100405	K-2238-1-7	1-Hole Complete	24" x 19-3/4" x 34-3/8"	Black	
083939	K-2238-1-96	1-Hole Complete	24" x 19-3/4" x 34-3/8"	Biscuit	
118373	K-2238-1-G9	1-Hole Complete	24" x 19-3/4" x 34-3/8"	Sandbar	
053435	K-2238-4-0	4"cc Complete	24" x 19-3/4" x 34-3/8"	White	
055044	K-2238-4-47	4"cc Complete	24" x 19-3/4" x 34-3/8"	Almond	
053439	K-2238-4-96	4"cc Complete	24" x 19-3/4" x 34-3/8"	Biscuit	
103890	K-2238-4-G9	4"cc Complete	24" x 19-3/4" x 34-3/8"	Sandbar	
100111	K-2238-4-K4	4"cc Complete	24" x 19-3/4" x 34-3/8"	Cashmere	
053440	K-2238-8-0	8"cc Complete	24" x 19-3/4" x 34-3/8"	White	
086799	K-2238-8-47	8"cc Complete	24" x 19-3/4" x 34-3/8"	Almond	
053441	K-2238-8-96	8"cc Complete	24" x 19-3/4" x 34-3/8"	Biscuit	
078333	K-2238-8-G9	8"cc Complete	24" x 19-3/4" x 34-3/8"	Sandbar	
227061	K-2238-8-K4	8"cc Complete	24" x 19-3/4" x 34-3/8"	Cashmere	



## Pedestal Lavatories

**27"**

**K-2258 Combination: K-2259 Basin, K-2267 Pedestal**

**27" x 22" x 35"**

Part #	Mfg #	Description	Dimensions	Color	Price
076811	K-2258-1-0	1-Hole Complete	27" x 22" x 35"	White	
069459	K-2258-1-96	1-Hole Complete	27" x 22" x 35"	Biscuit	
060135	K-2258-8-0	8"cc Complete	27" x 22" x 35"	White	
056306	K-2258-8-47	8"cc Complete	27" x 22" x 35"	Almond	
066655	K-2258-8-7	8"cc Complete	27" x 22" x 35"	Black	
064305	K-2258-8-96	8"cc Complete	27" x 22" x 35"	Biscuit	
086461	K-2258-8-G9	8"cc Complete	27" x 22" x 35"	Sandbar	

### Memoirs® Stately Pedestal Lavatory

- Overflow drain



**24"**

**K-2344 Combination: K-29999 Basin, K-2267 Pedestal**

**24-1/2" x 20-1/2" x 34-3/4"**

Part #	Mfg #	Description	Dimensions	Color	Price
100157	K-2344-1-0	1-Hole Complete	24-1/2" x 20-1/2" x 34-3/4"	White	
126250	K-2344-1-96	1-Hole Complete	24-1/2" x 20-1/2" x 34-3/4"	Biscuit	
091723	K-2344-4-0	4"cc Complete	24-1/2" x 20-1/2" x 34-3/4"	White	
146189	K-2344-4-47	4"cc Complete	24-1/2" x 20-1/2" x 34-3/4"	Almond	
110379	K-2344-4-96	4"cc Complete	24-1/2" x 20-1/2" x 34-3/4"	Biscuit	
123356	K-2344-4-K4	4"cc Complete	24-1/2" x 20-1/2" x 34-3/4"	Cashmere	
092085	K-2344-8-0	8"cc Complete	24-1/2" x 20-1/2" x 34-3/4"	White	
143698	K-2344-8-47	8"cc Complete	24-1/2" x 20-1/2" x 34-3/4"	Almond	
086651	K-2344-8-96	8"cc Complete	24-1/2" x 20-1/2" x 34-3/4"	Biscuit	
108530	K-2344-8-G9	8"cc Complete	24-1/2" x 20-1/2" x 34-3/4"	Sandbar	
103601	K-2344-8-K4	8"cc Complete	24-1/2" x 20-1/2" x 34-3/4"	Cashmere	

**30"**

**K-2268 Combination: K-2269 Stately Lavatory, K-2267 Pedestal**

**30" x 21-3/4" x 34-3/4"**

Part #	Mfg #	Description	Dimensions	Color	Price
073963	K-2268-1-0	1-Hole Complete	30" x 21-3/4" x 34-3/4"	White	
121108	K-2268-1-47	1-Hole Complete	30" x 21-3/4" x 34-3/4"	Almond	
155626	K-2268-1-7	1-Hole Complete	30" x 21-3/4" x 34-3/4"	Black	
101377	K-2268-1-96	1-Hole Complete	30" x 21-3/4" x 34-3/4"	Biscuit	
053525	K-2268-8-0	8"cc Complete	30" x 21-3/4" x 34-3/4"	White	

## Pedestal Lavatories

### Fireclay Pedestal Lavatories (Continued)

#### Memoirs® Stately Pedestal Lavatory

30"

Part #	Mfg #	Description	Dimensions	Color	Price
096305	K-2268-8-47	8"cc Complete	30" x 21-3/4" x 34-3/4"	Almond	
116575	K-2268-8-7	8"cc Complete	30" x 21-3/4" x 34-3/4"	Black	
058173	K-2268-8-95	8"cc Complete	30" x 21-3/4" x 34-3/4"	Ice Grey	
055824	K-2268-8-96	8"cc Complete	30" x 21-3/4" x 34-3/4"	Biscuit	
094953	K-2268-8-G9	8"cc Complete	30" x 21-3/4" x 34-3/4"	Sandbar	
084567	K-2268-8-K4	8"cc Complete	30" x 21-3/4" x 34-3/4"	Cashmere	

#### Tresham® Pedestal Lavatory

- Overflow drain



K-2844

K-2845

24"

K-2844 Combination: K-2757 Lavatory Basin, K-2767 Pedestal Leg

24" x 19-1/2" x 34-5/8"

Part #	Mfg #	Description	Dimensions	Color	Price
146263	K-2844-1-0	1-Hole Complete	24" x 19-1/2" x 34-5/8"	White	
149926	K-2844-1-96	1-Hole Complete	24" x 19-1/2" x 34-5/8"	Biscuit	
224495	K-2844-1-NY	1-Hole Complete	24" x 19-1/2" x 34-5/8"	Dune	
143740	K-2844-4-0	4"cc Complete	24" x 19-1/2" x 34-5/8"	White	
153446	K-2844-4-7	4"cc Complete	24" x 19-1/2" x 34-5/8"	Black	
146033	K-2844-8-0	8"cc Complete	24" x 19-1/2" x 34-5/8"	White	
170164	K-2844-8-47	8"cc Complete	24" x 19-1/2" x 34-5/8"	Almond	
149006	K-2844-8-96	8"cc Complete	24" x 19-1/2" x 34-5/8"	Biscuit	
159945	K-2844-8-K4	8"cc Complete	24" x 19-1/2" x 34-5/8"	Cashmere	

30"

K-2845 Combination: K-2758 Lavatory Basin, K-2767 Pedestal Leg

30" x 19-1/2" x 34-5/8"

Part #	Mfg #	Description	Dimensions	Color	Price
150536	K-2845-1-0	1-Hole Complete	30" x 19-1/2" x 34-5/8"	White	
162721	K-2845-1-96	1-Hole Complete	30" x 19-1/2" x 34-5/8"	Biscuit	
147921	K-2845-8-0	8"cc Complete	30" x 19-1/2" x 34-5/8"	White	
155380	K-2845-8-96	8"cc Complete	30" x 19-1/2" x 34-5/8"	Biscuit	
154952	K-2845-8-K4	8"cc Complete	30" x 19-1/2" x 34-5/8"	Cashmere	

## Pedestal Lavatories

### Rêve® Pedestal Lavatory — 23-5/8" x 18-5/16" x 35-1/2"

- Fireclay
- Deep, V-shaped basin
- Overflow drain included with K-4061 chrome cap



K-5152-1-

**23"**

**K-5152 Combination: K-5027 Lavatory Basin, K-5032 Pedestal Leg**

**23-5/8" x 18-5/16" x 35-1/2"**

Part #	Mfg #	Description	Dimensions	Color	Price
155429	K-5152-1-0	1-Hole Complete	23-5/8" x 18-5/16" x 35-1/2"	White	
246091	K-5152-8-0	8"cc Complete	23-5/8" x 18-5/16" x 35-1/2"	White	

**39"**

**K-5149 Combination: K-5026 Lavatory Basin, K-5032 Pedestal Leg**

**39-3/8" x 18-5/16" x 6-5/16"**

Part #	Mfg #	Description	Dimensions	Color	Price
238965	K-5149-1-0	1-Hole Complete	39-3/8" x 18-5/16" x 6-5/16"	White	

### Vitreous China Pedestal Lavatories

#### Archer™ Pedestal Lavatory — 24" x 20-7/16" x 35-1/4"

- Overflow drain
- Faucet sold separately



K-2359

**K-2359 Combination: K-2358 Lavatory, K-2357 Pedestal**

Part #	Mfg #	Description	Dimensions	Color	Price
108319	K-2359-1-0	1-Hole Complete	24" x 20-7/16" x 35-1/4"	White	
130107	K-2359-1-96	1-Hole Complete	24" x 20-7/16" x 35-1/4"	Biscuit	
114406	K-2359-1-G9	1-Hole Complete	24" x 20-7/16" x 35-1/4"	Sandbar	
172853	K-2359-1-NY	1-Hole Complete	24" x 20-7/16" x 35-1/4"	Dune	
107989	K-2359-4-0	4"cc Complete	24" x 20-7/16" x 35-1/4"	White	
168117	K-2359-4-7	4"cc Complete	24" x 20-7/16" x 35-1/4"	Black	
174338	K-2359-4-95	4"cc Complete	24" x 20-7/16" x 35-1/4"	Ice Grey	
109539	K-2359-4-96	4"cc Complete	24" x 20-7/16" x 35-1/4"	Biscuit	
131492	K-2359-4-G9	4"cc Complete	24" x 20-7/16" x 35-1/4"	Sandbar	
128732	K-2359-4-K4	4"cc Complete	24" x 20-7/16" x 35-1/4"	Cashmere	
103963	K-2359-8-0	8"cc Complete	24" x 20-7/16" x 35-1/4"	White	
126085	K-2359-8-47	8"cc Complete	24" x 20-7/16" x 35-1/4"	Almond	
121249	K-2359-8-95	8"cc Complete	24" x 20-7/16" x 35-1/4"	Ice Grey	

## Pedestal Lavatories

### Vitreous China Pedestal Lavatories (Continued)

#### Archer™ Pedestal Lavatory — 24" x 20-7/16" x 35-1/4"

Part #	Mfg #	Description	Dimensions	Color	Price
110177	K-2359-8-96	8"cc Complete	24" x 20-7/16" x 35-1/4"	Biscuit	
111882	K-2359-8-G9	8"cc Complete	24" x 20-7/16" x 35-1/4"	Sandbar	
188485	K-2359-8-NY	8"cc Complete	24" x 20-7/16" x 35-1/4"	Dune	

#### Bancroft™ Pedestal Lavatory

- Overflow drain
- Faucet sold separately
- Available in 24" and 30" widths



24"

K-2338 Combination: K-2340 Lavatory, K-2346 Pedestal

24" x 21" x 35-1/4"

Part #	Mfg #	Description	Dimensions	Color	Price
090404	K-2338-1-0	1-Hole Complete	24" x 21" x 35-1/4"	White	
093338	K-2338-1-47	1-Hole Complete	24" x 21" x 35-1/4"	Almond	
102336	K-2338-1-96	1-Hole Complete	24" x 21" x 35-1/4"	Biscuit	
090402	K-2338-4-0	4"cc Complete	24" x 21" x 35-1/4"	White	
104025	K-2338-4-47	4"cc Complete	24" x 21" x 35-1/4"	Almond	
122319	K-2338-4-95	4"cc Complete	24" x 21" x 35-1/4"	Ice Grey	
095486	K-2338-4-96	4"cc Complete	24" x 21" x 35-1/4"	Biscuit	
096035	K-2338-4-G9	4"cc Complete	24" x 21" x 35-1/4"	Sandbar	
164678	K-2338-4-NY	4"cc Complete	24" x 21" x 35-1/4"	Dune	
087318	K-2338-8-0	8"cc Complete	24" x 21" x 35-1/4"	White	
098033	K-2338-8-47	8"cc Complete	24" x 21" x 35-1/4"	Almond	
105208	K-2338-8-7	8"cc Complete	24" x 21" x 35-1/4"	Black	
093501	K-2338-8-96	8"cc Complete	24" x 21" x 35-1/4"	Biscuit	
101855	K-2338-8-G9	8"cc Complete	24" x 21" x 35-1/4"	Sandbar	
142121	K-2338-8-K4	8"cc Complete	24" x 21" x 35-1/4"	Cashmere	

30"

K-2347 Combination: K-2348 Lavatory, K-2346 Pedestal

30-3/8" x 22-1/4" x 35-1/4"

Part #	Mfg #	Description	Dimensions	Color	Price
107510	K-2347-1-0	1-Hole Complete	30-3/8" x 22-1/4" x 35-1/4"	White	
129953	K-2347-1-47	1-Hole Complete	30-3/8" x 22-1/4" x 35-1/4"	Almond	
095064	K-2347-1-96	1-Hole Complete	30-3/8" x 22-1/4" x 35-1/4"	Biscuit	
237224	K-2347-1-G9	1-Hole Complete	30-3/8" x 22-1/4" x 35-1/4"	Sandbar	
092829	K-2347-8-0	8"cc Complete	30-3/8" x 22-1/4" x 35-1/4"	White	

## Pedestal Lavatories

### Vitreous China Pedestal Lavatories (Continued)

#### Bancroft™ Pedestal Lavatory

30"

Part #	Mfg #	Description	Dimensions	Color	Price
156857	K-2347-8-47	8"cc Complete	30-3/8" x 22-1/4" x 35-1/4"	Almond	
093137	K-2347-8-96	8"cc Complete	30-3/8" x 22-1/4" x 35-1/4"	Biscuit	
098956	K-2347-8-G9	8"cc Complete	30-3/8" x 22-1/4" x 35-1/4"	Sandbar	

#### Cimarron™ Pedestal Lavatory — 22-3/4" x 18-7/8" x 34-1/2"

- *Stately design*
- *Generous interior basin and deck size*
- *Pedestal designed to conceal water supplies and drain*
- *Faucet sold separately*

#### K-2362 Combination: K-2363 Lavatory, K-2364 Pedestal

Part #	Mfg #	Description	Dimensions	Color	Price
100175	K-2362-1-0	1-Hole Complete	22-3/4" x 18-7/8" x 34-1/2"	White	
126152	K-2362-1-47	1-Hole Complete	22-3/4" x 18-7/8" x 34-1/2"	Almond	
157185	K-2362-1-7	1-Hole Complete	22-3/4" x 18-7/8" x 34-1/2"	Black	
145243	K-2362-1-95	1-Hole Complete	22-3/4" x 18-7/8" x 34-1/2"	Ice Grey	
106738	K-2362-1-96	1-Hole Complete	22-3/4" x 18-7/8" x 34-1/2"	Biscuit	
138518	K-2362-1-G9	1-Hole Complete	22-3/4" x 18-7/8" x 34-1/2"	Sandbar	
093834	K-2362-4-0	4"cc Complete	22-3/4" x 18-7/8" x 34-1/2"	White	
140238	K-2362-4-47	4"cc Complete	22-3/4" x 18-7/8" x 34-1/2"	Almond	
118180	K-2362-4-7	4"cc Complete	22-3/4" x 18-7/8" x 34-1/2"	Black	
103615	K-2362-4-96	4"cc Complete	22-3/4" x 18-7/8" x 34-1/2"	Biscuit	
093836	K-2362-8-0	8"cc Complete	22-3/4" x 18-7/8" x 34-1/2"	White	
111839	K-2362-8-47	8"cc Complete	22-3/4" x 18-7/8" x 34-1/2"	Almond	
103453	K-2362-8-7	8"cc Complete	22-3/4" x 18-7/8" x 34-1/2"	Black	
173291	K-2362-8-95	8"cc Complete	22-3/4" x 18-7/8" x 34-1/2"	Ice Grey	
094415	K-2362-8-96	8"cc Complete	22-3/4" x 18-7/8" x 34-1/2"	Biscuit	
135741	K-2362-8-G9	8"cc Complete	22-3/4" x 18-7/8" x 34-1/2"	Sandbar	

## Pedestal Lavatories

### Devonshire® Pedestal Lavatory

- Faucet sold separately



2286-4-0

24"

K-2286 Combination: K-2287 Lavatory, K-2288 Pedestal

24-1/8" x 19-3/4" x 33-1/2"

Part #	Mfg #	Description	Dimensions	Color	Price
053460	K-2286-1-0	1-Hole Complete	24-1/8" x 19-3/4" x 33-1/2"	White	
082605	K-2286-1-7	1-Hole Complete	24-1/8" x 19-3/4" x 33-1/2"	Black	
058957	K-2286-1-95	1-Hole Complete	24-1/8" x 19-3/4" x 33-1/2"	Ice Grey	
064249	K-2286-1-96	1-Hole Complete	24-1/8" x 19-3/4" x 33-1/2"	Biscuit	
053448	K-2286-4-0	4"cc Complete	24-1/8" x 19-3/4" x 33-1/2"	White	
063363	K-2286-4-47	4"cc Complete	24-1/8" x 19-3/4" x 33-1/2"	Almond	
071491	K-2286-4-95	4"cc Complete	24-1/8" x 19-3/4" x 33-1/2"	Ice Grey	
053449	K-2286-4-96	4"cc Complete	24-1/8" x 19-3/4" x 33-1/2"	Biscuit	
057605	K-2286-4-G9	4"cc Complete	24-1/8" x 19-3/4" x 33-1/2"	Sandbar	
053450	K-2286-8-0	8"cc Complete	24-1/8" x 19-3/4" x 33-1/2"	White	
096303	K-2286-8-47	8"cc Complete	24-1/8" x 19-3/4" x 33-1/2"	Almond	
067102	K-2286-8-7	8"cc Complete	24-1/8" x 19-3/4" x 33-1/2"	Black	
054739	K-2286-8-95	8"cc Complete	24-1/8" x 19-3/4" x 33-1/2"	Ice Grey	
053456	K-2286-8-96	8"cc Complete	24-1/8" x 19-3/4" x 33-1/2"	Biscuit	
056763	K-2286-8-G9	8"cc Complete	24-1/8" x 19-3/4" x 33-1/2"	Sandbar	
106000	K-2286-8-K4	8"cc Complete	24-1/8" x 19-3/4" x 33-1/2"	Cashmere	

27"

K-2294 Combination: K-2295 Lavatory, K-2288 Pedestal

27-1/2" x 19-7/8" x 33-1/2"

Part #	Mfg #	Description	Dimensions	Color	Price
059570	K-2294-1-0	1-Hole Complete	27-1/2" x 19-7/8" x 33-1/2"	White	
076675	K-2294-1-95	1-Hole Complete	27-1/2" x 19-7/8" x 33-1/2"	Ice Grey	
056651	K-2294-1-96	1-Hole Complete	27-1/2" x 19-7/8" x 33-1/2"	Biscuit	
142857	K-2294-1-K4	1-Hole Complete	27-1/2" x 19-7/8" x 33-1/2"	Cashmere	
056199	K-2294-8-0	8"cc Complete	27-1/2" x 19-7/8" x 33-1/2"	White	
071931	K-2294-8-47	8"cc Complete	27-1/2" x 19-7/8" x 33-1/2"	Almond	
066453	K-2294-8-7	8"cc Complete	27-1/2" x 19-7/8" x 33-1/2"	Black	
107495	K-2294-8-95	8"cc Complete	27-1/2" x 19-7/8" x 33-1/2"	Ice Grey	
061724	K-2294-8-96	8"cc Complete	27-1/2" x 19-7/8" x 33-1/2"	Biscuit	
072243	K-2294-8-G9	8"cc Complete	27-1/2" x 19-7/8" x 33-1/2"	Sandbar	
092213	K-2294-8-K4	8"cc Complete	27-1/2" x 19-7/8" x 33-1/2"	Cashmere	



## Pedestal Lavatories

### Parigi® Pedestal Sink — 19-3/4" x 14" x 32-7/8"

- D-Shaped basin
- Beveled basin ledge

**K-2175 Combination: K-2176 Sink Basin, K-2177 Pedestal**



Part #	Mfg #	Description	Dimensions	Color	Price
067025	K-2175-1-0	1-Hole Complete	19-3/4" x 14" x 32-7/8"	White	
182419	K-2175-1-96	1-Hole Complete	19-3/4" x 14" x 32-7/8"	Biscuit	
056320	K-2175-4-0	4"cc Complete	19-3/4" x 14" x 32-7/8"	White	
100557	K-2175-4-47	4"cc Complete	19-3/4" x 14" x 32-7/8"	Almond	
108868	K-2175-4-96	4"cc Complete	19-3/4" x 14" x 32-7/8"	Biscuit	

### Portrait® Pedestal Sink — 27" x 19-3/8" x 36-1/2"

- Overflow drain
- Oval basin

**K-2221 Combination: K-2222-8 Lavatory, K-2223 Pedestal**



Part #	Mfg #	Description	Dimensions	Color	Price
126604	K-2221-1-0	1-Hole Complete	27" x 19-3/8" x 36-1/2"	White	
062669	K-2221-1-96	1-Hole Complete	27" x 19-3/8" x 36-1/2"	Biscuit	
053442	K-2221-4-0	4"cc Complete	27" x 19-3/8" x 36-1/2"	White	
053443	K-2221-4-47	4"cc Complete	27" x 19-3/8" x 36-1/2"	Almond	
053444	K-2221-4-96	4"cc Complete	27" x 19-3/8" x 36-1/2"	Biscuit	
071780	K-2221-4-G9	4"cc Complete	27" x 19-3/8" x 36-1/2"	Sandbar	
053445	K-2221-8-0	8"cc Complete	27" x 19-3/8" x 36-1/2"	White	
053446	K-2221-8-47	8"cc Complete	27" x 19-3/8" x 36-1/2"	Almond	
066474	K-2221-8-7	8"cc Complete	27" x 19-3/8" x 36-1/2"	Black	
053447	K-2221-8-96	8"cc Complete	27" x 19-3/8" x 36-1/2"	Biscuit	
061535	K-2221-8-G9	8"cc Complete	27" x 19-3/8" x 36-1/2"	Sandbar	
080974	K-2221-8-K4	8"cc Complete	27" x 19-3/8" x 36-1/2"	Cashmere	

## Pedestal Lavatories

### Veer™ Pedestal Lavatory

- Ample side deck space for toiletries



21"

K-5265 Combination: K-5247 Lavatory, K-5246 Pedestal

21" x 18-1/4" x 35-1/2"

Part #	Mfg #	Description	Dimensions	Color	Price
171164	K-5265-1-0	1-Hole Complete	21" x 18-1/4" x 35-1/2"	White	
182796	K-5265-1-96	1-Hole Complete	21" x 18-1/4" x 35-1/2"	Biscuit	
171853	K-5265-4-0	4" cc Complete	21" x 18-1/4" x 35-1/2"	White	
162671	K-5265-8-0	8"cc Complete	21" x 18-1/4" x 35-1/2"	White	

24"

K-5266 Combination: K-5248 Lavatory, K-5246 Pedestal

24" x 18-1/4" x 35-1/2"

Part #	Mfg #	Description	Dimensions	Color	Price
170076	K-5266-1-0	1-Hole Complete	24" x 18-1/4" x 35-1/2"	White	
190005	K-5266-1-96	1-Hole Complete	24" x 18-1/4" x 35-1/2"	Biscuit	
165843	K-5266-1-NY	1-Hole Complete	24" x 18-1/4" x 35-1/2"	Dune	
172951	K-5266-4-0	4"cc Complete	24" x 18-1/4" x 35-1/2"	White	
186491	K-5266-4-96	4"cc Complete	24" x 18-1/4" x 35-1/2"	Biscuit	
246956	K-5266-8-0	8"cc Complete	24" x 18-1/4" x 35-1/2"	White	

### Wellworth™ Pedestal Lavatory — 22-1/4" x 18-1/4" x 34-7/8"

- Faucet sold separately

K-2293 Combination: K-2296 Lavatory, K-2019 Pedestal



K-2293-4-0

Part #	Mfg #	Description	Dimensions	Color	Price
054157	K-2293-1-0	1-Hole Complete	22-1/4" x 18-1/4" x 34-7/8"	White	
142950	K-2293-1-47	1-Hole Complete	22-1/4" x 18-1/4" x 34-7/8"	Almond	
087456	K-2293-1-96	1-Hole Complete	22-1/4" x 18-1/4" x 34-7/8"	Biscuit	
053458	K-2293-4-0	4"cc Complete	22-1/4" x 18-1/4" x 34-7/8"	White	
059695	K-2293-4-47	4"cc Complete	22-1/4" x 18-1/4" x 34-7/8"	Almond	
062693	K-2293-4-96	4"cc Complete	22-1/4" x 18-1/4" x 34-7/8"	Biscuit	
053459	K-2293-8-0	8"cc Complete	22-1/4" x 18-1/4" x 34-7/8"	White	

## Pedestal Lavatories

### Vitreous China Pedestal Lavatories (Continued)

#### Wellworth™ Pedestal Lavatory — 22-1/4" x 18-1/4" x 34-7/8"

Part #	Mfg #	Description	Dimensions	Color	Price
073773	K-2293-8-47	8"cc Complete	22-1/4" x 18-1/4" x 34-7/8"	Almond	
055800	K-2293-8-96	8"cc Complete	22-1/4" x 18-1/4" x 34-7/8"	Biscuit	

### Console Table Legs

#### Kathryn® Table Legs

- Square tapered Fireclay table legs
- Set of (2) legs
- Combines with Kathryn® console tabletop's
- Includes leg-leveling hardware



Part #	Mfg #	Description	Dimensions	Color	Price
084795	K-2318-0	Console Legs Only	3-1/4" x 3-1/4" x 31-7/8"	White	
176951	K-2318-7	Console Legs Only	3-1/4" x 3-1/4" x 31-7/8"	Black	
074474	K-2318-96	Console Legs Only	3-1/4" x 3-1/4" x 31-7/8"	Biscuit	

### Memoirs® Table Legs

- Set of two legs
- Solid brass
- For K-2269 Memoirs® sink
- Includes a towel rail
- Integrated leveling feature



**Required:**

**K-2269-1 Above-counter bathroom sink**

or

**K-2269-8 Above-counter bathroom sink**

Part #	Mfg #	Description	Dimensions	Color	Price
241292	K-30003-BN	Console Legs Only	23" x 17-1/4" x 32-1/4"	*Brushed Nickel	

### Pedestal Tops Only

#### Archer® Pedestal Lavatory Top — 23-15/16" x 20-7/16"

- Overflow drain

Combines with K-2357 Pedestal to create the K-2359 Complete Pedestal Sink

Combines with K-2449 Petite Vanity to create Complete Console Vanity



Part #	Mfg #	Description	Dimensions	Color	Price
108318	K-2358-1-0	1-Hole Basin Only	23-15/16" x 20-7/16"	White	

## Pedestal Lavatories

### Pedestal Tops Only (Continued)

#### Archer® Pedestal Lavatory Top — 23-15/16" x 20-7/16"

Part #	Mfg #	Description	Dimensions	Color	Price
111191	K-2358-1-47	1-Hole Basin Only	23-15/16" x 20-7/16"	Almond	
119297	K-2358-1-96	1-Hole Basin Only	23-15/16" x 20-7/16"	Biscuit	
109457	K-2358-1-G9	1-Hole Basin Only	23-15/16" x 20-7/16"	Sandbar	
131153	K-2358-1-K4	1-Hole Basin Only	23-15/16" x 20-7/16"	Cashmere	
172850	K-2358-1-NY	1-Hole Basin Only	23-15/16" x 20-7/16"	Dune	
107988	K-2358-4-0	4"cc Basin Only	23-15/16" x 20-7/16"	White	
126510	K-2358-4-47	4"cc Basin Only	23-15/16" x 20-7/16"	Almond	
168115	K-2358-4-7	4"cc Basin Only	23-15/16" x 20-7/16"	Black	
174334	K-2358-4-95	4"cc Basin Only	23-15/16" x 20-7/16"	Ice Grey	
109538	K-2358-4-96	4"cc Basin Only	23-15/16" x 20-7/16"	Biscuit	
131490	K-2358-4-G9	4"cc Basin Only	23-15/16" x 20-7/16"	Sandbar	
120237	K-2358-4-K4	4"cc Basin Only	23-15/16" x 20-7/16"	Cashmere	
103425	K-2358-8-0	8"cc Basin Only	23-15/16" x 20-7/16"	White	
112763	K-2358-8-47	8"cc Basin Only	23-15/16" x 20-7/16"	Almond	
121247	K-2358-8-95	8"cc Basin Only	23-15/16" x 20-7/16"	Ice Grey	
110176	K-2358-8-96	8"cc Basin Only	23-15/16" x 20-7/16"	Biscuit	
111880	K-2358-8-G9	8"cc Basin Only	23-15/16" x 20-7/16"	Sandbar	
103537	K-2358-8-K4	8"cc Basin Only	23-15/16" x 20-7/16"	Cashmere	

#### Tresham® Pedestal Lavatory Basin — 24" x 19-1/2"

- Fireclay
- Overflow drain
- Basin depth: 3-1/4"
- 24"L x 7-5/16"H x 19-1/2"W



Combination: K-2767 pedestal to create K-2844-1 Tresham® pedestal sink

Part #	Mfg #	Description	Dimensions	Color	Price
238220	K-2757-1-7	Single Hole Basin	24" x 19-1/2"	Black	
238221	K-2757-8-7	8"cc Basin	24" x 19-1/2"	Black	

#### Memoirs® Stately Pedestal-Top — 30" x 21-3/4"

- Rectangular basin
- Overflow drain



Combines with K-2267 pedestal to create the K-2268 pedestal sink

Combines with K-6880 console table legs to create a console table

Part #	Mfg #	Description	Dimensions	Color	Price
073965	K-2269-1-0	Single Hole Basin	30" x 21-3/4"	White	
121107	K-2269-1-47	Single Hole Basin	30" x 21-3/4"	Almond	
155625	K-2269-1-7	Single Hole Basin	30" x 21-3/4"	Black	

## Pedestal Lavatories

### Pedestal Tops Only (Continued)

#### Memoirs® Stately Pedestal-Top — 30" x 21-3/4"

Part #	Mfg #	Description	Dimensions	Color	Price
101376	K-2269-1-96	Single Hole Basin	30" x 21-3/4"	Biscuit	
053523	K-2269-8-0	8"cc Basin	30" x 21-3/4"	White	
096304	K-2269-8-47	8"cc Basin	30" x 21-3/4"	Almond	
083632	K-2269-8-7	8"cc Basin	30" x 21-3/4"	Black	
058175	K-2269-8-95	8"cc Basin	30" x 21-3/4"	Ice Grey	
055823	K-2269-8-96	8"cc Basin	30" x 21-3/4"	Biscuit	
094952	K-2269-8-G9	8"cc Basin	30" x 21-3/4"	Sandbar	
084566	K-2269-8-K4	8"cc Basin	30" x 21-3/4"	Cashmere	
167791	K-2269-8-NY	8"cc Basin	30" x 21-3/4"	Dune	
249567	K-29999-1-0	1-Hole Basin	24-1/2" x 20-1/2" x 8-5/8"	White	
249577	K-29999-1-96	1-Hole Basin	24-1/2" x 20-1/2" x 8-5/8"	Biscuit	
249578	K-29999-1-G9	1-Hole Basin	24-1/2" x 20-1/2" x 8-5/8"	Sandbar	
250507	K-29999-4-0	4"cc Basin	24-1/2" x 20-1/2" x 8-5/8"	White	
250509	K-29999-8-0	8"cc Basin	24-1/2" x 20-1/2" x 8-5/8"	White	
260537	K-29999-8-96	8"cc Basin	24-1/2" x 20-1/2" x 8-5/8"	Biscuit	

#### Veer® Vanity-Top — 24" x 18-1/4"

- Vitreous china
- Overflow drain
- Basin depth: 4"
- 24"L x 8"H x 18-1/4"W



Combines with K-5246 Veer Pedestal and K-5266-8 Veer Pedestal Sink

Part #	Mfg #	Description	Dimensions	Color	Price
246955	K-5248-8-0	8"cc Basin	24" x 18-1/4"	White	



## Pedestal Lavatories

### Pedestal Lavatories

#### Avalanche® Petite Pedestal Lavatory

- Transitional design
- Concealed front overflow
- Wall-hanger included (99-161)
- Faucet and drain separately
- Rear-oriented drain hole location



23-598 Combination 13-598 Petite Basin, 29-834 Pedestal Base  
23-591 Combination 13-591 Petite Basin, 29-834 Pedestal Base

Part #	Mfg #	Description	Dimensions	Color	Price
239999	13-591	4"cc Petite Sink	22-3/4" x 18-7/8"	White	
238228	13-598	8"cc Petite Sink	22-3/4" x 18-7/8"	White	
240000	23-591	Single Hole Complete	22-3/4" x 18-7/8"	White	

#### Avalanche® Vitreous China Standard Pedestal Lavatory

- Concealed front overflow
- Wall-hanger included (99-161)
- Faucet and drain separately
- Rear-oriented drain hole location



23-592 Combination 13-592 Petite Basin, 29-834 Pedestal Base  
23-595 Combination 13-595 Petite Basin, 29-834 Pedestal Base  
23-599 Combination 13-599 Petite Basin, 29-834 Pedestal Base

Part #	Mfg #	Description	Dimensions	Color	Price
238343	23-592	Single Hole Complete	34"H x 25-1/4"W x 21-1/4"D	White	
242066	23-595	4"cc Complete	34"H x 25-1/4"W x 21-1/4"D	White	

#### Allerton™ Vitreous China Pedestal Lavatory

- Concealed front overflow
- Faucet sold separately



22-565 Combination: 12-565 Petite Basin, 29-843 Pedestal Base  
22-569 Combination: 12-569 Petite Basin, 29-843 Pedestal Base  
22-575 Combination: 12-575 Basin, 29-843 Pedestal Base  
22-579 Combination: 12-579 Basin, 29-843 Pedestal Base

Part #	Mfg #	Description	Dimensions	Color	Price
104973	22-565	4"cc Complete	21-1/2" x 18-3/4" x 35"	White	
138049	22-565-09	4"cc Complete	21-1/2" x 18-3/4" x 35"	Biscuit	
104974	22-569	8"cc Complete	21-1/2" x 18-3/4" x 35"	White	
104671	22-575	4"cc Complete	25-1/2" x 21" x 36-3/8"	White	
104975	22-579	8"cc Standard Complete	25-1/2" x 21" x 35"	White	
151172	22-579	8"cc Complete	25-1/2" x 21" x 35"	Bone/Wheat	





## Pedestal Lavatories

### Blaze® Vitreous China Pedestal Lavatory

- *Concealed front overflow*
- *Faucet sold separately*



**22-512 Combination: 12-512 Lavatory, 29-848 Pedestal Base**

**22-515 Combination: 12-515 Lavatory, 29-848 Pedestal Base**

**22-519 Combination: 12-519 Lavatory, 29-848 Pedestal Base**

Part #	Mfg #	Description	Dimensions	Color	Price
173723	22-512	Single Hole Complete	23-7/8" x 20-1/4" x 35-1/8"	White	
182774	22-515	4"cc Complete	23-7/8" x 20-1/4" x 35-1/8"	White	
189167	22-519	8"cc Complete	23-7/8" x 20-1/4" x 35-1/8"	White	
235401	22-519-09	8"cc Complete	23-7/8" x 20-1/4" x 35-1/8"	Biscuit	

### Brienne Vitreous China Pedestal Lavatory

- *Concealed front overflow*
- *Faucet sold separately*



**22-535 Combination: 12-535 Lavatory, 29-846 Pedestal**

Part #	Mfg #	Description	Dimensions	Color	Price
104938	22-535	4"cc Complete	23-7/8" x 19-3/4" x 35-3/4"	White	
172792	22-535-09	4"cc Complete	23-7/8" x 19-3/4" x 35-3/4"	Biscuit	

### Hinsdale™ Vitreous China Contemporary Pedestal Lavatory

- *Rear overflow*
- *Contemporary design*
- *Rear-oriented drain hole*
- *Includes wall hanger (99-161)*
- *Faucet and drain sold separately*



**23-502 Combination: 13-502 Lavatory, 29-831 Pedestal Base**

**23-505 Combination: 13-502 Lavatory, 29-831 Pedestal Base**

**23-509 Combination: 13-509 Lavatory, 29-831 Pedestal Base**

Part #	Mfg #	Description	Dimensions	Color	Price
246265	23-505	4" cc Complete	34"H x 21-1/4"W x 18-1/8"D	White	



## Pedestal Lavatories

### Hinsdale™ Vitreous China Traditional Pedestal Lavatory

- Rear overflow
- Traditional design
- Rear-oriented drain hole
- Includes wall hanger (99-161)
- Faucet and drain sold separately



23-501 Combination: 13-501 Lavatory, 29-831 Pedestal Base

23-504 Combination: 13-504 Lavatory, 29-831 Pedestal Base

23-508 Combination: 13-508 Lavatory, 29-831 Pedestal Base

Part #	Mfg #	Description	Dimensions	Color	Price
242073	23-501	1-Hole Complete	34-13/16"H x 25"W x 21"D	White	

### La Mer™ Vitreous China Pedestal Lavatory

- Back overflow
- 1-Piece wall hanger
- Combined height with standard pedestal: 32"
- Combined height with extended pedestal: 36"
- Faucet sold separately



22-554

22-554 Combination: 12-544 Basin, 29-840 Pedestal Base

Part #	Mfg #	Description	Dimensions	Color	Price
004623	22-554	4"cc Complete	32" x 24" x 20"	White	

### La Mer™ Petite Vitreous China Pedestal Lavatory

- Back overflow
- 1-Piece wall hanger
- Combined height with standard pedestal: 32"
- Combined height with extended pedestal: 36"
- Faucet sold separately



22-534

22-534 Combination: 12-524 Basin, 29-840 Pedestal

Part #	Mfg #	Description	Dimensions	Color	Price
004619	22-534	4"cc Complete	31-3/4" x 20" x 17-1/4"	White	



## Pedestal Lavatories

### La Rive™ Vitreous China Pedestal Lavatory

- Back overflow
- 1-Piece wall hanger
- Combined height with standard pedestal: 32"
- Combined height with extended pedestal: 36"
- Faucet sold separately



22-574

**22-574 Combination: 12-564 Basin, 29-840 Pedestal**

**22-578 Combination: 12-568 Basin, 29-840 Pedestal**

Part #	Mfg #	Description	Dimensions	Color	Price
107189	22-571	Single-Hole Complete	32" x 25-1/2" x 21-1/2"	White	
004631	22-574	4"cc Complete	32" x 25-1/2" x 21-1/2"	White	
004636	22-578	8"cc Complete	32" x 25-1/2" x 21-1/2"	White	

### Logan Square™ Vitreous China Pedestal Lavatory

- Rear overflow
- Square pedestal leg
- Wash basin with large deck space



**22-555 Combination: 12-555 Petite Basin, 29-847 Pedestal**

**22-559 Combination: 12-559 Petite Basin, 29-847 Pedestal**

**22-582 Combination: 12-582 Basin, 29-847 Pedestal**

**22-585 Combination: 12-585 Basin, 29-847 Pedestal**

Part #	Mfg #	Description	Dimensions	Color	Price
125088	22-555	4"cc Petite Complete	34-1/2" x 24-1/4" x 20-1/8"	White	
129816	22-559	8"cc Petite Complete	34-1/2" x 24-1/4" x 20-1/8"	White	
242480	22-582	1-Hole Complete	35" x 27-3/8" x 21-1/4"	White	
145105	22-585	4"cc Complete	35" x 27-3/8" x 21-1/4"	White	
154768	22-585-09	4"cc Complete	35" x 27-3/8" x 21-1/4"	Biscuit	

### Maxwell™ Vitreous China Pedestal Lavatory

- Concealed front overflow
- Discrete backslash
- Faucet sold separately



**22-504 Combination: 12-504 Basin, 29-842 Pedestal Base**

**22-514 Combination: 12-514 Basin, 29-842 Pedestal Base**

**22-518 Combination: 12-518 Basin, 29-842 Pedestal Base**

Part #	Mfg #	Description	Dimensions	Color	Price
080412	12-504	4"cc Lavatory Basin	20-7/16" x 17-3/4"	White	
080413	12-514	4"cc Lavatory Basin	25-1/2" x 20-1/2"	White	
080416	22-504	4"cc Petite Complete	27-3/8" x 21-1/4"	White	
114194	22-504-09	4"cc Petite Complete	27-3/8" x 21-1/4"	Biscuit	
080417	22-514	4"cc Standard Complete	27-3/8" x 21-1/4"	White	
080418	22-518	8"cc Standard Complete	27-3/8" x 21-1/4"	White	



## Pedestal Lavatories

### Viper® Vitreous China Pedestal Lavatory

- Exposed rear overflow
- Includes wall hanger (99-161)



23-561 Combination: 13-561 Basin, 29-834 Pedestal Base  
 23-562 Combination: 13-562 Basin, 29-834 Pedestal Base  
 23-568 Combination: 13-568 Basin, 29-834 Pedestal Base

Part #	Mfg #	Description	Dimensions	Color	Price
242053	23-561	1-Hole Petite Complete	24-1/16" x 21-7/8"	White	
235210	23-562	1-Hole Standard Complete	23-15/16" x 20-7/16"	White	
235106	23-565	4"cc Standard Complete	23-15/16" x 20-7/16"	White	
246688	23-568	8"cc Petite Complete	21-7/8" x 18-1/2"	White	

### Wicker Park™ Vitreous China Pedestal Lavatory

- Curved rectangular basin
- Rear overflow

22-592 Combination: 12-592 Basin, 29-845 Pedestal Base



Part #	Mfg #	Description	Dimensions	Color	Price
237345	22-592	1-Hole Lavatory Basin	24-5/8" x 19-3/8"	White	

**Pedestal Lavatories**

**Vitreous China Pedestal Lavatories**

**Sacramento™ Pedestal Lavatory**

- 34" Height installed
- Faucet sold separately
- Limited 5-year warranty



442124 Complete: 448120 Pedestal Leg, 446124 Lavatory Basin

Part #	Mfg #	Description	Dimensions	Color	Price
081841	446124-0	4"cc Lavatory Basin	21-1/4" x 18-1/4"	White	
098213	446124-96	4"cc Lavatory Basin	21-1/4" x 18-1/4"	Biscuit	
081842	448120-0	Pedestal Leg	-	White	
098214	448120-96	Pedestal Leg	-	Biscuit	

**Southampton® Pedestal Lavatory**

- Oval basin
- With overflow
- Vitreous China



442421 Complete: 448420 Pedestal Leg, 446421 Lavatory Basin

Part #	Mfg #	Description	Dimensions	Color	Price
190056	442421-0	1-Hole Lavatory Basin	23-3/8" x 18-1/4"	White	

## Pedestal Lavatories

### Pedestal Lavatories Alto IV Pedestal Lavatory

- *Concealed front overflow*
- *34-1/4" High*
- *Available in single hole, 4" or 8" faucet centers*



**290 Combination: 292 Lav Basin, 293 Pedestal**

Part #	Mfg #	Description	Dimensions	Color	Price
192330	290-4-WH	4"cc Complete	25" x 19"	White	
192343	240-4-BI	4"cc Complete	25" x 19"	Biscuit	
192331	290-4-BN	4"cc Complete	25" x 19"	Bone	
192332	290-8-WH	8"cc Complete	25" x 19"	White	
193220	290-8-BI	8"cc Complete	25" x 19"	Biscuit	
192333	290-8-BN	8"cc Complete	25" x 19"	Bone	



## Top-Mount Lavatories

### Vitreous China Drop-In Lavatories

#### Archer® Drop-In Lavatory — 22-5/8" x 19-7/16"

- Basin depth: 7-7/8"
- Overflow drain



Part #	Mfg #	Description	Dimensions	Color	Price
108558	K-2356-1-0	1-Hole Basin	22-5/8" x 19-7/16"	White	
120714	K-2356-1-7	1-Hole Basin	22-5/8" x 19-7/16"	Black	
222345	K-2356-1-95	1-Hole Basin	22-5/8" x 19-7/16"	Ice Grey	
120952	K-2356-1-96	1-Hole Basin	22-5/8" x 19-7/16"	Biscuit	
129535	K-2356-1-G9	1-Hole Basin	22-5/8" x 19-7/16"	Sandbar	
113055	K-2356-4-0	4"cc Basin	22-5/8" x 19-7/16"	White	
126193	K-2356-4-47	4"cc Basin	22-5/8" x 19-7/16"	Almond	
241407	K-2356-4-95	4"cc Basin	22-5/8" x 19-7/16"	Ice Grey	
120951	K-2356-4-96	4"cc Basin	22-5/8" x 19-7/16"	Biscuit	
168556	K-2356-4-G9	4"cc Basin	22-5/8" x 19-7/16"	Sandbar	
106901	K-2356-8-0	8"cc Basin	22-5/8" x 19-7/16"	White	
115709	K-2356-8-47	8"cc Basin	22-5/8" x 19-7/16"	Almond	
173462	K-2356-8-7	8"cc Basin	22-5/8" x 19-7/16"	Black	
110694	K-2356-8-96	8"cc Basin	22-5/8" x 19-7/16"	Biscuit	
153621	K-2356-8-K4	8"cc Basin	22-5/8" x 19-7/16"	Cashmere	
162843	K-2356-8-NY	8"cc Basin	22-5/8" x 19-7/16"	Dune	

#### Brookline™ Drop-In Lavatory — 19" Diameter

- Includes sealant
- Basin depth: 8-3/8"



Part #	Mfg #	Description	Dimensions	Color	Price
068028	K-2202-1-0	1-Hole ADA Basin	19" Diameter	White	
126768	K-2202-1-47	1-Hole ADA Basin	19" Diameter	Almond	
058332	K-2202-1-96	1-Hole ADA Basin	19" Diameter	Biscuit	
055055	K-2202-4-0	4"cc ADA Basin	19" Diameter	White	
054045	K-2202-4-47	4"cc ADA Basin	19" Diameter	Almond	
063996	K-2202-4-7	4"cc ADA Basin	19" Diameter	Black	
125579	K-2202-4-95	4"cc ADA Basin	19" Diameter	Ice Grey	
055056	K-2202-4-96	4"cc ADA Basin	19" Diameter	Biscuit	
167310	K-2202-4-NY	4"cc ADA Basin	19" Diameter	Dune	
055057	K-2202-8-0	8"cc ADA Basin	19" Diameter	White	
055058	K-2202-8-96	8"cc ADA Basin	19" Diameter	Biscuit	

## Top-Mount Lavatories

### Bryant® Oval Drop-In Lavatory — 20-1/8" x 16-1/2"

- With overflow
- Basin depth: 7-5/8"



Part #	Mfg #	Description	Dimensions	Color	Price
144885	K-2699-1-0	1-Hole ADA Basin	20-1/8" x 16-1/2"	White	
148761	K-2699-1-96	1-Hole ADA Basin	20-1/8" x 16-1/2"	Biscuit	
248482	K-2699-1-NY	1-Hole ADA Basin	20-1/8" x 16-1/2"	Dune	
138046	K-2699-4-0	4"cc ADA Basin	20-1/8" x 16-1/2"	White	
149239	K-2699-4-47	4"cc ADA Basin	20-1/8" x 16-1/2"	Almond	
158644	K-2699-4-96	4"cc ADA Basin	20-1/8" x 16-1/2"	Biscuit	
250469	K-2699-4-G9	4"cc ADA Basin	20-1/8" x 16-1/2"	Sandbar	
144886	K-2699-8-0	8"cc ADA Basin	20-1/8" x 16-1/2"	White	
152703	K-2699-8-47	8"cc ADA Basin	20-1/8" x 16-1/2"	Almond	
175100	K-2699-8-K4	8"cc ADA Basin	20-1/8" x 16-1/2"	Cashmere	

### Bryant® Drop-In Lavatory — 18-7/8" x 18-7/8" x 7-5/8"

- With overflow
- Basin depth: 7-5/8"



Part #	Mfg #	Description	Dimensions	Color	Price
156185	K-2714-1-0	1-Hole ADA Basin	18-7/8" x 18-7/8" x 7-5/8"	White	
145729	K-2714-4-0	4"cc ADA Basin	18-7/8" x 18-7/8" x 7-5/8"	White	
144033	K-2714-4-96	4"cc ADA Basin	18-7/8" x 18-7/8" x 7-5/8"	Biscuit	
149508	K-2714-8-0	8"cc ADA Basin	18-7/8" x 18-7/8" x 7-5/8"	White	
167172	K-2714-8-58	8"cc ADA Basin	18-7/8" x 18-7/8" x 7-5/8"	Thunder Grey	

### Cimarron® Drop-In Lavatory — 23" x 18-3/16"

- Basin depth: 7-7/8"
- Faucet sold separately



Part #	Mfg #	Description	Dimensions	Color	Price
137765	K-2351-1-0	1-Hole ADA Basin	23" x 18-3/16"	White	
183026	K-2351-1-7	1-Hole ADA Basin	23" x 18-3/16"	Black	
134801	K-2351-1-96	1-Hole ADA Basin	23" x 18-3/16"	Biscuit	
105732	K-2351-1-G9	1-Hole ADA Basin	23" x 18-3/16"	Sandbar	
093837	K-2351-4-0	4"cc ADA Basin	23" x 18-3/16"	White	
106200	K-2351-4-95	4"cc ADA Basin	23" x 18-3/16"	Ice Grey	
112659	K-2351-4-96	4"cc ADA Basin	23" x 18-3/16"	Biscuit	
093838	K-2351-8-0	8"cc ADA Basin	23" x 18-3/16"	White	
107929	K-2351-8-47	8"cc ADA Basin	23" x 18-3/16"	Almond	
141462	K-2351-8-95	8"cc ADA Basin	23" x 18-3/16"	Ice Grey	
111716	K-2351-8-96	8"cc ADA Basin	23" x 18-3/16"	Biscuit	
123483	K-2351-8-G9	8"cc ADA Basin	23" x 18-3/16"	Sandbar	

## Top-Mount Lavatories

### Compass® Drop-In/Under-Mount Lavatory

- 13-1/4" Diameter
- No faucet holes
- Basin depth: 7"



Part #	Mfg #	Description	Dimensions	Color	Price
060819	K-2298-0	Less Faucet Holes, ADA Basin	13-1/4" x 13-1/4"	White	

### Devonshire® Drop-In Lavatory

- With overflow
- 19-3/4" x 16-7/8"
- Water depth: 4-1/2"



Part #	Mfg #	Description	Dimensions	Color	Price
240589	K-2279-1-47	1-Hole ADA Basin	19-3/4" x 16-7/8"	Almond	
123003	K-2279-1-96	1-Hole ADA Basin	19-3/4" x 16-7/8"	Biscuit	
054173	K-2279-4-0	4"cc ADA Basin	19-3/4" x 16-7/8"	White	
059953	K-2279-8-0	8"cc ADA Basin	19-3/4" x 16-7/8"	White	

### Inia® Glass Lavatory

- No faucet holes
- Drain sold separately
- Without Overflow



Part #	Mfg #	Description	Dimensions	Color	Price
236621	K-2773-B11	No Faucet Deck	20-5/8" x 14-15/16"	Ice	

### Intaglio® Drop-In Lavatory — 17" x 14" x 8-1/4"

- Centered drain
- No faucet holes; requires wall- or counter-mount faucet



Part #	Mfg #	Description	Dimensions	Color	Price
060596	K-2292-0	No Faucet Deck	17" x 14" x 8-1/4"	White	
056884	K-2292-96	No Faucet Deck	17" x 14" x 8-1/4"	Biscuit	

### Kathryn® Drop-In Lavatory — 24" x 19"

- Overflow drain
- Rectangular basin



Part #	Mfg #	Description	Dimensions	Color	Price
185584	K-2325-1-0	1-Hole Basin	24" x 19"	White	
085171	K-2325-8-0	8"cc	24" x 19"	White	

## Top-Mount Lavatories

### Kelston® Drop-in Lavatory — 23-7/16" x 20-11/16" x 5-5/16"

- Uniquely-shaped shallow basin
- Overflow drain



Part #	Mfg #	Description	Dimensions	Color	Price
116589	K-2381-1-0	1-Hole ADA Shallow Basin	23-7/16" x 20-11/16" x 5-5/16"	White	
183030	K-2381-1-96	1-Hole ADA Shallow Basin	23-7/16" x 20-11/16" x 5-5/16"	Biscuit	
123867	K-2381-4-0	4"cc ADA Shallow Basin	23-7/16" x 20-11/16" x 5-5/16"	White	
183031	K-2381-4-7	4"cc ADA Shallow Basin	23-7/16" x 20-11/16" x 5-5/16"	Black	
168214	K-2381-4-G9	4"cc ADA Shallow Basin	23-7/16" x 20-11/16" x 5-5/16"	Sandbar	
118000	K-2381-4-96	4"cc ADA Shallow Basin	23-7/16" x 20-11/16" x 5-5/16"	Biscuit	
111713	K-2381-8-0	8"cc ADA Shallow Basin	23-7/16" x 20-11/16" x 5-5/16"	White	
129226	K-2381-8-47	8"cc ADA Shallow Basin	23-7/16" x 20-11/16" x 5-5/16"	Almond	
183032	K-2381-8-7	8"cc ADA Shallow Basin	23-7/16" x 20-11/16" x 5-5/16"	Black	
180965	K-2381-8-95	8"cc ADA Shallow Basin	23-7/16" x 20-11/16" x 5-5/16"	Ice Grey	

### Memoirs® Classic Drop-In Lavatory — 22-3/4" x 18"

- Overflow drain
- Faucet sold separately



Part #	Mfg #	Description	Dimensions	Color	Price
071265	K-2241-1-0	1-Hole Classic Basin	22-3/4" x 18"	White	
059006	K-2241-1-96	1-Hole Classic Basin	22-3/4" x 18"	Biscuit	
117169	K-2241-1-G9	1-Hole Classic Basin	22-3/4" x 18"	Sandbar	
057383	K-2241-4-0	4"cc Classic Basin	22-3/4" x 18"	White	
073661	K-2241-4-47	4"cc Classic Basin	22-3/4" x 18"	Almond	
230599	K-2241-4-7	4"cc Classic Basin	22-3/4" x 18"	Black	
057286	K-2241-4-95	4"cc Classic Basin	22-3/4" x 18"	Ice Grey	
065803	K-2241-4-96	4"cc Classic Basin	22-3/4" x 18"	Biscuit	
080539	K-2241-4-G9	4"cc Classic Basin	22-3/4" x 18"	Sandbar	
054529	K-2241-8-0	8"cc Classic Basin	22-3/4" x 18"	White	
105463	K-2241-8-47	8"cc Classic Basin	22-3/4" x 18"	Almond	
074564	K-2241-8-7	8"cc Classic Basin	22-3/4" x 18"	Black	
075333	K-2241-8-95	8"cc Classic Basin	22-3/4" x 18"	Ice Grey	
056477	K-2241-8-96	8"cc Classic Basin	22-3/4" x 18"	Biscuit	
074958	K-2241-8-G9	8"cc Classic Basin	22-3/4" x 18"	Sandbar	
231997	K-2241-8-NY	8"cc Classic Basin	22-3/4" x 18"	Dune	

## Top-Mount Lavatories

### Memoirs® Stately Drop-In Lavatory — 22-3/4" x 18"

- Basin depth: 8-7/8"
- Faucet sold separately



Part #	Mfg #	Description	Dimensions	Color	Price
097048	K-2337-1-0	Single Hole Basin	22-3/4" x 18"	White	
126404	K-2337-1-47	Single Hole Basin	22-3/4" x 18"	Almond	
119528	K-2337-1-96	Single Hole Basin	22-3/4" x 18"	Biscuit	
092002	K-2337-4-0	4"cc Stately Basin	22-3/4" x 18"	White	
131030	K-2337-4-47	4"cc Stately Basin	22-3/4" x 18"	Almond	
171844	K-2337-4-58	4"cc Stately Basin	22-3/4" x 18"	Thunder Grey	
100605	K-2337-4-95	4"cc Stately Basin	22-3/4" x 18"	Ice Grey	
093771	K-2337-4-96	4"cc Stately Basin	22-3/4" x 18"	Biscuit	
093018	K-2337-8-0	8"cc Stately Basin	22-3/4" x 18"	White	
128945	K-2337-8-47	8"cc Stately Basin	22-3/4" x 18"	Almond	
153587	K--2337-8-95	8"cc Stately Basin	22-3/4" x 18"	Ice Grey	
093518	K-2337-8-96	8"cc Stately Basin	22-3/4" x 18"	Biscuit	

### Pennington™ Drop-In Lavatory Basin — 20-1/4" x 17-1/2"

- Includes sealant
- Basin depth: 8-1/2"
- Faucet sold separately



Part #	Mfg #	Description	Dimensions	Color	Price
055265	K-2196-1-0	1-Hole ADA Basin	20-1/4" x 17-1/2"	White	
055266	K-2196-1-47	1-Hole ADA Basin	20-1/4" x 17-1/2"	Almond	
060407	K-2196-1-7	1-Hole ADA Basin	20-1/4" x 17-1/2"	Black	
145417	K-2196-1-95	1-Hole ADA Basin	20-1/4" x 17-1/2"	Ice Grey	
059748	K-2196-1-96	1-Hole ADA Basin	20-1/4" x 17-1/2"	Biscuit	
167308	K-2196-1-NY	1-Hole ADA Basin	20-1/4" x 17-1/2"	Dune	
053189	K-2196-4-0	4"cc ADA Basin	20-1/4" x 17-1/2"	White	
055714	K-2196-4-47	4"cc ADA Basin	20-1/4" x 17-1/2"	Almond	
056391	K-2196-4-7	4"cc ADA Basin	20-1/4" x 17-1/2"	Black	
060550	K-2196-4-95	4"cc ADA Basin	20-1/4" x 17-1/2"	Ice Grey	
053308	K-2196-4-96	4"cc ADA Basin	20-1/4" x 17-1/2"	Biscuit	
174325	K-2196-4-G9	4"cc ADA Basin	20-1/4" x 17-1/2"	Sandbar	
053190	K-2196-8-0	8"cc ADA Basin	20-1/4" x 17-1/2"	White	
057960	K-2196-8-47	8"cc ADA Basin	20-1/4" x 17-1/2"	Almond	
086833	K-2196-8-7	8"cc ADA Basin	20-1/4" x 17-1/2"	Black	
069228	K-2196-8-95	8"cc ADA Basin	20-1/4" x 17-1/2"	Ice Grey	
053309	K-2196-8-96	8"cc ADA Basin	20-1/4" x 17-1/2"	Biscuit	

## Top-Mount Lavatories

### Portrait® Drop-In Lavatory Basin — 22-5/8" x 18-7/8"

- Includes sealant
- Basin depth: 8-7/8"
- Faucet sold separately



Part #	Mfg #	Description	Dimensions	Color	Price
067661	K-2189-1-0	Single Hole Basin	22-5/8" x 18-7/8"	White	
053289	K-2189-8-96	8"cc ADA Basin	22-5/8" x 18-7/8"	Biscuit	

### Serif® Drop-In Lavatory Basin — 22-1/8" x 16-1/4"

- Oval basin
- Overflow drain



Part #	Mfg #	Description	Dimensions	Color	Price
073654	K-2075-1-0	Single Hole Basin	22-1/8" x 16-1/4"	White	
094721	K-2075-1-47	Single Hole Basin	22-1/8" x 16-1/4"	Almond	
103900	K-2075-1-7	Single Hole Basin	22-1/8" x 16-1/4"	Black	
071837	K-2075-1-96	Single Hole Basin	22-1/8" x 16-1/4"	Biscuit	
078604	K-2075-4-0	4"cc Basin	22-1/8" x 16-1/4"	White	
090338	K-2075-4-47	4"cc Basin	22-1/8" x 16-1/4"	Almond	
080582	K-2075-4-96	4"cc Basin	22-1/8" x 16-1/4"	Biscuit	
076847	K-2075-8-0	8"cc Basin	22-1/8" x 16-1/4"	White	
080055	K-2075-8-47	8"cc Basin	22-1/8" x 16-1/4"	Almond	
084548	K-2075-8-7	8"cc Basin	22-1/8" x 16-1/4"	Black	
126410	K-2075-8-95	8"cc Basin	22-1/8" x 16-1/4"	Ice Grey	
074100	K-2075-8-96	8"cc Basin	22-1/8" x 16-1/4"	Biscuit	
227479	K-2075-8-NY	8"cc Basin	22-1/8" x 16-1/4"	Dune	

### Tresham® Drop-In Lavatory Basin — 21-13/16" x 16-9/16"

- Basin depth: 8"
- Rectangular basin with raised rim
- Overflow drain



Part #	Mfg #	Description	Dimensions	Color	Price
150616	K-2991-1-0	Single Hole Basin	21-13/16" x 16-9/16"	White	
173996	K-2991-1-7	Single Hole Basin	21-13/16" x 16-9/16"	Black	
154591	K-2991-1-95	Single Hole Basin	21-13/16" x 16-9/16"	Ice Grey	
175376	K-2991-4-0	4"cc Basin	21-13/16" x 16-9/16"	White	
156201	K-2991-4-96	4"cc Basin	21-13/16" x 16-9/16"	Biscuit	
146103	K-2991-8-0	8"cc Basin	21-13/16" x 16-9/16"	White	
183561	K-2991-8-47	8"cc Basin	21-13/16" x 16-9/16"	Almond	
144318	K-2991-8-96	8"cc Basin	21-13/16" x 16-9/16"	Biscuit	



## Top-Mount Lavatories

### Tresham® Drop-In Lavatory Basin — 22-13/16" x 19-1/4"

- Basin depth: 8-3/4"
- Oval basin with raised rim
- Overflow drain



Part #	Mfg #	Description	Dimensions	Color	Price
228008	K-2992-1-96	Single Hole Basin	22-13/16" x 19-1/4"	Biscuit	
172665	K-2992-4-47	4"cc Basin	22-13/16" x 19-1/4"	Almond	
160351	K-2992-4-96	4"cc Basin	22-13/16" x 19-1/4"	Biscuit	
156862	K-2992-8-0	8"cc Basin	22-13/16" x 19-1/4"	White	

### Cast Iron Drop-In Lavatories

ADA - Compliant when installed according to the Accessibility Guidelines, Section 606 Lavatories and Mirrors, of the Act

### Dolce Vita® Drop-In Lavatory — 17-1/2" x 17-1/2"

- Cast iron
- Basin depth: 7-7/8"
- No faucet holes



Part #	Mfg #	Description	Dimensions	Color	Price
074293	K-2815-0	No Faucet Holes	17-1/2" x 17-1/2"	White	
103638	K-2815-96	No Faucet Holes	17-1/2" x 17-1/2"	Biscuit	

### Farmington™ Drop-In Lavatory Basin — 19-1/4" x 16-1/4"

- Cast iron
- With overflow
- Basin depth: 8-3/4"
- Faucet sold separately



Part #	Mfg #	Description	Dimensions	Color	Price
070879	K-2905-1-0	1-Hole ADA Basin	19-1/4" x 16-1/4"	White	
185225	K-2905-1-7	1-Hole ADA Basin	19-1/4" x 16-1/4"	Black Black	
181571	K-2905-1-95	1-Hole ADA Basin	19-1/4" x 16-1/4"	Ice Grey	
175393	K-2905-1-FD	1-Hole ADA Basin	19-1/4" x 16-1/4"	Cane Sugar	
053226	K-2905-4-0	4"cc ADA Basin	19-1/4" x 16-1/4"	White	
058526	K-2905-4-47	4"cc ADA Basin	19-1/4" x 16-1/4"	Almond	
061510	K-2905-4-95	4"cc ADA Basin	19-1/4" x 16-1/4"	Ice Grey	
061188	K-2905-4-96	4"cc ADA Basin	19-1/4" x 16-1/4"	Biscuit	
053227	K-2905-8-0	8"cc ADA Basin	19-1/4" x 16-1/4"	White	
085239	K-2905-8-47	8"cc ADA Basin	19-1/4" x 16-1/4"	Almond	
054907	K-2905-8-96	8"cc ADA Basin	19-1/4" x 16-1/4"	Biscuit	

## Top-Mount Lavatories

### Iron/Tones™ Drop-In/Under-Mount Lavatory Basin

- Cast iron
- Without overflow
- Top-mount or under-mount
- No faucet holes



16"  
16-3/8" X 15-5/8" X 5-3/4"

Part #	Mfg #	Description	Dimensions	Color	Price
108554	K-2827-0	No Faucet Holes	16-3/8" x 15-5/8" x 5-3/4"	White	
103512	K-2827-47	No Faucet Holes	16-3/8" x 15-5/8" x 5-3/4"	Almond	
109651	K-2827-96	No Faucet Holes	16-3/8" x 15-5/8" x 5-3/4"	Biscuit	
152348	K-2827-FD	No Faucet Holes	16-3/8" x 15-5/8" x 5-3/4"	Cane Sugar	
119872	K-2827-FF	No Faucet Holes	16-3/8" x 15-5/8" x 5-3/4"	Sea Salt	
118085	K-2827-FT	No Faucet Holes	16-3/8" x 15-5/8" x 5-3/4"	Basalt	
183036	K-2827-KA	No Faucet Holes	16-3/8" x 15-5/8" x 5-3/4"	Black n' Tan	

24"  
24-3/4" x 15-5/8" x 5-7/8"

Part #	Mfg #	Description	Dimensions	Color	Price
111048	K-2826-0	No Faucet Holes	24-3/4" x 15-5/8" x 5-7/8"	White	
116918	K-2826-96	No Faucet Holes	24-3/4" x 15-5/8" x 5-7/8"	Biscuit	
136195	K-2826-FF	No Faucet Holes	24-3/4" x 15-5/8" x 5-7/8"	Sea Salt	

### Man's Lav™ Drop-In Lavatory Basin

- Cast iron
- Overflow drain
- Sloped rectangular basin



Part #	Mfg #	Description	Dimensions	Color	Price
069098	K-2885-1-0	1-Hole	28" x 19"	White	
182425	K-2885-1-47	1-Hole	28" x 19"	Almond	
071977	K-2885-1-96	1-Hole	28" x 19"	Biscuit	
243135	K-2885-1-KA	1-Hole	28" x 19"	Black 'n Tan	
072713	K-2885-8-0	8"cc	28" x 19"	White	
069309	K-2885-8-47	8"cc	28" x 19"	Almond	
075667	K-2885-8-96	8"cc	28" x 19"	Biscuit	

### Tahoe® Drop-In Lavatory Basin

- Cast iron
- Overflow drain



Part #	Mfg #	Description	Dimensions	Color	Price
082817	K-2895-1-0	Single Hole Basin	21" x 19"	White	
079131	K-2895-1-96	Single Hole Basin	21" x 19"	Biscuit	

## Top-Mount Lavatories

### Cast Iron Drop-In Lavatories (Continued)

#### Tahoe® Drop-In Lavatory Basin

Part #	Mfg #	Description	Dimensions	Color	Price
053224	K-2895-4-0	4"cc Basin	21" x 19"	White	
060570	K-2895-4-47	4"cc Basin	21" x 19"	Almond	
054160	K-2895-4-96	4"cc Basin	21" x 19"	Biscuit	
053225	K-2895-8-0	8"cc Basin	21" x 19"	White	
182430	K-2895-8-47	8"cc Basin	21" x 19"	Almond	
053655	K-2895-8-96	8"cc Basin	21" x 19"	Biscuit	

#### Tahoe® Drop-In Lavatory Basin For Use with Metal Frame

- Cast iron
- Overflow drain
- Metal frame installation



Part #	Mfg #	Description	Dimensions	Color	Price
056418	K-2890-4-0	4"cc Basin	20" x 18"	White	

#### Thoreau® Drop-In Lavatory Basin

- Cast iron
- Basin depth: 8-5/8"



Part #	Mfg #	Description	Dimensions	Color	Price
071237	K-2907-1-0	Single Hole Basin	24" x 18"	White	
066998	K-2907-1-96	Single Hole Basin	24" x 18"	Biscuit	
055598	K-2907-4-0	4"cc Basin	24" x 18"	White	
115615	K-2907-4-96	4"cc Basin	24" x 18"	Biscuit	
070319	K-2907-8-0	8"cc Basin	24" x 18"	White	
075011	K-2907-8-96	8"cc Basin	24" x 18"	Biscuit	

#### Tides® Drop-In Lavatory Basin

- Cast iron
- Undulating oval basin
- Basin depth: 9-5/16"



Part #	Mfg #	Description	Dimensions	Color	Price
139738	K-2839-1-0	1-Hole ADA Basin	20" x 17"	White	
140894	K-2839-1-96	1-Hole ADA Basin	20" x 17"	Biscuit	
168444	K-2839-1-FD	1-Hole ADA Basin	20" x 17"	Cane Sugar	
163954	K-2839-1-FF	1-Hole ADA Basin	20" x 17"	Sea Salt	
190405	K-2839-1-FT	1-Hole ADA Basin	20" x 17"	Basalt	
154304	K-2839-4-0	4"cc ADA Basin	20" x 17"	White	
185283	K-2839-4-7	4" cc ADA Basin	20" x 17"	Black Black	

## Top-Mount Lavatories

### Cast Iron Drop-In Lavatories (Continued)

#### Tides® Drop-In Lavatory Basin

Part #	Mfg #	Description	Dimensions	Color	Price
155743	K-2839-4-96	4"cc ADA Basin	20" x 17"	Biscuit	
153428	K-2839-4-FF	4"cc ADA Basin	20" x 17"	Sea Salt	
147944	K-2839-8-0	8"cc ADA Basin	20" x 17"	White	
147713	K-2839-8-96	8"cc ADA Basin	20" x 17"	Biscuit	
145744	K-2839-8-FF	8"cc ADA Basin	20" x 17"	Sea Salt	

### Vanity Tops

#### Ceramic/Impressions® Drop-in Bathroom Sink

- L37", H7-1/2", W22-3/8"
- Vitreous/Fireclay
- Overflow drain
- Dimensional colors
- Raised outer edge
- Integrated top and bowl



#### Ceramic/Impressions™

- Vitreous china
- Integrated top and bowl
- Raised outer edge helps contain water and prevents items from rolling off the vanity top
- Overflow drain



25" x 22-3/8"

Part #	Mfg #	Description	Dimensions	Color	Price
185929	K-2777-1-G81	1-Hole, Rectangular Basin	25" x 22-3/8"	White	
237371	K-2777-1-G82	1-Hole, Rectangular Basin	25" x 22-3/8"	Dune	
236815	K-2777-1-G83	1-Hole, Rectangular Basin	25" x 22-3/8"	Biscuit	
183676	K-2777-8-G81	8"cc, Rectangular Basin	25" x 22-3/8"	White	

31" x 22-3/8"

Part #	Mfg #	Description	Dimensions	Color	Price
169471	K-2779-1-G81	1-Hole, Square Basin	31" x 22-3/8"	White	
166457	K-2779-1-G85	1-Hole, Square Basin	31" x 22-3/8"	Sandbar	
183556	K-2779-1-G88	1-Hole, Rectangular Basin	31" x 22-3/8"	Thunder Grey	
173318	K-2779-8-G81	8"cc, Square Basin	31" x 22-3/8"	White	
175862	K-2779-8-G83	8"cc, Square Basin	31" x 22-3/8"	Biscuit	
183557	K-2779-8-G88	8"cc Rectangular Basin	31" x 22-3/8"	Thunder Grey	
176730	K-2796-1-G81	1-Hole, Oval Basin	31" x 22-3/8"	White	

37" x 22-3/8"

Part #	Mfg #	Description	Dimensions	Color	Price
168991	K-2781-1-G81	1-Hole, Square Basin	37" x 22-3/8"	White	

## Top-Mount Lavatories

### Vanity Tops (Continued)

#### Ceramic/Impressions™

37" x 22-3/8"

Part #	Mfg #	Description	Dimensions	Color	Price
238483	K-2781-1-G88	1-Hole, Rectangular Basin	37" x 22-3/8"	Thunder Grey	
172777	K-2781-8-G81	8"cc, Square Basin	37" x 22-3/8"	White	
190351	K-2781-8-G83	8"cc Rectangular Basin	37" x 22-3/8"	Biscuit	
183558	K-2781-8-G88	8"cc Rectangular Basin	37" x 22-3/8"	Thunder Grey	
181473	K-2798-8-G85	8"cc, Oval Basin	37" x 22-3/8"	Sandbar	
231064	K-2798-8-G81	8" cc Oval Basin	37" x 22-3/8"	White	

49" x 22-3/8"

Part #	Mfg #	Description	Dimensions	Color	Price
180837	K-2783-1-G81	1-Hole, Square Basin	49" x 22-3/8"	White	
176807	K-2783-8-G81	8"cc, Square Basin	49" x 22-3/8"	White	
256479	K-2783-8-G82	8"cc Rectangular Basin	49" x 22-3/8"	Dune	
220820	K-2783-8-G86	8"cc, Square Basin	49" x 22-3/8"	Cashmere	
171288	K-2783-8-G88	8"cc, Square Basin	49" x 22-3/8"	Thunder Grey	
175679	K-2891-1-G81	1-Hole, Oval Basin	49" x 22-3/8"	White	

#### Iron/Impressions® Rectangular Basin Vanity-Top

- Cast iron
- Integrated top and bowl
- Sloped-wall rectangular basin
- Without overflow



31" x 22-1/4"

Part #	Mfg #	Description	Dimensions	Color	Price
156973	K-3049-1-47	1-Hole	31-5/8" x 22-1/4"	Almond	
137028	K-3049-1-FD	1-Hole	31-5/8" x 22-1/4"	Cane Sugar	
159483	K-3049-1-KA	1-Hole	31-5/8" x 22-1/4"	Black 'n Tan	
120079	K-3049-8-0	8"cc	31-5/8" x 22-1/4"	White	
108688	K-3049-8-96	8"cc	31-5/8" x 22-1/4"	Biscuit	
188540	K-3049-8-FD	8"cc	31-5/8" x 22-1/4"	Cane Sugar	
108656	K-3049-8-FF	8"cc	31-5/8" x 22-1/4"	Sea Salt	
107101	K-3049-8-KA	8"cc	31-5/8" x 22-1/4"	Black 'n Tan	

## Top-Mount Lavatories

### Iron/Impressions® Oval Basin Vanity-Top

- Cast iron
- Integrated top and bowl
- Sloped-wall oval basin
- Without overflow



**25" x 22-1/4"**

Part #	Mfg #	Description	Dimensions	Color	Price
181990	K-3048-1-FF	1-Hole	25-5/8" x 22-1/4"	Sea Salt	
183047	K-3048-8-0	8"cc	25-5/8" x 22-1/4"	White	
240406	K-3048-8-FF	8"cc	25-5/8" x 22-1/4"	Sea Salt	

**37" x 22-1/4"**

Part #	Mfg #	Description	Dimensions	Color	Price
177356	K-3051-1-96	1-Hole	37-5/8" x 22-1/4"	Biscuit	
117938	K-3051-1-FD	1-Hole	37-5/8" x 22-1/4"	Cane Sugar	
107145	K-3051-1-KA	1-Hole	37-5/8" x 22-1/4"	Black 'n Tan	
145664	K-3051-1-7	1-Hole	37-5/8" x 22-1/4"	Black	
112576	K-3051-8-FD	8"cc	37-5/8" x 22-1/4"	Cane Sugar	
100975	K-3051-8-FF	8"cc	37-5/8" x 22-1/4"	Sea Salt	
103423	K-3051-8-G9	8"cc	37-5/8" x 22-1/4"	Sandbar	
099449	K-3051-8-KA	8"cc	37-5/8" x 22-1/4"	Black 'n Tan	
101594	K-3051-8-0	8"cc	37-5/8" x 22-1/4"	White	
097355	K-3051-8-95	8"cc	37-5/8" x 22-1/4"	Ice Grey	
150621	K-3051-8-96	8"cc	37-5/8" x 22-1/4"	Biscuit	

**43" x 22-1/4"**

Part #	Mfg #	Description	Dimensions	Color	Price
183048	K-3052-1-FD	1-Hole	43-5/8" x 22-1/4"	Cane Sugar	
232325	K-3052-1-FF	1-Hole	43-5/8" x 22-1/4"	Sea Salt	
121504	K-3052-8-0	8"cc	43-5/8" x 22-1/4"	White	
121321	K-3052-8-FD	8"cc	43-5/8" x 22-1/4"	Cane Sugar	
125199	K-3052-8-KA	8"cc	43-5/8" x 22-1/4"	Black 'n Tan	

**49" x 22-1/4"**

Part #	Mfg #	Description	Dimensions	Color	Price
144929	K-3053-1-0	1-Hole	49-5/8" x 22-1/4"	White	
109455	K-3053-1-7	1-Hole	49-5/8" x 22-1/4"	Black	
183049	K-3053-1-96	1-Hole	49-5/8" x 22-1/4"	Biscuit	
232300	K-3053-1-FT	1-Hole	49-5/8" x 22-1/4"	Basalt	
139845	K-3053-1-KA	1-Hole	49-5/8" x 22-1/4"	Black 'n Tan	
136113	K-3053-8-0	8"cc	49-5/8" x 22-1/4"	White	
176243	K-3053-8-96	8"cc	49-5/8" x 22-1/4"	Biscuit	
115363	K-3053-8-FF	8"cc	49-5/8" x 22-1/4"	Sea Salt	



## Top-Mount Lavatories

### Vanity Tops (Continued)

#### Iron/Impressions® Oval Basin Vanity-Top

49" x 22-1/4"

Part #	Mfg #	Description	Dimensions	Color	Price
168232	K-3053-8-G9	8"cc	49-5/8" x 22-1/4"	Sandbar	
125966	K-3053-8-KA	8"cc	49-5/8" x 22-1/4"	Black 'n Tan	

#### Solid/Expressions™ Vanity Top with Double Verticyl® Oval Cutout

- Solid surface
- Sculpted edge
- Field trimmable for alcove corner installations
- Pilot holes for 8" widespread, 4" Centerset or single faucet
- Pairs with Verticyl® oval under-mount lavatory sinks or other Kohler® 17" x 14" oval under-mount lavatory sinks



Part #	Mfg #	Description	Dimensions	Color	Price
172833	K-5433-S33	Pilot holes for 4"cc and 8"cc	61" x 22-13/16"	White	

#### Solid/Expressions® Vanity Top with Double Verticyl® Rectangular Cutout

- Solid surface
- Sculpted edge
- Field trimmable for alcove and corner installations
- Pilot holes for 8" widespread, 4" Centerset or single faucet
- Includes mounting hardware for sinks
- Optional side and backsplashes available (sold separately)
- Pre-cut for Verticyl® (K-2882) under-mount lavatory sink



Part #	Mfg #	Description	Dimensions	Color	Price
246219	5461-S33	Pilot holes for 4"cc, 8"cc, Single faucet	61-5/8" x 22-13/16"	White	

#### Solid/Expressions™ Universal Side splash

- Includes one panel
- Solid surface
- For use with Kohler® Solid/Expressions™ solid-surface vanity tops



Part #	Mfg #	Description	Dimensions	Color	Price
172835	K-5451-S33	21-1/4" Side splash Kit	21-1/4" x 3-1/2"	White	
253209	K-5451-S35	21-1/4" Side splash Kit	21-1/4" x 3-1/2"	Biscuit	

#### Solid/Expressions™ Back Splash

- Solid surface



Part #	Mfg #	Description	Dimensions	Color	Price
253211	K-5444-S35	25" Backsplash Kit	25" x 3-1/2"	Biscuit	
173943	K-5446-S33	37" Backsplash Kit	37" x 3-1/2"	White	
172834	K-5448-S33	61" Backsplash Kit	61" x 3-1/2"	White	

## Top-Mount Lavatories

### Solid/Expressions™ Vanity Top

- Solid surface
- Pilot holes for 8" widespread, 4" Centerset or single faucet
- Single Verticyl® cutouts



Part #	Mfg #	Description	Dimensions	Color	Price
171791	K-5422-S33	1 Hole, Oval Basin	31" x 22-13/16"	White	
185569	K-5456-S33	1 Hole Rectangular Basin	31" x 22-13/16"	White	
242252	K-5459-S33	1-Hole Rectangular Basin	61" x 22-13/16"	White	

### Solid/Expressions™ Vanity Top without Cutout

- Solid surface
- Vessel or drop-in lavatory sink required



Part #	Mfg #	Description	Dimensions	Color	Price
173940	K-5438-S33	Less Holes	37" x 22-13/16"	White	
237536	K-5441-S33	Less Holes	61" x 22-13/16"	White	

### Kathryn® Console Tabletop — 24" x 22"

- Pre cut for a KOHLER® 17- by 14-inch under-mount sink K-2205-G or K-2210-G
- Coordinates with Kathryn® console legs and other products in the Kathryn® collection



Requires: K-9699 frame kit with hardware

Part #	Mfg #	Description	Dimensions	Color	Price
182855	K-3023-NM	8"cc	24" x 22"	Nero Marquina Marble	

### Kathryn® Lavastone Tabletop

- Enameled lavastone
- 10" center faucet holes
- Pre cut for the K-2297-G Kathryn® under-mount sink



Part #	Mfg #	Description	Dimensions	Color	Price
182857	K-3028-K2	10"cc	42" x 22"	Grey Flannel	
099490	K-3029-0	10"cc	42" x 22"	White	

### Persuade® Vanity-Top Bathroom Sink — 25-1/4" x 22"

- Basin with square back and curved front
- Basin depth: 6"
- Overflow drain



Part #	Mfg #	Description	Dimensions	Color	Price
139284	K-2956-1-0	Single Hole Basin	25-1/4" x 22"	White	

## Top-Mount Lavatories

### Vanity Tops (Continued)

#### Persuade® Vanity-Top Bathroom Sink — 25-1/4" x 22"

Part #	Mfg #	Description	Dimensions	Color	Price
130294	K-2956-8-0	8"cc Basin	25-1/4" x 22"	White	

#### Tresham® Vanity-Top — 25-7/16" x 19-1/16"

- Vitreous china
- Overflow drain



Combines with K-2604 Tresham Vanity and other industry-standard 24" by 18" vanities

Part #	Mfg #	Description	Dimensions	Color	Price
149141	K-2979-1-0	1-Hole	25-7/16" x 19-1/16"	White	
259367	K-2979-1-NY	1-Hole	25-7/16" x 19-1/16"	Dune	
144152	K-2979-4-0	4"cc	25-7/16" x 19-1/16"	White	
144484	K-2979-4-96	4"cc	25-7/16" x 19-1/16"	Biscuit	
146479	K-2979-8-0	8"cc	25-7/16" x 19-1/16"	White	
144494	K-2979-8-96	8"cc	25-7/16" x 19-1/16"	Biscuit	
146068	K-2979-8-K4	8"cc	25-7/16" x 19-1/16"	Cashmere	

## Top-Mount Lavatories

### Drop-In Lavatories

#### Alto II Drop-In Lavatory

- Self-rimming lavatory
- Available in 4" or 8" faucet centers
- Concealed front overflow
- Faucet sold separately



Part #	Mfg #	Description	Dimensions	Color	Price
192324	251-4-WH	4"cc, 15-1/2" x 10-1/8" Basin	19" x 16"	White	

#### Maverick™ I Drop-In Lavatory

- Self-rimming lavatory
- Available in single hole, 4" or 8" faucet centers
- Concealed front overflow
- Complies with ADA requirements for accessibility

Part #	Mfg #	Description	Dimensions	Color	Price
192323	249-4-WH	4"cc, 14-3/4" x 12-1/8" Basin	19"	White	

#### Maverick™ II Drop-In Lavatory

- Self-rimming lavatory
- Available in single hole, 4" or 8" faucet centers
- Concealed front overflow
- Complies with ADA requirements for accessibility



Part #	Mfg #	Description	Dimensions	Color	Price
220999	267-1-WH	1-Hole, 15-1/2"x10-1/2" Basin	20" x 17"	White	
192299	267-4-WH	4"cc, 15-1/2" x 10-1/2" Basin	20" x 17"	White	
198460	267-4-BI	4"cc, 15-1/2" x 10-1/2" Basin	20" x 17"	Biscuit	

#### Barrett™ Drop-In Lavatory

- Traditional style
- 23-1/6" x 18-5/8"
- Concealed front overflow
- Part of the Barrett™ bathroom collection
- Available in single hole, 4" or 8" faucet centers
- Complies with ADA requirements for accessibility



Part #	Mfg #	Description	Dimensions	Color	Price
225295	268-4-WH	4"cc, 16-1/4" x 10-1/2" Basin	23-1/6" x 18-5/8"	White	

## Top-Mount Lavatories

### Brentwood Drop-In Lavatory

- Traditional Style
- 22-7/16" x 18-15/16"
- Concealed front overflow
- Availbe in single hole, 4" or 8" faucet centers
- Part of the Brentwood Bathroom Collection



Part #	Mfg #	Description	Dimensions	Color	Price
238434	254-8-WH	8"cc, 18-11/16" x 12-7/16" Basin	22-7/16" x 18-15/16"	White	



## Top-Mount Lavatories

### Drop-In Lavatories

#### Logan Square Self-Rimming Lavatory

- Concealed front overflow
- Generous wash basin with large deck space
- Faucet sold separately



Part #	Mfg #	Description	Dimensions	Color	Price
130570	12-875	4"cc Square Lavatory Basin	23-5/8" x 18-1/8" x 7-3/8"	White	

#### Luxoval™ Self-Rimming Lavatory

- Concealed front overflow
- Faucet sold separately



12-844

Part #	Mfg #	Description	Dimensions	Color	Price
004511	12-844	4"cc Oval Lavatory Basin	8-3/4" x 20" x 17"	White	
004514	12-844-09	4"cc Oval Lavatory Basin	8-3/4" x 20" x 17"	Biscuit	
004518	12-848	8"cc Oval Lavatory Basin	8-3/4" x 20" x 17"	White	
023982	12-848-09	8"cc Oval Lavatory Basin	8-3/4" x 20" x 17"	Biscuit	

#### Maxwell Self-Rimming Lavatory

- Concealed front overflow
- Faucet sold separately



Part #	Mfg #	Description	Dimensions	Color	Price
077454	12-884	4"cc Lavatory Basin	19-1/4" Round	White	
086324	12-888	8"cc Lavatory Basin	19-1/4" Round	White	
077452	12-834	4"cc Lavatory Basin	21" x 17-7/8" Oval	White	
105217	12-834-09	4"cc Lavatory Basin	21" x 17-7/8" Oval	Biscuit	
175068	12-834-25	4"cc Lavatory Basin	21" x 17-7/8" Oval	Bone/Wheat	

#### Rotunda Self-Rimming Lavatory

- Concealed front overflow
- Faucet sold separately



Part #	Mfg #	Description	Dimensions	Color	Price
004525	12-894	4"cc Lavatory Basin	9-1/2" x 19" x 19"	White	
004527	12-894-25	4"cc Lavatory Basin	9-1/2" x 19" x 19"	Bone	





## Top-Mount Lavatories

### Drop-In Lavatories (Continued)

#### Rotunda Self-Rimming Lavatory

Part #	Mfg #	Description	Dimensions	Color	Price
024850	12-894-09	4"cc Lavatory Basin	9-1/2" x 19" x 19"	Biscuit	

#### Wicker Park™ Self-Rimming Lavatory

- Concealed front overflow
- Rear-oriented drain location
- Faucet sold separately



Part #	Mfg #	Description	Dimensions	Color	Price
247455	13-894	4"cc Lavatory Basin	7-7/8" x 22" x 17-3/4"	White	
244324	13-898	8"cc Lavatory Basin	7-7/8" x 22" x 17-3/4"	White	

## Top-Mount Lavatories

### Vitreous China Drop-In Lavatories

#### Oak Lawn Drop-In Oval Lavatory

- 7-7/8" Depth
- 4"cc
- Inside bowl dimensions: 10-1/2"x16"
- ADA Compliant when installed in a 21" min depth countertop
- Deep bowl with wash area



Part #	Mfg #	Description	Dimensions	Color	Price
235397	006-623	3-Hole, 4"cc Oval	20"x17"x7-1/2"	White	

## Under-Mount Lavatories

### Vitreous China Under-Mount Lavatories

ADA - Compliant when installed according to the Accessibility Guidelines, Section 606 Lavatories and Mirrors, of the Act

#### Archer™ Under-Mount Lavatory

- Overflow drain
- Includes 52047 clamp assembly
- Exterior dimensions: 19-5/8" x 15-5/16"
- Basin depth: 7-1/2"



Part #	Mfg #	Description	Interior Dimensions	Color	Price
102866	K-2355-0	ADA Basin	17-5/16" x 13"	White	
112534	K-2355-47	ADA Basin	17-5/16" x 13"	Almond	
111215	K-2355-58	ADA Basin	17-5/16" x 13"	Thunder Grey	
112591	K-2355-7	ADA Basin	17-5/16" x 13"	Black	
158430	K-2355-95	ADA Basin	17-5/16" x 13"	Ice Grey	
107494	K-2355-96	ADA Basin	17-5/16" x 13"	Biscuit	
116214	K-2355-G9	ADA Basin	17-5/16" x 13"	Sandbar	
179978	K-2355-NY	ADA Basin	17-5/16" x 13"	Dune	

#### Camber® Under-Mount Lavatory

- Round basin
- Without overflow



Part #	Mfg #	Description	Dimensions	Color	Price
083350	K-2349-0	ADA Basin Less Overflow	14" Diameter	White	
183025	K-2349-47	ADA Basin Less Overflow	14" Diameter	Almond	
101747	K-2349-96	ADA Basin Less Overflow	14" Diameter	Biscuit	
094624	K-2349-HV	ADA Basin Less Overflow	14" Diameter	Boucle Tweed	
094362	K-2349-HW	ADA Basin Less Overflow	14" Diameter	Boucle Muslin	

#### Caxton® Under-Mount Lavatory with Caravan® Collection Persia

- Decorated with a Moorish design on White background.
- Deep oval basin.
- No faucet holes; requires wall- or counter-mount faucet.
- Persia design.
- Fits standard 14- x 17-inch countertop cutout.



Part #	Mfg #	Description	Dimensions	Color	Price
175256	K-14218-SR2-0	ADA Basin, Caravan Collection Persia	19-1/4" x 16-1/8"	White	

## Under-Mount Lavatories

### Caxton® Under Mount Lavatory with Caravan® Collection Nepal

- Decorated with a Henna pattern on translucent blue background
- Deep oval basin
- No faucet holes; requires wall-or-counter-mount faucet
- Nepal design
- Fits standard 14- x 17-inch countertop cutout



Part #	Mfg #	Description	Dimensions	Color	Price
183673	K-14218-SR1-K7	ADA Basin, Caravan Collection Nepal	19-1/4" x 16-1/8"	Nepal	

### Caxton® Under-Mount Lavatory Basin

- Overflow drain
- Clamp assembly
- Basin depth: 7-1/2"
- Exterior dimensions: (2205) 19-1/4" x 16-1/8", (2209) 15" x 12" (2210) 19-1/4" x 16-1/4", (2211) 21-1/4" x 17-1/4"
- (K-2205) includes center drain with overflow



K-2209 Shown

Part #	Mfg #	Description	Interior Dimensions	Color	Price
066609	K-2205-0	ADA Basin with Overflow, Center Drain	17" x 14" x 8-1/4"	White	
093535	K-2205-47	ADA Basin with Overflow, Center Drain	17" x 14" x 8-1/4"	Almond	
064358	K-2205-96	ADA Basin with Overflow, Center Drain	17" x 14" x 8-1/4"	Biscuit	
057876	K-2209-0	ADA Basin with Overflow	15" x 12" x 7-1/2"	White	
083330	K-2209-47	ADA Basin with Overflow	15" x 12" x 7-1/2"	Almond	
179520	K-2209-58	ADA Basin with Overflow	15" x 12" x 7-1/2"	Thunder Grey	
081075	K-2209-95	ADA Basin with Overflow	15" x 12" x 7-1/2"	Ice Grey	
059880	K-2209-96	ADA Basin with Overflow	15" x 12" x 7-1/2"	Biscuit	
175696	K-2209-NY	ADA Basin with Overflow	15" x 12" x 7-1/2"	Dune	
053183	K-2210-0	ADA Basin with Overflow	17" x 14" x 7-1/2"	White	
069336	K-2210-47	ADA Basin with Overflow	17" x 14" x 7-1/2"	Almond	
085333	K-2210-58	ADA Basin with Overflow	17" x 14" x 7-1/2"	Thunder Grey	
059653	K-2210-7	ADA Basin with Overflow	17" x 14" x 7-1/2"	Black	
073066	K-2210-95	ADA Basin with Overflow	17" x 14" x 7-1/2"	Ice Grey	
059062	K-2210-96	ADA Basin with Overflow	17" x 14" x 7-1/2"	Biscuit	
062319	K-2210-G9	ADA Basin with Overflow	17" x 14" x 7-1/2"	Sandbar	
081511	K-2210-K4	ADA Basin with Overflow	17" x 14" x 7-1/2"	Cashmere	
147692	K-2210-NY	ADA Basin with Overflow	17" x 14" x 7-1/2"	Dune	
249483	K-2210-N-47	ADA Basin with Sealed Overflow and Clamp Assy	17" x 14" x 7-1/2"	Almond	
059574	K-2211-0	ADA Basin with Overflow	19" x 15" x 7-1/2"	White	
062145	K-2211-47	ADA Basin with Overflow	19" x 15" x 7-1/2"	Almond	
061060	K-2211-7	ADA Basin with Overflow	19" x 15" x 7-1/2"	Black	
057480	K-2211-96	ADA Basin with Overflow	19" x 15" x 7-1/2"	Biscuit	
171107	K-2211-58	ADA Basin with Overflow	19" x 15" x 7-1/2"	Thunder Grey	
189533	K-2211-NY	ADA Basin with Overflow	19" x 15" x 7-1/2"	Dune	

## Under-Mount Lavatories

### Vitreous China Under-Mount Lavatories (Continued)

#### Caxton® Under-Mount Lavatory Basin

Part #	Mfg #	Description	Interior Dimensions	Color	Price
091044	K-2211-G-0	ADA Basin with Overflow, Glazed Underside	19" x 15" x 7-1/2"	White	
182421	K-2211-G-96	ADA Basin with Overflow, Glazed Underside	19" x 15" x 7-1/2"	Biscuit	

#### Caxton® Rectangle Under-Mount Lavatory — 17-3/8" x 13"

- Overflow drain
- Vitreous china
- 7-5/16" Depth



Part #	Mfg #	Description	Dimensions	Color	Price
226842	K-20000-0	ADA Basin with Overflow	17-3/8" x 13" x 7-5/16"	White	
233970	K-20000-58	ADA Basin with Overflow	17-3/8" x 13" x 7-5/16"	Thunder Grey	
237674	K-20000-7	ADA Basin with Overflow	17-3/8" x 13" x 7-5/16"	Black	
245616	K-20000-95	ADA Basin with Overflow	17-3/8" x 13" x 7-5/16"	Ice Grey	
229507	K-20000-96	ADA Basin with Overflow	17-3/8" x 13" x 7-5/16"	Biscuit	
229506	K-20000-G9	ADA Basin with Overflow	17-3/8" x 13" x 7-5/16"	Sandbar	
242438	K-20000-NY	ADA Basin with Overflow	17-3/8" x 13" x 7-5/16"	Dune	

#### Derring® Under-Mount Lavatory — 17" x 14"

- Without overflow
- Vitreous china
- 5-1/4" Depth
- Carved textural pattern with artisanal glazes
- Fits Caxton® 17" x 14" countertop cutout



Part #	Mfg #	Description	Dimensions	Color	Price
240027	17889-RL-K8	ADA Basin without Overflow	17" x 14"	Translucent White	
238302	17889-RL-RB2	ADA Basin without Overflow	17" x 14"	Bourbon Rutile	

#### Devonshire® Under-Mount Lavatory Basin — 18-1/8" x 14"

- Overflow drain
- Vitreous china
- 8-5/8" Depth



Part #	Mfg #	Description	Interior Dimensions	Color	Price
076321	K-2336-0	ADA Basin	18-1/8" x 14"	White	
079195	K-2336-47	ADA Basin	18-1/8" x 14"	Almond	
149624	K-2336-58	ADA Basin	18-1/8" x 14"	Thunder Grey	
100993	K-2336-7	ADA Basin	18-1/8" x 14"	Black	
105168	K-2336-95	ADA Basin	18-1/8" x 14"	Ice Grey	
080618	K-2336-96	ADA Basin	18-1/8" x 14"	Biscuit	

## Under-Mount Lavatories

### Vitreous China Under-Mount Lavatories (Continued)

#### Devonshire® Under-Mount Lavatory Basin — 18-1/8" x 14"

Part #	Mfg #	Description	Interior Dimensions	Color	Price
094835	K-2336-G9	ADA Basin	18-1/8" x 14"	Sandbar	
094799	K-2336-K4	ADA Basin	18-1/8" x 14"	Cashmere	

#### Devonshire® Under-Mount Lavatory — 16-7/8" x 13-11/16"

- Vitreous china
- 8-5/8" Depth



Part #	Mfg #	Description	Interior Dimensions	Color	Price
083489	K-2350-0	ADA Basin	16-7/8" x 13-11/16"	White	
086017	K-2350-47	ADA Basin	16-7/8" x 13-11/16"	Almond	
105971	K-2350-7	ADA Basin	16-7/8" x 13-11/16"	Black	
189541	K-2350-95	ADA Basin	16-7/8" x 13-11/16"	Ice Grey	
085876	K-2350-96	ADA Basin	16-7/8" x 13-11/16"	Biscuit	
090983	K-2350-G9	ADA Basin	16-7/8" x 13-11/16"	Sandbar	
181552	K-2350-K4	ADA Basin	16-7/8" x 13-11/16"	Cashmere	
246371	K-2350-NY	ADA Basin	16-7/8" x 13-11/16"	Dune	

#### Kathryn® Under-Mount Lavatory

- Overflow drain
- Basin Depth: 6-3/4"



Part #	Mfg #	Description	Dimensions	Color	Price
083988	K-2330-0	ADA Basin with Overflow	19-3/4" x 15-5/8"	White	
237209	K-2330-47	ADA Basin with Overflow	19-3/4" x 15-5/8"	Almond	
090986	K-2330-7	ADA Basin with Overflow	19-3/4" x 15-5/8"	Black	
090271	K-2330-96	ADA Basin with Overflow	19-3/4" x 15-5/8"	Biscuit	
085008	K-2297-0	ADA Basin with Overflow	23-7/8" x 15-5/8"	White	
185956	K-2297-95	ADA Basin with Overflow	23-7/8" x 15-5/8"	Ice Grey	
089029	K-2297-96	ADA Basin with Overflow	23-7/8" x 15-5/8"	Biscuit	
082432	K-2297-G-0	ADA Basin w/ Overflow and Glazed Underside	23-7/8" x 15-5/8"	White	
128503	K-2297-G-7	ADA Basin w/ Overflow and Glazed Underside	23-7/8" x 15-5/8"	Black	

#### Kelston® Under-Mount Lavatory — 20-3/8" x 15-1/4"

- Overflow drain
- Basin depth: 5"



Part #	Mfg #	Description	Dimensions	Color	Price
117394	K-2382-0	ADA Basin with Overflow	20-3/8" x 15-1/4"	White	
141583	K-2382-47	ADA Basin with Overflow	20-3/8" x 15-1/4"	Almond	
173084	K-2382-7	ADA Basin with Overflow	20-3/8" x 15-1/4"	Black	
127879	K-2382-95	ADA Basin with Overflow	20-3/8" x 15-1/4"	Ice Grey	



## Under-Mount Lavatories

### Vitreous China Under-Mount Lavatories (Continued)

#### Kelston® Under-Mount Lavatory — 20-3/8" x 15-1/4"

Part #	Mfg #	Description	Dimensions	Color	Price
122615	K-2382-96	ADA Basin with Overflow	20-3/8" x 15-1/4"	Biscuit	
178526	K-2382-NY	ADA Basin with Overflow	20-3/8" x 15-1/4"	Dune	

#### Ladena™ Under-Mount Lavatory — 20-7/8" x 14-3/8"

- Vitreous china
- Basin depth: 8-1/8"



Part #	Mfg #	Description	Interior Dimensions	Color	Price
073188	K-2214-0	ADA Basin with Overflow	20-7/8" x 14-3/8" x 8-1/8"	White	
101463	K-2214-47	ADA Basin with Overflow	20-7/8" x 14-3/8" x 8-1/8"	Almond	
159003	K-2214-58	ADA Basin with Overflow	20-7/8" x 14-3/8" x 8-1/8"	Thunder Grey	
089865	K-2214-7	ADA Basin with Overflow	20-7/8" x 14-3/8" x 8-1/8"	Black	
164687	K-2214-95	ADA Basin with Overflow	20-7/8" x 14-3/8" x 8-1/8"	Ice Grey	
070312	K-2214-96	ADA Basin with Overflow	20-7/8" x 14-3/8" x 8-1/8"	Biscuit	
099126	K-2214-G9	ADA Basin with Overflow	20-7/8" x 14-3/8" x 8-1/8"	Sandbar	
143062	K-2214-K4	ADA Basin with Overflow	20-7/8" x 14-3/8" x 8-1/8"	Cashmere	
175695	K-2214-NY	ADA Basin with Overflow	20-7/8" x 14-3/8" x 8-1/8"	Dune	

#### Ladena™ Under-Mount Lavatory Sink with Glazed Underside — 20-7/8" x 14-3/8"

- Vitreous china
- 8-1/8" Depth



Part #	Mfg #	Description	Interior Dimensions	Color	Price
070679	K-2214-G-0	ADA Basin	20-7/8" x 14-3/8" x 8-1/8"	White	
158283	K-2214-G-47	ADA Basin	20-7/8" x 14-3/8" x 8-1/8"	Almond	
157775	K-2214-G-7	ADA Basin	20-7/8" x 14-3/8" x 8-1/8"	Black	
156076	K-2214-G-96	ADA Basin	20-7/8" x 14-3/8" x 8-1/8"	Biscuit	

#### Ladena™ Under-Mount Lavatory Sink with Overflow Drain — 23-1/4" x 16-1/4"

- Vitreous china
- Basin depth: 8-1/8"
- ADA-compliant when installed in a 21" minimum depth countertop



Part #	Mfg #	Description	Interior Dimensions	Color	Price
058988	K-2215-0	ADA Basin with Overflow	23-1/4" x 16-1/4"	White	
080728	K-2215-47	ADA Basin with Overflow	23-1/4" x 16-1/4"	Almond	
160232	K-2215-58	ADA Basin with Overflow	23-1/4" x 16-1/4"	Thunder Grey	
169972	K-2215-7	ADA Basin with Overflow	23-1/4" x 16-1/4"	Black	
103063	K-2215-95	ADA Basin with Overflow	23-1/4" x 16-1/4"	Ice Grey	
075914	K-2215-96	ADA Basin with Overflow	23-1/4" x 16-1/4"	Biscuit	
078633	K-2215-G9	ADA Basin with Overflow	23-1/4" x 16-1/4"	Sandbar	

## Under-Mount Lavatories

### Vitreous China Under-Mount Lavatories (Continued)

#### Ladena™ Under-Mount Lavatory Sink with Overflow Drain — 23-1/4" x 16-1/4"

Part #	Mfg #	Description	Interior Dimensions	Color	Price
117225	K-2215-K4	ADA Basin with Overflow	23-1/4" x 16-1/4"	Cashmere	
189534	K-2215-NY	ADA Basin with Overflow	23-1/4" x 16-1/4"	Dune	

#### Memoirs® Under-Mount Lavatory Sink — 18-1/4" x 14-1/2"

- Vitreous china
- 8-5/8" Depth



Part #	Mfg #	Description	Interior Dimensions	Color	Price
078909	K-2339-0	ADA Basin	18-1/4" x 14-1/2"	White	
083715	K-2339-47	ADA Basin	18-1/4" x 14-1/2"	Almond	
077085	K-2339-7	ADA Basin	18-1/4" x 14-1/2"	Black	
079155	K-2339-96	ADA Basin	18-1/4" x 14-1/2"	Biscuit	
086203	K-2339-G9	ADA Basin	18-1/4" x 14-1/2"	Sandbar	
108484	K-2339-K4	ADA Basin	18-1/4" x 14-1/2"	Cashmere	

#### Thoreau® Under-Mount Lavatory Sink

- Oversized holes accommodate 8" cc or 1-hole faucet
- Oval basin
- Cast Iron
- 24" x 18"



Part #	Mfg #	Description	Dimensions	Color	Price
058658	K-2907-8U-0	ADA Basin	24" x 18"	White	
091858	K-2907-8U-47	ADA Basin	24" x 18"	Almond	
064439	K-2907-8U-96	ADA Basin	24" x 18"	Biscuit	

#### Sartorial™ Under-Mount Lavatory Sink without Overflow — 19-1/4" x 16-1/4"

- Vitreous china
- Basin depth: 6-3/8"
- 17" x 14" Countertop cut-out
- Decorated with a textural Herringbone design in white on a Caxton® under-mount sink



Part #	Mfg #	Description	Dimensions	Color	Price
238484	K-14218-HD1-0	ADA Basin	19-1/4" x 16-1/4"	Herringbone	

#### Verticyl™ Oval Under-Mount Lavatory Sink with Overflow Drain

- Vitreous china



Part #	Mfg #	Description	Interior Dimensions	Color	Price
124338	K-2881-0	Oval ADA Basin	17" x 14"	White	
124340	K-2881-47	Oval ADA Basin	17" x 14"	Almond	
166402	K-2881-58	Oval ADA Basin	17" x 14"	Thunder Grey	

## Under-Mount Lavatories

### Vitreous China Under-Mount Lavatories (Continued) Verticyl™ Oval Under-Mount Lavatory Sink with Overflow Drain

Part #	Mfg #	Description	Interior Dimensions	Color	Price
132631	K-2881-7	Oval ADA Basin	17" x 14"	Black	
183044	K-2881-95	Oval ADA Basin	17" x 14"	Ice Grey	
124339	K-2881-96	Oval ADA Basin	17" x 14"	Biscuit	
136652	K-2881-G9	Oval ADA Basin	17" x 14"	Sandbar	
129261	K-2881-K4	Oval ADA Basin	17" x 14"	Cashmere	

#### Verticyl™ Under-Mount Lavatory Sink with Overflow

- Vitreous china.
- Exterior dimensions: 19-13/16" x 15-5/8"
- Interior dimensions: 17-1/4" x 13"



Part #	Mfg #	Description	Interior Dimensions	Color	Price
124345	K28820	ADA Basin	17-1/4" x 13"	White	
124347	K-2882-47	ADA Basin	17-1/4" x 13"	Almond	
146683	K-2882-58	ADA Basin	17-1/4" x 13"	Thunder Grey	
129813	K-2882-7	ADA Basin	17-1/4" x 13"	Black	
170067	K-2882-95	ADA Basin	17-1/4" x 13"	Ice Grey	
124346	K-2882-96	ADA Basin	17-1/4" x 13"	Biscuit	
183045	K-2882-G9	ADA Basin	17-1/4" x 13"	Sandbar	
133998	K-2882-K4	ADA Basin	17-1/4" x 13"	Cashmere	
181967	K-2882-NY	ADA Basin	17-1/4" x 13"	Dune	

#### Verticyl™ Under-Mount Lavatory Sink with Overflow

- Vitreous china
- Exterior dimensions: 15-3/4" diameter
- Interior dimensions: 13-3/4" diameter
- 6-3/4" Depth



Part #	Mfg #	Description	Dimensions	Color	Price
124348	K-2883-0	Round ADA Basin	13-3/4" Dia	White	
124350	K-2883-47	Round ADA Basin	13-3/4" Dia	Almond	
178160	K-2883-95	Round ADA Basin	13-3/4" Dia	Ice Grey	
124349	K-2883-96	Round ADA Basin	13-3/4" Dia	Biscuit	
156547	K-2883-G9	Round ADA Basin	13-3/4" Dia	Sandbar	

#### Vintage® Under-Mount Classic Elliptical Lavatory Sink with Overflow Drain — 21-1/4" x 12-1/4"

- Vitreous china
- Exterior dimensions: 23-7/8" x 14-3/8"
- Water depth: 4-7/8"



Part #	Mfg #	Description	Dimensions	Color	Price
059087	K-2240-0	ADA Elliptical Basin	21" x 12"	White	

## Under-Mount Lavatories

### Vitreous China Under-Mount Lavatories (Continued)

#### Vintage® Under-Mount Classic Elliptical Lavatory Sink with Overflow Drain — 21-1/4" x 12-1/4"

Part #	Mfg #	Description	Dimensions	Color	Price
182422	K-2240-47	ADA Elliptical Basin	21" x 12"	Almond	
062987	K-2240-96	ADA Elliptical Basin	21" x 12"	Biscuit	

#### Lilies Lore® Cast Bronze Under-Mount Lavatory

- 17" x 14"
- Without overflow
- Integrally cast drain
- Drain is integrated into the sink
- Intricate Art Nouveau-inspired textured floral pattern
- No faucet holes; requires wall- or counter-mount faucet
- Not recommended for commercial applications
- Fits standard 14" x 17" countertop cutout



Part #	Mfg #	Description	Dimensions	Color	Price
131710	K-14297-MP1	ADA Basin	17" x 14"	Medium Patina	

### Cast Iron Under-Mount Lavatories

ADA - Compliant when installed according to the Accessibility Guidelines, Section 606 Lavatories and Mirrors, of the Act

#### Canvas® Under-Mount Lavatory Sink with Overflow Drain — 19-7/16" x 16-1/16"

- Cast iron
- Basin depth: 3-15/16"



Part #	Mfg #	Description	Interior Dimensions	Color	Price
136735	K-2874-0	ADA Basin	19-7/16" x 16-1/16"	White	
147500	K-2874-47	ADA Basin	19-7/16" x 16-1/16"	Almond	
162016	K-2874-95	ADA Basin	19-7/16" x 16-1/16"	Ice Grey	
142825	K-2874-96	ADA Basin	19-7/16" x 16-1/16"	Biscuit	
132942	K-2874-FD	ADA Basin	19-7/16" x 16-1/16"	Cane Sugar	
138669	K-2874-FF	ADA Basin	19-7/16" x 16-1/16"	Sea Salt	
154813	K-2874-G9	ADA Basin	19-7/16" x 16-1/16"	Sandbar	
182803	K-2874-FT	ADA Basin	19-7/16" x 16-1/16"	Basalt	
135230	K-2874-KA	ADA Basin	19-7/16" x 16-1/16"	Black n' Tan	

#### Garamond® Under-Mount Lavatory Sink — 21-1/16" x 16-1/4"

- Enameled cast iron
- 5-1/2" Water depth



Part #	Mfg #	Description	Dimensions	Color	Price
095184	K-2832-0	ADA Basin	21-1/16" x 16-1/4"	White	
117130	K-2832-47	ADA Basin	21-1/16" x 16-1/4"	Almond	
093172	K-2832-96	ADA Basin	21-1/16" x 16-1/4"	Biscuit	

## Under-Mount Lavatories

### Cast Iron Under-Mount Lavatories (Continued)

#### Garamond® Under-Mount Lavatory Sink — 21-1/16" x 16-1/4"

Part #	Mfg #	Description	Dimensions	Color	Price
122579	K-2832-FD	ADA Basin	21-1/16" x 16-1/4"	Cane Sugar	
097422	K-2832-FF	ADA Basin	21-1/16" x 16-1/4"	Sea Salt	
117835	K-2832-FT	ADA Basin	21-1/16" x 16-1/4"	Basalt	

#### Iron Plains® Wading Pool® Dual-Mount Lavatory Sink with Overflow Drain — 18-9/16" x 15-3/4"

- Drop-in or undermount
- Models K-5400-P5-KA & 5400-W-0 have black painted underside



Part #	Mfg #	Description	Dimensions	Color	Price
175174	K-5400-FF	ADA Basin	18-9/16" x 15-3/4"	Sea Salt	
167217	K-5400-FT	ADA Basin	18-9/16" x 15-3/4"	Basalt	
257777	K-5400-P5-0	ADA Basin, w/ Black Painted Underside	18-9/16" x 15-3/4"	White	
183578	K-5400-P5-KA	ADA Basin, w/ Black Painted Underside	18-9/16" x 15-3/4"	Black 'n tan	
184189	K-5400-W-0	ADA Basin, w/ Black Painted Underside	18-9/16" x 15-3/4"	White	
167216	K-5400-0	ADA Basin	18-9/16" x 15-3/4"	White	
240819	K-5400-47	ADA Basin	18-9/16" x 15-3/4"	Almond	
166509	K-5400-96	ADA Basin	18-9/16" x 15-3/4"	Biscuit	

#### Ledges® Under-Mount Lavatory Sink with Overflow Drain — 21-1/2" x 16-1/8"

- 6" Deep basin
- Two side ledges



Part #	Mfg #	Description	Dimensions	Color	Price
111186	K-2838-0	Rectangular Basin	21-1/2" x 16-1/8"	White	
113707	K-2838-47	Rectangular Basin	21-1/2" x 16-1/8"	Almond	
113049	K-2838-96	Rectangular Basin	21-1/2" x 16-1/8"	Biscuit	
143186	K-2838-FD	Rectangular Basin	21-1/2" x 16-1/8"	Cane Sugar	
146882	K-2838-FF	Rectangular Basin	21-1/2" x 16-1/8"	Sea Salt	
137264	K-2838-KA	Rectangular Basin	21-1/2" x 16-1/8"	Black 'n Tan	

#### Man's Lav Under-Mount Lavatory Sink with Overflow Drain — 28" x 19"

- Cast iron
- Drilled for 8"cc deck-mount faucet



Part #	Mfg #	Description	Dimensions	Color	Price
071736	K-2885-8U-0	ADA Rectangular Basin	28" x 19" x 7-7/8"	White	
229069	K-2885-8U-47	ADA Rectangular Basin	28" x 19" x 7-7/8"	Almond	
075016	K-2885-8U-96	ADA Rectangular Basin	28" x 19" x 7-7/8"	Biscuit	

## Under-Mount Lavatories

### Serif® Under-Mount Lavatory Sink — 20-5/8" x 15-1/4"

- Basin depth: 8-7/16"
- Without overflow or faucet holes



Part #	Mfg #	Description	Interior Dimensions	Color	Price
087771	K-2824-0	ADA Basin	20-5/8" x 15-1/4"	White	
083816	K-2824-47	ADA Basin	20-5/8" x 15-1/4"	Almond	
120112	K-2824-7	ADA Basin	20-5/8" x 15-1/4"	Black	
164472	K-2824-95	ADA Basin	20-5/8" x 15-1/4"	Ice Grey	
085289	K-2824-96	ADA Basin	20-5/8" x 15-1/4"	Biscuit	
099931	K-2824-FD	ADA Basin	20-5/8" x 15-1/4"	Cane Sugar	
102203	K-2824-FF	ADA Basin	20-5/8" x 15-1/4"	Sea Salt	
090984	K-2824-G9	ADA Basin	20-5/8" x 15-1/4"	Sandbar	
087448	K-2824-KA	ADA Basin	20-5/8" x 15-1/4"	Black n' Tan	
184222	K-2824-NY	ADA Basin	20-5/8" x 15-1/4"	Dune	

## Glass Under-Mount Lavatories

### Whist® Glass Under-Mount Lavatory Sink — 19" x 16-1/8"

- Basin depth: 5-3/8"
- Concentric ring styling
- No faucet or overflow holes
- (-G3) Opaque lavatory in doe



Part #	Mfg #	Description	Dimensions	Color	Price
153881	K-2741-B11	ADA Basin	19" x 16-1/8"	Ice	
241297	K-2741-G1-B11	ADA Basin	19" x 16-1/8"	Opaque Dusk	
143392	K-2741-G3-B11	ADA Basin	19" x 16-1/8"	Opaque Doe	
259489	K-2741-G6-B11	ADA Basin	19" x 16-1/8"	Opaque Sapphire	
183513	K-2741-TG1	ADA Basin	19" x 16-1/8"	Translucent Dusk	
238057	K-2741-TG8	ADA Basin	19" x 16-1/8"	Translucent Stone	

### Kallos® Under-Mount Glass Lavatory Sink

- Basin depth: 4-1/4"
- Distinctive round spun-glass basin
- No faucet holes; requires wall- or counter-mount faucet



Part #	Mfg #	Description	Dimensions	Color	Price
231781	K-2361-TG8	ADA Basin	16" Diameter	Translucent Stone	
231224	K-2361-TG3	ADA Basin	16" Diameter	Translucent Doe	



## Under-Mount Lavatories

### Stainless Steel Under-Mount Lavatories

#### Bachata® Dual-Mount Lavatory Sink without Overflow Drain — 19-7/8" x 16-11/16"

- 20 Gauge stainless steel
- Fits standard 14- x 17-inch countertop cutout



Part #	Mfg #	Description	Dimensions	Color	Price
171186	K-2608-MU-NA	ADA Basin, 5-3/4" Depth	19-7/8" x 16-11/16"	Mirror Finish	
168004	K-2608-SU-NA	ADA Basin, 5-3/4" Depth	19-7/8" x 16-11/16"	Luster Finish	

#### Bachata® Dual-Mount Lavatory Sink with Overflow Drain — 19-7/8" x 16-11/16"

- 20 Gauge stainless steel
- Fits standard 14- x 17-inch countertop cutout



Part #	Mfg #	Description	Dimensions	Color	Price
171029	K-2609-MU-NA	ADA Basin, 7-3/8" Depth	19-7/8" x 16-11/16"	Polished	
163138	K-2609-SU-NA	ADA Basin, 7-3/8" Depth	19-7/8" x 16-11/16"	Brushed	

#### Bolero® Under-Mount/Drop-In Lavatory

- 11-1/2" Diameter
- 20 Gauge stainless steel



Part #	Mfg #	Description	Dimensions	Color	Price
065755	K-2610-SU-NA	ADA Basin, 5-1/4" Depth	11-1/2" Diameter	Satin Finish	

#### Bolero® Under-Mount/Drop-In Lavatory

- Satin finish
- Water depth: 5-1/2"
- 20 Gauge stainless steel



Part #	Mfg #	Description	Dimensions	Color	Price
067278	K-2611-SU-NA	ADA Basin, 5-1/2" Depth	16-3/4" x 11-3/4"	Satin Finish	

#### Rhythm® Elliptical Under-Mount Lavatory with Satin Finish

- Basin depth: 6-1/4"
- Without overflow
- 20-gauge stainless steel
- No faucet holes; requires wall- or counter-mount faucet



Part #	Mfg #	Description	Dimensions	Color	Price
063582	K-2602-SU-NA	ADA Basin	18" x 13"	Satin Finish	



DECOLAV®



DECOLAV®

## Under-Mount Lavatories

### Vitreous China Undermount Lavatories

#### Classically Redefined™ Lavatory

- With overflow



Oval

Part #	Mfg #	Description	Dimensions (H x W x D)	Color	Price
107838	1401-CWH	ADA Oval Basin	7.13" x 19.25" x 16.25"	Ceramic White	
107839	1401-CBN	ADA Oval Basin	7.13" x 19.25" x 16.25"	Ceramic Biscuit	
107840	1402-CWH	ADA Rectangular Basin	8.25" x 21.63" x 15.75"	Ceramic White	
107841	1402-CBN	ADA Rectangular Basin	8.25" x 21.63" x 15.75"	Ceramic Biscuit	



## Under-Mount Lavatories

### Undermount Lavatories

#### Logan Square™ Undercounter Lavatory

- *Concealed front overflow*



Part #	Mfg #	Description	Dimensions	Color	Price
128363	12-760	Lavatory Basin	7-5/8"H x 20-1/2"W x 17-1/8"D	White	
130171	12-760-09	Lavatory Basin	7-5/8"H x 20-1/2"W x 17-1/8"D	Biscuit	
150876	12-765	Petite Lavatory Basin	6-3/4"H x 18-3/4"W x 14-3/4"D	White	

#### Luxoval™ Undercounter Lavatory

- *Installs with #99-190 anchoring kit (not included)*



Part #	Mfg #	Description	Dimensions	Color	Price
019082	12-780	Lavatory Basin	8-1/8"H x 19-1/8"W x 15"D	White	
046531	12-780-09	Lavatory Basin	8-1/8"H x 19-1/8"W x 15"D	Biscuit	

#### Luxoval™ Undercounter Lavatory

- *Concealed front overflow*



Part #	Mfg #	Description	Dimensions	Color	Price
242119	13-743	Lavatory Basin	7"H x 17-5/8"W x 14-5/8"D	White	

#### Wicker Park™ Rectangular Undercounter Lavatory

- *19-5/8" x 15-1/2" Square Lavatory*
- *Front overflow for seamless visual appearance in any bathroom or powder room setting*
- *No faucet holes; wall-mount or deckmounted faucet required for installation*
- *Anchoring kit sold separately (99-190)*



Part #	Mfg #	Description	Dimensions	Color	Price
188709	12-791	Lavatory Basin	6-7/8"H x 19-5/8"W x 15-1/2"D	White	

### Mounting Hardware

#### Anchoring Kit

Part #	Mfg #	Description	Price
019081	99-190	Anchoring Kit for Undermount Lavatories	

**Under-Mount Lavatories**

**Vitreous China Undercounter Lavatories**

**Wescott™ Undercounter Lavatory**

- Center drain and overflow



Part #	Mfg #	Description	Dimensions	Color	Price
096764	442040-96	Oval Basin	17" x 13"	Biscuit	

**Under-Mount Lavatories**

**Stainless Steel Lavatory Sinks**

**Asana Lustertone® Undermount SS Single Bowl Lavatory Sink**

- 18" Gauge
- Lustrous highlighted satin finish
- Sound gaurd undercoating
- Includes overflow assembly



Part #	Mfg #	Overall Size	Holes	Depth	Drain Opening	Min Sink	Price
048516	ELUH1511	18" x 14"	N/A	6"	1-1/2"	21"	
177137	ELUH1811	19-1/2" x 13-13/16"	N/A	6"	1-1/2"	27"	

**Asana® Dual-Mount SS Single Bowl Lavatory Sink**

- 18" Gauge
- Hammered mirror finish
- Fully undercoated
- Includes overflow assembly



Part #	Mfg #	Overall Size	Holes	Depth	Drain Opening	Min Sink	Price
157863	SCF16SH	16-1/4" Dia	N/A	7"	1-1/2"	21"	

**Asana® Lustertone Undermount SS Round Single Bowl Sink**

- 18" Gauge
- Lustrous highlighted satin finish
- Fully undercoated with pad(s)
- Includes overflow assembly



Part #	Mfg #	Overall Size	Holes	Depth	Drain Opening	Min Sink	Price
074995	ELUH16LV	18-3/8" Dia	N/A	8"	1-1/2"	24"	

**The Mystic® Lustertone® Undermount SS Single Bowl Lavatory Sink**

- 18" Gauge
- Lustrous highlighted finish
- Fully undercoated with pad(s)



Part #	Mfg #	Overall Size	Holes	Depth	Drain Opening	Min Sink	Price
122716	ELUH12	14-3/8" x 14-3/8"	N/A	6"	2"	18"	
159294	ELUH16	18-3/8" Dia	N/A	8"	2"	24"	

## Under-Mount Lavatories

### Under-Mount Lavatories

#### Brentwood Under-Mount Lavatory

- Traditional Style
- Part of the Brentwood Bathroom Collection
- Undercounter lavatory
- Concealed front overflow



Part #	Mfg #	Description	Dimensions	Color	Price
220856	234-WH	ADA Basin: 18-15/16" x 13"	20-5/16" x 14-3/16"	White	
215018	234-BI	ADA Basin: 18-15/16" x 13"	20-5/16" x 14-3/16"	Biscuit	

#### Maple Under-Mount Lavatory

- Undercounter lavatory
- Concealed front overflow
- Complies with ADA requirements for accessibility



Part #	Mfg #	Description	Dimensions	Color	Price
195313	217-WH	ADA Basin: 17-5/16" x 14-1/8"	19-3/4" x 16"	White	

#### Petite Covington Under-Mount Lavatory

- Undercounter lavatory
- Concealed front overflow
- Complies with ADA requirements for accessibility



Part #	Mfg #	Description	Dimensions	Color	Price
213194	218NS-WH	ADA Basin 19" x 11-3/8"	21-3/8" x 13-1/2"	White	



---



---

## Under-Mount Lavatories

---



---

### Vitreous China Under-Mount Lavatories

#### Forsyth Under-Mount Lavatory Bowl

- *Inside bowl dimensions: 15-3/8" x 12-3/16"*
- *ADA Compliant when installed in a 21" min depth countertop*
- *Flat-back rim allows positioning of this lav closer to faucets*
- *Polished top rim with large wash area*
- *Deep bowl with large wash area*



Part #	Mfg #	Description	Dimensions	Color	Price
233768	561-0584	Under-Mount with Unglazed Rim	15"x12"x7-1/2"	White	

## Vessel Bowl Lavatories

### Above-Counter Lavatories

#### Antilia® Glass Wading Pool

- No faucet holes
- Drain sold separately
- Without overflow



Part #	Mfg #	Description	Dimensions	Color	Price
107701	K-2369-B11	No Faucet Holes	28-1/16" x 17-1/16"	Ice	

#### Briolette™ Glass Vessel — 17-1/2" Diameter

- No faucet holes
- Drain sold separately



Part #	Mfg #	Description	Dimensions	Color	Price
139568	K-2373-B11	No Faucet Holes	17-1/2" x 17-1/2"	Ice	
181690	K-2373-TG3	No Faucet Holes	17-1/2" x 17-1/2"	Translucent Doe	
225246	K-2373-TG8	No Faucet Holes	17-1/2" x 17-1/2"	Translucent Stone	

#### Carillon™ Wading Pool® Above Counter Lavatory

- Without overflow
- No faucet holes; requires wall or counter mount faucet
- Wading pool design accommodates a wide variety of faucets



Part #	Mfg #	Description	Dimensions	Color	Price
183687	K-7799-0	Rectangle Basin, No Faucet Holes	21-1/8" x 14-9/16"	White	
188093	K-7799-96	Rectangle Basin, No Faucet Holes	21-1/8" x 14-9/16"	Biscuit	
186521	K-7799-NY	Rectangle Basin, No Faucet Holes	21-1/8" x 14-9/16"	Dune	
183688	K-7806-0	Round Basin, No Faucet Holes	17-11/16" x 17-11/16"	White	
256620	K-7806-7	Round Basin, No Faucet Holes	17-11/16" x 17-11/16"	Black	
228783	K-7608-NY	Round Basin, No Faucet Holes	17-11/16" x 17-11/16"	Dune	

#### Conical Bell® Vessel Above-Counter Lavatory

- No faucet holes
- 16-1/4" Outside diameter
- Glazed underside (-G models only)



Part #	Mfg #	Description	Dimensions	Color	Price
060286	K-2200-0	Less Faucet Deck	16-1/4" x 6-3/8"	White	
078715	K-2200-47	Less Faucet Deck	16-1/4" x 6-3/8"	Almond	
059861	K-2200-96	Less Faucet Deck	16-1/4" x 6-3/8"	Biscuit	
090738	K-2200-G9	Less Faucet Deck	16-1/4" x 6-3/8"	Sandbar	

## Vessel Bowl Lavatories

### Above-Counter Lavatories (Continued)

#### Conical Bell® Vessel Above-Counter Lavatory

Part #	Mfg #	Description	Dimensions	Color	Price
137496	K-2200-HV	Less Faucet Deck	16-1/4" x 6-3/8"	Bouclé Tweed	
085223	K-2200-K4	Less Faucet Deck	16-1/4" x 6-3/8"	Cashmere	
056793	K-2200-G-0	Less Faucet Deck, Glazed Underside	16-1/4" x 6-3/8"	White	
077004	K-2200-G-7	Less Faucet Deck, Glazed Underside	16-1/4" x 6-3/8"	Black	
089322	K-2200-G-G9	Less Faucet Deck, Glazed Underside	16-1/4" x 6-3/8"	Sandbar	
162283	K-2200-G-K4	Less Faucet Deck, Glazed Underside	16-1/4" x 6-3/8"	Cashmere	

#### DemiLav® Wading Pool® Lavatory — 18-1/4" x 15-5/8"

- Shaped rectangular basin
- No faucet or overflow holes
- Enameled cast iron



Part #	Mfg #	Description	Dimensions	Color	Price
093425	K-2833-0	No Faucet Holes	18-1/4" x 15-5/8"	White	
107455	K-2833-47	No Faucet Holes	18-1/4" x 15-5/8"	Almond	
157023	K-2833-58	No Faucet Holes	18-1/4" x 15-5/8"	Thunder Grey	
107471	K-2833-7	No Faucet Holes	18-1/4" x 15-5/8"	Black	
111056	K-2833-95	No Faucet Holes	18-1/4" x 15-5/8"	Ice Grey	
091948	K-2833-96	No Faucet Holes	18-1/4" x 15-5/8"	Biscuit	
098268	K-2833-FD	No Faucet Holes	18-1/4" x 15-5/8"	Cane Sugar	
093462	K-2833-FF	No Faucet Holes	18-1/4" x 15-5/8"	Sea Salt	
154399	K-2833-FT	No Faucet Holes	18-1/4" x 15-5/8"	Basalt	
096321	K-2833-G9	No Faucet Holes	18-1/4" x 15-5/8"	Sandbar	
097448	K-2833-KA	No Faucet Holes	18-1/4" x 15-5/8"	Black n' Tan	
102886	K-2833-K4	No Faucet Holes	18-1/4" x 15-5/8"	Cashmere	
183559	K-2833-NY	No Faucet Holes	18-1/4" x 15-5/8"	Dune	

#### Derring™ Wading Pool® Above-Counter Lavatory

- No overflow
- Basin with carved textural pattern
- Wading pool® design
- No faucet holes; requires wall or counter mount faucet



Part #	Mfg #	Description	Dimensions	Color	Price
183674	K-17890-RL-K8	Round Basin, No Faucet Holes	17-11/16" x 17-11/16"	Translucent White	
228253	K-17890-RL-RB2	Round Basin, No Faucet Holes	17-11/16" x 17-11/16"	Bourbon Rutile	
183675	K-17916-RL-RB2	Rectangle Basin, No Faucet Holes	21-1/8" x 14-9/16"	Bourbon Rutile	
245950	K-17916-RL-RB3	Rectangle Basin, No Faucet Holes	21-1/8" x 14-9/16"	Bluestone Rutile	

## Vessel Bowl Lavatories

### Iron Plains® Trough Dual-Mount Vessel Bathroom Sink

- Overflow drain
- Cast iron
- No faucet holes; requires wall-or counter-mount faucet
- (-P5) Iron black painted underside
- (-W) White painted underside



Part #	Mfg #	Description	Dimensions	Color	Price
256159	K-20212-W-0	Rectangle Basin w/ White Painted Underside	30" x 15-5/8"	White	

### Iron Plains® Wading Pool® Above-Counter Lavatory

- Overflow drain
- Cast iron
- Vessel, drop-in, or undermount installation
- No faucet holes; requires wall-or counter-mount faucet
- (P5-Black painted underside, W-White painted underside, B-Biscuit painted underside)



Part #	Mfg #	Description	Dimensions	Color	Price
237813	K-5400-P5-0	Rectangle Basin, w/ Black Painted Underside	19" x 16"	White	
186965	K-5400-W-FF	Rectangle Basin, w/ White Painted Underside	19" x 16"	Sea Salt	

### Iron Plains® Wading Pool® Vessel Bathroom Sink — 20-3/4" x 14-1/4"

- Oval basin
- No faucet holes
- Overflow drain
- (P5-Black painted underside, W-White painted underside, B-Biscuit painted underside)



Part #	Mfg #	Description	Dimensions	Color	Price
222201	K-5403-B-96	No Faucet Holes, Biscuit Underside	20-3/4" x 14-1/4"	Biscuit	
246735	K-5403-B-FD	No Faucet Holes, Biscuit Underside	20-3/4" x 14-1/4"	Cane Sugar	
225510	K-5403-P5-0	No Faucet Holes, Iron Black Underside	20-3/4" x 14-1/4"	White	
228782	K-5403-P5-FD	No Faucet Holes, Iron Black Underside	20-3/4" x 14-1/4"	Cane Sugar	
169868	K-5403-P5-KA	No Faucet Holes, Iron Black Underside	20-3/4" x 14-1/4"	Black n' Tan	
227062	K-5403-P5-K4	No Faucet Holes, Iron Black Underside	20-3/4" x 14-1/4"	Cashmere	
176493	K-5403-W-0	No Faucet Holes, White Underside	20-3/4" x 14-1/4"	White	

### Inscribe® Wading Pool Drop-In Bathroom Sink

- Circular basin with sloping walls
- Centered drain
- No faucet holes, requires wall- or counter-mount faucet
- Cast iron



Part #	Mfg #	Description	Dimensions	Color	Price
116583	K-2388-0	ADA Basin	16-1/2" x 16-1/2"	White	
183033	K-2388-7	ADA Basin	16-1/2" x 16-1/2"	Black	
122955	K-2388-96	ADA Basin	16-1/2" x 16-1/2"	Biscuit	
123530	K-2388-FF	ADA Basin	16-1/2" x 16-1/2"	Sea Salt	
130395	K-2388-G9	ADA Basin	16-1/2" x 16-1/2"	Sandbar	

## Vessel Bowl Lavatories

### Leaf™ Vessel Above-Counter Lavatory

- Overflow drain with K-4061 polished chrome cap
- No faucet holes
- Fireclay



Part #	Mfg #	Description	Dimensions	Color	Price
121902	K-2530-0	Less Faucet Deck	23-5/8" x 15"	White	
183034	K-2530-47	Less Faucet Deck	23-5/8" x 15"	Almond	
170406	K-2530-96	Less Faucet Deck	23-5/8" x 15"	Biscuit	

### Pallene™ Glass Vessel

- No faucet holes
- Drain sold separately



Part #	Mfg #	Description	Dimensions	Color	Price
236807	K-14016-B11	Less Faucet Deck	19" x 19"	Ice	

### Purist® Wading Pool® Above-Counter Lavatory — 24" x 23-1/2" x 4-1/16"

- Square, shallow basin with 1-3/4" depth



Part #	Mfg #	Description	Dimensions	Color	Price
123241	K-2314-0	Less Faucet Deck	24" x 23-1/2" x 4-1/16"	White	
085047	K-2314-96	Less Faucet Deck	24" x 23-1/2" x 4-1/16"	Biscuit	
101254	K-2314-1-0	1-Hole	24" x 23-1/2" x 4-1/16"	White	
221808	K-2314-1-47	1-Hole	24" x 23-1/2" x 4-1/16"	Almond	
067238	K-2314-8-0	8"cc	24" x 23-1/2" x 4-1/16"	White	
109874	K-2314-8-47	8"cc	24" x 23-1/2" x 4-1/16"	Almond	
097764	K-2314-8-96	8"cc	24" x 23-1/2" x 4-1/16"	Biscuit	

### Reve® Vessel Above-Counter Lavatory

- Deep, V-shaped basin
- Overflow drain with included K-4061 Polished Chrome cap
- No faucet holes; requires wall- or counter-mount faucet
- Coordinates with other products in the Rêve collection



Part #	Mfg #	Description	Dimensions	Color	Price
135820	K-4819-0	Less Faucet Deck	21-5/8" x 14-3/4"	White	
183075	K-4819-47	Less Faucet Deck	21-5/8" x 14-3/4"	Almond	
151838	K-4819-96	Less Faucet Deck	21-5/8" x 14-3/4"	Biscuit	

## Vessel Bowl Lavatories

### Sartorial™ Wading Pool® Vessel Lavatory

- Without overflow
- Subtle lift at edges
- Herringbone white on Carillon™
- No faucet holes; requires wall- or counter-mount faucet



Part #	Mfg #	Description	Dimensions	Color	Price
248738	K-75748-FP1-0	Less Faucet Deck	17-11/16" x 17-11/16"	French Paisley	
232138	K-75748-HD1-0	Less Faucet Deck	17-11/16" x 17-11/16"	Herringbone	

### Sartorial™ Wading Pool® Vessel Lavatory

- Without overflow
- Herringbone white on Carillon™
- No faucet holes; requires wall- or counter-mount faucet



Part #	Mfg #	Description	Dimensions	Color	Price
243579	K-75749-HD1-0	Less Faucet Deck	21-1/8" x 14-9/16"	White	

### Shagreen Carillon® Wading Pool® Vessel Lavatory Sink

- Without overflow
- No faucet holes; requires wall- or counter-mount faucet



Part #	Mfg #	Description	Dimensions	Color	Price
244850	K-77716-SSP	Less Faucet Deck	21-1/8" x 14-9/16"	Oyster Pearl	

### Spun Glass® Vessel Above-Counter Lavatory

- Translucent glass round vessel
- No faucet holes



Part #	Mfg #	Description	Dimensions	Color	Price
121260	K-2276-B11	Less Faucet Deck	17-1/2" x 17-1/2"	Ice	
257577	K-2276-TG1	Less Faucet Deck	17-1/2" x 17-1/2"	Translucent Dusk	
181476	K-2276-TG2	Less Faucet Deck	17-1/2" x 17-1/2"	Translucent Dew	
245886	K-2276-TG6	Less Faucet Deck	17-1/2" x 17-1/2"	Translucent Sapphire	



## Vessel Bowl Lavatories

### WaterCove® Wading Pool® Bathroom Sink

- Unique shallow basin
- No faucet holes; requires wall- or counter-mount faucet



Part #	Mfg #	Description	Dimensions	Color	Price
084860	K-2332-0	Less Faucet Deck	18-5/8" x 16-3/16"	White	

### Veil® Vessel Bathroom Sink

- Fireclay with supramic technology
- No faucet holes; requires wall- or counter-mount faucet
- Includes color-matched brass drain cover



With Overflow  
K-20704-0



Without Overflow  
K-20704-N-0

Part #	Mfg #	Description	Dimensions	Color	Price
248580	K-20704-0	Less Faucet Deck, With Overflow	21-1/8" x 14-1/16"	White	
247474	K-20704-N-0	Less Faucet Deck, W/O Overflow	21-1/8" x 14-1/16"	White	

### Veil® Tall Vessel/Pedestal Bathroom Sink

- Fireclay with supramic technology
- No faucet holes; requires wall- or counter-mount faucet
- Includes color-matched overflow cap and brass drain cover
- With overflow



**K-20701 Combination: K-20702 pedestal and K-20703 lavatory**

Part #	Mfg #	Description	Dimensions	Color	Price
241293	K-20703-0	Less Faucet Deck, with Overflow	16" x 16"	White	

### Veil® Trough Vessel Bathroom Sink

- Fireclay with Supramic technology
- Large asymmetrical oval basin
- Trough-style basin allows for two-faucet application or striking large vanity installation
- No faucet holes; requires wall- or counter-mount faucet
- Overflow drain
- Innovative Supramic technology provides superior strength and ultra-thin edge profiles
- Includes color-matched overflow cap and color-matched brass drain cover
- Coordinates with other products in the Veil collection



Part #	Mfg #	Description	Dimensions	Color	Price
249101	K-20705-0	Less Faucet Deck, With Overflow	16" x 39-9/16" x 8-5/8"	White	

## Vessel Bowl Lavatories

### Vox® Lavatory Vessel Sinks

- Basin depth: 6-7/8"
- Faucet sold separately
- With overflow



K-2660-1-0



K-2661-0



K-14800-0

Part #	Mfg #	Description	Dimensions	Color	Price
145676	K-14800-0	Round Basin, Less Faucet Deck	16-1/2" Diameter	White	
257328	K-14800-7	Round Basin, Less Faucet Deck	16-1/2" Diameter	Black	
160746	K-14800-95	Round Basin, Less Faucet Deck	16-1/2" Diameter	Ice Grey	
183465	K-14800-96	Round Basin, Less Faucet Deck	16-1/2" Diameter	Biscuit	
138528	K-2661-0	Square Basin, Less Faucet Deck	16-1/4" x 16-1/4"	White	
247371	K-2661-95	Square Basin, Less Faucet Deck	16-1/4" x 16-1/4"	Ice Grey	
183152	K-2661-96	Square Basin, Less Faucet Deck	16-1/4" x 16-1/4"	Biscuit	
139503	K-2660-1-0	Rectangle Basin, Single Hole Faucet Deck	23" x 18-1/8"	White	
251343	K-2660-1-7	Rectangle Basin, Single Hole Faucet Deck	23" x 18-1/8"	Black	
230627	K-2660-1-95	Rectangle Basin, Single Hole Faucet Deck	23" x 18-1/8"	Ice Grey	
183509	K-2660-1-96	Rectangle Basin, Single Hole Faucet Deck	23" x 18-1/8"	Biscuit	
139117	K-2660-8-0	Rectangle Basin, 8"cc Faucet Deck	23" x 18-1/8"	White	
183511	K-2660-8-47	Rectangle Basin, 8" cc Faucet Deck	23" x 18-1/8"	Almond	
238219	K-2660-8-7	Rectangle Basin, 8"cc Faucet Deck	23" x 18-1/8"	Black	
255866	K-2660-8-95	Rectangle Basin, 8" cc Faucet Deck	23" x 18-1/8"	Ice Grey	
227478	K-2660-8-96	Rectangle Basin, 8" cc Faucet Deck	23" x 18-1/8"	Biscuit	
181186	K-5373-0	Rectangle Basin, Less Faucet Deck	21-5/8" x 14-3/4"	White	
187286	K-99183-0	Oval Basin, Less Faucet Deck	20" x 14-7/8"	White	

## Vessel Bowl Lavatories

### Above-Counter Lavatories

#### Aramis Above-Counter Vessel Lavatory Sink

- *Modern and ergonomic design*
- *Without overflow*
- *Hidden drain*
- *Ample ledge*



Part #	Mfg #	Description	Dimensions	Color	Price
239754	804-WH	Single Hole	18-7/8" x 14-5/8"	White	

#### Enso Above-Counter Lavatory

- *Contemporary style*
- *Available in single hole faucet center*  
*-Faucet sold separately*
- *Integral rear overflow with chrome-finished cover*



Part #	Mfg #	Description	Dimensions	Color	Price
205263	311-WH	Round 18"x11" Basin Size, Single-Hole	21-1/2" x 19-1/2"	White	
205264	884	JAVA Wood Lav Vanity Enso	15-1/2" x 10-1/2"	Dark Brown	



DECOLAV®



DECOLAV®

## Sink Accessories

### Parts & Accessories Glass Vessel Mounting Ring



Part #	Mfg #	Size	Finish	Price
090808	9020-CP	3/4"	Pol Chrome	
098254	9020-DB	3/4"	Deco Bronze	
081465	9020-SN	3/4"	Satin Nickel	



## Wall Hung Lavatories

### Wall-Mount Lavatories

#### Eaton™ Wheelchair Hung Lavatory Sink

- 20" x 27" for Concealed Carrier Arm Support\*
- 4" Faucet Centers
- 16" x 16" Bowl
- Back Overflow
- ADA compliant



Part #	Mfg #	Description	Dimensions	Color	Price
004486	12-464	4"cc Wall-Mount	20" x 27" x 7"	White	

#### Hayes Wall-Mount Lavatory

- Ledge type
- Front overflow
- (2) Self-draining soap dishes
- 1-Piece wall hanger
- Holes provided for legs and towel bars
- Faucet sold separately



Part #	Mfg #	Description	Dimensions	Color	Price
004482	12-384	4"cc Wall-Mount	10-1/2" x 20" x 18"	White	

#### Monticello II Wall-Mount Lavatory

- Ledge type
- Back overflow
- (2) Self-draining soap dishes
- 1-Piece wall hanger
- Faucet sold separately



Part #	Mfg #	Description	Dimensions	Color	Price
046541	12-654	4"cc Wall-Mount	20" x 18"	White	

#### Plymouth Wall-Mount Lavatory

- Ledge type
- Back overflow
- (2) Self-draining soap dishes
- 1-Piece wall hanger
- Holes provided for legs and towel bars
- Faucet sold separately



Part #	Mfg #	Description	Dimensions	Color	Price
004479	12-314	4"cc Wall-Mount	12-3/4" x 19" x 17"	White	



## Wall Hung Lavatories

### North Point Wall-Mount Lavatory

- Recessed self draining deck
- Back overflow
- Optional wall hung shroud (29-832)
- ADA Compliant

22-47\* Combination: 12-47\* Lavatory, 29-832 Shroud



Part #	Mfg #	Description	Dimensions	Color	Price
163811	12-478	8"cc Wall-Mount Less Shroud	22" x 21-1/2"	White	
149578	12-474	4"cc Wall-Mount Less Shroud	22" x 21-1/2"	White	
163812	22-478	8"cc Wall-Mount w/ Shroud	22" x 21"	White	
149577	22-474	4"cc Wall-Mount w/ Shroud	22" x 21"	White	

### Shroud Only

For 22-47\* Wall-Hung Lavatory Combination

Part #	Mfg #	Description	Dimensions	Color	Price
149579	29-832	Wall-Mount Shroud Only: Requires Lavatory	N/A	White	

### West Point Wall-Mount Lavatory

- Ledge type
- Space saver
- Front overflow
- (2) Self-draining soap dishes
- 1-Piece wall hanger
- Faucet sold separately



Part #	Mfg #	Description	Dimensions	Color	Price
004481	12-354	4"cc Wall-Mount	8-1/8" x 14" x 12"	White	

### Wicker Park™ Wall-Mount Lavatory

- Curved rectangular
- Rear overflow
- ADA Compliant



Part #	Mfg #	Description	Dimensions	Color	Price
155711	12-592	1-Hole	24-5/8" x 19-3/8"	White	



## Wall Hung Lavatories

### Vitreous China Wall-Mount Lavatories

#### Brenham™ Commercial Wall-Mount Lavatory — 21-15/16" x 19-3/4"

- Basin depth: 6-9/16"
- Includes wall hanger and overflow  
—Model (K-1997-1N-0) has sealed overflow drain
- Drilled for concealed arm carrier
- Optional soap dispenser hole on left or right  
—Right hole dispenser included with (K-1997-1R-0) model
- Model (K-199910) includes shroud
- TAS compliant



Part #	Mfg #	Description	Dimensions	Color	Price
140094	K-1997-1-0	1-Hole ADA Basin	21-15/16" x 19-3/4"	White	
186390	K-1997-1N-0	1-Hole ADA Basin, No Overflow	21-15/16" x 19-3/4"	White	
173635	K-1997-1R-0	2-Hole ADA Basin w/ RH Soap Dispenser Hole	21-15/16" x 19-3/4"	White	
140095	K-1997-4-0	4"cc ADA Basin	21-15/16" x 19-3/4"	White	
183024	K-1997-8-7	8"cc ADA Basin	21-15/16" x 19-3/4"	Black	
171114	K-1999-1-0	1-Hole ADA Basin with Shroud	21-15/16" x 19-3/4"	White	
140982	K-1999-4-0	4"cc ADA Basin with Shroud	21-15/16" x 19-3/4"	White	

#### Chesapeake™ Commercial Wall-Mount Lavatory with Overflow Drain

- 10-1/2" Basin depth
- Ledge-back with hanger
- Drilled for concealed arm carrier
- Model (K-1728-0) — 19-1/4" x 17-1/4"



Part #	Mfg #	Description	Dimensions	Color	Price
076540	K-1722-0	1-Hole ADA Basin	19-1/4" x 17-1/4"	White	
096722	K-1724-0	8"cc ADA Basin	19-1/4" x 17-1/4"	White	
053182	K-1728-0	4"cc ADA Basin	19-1/4" x 17-1/4"	White	
110604	K-1728-96	4"cc ADA Basin	19-1/4" x 17-1/4"	Biscuit	
056627	K-1729-0	4"cc ADA Basin	20" x 18-1/4"	White	
182410	K-1729-96	4"cc ADA Basin	20" x 18-1/4"	Biscuit	

#### Greenwich™ Wall-Mount Lavatory — 20-3/4" x 18-1/4"

- Ledge-back with hanger
- Drilled for concealed arm carrier
- Overflow drain
- Basin depth: 12-7/8"
- Faucet sold separately

Part #	Mfg #	Description	Dimensions	Color	Price
053160	K-2030-0	8"cc ADA Basin	20-3/4" x 18-1/4"	White	
189170	K-2030-R-0	8"cc ADA Basin w/ RH Soap Dispenser Hole	20-3/4" x 18-1/4"	White	
053164	K-2031-0	1-Hole ADA Basin	20-3/4" x 18-1/4"	White	
177282	K-2031-R-0	2-Hole ADA Basin w/ RH Soap Dispenser Hole	20-3/4" x 18-1/4"	White	
053161	K-2032-0	4"cc ADA Basin	20-3/4" x 18-1/4"	White	

## Wall Hung Lavatories

### Hampton™ Wall-Mount Lavatory Less Triton® Faucet

- Cast Iron
- Shelf-back



Part #	Mfg #	Description	Dimensions	Color	Price
182521	K-2703-EH-0	3-Hole ADA Basin	22" x 19"	White	
182423	K-2705-EH-0	3-Hole ADA Basin	19" x 17"	White	
053914	K-2705-0	3-Hole ADA Basin w/ Factory Installed 8040-2A Faucet	19" x 17"	White	

### Hudson™ Commercial Wall-Mount/Concealed Arm Carrier Lavatory

- With overflow
- Basin Depth: 13-1/2"
- Lugs for chair carrier
- Faucet not included



Part #	Mfg #	Description	Dimensions	Color	Price
168955	K-2812-0	1-Hole	20" x 18"	White	
058147	K-2867-0	4"cc	20" x 18"	White	

### Hudson™ Commercial Wall-Mount Lavatory

- Basin Depth: 13-1/2"
- Faucet not included
- Made from premium materials that withstand high-volume usage



Part #	Mfg #	Description	Dimensions	Color	Price
062770	K-2805-0	1-Hole	19" x 17"	White	
057996	K-2861-0	4"cc ADA Basin	19" x 17"	White	

### Kingston™ Wall-Mount Lavatory — 21-1/4" x 18-1/8"

- With back, wall hanger
- Drilled for concealed arm carrier
- Faucet sold separately
- (-R) Right-hand soap dispenser hole
- (-L) Left-hand soap dispenser hole



K-2005



K-2006



K-2007

Part #	Mfg #	Description	Dimensions	Color	Price
053157	K-2005-0	4"cc ADA Basin	21-1/4" x 18-1/8"	White	
080348	K-2005-R-0	4"cc ADA Basin	21-1/4" x 18-1/8"	White	
120125	K-2005-47	4"cc ADA Basin	21-1/4" x 18-1/8"	Almond	
079393	K-2005-7	4"cc ADA Basin	21-1/4" x 18-1/8"	Black	
059463	K-2005-96	4"cc ADA Basin	21-1/4" x 18-1/8"	Biscuit	
053159	K-2006-0	8"cc ADA Basin	21-1/4" x 18-1/8"	White	
059834	K-2007-0	1-Hole ADA Basin	21-1/4" x 18-1/8"	White	

## Wall Hung Lavatories

### Vitreous China Wall-Mount Lavatories (Continued)

#### Kingston™ Wall-Mount Lavatory — 21-1/4" x 18-1/8"

Part #	Mfg #	Description	Dimensions	Color	Price
149216	K-2007-L-0	1-Hole ADA Basin	21-1/4" x 18-1/8"	White	

#### Marston™ Corner Wall-Mount Lavatory Less Triton™ Faucet

- 16" x 16"
- Cast iron
- Shelf-back



Part #	Mfg #	Description	Dimensions	Color	Price
159141	K-2766-EH-0	4"cc Basin	16" x 16"	White	

#### Marston™ Corner Wall-Mount Lavatory with Triton™ Faucet

- 16" x 16"
- Cast iron
- Shelf-back
- Faucet includes grid drain and aerator



Part #	Mfg #	Description	Dimensions	Color	Price
068786	K-2766-0	4"cc Basin	16" x 16"	White	

#### Morningside™ Wall-Mount Concealed Wheelchair Bathroom Sink — 20" x 27"

- 11-1/2" Centers (K-12634-0) or 4"cc centers (K-12636-0)
- Drilled for concealed arm carrier
- ADA-compliant when installed with K-13885 offset drain



Part #	Mfg #	Description	Dimensions	Color	Price
053812	K-12634-0	3-Hole, 11-1/2"cc	20" x 27"	White	
053814	K-12636-0	3-Hole, 4"cc	20" x 27"	White	
053815	K-12638-0	1-Hole, 11-1/2"	20" x 27"	White	

#### Pinior® Wall-Mount Lavatory Sink — 22" x 18"

- Oval basin
- Overflow drain
- Vitreous china



#### K-2035 Combination: K-2028 Sink and K-2057 Shroud

Part #	Mfg #	Description	Dimensions	Color	Price
101153	K-2035-1-0	1-Hole ADA Basin	22" x 18"	White	
060872	K-2035-1-96	1-Hole ADA Basin	22" x 18"	Biscuit	
081981	K-2035-4-0	4"cc ADA Basin	22" x 18"	White	
081978	K-2035-4-96	4"cc ADA Basin	22" x 18"	Biscuit	

## Wall Hung Lavatories

### Vitreous China Wall-Mount Lavatories (Continued)

#### Pinior® Wall-Mount Lavatory Sink — 22" x 18"

Part #	Mfg #	Description	Dimensions	Color	Price
109305	K-2035-8-0	8"cc ADA Basin	22" x 18"	White	
139307	K-2035-8-47	8"cc ADA Basin	22" x 18"	Almond	
079197	K-2035-8-96	8"cc ADA Basin	22" x 18"	Biscuit	

#### Reve® Semi-Pedestal Wall-Mount Lavatory

- Fireclay
- Deep, v-shaped basin
- Overflow drain with included K-4061-CP cap



**K-5148 Combination: K-5026-1 Basin, K-5031 Shroud**

**K-5150 Combination: K-5027-1 Basin, K-5031 Shroud**

Part #	Mfg #	Description	Dimensions	Color	Price
154960	K-5148-1-0	1-Hole Basin	39-3/8" x 18-5/16"	White	
127111	K-5150-1-0	1-Hole Basin	23-5/8" x 18-5/16"	White	

#### Soho® Wall-Mount Concealed Carrier Bathroom Sink

- Drilled for right or left concealed arm carrier  
—Included with sink if (L) or (R) appears in model number



Part #	Mfg #	Description	Dimensions	Color	Price
243113	K-2053-R-0	8"cc Basin w/ RH Soap Dispenser Hole	20" x 18"	White	
059526	K-2054-0	4"cc Basin	20" x 18"	White	
169879	K-2054-47	4"cc Basin	20" x 18"	Almond	
068118	K-2084-0	1-Hole Basin	20" x 18"	White	
182415	K-2084-L-0	2-Hole Basin w/ LH Soap Dispenser Hole	20" x 18"	White	
182416	K-2084-R-0	2-Hole Basin w/ RH Soap Dispenser Hole	20" x 18"	White	

### Parts & Accessories

Part#	Mfg#	Description	Price
241023	K-1808-P-NA	Bathroom Sink Brackets for Greenwich™ Wall-Hung Sink	

## Wall Hung Lavatories

### Wall Hung Lavatories

#### Spruce Cove Wall Mount Lavatory

- Wall-mount lavatory
- Compact size is a perfect fit when space is limited
- Concealed front overflow
- Includes hanger
- 4" faucet center



Part #	Mfg #	Description	Dimensions	Color	Price
192325	1613NS-WH	Wall Hung Basin	16-1/8" x 13-1/4"	White	

#### Grande Isle Wall Hung Lavatory

- Wall-mount lavatory
- Full 4" high backsplash
- Drilled for concealed arm carrier
- Concealed front overflow
- Available in single hole, 4" and 8" faucet centers



Part #	Mfg #	Description	Dimensions	Color	Price
211914	2018HB-NS-1-W H	Wall Hung ADA Basin	22" x 18-1/8"	White	
193469	2018HB-NS-4-W H	Wall Hung ADA Basin	22" x 18-1/8"	White	

**Wall Hung Lavatories**

**Wall-Hung Lavatories**

**SS-3003 Wall-Hung Lavatory with Backsplash**

- Vitreous china
- Front overflow
- 4" Integral backsplash
- Carrier not included
- All mounting hardware included



Part #	Mfg #	Description	Dimensions	Color	Price
154060	3873003	4"cc Basin	20" x 18"	White	





## Cleaners

### Hand Cleaners

#### Cit-Grit Hand Cleaner

- Natural citrus formula, biodegradable
- Contains aloe, lanolin and jojoba oil
- Flip-top spout plastic bottle



Part #	Mfg #	Description	Price
005539	38125	15 fl oz	

**Cleaners**

**Ice Machine Maintenance**

**IMS-III Sanitizing Concentrate**

- EPA Registered
- Registered in all 50 states
- Controls slime build-up on all hard surface areas
- Bacteria will not grow or multiply
- Controls mold and mildew formation
- Eliminates odor



Part #	Mfg #	Description	Price
202563	4211-34	16 fl oz	

**De-Greasing Solvents**

**Degreasing Solvent EF**

- Dries at a controlled rate, leaving no residue
- Dissolves grease and oil in seconds
- Has a dielectric strength greater than 26,000 volts
- Non-corrosive
- Environmentally & Ozone safe



Part #	Mfg #	Description	Price
221598	4083-75	EF- 14oz Can	

**Nickel-Safe IMC**

- Specially formulated citric/phosphoric food-grade product for removing scale deposits from ice makers having nickel-plated or tin-plated evaporators



Part #	Mfg #	Description	Price
208988	4287-08	1 Gallon	
208987	4287-34	16 fl oz	

**Hand Cleaners**

**Great Wipes**

- Industrial strength hand towels
- Waterless wipes made specifically for the A/C, and Plumbing services
- Absorbent, non-scratching abrasive hand towels



Part #	Mfg #	Description	Price
189899	4185-75	75/Pk	

**Urinal Cleaners**

**UrinaKleen Urinal Cleaner**

- Acid-based bowl cleaner removes scale deposits and odors
- Ideal for dissolving rust, urinary salts and mineral scale from flush tanks, urinal drains and bowls



Part #	Mfg #	Description	Price
159421	4590-24	1 Quart	
159422	4590-08	1 Gallon	



---

---

## Cleaners

---

---

### Cleaners

#### Gel-Gloss® Cleaner

- Contains non-harmful abrasive cleaning agents that remove surface oxidation and light scratches while leaving behind a protective carnauba wax coating
- Cleans, protects and restores luster while providing a long lasting protective finish

Part #	Mfg #	Description	Price
120346	GA-12	12 oz, Aerosol	

#### Gel-Gloss® No-Streak Glass & Silver Polish Cleaner

- Contains silicone and protects like a wax
- Wipe it on, allow it to dry to a haze and polish it off
- Cleaner works aggressively on hard water spots and tough residue
- Beads water and leaves behind a protective coating

Part #	Mfg #	Description	Price
141442	NS-8	1/2 pt	



## Lubricants

### Pipe Joint Lubricant

#### Plumber's Faucet & Valve Grease

- *Waterproof*
- *Resists high temperature*
- *Frees sticky faucets, prevents rust*
- *Use on hot water or steam up to 350°F*



Part #	Mfg #	Description	Price
029140	05005012	1 oz Tube	

**Lubricants**

**Lubricants**

**Pull-A-Spout Oiler**

- All purpose oiler
- 14" Telescoping spout



Part #	Mfg #	Size	Price
002300	CO-1	4 oz	

**Rust Breaker**

- Loosens rusted bolts, screws, shafts, piping etc
- Telescoping spout applicator



Part #	Mfg #	Size	Price
002299	CR-1	4 oz	



## Lubricants

### Lubricants

#### Dow 111 Silicone Lubricant

- For o-rings and valve stems



Part #	Mfg #	Tub Size	Price
060945	963-01	1/4 Ounce	



---

---

**Acid Waste Pipe**

---

---

**Acid Waste Pipe**

**Blueline Sch 40 Prox Pipe - 10' Length**

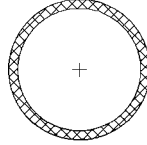

Part #	Mfg #	Size	Price
148517	ORIONBLUEP40112	1-1/2"	
096421	ORIONBLUEP402	2"	
096422	ORIONBLUEP403	3"	

## Aluminum Tubing

### Aluminum Tubing

- 1100 Alloy
- "O" Temper
- Dead soft
- 50' Coils



Part #	Mfg #	OD	Wall Thickness	Price
014965	38ALTB50	3/8"	.035	

**Aluminum Tubing**

**Service Products & Parts**

(Aluminum Tubing)

- Wall thickness: 0.035"
- Meets ASTM standards



Part #	Mfg #	OD Size	Length	Price
074787	11-291	1/8"	5' w/Fittings	
044424	11-293	1/4"	5' w/Fittings	

## Black Steel Pipe

### Black Steel Pipe

#### Black Steel Std Wt TBE Pipe



Part #	Model	Size	Price
042650	1210TBE	1/2" x 10'	
042651	3410TBE	3/4" x 10'	
042654	110TBE	1" x 10'	

#### Black Steel Cut Pipe - TBE

• Import



Part #	Model	Size	Price
145907	1210TBEI	1/2" x 10'	
145908	3410TBEI	3/4" x 10'	
145909	110TBEI	1" x 10'	

#### Black Steel A53 Threaded & Coupled Pipe



Part #	Model	Size	Price
013660	18BTC	1/8"	
013473	14BTC	1/4"	
014985	38BTC	3/8"	
013051	12BTC	1/2"	
014629	34BTC	3/4"	
012189	1BTC	1"	
012770	114BTC	1-1/4"	
012388	112BTC	1-1/2"	
013760	2BTC	2"	
014062	212BTC	2-1/2"	
014313	3BTC	3"	

#### Black Steel Std Wt Pipe - T&C

• Import



Part #	Model	Size	Price
190537	38BTCl	3/8"	
190536	14BTCl	1/4"	
145897	12BTCl	1/2"	
145901	34BTCl	3/4"	

### Black Steel Pipe (Continued)

#### Black Steel Std Wt Pipe - T&C

Part #	Model	Size	Price
145902	1BTCl	1"	
145903	114BTCl	1-1/4"	
145904	112BTCl	1-1/2"	
145905	2BTCl	2"	
208194	212BTCl	2-1/2"	
208195	3BTCl	3"	
208196	4BRCl	4"	

#### Black Steel A53 PE Pipe

• (-I) Import



Part #	Model	Size	Price
013460	14BPE	1/4"	
013037	12BPE	1/2"	
014614	34BPE	3/4"	
012175	1BPE	1"	
012758	114BPE	1-1/4"	
012375	112BPE	1-1/2"	
013750	2BPE	2"	
014309	3BPE	3"	
015195	4BPE	4"	
098869	4BPE	4"	
015505	5BPE	5"	

#### Black Steel A53 PE ERW Pipe



Part #	Model	Size	Price
014058	212BPE	2-1/2"	
014309	3BPE	3"	
015195	4BPE	4"	
015619	6BPE	6"	

#### Black Steel Extra-Heavy A53 PE Pipe



Part #	Model	Size	Price
013215	12XHPE	1/2"	
014781	34XHPE	3/4"	
012295	1XHPE	1"	
012879	114XHPE	1-1/4"	

## Black Steel Pipe

### Black Steel Pipe (Continued)

#### Black Steel Extra-Heavy A53 PE Pipe

Part #	Model	Size	Price
012557	112XHPE	1-1/2"	
013949	2XHPE	2"	
014461	3XHPE	3"	

#### Black Steel Extra-Heavy A53 Threaded & Coupled Pipe



Part #	Model	Size	Price
034190	12XHTC	1/2"	
040292	34XHTC	3/4"	
069165	2XHTC	2"	

#### Black Steel Sch 40 ERW Grooved Pipe

Part #	Model	Size	Price
123833	2S40BLKGROOVBN	2"	
051979	212S40BLKGROOV	2-1/2"	
030523	3S40BLKGROOVBN	3"	
030522	4S40BLKGROOVBN	4"	
085328	5S40BLKGROOVBN	5"	
030521	6S40BLKGROOVBN	6"	

#### Black Steel A106 Sch40 Seamless PE Pipe

- Imported

Part #	Model	Size	Price
237901	2A106S40PEI	2"	

## Black Steel Pipe

### A106 Seamless Sch80 Plain End Pipe

Part #	Model #	Size	Price
152446	12A106S80PE	1/2"	
161771	34A106S80PE	3/4"	
152450	1A106S80PE	1"	
161772	114A106S80PE	1-1/4"	
165463	112A106S80PE	1-1/2"	
152449	2A106S80PE	2"	
165997	212A106S80PE	2-1/2"	
166834	3A106S80PE	3"	
176654	4A106S80PE	4"	
178223	6A106S80PE	6"	
178226	8A106S80PE	8"	

### A106 Seamless Sch40 Plain End Pipe

Part #	Model #	Size	Price
177131	34A106S40PE	3/4"	
167887	1A106S40PE	1"	
039336	2A106S40PE	2"	
038922	212A106S40PE	2-1/2"	
122176	3A106S40PE	3"	
161773	4A106S40PE	4"	
177132	5A106S40PE	5"	
161962	6A106S40PE	6"	
161963	8A106S40PE	8"	

### A53 Extra Heavy Plain End Pipe

Part #	Model #	Size	Price
014064	212XHPE	2-1/2"	
069169	4XHPE	4"	

### A53 Extra Heavy Threaded & Coupled Pipe

Part #	Model #	Size	Price
045087	1XHTC	1"	





## Cast Iron Pipe

### Cast Iron No-Hub Soil Pipe



#### Cast Iron No-Hub Soil Pipe 10' Lengths

Part #	Mfg #	Size	Price
012485	11210NHSP	1-1/2" x 10'	
013857	210NHSP	2" x 10'	
014379	310NHSP	3" x 10'	
015250	410NHSP	4" x 10'	
015513	510NHSP	5" x 10'	
015631	610NHSP	6" x 10'	
015790	810NHSP	8" x 10'	
040265	1010NHSP	10" x 10'	
052840	1210NHSP	12" x 10'	
052841	1510NHSP	15" x 10'	

### Cast Iron Service-Weight Single-Hub Soil Pipe

#### Cast Iron Service-Weight Single-Hub Soil Pipe 5' Lengths

Part #	Mfg #	Size	Price
014273	25SHSP	2" x 5'	
014951	35SHSP	3" x 5'	
015493	45SHSP	4" x 5'	
015552	55SHSP	5" x 5'	
015742	65SHSP	6" x 5'	
015854	85SHSP	8" x 5'	
012328	105SHSP	10" x 5'	
013375	125SHSP	12" x 5'	

#### Cast Iron Service-Weight Single-Hub Soil Pipe 10' Lengths

Part #	Mfg #	Size	Price
013976	210SHSP	2" x 10'	
014475	310SHSP	3" x 10'	
015360	410SHSP	4" x 10'	
015534	510SHSP	5" x 10'	
015706	610SHSP	6" x 10'	
015838	810SHSP	8" x 10'	
012321	1010SHSP	10" x 10'	

### Cast Iron Service-Weight Single-Hub Soil Pipe (Continued)

#### Cast Iron Service-Weight Single-Hub Soil Pipe 10' Lengths

Part #	Mfg #	Size	Price
013224	1210SHSP	12" x 10'	
013623	1510SHSP	15" x 10'	

### Cast Iron Service-Weight Double-Hub Soil Pipe

#### Cast Iron Service-Weight Double-Hub Soil Pipe 5' Lengths

Part #	Mfg #	Size	Price
014271	25DHSP	2" x 5'	
014949	35DHSP	3" x 5'	
015491	45DHSP	4" x 5'	
015551	55DHSP	5" x 5'	
015740	65DHSP	6" x 5'	

## Copper Pipe

### Line Sets



#### Mini-Split Line Set - 3/8" Insulation Both Lines Insulated

Part #	Mfg #	Liq Line	Suct Line	Length	Price
096828	LS143825MS	1/4"	3/8"	25'	
146400	LS143835MS	1/4"	3/8"	35'	
096832	LS143850MS	1/4"	3/8"	50'	
096834	LS141225MS	1/4"	1/2"	25'	
096836	LS141250MS	1/4"	1/2"	50'	
096840	LS145825MS	1/4"	5/8"	25'	
096838	LS145850MS	1/4"	5/8"	50'	
149515	LS381225MS	3/8"	1/2"	25'	
149517	LS381250MS	3/8"	1/2"	50'	
096843	LS385825MS	3/8"	5/8"	25'	
096845	LS385850MS	3/8"	5/8"	50'	

#### Series 410 - 3/8" Insulation Line Set

Part #	Mfg #	Liq Line	Suct Line	Length	Price
013612	LS145825	1/4"	5/8"	25'	
013613	LS145850	1/4"	5/8"	50'	

#### Series 412 - 3/8" Insulation Line Set

Part #	Mfg #	Liq Line	Suct Line	Length	Price
013593	LS143425	1/4"	3/4"	25'	
082476	LS143435	1/4"	3/4"	35'	
013594	LS143450	1/4"	3/4"	50'	

#### Series 512 - 3/8" Insulated Line Set

Part #	Mfg #	Liq Line	Suct Line	Length	Price
034271	LS5163425	5/16"	3/4"	25'	

#### Series 610 - 3/8" Insulation Line Set

Part #	Mfg #	Liq Line	Suct Line	Length	Price
015165	LS385825	3/8"	5/8"	25'	
015166	LS385850	3/8"	5/8"	50'	

#### Series 612 - 3/8" Insulation Line Set

Part #	Mfg #	Liq Line	Suct Line	Length	Price
015131	LS383425	3/8"	3/4"	25'	
082477	LS383435	3/8"	3/4"	35'	
015132	LS383450	3/8"	3/4"	50'	

#### Series 614 - 3/8" Insulation Line Set

Part #	Mfg #	Liq Line	Suct Line	Length	Price
015172	LS387825	3/8"	7/8"	25'	
082478	LS387835	3/8"	7/8"	35'	
015173	LS387850	3/8"	7/8"	50'	

#### Series 618 - 3/8" Insulation Line Set

Part #	Mfg #	Liq Line	Suct Line	Length	Price
053832	LS3811825	3/8"	1-1/8"	25'	
182038	LS3811850WHT	3/8"	1-1/8"	50'	

## Copper Pipe

### Type DWV Copper Drainage Tube

- Used for drainage, waste and vents
- For drainage waste, vents, soil and other non-pressure applications
- ASTM B306



### Type DWV Hard Copper Water Tube - Straight Lengths

Part #	Mfg #	Size	Length	Price
012452	112CDH	1-1/2"	20'	
013822	2CDH	2"	20'	
014357	3CDH	3"	20'	

### Type K (Heavy Wall) Copper Water Tube

- ASTM B88



### Type K Soft Copper Water Tube - Coils

Part #	Mfg #	Size	Length	Price
013529	14CKS60	1/4"	60'	
013528	14CKS100	1/4"	100'	
015048	38CKS60	3/8"	60'	
015047	38CKS100	3/8"	100'	
013158	12CKS60	1/2"	60'	
013157	12CKS100	1/2"	100'	
014729	34CKS60	3/4"	60'	
014728	34CKS100	3/4"	100'	
012257	1CKS60	1"	60'	
012256	1CKS100	1"	100'	
012848	114CKS60	1-1/4"	60'	
012478	112CKS60	1-1/2"	60'	
013844	2CKS40	2"	40'	
166166	2CKS60	2"	60'	

### Type K Soft Copper Water Tube - Straight

Part #	Mfg #	Size	Length	Price
051141	112CKS20	1-1/2"	20'	
013843	2CKS20	2"	20'	

### Type K Hard Copper Water Tube - Straight Lengths

Part #	Mfg #	Size	Length	Price
015046	38CKH	3/8"	20'	
013156	12CKH	1/2"	20'	
014727	34CKH	3/4"	20'	
012255	1CKH	1"	20'	
012846	114CKH	1-1/4"	20'	
012477	112CKH	1-1/2"	20'	
013842	2CKH	2"	20'	
019720	212CKH	2-1/2"	20'	
014367	3CKH	3"	20'	

### Type K OXY/MED Copper Tube

- Use for medical gas systems
- Special care and handling to prevent contamination of the system
- Specially cleaned for use in medical gas systems and meets the same allowable residue limit of 0.0035 g/sq ft of interior tube surface area
- ASTM B819



### Green Capped Copper Tube - Straight Lengths

- After cleaning, fitted with plastic caps to maintain the clean interior surface

Part #	Mfg #	Size	Length	Price
013526	14CKCC	1/4"	20'	
013155	12CKCC	1/2"	20'	
014726	34CKCC	3/4"	20'	
012254	1CKCC	1"	20'	
020310	114CKCC	1-1/4"	20'	
020311	112CKCC	1-1/2"	20'	
071190	2CKCC	2"	20'	

### Type L (Medium Wall) Copper Water Tube

- For residential and commercial use
- For domestic water service and distribution, fire protection, solar, fuel/fuel oil, HVAC, snow melting, compressed air, natural gas, liquefied petroleum (LP) gas, vacuum uses
- ASTM B88



### Type L Soft Copper Water Tube - Coils

Part #	Mfg #	Size	Length	Price
013532	14CLS60	1/4"	60'	

## Copper Pipe

### Type L (Medium Wall) Copper Water Tube (Continued)

#### Type L Soft Copper Water Tube - Coils

Part #	Mfg #	Size	Length	Price
026713	14CLS100	1/4"	100'	
014732	34CLS60	3/4"	60'	
014731	34CLS100	3/4"	100'	
015051	38CLS60	3/8"	60'	
015050	38CLS100	3/8"	100'	
013162	12CLS60	1/2"	60'	
013161	12CLS100	1/2"	100'	
012259	1CLS60	1"	60'	
185847	1CLS100	1"	100'	
185849	114CLS60	1-1/4"	60'	
185850	114CLS100	1-1/4"	100'	
185851	2CLS60	2"	60'	

#### Type L Hard Copper Water Tube - Straight Lengths

Part #	Mfg #	Size	Length	Price
013530	14CLH	1/4"	20'	
015049	38CLH	3/8"	20'	
082682	12CLH10	1/2"	10'	
013159	12CLH	1/2"	20'	
082683	34CLH10	3/4"	10'	
014730	34CLH	3/4"	20'	
082684	1CLH10	1"	10'	
012258	1CLH	1"	20'	
012849	114CLH	1-1/4"	20'	
012479	112CLH	1-1/2"	20'	
013846	2CLH	2"	20'	
014104	212CLH	2-1/2"	20'	
014369	3CLH	3"	20'	
015239	4CLH	4"	20'	
026846	6CLH	6"	20'	

### Type M (Light Wall) Copper Water Tube

- For above ground residential and light commercial use
- For general plumbing and heating purposes; drainage waste, vent and other light pressure uses
- ASTM B88



#### Type M hard Copper Water Tube - Straight Lengths

Part #	Mfg #	Size	Length	Price
015052	38CMH	3/8"	20'	
013164	12CMH10	1/2"	10'	
013163	12CMH	1/2"	20'	
014734	34CMH10	3/4"	10'	
014733	34CMH	3/4"	20'	
040503	1CMH10	1"	10'	
012260	1CMH	1"	20'	
012850	114CMH	1-1/4"	20'	
185848	112CMH10	1-1/2"	10'	
012480	112CMH	1-1/2"	20'	
013848	2CMH	2"	20'	
014105	212CMH	2-1/2"	20'	

### (ACR/OXY/MED) Copper Tube

- Use for air conditioning and refrigeration and medical gas systems
- Specially cleaned for use in medical gas systems
- ASTM B280/ASTM B819



#### Blue Nitrogen Charged Copper Tube - Straight Lengths

- Nitrogen pressurized ACR tube
- Purged w/dry nitrogen and ends sealed w/rubber plugs
- Ink marked "N2 Gas" to clearly identify to user

Part #	Mfg #	Size	Length	Price
161779	14CACR	1/4"	20'	
014963	38CACR	3/8"	20'	
013023	12CACR	1/2"	20'	
015558	58CACR	5/8"	20'	
014601	34CACR	3/4"	20'	
015766	78CACR	7/8"	20'	
013013	118CACR	1-1/8"	20'	
013446	138CACR	1-3/8"	20'	
013630	158CACR	1-5/8"	20'	

## Copper Pipe

### (ACR/OXY/MED) Copper Tube (Continued)

#### Blue Nitrogen Charged Copper Tube - Straight Lengths

Part #	Mfg #	Size	Length	Price
014202	218CACR	2-1/8"	20'	
018617	258CACR	2-5/8"	20'	
021189	318CACR	3-1/8"	20'	

### Soft Copper Refrigeration Tube - Coils

- For manufacture, installation and maintenance of refrigeration equipment
- ASTM B280



Part #	Mfg #	Size	Length	Price
013686	18CREF	1/8"	50'	
013538	14CREF	1/4"	50'	
015055	38CREF	3/8"	50'	
015537	516CREF	5/16"	50'	
013198	12CREF	1/2"	50'	
015583	58CREF	5/8"	50'	
014764	34CREF	3/4"	50'	
015777	78CREF	7/8"	50'	
013019	118CREF	1-1/8"	50'	
023871	38CREF100	3/8"	100'	
033518	14CREF100	1/4"	100'	
027157	12CREF100	1/2"	100'	
033519	58CREF100	5/8"	100'	
032232	34CREF100	3/4"	100'	
033516	78CREF100	7/8"	100'	
033517	516CREF100	5/16"	100'	
033518	14CREF100	1/4"	100'	
033519	58CREF100	5/8"	100'	



## CPVC Schedule 80 Pipe

### CPVC Schedule 80 Pipe

#### CPVC Sch 80 Pipe - 20' Lengths



Part #	Mfg #	Size	Price
020016	12CPVCP8	1/2" x 20'	
018017	34CPVCP8	3/4" x 20'	
018026	1CPVCP8	1" x 20'	
018027	114CPVCP8	1-1/4" x 20'	
018028	112CPVCP8	1-1/2" x 20'	
018021	2CPVCP8	2" x 20'	
087749	212CPVCP8	2-1/2" x 20'	
018022	3CPVCP8	3" x 20'	
018023	4CPVCP8	4" x 20'	
031711	6CPVCP8	6" x 20'	
136946	8CPVCP8	8" x 20'	

#### LabWaste™ CPVC Pipe - 10' Lengths



Part #	Mfg #	Size	Price
242523	8CPLWP	8" x 10'	

#### FlameGuard® CPVC Fire Sprinkler Pipe

- SDR 13.5
- 10' Lengths



Part #	Mfg #	Size	Price
189327	1CPFPG	1"	
189328	11410CPFPG	1-1/4"	
189329	112CPFPG	1-1/2"	





## CPVC Pipe

### CPVC Hot/Cold Pipe (NSF-pw)

- 100 psi @ 180°F
- ASTM D-2846

Part #	Mfg #	Nom Pipe Size	Price
221388	310CPVC	3" x 10'	

### CPVC Pipe



### CPVC Sch 40 Pipe - 20' Lengths

Part #	Mfg #	Size	Price
025283	2CPVCP4	2" x 20'	
147042	212CPVCP4	2-1/2" x 20'	
025286	4CPVCP4	4" x 20'	



## CPVC Schedule 80 Pipe

### LabWaste™ CPVC Corrosive Waste Drainage System Pipe



Part #	Mfg #	Size	Price
085948	112CPLWP	1-1/2"	
085947	2CPLWP	2"	
085946	3CPLWP	3"	
089663	4CPLWP	4"	

---

---

## CPVC Pipe

---

---

### CPVC Hot/Cold Pipe (NSF-pw)

- 100 psi @ 180°F
- ASTM D-2846

Part #	Mfg #	Nom Pipe Size	Price
013220	1210CPVC	1/2" x 10'	
014788	3410CPVC	3/4" x 10'	
135708	3420CPVC	3/4" x 20'	
110030	110CPVC	1" x 10'	
065273	210CPVC	2" x 10'	

**Flexible Gas Pipe**



**TracPipe® PS-II Flexible Underground Gas Piping**

- Pre-sleeved with flexible black jacket and yellow lay line for underground applications
- Vented containment system for added safety
- Extremely resistant to damage
- Quick attachment fittings
- Supports/contains NPT connections
- Installs in long lengths without joints



Part #	Mfg #	Size	Length	Price
119633	TP12100UGP	1/2"	100'	
119634	TP34100UGP	3/4"	100'	

**TracPipe® CounterStrike® Flexible Gas Piping**

- CSA Approved semi-rigid 300 Series stainless steel jacketed with proprietary polymer
- Bends and conforms by hand
- Cuts with a standard tube cutter
- Rated for indoor and outdoor use
- Up to 75% fewer joints than black iron pipe per installation
- Weighs a fraction of black iron pipe



Part #	Mfg #	Size	Length	Price
134930	TP1250CS	1/2"	50'	
115274	TP12100CS	1/2"	100'	
119604	TP12250CS	1/2"	250'	
142278	TP12500CS	1/2"	500'	
140664	TP3450CS	3/4"	50'	
119606	TP34100CS	3/4"	100'	
119605	TP34250CS	3/4"	250'	
142279	TP150CS	1"	50'	
117807	TP1100CS	1"	100'	
119607	TP1180CS	1"	180'	
137811	TP114150CS	1-1/4"	150'	
144080	TP112150CS	1-1/2"	150'	

## Flexible Gas Pipe

### Wardflex Tubing

#### 304 Wardflex CSST Tubing Stainless Steel

- Quick and easy installation
- Lightweight and flexible
- Fewer fittings
- Polyethylene jacket-  
UV Inhibitors - ASTM E84  
compliant
- Coating marked every 2 feet
- 100% leak tested



Part #	Mfg #	Size	Length	Price
193682	WF118	1/2"	50'	
193681	WF116	1/2"	100'	
190544	WF114	1/2"	250'	
193684	WF128	3/4"	50'	
193683	WF126	3/4"	100'	
190545	WF125	3/4"	180'	
194732	WF138	1"	50'	
194712	WF136	1"	100'	
196154	WF148	1-1/4"	50'	

#### Wardflex Max CSST Corrugated Stainless Steel Tubing

- Quick and easy installation
- Lightweight and flexible
- Fewer fittings
- Conductive Polyethylene jacket  
Conductive Coating - UV Inhibitors
- Coating marked every 2 feet
- 100% leak tested"



Part #	Mfg #	Size	Length	Price
221642	WFC18	1/2"	50'	
219063	WFC16	1/2"	100'	
221644	WFC28	3/4"	50'	
221643	WFC26	3/4"	100'	
221646	WFC38	1"	50'	
219064	WFC36	1"	100'	

**Flexible Gas Pipe**

**Safety System™ Flexible Gas Connectors**

- Design certified for 0.5 psig maximum operating pressure
- Minimum required BTUH capacities for B & BP model gas connectors are defined by ANSI Z21.69/CSA 6.16
- Flow rating BTUH 0.64 SP.GR @ 0.5"wc pressure drop

**Safety System™ Moveable Gas Connector**



Part #	Mfg #	Inside Dia	BTUH	Lgth	Price
138011	1675 BP 48	3/4"	225,000	48"	
138013	16100 BP 36	1"	512,000	36"	

**Supr-Safe® Quick Disconnect Gas Appliance Connector Assemblies**

- Stainless steel corrugated hose, encased in stainless steel braid, covered by thick Supr-Flex™ coating
- Fitted with an A type "push-to-connect" quick disconnect coupling



Part #	Mfg #	Size	Price
138012	1675-BPQR-48	3/4" x 48", with Restraining Device	



**Gas Flex Connectors**

**Corrugated Gas Appliance Connectors -  
ProCoat® Coated Stainless Steel**

- Superior corrosion resistance
- CSA Design-certified for indoor and outdoor use
- 100% Leak tested

**Large Diameter ProCoat® Gas Connector - 3/4"  
ID (7/8" OD) Tube with Fittings**

Part #	Mfg #	Size	Length	Price
112020	CSSB22-24	3/4" FIP x 3/4" FIP	24"	
091108	CSSB22-36	3/4" FIP x 3/4" FIP	36"	

**ProCoat® SS Gas Connector - 1/2" ID (5/8" OD)  
Tube with Fittings**



Part #	Mfg #	Size	Length	Price
070254	CSSC22-12	3/4" FIP x 3/4" FIP	12"	
070255	CSSC22-18	3/4" FIP x 3/4" FIP	18"	
070256	CSSC22-24	3/4" FIP x 3/4" FIP	24"	
070258	CSSC22-36	3/4" FIP x 3/4" FIP	36"	
070259	CSSC22-48	3/4" FIP x 3/4" FIP	48"	
070260	CSSC22-60	3/4" FIP x 3/4" FIP	60"	
098505	CSSC54-60	1/2" FIP x 1/2" MIP	60"	

**ProCoat® SS Gas Connector - 3/8" ID (1/2" OD)  
Tube with Fittings**

Part #	Mfg #	Size	Length	Price
070261	CSSD55-12	1/2" FIP x 1/2" FIP	12"	
070262	CSSD55-18	1/2" FIP x 1/2" FIP	18"	
070265	CSSD55-24	1/2" FIP x 1/2" FIP	24"	
070266	CSSD55-36	1/2" FIP x 1/2" FIP	36"	
070267	CSSD55-48	1/2" FIP x 1/2" FIP	48"	
073871	CSSD55-60	1/2" FIP x 1/2" FIP	60"	

## Galvanized Steel Pipe

### Galvanized Steel A53 Standard Pipe

- 21 Ft Lengths

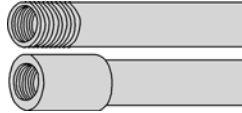

Part #	Size	Type	Price
013522	1/4"	T&C	
015041	3/8"	T&C	
013149	1/2"	T&C	
014718	3/4"	T&C	
012249	1"	T&C	
012840	1-1/4"	T&C	
012471	1-1/2"	T&C	
013836	2"	T&C	
014100	2-1/2"	T&C	
014362	3"	T&C	
015233	4"	T&C	

### Galvanized Steel A53 Extra Heavy Pipe

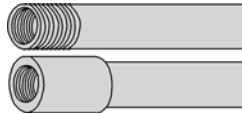

Part #	Size	Type	Price
056924	3/4"	T&C	
028253	1/2"	PE	
041388	3/4"	PE	
028254	2"	PE	

---



---

## Galvanized Steel Pipe

---



---

### Galvanized Import Pipe



Part #	Model	Size	Price
190538	14GTCI	1/4"	
208032	12GTCI	1/2"	
208197	34GTCI	3/4"	
208198	1GTCI	1"	
208200	114GTCI	1-1/4"	
208199	112GTCI	1-1/2"	
208201	2GTCI	2"	
190540	212GTCI	2-1/2"	
190541	3GTCI	3"	
190542	4GTCI	4"	

## Linesets

### EZ-Pull™ Line Sets

- Type B  
- without flare nuts



Part #	Mfg #	Size	Price
182029	LS385825EP	3/8 x 5/8 x 25'	
182030	LS385850EP	3/8 x 5/8 x 50'	
182031	LS383425EP	3/8 x 3/4 x 25'	
182032	LS383435EP	3/8 x 3/4 x 35'	
182033	LS383450EP	3/8 x 3/4 x 50'	
182034	LS387825EP	3/8 x 7/8 x 25'	
182035	LS387835EP	3/8 x 7/8 x 35'	
182036	LS387850EP	3/8 x 7/8 x 50'	
227098	LS3834100EP	3/8 x 3/4 x 100'	
227099	LS3858100EP	3/8 x 5/8 x 100'	
227100	LS383440EP	3/8 x 3/4 x 40'	
227101	LS385840EP	3/8 x 5/8 x 40'	
188447	LS141250EPINSUL	1/4 x 1/2 x 50'	
188448	LS381250EPINSUL	3/8 x 1/2 x 50'	
188449	LS121250EPINSUL	1/2 x 1/2 x 50'	
188450	LS581250EPINSUL	5/8 x 1/2 x 50'	
188451	LS341250EPINSUL	3/4 x 1/2 x 50'	
188452	LS781250EPINSUL	7/8 x 1/2 x 50'	

### Mini-Spilt EZ-Pull™ Line Sets

- Both lines insulated



Part #	Mfg #	Size	Price
179459	LS143835MSEP	1/4 x 3/8 x 35'	
179461	LS141225MSEP	1/4 x 1/2 x 25'	
179462	LS141250MSEP	1/4 x 1/2 x 50'	
179463	LS145825MSEP	1/4 x 5/8 x 25'	
179464	LS145850MSEP	1/4 x 5/8 x 50'	
179458	LS143825MSEP	1/4 x 3/8 x 25'	
179460	LS143850MSEP	1/4 x 3/8 x 50'	
179467	LS385825MSEP	3/8 x 5/8 x 25'	
179468	LS385850MSEP	3/8 x 5/8 x 50'	
179465	LS381225MSEP	3/8 x 1/2 x 25'	
179466	LS381250MSEP	3/8 x 1/2 x 50'	
186575	LS383425MSEP	3/8 x 3/4 x 25'	
188337	LS383450MSEP	3/8 x 3/4 x 50'	
226299	LS1438100MSEP	1/4 x 3/8 x 100'	

### Linesets

#### Duraguard™ Streamline® Line Sets

- Durable, tear resistant polyethylene outer layer
- High insulating properties
- Mold, and mildew resistant
- Meets ASTM E84 25/50 flame/smoke rating
- White coloring for easy field identification
- Copper tube UL recognized to 700 PSI MWP
- UV retardant added to minimize ultraviolet degradation
- R-410A engineered & tested
- Marked every foot
- 10 Year limited warranty on copper tube
- Made in USA



Part #	Mfg #	Size	Price
235571	LS383425DG	3/8 x 3/4 x 25'	
235567	LS383435DG	3/8 x 3/4 x 35'	
235568	LS383450DG	3/8 x 3/4 x 50'	
235572	LS387825DG	3/8 x 7/8 x 25'	
235569	LS387835DG	3/8 x 7/8 x 35'	
235570	LS387850DG	3/8 x 7/8 x 50'	
250702	LS385825DGW	3/8 x 5/8 x 25'	

#### Duraguard™ MS Streamline® Line Sets

- Black

Part #	Mfg #	Size	Price
259440	LS143825MSDGB	1/4 x 3/8 x 25'	
259441	LS143835MSDGB	1/4 x 3/8 x 35'	
259442	LS143850MSDGB	1/4 x 3/8 x 50'	
259443	LS141225MSDGB	1/4 x 1/2 x 25'	
259444	LS141235MSDG	1/4 x 1/2 x 35'	
259445	LS141250MSDGB	1/4 x 1/2 x 50'	
259446	LS385825MSDGB	3/8 x 5/8 x 25'	
259447	LS385835MSDGB	3/8 x 5/8 x 35'	
259448	LS385850MSDGB	3/8 x 5/8 x 50'	

#### Duraguard™ Streamline® Line Sets

- Black

Part #	Mfg #	Size	Price
259449	LS385825DGB	3/8 x 5/8 x 25'	
259450	LS385835DGB	3/8 x 5/8 x 35'	
259451	LS385850DGB	3/8 x 5/8 x 50'	
259452	LS383425DGB	3/8 x 3/4 x 25'	

---

---

## Linesets

---

---

### Linesets (Continued)

#### Duraguard™ Streamline® Line Sets

Part #	Mfg #	Size	Price
259453	LS383435DGB	3/8 x 3/4 x 35'	
259454	LS383450DGB	3/8 x 3/4 x 50'	
259455	LS387825DGB	3/8 x 7/8 x 25'	
259456	LS387835DGB	3/8 x 7/8 x 35'	
259457	LS387850DGB	3/8 x 7/8 x 50'	



---

---

## Niron Pipe

---

---

### Niron Pipe Multi-Clima Pipe



Part #	Mfg #	Size	SDR	Price
248059	NUPI1CGREY9	1"	9	



## PEX Tubing

### Uponor AquaPEX® Non-Barrier Tubing

- Can be used in hot and cold potable water distribution systems and hydronic heating applications where the system contains no ferrous corrodible components or where ferrous components are isolated from the tubing
- Colored coded tubing for installation purposes

#### AquaPEX® White Tubing



Part #	Mfg #	Size	Length	Price
030788	14AP100	1/4"	100'	
121223	12AP100	1/2"	100'	
022597	12AP300	1/2"	300'	
027954	12AP1000	1/2"	1,000'	
114360	34AP100	3/4"	100'	
022038	34AP300	3/4"	300'	
069777	1AP100	1"	100'	
027060	1AP300	1"	300'	
040373	1AP500	1"	500'	
040647	114AP100	1-1/4"	100'	
039657	112AP100	1-1/2"	100'	
070885	112AP300	1-1/2"	300'	
107684	2AP100	2"	100'	
142637	2AP200	2"	200'	
113323	2AP300	2"	300'	

#### AquaPEX® White Straight Length



Part #	Mfg #	Size	Length	Price
024694	12AP20	1/2"	20'	
024695	34AP20	3/4"	20'	
031578	1AP20	1"	20'	
087229	114AP20	1-1/4"	20'	
099651	112AP20	1-1/2"	20'	
104100	2AP20	2"	20'	
185086	212AP20	2-1/2"	20'	
135531	3AP20	3"	20'	

### AquaPEX® Plus Red Tubing



Part #	Mfg #	Size	Length	Price
106201	12AP100R	1/2"	100'	
082248	12AP300R	1/2"	300'	
082250	12AP1000R	1/2"	1,000'	
109383	34AP100R	3/4"	100'	
082246	34AP300R	3/4"	300'	
121224	1AP100R	1"	100'	

#### AquaPEX® Plus Red Straight Length



Part #	Mfg #	Size	Length	Price
086380	12AP20R	1/2"	20'	
086382	34AP20R	3/4"	20'	
108508	1AP20R	1"	20'	

### AquaPEX® Plus Blue Tubing



Part #	Mfg #	Size	Length	Price
086810	12AP100B	1/2"	100'	
082249	12AP300B	1/2"	300'	
082251	12AP1000B	1/2"	1,000'	
109382	34AP100B	3/4"	100'	
082247	34AP300B	3/4"	300'	
105063	1AP100B	1"	100'	
104483	1AP300B	1"	300'	

#### AquaPEX® Plus Blue Straight Length



Part #	Mfg #	Size	Length	Price
086379	12AP20B	1/2"	20'	
086381	34AP20B	3/4"	20'	

**PEX Tubing**

**Uponor AquaPEX® Non-Barrier Tubing  
(Continued)**

**AquaPEX® Plus Blue Straight Length**

Part #	Mfg #	Size	Length	Price
086383	1AP20B	1"	20'	

**Pre-Sleeved AquaPEX® Coils**



**Blue**

Part #	Mfg #	Size	Length	Price
246039	12APPSB400	1/2"	400'	
246038	12APPSR400	3/4"	400'	

**Red**

Part #	Mfg #	Size	Length	Price
246041	34APPSB400	1/2"	400'	
246040	34APPSR400	3/4"	400'	

**Uponor Pre-Insulated AquaPEX® Tubing**

- Complies with energy-code requirements
- Easily installed in tight, confined spaces
- Insulation runs entire length of tubing
- Reduces water waste and hot-water delivery wait times

**AquaPEX® Pre-Insulated Tubing - 1/2" Insulation**



Part #	Mfg #	Size	Length	Price
136760	12AP100INSLT	1/2"	100'	
136763	34AP100INSLT	3/4"	100'	
136764	1AP100INSLT	1"	100'	

**Tubing Supports**

**PEX-a Pipe Support**

- Available in 1/2" to 3-1/2" sizes for suspended piping applications in commercial plumbing and hydronic distribution systems
- Each package includes 15 support straps



Part #	Mfg #	Description	Price
164952	WIF7040500	1/2", 9-ft Length 5/Pkg	
160457	WIF7040750	3/4", 9-ft Length 5/Pkg	
153171	WIF7041000	1", 9-ft Length 5/Pkg	
153172	WIF7041250	1-1/4", 9-ft Length 5/Pkg	
153173	WIF7041500	1-1/2", 9-ft Length 5/Pkg	
153174	WIF7042000	2", 9-ft Length 5/Pkg	
226338	WIF7042500	2-1/2", 9-ft Length 5/Pkg	
185293	WIF7043000	3", 9-ft Length 5/Pkg	

**PEX Tubing**

**Reel Tubing**

**Red Stud Reel with Tubing**

Part #	Mfg#	Order #	Size	Price
100558	38WP500SRR	0651018	3/8" x 500'	
100560	12WP300SRR	0651020	1/2" x 300'	

**Blue Stud Reel with Tubing**

Part #	Mfg#	Order #	Size	Price
100559	38WP500SRB	0651017	3/8" x 500'	
100561	12WP300SRB	0651019	1/2" x 300'	

**WaterPEX® Potable PEX Plumbing**



**Red Coil**

Part #	Mfg#	Order #	Size	Price
075750	38WP100R	0650375	3/8" x 100'	
106897	12WP100R	0650377	1/2" x 100'	
129429	12WP300R	0650996	1/2" x 300'	
075548	12WP500R	0650378	1/2" x 500'	
075556	34WP100R	0650380	3/4" x 100'	

**Red 20' Sticks**

Part #	Mfg#	Order #	Size	Price
075565	12WP20R	0650404	1/2" x 20'	
075569	34WP20R	0650405	3/4" x 20'	

**Blue Coil**

Part #	Mfg#	Order #	Size	Price
106896	12WP100B	0650385	1/2" x 100'	
129430	12WP300B	0650997	1/2" x 300'	
075560	12WP500B	0650386	1/2" x 500'	
075562	34WP100B	0650388	3/4" x 100'	

**Blue 20' Sticks**

Part #	Mfg#	Order #	Size	Price
120887	1WP20B	0651082	1" x 20'	
075567	12WP20B	0650406	1/2" x 20'	

**WaterPEX® Potable PEX Plumbing  
(Continued)**

**Blue 20' Sticks**

Part #	Mfg#	Order #	Size	Price
075570	34WP20B	0650407	3/4" x 20'	

**White Coil**

Part #	Mfg#	Order #	Size	Price
130416	12WP100W	0650394	1/2" x 100'	
130418	12WP300W	0650998	1/2" x 300'	
130420	34WP100W	0650397	3/4" x 100'	
077564	1WP100W	0650400	1" x 100'	

**White 20' Sticks**



Part #	Mfg#	Order #	Size	Price
130419	12WP20W	0650408	1/2" x 20'	
130421	34WP20W	0650409	3/4" x 20'	
077565	1WP20W	0650410	1" x 20'	



## PEX Tubing

### Viega PureFlow® Tubing

#### ViegaPEX™ - Coil

- Red
- ASTM F876/F877
- PEX 5006 (CL5)
- Zero Lead™



Part #	Mfg #	Size	Price
099927	38VP500R	3/8" x 500'	
099594	12VP100R	1/2" x 100'	
099792	12VP300R	1/2" x 300'	
087148	12VP500R	1/2" x 500'	
088823	34VP100R	3/4" x 100'	
099794	34VP300R	3/4" x 300'	
099793	34VP500R	3/4" x 500'	

#### ViegaPEX™ - Straight Length

- Red
- ASTM F876/F877
- PEX 5006 (CL5)
- Zero Lead™



Part #	Mfg #	Size	Price
092778	12VP20R	1/2" x 20'	
092775	34VP20R	3/4" x 20'	

#### ViegaPEX™ - Coil

- Blue
- ASTM F876/F877
- PEX 5006 (CL5)
- Zero Lead™



Part #	Mfg #	Size	Price
099593	12VP100B	1/2" x 100'	
099789	12VP300B	1/2" x 300'	
087149	12VP500B	1/2" x 500'	
088824	34VP100B	3/4" x 100'	
099790	34VP300B	3/4" x 300'	
099791	34VP500B	3/4" x 500'	
105393	1VP100B	1" x 100'	

### ViegaPEX™ - Straight Length

- Blue
- ASTM F876/F877
- PEX 5006 (CL5)
- Zero Lead™



Part #	Mfg #	Size	Price
092777	12VP20B	1/2" x 20'	
092774	34VP20B	3/4" x 20'	

#### ViegaPEX™ - Coil

- White
- ASTM F876/F877
- PEX 5006 (CL5)
- Zero Lead™



Part #	Mfg #	Size	Price
099782	12VP100W	1/2" x 100'	
102117	12VP300W	1/2" x 300'	
099783	12VP1000W	1/2" x 1,000'	
099786	34VP100W	3/4" x 100'	
099787	34VP300W	3/4" x 300'	

### ViegaPEX™ FrostaPEX™ - Straight Length

- Silver
- PEX/AL/PE
- ASTM F876, ASTM F877
- Up to 6 months UV resistance
- PEX 5306



Part #	Mfg #	Size	Price
152664	12VP20FP	1/2" x 20'	
152665	34VP20FP	3/4" x 20'	
155343	1VP20FP	1" x 20'	



## PEX Tubing

### ViegaPEX™ Ultra - Straight Length

- Red
- ASTM F876/F877
- PEX 5006 (CL5)
- Up to 6 months UV resistance
- Zero Lead™



Part #	Mfg #	Size	Price
108436	1VP20R	1" x 20'	

### ViegaPEX™ Ultra - Straight Length

- Blue
- ASTM F876/F877
- PEX 5006 (CL5)
- Up to 6 months UV resistance
- Zero Lead™



Part #	Mfg #	Size	Price
105396	1VP20BU	1" x 20'	

### ViegaPEX™ Ultra - Straight Length

- White
- ASTM F876, ATSM F877
- PEX 5306
- Up to 6 months UV resistance



Part #	Mfg #	Size	Price
092779	1VP20W	1" x 20'	

### ViegaPEX™ Ultra - Coil

- Black
- ASTM F876/F877
- PEX 5006 (CL5)
- Up to 6 months UV resistance
- Zero Lead™



Part #	Mfg #	Size	Price
130538	12VP100BL	1/2" x 100'	
105170	12VP300BL	1/2" x 300'	

### UL listed for NFPA 13D Systems

Part #	Mfg #	Size	Price
110755	34VP100BL	3/4" x 100'	
106536	1VP100BL	1" x 100'	

### ViegaPEX™ Ultra - Coil

- Blue
- ASTM F876/F877
- PEX 5306
- Up to 6 months UV resistance
- Zero Lead™



Part #	Mfg #	Size	Price
099924	38VP500B	3/8" x 500'	
105395	1VP300B	1" x 300'	

### ViegaPEX™ Ultra - Coil

- White
- ASTM F876/F877
- PEX 5306
- Up to 6 months UV resistance
- Zero Lead™



Part #	Mfg #	Size	Price
092781	1VP100W	1" x 100'	

### ViegaPEX™ Ultra - Straight Length

- Black
- ASTM F876/F877
- PEX 5006 (CL5)
- Up to 6 months UV resistance
- Zero Lead™



Part #	Mfg #	Size	Price
099823	12VP20BL	1/2" x 20'	
099824	34VP20BL	3/4" x 20'	
099825	1VP20BL	1" x 20'	
187699	114VP20BL	1-1/4" x 20'	
187700	112VP20BL	1-1/2" x 20'	
187701	2VP20BL	2" x 20'	



## PEX Tubing

### ViegaPEX™ Ultra Stud Reel

- For installation between studs
- ASTM F876, F877
- ManaPac
- Recycled plastic reels
- PEX 5306
- Up to 6 months UV resistance



Part#	Mfg#	Size	Color	Price
226351	38VP500SRR	3/8" x 500'	Red	
226352	12VP300SRB	1/2" x 300'	Blue	
226354	12VP300SRR	1/2" x 300'	Red	
226350	38VP500SRB	3/8" x 500'	Blue	



## PEX Tubing

### PowerPEX

#### PEX Tubing—20' Stick Bundles

- Complete offering
- Quality
- Made in America



Part #	Mfg #	Color	Size	Price
226729	664X2B20	Blue	1/2"	
226751	664X3B20	Blue	3/4"	
226732	664X4B20	Blue	1"	
226734	664X2R20	Red	1/2"	
226735	664X3R20	Red	3/4"	
226736	664X4R20	Red	1"	
226760	664X2W20	White	1/2"	
226761	664X3W20	White	3/4"	
230192	664X4W20	White	1"	

#### PEX Tubing - Coils

- Complete offering
- Quality
- Made in America



Part #	Mfg #	Color	Size	Price
230193	665X4W100	White	1" x 100'	
230194	665X3W100	White	3/4" x 100'	
230195	665X2W100	White	1/2" x 100'	

## PEX Tubing

### Zurn PEX Non-Barrier Tubing

#### PEX Clear Coiled Tubing

- Flexible, easy to install, low-lead compliant tubing
- Requires fewer fittings
- Resistant to mineral build-up and freeze damage



Part #	Mfg #	Size	Price
193020	Q0PC100	1/8" x 100'	

#### PEX Blue Coiled Tubing

- Flexible, low-lead compliant tubing, used in potable plumbing applications
- Easy to install and requires fewer fittings
- Resistant to mineral build-up and freeze damage
- (-SP) Spooled



Part #	Mfg #	Size	Price
240812	Q2PC500XBLUESP	3/8" x 500'	
194178	Q3PC100XBLUE	1/2" x 100'	
240178	Q3PC1000XBLUE	1/2" x 1,000'	
203758	Q3PC300XBLUE	1/2" x 300'	
240814	Q3PC300XBLUESP	1/2" x 300'	
194179	Q3PC500XBLUE	1/2" x 500'	
194180	Q4PC100XBLUE	3/4" x 100'	
240817	Q4PC300XBLUE	3/4" x 300'	
194181	Q4PC500XBLUE	3/4" x 500'	
199674	Q5PC100XBLUE	1" x 100'	
203761	Q5PC300XBLUE	1" x 300'	

#### PEX Red Coiled Tubing

- Flexible, low-lead compliant tubing, used in potable plumbing applications
- Easy to install and requires fewer fittings
- Resistant to mineral build-up and freeze damage
- (-SP) Spooled



Part #	Mfg #	Size	Price
240813	Q2PC500XREDSP	3/8" x 500'	
218321	Q2PC500XRED	3/8" x 500'	
194173	Q3PC100XRED	1/2" x 100'	
240179	Q3PC1000XRED	1/2" x 1,000'	
203759	Q3PC300XRED	1/2" x 300'	
240815	Q3PC300XREDSP	1/2" x 300'	

### Zurn PEX Non-Barrier Tubing (Continued)

#### PEX Red Coiled Tubing

Part #	Mfg #	Size	Price
194174	Q3PC500XRED	1/2" x 500'	
194175	Q4PC100XRED	3/4" x 100'	
240816	Q4PC300XRED	3/4" x 300'	
194176	Q4PC500XRED	3/4" x 500'	
216381	Q5PC100XRED	1" x 100'	
203762	Q5PC300XRED	1" x 300'	

#### PEX White Coiled Tubing

- Flexible, easy to install, low-lead compliant tubing
- Requires fewer fittings
- Resistant to mineral build-up and freeze damage



Part #	Mfg #	Size	Price
193009	Q1PC100X	1/4" x 100'	
193010	Q2PC100X	3/8" x 100'	
193011	Q3PC100X	1/2" x 100'	
240177	Q3PC1000X	1/2" x 1,000'	
203760	Q3PC300X	1/2" x 300'	
193012	Q3PC500X	1/2" x 500'	
193013	Q4PC100X	3/4" x 100'	
203763	Q4PC300X	3/4" x 300'	
193014	Q4PC500X	3/4" x 500'	
193015	Q5PC100X	1" x 100'	
193016	Q5PC300X	1" x 300'	
211126	Q5PC500X	1" x 500'	

#### PEX Blue Strait Tubing

- Flexible, low-lead compliant tubing, used in potable plumbing applications
- Easy to install and requires fewer fittings
- Resistant to mineral build-up and freeze damage



Part #	Mfg #	Size	Price
194205	Q3PS20XBLUE	1/2" x 20'	
194206	Q4PS20XBLUE	3/4" x 20'	
194207	Q5PS20XBLUE	1" x 20'	



## PEX Tubing

### PEX Red Strait Tubing

- Flexible, low-lead compliant tubing, used in potable plumbing applications
- Easy to install and requires fewer fittings
- Resistant to mineral build-up and freeze damage



Part #	Mfg #	Size	Price
194203	Q3PS20XRED	1/2" x 20'	
194204	Q4PS20XRED	3/4" x 20'	
196492	Q5PS20XRED	1" x 20'	

### PEX White Strait Tubing

- Flexible, low-lead compliant tubing, used in potable plumbing applications
- Easy to install and requires fewer fittings
- Resistant to mineral build-up and freeze damage



Part #	Mfg #	Size	Price
193017	Q3PS20X	1/2" x 20'	
193018	Q4PS20X	3/4" x 20'	
193019	Q5PS20X	1" x 20'	
212554	Q7PS20X	1-1/2" x 20'	
212555	Q8PS20X	2" x 20'	

**Radiant - PEX Tubing**

**Uponor hePEX™ plus Barrier Tubing**

- EVOH Oxygen diffusion barrier
- Compatible with ProPEX® fitting connectors and QS-style fittings



**NOTE: 5/16" hePEX plus tubing is used for the Uponor QuikTrak® system**

Part#	Prod	Size	Length	Price
040683	WI516250	5/16"	250'	
040684	WI5161000	5/16"	1,000'	
027977	WI12300	1/2"	300'	
032213	WI121000	1/2"	1,000'	
033670	WI381000	3/8"	1000'	
159904	WI12100	1/2"	100'	
011783	WI58300	5/8"	300'	
152064	WI58400	5/8"	400'	
011782	WI581000	5/8"	1,000'	
143505	WI34100	3/4"	100'	
029223	WI34300	3/4"	300'	
061611	WI34500	3/4"	500'	
158245	WI341000	3/4"	1000'	
142507	WI1100	1"	100'	
045199	WI1300	1"	300'	
114130	WI114100	1-1/4"	100'	
030575	WI114300	1-1/4"	300'	
114131	WI112100	1-1/2"	100'	
057608	WI112300	1-1/2"	300'	
114132	WI2100	2"	100'	
030573	WI2300	2"	300'	

**hePEX™ Straight Length**

- In 20' lengths



Part#	Prod	Size	Length	Price
148441	WI3420	3/4"	300'	
152501	WI120	1"	100'	
152500	WI11420	1-1/4"	100'	
148486	WI11220	1-1/2"	100'	
119354	WI220	2"	100'	

## Radiant - PEX Tubing

### RadiantPEX® Tubing

- For radiant heating and snow melting applications
- Durable, flexible, cross-linked polyethylene
- Meets ASTM standards, ICC listed, & NSF listed
- 25-Year limited warranty for hydronic heating, floor heating, and snow melting applications

#### RadiantPEX® Barrier Coil

- Barrier PEX tubing for radiant heating and snow melting
- 4-Layer PEX



Part #	Mfg #	Order #	Size	Price
113981	WT12300	81003406	1/2" x 300'	
114089	WT121000	81001681	1/2" x 1,000'	
117481	WT58300	81009852	5/8" x 300'	
117483	WT58500	81009711	5/8" x 500'	
127082	WT581000	81010815	5/8" x 1000'	
120150	WT34300	81005303	3/4" x 300'	
132555	WT341000	81009868	3/4" x 1000'	

### RadiantPEX® Stick

Part #	Mfg #	Order #	Size	Price
129222	WT1300	81009361	1" x 300'	

### RadiantPERT Tubing

- Polyethylene raised temperature tubing with oxygen barrier
- Recyclable



Part #	Mfg #	Order #	Size	Price
158856	WTP12300	81016323	1/2" x 300'	
169666	WTP34300	81016327	3/4" x 300'	
170101	WTP1300	81016330	1" x 300'	
234127	WTP58300	81019453	5/8" x 300'	
170100	WTP581200	81016326	5/8" x 1200'	
170099	WTP121000	81016324	1/2" x 1000'	
170102	WTP58500	81016325	5/8" x 500'	

## Polyethylene Pipe

### Geo-Tubing Polyethylene Pipe

#### Geothermal Pipe Coil

- Polyethylene
- HDPE



Part #	Mfg #	Size	Price
054671	3420GEO	3/4" x 20'	
054660	34600GEO160	3/4" x 600'	
054669	34700GEO160	3/4" x 700'	
099614	34800GEO160	3/4" x 800'	
054662	1300GEO160	1" x 300'	
054673	11420GEO	1-1/4" x 20'	
054663	114100GEO160	1-1/4" x 100'	
168360	114150GEO160	1-1/4" x 150'	
054664	114200GEO160	1-1/4" x 200'	
116471	114300GEO160	1-1/4" x 300'	
107160	114500GEO160	1-1/4" x 500'	
054665	112100GEO160	1-1/2" x 100'	
054675	220GEO	2" x 20'	
054667	2100GEO160	2" x 100'	
054668	2200GEO160	2" x 200'	
098302	2300GEO160	2" x 300'	

#### U-Bend Pipe Coil

- SDR11
- 160 psi



Part #	Mfg #	Description	Price
116060	342205GEO160R	3/4" x (2) 205' Reverse Rolls	
098437	342205GEO160	3/4" x (2) 205' Rolls	



**Polyethylene Pipe**

**Polyethylene Flexible Pipe**

**PE 3408 Flexible Potable Water Pipe (SIDR-7 NSF-pw)**

- Conforms to PE3408, ASTM 2239

Part #	Mfg #	Size	Price
018081	1300HD200	1" x 300'	

**PE 3408 Flexible Potable Water Pipe (SIDR-9 NSF-pw)**

- Conforms to PE3408, ASTM 2239

Part #	Mfg #	Size	Price
005352	34100HD160	3/4" x 100'	
005353	34400HD160	3/4" x 400'	
005346	1100HD160	1" x 100'	
005351	1300HD160	1" x 300'	
005349	114100HD160	1-1/4" x 100'	
027156	114200HD160	1-1/4" x 200'	
005350	114300HD160	1-1/4" x 300'	
005347	112100HD160	1-1/2" x 100'	

**PE 3408 Flexible Potable Water Pipe (SIDR-19 NSF-pw)**

- Conforms to PE3408, ASTM 2239

Part #	Mfg #	Size	Price
147889	1300HD80	1" x 300'	

**HD Flexible Pipe**

Part #	Mfg #	Size	Price
005332	1100HD100	1" x 100'	100#
005345	34100HD125	3/4" x 100'	125#
005334	114100HD100	1-1/4" x 100'	100#
005335	1300HD100	1" x 300'	100#
005337	34100HD100	3/4" x 100'	100#
005338	34400HD100	3/4" x 400'	100#
005340	1100HD125	1" x 100'	125#
005344	1300HD125	1" x 300'	125#
005348	112250HD160	1-1/2" x 250'	160#
005357	2100HD160	2" x 100'	160#

**Polyethylene Flexible Pipe (Continued)**

**HD Flexible Pipe**

Part #	Mfg #	Size	Price
018079	34100HD200	3/4" x 100'	200#
018595	2200HD160	2" x 200'	160#
192992	34400HD125	3/4" x 400'	125#
056148	1500HD160	1" x 500'	160#

**Polyethylene Pipe**

**CE Blue® Flexible Polyethylene Tubing**

**SIDR-9 160 PSI CE Blue® Flexible Polyethylene Tubing**

- 160 psi - IPS SIDR-9
- For potable water
- ASTM D-2239

Part #	Mfg #	Size	Price
047301	34100COEX160	3/4" x 100'	
047302	34400COEX160	3/4" x 400'	
047303	1100COEX160	1" x 100'	
047304	1300COEX160	1" x 300'	
047308	114100COEX160	1-1/4" x 100'	

**SIDR-7 200 PSI CE Blue® Flexible Polyethylene Tubing**

- 200 psi - IPS SIDR-7
- For potable water
- AWWA C-901
- ASTM D-2239

Part #	Mfg #	Size	Price
047311	34100COEX200	3/4" x 100'	
047312	34400COEX200	3/4" x 400'	
047313	1100COEX200	1" x 100'	
047314	1300COEX200	1" x 300'	
047321	114300COEX200	1-1/4" x 300'	
047316	1500COEX200	1" x 500'	
047319	114100COEX200	1-1/4" x 100'	

**SDR-9 200 PSI Flexible Polyethylene Tubing**

- 200 psi - CTS SDR-9
- For potable water
- AWWA C-901
- ASTM D-2737

Part #	Mfg #	Size	Price
104835	CE200BLUE34100	3/4" x 100'	CTS
104836	CE200BLUE34300	3/4" x 300'	CTS
224640	CE200BLUE34500	3/4" x 500'	CTS
104837	CE200BLUE1100	1" x 100'	CTS
104838	CE200BLUE1300	1" x 300'	CTS
224672	CE200BLUE1500	1" x 500'	CTS
121056	CE200BLUE114100	1-1/4" x 100'	CTS
121055	CE200BLUE114300	1-1/4" x 300'	CTS
172051	CE200BLUE112100	1-1/2" x 100'	CTS
224678	CE200BLUE112300	1-1/2" x 300'	CTS

**CE Blue® Flexible Polyethylene Tubing (Continued)**

**SDR-9 200 PSI Flexible Polyethylene Tubing**

Part #	Mfg #	Size	Price
113050	CE200BLUE2100	2" x 100'	CTS
149129	CE200BLUE2200	2" x 200'	CTS
127076	CE200BLUE2300	2" x 300'	CTS



## Polyethylene Pipe

### Mur-lok® Linear Low Density Polyethylene (LLDPE) Tube

- For use with Mur-lok Polypropylene quick-connect and standard fittings on point-of-use drinking water systems
- BPA-Free, FDA approved

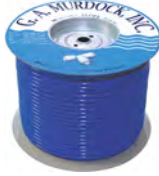

Part #	Mfg #	OD	ID	Lgth	Color	Price
052016	JGPIPE14250	1/4"	0.170"	250'	Blue	
052022	JGPIPE38250	3/8"	1/4"	250'	Blue	
097709	JGPIPE12250	1/2"	0.375"	250'	Blue	

**PVC Pipe**

**DWV Sch 40 PVC Pipe  
PVC DWV Sch 40 Pipe Plain**



Part #	Nom Pipe Size	Price
012581	1-1/2" x 10'	
012686	1-1/2" x 20'	
013975	2" x 10'	
014210	2" x 20'	
014473	3" x 10'	
014552	3" x 20'	
015354	4" x 10'	
015413	4" x 20'	
015700	6" x 10'	
015712	6" x 20'	
015842	8" x 20'	
018961	10" x 20'	
026816	12" x 20'	
030460	14" x 20'	
078110	16" x 20'	

**PVC DWV Cellular Core Bell End Pipe**

Part #	Nom Pipe Size	Price
094246	4" x 20'	

**PVC DWV Sch 40 Foam Core Plain End Pipe**

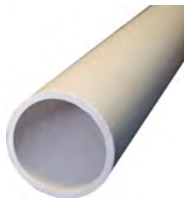

Part #	Nom Pipe Size	Price
012579	1-1/2" x 10'	
012685	1-1/2" x 20'	
013974	2" x 10'	
014209	2" x 20'	
014472	3" x 10'	

**DWV Sch 40 PVC Pipe  
(Continued)**

**PVC DWV Sch 40 Foam Core Plain End Pipe**

Part #	Nom Pipe Size	Price
014551	3" x 20'	
015353	4" x 10'	
015412	4" x 20'	
015699	6" x 10"	
015711	6" x 20'	
015841	8" x 20'	

**PVC Schedule 40 Pipe**

**PVC Sch 40 Plain End**



Part #	Nom Pipe Size	Price
030322	1" x 10'	

**PVC Sch 40 Bell End**



Part #	Nom Pipe Size	Price
087299	1-1/2" x 10'	
013174	1/2" x 20'	
014741	3/4" x 20'	
012263	1" x 20'	
012856	1-1/4" x 20'	
012524	1-1/2" x 20'	
013899	2" x 20'	
014106	2-1/2" x 20'	
014413	3" x 20'	
015288	4" x 20'	
226460	4" x 20'	
023115	6" x 20'	
022823	8" x 20'	
018598	10" x 20'	

**PVC Type 1120 Pressure Pipe**

**PVC SDR-21 200 PSI Bell End**

Part #	Nom Pipe Size	Price
014740	3/4" x 20'	
012262	1" x 20'	
012855	1-1/4" x 20'	
012523	1-1/2" x 20'	
013897	2" x 20'	

**PVC SDR-13.5 315 PSI Bell End**

Part #	Nom Pipe Size	Price
035005	1/2" x 20'	

**PVC Schedule 80 Pipe**

**PVC Sch 80 Plain End**



Part #	Nom Pipe Size	Price
013189	1/2" x 20'	
014758	3/4" x 20'	
012277	1" x 20'	
012868	1-1/4" x 20'	
012539	1-1/2" x 20'	
013912	2" x 20'	
019716	2-1/2" x 20'	
014423	3" x 20'	
015296	4" x 20'	
015663	6" x 20'	
019345	8" x 20'	
053509	10" x 20'	
063360	12" x 20'	
065236	14" x 20'	
094984	16" x 20'	

**PVC Pipe & Fittings**

**PVC Type 1120 Pressure Pipe**

**PVC DWV Cellular Core Pipe (NSF- DWV)**

- ASTM F-891, NSF- DWV

**PVC 1120 SDR-21 Plain End**

Part #	Mfg #	Nom Pipe Size	Price
021862	3410P200PE	3/4" x 10'	
021863	110P200PE	1" x 10'	

**PVC 1120 SDR-21 Bell End**

Part #	Mfg #	Pipe Size	Ends	Price
023209	212P200BE	2-1/2"		

**PVC 1120 SDR-21 Gasket End**

Part #	Mfg #	Nom Pipe Size	Price
025066	112P200GJ	1-1/2"	
018124	2P200GJ	2"	

**PVC SDR-26 160 PSI Gasket End**

Part #	Mfg #	Nom Pipe Size	Price
099528	414SDR26GJ	4" x 14'	
099529	614SDR26GJ	6" x 14'	

**ABS-DWV Cellular Core Pipe**

Part #	Mfg #	Pipe Size	Ends	Price
012577	11210ADCC	1-1/2" x 10'		

**PVC 1120 Sch 40 Pressure Pipe (NSF-pw)**

- ASTM D1785
- Potable water

**PVC Sch 40 Plain End**

Part #	Mfg #	Nom Pipe Size	Price
101363	1210P4PE	1/2" x 10'	
062668	110P4PE	1" x 10'	
019969	12P4PE	1/2" x 20'	

**PVC Sch 40 Bell End**

Part #	Mfg #	Nom Pipe Size	Price
077796	1210P4BE	1/2" x 10'	
077795	3410P4BE	3/4" x 10'	
077794	110P4BE	1" x 10'	

**PVC Type 1120 Pressure Pipe (Continued)**

**PVC 1120 Sch 40 Pressure Pipe (NSF-pw)**

**PVC Sch 40 Bell End**

Part #	Mfg #	Nom Pipe Size	Price
150667	11410P4BE	1-1/4" x 10'	
103472	210P4BE	2" x 10'	
184978	310P4BE	3" x 10'	
159334	410P4BEFP	4" x 10'	

**PVC Drain Waste & Vent Pipe**

**PVC DWV Sch 40 Pipe (NSF- DWV)**

- ASTM D2665, NSF- DWV
- ASTM D1785, NSF-pw

Part #	Mfg #	Nom Pipe Size	Ends	Price
019971	114P4PE	1-1/4" x 20'	PE	
041045	410P4BE	4" x 10'	BOE	
078807	410PDCCBE	4" x 10'	Bell End	
040883	4P4BEFP20	4" x 20'	Bell End	

**PVC Sewer and Drain Pipe**

**PVC-DS ASTM D-2729 Sewer & Drain Pipe**

Part #	Mfg #	Nom Pipe Size	Type	Price
014474	310SD2729	3" x 10'	Solid BE	
015356	410SD2729	4" x 10'	Solid BE	
192161	410SD2729GREE N	4" x 10'	Solid BE	
015357	410SD2729PF	4" x 10'	Perf BE	
015702	610SD2729	6" x 10'	Solid BE	
192162	410SD2729PFGRE E	4" x 10'	Perf Green	
192163	610SD2729GREE N	6" x 10"	Perf Green	
015703	610SD2729PF	6" x 10'	Perf	

**PVC SDR-23.5 D-2751 Sewer & Drain Pipe**

Part #	Mfg #	Nom Pipe Size	Type	Price
099542	414SDR235GJ	4" x 14'	Gasketed	
099544	614SDR235GJ	6" x 14'	Gasketed	

**PVC SDR35 Solvent Weld Pipe**

Part #	Mfg #	Nom Pipe Size	Type	Price
099533	414SDR35GJ	4" x 14'	Gasketed	
099535	814SDR35GJ	8" x 14'	Gasketed	

**PVC Pipe & Fittings**

**PVC Sewer and Drain Pipe (Continued)**

**PVC SDR35 Solvent Weld Pipe**

Part #	Mfg #	Nom Pipe Size	Type	Price
015704	610SD3034	6" x 10'	Solid	
015837	810SD3034	8" x 10'	Solid	
015705	610SD3034PF	6" x 10'	Perf Green	
068776	820SDGJ	8" x 20'	Gasketed	
099534	614SDR35GJ	6" x 14'	Gasketed	
099536	1014SDR35GJ	10" x 14'	Gasketed	
099540	1214SDR35GJ	12" x 14'	Gasketed	
192164	420SDR35GJ	4" x 20'	Gasketed	
192165	620SDR35GJ	6" x 20'	Gasketed	

**PVC D-3034 Type PSM ASTM**

Part #	Mfg #	Nom Pipe Size	Type	Price
015358	410SD3034	4" x 10'	Solid	
015359	410SD3034PF	4" x 10'	Perforated	
219178	410SD3034W	4" x 10'	Solid	
230622	410SD3034PFW	4" X 10'	Perf White	

**PVC Drop Pipe**

**PVC Sch 80 Drop Pipe Threaded Well Pipe**

Part #	Mfg #	Nom Pipe Size	Price
012279	1P8DP	1" x 20'	
012865	114P8DP	1-1/4" x 20'	

**PVC Sch 120 Drop Pipe Threaded Well Pipe**

Part #	Mfg #	Pipe Size	Ends	Price
147468	114P120DP	1-1/4"		
148477	2P120DP	2"		





## PVC Pipe

### Pipe

#### Gravel-less Leach Pipe



Part #	Mfg #	Size	Price
194851	HAN1010	10" x 10'	
192975	HAN1020	10" x 20'	

#### F-477 Sure-Lok® Culvert Pipe

- Dual wall
- Black
- Plain End

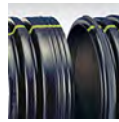

Part #	Mfg #	Size	Price
193850	HAN1220	12" x 20'	
193851	HAN1520	15" x 20'	
195330	HAN2420	24" x 20'	

#### Perforated Corrugated Drain Pipe

- Single wall



Part #	Mfg #	Size	Price
194882	HAN4100PS	4" x 100' with Sock	
194881	HAN4100P	4" x 100'	
194879	HAN6100P	6" x 100'	

#### Corex Solid Drain Pipe



Part #	Mfg #	Size	Price
194880	HAN4100S	4" x 100'	
194878	HAN6100S	6" x 100'	

### Corrugated Solid Pipe

- Triple wall
- ASTM F810



Part #	Mfg #	Size	Price
213037	HAN4TWS	4" x 10'	

### Corrugated Perforated Pipe

- Triple wall
- ASTM F810



Part #	Mfg #	Size	Price
213038	HAN4TWP	4" x 10'	

## Stainless Steel Pipe

### Sch 10 Welded Pipe

#### 316 Stainless Steel



Part #	Size	Price
174257	1/2" x 20'	
174258	3/4" x 20'	
174244	1" x 20'	
174245	1-1/4 x 20'	
174246	1-1/2" x 20'	
174247	2-1/2" x 20'	
174249	6" x 20'	
174250	8" x 20'	

### Seamless Tubing

#### 304/L SS Tubing



• Tube OD x wall thickness

Part #	Size	Price
164999	1/2" x .035	
164996	1/4" x .049	
164997	3/8" x .049	
164995	1/2" x .049	
164998	3/4" x .049	

### Sch 40 Welded Pipe

#### 304 Stainless Steel



Part #	Size	Price
226434	3/8" x 20'	
065197	1/2" x 20'	
065198	3/4" x 20'	
076078	1" x 20'	
065201	1-1/4 x 20'	
160424	1-1/2" x 20'	
076080	2" x 20'	
177139	3" x 20'	
153486	4" x 20'	
177140	6" x 20'	

#### 316 Stainless Steel



Part #	Size	Price
097943	1/2" x 20'	
160886	3/4" x 20'	
131052	1" x 20'	
160887	1-1/4" x 20'	
160888	1-1/2" x 20'	
160797	2" x 20'	
174251	2-1/2" x 20'	
174252	3" x 20'	
174253	4" x 20'	
174254	6" x 20'	
174255	8" x 20'	



## Stainless Steel Pipe

### 304/316 Stainless Steel Tubing

Polished ID/OD Tubing

• 20' Length



Part #	Mfg #	Size	Nominal Wall	Price
175043	1SST065304FG	1"	.065	
175044	112SST065304F G	1-1/2"	0.65	
175045	2SST065304FG	2"	.065	
177831	212SST065304F G	2-1/2"	0.65	
175047	3SST065304FG	3"	.065	
175048	4SST083304FG	4"	.083	

### 316 Stainless Steel

Part #	Mfg #	Size	Nominal Wall	Price
177832	1SST065316FG	1"	.065	
177833	112SST065316F G	1-1/2"	.065	
177834	2SST065316FG	2"	.065	
177835	3SST065316FG	3"	.065	



---

---

## Stainless Steel Pipe

---

---

### Sch 10 Plain End Pipe

#### 304 Stainless Steel

Part #	Mfg #	Size	Price
177778	112304SSS10PE	1-1/2" x 20'	
177779	2304SSS10PE	2" x 20'	
150033	3304SSS10PE	3" x 20'	
148590	4304SSS10PE	4" x 20'	
178207	6304SSS10PE	6" x 20'	
178208	8304SSS10PE	8" x 20'	

---



---

## Underground Gas Pipe & Ftgs

---



---

### Poly Gas Pipe

#### MDPE 3810 PE2406 Yellow Polyethylene Pipe

- *Manufactured in accordance with ASTM D2513*
- *Other dimensional standards or custom requirements are acceptable as agreed upon between the buyer & manufacturer*

#### MDPE 3810 PE2406 Yellow Pipe - IPS

Part #	Mfg #	Size	SDR	Price
126619	UGP34IPS150	3/4" x 150'	11	
171065	UGP34IPS300	3/4" x 300'	11	
206232	UGP1IPS50	1" x 50'	11	
169966	UGP1IPS150	1" x 150'	11	
126621	UGP114IPS150	1-1/4" x 150'	11	
152149	UGP114IPS100	1-1/4" x 100'	11	
157624	UGP112IPS150	1-1/2" x 150'	11	
160538	UGP2IPS100	2" x 100'	11	
144666	UGP2IPS500	2" x 500'	11	
226479	UGP34IPS50	3/4" x 50'	11	

#### MDPE 3810 PE2406 Yellow Pipe - CTS

Part #	Mfg #	Size	SDR	Price
160536	UGP12CTS150	1/2" x 150'	7	
131976	UGP12CTS500	1/2" x 500'	7	
135459	UGP1CTS100	1" x 100'	11.5	
126620	UGP1CTS150	1" x 150'	11	
135458	UGP1CTS500	1" x 500'	11	



## Underground Gas Pipe & Ftg

### Underground Gas Products

#### Con-Stab® Anodeless Meter Riser

- Fusion-bonded epoxy coating
- Anodeless and corrosion resistant
- Patented "ID-Seal" fitting



Part #	Mfg #	Size	SDR	Price
204167	UG12CTSRISERCS	1/2" CTS		
136701	UG1CTSRISERCS	1" CTS	SDR-11.5	

#### Con-Stab® Coupling



Part #	Mfg #	Size	SDR	Price
131975	UG12CTSCPCS	1/2" CTS	SDR-7	

#### CON-STAB® Tee



Part #	Mfg #	Size	Price
199923	GAS2883000	1/2" CTS	
237062	UG34IPSTEE	3/4" IPS	SDR-11

#### CON-STAB® Reducing Tee



Part #	Mfg #	Size	Price
213653	GAS2883080	1-1/2" SDR11 x 3/4" SDR11	

#### Con-Stab® Male Adapter

- 18" Overall length



Part #	Mfg #	Size	Price
136704	UG12CTSMA18CS	1/2" CTS	
136706	UG1CTSMA18CS	1" CTS	
198280	UG1IP SMA	1" IPS SDR-11	

### Burial Tape

- Non-detectable



Part #	Mfg #	Size	Color	Price
252370	UGBURIALTAPE	3" x 1000'	Yellow	

### Universal Bracket For Anodeless Risers

- Fits 3/4" - 2" anodeless risers
- Adjustable from 6" - 10" from wall



Part #	Mfg #	Size	Price
153727	UGRISERBRACKE T	3/4" to 2"	





## Underground Gas Pipe & Ftg

### Underground Gas Products

#### Stab Coupling

Part #	Mfg #	Size	Price
173421	UG34IPSCPCS	3/4"	
173422	UG1CPCS	1"	
173423	UG114CPCS	1-1/4"	

#### Steel Riser

Part #	Mfg #	Size	Length	Price
173420	UG1143030RISER	1-1/4"	30" x 30"	
173418	UG343030RISER	3/4"	30" x 30"	
173428	UG343018RISER	3/4"	30" x 18"	

#### Ground Gas Riser

Part #	Mfg #	Size	Price
198277	UG1IPSRISERCS	1"	
198278	UG114IPSRISERCS	1-1/4"	
198279	UG2IPSRISERCS	2"	
198397	UG112IPSRISERCS	1-1/2"	
173419	UG1CTSRISER	1"	

#### Male Adapter

Part #	Mfg #	Size	Price
198281	UG114IP SMA	1-1/4"	
220686	UG34IP SMA	3/4"	
198398	UG112IP SMA	1-1/2"	
136705	UG34IP SMA18CS	3/4" IPS x 18" MIP	

#### 90° Elbow

Part #	Mfg #	Size	Price
198282	UG2IPS90	2" IPS	
199186	UG34IPS90	3/4" IPS	
221404	UG1IPS90	1" IPS	
199922	UG12CTS90	1/2" CTS	

#### Coupling

Part #	Mfg #	Size	Price
198283	UG1IPSCP	1" IPS	
198284	UG114IPSCP	1-1/4" IPS	
198285	UG2IPSCP	2" IPS	
198394	UG112IPSCP	1-1/2" IPS	

### Underground Gas Products (Continued)

#### Coupling

Part #	Mfg #	Size	Price
220545	UG1234CTSCP	1/2" CTSx3/4" SDR11	

#### Tee

Part #	Mfg #	Size	Price
199607	UG221IPST	2" x 2" x 1" IPS	
199608	UG114IPST	1-1/4" IPS	
200466	UG1IPST	1" IPS	
173424	UG1CTSTEECS	1" CTS	

### Tools

#### Con Stab Chamfer Tool

Part #	Mfg #	Size	Price
173425	UG34IP SCHAMTOO L	3/4" IPS	
173426	UG1CT SCHAMTOOL	1" CTS	
173427	UG114IP SCHAMTO O	1-1/4"	

#### SDR-11 Tool

Part #	Mfg #	Size	Price
198286	UG1IPSTOOL	1" IPS	
198288	UG2IPSTOOL	2" IPS	
198395	UG112IPSTOOL	1-1/2" IPS	

#### SDR-7 Tool

Part #	Mfg #	Size	Price
136709	UG12CTSTOOL	1/2" CTS	

## Underground Gas Pipe & Ftgs

### Servi-Sert® Top-Connected Flex Risers

- 1-Piece construction
- No special tools or installation equipment
- Zinc-plated service head adapter
- Independent gripping and sealing components
- Available in all-flex, stubflex, or prebent steel casing configurations
- Includes moisture seal shear protection fitting
- Outlets/inlets/metric
- Servi-Sert service heads available separately



### Commonly Used All-Flex Risers for Natural Gas

Part #	Mfg #	Threaded Outlet Length	PE Tubing	Flex	Price
133072	UG34IPSRISERCS	3/4" NPT	1/2" CTS	36"	

---



---

## Underground Gas Pipe & Ftgs

---



---

### Permasert® Natural Gas Fittings

- *Fast & easy installation*
- *No special tools/costly installation equipment*
- *Molded from industry proven polyethylene (PE)*
- *Non-corrosive components eliminate need for cathodic protection or protective coatings*
- *Minimal stress on PE piping*
- *Metric sizes available*

#### Permasert® Mechanical Coupling

- *PE Material - PE4710/Bimodal PE3408 Resin*



Part #	Mfg #	Size	SDR/Wall	Price
056984	UG1CP	1" CTS	.090/.099/.102"	
062824	UG114CP	1-1/4" IPS	SDR 10	



## Underground Gas Pipe & Ftgs

### Flexible Meter Risers

- *Integrated swivel service head adapter*
- *Sealastic leak resistant design with molded rubber seal*
- *Seal ferrule and built-in barbed tube stiffener*
- *Hex construction nut and body*



Part #	Mfg #	Size	SDR	Price
154037	UG12CTS36FLXRI S	1/2" CTS	SDR-11	
241126	UG12IPS36FLXRI	1/2" IPS	SDR-11	
146273	UG34IPS36FLXRIS	3/4" IPS	SDR-11	
146274	UG1CTS36FLXRIS	1" CTS	SDR-11	
153318	UG1IPS36FLXRIS	1" IPS	SDR-11	
146276	UG114IPS36FLXRI	1-1/4" IPS	SDR-11	
148233	UG112IPS36FLXRI	1-1/2" IPS	SDR-11	
241129	UG2IPS36FLXRI	2" IPS	SDR-11	

## Vinyl Tubing

### Tubing

#### Polyethylene Tubing

- *Designed for pneumatic control tubing*
- *Also for water supply tubing, ice makers and humidifiers*



Part #	Mfg #	Size	Price
013534	14POLYTUBE	1/4" OD x 100' Roll	



---

---

## Vinyl Tubing

---

---

### Low Density Polyethylene (LDPE) Pipe

#### LDPE Pipe

Part #	Mfg #	Size	Price/Ft
044037	14POLYTUBES P	1/4" OD x 100'	
044036	38POLYTUBES P	3/8" OD x 100'	
068934	58POLYTUBES P	5/8" OD x 100'	



## Vinyl Tubing

### Vinyl Tubing

#### Clear Vinyl Tubing

- For air conditioning and refrigeration condensate drains, condensate pump discharge lines and humidifier overflows



Part #	Mfg #	ID	Size	Price
013540	14VINYL TUBE	1/4" ID	100'/Roll	
015060	38VINYL TUBE	3/8" ID	100'/Roll	
013212	12VINYL TUBE	1/2" ID	100'/Roll	
015586	58VINYL TUBE	5/8" ID	100'/Roll	
014777	34VINYL TUBE	3/4" ID	100'/Roll	
075861	78VINYL TUBE	7/8" ID	50'/Roll	

#### Braided Vinyl Tubing



Part #	Mfg #	ID	Size	Price
251499	14BRAIDED TUBE	1/4" ID	100'/Roll	
251500	38BRAIDED TUB	3/8" ID	100'/Roll	
251501	12BRAIDED TUBE	1/2" ID	100'/Roll	
251502	58BRAIDED TUBE	5/8" ID	100'/Roll	
251503	34BRAIDED TUBE	3/4" ID	100'/Roll	

## Anchors

### Anchors

#### Tapcon® Anchor - Hex Head

- Works in all masonry base materials
- Fast and easy
- No hole spotting or inserts required
- Removable and reusable
- Climaseal™ coated



Part #	Mfg #	Anchor Size	Price
081633	HW4-114	1/4" x 1-1/4"	
081634	TAPCON14134	1/4" x 1-3/4"	
081635	HW4-214	1/4" x 2-1/4"	
081636	HW4-234	1/4" x 2-3/4"	
081637	HW4-314	1/4" x 3-1/4"	
081639	HW4-400	1/4" x 4"	

#### Tapcon® Anchor - Flat Head

- Works in all masonry base materials
- Fast and easy
- No hole spotting or inserts required
- Removable and reusable
- Climaseal™ coated



Part #	Mfg #	Anchor Size	Price
081646	PF4-114	1/4" x 1-1/4"	
081647	PF4-134	1/4" x 1-3/4"	
081648	PF4-214	1/4" x 2-1/4"	
081649	PF4-234	1/4" x 2-3/4"	
081650	PF4-314	1/4" x 3-1/4"	
081651	PF4-334	1/4" x 3-3/4"	
081652	PF4-400	1/4" x 4"	

#### Trubolt® Carbon Steel Wedge Anchor

- Versatile fully threaded design
- One piece stainless steel expander clip resists corrosion
- Non bottom-bearing
- Complete with nut and washer
- Heavy-duty pull-out and shear capacities



Part #	Mfg #	Thread Length	Anchor/ Drill Bit	Overall Length	Price
081553	WS-3830	1-3/4"	3/8" - 16	3"	
081554	WS-3850	2-1/2"	3/8" - 16	5"	
081557	WS-1236	2-1/4"	1/2" - 13	3-3/4"	
081560	WS-1254	4"	1/2" - 13	5-1/2"	

### Hammer-Set Nail Drive Anchor

- Single-piece zinc plated steel
- Works in concrete, block and brick
- Install through material to be fastened
- Low profile mushroom head style
- For use in electric boxes, conduit clips, drywall track and roof flashing
- Not for use in overhead applications

Part #	Mfg #	Drill Size	Anchor Size	Qty	Price
081657	HS-1406	1/4"	1/4" x 3/4"	100	
081658	HS-1410	1/4"	1/4" x 1"	100	
081659	HS-1412	1/4"	1/4" x 1-1/4"	100	
081661	HS-1420	1/4"	1/4" x 2"	100	

### E-Z Ancor™ Self Drilling Drywall Anchor

- Self-drilling
- Includes:
  - (25) Anchors
  - (25) #8-1-1/4" Sheet metal screws

Part #	Mfg #	Description	Price
081654	EZKITZINC	Zinc Anchors	
081655	EZP25	Plastic Anchors	

### RM Drop-In Anchor

- Flanged top
- Internally threaded
- Keeps anchor flush
- Keeps all rods same length



Part #	Mfg #	Size	Box Qty	Price
081593	RM-14	1/4"	100	
081594	RM-38	3/8"	50	
081595	RM-12	1/2"	50	
081597	RM-34	3/4"	25	
081596	RM-58	5/8"	25	

### RX Drop-In Anchor

- Internally threaded
- Optimized (only 3/4" long) for use in hollow-core, pre-cast plank and post-tension slabs
- Lip keeps anchor flush during installation
- Shallow drilling — fast installation



Part #	Mfg #	Size	Box Qty	Price
110770	RX-38	3/8"	100	
143748	RX-12	1/2"	50	

## Anchors

### Anchor Setting Tool

Part #	Mfg #	Description	Price
081599	RT-114	1/4" Concrete Setting Tool	
081600	RT-138	3/8" Concrete Setting Tool	
081601	RT-112	1/2" Concrete Setting Tool	
081602	RT-158	5/8" Concrete Setting Tool	
110771	RTX-138	3/8" Size 1/2" Shallow Drop-In Anchor Tool for Use with RX-38 Only	

### Condriive 1000 Installation Tools

- *Fast change from drilling to driving*
- *Eliminates need for two tools*
- *Includes bits for all sizes hex & Phillips head*



Part #	Mfg #	Description	Price
081653	C1000	Tapcon® Condriive Tool Kit	

---



---

**Anchors**

---



---

**Anchor Kits****Plastic Anchor Kit**

- *Kit made of shatter proof plastic*
- *Has slot for hanging on peg-board*
- *(100) Anchors per kit*



Part #	Mfg #	Description	Price
002306	6607	3/16" x 7/8" Phillips/Slot Pan Head	

---

---

## Anchors

---

---

### Anchors

#### Red Lip Plastic Anchor Kit with Hex Washer Head Screws

• Includes:

- (100) Screws and (100) anchors
- (1) Matching carbide tip drill bit
- Reusable hinged clear vinyl box



Part #	Mfg #	Anchor Size	Screw Size	Price
006470	PA1012KW	1/4" x 1"	HW10x1Z	

## Anchors

### Drop-In Anchors

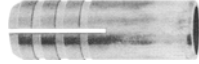

Part #	Mfg #	Size	Price
035429	R204905	3/8"	

### Anchor Kits

Part #	Mfg #	Description	Price
008873	RSR199	PK-80-S Anchor Kit 6	
074817	R199720	PK-80-H Anchor Kit	
008874	R199800	K-6-R Anchor Kit	



## Anchors

### Anchor Screw Kits

- Includes:
  - (100) #10 x 1" Zinc-plated screws
  - (100) Flanged plastic anchors
  - (1) 1/4" Carbide masonry drill bit



Part #	Mfg #	Description	Price
127001	590-10	Anchor Screw Kit	

### Deck Anchors

#### Cast-In Place Deck Anchors for All-Thread Rod

- Install on wood or metal corrugated decks prior to the concrete pour
- Allows insert locations to be pre-planned eliminating overhead masonry anchors
- Color-coded by rod size, plastic sleeve keeps threads clean
- Easy to locate after the pour
- Installs quickly and easily to reduce labor costs



Part #	Mfg #	Deck Insert	Size	Price
183482	544-3MD	Metal	1/2"	
183480	544-2WD	Wood	3/8"	
183484	544-3WD	Wood	1/2"	
183485	544-4WD	Wood	5/8"	

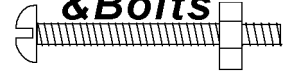
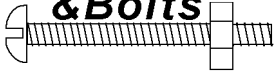

---

---

**Anchors**

---

---

**Anchors**

**Toggle Bolt**

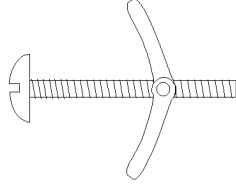

Part #	Mfg #	Size	Price
099223	14WALLANCHOR	1/4" x 2"	

**Cable Ties**

**Cable Ties**

- Available in black or natural
- 1/16" Minimum bundle diameter
- Point of purchase packaging



Part #	Mfg #	Description	Price
110179	15034	7", Black, 2", 1000/Pk	

**Straps**

**Rubber Tie-Down Straps**

- Engineered to perform
- Sunlight and temperature resistant
- Features heavy-duty galvanized "S" hooks



Part #	Mfg #	Description	Price
002269	BC0173	15", 100/Pk	

## Cable Ties

### Cable and Wire Ties

#### Heavy-Duty Cable Ties

- 6.6 Nylon, smooth insertion, locking mechanism
- Tensile: 175 lb



Part #	Mfg #	Description	Price
002297	7-P24	24"	
195890	7-P36	36"	
195891	7-P48	48"	

#### Wire Ties

- White
- Nylon
- 50 Tensile strength
- 100/Pack



Part#	Mfg#	Length	Color	Price
232124	6263CX	11"	White	
113144	6263BCX	11"	Black	
231265	WT07C	7"	White	
193267	WTB07C	7"	Black	

#### Wire and Cable Clamps - Nylon

- These wire ties are perfect for securing wires.
- You can choose from an assortment of diameter sizes.



Part #	Mfg #	Description	Price
155515	WC04	1/4" 35 Pack	
155516	WC06	3/8" 30 Pack	

#### Nylon Cable Ties

- Black ties are weather and UV resistant



Part #	Mfg #	Description	Price
172259	6262BMX	7" Black 1000 Pack	
247518	6263LX	11" White 50 Pack	



## Cable Ties

### Nylon Cable Ties

#### Standard Black Cable Tie



Part #	Mfg #	Max Length x Width	Bundle	Price
036417	554-08	8" x 3/16"	2"	
036416	554-14	14-1/2" x 3/16"	4"	

#### Mounting Black Cable Tie



Part #	Mfg #	Max Length x Width	Bundle	Price
147930	554-608	8" x 3/16"	2-3/8"	



## Cable Ties

### Cable Ties

#### Heavy Duty Cable Ties

- 175lb
- UL 181B Listed
- Indoor and outdoor use
- Working temperatures from -40° F to 185° F
- High tensile strength with low insertion force
- Used in HVAC, industrial and commercial



Part #	Mfg #	Description	Price
221619	AL-24-175-L	24", UV Black	

#### Mounting Hole Cable Ties

- UV Black Nylon
- Screw size: #10
- Tensile strength: 50 lbs



Part #	Mfg#	Length	Qty/Bag	Price
238949	AL-11-50-MH-O-C	11"	100	



## DWV Pipe Hangers

### J-Hooks

#### Hangs Tuff™ DWV Pipe Hanger

- Strong and rigid I-beam design
- (2) Ring-shank nails included
- 100% Corrosion proof, impact resistant ABS
- Can be glued to ABS or PVC pipe with all purpose glue



553-9W

Part #	Mfg #	Connection	Color	Price
010011	112JHOOK	1-1/2"	White	
010012	2JHOOK	2"	White	
010013	3JHOOK	3"	White	
010014	4JHOOK	4"	White	

#### ZipStick™ Universal Pipe Hanger

- Perfect for hanging wrapped or insulated pipe, bundles of PEX, cable, wiring, or supporting vent pipe in attics
- Universal cradle hangs any pipe from 1" CTS to 6" IPS
- Releasable locking mechanism
- Graduated numerals at nail ways for easy measuring



Part #	Mfg #	Length	Material	Price
106691	553-010W	10"	White Nylon	
030424	553-014W	14"	White Nylon	
056393	553-026W	26"	White Nylon	

#### Swivel J-Hanger

- Cradle swivels 360° allowing installers to hang pipe at any angle
- Allows for expansion and contraction
- Ideal when running vent pipes across the attic



Part #	Mfg #	Size	Material	Price
150577	553-6WZ	1-1/2" DWV	White ABS	
150576	553-8WZ	3" DWV	White ABS	

### Pipe Clamps

#### Stick-Em Up™ DWV Pipe Support

- 100% Corrosion proof, impact resistant, ABS
- Strong I-beam design
- Can be glued to ABS or PVC pipe with all-purpose glue
- Each model supports (2) pipe sizes



549-712

Part #	Mfg #	Size	Price
074860	549-712	1-1/2" - 2"	
183487	549-712PK	1-1/2" - 2"-IBC	
074861	549-734	3" - 4"	

#### Tomahawk™ DWV Ground Stake

- Prevents pipe from floating or moving during concrete pours
- Secures 1-1/2" - 6" Sch 40 DWV Pipe



535-1

Part #	Mfg #	Length	Head	Price
077331	535-14	14"	All Carbon Steel	
035028	535-914	14"	Polyethylene	
039232	535-926	26"	Polyethylene	



## Duct Hangers

### Slider™ Multi-Purpose Flat Bracket

- Two-piece design adjusts to a range of openings
- 20-gauge galvanized steel or copper-plated steel for spot soldering (heat the tube, not the bracket)
- Pre-drilled models have 1/8" pilot holes on 13/64" centers
- Adjustable bracket with flat tabs length—12"-19"

### Adjustable Bracket with Flat Tabs

Part #	Mfg #	Material	Pilot Holes	Price
183442	520-419TC	Copper-Plated	Yes	

## Flashings

### No-Calk® Roof Flashing

#### Aluminum Base No-Calk® Roof Flashing

- Slides over pipe - for pitch to 40°
- Rustproof .032 stamped aluminum standard base
- Non-fading, sealing collar
- Rated 180°F continuous heat
- Approved for Type B installations
- Not for hot-mopped or built-up roofs
- Soft aluminum base (18" x 18") allows for easy molding to tile roofing
- Do not use petroleum based products on collars



#### Aluminum Base No-Calk® Roof Flashing - Standard Base

Part #	Mfg #	Size	Qty	Price
007939	12920	1-1/4" - 1-1/2"	12	
007958	12933	2"	12	
007961	12946	3"	12	
007991	12959	4"	12	

#### Galvanized No-Calk® Roof Flashing - Standard Base

- Roof flashing slides over DWV pipe for pitch to 40 degrees
- Made of rust-proof, stamped 29 gauge galvanized steel
- Non-fading sealing collar
- Approved for Type B installations
- Not for hot-mopped or built-up roofs
- Do not use paint or petroleum based products on rubber collars

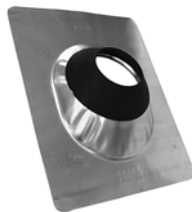

Part #	Mfg #	Size	Pipe Dia.	Price
121042	11879	12" x 15"	4"	

### Thermoplastic Base No-Calk® Roof Flashing

- Slides over pipe - for pitch to 45°
- Non-fading and non-cracking, rigid black thermoplastic base
- Non-fading, sealing collar
- Do not use petroleum based products on plastic bases or rubber collars
- Rated 180°F continuous heat
- Approved for Type B installations
- Not for hot-mopped or built-up roofs

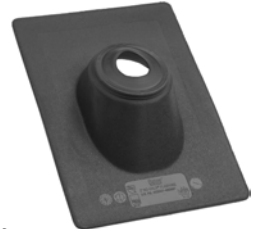

#### Thermoplastic Base No-Calk® Roof Flashing - Standard Base

Part #	Mfg #	Size	Price
038898	11908	1-1/4" - 1-1/2"	
038897	11909	2"	
038899	11910	3"	
038900	11911	4"	

### Flex-Flash® Roof Flashing

- Slides over pipe - for pitch to 45°
- 100% Completely flexible/foldable
- Do not use petroleum based products on rubber bases or rubber collars
- Non-fading TPR base and collar
- No caulking needed
- Rated 180°F continuous heat
- Not for hot-mopped or built-up roofs

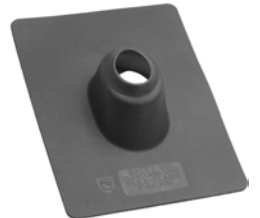

Part #	Mfg #	Size	Price
007940	14009	1-1/4" - 1-1/2"	
007959	14012	2"	
007962	14038	3"	
007998	14041	4"	

## Flashings

### All-Flash® No-Calk® Highrise® Roof Flashing

- Slides over pipe for pitch 10° to 60°
- Do not use petroleum based products on plastic bases or rubber collars
- Ring on collar tears off, allowing flashings to seal different pipe diameters
- Rated 180°F continuous heat
- Not for hot-mopped or built-up roofs
- Non-fading, non-cracking and non-rusting rigid black TPE base and sealing collars
- Approved for Type B installations



Part #	Mfg #	Size	Price
035272	11930	1-1/2" - 3"	
035273	11931	3" - 4"	

### Master Flash® Roof and Wall Flashing

- Slides over pipe - for pitch to 45°
- Use silicone sealant between base and surface and secure with sheet metal screws
- Multi-size pipe sealing range
- Molds to metal, plastic, etc.
- Non-fading EPDM collar
- Rated 212°F continuous heat
- Approved for Type B installations



Part #	Mfg #	Size	Price
023206	14052	1/4" - 4"	
007942	14053	3" - 6"	
007943	14055	5" - 9"	
031273	14057	7" - 13"	
077873	14059	10" - 18", Bulk	

### Rain Collar for No-Calk® Roof Flashing

- Use as a protective water shield (slides down over pipe)
- No caulking needed
- Do not use petroleum based products on rubber collars
- Non-fading EPDM collar
- Rated 212°F continuous heat
- Approved for Type B installations



Part #	Mfg #	Size	Price
191439	14122	1-1/4" - 1-1/2"	
118156	14135	2"	
118157	14193	3"	
118158	14203	4"	

---



---

## Flashings

---



---

### Roof Flashings

#### "Snap-Fit®" Thermoplastic Roof Flashing

- Weatherproof
- Feature a replacement boot
- Provide a permanent seal around plumbing vent pipes
- Corrosion proof
- Can be used on all types of plumbing pipe and electrical conduit
- Base dimensions: 12" x 16"



Part #	Mfg #	Size	Price
099225	14563	3"	
099224	14564	4"	

## Trap Primers

### Trap Primer Valves

#### Prime Perfect™ Trap Primer Valve

- Automatically activates to replenish evaporated water in floor drain traps
- Large port openings in debris screen prevent clogging from sediment and debris
- Activates with a 10 psig pressure drop at operating pressure of 30 - 150 psig
- Water release is factory set 0.25 oz per activation
- Single trap primer can service up to eight traps using splitter and distributors



Part #	Mfg #	Cap & Body Material	Price
054065	695-01	Brass Plated	

#### Trap Primer Wye Splitter

- 1/2" FIP Swivel connection
- Use with trap primer distributors to service up to (8) traps from a single trap primer



Part #	Mfg #	Branches	Price
138573	695-Y52	(2) 1/2" MIP	

#### Commercial Trap Primer Adapter Sch. 40 Hub (with 1/2" FIP Port)

- Faster and more professional installation of trap primer supply
- Allows trap primer inlet to be positioned anywhere on the vertical waste line above the trap
- Universal 1/2" FIP thread trap primer supply connection
- Accommodates supply lines from any direction

Part #	Mfg #	Connection	PVC/ABS	Price
223074	695-2P	2" Hub	PVC	
183797	695-4P	4" Hub	PVC	

#### Splitters Trap Priming Distributor

- 1/2" FIP swivel connection
- Available with 2, 3, or 4 flexible copper branches
- Evenly distributes water to each branch every time



Part #	Mfg #	Branches	Size	#	Price
101135	695-D20	MSwt	1/4"	2	
183798	695-D30	MSwt	1/4"	3	
183799	695-D432	MSwt & Spin-Closed	1/4"	2	
183800	695-D4325	FSwt & Spin-Closed	1/2"	2	
141596	695-D4325F	FIP w/ 2 Plugs	1/2"	4	



---

---

## Trap Primers

---

---

### Trap Seal Primers

#### Trap Seal Primer with Integral Vacuum Breaker

- Flow activated



Part #	Mfg #	Description	Price
080441	A-200	1/2" Sweat, Bronze	

## Hanger Straps

### DWV Hangers

#### ZipStrap™ Ratchet-Locking Strap

- Extends total strap length on ZipStick™ for large O.D. applications
- Compatible with copper, PEX or CPVC

Part #	Mfg #	Finish/Color	Price
164881	553-OLW	White	

#### Galvanized Steel Metal Hanger Strap

- Alternating 1/4" and 3/16" holes



Part #	Mfg #	Size	Gauge	Price
010002	524-10	3/4" x 10' Coil	24	
183449	528-10	3/4" x 10' Coil	28	
010004	528-100	3/4" x 100' Coil	28	

#### Copper-Plated Steel Metal Hanger Strap

- Alternating 1/4" and 3/16" holes



Part #	Mfg #	Size	Gauge	Price
010003	524-10C	3/4" x 10'	24	

#### Ape Tape™ Woven Polypropylene Hanger Strap

- No sharp edges to cut installer's hand or pipe
- Strong, durable material yet lightweight
- Does not fracture in extremely cold temperatures
- Cut to desired length
- Allows installer to position screw or nail at any location

Part #	Mfg #	Size	Price
116992	554-100W	5/8" x 100'	

#### Polypropylene Hanger Strap with 1/8" Holes

- Not recommended in extremely cold climates (below 32°F)
- Max load: 20 lbs.

Part #	Mfg #	Size	Price
183502	554-100	3/4" x 100' Coil	

### Hanger Straps

#### 2-Hole Tube Strap

- Copper & copper plated steel for CTS tube
- Galvanized steel for IPS pipe  
—Galvanized straps comply with MSS SP58 Type 26



#### Copper-Plated

Part #	Mfg #	Size	Gauge	Nails	Price
021293	501-1	3/8" CTS	24	Zinc-Coated	
009975	501-2	1/2" CTS	24	Zinc-Coated	
009976	501-3	3/4" CTS	24	Zinc-Coated	
009977	501-4	1" CTS	22	Zinc-Coated	
009978	501-5	1-1/4" CTS	22	Ring-Shank	
009979	501-6	1-1/2" CTS	22	Ring-Shank	
009980	501-7	2" CTS	22	Ring-Shank	

#### Galvanized Steel

Part #	Mfg #	Size	Gauge	Nails	Price
009981	12GTS	1/2" IPS	22	—	
009982	34GTS	3/4" IPS	22	—	
009983	1GTS	1" IPS	20	—	
009984	114GTS	1-1/4" IPS	20	—	
009985	112GTS	1-1/2" IPS	20	—	
009986	2GTS	2" IPS	18	—	
009987	212GTS	2-1/2" IPS	16	—	
009988	3GTS	3" IPS	16	—	
009989	4GTS	4" IPS	16	—	

### Tube Hangers

#### Bell Type Hanger

- Self-tapping mounting screw for penetrating metal studs
- Includes (2) clamp screws and (1) 2-1/2" mounting screw



508-2

Part #	Mfg #	Size	Price
047091	508-2	1/2" CTS	
047092	508-3	3/4" CTS	
047093	508-4	1" CTS	

## Hanger Straps

### Solder Straps—Copper-Eared Tube Hanger

- 1/8" mounting holes align with most conventional brackets
- Spot solder to copper tube (heat the tube, not the strap)



505-2

#### Square O Strap™

Part #	Mfg #	Size	Gauge	Price
153419	505-24	1/2" CTS	17	
183439	505-34	3/4" CTS	17	
225551	505-44	1" CTS	17	

#### Solder O Strap™

Part #	Mfg #	Size	Gauge	Price
030423	505-29	1/2" CTS	17	

## Hanger Straps

### Hanger Strap

#### Plastic Hanger Strap

- *Nail holes*
- *Non-corrosive, non-conductive, with nail holes*
- *Quick and inexpensive way to hang pipe from joists and rafters*
- *1/8" Nominal hole size*
- *Polyethylene*



Part #	Mfg #	Size	Price
041348	33925	3/4" x 25'	
252035	33928	3/4" x 10'	
007975	33926	3/4" x 50'	

#### Standard Pipe Clamp

- *Clamp design allows pipe to be flush mounted to walls and joists*
- *Minimizes the transmission of water line noise*
- *No corrosion -- made of durable polypropylene (gray color)*
- *Ribbed design allows pipe to cool faster and expand/contract freely*
- *Can be used on hydronic systems*



Part #	Mfg #	Size	Price
252033	33946	2"	

**Hanger Straps**

**Hanging Wire**

- 18 Gauge galvanized or soft black annealed



Part #	Mfg #	Description	Price
002305	6502	5# Reel (830') Galvanized	

**Hanger Straps**

**Plastic Hanger Strap**

- Flexible, non-conductive
- Can be cut to length with scissors or utility knife
- Use for pipe hanger, duct hanger, tubing strap, strap, etc.

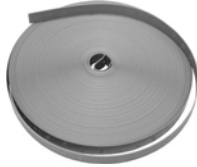

Part #	Mfg #	Description	Price
002289	13038	3/4" x 100' Roll (Box)	

**Polypropylene Webbing Strap**

- 3" Tensile strength: 640 lbs average
- For hanging flex-duct, etc.
- 300' Rolls



Part #	Mfg #	Description	Price
096479	16105	3" Black	



## Hanger Straps

### Stub-Out Bars

#### Multi-size Stub-Out Bar

- Fits 1/2", 3/4", and 1" tubing
- 1/2" Hole with 3/4" and 1" knockout holes on 2" centers
- Reinforcing ribs for additional strength

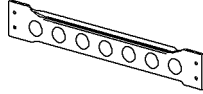

Part #	Mfg #	Gauge	Length	Ctn Qty	Price
019744	MS-20	18	20"	50	

### Two Hole Hanger Strap

- Heavy-duty galvanized steel
- Allows for a clean, professional installation



Part #	Mfg #	Size	Ctn Qty	Price
191938	1THS-GNN	1"	100	
191941	HANG2THSGNN	2"	50	
191942	HANG3THSGNN	3"	25	
191943	HANG4THSGNN	4"	25	
191936	HANG12THSGNN	1/2"	100	
191937	HANG34THSGNN	3/4"	100	
191940	HANG112THSGN N	1-1/2"	50	
191939	HANG114THSGN N	1-1/4"	50	
191944	HANG212THSGN N	2-1/2"	25	



**Heating Cables**

**Freeze Free<sup>®</sup> Pipe Freeze Prevention Cable**

- Self-regulating pipe heating cable
- Keeps plastic and metal water pipes from freezing to -60°F
- Braided metal jacket
- Rated 3W per foot
- 120VAC at 50°F
- UL Listed & CSA Certified



**Connection Kit**

Part #	Mfg #	Description	Price
021899	10803	(25) Packs of Plug & End Seal	

**SR Trace<sup>®</sup> Freeze Protection Cable**

- The cut-to-length design allows for easy field sizing and installation
- All power densities are available from the factory in cut-to-order lengths or in easy to use 250 self-dispensing reel boxes
- Normally installed in commercial applications
- Suffix: J = jacketed cable (can be followed by reel length)

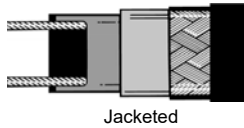

Part #	Mfg #	Description	Price
004398	SR51J	5W/ft 120VAC Cut-to Order	

## Innerlynx Modular Seal

### Pipe Penetration Seals

- *Forms a mechanical seal between pipes going through walls, floors, vaults, tanks & pipeline casings going through walls, floors, vaults*
- *Helps absorb vibrations, shocks & sound waves*
- *Non-conductive*
- *Installed quickly & easily by one worker with no special tools required*

#### Standard Pipe Penetration Seal

- *Plated steel*
- *EPDM black*
- *Temperature range: -40° to 250°F*
- *Composite pressure plates*
- *Plated steel fasteners and nuts*
- *Suitable for most standard applications including: above ground, direct underground burial, wet conditions and where cathodic protection - electrical insulation is desired*



Part #	Mfg #	Actual Thickness	Width	Chord Length	Price
108030	IL-200C	0.50"	1.80"	1.15"	
108032	IL-275C	0.63"	1.80"	0.89"	
108033	IL-300C	0.70"	2.57"	1.50"	
108034	IL-315C	0.83"	2.48"	1.47"	
108035	IL-325C	0.95"	3.04"	3.15"	
108036	IL-340C	1.00"	2.76"	1.52"	
108037	IL-360C	1.23"	2.80"	2.08"	
108038	IL-400C	1.41"	3.56"	3.63"	
108040	IL-425C	1.13"	3.54"	3.60"	
108041	IL-475C	1.61"	3.16"	2.68"	
108044	IL-575C	1.81"	3.78"	3.16"	

**Pipe Pier**

**Roof Top Blox®**

- Molded of UV resistant polypropylene
- Heavy-duty load-bearing design
- Notched saddle-top design for easy pipe alignment
- Protective padded base
- Reinforced screw starter guides
- Convenient install-from-the-top engineering



Part #	Mfg #	Description	Price
175361	RTB-01	#80600	

**1.5" Blox Height Extension**

- Polypropylene
- Fastens directly on top of Blox with two #10 screws



Part #	Mfg #	Description	Price
207876	80602	1-1/2", 48/Pk	

**Pipe Pier**

**Caddy® Cable/Conduit Supports**

**Caddy® Pyramid 50 Pipe and Equipment Support**

- Recommended load: 50 lbs
- Polyethylene closed-cell foam and steel construction
- Metal top designed to shed water and minimize water collection on foam base



Part #	Mfg #	Size	Price
048247	RPS50H4EG	4"H x 4"W x 10-3/8"D	

**Caddy® Pyramid ST Fixed Strut Support**

- Polyethylene, Polypropylene, Steel
- Hot-Dip Galvanized
- -50 to 150 °F



Part #	Mfg #	Size	Price
166209	PSF10C	4.8"H x 8"W x 12-1/2"L	

## Plastic Hangers

### J-Hooks

#### Hangs Tuff Jr.™ CTS Tube Hanger

- Hangs any 1/2" – 1 1/4" CTS copper, PEX or CPVC tube
- 100% corrosion proof, impact resistant ABS
- Two ring-shank nails conveniently supplied



553-3W

Part #	Mfg #	Size	Price
010009	553-2W	1/2" CTS	
010010	553-3W	3/4" CTS	
079196	553-4W	1" CTS	
183500	553-5W	1-1/4" CTS	

### Double Hooks



Part #	Mfg #	Size	Price
022740	553-22W	1/2" x 1/2" CTS	
022741	553-33W	3/4" x 3/4" CTS	

#### Swivel J-Hanger™ Extension Hanger

- Cradle swivels 360°
- Install pipe from any direction
- Allows for expansion and contraction
- Ideal for running vent pipes across the attic
- 100% corrosion proof
- UV resistant



Part #	Mfg #	Size	Price
147251	553-7WZ	2" DWV	

### Pipe Clamps

#### TouchDown™ Large Universal Pipe Clamp

- Supports 1/2" CTS through 2" IPS
- Supports multiple supply lines within a single clamp
- Stack bridges to hold different pipe sizes
- Flat base can be used with PowerBar™ or PowerBar MiniStrut™
- Strut foot model fits common 1-5/8" channel
- Metal inserts prevent strut clamp from slipping within the strut
- Optional PipeDown™ acoustical cushions available
- IAPMO Listed



Part #	Mfg #	Bridge	Base	Screws	Price
233138	550-2111	1	1	2	

### With Two Pipe Down™ Noise Absorbing Inserts

- Thermoplastic elastomer reduces noise
- Not for use with Plenum Safe™ clamps

Part #	Mfg #	Bridge	Base	Screws	Price
183488	550-2111 Q	1	1	2	

#### TouchDown™ Universal Pipe Clamp

- Clamps 1/4" - 1" CTS tube (copper or plastic) and 1/8" - 1" Sch 40 pipe (steel or plastic)
- Releasable locking mechanism
- Perfect when various pipe and tube sizes are used
- Variable clamping tension allows for expansion and contraction of tube
- Provides 1/4" stand-off
- For use with any CTS pipe (copper, PEX, CPVC, PB)



Part #	Mfg #	Bridge	Base	Screws	Price
036418	550-11	1	1	1	

#### Pipe Eye™ Metal Stud Insulator

- Compatible with copper, PEX and CPVC
- Fits 1-11/32" holes in metal studs or brackets
- Split design, offset hole for adjustable tube position
- Reduces noise caused by expansion and contraction
- Flame retardant models meet UL94 V 2 flame rating
- PlenumSafe™ models meet ASTM E84 25/50 Flame/Smoke Spread and UL94 V-0 flame rating



558-M2

#### Standard

Part #	Mfg #	Size	Color	Price
078839	558-M2	1/2" CTS	Black	
247173	558-M23	1/2"-3/4" CTS	Black	
183507	558-M3C	3/4" CTS	Blue	
183508	558-M3H	3/4" CTS	Red	
078840	558-M4	1" CTS	Black	

#### Flame Retardant & Glueable

Part #	Mfg #	Size	Color	Price
243373	558-M23R	1/2"-3/4" CTS	Natural	

#### PlenumSafe™

Part #	Mfg #	Size	Price
117292	558FM2	E84 1/2" CTS	
117293	558FM3	E84 3/4" CTS	

## Plastic Hangers

### Pipe Clamps (Continued)

#### Pipe Eye™ Metal Stud Insulator PlenumSafe™

Part #	Mfg #	Size	Price
117294	558FM4	E84 1" CTS	

#### Suspensulator™ Tube Clamp & Insulator

- Designed to work in both 1 3/8" and 1 11/32" holes in wood or metal studs
- Side fins lock perfectly into I-joist knockout
- Split design allows for use after piping is run
- Durable, UV resistant, high-density polyethylene is 100% corrosion proof and reduces noise due to expansion and contraction in hot water lines
- Compatible with copper, PEX or CPVC



Part #	Mfg #	Size	Color	Price
077500	558-E2	1/2" CTS	Black	
077501	558-E3	3/4" CTS	Black	

#### Tube Talon™ Drive Hook Tube Hanger with Nail

- Absorbs vibration
- Compatible with copper, PEX and CPVC
- For IPS piping (PVC and iron pipe) use next larger size Tube Talon
- Preloaded ring-shank nails ensure a permanent hold
- Install in alternating directions to ensure secure piping
- Tube is not damaged if nail is overdriven



Part #	Mfg #	Size	Color	Price
010015	12TCHC	1/2" CTS	Black	
100959	38TCHC	3/8" CTS	Black	
010016	34TCHC	3/4" CTS	Black	
043092	1TCHC	1" CTS	Black	
183503	555-2BK	1/2" CTS, 1,800/Bucket	Black	
183504	555-3BK	3/4" CTS, 1,000/Bucket	Black	
183505	555-4BK	1" CTS, 500/Bucket	Black	

#### Pick-Up Talon™ Isolating Drive Hook with Nail

- The most affordable solution to keeping tube off the mounting surface for a quiet system
  - Installation is fast and easy; snaps onto tube with preloaded nails/screws
  - Install in alternating directions to secure piping
  - All models with screws feature self-drilling tips
  - Compatible with copper, PEX and CPVC
- S models = with Screw**



556-2

Part #	Mfg #	Size	Color	Price
183506	556-1	3/8" CTS	Black	
108286	556-2	1/2" CTS	Black	
232279	556-2S	1/2" CTS	Brown	
108287	556-3	3/4" CTS	Black	
108288	556-4	1" CTS	Black	
223089	556-5	1-1/4" CTS	Black	

#### By the Bucket

Part #	Mfg #	Size	Bucket Qty	Price
230787	556-2BK	1/2" CTS	1600	
230788	556-3BK	3/4" CTS	800	

#### Twin Talon™ Double-Duty Drive Hook with Nail

- 555-23 series affixes 1/2", 5/8" and 3/4" nominal tube (copper or plastic) and 1/2" Sch. 40 IPS pipe (steel or plastic)
- Available with shorter nail for radiant heat, nail-up applications. 1-5/8" nail wont penetrate 3/4" floors
- Compatible with copper, PEX and CPVC



555-23

Part #	Mfg #	Size	Price
028473	555-23	1/2"-3/4" CTS	
089111	555-23BK	1/2"-3/4" CTS, 850/Bucket	

#### Padlock™ Tube Hanger

- Nail or screw locks tube into hanger so there is no way for tube to escape
- Allows tube to expand and contract
- Will not damage tube if nail or screw is over-driven
- Fits and fastens to the GridIron™ bracket
- Compatible with copper, PEX and CPVC
- Isolates tube from surface to reduce heat loss and noise transfer



551-P2

Part #	Mfg #	Size	Nail or Screw	Price
039374	551-P2	1/2" CTS	Nail	
078585	551-P2S	1/2" CTS	Screw	



## Plastic Hangers

### Pipe Clamps (Continued)

#### Padlock™ Tube Hanger

Part #	Mfg #	Size	Nail or Screw	Price
078586	551-P3S	3/4" CTS	Screw	

#### Sioux Strap™ Tube Hanger with Nail

- Provides 1/4" stand-off
- Compatible with copper, PEX and CPVC
- Preloaded ring-shank nail ensures a permanent hold
- Isolates tube from surface to reduce heat loss and noise transfer
- Snaps onto tube for "hands-free" installation
- Allows tube to expand and contract



Part #	Mfg #	Size	Color	Price
032464	12TC	1/2" CTS	Black	
038630	34TC	3/4" CTS	Black	
042878	1TC	1" CTS	Black	
074850	551-2BK	1/2" CTS, 1000/Bucket	Black	
138265	551-3BK	3/4" CTS, 600/Bucket	Black	

#### Totem™ Offset CTS Hanger

- Single, twin, or stacked offset hanger
- Provides 1" offset from mounting surface to bottom of tube
- Secures to surface in any position
- Unique V-shaped base easily adapts to engineered wood I-beam joists
- Locking finger holds pipe securely in place
- 100% corrosion proof, impact resistant
- Bulk ring-shank nails included (but not pre-loaded)
- Compatible with copper, PEX and CPVC



552-B33  
Twin Offset

Part #	Mfg #	Size	Offset	Price
157295	552-A2	1/2" CTS	Single	
157300	552-A3	3/4" CTS	Single	
117500	552-B22	1/2" x 1/2" CTS	Twin	
157301	552-B33	3/4" x 3/4" CTS	Twin	
117501	552-C22	1/2" x 1/2" CTS	Stacked	
183491	552-C33	3/4" x 3/4" CTS	Stacked	

#### EZGlide™ Tube Insulator

- Ribs allow pipe to glide easier and more quietly when the pipe expands and contracts
- Split design allows for use after piping run
- Fits both 1-11/32" and 1-3/8" holes in metal or wood studs
- Compatible with copper, PEX or CPVC



558-2

Part #	Mfg #	Size	Price
030697	558-2	1/2" CTS	
030801	558-3	3/4" CTS	
043198	558-4	1" CTS	

#### EZGlide™ Suspension Clamp

- Ribs allow pipe to glide easier and more silently when the pipe expands and contracts
- Split design allows for use after piping run
- For use with any CTS pipe (copper, PEX, CPVC, PB)
- Available in standard or plenum-safe models



557-2

Part #	Mfg #	Size	Price
027599	557-2	1/2" CTS	
027600	557-3	3/4" CTS	
042403	557-4	1" CTS	
044855	557-5	1-1/4" CTS	

#### EZGlide™ Standard Tube Clamp

- Ribs allow pipe to glide easier & more quietly when the pipe expands & contracts
- V-shaped split design for easy installations
- Compatible with copper, PEX or CPVC
- Plenum Safe™ models meet ASTM E84 25/50 flame/smoke spread and UL94 V-0 flame rating



559-2

Part #	Mfg #	Size	Price
010017	559-2	1/2" CTS	
010018	559-3	3/4" CTS	
030988	559-4	1" CTS	
030987	559-5	1-1/4" CTS	
042879	559-6	1-1/2" CTS	
130138	559-7	2" CTS	

## Plastic Hangers

### Power Bar™ Universal Slider Bracket for 9" - 16"

- Galvanized steel bracket and tough plastic clamp support pipe in numerous applications
- For use with any CTS pipe (copper, PEX, CPVC, PB)



523-1624

Part #	Mfg #	Bracket	Clamps	Screws	Price
122569	523-1624	1	(2) Touchdown	(4) Drill-Tip	

### PipeTitan™ Universal Bracketing System (Plus Five Kit)

- Non-metallic – no electrolysis worries
- Isolates pipe and reduces noise
- Compatible with copper, PEX and CPVC



572-20

**Standard Green**

Part #	Mfg #	Bracket	Straps	Clamp	Band	Price
183510	570-20	1	2	1	5" SS	

**Flame Retardant Red**

Part #	Mfg #	Bracket	Straps	Clamp	Band	Price
183512	572-20	1	2	1	5" SS	

**PVC 40  
Fittings**



**PVC 40  
Fittings**

---

---

**Plastic Hangers**

---

---

**PVC Sch 40 Fittings**  
**PVC Sch 40 2-Hole Pipe Clamp**



Part #	Size	Price
034520	1/2"	
034521	3/4"	
034522	1"	
072121	1-1/4"	
036755	1-1/2"	
034523	2"	

---

---

**Plastic Hangers**

---

---

**Pipe Clamps****Full Clamp with Barbed Nail**

Part #	Mfg #	Size	Pkg Qty	Price
007941	OT12FTCLAMP	1/2"	100	
007973	OT34FTCLAMP	3/4"	50	
007935	OT1FTCLAMP	1"	25	

## Potable Water Expansion

### Potable Thermal Expansion Tanks

#### Therm-X-Trol® Thermal Expansion Tank

- For use with potable water heaters only
- Non-ASME
- Pre-pressurized, diaphragm type
- Drawn steel domes, welded steel construction
- Rigid polypropylene liner
- Butyl diaphragm, diaphragm hoop ring mechanically grooved for permanent air-tight seal
- Stainless steel system connection
- Maximum operating system: 200°F
- Maximum working pressure: 150 psig
- Factory pre-charge: 40 psig
- 5-Year limited warranty



#### Therm-X-Trol® In-Line Thermal Expansion Tank

Part #	Mfg #	Dia	Height	Volume	Price
241328	ST-1	3"	4"	Tankless	
001998	ST-5	8"	13"	2.0 gal	
111686	ST-8	9"	15"	3.2 gal	
001996	ST-12	11"	15"	4.4 gal	

#### Therm-X-Trol® Vertical Stand Thermal Expansion Tank

Part #	Mfg #	Dia	Height	Volume	Price
001997	ST-25V	15"	19"	10.3 gal	
021624	ST-42V	15"	32"	20.0 gal	
024494	ST-210V	24"	57"	90 gal	
026688	ST-60V	16"	32"	25 gal	

#### Therm-X-Span® Inline Thermal Expansion Tanks T-Series

- For use in closed, potable water systems to control pressure build-up
- Heavy Duty steel shell with polypropylene liner
- 1-Year Warranty

Part #	Mfg #	Dia	Height	Volume	Price
170431	T-5	8"	13"	2.0 gal	
193096	T-12	11"	15"	4.4 gal	

## Potable Water Expansion

### Hydronic Expansion Tanks

#### PLT - Potable Water Expansion Tank (MNPT)

- Lead-free, polypropylene liner; rugged flexible butyl diaphragm
- Field adjustable pre-charge
- Use with most standard direct fired water heaters and storage tanks
- Maximum pressure: 150 psi
- Maximum temperature: 200°F
- 3/4" MNPT Connections



Part #	Mfg #	Model	Volume	Price
098950	0067370	PLT5	2.1 gal	
128649	0067371	PLT12	4.5 gal	





## Pipe Cutting Oil

### Thread Cutting Oil

- Can be used on most metals
- For heavy-duty cutting, threading, tapping and broaching of steel



Part #	Mfg #	Description	Price
005511	HV016150	1 gal, Clear	
017673	HVOILQT	Dark, qt	
017674	HVOILGL	Dark, gal	

---

---

## Pipe Cutting Oil

---

---

### Lubricants Dark Cutting Oil



Part #	Mfg #	Model #	Size	Price
145665	80421	R1625	1 gal	



## Pipe Cutting Oil

### Thread Cutting Oil

#### Dark Cutting Oil

- *Compounded for cutting clean, unbroken threads when using high-speed threading machines on steel or brass pipe*
- *Low torque means less work*



Part #	Mfg #	Description	Price
192892	40-210	1 Pint	
192893	40-215	1 Quart	
192894	40-220	1 Gallon	

#### Clear Cutting Oil

- *Contains activated sulfur-lard and extreme pressure-antiwear additives*
- *Free of chlorine, other halogens, PCBs and heavy metals*
- *Also used for hacksawing and light drilling*
- *Better heat dissipation*
- *Long lasting formula with less residue backup*



Part #	Mfg #	Description	Price
192888	40-115	1 Quart	
192891	40-120	1 Gallon	

**Pressure Gauges**

**Pressure Gauges - Thermometers**

**Lazy Hand Water Test Gauge**

- Regular pressure hand pushes Lazy Hand to peak operating or surge pressure point where it remains until manually reset
- Excellent to determine if P/T valve is leaking from failure or if leaking is caused by surge or excessive pressures (gauge attached to boiler drain overnight)
- Lazy Hand operates over entire gauge range
- Plastic face
- Supplied with protective filter washer
- 3/4" FHT Brass swivel connection



Part #	Mfg #	PSI	Price
029882	1428	0-300#	

**Air Test Gauge Assembly**

- Plastic face
- All parts precision made and assembled with sealant
- 3/4" FPT
- 2" Gauge



Part #	Mfg #	Description	Price
022357	1427	0 - 30 psi, 1/3# Increments	
068334	1421	0 - 100 psi, 2# Increments	

**Bell Reducer Air Test Gauge Assembly**

- Bell reducer type
- All parts precision made and assembled with sealant
- 3/4" or 1" FPT
- 2" Gauge
- Snifter valve



Part #	Mfg #	PSI	Connection	Price
142941	1413	0-100#	3/4" FPT	
029299	1414	0-30#	1" FPT	

## Sealants, Cements & Lubricants

### Toilet Repair Aids

#### LiquiLock™ Gel

- Solidifies water for easy toilet removal
- Prevents water spills
- Gel formed in 4 minutes
- Non-toxic, Lo-VOC



Part #	Mfg #	Size	Pkg Qty	Price
133661	OT31417	0.6 oz	50	

### Plastic Pipe Cement

#### All Purpose Cement

- Medium-bodied milky clear cement for ABS, PVC and CPVC pipe and fittings up to 6" diameter with interference fit
- Recommended for potable water, conduit and DWV
- Recommended application temperature: 40° to 110°F
- Meets performance requirements of ASTM D2564, D2235 and F493



30847

Part #	Mfg #	Size	Price
007992	PL4AP	4 oz	
008006	PL8AP	8 oz	
007945	PL16AP	16 oz	
007965	PL32AP	32 oz	
146051	PL1GALAP	1 gal	

### PVC Heavy-Duty Clear Cement

- Heavy-bodied clear cement for PVC pipe and fittings up to 12" diameter with interference fit, up to 18" for non-pressure
- Thick formula fills gaps in large diameter pipe and loose fitting joints
- Recommended for potable water, pressure pipe, conduit and DWV
- Recommended application temperature: 40° to 110°F
- Meets ASTM D2564



31008

Part #	Mfg #	Size	Price
007997	PL4HD	4 oz	
008009	PL8HD	8 oz	
007951	PL16HD	16 oz	
007968	PL32HD	32 oz	

### PVC Medium Clear Cement

- Medium-bodied clear cement for use on PVC pipe and fittings up to 6" diameter for Sch 40 and Sch 80
- Recommended application temperature: 40° to 110°F
- Recommended for potable water, pressure pipe, conduit and DWV
- Meets ASTM D2564



31020

Part #	Mfg #	Size	Price
191436	PL4M	4 oz	
008010	PL8M	8 oz	
007953	PL16M	16 oz	
007969	PL32M	32 oz	
191437	PL1GM	1 Gal	

### PVC Regular Clear Cement

- Regular-bodied clear cement for use on PVC pipe and fittings up to 4" for DWV Sch 40 and up to 2" for Sch 80
- Recommended for all grades and types of PVC pipe and fittings, potable water, pressure pipe, gas, conduit and DWV



Part #	Mfg #	Size	Price
191433	PL4R	4 oz	
136357	PL16R	16 oz	
191434	PL32R	32 oz	
191435	OT31016	1 Gal	

### PVC Heavy-Duty Gray Cement

- Heavy-bodied gray cement for use on PVC pipe and fittings up to 12" diameter with interference fit, up to 18" for non-pressure
- Thick formula fills gaps in large diameter pipe and loose fitting joints
- Recommended for potable water, pressure pipe, conduit and DWV
- Recommended application temperature: 40° to 110°F
- Meets ASTM D2564



Part #	Mfg #	Size	Price
007952	PL16HD80	16 oz	
007937	PL1GHD80	1 Gal	

## Sealants, Cements & Lubricants

### PVC Medium Gray Cement

- Lo-V.O.C. Solvent Cement
- Recommended for potable water, pressure pipe, conduit and DWV
- Recommended application temperature 40°F to 110°F / 4°C to 43°C
- Meets ASTM D2564



### PVC Polar-Weld™ All Weather Clear Cement

- Medium-bodied cold weather cement for PVC pipe and fittings up to 6" diameter for Sch 40 and 80
- Formulated for fast-setting at temperatures down to -5° to 110°F
- PVC Cement is Low-VOC Compliant
- Meets ASTM-D2564



Part #	Mfg #	Size	Price
195606	OT30886	32 oz	

Part #	Mfg #	Size	Price
139844	OT1GPOLAR	1 gal	
083935	OT16POLAR	16 oz	

### PVC Rain-R-Shine® Blue Cement

- Medium bodied blue colored cement for use on PVC pipe and fittings up to 6" dia
- Very fast setting cement formulated for wet conditions &/or quick pressurization and fast installation
- Use with Sch 40 and 80
- Pool/irrigation
- Recommended application temperature: 40° to 100°F
- No primer needed on non-pressure DWV, where local codes permit
- Meets ASTM D-2564



30894

### Hot Medium Blue Lava PVC Cement

- Lo-V.O.C. Solvent Cement
- Very fast setting
- Recommended for potable water, sewer and DWV applications
- Recommended application temperature 40°F to 110°F / 4°C to 43°C
- No primer needed on non-pressure DWV, where local codes permit
- Meets ASTM D2564
- Acceptable for use as a one-step application where local code permits



Part #	Mfg #	Size	Price
029260	PL8RS	8 oz	
007956	PL16RS	16 oz	
007971	PL32RS	32 oz	

Part #	Mfg #	Size	Price
233164	OT32163	32 oz	

### PVC All Weather Clear Cement

- Medium-bodied clear cement for use on PVC pipe and fittings up to 6" diameter with interference fit
- Recommended application temperature: -15° to 110°F
- Recommended for use on potable water, drain, waste and vent systems
- No primer needed on non-pressure DWV, where local codes permit
- Meets ASTM D2564



31133

### ABS To PVC Transition Green Cement

- Medium-bodied green cement for use in joining ABS to PVC in non-pressure transition joints up to 6" diameter
- Recommended application temperature: 40° to 110°F
- Meets ASTM D3138



Part #	Mfg #	Size	Price
007946	PL16AW	16 oz	
007966	PL32AW	32 oz	

Part #	Mfg #	Size	Price
037607	OT4TRAN	4 oz	



## Sealants, Cements & Lubricants

### CPVC Medium Orange Cement

- Medium-bodied orange cement for use on CPVC pipe and fittings up to 6" diameter
- For residential and commercial hot and cold water systems up to 200°F
- Recommended application temperature 40° to 110°F
- Meets ASTM F-493 and ASTM D-2846



Part #	Mfg #	Size	Price
007994	PL4CPVC	4 oz	
008008	PL8CPVC	8 oz	

### CPVC Medium All Weather Yellow Cement

- Lo-V.O.C. Solvent Cement
- For cold water systems and hot water systems up to 200°F / 93°C
- May be used without primer where local coders permit
- Recommended application temperature 0°F to 110°F / -17°C to 43°C
- Meets ASTM F493
- FlowGuard Gold® is a registered trademark of The Lubrizol Corporation



Part #	Mfg #	Size	Price
034837	OT8FGCPVC	8 oz	

### Oateyweld™ Solvent Cement

- Provides a permanent, watertight seal to form a larger membrane from CPE liners in tile showers and other concealed waterproofing applications
- Specially formulated for extended working times
- Provides exceptional sheet to sheet bonding
- Use ONLY on CPE shower pan liners



Part #	Mfg #	Size	Price
177849	OT30810	160 oz	

### Plastic Pipe Primers/Cleaners

#### Clear Primer - NSF Listed

- Clear aggressive primer for use on PVC and CPVC pipe and fittings
- Removes surface dirt, grease and grime as well as softens the pipe surface to allow a fast, secure solvent weld
- NSF Listed
- Meets ASTM F656



30753

Part #	Mfg #	Size	Price
191430	PL4CLPRMR	4 oz	
193794	PL8CLPRMR	8 oz	
007948	PL16CLPRMR	16 oz	
043557	PL32CLPRMR	32 oz	
194786	PL1GCLPRM R	1 Gal	

#### Purple Primer/Cleaner

- Purple tinted all purpose primer/cleaner for PVC and CPVC pipe and fittings
- Removes surface dirt, grease and grime as well as softens pipe in preparation for solvent cement
- Purple tint for verification for code
- Less aggressive than clear and purple primer



30806

Part #	Mfg #	Size	Price
007999	PL4PPRMR	4 oz	
008012	PL8PPRMR	8 oz	
007954	PL16PPRMR	16 oz	
007970	PL32PPRMR	32 oz	

#### Purple Primer/Cleaner

- Lo-V.O.C. Primer
- Removes surface dirt, grease, & grime as well as softens the pipe surface to allow a fast, secure solvent weld
- Meets ASTM F656
- For use with PVC and CPVC pipe & fittings



Part #	Mfg #	Size	Price
205227	OT30758	32 oz	

## Sealants, Cements & Lubricants

### Clear Cleaner

- Clear cleaner for ABS, PVC and CPVC pipe and fittings
- All schedules and all diameters
- Flows freely and evaporates quickly
- Fast removal of surface dirt, grease and grime



30805

Part #	Mfg #	Size	Price
007993	PL4CLNR	4 oz	
008007	PL8CLNR	8 oz	
007947	PL16CLNR	16 oz	
007967	PL32CLNR	32 oz	
007964	PL1GCLNR	1 gal	

### Pipe/Gasket Lube

- Non-toxic, soft, paste like material for lubricating bell joint pipe gaskets
- Will not deteriorate natural or synthetic rubber
- Will not support bacteria
- Dissolves in hot water



Part #	Mfg #	Size	Price
006176	LUBEQT	1 qt	
006175	LUBEGAL	1 gal	

### Pipe Compounds

#### Great Blue® Pipe Joint Compound

- Flexible blue, non-hardening, non-separating, non-toxic paste, no odor, easy clean-up
- Use on PVC, CPVC, ABS, polyethylene, polypropylene, iron, steel, copper or brass threads up to and including 2"
- Withstands up to 3,000 PSI on gases from -50° to +400°F and 10,000 PSI on liquids from -50° to +500°F
- For use with water, steam, caustics or dilute acid lines of PVC, CPVC, ABS, cycolac, polypropylene, iron, steel or copper
- Lubricates and seals thread on water, natural gas, steam, air lines, caustics and dilute acids



Part #	Mfg #	Size	Price
175512	OT31262	8 oz	
187715	OT31263	16 oz	

#### Great White® Pipe Joint Compound with PTFE



Part #	Mfg #	Size	Price
018484	PLTEFLON8	8 oz	
251972	OT31232	16 oz	

### Solvent Cement and Primer Accessories

#### Adjustable Daubers

- Ideal for apply solvent cement to pipe and fittings
- The adjustable handle extends to 6" length
- To fit 8 oz to quart size containers



Part #	Mfg #	Size	Price
167736	OT31301	100 Pack, For 8oz to Quart	
162264	OT31312	48 Pack, For 32 oz	
197683	OT31302	50 Pack, 1" Ball	

#### Applicator

- Fits wide and standard mouth sizes



Part #	Mfg #	Description	Price
051994	OT31275	12" Gallon Can Roller	

#### 32 oz. Can Cement Carrier

- Cement Carrier holds two 32 oz. cans to make it easier to keep cement and cleaner ready for use on the job



Part #	Mfg #	Size	Price
023946	OT31250	Holds 2 cans	

## Sealants, Cements & Lubricants

### Cement

#### PVC 702™ Clear Regular Bodied Low VOC Cement



Part #	Mfg #	Model #	Size	Price
142555	IPS702CEMENTPT	10976	1 pt	

#### PVC 701™ Medium Bodies Plumbing Cement

- Formulated for all classes and schedules with interference fit through 6" (160 mm) diameter, Schedule 80 through 4" (110 mm) diameter for plumbing applications
- Medium-bodied, fast-setting, low-VOC PVC cement
- Can be used without primer on non-pressure systems if local code
- Available in clear and gray

Part #	Mfg #	Model #	Size	Price
118244	IPS781GRAYQT	14011	1 qt	
142557	IPS781GLUEPT	14007	1 pt	

#### PVC 711™ Heavy Bodied Plumbing Cement

- Cement for all classes and schedules with interference fit, including SCH80 through 12" diameter
- Medium set allows more working time in warm weather
- High-strength formula idea for industrial piping systems



Part #	Mfg #	Model #	Size	Price
142819	IPS711GLUEQT	10119	1 qt	

#### PVC 782™ Clear Heavy Bodied Low VOC Cement

- Quality formulation for plumbing, industrial, pool, irrigation and electrical piping systems
- Good gap filling properties
- Maximum recommended pipe size: 12" PVC
- Medium set time allows for more working time in warm weather



Part #	Mfg #	Model #	Size	Price
142416	IPS782CLEAR4OZ	14019	1/4 pt	
142415	IPS782CLEAR8OZ	14018	1/2 pt	
142412	IPS782CLEARPT	14017	1 pt	

### Cement (Continued)

#### PVC 782™ Clear Heavy Bodied Low VOC Cement

Part #	Mfg #	Model #	Size	Price
123475	IPS782CLEARQT	14016	1 qt	
068855	IPS782GLUEGAL	14015	1 gal	

#### PVC 782™ Gray Heavy Bodied Low VOC Cement

- Quality formulation for plumbing, industrial, pool, irrigation and electrical piping systems
- Good gap filling properties
- Maximum recommended pipe size: 12" PVC
- Medium set time allows for more working time in warm weather



Part #	Mfg #	Model #	Size	Price
108711	IPS782GRAYQT	14021	1 qt	
107542	IPS782GLUEGALGR	14020	1 gal	

#### PVC 721™ Blue Medium Bodied Low VOC Cement

- Fast set time
- For use on rigid PVC with interference fit Sch. 40 thru 6" and Sch. 80 thru 4"



Part #	Mfg #	Model #	Size	Price
244757	IPS721GLUEQT	10161	1 qt	

#### CPVC 724 Industrial Grade Cement

- Low VOC
- ASTM F 496  
NSF/ANSI 14  
NSF/ANSI 61
- For all rigid CPVC



Part #	Mfg #	Model #	Size	Price
124507	IPS724GLUEQTGR	11659(Gray)	1 qt	
068856	IPS724GLUEGAL	12233(Gray)	1 gal	
118245	IPS724GLUEQT	12818(Orange)	1 qt	



## Sealants, Cements & Lubricants

### PVC 727™ Clear Medium Bodied Hot 'R Cold Cement



Part #	Mfg #	Model #	Size	Price
142425	IPS727GLUEPT	10842	1 pt	
142424	IPS727GLUEQT	10841	1 qt	
074086	IPS727GLUEGAL	10840	1 gal	

### PVC 735™ Wet 'N Fast™ Blue Medium Bodied Cement

- Plumbing quality cement for wet conditions and/or quick pressurization
- Can be used without primer or non-pressure systems if local codes permit
- Maximum recommended pipe size:
  - 6" PVC
  - 4" Sch 80 PVC - PN 10 and 16
- Extremely fast set time



Part #	Mfg #	Model #	Size	Price
142427	IPS735GLUEPT	12496	1 pt	
142426	IPS735GLUEQT	12495	1 qt	

### PVC/CPVC/ABS/Styrene 790™ Clear Medium Bodied Multi-Purpose Cement



Part #	Mfg #	Model #	Size	Price
131652	IPS790GLUEPT	10258	1 pt	
166883	IPS790GLUEQT	10257	1 qt	

### 505 Key Tite™ Metal Pipe Sealant

- Special formulation seats and lubricates metal pipe joints as well as protects them from rusting and seizing
- Applicable for all types of metal joints (threaded, flanged, or gasketed)
- For sealing and lubricating all metal piping systems carrying various materials



Part #	Mfg #	Model #	Size	Price
190960	KEYT12	10068	8 oz	

### Primers & Cleaners

#### PVC/CPVC P-68™ Low VOC Purple Primer

- Quality primer essential for proper softening and preparation of PVC and CPVC pipe and fitting surfaces



Part #	Mfg #	Model #	Size	Price
142423	IPSP68PPRMRPT	10212	1 pt	
142421	IPSP68PPRMRQT	10210	1 qt	

#### PVC/CPVC P-68™ Low VOC Clear Primer

- Quality primer essential for proper softening and preparation of PVC and CPVC pipe and fitting surfaces



Part #	Mfg #	Model #	Size	Price
142422	IPSP68CLPRMRPT	10211	1 pt	
110766	IPSP68CLPRMRQT	10209	1 qt	
068858	IPSP68CLPRMRGAL	10207	1 gal	

#### PVC/CPVC Low VOC Purple Primer



Part #	Mfg #	Model #	Size	Price
154197	IPS8PPRMR	14027	8 oz	

#### PVC/CPVC P-70™ Industrial Grade Low VOC Purple Primer

- Premium industrial strength primer essential for proper softening and preparation of PVC and CPVC pipe and fitting surfaces
- Specially recommended for use on Sch 80 (PN 10 and higher) and larger pipe
- Excellent for cold weather applications



Part #	Mfg #	Model #	Size	Price
007938	PL1GPPRMR	10221	1 gal	

## Sealants, Cements & Lubricants

### PVC/CPVC P-70™ Industrial Grade Low VOC Clear Primer

- For Sch 80 and large size pipe

Part #	Mfg #	Model #	Size	Price
118388	IPSP70CLEANERQT	10222	1 qt	
082781	IPSP70CLEANRGAL	10220	1 gal	

### PVC/CPVC/ABS/Styrene C-65™ Low VOC Clear Cleaner

- For removal of oil and grease from the surfaces of PVC, CPVC, ABS and Styrene pipe and fittings for bonding
- Recommended for use before priming of pipe and fittings



Part #	Mfg #	Model #	Size	Price
142419	IPSC65CLEANR8OZ	10203	1/2 pt	
142418	IPSC65CLEANRPT	10202	1 pt	
142417	IPSC65CLEANRQT	10201	1 qt	
068857	IPSC65CLEANRGAL	10200	1 gal	

### Solvent Welding Applicators

#### Roller & Swab



14111



7020

4020

Part #	Mfg #	Description	Price
034500	IPSPROLLER7	006310000 7020 Jumbo Roll-A-Weld 7" Roller for MT-648 Gallon Can	
034499	IPSSWAB4	006320000 4020 4" Swab for MT-648 Gal Can	
216013	IPS14108	Superswab - Swabs and Handles 12/PK	
167691	IPSSUPERSWAB	Superswab - Swabs and Handles 24/PK	
167692	IPSSWABREPLACE M	Replacement Swabs 24/PK	

### Can-Tote Cement and Primer Carrier



Part #	Mfg #	Description	Price
127106	IPSQTCANTOTE	For Quart & Pint Cans	

### Storage Cans

#### Empty Solvent Welding Container



Part #	Mfg #	Description	Price
068861	IPSCANGAL	006480000 MT-648 Gallon Can with 2-7/8" Neck	

---

---

## Sealants, Cements & Lubricants

---

---

### Lead Ingot

Part #	Mfg #	Description	Price
005984	02INGOTLEAD	Lead Ingot, 25 lb Brick or (5) 5 lb blocks	

### Lead Wool

Part #	Mfg #	Description	Price
005985	02LEADWOOL	5 lb Bag	



**Sealants, Cements & Lubricants**

**Thread Sealants**

**Gasoil® Soft-Set Pipe Seal with PTFE**

- *General purpose, use on all metals and most plastics*
- *Non-toxic*
- *Remains pliable in cold temperatures*
- *Non-separating*
- *Not for use with oxygen systems*



Part #	Mfg #	Description	Price
034248	SS04	1/4 pt Can w/Brush Top	
034249	SS08	1/2 pt Can w/Brush Top	
034250	SS16	1 pt Can w/Brush Top	



## Sealants, Cements & Lubricants

### Specialty Sealants

Part #	Mfg #	Description	Price
005521	TEF34260	260' Spool 3/4" x 144	

#### PTFE Tape

- White virgin Teflon, 0.4 density, 0.003" thick
- Over 50% elongation, chemically inert
- Tolerates -400° to +500°F
- For use on oxygen systems
- Non-toxic and non-flammable



Part #	Mfg #	Size	Qty/Case	Price
192922	PLTAPE34520	3/4" x 520' Spool	144	
215984	017524-144	1/2" x 520' Spool	144	
005522	TEF1520	1" x 520' Spool	144	
212442	TEF34520	3/4" x 520' Spool	144	
017669	PLTAPE260	1/2" x 260"		
017670	PLTAPE520	1/2" x 520"		

#### Yellow Gas Line PTFE Tape

- Extra heavy, full density
- Especially for gas lines
- Pressure rating: 10,000 psi
- 0.0035 mil Thick
- Tolerates -450° to 500°F
- UL Listed, meets Federal Specification T-27730A



Part #	Mfg #	Description	Price
046505	12YGTT	1/2" x 260" Spool, 144/Case	

#### TFE Paste

- Teflon pure white thread lubricant and sealant
- Non-hardening
- Withstands up to 10,000 psi
- Tolerates -100° to +500°F
- Not for use on fluorine or oxygen systems



Part #	Mfg #	Description	Price
005527	DOPEHV023015	1 oz Tube	
005529	DOPEHV023030	4 oz Brush Top Bottle	
111294	023045	8 oz Brush Top Bottle	

### Harveyseal Thread Sealant

- For all types of gas lines
- Tolerates -50° to +400°F
- Gas to 3,000 psi, liquid to 6,000 psi
- Soft, slow drying



Part #	Mfg #	Description	Price
048148	25050	8 oz Brush-Top Bottle	

### Pipe Thread Compound

- Gray, thixotropic non-drip paste for lines carrying water, steam, air or natural gas
- Never hardens
- Contains no lead, non-toxic



Part #	Mfg #	Description	Price
005534	DOPEHV02800514	2 oz Pipe 4	

### Pipe Thread Stick

- Maximum pressure: 2,000 psi
- Maximum temperature: 350°F
- Not for use on oxygen systems



Part #	Mfg #	Description	Price
005537	DOPEHV03000548	1.25 oz Stick, 48/Case	

### Cleaners

#### Clear Pipe Cleaner

- Fast-acting, all-purpose clear cleaner for ABS, CPVC, and PVC pipe & fittings



Part #	Mfg #	Description	Price
253781	019110-24	8 oz	

**Sealants, Cements & Lubricants**

**Thread Sealants**

**Slic-tite® Paste with PTFE - Premium Thread Sealant**

- Contains more PTFE particles for sealing power
- Brushes easily on wet or oily threads
- Sticks to hot, oily threads
- Non-toxic, non-drying
- Washes off hands and clothing easily
- Seals to high pressures:
  - 10,000 psi for Liquids
  - 3,000 psi for Gases
- Sealing temperature range: -50° to 500°F
- For sealing water, air, steam, natural gas, LP gas, refrigerants, ammonia, gasoline and oil
- Use on metal, PVC, CPVC and ABS plastic pipe threads



42009

Part #	Mfg #	Description	Qty/Case	Price
005978	42009	1/4 pt Brush-in-Cap	24	
005979	DOPELC4 2019	1/2 pt Brush-in-Cap	24	
005980	42029	1 pt Brush-in-Cap	24	

**Slic-Tite® Stik with PTFE**

- PTFE Particles for greater sealing power
- Non-toxic, non-staining, non-drying
- Washes off easily
- For sealing water, air, natural gas, steam, gasoline, oil, refrigerants and ammonia
- Sealing temperature: -50° to 350°F



Part #	Mfg #	Size	Price
005977	41600	1-1/4 oz	

**Pipe Dope**

- No-drip siliconized for fast application on metal threads
- For sealing water, steam, air and natural gas
- Lead-free, non-toxic
- Seal temperature up to 350°F



Part #	Mfg #	Description	Price
005968	12219	1/2 pt T-o-t	

**PIPETITE™ Paste - Soft Set Thread Compound**

- For sealing water, steam, air, natural gas, LP gas, refrigerants, gasoline, oil and butane
- Seal temperature up to 400°F



Part #	Mfg #	Description	Price
005967	12112	1 pt Brush-in-Cap	

**Pipetite-Stik®**



- For sealing water, steam, air, natural gas and LP gas

Part #	Mfg #	Description	Price
005964	11175	Thread Sealant in a Stick	



## Sealants, Cements & Lubricants

### Tape

#### Blue Monster™ PTFE Thread Seal Tape

- Seals fittings at pressures up to 10,000 psi
- Temperature range: -450° to 500°F
- Seals threads effectively in more applications
- Acts as a thread lubricant and anti-seize



Part #	Mfg #	Size	Price
110975	70885	1/2" x 1,429" Roll	
110978	70886	3/4" x 1,429" Roll	
110979	70887	1" x 1,429" Roll	

#### Blue Monster™ Compression Seal Tape

- Self-fusing layers
- Waterproof compression seal
- Seal leaks up to 150 psi on any type of rigid piping



Part #	Mfg #	Size	Price
164387	76085	1" x 12' Roll	
175963	76086	2" x 12' Roll	

#### Green Full Density Oxygen PTFE Thread Seal Tape

- Applications:
  - Oxygen lines, systems and other flammable environments
  - Liquid, oil and chemical installations
- 99.6% PTFE
- Pressure rating: up to 2,173.9 psi
- Temperature range: -450° to 500°F



Part #	Mfg #	Size	Price
023758	70796	1/2" x 260" Roll, 10/Pk	
043337	70850	1/2" x 260" Roll, 10/Pk	
107060	70852	3/4" x 260" Roll, 6/Pk	

### 3-Wrap Stainless Steel Teflon PTFE Thread Seal Tape

- 90% PTFE/10% nickel
- Silver
- Density: 1.6g/cm3 +/-10%
- Elongation: 50%



Part #	Mfg #	Size	Price
174175	70891	1/2" x 260'	
174176	70892	3/4" x 260'	

### Thread Sealing Compounds

#### Blue Monster™ PTFE Heavy-Duty Industrial Grade Thread Sealant

- Slow-drying, soft-setting, non-hardening pipe thread compound
- Recommended for on-site or assembly line work
- Lead-free, non-toxic and will not harden or separate in the can
- Pressure ratings:
  - Gases up to 3,000 psi
  - Liquids up to 10,000 psi



Part #	Mfg #	Size	Price
126236	76003	1/2 pt	
126237	76005	1 pt	

#### Blue Monster™ Anti-Seize Lubricant

- High temperature lubricant and thread sealant for use on ss, PVC, CPVC, nylon, polypropylene, plastics, and all metals
- Temperature range use:
  - Gases: -0°F to 2600°F
  - Liquids: -0°F to 2600°F
  - Brushable to: 10°F
  - Pour point: 32°F



Part #	Mfg #	Size	Price
154013	76020	8oz	



## Sealants, Cements & Lubricants

### Drain Cleaner / Clog Removers

#### Blue Monster Drain Banger

- Professional grade drain cleaner
- Devours hair, grease, soap, and oils that slow and plug the drain lines in less than 60 seconds



Part #	Mfg #	Size	Price
169959	76055	1 lb	
169960	76057	2 lbs	
235841	76059	6 lbs	





## Sealants, Cements & Lubricants

### Cement

#### Below Zero PVC Clear Cement

- Dauber in cap
- For use down to -10°F on all schedules of PVC pipe & fittings up to 6" diameter with interference fit



Part #	Mfg #	Size	Price
243840	60142	8 oz	

#### Grrip™ All-Purpose Pipe Joint and Gasket Seal

- Safe for drinking water lines
- Brushable
- Applicator in lid
- Non-petroleum, hydrocarbon-based
- For use on all metals and on PVC, ABS, CPVC plastic
- Non-separating, and will not harden or shrink
- Performs over a temperature range of minus 90 degrees to 450 degrees Fahrenheit (on steel pipe), 12,000 PSI (hydraulic) and 2600 PSI (gas)



Part #	Mfg #	Size	Price
180940	15515	1 Pint	

#### High-Heat Furnace Cement

- Ready to use, air-setting, high temperature refractory and retort cement for mortar acing, caulking or coating
- Patented Clean 'n Friendly™ formulation contains no oils, asbestos or silicon dioxide
- Will not shrink, crack or crumble
- Can be used on oil, gas, coal, and woodburning heating
- Freeze point below +10°F for uncured material
- Meets or exceeds OSHA requirement for minimal silica content



Part #	Mfg #	Size	Price
192890	35515	1/2 gal	
228610	35526	1 gal	

### Thread Sealants

#### Pro Dope® Pipe Joint Compound Thread Sealant

- Lead-free, no-drip, no-spill and non-toxic
- No mixing - will not harden - uniform throughout can
- Lubricates while forming tight pressure seal
- Inhibits rust and corrosion
- Wipes clean from hands



Part #	Mfg #	Size	Price
145618	15420	1/2 pt	

#### Megaloc® Thread Sealant

- Made with DuPont™ KEVLAR®
- Lead-free, blue, grit-free high performance thread sealant
- Leak-proof hydraulic resistance up to 12,000 psi
- Withstands gas pressure up to 2,600 psi
- Performs over temperatures of -50° to 400°F
- Odorless, non-separating and non-hazardous
- Never hardens, cracks or becomes brittle
- Wipes clean from hands with a dry rag



15806

Part #	Mfg #	Size	Price
255208	15802	1.1 oz	
192907	15804	4 oz	
063183	15806	1/2 pt	
083769	15808	1 pt	

#### Real-Tuff™ Thread Sealant

- Lead-free, multi-purpose, heavy-duty PTFE paste thread sealant
- Non-toxic and non-separating
- Positive, leak-proof seal on all piping material and for all liquids and gases except oxygen



Part #	Mfg #	Size	Price
192874	15605	2 oz Tube	
118663	15615	1/4 pt Brush-in-Cap	
101959	15620	1/2 pt Brush-in-Cap	
192906	15625	1 pt Brush-in-Cap	





## Sealants, Cements & Lubricants

### Block™ Thread Sealant

- Lead-free, brushable, blue, all-purpose, leak-proof non-hardening, pipe joint and gasket sealing compound
- Semi-liquid forms tough, pliable film on joints, valves, flanges and gaskets



Part #	Mfg #	Size	Price
098040	15707	1/2 pt	
181253	15711	1 pt	

### Hercules® Plastic Seal™

- Adheres to metal, plastic, vitreous china, porcelain and tile
- Ideal for joining dissimilar materials
- Seals soil-pipe joints quickly
- Waterproof
- Will not shrink or crack
- Multi-purpose repair product can also be used for caulking the perimeters of frame openings, ductwork, wood or masonry expansion joints and for glazing both inside and out



Part #	Mfg #	Size	Price
148340	25215	10.3 oz	

### PTFE Tape

#### Megatape Professional PTFE Tape

- Requires fewer wraps and resists tearing/ripping
- Improved aesthetics versus white, yellow, blue or orange tapes
- cUL-listed
- Chemically inert
- No tape contains more PTFE than MEGATAPE
- Seals threads on virtually any piping system, including stainless steel pipe, cast iron, PVC, CPVC and ABS pipe, brass and chrome fittings, and gas connections
- High density - 35 mils thick
- Available in 1/2", 3/4" and 1" widths



Part #	Mfg #	Size	Price
247908	15050D	1/2" x 260"	

#### Extra Large 1000' Spool

Part #	Mfg #	Size	Price
155540	15100	1/2" x 1000"	
155541	15110	3/4" x 1000"	
155542	15120	1" x 1000"	

### Hercules® TFE Pipe Joint Tape

- Weather-resistant, flexible, non-stick, non-flammable and chemically inert tape that can be used at low temperatures



Part #	Mfg #	Size	Price
192868	15162	1/2" x 260"	
192869	15164	1/2" x 520"	
192871	15176	3/4" x 520"	
192870	15183	1" x 520"	

### Plastic Pipe Primers and Cleaners

#### PVC and CPVC UnPurple Primer® (Green Label)

- Softens and prepares surfaces of PVC pipe and fittings before applying solvent cements
- Special purple dye appears clear - purple color revealed only under UV light



Part #	Mfg #	Size	Price
136419	60445	1 pt	

#### PVC Primer - Clear

- Professional grade primer for use on all schedules and classes of PVC pipe and fittings
- Lo-V.O.C. Solvent Cement meets California South Coast Air Quality Management District (SCAQMD) 1168/316A
- Removes surface dirt, grease and grime as well as softens the pipe surface to allow a fast, secure solvent weld
- Meets ASTM F656



Part #	Mfg #	Size	Price
168280	60465	32 oz, Jumbo Dauber	



## Sealants, Cements & Lubricants

### R-D™ Root Destroyer

- Non-acid
- Safe to use in lines leading to septic tanks, cesspools, and drywells
- Dissolves slowly
- Not for use in CT



Part #	Mfg #	Size	Price
163209	20602	2 lbs	

### Lubricants

#### Duck Butter Pipe Joint Lubricant

- Use to lubricate pipe joints
- Use on PW, DWV and sewer systems
- Compatible with copper pipe
- Clean, odorless, non-staining
- Adheres to wet and dry surfaces, preventing needless overuse of lubricant
- Certified to ANSI/NSF 61
- Dissolves in hot water



Part #	Mfg #	Size	Price
192896	40-501	2 lb	

#### 300 Degree Plumber's Grease

- Petroleum oil-based valve and faucet stem grease
- Waterproof; prevents corrosion
- Non-melting, non-hazardous
- Withstands temperatures from -20°F to 300°F.



Part #	Mfg #	Size	Price
160776	40601	2 oz	

#### Lube Oil with Extenda-Spout

- Multi-purpose, commercial-duty, low-viscosity lubricating oil made with premium-grade mineral oils for use on motors, bearings and wherever metal lubrication is needed
- NOT FOR USE WITH LIGHT ELECTRIC MOTORS



Part #	Mfg #	Size	Price
192895	40404	4 oz	



## Sealants, Cements & Lubricants

### Coil Cleaners

#### Break-Out™ Anti-Seize Coil Cleaner

- Bronze
- High temperature up to 1800°F
- Corrosion resistant grease
- For use on bolts, nuts, & screws



Part #	Mfg #	Size	Color	Price
239681	73551	8 Ounces	Bronze	

### Pipe Thread Sealants

#### RectorSeal® T Plus 2® Pipe Thread Sealant

- White color
- Non-setting, multipurpose compound
- Contains PTFE, plus synthetic fibers to create a stronger seal



Part #	Mfg #	Size	Price
008858	23551	1/2 pt Brush Top	

#### RectorSeal® No. 5® Pipe Thread Sealant

- Yellow color
- Multipurpose, soft-set



Part #	Mfg #	Size	Price
008862	RL25631	1/4 pt Brush Top	
008861	RL25551	1/2 pt Brush Top	
008860	25431	1 pt Brush Top	

#### RectorSeal® No. 21 Black Jack™ Pipe Thread Sealant

- Black color
- Slow dry, soft set



Part #	Mfg #	Size	Price
022732	28541	1 pt Brush Top	

#### RectorSeal® Tru-Blu™ Pipe Thread Sealant

- Blue color
- Contains PTFE for high vibration environments



Part #	Mfg #	Size	Price
078593	31431	1 pt Brush Top	
102204	31551	1/2 pt Brush Top	
093177	31780	1-3/4 oz Tube	

**Sealants, Cements & Lubricants**

**Adhesives & Sealants**

**Leak Lock Sealant**

- Pipe joint sealant
- Seals threaded joints, flanged joints, gasket surfaces & mating surfaces
- Effective in temperatures from -200° to 400°F, full vacuums & pressures to 10,000 psi
- Never hardens



Part #	Mfg #	Description	Price
140418	85-10001	1.33 oz Tube	
149946	85-10004	4 oz Can	

**Coil Cleaners**

**Non-Acid Condenser Coil Cleaner**

- Aerosol can
- Alkaline type
- High-foaming
- Rinse required



Part #	Mfg #	Description	Price
140445	85-CO1	16 oz Can	



---



---

## Sealants, Cements & Lubricants

---



---

### Gruvlok® Chemicals

#### Standard Lubricant

Part #	Mfg #	Description	Price
048524	GLLUBETUBE	4.5 oz Tube	
048523	GLLUBEQT	1 Quart	

#### Extreme Temperature Silicone Lubricant

Part #	Mfg #	Description	Price
108540	GLEXTREMELUBE	2.2 lb Can	

#### Gruvlok® Xtreme™ Lubricant

- *Operating temp range: -65°F to 400°F*
- *Waterproof*

Part #	Mfg #	Size	Price
165942	GLEXTREME10OZ	10 oz	



## Sealants, Cements & Lubricants

### LabWaste™ CPVC Corrosive Waste Drainage System Accessories

#### LabWaste™ One-Step CPVC Cement



Part #	Mfg #	Size	Price
085971	CPLWCEMENTQT	Quart	

### Flameguard® Fire Sprinkler Products (Continued)

#### FS-5 One-Step Cement

Part #	Mfg #	Size	Price
189377	CPFGCEMENTQT	Quart	

### Sealant and Cement Accessories

#### Cap Dauber



Part #	Mfg #	Size	Price
189379	CPFGDAUBERQT	1-1/4" for Quart	

### Low Extractable Ultra Pure Water System Accessories

#### Low Extractable One-Step Cement



Part #	Mfg #	Size	Price
134402	PTLXTCEMENT	Pint	
095539	QTLXTCEMENT	Quart	

### Flameguard® Fire Sprinkler Products

#### Blue 75™ Thread Sealant



Part #	Mfg #	Size	Price
189373	CPFGSEALANTPT	Pint	

#### FS-5 One-Step Cement



Part #	Mfg #	Size	Price
189376	CPFGCEMENTPT	Pint	



**Soldering & Brazing**

**Nitrogen Tanks & Contents**



Part #	Mfg #	Description	Price
105666	80-N-TANK	80 cu ft Nitrogen Tank	

**Soldering & Brazing**

**Regulators**

**RPH Series High Pressure Delivery Regulator for Purging and Pressure Testing**

- 2" Gauges
- Piston actuated seat
- Protective rubber gauge boots
- "T" Handle for easy pressure adjustment
- Delivery/contents: 600/4000 psi
- Outlet Connection: 1/4" Flare (M)
- Replacement gauges: G8S & G7S



Part #	Mfg #	CGA Inlet	psig	Price
103342	87-RHP400	580 Nitrogen	20-400	

**Soldering & Brazing**

**Gas Cylinders**



Nitrogen



Oxygen

Part #	Description	Price
006537	Acetylene, MC 10 cu ft Gas Only	
006536	Acetylene, MC 10 cu ft Tank Only	
006535	Acetylene, MC 10 cu ft Gas & Tank Combo	
002678	Acetylene, B 40 cu ft Gas Only	
002677	Acetylene, B 40 cu ft Tank Only	
002676	Acetylene, B 40 cu ft Gas & Tank Combo	
055895	Nitrogen, 40 cu ft Gas Only	
055894	Nitrogen, 40 cu ft Tank Only	
101954	Nitrogen, 40 cu ft Gas & Tank Combo	
063836	Nitrogen, 80 cu ft	
104873	Oxygen, 20 cu ft Gas Only	
042487	Oxygen, 20 cu ft Tank Only	
042488	Oxygen, 20 cu ft Gas & Tank Combo	



## Soldering & Brazing

### Flux

All Hercules Flux Can be Used with Soft Solder Alloys on Commonly Soldered Metals, but NOT Recommended for Use on Aluminum or Some Grades of Stainless Steel

#### Climate Smooth™ Soldering Paste

- Self-cleaning lead-free formula
- Made to withstand extreme climate temperatures
- Smooth, easily applied paste flux for easy flow in hot or cold weather
- For sweat soldering on most common metals



Part #	Mfg #	Size	Price
128565	10621	1 lb	
192865	10616	1/2 lb	
192866	10608	2 oz	

#### Jel-Flux™ Soldering Flux

- Usable on most common metals except aluminum and stainless steels
- Prevents oxidation during heating
- Enhances uniform solder flow to form perfect, leak free joints
- Lead-free and safe for potable water
- Does not freeze or decompose at high temperatures
- Environmentally friendly



Part #	Mfg #	Size	Price
217933	10810	4 oz	

### Abrasives

#### Open Mesh Cloth

- Waterproof abrasive open mesh cloth
- Designed for cleaning and preparing copper pipe & fittings for soldering
- Non-clogging, long lasting



Part #	Mfg #	Size	Price
193442	45-013	1-1/2" x 10 Yds	

#### Grit Roll™ Waterproof Abrasive Sandcloth

- Use for deburring and roughing copper tubing, as well as plastic pipe
- Sandcloth backing is covered 100% with a tough aluminum oxide abrasive that provides fast cleaning



Part #	Mfg #	Size	Price
193443	45-025	1-1/2" x 10 Yds	



## Soldering & Brazing

### Brazing Alloys

#### Stay-Silv® 15 Brazing Alloy

- Used for air conditioning and refrigeration

RoHS COMPLIANT  
**USA MADE IN**



Part #	Mfg #	Description	Price
010298	SOLDSS15STIX	1#, .050 x 1/8" x 28 Stick	

#### Blockade™ Silicon Brazing Alloy

- Color changes in the finished braze alloys
- For copper and brass
- Easily brazes brass and brass alloys without the addition of silver



Part #	Mfg #	Description	Price
064470	SOLDBLOCKADE	2mm x 20 Stick, Bare Rod	

#### Dynaflow® PhosCopper Brazing Alloy

- Melts and flows at temperatures very closer to Stay Silv



Part #	Mfg #	Description	Price
224235	SOLDDF1	.050" x 1/8" x 20" x 28 Stick	

### Solder

#### Bridgit® Lead-Free Solder

- Contains nickel for strong joints
- Excellent for large diameter fittings and ill-fitting or non-concentric pipes

USA MADE IN  
RoHS COMPLIANT



Part #	Mfg #	Description	Price
005079	SOLDHBLF	1/8" x 1 lb Spool	

#### NICK™ Lead-Free Solder

- For joining copper pipe in potable water systems
- Excellent wetting and capping characteristics
- Produces extremely strong joint

Part #	Mfg #	Description	Price
027102	SOLDNICK	1/8" x 1 lb Spool	

#### Stay-Brite® Silver Solder

- Bonds with all of the ferrous and non-ferrous alloys

USA MADE IN  
RoHS COMPLIANT



Part #	Mfg #	Description	Price
009822	SOLDSB	1/8" x 1 lb, 4%	
045432	SOLDSB8	#8, 1/8" x 1 lb, 6%	

#### Premium Lead-Free Sterling Solder

- NSF 61 Certified for safe use in potable water applications
- Melting temperature 410°F
- Tensile strength 7,130 psi



Part #	Mfg #	Description	Price
010355	SOLDTARAMETLF	1 lb Spool	

#### Lead-Free Solder

- Patented formula advantages
- Low melting temperature: 419°F
- Increased flow properties
- High tensile strength: 6,950 psi



Part #	Mfg #	Description	Price
004142	SOLDDUTCHB	1 lb Spool	
010264	SOLD9551	Lenox Lead Free-Solder 95/5 11 716447911259	

#### 50/50 Leaded Solder

- 50% Tin, 50% lead solder
- For use in non-potable water applications



Part #	Mfg #	Description	Price
010263	SOLD50501	1 lb Spool	

#### Quicksilver

Part #	Mfg #	Description	Price
034505	SOLDQSSTIX	1#, .050 x 1/8" x 28 Stick	



## Soldering & Brazing

### Flux

#### Bridgit® HT Paste Flux

- Stays active to 800°F
- Meets all the requirements of the Safe Drinking Water Act
- Designed for copper tube applications

**USA  
MADE IN**



Part #	Mfg #	Description	Price
002564	FLUXBRPAS4OZ	4 oz Hi Temp Flux	
002600	FLUXBRPA1#	1 lb Hi Temp Flux	

#### Stay-Clean® Liquid Soldering Flux

- General purpose zinc chloride flux
- For soldering with all soft solders
- Use with tin/lead, tin/antimony, and Stay-Brite solders
- For virtually all metals except aluminum, magnesium, or titanium
- Not recommended for use in electrical or electronic applications

**USA  
MADE IN**



SCLF SCLF1

Part #	Mfg #	Description	Price
009966	FLUXSC4OZ	4 oz Flip Top	
009965	FLUXSC16OZ	16 oz Bottle	

#### Stay-Clean® Paste Soldering Flux

- Active soldering flux for use with tin/lead, tin/antimony, and tin/silver solders
- For most metals, copper, brass, bronze, steel, stainless steel, galvanized, monel
- Not recommended for aluminum, magnesium, or titanium
- Not recommended for use in electrical or electronic applications

**USA  
MADE IN**



Part #	Mfg #	Description	Price
009967	FLUXST4OZ	4 oz Brush Cap	

#### Stay-Silv® Brazing Flux

- For use with silver brazing alloys on all metals except aluminum, magnesium or titanium
- Effective to 1600°F
- Meets AMS 3411, AWS 5.31, Class FB3C; Fed Spec. 0-F-499D, Type B

**USA  
MADE IN**



Part #	Mfg #	Description	Price
010299	FLUXSSF7OZ	7 oz Brush Cap	



## Soldering & Brazing

### Solder and Abrasive Supplies

#### Silver Lead Free Plumbing Solder



Part #	Mfg #	Description	Price
007932	SOLDOT1LF	1 lb Lead-Free Solder	

#### Abrasive Sandcloth

- Aluminum oxide
- 120 Grit
- 2 Layers of special adhesive and water-resistant resin



Part #	Mfg #	Description	Price
017657	PLSAND	Plumb Label, 10 yds	
017658	PLSAND25	Plumb Label, 25 yds	

#### Open Mesh Abrasive Sandcloth

- Premium grade, 180 grit
- Fully waterproof
- Open nylon fabric with phenolic resin adhesive and aluminum oxide
- Can be used on both surfaces



Part #	Mfg #	Description	Price
017656	PLSANDOPEN	Plumb Label, 10 yds	

### Flux

#### No. 5 Paste Flux

- Cleans and fluxes at the same time
- Effective on all metals except aluminum, magnesium and stainless steel
- 100% Lead-free
- Blended to clean surface oxidation



30041

Part #	Mfg #	Size	Price
032262	FLUX17OTPF	1.7 oz	
101958	FLUXOT58OZ	8 oz	
020767	FLUXOT516OZ	16 oz	

#### No. 95 Tinning Flux

- Formulated with the same high quality as No. 5 however, patented Oatey® silver solder powder is added to pre-tin the copper pipe
- Flux can never burn out
- 100% Lead-free
- Excellent for large diameter copper
- Does not turn copper green



30372

Part #	Mfg #	Size	Price
008013	FLUXOT95TF8	8 oz	
007957	FLUXOT95TF17	1.7 oz	
162987	FLUXOT95TF16	16 oz	

#### H-20@95 Tinning Flux

- Effective on all metals, except aluminum and stainless steel
- Compatible with all common plumbing solder alloys
- Will not turn copper piping green



Part #	Mfg #	Size	Price
133660	FLUX80TH2095TF	8 oz	
163844	FLUX160TH2095TF	16 oz	

#### H-205 Water Soluble Paste Flux

- Effective on most metals, excluding aluminum and stainless steel
- Compatible with common plumbing solder alloys
- Can be used on copper piping without discoloration
- Good for large diameter copper piping
- 100 percent lead-free paste cleans, fluxes and copper piping to provide uniform solder flow
- Meets ASTM standard B-813
- Safe for use in potable water applications
- NSF standard 14 (Performance) and standard 61 (Health Effects) certified



Part #	Mfg #	Size	Price
036559	FLUX80TH20	8 oz	

**Soldering & Brazing**

**Parts & Accessories**

**Flame Protector Heat Shield**

- Can be used while soldering near studs, joists or walls
- Ideal for use with propane and Max Power Propylene gas torches
- 9" x 12" cloth
- Made with flame-retardant Zoltek Pyron fibers
- Withstands temperatures up to 2,500 degrees Fahrenheit
- Includes brass eyelets for hanging from a stud or wall



Part #	Mfg #	Size	Price
190735	OT31400	9" x 12"	

**4-in-1 Brush**

- Use to clean 1/2" and 3/4" copper and plastic tubes
- High-carbon steel ID brush
- Hard-tempered steel OD brush
- High-impact polystyrene cover



Part #	Mfg #	Size	Price
251944	OT31348	1/2" & 3/4"	

**Soldering & Brazing**

**Brazing/Soldering Flux and Pastes**

**Regular Flux Paste**

- Super detergent action cleans as it solders
- Water soluble for faster flushing from pipe lines
- Non-acid, non-toxic, lead-free
- Contains no zinc chloride
- For use on most metal types
- Use with all lead-free and common soft solders
- Meets MIL Spec MIL-F-4995 type II



22107

Part #	Mfg #	Size	Price
005970	22104	4 oz	
005971	22107	1 lb	

## Soldering & Brazing

### Soldering Flux

#### NOKORODE® Aqua Flux™

- Cream color
- Water washable flux
- Conforms to ASTM B-813



74046

### Soldering Flux (Continued)

#### NOKORODE® Cold Weather Paste Flux

Part #	Mfg #	Size	Price
007742	14730	1 lb	

Part #	Mfg #	Size	Price
149852	74044	2 oz	
149853	74046	16 oz	

#### NOKORODE® Hot Weather Paste Flux

- Stays firm and stable in hot weather
- Recommended for use on all solder alloys including 95/5 and all lead-free solders



Part #	Mfg #	Size	Price
007743	14830	1 lb	

#### NOKORODE® Regular Paste Flux

- Will not freeze or decompose
- Odorless and lead-free
- Recommended for use on all solder alloys including 95/5 and all lead-free solders



14030

Part #	Mfg #	Size	Price
007744	14000	1.7 oz	
224283	14020	8 oz	
007741	14030	1 lb	

#### NOKORODE® Cold Weather Paste Flux

- Lead-free, soft soldering paste
- Ideal for use with 95/5
- Flux and cleans and at one time
- Remains soft and sticky in colder temperatures
- Low corrosivity, scorching and spattering



Part #	Mfg #	Size	Price
193269	14700	1.7 oz	
129861	14720	8 oz	



---

---

## Soldering & Brazing

---

---

### Soldering Flux

#### Soldering Paste

- For copper sweat joints and brass fittings

Part #	Mfg #	Description	Price
075792	05-04	3 oz Bottle, 24/Case	
075793	05-09	1 lb Jar	

## Soldering & Brazing

### Fitting Brushes

#### #6100 Standard Fitting Brush - Good Quality A

- Heavy gauge galvanized stem wire
- Single stem, single spiral construction
- Crimped high-carbon fill material



Part #	Mfg #	Nominal ID	Price
026528	61000	1/8"	
007446	61070	1/4"	
007447	61150	3/8"	
159126	61270	5/8"	
007448	61210	1/2"	
007449	61330	3/4"	
007450	61450	1"	
007451	61500	1-1/4"	
007452	MR6156 0	1-1/2"	
007453	61620	2"	

#### #6800 All Stainless Steel, Rust-Resistant "Quick Twist" Brush Superior Quality AA

- Only "all" stainless steel fitting brush
- Spark proof, will not rust



Part #	Mfg #	ID	OD	Price
036060	68120	2-1/2"	2-5/8"	
174376	68031	1/2"	5/8"	
174377	68051	3/4"	7/8"	

#### #6600 Hex Shank Power Fitting Brushes - Superior Quality AA

##### Carbon Steel 1/4" Hex Shank Power Fitting Brush

- Bulk (plumbing)
- For quick cleaning of fittings, tubing, drill holes, as well as deburring soft steel, stainless steel, brass, copper, aluminum, plastic and other materials



Part #	Mfg #	ID	OD	Price
062503	66430	1/2"	5/8"	
062504	66450	3/4"	7/8"	
062505	66470	1"	1-1/8"	

### Cleaning Brushes

#### Power-Deuce Brushing Tool

- Fitting brush and OD tube cleaning brush designed for use with a cordless drill or power driver
- Self cleaning
- Power or manual use
- Rust-proof stainless steel bristles for plumbing and HVAC projects
- Durable ABS housing



Part #	Mfg #	Description	Price
068844	62821	1/2" ID (5/8" OD) Brush	
068845	62831	3/4" ID (7/8" OD) Brush	
097366	62841	1" ID (1-1/4" OD) Brush	
097367	62850	3 Size Power Pack, Quik-Change Chuck Adapter	

### Multi-Function Brushes

#### Blue Monster Six-in-One Brush

- Clean the inside diameter of tubing
- Deburring plate to ream and debur the I.D. of tubing
- B-Tank gas key
- Can also serve as a bottle opener



Part #	Mfg #	Description	Price
134842	70255	1/2" x 3/4" ID Blue Monster (Plumbing)	

### Paint Brushes

#### Poly Chip Brushes



Part #	Mfg #	Description	Price
191010	70450	1-1/2" Throw away brush	
191011	70460	2" Throw away brush	



## Soldering & Brazing

### Abrasive Products

#### Blue Monster™ Aluminum Oxide Open Mesh

- 21 x 21 Mesh - resists clogging
- Premium blended 165 grit white aluminum oxide
- Waterproof
- Bright blue color



Part #	Mfg #	Size	Qty	Price
135950	70154	2" x 10 yd Roll	24/Pk	

### Cleaning Towels

#### Blue Monster™ Heavy-Duty Citrus Scrubbing Towel Floor Display

- Pre-moistened, heavy-duty cleaning towel
- Flip-top container
- Free of harsh solvents and chemicals
- Lint free, quick drying



Part #	Mfg #	Description	Price
130861	MR7709	10" x 12" Towels, 75 Count	
	5		

### Maintenance & Applicator Brushes

#### Acid, Solder Paste & Flux, Adhesive Applicator Brush

- Made with durable, coated in tin paste metal handles
- Handles are stamped firmly to the bristles to eliminate bristle fall-out
- Offered in three sizes with pure, stiff black-graded natural horsehair
- #70240 Brush has a hardwood handle with seamless aluminum ferrule



70210



70240

Part #	Mfg #	Size	Wire	Price
007458	70210	#1	1/4"	
007459	70220	#2	3/8"	
190981	70230	#3	1/2"	

## Soldering & Brazing

### Brushes

#### Acid Brush with Metal Handle

- 100% horse hair bristles
- Available in 3/8" or 1/2" wide



Part #	Mfg #	Wide	Long	Price
183832	771	3/8"	6"	

#### Fitting Brushes

- **Deluxe wood handle:**  
—Solid wood, screwdriver type handle is easy to hold and turn  
—stainless steel bristles
- **Plastic handle & open-loop handle**  
—Carbon or stainless steel bristles
- **Drill Attachment:**  
—Stem fits all power drill chucks  
—Carbon or stainless steel bristles



706-4

#### Plastic Handle

Part #	Mfg #	Material	Size	Price
043891	700-2	Carbon Steel	1/2" CTS	
183817	700-4	Carbon Steel	1" CTS	
183818	700-5	Carbon Steel	1-1/4" CTS	
183819	700-6	Carbon Steel	1-1/2" CTS	
183820	700-7	Carbon Steel	2" CTS	

#### Drill Attachment

Part #	Mfg #	Material	Size	Price
083787	706-2	Carbon Steel	1/2" CTS	
083788	706-3	Carbon Steel	3/4" CTS	
083789	706-4	Carbon Steel	1" CTS	
183821	707-2	Stainless Steel	1/2" CTS	
183824	707-3	Stainless Steel	3/4" CTS	

### Sand Cloths

#### Abrasive Mesh

- 180 grit open mesh is waterproof
- Rinse when mesh gets loaded with debris



Part #	Mfg #	Dispenser Box	Grit	Price
183825	730-10	10 Yard Roll	180	

#### General Purpose Cleaning Nylon Pad

- Use wet or dry
- Cleans copper tube and fittings for soldering

Part #	Mfg #	Size	Grit	Weave	Pad	Price
183826	750-69	6"x9"x1/4"	Fine	Tight	Red	

**Soldering & Brazing**

**Pipe Brushes**

**Inner-Outer Copper Cleaning Brush**

- High carbon steel brushes quickly cleans 1/2" or 3/4" nominal tube and fittings in preparation for soldering or brazing
- Durable plastic construction designed for easy brush replacement



Part #	Mfg #	Model	Description	Price
008730	34142	4100	I-O Copper Cleaning Brush	
019034	34147		Replacement Brush Set	

## Soldering & Brazing

### MAPP Gas & Tanks



Part #	Mfg #	Description	Price
112728	MAPPRO	14.1 oz MAPP, Throwing Gas Cylinder	

### Torches

#### Self-Igniting Hand Torch



330544 &  
330545

Part #	Mfg #	Description	Price
080597	LX331785	Self-Igniting w/Adj Swirl Flame	
080624	330545	Self-Igniting Adj Swirl Flame Replacement Assembly	
080598	330546	Self-Igniting Adj Ultra Swirl Flame	
084220	330554	Replacement Tip for LT92	
086360	330555	Replacement Tip for LT90 & LT91	

### Mobile Torch System



Part #	Mfg #	Description	Price
107079	10883	LX300PS Mobile Torch System with LP300 3/8" Tip Included	
132787	330533	LX400FB Mobile Torch System Kit	

### Self-Igniting Swirl Flame



Part #	Mfg #	Size	Price
113302	330590	1/2"	

### "B" Air Acetylene Kit

- Includes:
  - Air acetylene piston regulator with TANKTOTE handle, GAUGE GUARD and 2" gauge
  - AA Torch handle
  - AA Hose
  - TANKTOTE sleeve
  - "B" Tank key
- Tank sold separately



Part #	Mfg #	Description	Price
089164	21839LX800B	LX800B Kit with AA800 5/16" Self-Igniting Swirl Flame Tip	

### "MC" Air Acetylene Kit

- Includes:
  - Air acetylene piston regulator with TANKTOTE handle, GAUGE GUARD and 2" gauge
  - AA Torch handle
  - AA Hose
  - TANKTOTE sleeve
  - "MC" Tank key
- Tank sold separately



Part #	Mfg #	Description	Price
089165	21843LX800MC	LX800MC Kit with AA800 3/8" Self-Igniting Swirl Flame Tip	

**Soldering & Brazing**

**Soldering and Welding**

**CutSkill® - CST Series Kit**

- **CST-P & CST-PT:**  
*Braze/weld 1/4" to 1-1/2"  
for HVAC, refrigeration  
and plumbing*
- **Includes:**
  - Handle (SKH-7A)
  - Brazing nozzles (0-W-J & 2-W-J)
  - Safety goggles (1423-0017)
  - Striker (1423-0023)
  - Check Valves
  - Hose (252-03P)
  - Tote case (1421-0084)



Part #	Mfg #	Oxy Reg	Fuel Reg	Price
112435	0386-1320	SKR-540R	SKR-200R	

\* 20 cu ft

**Soldering & Brazing**

**Heat Barriers**

**Cool Gel<sup>®</sup> Heat Barrier Spray**

- *Unique gelled formula sticks to surfaces without dripping or running off*
- *Clear, non-staining gel leaves no residue eliminating clean-up*
- *Safe, non-toxic, harmless to skin and odorless*
- *Convenient trigger spray*
- *Helps protect rubber, plastic, distortion, painted, and finished surfaces during soldering, brazing or welding*
- *Reduces danger of fire to surrounding surfaces*

Part #	Mfg #	Size	Price
041661	11509	1 qt	



**Soldering & Brazing**

**Thermal Shield Spray**

**Cold Shield Thermal Shield**

- Functions as a heat sink and a heat shielding material
- Non-toxic, environmentally safe, non-corrosive and non-flammable
- Stops heat from traveling through most metals
- Provides a heat barrier from direct, open flame contact



Part #	Mfg #	Description	Price
140751	86-1274-7	32 oz Tub Paste	

**Soldering & Brazing**

**Heat Pastes**

**Thermo-Trap®**

- Heat absorbing paste to isolate heat encountered in soldering, welding, and brazing
- USDA Approved



Part #	Mfg #	Description	Price
140750	4371-36	11 oz Tube	

## Soldering & Brazing

### Heat Shields

#### Torch Guard® Flame Blanket

- Asbestos-free and features high-strength needle-punched carbon fiber
- Ideal for confined working areas
- Flexible and provides heat resistance up to 2500°F
- Shield studs, wall, floors and surfaces from flames, sparks and molten splash during soldering and brazing operations
- Includes (2) brass grommets for hanging

Part #	Mfg #	Size	Price
007461	71034	12" x 12"	

### Water-Gate Water Shut-Off Tools

- Solder without draining the entire water system
- Change out a valve, solder or glue on fittings, make line repairs and test lines while under pressure
- Ideal for refrigeration and boiler applications
- Seals withstands temperatures from -20° to 225°F
- Works on copper, steel or PVC lines
- Pressure rated to 65 psi



Part #	Mfg #	Size	Price
085299	77000	1/2"	
085300	77005	3/4"	
085301	77010	1"	
085302	77015	1-1/4"	
085303	77020	1-1/2"	
085304	77025	2"	

### Water-Gate Replacement Seal



Part #	Mfg #	Size	Price
085308	77001	1/2"	
085309	77006	3/4"	
085310	77011	1"	
085311	77016	1-1/4"	
085312	77021	1-1/2"	
085313	77026	2"	

### Tools

#### Deburring Tool

- Remove rough or irregular I.D. edges on plastic, ferrous and non-ferrous metals
- A fast and easy way to smooth edges of pipe and tubing
- Fixed blade "pencil" deburring tool clips on shirt pockets and fits anywhere
- Features hand-contoured handle and snap-on cap for convenient storage of replacement toolblades



Part #	Mfg #	Description	Price
057936	70415	Deburring Tool, Carded with (3) Blades	
066641	70417	(5) Replacement Blades	

---

---

## Soldering & Brazing

---

---

### Deburring Tools

#### Pocket Size Deburring Tool

- Deburrs nominal 1/4" or larger tubing and fittings
- Freely rotating, hardened steel blade holds its edge in copper and ABS/PVC plastic
- Under 6" overall length



Part #	Mfg #	Description	Price
006481	R308	Swivel Reamer, 1 oz	

## Soldering & Brazing

### Jet Swet™

- Jet Swet™s are made from the highest quality steel and aircraft aluminum
- Jet Swet™ gasket is a unique EPDM/silicone composite, made to withstand the intense heat of soldering and braising
- Jet-Swet™s have a 1-year warranty from manufacturers defect on the entire tool except for the disposable, replaceable gaskets



### Jet Swet™ Single Tool



R498400



R498405

Part #	Mfg #	Description	Price
051876	R498400	1/2" Jet Swet™	
051877	R498405	3/4" Jet Swet™	

### Jet Swet™ Replacement Gasket



R498605



R498610

Part #	Mfg #	Description	Price
077644	R498605	3/4" Jet Swet™ Gasket	
091470	R498610	1" Jet Swet™ Gasket	

### Torch Safes

Part #	Mfg #	Description	Price
123302	R445450	Torch Safe	

---



---

**Soldering & Brazing**

---



---

**Freeze-Pak****Quick Freeze Pipe Freezing Spray**

- Aerosol can
- For plumbing repairs without system draining or interruption of water supply

Part #	Mfg #	Description	Price
117411	64001	17.5 oz Quick Freeze Spray	

**Instant Pipe Freezing Kit**

- Make quick repairs without draining or interruption of water supply
- Produces a temporary ice plug in plumbing and heating systems that will last up to 30 minutes
- Kit includes:
  - (1) Can Quick Freeze spray
  - (2) Foam pipe jackets
  - (4) Plastic ties



Part #	Mfg #	Description	Price
117409	64004	Instant Pipe Freezing Kit	



## Soldering & Brazing

### Acetylene Torches

#### Extreme™ Air Acetylene Torch Kit

- Extreme™ swirl technology
- All tips feature quick disconnect couplings
- Color-coded o-rings for gas identification
- Rear valve position
- Includes:
  - Traditional manual lighting torch
  - Hose (AH-12)
  - Handle (G4)



Part #	Mfg #	Soft Solders To:	Silver Brazes To:	Regulator	Tips	Tank Connection	Price
010464	0386-0335	3"	1-5/8"	AR-B	A-3, A-11	B	

#### Extreme™ Air Acetylene Standard Tip

- Quick disconnect couplings
- Color-coded o-rings for gas identification
- Can be used with any Acetylene torch handle (PLF-A5 or G-4)



Part #	Mfg #	Tip Size	Soft Solder To:	Silver Brazes To:	Price
026296	0386-0100	1/8"	1/8" - 1/2"	1/8" - 1/4"	
010435	0386-0101	3/16"	1/4" - 1"	1/8" - 1/2"	
010437	0386-0102	1/4"	3/4" - 1-1/2"	1/4" - 3/4"	
010439	0386-0103	5/16"	1" - 2"	1/2" - 1"	
010433	0386-0104	7/16"	1-1/2" - 3"	7/8"-1-5/8"	
010434	0386-0105	1/2"	2" - 3-1/2"	1" - 2"	
021269	0386-0106	3/4"	4" - 6"	1-1/2" - 4"	

#### Extreme™ Self-Lighting Air Acetylene Torch Kit

- Extreme™ swirl technology
- Quick disconnect handle and tip
- Replaceable tip
- Color-coded o-rings for gas identification
- Includes:
  - Gauge guards
  - Cylinder wrench
  - Hose (AH-12)
  - Instruction manual



Part #	Mfg #	Soft Solders To:	Silver Brazes To:	Regulator	Handle	Tip	Tank Connection	Valve Position	Price
010440	0386-0833	1-1/2"	3/4"	AR-B	G4	PL-5A	B	Rear	

## Soldering & Brazing

### Extreme™ Self-Lighting Air Acetylene Replacement Tip

- Removable orifice screw
- Color-coded o-rings for gas identification



Part #	Mfg #	Tip Size	Soft Solders To:	Silver Brazes To:	Price
010450	0386-0818	1/4"	3/4" - 1-1/2"	1/4" - 3/4"	

### Extreme™ Air Acetylene Pro-Line™ Replacement Tip End



Part #	Mfg #	Description	Price
028216	0386-1064	For PL-5A Tip	
033482	0386-1065	For PL-8A Tip	

### Air Acetylene Components Acetylene Regulator



Part #	Mfg #	Description	Price
010432	0386-0725	Acetylene Regulator Fits "B" Tank	
042545	0386-0726	Acetylene Regulator Fits "MC" Tank	

### Acetylene Gauge



Part #	Mfg #	Description	Price
022532	0386-1200	Fuel Gauge for Acetylene Regulator	

## Soldering & Brazing

### Propane & MAP-Pro™ Standard Propane and MAP-Pro™ Tip



T-2



T-3



T-4

Part #	Mfg #	Tip Size	LP Soft Solder To:	MAPP Solder To:	Price
010459	0386-0150	5/16"	1/8" - 1/4"	1/8" - 1/2"	
010460	0386-0151	7/16"	1/4" - 1"	1/4" - 1-1/2"	
010461	0386-0152	1/2"	1/4" - 1-1/2"	1/4" - 2-1/2"	

### ProLine™ Self-Lighting Propane and MAP-Pro™ Tip



Part #	Mfg #	Tip Size	LP Soft Solder To:	MAPP Solder To:	Price
010449	0386-0822	7/16"	1/4" - 1-1/2"	1/4" - 2-1/2"	

### "Total LP" Hose

- 3/16" ID T Grade with 9/16" 18 Left-hand thread
- Fits H-4 handle, T-8 torch, R-LP adjustable LP regulator



Part #	Mfg #	Description	Price
010445	1412-0080	12' Propane Hose	

## Soldering & Brazing

### Extreme Self-Lighting Propane & MAP-Pro™ Hand Torch

- Extreme™ swirl technology
- High capacity applications
- Self-lighting triggers
- Quick disconnect couplings between handle and tips



TX-504

Part #	Mfg #	LP Soft Solder To:	MAPP Solder To:	Price
072954	0386-1297	1/8" - 2"	1/8" - 3"	
072952	0386-1293	3/4" - 3"	3/4" - 4"	

### Extreme™ Self-Lighting Torch Replacement Tip

Part #	Mfg #	Description	Price
072955	0386-1298	Replacement Tip Assembly for TX503, Packaged	

### Extreme™ STK Propane and MAP-Pro™ Torch

- Extreme™ swirl technology
- 360° Swivel tips and easy to clean orifice screws
- Includes:
  - Pressure regulator (STK-R)
  - Connection (CGA-600)
  - Instruction manual



ST-3



ST-33

Part #	Mfg #	Tip	LP Soft Solder To:	MAPP Solder To:	Price
010454	0386-0403	ST-3	1/4" - 3"	1/4" - 3-1/2"	
022969	0386-0851	ST-33	1/4" - 3"	1/4" - 3-1/2"	

### Extreme™ STK Self-Lighting Hand Torch Tip Assembly Only

- Fits existing STK-9 and STK-99 torches



Part #	Mfg #	LP Soft Solder To:	MAPP Soft Solder To:	Price
022968	0386-0850	1/4" - 3"	1/4" - 3-1/2"	

## Soldering & Brazing

### Nitrogen Purge Kits

#### NPK-TT Nitrogen Purge and Blow Gun Kit

- Includes:
  - Nitrogen regulator
  - Turbo Tornado™
  - (2) Cone plugs (1/2" and 3/4")
  - Needle tip
  - CO2 Adapter
  - Standard charge hose (36" x 1/4")
  - Standard charge hose (72" x 1/4")
  - Blow gun



Part #	Mfg #	Description	Price
126453	0386-1370	Nitrogen Purge & Blow Gun Kit	

### Turbototes® Carriers

#### Turbototes® Tank and Cylinder Carrier

- Heavy-duty steel construction



Part #	Mfg #	Description	Price
020400	1421-0034	For "B" Tanks	

### TurboTorch® Parts & Accessories

#### Flints & Flint Striker



L-1



F-1

Part #	Mfg #	Description	Price
010447	1423-0023	Cup Type Single Flint Striker, Round File	
010441	1423-0024	Box of (5) Flints for L-1 Striker	

#### Hose



Part #	Mfg #	Description	Price
010431	0386-1090	12' Acetylene Hose with "A" Fittings	

#### TurboTorch Part



Part #	Mfg #	Description	Price
010455	0386-1226	Tank Key for "B" & "MC" Tank Valves	



## Spacer Caps

### Plumbing Construction Materials

#### Big Red Closet Bend Spacer

- Keeps poured concrete away from waste lines and closet bends
- Fits 3" and 4" waste lines



Part #	Mfg #	Description	Price
002541	012005	Plastic 6" OD x 4"H	





---

---

## Spacer Caps

---

---

### Closet Flange Spacers

Part #	Mfg #	Description	Price
005486	R383300	3" Kollar Kap	
008871	R383400	4" Kollar Kap	

## Stainless Steel Clamps

### Stainless Steel Clamps

#### Series M62

- 5/16" Wide band
- 300 Series stainless steel band and housing
- 400 Series 1/4" hex head stainless steel screw



Part #	Mfg #	Min Dia	Max Dia	Price
013611	M62602	1/4"	5/8"	
015539	M62606	7/16"	7/8"	

#### Series M677

- 1/2" Wide band
- 300 Series stainless steel band and housing
- 300 Series 5/16" hex head stainless steel screw
- Marine grade quality clamp
- UPC Approved



Part #	Mfg #	Min Dia	Max Dia	Price
015171	M67067	3/8"	7/8"	
013233	M67107	9/16"	1-1/8"	
014794	ID6816	3/4"	1-1/2"	
014843	M67207	3/4"	1-3/4"	
013078	M67247	1"	2"	
013725	M67327	1-5/8"	2-1/2"	
013022	M67407	2"	3"	
068921	M67487	2-1/2"	3-1/2"	
014206	M67567	3"	4"	
014512	M67727	2"	5"	
051627	M67967	3-1/2"	6-1/2"	



## Stainless Steel Clamps

### Ideal Clamps

#### Series 68 - Hy-Gear

- 9/16" Wide band
- One-piece housing
- 5/16" Hex-head screw
- Stainless steel band, housing and screw
- Double-locking security and high band tension for high sealing pressures



Part #	Mfg #	Min Dia	Max Dia	Price
115004	6808	7/16"	1"	
115005	6810	1/2"	1-1/16"	
115006	6812	1/2"	1-1/4"	
115007	6816	11/16"	1-1/2"	
115008	6820	3/4"	1-3/4"	
115009	6824	1"	2"	

**Hangers**

**Caddy® Clamps**

**Caddy® Reversible Beam Clamp**

- Hardened cup point setscrew to provide secure grip on tapered sections
- Structural attachment to top or bottom of metal beams, purlins, channel, or angle iron



Part #	Mfg #	Rod Size	Flange Size	Finish	Price
015560	58BEAM	5/8"	3/4"	PL	
014609	34BEAM	3/4"	3/4"	PL	
178644	14BEAM	1/4"	13/16"	EG	

**Beam Clamp**

- Reversible for attachment to top or bottom flange
- Locknut and hardened cup point set screw to provide secure grip on tapered sections



Part #	Mfg #	Rod Size	Flange Size	Finish	Price
163231	3000050EG	1/2"	13/16"	EG	
013031	3000050PL	1/2"	13/16"	PL	

**310 Beam Clamp with Wide Mouth (Thick Flange)**

- Universal clamp for thick beams
- Conforms with Federal specification WH-H-171 (Type 23) ANSI/MSS-SP-58 (Type 19 and 23)



Part #	Mfg #	Rod Size	Flange Size	Finish	Price
079264	3100037PL	3/8"	1-1/4"	PL	
106633	3100050PL	1/2"	1-1/4"	Plain	

**Caddy® Bolt Close Pipe Clamp**

- For copper tube
- Retained bolt and built-in nut
- Combo head bolt works with slotted, hex, #3 Phillips, or #2 robertson drivers



Part #	Mfg #	Size	Price
227807	CD0B37CP	1/2"	
227815	CD1B37CP	3/4"	
227817	CD2B37CP	1"	

**Caddy® Clamps (Continued)**

**Caddy® Bolt Close Pipe Clamp**

Part #	Mfg #	Size	Price
227818	CD3B37CP	1-1/2"	

**92 Universal C-Type Clamp**

- Standard throat
- Ductile iron, hardened steel cup point set screw and locknut



Part #	Mfg #	Size	Price
030459	38GBEAM	3/8"	

**AF-TI/T Rod to Z Purlin Clip**

- Supports 1/4" and 3/8" threaded rod from purlin beam flanges 1/16" thru 1/4" thick
- Hammer-on or install from the floor with VAFT tool
- Provides method for attaching rod to Z Purlin



Part #	Mfg #	Size	Price
082504	AF146TI	3/8" HS, 1/16"-1/4" FT	

**Caddy® Hangers & Hanging Systems**

**Caddy® Big Beam Clamp**

- Zinc electrogalvanized



Part #	Mfg #	Size	Price
122882	BC400	3/4"	

**Caddy® Speed Link SD with Hook**

- All steel construction
- Small, lightweight design
- Includes:
  - Wire
  - Locking device
  - Pre-assembled hook end fitting
- Static load:
  - SLD2: 100 lbs
  - SLD3: 200 lbs



Part #	Mfg #	Rope Dimensions	Price
076797	SLD2L1	0.079" Dia x 3.3'	
076800	SLD2L5	0.079" Dia x 16.4'	
076803	SLD3L2	0.118" Dia x 6.6'	
076804	SLD3L3	0.118" Dia x 9.9'	

**Hangers**

**Caddy® Hangers & Hanging Systems  
(Continued)**

**Caddy® Speed Link SD with Hook**

Part #	Mfg #	Rope Dimensions	Price
076805	SLD3L5	0.118" Dia x 16.4'	
076806	SLD3L10	0.118" Dia x 32.8'	
076799	SLK2L3	0.079" Dia x 9.9'	

**Caddy® Speed Link SLK Locking Device**

- Push/pull keyless release allows easy adjustments
- Low-profile locking device minimizes visual impact
- Cable spread of 90 degrees allows positioning the device closer to the load
- Keyless release tubes are easy to operate while wearing gloves
- Double-sided locking mechanism enables simple height adjustment



2.15"H x 3/4"W x 1/2"

Part #	Mfg #	Size	Price
174428	SLK2C200	Locking Device Only	
174427	SLK2L3LP	Locking Device with Loop	

**Riser Clamps**

**Caddy® EZ Riser for Vertical Pipe Support**

- Electro-galvanized



Part #	Mfg #	Nom Size	Price
063714	5100125EG	1-1/4"	

**EZR Riser Clamp**



Part #	Mfg #	Size	Price
257095	12STACKEZR	1/2"	
257096	34STACKEZR	3/4"	
257097	1STACKEZR	1"	
257098	114STACKEZR	1-1/4"	
257099	112STACKEZR	1-1/2"	
257100	2STACKEZR	2"	
257101	212STACKEZR	2-1/2"	
257102	3STACKEZR	3"	
257103	312STACKEZR	3-1/2"	

**Riser Clamps (Continued)**

**EZR Riser Clamp**

Part #	Mfg #	Size	Price
257104	4STACKEZR	4"	
257105	5STACKEZR	5"	
257106	6STACKEZR	6"	
257107	8STACKEZR	8"	
257108	10STACKEZR	10"	
257109	12INSTACKEZR	12"	

**Ceiling/Wall Plates**

**Ceiling or Wall Plate 365M**

- EG: Electro-zinc plated finish
- CP: Copper-colored coating for identification purposes only



Part #	Mfg #	Size	Finish	Price
121939	365M0050EG	1/2"	EG	
087799	365M0050CP	1/2"	CP	

**Caddy® Swivel Loop Hangers**

**Caddy® Adjustable Band Loop Hanger for Copper Tubing**

- Meets MSS requirements
- Copper-colored coating for identification purposes only



Part #	Mfg #	Pipe Size	Height	Price
032347	1010050CP	1/2"	3-3/16"	
068565	1010075CP	3/4"	3-1/8"	

**115 Standard Duty Loop Hanger**

- Idea for suspending stationary, non-insulated pipe lines (CPVC, fire sprinkler systems)
- Knurled insert nut
- Flared edges on base
- Pregalvanized steel



Part #	Mfg #	Pipe Size	Height	Price
051628	1150800EG	8"	12-7/8"	

## Hangers

### Caddy® Split Ring Hangers

#### Caddy® Split Ring Stand-Off Hanger - Malleable Iron

- PL: Plain without coating
- EG: Electro-galvanized



Part #	Mfg #	Size	Finish	Price
013918	4550200PL	2"	PL	
145257	4550250EG	2-1/2"	EG	
082051	4550300EG	3"	EG	
050638	4550300PL	3"	PL	
125189	4550400EG	4"	EG	
064486	4550400PL	4"	PL	

#### Caddy® Split Ring Stand-Off Hanger - Malleable Iron for Copper Tubing



Part #	Mfg #	Size	Price
072403	4560250CP	2-1/2"	
040951	4560300CP	3"	

### Nuts, Washers & Hardware

#### #51 Hardware Threaded Stud

- Plain finish
- Attaches hangers to structural attachments without threading or cutting the rod

Part #	Mfg #	Rod Size	Length	Max Load	Price
077828	0513702PL	3/8"	2"	610 lbs	

#### Snap-On Nail Plate

- Protects electrical and mechanical installation through studs
- For wood and metal studs
- Press-on installation
- No tools required
- Breakable tabs permit multiple plates to be ganged together
- Holes on legs and surface of plate are provided to secure with nail or screw



Part#	Mfg#	Size	Hole Size	Price
216664	304B2	3-1/8"x1-1/2"	3/16"	

### Plastic Hangers

#### Caddy® Superklip Tube Clamp

- Closes and locks automatically when the pipe, tube or cable is inserted
- One-piece clamp for fast and convenient installation
- Fasten with either wood screw, dual threaded screw with or without collar, nail with collar, threaded rod, mounting plate or shot-fire bracket



#### CTS

Part #	Mfg #	Size	Price
251029	389002	1/2"	
251032	389005	3/4"	
251039	389007	1"	
251040	389009	1-1/4"	
251041	389013	2"	

#### IP

Part #	Mfg #	Size	Price
251030	389003	3/8"	
251033	389004	1/2"	
251034	389006	3/4"	
251035	389008	1"	
251036	389011	1-1/4"	
251037	389012	1-1/2"	
251038	389014	2"	

### Clevis Hangers

#### Black Adjustable Clevis Hanger

- Black carbon steel
- For suspension of stationary pipe lines
- Maximum temperature: 650°F

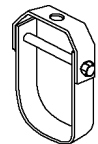

Part #	Mfg #	Size	Price
021826	12CLEVIS	1/2"	
021827	34CLEVIS	3/4"	
021828	1CLEVIS	1"	
021829	114CLEVIS	1-1/4"	
021830	112CLEVIS	1-1/2"	
021831	2CLEVIS	2"	
021833	3CLEVIS	3"	
023625	312CLEVIS	3-1/2"	
021834	4CLEVIS	4"	
015509	5CLEVIS	5"	



---

---

## Hangers

---

---

### Clevis Hangers (Continued)

#### Black Adjustable Clevis Hanger

Part #	Mfg #	Size	Price
015622	6CLEVIS	6"	
015786	8CLEVIS	8"	
012297	10CLEVIS	10"	
013084	12INCHCLEVIS	12"	
070755	14CLEVIS	14"	
070754	16CLEVIS	16"	
078319	18CLEVIS	18"	

## Steel Hangers

### Pipe Rings

#### Galvanized Adjustable Swivel Hanger

- Plated carbon steel
- For suspension of non-insulated stationary pipe line
- Maximum temperature: 650°F



Part #	Mfg #	Size	Price
013209	12SWIVEL	1/2"	
014775	34SWIVEL	3/4"	
012292	1SWIVEL	1"	
012875	114SWIVEL	1-1/4"	
012552	112SWIVEL	1-1/2"	
013941	2SWIVEL	2"	
014117	212SWIVEL	2-1/2"	
014452	3SWIVEL	3"	
015340	4SWIVEL	4"	
015691	6SWIVEL	6"	

### Galvanized Pipe Clamps

#### Galvanized Riser Clamp

- Galvanized carbon steel
- For support and steadying of steel pipe risers either insulated or bare, cast iron or conduit; not intended for use with hanger rods
- Maximum temperature: 650°F

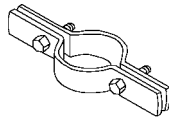

Part #	Mfg #	Size	Price
014771	34STACK	3/4"	
012289	1STACK	1"	
012549	112STACK	1-1/2"	
013922	2STACK	2"	
021806	212STACK	2-1/2"	
014433	3STACK	3"	
015520	5STACK	5"	
015823	8STACK	8"	
012315	10STACK	10"	
040554	12INSTACK	12"	

### Split Ring Hangers

#### Copper Coated Split Ring Hanger

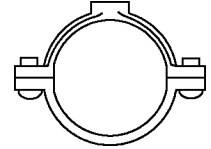

Part #	Mfg #	Size	Price
013110	12CSPLITRING	1/2"	
014683	34CSPLITRING	3/4"	
012220	1CSPLITRING	1"	
012811	114CSPLITRING	1-1/4"	
012442	112CSPLITRING	1-1/2"	
013812	2CSPLITRING	2"	

#### Galvanized Split Ring Hanger

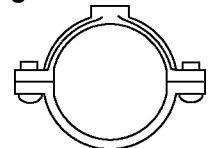

Part #	Mfg #	Size	Price
019413	12GSPLITRING	1/2"	
014713	34GSPLITRING	3/4"	
012245	1GSPLITRING	1"	
012836	114GSPLITRING	1-1/4"	
012467	112GSPLITRING	1-1/2"	
013832	2GSPLITRING	2"	

#### Black Split Ring Hanger

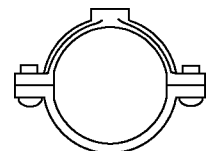

Part #	Mfg #	Size	Price
015056	38SPLITRING	3/8"	
013197	12SPLITRING	1/2"	
014767	34SPLITRING	3/4"	
012288	1SPLITRING	1"	
012872	114SPLITRING	1-1/4"	
012547	112SPLITRING	1-1/2"	

## Steel Hangers

### Clevis Hangers

#### 304SS Clevis Hanger

Part #	Mfg #	Size	Price
178044	12SSCLEVIS	1/2"	
178045	34SSCLEVIS	3/4"	
178046	1SSCLEVIS	1"	
178047	114SSCLEVIS	1-1/4"	
178048	112SSCLEVIS	1-1/2"	
178049	2SSCLEVIS	2"	
178050	3SSCLEVIS	3"	
178051	4SSCLEVIS	4"	
178052	6SSCLEVIS	6"	
178053	8SSCLEVIS	8"	

#### Black Adjustable Clevis Hanger

- Black carbon steel
- For suspension of stationary pipe lines
- Maximum temperature: 650°F

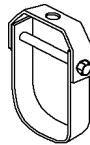

Part #	Mfg #	Size	Price
021826	12CLEVIS	1/2"	
021827	34CLEVIS	3/4"	
021828	1CLEVIS	1"	
021829	114CLEVIS	1-1/4"	
012800	114VLEVISLT	1-1/4", LT	
021830	112CLEVIS	1-1/2"	
021831	2CLEVIS	2"	
013804	2CLEVISLT	2", LT	
021832	212CLEVIS	2-1/2"	
021833	3CLEVIS	3"	
023625	312CLEVIS	3-1/2"	
021834	4CLEVIS	4"	
015219	4CLEVISLT	4", LT	
015509	5CLEVIS	5"	
015622	6CLEVIS	6"	
015786	8CLEVIS	8"	
012297	10CLEVIS	10"	
013084	12INCHCLEVIS	12"	
070755	14CLEVIS	14"	
070754	16CLEVIS	16"	
078319	18CLEVIS	18"	

### Beam Clamps

#### Standard Throat Universal C-Clamp

- Ductile iron clamp, hardened steel cup point set screw and locknut
- For use under roof installations with bar joist type construction, or for attachment to top or bottom flange of structural shapes where vertical hanger rod is required to be offset from edge of flange and where thickness of joist or flange does not exceed 3/4"

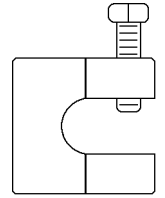

Part #	Mfg #	Size	Price
014970	38BEAM	3/8"	

#### Wide Throat C-Clamp

- 3/8" Ductile iron, 1/2" malleable iron clamp, hardened steel cup point set screw and locknut
- For use under roof installations with bar joist type construction, or for attachment to top or bottom flange of structural shapes where vertical hanger rod is required to be offset from edge of flange and where thickness of joist or flange does not exceed 1-1/4"

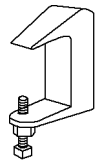

Part #	Mfg #	Size	Price
049604	38WTCCLAMP	3/8"	

#### Wide Throat Top Beam C-Clamp

- 5/8" Malleable iron, 3/4" ductile iron clamp, hardened steel cup point set screw and locknut
- For use under roof installations with bar joist type construction, or for attachment to top flange of structural shapes where vertical hanger rod is required to be offset from the edge of flange and where thickness of joist or flange does not exceed 1-5/16"

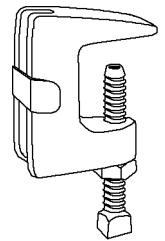

Part #	Mfg #	Size	Price
114005	34BEAMWM	3/4"	

## Steel Hangers

### Ceiling Flanges

#### Black Ceiling Flange

- Black malleable iron
- For attachment to wood beams or ceiling

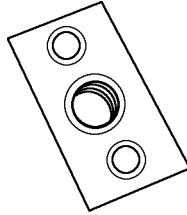

Part #	Mfg #	Size	Price
014967	38BCF	3/8" NPT	
039428	12BCF	1/2" NPT	

#### Galvanized Ceiling Flange

- Galvanized malleable iron
- For attachment to wood beams or ceiling

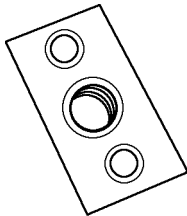

Part #	Mfg #	Size	Price
015063	38GCF	3/8" Rod	

### Copper Tubing Hangers

#### Countersunk Riser Clamp

- Carbon steel with copper finish
- For support and steadying of copper tubing risers

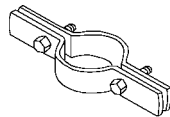

Part #	Mfg #	Size	Price
013111	12CSTACK	1/2"	
014684	34CSTACK	3/4"	
012221	1CSTACK	1"	
012812	114CSTACK	1-1/4"	
012443	112CSTACK	1-1/2"	
013813	2CSTACK	2"	
014085	212CSTACK	2-1/2"	
056082	3CSTACK	3"	
027166	4CSTACK	4"	

#### CTS Adjustable Swivel Hanger

- Steel with copper finish



Part #	Mfg #	Size	Price
083891	121SWIVEL	1/2" - 1"	

### Copper Tubing Hangers (Continued)

#### CTS Adjustable Swivel Hanger

Part #	Mfg #	Size	Price
082241	12114CSWIVEL	1/2" - 1-1/4"	
012222	1CSWIVEL	1"	
012816	114CSWIVEL	1-1/4"	
012446	112CSWIVEL	1-1/2"	
013814	2CSWIVEL	2"	
014086	212CSWIVEL	2-1/2"	
014348	3CSWIVEL	3"	
015224	4CSWIVEL	4"	

#### Copper Adjustable Light-Duty Clevis Hanger

- Carbon steel with copper finish

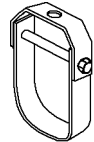

Part #	Mfg #	Size	Price
013061	12CCLEVIS	1/2"	
014640	34CCLEVIS	3/4"	
012199	1CCLEVIS	1"	
012779	114CCLEVIS	1-1/4"	
012399	112CCLEVIS	1-1/2"	
013769	2CCLEVIS	2"	
014068	212CCLEVIS	2-1/2"	
014318	3CCLEVIS	3"	
015203	4CCLEVIS	4"	

#### Copper Ceiling Flange

- Malleable iron with copper finish

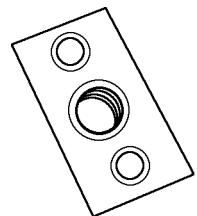

Part #	Mfg #	Size	Price
014991	38CCF	3/8" Rod	

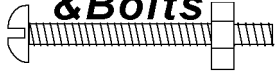

---

---

**Steel Hangers**

---

---

**Spacers & Standoffs**

**Round Standoff**

Part #	Size	Price
078486	3/8" x 3"	

## Steel Hangers

### Wire Pipe Hooks

#### Wire Pipe Hook

- 10-gauge
- Vinyl-coated steel
- Do not use vinyl-coated wire pipe hooks with CPVC pipe or fittings



506-24

#### Plain Steel

Part #	Mfg #	Size	Price
009993	506-26	1/2" IPS x 6"	
009995	506-34	3/4" IPS x 4"	
009997	506-36	3/4" IPS x 6"	
009999	506-46	1" IPS x 6"	

#### Copper-Plated Steel

Part #	Mfg #	Size	Price
009992	506-24C	1/2" IPS x 4"	
009994	506-26C	1/2" IPS x 6"	
183441	506-32C	3/4" IPS x 2-1/2"	
009996	506-34C	3/4" IPS x 4"	
009998	506-36C	3/4" IPS x 6"	

#### Copper-Plated Steel Drive Hook

- Do not use vinyl-coated hooks with CPVC pipe or fittings



503-2

#### J-Hook

Part #	Mfg #	Size	Price
183438	503-2	1/2" CTS	
030805	503-3	3/4" CTS	

#### Tube Nailer

Part #	Mfg #	Size	Price
159628	504-3	1/2"-3/4" CTS	

### Split Ring Hangers

Part#	Mfg#	Size	Material	Price
229470	516-4GB	1" IPS	Galvanized	
229469	516-7GB	2" IPS	Galvanized	



**Struts**

**Caddy® Strut Systems**

**Caddy® Strut Post Base**

- For "A" channel
- Electro-zinc plated

Part #	Mfg #	Size	Price
130266	P090000EG	6" x 3-1/2" x 3-1/2"	

**Caddy® Square Post Base**

- For channel
- Electro-zinc plated

Part #	Mfg #	Description	Price
076402	P11SQ000EG	Square Post Base	

**CADDY® 4-Hole Flat Tee Plate**

- Electrogalvanized steel
- 5-3/8" x 3-1/2"



Part #	Mfg #	Size	Price
140771	F250000EG	5-3/8" x 3-1/2"	

**Caddy® Beam Clamps**

**Strut Beam Clamp**

- Channel to beam clamp
- Electro-zinc plated finish
- Fits 'A' and 'D' channels



Part #	Mfg #	Size	Price
106899	BC17A000EG	3-3/8" x 3"	

**Caddy® Channel**

**Caddy® Eristrut Channel A12**

- 1-5/8" x 1-5/8"
- 12 Gauge
- For heavy applications
- For individual fastening or for efficiently constructing pipe or tube routes
- Standard lengths: 10', 20'
- Pre-galvanized, painted green, gold chromate, plain



Part #	Mfg #	Length	Finish	Hole Slot	Price
115204	A12A2000PG	20'	PG	Solid	
250936	A122000PL	20'	Plain	Solid	

**Caddy® Eristrut Channel A14**

- 1-5/8" x 1-5/8"
- 14 Gauge
- For light and medium applications
- Half slot configuration
- GN: Painted green finish



Part #	Mfg #	Length	Finish	Hole Slot	Price
121545	C14H1000GN	10'	GN	Half Slot	

**Caddy® Eristrut Channel C12**

- 1-5/8" x 3/16"
- 12 Gauge
- For individual fastening or for efficiently constructing pipe or tube routes
- GN: Painted green finish

Part #	Mfg #	Length	Finish	Hole/Slot	Price
013405	C12H2000GN	20'	GN	Half Slot	

**Caddy® Eristrut Channel E12**

- 1-5/8" x 3-1/4"
- 12 Gauge
- For heavy applications
- For individual fastening or for efficiently constructing pipe or tube routes
- GN: Painted green finish

Part #	Mfg #	Length	Finish	Hole/Slot	Price
121385	E12H2000GN	20'	GN	Half Slot	

**One-Hole Corner Angle Bracket**

- Used to create metal frames with CADDY ERISTRUT channels
- Electrogalvanized steel



Part #	Mfg #	Size	Price
192266	L110000EG	2" x 1-7/8"	

**Two-Hole Corner Angle Washer**

- EG: Electro-zinc plated finish

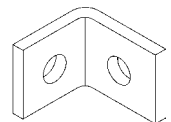

Part #	Mfg #	Size	Finish	Price
116112	L100000EG	2-1/4" x 1-5/8"	EG	

**Struts**

**Four-Hole Strut Corner Angle**

- Width: 1-5/8"
- Hole size: 9/16"
- Spacing:
  - 13/16" From edge
  - 1-7/8" On center
- EG: Electro-zinc plated finish

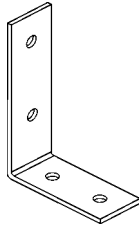

Part #	Mfg #	Size	Finish	Price
035437	L220000EG	4-1/8" x 3-1/2"	EG	

**Strut Angle - Two-Hole Open Angle**

- Electro-zinc plated



Part #	Mfg #	Description	Price
116113	L460450EG	45° Angle	

**Strut Angle - Two-Hole Closed Angle**

- Electro-zinc plated



Part #	Mfg #	Description	Price
116114	L470450EG	45° Angle	

**Four-Hole Splice Plate**

- Electro-zinc plated

Part #	Mfg #	Size	Price
116110	F230000EG	7-1/4" x 1-5/8"	

**Strut Four-Hole Half-Tee Plate**

- Electro-zinc plated

Part #	Mfg #	Size	Price
116111	F370000EG	3-1/2" x 5-3/8"	

**U-Bolts**

**150M Standard U-Bolt**

- Pipe support for general piping applications
- Comes complete with 4 nuts
- Conforms with Federal Specification: WW-H-171 (Type 24)
- Manufacturers Standardization Society ANSI/MSS-SP-58 (Type 24)



Part #	Mfg #	Size	Price
163340	150M0050EG	1/2"	
163341	150M0075EG	3/4"	
163342	150M0100EG	1"	
163344	150M0150EG	1-1/2"	
163345	150M0200EG	2"	
163346	150M0250EG	2-1/2"	
163347	150M0300EG	3"	
163348	150M0400EG	4"	
163349	150M0500EG	5"	
163350	150M0600EG	6"	
163351	150M0800EG	8"	
163352	150M1000EG	10"	
163353	150M1200EG	12"	

**Struts**

**CADDY® Eristrut Channels**

**A12 Slotted Steel Channel**

- PG = Pre-galvanized
- GN = Painted green



Part #	Size	Finish	Gauge	Price
040173	1-5/8" x 1-5/8" x 20'	PG	12ga	
012312	1-5/8" x 1-5/8" x 10'	GN	12ga	
044274	1-5/8" x 1-5/8" x 10'	PG	12ga	
013953	1-5/8" x 1-5/8" x 20'	GN	12ga	
167288	1-5/8" x 1-5/8" x 10'	SS	12ga	

**A14 Slotted Steel Channel**

- PG = Pre-galvanized



Part #	Size	Finish	Gauge	Price
044275	1-5/8" x 13/16" x 20'	PG	14ga	

**C14 Slotted Steel Channel**

- PG = Pre-galvanized



Part #	Size	Finish	Gauge	Price
133688	1-5/8" x 13/16" x 10'	PG	14ga	

**Brackets**

**Strut Splice Plate**

Part #	Description	Price
065325	2-Hole, Green	

## Strut Hangers

### Universal Pipe Strut Clamps

#### PlenumSafe™ TouchDown™ II Strut Clamp

- One clamp fits 1/2" CTS tube (copper, PEX or CPVC) – 2" IPS (steel or plastic)
- Releasable locking mechanism allows for variable clamping tension for expansion and contraction
- PlenumSafe™ model meets ASTM E84 25/50 Flame/Smoke Spread and UL-94 V0 flame ratings



Part #	Mfg #	Bridge	Strut Clamp Base	Price
220317	550F2T	1	1	

#### TouchDown II™ Strut Clamp

- Large universal pipe clamp for strut
- No tools required for fast and easy installation
- One clamp fits 1/2" CTS tube (copper, PEX or CPVC) – 2" IPS (steel or plastic)
- Use two bridges for tandem pipe runs
- Great for retro-fit applications



550-2T

Part #	Mfg #	Bridge	Strut Clamp Base	Price
094745	550-2T	1	1	
232205	550-2121	1	1	
176282	550-22T	50	50	

#### TouchDown II™ Large Universal Pipe Clamp with PipeDown™ Noise Absorbing Inserts

- Clamps 1/2" – 2" CTS tube (copper, PEX or CPVC) and 3/8" – 2" Sch. 40 pipe (steel or plastic)
- Releasable locking mechanism allows for variable clamping tension for expansion and contraction
- Provides 5/8" stand-off from mounting surface
- PlenumSafe™ model meets ASTM E84 25/50 Flame/Smoke Spread and UL-94 V0 flame ratings
- Acoustical options available
- \*Acoustical options are not plenum-rated

#### Standard

Part #	Mfg #	Bridges	Bases	Screws	Price
177775	550-22	50	50	100	

---

---

## Strut Hangers

---

---

### Strut Hangers & Clamps

Part #	Mfg #	Description	Price
015057	38STRUTNUTW S	3/8" w/Regular Spring	
123848	12STRUTNUTW S	1/2" w/Regular Spring	
020035	38TOPGRIPNUT	3/8" Top Grip™ Nut w/Spring on Top	
020036	12TOPGRIPNUT	1/2" Top Grip™ Nut w/Spring on Top	
064430	8CONDCLAMP	8" Rigid Cond/Pipe Clamp Strut	

**Strut Hangers**

**Caddy® Strut Nuts**

**Caddy® SLICK Threaded Strut Nut**

- Eliminates the need for a washer
- Replaces spring nuts



Part #	Mfg #	Thread Size	Recommended Torque	Price
055268	SLICK375	3/8"-16	15 ft-lbs	
055269	SLICK500	1/2"-13	20 ft-lbs	

**Caddy® Strut Nut w/ Spring, Channel Type A**

- Used to create metal frames with CADDY ERISTRUT channels
- Spring allows for easy installation



Part #	Mfg #	Thread Size	Recommended Torque	Price
070760	58STRUTNUTWS	5/8"	50 ft-lbs	

**Caddy® Strut Clamps**

**Caddy® Cushion Clamp - Tube Series**

- Fits any standard 1-5/8" wide strut channel
- Ideal for multiple pipe runs while absorbing shock and vibration, reducing unwanted noise and preventing galvan corrosion
- Interlock design helps to ensure that the cushion remains in place



Part #	Mfg #	Copper & Steel	Copper Water	Price
033422	TCC0162CP	1-5/8"	1-1/2"	

**Caddy® Cushion Clamp - Insulated Strut Clamp**

- For pipe/tube
- Steel polypropylene
- Includes nylon locknut
- Plastic channel is hinged
- Fits into open side of strut channel



Part #	Mfg #	Size	Price
139308	CCC0025	1/4" O.D.	

**Caddy® Bolt Close Conduit/Pipe Clamp**

- Combo head bolt works with slotted, hex, #3 phillips or #2 robertson drivers
- Electrogalvanized steel
- Hex nut



Part #	Mfg #	Size	Price
152190	3CONDUITCLAMP	3"	

**Eritech® Welded Electrical Connections Products**



**Eritech® Grounding Clamp**

- For connecting copper conductors to metallic water pipe (including copper tubing) or ground rods
- Bond corrugated stainless steel tubing (CSST) or flexible gas pipe systems to the electrical system in accordance with the National Fuel Gas Code (NFGC) and the National Electrical Code® (NEC)
- Applications include lightning protection, fault current ground, signal reference grid and static ground
- Fits hex fittings, copper grounding conductors, galvanized water pipes, copper water tubing or copper ground rods ranging from 1/2" to 4"
- High-strength silicone bronze clamps connect brass hex fittings
- UL Listed (ANSI/UL 467 - Category KDER)



Part #	Mfg #	For Pipe Size	For Hex Nut Size	Price
105482	CWP1J	1/2" - 1"	1" - 1-1/4"	

**Caddy® Strut Channel**

**Strut Channel Nut less Spring**

- EG: Electro-zinc plated finish
- Fits A, B, D, and E channels



Part #	Mfg #	Thread Size	Price
021030	NUT0050EG	1/2"	
123849	NUT0075EG	3/4"	



**Strut Hangers**

**Strut Channel Washer**

- EG: Electro-zinc plated finish

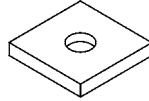

Part #	Mfg #	Hole Size	Bolt Size	Finish	Price
020781	F140000EG	3/8"	7/16"	EG	
013203	F150000EG	1/2"	9/16"	EG	

**Caddy® Parts & Accessories**

Part #	Mfg #	Size	Price
201773	QLD200	Speed Link SD Locking Devise	

## Strut Hangers

### Pipe Clamps

#### Standard Steel Pipe Clamp (GRC & IMC)

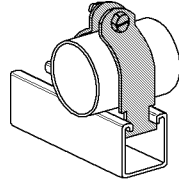

Part #	Mfg #	Size	Price
013202	12CONDPCLAMP	1/2"	
014773	34CONDPCLAMP	3/4"	
012291	1CONDPCLAMP	1"	
012874	114CONDPCLAMP	1-1/4"	
012551	112CONDPCLAMP	1-1/2"	
013923	2CONDPCLAMP	2"	
014116	212CONDPCLAMP	2-1/2"	
014434	3CONDPCLAMP	3"	
015318	4CONDPCLAMP	4"	
015680	6CONDPCLAMP	6"	

#### Cushion Clamp

- Electro-galvanized standard finish
- Pre-assembled

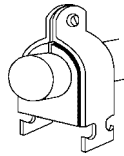

Part #	Mfg #	OD Size	Price
052645	38VIBE	3/8"	
058284	12VIBE	1/2"	
033418	58VIBE	5/8"	
033413	34VIBE	3/4"	
033419	78VIBE	7/8"	
033420	118VIBE	1-1/8"	
033421	138VIBE	1-3/8"	
033423	218VIBE	2-1/8"	
046559	258VIBE	2-5/8"	
059578	318VIBE	3-1/8"	

### Conduit Clamps

#### Plated Conduit Clamp

Part #	Mfg #	Size	Price
020360	12CONDUITCLAMP	1/2"	
020361	34CONDUITCLAMP	3/4"	
020362	1CONDUITCLAMP	1"	
020363	114CONDUITCLAMP	1-1/4"	
020364	112CONDUITCLAMP	1-1/2"	

### Conduit Clamps (Continued)

#### Plated Conduit Clamp

Part #	Mfg #	Size	Price
020365	2CONDUITCLAMP	2"	

### Strut Clamps

#### Copper-Plated Strut Clamp (CTS Size)

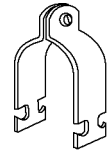

Part #	Mfg #	Size	Price
015058	38STRUTTBCLAMP	3/8" OD	
015584	58STRUTTBCLAMP	5/8" OD	
015778	78STRUTTBCLAMP	7/8" OD	
013020	118STRUTTBCLAMP	1-1/8" OD	
013451	138STRUTTBCLAMP	1-3/8" OD	
013632	158STRUTTBCLAMP	1-5/8" OD	
014205	218STRUTTBCLAMP	2-1/8" OD	
014279	258STRUTTBCLAMP	2-5/8" OD	
038475	318STRUTTBCLAMP	3-1/8" OD	
015378	418STRUTTBCLAMP	4-1/8" OD	

**Threaded Rods, Bolts, Nuts, & Gaskets**

**Nuts**

**Zinc-Plated Hex Nut**



Part #	Mfg #	Size	Price
028485	38NUTSZPLT	3/8"	
028486	12NUTSZPLT	1/2"	
078474	34NUTSZPLT	3/4"	
072043	58NUTSZPLT	5/8"	
072046	78PNUT	7/8"	

**Heavy Hex Nuts**

Part #	Mfg #	Size	Price
015581	58NUTS	5/8" x 11"	
014735	34NUTS	3/4" x 10"	

**Bolts**

**Hex Head Bolt**

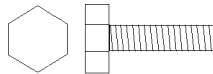

Part #	Mfg #	Size	Price
114092	34312SCREWZPLT	3/4"-10 x 3"	

**Zinc-Plated Hex Head Bolt**

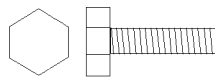

Part #	Mfg #	Size	Price
122398	3834BOLT	3/8" x 3/4"	
040538	381BOLT	3/8" x 1"	
122400	38114BOLT	3/8" x 1-1/4"	
122401	38112BOLT	3/8" x 1-1/2"	

**Screws**

**Hex Cap Screw**

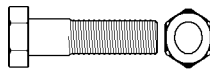

Part #	Mfg #	Size	Price
095900	381SCREWZPLT	3/8" x 1"	
095901	38114SCREWZPLT	3/8" x 1-1/4"	
095902	38112SCREWZPLT	3/8" x 1-1/2"	

**Zinc Cap Screw**

Part #	Mfg #	Size	Price
166019	58112SCREWZPLT	5/8" x 1-1/2"	
166020	58134SCREWZPLT	5/8" x 1-3/4"	

**Screws (Continued)**

**Zinc Cap Screw**

Part #	Mfg #	Size	Price
114093	58312SCREWZPLT	5/8"-10 x 3-1/2"	
166021	34134SCREWZPLT	3/4" x 1-3/4"	
166022	342SCREWZPLT	3/4" x 2"	
166023	34214SCREWZPLT	3/4" x 2-1/4"	

**Washers**

**Steel Cut Flat Washer**



Part #	Mfg #	Size	Price
015587	58WASHER	5/8"	

**Zinc-Plated Steel Cut Flat Washer**

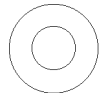

Part #	Mfg #	Size	Price
028487	38WASHERZPLT	3/8"	
028488	12WASHERZPLTD	1/2"	
072045	58WASHERSZPLT	5/8"	
078482	34WASHERSZPLT	3/4"	
026021	78WASHER	7/8"	

**Zinc-Plated Steel Lock Washer**



Part #	Mfg #	Size	Price
122402	38LOCKWASHER	3/8"	

**Zinc-Plated Fender Washer**

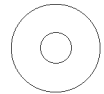

Part #	Mfg #	Size	Price
095276	14FWP	1/4" x 1-1/4"	
035135	38FWP	3/8" x 1-1/2"	
066354	12FWP	1/2" x 2"	

---



---

## Threaded Rods, Bolts, Nuts, & Gaskets

---



---

### Hanger Rods

#### Electro-Galvanized All Thread Rod

- EG Carbon steel 
- Continuous right-hand threads
- Maximum temperature: 750°F

Part #	Mfg #	Size	Price
013533	14PALLTHREAD	1/4" x 10'	
015054	38PALLTHREAD	3/8" x 10'	
013166	12PALLTHREAD	1/2" x 10'	
015582	58PALLTHREAD	5/8" x 10'	
014736	34PALLTHREAD	3/4" x 10'	
015776	78PALLTHREAD	7/8" x 10'	

#### 146 Cont. Threaded Rod

- Carbon steel 
- Rod threaded complete length

Part #	Mfg #	Size	Price
013024	12ALLTHREAD	1/2" x 10'	

**Threaded Rods, Bolts, Nuts, & Gaskets**

**Fasteners and Inserts**

**Standard Steel Rod Coupling**

- EG: Electro-zinc plated finish



Part #	Mfg #	Size	Finish	Price
016078	0250037EG	3/8"	EG	
064708	0250050EG	1/2"	EG	
075031	0250062EG	5/8"	EG	
075032	0250075EG	3/4"	EG	

**Threaded Rod**

- EG: Electro-Galvanized finish  
PL: Plain finish
- Tensile strength: 58,000 psi
- Yield Strength: 36,000 psi
- Static load: 600 lb



Part #	Mfg #	Size	Price
193129	0503706EG	3/8" x 6'	
193130	0505006EG	1/2" x 6'	
190986	0503712EG	3/8" x 12'	
194127	0505012EG	1/2" x 12'	
190983	0503712PL	3/8" x 12'	

**370A Single Concrete Insert Plate and Rod**

- Steel



Part #	Mfg #	Size	Price
138396	370A0037PL	3/8" x 8"	

**Strut Nut without Spring**

- Electrogalvanized steel finish
- 3/8" Rod size and thickness



Part #	Mfg #	Size	Price
192268	NUT0037EG	3/8"	

**Ground Clamps & Rods**

**Ground Rod Clamp**



Part #	Mfg #	Description	Price
105024	CP38	Std 10 Sol/4 Str, 3/8" Dia	

**Ground Rod**

Part #	Mfg #	Description	Price
105025	613852	5 Ft Ground Rod	

**Threaded Rods, Bolts, Nuts, & Gaskets**

**Vertical Mounting Rod Fasteners**

- For hanging pipe, conduit, fluorescent fixtures, unit heaters and more

**Sammys® for Concrete - Vertical Application**

- Self-tapping
- 1/4" Pre-drilled hole required



Part #	Prod	Size	Rod	Price
035774	CST 20	1-1/2"	3/8"-16	

**Sammys® for Steel - Vertical Application**

- Made with Teks® self-drilling fasteners
- No pre-drilling required
- Install with Sammys Nut Driver and an 18V cordless drill/driver
- A standard screw gun with a depth sensitive nosepiece should be used to install TEKS
- "R" Suffix denotes retaining nut



Part #	Prod	Size	Rod	Price
020584	DSTR 1	1/4-20 x 1"	3/8"-16	
020587	DST 10	1/4-14 x 1"	3/8"-16	
108139	DST 100	1/4-14 x 1"	1/4"	
020589	DST 20	1/4-14 x 2"	3/8"-16	
020592	TEK 50	12-24 x 1-1/2"	3/8"-16	

**Sammy® X-Press® - Vertical Application**

- Installs into metal deck, purlin or tubular steel
- Expands to provide direct vertical attachment
- Use in applications where access to back of installed fastener is prohibited
- Installs in seconds with Sammy X-Press It® tool
- No retaining nut required



Part #	Prod	Rod	Pullout	Price
091332	XP 35	3/8"-16	1783 lbs (16ga)	

**Sammys® for Wood - Vertical Application**

- No pre-drilling required
- Install with Sammys Nut Driver and an 18V cordless drill/driver



Part #	Prod	Size	Rod	Price
021728	GST 10	1/4 x 1"	3/8"-16	
020590	GST 20	1/4 x 2"	3/8"-16	

**Vertical Mounting Rod Fasteners (Continued)**

**Sammys® for Wood - Vertical Application**

Part #	Prod	Size	Rod	Price
020591	GST 30	1/4 x 3"	3/8"-16	
150007	GST 200	1/4 x 2"	1/4"-20	

**Horizontal Mounting Rod Fasteners**

**Sidewinder® for Steel - Horizontal Application**

- Made with Teks® self-drilling fasteners
- No pre-drilling required
- Install with Sammys Nut Driver and an 18V cordless drill/driver
- A standard screw gun with a depth sensitive nosepiece should be used to install TEKS
- "R" Suffix denotes retaining nut



Part #	Prod	Size	Rod	Price
020594	SWD 20	1/4-14 x 1"	3/8"	
048590	SWDR516	5/16-18 x 1-1/4"	3/8"-16	

**Sidewinder® for Wood - Horizontal Application**

- No pre-drilling required
- Install with Sammys Nut Driver and an 18V cordless drill/driver



Part #	Prod	Size	Rod	Price
020593	SFSWG20	1/4 x 2"	3/8"-16	

**Sammys Sidewinder™ Horizontal Threaded Rod Anchor**

- Two-sided installation process
- 91° attachment angle
- Installs with SAMMYS nut driver



Part #	Prod	Size	Rod	Price
066887	SWC20	3/8"	3/8" - 16	

**Installation Tools**

**Nut Driver**



Part #	Prod	Rod Size	Color	Price
020596	14	1/4" & 3/8"	Black	





## Threaded Rods, Bolts, Nuts, & Gaskets

### Riex Gaskets

#### 1/8" Full Face Red Rubber Gasket - 150#

Part #	Mfg #	Size	Price
113499	2FFRRG18150	2"	
113497	212FFRRG18150	2-1/2"	
113498	3FFRRG18150	3"	
080314	4FFRRG18150	4"	
080315	6FFRRG18150	6"	
080316	8FFRRG18150	8"	
128777	12INFFRRG18150	12"	

#### 1/16 Ring Flange Gasket

Part #	Mfg #	Size	Price
013916	2RING	2"	
014114	212RING	2-1/2"	
014428	3RING	3"	
015300	4RING	4"	
015519	5RING	5"	
015665	6RING	6"	
015808	8RING	8"	

#### 1/8 Ring Flange Gasket - 150#

Part #	Mfg #	Size	Price
034783	2RING18	2"	
034784	212RING18	2-1/2"	
034785	3RING18	3"	
034786	4RING18	4"	
034787	5RING18	5"	
034788	6RING18	6"	
034789	8RING18	8"	

### BP Pizza Box Flange Gasket

#### 150#

Part #	Mfg #	Size	Price
029426	BP15	1-1/2"	
002566	BP20	2"	
002567	BP25	2-1/2"	
029027	BP25Z	2-1/2" Full Faced	
002568	BP30	3"	
028766	BP30Z	3" Full Faced	
002569	BP40	4"	

### Riex Gaskets (Continued)

#### BP Pizza Box Flange Gasket

#### 150#

Part #	Mfg #	Size	Price
029026	BP40Z	4" Full Faced	
002570	BP50	5"	
002571	BP60	6"	
002572	BP80	8"	
002565	BP100	10"	
068865	BP60Z	6" Full Faced	

#### 300#

Part #	Mfg #	Size	Price
026133	BP20T3	2"	

#### #1 Full Face Gasket

Part #	Mfg #	Size	Price
030598	FLANGEGASK ET212	2-1/2"	
030599	FLANGEGASK ET3	3"	

### LBV Zinc Butterfly Gasket - 150#

Part #	Mfg #	Size	Price
053676	LBVAZ202.00	2"	
053677	LBVAZ203.00	3"	
053678	LBVAZ204.00	4"	
067638	LBVAZ206.00	6"	



---

---

## Threaded Rods, Bolts, Nuts, & Gaskets

---

---

### Red Rubber Sheet Packing

36" Wide Roll



Part #	Mfg #	Description	Price
006182	1003	1/8" Thick, 100 lb Roll	

---



---

## Threaded Rods, Bolts, Nuts, & Gaskets

---



---

### Pipe Hangers & Fasteners

#### Steel HEX nut for Threaded Rod



Part #	Mfg #	Size	TPI	Price
191511	38NUTS	3/8"	16	
191512	12NUTS	1/2"	13	

#### Steel Washer for Threaded Rod



Part #	Mfg #	Size	OD	Price
191506	14WASHERFENDER	1/4"	3/4"	
191507	38WASHERFLAT	3/8"	1"	
191509	38WASHERFENDER	3/8"	1-1/2"	

## Tubing Brackets

### Copper Tubing Hangers & Fasteners

#### Vinyl-Coated Steel Clamp with 1" Screw

- Perfect for hydronic heating
- Use with power bar universal slider bracket
- Complies with 2009 National Fuel Gas Code for supporting CSST
- Do not use with CPVC pipe or fittings
- Model **(523-31)** also for 3/8" nom. tube # 3 rebar



Part #	Mfg #	Size	For:	Price
164878	523-31	5/16"	3/8" Threaded Rod	
142241	523-32	5/8"	1/2" CTS	
164879	523-33	7/8"	3/4" CTS	
164880	523-34	1-1/8"	1" CTS	

### Tube Brackets & Hangers

#### ChaseBracket™ Copper-Plated Support Bracket

- Heavy duty 16 gauge
- Spot solder to copper water header —heat the pipe, not the bracket
- Cradles copper water headers up to 3" diameter
- Available with or without 5" stainless steel band
- Wide cradle gives maximum soldering surface
- Made in the USA



Part #	Mfg #	Includes:
112589	521-723	5" Stainless Steel Band
183443	521-723BB	Chase Bracket

#### Copper-Plated Stub-Out Bracket

- A-Frame design
- Self-nailing, 16 gauge
- Heat the tube, not the bracket
- Positions 1/2" CTS at 2", 3" or 5-3/4" from floor
- Positions 3/4" CTS at 3-1/2" from floor



Part #	Mfg #	1/2" CTS	3/4" CTS	Price
052124	SC5216415	3"	1"	

### Edge Support System™ Bracket with Angle



- Provides a rigid cross brace between studs
- One clamp supports vertical and horizontal applications
- Perforated angle designed for undersized stud bays

Part #	Mfg #	Material	Includes:	Price
029292	520-E16C	Copper-Plated	Flat Tabs	

### Secure-All™ Copper-Plated Flat Bracket

- Reduce inventory with one bracket that features multiple hole sizes and notches
- Stiffening ribs on top and bottom provide ultimate rigidity
- Heavy 18 gauge copper-plated steel
- All holes and notches are extruded for maximum soldering surface
- Bracketing area on 521-851 is 14" and on 521-852 is 22"
- Heat the tube, not the bracket



Part #	Mfg #	Description	Price
151154	521-851	2" x 20" (H): 1/2"=7 3/4"=3 1"=3, (N):1/2"=7 3/4"=6	

### Secure-All™ Copper-Plated Bracket

- Heavy gauge copper-plated steel
- Holes: (11) 1/2" CTS, (5) 3/4" CTS, (5) 1" CTS;  
Notches: (11) 1/2" CTS, (10) 3/4" CTS



Part #	Mfg #	Size	Gauge	Price
081848	521-852	2-3/8" x 26"	18	

### StainlessStar™ Metal IPS/CTS Supply Hanger

- Do not use on PEX or CPVC
- 23-ga. type 304 stainless steel
- Slides over and locks copper tube into place



Part #	Mfg #	Size	O.D.	Price
241507	612-2S	1/2"	2"	

## Tubing Brackets

### Copper-Plated Stub-Out Bracket

- Extruded models provide four times the soldering surface for extra strength
- Heat the tube, not the bracket

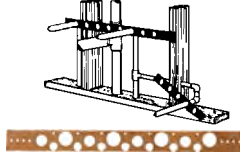

#### Flat Holes

521-810

Part #	Mfg #	Description	Price
005361	521-118	1-1/4" x 22" (8) Holes 1/2" CTS	
005362	521-126	1-1/4" x 26" (11) Holes 1/2" CTS	
005363	521-810	1-3/4" x 20", (7) Holes 1/2" CTS, (4) Holes 3/4" CTS, (4) Holes 1" CTS	

#### Extruded Holes

Part #	Mfg #	Description	Price
033296	521-820	1-3/4" x 20" (7) Holes 1/2" CTS, (4) Holes 3/4" CTS, (3) Holes 1" CTS	
005360	521-118R	1-1/4" x 20" (7) Holes 1/2" CTS	

### Copper-Plated Carrier Bracket with Washers

- Channel design extends the entire length of the bracket for maximum strength and rigidity
- Supports water pipe for flush valve 26½" above floor and offsets stub out at 4½" or 4¾" from carrier center
- Washers included



Part #	Mfg #	Size	Holes	Conn	Price
052267	521-725	1"	1	CTS	
254702	521-729	1"	2	CTS	

### Copper-Plated Commercial Alignment Bracket

- Aligns vertical or horizontal pipes in straight runs, especially between floors
- Attaches to vent or waste pipe
- 18-gauge copper-plated steel
- Includes snap-lock stainless steel band and self-adhesive felt



Part #	Mfg #	Stub Outs	Centers	Price
123468	521-110	1/2"	4" or 8"	

### L-Bracket

- Can be used for:
  - Hangs Tuff™ DWV pipe hanger
  - ZipStick™ universal pipe hanger
  - ZipStrap™ ratchet-locking strap



Part #	Mfg #	For:	Price
180438	521-210	3/8" All Thread Rod	

### Pipe Eye™ Overhead Suspension Bracket

- Commercial product
- Supports copper, PEX or CPVC tubing
- Includes one, two or four 1 11/32" holes
- Use with Pipe Eye™ insulators
- Suspend bracket with 3/8" all-thread rod
- Multiple nail holes and slots for installation flexibility
- Can be mounted to a concrete pan before the pour



521-55

Part #	Mfg #	Holes	Price
155230	521-558	Double	

### WiderSlider™ Adjustable Stub-Out Bracket

- Available in two lengths for 16" or 24" stud bays
- 1-3/8" wide x 22-ga. high quality G90 galvanized steel
- Pilot holes for standard DE 90s and wide enough for securing 3-ear DE 90s
- Eliminates cutting and fabricating metal studs or wood blocks
- Pre-dimensioned hash marks for quicker, more precise installations
- Pre-assembled and fully adjustable with interlocking tab to secure safe overlap and prevent disassembly
- Mount to face of studs or bend tabs to recess at 3/4", 1-1/2" or 2-1/2" depths within stud cavity



520-62

Part #	Mfg #	Adjusting Size	Price
187711	520-626	17-26"	

### Full-Slip Male Adapter (Female Swt x MIP Thread)

- Eliminates tedious measuring
- Replaces male adapters when hex is not necessary



Part #	Mfg #	Brass F Swt x MIP Thread	Price
177370	614-2	1/2" x 1/2"	
183529	614-3	3/4" x 3/4"	
183532	614-4	1" x 1"	

## Tubing Brackets

### PowerBar™ Universal Brackets

#### PowerBar® Universal Slider Bracket TouchDown™ Universal Pipe Clamp

- Clamps 1/4" – 1" CTS (copper, CPVC or PEX) tube and 1/8" - 1" Sch. 40 pipe
- Optional PipeDown™ noise absorption blocks available

#### PowerBar™ for 14"–26"



Part #	Mfg #	Brackets	Clamps	Price
178130	523-2404	1	—	6
150890	523-2424	1	2	4

#### PowerBar™ for 9"–16"



Part #	Mfg #	Brackets	Clamps	Price
181335	523-1610	1	1	—

#### TouchDown™ Clamp with PowerBar™ Foot

Part #	Mfg #	Bases	Bridges	Inserts	Price
151611	522-101	—	100	—	

### PowerBar™ Light Duty Mini Strut—20 Gauge Steel

- Single Bracket with two pre-drilled holes accepts 3/8" threaded rod
- Available with or without pre-loaded TouchDown™ clamps
- Ideal for a variety of overhead piping needs



523-2MS3

Part #	Mfg #	Bracket	Clamps	Price
156294	523-2MS3	1	3	

### Strong Arm™ Bracketing System

#### Strong Arm™ Bracketing System with Lock Block™

- Rigidly secures any 1/2"-1" CTS stub out
- Lock Blocks™ are pre-assembled on a pair of brackets or available with 2-1/2" screws
- Twisted brackets mount to the face of the stud and L-bent brackets mount inside stud
- Lock Blocks™ compress on tube and brackets after screws are tightened



#### Strong Arm™ with Standard Lock Blocks™ (For 16" Stud Bays)

Part #	Mfg #	Bracket	Lock Block	Price
243496	525-1613	StrongArm	(1) 3/4" Lock Block™	
243497	525-1614	StrongArm	(1) 1" Lock Block™	

#### Strong Arm™ Bracketing System with PEX Bend Lock Block™ CTS Tube Clamp

- Rigidly secures any CTS stub-out and prevents movement
- Lock Blocks™ are pre-assembled on each pair of brackets
- Twisted brackets mount to the face of the stud
- Lock Blocks™ compress on tube and brackets once screws are tightened down
- For use with any 1/2" - 1" CTS pipe (copper, PEX, CPVC, PB)



525-161P

#### Strong Arm™ with Standard Lock Blocks™ (For 16" Stud Bays)

Part #	Mfg #	Bracket	Lock Block	Price
183444	525-161PB	Twisted	1 PEX Bend	
123159	525-161PBL	L-Bent	1 PEX Bend	
129806	525-162PB	Twisted	2 PEX Bend	

#### Strong Arm™ with PEX Bend Lock Block™ (For 24" Stud Bays)

Part #	Mfg #	Bracket	Lock Block	Price
159440	525-242PB	Twisted	2 PEX Bend	



## Tubing Brackets

### StrongArm™ Bracketing System with Lock Block™ CTS Tube Clamp For 16" Stud Bays

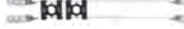
- Rigidly secures any 1/2" – 1" CTS  stub out and prevents all movement 525-162
- LockBlocks™ are pre-assembled on a pair of brackets or available with 2-1/2" screws to mount directly to structure
- LockBlocks™ compress on tube and brackets after screws are tightened
- Twisted brackets easily mount to the face of the stud and L-bent brackets mount inside the stud cavity
- Brackets-16 gauge galvanized steel
- Standard (black) blocks-ABS

#### Strong Arm with Standard Lock Blocks (For 16" Stud Bays)

Part #	Mfg #	Bracket	Lock Block	#	Price
222428	525-1612	Twisted	1/2"	1	
118450	525-1622	Twisted	1/2"	2	
183445	525-1622PK	Twisted	1/2"	2	
	1				

#### Strong Arm with Standard Lock Blocks (For 24" Stud Bays)

Part #	Mfg #	Bracket	Lock Block	#	Price
159439	525-2422	Twisted	1/2"	2	

### StrongArm™ Vent Support

- Secure directly to vent pipe when studs are not available (ideal for pedestal and island sinks) 
- Completely pre-assembled to reduce labor
- Snap-lock band secures to 1-1/2" – 2" DWV 525-162PBV

#### Strong Arm with PEX Bend Lock Blocks & Bands (Vent Pipe Application)

Part #	Mfg #	SS Band	Block	Clamp	Price
183447	525-162PBV	Snap	(2)1/2"	Saddle	

### PEX Bend LockBlock™

- Plastic elbow swivels 360°
- Secure bend elbow only (without LockBlocks™) directly to the studs 

239720	525-P2M1	Face Plate w/ PEX Bend Support			
--------	----------	--------------------------------	--	--	--

## Tubing Brackets

### PexRite® for PEX

#### 708 PexRite® Pop-Up™ In-Slab Flexible Tube Support

**PEXRITE®**

- Manifold capability with interlocking feet
- Compatible with PEX, soft copper, flexible conduit
- Unique design allows for side-entry of tubing



Part #	Mfg #	Description	Price
121159	708	2 Tubes, Up to 1-1/8" OD	

### ProGuard™ PEX Supports

#### ProGuard™ Turn-Out Support

- Eliminates in wall fittings & concealed joints
- For use with #SB3 & #SB4 brackets only
- Prevents unwanted turning radius that may cause PEX to kink
- Provides PEX stub outs with the ideal turning radius



Part #	Mfg #	Pipe Size	Price
179849	734	1/2"	

#### ProGuard™ Stub-Out Clamp Support

- For 1/2" CTS PEX-to-copper transition, copper or CPVC at lavatory/sink or toilet
- Integrates with model #SB3 and #SB4
- Use w/ PEX, CPVC or copper tubing
- Flame Rated: UL 94 V-0



Part #	Mfg #	Pipe Size	Price
179847	731	1/2"	
179848	732	3/4"	

### Overhead Supports

#### Variable Strut Clamp

- Variable-size isolated strut clamp
- Ideal for securing Copper, PEX, CPVC and gas tubing directly to strut/channel
- No tools required
- Fire retardant framework meets requirements UL 94 V-2 rating
- Sound-rated/isolation pads to reduce noise & vibration

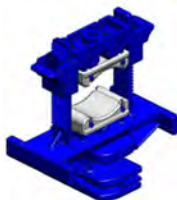

Part #	Mfg #	Size	Pipe Size	Price
179857	287-P	3-1/2"x4-7/8"	1" - 2"	
179856	257-P	2-1/2"x2-7/8"	3/8" - 1"	

### Telescoping Supports

#### Stout Bracket

- Galvanized steel
- Supports CPVC, copper, & PEX tubing
- Supports both 2-eared & 3-eared 90s



Part #	Mfg #	Size	Price
179845	SB3	10-1/4" - 17-1/2"	
179846	SB4	15-1/4" - 25-1/2"	

### Prefab Brackets

#### Copper Pipe-on-Pipe Bracket

- Ideal for horizontal applications such as plumbing chase walls
- Easy pre-fabrication at the shop or on the job site
- Mounts to waste/vent pipe or building structure prior to studs being erected
- Copper-Bonded, heavy-gage steel bracket, Supports 1/2" to 3" tubing with a 250 pound load capacity
- Comes with self-locking stainless steel band and isolating felt pad



Part #	Mfg #	Description	Price
183754	V2	4-1/2" x 4-1/2"	

### Firestopping Products

#### HydroFlame™ Pro Series Telescoping Sleeves

- For insulated & non-insulated pipes
- Includes locator whiskers
- Cut to as short as 2-1/2"
- Dimensions on sleeves
- Interlocking base capability
- Telescoping design adjusts from 8" to 12", in 1/4" increments
- Extensions available for slabs over 12"



Part #	Mfg #	Pipe Size	Pipe Type	Price
230972	HFP-P4	3"-4"	Plastic & Metal	



## Tubing Brackets

### HydroFlame™ Pro Series Closet Flange Sleeve

- UL Listed firestop device – 3 hour F-Rating
- Models for 3" or 4" toilet flanges (flanges not included)
- For both plastic and no-hub cast iron drain piping
- Mid-body seal provides water-tight penetration
- Adjustable height sleeve up to 12"
- Extensions are available for slabs over 12"

Part #	Mfg #	Pipe Size	Pipe Type	Price
230976	HFP-CF3PL	3"	Plastic	

### HydroFlame™ Pro Series Shower Drain Sleeve

- UL Listed firestop device – 3 hour F-Rating
- For 2" shower/floor drains (drain not included)
- Allows for a recessed drain body in shower pans and shower stalls
- Accepts plastic drain piping
- Adjustable height sleeve – up to 14 ¾" slab height
- Extensions available

Part #	Mfg #	Pipe Size	Pipe Type	Price
230975	HFP-SH2-DRN	2"	Plastic	

## Misc. Fittings

### TestRite PVC/DWV Test/Cleanout Tee with Plug

- TESTRITE PVC DWV Test/Cleanout Tee with Plug
- Includes PVC Test/Cleanout Tee, PVC Spanner Ring and Cleanout Plug
- Ideal for horizontal and vertical testing
- Made in the USA
- Lab tested and IAPMO (UPC/IPC) Listed



Part #	Mfg #	Pipe Size	Price
180002	TRPVC2A	2"	
180003	TRPVC3A	3"	

## Vacuum Breakers

### Watts Vacuum Breakers

#### LF288A Series Anti-Siphon Irrigation Vacuum Breaker (FNPT)

- To prevent back siphonage of contaminated water into potable water supply
- Health hazard cross-connections not subject to continuous pressure
- Maximum temperature: 180°F
- Maximum working pressure: 125 psi



Part #	Mfg #	Model	Size	Finish	Price
157297	0792037	LF288A	3/8"	Plain Brass	
157298	0792038	LF288A	1/2"	Plain Brass	
157299	0792039	LF288A	3/4"	Plain Brass	
157303	0792052	LF288AC	1/2"	Pol Chrome	
157304	0792053	LF288AC	3/8"	Pol Chrome	

#### LF800 Anti-Siphon Vacuum Breaker

- Anti-Siphon Pressure
- Replaceable plastic seat
- Easy maintenance of internal parts
- Acetal bonnet acts as "freeze plug" to prevent body damage
- O-ring bonnet seal
- Silicone seat disc for durability
- Test cocks positioned for easy testing and winterization
- Compact space saving design
- Standardly equipped with tee handle quarter turn ball valve shut offs
- 1/2" – 1" (15 – 25mm). The 1 1/4" - 2" (32 - 50mm) feature lever handles.



Part #	Mfg #	Model	Size	Price
157198	0792010	LF800M4-QT	1/2"	
157211	0792011	LF800M4-QT	3/4"	
157212	0792012	LF800M4-QT	1"	

#### LF008PCQT Anti-Siphon Spill-Resistant Vacuum Breaker

- Standardly supplied with internal polymer coating
- Standardly supplied with Tee handles
- Available less Tee handle with stem wrench flats
- Available in left-handed or right-handed outlet
- Spill-resistant design for indoor use
- Modular cartridge for ease of service
- Vent uses an O-ring for reliable operation
- Lead Free\* cast copper silicon alloy body for durability
- Compact space saving design



Part #	Mfg #	Model	Size	Price
157167	0792024	LF008PCQT	1/2"	

#### LFN36 Water Service Vacuum Relief Valve

- Low profile
- All Lead Free\* brass body
- Protective cap
- Suitable for low pressure steam and water service
- Tested and rated to ANSI Z21.22
- CSA certified



Part #	Mfg #	Model	Size	Price
156646	0556030	LFN36-M1	1/2"	
157272	0556031	LFN36-M1	3/4"	

## Vacuum Breakers

### Vacuum Breakers

#### Nidel® Single Check Anti-Siphon Vacuum Breaker

- ASSE 1011
- H Models: for non-freezing areas only
- HD Models: for freezing areas
- HA Models: Std on models 25 and 65
- HF Models: Std on models 24, 43, 44, 45, 46, 74, 75 and 84



34H



34HA



34HD



34HF

Part #	Mfg #	Description	Price
011713	34H-CH	Chrome	
023046	34HA-CH	Chrome	
011728	34HA-BR	Brass	
011714	34HD-CH	Chrome	
047118	34HF-CH	Chrome	

#### Vacuum Breaker Kit

Part #	Mfg #	Thickness	Price
119024	RK-17VB	For Model 17	

### Backflow Preventers

#### Nidel® Double Check Anti-Siphon Backflow Preventer

- ASSE 1052
- HA Models: Std on models 67
- 37HA converts model 65 to model 67
- HF Models: Std on models 76, 79, 86



Part #	Mfg #	Description	Price
065086	37HA-CH	Chrome	

#### SL-17 Stem Lock for 17 Series Wall Faucets

- Vandal resistant



Part #	Mfg #	Description	Price
139153	SL-17	17 Series	



## Access Panels

### Access Panels

- For spa pumps and security systems
- Works on ceilings and walls
- No visible clamps or screws



Part #	Mfg #	Size	Price
017283	AP-0808	8" x 8"	
017284	AP-1414	14" x 14"	



## Plumbing Miscellaneous

### Oatey Access Panels

- For plumbing, electrical security systems, telephone, TV, computer cables and sprinkler system applications
- Manufactured from high-impact ABS
- Textured surface
- Reversible - can be flushed-mounted and surface mounted, no framing required
- Can be painted, wallpapered or tiled to match any decor
- 4" x 6", 8" x 8" and 6" x 9" Panels have knockouts to accommodate 1/4" waterlines



Part #	Mfg #	Size	Price
124715	34055	6" x 9"	
027894	34056	14" x 14"	
102464	34044	14" x 29"	
192897	34045	8" x 8"	

### Pipe Sleeves

#### Pipe Guard



Part #	Mfg #	Size	Color	Price
251984	38707	1/2"-1" x 200'	Blue	
251983	38708	1/2"-1" x 200'	Red	



---

---

## Access Panels

---

---

### Access Panels

#### One-Piece Plastic Access Panel

- Provides economical access to pressure and drainage plumbing, pipes and wiring
- Surface allows for painting or wallpapering
- Four countersunk holes
- 1/8" thick



Part #	Mfg #	Size	Material	Price
159813	970-112	White ABS	12" x 12"	

**RTV Sealants**

**Silicone RTV Sealants**

**RD PRO® 100% Silicone Sealant, Heat Resistant RTV**

- Withstands temperatures up to 600°F
- Solvent cleanup
- 50-Year warranty



Part #	Mfg #	Size	Color	Price
024216	0809OI	10.1 oz	Red	

**RD PRO® 100% Silicone Sealant, Industrial Grade RTV**

- 100% Silicone
- Remains flexible and resists vibration
- Interior/exterior use
- Solvent clean up, not paintable
- 50-Year durability



Part #	Mfg #	Size	Color	Price
008383	0816OI	10.1 oz	White	
118017	0816/5I	10.1 oz	Gray	



## Adhesives & Sealants

### Waterproofing Products

#### Waterplug® Hydraulic Cement Mortar

- *Waterproof cement-based coating for concrete, block, brick or stucco*
- *Can be used above or below grade, interior or exterior*
- *Resists water under pressure or wind-driven rain*



Part #	Mfg #	Description	Price
115728	T5002	10 lb Can	

## Adhesives & Sealants

### Adhesive Sealing Compounds

#### Pro-Air Spray Adhesive

- Disposable cylinder
- Pressure sensitive aerosol
- Coverage: 90-100 Square feet per lb



Part #	Mfg #	Weight	Price
193493	GP1-40BL	38 lbs.	

#### Pro-Air Duct Sealant

- For indoor/outdoor use
- UL 181 AM-BM listed
- Use on metal heating, ventilating, & A/C duct systems
- Also use on fiberglass duct board & flex duct systems
- Recommended for use to 10" of water column pressure without the need for fiberglass mesh reinforcement



Part #	Mfg #	Description	Price
194137	800-008	10.5 oz. Gallon Tube	
194959	800-009	1 Gallon Pail	

#### Silicone Sealant

- Food grade 100% RTV
- 450° UV & water resistant
- Use in standard caulk gun or in 3 fl. oz. squeeze tube



Part #	Mfg #	Size	Type	Price
193565	7-4100	10.3 fl. oz. Tube	White	

#### Sure-Stick Adhesive Spray

- Wide web spray
- Water-proof
- Transparent
- Non-staining
- Not for use on vinyl



Part #	Mfg #	Description	Price
162305	315-20	12 oz Aerosol	

### PRO-TITE™ Resin Based Thread Sealant

- Resin based thread sealant
- For use on metals and plastics subject to extreme vibration
- Serviceable at temperatures from -100°F (-73°C) to 400°F (204°C) and from full vacuum to 10,000 PSI.
- Pro-Tite™ is impervious to most chemicals including refrigerants, petroleum products, gases, steam, etc
- Alcohol based



Part #	Mfg #	Description	Price
213689	CLL-1	1.4 oz	

### Foam Sealant - One Component

- One component closed-cell expanding polyurethane foamsealant for lineal caulking applications
- Tack free in 20 minutes; fully cured in 12 hours
- Use for insulating and sealing around windows, doors, pipes, ducts and vents
- Air-moisture cure
- Paintable
- Non-toxic when cured
- Paint to protect from UV exposure
- R value 4.7 (1in. thickness)
- Foam contains fire retarding chemical and is U.L. Listed but not rated as a firestop product



Part #	Mfg #	Description	Price
209924	01714	12 oz.	

### Adhesive Tape

#### Self-Adhesive Insulation Tape

- Easily cut and molded
- Can be used on hot or cold pipes
- Fits well around valves & fittings



#### Foam

Part #	Mfg #	Size	Color	Price
178041	6-9718	1/8"x2"x30ft Roll	Black	

#### Cork

Part #	Mfg #	Size	Color	Price
178040	6-330	1/8"x2"x30ft Roll	Black	

---

---

**Adhesives & Sealants**

---

---

**Caulk Guns****Caulk Gun**

- *Caulk guns can be used to hold the sealant to seal duct work.*



Part #	Mfg #	Description	Price
193570	7-200	Standard Duty	



## Boxes

### Fire Rated Boxes

#### Fire Rated Box

- 1/4 Turn brass ball valve with water hammer arrestor
- 1/2" ASTM F1960 PEX
- Standard Pack
- For washing machine applications



Part #	Mfg #	Size	Price
186036	38481	Hammer Standard	

#### Fire Rated Box

- 1/4 Turn brass ball valve with water hammer arrestor
- Standard Pack
- For washing machine applications



Part #	Mfg #	Size	Price
116106	38470	Copper Standard	

#### Fire Rated Box - Low Lead

- 1/4 Turn brass ball valve
- F1960
- Standard Pack
- For ice-maker applications



Part #	Mfg #	Size	Price
222725	39120	No Hammer Standard	
186035	39124	Hammer Standard	

### Tub Boxes

- Provides a quick, economical and clean method of installing tub waste and drain
- Manufactured from semi-flexible, very durable plastic polymer
- Built in cut-out for up to 2" Sch 40 drain
- Enables installer to form a clean cavity in a concrete slab so a trap can be easily connected to the drain system
- Bottom ID: 11-1/2" x 11-1/2"
- Top ID: 13" x 13", 6-1/2" Depth



Part #	Mfg #	Description	Price
046615	34080	Standard Tub Box	

### Washing Machine Outlet Boxes

#### 2 X 4 Washing Machine Outlet Box

- Ability to attach water lines from bottom or top
- Mount for condensate line
- Knockout drain caps
- Direct stud mount capability
- Snap-on faceplate frame accommodates up to 1" dry wall
- Two support brackets and direct stud mount for easy mounting
- Box, faceplate, and brackets made from PVC



Part #	Mfg #	Description	Pack	Price
171012	38201	Copper Sweat	Standard	

#### 2 X 4 Washing Machine Outlet Box

- Hammer Assembled

Part #	Mfg #	Description	Pack	Price
227681	38219	Hammer	Standard	

#### Centro II Washing Machine Outlet Box

- 2" Socket hubs
- 2 Support brackets
- 2 Knockout drain caps
- Brackets & faceplate made of HIPS
- Mountable valves on top or bottom
- 2-Pc valves come uninstalled or installed
- Used for commercial & residential applications



#### No Hammer Unassembled

Part #	Mfg #	Description	Pack	Price
243386	38114	1/4" ASTM F1960	Standard	

#### Washing Machine Outlet Box with 1/4-Turn Brass Single Lever Ball Valve



Part #	Mfg #	Description	Pack	Price
047525	38673	Copper Swt	Standard	

## Boxes

### Reversible Metal Washing Machine Outlet Box

- 20 gauge steel
- 2 Support brackets
- 1/2" Removable cap knockouts
- Allows for left or right hand drain
- 2" Drain opening—rubber coupling or solvent weld
- Screw-on faceplate frame accommodates up to 1" drywall (faceplate made of 18 gauge steel)



Part #	Mfg #	Description	Pack	Price
242271	38985	Copper Swt	Standard	

### Washing Machine Outlet Box Valve

- 1/4 Turn
- Single lever valves
- No hammer
- PEX (F1807)

Part #	Mfg #	Size	Color	Price
217596	38977	3/4"	Red	
217595	38978	3/4"	Blue	

### Quadro™ Washing Machine Outlet Boxes

- 2" Drain opening fits PVC or ABS Sch 40 DWV pipe
- Box made of high impact polystyrene
- (4) Support brackets
- Easy to remove knockout
- Snap-on faceplate frame accommodates up to 1" dry wall
- 'Lock and Load' valve mounting system

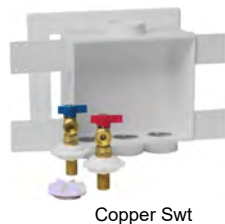

Copper Swt

### QUADTRO™ 1/4-Turn Brass Ball Valve

Part #	Mfg #	Connection	Pack	Price
071807	38530	Copper Swt	Standard	
090793	38532	F1807 PEX	Standard	
071806	38533	WIRSO	Standard	
125083	38577	Quadro Hub/O-Ring	-	
187029	38562	F1807 PEX	Contractor	

### QUADTRO™ 1/4-Turn Brass Hammer Ball Valve

Part #	Mfg #	Connection	Pack	Price
197980	38540	Copper Swt	Standard	
217058	38542	F1807 PEX	Standard	
248121	38543	F1960 PEX	Standard	

### QUADTRO™ Brass Boiler Drain Valve

Part #	Mfg #	Connection	Pack	Price
194139	38552	Copper Swt	Standard	
192945	38554	Copper Swt	NAFTA Stndrd	

### QUADTRO™ Single Lever Ball Valve

Part #	Mfg #	Connection	Pack	Price
137698	38535	Copper Swt	Standard	

### Replacement Valve for Washing Machine Outlet Box

Part #	Mfg #	Description	Price
072033	38870	1/4 Turn Red Valve (Hot) w/Long Shank	
069188	38871	1/4 Turn Blue Valve (Cold) w/Long Shank	

### Ice Maker Outlet Boxes

- Valves comply with requirements of NSF 61, Section 9
- High impact polystyrene boxes

### Center Drain with 1/4-Turn Brass Ball Valves

- (2) Support brackets
- Dimensions
  - Box: 6"H x 6"W x 3-3/8"D
  - Faceplate: 8-1/4"H x 8-1/4"W



Part #	Mfg #	Connection	Pack	Price
048586	38810	Box Only	Standard	
245125	39142	Copper Swt	Standard	

### 12K™ Ice Maker Box with Nails with 1/4-Turn Brass Ball Valve

- Nails preloaded - no support bracket needed
- Right or left hand installation
- Provides quick, safe water supply and shutoff for refrigerator ice maker and water dispenser
- Dimensions:
  - Box: 3-1/4"W x 4"H x 2-1/2"D
  - Faceplate: 5"W x 6"H



Part #	Mfg #	Connection	Pack	Price
145998	38619	Box Only	Standard	
058375	38621	FacePlate	1/2" Deep	

## Boxes

### 12K Ice maker Outlet Box

- Preloaded nails
- Right or left hand installation
- Provides quick, safe water supply and shutoff for refrigerator ice maker and water dispenser
- Dimensions:  
-Box: 3-1/4"W x 4"H x 2-1/2"D  
-Faceplate: 5"W x 6"H



Part #	Mfg #	Size	Price
223965	39125	Copper, Hammer Contractor	
155615	39128	F1960 Contractor	
155614	39132	F1960 Contractor	
155611	39134	Copper Swt Standard	
155612	39136	F1807 Standard	

### Metal Ice Maker Outlet Box

- Made of 20 gauge steel
- Nail plate support brackets
- Dimensions:  
-Box: 5-1/2"W x 5"H x 2-1/2"D  
-Faceplate Interior: 5"W x 5"H  
-Faceplate Exterior: 6-3/4"W x 6-3/4"H



Part #	Mfg #	Size	Price
225777	39140	Copper Hammer Standard	
155619	39141	Copper Swt Standard	

### Square Ice Maker Outlet Box

- 2 Support brackets
- Provides quick, safe water supply and shut off for refrigerator ice maker and water dispenser
- High impact polystyrene
- Dimensions:  
-Box: 6"W x 6"H x 3-3/8"D  
-Faceplate: 8-1/4"W x 8-1/4"H



Part #	Mfg #	Size	Price
155618	39152	Copper Swt Standard	
155616	39155	CPVC Standard	
155123	39158	F1807 Standard	
155617	39161	F1960 Standard	
192946	39156	Copper Swt No Hammer	
248122	39150	F1960 Hammer	

### WMOB and IMOB Faceplate

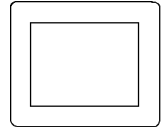

Part #	Mfg #	Description	Price
028026	38940	WMOB White Faceplate - Double Offset	
020797	38941	WMOB White Faceplate - Center Drain & Offset	

### Plastic Icemaker Box Faceplate

- Dimensions: 8-1/4"W x 8-1/4"H



Part #	Mfg #	Description	Price
036530	38942	Square	

### Box Accessories and Parts

#### Moda® Test Plug

- For washing machine, ice maker, lavatory, toilet, dishwasher, and SureVent® Air Admittance valve applications



Part #	Mfg #	Description	Price
149338	38576	DWV 1/4 Turn	

## Boxes

### Ox Box™ Outlet Boxes

#### Ox-Box™ Kitchen Supply Outlet Box with MiniRester™ Water Hammer Arresters

- ABS boxes mount securely to stud or over studs
- Allows for straight and secure supply stops recessed into wall
- Debris covers included to protect boxes from Drywall mud and paint
- 1/4" Ball valves with 3/8" O.D. compression outlet connections



Part #	Mfg #	Connection	Price
244413	696-G3011WR	1/2" PEX F1960	

#### Ox Box™ Ice Maker Outlet Box with Mini-Rester Water Hammer Arresters (No Lead)

- Standard Pack
- Boxes mount securely to stud or over studs
- Durable ABS stands up to job site abuse
- Debris covers included to protect boxes from dry wall mud and paint
- High-quality 1/4 turn ball valve
- 1/4" O.D. Compression outlet connection
- The debris cover protects valves from Drywall mud and paint during construction.



Part #	Mfg #	Connection	Price
144576	696-G1010MF	1/2" FSwt	
183807	696-G1010XF	1/2" PEX F1807	
186555	696-G1010WF	1/2" PEX F1960	

#### Ox-Box™ Washing Machine Outlet Box —No Lead (Standard Pack)

- Boxes mount securely to stud
- Separates supply and drainage systems into (2) stud bays
- Separate boxes offer flexible layout
- Durable ABS stands up to job site abuse
- Drain knockout is easy to remove with pliers
- Debris covers included to protect boxes from dry wall mud and paint
- High-quality 1/4-turn ball valve
- 3/4" Male hose-thread outlet connection

Part #	Mfg #	Connection	Price
183810	696-G2303MF	1/2" FSwt	
174844	696-G2303WF	1/2" PEX 1960	

### Ox Box™ Outlet Boxes (Continued)

#### Ox-Box™ Washing Machine Outlet Box —No Lead (Standard Pack)

Part #	Mfg #	Connection	Price
097546	696-G2303XF	1/2" PEX F1807	

#### Fire-Rated Ox-Box™ Washing Machine Outlet Box (Standard Pack—No Lead)

- Boxes mount securely to stud
- Separates supply and drainage systems into (2) stud bays
- Drain knockout is easy to remove with pliers
- Supply lines can be mounted from above or below
- High-quality 1/4-turn ball valve
- 3/4" Male hose-thread outlet connection

Part #	Mfg #	Connection	Price
187523	696RG2303WF	1/2" PEX 1960	
169781	696RG2303XF	1/2" PEX F1807	

#### Fire-Rated Ox-Box™ Washing Machine Outlet Box with MiniRester™ Water Hammer Arresters

- Standard pack—no lead
- Boxes mount securely to stud
- Separates supply and drainage systems into (2) stud bays
- Supply lines can be mounted from above or below
- High-quality 1/4-turn ball valves with 3/4" male hose-thread outlet connections



Part #	Mfg #	Connection	Price
183816	696RG2303MF	1/2" FSwt	

#### Fire-Rated Ox-Box™ Ice Maker Outlet Box—No lead (Standard Pack)

- Boxes mount securely to stud
- Separates supply and drainage systems into (2) stud bays
- High-quality 1/4-turn ball valves with 3/4" male hose-thread outlet connections
- Supply lines can be mounted from above or below



Part #	Mfg #	Connection	Price
159258	696RG1000WF	1/2" PEX 1960	
165313	696RG1000XF	1/2" PEX F1807	



## Boxes

### Fire-Rated Ox-Box™ Ice Maker Outlet Box with MiniRester™ Water Hammer Arresters—No Lead

- Standard pack
- Boxes mount securely to stud or over studs
- Box mounts easily to stud for top or bottom supply
- High-quality quarter-turn ball valves with 1/4" O.D. compression outlet connection



Part #	Mfg #	Connection	Price
183814	696RG1010MF	1/2" FSwt	

### Ox-Box™ Washing Machine Outlet Box with Two Mini-Rester Water Hammer Arresters

- Standard pack
- Boxes mount securely to stud
- Separates supply and drainage systems into (2) stud bays
- Separate boxes offer flexible layout
- Durable ABS stands up to job site abuse
- Drain knockout is easy to remove with pliers
- Debris covers included to protect boxes from dry wall mud and paint
- High-quality 1/4-turn ball valves
- 3/4" Male hose thread outlet connection



696-2313M

Part #	Mfg #	Connection	Price
183811	696-2313MF	1/2" FSwt	
183813	696-2313XF	1/2" PEX F1807	
175891	696-G2313WF	1/2" PEX 1960, No Lead	

### Ox Box™ Outlet Box

- Made from tough ABS
- Installs directly to stud or by bracket
- May be installed with supply from above or below
- One-hole box for ice maker, two-hole box for washing machine
- Washing machine supply box can be placed above, to the left, and to the right of drain box
- Includes debris cover



Part #	Mfg #	Box Type	Includes	Price
122975	696-R3	Drain	Fire Pad&Frame	

### Ox Box™ Frame

- Textured and paintable ABS
- Single frame for ice maker 696-1F
- Double frame for washing machine application easily splits for separated box installations



Part #	Mfg #	Type	Price
119252	696-1F	Single	
122898	696-2F	Double	

### Ox Box™ Frame Insert

Part #	Mfg #	Description	Price
250263	696-LC	Louvered	
256028	696-SC1	Solid with Valve Cutout	

### Ox Box™ Secondary Drainage Funnel

- Ideal for adding condensate lines to drain box
- Can be used in conjunction with washing machine drain hose
- Drains 7 gpm
- Securely sets into drain box through integral bottom ridges of the drain box
- Two-piece design snaps together for fast installation and easy cleaning
- Fingers in top housing hold 1/2" CTS - 1" DWV piping firmly in place
- UPC Listed to IAPMO PS 65-2002



Part #	Mfg #	Material	Price
125300	696-CF	White ABS	

### OxBox™ Toilet/Dishwasher Outlet Box (No Lead) (Standard Pack)

- ABS boxes mount securely to stud or over studs
- Allows for straight and secure supply stops recessed into the wall
- Eliminates backbreaking labor of cleaning stub outs and installing supply stops
- Debris covers included to protect boxes from drywall mud and paint
- High-quality quarter-turn ball valves with 3/8" O.D. compression outlet connection



696-G1001M

Part #	Mfg #	Connection	Price
183805	696-G1001MF	1/2" FSwt	
180997	696-G1001WF	1/2" PEX 1960	
183806	696-G1001XF	1/2" PEX F1807	

## Boxes

### OxBox™ Toilet/Dishwasher Outlet Box with MiniRester™ Water Hammer Arresters (No Lead)

- Standard pack
- ABS boxes mount securely to stud or over studs
- Allows for straight and secure supply stops recessed into the wall
- Eliminates backbreaking labor of cleaning stub outs and installing supply stops
- Debris covers included to protect boxes from drywall mud and paint
- High-quality quarter-turn ball valves with 3/8" O.D. compression outlet connection



Part #	Mfg #	Connection	Price
151275	696-1011MF	1/2" FSwt	

### OxBox™ Toilet/Dishwasher Outlet Box with MiniRester™ Water Hammer Arresters (No Lead)

- Standard pack
- ABS boxes mount securely to stud or over studs
- Allows for straight and secure supply stops recessed into the wall
- Eliminates cleaning stub outs and installing supply stops
- Debris covers included to protect boxes from drywall mud and paint
- High-quality 1/4"-turn ball valves with 3/8" O.D. compression outlet connection



Part #	Mfg #	Connection	Price
239660	696-G1011MF	1/2" MIP/FSwt	

### OxBox™ Lavatory Outlet Box —No Lead

- ABS boxes mount securely to stud or over studs
- Allows for straight and secure supply stops recessed into the wall
- Eliminates backbreaking labor of cleaning stub outs and installing supply stops
- Debris covers included to protect boxes from drywall mud and paint
- High-quality quarter-turn ball valves with 3/8" O.D. compression outlet connections



696-G2001M

#### Standard Pack

Part #	Mfg #	Connection	Price
183808	696-G2001MF	1/2" FSwt	
180998	696-G2001WF	1/2" PEX 1960	
183809	696-G2001XF	1/2" PEX F1807	

### Rough-In Pack

Part #	Mfg #	Connection	Price
255234	696-G2001WR	1/2" PEX F1960	

### OxBox™ Gas Valve Outlet Box

- 1/4"-turn ball valve for easy, secure, accessible operation
- Box is available for 1/2" or 3/4" iron-pipe applications or 1/2" CSST applications in both standard and fire-rated products
- Recessed box is made of high-impact ABS providing the strongest finished installation for all gas appliance needs
- Valve has CSA certification to ANSI Z21.15-1997 / CGA 9.1-M97



Part #	Mfg #	Valve & Adapter	Price
153746	696-1021GF	1/2" NPT for Iron Pipe	

### OxBox™ No Lead Ice Maker Outlet Box

- Boxes mount securely to stud or over studs
- Durable ABS stands up to job site abuse
- Debris covers included to protect boxes from drywall mud and paint
- High-quality quarter-turn ball valve
- 1/4" O.D. compression outlet connection
- Box mounts easily to stud for top or bottom supply
- The debris cover protects valves from drywall mud and paint during construction.



Part #	Mfg #	Connection	Price
168331	696-G1000XF	1/2" PEX F1807	
255253	696-G1001WR	1/2" PEX F1960	
162651	696-G1000MF	1/2" FSwt	

### OxBox™ ONE Small Profile Laundry Supply & Drain Box with Water Hammer Arresters

- Least obtrusive of any laundry box
- Economical alternative
- Perfect for top mounted supply run from overhead
- Debris cover included

Part #	Mfg #	Connection	Hose	Price
183804	696-2413MF	1/2" FSwt /MIP	3/4"	



## Boxes

### Over/Under™ Two-Piece Plastic Access Panel

- Easily installs before or after wallboard installation
- No need for glue or adhesives
- Can be painted or wallpapered
- Pre-wallboard installation works with 1/2" – 3/4" wallboard thickness
- Provides instant access to plumbing, electrical, telephone and other electronic cables
- Seamless finish panel is beveled and textured
- Durable HIPS material



Part #	Mfg #	Outside	Inside	Price
223845	970-214S	8-1/2"x11-1/2"	6"x9"	

### Hinged Two-Piece Metal Access Panel

- Made in the USA
- Easy installation and can be painted
- Provides instant access to plumbing, electrical, telephone and various other electronic cables



Part #	Mfg #	Outside	Inside	Price
167431	971-1414	15-1/4"x15-1/4"	14"x14"	

## Boxes

### Washing Machine Outlet Boxes

#### Center Drain Galvanized Washing Machine Outlet Box

- 20 Gauge box and faceplate
- G90 Hot dipped galvanized steel (unpainted)
- Includes male threaded drain fitting and locknut
- Rough opening: 8-3/4"H x 10"W x 3-1/2"D
- Faceplate dimension: 9-1/2"H x 11-5/8"W
- Domestic valves
- Unassembled



Part #	Mfg #	Description	Price
004881	82032	B200 1/2" MIP/Swt, 2" Thrd Drain Ftg	
004876	82036	BB200TS Top-Mt 1/2" MIP/Swt, 2" Thrd Drain Ftg	

#### Center Drain Galvanized Washing Machine Outlet Box w/ Duplex & Dryer Receptacles

- 20 Gauge Box / 20 Gauge Faceplate
- G90 Hot Dipped Galvanized Steel (Unpainted)
- Male Threaded Drain Fitting & Locknut Included
- Duplex Receptacle: 20 Amp, 125 Volt
- Dryer Receptacle: 30 Amp, 250 Volt



Part #	Mfg #	Connection	Price
030760	82038	BBED200TS Top Mount 1/2" MIP/Sweat Valves -2" Threaded Drain-Duplex & 3 Wire Recpt.	

#### Right Drain Galvanized Washing Machine Outlet Box with Hammer Arrestor Valves

- Includes male threaded drain fitting and locknut
- G90 Hot dipped galvanized steel (unpainted)
- 20 Gauge box and faceplate



Part #	Mfg #	Connection	Price
158375	82048	WB200HA 2" 1-Lvr Vlv	

### Right Drain Outlet Boxes

- 20 Gauge box
- G90 Hot Dipped Galvanized Steel (Unpainted)
- Male Threaded Drain Fitting & Locknut Included
- Rough Opening: 10" W x 8 3/4" H x 3 1/2" D
- Dimensions: 11 5/8" W x 9 1/2" H



Part #	Mfg #	Connection	Price
030088	82043	WB200 1/2" MIP/Sweat Conx. Single Lever Valve - 2" Threaded Drain	

#### "T" Series Center Drain Washing Machine Outlet Box

- White powder coated cold rolled steel
- 20 Gauge box and faceplate
- Knockouts in top, bottom and sides
- Watertight construction with sloped bottom
- 2" PVC, ABS or slipnut drain kit
- Rough opening: 8-1/4"H x 12-3/4"W x 3"D
- Faceplate dimension: 9-1/4"H x 14"W
- Slipnut to be used with 2" male adapter or 2" pipe nipple (not included)
- Unassembled



Part #	Mfg #	Description	Price
004885	82135	T200TP PVC Domestic MIP, 1/2" Swt, 2" PVC Drain Fitting	

#### FR-12 Washing Maching Outlet Box with Single Lever Valve w/ Hammer Arrestors

- Intumescent pad attached to back of outlet box
- Snap-On frame accommodates two 5/8" drywall
- Preloaded nails for right or left stud bay installation
- 1hr & 2hr Rated
- Made of High Temperature Resin



Part #	Mfg #	Connection	Price
168792	82379	Fire Rated WMOB w/ 1/2" Sweat/ Single Lever/ Arrestor	

**Boxes**

**Center Drain White Powder Coated Econo Metal Washing Machine Outlet Box**

- 20 Gauge Box / 20 gauge faceplate
- White powder coat on cold rolled steel finish
- Lip guard on bottom to prevent overflow
- Extra deep faceplate accommodates up to 2 Pieces of 5/8" drywall
- Reversible right or left and center drain option
- 2" PVC, ABS, or slipnut drain kit
- Slipnut to be used with 2" male adapter or 2" pipe nipple (not included)
- Valves installed



Part #	Mfg #	Connection	Price
140659	82122	MWB13 1/4 Turn Valves Installed - 1/2" Sweat Conx. - 2" Slipnut Drain Kit	

**Ice Maker Outlet Boxes**

**Galvanized Ice Maker Outlet Box**

- 20 Gauge Box / 20 Gauge Faceplate
- G90 Hot Dipped Galvanized Steel (Unpainted)
- Furnished with 1/2" FIP Inlet x 1/4" OD Outlet Compression Angle Valve. Supply Connection is 1/2" MPT or 5/8" OD Sweat Connection
- Rough Opening:  
10" W x 8 3/4" H x 3 1/2" D
- Dimensions: 11 5/8" W x 9 1/2" H



Part #	Mfg #	Description	Price
051338	88158	BIM-875AB 1/2" MIP/Swt	

**White Powder Coated Ice Maker Outlet Box**

- Furnish and install recessed
- Brass quarter turn valve, installed



Part #	Mfg #	Connection	Price
081716	88133	MIB1AB 1/2" Swt Conx	

**Miscellaneous**

**Brass Valve Caps**

- Gasketed, brass valve caps fit any style valve
- Used during testing to protect valve
- Sold in pairs



Part #	Mfg #	Connection	Price
014618	34BRHC	3/4" Cap for Washing Machine Valves	
	A		



---

---

## Sheet Metal Duct & Fittings

---

---

### Galvanized Dryer Vents & Accessories

#### Galv Dryer Box

Part #	Description	Price
064143	Upflow for 2" x 4" Walls	
064144	Upflow for 2" x 6" Walls	
086205	Downflow for 2" x 4" Walls	
087158	Downflow for 2" x 6" Walls	

**Caulk**

**Caulk**

**Bramec® Silicone Sealant**

- Permanently flexible -60° to 450°F
- 100% RTV Silicone
- Insulates thermally and electrically
- Waterproof and weatherproof seal



Part #	Mfg #	Description	Price
094478	20082	10.1 oz Tube, Aluminum	

**Cleaners**

**Sprayway Penetrating Coil Cleaner**

- Delayed foam action
- Deodorizes drain pans
- Reaches hard to get areas
- Non-acid, non-chlorinated, alkaline surfactant
- Dual foaming action expands and flushes coils



Part #	Mfg #	Size	Price
123027	18299	19oz	



## Caulk

### Sealants & Caulk

#### 100% RTV Silicone Rubber Sealant

- 100% Silicone rubber cures and bonds in 24 hours
- Withstands temperatures from -60° to +450°F
- Creates seal between dissimilar materials
- Waterproof, can be used indoors or outdoors
- Dries to the touch in 1 hour
- Meets Federal Specification TT-S-001543A



031350

Part #	Mfg #	Description	Price
044630	031350	10.3 oz Cartridge, White	
017661	031310	Clear	

#### Latex Tub Seal

- Water based acrylic caulk w/silicone for added adhesion and low temperature flexibility
- Easy application, soap and water cleanup
- Fills joints up to 3/8" wide x 3/8" deep
- Tack-free in 30 minutes, paintable in 2 hours with latex or oil based paints



03200

Part #	Mfg #	Description	Price
043425	032005	Clear, 5.5 oz	
017662	PLTUB	White, 5.5 oz	
005561	032106	Bone, 5.5 oz	
068208	032150	Biscuit, 5.5 oz	

### Caulk Guns

#### Economy Caulking Gun

Part #	Mfg #	Description	Price
234965	040010	Caulking Gun	





## Caulk

### Caulk

#### Plumbers Caulk

- *Siliconized acrylic makes flexible, durable, mildew-resistant, waterproof seal*
- *Interior or exterior applications*
- *Flows easily, does not harden in tube or cartridge, does not crumble, and resists shrinkage*
- *Easy clean-up with soap water*



Part #	Mfg #	Size	Color	Price
084092	25641	5.5 oz	Biscuit/Linen	
192909	25605	5.5 oz	Bright White	
192911	25631	5.5 oz	Almond/Bone	

**Caulk**

**Caulk**

**DuraGuard™ Kitchen & Bath Siliconized Acrylic Caulk**

- Provides a durable, watertight seal
- Offers adhesion, flexibility and durability
- Paintable
- Water clean up
- Low VOC
- Mold and mildew resistant



Part #	Mfg #	Size	Color	Price
008382	0406	10.1 oz	White	

**DuraGuard™ Kitchen & Bath Siliconized Acrylic Caulk Squeeze Tube**

- Provides a durable, watertight seal
- Offers adhesion, flexibility and durability
- Paintable
- Water clean up
- Low VOC
- Mold and mildew resistant



Part #	Mfg #	Size	Color	Price
044074	040520	10.1 oz	Almond	

**Caulk**

**Vulkem® 116 Weatherproofing Sealants**

- One-part moisture-curing
- Gun-grade polyurethane sealant
- Flexible
- Does not require primer on most construction materials
- For use in precast, masonry, window frame perimeters, and similar types of construction joints
- Do not apply over damp or contaminated surfaces
- Suitable for continual immersion in water
- Designed for exterior and interior use



Part #	Mfg #	Description	Price
051545	VULKEM116AL	Vulkem #116 Aluminum	
051543	VULKEM116BL	Vulkem #116 Black	
051542	VULKEM116GY	Vulkem #116 Gray	
051546	VULKEM116IVY	Vulkem #116 Ivory	
051544	VULKEM116LS	Vulkem #116 Limestone	
051540	VULKEM116WH T	Vulkem #116 White	
139198	VULKEM116DB	Vulkem #116 Dark Bronze	



## Caulk

### Caulk

#### Alex Plus® All-Purpose Acrylic Latex Caulk Plus Silicone

- Excellent adhesion
- Cured caulk is mold and mildew resistant
- Easy to apply and tool
- Paintable
- Easy water clean-up
- Indoor/outdoor use
- Exceeds ASTM Specification C834
- Highly flexible and durable for a waterproof seal



Part #	Mfg #	Size	Color	Price
177194	18152	10.1 oz	White	
194388	18156	10.1 oz	Clear	

#### Kwik Seal® Kitchen & Bath Adhesive Caulk

- Bonds like glue and seals like a caulk
- Watertight seal
- Mildew resistant
- Paintable



Part #	Mfg #	Size	Color	Price
177196	18032	10.1 oz	White	
194680	18008	5.5 oz	Clear	
190978	18001	5.5 oz	White	
255870	18013	5.5 oz	Almond	

### Silicone Sealants

#### 100% Silicone Kitchen & Bath Sealant

- Silicone rubber sealant
- Waterproof



Part #	Mfg #	Size	Color	Price
177195	08640	9.8 oz	Clear	

### 100% Silicone Window & Door Sealant

- Silicone rubber sealant
- Resists cracking, crumbling and chalking
- Cured sealant is mildew resistant
- Indoor/outdoor use
- Meets ASTM C920, Specification C719, Class 25



Part #	Mfg #	Size	Color	Price
190974	00753	2.8 oz	Clear	
190975	00752	2.8 oz	White	
190977	08641	10.1 oz	Clear	
190976	08646	10.1 oz	White	
213023	08642	10.1 oz	Black	

#### Commercial Kitchen 100% Silicone Sealant

- Suitable for food-zone areas
- Waterproof
- Temp range: -75°F to 350°F
- Meets FDA Reg 21 CFR 177.2600
- NSF to NSF/ANSI Standard #51



Part #	Mfg #	Size	Color	Price
256248	08660	9.8 oz	St Steel	

#### HVAC RTV Silicone Sealant

- Seals All Extreme Temperature Applications
- Long Lasting Durability
- Remains Flexible up to 475°F
- Will Not Crack or Shrink
- Weather Resistant
- Exterior/Interior



Part #	Mfg #	Size	Color	Price
242150	08010	10.3 oz	White	
242151	08011	10.3 oz	Clear	
242152	08012	10.3 oz	Almond	



## Caulk

### High Temp RTV Silicone Sealant

- *Seals All Extreme Temperature Applications*
- *Remains Flexible up to 550°F (INTERMITTENT)*
- *Will Not Crack or Shrink*
- *Weather Resistant*
- *Exterior/Interior*



Part #	Mfg #	Size	Color	Price
242153	08013	10.3 oz	Red	



## Chemicals

### Drain and Waste System Cleaners

#### Clobber® Drain & Waste System Cleaner

- For professional use only, not for retail sale
- Fastest method for clearing emergency waste line stoppages
- No mechanical equipment needed
- Rapidly disintegrates paper, rags, sanitary napkins, food scraps and all organic matter, melts ice and liquefies grease
- Special inhibitors prevent corrosion of cast iron, copper, and steel piping
- Jugs with child-resistant caps packed in plastic bags



Part #	Mfg #	Size	Price
044672	20-205	1 qt	
192877	20-211	1/2 gal	

#### Sizzle® Cleaner

- For professional use only, not for retail sale
- Removes lime, rust, scale, concrete, hard mineral deposits and insoluble salts from water systems, waste lines, humidifiers, heating, processing and air conditioning equipment
- Dissolves urinary salts
- Special inhibitors make it safe for iron, steel, copper, brass, bronze, lead and plastic



Part #	Mfg #	Size	Price
044671	20-305	1 qt	
192878	20-310	1 Gal	

#### Haymaker™ Tankless Water Heater Descaler

- Safe for septic systems and sewers
- Safe for potable water systems
- Removes carbonates, sulfates, phosphates, rust, oxides and other mineral deposits
- Compatible with most commonly found plumbing-related materials including PVC, CPVC, ABS, rubber, steel and most metals
- Other applications include descaling non-aluminum heat exchangers and water heaters
- Extends the life of the appliance when used as part of a regularly scheduled preventative maintenance program
- Citric acid-based, non-corrosive and VOC-free



Part #	Mfg #	Size	Price
216896	35230	32 oz	

#### Haymaker Descaler Kit

- Includes: 3.5 gallon pail, 32oz Haymaker Solution, (2) 5ft hoses w/ 3/4" NPT Fittings, Electric pump with 25' power cord

Part #	Mfg #	Size	Price
217126	35235	Kit	

#### GLUG® Crystals Drain Opener

- Non-acid crystals clear sluggish drains and prevent clogging
- Harmless to metal and plastic pipe, valves and fittings
- Leaves no offensive after-odor



Part #	Mfg #	Size	Price
137613	20-412	16 oz	

#### WHAM® Drain and Waste System Cleaner

- Environmentally safe, biodegradable cleaner for septic tanks and cesspools
- Liquefies and disperses grease, soap, detergents and other organic waste responsible for system failures
- Non-acid/non-caustic formula will not harm digestive bacteria
- Non-corrosive to metal, enamel ware, ceramics and concrete
- Floral scent



Part #	Mfg #	Size	Price
192875	20-110	1 qt	
192876	20-115	1 gal	

#### Cloroben® PT-B101 Bio-Active Build-Up Remover

- Eliminates drain line build up and controls odors with grease and waste digesting bacteria and biodegradable grease and soil removers
- Contains no acids, caustics, solvents or other harsh chemicals
- Safe for use in all types of drainage plumbing
- USDA authorized for use in food processing plants Certified Salmonella sp free



Part #	Mfg #	Size	Price
246658	137303	1 gal	





## Chemicals

### Bacta-Life® Septic System Bacterial Activator

- Blend of specialized microbes, highly potent enzymes, micro-nutrients, and growth accelerators
- Digests grease, soap scum, starch, proteins, carbohydrates and paper
- Contains no acids, caustics or solvents
- Safe for use in all areas of wastewater plumbing
- Use immediately after pumping your septic or cesspool system



Part #	Mfg #	Size	Price
236392	222031	1 lb	

### Hand Cleaners

#### Hercules for Hands™ Anti-Bacterial Hand Cleaning Towel

- Ready-to-use, pre-saturated towels remove plastic pipe cement, grease and grime, tar and ink from users' hands
- Contains aloe, lanolin, and vitamin E
- Towels will not shred and leaves no residue



Part #	Mfg #	Description	Price
063184	45-333	Dispenser Tub of (70) Towels	

#### Hercules for Hands™ Pumice Lotion Hand Cleaner

- Removes plastic pipe cement, sealants, adhesives, caulks, paints, tar, printer's ink and grease
- With aloe vera, vitamin E and lanolin
- Non-irritating formula with citrus scent
- Requires no water and no rinsing
- Dries immediately leaving no residue



Part #	Mfg #	Size	Price
192899	45-325	15 fl oz	



---

---

## Chemicals

---

---

### Drain Systems

#### Septic Tank Accelerator

Part #	Mfg #	Description	Price
004206	SA-13	13 oz	

## Chemicals

### Flush N' Sparkle™ Toilet Cleaning System

- *Repels stains*
- *Leaves no residue*
- *8100 Is surfactant-based cleaning agent*
- *Easily installed*
- *5-Year warranty on dispenser*



Part #	Mfg #	Description	Price
064607	8100	Flush N Sparkle™ Toilet Bowl Cleaner	
064609	8102	Flush N Sparkle™ Refill Cartridge for 8100	
071473	8300	Flush N Sparkle™ Toilet Bowl Cleaner	
071475	8302	Flush N Sparkle™ Refill Cartridge for 8300	

### Bio Balance™ Septic Tank Care System

- *Instant septic bio-action with every flush*
- *No residue or harsh chemicals*
- *Repels stains and mineral build-up*
- *Easy to install*
- *5-Year warranty on dispenser*



Part #	Mfg #	Description	Price
064608	8200	Bio Balance™ Septic Tank Care System	
064610	8202P8	Bio Balance™ Septic Tank Care Refill cartridge	

**Chemicals**

**Drain Openers**

**Safe on Pipes, Traps and Septic Systems**

- Santeen S-T Drain Opener is a unique formulation of concentrated sulfuric acid that will quickly dissolve all rags, paper and organic blockages such as: grease, hair, bone scraps, coffee grounds, rinds and soap
- Professional strength



Part #	Mfg #	Size	Price
009806	S-T	1 qt	

**De-Limer/Cleaners**

**Chrome & Tile Cleaner**

- A unique formulation of phosphoric acid in an industrial strength formula that is effective for cleaning brick, chrome, stainless steel, enamel, tile, brass, copper, porcelain and shower doors
- Dissolves rust, lime and scale



Part #	Mfg #	Size	Price
009799	Chrome-R-Tile	22 oz	
009808	Chrome-R-Tile	1 qt	

**Parts & Accessories**



Part #	Mfg #	Description	Price
009804		Nylon Acid Proof Applicator	

**Chemicals**

**Drain Cleaners**

**Non-Acid Drain Cleaner**

- For use on small drains, grease traps, septic systems, root control
- Dry, odorless crystals activated by water and within 60 seconds clears blockage



Part #	Mfg #	Size	Price
010369	T-100	1 lb	
191006	T-200	2 lb	
033389	T-600	6 lbs	

**Super-Pro Heavy-Duty Acid Drain Cleaner**

- Environmentally safe
- Safe odor
- No need to evacuate water from facilities
- For use on small drains, waste lines, traps, tubs & toilet bowls, shower stalls



Part #	Mfg #	Size	Price
025629	SP-32	32 oz	

**Calci-Buster**

- Removes scale and clogs
- Dissolves calcium, magnesium, sodium, lime and rust without harming pipes



Part #	Mfg #	Size	Price
133879	CB-32	1 Qt	

## Chemicals

### Industrial Acid Cleaners

#### Calci-Solve® Drain Cleaner

- For cleaning boilers, heaters, water pumps, evaporators, heat exchangers, and other air conditioning equipment
- Rids drains of clogs and odors
- Removes scales from lines



Part #	Mfg #	Description	Price
007784	4134-24	1 qt Bottle	
007783	4134-08	1 gal Bottle	



## Chemicals

### Cleaners

#### Floweasy™ Drain Opener

- Made in USA
- Sold only in full case quantities
- Will not harm metal, PVC pipe or septic tanks, and is safe to use for all common drains, cleanouts, sinks and toilets.
- Powerful – proprietary formulation of 94% virgin sulfuric acid with 12 buffers/inhibitors that dissolves any organic material including coffee grounds, grease, hair, paper, sanitary napkins, rags, sludge and/or soap.
- Professional strength unclogs drains fast -- the clog is typically free-flowing within 15-minutes of treatment.
- Little to no odor with safety-focused packaging including a child-proof cap on the quart bottles and a metal heat-welded seal on all bottles.

963-HTL-FE2



Part #	Mfg #	Bottle Size	Price
177651	963-HTL-FE2 0	20 Ounces	
177652	963-HTL-FE3 2	1 Quart	

**Cleanouts & Covers**

**Cast Iron Specialties**

**Cleanout Cover Plate with Bolts**

- Polished stainless steel
- Countersunk hole will accept both 1/4" and 5/16" bolts
- Covers unsightly waste cleanouts
- Polished face covered with protective paper
- 22 Gauge metal
- Includes 1/4" x 20" x 4" bolts

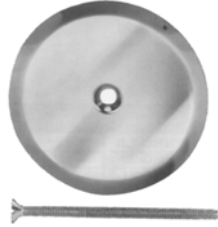

Part #	Mfg #	Plate Size	Price
008062	1840	3"	
008063	1841	4"	
008064	1842	5"	
008065	1843	6"	
008066	1845	8"	

**Cleanout Cover Plate Bolt**



Part #	Mfg #	Size	Price
008052	1649	1/4" x 20" x 4"	

## Cleanouts & Covers

### Round Covers

#### Commercial Flat Cleanout Cover

##### ABS

- Models in chrome plated, white and ivory finishes

Part #	Mfg #	Finish	Dia.	Price
036901	871-4	White ABS	4-1/2"	
045440	871-6	White ABS	6-1/2"	
133035	871-8	White ABS	8-1/2"	

##### Stainless Steel

- 20 gauge

Part #	Mfg #	Finish	Dia.	Price
005897	3EXCV	20g Stainless Steel	3"	
005898	4EXCV	20g Stainless Steel	4"	
005899	5EXCV	20g Stainless Steel	5"	
005900	6EXCV	20g Stainless Steel	6"	
005901	8EXCV	20g Stainless Steel	8"	
123074	12EXCV	20g Stainless Steel	12"	

##### Stainless Steel

- 16 gauge

Part #	Mfg #	Push-Joint	Height	Dia	Price
190745	4EXCVSS	16g Stainless Steel		4"	
190746	5EXCVSS	16g Stainless Steel		5"	
190747	6EXCVSS	16g Stainless Steel		6"	

#### Commercial Raised Cleanout Cover

- Includes head adapter, ring and cover
- 1-1/4" High
- Flat ABS models in chrome plated, white and ivory finishes
- Stainless steel models in standard 20 gauge or thicker, stronger 16 gauge



871-16

Part #	Mfg #	Finish	Dia.	Price
143195	871-16	White ABS	7-1/4"	
057828	872-16	Chrome ABS	7-1/4"	

#### Commercial Finish Line™ Halo™ Cover

- Includes head adapter, ring and cover

Part #	Mfg #	Finish	Dia.	Price
227609	834-3HNR	Nickel Bronze	5-1/2"	

### Square Covers

#### Commercial Finish Line™ Cover

- Includes head adapter, ring and cover
- Nickel-bronze covers for use in pedestrian areas.
- Ductile iron covers for use in heavy duty applications



834-4DHNQ

Part #	Mfg #	Finish	Size	Price
145763	834-4DHNQ	Nickel Bronze	6-5/8"	

### Cleanout Plugs

#### Commercial Cleanout Bushing—ABS

- Bushing fits inside Sch 40 pipe
- Plug has threaded brass insert



875-4P

Part #	Mfg #	Plug Size	Color	Conn.	Price
141447	875-3P	2-1/2"	White	3"	
079414	875-4P	3-1/2"	White	4"	

#### Commercial Rough-In Cleanout—Push-Joint Connection

- Includes: base adapter, coring sleeve & coring plug
- Coring plug material: high-impact polymer
- Pre-pour height:
  - (834-63DF) 5-5/8" - 6-7/8"
  - (834-64DF) 5-7/8" - 7-1/8"

Part #	Mfg #	After Pour Height	Conn.	Price
183923	834-63DF	4-3/4"	3"	
183924	834-64DF	5"	4"	

## Cleanouts & Covers

### Round Cleanouts

#### Commercial Halo™ Round Cleanout—Ductile Iron

##### (3" No Hub Connection— with Deck Flange )

- Includes rough-in cleanout & boxed finish fixture
- Base and head adapter: ductile iron
- Ring and Strainer: nickel bronze, 301 stainless steel
- Head adjusts up to 3/4" above flush to accommodate most flooring types
- Stainless steel deck flange and T-cone style cleanout plug
- 9-1/2" Deck flange (18-gauge 430 stainless)
- 4-3/8" Body height
- Adjustable finish height: round/ square —0"-3/4"/5/16"-3/4"
- Sealing plug: elastomer gasket, polypro drive screw
- Installs easily in cored concrete floors or corrugated decks
- Finish Line™ models are adjustable AFTER the pour

Part #	Mfg #	Finish	Dia.	Price
183872	822-C3DNR	Nickel Bronze	5-1/2"	

#### Commercial Finish Line™ Round Cleanout (Ductile Iron—No-Hub Connection)

- Adjustable AFTER the pour
- Poly coring plug
- Ductile iron base adapter with polypro cleanout plug.
- Ductile iron coring sleeve and head adapter.
- Nickel-bronze covers for use in pedestrian areas.
- Ductile iron covers for use in heavy duty applications

834-4DNR



• Connection	• Pre-Pour Height
• 3" No-Hub	• 5-1/4" - 6-1/2"
• 4" No-Hub	• 5-1/2" - 6-3/4"

- After-pour height: 0-1-1/4"
- (-H) Special duty reinforced cover

Part #	Mfg #	Finish	Conn.	Dia.	Price
183920	834-4DIR	Ductile	3"	6-1/2"	
183921	834-4DNR	Nkl Bronze	4"	6-1/2"	
250743	834-4DNRH	Nkl Bronze	4"	6-1/2"	

#### Commercial FinishLine™ Round Cleanout (Ductile Iron—Push-Joint Connection)

- Adjustable AFTER the pour
- Ductile iron base adapter with polypro cleanout plug.
- Ductile iron coring Sleeve and head Adapter.
- Poly Coring Plug
- Nickel-bronze covers for use in pedestrian areas.
- Ductile iron covers for use in heavy duty applications

• Connection	• Pre-Pour Height
• 3" No-Hub	• 5-5/8 - 6-7/8"
• 4" No-Hub	• 5-7/8" - 7-1/8"

- After-pour height: 0-1-1/4"

Part #	Mfg #	Finish	Conn.	Dia.	Price
183925	834-64DIR	Ductile	4"	6-1/2"	
183926	834-64DNR	Nkl Bronze	4"	6-1/2"	

#### Commercial FinishLine™ Adjustable Cleanout (Ductile Iron—No-Hub Connection)

- Adjustable AFTER the pour
- Includes rough-in cleanout, boxed in finish fixture, and ring & cover
- Ductile iron base adapter with 6" polypro cleanout plug
- Medium-duty nickel-bronze and stainless steel covers
- Ductile iron cover for use in heavy-duty applications

Part #	Mfg #	Finish	No-Hub	Price
183928	834-6DNR	Nickel Bronze	6"	

#### Commercial Adjustable Cleanout—Cast Iron (Push-Joint Connection)

- Neoprene gasket, polypro plug with threaded brass insert included
- Over 1-1/2" of vertical adjustment available
- Nickel-bronze and tenzalloys covers for use in pedestrian traffic areas
- Cast iron covers for use in heavy duty applications
- Push-joint connection is the same size as plug



851-64N

##### Nickel Bronze Cover

Part #	Mfg #	Height	Conn.	Dia.	Price
183993	851-64N	4"-5-1/4"	4"	6"	
183994	851-66N	4-3/4"-6"	6"	8-3/8"	

## Cleanouts & Covers

### Square Cleanouts

#### Halo™ Cleanout Adjustable Cleanout with Deck Flange Ductile Iron No-Hub Connection

- 3" no-hub connection
- Head adjusts up to 3/4" above flush to accommodate most flooring types
- Stainless steel deck flange and T-cone style cleanout plug
- Finish Line™ models are adjustable AFTER the pour
- Installs easily in cored concrete floors or corrugated decks



#### Complete Assembly

Part #	Mfg #	Finish	Conn.	Dia.	Price
257532	822-CF3DNQ	Nkl Brz	3"	5-7/8"	

### Accessories

#### Commercial Cleanout Cover Accessories

- 1/4" x 20 threaded wall bar carpet marker for cleanouts
- 1/4" x 20 cleanout cover screw 874-6

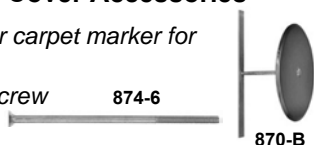

#### Threaded Wall Bar

Part #	Mfg #	Length	Price
152568	870-B	9"	

#### Cleanout Cover Screw

Part #	Mfg #	Finish	Length	Price
036902	874-3W	Epoxy White	3"	
154091	874-6W	Epoxy White	6"	

#### Stainless Steel Screw

- Bolt for ext cover

Part #	Mfg #	Finish	Length	Price
005895	144BLT	1/4" x 4"	Stainless Steel	
005896	146BLT	1/4" x 6"	Stainless Steel	

#### Commercial Wall Cleanout Cover Kit

- 20 Gauge stainless steel
- Available with 9" wall bar or countersunk brass plug

#### Cover, Screw and Countersunk Brass Plug (2-1/2" Screw Length)

Part #	Mfg #	Cover Dia.	Plug Size	Price
168952	873-460	6"	4" IPS	

### Cover, Screw, and 9" Bar

Part #	Mfg #	Cover Dia.	Screw Size	Price
177008	870-B6	6"	6"	
253196	870-B8	8"	6"	

#### Commercial Replacement Covers for Cleanouts

- Fits: 851 series
- Options: (B)
  - Beveled edge for floor plate
  - (not available on cast iron covers)

Part #	Mfg #	Finish	Dia.	Price
227379	851-CT8-B	Tenzalloy	8-3/8"	

#### Commercial Replacement Covers for Cleanouts

- Fits: 834 series, 852 series
- 3/16" Thickness

#### Nickel Bronze Cover with Screws

Part #	Mfg #	Dia.	Screws	Price
183999	852-CN3	5-1/8"	3-7/8"	
184000	852-CN4	6-1/8"	4-7/8"	

#### Commercial Vandal Resistant Screws & Bits

- 1/4" Shank
- 1/4"-20 Size
- Snake-eye pattern

Part #	Mfg #	Finish	Length	Price
253224	850-V425	Stainless	2-1/2"	

## Cleanouts & Covers

### Cleanout Covers

#### Flat Cover Plate

- 5 in in diameter and 1-1/4 in depth
- Provides a clean look and allows easy access to the cleanout plug (sold separately)
- Individually bagged to protect the finish
- Use to conceal a cleanout plug



Part #	Mfg #	Size	Price
252110	34410	4"	
252109	34411	5"	

#### Bell Cover Plate

- 5 in in diameter and 1-1/4 in depth
- Provides a clean look and allows easy access to the cleanout plug
- Individually bagged to protect the finish
- Use to conceal a cleanout plug



Part #	Mfg #	Size	Price
252107	34420	4"	

### Cleanouts

#### Cleanout w/ Cover and Round Ring



Part #	Mfg #	Size	Strainer Size	Price
252125	74137	4"	6"	



## Concrete Mix & Gravel

### QUIKRETE® All Purpose Gravel



- High quality clean gravel w/ approximate top size 3/8"
- For landscaping, concrete manufacture and a variety of other purposes
- Meets ASTM C33, standard specification for concrete aggregates

Part #	Mfg #	Size	Pack Qty	Price
116235	105521	50 lb Bag	56/Pallet	

### QUIKRETE® Concrete Mix

- Pre-blended mixture of cement and aggregates for general structural uses, requiring only the addition of water
- Designed for pouring concrete 2" thick or more and building or repairing anything out of concrete



Part #	Mfg #	Size	Pack Qty	Price
004904	101356	60 lb Bag	56/Pallet	

### QUIKRETE® Mortar Mix - Type N

- Construction grade mortar mix designed for laying brick, concrete masonry units and stone
- Pre-blended, sand product
- Just add water
- Standard formulation meets ASTM C 270 and C 1714 for type N mortar



Part #	Mfg #	Size	Pack Qty	Price
006485	100533	60 lb Bag	56/Pallet	

### QUIKRETE® Sand Mix

- Consists of a uniformly blended mixture of Portland cement and commercial grade sands
- Used for repairing and topping damaged concrete surfaces less than 2" thick
- Just add water
- 5,000 psi



Part #	Mfg #	Size	Pack Qty	Price
009803	101231	60 lb Bag	56/Pallet	



## Concrete Mix & Gravel

### Concrete Mix Cement Stop Leak

- Perfect for patching sewer outlet, water service and around drains
- Sets up in just five minutes
- Mixing cup included in each jar
- 5 lb. plastic jar



Part #	Mfg #	Description	Price
184082	963-05	5 lb. Plastic Jar	



## Fire Caulk

### Fire Rated Sealants

#### Roof and Flashing Sealant

- Special bituminous composition with superior adhesion under the most severe weather conditions
- Heavy, paste-like consistency, easily applied with trowel or putty knife
- Adheres to wet/moist surfaces - can be applied in rain
- Forms durable, flexible, weatherproof coating



Part #	Mfg #	Size	Price
135939	25403	10.3 oz	

#### Firestop Caulk

- Tested & Classified for Fire Resistance
- Metallic pipes including steel, iron, or copper pipe and tubing
- Nonmetallic pipes, conduits & tubing including PVC, CPVC, ABS, and PEX
- Electrical & electronic cabling including service entrance, power distribution, computer, telephone, and television
- Metal ductwork including HVAC, bath, and dryer vents
- Insulated pipes including heating, cooling, and condensation applications
- Complete wood floor fire stopping package for electrical, plumbing, HVAC, telephone, and television



Part #	Mfg #	Size	Price
250843	25696	10 oz	

## Fire Caulk & Fire Rated Boxes

### Firestopping Products

#### Metacaulk® 1000

- Water-based, highly intumescent, single-component, fire-rated general purpose sealant for through-penetrations
- For use on construction joints, both vertical and horizontal surfaces and interior use



Part #	Mfg #	Description	Price
022960	66640	10.3 oz Cartridge (12-Pk)	
141952	66312	20.2 oz Sausage Pack	

#### SureSeal® Plus Trap Seal

- Waterless in-line floor drain trap seal with backwater protection
- Installs into standard 2" or 3" drain



Part #	Mfg #	Size	Price
238218	97045	2"	

#### Metacaulk® Pipe Collar

- UL classified for both open and closed pipe systems
- Simple locking mechanism for easy installation
- Recommended for: PVC, CPVC, ABS, PVC foam core, ABS foam core, FRPP, PEX pipe, and electrical cable

Part #	Mfg #	Size	Price
028239	66352	1-1/2"	

#### Metacaulk® 950 Water-Based Firestop Sealant

- Interior use, for metal pipe
- Can be used on glass pipe, as well as telephone and power cables
- Suitable for use with PVC and CPVC on closed pressure systems



Part #	Mfg #	Size	Price
004409	66643	10.3 oz, #950	

#### Metacaulk® MC 150+ Firestop Sealant

Part #	Mfg #	Size	Price
225119	66648	10.3 oz Cartridge	

**Ice Maker Kits**

**Ice Maker Installation Kit**

- For ice makers, humidifiers, evaporate coolers
- Contains self-tapping valve, 25' of 1/4" tubing and all necessary fittings



Part #	Mfg #	Description	Price
002267	0130	Kit with Polyethylene Tubing (Poly Bag)	

**Ice Maker Kits**

**Self-Piercing Tap Valve Kit**

- For 3/8" - 1" OD tube

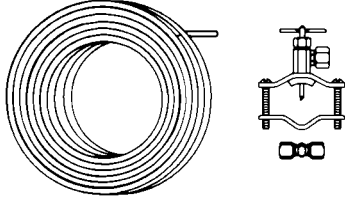

Part #	Mfg #	Comp x Outlet	Material	Price
002576	BC96X	1/4" OD x 25' L	Poly	



**Ice Maker Kits**

**EZ Quick™ Water Line Installation Kits**

**EZ Quick™ Ice Maker Kit**

- Patented "tool-less" quick-connect
- Will not corrode
- 1/4-Turn shut-off
- Leak resistant
- Kink resistant PEX



Part #	Mfg #	Description	Price
144133	IMIK-01-25-P5	1/2" Valve w/25' Tube	

## Lavatory Insulation Kits

### TRUEBRO® Lav Shields & Guards

#### Lav Shield® Lavatory Protective Enclosure

- ADA Compliant
- Heavy-duty, vandal-resistant, durable, single-piece construction
- Impact/stain/chemical-resistant, rigid vinyl



Part #	Mfg #	Color	Price
058688	2018	White	

#### Custom Factor Pre-Cut Models

Part #	Mfg #	Description	Price
080826	2018-KO-K	F/ Kohler Kingston	

#### TRUEBRO® Lav Guard® 2 Fast-Fit Undersink Piping Covers

- For tubular and cast brass P-traps
- ADA Compliant
- Built-in E-Z grip and E-Z Tear-to-Fit trimming feature for installation without tools
- Valve cover completely encloses angle valve and supply tube for both handled and keyed water stops



Part #	Mfg #	Includes:	Price
010356	102EZ	(1) P-Trap Cover & (2) Angle Valve Covers	
107111	103EZ	(1) P-Trap Covers, (2) Angle Valve Covers, (1) 5" Offset Tailpiece Strainer Cover	
010359	105W	1 Drain Kit	
092917	106EZ	(1) Basket Strainer Cover & (1) Offset Waste Cover	

## Lavatory Insulation Kits

### Pro-Extreme™ Protector Kits

- Molded PVC covers containing anti-microbial/anti-fungal & UV inhibitors
- Fastening system is tamper-resistant, smooth, non-abrasive snap-locks
- Dual drainage holes
- Internal flexible self-adjusting structures

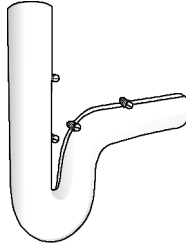

P-Trap Cover

Part #	Mfg #	Description	Price
103834	X4114	Wheelchair Offset Strainer Cover	
097293	X4333	(1) P-Trap Cover, (2) Valve & Supply Covers, Hardware	
101063	X4444	(1) P-Trap Cover, (1) Wheelchair Offset Strainer Cover, (2) Valve & Supply Covers, Hardware	

**Log Lighters**

**Log Lighters**

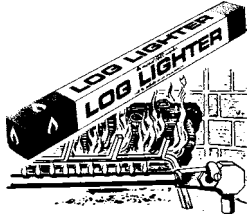

R321000

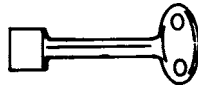

R322730

Part #	Mfg #	Description	Price
121683	R321000	Combo Pack "S" NG Chrome	
124212	R322730	12" Key with 1/4" + 5/16" Socket, Chrome	

## Log Lighters

### Log Lighter Specialties

#### Hearthmaster™ Log Lighter Kit

- Angle and straight ball valve kits
- Quarter-turn style ball valves
- Log lighter bar, valve, flange and key installation in one convenient box
- Chrome-plated flange and 3-3/4" cast zinc key
- Each chrome-plated component is individually bagged
- Our kits can be customized to fit the specific needs of most any job
- Log lighter bar is for NATURAL GAS ONLY



Price	Mfg #	FIP Inlets	Flame Outlets	Valve	Price
071742	953	3	16	Angle	
184077	955	3	16	Straight	
184079	955-12	3	16	Straight	

**Log Lighters**

**Log Lighter Parts & Accessories**

**Heater Furnace Log Lighter Key**

- Die cast



Part #	Mfg #	Size	Stem Length	Price
008059	1707	5/16"	10"	

**Spark Lighter**

- Large hood
- Flints good for 1,500 ignitions

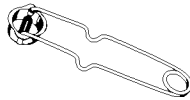

Part #	Mfg #	Description	Price
008103	4430	Lighter, 12/Pkg	



**Pans**

**Durapan™ Washer Pans**

- Choice of center or side drain outlet
- Removable aluminum threshold for ease of washer placement
- Reinforced surface for "filled" washer
- Remains stationary - can be secured to floor
- Code approved material - per ASTM standards D635, E84, E162



Part #	Mfg #	Size	Drain	Price
023706	99	32"W x 30"L x 2-1/2"D	Center	

## Pans

### Bath Tub Pans

#### Bath Tub Protector

- Semi-flexible plastic



34068



34069

Part #	Mfg #	Size	Price
007974	34068	14" Tubs	
241515	34069	14" Tubs	

### Washing Machine Pans

- Provides lasting protection from washing machine overflow or hose failure
- Made from high impact plastic
- Will not rust or corrode
- Pans have formed hole to punch out for the furnished, 1" PVC plastic fitting



Part #	Mfg #	Description	Price
041357	34067	28" x 30" Plastic	

### Water Heater Pans

#### Aluminum Water Heater Pan

- Manufactured from prime aluminum and are expertly worked to exact specifications under strict quality control
- Recommended for gas or electric water heaters
- Meets requirements of Southern Building Code
- Exposed edges have been rolled to protect the installer from injury



Part #	Mfg #	Size	Fitting	Price
042135	34079	18"	1" PVC	
100060	34151	20"	1" PVC	
121253	34152	22"	1" PVC	
193281	34153	24"	1" or 1-1/2" PVC	
166347	34154	26"	1" PVC	
023853	34083	24"	1-1/2" PVC	
023852	34085	30"	1" PVC	

### Plastic Polymer Water Heater Pan

- Manufactured from semi-flexible, tough and durable .0625" plastic polymer
- Will not rust or corrode
- Meets requirements of Southern Building Code
- Pans pre-drilled to accommodate fittings
- Recommended for electric water heaters



Part #	Mfg #	Size	Fitting	Price
252018	34060	18"	1-1/2" PVC	
073509	34061	20"	1-1/2" PVC	
041353	34062	22"	1" PVC	
129896	34063	24"	1" PVC	
007960	34064	26"	1" PVC	
252015	34164	26"	1-1/2" PVC	
094396	34072	28"	1-1/2" PVC	
252012	34165	30"	1-1/2" PVC	

### Water Heater Pan Adapter



Part #	Mfg #	Size	Price
089144	34088	1" PVC	

### Water Heater Stands

- Allows the placement of water heater tanks 18" above the ground as required by the National Fuel Gas Code
- Constructed of 18 gauge spangled galvanized sheet metal, holds up to 50 gallon water heaters



Part #	Mfg #	Description	Price
027895	34057	21" Square x 18" High	



## Putty

### Putty

#### Plumber's Putty

- *Stainless, long lasting, easy to use*
- *Will not support bacteria*
- *Will not harden, shrink, crack or crumble*
- *Meets Federal Specification TT-P-1536A*



43031



043050



43107

Part #	Mfg #	Description	Price
017659	PLPUTTY	14 oz	
008296	PUTTY	3 lb	
017660	PLPUTTY5	5 lb	

**Putty**

**Pipe Joint Compounds**

**SOFT SEAL™ Plumber's Putty**

- *For setting and sealing plumbing fixtures and drains*
- *Will not harden, crack or crumble*
- *Lead-free, non-corrosive and stainless*
- *100% Waterproof*



Part #	Mfg #	Model #	Size	Price
144693	80100	R5101	14 oz	
144695	80105	R5105	5 lbs	



## Putty

### Putty

#### Sta Put® Plumbers Putty

- Flexible, stretchable, plastic putty that will not harden, crumble, crack or shrink
- Will not stick to fingers or hands



25105

Part #	Mfg #	Size	Price
192881	25-101	14 oz	
095774	25-103	3 lbs	
124148	25-105	5 lbs	
124149	25-110	7 lbs	

#### Sta Put® Ultra™ Stainless Plumbers Putty

- Oil-free and can be used without pre-treatment for natural, porous surfaces such as stone, marble, granite, plastics, rubber, fiberglass, grout on manufactured sinks, shower bases, countertops, etc
- Safe for most types of plumbing fixtures and surfaces
- Molds easily, remains permanently soft, malleable and flexible
- Will not melt, rot, crumble, dry out or shrink
- No greasy residue on hands or surfaces



Part #	Mfg #	Size	Price
136038	25-171	14 oz	

#### Pro-Poxy® Epoxy Putty

- Fast-acting
- Co-extruded
- Single stick
- Forms a permanent, steel-hard bond in 20 minutes



Part #	Mfg #	Size	Price
063406	25-515	4 oz	

### Plastic Poxy™ Epoxy Putty

- Fully hardens in 40 minutes
- Kneads quickly and easily
- Comes in a single, easy-to-use package
- Made of pre-measured epoxy resin with a rod of hardener imbedded in the center
- Contains fading blue dye which causes the hardened product to appear off-white when fully mixed



Part #	Mfg #	Size	Price
192908	25-531	4 oz	

---



---

## Putty

---



---

### Sealants

#### THUM-GUM™ Sealing Compounds

- *Non-hardening putty for larger sealing jobs*
- *For plugging openings through foundations and refrigeration tube entry*
- *Does not contain asbestos*



Part #	Mfg #	Description	Price
002284	1003	1 lb Bag	
016079	1004	2 lb Box	



**Putty**

**Caulk Sealants**

**Tub and Tile Caulk**

- *White, flexible, latex sealant*
- *Fills and seals cracks and joints*
- *For caulking around showers, tubs, lavatories and sinks*
- *Can be used to reset loose tiles*
- *Can be painted when dry with either oil base or latex paint*
- *Cleans up with soap and water*



Part #	Mfg #	Size	Price
008003	OT6TTCK	6 oz, 24/Pk	

**Plumber's Epoxy Putty**

- *Plugs, seals, mends, patches*
- *Excellent to rebuild or fabricate parts*
- *Use as an all-purpose adhesive*
- *Can be drilled, tapped, filed, sanded and painted*
- *Hardens like steel in 20 minutes*
- *Ideal for use underwater*
- *Non-toxic*



Part #	Mfg #	Description	Price
017671	PLEPOXY	4 oz	

## Shock Arrestors

### Water Hammer Arrestors

#### Hydra-Rester® Engineered Water Hammer Arrestor

- Certified by the American Society of Sanitary Engineering to the ANSI/ASSE 1010-2004 Standard
- Lifetime cycle tested at U.S. Testing Laboratories to withstand 10,000 shock cycles. Factory tested to withstand 500,000 cycles without failure (654-C tested)
- HydraRester™ male sweat fittings are compatible with press-fitting systems, such as Viega ProPress™ and all push-fitting systems
- Allows for installation in 2 x 4 wall cavity
- Installs at any angle
- ASSE 1010 certified as a water hammer arrester that is “designed to provide continuous protection, without maintenance” allowing the HydraRester to be installed without access panels

#### MIP Connection



652-A



653-B



654-C



655-D

Part #	Mfg #	L x W	Conn.	Price
010019	652-A	6-1/2"x1-3/8"	1/2"	
019089	653-B	8-3/4"x1-3/8"	3/4"	
025203	654-C	11"x1-3/8"	1"	
025204	655-D	10-1/8"x2-1/8"	1"	
041561	656-E	12-5/8"x2-1/8"	1"	
032465	657-F	15-1/8"x2-1/8"	1"	

#### Male Swt/Press Fitting



652-AS



653-BS



654-CS

Part #	Mfg #	L x W	Conn.	Price
036311	652-AS	8-1/4"x1-3/8"	1/2"	
066491	653-BS	10"x1-3/8"	3/4"	
183768	654-CS	12-1/2"x1-3/8"	1"	
183770	655-DS	11"x2-1/8"	1"	

### PEX Crimp ASTM F1807

Part #	Mfg #	L x W	Conn.	Price
183765	652-AX	6-1/2"x1-3/8"	1/2"	
183767	652-BX	8-3/4"x1-3/8"	3/4"	

#### Bullet™ No Lead Reducing Air Chamber

- Extra-large volume air chamber is spin reduced for 1/2" male sweat connection 629-12
- M copper type or L copper type (629-L15 & 629WCL)

Part #	Mfg #	Length	CTS	Price
183722	629-06	1"	6"	
183723	629-12	1"	12"	

#### MegaRester™ Industrial Water Hammer Arrestor

- Dual o-ring piston lubricated with Dow 111 FDA approved silicone compound
- Cast brass flange, or wrought copper male thread fitting with lead-free solder joints
- 4" nominal Type L copper tube barrel
- 600 lb. (40 bar) liquid filled gauge
- Factory air charge
- Measurement information:
  - Volume (V) Inches
  - Height (H) Inches

Part #	Mfg #	V x H	Conn.	Price
174511	658-1503	150x23.25	3" MIP	
174512	658-2002	200"x29.25"	2" MIP	
126344	658-4004	400"x42.50"	4" MIP	
242161	658-4004F2	400"x41.75"	4" Flange	

## Shock Arrestors

### MiniRester™ Residential Water Hammer Arrestor (Straight—No Lead)

- Straight sweat arresters are compatible with press-fitting systems, such as Viega ProPress™ and all push-fitting systems
- Straight compression arresters install on any 1/2" nom. copper leg or riser and are especially popular in retrofitting 1/2" nom. air chambers
- MIP thread arresters install on any new rough-in or retrofit installation with 1/2" FIP fittings
- CPVC solvent weld arresters install on 1/2" CPVC tube or fittings in rough-in or retrofit applications
- PEX MiniResters™ are available with F1807, F1960 and Viega® PexPress® connections
- Products marked with the "No Lead" icon comply with national, no lead product material requirements and also comply with NSF 61, which allows the product to contain no more than 0.25% lead
- All MiniResters are AA size

660-X2B



#### With Clamshell

Part #	Mfg #	Connection	Price
010023	660-G2	1/2" MIP Thread	
183772	660-C	5/8" OD Comp	

#### Without Clamshell

Part #	Mfg #	Connection	Price
030428	660-SB	1/2" Male Swt	
183778	660-X2B	1/2" F1807 PEX	

### MiniRester™ Residential Water Hammer Arrestor (Female Compression Tee)

- No lead
- Installs either between stub out and supply stop, or between supply stop and supply tube for faucets, dishwashers, toilets or ice makers

#### With Clamshell

Part #	Mfg #	OD Comp X OD Fml Comp	Price
223384	660-GTR	5/8" x 5/8"	
183775	660-GTR1	3/8" x 3/8"	

### MiniRester™ Residential Water Hammer Arrestor (PEX Tee)

- Great for in-line PEX installation for quick closing faucets
- No lead

Part #	Mfg #	Description	Price
183776	660-GTW2B	1/2" PEX Cold Expansion, F1960	
221336	660-GTX2	1/2" PEX Crimp Tee, F1807, Clamshell	

### MiniRester™ Residential Water Hammer Arrestor (Compression Tee)

- Install in-line on ice maker lines, lavatory or dishwasher supply tubes

#### With Clamshell

Part #	Mfg #	For:	O.D.	Price
183773	660-T	1/2" Nom. Copper Tube	5/8"	
161222	660-TCO	Ice Maker Tube	1/4"	

### MiniRester™ Residential Water Hammer Arrestor (Tee)

- Full slip tee sweats in-line on 1/2" CTS near problem valve or fixture
- Hose tee arresters install on washing machine supply valves or directly to washing machine

#### With Clamshell

Part #	Mfg #	Size	Price
010021	600-H	3/4" (Female Swivel Hose Thread X Male Hose Thread)	
090564	600-TK	Female Swivel Ballcock Nut x Male Ballcock Thread Tee	

## Shock Arrestors

### MiniRester™ Residential Water Hammer Arrestor (Tub/Shower Valve)

- Sweat branch arresters install easily on sweat tub/shower valves
- FIP swivel thread arresters install on MIP tub/shower valves. No more heat damaged cartridges from soldering valve



Part #	Mfg #	Open End Branch X Tee	Price
183777	660-TS	1/2" Male Swt x 1/2" FSwt	

### StubAir™ Air Chamber Tee Fitting—Spin Closed

- 1/2" CTS No lead
- Turns variable job-to-job costs like measuring, cutting, cleaning, fluxing and soldering of up to four joints into fixed costs
- Sturdy, fracture-resistant brazed saddle joint will not be damaged during field soldering
- Optional branch length, branch end and trunk size for many different job site applications
- Guaranteed leak proof spin closures and brazed joints
- (L) L copper type or (M) M copper type



Part #	Mfg #	Air Chamber	Branch	Price
183795	682-L5140	8"	12"	
183796	682-M5140	8"	12"	

## Shock Arrestors

### Shock Arrestors

#### Series SG Shok-Gards Copper Shock Arrestor

- PDI Certified
- Pre-charged with brass piston, EPDM o-ring and male IPS threaded connection
- Operating pressure: Domestic and commercial lines up to 150 psi
- Temperature range: 33° - 180°F



Part #	Mfg #	PDI Rating	Fixture Unit Capacity	Pipe Size	Price
046336	SG-050	A	1 - 11	1/2"	
046340	SG-075	B	12 - 32	3/4"	

#### Stainless Steel Shock Arrestor

- Pre-charged stainless steel arrestor
- Male IPS threaded connection
- Temperature range: -100° to 300°F
- Operating pressure: Domestic and commercial lines up to 15 psi
- Stainless steel elbows



Part #	Mfg #	PDI Rating	Fixture Unit Capacity	Pipe Size	Price
046341	SG-C	C	33 - 60	1"	
052624	SG-D	D	61 - 113	1"	

#### Water Hammer Arrestor

- Pre-charged air chamber
- Sealed in diaphragm
- Complete stainless steel chamber construction
- Rechargeable



For residential/domestic water systems only

Part #	Mfg #	Description	Price
225413	LF150A	1/2"	

## Shock Arrestors

### Residential Shock Arrestors

#### Quiet Pipes® Hammer Arrestor



34472



34457

#### Straight

Part #	Mfg #	Size	Connection	Price
256131	34457	1/2"	Male Swt	
257116	34461	1/2"	F1807	

#### PEX Tee

Part #	Mfg #	Size	Connection	Price
257117	34472	1/2"	F1807	

### Commercial Shock Arrestors

#### Quiet Pipes® Hammer Arrestors



34479

#### Straight Male Iron Pipe

Part #	Mfg #	Size	Connection	Price
256132	34481	1/2"	MIP	
256130	34484	3/4"	MIP	
257119	34485	1"	MIP	
257120	34479	1"	MIP	

#### Straight Male Sweat/Press Fitting

Part #	Mfg #	Size	Connection	Price
256133	34486	1/2"	Male Swt	



---

---

**Stud Guards**

---

---

**Stud Guards**

- Provide protection for pipes and wiring installations
- Special self-nailing feature
- Made of 18 gauge steel

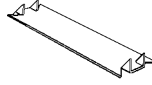

Part #	Mfg #	Description	Price
010005	3STUDG	1-1/2" x 3", 2-1/2" Between Points	
010006	5STUDG	1-1/2" x 5", 4-1/2" Between Points	

## Stud Guards

### Stud Guards & Plates

#### Stud Shoe Bracket

- 16 Gauge steel
- Formed rib provides added strength
- Installs over pipe up to 2-3/8" O.D.
- Meets IRC 602.6



533-1

Part #	Mfg #	Studs	Size	Price
091708	533-1	Single	1.58"	
183450	533-2	Double	3.125"	
183451	533-3	Triple	4.7"	

#### BOCA Shield Plate with Nail Holes

- Available in 16- or 18-gauge material
- Model **(536-616)** is galvanized



536-09

Part #	Mfg #	Size	Holes	Gauge	Price
183469	536-09	1-1/2"×9"	8	16	
183470	536-12	1-1/2"×12"	8	16	
010007	536-18	1-1/2"×18"	16	16	
165086	536-616	6"×16"	2	16	
047221	538-09	1-1/2"×9"	8	18	
010008	538-12	1-1/2"×12"	8	18	
083337	538-18	1-1/2"×18"	8	18	
078419	SC53918	3-1/2"×18"	16	16	

#### Stud Guard

- Available in 16-gauge or 18-gauge material
- 530-6M is ideal for metal stud projects



530-1635

Part #	Mfg #	Size	Nails	Gauge	Price
033537	530-166	1-1/2" x 6"	Self-Nailing	16	
117970	530-6M	1-1/2" x 6"	Nail Holes	16	
229463	530-165	1-1/2" x 5"	Self-Nailing	16	
080518	530-1635	3" x 5"	Self-Nailing, Double	16	
179567	536-36	3-1/2" x 6"	Self-Nailing	16	
080814	536-58	5" x 8"	Self-Nailing w/Holes	16	
183472	536-68E	6" x 8"	Offset Self-Nailing	16	



## Stud Guards

### Nail Plates



FHA-300



FHA-500

Part#	Mfg#	Size	Gauge	Holes	Price
204203	FHA-500-1816-6	5"x18"	16	6	
219456	FHA-300-1216	3"x12"	16	4	

### Boca Safety Plates

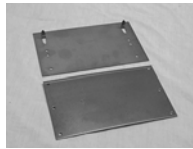

Part #	Mfg #	Size	Gauge	Price
208228	P312616SN	3-1/2" x 6"	16	

## Test Plugs & Balls

### Pneumatic Test Plugs

#### Standard Pressure Relief Pneumatic Test Plug

- Automatically resets for each inflation
- Pressure relief has no moving parts
- One-piece rubber portion is molded with no seams or bonded parts
- Works in place of other "standard" pneumatic plugs
- Maximum back pressure water head: 30', Air 13 psig
- 3-Year limited warranty



Part #	Mfg #	Size	Price
132244	IPS2PRTESTPLUG	2"	
132245	IPS3PRTESTPLUG	3"	
132246	IPS4PRTESTPLUG	4"	

#### Cleanout Test Plug

- Designed for the testing of plumbing pipelines above the cleanout tee
- After deflation the plug can be unscrewed from the test tee
- Each size is designed for one specific pipe size
- Design of this plug will allow for passing of the test water or air by deflating the plug
- Manufactured from a durable natural rubber compound
- Each size comes with a molded in inflation valve



Part #	Mfg #	Description	Price
163676	IPS2CLEANSEAL	2"	
163677	IPS3CLEANSEAL	3"	
163678	IPS4CLEANSEAL	4"	

### Mechanical Test Plugs

#### Mechanical Cleanout Test Plug

- Used in cleanout to test up to 40 vertical feet of pipe
- Clear cap for visual monitoring
- Expandable rubber gasket for air and water tight seal



Part #	Mfg #	Size	Price
131978	IPS2COTESTPLUG	2"	
131979	IPS3COTESTPLUG	3"	
131980	IPS4COTESTPLUG	4"	

### T-Cone Cleanout Repair Plugs

- Easy and economical repairs to damaged/corroded, metal or plastic
- Cleanout threads - no need to replace fitting
- Epoxy sealant included for airtight and watertight repairs



Part #	Mfg #	Description	Price
256394	86335	Fits 1-1/2" Female Cleanout Adapters	
256395	86340	Fits 2" Female Cleanout Adapters	
256396	86345	Fits 3" Female Cleanout Adapters	
256397	86350	Fits 3-1/2" Female Cleanout Adapters	
256398	86355	Fits 4" Female Cleanout Adapters	

### T-Cone Combination Test Plug

- Economical, rust-proof and reusable
- Positive sealing
- Tests up to 50 ft of head pressure



Part #	Mfg #	Description	Price
255010	86385	Tests 2" Sch. 40 DWV & Type "M" Copper Tube	
255011	86390	Tests 3" Sch40 & Copper DWV; 2" Cast Iron Hub	
255012	86400	Tests 4" Sch. 40 & Copper DWV, PVC SW, Cast Iron & VCP Barrel; 3" Cast Iron Hub	

### Flush Mechanical Cleanout Repair Plug

- Holds up to 50' of back pressure
- Seals air tight (does not rely on threads to seal)
- Back pressure actually increases sealing ability
- Completely flush inside and out
- Stainless steel flat head screw
- Cannot fall into the pipe
- Includes wrench



Part #	Mfg #	Size	Price
106904	IPS2COPLUG	2"	
106906	IPS3COPLUG	3"	

## Test Plugs & Balls

### Mechanical Test Plugs (Continued)

#### Flush Mechanical Cleanout Repair Plug

Part #	Mfg #	Size	Price
106907	IPS312COPLUG	3-1/2"	
106908	IPS4COPLUG	4"	

### Test Caps

#### High Pressure Techno-Caps

- Heavy duty PVC
- Will not clog or fall into pipe
- Solvent welded on PVC pipe
- Can be tested up to 40' of water of 17 psig



Part#	Mfg#	Size	Pipe	Bag Qty	Price
176228	IPS112PDTESTCAP	1-1/2"	DWV	100	
176229	IPS2PDTESTCAP	2"	DWV	100	
176230	IPS3PDTESTCAP	3"	DWV		
176231	IPS4PDTESTCAP	4"	DWV	100	

**Miscellaneous**

**Parts & Accessories**

**Single Shot® Insulating Suspension Clamp**

- *Preloaded nail*
- *Key-hole closure*
- *Stabilizing foot*
- *Securely supports CTS piping system when installed at 6' or less interval spacing, as per local codes*
- *Compatible with copper, CPVC, & PEX tubing*



Part #	Mfg #	Size	Price
171536	82980	1/2"	
171537	82981	3/4"	
171538	82982	1"	





## Test Plugs & Balls

### Pneumatic Pipe Plugs

#### Test-Ball® Plug with Removable Chain

- Durable, rugged and effective in any type of pipe
- 1/4" Schrader tire valve standard on all plugs
- All Test-Balls® are bendable to 90°



Part #	Mfg #	Nominal Size	Plug Length	Price
002967	270016	1-1/4" - 1-1/2"	5.50"	
002969	270024	2"	3.50"	
002972	270032	3"	5.25"	
002975	270040	4"	6.50"	
062104	270059	5"		
024619	270067	6"	9.00"	
160947	276128	1-1/4"-2"		
154317	041408	12"		
225991	276238	2" - 3"		

#### Muni-Ball® Plugs (Underground)

- Works in all types of pipe.
- Easily converts to an air test plug with use of a conversion kit
- Durable natural rubber construction seals the roughest of surfaces
- 8", 10", 12" and 15" plugs include two-port plug for easy use in sewer air tests
- Threaded aluminum bypass



Part #	Mfg#	Size	ByPass	Price
226286	262010	2"	1/8"	

#### Long TEST-BALL®

- Maximum pressure: 13 psi/30 ft



Part #	Mfg #	Size (Nom)	Price
108615	271039	3"	
020961	271047	4"	

### Clean Seal Plugs



Part #	Mfg #	Size	Price
090297	271508	1-1/2"	
002968	271705	2"	
002971	271713	3"	
034376	271721	4"	
118329	271758	6"	

#### Clean-Seal 2® Plugs

- Patent pending design
- Plug, fill and drain from same cleanout tee.
- Multi-lobe gasket allows sealing of all tees including cast iron
- Hand-tighten in place, no tools required
- Rubber cap protects hose connection when not in use.
- Check-valve allows removal of hose after filling system and keeps DWV water from back-filling into potable lines



Part #	Mfg #	Size	Price
187666	271828	2"	
187667	271838	3"	
187668	271848	4"	

### Mechanical Pipe Plugs

#### Hub-Fit Gripper™ Plug

- Natural rubber o-ring
- Yellow glass-reinforced ABS plastic
- Pressure rated to conducting DWV tests
- For use in hub fittings and bell-end pipe
- Galvanized carriage bolt



Part #	Mfg #	Size	Price
035625	270528	2"	
090565	270538	3"	
213214	270548	4"	



## Test Plugs & Balls

### Kwik'N Sure® Plug

- Works on all types of pipe
- Wint nut on 3/8" - 1-1/4" sizes
- Hex nut on 1.5" through 5" sizes
- Natural rubber o-ring



Part #	Mfg #	Size	Price
172874	269840	1/2"	
232112	269867	3/4"	
092561	269883	1-1/4"	
128511	269891	1-1/2"	
075828	269905	2"	
120348	269913	2-1/2"	

### Econ-O-Grip® Plug

- Natural rubber O-ring
- Effective pipe dust cover
- Not recommended for pressure tests



Part #	Mfg #	Size	Price
251891	271519	1-1/2"	
251892	271527	2"	
028256	271535	3"	
251893	271543	4"	
251894	271578	6"	

### End of Pipe Gripper® Plug



Part #	Mfg #	Size	Price
002965	270210	1-1/2"	
002970	270229	2"	
002973	270237	3"	
002976	270245	4"	
002977	270261	6"	
002978	270270	8"	

### Petro ECON-O-GRIP® Chemical Resistant Plug

- Chemical-resistant nitrile rubber and stainless steel hardware
- Not recommended for pressure tests



Part #	Mfg #	Size	Price
237184	273338	3"	

### T-Handle Aluminum Gripper® Plug (Underground)

- Can be used in long-term applications
- Chemical-resistant neoprene O-ring
- Made of heavy-duty aluminum



Part #	Mfg #	Size	Price
225370	272922	12"	

### Sure-Grip® Plug

- Can be installed without tools and are ideal for both water and air testing of plumbing systems or blocking stub out lines as a temporary or permanent plug
- Polypropylene construction with natural rubber O-ring
- Can be used as a permanent or temporary plug
- Fits all type of pipe at nominal sizes
- Can be tapped for use with cleanout cover



Part #	Mfg #	Size	Price
188321	271158	1-1/2"	

### Clean - Out Gripper® Plug

- Seals any damaged threads
- Made with glass-reinforced ABS plastic
- Black color blends with cast-iron pipe
- Stainless steel hardware
- NPT Sizes
- Natural rubber threaded o-ring for positive seal
- Maximum back pressure: 17 psi @ 40'



Part #	Mfg #	Nom Size	Price
101890	270168	2"	
063070	270178	3"	



## Test Plugs & Balls

### Mechanical Pipe Plugs (Continued)

#### Clean - Out Gripper® Plug

Part #	Mfg #	Nom Size	Price
078393	270138	3-1/2"	
063071	270188	4"	

### Test Pumps

#### Air Max® Test Pump

- Gauge raised from base for protection
- Durable steel barrel
- Textured steel base prevents pump from slipping
- Durable, no-kink hose
- Weight: 3.6 lbs



Part #	Mfg #	Description	Price
052322	273958	Air-Max Test Pump	

### Test Gauges

#### Cherne Test Gauge with Hexagonal Test Body

- 2" Plastic face
- Chrome plated body
- 1/8" Schrader valve
- 3/4" NPT Pipe connection

Part #	Mfg #	Pressure Range	Price
098893	19698	0-30 psi	

### Accessories

#### Inflation Fitting



Part #	Mfg #	Description	Price
138040	277037	Valve, Snifter & Cap	

#### Extension Hose

- Suited for plugs up to 15"
- 3/16" ID Hose



Part #	Mfg #	Size	Price
039288	274011	2'	

### Accessories (Continued)

#### Extension Hose

Part #	Mfg #	Size	Price
002974	274038	3'	
113691	274054	5'	
226449	274208	20'	

#### Replacement Hose Assembly

- With thumb lock



Part #	Mfg #	Description	Price
054562	034588	For Air-Max™	

## Test Plugs & Balls

### Test Caps

#### MS End-Cap™ Test Cap

- Seal pipe ends economically
- For use on schedule 40 ABS and PVC DWV pipe



Part #	Mfg #	Size	Back Pressure PSI	Feet of Head	Ctn Qty	Price
132445	OT33478	1-1/2" - 2"	15	40'	50	

#### Knock-Out™ inset Test Cap / Plug, ABS



Part #	Mfg #	Size	Ctn Qty	Price
251970	OT33460	1-1/2"		
190303	OT33461	2"	100	
251969	OT33462	3"		
251968	OT33463	4"		

#### Knock-Out Test Cap



Part #	Mfg #	Size	Ctn Qty	Price
247760	OT39101	2"	20	

#### Push-Cap™ Test Cap



Part #	Mfg #	Size	Price
251967	OT33464	1-1/2"	
251965	OT33465	2"	
251964	OT33466	3"	
251962	OT33467	4"	

**Test Plugs & Balls**

**"Sure Test" Inflatable Econo Test Plugs**

- "Grip-Rib" Design acts as a suction cup
- Hard rubber ends are molded inside the plug with o seams, to prevent stem and end blow-off
- All brass tire stem valves are uniquely molded in plug end - prevents stem from being pulled off
- Durable chain eye is molded as part of plug
- Pull chain is strong, steel sash
- Inflation and back pressure information permanently molded in plug
- Maximum back pressure: Air 10 PSIG, Water 30' Hd.
- 30 psi Maximum plug inflation
- With rubber flange that grips end of pipe
- 3" & 4" Test plugs supplied with Superfly wing nut
- For plastic, cast iron DWV
- Made in USA



Part #	Mfg #	Description	Price
094178	4801	1" Test Plug	
051054	4802	1-1/4" Test Plug	
094179	4803	1-1/2" Test Plug	
094180	4804	2" Test Plug	
094181	4806	3" Test Plug	
094182	4808	4" Test Plug	

**EZ Rough-In Test Plug**

- Reusable
- Hand tighten
- Blue plastic poly
- 1/2" MPT
- O-Ring sealed gasket

Part #	Mfg #	Description	Price
253553	4760	1/2" Rough-In	

## Test Plugs & Balls

### Test Plugs & Caps

#### Quick Plug™ Trap Adapter Test Plug

- Eliminates traditional test plugs
- Allows fitting the trap adapter tightly against the wall
- Requires use of 1-1/2" slip joint washer-sold separately



Part #	Mfg #	Size	Price
100451	234-QP	1-1/2"	

#### HandTite™ Mechanical Test plug

- For 4" – 6" models, use 3/4" male garden hose thread adapter and drill-out wall on stem for water or air by-pass tests
- For 8" model, tap stem 1/2" NPT and drill through bulk head to allow for water or air by-pass tests
- Nylon body and ASTM 361 rubber gasket



Part #	Mfg #	Diameter	Price
184071	882-98	8" Large	

#### Test Titan™ Cleanout Test Plug

- Seals 1-1/2" - 4" female cleanout threads
- Ideal for use on damaged cleanout openings and damaged or deteriorated threads



Part #	Mfg #	Size	Price
031656	882-35	3-1/2"	

#### Test Titan™ Mechanical Test Plug

- Back to front wedge design prevents blowouts at high and low temperatures
- Provides leak-free seal
- Non-slip shoulder



Part #	Mfg #	Size	Price
089876	882-1	1-1/2"	
048035	882-2	2"	
048036	882-3	3"	

#### Grip Tip™ Test Cap and Test Plug

- Test nipple is 1/2" CTS (5/8" OD)
- Durable, virgin ABS may be glued to pipe with all-purpose glue
- Tip acts as a handle while applying glue and can be snipped to allow filling and bleeding with water or air for testing
- Deeper glue surface ensures a good seal especially on unevenly cut pipe



880-82

Part #	Mfg #	Size	Type	Color	Price
111243	880-81	1-1/2"	Cap	White	
086044	880-82	2"	Cap	White	
086045	880-83	3"	Cap	White	
134436	880-84	4"	Cap	White	
073910	881-10	1-1/2"	Plug	White	
073911	881-12	2"	Plug	White	
073912	881-13	3"	Plug	White	

#### Double Duty™ Test Plug

- Double Duty™ seals drain for DWV pressure test and shower pan water test
- Plug is easy to install and remove, eliminates reaching through the collar to remove test caps
- No blow-up balls, no glue-in wafers, no mechanical plugs



Part #	Mfg #	For:	Price
224912	821-TP	821 Series Drains	

#### Dual Fit Knockout Test Plug & Cap

- Standard knockout test plugs solvent weld into PVC or ABS Sch. 40 pipe
- Dual fit knockout test caps solvent weld over 1-1/2" and 2", or 3" and 4" PVC or ABS Sch. 40 pipe

880-01



Part #	Mfg #	Size	Price
184068	880-012	1-1/2" and 2"	
153147	880-034	3" and 4"	

### Test Assemblies

#### Combination Air and Water Test Assembly

- 3/4" Female hose swivel
- Schrader valve and 1/4-turn valve



Part #	Mfg #	PSI	Price
139409	360-300PK1	300	



## Test Plugs & Balls

### TeePee™ Mechanical Cleanout Tee Test Tool

- *Designed to work on cast iron as well as plastic pipe waste systems*
- *No couplings to install and remove*
- *Perfect for high rise construction —will hold 14 floors of pressure*
- *Completely mechanical device —no air compressor/pump required*
- *Replacement seals available*
- *Not recommended for installations where temperatures are below 32°F*
- *6" and 8" tools must be retrofitted with legs (included) for Charlotte pipe tees*



881-53

Part #	Mfg #	Size	Price
184069	881-52	2"	
184070	881-53	3"	
123470	881-54	4"	



---

---

## Test Plugs & Balls

---

---

### Flood-Guard™



Part #	Mfg #	Description	Price
023693	2F	2" Float Model	
023904	3F	3" Float Model	
023905	4F	4" Float Model	

---

---

**Test Plugs & Balls**

---

---

**Floor Drain Stoppers**



Part #	Mfg #	Description	Price
135215	R153905	1-1/4" TwisTite	
135216	R153910	1-1/2" TwisTite	
135217	R153920	2" TwisTite	
135218	R153930	2-1/2" TwisTite	
135220	R153950	3-1/2" TwisTite	
135221	R153960	4" TwisTite	

**Vents**

**Vents**

**Maxi Vent®**

- Vents up to 500 DFUs



Part #	Mfg #	Description	Price
034397	20342	Fits 3" to 4" stack vent	

## Vents

### Air Admittance Valve Vents

- Eliminates extensive piping to the exterior for the individual, common, wet, loop, circuit island and stack vents
- Compatible with all DWV piping materials

#### Mini-Vent® Valve Vent

- Can be used as an individual branch, circuit or stack vent
- Will vent up to 24 DFUs on a stack and up to 160 DFUs on a branch
- Fits 1-1/2" and 2" pipe sizes
- Reduces the number of fire-stopping applications
- Exclusive vermin protection system
- Limited lifetime warranty for replacement of defective valves



Part #	Mfg #	Description	Price
034396	20341	Mini-Vent® for PVC 24/Pk	



---

---

## Vents

---

---

### Chrome Plated Brass Air Cocks

#### Brass Polished Air Cock (FIP x FIP)

- Tee handle, round shoulder

Part #	Mfg #	Size	Price
013504	14DFAC	1/4"	



## Vents

### Valves

#### Sure-Vent® Air Admittance Valve - 6 DFU

- One-way
- Includes PVC adapter



Part #	Mfg #	Size	Price
167758	39228	1-1/2"	

#### Sure-Vent® Air Admittance Valve - 20DFU

- PVC valve with 2" NPT threads
- For use as a secondary vent
- Vents DWV 2" and smaller
- Sweet Spot™ technology
- Protective rubber sleeve
- Opens at -.01 psi & seals at 0+ psi
- Screening on air inlets to guard the seal



Part #	Mfg #	Size	Price
194086	39017	1-1/2" x 2" PVC or ABS Adapter	

#### Sure-Vent® Air Admittance Valve - 160DFU

- For use as a secondary vent



Part #	Mfg #	Description	Price
095161	39220	2" x 3", PVC 40 Adapter	

#### Sure-Vent® Air Admittance Valve - 500DFU

- For use as a secondary vent



Part #	Mfg #	Description	Price
143619	39223	3" x 4", PVC 40 Adapter	

### Sure Vent® II Air Admittance Valve



Part #	Mfg #	Description	Price
063037	39016	1-1/2" with 1-1/2" to 2" PVC Adapter	

### In-Line Vent

- Mechanical vent installs on the drain line and vents the line without allowing sewer gas to enter the home
- For venting sinks, tubs, showers, washing machines, etc.
- Eliminates the need for secondary stacks



Part #	Mfg #	Description	Price
010710	39012	ABS	

## Vents

### Vents

#### Anti-Siphon Auto Vent

- For secondary venting only. Each drainage system must have a main vent stack
- Sealing disc of auto vent must be located at least 6" above the top of the trap arm
- To be installed in a readily accessible location with free flow of air, never in a sealed wall cavity
- Two fixtures may be drained by a common 1-1/2" drain pipe. Three or more fixtures will require a 2" drain pipe



Part #	Mfg #	Connection	Material	Price
183381	239	1-1/2" MIP	ABS	

### Air Admittance Valves

#### TurboVent™ Residential Air Admittance Valve (PVC Sch. 40 Hub Connection)

- Actuating device within the unit spins with each activation, keeping the seal free of dust and debris
- Each unit is available with DWV adapter 250-11
- Quick opening air valve at 0.01" negative pressure. Positive seal with 13 PSIG of back-pressure
- Protective debris cover ships with each unit
- New contractor packs available



#### With Adapter

Part #	Mfg #	Conn.	Stack	Branch	Price
156566	250-11P	1-1/2" PVC	8	20	
166318	250-12P	2" PVC	24	160	

## Pan Lining, Solvent, & Sheet Lead

### Shower Pan Liners

#### PVC Shower Pan Liner

- Economical, time-tested flexible pan liner
- Available in 30 and 40 mil thickness
- Liner marked in 6" increments for ease of measuring
- Dam corners available
- Meets ASTM Spec D4551
- Superior cold weather characteristics



Part #	Mfg #	Size	mil	Color	Price/Ft
008001	OT450PVCSP	4' x 50'	40	Gray	
	L				
008002	OT540PVCSP	5' x 40'	40	Gray	
	L				
008004	OT650PVCSP	6' x 50'	40	Gray	
	L				

#### CPE Shower Pan Liner

- Original flexible pan liner
- Available in 40 mil thickness
- Liner marked in 6" increments for ease of measuring
- Meets ASTM Spec. D4068



Part #	Mfg #	Size	mil	Color	Price/Ft
177674	OT41584	6' x 33'	40	Black	
007933	OTLINER	5' x 40'	40	Black	

#### Shower Pan Dam Corner

- For use at junction of curb and door jamb
- Universal right/left design



Part #	Mfg #	Description	Price
062140	OT41602	PVC 40 mil Each	

#### X-15 PVC Solvent

- Specially formulated for extended working times
- Provides exceptional sheet to sheet bonding



Part #	Mfg #	Description	Price
007955	OT16PVC	16 oz with Dauber	

---

---

## Pan Lining/Solvent/Sheet Lead

---

---

### Lead Sheet

Part #	Mfg #	Description	Price
005986	32420	2-1/2 lbs, 4' Wide	
005987	34420	4 lbs, 4' Wide	

## Fiberglass Showers

### One-Piece Fiberglass Shower Modules

#### SH-6036 Vursa Series 1-Pc Fiberglass Shower Module with Seat

- Low profile dam standard
- Elevated corner accessory tower
- Multi-level back wall shelving
- Single, ergonomic seat
- Ergonomic corner foot rest for shaving
- Flat wall design to accommodate grab bar applications
- Center, lower accessory shelf with wash cloth rod



Part #	Mfg #	H x W x D	Seat	Drain	Finish	Price
118141	SH-6036LS-WHT	77-1/4" x 60" x 36"	LH	Center	White	
118140	SH-6036RS-WHT	77-1/4" x 60" x 36"	RH	Center	White	
118138	SH-6036LS-B BI	77-1/4" x 60" x 36"	LH	Center	Biscuit	
118139	SH-6036RS-BI	77-1/4" x 60" x 36"	RH	Center	Biscuit	

#### SH-6036 ABF Vursa Series 1-Pc Fiberglass Shower Module with Seat - Above Floor Rough

- Low profile dam standard
- Elevated corner accessory tower
- Multi-level back wall shelving
- Single, ergonomic seat
- Ergonomic corner foot rest for shaving
- Flat wall design to accommodate grab bar applications
- Center, lower accessory shelf with wash cloth rod



Part #	Mfg #	H x W x D	Seat	Drain	Finish	Price
139735	SH-6036LS-ABF	77-1/4" x 60" x 36"	LH	Center	White	
158104	SH-6036RS-ABF	77-1/4" x 60" x 36"	RH	Center	White	
224126	SH-6036LS-ABF-BI	77-1/4" x 60" x 36"	LH	Center	Biscuit	
222936	SH-6036RS-ABF-BI	77-1/4" x 60" x 36"	RH	Center	Biscuit	

#### SH-6034 Vursa Series 1-Pc Fiberglass Shower Module

- Center drain
- Flat wall design to accommodate grab bar & seat applications
- Dual elevated shelves
- Textured floor pattern



Part #	Mfg #	H x W x D	Seat	Drain	Finish	Price
179973	SH-6034	74-3/8" x 60" x 34"	None	Center	White	

## Fiberglass Showers

### One-Piece Fiberglass Shower Modules (Continued)

#### SH-6034 Vursa Series 1-Pc Fiberglass Shower Module

Part #	Mfg #	H x W x D	Seat	Drain	Finish	Price
232550	SH6034-DS	74-3/8" x 60" x 34"	Dual	Center	White	

#### SH-4836 Vursa Series 1-Pc Fiberglass Shower Module

- Low profile dam standard
- Twin, elevated corner accessory towers
- Generous back wall shelving
- Flat wall design to accommodate grab bar applications
- Center, lower accessory shelf with wash cloth rod
- (-ABF) provides 3" of drain clearance



Part #	Mfg #	H x W x D	Seat	Drain	Finish	Price
118012	SH-4836-WHT	75-1/2" x 48" x 36"	None	Center	White	
224412	SH-4836-WHT-ABF	75-1/2" x 48" x 36"	None	Center	White	
129029	SH-4836-BI	75-1/2" x 48" x 36"	None	Center	Biscuit	

#### SH-4836 Vursa Series 1-Pc Fiberglass Shower Module with Seat

- Low profile dam standard
- Elevated corner accessory tower
- Multi-level back wall shelving
- Single, ergonomic seat
- Ergonomic corner foot rest for shaving
- Flat wall design to accommodate grab bar applications
- Center, lower accessory shelf with wash cloth rod



Part #	Mfg #	H x W x D	Seat	Drain	Finish	Price
137867	SH-4836LS-WHT	75-1/2" x 48" x 36"	LH	Center	White	
137863	SH-4836RS-WHT	75-1/2" x 48" x 36"	RH	Center	White	
137869	SH-4836LS-BI	75-1/2" x 48" x 36"	LH	Center	Biscuit	
137866	SH-4836RS-BI	75-1/2" x 48" x 36"	RH	Center	Biscuit	



## Fiberglass Showers

### SH-4836 ABF Vursa Series 1-Pc Fiberglass Shower Module with Seat - Above Floor Rough

- Low profile dam standard
- Elevated corner accessory tower
- Multi-level back wall shelving
- Single, ergonomic seat
- Ergonomic corner foot rest for shaving
- Flat wall design to accommodate grab bar applications
- Center, lower accessory shelf w/wash cloth rod
- ABF = Above floor rough-in provides 3" drain clearance



Part #	Mfg #	H x W x D	Seat	Drain	Finish	Price
114536	SH-4836LS ABF-WHT	75-1/2" x 48" x 36"	LH	Center	White	
114535	SH-4836RS ABF-WHT	75-1/2" x 48" x 36"	RH	Center	White	
116317	SH-4836LS ABF- BI	75-1/2" x 48" x 36"	LH	Center	Biscuit	
116316	SH-4836RS ABF- BI	75-1/2" x 48" x 36"	RH	Center	Biscuit	

### Legacy Series 1-Pc Fiberglass Shower Module

- Low profile dam standard
- Textured floor pattern
- 3-3/8" Diameter center drain
- Elevated back wall shelving
- Balsa wood core floor structure
- Flat wall design to accommodate grab bar applications
- Sanitary grade polyester gelcoat surface
- ABF = Above floor rough with 3" drain clearance



Part #	Mfg #	H x W x D	Seat	Drain	Finish	Price
159901	SH-3232	72" x 36" x 36"	None	Center	White	
186040	SH-3636	72" x 36" x 36"	None	Center	White	
185902	SH-3636-ABF	72 x 36" x 35-3/4"	None	Center	White	
092385	SH-3636-BI	72" x 36" x 36"	None	Center	Biscuit	
187851	SH-4234	72" x 42" x 34"	None	Center	White	
187852	SH-4234-BI	72" x 42" x 34"	None	Center	Biscuit	
222395	SH-4834	74-1/2" x 48" x 34"	None	Center	White	

## Fiberglass Showers

### Legacy Series 1-Pc Neo-Angle Fiberglass Shower Module

- One - piece fiberglass composite construction
- Sanitary grade polyester gelcoat surface
- 3-3/8" Dia. center drain (see reverse side for location)
- Single, elevated corner shelf
- Textured floor pattern
- Balsa wood core floor structure



Part #	Mfg #	H x W x D	Seat	Drain	Finish	Price
250958	SH-NA-3838	38" x 38" x 79-1/4"	None	Center	White	

### One-Piece Acrylic Shower Module

#### Acryllus Series 1-Pc Shower Module

- One - Piece fiberglass composite construction
- Vacuum formed acrylic surface
- 3-3/8" Dia. center drain (see reverse side for location)
- Gelcoat style mounting flanges
- Low profile dam (standard)
- Generous, multi-level back wall shelving
- Balsa wood core floor structure



Part #	Mfg #	H x W x D	Seat	Drain	Finish	Price
153984	SHA-4833	75-1/4" x 48" x 32-3/4"	None	Center	White	
156168	SHA-603RS	75-1/4" x 60" x 32-3/4"	Right	Center	White	

### Three-Piece Fiberglass Shower Modules

- Sanitary grade polyester gel coat surface
- 3-3/8" Diameter drain
- Textured floor pattern
- Balsa wood core floor structure

#### SH3P-6032 Vursa Series 3-Pc Fiberglass Shower Module

- Elevated corner accessory tower
- Multi-level back wall shelving
- Single, ergonomic seat
- Ergonomic corner foot rest for shaving
- Flat wall design to accommodate grab bar applications
- Center, lower accessory shelf with wash cloth rod
- ABF = Above floor rough-in provides 3" drain clearance
- BP1-60 = 2-Bar only package
- BP2-60 = 3-Bar only package
- MD = Minimal damn



Part #	Mfg #	H x W x D	Seat	Drain	Finish	Price
136661	SH3P-6032L-RS-WHT	77-1/2" x 60" x 32" w/ 4" Dam	RH	LH	White	

## Fiberglass Showers

### Three-Piece Fiberglass Shower Modules (Continued)

#### SH3P-6032 Vursa Series 3-Pc Fiberglass Shower Module

Part #	Mfg #	H x W x D	Seat	Drain	Finish	Price
136659	SH3P-6032R-LS-WHT	77-1/2" x 60" x 32" w/ 4" Dam	LH	RH	White	
136662	SH3P-6032L-RS- BI	77-1/2" x 60" x 32" w/ 4" Dam	RH	LH	Biscuit	
136660	SH3P-6032R-LS- BI	77-1/2" x 60" x 32" w/ 4" Dam	LH	RH	Biscuit	
150330	SH3P-6032R-LS-ABF-WHT	77-1/2" x 60" x 32" w/ 4" Dam	LH	RH	White	
150329	SH3P-6032L-RS-ABF-BSC	77-1/2" x 60" x 32" w/ 4" Dam	RH	LH	Biscuit	
225065	SH3P-6032L-RS-BP1-60	75-1/2" x 60" x 32" w/ 4" Dam	RH	LH	White	
145959	SH3P-6032L-RS-BP2-60	75-1/2" x 60" x 32" w/ 4" Dam	RH	LH	White	
142414	SH3P-MD-6032-TL-RS	77-1/2" x 60" x 32", Minimal Dam	RH	LH	White	

#### No Seat

Part #	Mfg #	H x W x D	Seat	Drain	Finish	Price
141111	SH3P-6032R-L-BP2-60	75-1/2" x 60" x 32" w/ 4" Dam	None	RH	White	
178721	SH3P-MD-6032L	77-1/2" x 60" x 32", Minimal Dam	None	LH	White	

#### SH3P-6030 Vursa Series 3-Pc Fiberglass Shower Module with Seat

- Elevated corner accessory tower
- Multi-level back wall shelving
- Single, ergonomic seat
- Ergonomic corner foot rest for shaving
- Flat wall design to accommodate grab bar applications
- Center, lower accessory shelf with wash cloth rod
- (-BP2) includes three stainless steel grab bars



Part #	Mfg #	H x W x D	Seat	Drain	Finish	Price
142474	SH3P-6030L-RS-WHT	77-1/2" x 60" x 30" w /4" Dam	LH	RH	White	
142783	SH3P-6030R-LS-WHT	77-1/2" x 60" x 30" w/ 4" Dam	RH	LH	White	
148744	SH3P-6030R-LS-BP2	77-1/2" x 60" x 30"	LH	RH	White	
153713	SH3P-6030L-RS-BP2	77-1/2" x 60" x 30"	RH	LH	White	

#### SH3P-4834 Vursa Series 3-Pc Fiberglass Shower Module with Seat

- Rough-in dimensions: 76-3/4" x 48" x 35-1/4"
- Anti-drip front dam ledge
- Corner accessory ledge
- Multi-level back wall shelving
- Single, ergonomic seat
- Ergonomic corner foot rest for shaving
- Wall design accommodates grab bar applications
- Textured floor pattern



Part #	Mfg #	H x W x D	Seat	Drain	Finish	Price
149155	SH3P-4834LS-WHT	77-1/2" x 48" x 34"	LH	Center	White	

## Fiberglass Showers

### Three-Piece Fiberglass Shower Modules (Continued)

#### SH3P-4834 Vursa Series 3-Pc Fiberglass Shower Module with Seat

Part #	Mfg #	H x W x D	Seat	Drain	Finish	Price
149156	SH3P-4834RS-WHT	77-1/2" x 48" x 34"	RH	Center	White	

#### SH3P-4834 ABF Vursa Series 3-Pc Fiberglass Shower Module with Seat - Above Floor Rough

- Anti-drip front dam ledge
- Multi-level back wall shelving
- Single, ergonomic seat
- Ergonomic corner foot rest for shaving
- Wall design accommodates grab bar applications
- Textured floor pattern
- ABF = Above floor rough-in provides 3" drain clearance



Part #	Mfg #	H x W x D	Seat	Drain	Finish	Price
133743	SH3P-4834LS ABF-WHT	77-1/2" x 48" x 34"	LH	Center	White	
133744	SH3P-4834RS ABF-WHT	77-1/2" x 48" x 34"	RH	Center	White	

#### Vursa Series 3-Pc Fiberglass Shower Module

- Three - Piece fiberglass composite construction
- Sanitary grade polyester gelcoat surface
- Front-side installation with minimal sealant requirements
- 1-3/8" Dia. center drain
- Anti-drip front dam ledge
- Back wall shelving
- Textured floor pattern
- 1/2" Balsa wood core floor structure
- ABF = Above floor drain (provides 3" drain clearance)



Part #	Mfg #	H x W x D	Seat	Drain	Finish	Price
146238	SH3P-4832	77-1/4 x 48" x 32"	No Seat	Center	White	
150236	SH3P-3232	75" x 32" x 32"	No Seat	Center	White	
141108	SH3P-3636	74-3/4" x 36" x 36"	No Seat	Center	White	
148636	SH3P-3636-ABF	74-3/4" x 36" x 36"	No Seat	Center	White	

## Fiberglass Showers

### Fiberglass Assisted-Living Shower Modules

- Sanitary grade polyester gel coat surface
- 3-3/8" Diameter drain
- 1/2" Threshold
- 1" Floor flange
- Textured floor pattern
- Balsa wood core floor structure

#### SHFW-6235/ADA-RI 1-Pc Standard Roll-In Barrier-Free Shower Module

- Contoured threshold
- Package includes:
  - (3) 1-1/2" Diameter stainless steel, horizontally mounted bars
  - (1) 1" Diameter stainless steel shower rod



Part #	Mfg #	H x W x D	Seat	Drain	Finish	Price
147567	SHFW-6235/ADA-RI-WHT	75" x 62" x 35"	None	Center	White	

#### 1-Pc Standard Roll-In Barrier-Free Shower Module

- One - Piece fiberglass composite construction
- Sanitary grade polyester gelcoat surface
- 3-3/8" Dia. center drain (see reverse side for location)
- 7/16" Threshold to aid in keeping water within confines of unit
- Contoured threshold to aid entry and exit
- 1" Floor flange to secure unit along threshold
- Flat wall design to accommodate grab bar & seat applications
- Textured floor pattern
- SHMD Models: Elevated back wall accessory ledges



Part #	Mfg #	H x W x D	Seat	Drain	Finish	Price
155266	SHFW-6235/ADA/TL-RS	75" x 62" x 35"	RH	Center	White	
151949	SHFW-6235/ADA/TL-LS	75" x 62" x 35"	LH	Center	White	
187220	SHMD-6232/ADA/TL-RS	75-1/4" x 62" x 32"	RH	Center	White	
172536	SHMD-6232/ADA/TL-LS	75-1/4" x 62" x 32"	LH	Center	White	

## Fiberglass Showers

### 1-Pc Barrier-Free Shower Module

- One - piece fiberglass composite construction
- Sanitary grade polyester gelcoat surface
- 3-3/8" Dia. center drain (see reverse side for location)
- 1/2" Threshold to aid in keeping water within confines of unit
- Contoured threshold to aid entry and exit
- 1" Floor flange to secure unit along threshold
- Textured floor pattern
- ANS17 = Folding seat



Part #	Mfg #	H x W x D	Seat	Drain	Finish	Price
154228	SHFW-3837-ANS17-RS	75-1/2" x 38" x 37"	RH	Center	White	



## Vikrell - Sterling Showers

### Vikrell® Shower Modules

- Solid Vikrell® material for strength and durability
- High-gloss finish



#### 6205 Transfer Swirl Gloss Shower Module

- Folding transfer seat with stainless steel support
- Modular 4-piece design
- Tongue-and-groove "snap together" design for easy installation
- Factory installed stainless steel grab bars
- Lightly pebbled, slip-resistant bottom for better traction and safer footing
- Low profile threshold for easy wheelchair access
- Complete direct-to-stud unit rough-in dimensions including flange: 73-1/4" x 39-5/8" x 40-5/8"
- 10-Year consumer limited warranty
- 3-Year commercial limited warranty



Part #	Mfg #	Description	Drain	Finished Dimensions	Color	Price
096859	62051100-0	Base Only	Center	1/2" x 39-3/8" x 39-3/8"	White	
105933	62052123-0	Back Wall with Grab Bar at Right	-	65-1/4" x 39-3/8"	White	
093971	62055125-0	End Wall Set w/Seat Left, Grab Bar Right	-	65-9/16" x 40-5/8"	White	

#### 63" ADA Shower with Age-In-Place Backers

- Durable swirl gloss finish
- Modular four-piece design
- 1/2" Threshold with 1/2" finished floor
- Finished dimensions: 63-1/4" x 39-3/8" x 72"
- Tongue-and-groove "snap together" installation



Product components: End wall set (62055106), Back wall set (62062106), Base (62061100)

Part #	Mfg #	Description	Drain	Finished Dimensions	Color	Price
176113	62070106-96	Shower Complete	Center	63-1/4" x 39-3/8" x 72"	Biscuit	

#### Accord® Seated Shower Module with Grab Bars

- Durable high-gloss finish
- Geometric back wall design
- Caulkless installation
- Ample storage shelves are recessed
- Four-piece modular design with pivot "snap together" installation
- 12" wide removable seat can be placed on either side of the shower
- Includes factory-installed Age-in-Place grab bars
  - (-V) Matte silver finish
  - (-N) Nickel finish



Part #	Mfg #	Description	Drain	Finished Dimensions	Color	Price
155726	72290103-V-0	Shower Complete	Center	74-1/2" x 60" x 36"	White	
155747	72290103-N-0	Shower Complete	Center	74-1/2" x 60" x 36"	White	

**Vikrell - Sterling Showers**

**7224 Accord® Alcove Shower Module**

- 3-Piece wall set
- Completely caulkless seams
- Interlocking wall clips click securely into place
- Large, deep shelves and semi-hidden storage design
- Complete unit rough-in dimensions for 72240100: 76" x 36-1/4" x 37-1/4"



Part #	Mfg #	Description	Drain	Finished Dimensions	Color	Price
122831	72240100-0	Shower Complete	Center	77" x 36" x 36"	White	
122830	72241100-0	Base Only	Center	36" x 36"	White	
122829	72242100-0	Back Wall Only	-	77" x 36"	White	
122039	72245100-0	End Wall Set	-	77" x 36"	White	
123022	72245100-96	End Wall Set	-	77" x 36"	Biscuit	
124292	72245106-0	End Wall Set with Backers	-	77" x 36"	White	

**7226 Accord® Alcove Shower Module**

- 3-Piece wall set
- Completely caulkless seams
- Interlocking wall clips click securely into place
- Large, deep shelves and semi-hidden storage design
- Complete unit rough-in dimensions for 72260100: 77" x 48-1/4" x 37-1/4"



Part #	Mfg #	Description	Drain	Finished Dimensions	Color	Price
123026	72260100-0	Shower Complete	Center	75-3/4" x 48" x 36"	White	
189315	72260103-N-0	Shower Complete, w/ Nickel Grab Bars	Center	75-3/4" x 48" x 36"	White	
123024	72261100-0	Base Only	Center	48" x 36"	White	
125073	72261100-96	Base Only	Center	48" x 36"	Biscuit	
123025	72262100-0	Back Wall Only	-	77" x 48"	White	
125072	72262100-96	Back Wall Only	-	77" x 48"	Biscuit	

**7227 Accord® Alcove Shower Module**

- 3-Piece wall set
- Completely caulkless seams
- Interlocking wall clips click securely into place
- Large, deep shelves and semi-hidden storage design
- Complete unit rough-in dimensions for 72270100: 77" x 60-1/4" x 37-1/4"



Part #	Mfg #	Description	Drain	Finished Dimensions	Color	Price
123418	72270100-0	Shower Complete	Center	77" x 60"	White	
123416	72271100-0	Base Only	Center	60" x 36"	White	
123417	72272100-0	Back Wall Only	-	77" x 60"	White	
123021	72272100-96	Back Wall Only	-	77" x 60"	Biscuit	

## Vikrell - Sterling Showers

### 7228 Accord® Seated Shower Module

- 3-Piece wall set
- Completely caulkless seams
- Interlocking wall clips click securely into place
- Large, deep shelves and semi-hidden storage design
- 12" Wide seat can be positioned on the left or right or removed
- Complete unit rough-in dimensions for 72280100/72280106: 76" x 48-1/4" x 37-1/4"
- (-AIP) Age-In Place grab bars in matte silver finish  
—Included with 72280103-V-0 model

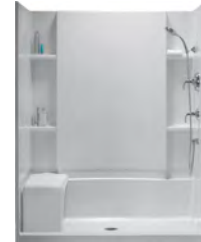

Part #	Mfg #	Description	Drain	Finished Dimensions	Color	Price
132600	72280100-0	Seated Shower Complete	Center	76" x 48" x 36"	White	
163758	72280103-V-0	Seated Shower, AIP grab bars	Center	74-1/2" x 48" x 36"	White	
132598	72281100-0	Base Only	Center	20-1/2" x 48" x 36"	White	
135853	72281100-96	Base Only	Center	20-1/2" x 48" x 36"	Biscuit	
132599	72284100-0	Complete Wall Set	-	55-1/8" x 48" x 36"	White	
135854	72284100-96	Complete Wall Set	-	55-1/8" x 48" x 36"	Biscuit	
138146	72284106-0	Complete Wall Set	-	55-1/8" x 48" x 36"	White	
140147	72286104-0	Removable Seat	-	16" x 12" x 21-1/4"	White	

### 7229 Accord® Seated Shower Module

- 3-Piece wall set
- Completely caulkless seams
- Interlocking wall clips click securely into place
- Large, deep shelves and semi-hidden storage design
- 12" Wide seat can be positioned on the left or right or removed
- Complete unit rough-in dimensions for 72290100: 75-7/8" x 60-1/4" x 37-1/4"



Part #	Mfg #	Description	Drain	Finished Dimensions	Color	Price
132654	72290100-0	Seated Shower Complete	Center	75-7/8" x 60" x 36"	White	
132439	72290106-0	Seated Shower Complete with Backers	Center	74-1/2" x 60" x 36"	White	
132437	72291100-0	Base Only	Center	20-1/2" x 60" x 36"	White	
133694	72291100-96	Base Only	Center	20-1/2" x 60" x 36"	Biscuit	
136390	72294103-96	Complete Wall Set	-	55-1/8" x 60" x 36"	Biscuit	

### 7210 Ensemble™ Tile Alcove Shower Module

- Order back wall and end walls separately
- Lightly pebbled base
- 3-Piece wall set
- Base can be installed using Ensemble™ Tile wall surround and Ensemble™ Curve wall surround, also perfect for tile down applications
- Realistic tile look
- Tongue and groove interlocking joints
- Shelving on back wall



Part #	Mfg #	Description	Drain	Finished Dimensions	Color	Price
067684	72101100-0	Base Only	Center	4-1/2" x 36" x 34"	White	
067173	72101100-96	Base Only	Center	4-1/2" x 36" x 34"	Biscuit	

**Vikrell - Sterling Showers**

**Vikrell® Shower Modules (Continued)**

**7210 Ensemble™ Tile Alcove Shower Module**

Part #	Mfg #	Description	Drain	Finished Dimensions	Color	Price
067876	72102100-0	Tile Back Wall	-	72-1/2" x 36"	White	
067878	72105100-0	Tile End Wall Set	-	72-1/2" x 36"	White	
067879	72105100-96	Tile End Wall Set	-	72-1/2" x 36"	Biscuit	
110396	72105106-0	Tile End Wall Set with Backers	-	72-1/2" x 35-1/4"	White	

**7211 Ensemble™ Tile Alcove Shower Module**

- Order back wall and end walls separately
- Lightly pebbled base
- 3-Piece wall set
- Base can be installed using Ensemble™ Tile wall surround and Ensemble™ Curve wall surround, also perfect for tile down applications
- Realistic tile look
- Tongue and groove interlocking joints
- Shelving on back wall



Part #	Mfg #	Description	Drain	Finished Dimensions	Color	Price
067124	72111100-0	Base Only	Center	4-1/2" x 42" x 34"	White	

**7212 Ensemble™ Tile Alcove Shower Module**

- Order back wall and end walls separately
- Lightly pebbled base
- 3-Piece wall set
- Base can be installed using Ensemble™ Tile wall surround and Ensemble™ Curve wall surround, also perfect for tile down applications
- Realistic tile look
- Tongue and groove interlocking joints
- Shelving on back wall
- Complete unit rough-in dimensions including nailing flange for 72120100: 77" x 48-1/4" x 35-1/4"



Part #	Mfg #	Description	Drain	Finished Dimensions	Color	Price
067941	72120100-0	Tile Shower Complete	Center	75-3/4" x 48" x 34"	White	
067663	72121100-0	Base Only	Center	4-1/2" x 48" x 34"	White	
067143	72121100-96	Base Only	Center	4-1/2" x 48" x 34"	Biscuit	
067909	72122100-0	Tile Back Wall	-	72-1/2" x 48"	White	

## Vikrell - Sterling Showers

### 7213 Ensemble™ Tile Alcove Shower Module

- Order back wall and end walls separately
- Lightly pebbled base
- 3-Piece wall set
- Base can be installed using Ensemble™ Tile wall surround and Ensemble™ Curve wall surround, also perfect for tile down applications
- Realistic tile look
- Tongue and groove interlocking joints
- Shelving on back wall
- Complete unit rough-in dimensions including nailing flange for 72130100: 77" x 60-1/4" x 35-1/4"



Part #	Mfg #	Description	Drain	Finished Dimensions	Color	Price
067945	72130100-0	Tile Shower Complete	Center	75-3/4" x 60" x 34"	White	
189506	72130106-96	Tile Shower Complete w/ Backer Boards	Center	75-3/4" x 60" x 34"	White	
067145	72131100-0	Base Only	Center	4-1/2" x 60" x 34"	White	
067915	72131100-96	Base Only	Center	4-1/2" x 60" x 34"	Biscuit	
067916	72132100-0	Tile Back Wall	-	72-1/2" x 60"	White	
067918	72132100-96	Tile Back Wall	-	72-1/2" x 60"	Biscuit	

### 7218 Ensemble™ 32" Curve Shower Module

- Caulk-free
- Durable high-gloss finish
- Tongue-and-groove interlocking joints
- Includes shaving ledge, foot rest, and shelves
- Complete unit finished dimensions: 74-3/4" x 60" x 32"
- Innovative Dry-Block™ seal and channeled water containment system
- Backer boards included with (72180126-0) model



Part #	Mfg #	Description	Drain	Finished Dimensions	Color	Price
172157	72180110-0	Shower Complete	LH	74-3/4" x 60" x 32"	White	
172158	72180120-0	Shower Complete	RH	74-3/4" x 60" x 32"	White	
177680	72180126-0	Shower Complete, Backer Boards	RH	74-3/4" x 60" x 32"	White	

### 7220 Ensemble™ Smooth Wall Curve Alcove Shower Module

- Lightly pebbled base
- 3-Piece wall set
- Base can be installed using Ensemble™ Tile wall surround and Ensemble™ Curve wall surround, also perfect for tile down applications
- Tongue and groove interlocking joints
- Shelving on back wall
- Complete unit rough-in dimensions for 72200100: 77" x 36-1/4" x 35-1/4"



Part #	Mfg #	Description	Drain	Finished Dimensions	Color	Price
067925	72200100-0	Curve Shower Complete	Center	75-3/4" x 36" x 34"	White	
067880	72202100-0	Curve Back Wall	-	72-1/2" x 36"	White	

**Vikrell - Sterling Showers**

**Vikrell® Shower Modules (Continued)**

**7220 Ensemble™ Smooth Wall Curve Alcove Shower Module**

Part #	Mfg #	Description	Drain	Finished Dimensions	Color	Price
067881	72202100-96	Curve Back Wall	-	72-1/2" x 36"	Biscuit	
067882	72205100-0	Curve End Wall Set	-	72-1/2" x 35-1/4"	White	
067883	72205100-96	Curve End Wall Set	-	72-1/2" x 35-1/4"	Biscuit	

**7221 Ensemble™ 34" Curve Shower Module**

- Durable high-gloss finish
- Tongue-and-groove interlocking joints
- Includes shaving ledge, foot rest, and shelves
- Complete unit finished dimensions: 75-3/4" x 42" x 34"
- Innovative Dry-Block™ seal and channeled water containment system form watertight seams



Part #	Mfg #	Description	Drain	Finished Dimensions	Color	Price
067822	72210100-0	Shower Complete	Center	75-3/4" x 42" x 34"		

**7221 Ensemble™ Smooth Wall Curve Alcove Shower Module**

- Lightly pebbled base
- 3-Piece wall set
- Base can be installed using Ensemble™ Tile wall surround and Ensemble™ Curve wall surround, also perfect for tile down applications
- Tongue and groove interlocking joints
- Shelving on back wall



Part #	Mfg #	Description	Drain	Finished Dimensions	Color	Price
067907	72212100-0	Curve Back Wall	-	72-1/2" x 42"	White	

**7222 Ensemble™ Smooth Wall Curve Alcove Shower Module**

- Lightly pebbled base
- 3-Piece wall set
- Base can be installed using Ensemble™ Tile wall surround and Ensemble™ Curve wall surround, also perfect for tile down applications
- Tongue and groove interlocking joints
- Shelving on back wall
- Complete unit rough-in dimensions for 72220100: 77" x 48-1/4" x 35-1/4"



Part #	Mfg #	Description	Drain	Finished Dimensions	Color	Price
067943	72220100-0	Curve Shower Complete	Center	75-3/4" x 48" x 34"	White	
067944	72220100-96	Curve Shower Complete	Center	75-3/4" x 48" x 34"	Biscuit	
067911	72222100-0	Curve Back Wall	-	72-1/2" x 48"	White	
067912	72222100-96	Curve Back Wall	-	72-1/2" x 48"	Biscuit	



## Vikrell - Sterling Showers

### 7223 Ensemble™ Smooth Wall Curve Alcove Shower Module

- Lightly pebbled base
- 3-Piece wall set
- Base can be installed using Ensemble™ Tile wall surround and Ensemble™ Curve wall surround, also perfect for tile down applications
- Tongue and groove interlocking joints
- Shelving on back wall
- Complete unit rough-in dimensions for 72230100: 77" x 60-1/4" x 35-1/4"



Part #	Mfg #	Description	Drain	Finished Dimensions	Color	Price
067947	72230100-0	Curve Shower Complete	Center	75-3/4" x 60" x 34"	White	
067948	72230100-96	Curve Shower Complete	Center	75-3/4" x 60" x 34"	Biscuit	
067919	72232100-0	Curve Back Wall	-	72-1/2" x 60"	White	
067920	72232100-96	Curve Back Wall	-	72-1/2" x 60"	Biscuit	
130591	72232106-0	Curve Back Wall with Backers	-	72-1/2" x 60"	White	

### Ensemble™ Shower Base

- 10-Year consumer and 3-year commercial limited warranty

Part #	Mfg #	Description	Drain	Finished Dimensions	Color	Price
124449	72151100-0	Base Only	Center	3-1/2" x 42" x 42"	White	
115043	72161100-0	Base Only	Center	3-1/2" x 36" x 36"	White	

### 7217 Ensemble™ Curve Shower Module

- Solid Vikrell® material for strength and durability
- High-gloss finish
- Tongue and groove 4-piece modular design with interlocking joints for snap together installation
- Curve wall with smooth look and feel
- Shelving on back wall
- Shaving ledge and foot rest
- Receptor can be ordered separately
- Complete unit rough-in dimensions: 76-1/2" x 60-1/4" x 31-1/4"
- 10-Year consumer and 3-year commercial limited warranty



Part #	Mfg #	Description	Drain	Finished Dimensions	Color	Price
146124	72170110-0	Curve Shower Complete	LH	75-1/4" x 60" x 30"	White	
243328	72170116-96	Curve Shower Complete, Backer Boards	LH	75-1/4" x 60" x 30"	Biscuit	
146155	72170120-0	Curve Shower Complete	RH	76-1/2" x 60" x 30"	White	
146119	72171110-0	Base Only	LH	4" x 60" x 30"	White	
146120	72171110-96	Base Only	LH	4" x 60" x 30"	Biscuit	
146153	72171120-0	Base Only	RH	4" x 60" x 30"	White	
146154	72171120-96	Base Only	RH	4" x 60" x 30"	Biscuit	
146121	72175100-0	Curved End Wall Set	-	71-1/4" x 60" x 30"	White	
146123	72175100-96	Curved End Wall Set	-	71-1/4" x 60" x 30"	Biscuit	
243331	72175106-96	Curved End Wall Set, Backer Boards	-	71-1/4" x 60" x 30"	Biscuit	

**Vikrell - Sterling Showers**

**7204 Intrigue™ Tile Neo-Angle Shower Module**

- Lightly pebbled base
- 2-Piece back wall
- Tongue and groove interlocking joints
- (3) Shelves in corner column
- Complete unit rough-in dimensions: 80-1/4" x 40-1/4" x 40-1/4"

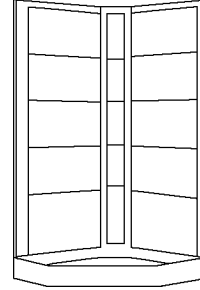

Part #	Mfg #	Description	Drain	Finished Dimensions	Color	Price
050273	72040100-0	Neo-Angle Shower Complete	Center	79" x 39"	White	
050271	72041100-0	Base Only	Center	39" x 39" Neo	White	
050272	72044100-0	Complete Tile Wall Set		75" x 39"	White	

**Store+™ Shower Module**

- Customizable 8-shelf storage system
- Holds up to 30 bottles
- Easy to clean - removable accessories are dishwasher safe
- Convenient molded-in shaving ledges
- Four-sided water containment with full-length threshold guard and weep channels for added protection
- Low 3-inch profile for easy entry and exit
- Durable high gloss finish
- Caulk-free installation
- Tongue-and-groove 4-piece modular design
- Sturdy accessories snap in place



Part #	Mfg #	Description	Drain	Finished Dimensions	Color	Price
223491	72320100-0	Four-Piece Complete	Center	75-3/4" x 48" x 34"		
224366	72320106-0	Four-Piece Complete with AIP Backers	Center	75-3/4" x 48" x 34"		
224686	72330100-0	Four-Piece Complete	Center	75-3/4" x 60" x 34"		

**Guard+™ Shower Base**

- Four-sided water containment with full-length threshold guard and weep channels for added protection
- Low 3-inch profile for easy entry and exit
- Durable high gloss finish
- Suitable for tile down application or with sterling STORE+™ wall surround



Part #	Mfg #	Description	Drain	Finished Dimensions	Color	Price
223488	72321100-0	Base Only	Center	3-1/8" x 48" x 34"		
224684	72331100-0	Base Only	Center	4-3/16" x 60" x 34"		

**Vikrell - Sterling Showers**

**Shower Seats**  
**Freestanding Seat**

- Fits any showering space
- Holds up to 300 pounds
- Integrated handles for easy transport



Part #	Mfg #	Dimensions	Color	Price
173234	72186104-0	21-7/16" x 17-3/8" x 13-1/8"	White	

## Fiberglass Showers

### Shower Modules

#### 1363TRIO Remodeline Sectional 3-Piece Shower Module

- Smooth wall finish
- Molded toiletry shelves
- Slip resistant, textured bottom



Part #	Mfg #	Finished Dimensions	Drain	Color	Price
029528	1363-TRIO-WH	36" x 36" x 72-3/4"	Center	White	

#### 1363-2P Remodeline Sectional 2-Piece Shower Module

- Smooth wall finish
- Molded toiletry shelf
- Requires 52" turning space
- Gelcoat surface



Part #	Mfg #	Finished Dimensions	Drain	Color	Price
029558	1363-2P-WH	36" x 36" x 72"	Center	White	

#### 1363C Everyday 1-Piece Shower Module

- Smooth wall finish
- Molded toiletry shelves
- Slip resistant textured bottom
- Gelcoat surface



Part #	Mfg #	Finished Dimensions	Drain	Color	Price
029568	1363C-WH	36" x 36" x 72"	Center	White	

## Fiberglass Showers

### 1382NA2P Remodeline 2-Piece Neo-Angle Shower Module

- Smooth wall finish
- 2-Wall neo-angle corner design
- Overhang drip ledge disguises horizontal seam
- Integral soap shelf on wall
- Slip resistant, textured bottom



Part #	Mfg #	Finished Dimensions	Drain	Color	Price
029581	1382NA2P-WH	38" x 38" x 72"	Center	White	

### 1382NAC Everyday 1-Piece Neo-Angle Corner Shower Module

- Smooth wall finish
- Two-wall, neo-angle corner design
- Molded toiletry shelf
- Slip resistant textured bottom
- Gelcoat surface



Part #	Mfg #	Finished Dimensions	Drain	Color	Price
029583	1382NAC-WH	38" x 38" x 72"	Center	White	

### 1423C Builders' Choice Everyday 1-Piece Shower Module

- Smooth wall finish
- Molded toiletry shelves
- Slip resistant textured bottom
- Gelcoat surface



Part #	Mfg #	Finished Dimensions	Drain	Color	Price
029990	1423C-WH	42" x 34" x 72"	Center	White	

### 1483CST Everyday 1-Piece Shower Module

- Smooth wall finish
- Molded toiletry shelf
- Slip resistant textured bottom



Part #	Mfg #	Finished Dimensions	Drain	Color	Price
032055	1483CST-WH	48" x 33-1/2" x 76"	Center	White	

## Fiberglass Showers

### 1483DTS Everyday 1-Piece Shower Module

- Diagonal tile surface
- Installed acrylic grab bar
- Molded seat
- Molded toiletry shelf
- Slip resistant textured bottom
- Gelcoat surface



Part #	Mfg #	Finished Dimensions	Drain	Seat	Color	Price
093699	1483DTS-L-WH	48" x 36" x 76"	Center	LH	White	
092082	1483DTS-L-BI	48" x 36" x 76"	Center	LH	Biscuit	
087765	1483DTS-R-WH	48" x 36" x 76"	Center	RH	White	

### 14832P Remodeline Sectional 2-Piece Shower Module

- Smooth wall finish
- Integral seat
- Molded toiletry shelf
- Requires 60" turning space
- Gelcoat surface



Part #	Mfg #	Finished Dimensions	Drain	Seat	Color	Price
029556	14832P-WH	48" x 34" x 72"	Center	(2) Seats	White	

### 1483SG Everyday 1-Piece Shower Module

- Smooth wall finish
- Molded seat
- Installed acrylic grab bar
- Molded toiletry shelves
- Slip resistant textured bottom



Part #	Mfg #	Finished Dimensions	Drain	Seat	Color	Price
029546	1483SG-WH	48" x 35" x 75"	Center	(2) Seats	White	



## Fiberglass Showers

### 1483STS Everyday 1-Piece Shower Module

- Smooth wall finish
- Integral toiletry shelves
- Molded seat
- Slip resistant, textured bottom
- East zone only
- Gelcoat surface



Part #	Mfg #	Finished Dimensions	Drain	Seat	Color	Price
126434	1483STS-L-WH	48" x 36" x 76"	Center	LH	White	
127164	1483STS-L-BI	48" x 36" x 76"	Center	LH	Biscuit	
126433	1483STS-R-WH	48" x 36" x 76"	Center	RH	White	
127166	1483STS-R-BI	48" x 36" x 76"	Center	RH	Biscuit	

### 148344PSC 4-Piece Shower Module

- Pocketed connection system locks sections together without fasteners
- Smooth wall finish
- Integral acrylic grab bar
- Integral seat
- Slip resistant, textured bottom
- Gelcoat surface



Part #	Mfg #	Finished Dimensions	Drain	Seat	Color	Price
111307	148344PSC-R	48" x 34" x 76"	Center	RH	White	

### 16033P Remodeline 3-Piece Shower Module

- Smooth wall finish
- Integral seats
- Molded toiletry shelf
- Slip resistant, textured bottom
- Gelcoat surface



Part #	Mfg #	Finished Dimensions	Drain	Seat	Color	Price
031321	16033P-WH	60" x 34" x 72"	Center	(2) Seats	White	

## Fiberglass Showers

### 1603DTS Everyday 1-Piece Shower Module

- Smooth tile finish with diagonal tile trim
- Molded seat
- Installed acrylic grab bar
- Molded toiletry shelves
- Slip resistant textured bottom
- Gelcoat surface



Part #	Mfg #	Finished Dimensions	Drain	Seat	Color	Price
072802	1603DTS-L-WH	60" x 36" x 76"	Center	LH	White	
094162	1603DTS-L-BI	60" x 36" x 76"	Center	LH	Biscuit	
083817	1603DTS-R-BI	60" x 36" x 76"	Center	RH	Biscuit	

### 1603STS Everyday 1-Piece Shower Module

- Smooth wall finish
- Integral toiletry shelves
- Molded seat
- Integral acrylic grab bar
- East zone only
- Slip resistant, textured bottom
- Gelcoat surface



Part #	Mfg #	Finished Dimensions	Drain	Seat	Color	Price
126438	1603STS-L-WH	60" x 36" x 76"	Center	LH	White	
129229	1603STS-L-BI	60" x 36" x 76"	Center	LH	Biscuit	
126437	1603STS-R-WH	60" x 36" x 76"	Center	RH	White	

**Shower Stalls**

**Durastall® Shower Stalls and Enclosures**

- Ideal for bathrooms, basements, breezeways, garages, utility rooms and vacation homes
- Free-standing knock-down construction
- Hi-gloss thermoplastic wall panels - choice of decorative trim
- Floor drain assembly and brass shower valve included
- Leak/rust resistant construction and components
- Resistant to mold and mildew, easy to clean



30, 70



80, 82, 140, 142

Part #	Mfg #	Height x Size	Base	Price
007503	30	73" x 30" x 30"	Standard	
007553	80	75-3/8" x 32" x 32"	Standard	
007486	140	75-3/8" x 36" x 36"	Standard	

## Shower Bases & Accessories

### Shower Bases

#### Archer™ Acrylic Low Threshold Shower Base

- Covered drain
- Alcove installation
- (3) Side tile flange



**36" x 36"**

Part #	Mfg #	Description	Drain	Color	Price
123460	K-9396-0	36" x 36" x 3-11/16", Low Threshold	Center	White	
183164	K-9396-47	36" x 36" x 3-11/16", Low Threshold	Center	Almond	
242092	K-9396-58	36" x 36" x 3-11/16", Low Threshold	Center	Thunder Grey	
225761	K-9396-7	36" x 36" x 3-11/16", Low Threshold	Center	Black	
145692	K-9396-95	36" x 36" x 3-11/16", Low Threshold	Center	Ice Grey	
144314	K-9396-96	36" x 36" x 3-11/16", Low Threshold	Center	Biscuit	
228602	K-9396-NY	36" x 36" x 3-11/16", Low Threshold	Center	Dune	

**48" x 36"**

Part #	Mfg #	Description	Drain	Color	Price
116143	K-9397-0	48" x 36" x 3-11/16", Low Threshold	Center	White	
174847	K-9397-58	48" x 36" x 3-11/16", Low Threshold	Center	Thunder Grey	
174847	K-9397-58	48" x 36" x 3-11/16", Low Threshold	Center	Thunder Grey	
243527	K-9397-7	48" x 36" x 3-11/16", Low Threshold	Center	Black Black	
174712	K-9397-95	48" x 36" x 3-11/16", Low Threshold	Center	Ice Grey	
119788	K-9397-96	48" x 36" x 3-11/16", Low Threshold	Center	Biscuit	
117761	K-9397-G9	48" x 36" x 3-11/16", Low Threshold	Center	Sandbar	
179515	K-9397-NY	48" x 36" x 3-11/16", Low Threshold	Center	Dune	

**48" x 48"**

Part #	Mfg #	Description	Drain	Color	Price
107459	K-9394-0	48" x 48" x 3-15/16", Low Threshold	Center	White	
129767	K-9394-33	48" x 48" x 3-15/16", Low Threshold	Center	Mexican Sand	
154199	K-9394-47	48" x 48" x 3-15/16", Low Threshold	Center	Almond	
119248	K-9394-96	48" x 48" x 3-15/16", Low Threshold	Center	Biscuit	
157836	K-9394-G9	48" x 48" x 3-15/16", Low Threshold	Center	Sandbar	
228469	K-9394-K4	48" x 48" x 3-15/16", Low Threshold	Center	Cashmere	

**60" x 36"**

Part #	Mfg #	Description	Drain	Color	Price
110016	K-9479-0	60" x 36" x 3-11/16", Low Threshold	Center	White	
139701	K-9479-47	60" x 36" x 3-11/16", Low Threshold	Center	Almond	
186377	K-9479-58	60" x 36" x 3-11/16" Low Threshold	Center	Thunder Grey	
178481	K-9479-95	60" x 36" x 3-11/16", Low Threshold	Center	Ice Grey	
111994	K-9479-96	60" x 36" x 3-11/16", Low Threshold	Center	Biscuit	

## Shower Bases & Accessories

### Shower Bases (Continued)

#### Archer™ Acrylic Low Threshold Shower Base

60" x 36"

Part #	Mfg #	Description	Drain	Color	Price
137310	K-9479-G9	60" x 36" x 3-11/16", Low Threshold	Center	Sandbar	
152795	K-9479-K4	60" x 36" x 3-11/16", Low Threshold	Center	Cashmere	
179640	K-9479-NY	60" x 36" x 3-11/16", Low Threshold	Center	Dune	

60" x 60"

Part #	Mfg #	Description	Drain	Color	Price
116073	K-9395-0	60" x 60" x 3-15/16", Low Threshold	Center	White	
237900	K-9395-33	60" x 60" x 3-15/16", Low Threshold	Center	Mexican Sand	
243347	K-9395-58	60" x 60" x 3-15/16", Low Threshold	Center	Thunder Grey	
170977	K-9395-96	60" x 60" x 3-15/16", Low Threshold	Center	Biscuit	

#### Ballast™ Low Threshold Shower Base

- Resin concrete core with acrylic surface



48" x 36"

Part #	Mfg #	Description	Drain	Color	Price
159806	K-1935-0	48" x 36" x 1-5/8"	Center	White	

60" x 32"

Part #	Mfg #	Description	Drain	Color	Price
159072	K-1936-0	60" x 32" x 1-15/16"	RH	White	
160324	K-1937-0	60" x 32" x 1-15/16"	LH	White	

66" x 36"

Part #	Mfg #	Description	Drain	Color	Price
157485	K-1938-0	66" x 36" x 1-5/8"	Center	White	

#### Bellwether® Single Threshold Shower Base

- Safeguard® slip-resistant finish
- Cast iron
- Recessed rain (can be used with K-9157 or K-9159 drain cover)



60" x 34"

Part #	Mfg #	Description	Drain	Color	Price
229434	K-9177-0	60" x 34" x 4-1/2"	LH	White	
222924	K-9178-0	60" x 34" x 4-1/2"	RH	White	
228056	K-9178-96	60" x 34" x 4-1/2"	RH	Biscuit	
225691	K-9178-G9	60" x 34" x 4-1/2"	RH	Sandbar	
170389	K-9193-0	60" x 34" x 4-1/2"	LH Offset	White	

## Shower Bases & Accessories

### Shower Bases (Continued)

#### Bellwether® Single Threshold Shower Base

60" x 34"

Part #	Mfg #	Description	Drain	Color	Price
223786	K-9193-96	60" x 34" x 4-1/2"	LH Offset	Biscuit	

60" x 32"

Part #	Mfg #	Description	Drain	Color	Price
167296	K-9163-0	60" x 32" x 4-1/2"	LH	White	
223644	K-9163-95	60" x 32" x 4-1/2"	LH	Ice Grey	
186226	K-9136-96	60" x 32" x 4-1/2"	LH	Biscuit	
224674	K-9164-G9	60" x 32" x 4-1/2"	RH	Sandbar	

#### Groove® Acrylic Low Threshold Shower Base

- Recessed rear drain
- Durable acrylic construction
- Single threshold for three wall or alcove installation



48" x 36"

Part #	Mfg #	Description	Drain	Color	Price
125049	K-9925-0	48" x 36" x 4-1/4", Low Threshold	Rear Center	White	
141746	K-9925-96	48" x 36" x 4-1/4", Low Threshold	Rear Center	Biscuit	
157588	K-9925-G9	48" x 36" x 4-1/4", Low Threshold	Rear Center	Sandbar	
180817	K-9925-NY	48" x 36" x 4-1/4", Low Threshold	Rear Center	Dune	

48" x 48"

Part #	Mfg #	Description	Drain	Color	Price
137180	K-9998-0	48" x 48" x 4-9/16", Low Threshold	Rear Center	White	

60" x 32"

Part #	Mfg #	Description	Drain	Color	Price
121538	K-9948-0	60" x 32" x 4-3/4", Low Threshold	RH Drain	White	
251303	K-9948-NY	60" x 32" x 4-3/4", Low Threshold	RH Drain	Dune	

60" x 36"

Part #	Mfg #	Description	Drain	Color	Price
126221	K-9928-0	60" x 36" x 4-3/8", Low Threshold	Rear Center	White	
167083	K-9928-47	60" x 36" x 4-3/8", Low Threshold	Rear Center	Almond	
144411	K-9928-96	60" x 36" x 4-3/8", Low Threshold	Rear Center	Biscuit	
184793	K-9928-G9	60" x 36" x 4-3/8", Low Threshold	Rear Center	Sandbar	



## Shower Bases & Accessories

### 60" x 42"

Part #	Mfg #	Description	Drain	Color	Price
126227	K-9996-0	60" x 42" x 4-9/16", Low Threshold	Rear Center	White	
134553	K-9996-47	60" x 42" x 4-9/16", Low Threshold	Rear Center	Almond	
120675	K-9996-95	60" x 42" x 4-9/16", Low Threshold	Rear Center	Ice Grey	
124326	K-9996-96	60" x 42" x 4-9/16", Low Threshold	Rear Center	Biscuit	
152044	K-9996-G9	60" x 42" x 4-9/16", Low Threshold	Rear Center	Sandbar	

### Kathryn® Single Threshold Shower Base — 48" x 36"

- Center drain
- Textured bottom surface
- Three-wall or alcove installation
- Cast iron with Safeguard® slip-resistant finish



Part #	Mfg #	Description	Drain	Color	Price
079072	K-9025-0	48" x 36" x 4-5/8", Low Threshold	Center	White	

### Memoirs® Single Threshold Acrylic Shower Base — 60" x 34"

- Textured floor pattern
- Single threshold for three-wall or alcove installation
- Rear center drain
- Internal flange
- Durable acrylic construction



Part #	Mfg #	Description	Drain	Color	Price
188743	K-9568-96	60" x 34" x 6", Single Threshold	Rear Center	Biscuit	

### Memoirs® Acrylic Single Threshold Shower Base with Seat

- Single threshold
- Integral seat design for comfort



Part #	Mfg #	Description	Drain	Color	Price
120357	K-9496-0	60" x 36" x 21", Single Threshold	RH Drain	White	
138466	K-9496-47	60" x 36" x 21", Single Threshold	RH Drain	Almond	
138116	K-9496-95	60" x 36" x 21", Single Threshold	RH Drain	Ice Grey	
103529	K-9496-96	60" x 36" x 21", Single Threshold	RH Drain	Biscuit	
174853	K-9496-G9	60" x 36" x 21", Single Threshold	RH Drain	Sandbar	
103352	K-9496-K4	60" x 36" x 21", Single Threshold	RH Drain	Cashmere	
237197	K-9496-NY	60" x 36" x 21", Single Threshold	RH Drain	Dune	
237198	K-9489-NY	60" x 36" x 21", Single Threshold	LH Drain	Dune	

## Shower Bases & Accessories

### Memoirs® Acrylic Single Threshold Neo-Angle Shower Base

- Single threshold
- Rear center drain
- Textured floor pattern



Part #	Mfg #	Description	Drain	Color	Price
063532	K-9542-0	42" x 42" x 6", Single Threshold	Center Rear Drain	White	

### Rely® Single Threshold Shower Base

- Textured bottom surface
- Three-wall or alcove installation
- Acrylic construction



Part #	Mfg #	Description	Drain	Color	Price
240220	K-8459-0	60" x 32" x 4-11/16"	Left Hand	White	
236975	K-8461-0	48" x 34" x 4-3/16"	Center Drain	White	
248615	K-8461-95	48" x 34" x 4-3/16"	Center Drain	Ice Grey	
257567	K-8461-96	48" x 34" x 4-3/16"	Center Drain	Biscuit	
258086	K-8638-95	48" x 32" x 4-3/8"	Right Hand	Ice Grey	
260779	K-8639-0	48" x 32" x 4-3/8"	Left Hand	White	
253123	K-8648-0	48" x 42" x 4-3/16"	Center Drain	White	
241595	K-8659-0	60" x 42" x 4-1/4"	Center Drain	White	
241042	K-8659-96	60" x 42" x 4-1/4"	Center Drain	Biscuit	

### Tresham® Acrylic Single Threshold Shower Base with Seat

- Left- or right-hand seat options
- For alcove installations
- (3) Side tile flange



**60" x 32"**

Part #	Mfg #	Description	Drain	Color	Price
157468	K-1976-0	60" x 32" x 21-1/8", Single Threshold	Right Hand	White	
186771	K-1976-47	60" x 32" x 21-1/8", Single Threshold	Right Hand	Almond	
157223	K-1976-96	60" x 32" x 21-1/8", Single Threshold	Right Hand	Biscuit	
156511	K-1977-0	60" x 32" x 21-1/8", Single Threshold	Left Hand	White	
175910	K-1977-95	60" x 32" x 21-1/8", Single Threshold	Left Hand	Ice Grey	
244571	K-1977-NY	60" x 32" x 21-1/8", Single Threshold	Left Hand	Dune	

**60" x 36"**

Part #	Mfg #	Description	Drain	Color	Price
152089	K-1978-0	60" x 36" x 21-1/8", Single Threshold	Right Hand	White	
190353	K-1978-NY	60" x 36" x 21-1/8", Single Threshold	Right Hand	Dune	
181701	K-1978-G9	60" x 36" x 21-1/8", Single Threshold	Right Hand	Sandbar	

## Shower Bases & Accessories

### Shower Bases (Continued)

#### Tresham® Acrylic Single Threshold Shower Base with Seat

60" x 36"

Part #	Mfg #	Description	Drain	Color	Price
149860	K-1979-0	60" x 36" x 21-1/8", Single Threshold	Left Hand	White	
159403	K-1979-96	60" x 36" x 21-1/8", Single Threshold	Left Hand	Biscuit	
181702	K-1979-G9	60" x 36" x 21-1/8", Single Threshold	Left Hand	Sandbar	

#### Tresham® Acrylic Single Threshold Shower Base

- Single, low-threshold design
- Center drain
- Reinforced with fiberglass (FRP)
- Molded-in floor pattern



Part #	Mfg #	Description	Drain	Color	Price
157719	K-1974-0	48" x 36" x 4-3/8", Single Threshold	Center	White	
223363	K-1974-47	48" x 36" x 4-3/8", Single Threshold	Center	Almond	
230266	K-1974-95	48" x 36" x 4-3/8", Single Threshold	Center	Ice Grey	
177483	K-1974-96	48" x 36" x 4-3/8", Single Threshold	Center	Biscuit	

#### Salient® Cast Iron Single Threshold Shower Base

- For Alcove installation with (3) tile-in flanges
- Safeguard® slip-resistant finish for added safety



60" x 30"

Part #	Mfg #	Description	Drain	Color	Price
108183	K-9053-0	60" x 30", Single Threshold	Center	White	
188742	K-9053-58	60" x 30", Single Threshold	Center	Thunder Grey	
124194	K-9053-96	60" x 30", Single Threshold	Center	Biscuit	
141897	K-9053-FF	60" x 30", Single Threshold	Center	Sea Salt	
140242	K-9053-FD	60" x 30", Single Threshold	Center	Cane Sugar	
183158	K-9053-G9	60" x 30", Single Threshold	Center	Sandbar	
238724	K-9054-58	60" x 30", Single Threshold	Right	Thunder Grey	

60" x 36"

Part #	Mfg #	Description	Drain	Color	Price
113436	K-9055-0	60" x 36", Single Threshold	Center	White	
113231	K-9055-47	60" x 36", Single Threshold	Center	Almond	
157521	K-9055-58	60" x 36", Single Threshold	Center	Thunder Grey	
123537	K-9055-7	60" x 36", Single Threshold	Center	Black	
117131	K-9055-95	60" x 36", Single Threshold	Center	Ice Grey	
119445	K-9055-96	60" x 36", Single Threshold	Center	Biscuit	
120565	K-9055-FF	60" x 36", Single Threshold	Center	Sea Salt	
127405	K-9055-FT	60" x 36", Single Threshold	Center	Basalt	

## Shower Bases & Accessories

### Shower Bases (Continued)

#### Salient® Cast Iron Single Threshold Shower Base 60" x 36"

Part #	Mfg #	Description	Drain	Color	Price
126659	K-9055-G9	60" x 36", Single Threshold	Center	Sandbar	
155028	K-9055-KA	60" x 36", Single Threshold	Center	Black n' Tan	
126534	K-9055-K4	60" x 36", Single Threshold	Center	Cashmere	
244583	K-9055-NY	60" x 36", Single Threshold	Center	Dune	

#### Purist® Cast Iron Shower Base

- Safeguard® slip-resistant finish
- Single threshold for tile-in or drop-in installation



Part #	Mfg #	Description	Drain	Color	Price
074444	K-9026-96	48" x 36", Single Threshold	Center	Biscuit	
188483	K-9026-NY	48" x 36", Single Threshold	Center	Dune	
084381	K-9026-0	48" x 36", Single Threshold	Center	White	

### Shower Lockers™

#### Choreograph® Shower Locker Storage

- Four removable shelves; easy for cleaning
- Unique design ensures no water can collect on shelves
- Shelves and basket are height-adjustable to 10 positions
- Acrylic with matte finish
- 3/16" x 95-5/16"



Part #	Mfg #	Description	Drain	Color	Price
183468	K-97630-G9		Sandbar		

#### Echelon™ Shower Locker

- Integral tile-in flange
- Four easy-to-clean, built in shelves
- One-piece configuration
- 17-3/8" x 61-7/8"



Part #	Mfg #	Description	Price
111811	K-1842-0	White	
129175	K-1842-47	Almond	
110546	K-1842-58	Thunder Grey	
127391	K-1842-7	Black	

## Shower Bases & Accessories

### Shower Lockers™ (Continued)

#### Echelon™ Shower Locker

Part #	Mfg #	Description	Price
150466	K-1842-95	Ice Grey	
107354	K-1842-96	Biscuit	
124605	K-1842-G9	Sandbar	
147153	K-1842-K4	Cashmere	
151074	K-1842-NY	Dune	

#### Pilaster® Shower Locker®

- 61" H x 6-3/16"W
- Four easy-to-clean adjustable shelves
- Shelf cutouts for razor and washcloth storage
- Aluminum frame with plastic construction



Part #	Mfg #	Description	Drain	Color	Price
107355	1840-MX		Matte Nickel		

### Shower Seats

#### Echelon® Shower Seat

- 17-3/8" x 43-1/2"
- Molded shower seat
- Integral tile-in flange



Part #	Mfg #	Description	Drain	Color	Price
186592	K-1843-95	Shower Seat	17-3/8" x 43-1/2"	Ice Grey	

#### Removable Shower Seat

- L 23-1/2", H 4", W 9-13/16"
- Plastic construction
- For use with Sonata® 4-foot and 5-foot shower stalls



Part #	Mfg #	Description	Drain	Color	Price
070471	K-9499-0	Shower Seat	23-1/2" x 4" x 9-13/16"	White	

## Shower Bases & Accessories

### Shower Accessories

#### Expanse® Curved Shower Rod

- Stainless steel construction
- Adjustable to fit standard 60- or 72-inch enclosures



#### Traditional Design

Part #	Mfg #	Description	Drain	Color	Price
151950	K-9349-BS		Brushed Stainless		
171615	K-9349-2BZ		Oil Rubbed Bronze		
145053	K-9350-BS		Brushed Stainless		
184901	K-9350-2BZ		Oil Rubbed Bronze		
142224	K-9350-S		Polished Stainless		

#### Contemporary Design

Part #	Mfg #	Description	Drain	Color	Price
132946	K-9351-BS		Brushed Stainless		
139106	K-9351-S		Polished Stainless		

#### Groove® Aluminum Drain Cover for 60" Receptor

- For use with the K-9928 or K-9996 Groove® acrylic shower base



Part #	Mfg #	Description	Drain	Color	Price
120676	K-9333-SH		Bright Silver		

#### Groove® Teak Drain Cover

- High-grade teak wood
- Model (K-9337-NA) for use with the K-9928 or K-9996 Groove® shower base
- Model (K-9336-NA) for use with the K-9925 or K-9998 Groove® shower base
- Model (K-9335-NA) for use with the K-9927 Groove® acrylic shower base



Part #	Mfg #	Description	Drain	Color	Price
142268	K-9335-NA	42" Receptor	Teak Wood		
129220	K-9336-NA	48" Receptor	Teak Wood		
156592	K-9337-NA	60" Receptor	Teak Wood		

#### Bellwether® Drain Cover for Bellwether® Shower Base

- Plastic construction



60" x 32"

Part #	Mfg #	Description	Drain	Color	Price
167297	K-9155-0	For 60" x 32" Bellwether® Shower Base	White		



## Shower Bases & Accessories

### Shower Accessories (Continued)

#### Bellwether® Drain Cover for Bellwether® Shower Base

**60" x 32"**

Part #	Mfg #	Description	Drain	Color	Price
223646	K-9155-95	For 60" x 32" Bellwether® Shower Base	Ice Grey		
188189	K-9155-96	For 60" x 32" Bellwether® Shower Base	Biscuit		
224675	K-9155-G9	For 60" x 32" Bellwether® Shower Base	Sandbar		
186227	K-9156-NX	For 60" x 32" Bellwether® Shower Base	Brushed Nickel		

**60" x 34"**

Part #	Mfg #	Description	Drain	Color	Price
170390	K-9157-0	For 60" x 34" Bellwether® Shower Base	White		
228057	K-9157-96	For 60" x 34" Bellwether® Shower Base	Biscuit		
225693	K-9157-G9	For 60" x 34" Bellwether® Shower Base	Sandbar		
224481	K-9159-NX	For 60" x 34" Bellwether® Shower Base	Brushed Nickel		
231114	K-9159-SH	For 60" x 34" Bellwether® Shower Base	Bright Silver		

#### Corner Shower Basket

- Available in 3 sizes
- Stainless steel construction
- Mounting hardware included



Part #	Mfg #	Size	L X W	Height	Color	Price
143663	K-1898-BS	Small	4-3/4" x 4-3/4"	1-1/8"	Brushed Stainless	
136961	K-1896-BS	Medium	6-1/4" x 6-1/4"	3"	Brushed Stainless	
178560	K-1897-2BZ	Large	8-1/16" x 8-1/16"	3"	Oil Rubbed Bronze	

## Shower Bases

### Shower Pans

#### 6030CPAN Shower Pan

- High gloss finish
- A<sup>2</sup> Composite surface
- Pre-leveled slip-resistant, textured bottom
- Weep channels in all (4) corners
- Finishing step for application of various finishing materials



Part #	Mfg #	Finished Dimensions	Drain	Color	Price
140399	6030CPAN-L-WH	60" x 30" x 6"	Left	White	
136929	6030CPAN-R-WH	60" x 30" x 6"	Right	White	

## Shower Bases & Accessories

### Fiberglass Shower Bases

#### Fiberglass Shower Base

- *Fiberglass composite*
- *Side drainage channels*
- *Textured floor*



Part #	Mfg #	Size	Drain	Finish	Price
166356	SB-3636	36" x 36" x 6"	Center	White	
144852	SB-4832	48" x 32" x 4"	Center	White	
155098	SB-4836	48" x 36" x 4"	Center	White	
153836	SB-4836-BI	48" x 36" x 4"	Center	Biscuit	
227397	SB-5430R	54" x 30" x 4"	Right	White	
227396	SB-5430L	54" x 30" x 4"	Left	White	
154305	SB-6036	60" x 36" x 4"	Center	White	
153796	SB-6036-BI	60" x 36" x 4"	Center	Biscuit	
188710	SB-6036L	60" x 36" x 4"	Left	White	
188816	SB-6036R	60" x 36" x 4"	Right	White	
190294	SB-6042	60" x 42" x 4"	Center	White	
176457	SB-7236	72" x 36" x 4"	Center	White	

#### Fiberglass Shower Base - Above Floor Drain

- *ABF=Above floor drain*
- *ABF Models provide 3" of drain clearance*
- *Integral tile flange*
- *Balsa wood core floor structure*
- *Fiberglass composite*
- *Side drainage channels*
- *Textured floor*



Part #	Mfg #	Size	Drain	Finish	Price
242866	SB-4832-ABF	48" x 32" x 4"	Center	White	
242867	SB-6032L-ABF	60" x 32" x 4"	Left	White	
242868	SB-6032R-ABF	60" x 32" x 4"	Right	White	

## Shower Bases & Accessories

### Fiberglass Shower Base - Barrier Free Threshold

- MD=Model floor flange & barrier-free threshold
- One-Piece fiberglass composite construction
- Sanitary grade polyester gelcoat surface
- Integral tile flange
- Dual / Ledge drain channels
- 1/2" Threshold aids in keeping water within unit
- Contoured threshold to aid entry and exit
- 1" Floor flange to secure unit along threshold
- Textured floor pattern
- Balsa wood core floor structure



Part #	Mfg #	Size	Drain	Finish	Price
142792	SB-MD-6032	60" x 32" x 4"	Center	White	
164039	SB-MD-6236	62" x 36" x 4"	Center	White	

### Fiberglass Shower Base with Seat

- One-Piece gelcoat surface
- 3-3/8" Center or end drain (see reverse side for location)
- Molded seat
- Integral tile flange
- Balsa wood core floor structure
- Textured floor pattern



Part #	Mfg #	Size	Drain	Finish	Price
244554	SB-6036L-RS	60" x 36"	LH Drain, RH Seat	White	

**Shower Bases**

**Durabase® Fiberglass Shower Floors and Barrier-Free Shower Floor System**

- Styles and sizes for every installation
- Sturdy 1-piece molded construction
- Ribbed underbody for extra strength, slip-resistant surface
- Integrally molded drain with seal - removable stainless steel strainer
- Semi-gloss surface, resistant to mold and mildew, easy to clean



**Fiberglass Square Shower Floor- Single Threshold**

Part #	Mfg #	Size	Color	Price
027149	3636M	36" x 36"	White	

**Fiberglass Neo-Angle Shower Floor - Corner Threshold**



Part #	Mfg #	Size	Color	Price
028425	3636CM	36" x 36"	White	

**CareGiver® Easy-Access Showers**

**Shower Tub™ - Single Threshold**

- 1-Piece molded fiberglass
- Slip-resistant floor

Part #	Mfg #	Description	Color	Price
070172	3060L	30" x 60", LH Drain	White	
068552	3060R	30" x 60", RH Drain	White	

**Barrier-Free Shower Floor with Entry Ramp**

- Easy wheelchair access
- Strong molded fiberglass
- Resistance to mold, mildew and stains
- Offset 8-1/2" x 15" to utilize existing plumbing when replacing standard 5' tub



Part #	Mfg #	Drain	Color	Price
023175	360R	RH	White	

## Shower Doors

### Shower Doors

#### Levity® Sliding Shower Door

- *Frameless, tempered glass*
- *Roller design simplifies installation*
- *Cushioned center guide provides quiet sliding action*
- *CleanCoat™ glass treatment repels water*



Part #	Mfg #	Description	Finished Dimensions	Frame Finish	Price
160774	K-706008-D3-MX	Frosted Glass w/ Blade Handles	74" x 44-5/8"-47-5/8"	Matte Nickel	
252666	K-706008-L-ABZ	Crystal Clear Glass w/ Blade Handles	74" x 43-5/8" x 47-5/8"	Anodized Dark Bronze	
159879	K-706008-L-MX	Crystal Clear Glass w/ Blade Handles	74" x 43-5/8"-47-5/8"	Matte Nickel	
165310	K-706008-L-SH	Crystal Clear Glass w/ Blade Handles	74" x 43-5/8"-47-5/8"	Bright Silver	
164126	K-706009-D3-MX	Frosted Glass w/ Blade Handles	74" x 56-5/8"-59-5/8"	Matte Nickel	
165697	K-706009-D3-SH	Frosted Glass w/ Blade Handles	74" x 56-5/8"-59-5/8"	Bright Silver	
160890	K-706009-L-MX	Crystal Clear Glass w/ Blade Handles	74" x 56-5/8"-59-5/8"	Matte Nickel	
157899	K-706009-L-SH	Crystal Clear Glass w/ Blade Handles	74" x 56-5/8"-59-5/8"	Bright Silver	
242203	K-706009-L-ABZ	Crystal Clear Glass w/ Blade Handles	74" x 56-5/8"-59-5/8"	Anodized Dark Bronze	
254288	K-706010-L-NX	Crystal Clear Glass w/ Blade Handles	74" x 44-5/8" x 47-5/8"	Brushed Nickel	
159546	K-706011-L-NX	Crystal Clear Glass w/ Blade Handles	82" x 44-5/8"-47-5/8"	Brushed Nickel	
164557	K-706013-L-NX	Crystal Clear Glass w/ Blade Handles	82" x 56-5/8"-59-5/8"	Brushed Nickel	
183627	K-706013-L-SHP	Crystal Clear Glass w/ Blade Handles	82" x 56-5/8"-59-5/8"	Bright Polished Silver	
159051	K-706014-D3-MX	Frosted Glass w/ Towel Bars	74" x 44-5/8"-47-5/8"	Matte Nickel	
163335	K-706014-L-MX	Crystal Clear Glass w/ Towel Bars	74" x 44-5/8"-47-5/8"	Matte Nickel	
229362	K-706014-L-SH	Crystal Clear Glass w/ Towel Bars	74" x 44-5/8"-47-5/8"	Bright Silver	
239141	K-706014-L-ABZ	Crystal Clear Glass w/ Towel Bars	74" x 44-5/8"-47-5/8"	Anodized Dark Bronze	
242215	K-706015-D3-ABZ	Frosted Glass w/ Towel Bars	74" x 56-5/8"-59-5/8"	Anodized Dark Bronze	
159940	K-706015-D3-MX	Frosted Glass w/ Towel Bars	74" x 56-5/8"-59-5/8"	Matte Nickel	
241979	K-706015-L-ABZ	Crystal Clear Glass w/ Towel Bars	74" x 56-8/8"-59-5/8"	Anodized Dark Bronze	
162114	K-706015-L-MX	Crystal Clear Glass w/ Towel Bars	74" x 56-8/8"-59-5/8"	Matte Nickel	
166702	K-706015-L-SH	Crystal Clear Glass w/ Towel Bars	74" x 56-8/8"-59-5/8"	Bright Silver	
255348	K-706016-L-SHP	Crysta Clear Glass w/ Towel Bars	74" x 47-5/8"-47-5/8"	Bright Polished Silver	
235757	K-706017-L-NX	Crystal Clear Glass w/ Towel Bars	82" x 44-5/8"-47-5/8"	Brushed Nickel	
253250	K-706018-L-SHP	Crystal Clear Glass w/ Towel Bars	74" x 56-5/8-59-5/8"	Bright Polished Silver	
238753	K-706019-L-NX	Crystal Clear Glass w/ Towel Bars	82" x 56-5/8"-59-5/8"	Brushed Nickel	



## Shower Doors

### Finial® Framless Pivot Shower Door

- Frameless, 1/2"-thick crystal clear tempered glass
- Out-of-plumb adjustability for easy installation
- Can be installed to open to the left or right
- CleanCoat™ glass treatment repels water
- Includes K-705759 and K-705762 glass, K-705769 handle, and
- K-705766 hardware components



Part #	Mfg #	Description	Finished Dimensions	Frame Finish	Price
257630	K-705741-L-SHP	Crystal Clear Glass w/ Handle	72-1/4" x 57-1/4"-59-3/4"	Bright Polished Silver	

### Fluence® Sliding Shower Door

- Frameless, tempered glass
- Out-of-plumb adjustability for easy installation
- Continuous door panel guide mechanism for smooth, quiet sliding action
- CleanCoat™ glass treatment repels water
- Gently curved inside and outside towel bars



Part #	Mfg #	Description	Finished Dimensions	Frame Finish	Price
107173	K-702206-L-SHP	Crystal Clear Glass w/ Towel Bars	70-5/16" x 56-5/8"-59-5/8"	Bright Polished Silver	

### Gradient™ Sliding Shower Door

- Frameless, tempered glass
- Improved bypassing mechanism for smoother feel
- Solid-metal contemporary towel bar design
- CleanCoat™ glass treatment repels water for improved ease of cleaning
- Reversible top track offers a choice of curved or flat profile
- Out-of-plumb adjustability for easy installation



Part #	Mfg #	Description	Finished Dimensions	Frame Finish	Price
235816	K-709064-L-ABZ	Crystal Clear Glass	70-1/16" x 59-5/8"	Anodized Dark Bronze	

## Shower Doors

### Revel® Sliding Shower Door

- *Frameless, tempered glass*
- *Center-guided door system for smooth, quiet sliding action*
- *Frameless design with minimal metal allows for greater ease of cleaning*
- *Contemporary towel bar and knob combination offers storage on the outside of the door without encroaching on the bathing space*
- *Low bottom track creates easy entry and exit to the bathing space*
- *CleanCoat® glass treatment repels water for improved ease of cleaning*
- *Out-of-plumb adjustability for simpler installation*



Part #	Mfg #	Description	Finished Dimensions	Frame Finish	Price
245526	K-707100-D3-SHP	Frosted Glass	70" x 44-5/8"-47-5/8"	Bright Polished Silver	
245472	K-707200-D3-SHP	Frosted Glass	70" x 56-5/8"-59-5/8"	Bright Polished Silver	
239229	K-707200-L-ABZ	Crystal Clear Glass	70" x 56-5/8"-59-5/8"	Anodized Dark Bronze	
234623	K-707200-L-SHP	Crystal Clear Glass	70" x 56-5/8"-59-5/8"	Bright Polished Silver	
226117	K-707201-L-SHP	Crystal Clear Glass, 5/16" Thick	70" x 56-5/8"-59-5/8"	Bright Polished Silver	
251531	K-707206-D3-BNK	Frosted Glass, 5/16" Thick	76" x 56-5/8"-59-5/8"	Anodized Brushed Nickel	
240880	K-707206-L-BNK	Crystal Clear Glass, 5/16" Thick	76" x 56-5/8"-59-5/8"	Anodized Brushed Nickel	
232552	K-707206-L-SHP	Crystal Clear Glass, 5/16" Thick	76" x 56-5/8"-59-5/8"	Bright Polished Silver	

### Revel® Pivot Shower Door

- *Frameless, tempered glass*
- *Center-guided door system for smooth, quiet sliding action*
- *Frameless design with minimal metal allows for greater ease of cleaning*
- *Contemporary towel bar and knob combination offers storage on the outside of the door without encroaching on the bathing space*
- *Low bottom track creates easy entry and exit to the bathing space*
- *CleanCoat® glass treatment repels water for improved ease of cleaning*
- *Out-of-plumb adjustability for simpler installation*



Part #	Mfg #	Description	Finished Dimensions	Frame Finish	Price
256311	K-707546-L-BNK	Crystal Clear Glass	74" x 39-1/8"-44"	Anodized Brushed Nickel	
236891	K-707506-L-SHP	Crystal Clear Glass	74" x 27-5/16"-31-1/8"	Bright Polished Silver	
236435	K-707551-D3-SHP	Frosted Glass	70" x 43-1/8"-48"	Bright Polished Silver	
226723	K-707551-L-ABZ	Crystal Clear Glass	70" x 43-1/8"-48"	Anodized Dark Bronze	
185711	K-707551-L-BNK	Crystal Clear Glass	70" x 43-1/8"-48"	Anodized Brushed Nickel	
253499	K-707556-L-BNK	Crystal Clear Glass	74" x 43-1/8"-48"	Anodized Brushed Nickel	

## Shower Doors

### Fluence® Pivot Shower Door

- *Frameless, tempered glass*
- *Inside and outside solid-brass pull handles*
- *Two roller-compression latches ensure smooth, secure closure*
- *CleanCoat™ glass treatment repels water*
- *Out-of-plumb adjustability for easy installation*
- *Can be installed to open to the left or right*



Part #	Mfg #	Description	Finished Dimensions	Frame Finish	Price
130055	K-702414-L-SH	Crystal Clear Glass	65-1/2" x 37-1/2"-39"	Bright Silver	

### Tub & Shower Doors

#### Levity® Sliding Bath Door

- *Frameless, tempered glass*
- *Roller design simplifies installation*
- *Cushioned center guide provides quiet sliding action*
- *CleanCoat™ glass treatment repels water*



Part #	Mfg #	Description	Finished Dimensions	Frame Finish	Price
234779	K-706000-L-MX	Crystal Clear Glass w/ Blade Handles	62" x 56-5/8"-59-5/8"	Matte Nickel	
169028	K-706000-L-SH	Crystal Clear Glass w/ Blade Handles	62" x 56-5/8"-59-5/8"	Bright Silver	
249170	K-706002-L-ABV	Crystal Clear Glass w/ Blade Handles Bronze	59-3/4" x 56-5/8" x 59-5/8"	Anodized Brushed	
242843	K-706003-L-NX	Crystal Clear Glass w/ Blade Handles	62" x 56-5/8"-59-5/8"	Brushed Nickel	
230186	K-706004-L-MX	Crystal Clear Glass w/ Towel Bars	62" x 56-5/8"-59-5/8"	Matte Nickel	
226625	K-706004-L-SH	Crystal Clear Glass w/ Towel Bars	62" x 56-5/8"-59-5/8"	Bright Silver	
245044	K-706005-D3-MX	Frosted Glass w/ Towel Bars	59-3/4" x 54"-57"	Matte Nickel	
244848	K-706005-D3-SH	Frosted Glass w/ Towel Bars	59-3/4" x 54"-57"	Bright Silver	
251838	K-706005-L-MX	Crystal Clear Glass w/ Towel Bars	59-3/4" x 54"-57"	Matte Nickel	
225694	K-706006-L-MX	Crystal Clear Glass w/ Towel Bars	59-3/4" x 56-5/8"-59-5/8"	Matte Nickel	
187881	K-706006-L-SH	Crystal Clear Glass w/ Towel Bars	59-3/4" x 56-5/8"-59-5/8"	Bright Silver	
254823	K-706007-L-NX	Crystal Clear Glass w/ Square Towel Bars	62" x 56-5/8"-59-5/8"	Brushed Nickel	
251070	K-706166-L-SHP	Crystal Clear Glass w/ Towel Bars	62" x 56-5/8" x 59-5/8"	Bright Polished Silver	

## Shower Doors

### Fluence® Sliding Bath Door

- *Frameless, tempered glass*
- *Out-of-plumb adjustability for easy installation*
- *Continuous door panel guide mechanism for smooth, quiet sliding action*
- *CleanCoat™ glass treatment repels water*
- *Gently curved inside and outside towel bars*



Part #	Mfg #	Description	Finished Dimensions	Frame Finish	Price
242312	K-702205-L-NX	Crystal Clear Glass w/ Towel Bars	58-5/16" x 56-5/8"-59-5/8"	Brushed Nickel	

### Revel® Sliding Bath Door

- *Frameless, tempered glass*
- *Frameless design with minimal metal allows for greater ease of cleaning*
- *Out-of-plumb adjustability for easy installation*
- *Center-guided door system for smooth, quiet sliding action*
- *CleanCoat™ glass treatment repels water*
- *Contemporary towel bar and knob combination offers storage on the outside of the door without encroaching on the bathing space*
- *Low bottom track creates easy entry and exit to the bathing space*
- *(K-70700) 1/4" door thickness or (K-707001) 5/16" door thickness*



Part #	Mfg #	Description	Finished Dimensions	Frame Finish	Price
254144	K-707000-D3-SHP	Frosted Glass	55-1/2" x 56-5/8"-59-5/8" x 1/4"	Bright Polished Silver	
254129	K-707000-L-SHP	Crystal Clear Glass	55-1/2" x 56-5/8"-59-5/8" x 5/16"	Bright Polished Silver	
240021	K-707001-L-SHP	Crystal Clear Glass	55-1/2" x 56-5/8"-59-5/8" x 5/16"	Bright Polished Silver	

### Aerie® Bath Screen

- *Frameless, tempered glass*
- *Swings in or out for easy access and cleaning*
- *Seal provides excellent water containment*
- *Square minimalist-style wall jamb*
- *CleanCoat® glass treatment repels water for improved ease of cleaning*
- *No exposed screws for a sleek, contemporary look*



Part #	Mfg #	Description	Finished Dimensions	Frame Finish	Price
246051	K-707105-L-SHP	Crystal Clear Glass	56-15/16" x 32"	Bright Polished Silver	

---



---

## Shower Doors

---



---

### Quick 'N Stall Framed Neo Angle Shower Doors

- For fiberglass
- Pre-assembled header and curb
- Centerline dimensions based on 3/4" wall thickness
- Requires exact measurement of your opening



Part #	Mfg#	Model #	Height	Glass	Frame	Price
043293	160ST	Sterling 72040100	68-1/2"	Obscure	Silver	

## Shower Doors

### Shower Doors

#### Deluxe Framed By-Pass Shower Door

- 1-1/2" Frame
- Reversible top track and towel bar
- Smooth, quiet operation
- Limited 3-year warranty



Part #	Mfg #	Description	Glass	Frame	Price
108710	5970-48S	70" x 48-7/8"	Pebble	Silver	
088977	5970-59S	70" x 59-3/8"	Pebble	Silver	
227306	5975-48S-G78	70" x 48-7/8"	Birchwood	Silver	
227301	5975-59S-G78	70" x 59-3/8"	Birchwood	Silver	

#### Finesse™ Frameless Hinge Shower Door

- CleanCoat® technology creates a barrier between the water and glass to help keep your shower door looking new
- Elegant rounded handles are mounted through the glass
- Two roller-compression latches allow for secure do
- Hidden continuous hinge runs the full-length of the jamb
- Limited 5-year warranty



Part #	Mfg #	Description	Glass	Frame	Price
077774	6305-34N	65-1/2" x 34"	Clear	Nickel	
075554	6305-34S	65-1/2" x 34"	Clear	Silver	
188793	6305-37N	65-1/2" x 37-3/4"	Clear	Nickel	
240022	6305-37S	65-1/2" x 37-3/4"	Clear	Silver	
115736	6305-39N	65-1/2" x 39"	Clear	Nickel	

#### Finesse™ Peak™ Sliding Shower Door

- 5/16" thick tempered glass
- CleanCoat® barrier
- Reversible top track can be installed with either the concave or flat side facing out
- Door tracking system features a hidden, cushioned, center guide for smooth, quiet sliding action
- Two through-the-glass vertical handles, located both inside and outside, showcase a clean, uninterrupted look
- Frameless design highlights showering area
- Anodized aluminum hardware prevents rusting or corrosion
- Out-of-plumb adjustability allows for easy installation

Part #	Mfg #	Description	Drain	Finished Dimensions	Color	Price
227043	547808-48N-G03	70-1/16" x 47-5/8"	Frosted	Nickel		



## Shower Doors

### Shower Doors (Continued)

#### Finesse™ Peak™ Sliding Shower Door

Part #	Mfg #	Description	Drain	Finished Dimensions	Color	Price
227158	542808-59S-G05	59-5/8" x 55-1/2"	Clear	Silver		

#### Finesse™ Frameless By-Pass Shower Door

- CleanCoat® glass coating
- Heavy-duty, anodized aluminum-framed glass doors
- Reversible top track can be installed with either the round or flat side facing out
- 1/4" Thick tempered glass
- (2) Through-the-glass towel bars



Part #	Mfg #	Description	Glass	Frame	Price
120218	SP5465-45S-G05	65-1/2" x 45-3/8"	Smooth Clear	Silver	
147401	5475-59N-G03	70-1/16" x 59-5/8"	Frosted	Nickel	
109153	5475-59N-G05	70-1/16" x 59-5/8"	Smooth Clear	Nickel	
109152	5475-59S-G05	70-1/16" x 59-5/8"	Smooth Clear	Silver	

#### Finesse™ Quick-Install™ Frameless By-Pass Shower Door

- CleanCoat® technology creates a barrier between the water and glass to help keep your shower door looking new
- Quick Install™ compression fit technology eliminates track cutting and tile drilling
- Pre-installed roller mechanisms for easier installation



Part #	Mfg #	Description	Glass	Frame	Price
227244	5305EZ-59S-G69	58-3/4" x 59-1/4"	Lake Mist	Silver	
224965	5325EZ-57S-G69	55-3/4" x 57"	Lake Mist	Silver	
189581	5375EZ-DR	70-5/16" x 57-1/2"	Clear	Deep Bronze	
104035	5375EZ-47N	70-5/16" x 47-1/4"	Smooth Clear	Nickel	
097861	5375EZ-47S	70-5/16" x 47-1/4"	Smooth Clear	Silver	

## Shower Doors

### Prevail® Framed Sliding Shower Door

- Can be installed to open to left or right
- Smooth, easy-to-clean wall jambs
- Featuring ComforTrack™ Technology - a cushioned bottom track that allows for easier access to the showering space
- Out-of-plumb adjustability allows for simpler installation



Part #	Mfg #	Description	Drain	Finished Dimensions	Color	Price
189157	572075-48ADR-G10	70-1/8" x 48-7/8"	Pebbled	Deep Bronze		
189398	572075-59N-G03	70-1/8" x 59-3/8"	Frosted	Nickel		

### Intrigue™ Framed Neo-Angle Shower Door

- Corner design
- Threshold direct water back into shower
- Watertight flexible door magnet and seal
- Tempered glass
- No track cutting required
- Aluminum components extruded from alloy 6063-T5
- Stainless steel hardware
- Made for Sterling Intrigue Series 7204



Part #	Mfg #	Description	Glass	Frame	Price
052640	SP2270A-38S	72" x 15-13/16" x 27-9/16"	Pebbled	Silver	
072958	SP2276A-38N	72" x 15-13/16" x 27-9/16"	Rain	Nickel	
057795	SP2276A-38S	72" x 15-13/16" x 27-9/16"	Rain	Silver	

### Solitaire® Frameless Neo-Angle Corner Shower Kit

- Installs left- or right-handed
- Easy to clean high-gloss finish
- Tempered glass ensures maximum safety and durability
- CleanCoat™ barrier
- Recessed walls provide more showering space
- Kit includes door, walls with corner caddy, drain, and 42" molded base
- Quick and easy to install with no track-cutting required



Part #	Mfg #	Description	Drain	Finished Dimensions	Color	Price
223390	2375-42S-G05	29-7/16" x 78-1/4"	Clear	Nickel		

## Shower Doors

### Meritor™ Frameless Sliding Bath Door

- Can be installed to open left or right
- Smooth, easy-to-clean wall jambs
- Frameless, 5/16" thick tempered glass door
- ComforTrack™ enables you to sit, lean or kneel on the bottom track of the door to easily bathe children or clean the bathing space
- CleanCoat® barrier
- Center-guided mechanism for smooth, quiet sliding action and easy cleaning
- Out-of-plumb adjustability allows for simpler installation



581005-59S-G05

Part #	Mfg #	Description	Drain	Finished Dimensions	Color	Price
244502	581005-59ADR-G05	54-3/8"-59-3/8" x 55-1/8"	Clear	Anodized Deep Bronze		
190385	581005-59S-G05	54-3/8"-59-3/8" x 55-1/8"	Clear	Silver		

### Meritor™ Frameless Sliding Shower Door

- Can be installed to open left or right
- Smooth, easy-to-clean wall jambs
- Frameless, 5/16" thick tempered glass door
- ComforTrack™ enables you to sit, lean or kneel on the bottom track of the door to easily bathe children or clean the bathing space
- CleanCoat® barrier
- Center-guided mechanism for smooth, quiet sliding action and easy cleaning
- Out-of-plumb adjustability allows for simpler installation



Part #	Mfg #	Description	Drain	Finished Dimensions	Color	Price
237730	581075-59ADR-G03	59-3/8" x 69-11/16"	Frosted Glass	Anodized Deep Bronze		

**Shower Doors**

**Doors for Durastall® Shower Stalls**

**Glass Shower Doors for Durastall® Shower Stall**

- Tempered safety glass panel
- Install to open from either side
- 64" Height



Part #	Mfg #	Opening	Fits Models	Glass	Frame	Price
007573	88.700	24"	80, 82	Obscure	Aluminum	
007535	48.700	28"	140, 142	Obscure	Aluminum	

## Shower Rods

### Shower Rods

#### Shower Rod

- Fits standard 72" x 72" shower curtains
- Adjusts around 5' tub surrounds
- 1-Year limited warranty



Part #	Mfg #	Finish	Price
132474	52-5	Chrome	
242169	52-5BN	Brushed Nickel	
143294	55-5	Satin Stainless	
143746	2-10155SS	Stainless Steel	

#### Tension Shower Rod

- Adjusts from 5' to 6'
- Features decorative covers



Part #	Mfg #	Finish	Price
142275	TR1000CH	Chrome	
142251	TR1000BN	Brushed Nickel	
142682	TR1000OWB	Old World Bronze	

#### Adjustable Length Curved Shower Rod

- Adjusts to fit shower enclosures between 54" and 72"
- Pivoting flanges
- Stainless steel rod and covers
- Works with standard shower curtains



Part #	Mfg #	Finish	Price
109408	CSR2160CH	Chrome	
114698	CSR2160BN	Brushed Nickel	
106621	CSR2160OWB	Old World Bronze	

#### Adjustable Curved Shower Rod

- Fits standard 72"x72" shower curtains
- Pivoting flanges make installation easier
- Adjustable bar



Part #	Mfg #	Finish	Price
181076	CSR2164BN	5' to 6', Brushed Nickel	
181278	CSR2164CH	5' to 6', Chrome	

### Shower Rods (Continued)

#### Adjustable Curved Shower Rod

Part #	Mfg #	Finish	Price
222587	CSR2164OWB	5' to 6', Old World Bronze	

#### Double Curved Shower Rod

- Fits standard 72"x72" shower curtains
- Adjusts up to 5' for a more flexible installation



Part #	Mfg #	Finish	Price
145182	DN2141CH	Chrome	
143453	DN2141BN	Brushed Nickel	

#### Fixed Length Curved Shower Rod

- Available in 5' and 6' lengths
- Pivoting flanges
- Stainless steel rod and covers
- Works with standard shower curtain



CSR2145

Part #	Mfg #	Finish	Price
108203	CSR2165CH	5', Chrome	
106324	CSR2165BN	5', Brushed Nickel	
111747	CSR2165OWB	5', Old World Bronze	
225903	CSR2145BN	5', Brushed Nickel	

#### Tension Curved Shower Rod



Part #	Mfg #	Finish	Price
171603	CSR2172BN	5', Brushed Nickel	
245007	CSR2172CH	5', Chrome	

## Shower Rods

### Shower Curtain Rings

- 12/Pk



SR2201



SR2100

Part #	Mfg #	Finish	Price
129883	SR2100BN	Brushed Nickel	
132169	SR2100CH	Chrome	
126034	SR2100OWB	Old World Bronze	
150444	SR2201BN	Brushed Nickel	
155982	SR2201CH	Chrome	
146651	SR2201OWB	Old World Bronze	

### Commercial Shower Rod Flange Set

- Concealed mounting screws
- (2) Assemblies per set
- Fits 1" diameter rods



Part #	Mfg #	Finish	Price
126389	55-F	Stainless	

### Shower Rod Flange



Part #	Mfg #	Finish	Price
098391	65-F-PS	Chrome	

### Commercial Accessories

#### 2-100-5 Commercial Shower Rod

- Dimensions: 1" diameter x 5' length
- No flanges

Part #	Mfg #	Finish	Price
106251	2-100-5SS	Stainless Steel	
190076	2-100-5A	Chrome	

#### 61-5 Commercial Shower Rod

- Fits standard 72" x 72" shower curtains
- Fits 5' tub surrounds
- Includes decorative covers for ends to conceal the mounting hardware



Part #	Mfg #	Finish	Price
106288	61-F	Chrome	
143747	61-5-SS	Stainless	



## Shower Walls

### Shower Wall Panels and Kits

#### Choreograph™ Shower Wall Kit 72"

- Factory installed edge - no need for trim
- Joint system hides caulk and silicone
- Serica™, KOHLER'S® proprietary composite material
- Adheres to water-resistant wallboard
- 72" Height



Part #	Mfg #	Description	Size	Color	Price
175301	K-97618-0	Shower Wall Kit	60" x 32" x 72"	White	
190223	K-97618-47	Shower Wall Kit	60" x 32" x 72"	Almond	
249471	K-97618-G9	Shower Wall Kit	60"x32"x72"	Sandbar	
238947	K-97618-7-NY	Shower Wall Kit	60" x 32" x 72"	Veincut Dune	
242098	K-97618-NY	Shower Wall Kit	60" x 32" x 72"	Dune	
225768	K-97618-W07	Shower Wall Kit	60" x 32" x 72"	VeinCut Dune	
186880	K-97618-W09	Shower Wall Kit	60" x 32" x 72"	VeinCut Sandbar	
189466	K-97618-W10	Shower Wall Kit	60" 32" x 72"	CrossCut Dune	
178629	K-97618-W11	Shower Wall Kit	60" x 32" x 72"	CrossCut Biscuit	
189430	K-97619-W09	Shower Wall Kit	60" x 36" x 72"	VeinCut Sandbar	
176800	K-97619-0	Shower Wall Kit	60" x 36" x 72"	White	
187246	K-97619-47	Shower Wall Kit	60" x 36" x 72"	Almond	
176720	K-97619-96	Shower Wall Kit	60" x 36" x 72"	Biscuit	
174059	K-97619-W07	Shower Wall Kit	60" x 36" x 72"	VeinCut Dune	
176915	K-97619-W08	Shower Wall Kit	60" x 36" x 72"	VeinCut Biscuit	
176914	K-97619-W10	Shower Wall Kit	60" x 36" x 72"	CrossCut Dune	
228265	K-97620-0	Shower Wall Kit	60" x 42" x 72"	White	
226145	K-97620-W11	Shower Wall Kit	60" x 42" x 72"	CrossCut Biscuit	

#### Choreograph™ Shower Wall Kit

- Factory installed edge - no need for trim
- Joint system hides caulk and silicone
- Serica™, KOHLER'S® proprietary composite material
- Adheres to water-resistant wallboard
- **(T01)** -Brick texture— **(T02)** -Core texture
- 96" Height



Part #	Mfg #	Description	Size	Color	Price
179769	K-97611-0	Shower Wall Kit	36" x 36" x 96"	White	
222448	K-97611-95	Shower Wall Kit	36" x 36" x 96"	Ice Grey	
229596	K-97611-T01-0	Shower Wall Kit, Brick Texture	36" x 36" x 96"	White	
228603	K-97611-W07	Shower Wall Kit	36" x 36" x 96"	VeinCut Dune	
240564	K-97613-W07	Shower Wall Kit	42" x 42" x 96"	VeinCut Dune	
176906	K-97614-0	Shower Wall Kit	48" x 36" x 96"	White	
176908	K-97614-96	Shower Wall Kit	48" x 36" x 96"	Biscuit	
223082	K-97614-G9	Shower Wall Kit	48" x 36" x 96"	Sandbar	

## Shower Walls

### Shower Wall Panels and Kits (Continued)

#### Choreograph™ Shower Wall Kit

Part #	Mfg #	Description	Size	Color	Price
187721	K-97614-W07	Shower Wall Kit	48" x 36" x 96"	VeinCut Dune	
176909	K-97614-W08	Shower Wall Kit	48" x 36" x 96"	VeinCut Biscuit	
225068	K-97614-W09	Shower Wall Kit	48" x 36" x 96"	VeinCut Sandbar	
176907	K-97614-W10	Shower Wall Kit	48" x 36" x 96"	CrossCut Dune	
226637	K-99659-W07	Shower Wall Kit	48" x 48" x 96"	VeinCut Dune	
177200	K-97615-0	Shower Wall Kit	60" x 32" x 96"	White	
236616	K-97615-W07	Shower Wall Kit	60" x 32" x 96"	VeinCut Dune	
224676	K-97615-W09	Shower Wall Kit	60" x 32" x 96"	VeinCut Sandbar	
180426	K-97615-W10	Shower Wall Kit	60" x 32" x 96"	CrossCut Dune	
176910	K-97616-0	Shower Wall Kit	60" x 36" x 96"	White	
176912	K-97616-96	Shower Wall Kit	60" x 36" x 96"	Biscuit	
246746	K-97616-9G9	Shower Wall Kit	60" x 36" x 96"	VeinCut Sandbar	
176798	K-97616-T01-0	Shower Wall Kit, Brick Texture	60" x 36" x 96"	White	
246042	K-97616-T01-47	Shower Wall Kit, Brick Texture	60" x 36" x 96"	Almond	
224176	K-97616-T01-95	Shower Wall Kit, Brick Texture	60" x 36" x 96"	Ice Grey	
244918	K-97616-T01-96	Shower Wall Kit, Brick Texture	60" x 36" x 96"	Biscuit	
188143	K-97616-T02-0	Shower Wall Kit, Core Texture	60" x 36" x 96"	White	
179868	K-97616-T02-96	Shower Wall Kit, Core Texture	60" x 36" x 96"	Biscuit	
180387	K-97616-T01-NY	Shower Wall Kit, Brick Texture	60" x 36" x 96"	Dune	
187722	K-97616-W07	Shower Wall Kit	60" x 36" x 96"	VeinCut Dune	
176913	K-97616-W08	Shower Wall Kit	60" x 36" x 96"	VeinCut Biscuit	
181697	K-97616-W09	Shower Wall Kit	60" x 36" x 96"	VeinCut Sandbar	
176911	K-97616-W10	Shower Wall Kit	60" x 36" x 96"	CrossCut Dune	
222211	K-97616-W11	Shower Wall Kit	60" x 36" x 96"	CrossCut Biscuit	
184797	K-97617-95	Shower Wall Kit	60" x 42" x 96"	Ice Grey	
226177	K-97617-W07	Shower Wall Kit	60" x 42" x 96"	VeinCut Dune	
177481	K-97617-W08	Shower Wall Kit	60" x 42" x 96"	VeinCut Biscuit	
226146	K-97617-W11	Shower Wall Kit	60" x 42" x 96"	CrossCut Biscuit	

#### Choreograph™ Shower Wall Kit

- Serica®
- Matte finish
- In-field trimmable
- Factory-installed edge trim
- Joint system hides caulk and silicone
- Includes three 60" x 96" walls and two 96" corner joints

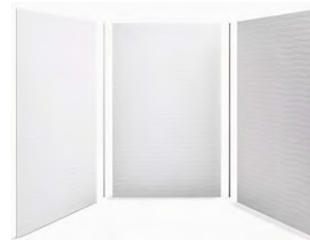

Part #	Mfg #	Description	Size	Color	Price
230143	K-99660-T01-0	Shower Wall Kit	60" x 60" x 96"	White	

## Shower Walls

### 72" Choreograph™ End Wall Panels

32"

Part #	Mfg #	Description	Size	Color	Price
189932	K-97605-0	Wall Panel Only	32" x 72"	White	
232585	K-97605-95	Wall Panel Only	32" x 72"	Ice Grey	
181817	K-97605-96	Wall Panel Only	32" x 72"	Biscuit	
229768	K-97605-G9	Wall Panel Only	32" x 72"	Sandbar	
225606	K-97605-W07	Wall Panel Only	32" x 72"	VeinCut Dune	
225582	K-97605-W10	Wall Panel Only	32" x 72"	CrossCut Dune	

36"

Part #	Mfg #	Description	Size	Color	Price
181712	K-97606-0	Wall Panel Only	36" x 72"	White	
181919	K-97606-G9	Wall Panel Only	36" x 72"	Sandbar	
181918	K-97606-W09	Wall Panel Only	36" x 72"	VeinCut Sandbar	

42"

Part #	Mfg #	Description	Size	Color	Price
246879	K-97607-G9	Wall Panel Only	42" x 72"	Sandbar	
187917	K-97607-W08	Wall Panel Only	42" x 72"	VeinCut Biscuit	

60"

Part #	Mfg #	Description	Size	Color	Price
230703	K-97608-W07	Wall Panel Only	60" x 72"	VeinCut Dune	
181816	K-97608-W09	Wall Panel Only	60" x 72"	VeinCut Sandbar	

### 96" Choreograph™ End Wall Panels

32"

Part #	Mfg #	Description	Size	Color	Price
225320	K-97600-0	Wall Panel Only	32" x 96"	White	
246877	K-97600-G9	Wall Panel Only	32" x 96"	Sandbar	
185839	K-97600-NY	Wall Panel Only	32" x 96"	Dune	
177480	K-97600-W08	Wall Panel Only	32" x 96"	VeinCut Biscuit	

36"

Part #	Mfg #	Description	Size	Color	Price
179770	K-97601-0	Wall Panel Only	36" x 96"	White	
186225	K-97601-96	Wall Panel Only	36" x 96"	Biscuit	
182130	K-97601-G9	Wall Panel Only	36" x 96"	Sandbar	
228415	K-97601-NY	Wall Panel Only	36" x 96"	Dune	
250572	K-97601-W07	Wall Panel Only	36" x 96"	VeinCut Dune	
225769	K-97601-W10	Wall Panel Only	36" x 96"	CrossCut Dune	
245071	K-97601-T01-96	Wall Panel Only, Brick Texture	36" x 96"	Biscuit	

## Shower Walls

### Shower Wall Panels and Kits (Continued)

#### 96" Choreograph™ End Wall Panels

36"

Part #	Mfg #	Description	Size	Color	Price
179518	K-97601-T01-NY	Wall Panel Only, Brick Texture	36" x 96"	Dune	
178423	K-97601-T02-0	Wall Panel Only, Cord Texture	36" x 96"	White	
225405	K-97601-T02-95	Wall Panel Only, Cord Texture	36" x 96"	Ice Grey	
179517	K-97601-T02-NY	Wall Panel Only, Cord Texture	36" x 96"	Dune	

42"

Part #	Mfg #	Description	Size	Color	Price
177531	K-97602-0	Wall Panel Only	42" x 96"	White	
245060	K-97602-W09	Wall Panel Only	42" x 96"	VeinCut Sandbar	
177556	K-97602-W10	Wall Panel Only	42" x 96"	CrossCut Dune	

48"

Part #	Mfg #	Description	Size	Color	Price
179972	K-97603-0	Wall Panel Only	48" x 96"	White	
223215	K-97603-G9	Wall Panel Only	48" x 96"	Sandbar	
179516	K-97603-W07	Wall Panel Only	48" x 96"	VeinCut Dune	
182129	K-97603-W09	Wall Panel Only	48" x 96"	VeinCut Sandbar	
255314	K-97603-W10	Wall Panel Only	48" x 96"	CrossCut Dune	

60"

Part #	Mfg #	Description	Size	Color	Price
177276	K-97604-T01-0	Wall Panel Only, Brick Texture	60" x 96"	White	
245073	K-97604-T01-96	Wall Panel Only, Brick Texture	60" x 96"	Biscuit	
232584	K-97604-W07	Wall Panel Only	60" x 96"	VeinCut Dune	
183132	K-97604-W09	Wall Panel Only	60" x 96"	VeinCut Sandbar	
251305	K-97604-W10	Wall Panel Only	60" x 96"	CrossCut Dune	
226144	K-97604-W11	Wall Panel Only	60" x 96"	CrossCut Biscuit	

#### Choreograph™ Accent Panels Stix, Hex, or Linen Texture

Part #	Mfg #	Description	Size	Color	Price
257812	K-97610-T03-95	Accent Panel Only, Hex Texture	60" x 28"	Ice Grey	
227481	K-97610-T04-0	Accent Panel Only, Stix Texture	60" x 28"	White	
176801	K-97610-T04-95	Accent Panel Only, Stix Texture	60" x 28"	Ice Grey	
229769	K-97610-T04-G9	Accent Panel Only, Linen Texture	60" x 28"	Sandbar	
176724	K-97610-T05-96	Accent Panel Only, Linen Texture	60" x 28"	Biscuit	

## Shower Walls

### Choreograph™ Joints and Trim

#### 72" Outside Corner Joint

- For use with Choreograph wall panels
- Aluminum construction
- Height in-field trimmable
- Set of 2



Part #	Mfg #	Description	Size	Color	Price
237654	K-90026-NY	Outside Corner Joint	72"	Dune	

#### 72" Wide Seam Joint

- For use with Choreograph wall and accent panels
- Aluminum construction
- Height in-field trimmable
- Set of 2



Part #	Mfg #	Description	Size	Color	Price
237653	K-90037-NY	Wide Seam Joint	72"	Dune	

## Shower Walls

### 96" Corner Joint

- For use with Choreograph wall panels
- Aluminum construction
- Height in-field trimmable
- Set of 2



Part #	Mfg #	Description	Size	Color	Price
176916	K-97635-0	Corner Joint	96"	White	
176802	K-97635-95	Corner Joint	96"	Ice Grey	
176732	K-97635-96	Corner Joint	96"	Biscuit	
176919	K-97635-ABZ	Corner Joint	96"	Anodized Dark Bronze	
176920	K-97635-BNK	Corner Joint	96"	Anodized Brushed Nickel	
182131	K-97635-G9	Corner Joint	96"	Sandbar	
176917	K-97635-NY	Corner Joint	96"	Dune	
176918	K-97635-SHP	Corner Joint	96"	Bright Polished Silver	

### 96" Outside Corner Joint

- For use with Choreograph wall panels
- Aluminum construction
- Height in-field trimmable
- Set of 2

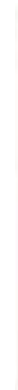

Part #	Mfg #	Description	Size	Color	Price
247784	K-90028-G9	Outside Corner Joint	96"	Sandbar	



## Shower Walls

### 96" Seam Joint

- For use with Choreograph wall panels and accent panels
- Use to install two shower wall panels vertically or horizontally on the wall
- Use to install an accent panel
- Use to install Shower Locker® storage
- Aluminum construction
- Height in-field trimmable
- Set of 2



For use only with KOHLER® wall panels with a rounded finish edge.  
Choreograph K-97635 corner joint or K-97638 edge trim may be required to complete rough-edge installations

Part #	Mfg #	Description	Size	Color	Price
176927	K-97636-0	Seam Joint	96"	White	
176803	K-97636-95	Seam Joint	96"	Ice Grey	
176728	K-97636-96	Seam Joint	96"	Biscuit	
176930	K-97636-ABZ	Seam Joint	96"	Anodized Dark Bronze	
176931	K-97636-BNK	Seam Joint	96"	Anodized Brushed Nickel	
183536	K-97636-G9	Seam Joint	96"	Sandbar	
176928	K-97636-NY	Seam Joint	96"	Dune	
176929	K-97636-SHP	Seam Joint	96"	Bright Polished Silver	

### 96" Edge Trim

- For use with Choreograph wall panels
- Aluminum construction
- Height in-field trimmable
- Set of 2



Part #	Mfg #	Description	Size	Color	Price
176922	K-97638-0	Edge Trim	96"	White	
176804	K-97638-95	Edge Trim	96"	Ice Grey	
176725	K-97638-96	Edge Trim	96"	Biscuit	
176925	K-97638-ABZ	Edge Trim	96"	Anodized Dark Bronze	
176926	K-97638-BNK	Edge Trim	96"	Anodized Brushed Nickel	
183467	K-97638-G9	Edge Trim	96"	Sandbar	
176923	K-97638-NY	Edge Trim	96"	Dune	
176924	K-97638-SHP	Edge Trim	96"	Bright Polished Silver	

## Shower Walls

### 72" Corner Joint

- For use with Choreograph wall panels
- Aluminum construction
- Height in-field trimmable
- Set of 2



Part #	Mfg #	Description	Size	Color	Price
189933	K-97735-0	Corner Joint	72"	White	
232586	K-97735-95	Corner Joint	72"	Ice Grey	
181818	K-97735-96	Corner Joint	72"	Biscuit	
181926	K-97735-G9	Corner Joint	72"	Sandbar	
175790	K-97735-NY	Corner Joint	72"	Dune	

### 72" Seam Joint

- For use with Choreograph wall panels and accent panels
- Use to install two shower wall panels vertically or horizontally on the wall
- Use to install an accent panel
- Use to install Shower Locker® storage
- Aluminum construction
- Height in-field trimmable
- Set of 2



For use only with KOHLER® wall panels with a rounded finish edge.  
Choreograph K-97735 corner joint or K-97738 edge trim may be required to complete rough-edge installations

Part #	Mfg #	Description	Size	Color	Price
180404	K-97736-0	Seam Joint	72"	White	
176727	K-97736-96	Seam Joint	72"	Biscuit	
179561	K-97736-BNK	Seam Joint	72"	Anodized Dark Bronze	
181925	K-97736-G9	Seam Joint	72"	Sandbar	
225583	K-97736-NY	Seam Joint	72"	Dune	

## Shower Walls

### 72" Edge Trim



Part #	Mfg #	Description	Size	Color	Price
176726	K-97738-96	Edge Trim	72"	Biscuit	
181924	K-97738-G9	Edge Trim	72"	Sandbar	
237668	K-97738-NY	Edge Trim	72"	Dune	

## Choreograph™ Accessories

### Choreograph™ 14" Shower Locker® Storage

- 16-13/16" x 95-5/16"
- For use with KOHLER Choreograph wall panels
- Four shelves; all removable for easy cleaning
- Unique design ensures no water can collect on the shelves
- Shower basket offers concealed storage for small items
- Shelves and basket are height-adjustable to 10 positions
- One shelf includes a hook for hanging storage and a cup for toothbrushes or razors
- Integrated foot ledge makes it easier to shave or wash your feet
- Recommended K-97636 Choreograph seam joint for installation (sold separately)



Part #	Mfg #	Description	Size	Color	Price
177532	K-97631-0	Shower Locker Storage	16-13/16" x 95-5/16"	White	
177547	K-97631-96	Shower Locker Storage	16-13/16" x 95-5/16"	Biscuit	
186909	K-97631-G9	Shower locker Storage	16-13/16" x 95-5/6"	Sandbar	
177549	K-97631-NY	Shower Locker Storage	16-13/16" x 95-5/16"	Dune	

## Shower Walls

### Choreograph™ 9" Shower Locker® Storage

- 10-7/8" x 95-5/16"
- For use with KOHLER Choreograph wall panels
- Four shelves; all removable for easy cleaning
- Unique design ensures no water can collect on the shelves
- Shower basket offers concealed storage for small items
- Shelves and basket are height-adjustable to 10 positions
- One shelf includes a hook for hanging storage and a cup for toothbrushes or razors
- Integrated foot ledge makes it easier to shave or wash your feet
- Recommended K-97636 Choreograph seam joint for installation (sold separately)



Part #	Mfg #	Description	Size	Color	Price
177158	K-97630-0	Shower Locker Storage	10-7/8" x 95-5/16"	White	
224184	K-97630-95	Shower Locker Storage	10-7/8" x 95-5/16"	Ice Grey	
176721	K-97630-96	Shower Locker Storage	10-7/8" x 95-5/16"	Biscuit	
177546	K-97630-NY	Shower Locker Storage	10-7/8" x 95-5/16"	Dune	

### Choreograph™ Freestanding Shower Stool

- 13-1/4" x 14" x 26-7/16"



Part #	Mfg #	Description	Size	Color	Price
177487	K-97632-0	Shower Stool	13-1/4" x 14" x 26-7/16"	White	

### Choreograph™ Shower Bar

- For use with Choreograph wall panels
- Slim, flat profile doubles as shower storage space
- 300 lbs of support



Part #	Mfg #	Description	Size	Color	Price
177540	K-97625-ABZ	Shower Bar	24"	Anodized Dark Bronze	
177541	K-97625-BNK	Shower Bar	24"	Anodized Brushed Nickel	
176722	K-97625-SHP	Shower Bar	24"	Bright Polished Silver	
176480	K-97626-ABZ	Shower Bar	36"	Anodized Dark Bronze	
176799	K-97626-BNK	Shower Bar	36"	Anodized Brushed Nickel	
174060	K-97626-SHP	Shower Bar	36"	Bright Polished Silver	
177543	K-97627-ABZ	Shower Bar	40"	Anodized Dark Bronze	
177533	K-97627-BNK	Shower Bar	40"	Anodized Brushed Nickel	
177542	K-97627-SHP	Shower Bar	40"	Bright Polished Silver	
177545	K-97628-ABZ	Shower Bar	54"	Anodized Dark Bronze	
175294	K-97628-BNK	Shower Bar	54"	Anodized Brushed Nickel	
177544	K-97628-SHP	Shower Bar	54"	Bright Polished Silver	

## Shower Walls

### Choreograph™ Hook

- 1-3/16" Reach
- Easily removed from wall cleat for easy cleaning
- Works inside and outside shower space



Part #	Mfg #	Description	Size	Color	Price
180388	K-97624-BNK	Shower Hook	1-3/16"	Anodized Brushed Nickel	
176481	K-97624-SHP	Shower Hook	1-3/16"	Bright Polished Silver	

### Choreograph™ Floating Shower Shelf

- Works best with KOHLER® Choreograph™ wall panels
- Can install over tile and other wall surfaces, inside or outside the shower space
- Includes trivet to hold bar of soap
- Designed for quick water drainage and easy cleaning
- Removable for more thorough cleaning
- Wall attachment is concealed
- Cleat system installation allows shelf to be removed without tools



Part #	Mfg #	Description	Size	Color	Price
177535	K-97621-ABZ	Shower Shelf	7"	Anodized Dark Bronze	
177010	K-97621-BNK	Shower Shelf	7"	Anodized Brushed Nickel	
177013	K-97621-SHP	Shower Shelf	7"	Bright Polished Silver	
177537	K-97622-ABZ	Shower Shelf	14"	Anodized Dark Bronze	
177534	K-97622-BNK	Shower Shelf	14"	Anodized Brushed Nickel	
177536	K-97622-SHP	Shower Shelf	14"	Bright Polished Silver	
177539	K-97623-ABZ	Shower Shelf	21"	Anodized Dark Bronze	
177011	K-97623-BNK	Shower Shelf	21"	Anodized Brushed Nickel	
177538	K-97623-SHP	Shower Shelf	21"	Bright Polished Silver	

---



---

## Shower Walls

---



---

### Walls

#### Tub & Shower Side Wall Set

- Includes (1) right and (1) left side wall

Part #	Mfg #	Dimensions	Color	Price
136931	2374CSW-WH	23" x 74"	White	

#### Tub & Shower Back Wall

Part #	Mfg #	Dimensions	Color	Price
136930	6074CBW-WHT	60" x 74"	White	



**Shower Walls**

**Durawall® Shower Walls**

**Durawall® Thermoplastic Deluxe Shower Wall**

- 5-Piece construction
- Overlapping edges
- Adhesive mount
- Formed shelves



Part #	Mfg #	Description	Color	Price
020226	260WHT	Up to 60"W & 34"D	White	

**Durawall® Fiberglass Premier Neo-Angle/Corner Shower Wall**

- 3-Piece molded fiberglass
- Walls interlock and mount with screws direct to stud walls
- Molded-in shelves
- Single threshold

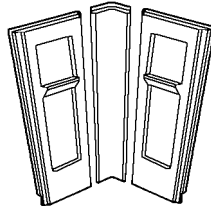

Part #	Mfg #	Fits Corner	Color	Price
007549	736CWHT	36" x 36"	White	

**Durawall® Fiberglass Alcove Shower Wall**

- 3-Piece molded fiberglass
- Molded-in shelves
- Single threshold
- Walls interlock and mount with screws direct to stud walls



Part #	Mfg #	Fits Alcove	Color	Price
007550	736WHT	36" x 36"	White	

## Bar/Entertainment Cast Iron Sinks

### Dual-Mount

#### Porto Fino™ Dual-Mount Bar Sink

- Single bowl round
- 21" Minimum base cabinet width
- No faucet holes



Part #	Mfg #	Overall Dimensions	Basin Depth	Holes	Color	Price
071318	K-6565-0	18-3/8" X 18-3/8"	8"	N/A	White	
084352	K-6565-47	18-3/8" X 18-3/8"	8"	N/A	Almond	
060870	K-6565-7	18-3/8" X 18-3/8"	8"	N/A	Black	
078506	K-6565-96	18-3/8" X 18-3/8"	8"	N/A	Biscuit	
099930	K-6565-FD	18-3/8" X 18-3/8"	8"	N/A	Cane Sugar	
237569	K-6565-FT	18-3/8" X 18-3/8"	8"	N/A	Basalt	
106132	K-6565-G9	18-3/8" X 18-3/8"	8"	N/A	Sandbar	
097387	K-6565-KA	18-3/8" X 18-3/8"	8"	N/A	Black n' Tan	
082467	K-6565-K4	18-3/8" X 18-3/8"	8"	N/A	Cashmere	
225241	K-6565-NY	18-3/8" X 18-3/8"	8"	N/A	Dune	

#### Iron/Tones® Dual-Mount Bar Sink

- Single bowl square
- 18" Minimum base cabinet width
- No faucet holes



Part #	Mfg #	Overall Dimensions	Basin Depth	Holes	Color	Price
059641	K-6584-0	18-3/4" X 17"	8-1/4"	N/A	White	
084356	K-6584-47	18-3/4" X 17"	8-1/4"	N/A	Almond	
064293	K-6584-7	18-3/4" X 17"	8-1/4"	N/A	Black	
142854	K-6584-95	18-3/4" X 17"	8-1/4"	N/A	Ice Grey	
062307	K-6584-96	18-3/4" X 17"	8-1/4"	N/A	Biscuit	
139468	K-6584-FD	18-3/4" X 17"	8-1/4"	N/A	Cane Sugar	
098428	K-6584-FF	18-3/4" X 17"	8-1/4"	N/A	Sea Salt	
153284	K-6584-FP	18-3/4" X 17"	8-1/4"	N/A	Caviar	
065894	K-6584-G9	18-3/4" X 17"	8-1/4"	N/A	Sandbar	
091560	K-6584-KA	18-3/4" X 17"	8-1/4"	N/A	Black n' Tan	
095504	K-6584-K4	18-3/4" X 17"	8-1/4"	N/A	Cashmere	
163271	K-6584-NY	18-3/4" X 17"	8-1/4"	N/A	Dune	

## Bar/Entertainment Cast Iron Sinks

### Iron/Tones® Dual-Mount Bar Sink

- Single bowl square
- 21" Minimum base cabinet width
- No faucet holes



Part #	Mfg #	Overall Dimensions	Basin Depth	Holes	Color	Price
055432	K-6587-0	20-7/8" X 20-7/8"	9-1/2"	N/A	White	
107316	K-6587-47	20-7/8" X 20-7/8"	9-1/2"	N/A	Almond	
134002	K-6587-58	20-7/8" X 20-7/8"	9-1/2"	N/A	Thunder Grey	
070119	K-6587-7	20-7/8" X 20-7/8"	9-1/2"	N/A	Black	
089413	K-6587-96	20-7/8" X 20-7/8"	9-1/2"	N/A	Biscuit	
107124	K-6587-FD	20-7/8" X 20-7/8"	9-1/2"	N/A	Cane Sugar	
153440	K-6587-FF	20-7/8" X 20-7/8"	9-1/2"	N/A	Sea Salt	
152233	K-6587-FP	20-7/8" X 20-7/8"	9-1/2"	N/A	Caviar	
107564	K-6587-G9	20-7/8" X 20-7/8"	9-1/2"	N/A	Sandbar	
093664	K-6587-KA	20-7/8" X 20-7/8"	9-1/2"	N/A	Black n' Tan	
146377	K-6587-K4	20-7/8" X 20-7/8"	9-1/2"	N/A	Cashmere	

### Iron/Tones® Dual-Mount Entertainment Sink

- Single bowl square
- 21" Minimum base cabinet width
- No faucet holes



Part #	Mfg #	Overall Dimensions	Basin Depth	Holes	Color	Price
067505	K-6585-0	24-1/4" X 18-3/4"	8-1/4"	N/A	White	
072123	K-6585-47	24-1/4" X 18-3/4"	8-1/4"	N/A	Almond	
066489	K-6585-7	24-1/4" X 18-3/4"	8-1/4"	N/A	Black	
059003	K-6585-96	24-1/4" X 18-3/4"	8-1/4"	N/A	Biscuit	
134178	K-6585-FD	24-1/4" X 18-3/4"	8-1/4"	N/A	Cane Sugar	
237183	K-6585-FP	24-1/4" X 18-3/4"	8-1/4"	N/A	Caviar	
068590	K-6585-G9	24-1/4" X 18-3/4"	8-1/4"	N/A	Sandbar	
097238	K-6585-KA	24-1/4" X 18-3/4"	8-1/4"	N/A	Black n' Tan	

## Top-Mount

### Northland™ Top-Mount Bar Sink

- Single bowl
- 15" Minimum base cabinet width
- Available with 1, 2, or 3 faucet holes



Part #	Mfg #	Overall Dimensions	Basin Depth	Holes	Color	Price
055501	K-6579-1-0	15" X 15"	7"	1	White	
127852	K-6579-1-47	15" X 15"	7"	1	Almond	
103202	K-6579-1-7	15" X 15"	7"	1	Black	

## Bar/Entertainment Cast Iron Sinks

### Top-Mount (Continued)

#### Northland™ Top-Mount Bar Sink

Part #	Mfg #	Overall Dimensions	Basin Depth	Holes	Color	Price
055502	K-6579-1-96	15" X 15"	7"	1	Biscuit	
055133	K-6579-2-0	15" X 15"	7"	2	White	
058062	K-6579-2-7	15" X 15"	7"	2	Black	
055503	K-6579-2-96	15" X 15"	7"	2	Biscuit	

### Under-Mount

#### Napa™ Under-Mount Bar Sink

- Single bowl
- 21" Minimum base cabinet width
- 2 Oversized faucet holes allow for easy installation (-2U Only)



Part #	Mfg #	Overall Dimensions	Basin Depth	Holes	Color	Price
222397	K-5848-0	18-3/4" X 20-7/8"	9"	N/A	White	
236860	K-5848-K4	18-3/4" X 20-7/8"	9"	N/A	Cashmere	

#### Northland™ Under-Mount Bar Sink

- Single bowl
- 15" Minimum base cabinet width
- No faucet holes
- Under-mount installation



Part #	Mfg #	Overall Dimensions	Basin Depth	Holes	Color	Price
061848	K-6589-U-0	15" X 12-3/8"	7"	N/A	White	
152048	K-6589-U-47	15" X 12-3/8"	7"	N/A	Almond	
060644	K-6589-U-7	15" X 12-3/8"	7"	N/A	Black	
054866	K-6589-U-95	15" X 12-3/8"	7"	N/A	Ice Grey	
060353	K-6589-U-96	15" X 12-3/8"	7"	N/A	Biscuit	
104223	K-6589-U-FD	15" X 12-3/8"	7"	N/A	Cane Sugar	
137983	K-6589-U-FF	15" X 12-3/8"	7"	N/A	Sea Salt	
149779	K-6589-U-FP	15" X 12-3/8"	7"	N/A	Caviar	
071753	K-6589-U-G9	15" X 12-3/8"	7"	N/A	Sandbar	
109378	K-6589-U-KA	15" X 12-3/8"	7"	N/A	Black n' Tan	
084989	K-6589-U-K4	15" X 12-3/8"	7"	N/A	Cashmere	

## Bar/Entertainment Stainless Steel Sinks

### Dual-Mount

#### Vault™ Dual-Mount Entertainment Sink

- 18 Gauge stainless steel
- Installation hardware and bottom basin rack included



Part #	Mfg #	Overall Dimensions	Basin Depth	Holes	Color	Price
142929	K-3840-1-NA	15" x 15"	9"	1	Single	
173444	K-3840-3-NA	15" x 15"	9"	3	Single	
138559	K-3822-1-NA	25" x 22"	9"	1	Single	
145189	K-3822-3-NA	25" x 22"	9"	3	Single	
132127	K-3822-4-NA	25" x 22"	9"	4	Single	

### Top-Mount

#### Brinx® Top-Mount Bar Sink

- 21-inch minimum base cabinet width
- 14-gauge stainless steel
- 6-inch depth
- 18-3/4" (476 mm) diameter



Part #	Mfg #	Overall Dimensions	Basin Depth	Holes	Color	Price
124188	K-3674-NA	18-3/4"	6"	N/A	Single	

#### Staccato™ Drop-In Entertainment Sink

- 18 Gauge stainless steel
- Installation hardware included



Part #	Mfg #	Overall Dimensions	Basin Depth	Holes	Color	Price
064857	K-3363-1-NA	20" x 20"	8"	1	Single	
083623	K-3362-1-NA	25" x 22"	8"	1	Single	

#### Taccato™ Drop-In Entertainment Sink

- 19 Gauge stainless steel
- Installation hardware included
- SilentShield® sound-absorption pads
- 18" Minimum base cabinet width



Part #	Mfg #	Overall Dimensions	Basin Depth	Holes	Color	Price
053333	K-3349-1-NA	15" x 15"	7"	1	Single	
053334	K-3349-2-NA	15" x 15"	7"	2	Single	

## Bar/Entertainment Stainless Steel Sinks

### Under-Mount

#### Poise® Under-Mount Entertainment Sink

- 16 Gauge stainless steel
- Silent Shield® sound-absorption pads
- Installation hardware included
- 21" Minimum base cabinet width



Part #	Mfg #	Overall Dimensions	Basin Depth	Holes	Color	Price
108769	K-3391-NA	18" x 18"	9"	Less Holes	Single	

#### Poise® Under-Mount Entertainment Sink with Bottom Bowl Rack and Cutting Board

- 16-gauge stainless steel
- 9-inch depth
- SilentShield® sound-absorption
- 21-inch minimum base cabinet width
- Includes installation hardware, bottom sink rack, and bamboo cutting board



Part #	Mfg #	Overall Dimensions	Basin Depth	Holes	Color	Price
108767	K-3161-NA	18" x 18"	9"	Less Holes	Single	

#### Strive™ Under-Mount Entertainment Sink

- 16 Gauge stainless steel
- Rear drain
- SilentShield® sound-absorption technology
- Includes dishcloth bar/utility shelf and bottom basin rack
- 27" Minimum base cabinet width



Part #	Mfg #	Overall Dimensions	Basin Depth	Holes	Color	Price
166623	K-5286-NA	24" x 18-1/4"	9"	Less Holes	Single	
166420	K-5287-NA	15" x 15"	9"	Less Holes	Single	

#### Undertone® Preserve™ Under-Mount Entertainment Sink

- 18 Gauge stainless steel
- SilentShield® sound-absorption technology
- Rear drain
- Innovative Preserve™ sink resists scratching
- Installation hardware included and bottom basin rack
- 27" Minimum base cabinet width



Part #	Mfg #	Overall Dimensions	Basin Depth	Holes	Color	Price
178499	K-3325-HCF-NA	23" x 17-1/2"	9-3/16"	Less Holes	Single	



## Bar/Entertainment Stainless Steel Sinks

### Undertone® Extra-Large Squared Under-Mount Entertainment Sink

- 18 Gauge stainless steel
- SilentShield® sound-absorption pads
- Rear drain
- Includes installation hardware
- 27-inch minimum base cabinet width



Part #	Mfg #	Overall Dimensions	Basin Depth	Holes	Color	Price
056174	K-3332-NA	23" x 17-1/2"	7-1/2"	Less Holes	Single	

### Undertone® Medium Squared Under-Mount Entertainment Sink

- 18 Gauge stainless steel
- SilentShield® sound-absorption pads
- Rear drain
- Includes installation hardware
- 21-inch minimum base cabinet width



Part #	Mfg #	Overall Dimensions	Basin Depth	Holes	Color	Price
054371	K-3331-NA	15-3/4" x 17-1/2"	7-1/2"	Less Holes	Single	

### Undertone® Under-Mount Entertainment Sink

- 18 Gauge stainless steel
- SilentShield® sound-absorption technology
- Center drain
- Installation hardware included and bottom basin rack
- 21" Minimum base cabinet width



Part #	Mfg #	Overall Dimensions	Basin Depth	Holes	Color	Price
094648	K-3182-NA	16-1/4" x 20-1/2"	8"	Less Holes	Single	

### Undertone® Trough Sink

- 16 Gauge stainless steel
- No faucet holes
- SilentShield® sound-absorption pads
- Includes installation hardware, wire storage basket, and wire rack



Part #	Mfg #	Overall Dimensions	Basin Depth	Holes	Color	Price
083596	K-3155-NA	33" x 8-1/4"	5-15/16"	Less Holes	Single	

**Bar/Entertainment Stainless Steel Sinks**

**Stainless Steel Entertainment Sinks**

**Self-Rimming Single Bowl Entertainment Sink**

- Ledge back
- Stud mounting
- Type 302 series nickel-bearing stainless steel
- Rounded corners
- Self-rimming; rolled rim
- SilentShield™ sound-absorption technology



Part #	Mfg #	Overall Dimensions	Depth	Holes	Drain	Finish	Price
081703	B153-2	15" x 15"	5-1/2"	2	3-5/8"	22ga Satin	

**Springdale® Undercounter Single Bowl Entertainment Sink**

- SilentShield™ sound-deadening system



Part #	Mfg #	Overall Dimensions	Depth	Holes	Drain	Finish	Price
102103	11448-NA	16-1/4" x 17-3/4"	8"	Less Holes	3-3/4"	18ga Satin	
102104	11449-NA	16" x 20-1/4"	8"	Less Holes	3-3/4"	18ga Satin	

**Undercounter Single Bowl Entertainment Sink**

- Wide undermount lip, rimless
- SilentShield™ sound deadening



Part #	Mfg #	Overall Dimensions	Depth	Holes	Drain	Finish	Price
099058	UCL1515	14-1/4" x 11-3/4"	7"	Less Holes	3-5/8"	18ga Satin	

**Bar/Entertainment Stainless Steel Sinks**

**Stainless Steel Bar Sinks**

**Steelart™ Precision™ Undermount Bar Sink**

- 304 Series, 18 gauge stainless steel
- 18/10 Chrome/nickel content
- Satin polished finish
- Rear drain placement
- Sound deadening pads



Part #	Mfg #	Finish	Bowl Depth	Overall Size	Cabinet Size	Drain Dia	Price
092900	512746	Stainless Steel	10"	20" x 15"	24"	3-1/2"	
126106	516209	Stainless Steel	10"	19" x 18"	21"	3-1/2"	

**Steelart™ Precision™ R10 Undermount Bar Sink**

- 304 Series, 18 gauge stainless steel
- 18/10 Chrome/nickel content
- 10mm radius corners
- Satin polished finish
- Rear drain placement
- Sound deadening pads



Part #	Mfg #	Finish	Bowl Depth	Overall Size	Cabinet Size	Drain Dia	Price
126381	515638	Stainless Steel	8"	17" x 17"	21"	3-1/2"	
137474	516224	Stainless Steel	10"	19" x 18"	21"	3-1/2"	
136268	516223	Stainless Steel	10"	22" x 18"	27"	3-1/2"	

**Stellar™ Undermount Bar Sink**

- 304 Series, 18 gauge stainless steel
- 18/10 Chrome/nickel content
- Refined brushed finish
- Rear drain placement



Part #	Mfg #	Finish	Bowl Depth	Overall Size	Cabinet Size	Drain Dia	Price
123284	441026	Stainless Steel	6-1/2"	15" x 15"	18"	3-1/2"	

**Blanco Quatrus™ Undermount Bar Sink**

- 304 Series, 18 gauge stainless steel
- 18/10 Chrome/nickel content
- Satin Finish
- Rear drain placement



Part #	Mfg #	Finish	Bowl Depth	Overall Size	Cabinet Size	Drain Dia	Price
153852	518168	Stainless Steel	8"	17" x 17"	21"	3-1/2"	

**Bar/Entertainment Stainless Steel Sinks**

**Quatrus™ R15 Undermount Bar Sink**

- 304 Series, 18 gauge stainless steel
- 18/10 Chrome/nickel content
- Satin finish
- Rear drain placement
- Sound deadening pads



Part #	Mfg #	Finish	Bowl Depth	Overall Size	Cabinet Size	Drain Dia	Price
168240	519545	Stainless Steel	8"	17" x 17"	21"	3-1/2"	

**Precision™ Bowl Undermount Bar Sink**

- 304 Series, 18 gauge stainless steel
- 18/10 Chrome/nickel content
- Zero radius corners
- Satin polished finish
- Rear drain placement
- Sound deadening pads



Part #	Mfg #	Finish	Bowl Depth	Overall Size	Cabinet Size	Drain Dia	Price
163060	516208	Stainless Steel	10"	15" x 18"	18"	3-1/2"	
115548	512743	Stainless Steel	8"	11" x 20"	15"	3-1/2"	

**Bar/Entertainment Stainless Steel Sinks**

**Stainless Steel Bar Sinks**

**Avado® Undermount SS Single Bowl Sink**

- 16" Gauge
- Polished satin finish
- Sound guard undercoating
- Drains not included



Part #	Mfg #	Overall Size	Holes	Depth	Drain Opening	Min Sink	Price
180433	EFRU131610	16" x 18-1/2"	N/A	10"	3-1/2"	21"	

**Avado® Undermount SS Single Bowl Sink with Zero Radius**

- 16" Gauge
- Polished satin finish
- Sound guard undercoating
- Drains not included



Part #	Mfg #	Overall Size	Holes	Depth	Drain Opening	Min Sink	Price
101669	EFU131610	16" x 18-1/2"	N/A	10"	3-1/2"	21"	

**Crosstown™ Dual Mount SS Single Bowl Bar Sink**

- 18" Gauge
- Polished satin finish
- 1 2 3 4 faucet holes (13169)
- 1 2 MR2 3 faucet holes (15159)
- 1 2 3 4 5 MR2 FR2 faucet holes (25229)
- Sound guard undercoating
- Includes bottom grid
- Drains not included



ECTSR25229BG



ECTSR15159BG

Part #	Mfg #	Overall Size	Holes	Depth	Drain Opening	Min Sink	Price
253485	ECTSR13169BG1	13" x 16"	1	9"	3-1/2"	18"	
185640	ECTSR15159BG1	15" x 15"	1	9"	3-1/2"	18"	
176608	ECTSR15159BG2	15" x 15"	2	9"	3-1/2"	18"	
174828	ECTSR15159BG3	15" x 15"	3	9"	3-1/2"	18"	
172005	ECTSR25229BG0	25" x 22"	0	9"	3-1/2"	30"	
173159	ECTSR25229BG3	25" x 22"	3	9"	3-1/2"	30"	
172757	ECTSR25229BG4	25" x 22"	4	9"	3-1/2"	30"	

**Bar/Entertainment Stainless Steel Sinks**

**Crosstown™ SS Undermount Single Bowl Sink**

- 18" Gauge
- Polished satin finish
- Sound guard deadening
- Drains not included
- (-DBG) Drain and bottom grid kit



ECTRU17179



ECTRU24179

Part #	Mfg #	Overall Size	Holes	Depth	Drain Opening	Min Sink	Price
166628	ECTRU12179	13-1/2" x 18-1/2"	N/A	9"	3-1/2"	18"	
248897	ECTRU12179DBG	13-1/2" x 18-1/2"	N/A	9"	3-1/2"	18"	
181091	ECTRU24179R	25-1/2" x 18-1/2"	N/A	9"	3-1/2"	30"	

**Gourmet® Celebrity® SS Self-Rimming Single Bowl Bar Sink**

- 20" Gauge
- Brushed satin finish
- 1 2 MR2 3 4 5 faucet holes
- Fully undercoated
- Coved corners: 3" radius
- BCR150-C Package includes:
  - Bar sink (BCR15)
  - 2-Handle faucet with 5-1/2" high deck to aerator gooseneck swing spout (LKA-2479-8)
  - Basket strainer (LK-58)
- Drains not included



BCR15MR

Part #	Mfg #	Overall Size	Holes	Depth	Drain Opening	Min Sink	Price
006049	BCR151	15" x 15"	1	6"	2"	18"	
006050	BCR152	15" x 15"	2	6"	2"	18"	

**Gourmet® Celebrity® SS Self-Rimming Single Bowl Bar Sink**

- 20" Gauge
- Brushed satin finish
- 1 2 MR2 3 faucet holes
- Fully undercoated
- Coved corners: 3" radius
- Drains not included



Part #	Mfg #	Overall Size	Holes	Depth	Drain Opening	Min Sink	Price
024578	CR17211	17" x 21-1/4"	1	6-7/8"	3-1/2"	21"	
006060	CR17212	17" x 21-1/4"	2	6-7/8"	3-1/2"	21"	
006061	CR17213	17" x 21-1/4"	3	6-7/8"	3-1/2"	21"	



**Bar/Entertainment Stainless Steel Sinks**

**Gourmet® Celebrity® SS Self-Rimming Single Bowl Bar Sink**

- 20" Gauge
- Brushed satin finish
- 1 2 MR2 3 4 5 faucet holes
- Fully undercoated
- Coved corners: 3" radius
- Drains not included



Part #	Mfg #	Overall Size	Holes	Depth	Drain Opening	Min Sink	Price
006063	CR25223	25" x 22"	3	7"	3-1/2"	30"	
006064	CR25224	25" x 22"	4	7"	3-1/2"	30"	

**Pursuit® SS Self-Rimming Single Bowl Bar Sink**

- 20" Gauge
- Brushed satin finish
- 1 3 MR2 5 faucet holes
- Fully undercoated
- Drains not included



Part #	Mfg #	Overall Size	Holes	Depth	Drain Opening	Min Sink	Price
079177	DCR2522101	25" x 22"	1	10-1/4"	3-1/2"	30"	
237093	DCR2522122	25" x 22"	3	12"	3-1/2"	30"	
239096	DCR252212MR2	25" x 22"	MR2	12"	3-1/2"	30"	

**Gourmet® Celebrity® SS Self-Rimming Single Bowl Bar Sink**

- 20" Gauge
- Brushed satin finish
- 1 2 MR2 3 4 5 faucet holes
- Fully undercoated
- Coved corners: 3" radius
- Drains not included



Part #	Mfg #	Overall Size	Holes	Depth	Drain Opening	Min Sink	Price
223769	GECCR25212	25" x 21-1/4"	2	5-3/8"	3-1/2"	30"	
091941	GECCR25213	25" x 21-1/4"	3	5-3/8"	3-1/2"	30"	
172751	GECCR25214	25" x 21-1/4"	4	5-3/8"	3-1/2"	30"	

**Gourmet® Lustertone® Self-Rimming Single Bowl Bar Sink**

- 18" Gauge
- Lustrous highlighted satin finish
- 1 2 MR2 3 faucet holes
- Fully undercoated
- Drains not included



Part #	Mfg #	Overall Size	Holes	Depth	Drain Opening	Min Sink	Price
098244	BLR152	15" x 15"	2	7-1/8"	2"	18"	
124162	BLR15MR2	15" x 15"	MR2	7-1/8"	2"	18"	

**Bar/Entertainment Stainless Steel Sinks**

**Stainless Steel Bar Sinks (Continued)**

**Gourmet® Lustertone® Self-Rimming Single Bowl Bar Sink**

Part #	Mfg #	Overall Size	Holes	Depth	Drain Opening	Min Sink	Price
102101	BLR153	15" x 15"	3	7-1/8"	2"	18"	
086402	BLR15162	15" x 15"	2	7-1/8"	3-1/2"	18"	
176562	BLR15602	15" x 15"	2	6-1/8"	2"	18"	

**Gourmet® Lustertone® Self-Rimming SS Single Bowl Sink**

- 18" Gauge
- Lustrous highlighted satin finish
- 1 2 MR2 3 faucet holes
- Fully undercoated
- Drains not included



Part #	Mfg #	Overall Size	Holes	Depth	Drain Opening	Min Sink	Price
167811	LR13161	13" x 16"	1	7-5/8"	3-1/2"	18"	
092351	LR15172	15" x 17-1/2"	2	7-5/8"	3-1/2"	18"	
085623	LR15173	15" x 17-1/2"	3	7-5/8"	3-1/2"	18"	

**Gourmet® Lustertone® Self-Rimming SS Single Bowl Sink—One Faucet Holes**

- 18" Gauge
- Lustrous highlighted satin finish
- 1 2 MR2 3 OS4 faucet holes
- Fully undercoated
- Drains not included



LR20221

Part #	Mfg #	Overall Size	Holes	Depth	Drain Opening	Min Sink	Price
098542	LR20221	19-1/2" x 22"	1	7-5/8"	3-1/2"	24"	

**Gourmet® Lustertone® Self-Rimming SS Single Bowl Sink—Two Faucet Holes**

- 18" Gauge
- Lustrous highlighted satin finish
- 1 2 MR2 3 OS4 faucet holes
- 1 2 MR2 2 4 5 faucet holes ( **models 2219, 2521** )
- MR2 holes are offset right
- Fully undercoated
- Drains not included
- (-PD) Includes perfect drain



LR17202

Part #	Mfg #	Overall Size	Holes	Depth	Drain Opening	Min Sink	Price
098824	LR17202	17" x 20"	2	7-5/8"	3-1/2"	21"	
187901	LR1716MR2	17" x 16"	MR2	7-5/8"	3-1/2"	21"	
006133	LR17222	17" x 22"	2	7-5/8"	3-1/2"	21"	
134834	LR1722MR2	17" x 22"	MR2	7-5/8"	3-1/2"	21"	
113491	LR19192	19-1/2" x 19"	2	7-1/2"	3-1/2"	24"	
170721	LR1919PD2	19-1/2" x 19"	2	7-1/2"	3-1/2"	24"	
223669	LR2022MR2	19-1/2" x 22"	1	7-5/8"	3-1/2"	24"	

**Bar/Entertainment Stainless Steel Sinks**

**Stainless Steel Bar Sinks (Continued)**

**Gourmet® Lustertone® Self-Rimming SS Single Bowl Sink—Two Faucet Holes**

Part #	Mfg #	Overall Size	Holes	Depth	Drain Opening	Min Sink	Price
108213	LR22192	22" x 19-1/2"	2	7-5/8"	3-1/2"	27"	
187900	LR2521MR2	25" x 21-1/4"	MR2	7-7/8"	3-1/2"	30"	

**Gourmet® Lustertone® Self-Rimming SS Single Bowl Sink—Three Faucet Holes**

- 18" Gauge
- Lustrous highlighted satin finish
- 1 2 MR2 3 OS4 faucet holes
- Fully undercoated
- Drains not included



LR1716

Part #	Mfg #	Overall Size	Holes	Depth	Drain Opening	Min Sink	Price
120161	LR17163	17" x 16"	3	7-5/8"	3-1/2"	21"	
176888	LR17223	17" x 22"	3	7-5/8"	3-1/2"	21"	
095325	LR19183	19" x 18"	3	7-1/2"	3-1/2"	24"	
088756	LR19193	19-1/2" x 19"	3	7-1/2"	3-1/2"	24"	
089074	LR22193	22" x 19-1/2"	3	7-5/8"	3-1/2"	27"	
240207	LR2219PD3	22" x 19-1/2"	3	7-5/8"	3-1/2"	27"	
089902	LR22223	22" x 22"	3	7-5/8"	3-1/2"	27"	
095309	LR25213	25" x 21-1/4"	3	7-7/8"	3-1/2"	30"	
099505	LR25223	25" x 22"	3	8-1/8"	3-1/2"	30"	

**Gourmet® Lustertone® Self-Rimming SS Single Bowl Sink—Four Faucet Holes**

- 18" Gauge
- Lustrous highlighted satin finish
- 1 2 MR2 3 OS4 faucet holes
- 1 2 MR2 2 4 5 faucet holes ( **models 2219, 2521** )
- Fully undercoated
- OS4 holes are evenly dispersed across faucet
- Drains not included



LR2222

Part #	Mfg #	Overall Size	Holes	Depth	Drain Opening	Min Sink	Price
033862	LR22224	22" x 22"	4	7-5/8"	3-1/2"	27"	
123797	LR25214	25" x 21-1/4"	4	7-7/8"	3-1/2"	30"	

**Bar/Entertainment Stainless Steel Sinks**

**Lustertone® Self-Rimming ADA Single Bowl Sink—One Faucet Hole**

- 18" Gauge
- Lustrous highlighted satin finish
- 1 2 MR2 3 OS4 faucet holes (**models 1716, 1720, 1918, 1919, 2022, 2219**)
- 1 2 MR2 2 4 5 faucet holes (**models 2219, 2521**)
- 1 2 MR2 3 faucet holes (**models 1517**)
- Fully undercoated
- Drains not included unless noted in model number
- (-Q) Quick-clip mounting system
- (-PD) Includes one LKPD1 perfect drain and strainer



LRAD151765

LRAD252165

Part #	Mfg #	Overall Size	Holes	Depth	Drain Opening	Min Sink	Price
143335	LRAD1517651	15" x 17-1/2"	1	6-1/2"	3-1/2"	18"	
243809	LRAD1522551	15" x 22"	1	5-1/2"	3-1/2"	18"	
224400	LRAD1716651	17" x 16"	1	6-1/2"	3-1/2"	21"	
167162	LRAD1720551	17" x 20"	1	5-1/2"	3-1/2"	21"	
157348	LRAD1918601	19" x 18"	1	6"	3-1/2"	24"	
178361	LRAD1918651	19" x 18"	1	6-1/2"	3-1/2"	24"	
185425	LRAD1919651	19-1/2" x 19"	1	6-1/2"	3-1/2"	24"	
244074	LRAD202255MR2	19-1/2" x 22"	MR2	5-1/2"	3-1/2"	24"	
155638	LRAD2022601	19-1/2" x 22"	1	6"	3-1/2"	24"	
174677	LRAD2219551	22" x 19-1/2"	1	5-1/2"	3-1/2"	27"	
152025	LRAD2219601	22" x 19-1/2"	1	6"	3-1/2"	27"	
236496	LRAD2222651	22" x 22"	1	6-1/2"	3-1/2"	27"	
210404	LRAD2521551	25" x 21-1/4"	1	5-1/2"	3-1/2"	30"	
236791	LRAD2521553	25" x 21-1/4"	3	5-1/2"	3-1/2"	30"	
122978	LRAD2521651	25" x 21-1/4"	1	6-1/2"	3-1/2"	30"	

**Gourmet® Lustertone® Self-Rimming ADA Single Bowl Sink—Two Faucet Holes**

- 18" Gauge
- Lustrous highlighted satin finish
- 1 2 MR2 3 OS4 faucet holes (**models 1716, 1720, 1722, 1918, 1919**)
- 1 2 MR2 3 4 5 faucet holes (**models 2219, 2222, 2522**)
- 1 2 MR2 3 faucet holes (**models 1316, 1517**)
- OS4 holes are evenly spread across faucet top
- MR2 holes are offset to the right
- Fully undercoated
- Drains not included
- (-Q) Quick-clip mounting system
- (-PD) Includes one LKPD1 perfect drain and strainer
- (-PDC) includes LK406GN04T4C faucet & LK500 perfect drain



LRAD131660

LRAD252255

Part #	Mfg #	Overall Size	Holes	Depth	Drain Opening	Min Sink	Price
158828	LRAD1316602	13" x 16"	2	6"	3-1/2"	18"	
245879	LRADQ131665PD3	13" x 16"	3	6-1/2"	3-3/8"	18"	
131530	LRAD1517552	15" x 17-1/2"	2	5-1/2"	3-1/2"	18"	
186047	LRAD1522552	15" x 22"	2	5-1/2"	3-1/2"	18"	

**Bar/Entertainment Stainless Steel Sinks**

**Stainless Steel Bar Sinks (Continued)**

**Gourmet® Lustertone® Self-Rimming ADA Single Bowl Sink—Two Faucet Holes**

Part #	Mfg #	Overall Size	Holes	Depth	Drain Opening	Min Sink	Price
155841	LRAD1716652	17" x 16"	2	6-1/2"	3-1/2"	21"	
181188	LRAD1720552	17" x 20"	2	5-1/2"	3-1/2"	21"	
151473	LRAD1722552	17" x 22"	2	5-1/2"	3-1/2"	21"	
158274	LRAD1918652	19" x 18"	2	6-1/2"	3-1/2"	24"	
171462	LRADQ1918652	19" x 18"	2	6-1/2"	3-1/2"	24"	
156430	LRAD191865MR2	19" x 18"	MR2	6-1/2"	3-1/2"	24"	
157831	LRAD191965MR2	19-1/2" x 19"	MR2	6-1/2"	3-1/2"	24"	
180925	LRAD2219602	22" x 19-1/2"	2	6"	3-1/2"	27"	
185800	LRAD221960MR2	22" x 19-1/2"	MR2	6"	3-1/2"	27"	
103157	LRAD2219652	22" x 19-1/2"	2	6-1/2"	3-1/2"	27"	
160562	LRAD221965MR2	22" x 19-1/2"	MR2	6-1/2"	3-1/2"	27"	
157832	LRAD222265MR2	22" x 22"	MR2	6-1/2"	3-1/2"	27"	
172756	LRAD2522552	25" x 22"	2	5-1/2"	3-1/2"	30"	
242663	LRAD2522503	25" x 22"	3	5"	3-1/2"	30"	

**Gourmet® Lustertone® Self-Rimming ADA Single Bowl Sink—Three Faucet Holes**

- 18" Gauge
- Lustrous highlighted satin finish
- 1 2 MR2 3 (models 1517, 1522)
- 1 2 MR2 3 OS4 faucet holes (models 1716, 1722, 1918, 1919)
- 1 2 MR2 3 4 5 faucet holes (models 2219, 2222, 2521, 2522)
- OS4 holes are evenly spread across faucet top
- MR2 holes are offset to the right
- Fully undercoated
- Drains not included



LRAD172240

Part #	Mfg #	Overall Size	Holes	Depth	Drain Opening	Min Sink	Price
188992	LRAD1517503	15" x 17-1/2"	3	5"	3-1/2"	18"	
175207	LRAD1517553	15" x 17-1/2"	3	5-1/2"	3-1/2"	18"	
141402	LRAD1517653	15" x 17-1/2"	3	6-1/2"	3-1/2"	18"	
157684	LRAD1522603	15" x 22"	3	6"	3-1/2"	18"	
092207	LRAD1716603	17" x 16"	3	6"	3-1/2"	21"	
166124	LRAD1722553	17" x 22"	3	5-1/2"	3-1/2"	21"	
140449	LRAD1722653	17" x 22"	3	6-1/2"	3-1/2"	21"	
107885	LRAD1918653	19" x 18"	3	6-1/2"	3-1/2"	24"	
150690	LRAD1919653	19-1/2" x 19"	3	6-1/2"	3-1/2"	24"	
175206	LRAD2219553	22" x 19-1/2"	3	5-1/2"	3-1/2"	27"	
127949	LRAD2219653	22" x 19-1/2"	3	6-1/2"	3-1/2"	27"	
068904	LRADQ2219553	22" x 19-1/2"	3	5-1/2"	3-1/2"	27"	
138901	LRADQ2219653	22" x 19-1/2"	3	6-1/2"	3-1/2"	27"	
115453	LRAD2222653	22" x 22"	3	6-1/2"	3-1/2"	27"	
188991	LRAD2521503	25" x 21-1/4"	3	5"	3-1/2"	30"	

**Bar/Entertainment Stainless Steel Sinks**

**Stainless Steel Bar Sinks (Continued)**

**Gourmet® Lustertone® Self-Rimming ADA Single Bowl Sink—Three Faucet Holes**

Part #	Mfg #	Overall Size	Holes	Depth	Drain Opening	Min Sink	Price
167416	LRAD2522553	25" x 22"	3	5-1/2"	3-1/2"	30"	
224377	LRAD2522603	25" x 22"	3	6"	3-1/2"	30"	

**Gourmet® Lustertone® Self-Rimming ADA Single Bowl Sink—Four Faucet Holes**

- 18" Gauge
- Lustrous highlighted satin finish
- 1 2 MR2 3 4 5 faucet holes
- 1 2 MR2 3 OS4 faucet holes (models 1720 & 1722)
- OS4 holes are evenly spread across faucet top
- MR2 holes are offset to the right
- Fully undercoated
- Drains not included



LRADQ222250

Part #	Mfg #	Overall Size	Holes	Depth	Drain Opening	Min Sink	Price
185172	LRAD172255OS4	17" x 22"	OS4	5-1/2"	3-1/2"	21"	
130331	LRAD2219654	22" x 19-1/2"	4	6-1/2"	3-1/2"	27"	
224381	LRAD2522604	25" x 22"	4	6"	3-1/2"	30"	
154692	LRADQ2222504	22" x 22"	4	5"	3-1/2"	27"	
154757	LRADQ2222604	22" x 22"	4	6"	3-1/2"	27"	
172885	LRADQ2522654	25" x 22"	4	6-1/2"	3-1/2"	30"	

**Gourmet® Lustertone® Self-Rimming SS Deep Single Bowl Sink**

- 18" gauge
- Lustrous highlighted satin finish
- 1 2 MR2 3 4 5 faucet holes
- 1 2 MR2 3 faucet holes (model 151710)
- 1 2 MR2 3 OS4 faucet hole (models 171610, 172010, 172210, & 202210)
- Fully undercoating
- Drains not included unless (PD) appears in model number



DLFR19181



DLR171610

Part #	Mfg #	Overall Size	Holes	Depth	Drain Opening	Min Sink	Price
116652	DLR1517102	15" x 17-1/2"	2	10"	3-1/2"	18"	
162110	DLR1716102	17" x 16"	2	10-1/8"	3-1/2"	21"	
088464	DLR1716103	17" x 16"	3	10-1/8"	3-1/2"	21"	
223922	DLR1720101	17" x 20"	1	10-1/8"	3-1/2"	21"	
051426	DLR1722101	17" x 22"	1	10-1/8"	3-1/2"	21"	
166123	DLR1722103	17" x 22"	3	10-1/8"	3-1/2"	21"	
128819	DLR172210MR2	17" x 22"	MR2	10-1/8"	3-1/2"	21"	
098818	DLR2022101	19-1/2" x 22"	1	10-1/8"	3-1/2"	24"	
143137	DLR202210MR2	19-1/2" x 22"	MR2	10-1/8"	3-1/2"	24"	
141322	DLR2219101	22" x 19-1/2"	1	10-1/8"	3-1/2"	27"	
096392	DLR2219103	22" x 19-1/2"	3	10-1/8"	3-1/2"	27"	
110513	DLR221910MR2	22" x 19-1/2"	MR2	10-1/8"	3-1/2"	27"	



**Bar/Entertainment Stainless Steel Sinks**

**Stainless Steel Bar Sinks (Continued)**

**Gourmet® Lustertone® Self-Rimming SS Deep Single Bowl Sink**

Part #	Mfg #	Overall Size	Holes	Depth	Drain Opening	Min Sink	Price
038381	DLR2222101	22" x 22"	1	10-1/8"	3-1/2"	27"	
048606	DLR2222102	22" x 22"	2	10-1/8"	3-1/2"	27"	
047469	DLR2222103	22" x 22"	3	10-1/8"	3-1/2"	27"	
167418	DLR2222104	22" x 22"	4	10-1/8"	3-1/2"	27"	
178712	DLR2222121	22" x 22"	1	12"	3-1/2"	27"	
185407	DLR2222122	22" x 22"	2	12"	3-1/2"	27"	
133137	DLR2222124	22" x 22"	4	12"	3-1/2"	27"	
172516	DLR2521104	25" x 21-1/4"	4	10-1/8"	3-1/2"	30"	
103335	DLR2522101	25" x 22"	1	10-3/8"	3-1/2"	30"	
110857	DLR2522103	25" x 22"	3	10-3/8"	3-1/2"	30"	
047543	DLR2522121	25" x 22"	1	12-1/8"	3-1/2"	30"	

**Lustertone Slim Rim Dual-Mount SS Single Bowl Sink**

- 18" Gauge
- Lustrous highlighted satin finish
- 1 2 MR2 3 4 5 faucet holes
- Sound guard undercoating
- Slim rim — ultra-thin edge virtually eliminates the barrier between sink and countertop
- Models with **(PD)** included in number have perfect drain kits
- Drains not included unless **(PD)** appears in model number



Part #	Mfg #	Overall Size	Holes	Depth	Drain Opening	Min Sink	Price
159221	DLSR2722104	27" x 22"	4	10"	3-1/2"	30"	
242370	LSR27221	27" x 22"	1	8"	3-1/2"	30"	
174185	LSR27222	27" x 22"	2	8"	3-1/2"	30"	

**Lustertone® Classic Undermount SS Single Bowl Sink**

- 18" Gauge
- Lustrous highlighted satin finish
- Sound guard undercoating
- Fully undercoated with pad(s) ( **ELUHAD** models)
- ELUHAD model is ADA compliant
- Includes:  
Perfect drain kit ( **ELUH1814PD** model)
- Drains not included unless **(PD)** appears in model number



Part #	Mfg #	Overall Size	Holes	Depth	Drain Opening	Min Sink	Price
236742	ELUH1212PD	14-1/2" x 14-1/2"	N/A	7"	3-1/2"	18"	
169886	ELUH1814PD	20-1/2 x 16-1/2"	N/A	7-7/8"	3-1/2"	24"	
159293	ELUHAD141455	16-1/2" x 16-1/2"	N/A	5-3/8"	3-1/2"	21"	
249961	ELUHAD141455PD	16-1/2" x 16-1/2"	N/A	5-3/8"	3-1/2"	21"	
159264	ELUHAD191655	21-1/2" x 18-1/2"	N/A	5-1/2"	3-1/2"	27"	

**Bar/Entertainment Stainless Steel Sinks**

**Stainless Steel Bar Sinks (Continued)**

**Lustertone® Classic Undermount SS Single Bowl Sink**

Part #	Mfg #	Overall Size	Holes	Depth	Drain Opening	Min Sink	Price
161792	ELUH2416	26-1/2" x 18-1/2"	N/A	8"	3-1/2"	30"	
168722	ELUH241610	26-1/2" x 18-1/2"	N/A	10"	3-1/2"	30"	

**Gourmet® Lustertone® Undermount SS Single Bowl Sink**

- 18" Gauge
- Lustrous highlighted satin finish
- Sound guard undercoating
- Drains not included



Part #	Mfg #	Overall Size	Holes	Depth	Drain Opening	Min Sink	Price
159292	ELUHAD211555	23-1/2" x 18-1/4"	N/A	5-1/2"	3-1/2"	27"	
237322	ELUHAD211545	23-1/2" x 18-1/4"	N/A	4-3/8"	3-1/2"	27"	

**Gourmet® Stainless Steel Undermount Bar Sink**

- 18" Gauge
- Hammered mirror finish
- Fully undercoated
- Drains not included



Part #	Mfg #	Overall Size	Holes	Depth	Drain Opening	Min Sink	Price
097413	SCUH1012SH	12" x 14"	N/A	6-1/2"	3-1/2"	15"	
087339	SCUH1212SH	14-1/8" x 14-1/8"	N/A	6-1/2"	3-1/2"	18"	
083010	SCUH1416SH	16" x 18"	N/A	7-1/2"	3-1/2"	21"	

**Gourmet® Lustertone® Undermount SS Single Bowl Sink**

- 18" Gauge
- Lustrous highlighted satin finish
- Sound guard undercoating
- Includes:
  - E-dock (for models **ELUH 231712L** & **ELUH281610** only)
  - Perfect drain (for models **ELUH281610PD** & **ELUH1316PD** )
- Drains not included unless **(PD)** appears in model number



Part #	Mfg #	Overall Size	Holes	Depth	Drain Opening	Min Sink	Price
026880	ELUH1316	16" x 18-1/2"	N/A	7-7/8"	3-1/2"	21"	
177205	ELUH1316PD	16" x 18-1/2"	N/A	7-7/8"	3-1/2"	21"	
088798	ELUH1616	18-1/2" x 18-1/2"	N/A	7-7/8"	3-1/2"	24"	
132390	ELUH1814	20-1/2" x 16-1/2"	N/A	7-7/8"	3-1/2"	24"	
080555	ELUH2115	23-1/2" x 18-1/4"	N/A	7-1/2"	3-1/2"	27"	
146047	ELUH231710R	25-1/2" x 19-1/4"	N/A	10"	3-1/2"	27"	
179679	ELUH231712L	25-1/2" x 19-1/4"	N/A	12"	3-1/2"	27"	

**Bar/Entertainment Stainless Steel Sinks**

**Gourmet® Lustertone® Undermount SS Single Bowl Sink**

- 18" Gauge
- Lustrous highlighted satin finish
- Sound guard undercoating
- Fully undercoated with pad(s) (for model **ELUHAD121250**)
- Drains not included unless **(PD)** appears in model number



ELUHAD12125



ELUHAD131645P

Part #	Mfg #	Overall Size	Holes	Depth	Drain Opening	Min Sink	Price
170066	ELUHAD121250	14-1/2" x 14-1/2"	N/A	5"	3-1/2"	18"	
187025	ELUHAD121255	14-1/2" x 14-1/2"	N/A	5-1/2"	3-1/2"	18"	
180779	ELUHAD131645PD	16" x 18-1/2"	N/A	4-1/2"	3-1/2"	21"	
156503	ELUHAD131655	16" x 18-1/2"	N/A	5-1/2"	3-1/2"	21"	
181343	ELUHAD131655PD	16" x 18-1/2"	N/A	5-1/2"	3-1/2"	21"	

**Pacemaker® SS Self-Rimming Single Bowl Sink**

- 20" Gauge
- Bright satin finish
- 1 2 MR2 3 4 5 faucet holes
- 1 2 MR2 3 OS4 faucet holes (**models 1716, 1720 & 1722, 19182**)
- 1 2 MR2 3 faucet holes (**models BPSR15, PSR1517**)
- Fully undercoated
- Drains not included



PSR2522MR2



BPSR152

Part #	Mfg #	Overall Size	Holes	Depth	Min Sink Base	Mount Type	Price
050396	BPSR152	15" x 15"	2	6-1/8"	2"	18"	
006148	PSR15173	15" x 17-1/2"	3	7-1/8"	3-1/2"	18"	
054097	PSR17202	17" x 20"	2	7-1/8"	3-1/2"	21"	
020930	PSR17203	17" x 20"	3	7-1/8"	3-1/2"	21"	
225852	PSR1722MR2	17" x 22"	MR2	7-1/8"	3-1/2"	21"	
006152	PSR19182	19" x 18"	2	7-1/8"	3-1/2"	24"	
016430	PSR19183	19" x 18"	3	7-1/8"	3-1/2"	24"	
071195	PSR22221	22" x 22"	1	7-1/8"	3-1/2"	27"	
006153	PSR22193	22" x 19-1/2"	3	7-1/8"	3-1/2"	27"	
242477	PSR25211	25" x 21-1/4"	1	7-1/2"	3-1/2"	30"	
079174	PSR25221	25" x 22"	1	7-1/2"	3-1/2"	30"	
006156	PSR25223	25" x 22"	3	7-1/2"	3-1/2"	30"	

**Gourmet® Slim Rim Dual-Mount Deep Single Bowl Sink**

- 20" Gauge
- Bright satin finish
- Fully undercoated
- Drains not included



Part #	Mfg #	Overall Size	Holes	Depth	Drain Opening	Min Sink	Price
155643	DPSSR2722101	27" x 22"	1	10"	3-1/2"	30"	

**Bar/Entertainment Stainless Steel Sinks**

**The Mystic® Lustertone® SS Undermount Single Bowl Sink**

- 18" Gauge
- Lustrous highlighted satin finish
- Sound guard undercoating
- FB-flat bottom sink
- Drains not included



Part #	Mfg #	Overall Size	Depth	Drain Opening	Min Sink Base	Description	Price
079941	ELUH16FB	18-3/8" x 18-3/8"	N/A	8"	3-1/2"	24"	

**Double Bowl Stainless Steel Bar Sinks**

**Lustertone® Classic Self-Rimming Equal Double Bowl Sink**

- 18" Gauge
- Lustrous highlighted satin finish
- 1 2 MR2 3 4 5 faucet holes
- Fully undercoated
- AD models are ADA compliant
- Drains not included



LR2519

Part #	Mfg #	Overall Size	Holes	Depth	Drain Opening	Min Sink	Price
115362	LR25193	25" x 19-1/2"	3	7-5/8"	3-1/2"	30"	
115313	LR25194	25" x 19-1/2"	4	7-5/8"	3-1/2"	30"	
100426	LR29183	29" x 18"	3	7-5/8"	3-1/2"	33"	
128316	LRAD2918554	29" x 18"	4	5-1/2"	3-1/2"	33"	
136724	LRAD2918654	29" x 18"	4	6-1/2"	3-1/2"	33"	
249932	LRAD2922553	29 x 22"	3	5-1/2"	3-1/2"	33"	
142330	LRAD2922602	29 x 22"	2	6"	3-1/2"	33"	

**Harmony™ Lustertone® Undermount SS Double Bowl Sink**

- 18" Gauge
- Lustrous highlighted satin finish
- Sound guard undercoating
- Drains not included



Part #	Mfg #	Overall Size	Holes	Depth	Drain Opening	Min Sink	Price
137228	ELUH272010R	26-3/4" x 20"	N/A	10"	3-1/2"	30"	

**Bar/Entertainment Composite Sinks**

**Bar Sinks**

**Diamond™ SILGRANIT® II Bar Sink**

- Versatile dual deck design can be installed as a drop-in or undermount
- Cutout size: 14-1/4" x 14-1/4"
- Under-mount clips NOT included



Part #	Mfg#	Overall Dimensions	Bowl Depth	Cabinet Size	Color	Price
147697	440205	15" x 15"	8"	17"	White	
089383	440204	15" x 15"	8"	17"	Anthracite	
147696	440203	15" x 15"	8"	17"	Metallic Gray	
143337	440202	15" x 15"	8"	17"	Cafe Brown	
129149	440206	15" x 15"	8"	17"	Biscuit	
144733	441219	15" x 15"	8"	17"	Biscotti	
147698	441295	15" x 15"	8"	17"	Truffle	
170401	441477	15" x 15"	8"	17"	Cinder	

**Performa™ Single Bowl Bar Sink**

- Under-mount clips included
- Cut out template included



Part #	Mfg#	Overall Dimensions	Bowl Depth	Cabinet Size	Color	Price
120416	440079	17-1/2" x 17"	9"	21"	Anthracite	
137265	440080	17-1/2" x 17"	9"	21"	Biscuit	
142902	440081	17-1/2" x 17"	9"	21"	White	
135196	440082	17-1/2" x 17"	9"	21"	Metallic Gray	
131541	441224	17-1/2" x 17"	9"	21"	Biscotti	
138247	441288	17-1/2" x 17"	9"	21"	Truffle	
172957	441475	17-1/2" x 17"	9"	21"	Cinder	
120697	440078	17-1/2" x 17"	9"	21"	Cafe Brown	

**Rondo™ SILGRANIT® II Bar Sink**

- Versatile dual deck design can be installed as drop-in or undermount
- Cutout size: 16-15/16"
- Under-mount clips NOT included



Part #	Mfg#	Overall Dimensions	Bowl Depth	Cabinet Size	Color	Price
069561	511632	17-11/16"	6-5/8"	18"	Anthracite	
152015	513382	17-11/16"	6-5/8"	18"	Metallic Gray	
114488	515803	17-11/16"	6-5/8"	18"	Cafe Brown	

**Bar/Entertainment Composite Sinks**

**Bar Sinks (Continued)**

**Rondo™ SILGRANIT® II Bar Sink**

Part #	Mfg#	Overall Dimensions	Bowl Depth	Cabinet Size	Color	Price
154338	513381	17-11/16"	6-5/8"	18"	Biscuit	
133060	517143	17-11/16"	6-5/8"	18"	Biscotti	
241207	517699	17-11/16"	6-5/8"	18"	Truffle	
177852	518911	17-11/16"	6-5/8"	18"	Cinder	

**Precis™ SILGRANIT® II Medium Under-Mount Sink**

- Under-mount installation clips included
- Cutout size: template provided



Part #	Mfg#	Overall Dimensions	Bowl Depth	Cabinet Size	Color	Price
139737	513422	13-3/4" x 18"	7-1/2"	18"	White	
097175	513424	13-3/4" x 18"	7-1/2"	18"	Anthracite	
152175	513425	13-3/4" x 18"	7-1/2"	18"	Metallic Gray	
117593	515653	13-3/4" x 18"	7-1/2"	18"	Cafe Brown	
149679	513423	13-3/4" x 18"	7-1/2"	18"	Biscuit	
164981	517110	13-3/4" x 18"	7-1/2"	18"	Biscotti	
152059	517676	13-3/4" x 18"	7-1/2"	18"	Truffle	

**Precis™ SILGRANIT® II Large Under-Mount Sink**

- Under-mount installation clips included
- Cutout template included with 1/8" reveal



Part #	Mfg#	Overall Dimensions	Bowl Depth	Cabinet Size	Color	Price
142666	513426	20-3/4" x 18"	7-1/2"	24"	White	
100106	513428	20-3/4" x 18"	7-1/2"	24"	Anthracite	
109579	513429	20-3/4" x 18"	7-1/2"	24"	Metallic Gray	
156209	515652	20-3/4" x 18"	7-1/2"	24"	Cafe Brown	
108828	513427	20-3/4" x 18"	7-1/2"	24"	Biscuit	
139471	517109	20-3/4" x 18"	7-1/2"	24"	Biscotti	
147871	517677	20-3/4" x 18"	7-1/2"	24"	Truffle	
170935	519049	20-3/4" x 18"	7-1/2"	24"	Cinder	



**Bar/Entertainment Composite Sinks**

**Vision™ SILGRANIT II® Large Under-Mount Sink**

- Under-mount installation clips included
- Cutout template included



Part #	Mfg#	Overall Dimensions	Bowl Depth	Cabinet Size	Color	Price
161635	441367	24" x 18"	7-3/4"	27"	Anthracite	
152416	441369	24" x 18"	7-3/4"	27"	Cafe Brown	
160364	441368	24" x 18"	7-3/4"	27"	Biscotti	
173643	441370	24" x 18"	7-3/4"	27"	Truffle	
161215	441472	24" x 18"	7-3/4"	27"	Cinder	

**Commercial Stainless Steel Sinks**

**Stainless Steel Scrub and Handwash Sinks**

**Wall-Mount SS Handwash Sink**

- 20" gauge
- Basin has 1-3/4" radius coved corners
- 7" High backsplash
- Buffed satin finish
- Exposed surfaces have a brushed finish
- Includes wall-hanger
- **CHS1716LRSC** comes with sidesplashes
- **CHSB1716C** Includes a chrome-plated gooseneck spout faucet with aerator
- **CHS1716SACMC** sink kit includes:
  - CHS1716 sink
  - LK500 p-trap
  - LK8 drain fitting
  - LK724 mechanical mixing valve
  - LKB722C sensor faucet AC/battery power
- **CHS1716SACC** sink kit includes:
  - CHS1716 sink
  - LK500 p-trap
  - LK8 drain fitting
  - LKB722C sensor faucet AC/battery power



No Faucet Holes



CHS17161

Part #	Mfg #	Overall Size	Holes	Depth	Drain Opening	Price
177259	CHS17160	16-3/4" x 15-1/2"	0	13"	2"	
051347	CHS17161	16-3/4" x 15-1/2"	1	13"	2"	
054177	CHS1716C	16-3/4" x 15-1/2"	2	13"	2"	
173847	CHS1716LRSC	16-3/4" x 15-1/2"	2	13"	2"	
249050	CHS1716SACC	16-3/4" x 15-1/2"	1	13"	2"	
240226	CHS1716SACMC	16-3/4" x 15-1/2"	1	13"	2"	
128656	CHSB1716C	16-3/4" x 15-1/2"	2	13"	2"	

**Wall-Mount Wheelchair Handwash Sink Kit**

- 18 Gauge, type 304 stainless steel
- Lustrous satin finish
- 1-3/4" Coved corners
- 2-1/2" apron, front, and sides
- 2-1/2" High backsplash
- Wide top deck with raised rim
- Sound absorbing pads
- Rear centered outlet
- Includes wall hangers and integral support brackets



Kit includes LKAD174L0 drain without overflow and LKD232SBH5C faucet

Part #	Mfg #	Overall Size	Holes	Depth	Drain Opening	Price
238592	WCL1923OSDC	19" x 23"	3	4"	1-5/8"	

**Commercial Stainless Steel Sinks**

**Wall-Mount Single Bowl Handwash Sink Kit**

- 14 Gauge, type 304 stainless steel
- Buffed satin finish
- 1-3/4" Coved covers
- 1-1/2" Rolled rims
- 6" High, full-length backsplash
- Rear center drain placement
- Wall hanger and stainless steel support brackets included
- Kit includes: (EWS2520) sink and one (LK940GN05T4H) faucet



Part #	Mfg #	Overall Size	Holes	Depth	Drain Opening	Price
243177	EWS2520W4C	25" x 19-1/2"	2"	10-1/2"	3-1/2"	

**Wall-Mount Stainless Steel Single Bowl Handwash Sink Kit**

- 18" Gauge
- Buffed satin finish
- 1-3/4" Coved corners
- 2-1/2" High backsplash, 2-1/2" apron front and sides
- Front and side decks with raised rim
- Bottom only pads
- Rear centered drain placement
- Includes wall hanger and integral stainless steel support brackets
- Kit includes: (ELVWO2219 sink, (LKB721C) AC/battery-powered sensor faucet, and (LKF297) overflow assembly



Part #	Mfg #	Overall Size	Holes	Depth	Drain Opening	Price
248003	ELVWO2219SACC	22" x 19"	1	5-1/2"	1-1/2"	

**Stainless Steel Rectangular Single Compartment Handwash Sink**

- 18" Gauge
- Buffed satin finish
- 1 2 CS3 faucet holes
- 1-3/4" Coved corners
- 2-1/2" High backsplash, 2-1/2" apron front and sides
- Front and side decks with raised rim
- Sound absorbing pads
- Rear centered outlet
- Includes wall hanger and integral stainless steel support brackets
- NSF certified
- Drains not included



Part #	Mfg #	Overall Size	Holes	Depth	Drain Opening	Price
075960	ELVWO2219CS3	22" x 19"	CS3	5-1/2"	1-1/2", Overflow	

**Commercial Stainless Steel Sinks**

**Stainless Steel Rectangular Single Compartment Handwash Sink with No Faucet Holes**

- 18" Gauge
- Buffed satin finish
- 1-3/4" Coved corners
- 2-1/2" High backsplash, 2-1/2" apron front and sides
- Front and side decks with raised rim
- Sound absorbing pads
- Rear centered outlet
- Includes wall hanger and integral stainless steel support brackets
- NSF certified
- Drains not included
- (-SACC) Includes LKB721C sensor faucet AC/battery power



Model ELV221990 does

Part #	Mfg #	Overall Size	Holes	Depth	Drain Opening	Price
174678	ELV22190	22" x 19"	0	5-1/2"	1-1/2", No Overflow	
251290	ELV2219SACC	22" x 19"	0	5-1/2"	1-1/2", No Overflow	

**Commercial Stainless Steel Multiple Station Hand Wash Sink**

- Four station wash sink
- 14" Gauge
- Buffed satin finish
- 1/4" Coved corners
- 1-1/2" Wide inward sloping to channel rims with 2" flat apron
- 10" Backsplash
- Square rim corners
- Slanted front
- Includes wall hangers and stainless steel support brackets



Part #	Mfg #	Overall Size	Holes	Depth	Drain Opening	Price
186325	EWMA96208	96" x 20"	8-Hole	8"	3-1/2"	

**Commercial Sensor Faucet Stainless Steel Single Compartment Wash Sink**

- 16" Gauge
- Buffed satin finish
- Wall hanger
- Slant-front design
- Keyed access door(s) to hide plumbing
- Coved corners
- 4" Backsplash
- Undercoated for maximum sound deadening
- Full enclosure
- Model includes **LK188** drain



Part #	Mfg #	Overall Size	Holes	Depth	Drain Opening	Price
188663	EWSF13026SACC	30" x 20"	1-Hole	11"	3-1/2"	

**Commercial Stainless Steel Sinks**

**48" Two Station Stainless Steel Wash Sink**

- 14" Gauge, 304 stainless steel
- Lustrous buffed satin finish
- 1/4" Coved corners
- 1-1/2" Wide inward sloping top channel rims, with 2" flat apron
- 10" High, full length backsplash
- Square rim corners
- Slanted front
- Furnished with wall hangers and stainless steel support brackets



Part #	Mfg #	Overall Size	Holes	Depth	Drain Opening	Price
076819	EWMA48202	48" x 20"	2-Hole	8"	3-1/2"	

**48" Two Station Handwash Sink—Sensor Faucet Package**

- 14" Gauge, 304 stainless steel
- Lustrous buffed satin finish
- 1/4" Coved corners
- 1-1/2" Wide inward sloping top channel rims, with 2" flat apron
- 10" High, full length backsplash
- Square rim corners
- Slanted front
- Furnished with wall hangers and stainless steel support brackets
- Model includes:
  - (2) **LKB722C** sensor faucets
  - AC/battery power
  - Thermostatic mixing valves



Part #	Mfg #	Overall Size	Holes	Depth	Drain Opening	Price
187263	EWMA4820SACTM C	48" x 20"	1-Hole	8"	3-1/2"	

**60" Three Station Handwash Sink Kit—Sensor Faucet Package**

- 14" Gauge, 304 stainless steel
- Buffed satin finish
- 1/4" Coved corners
- 1-1/2" Wide inward sloping top channel rims, with 2" flat apron
- 10" High, full length backsplash
- Square rim corners
- Furnished with wall hangers and stainless steel support brackets
- Model includes:
  - EWMA6020 sink
  - (3) **LKB722C** sensor faucets AC/battery power
  - (3) **LK723** thermostatic mixing valves
  - (1) **LK18B** grid drain



Part #	Mfg #	Overall Size	Holes	Depth	Drain Opening	Price
249675	EWMA6020SACTM C	60" x 20"	1-Hole	8"	3-1/2"	

**Commercial Stainless Steel Sinks**

**Commercial Foodservice Scrub and Handwash sinks**

**Foodservice Stainless Steel Economy Series Handwash Sink with Gooseneck Faucet**

- 18" Gauge
- 6" Backsplash with 2" return
- Faucet and strainer included
- Z-clip mounting bracket
- NSF certified



Part #	Mfg #	Overall Size	Holes	Depth	Drain Opening	Price
132730	EHS14X	14" x 16-1/2"	11"	5"	1-1/2"	
142566	EHS18X	18" x 14-1/2"	11"	5"	1-1/2"	

**Foodservice Stainless Steel Super Economy Series Handwash Sink with Gooseneck Faucet**

- 20" Gauge
- 6" Backsplash with 2" return
- Faucet and strainer included
- Z-clip mounting bracket
- NSF certified



Part #	Mfg #	Overall Size	Holes	Depth	Drain Opening	Price
251536	SEHS17X	17" x 15"	11"	5"	1-1/2"	

**Foodservice Stainless Steel Economy Series Handwash Sink—Hands Free**

- 18" Gauge
- 6" Backsplash with 2" return
- Includes:
  - Strainer
  - Goose neck faucet
  - Knee Valve
- Z-clip mounting bracket
- NSF certified



Part #	Mfg #	Overall Size	Holes	Depth	Drain Opening	Price
226570	EHS18KVX	18" x 14-1/2"	11"	5"	1-1/2"	



**Commercial Stainless Steel Sinks**

**Stainless Steel Classroom Sinks**

**Celebrity® Stainless Steel Classroom Sink**

- 20" Gauge
- 3" corner radius
- Brushed satin finish
- Underside sink is fully coated
- 5/32" Raised rim
- AD models ADA compliant



Part #	Mfg #	Overall Size	Holes	Depth	Drain Opening	Price
178506	CDKAD2517652	25" x 17"	2	6-1/2"	3-1/2" 30"	

**Lustertone® Stainless Steel Self-Rimming Classroom Sink**

- 18" Gauge
- Lustrous highlighted satin finish
- 2, 2LM, 4, FR2, 2FRM, FR4 faucet holes
- 2, 3, 4 Faucet holes (L2 or 4 and R2 or 4 models only)
- AD models ADA compliant
- RQ models include Quick-Clip®
- **DRKR2217RC & DRKRQ2517C** models include:
  - LKD208513C Faucet
  - LKD2439C Faucet (for model **DRKRQ2517C**)
  - LK35 Strainer
  - LK1141A Bubbler



Part #	Mfg #	Overall Size	Holes	Depth	Drain Opening	Price
244336	DRKAD2220550	22" x 19-1/2"	0	5-1/2"	3-1/2" 27"	
189528	DRKAD2517402LM	25" x 17"	2LM	4"	3-1/2" 30"	
171583	DRKAD252250R2	25" x 22"	2	5"	3-1/2" 30"	
167959	DRKAD3119502	31" x 19-1/2"	2	5"	3-1/2" 36"	
178020	DRKAD3119652	31" x 19-1/2"	2	6-1/2"	3-1/2" 36"	
158936	DRKR2220L2	22" x 19-1/2"	2	7-1/2"	3-1/2" 27"	
158935	DRKR2220R2	22" x 19-1/2"	2	7-1/2"	3-1/2" 27"	
168221	DRKR2522L4	25" X 22"	4	7-5/8"	3-1/2" 30"	
168222	DRKR2522R4	25" X 22"	4	7-5/8"	3-1/2" 30"	

**Commercial Stainless Steel Sinks**

**Stainless Steel Foodservice Dish Tables**

**Commercial Stainless Steel Foodservice Soiled Dish Table**

- 16" Gauge
- Welded construction
- 3/4" Coved corners
- Rolled edge
- 10" Backsplash
- 1-1/2" Edge rim design
- 1-5/8" galvanized legs with 1" adjustable feet
- NSF certification



Part #	Mfg #	Overall Size	Height	Depth	Drain Opening	Price
177917	DDT48LX	36" x 30"	44.75"	6"	3-1/2"	

**Stainless Steel Foodservice Scullery Sinks**

**Commercial Stainless Steel 12" Standard Series Single Compartment Scullery**

- 16" Gauge
- Welded construction
- 3/4" Coved radius
- 10" Backsplash
- 1-1/2" Edge rim design
- Basket strainers included with drain
- 1-5/8" Galvanized legs with 1" adjustable feet
- NSF certified



Part #	Mfg #	Overall Size	Height	Depth	Drain Opening	Price
240128	1C18X24218X	54" x 29.8"	44.8"	12"	3-1/2"	

**Commercial Stainless Steel 12" Standard Series Double Compartment Scullery**

- 16" Gauge
- Welded construction
- 3/4" Coved radius
- 2" Divider between each tub
- 10" Backsplash
- 1-1/2" Edge rim design
- Basket strainers included with drain
- 1-5/8" Galvanized legs with 1" adjustable feet
- NSF certified



Part #	Mfg #	Overall Size	Height	Depth	Drain Opening	Price
226505	2C18X180X	43" x 23.8"	44.8"	12"	3-1/2"	

**Commercial Stainless Steel Sinks**

**Commercial Stainless Steel 12" Standard Series Double Compartment Scullery Sink with Drain board**

- 16" Gauge
- Left, right, or both drain boards
- Welded construction
- 3/4" Coved radius
- 2" Divider between each tub
- 10" Backsplash
- 1-1/2" Edge rim design
- Drain boards are die stamped
- Basket strainers included with drain
- 1-5/8" Galvanized legs with 1" adjustable feet
- NSF certified



2C24X24R24X



2C18X18218X

Part #	Mfg #	Overall Size	Height	Depth	Drain Opening	Price
247612	2C18X18218X	74" x 23.8"	44.8"	12"	3-1/2"	
172672	2C24X24R24X	76.5" x 29.8"	44.8"	12"	3-1/2"	

**Commercial Stainless Steel 12" Standard Series Triple Compartment Scullery Sink**

- 16" Gauge
- Drain board not included
- Welded construction
- 3/4" Coved radius
- 2" Divider between each tub
- 10" Backsplash
- 1-1/2" Edge rim design
- Basket strainers included with drain
- 1-5/8" Galvanized legs with 1" adjustable feet
- NSF certified



Part #	Mfg #	Overall Size	Height	Depth	Drain Opening	Price
153793	3C18X180X	63" x 23.8"	44.8"	12"	3-1/2"	

**Commercial Stainless Steel 12" Standard Series Triple Compartment Scullery Sink with Drain boards**

- 16" Gauge
- Left and right drain boards
- Welded construction
- 3/4" Coved radius
- 2" Divider between each tub
- 10" Backsplash
- 1-1/2" Edge rim design
- Basket strainers included with drain
- 1-5/8" Galvanized legs with 1" adjustable feet
- NSF certified



Part #	Mfg #	Overall Size	Height	Depth	Drain Opening	Price
168415	3C18X24218X	94" x 99.8"	44.8"	12"	3-1/2"	

**Commercial Stainless Steel Sinks**

**Commercial Stainless Steel 14" Standard Series Double Compartment Scullery Sink with Drain board**

- 16" Gauge
- Welded construction
- 3/4" Coved corners
- 2" Divider between tubs
- Left or right drain board
- Drain boards are die stamped
- 9" Backsplash with tile ledge
- 1-1/2" Edge rim design
- Basket strainers included with drain
- 1-5/8" Galvanized legs with 1" adjustable feet
- NSF certified



Part #	Mfg #	Overall Size	Height	Depth	Drain Opening	Price
177921	142C16X20L18X	54.5" x 25.8"	43.8"	14"	3-1/2"	
166147	142C16X20R18X	54.5" x 25.8"	43.8"	14"	3-1/2"	

**Commercial Stainless Steel 14" Standard Series Double Compartment Scullery Sink with Drain board**

- 16" Gauge
- Welded construction
- 3/4" Coved corners
- 2" Divider between tubs
- Left and right drain boards
- Drain boards are die stamped
- 9" Backsplash with tile ledge
- 1-1/2" Edge rim design
- Basket strainers included with drain
- 1-5/8" Galvanized legs with 1" adjustable feet
- NSF certified



Part #	Mfg #	Overall Size	Height	Depth	Drain Opening	Price
226498	142C18X24218X	74" x 29.8"	43.8"	14"	3-1/2"	

**Commercial Stainless Steel Sinks**

**Commercial Stainless Steel 14" Standard Series Triple Compartment Scullery Sink**

- 16" Gauge
- Welded construction
- 3/4" Coved corners
- 2" Divider between tubs
- Drain boards not included
- 9" Backsplash with tile ledge
- 1-1/2" Edge rim design
- Basket strainers included with drain
- 1-5/8" Galvanized legs with 1" adjustable feet
- NSF certified



Part #	Mfg #	Overall Size	Height	Depth	Drain Opening	Price
177915	143C18X240X	57" x 25.8"	43.8"	14"	3-1/2"	

**Commercial Stainless Steel 14" Standard Series Triple Compartment Scullery Sink with Drain board**

- 16" Gauge
- Welded construction
- 3/4" Coved corners
- 2" Divider between tubs
- All drain boards are die stamped
- 9" Backsplash with tile ledge
- 1-1/2" Edge rim design
- Basket strainers included with drain
- 1-5/8" Galvanized legs with 1" adjustable feet
- NSF certified



Part #	Mfg #	Overall Size	Height	Depth	Drain Opening	Price
247466	143C16X20224X	100" x 25.8"	43.8"	14"	3-1/2"	
249651	143C18X24218X	94" x 29.8"	43.8"	14"	3-1/2"	
159296	143C18X24XR24X	72.5" x 25.8"	43.8"	14"	3-1/2"	

**Commercial Stainless Steel Super Economy Series Single Compartment Scullery Sink**

- 18" Gauge
- Welded construction
- 3/4" Coved radius
- Drain boards are die stamped
- 9" Backsplash with tile edge
- 1-1/2" Edge rim design
- Basket strainers included with drain
- 1-5/8" galvanized legs with 1" adjustable feet
- NSF certified



SE1C18X18L18



SE1C24X240X

Part #	Mfg #	Overall Size	Height	Depth	Drain Opening	Price
153435	SE1C18X18L18X	38.5" x 23.8"	43.8"	11"	3-1/2"	
241379	S1C24X240X	29" x 29.8"	43.8"	14"	3-1/2"	

**Commercial Stainless Steel Sinks**

**Commercial Stainless Steel Super Economy Series Double Compartment Scullery Sink**

- 18" Gauge
- Welded construction
- 3/4" Coved radius
- Drain boards are die stamped
- 9" Backsplash with tile edge
- 1-1/2" Edge rim design
- Basket strainers included with drain
- 1-5/8" galvanized legs with 1" adjustable feet
- NSF certified



S2C18X18R18X



S2C18X18218X

Part #	Mfg #	Overall Size	Height	Depth	Drain Opening	Price
244475	S2C18X18R18X	56.5" x 23.8"	43.8"	14"	3-1/2"	
244701	S2C18X18218X	72" x 23.8"	43.8"	14"	3-1/2"	

**Commercial Stainless Steel Economy Series Single Compartment Scullery Sink**

- 18" Gauge
- Drain boards not included
- Welded construction
- 3/4" Coved radius
- 2" Divider between each tub
- Basket strainers included with drain
- 9" Backsplash
- 1-1/2" Edge rim design
- 1-5/8" Galvanized legs with 1" adjustable feet
- NSF certified



Part #	Mfg #	Overall Size	Height	Depth	Drain Opening	Price
171718	E1C16X200X	21" x 25.8"	43.8"	12"	3-1/2"	
185679	E1C24X240X	29" x 29.8"	43.8"	12"	3-1/2"	

**Commercial Stainless Steel Economy Series Single Compartment Scullery Sink with Drain board**

- 18" Gauge
- Includes left or right drain board
- Welded construction
- 3/4" Coved radius
- 2" Divider between each tub
- Drain boards are die stamped
- Basket strainers included with drain
- 9" Backsplash
- 1-1/2" Edge rim design
- 1-5/8" Galvanized legs with 1" adjustable feet
- NSF certified



Part #	Mfg #	Overall Size	Height	Depth	Drain Opening	Price
177341	E1C16X20R18X	36-1/2" x 25-3/4"	36"	12"	3-1/2"	
138952	E1C20X20R20X	42-1/2" x 25-3/4"	36"	12"	3-1/2"	



**Commercial Stainless Steel Sinks**

**Stainless Steel Foodservice Scullery Sinks (Continued)**

**Commercial Stainless Steel Economy Series Single Compartment Scullery Sink with Drain board**

Part #	Mfg #	Overall Size	Height	Depth	Drain Opening	Price
162506	E1C24X24L24X	50-1/2" x 29-3/4"	36"	12"	3-1/2"	

**Commercial Stainless Steel Economy Series Double Compartment Scullery Sink**

- 18" Gauge
- Drain boards not included
- Welded construction
- 3/4" Coved radius
- 2" Divider between each tub
- Basket strainers included with drain
- 9" Backsplash
- 1-1/2" Edge rim design
- 1-5/8" Galvanized legs with 1" adjustable feet
- NSF certified



Part #	Mfg #	Overall Size	Height	Depth	Drain Opening	Price
177421	E2C16X200X	39" x 25.8"	43.8"	12"	3-1/2"	

**Commercial Stainless Steel Economy Series Triple Compartment Scullery Sink with Drain boards**

- 18" gauge
- Includes left or right drain boards
- Welded construction
- 3/4" Coved radius
- 2" Divider between each tub
- Drain boards are die stamped
- Basket strainers included with drain
- 9" Backsplash
- 1-1/2" Edge rim design
- 1-5/8" Galvanized legs with 1" adjustable feet
- NSF certified



Part #	Mfg #	Overall Size	Height	Depth	Drain Opening	Price
237517	E3C16X20218X	88" x 25.8"	43.8"	12"	3-1/2"	
177422	E3C16X20R18X	72.5" x 25.8"	43.8"	12"	3-1/2"	

**Commercial Stainless Steel Sinks**

**Commercial Economy Series Triple Compartment Complete Scullery Sink**

- 18" gauge
- Includes left and right drain boards
- Welded construction
- 3/4" Coved radius
- 2" Divider between each tub
- Drain boards are die stamped
- Basket strainers included with drain
- 9" Backsplash
- 1-1/2" Edge rim design
- 1-5/8" Galvanized legs with 1" adjustable feet
- NSF certified



Part #	Mfg #	Overall Size	Height	Depth	Drain Opening	Price
169324	E3C20X20220X	104" x 25.8"	43.8"	12"	3-1/2"	

**Commercial Stainless Steel Super Economy Series Triple Compartment Scullery Sink**

- 18" Gauge
- Welded construction
- 3/4" Coved radius
- Drain boards are die stamped
- 9" Backsplash with tile edge
- 1-1/2" Edge rim design
- Basket strainers included with drain
- 1-5/8" galvanized legs with 1" adjustable feet
- NSF certified



Part #	Mfg #	Overall Size	Height	Depth	Drain Opening	Price
251083	S3C24X24224X	120" x 29.8"	43.8"	14"	3-1/2"	

**Commercial Deli Series Triple Compartment Scullery Sink**

- 16" Gauge, stainless steel
- Welded construction
- Drain boards not included
- 3/4" Coved radius
- 2" Divider between tubs
- 9" Backsplash
- 1-1/2" Edge rim design
- Basket strainers included with drain
- 1-5/8" Galvanized legs with 1" adjustable feet
- NSF certified



Part #	Mfg #	Overall Size	Height	Depth	Drain Opening	Price
189950	3C10X140X	39" x 19.8"	43.8"	10"	3-1/2"	

**Commercial Stainless Steel Sinks**

**Commercial Stainless Steel Deli Series Triple Compartment Scullery Sink with Drain boards**

- 16" Gauge
- Left or right drain boards
- Welded construction
- Drain boards are die stamped
- 2" Divider between each tub
- 9" Backsplash
- 3/4" Coved radius
- Basket strainers included with drain
- Raised 1-1/2" diameter rolled edge
- 1-5/8" galvanized legs with 1" adjustable plastic feet



Part #	Mfg #	Overall Size	Height	Depth	Drain Opening	Price
187270	3C10X14L12X	48.5" x 19.8"	44.8"	10"	3-1/2"	
187836	3C10X14R12X	48.5" x 19.8"	44.8"	10"	3-1/2"	

**Deli Series Complete Triple Compartment Scullery Sink**

- 16" Gauge, stainless steel
- Welded construction
- 3/4" Coved corners
- Includes left and right drain boards
- Drain boards are die stamped
- 9" Backsplash
- Raised 1-1/2" diameter rolled edge
- Basket strainers included with drain
- 1-5/8" Galvanized legs with 1" adjustable plastic feet
- 2" Divider between each tub



Part #	Mfg #	Overall Size	Height	Depth	Drain Opening	Price
227337	3C10X14216X	66" x 19-3/4"	36"	10"	3-1/2"	
189835	3C12X16216X	72" x 21-3/4"	36"	10"	3-1/2"	

**Rigidbilt® Commercial Single Compartment Complete Scullery Sink**

- 16" Gauge, stainless steel
- Lustrous satin finish
- Left and right drain boards
- Large die-drawn sink compartments pitched to drain
- Seamless drawn 3-1/2" radius coved corners
- Optional undercoating
- Steel channel reinforced drain boards have a conical shaped pitch for drainage
- 8" Backsplash with 45° slope
- Channel rim design with 1" apron
- Stainless steel tubular legs with cross-brace supports
- 1-5/8" O.D. with up to 1" adjustable bullet shaped stainless steel feet
- NSF certified



Part #	Mfg #	Overall Size	Height	Depth	Drain Opening	Price
223623	RNSF8124LR2	63" x 29-3/4"	36"	12-3/4"	3-1/2"	

**Commercial Stainless Steel Sinks**

**Rigidbilt® Commercial Two Compartment Complete Scullery Sink**

- 16" Gauge, stainless steel
- Buffed satin finish
- Left and right drain boards or no drain boards
- Large die-drawn sink compartments pitched to drain
- Seamless drawn 3-1/2" radius coved corners
- Optional undercoating
- Steel channel reinforced drain boards have a conical shaped pitch for drainage
- 8" Backsplash with 45° slope
- Channel rim design with 1" apron
- Stainless steel tubular legs with cross-brace supports
- 1-5/8" O.D. with up to 1" adjustable bullet shaped stainless steel feet
- NSF certified



RNSF8248L



RNSF82362

Part #	Mfg #	Overall Size	Height	Depth	Drain Opening	Price
241970	RNSF82362	47-1/4" x 29-3/4"	36"	12-3/4"	3-1/2"	
244220	RNSF8236LR2	77-1/4" x 29-3/4"	36"	12-3/4"	3-1/2"	
237108	RNSF8248L	89-1/4" x 29-3/4"	36"	12-3/4"	3-1/2"	

**Weldbilt® Commercial Stainless Steel Triple Compartment Scullery Sink**

- 14" Gauge
- Buffed satin finish
- Welded construction
- Left (L), right (R), or no drain board
- 1/4" Coved radius
- 8" Backsplash
- Channel rim design with 2" apron
- 1-5/8" O.D. tubular legs with 1" adjustable bullet shaped feet
- NSF certified



Part #	Mfg #	Overall Size	Height	Depth	Drain Opening	Price
251538	WNSF8345L	70-1/2" x 27-1/2"	44"	14"	3-1/2"	
159186	WNSF83604	63" x 27-1/2"	36"	14"	3-1/2"	

**Commercial Stainless Steel Sinks**

**Weldbilt® Commercial Stainless Steel Single Compartment Scullery Sink**

- 14" Gauge
- Buffed satin finish
- Welded construction
- Left (L) or right (R) drain board
- Drain board and sink compartments pitched to drain
- 1/4" Coved radius
- 8" Backsplash
- Channel rim design with 2" apron
- 1-5/8" O.D. tubular legs with 1" adjustable bullet shaped feet
- NSF certified



Part #	Mfg #	Overall Size	Height	Depth	Drain Opening	Price
240192	WNSF8124L2	49-1/2" x 27-1/2"	36"	14"	3-1/2"	
161623	WNSF8124R2	49-1/2" x 27-1/2"	36"	14"	3-1/2"	

**General Use Stainless Steel Sinks**

**Commercial Stainless Steel Self-Rimming Specialty Cup Sink**

- 16" Gauge
- 1-3/16" Flat rim with crimped edges



Part #	Mfg #	Overall Size	Holes	Depth	Drain Opening	Price
252470	CUPR5	7-3/8" x 7-3/8"	5"	4"	1-1/2"	
134653	CUPR6	8-7/8" x 8-7/8"	6-1/2"	5"	1-1/2"	

**Copper Sinks**

**Copper Kitchen & Bar Sinks**

**Harmony™ Undermount Apron Front Single Bowl Copper Sink**

- 16" Gauge
- Antique copper hammered finish
- 10" Apron height
- Sound dampening pads



Part #	Mfg #	Overall Size	Holes	Depth	Drain Opening	Min Sink	Price
118508	ECUFS2915ACH	33" x 22"	N/A	10"	3-1/2"	36"	

**Harmony™ Undermount Copper Double Bowl Kitchen Sink**

- 16" Gauge
- Antique copper hammered finish
- Sound dampening



Part #	Mfg #	Overall Size	Holes	Depth	Drain Opening	Min Sink	Price
189172	ECU311910RACH	31-1/4" x 20"	N/A	10"	3-1/2"	36"	

**The Mystic® Undermount Single Bowl Copper Bar Sink**

- 16" Gauge
- Antique copper hammered finish
- Sound dampening pads



Part #	Mfg #	Overall Size	Holes	Depth	Drain Opening	Min Sink	Price
115294	ECU16FBACH	16" x 18-3/8"	N/A	7-3/4"	3-1/2"	24"	

**Copper Lavatory Sinks**

**Asana® Copper Single Bowl Lavatory Vessel Sink**

- 16" Gauge
- Vessel rests on countertop
- Antique copper hammered finish
- 6-1/2" Height above countertop



Part #	Mfg #	Overall Size	Holes	Depth	Drain Opening	Min Sink	Price
112230	ECU15ACH	16" x 15-3/4"	N/A	6-1/4"	1-1/2"	21"	



## Kitchen Cast Iron Sinks

### Cast Iron Drop-In Kitchen Sinks

#### Brookfield™ Drop-In Double Bowl Kitchen Sink

- Equal size bowl compartments with 9" depth
- 33" Minimum base cabinet width
- Rear drain increases workspace
- Available with 1, 3, or 4 faucet holes



Part #	Mfg #	Overall Dimensions	Basin Depth	Holes	Color	Price
161304	K-5846-1-0	33" x 22"	9"	1	White	
256578	K-5846-1-47	33" x 22"	9"	1	Almond	
173601	K-5846-1-96	33" x 22"	9"	1	Biscuit	
168932	K-5846-3-0	33" x 22"	9"	3	White	
238761	K-5846-3-47	33" x 22"	9"	3	Almond	
243890	K-5846-3-96	33" x 22"	9"	3	Biscuit	
173536	K-5846-4-0	33" x 22"	9"	4	White	
187472	K-5846-4-96	33" x 22"	9"	4	Biscuit	

#### Cape Dory® Drop-In Single Bowl Kitchen Sink

- 9" Depth
- 33" minimum base cabinet width
- Three faucet holes with one accessory hole to the right



Part #	Mfg #	Overall Dimensions	Basin Depth	Holes	Color	Price
088078	K-5863-4-0	33" x 22"	9"	4	White	
086768	K-5863-4-7	33" x 22"	9"	4	Black	
104843	K-5863-4-96	33" x 22"	9"	4	Biscuit	

#### Deerfield® Drop-In Double Bowl Kitchen Sink

- Equal size bowl compartments
- 33" Minimum base cabinet width
- Available with 1, 3, or 4 faucet holes



Part #	Mfg #	Overall Dimensions	Basin Depth	Holes	Color	Price
160546	K-5873-1-0	33" x 22"	9"	1	White	
164929	K-5873-1-7	33" x 22"	9"	1	Black	
183600	K-5873-1-47	33" x 22"	9"	1	Almond	
167243	K-5873-1-96	33" x 22"	9"	1	Biscuit	
241090	K-5873-1-FD	33" x 22"	9"	1	Cane Sugar	
185072	K-5873-1-FF	33" x 22"	9"	1	Sea Salt	
183599	K-5873-1-K4	33" x 22"	9"	1	Cashmere	
157646	K-5873-3-0	33" x 22"	9"	3	White	
170082	K-5873-3-7	33" x 22"	9"	3	Black	
159542	K-5873-3-96	33" x 22"	9"	3	Biscuit	

## Kitchen Cast Iron Sinks

### Cast Iron Drop-In Kitchen Sinks (Continued)

#### Deerfield® Drop-In Double Bowl Kitchen Sink

Part #	Mfg #	Overall Dimensions	Basin Depth	Holes	Color	Price
169336	K-5873-3-FF	33" x 22"	9"	3	Sea Salt	
177530	K-5873-3-K4	33" x 22"	9"	3	Cashmere	
156999	K-5873-4-0	33" x 22"	9"	4	White	
190390	K-5873-4-47	33" x 22"	9"	4	Almond	
160827	K-5873-4-7	33" x 22"	9"	4	Black	
157000	K-5873-4-96	33" x 22"	9"	4	Biscuit	
242740	K-5873-4-K4	33" x 22"	9"	4	Cashmere	

#### Delafield® Drop-In Double Bowl Kitchen Sink

- Equal size bowl compartments
- 33" Minimum base cabinet width
- Available with 3 or 4 faucet holes



Part #	Mfg #	Overall Dimensions	Basin Depth	Holes	Color	Price
082618	K-5817-3-0	33" x 22"	8"	3	White	
086420	K-5817-3-47	33" x 22"	8"	3	Almond	
082620	K-5817-3-96	33" x 22"	8"	3	Biscuit	
082450	K-5817-4-0	33" x 22"	8"	4	White	
085801	K-5817-4-47	33" x 22"	8"	4	Almond	
182048	K-5817-4-7	33" x 22"	8"	4	Black	
082619	K-5817-4-96	33" x 22"	8"	4	Biscuit	

#### Efficiency™ Drop-In Double Bowl Kitchen Sink

- Large/medium bowl compartments
- 33" Minimum base cabinet width
- Three faucet holes with one accessory hole to the right
- Offset faucet ledge
- 6-3/4" Depth and 10"8" basin depth



Part #	Mfg #	Overall Dimensions	Basin Depth	Holes	Color	Price
251737	K-5948-3-7	33" x 22"	6-3/4"	3	Black Black	
053223	K-5948-4-0	33" x 22"	6-3/4"	4	White	
186602	K-5948-4-7	33" x 22"	6-3/4"	4	Black Black	

## Kitchen Cast Iron Sinks

### Executive Chef™ Drop-In Double Bowl Kitchen Sink

- Large/medium size bowls
- 10" Left bowl depth, 8" right bowl depth
- 33" Minimum base cabinet width
- Offset faucet ledge
- Available with 4 faucet holes



Part #	Mfg #	Overall Dimensions	Basin Depth	Holes	Color	Price
053214	K-5932-4-0	33" x 22"	10"/8"	4	White	
053215	K-5932-4-47	33" x 22"	10"/8"	4	Almond	
076220	K-5932-4-7	33" x 22"	10"/8"	4	Black	
053216	K-5932-4-96	33" x 22"	10"/8"	4	Biscuit	

### Hartland® Drop-In Double Bowl Kitchen Sink

- Equal double bowl compartments
- 36" Minimum base cabinet width
- 9" Depth
- Available with 1, 2, 3, or 4 faucet holes



Part #	Mfg #	Overall Dimensions	Basin Depth	Holes	Color	Price
130973	K-5818-1-0	33" x 22"	9"	1	White	
144716	K-5818-1-47	33" x 22"	9"	1	Almond	
131350	K-5818-1-7	33" x 22"	9"	1	Black	
131933	K-5818-1-96	33" x 22"	9"	1	Biscuit	
133267	K-5818-2-0	33" x 22"	9"	2	White	
136863	K-5818-2-47	33" x 22"	9"	2	Almond	
142283	K-5818-2-7	33" x 22"	9"	2	Black	
138351	K-5818-2-96	33" x 22"	9"	2	Biscuit	
138933	K-5818-2-FD	33" x 22"	9"	2	Cane Sugar	
136647	K-5818-2-K4	33" x 22"	9"	2	Cashmere	
136408	K-5818-3-0	33" x 22"	9"	3	White	
133606	K-5818-3-47	33" x 22"	9"	3	Almond	
130173	K-5818-3-7	33" x 22"	9"	3	Black	
150702	K-5818-3-96	33" x 22"	9"	3	Biscuit	
132063	K-5818-4-0	33" x 22"	9"	4	White	
131475	K-5818-4-47	33" x 22"	9"	4	Almond	
157464	K-5818-4-7	33" x 22"	9"	4	Black	
132114	K-5818-4-96	33" x 22"	9"	4	Biscuit	

## Kitchen Cast Iron Sinks

### Langlade® Drop-In Double Bowl Kitchen Sink

- Equal size bowls
- 33" Minimum base cabinet width
- Smart Divide® lower bowl divider
- Available with 1, 2, 3, 3F, 4, and 5 faucet holes



Part #	Mfg #	Overall Dimensions	Basin Depth	Holes	Color	Price
093456	K-6626-1-0	33" x 22"	9"	1	White	
093158	K-6626-1-7	33" x 22"	9"	1	Black	
094085	K-6626-1-96	33" x 22"	9"	1	Biscuit	
153779	K-6626-1-FD	33" x 22"	9"	1	Cane Sugar	
117062	K-6626-1-FF	33" x 22"	9"	1	Sea Salt	
100320	K-6626-1-K4	33" x 22"	9"	1	Cashmere	
097751	K-6626-2-0	33" x 22"	9"	2	White	
183105	K-6626-2-47	33" x 22"	9"	2	Almond	
096699	K-6626-2-7	33" x 22"	9"	2	Black	
246258	K-6626-2-95	33" x 22"	9"	2	Ice Grey	
109552	K-6626-2-96	33" x 22"	9"	2	Biscuit	
127848	K-6626-2-FD	33" x 22"	9"	2	Cane Sugar	
118346	K-6626-2-FF	33" x 22"	9"	2	Sea Salt	
109402	K-6626-2-K4	33" x 22"	9"	2	Cashmere	
097173	K-6626-4-0	33" x 22"	9"	4	White	
106343	K-6626-4-47	33" x 22"	9"	4	Almond	
120457	K-6626-4-7	33" x 22"	9"	4	Black	
096446	K-6626-4-96	33" x 22"	9"	4	Biscuit	
126788	K-6626-4-FD	33" x 22"	9"	4	Cane Sugar	
099960	K-6626-4-K4	33" x 22"	9"	4	Cashmere	

### Mayfield™ Drop-In Single Bowl Kitchen Sink

- 25" x 22"
- 8-3/4-inch depth
- 27-inch minimum base cabinet width
- Acid-resistant enamel finish
- Three faucet holes with one accessory hole to the right



Part #	Mfg #	Overall Dimensions	Basin Depth	Holes	Color	Price
065830	K-5964-1-0	25" x 22"	8-3/4"	1	White	
240052	K-5964-1-47	25" x 22"	8-3/4"	1	Almond	
062598	K-5964-4-0	25" x 22"	8-3/4"	4	White	

## Kitchen Cast Iron Sinks

### Riverby® Drop-In Single Bowl Kitchen Sink

- 36" Minimum base cabinet width
- Available with 1, 3, or 4 faucet holes
- Offset drain
- Includes K-6239 colander and K-6237 LH bottom basin rack



Part #	Mfg #	Overall Dimensions	Basin Depth	Holes	Color	Price
162363	K-5871-1A2-0	33" x 22"	9"	1	White	
183595	K-5871-1A2-20	33" x 22"	9"	1	Suede	
152294	K-5871-1A2-96	33" x 22"	9"	1	Biscuit	
238529	K-5871-3A2-0	33" x 22"	9"	3	White	
152484	K-5871-3A2-FF	33" x 22"	9"	3	Sea Salt	
244067	K-5871-3A2-KA	33" x 22"	9"	3	Black 'n Tan	
185129	K-5871-4A2-0	33" x 22"	9"	4	White	
183992	K-5871-4A2-96	33" x 22"	9"	4	Biscuit	
226386	K-5871-4A2-FF	33" x 22"	9"	4	Sea Salt	
162514	K-5871-4A2-KA	33" x 22"	9"	4	Black n' Tan	
181517	K-5871-4A2-K4	33" x 22"	9"	4	Cashmere	

### Riverby® Drop-In Medium Size Single Bowl Sink

- 25" Minimum base cabinet width
- Available with 1, 3 or 4 faucet holes
- Offset drain
- Stainless-steel basin rack included



Part #	Mfg #	Overall Dimensions	Basin Depth	Holes	Color	Price
171608	K-5872-1A1-0	25" x 22"	9"	1	White	
172091	K-5872-1A1-47	25" x 22"	9"	1	Almond	
167337	K-5872-1A1-7	25" x 22"	9"	1	Black	
179273	K-5872-1A1-K4	25" x 22"	9"	1	Cashmere	
183598	K-5872-3A1-0	25" x 22"	9"	3	White	
237082	K-5872-4A1-0	25" x 22"	9"	4	White	
225280	K-8668-1A1-0	27" x 22"	9"	1	White	

## Cast Iron Under-Mount Kitchen Sinks

### Bakersfield™ Under-Mount Single Bowl Kitchen Sink

- 33" Minimum base cabinet width
- 5 Oversized faucet holes allow for easy installation
- Includes under-mount installation kit



Part #	Mfg #	Overall Dimensions	Basin Depth	Holes	Color	Price
132329	K-5832-5U-0	31" x 22"	8"	5U	White	

## Kitchen Cast Iron Sinks

### Cast Iron Under-Mount Kitchen Sinks (Continued)

#### Bakersfield™ Under-Mount Single Bowl Kitchen Sink

Part #	Mfg #	Overall Dimensions	Basin Depth	Holes	Color	Price
145080	K-5832-5U-47	31" x 22"	8"	5U	Almond	
183083	K-5832-5U-96	31" x 22"	8"	5U	Biscuit	

#### Brookfield™ Under-Mount Double Bowl Kitchen Sink

- Equal size bowl compartments
- 36" minimum base cabinet width
- Includes cutout template
- Oversized holes for easy installation of faucets and accessories



Part #	Mfg #	Overall Dimensions	Basin Depth	Holes	Color	Price
162541	K-5846-5U-0	33" x 22"	9"	5U	White	
185533	K-5846-5U-58	33" x 22"	9"	5U	Thunder Grey	
159702	K-5846-5U-7	33" x 22"	9"	5U	Black	
225759	K-5846-5U-95	33" x 22"	9"	5U	Ice Grey	
183593	K-5846-5U-FD	33" x 22"	9"	5U	Cane Sugar	
183685	K-5846-5U-FF	33" x 22"	9"	5U	Sea Salt	
164459	K-5846-5U-FP	33" x 22"	9"	5U	Caviar	
183594	K-5846-5U-FT	33" x 22"	9"	5U	Basalt	
158262	K-5846-5U-G9	33" x 22"	9"	5U	Sandbar	
159442	K-5846-5U-KA	33" x 22"	9"	5U	Black n' Tan	
169160	K-5846-5U-K4	33" x 22"	9"	5U	Cashmere	

#### Cape Dory® Under-Mount Single Bowl Kitchen Sink

- 36" Minimum base cabinet width
- 3 Oversized faucet holes allow for easy installation
- Under-mount installation kit and mounting hardware included



Part #	Mfg #	Overall Dimensions	Basin Depth	Holes	Color	Price
085450	K-5864-5U-0	33" x 22"	9"	5U	White	
183087	K-5864-5U-58	33" x 22"	9"	5U	Thunder Grey	
090473	K-5864-5U-7	33" x 22"	9"	5U	Black	
241348	K-5864-5U-95	33" x 22"	9"	5U	Ice Grey	
079533	K-5864-5U-96	33" x 22"	9"	5U	Biscuit	
121230	K-5864-5U-FD	33" x 22"	9"	5U	Cane Sugar	
143755	K-5864-5U-FF	33" x 22"	9"	5U	Sea Salt	
184858	K-5864-5U-FT	33" x 22"	9"	5U	Basalt	
103523	K-5864-5U-G9	33" x 22"	9"	5U	Sandbar	
093121	K-5864-5U-KA	33" x 22"	9"	5U	Black n' Tan	
087592	K-5864-5U-K4	33" x 22"	9"	5U	Cashmere	



## Kitchen Cast Iron Sinks

### Deerfield® Under-Mount Double Bowl Kitchen Sink

- 9-inch depth
- Rear drain
- Equal size bowl compartments
- 36" Minimum base cabinet width
- 5 Oversized faucet holes allow for easy faucet installation
- Includes cutout template



Part #	Mfg #	Overall Dimensions	Basin Depth	Holes	Color	Price
167035	K-5873-5U-0	33" x 22"	9"	5U	White	
253054	K-5873-5U-7	33" x 22"	9"	5U	Black	
166511	K-5873-5U-47	33" x 22"	9"	5U	Almond	
187821	K-5873-5U-95	33" x 22"	9"	5U	Ice Grey	
170571	K-5873-5U-96	33" x 22"	9"	5U	Biscuit	
159506	K-5873-5U-FD	33" x 22"	9"	5U	Cane Sugar	
183602	K-5873-5U-FF	33" x 22"	9"	5U	Sea Salt	
183133	K-5873-5U-G9	33" x 22"	9"	5U	Sandbar	
176159	K-5873-5U-KA	33" x 22"	9"	5U	Black 'n Tan	
183603	K-5873-5U-K4	33"x 22"	9"	5U	Cashmere	

### Executive Chef™ Under-Mount Double Bowl Kitchen Sink

- Large/medium size bowls
- 10" Left bowl depth, 8" right bowl depth
- 33" Minimum base cabinet width
- Offset faucet ledge
- 4 oversized faucet holes allow for easy installation



Part #	Mfg #	Overall Dimensions	Basin Depth	Holes	Color	Price
058752	K-5931-4U-0	33" x 22"	10"/8"	4U	White	
090280	K-5931-4U-47	33" x 22"	10"/8"	4U	Almond	
106973	K-5931-4U-58	33" x 22"	10"/8"	4U	Thunder Grey	
066261	K-5931-4U-7	33" x 22"	10"/8"	4U	Black	
078515	K-5931-4U-95	33" x 22"	10"/8"	4U	Ice Grey	
056544	K-5931-4U-96	33" x 22"	10"/8"	4U	Biscuit	
120337	K-5931-4U-FD	33" x 22"	10"/8"	4U	Cane Sugar	
106430	K-5931-4U-FF	33" x 22"	10"/8"	4U	Sea Salt	
158125	K-5931-4U-FP	33" x 22"	10"/8"	4U	Caviar	
183088	K-5931-4U-FT	33" x 22"	10"/8"	4U	Basalt	
064353	K-5931-4U-G9	33" x 22"	10"/8"	4U	Sandbar	
086487	K-5931-4U-KA	33" x 22"	10"/8"	4U	Black n' Tan	
081396	K-5931-4U-K4	33" x 22"	10"/8"	4U	Cashmere	
188733	K-5931-4U-NY	33" x 22"	10"/8"	4U	Dune	

## Kitchen Cast Iron Sinks

### Hartland® Under-Mount Double Bowl Kitchen Sink

- Equal bowl compartments
- 36" Minimum base cabinet width
- Under-mount installation kit included



Part #	Mfg #	Overall Dimensions	Basin Depth	Holes	Color	Price
139832	K-5818-5U-0	33" x 22"	9"	5U	White	
150984	K-5818-5U-47	33" x 22"	9"	5U	Almond	
183080	K-5818-5U-58	33" x 22"	9"	5U	Thunder Grey	
136918	K-5818-5U-7	33" x 22"	9"	5U	Black	
142853	K-5818-5U-95	33" x 22"	9"	5U	Ice Grey	
138590	K-5818-5U-96	33" x 22"	9"	5U	Biscuit	
139360	K-5818-5U-FD	33" x 22"	9"	5U	Cane Sugar	
158597	K-5818-5U-FF	33" x 22"	9"	5U	Sea Salt	
132939	K-5818-5U-FP	33" x 22"	9"	5U	Caviar	
138289	K-5818-5U-G9	33" x 22"	9"	5U	Sandbar	
132273	K-5818-5U-KA	33" x 22"	9"	5U	Black n' Tan	
141874	K-5818-5U-K4	33" x 22"	9"	5U	Cashmere	

### Indio® Under-Mount Double Bowl Kitchen Sink

- Large/medium size bowls
- 36" Minimum base cabinet width
- Smart Divide® lower bowl divider
- Integrated faucet deck provides additional water containment
- Includes 2) bottom basin racks, cutting board, and colander
- Under-mount installation kit also included



Part #	Mfg #	Overall Dimensions	Basin Depth	Holes	Color	Price
160984	K-6411-1-0	33" x 22"	9"	1	White	
139526	K-6411-1-58	33" x 22"	9"	1	Thunder Grey	
143295	K-6411-1-7	33" x 22"	9"	1	Black	
183095	K-6411-1-96	33" x 22"	9"	1	Biscuit	
136645	K-6411-1-FD	33" x 22"	9"	1	Cane Sugar	
148531	K-6411-1-FF	33" x 22"	9"	1	Sea Salt	
135774	K-6411-1-FP	33" x 22"	9"	1	Caviar	
137333	K-6411-1-G9	33" x 22"	9"	1	Sandbar	
183094	K-6411-1-KA	33" x 22"	9"	1	Black n' Tan	
181495	K-6411-1-K4	33" x 22"	9"	1	Cashmere	
182684	K-6411-1-NY	33" x 22"	9"	1	Dune	
154458	K-6411-2-0	33" x 22"	9"	2	White	
178277	K-6411-2-47	33" x 22"	9"	2	Almond	
176902	K-6411-2-58	33" x 22"	9"	2	Cashmere	
183097	K-6411-2-7	33" x 22"	9"	2	Black	
183098	K-6411-2-96	33" x 22"	9"	2	Biscuit	
139469	K-6411-2-FD	33" x 22"	9"	2	Cane Sugar	

## Kitchen Cast Iron Sinks

### Cast Iron Under-Mount Kitchen Sinks (Continued)

#### Indio® Under-Mount Double Bowl Kitchen Sink

Part #	Mfg #	Overall Dimensions	Basin Depth	Holes	Color	Price
140211	K-6411-2-FF	33" x 22"	9"	2	Sea Salt	
183096	K-6411-2-FP	33" x 22"	9"	2	Caviar	
139009	K-6411-2-G9	33" x 22"	9"	2	Sandbar	
172075	K-6411-2-K4	33" x 22"	9"	3	Cashmere	
162247	K-6411-3-0	33" x 22"	9"	3	White	
183100	K-6411-3-47	33" x 22"	9"	3	Almond	
183101	K-6411-3-7	33" x 22"	9"	3	Black	
241110	K-6411-3-95	33" x 22"	9"	3	Ice Grey	
151163	K-6411-3-96	33" x 22"	9"	3	Biscuit	
163738	K-6411-3-FF	33" x 22"	9"	3	Sea Salt	
183099	K-6411-3-FP	33" x 22"	9"	3	Caviar	
134740	K-6411-3-FT	33" x 22"	9"	3	Basalt	
168536	K-6411-3-KA	33" x 22"	9"	3	Black n' Tan	
140236	K-6411-3-K4	33" x 22"	9"	3	Cashmere	
223517	K-6411-3-NY	33" x 22"	9"	3	Dune	

#### Langlade® Under-Mount Double Bowl Kitchen Sink

- Equal size bowl compartments
- 36" Minimum base cabinet width
- Smart Divide® lower bowl divider
- 6 Oversized faucet holes allow for easy installation



Part #	Mfg #	Overall Dimensions	Basin Depth	Holes	Color	Price
100294	K-6626-6U-0	33" x 22"	9"	6U	White	
102206	K-6626-6U-47	33" x 22"	9"	6U	Almond	
107082	K-6626-6U-58	33" x 22"	9"	6U	Thunder Grey	
094364	K-6626-6U-7	33" x 22"	9"	6U	Black	
169824	K-6626-6U-95	33" x 22"	9"	6U	Ice Grey	
094769	K-6626-6U-96	33" x 22"	9"	6U	Biscuit	
098957	K-6626-6U-FD	33" x 22"	9"	6U	Cane Sugar	
124488	K-6626-6U-FF	33" x 22"	9"	6U	Sea Salt	
138932	K-6626-6U-FP	33" x 22"	9"	6U	Caviar	
176217	K-6626-6U-FT	33" x 22"	9"	6U	Basalt	
096618	K-6626-6U-G9	33" x 22"	9"	6U	Sandbar	
090083	K-6626-6U-KA	33" x 22"	9"	6U	Black n' Tan	
095507	K-6626-6U-K4	33" x 22"	9"	6U	Cashmere	
188995	K-6626-6U-NY	33" x 22"	9"	6U	Dune	

## Kitchen Cast Iron Sinks

### Riverby® Under-Mount Single Bowl Kitchen Sink

- 36" Minimum base cabinet width
- 5 Oversized faucet holes for easy installation
- Offset drain
- Includes K-6194 utility rack, K-6239 colander, and K-6237 LH bottom basin rack



Part #	Mfg #	Overall Dimensions	Basin Depth	Holes	Color	Price
147531	K-5871-5UA3-0	33" x 22"	9"	5U	White	
164943	K-5871-5UA3-58	33" x 22"	9"	5U	Thunder Grey	
170801	K-5871-5UA3-7	33" x 22"	9"	5U	Black	
170711	K-5871-5UA3-95	33" x 22"	9"	5U	Ice Grey	
171533	K-5871-5UA3-96	33" x 22"	9"	5U	Biscuit	
149421	K-5871-5UA3-FD	33" x 22"	9"	5U	Cane Sugar	
228419	K-5871-5UA3-FF	33" x 22"	9"	5U	Sea Salt	
180382	K-5871-5UA3-FP	33" x 22"	9"	5U	Caviar	
230794	K-5871-5UA3-FT	33" x 22"	9"	5U	Basalt	
169387	K-5871-5UA3-G9	33" x 22"	9"	5U	Sandbar	
158174	K-5871-5UA3-KA	33" x 22"	9"	5U	Black n' Tan	
165155	K-5871-5UA3-K4	33" x 22"	9"	5U	Cashmere	
229137	K-5871-5UA3-NY	33" x 22"	9"	5U	Dune	

### Riverby® Under-Mount Single Bowl Sink

- 27" Minimum base cabinet width
- 5 Oversized faucet holes allow for easy installation
- Offset drain
- 5-1/4" Depth
- Includes cutout template



Part #	Mfg #	Overall Dimensions	Basin Depth	Holes	Color	Price
246757	K-5479-5U-0	25" x 22"	5-1/4"	5U	White	

### Riverby® Under-Mount Medium Size Single Bowl Sink

- 28" Minimum base cabinet width
- 5 Oversized faucet holes allow for easy installation
- Offset drain
- Stainless-steel basin rack included



Part #	Mfg #	Overall Dimensions	Basin Depth	Holes	Color	Price
159860	K-5872-5UA1-0	25" x 22"	9"	5U	White	
179808	K-5872-5UA1-FF	25" x 22"	9"	5U	Sea Salt	
156974	K-5872-5UA1-FP	25" x 22"	9"	5U	Caviar	
163078	K-5872-5UA1-G9	25" x 22"	9"	5U	Sandbar	
226442	K-5872-5UA1-K4	25" x 22"	9"	5U	Cashmere	
189224	K-8668-5UA2-0	27" x 22"	9"	5U	White	
186741	K-8668-5UA2-FT	27" x 22"	9"	5U	Basalt	

## Kitchen Cast Iron Sinks

### Riverby® Under-Mount Double Bowl Kitchen Sink

- 36" Minimum base cabinet width
- Oversized holes
- Offset drains
- Includes: K-6239 colander with integral cutting board  
K-6194 utility rack with soaking cup

**K-8669**

**Large/Medium Bowls**

**K-9234 Left-hand bottom basin rack**



K-8669-5UA3



K-8679-5UA3

**K-8679**

**Double Equal Bowls**

**K-9238 bottom basin rack**

Part #	Mfg #	Overall Dimensions	Basin Depth	Holes	Color	Price
243435	K-8669-1A2-0	33" x 22"	9"	1	White	
238401	K-8669-1A2-47	33" x 22"	9"	1	Almond	
254786	K-8669-1A2-KA	33" x 22"	9"	1	Black n' Tan	
232711	K-8669-5UA3-0	33" x 22"	9"	5U	White	
244190	K-8669-5UA3-96	33" x 22"	9"	5U	Biscuit	
236413	K-8669-5UA3-FF	33" x 22"	9"	5U	Sea Salt	
247938	K-8669-5UA3-FT	33" x 22"	9"	5U	Basalt	
188674	K-8669-5UA3-G9	33" x 22"	9"	5U	Sandbar	
240561	K-8669-5UA3-NY	33" x 22"	9"	5U	Dune	
238530	K-8679-1A2-47	33" x 22"	9"	1	Almond	
257063	K-8679-3A2-0	33" x 22"	9"	3	White	
230863	K-8679-5UA3-0	33" x 22"	9"	5U	White	
229428	K-8679-5UA3-KA	33" x 22"	9"	5U	Black n' Tan	

### Tile-In and Dual-Mount Cast Iron Kitchen Sinks

#### Assure™ Tile-In/Under-Mount Double Bowl Kitchen Sink

- High/low, large/small bowl sizes
- 4-1/4" left depth, 6-1/4" right depth
- 36" Minimum base cabinet width
- Available with 3 or 4 faucet holes
- ADA compliant



Part #	Mfg #	Overall Dimensions	Basin Depth	Holes	Color	Price
135466	K-6536-3-0	36" x 25-1/2"	4-1/4" and 6-1/4"	3	White	
253412	K-6536-4-0	36" x 25-1/2"	4-1/4" and 6-1/4"	4	White	

## Kitchen Cast Iron Sinks

### Delafield® Tile-In/Metal Frame Drop-In Double Bowl Kitchen Sink

- 8" Depth
- Equal size bowl compartments
- 33" Minimum base cabinet width
- Available with 3 or 4 faucet holes
- Tile-in or drop-in installation



Part #	Mfg #	Overall Dimensions	Basin Depth	Holes	Color	Price
058969	K-5950-4-0	33" x 22"	8"	4	White	

### Executive Chef™ Tile-In Double Bowl Kitchen Sink

- Large/medium size bowls
- 10" Left bowl depth, 8" right bowl depth
- 33" Minimum base cabinet width
- Offset faucet ledge
- Available with 4 faucet holes



Part #	Mfg #	Overall Dimensions	Basin Depth	Holes	Color	Price
078826	K-5931-4-0	33" x 22"	10"/8"	4	White	
110411	K-5931-4-7	33" x 22"	10"/8"	4	Black	

### Iron/Tones® Dual-Mount Double Bowl Kitchen Sink

- Large/medium size bowls
- 33" Minimum base cabinet for top-mount installation
- 36" Minimum base cabinet for under-mount installation
- Top-mount or under-mount installation
- Smart Divide® lower bowl divider



Part #	Mfg #	Overall Dimensions	Basin Depth	Holes	Color	Price
089516	K-6625-0	33" x 22"	9"	N/A	White	
095433	K-6625-47	33" x 22"	9"	N/A	Almond	
139033	K-6625-58	33" x 22"	9"	N/A	Thunder Grey	
096611	K-6625-7	33" x 22"	9"	N/A	Black	
161482	K-6625-95	33" x 22"	9"	N/A	Ice Grey	
089517	K-6625-96	33" x 22"	9"	N/A	Biscuit	
106583	K-6625-FD	33" x 22"	9"	N/A	Cane Sugar	
094243	K-6625-FF	33" x 22"	9"	N/A	Sea Salt	
156940	K-6625-FP	33" x 22"	9"	N/A	Caviar	
178621	K-6625-FT	33" x 22"	9"	N/A	Basalt	
097537	K-6625-G9	33" x 22"	9"	N/A	Sandbar	
101070	K-6625-KA	33" x 22"	9"	N/A	Black n' Tan	
098197	K-6625-K4	33" x 22"	9"	N/A	Cashmere	



## Kitchen Cast Iron Sinks

### Iron/Tones® Equal Double Bowl Kitchen Sink

- Equal size bowls
- 33" Minimum base cabinet for top-mount installation
- 36" Minimum base cabinet for under-mount installation
- Top-mount or under-mount installation
- Smart Divide® lower bowl divider



Part #	Mfg #	Overall Dimensions	Basin Depth	Holes	Color	Price
250803	K-5312-FF	33" x 18-3/4"	9"	N/A	Sea Salt	

### Apron Front Kitchen Sinks

#### Dickinson® Tile-In Apron- Front Kitchen Sink

- Single bowl
- Center drain
- 33" Minimum apron sink base cabinet width
- Available with 3, or 4 faucet holes



Part #	Mfg #	Overall Dimensions	Basin Depth	Holes	Color	Price
080809	K-6546-3-0	33" x 22"	8"	3	White	
089072	K-6546-4-0	33" x 22"	8"	4	White	

#### Dickinson® Under-Mount Apron Front Kitchen Sink

- Single bowl
- Center drain
- 33" Minimum apron sink base cabinet width
- 4 Oversized faucet holes allow for easy installation
- (K-14579-KG-G9) Alencon Lace™ Sandbar finish



Part #	Mfg #	Overall Dimensions	Basin Depth	Holes	Color	Price
068783	K-6546-4U-0	33" x 22"	8"	4U	White	
104849	K-6546-4U-47	33" x 22"	8"	4U	Almond	
061698	K-6546-4U-7	33" x 22"	8"	4U	Black	
059926	K-6546-4U-96	33" x 22"	8"	4U	Biscuit	
126665	K-6546-4U-FD	33" x 22"	8"	4U	Cane Sugar	
138288	K-6546-4U-FF	33" x 22"	8"	4U	Sea Salt	
080036	K-6546-4U-G9	33" x 22"	8"	4U	Sandbar	
108176	K-6546-4U-KA	33" x 22"	8"	4U	Black n' Tan	
136841	K-6546-4U-K4	33" x 22"	8"	4U	Cashmere	
182811	K-14579-KG-G9	33" x 22-1/8"	8"	4U	Alencon Lace™ Sandbar	

## Kitchen Cast Iron Sinks

### Hawthorne™ Tile-In Apron Front Kitchen Sink

- Equal size bowl compartments
- 33" Minimum base cabinet width
- Available with 3 or 4 faucet holes



Part #	Mfg #	Overall Dimensions	Basin Depth	Holes	Color	Price
189196	K-6534-4U-58	33" x 22"	8"	4U	Thunder Grey	

### Hawthorne™ Under-Mount Apron Front Kitchen Sink

- Equal size bowl compartments
- 33" Minimum base cabinet width
- 3 Oversized faucet holes allow for easy installation



Part #	Mfg #	Overall Dimensions	Basin Depth	Holes	Color	Price
055651	K-6534-4U-0	33" x 22"	8"	4U	White	
077875	K-6534-4U-47	33" x 22"	8"	4U	Almond	
085844	K-6534-4U-7	33" x 22"	8"	4U	Black	
059595	K-6534-4U-96	33" x 22"	8"	4U	Biscuit	
158255	K-6534-4U-FD	33" x 22"	8"	4U	Cane Sugar	
127242	K-6534-4U-FF	33" x 22"	8"	4U	Sea Salt	
116245	K-6534-4U-FT	33" x 22"	8"	4U	Basalt	
080027	K-6534-4U-G9	33" x 22"	8"	4U	Sandbar	
105752	K-6534-4U-KA	33" x 22"	8"	4U	Black n' Tan	
101540	K-6534-4U-K4	33" x 22"	8"	4U	Cashmere	
175999	K-6534-4U-NY	33" x 22"	8"	4U	Dune	

### Whitehaven® Under-Mount Short Apron-Front Sink

- Short, self-trimming apron
- Offset drain
- No faucet holes



Part #	Mfg #	Overall Dimensions	Basin Depth	Holes	Color	Price
167839	K-5826-0	33" x 22"	9"	N/A	White	
247085	K-5826-96	33" x 22"	9"	N/A	Biscuit	
178135	K-5826-FF	33" x 22"	9"	N/A	Sea Salt	
176865	K-5826-K4	33" x 22"	9"	N/A	Cashmere	
154602	K-6486-0	30" x 22"	9"	N/A	White	
183612	K-6486-95	30" x 22"	9"	N/A	Ice Grey	
183613	K-6486-96	30" x 22"	9"	N/A	Biscuit	
159495	K-6486-FD	30" x 22"	9"	N/A	Cane Sugar	

## Kitchen Cast Iron Sinks

### Apron Front Kitchen Sinks (Continued)

#### Whitehaven® Under-Mount Short Apron-Front Sink

Part #	Mfg #	Overall Dimensions	Basin Depth	Holes	Color	Price
183610	K-6486-FF	30" x 22"	9"	N/A	Sea Salt	
183611	K-6486-NY	30" x 22"	9"	N/A	Dune	
152198	K-6488-0	36" x 22"	9"	N/A	White	
245807	K-6488-47	36" x 22"	9"	N/A	Almond	
245039	K-6488-58	36" x 22"	9"	N/A	Thunder Grey	
150107	K-6488-96	36" x 22"	9"	N/A	Biscuit	
160637	K-6488-FD	36" x 22"	9"	N/A	Cane Sugar	
157024	K-6488-FF	36" x 22"	9"	N/A	Sea Salt	
244416	K-6488-G9	36" x 22"	9"	N/A	Sandbar	
163717	K-6488-KA	36" x 22"	9"	N/A	Black n' Tan	
244417	K-6488-K4	36" x 22"	9"	N/A	Cashmere	
225972	K-6488-NY	36" x 22"	9"	N/A	Dune	

#### Center Drain 23-1/2" x 21-9/16"

Part #	Mfg #	Overall Dimensions	Basin Depth	Holes	Color	Price
178171	K-5664-0	23-1/2" x 21-9/16"	9"	N/A	White	
229000	K-5664-58	23-1/2" x 21-9/16"	9"	N/A	Thunder Grey	
239865	K-5664-FF	23-1/2" x 21-9/16"	9"	N/A	Sea Salt	
186524	K-5664-FP	23-1/2" x 21-9/16"	9"	N/A	Caviar	

#### Whitehaven® Under-Mount Single Bowl Apron-Front Sink

- Tall, self-trimming apron
- Offset drain
- No faucet holes



Part #	Mfg #	Overall Dimensions	Basin Depth	Holes	Color	Price
167840	K-5827-0	33" x 22"	9"	N/A	White	
228696	K-5827-47	33" x 22"	9"	N/A	Almond	
223917	K-5827-58	33" x 22"	9"	N/A	Thunder Grey	
223427	K-5827-7	33" x 22"	9"	N/A	Black	
224691	K-5827-95	33" x 22"	9"	N/A	Ice Grey	
183682	K-5827-96	33" x 22"	9"	N/A	Biscuit	
169871	K-5827-FF	33" x 22"	9"	N/A	Sea Salt	
255598	K-5827-FP	33" x 22"	9"	N/A	Caviar	
185404	K-5827-G9	33" x 22"	9"	N/A	Sandbar	
183590	K-5827-K4	33" x 22"	9"	N/A	Cashmere	
183591	K-5827-NY	33" x 22"	9"	N/A	Dune	
146022	K-6487-0	30" x 22"	9"	N/A	White	

## Kitchen Cast Iron Sinks

### Apron Front Kitchen Sinks (Continued)

#### Whitehaven® Under-Mount Single Bowl Apron-Front Sink

Part #	Mfg #	Overall Dimensions	Basin Depth	Holes	Color	Price
151082	K-6487-7	30" x 22"	9"	N/A	Black	
185168	K-6487-95	30" x 22"	9"	N/A	Ice Grey	
153113	K-6487-96	30" x 22"	9"	N/A	Biscuit	
183618	K-6487-FD	30" x 22"	9"	N/A	Cane Sugar	
228139	K-6487-G9	30" x 22"	9"	N/A	Sandbar	
183619	K-6487-KA	30" x 22"	9"	N/A	Black n' Tan	
188964	K-6487-K4	30" x 22"	9"	N/A	Cashmere	
165905	K-6487-NY	30" x 22"	9"	N/A	Dune	
148357	K-6489-0	36" x 22"	9"	N/A	White	
153392	K-6489-47	36" x 22"	9"	N/A	Almond	
179437	K-6489-58	36" x 22"	9"	N/A	Thunder Grey	
145950	K-6489-7	36" x 22"	9"	N/A	Black	
144356	K-6489-96	36" x 22"	9"	N/A	Biscuit	
148797	K-6489-FD	36" x 22"	9"	N/A	Cane Sugar	
141638	K-6489-FF	36" x 22"	9"	N/A	Sea Salt	
163646	K-6489-FP	36" x 22"	9"	N/A	Caviar	
237568	K-6489-FT	36" x 22"	9"	N/A	Basalt	
153770	K-6489-G9	36" x 22"	9"	N/A	Sandbar	
149955	K-6489-KA	36" x 22"	9"	N/A	Black n' Tan	
157415	K-6489-K4	36" x 22"	9"	N/A	Cashmere	
148645	K-6489-NY	36" x 22"	9"	N/A	Dune	

#### Center Drain

Part #	Mfg #	Overall Dimensions	Basin Depth	Holes	Color	Price
176667	K-5665-0	23-1/2" x 21-9/16"	9"	N/A	White	
241714	K-5665-96	23-1/2" x 21-9/16"	9"	N/A	Biscuit	
183681	K-5665-FD	23-1/2" x 21-9/16"	9"	N/A	Cane Sugar	

#### Whitehaven® Under-Mount Double Bowl Apron Front Kitchen Sink with Short Apron

- Large/medium size bowls
- 36" Minimum base cabinet width
- Smart Divide® lower bowl divider
- Short apron



Part #	Mfg #	Overall Dimensions	Basin Depth	Holes	Color	Price
164009	K-6426-0	36" x 22"	9"	N/A	White	
179442	K-6426-58	36" x 22"	9"	N/A	Thunder Grey	
186077	K-6426-96	36" x 22"	9"	N/A	Biscuit	
255059	K-6426-FF	36" x 22"	9"	N/A	Sea Salt	
159801	K-6426-G9	36" x 22"	9"	N/A	Sandbar	

## Kitchen Cast Iron Sinks

### Apron Front Kitchen Sinks (Continued)

#### Whitehaven® Under-Mount Double Bowl Apron Front Kitchen Sink with Short Apron

Part #	Mfg #	Overall Dimensions	Basin Depth	Holes	Color	Price
168922	K-6426-NY	36" x 22"	9"	N/A	Dune	

#### Whitehaven® Under-Mount Apron Front Kitchen Sink

- Large/medium size bowls
- 36" Minimum base cabinet width
- Smart Divide® lower bowl divider
- Tall Apron



Part #	Mfg #	Overall Dimensions	Basin Depth	Holes	Color	Price
159678	K-6427-0	36" x 22"	9"	N/A	White	
172168	K-6427-47	36" x 22"	9"	N/A	Almond	
180909	K-6427-58	36" x 22"	9"	N/A	Thunder Grey	
182084	K-6427-7	36" x 22"	9"	N/A	Black	
172510	K-6427-96	36" x 22"	9"	N/A	Biscuit	
183608	K-6427-FF	36" x 22"	9"	N/A	Sea Salt	
179788	K-6427-FP	36" x 22"	9"	N/A	Caviar	
189040	K-6427-G9	36" x 22"	9"	N/A	Sandbar	
162053	K-6427-KA	36" x 22"	9"	N/A	Black n' Tan	
229641	K-6427-K4	36" x 22"	9"	N/A	Cashmere	
189143	K-6427-NY	36" x 22"	9"	N/A	Dune	

#### Whitehaven® Hayridge™ Design Under-Mount Apron Front Kitchen Sink

- Textured ridge design on apron-front
- Self-Trimming apron overlaps the cabinet face
- Basin slopes 2° toward drain to minimize water pooling



Part #	Mfg #	Overall Dimensions	Basin Depth	Holes	Color	Price
228948	K-7251-0	29-11/16" x 21-9/16"	9"	N/A	White	
182003	K-6351-0	35-11/16" x 21-9/16"	9"	N/A	White	

## Kitchen Cast Iron Sinks

### Whitehaven® Hayridge™ Design Under-Mount Apron Front Kitchen Sink

- Textured ridge design on apron-front
- Self-Trimming apron overlaps the cabinet face
- Basin slopes 2° toward drain to minimize water pooling



Part #	Mfg #	Overall Dimensions	Basin Depth	Holes	Color	Price
177022	K-6349-0	35-11/16" x 21-9/16"	9"	N/A	White	

### Cast Iron Kitchen Sink Accessories



#### Alcott™ Bottom Sink Rack

- 19-5/8" x 13-3/8"



Part #	Mfg #	Overall Dimensions	Basin Depth	Holes	Color	Price
170868	K-6005-ST	For Alcott™ Kitchen Sink, Stainless Steel				

#### Bakersfield™ Bottom Sink Rack

- 25" x 12-3/4"



Part #	Mfg #	Overall Dimensions	Basin Depth	Holes	Color	Price
109399	K-6517-ST	For Model K-5832 Bakersfield™				

#### Brookfield™ Bottom Sink Rack

- 12-7/8" x 14-7/8"

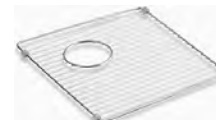

Part #	Mfg #	Overall Dimensions	Basin Depth	Holes	Color	Price
162177	K-6197-ST	For Model K-5846, Left Bowl				

#### Cairn™ Bottom Sink Rack for Model K-8204

- Small Bowl—10-3/8" x 14-1/4" or large Bowl—17-1/4" x 14"

Part #	Mfg #	Overall Dimensions	Basin Depth	Holes	Color	Price
178512	K-5198-ST	Small Bowl				
178511	K-5655-ST	Large Bowl				



## Kitchen Cast Iron Sinks

### Cape Dory™ Bottom Sink Rack for Models K-5863 and K-5864

- 13-3/8" x 27-1/2"

Part #	Mfg #	Description	Price
102211	K-6063-ST	For Models K-5863 and K-5864	

### Dickinson® Bottom Sink Rack

- 27-1/2" x 13-1/4"



Part #	Mfg #	Overall Dimensions	Basin Depth	Holes	Color	Price
081337	K-6026-ST	For Model K-6546				

### Deerfield® Bottom Sink Rack for Models K-5815 and K-5838

- 14-15/16" x 12-1/8"



Part #	Mfg #	Overall Dimensions	Basin Depth	Holes	Color	Price
161861	K-6039-ST	For Models K-5815 and K-5838				

### Efficiency™ Executive Chef™ Sink Basket for Right Side Bowl

- 11-1/2" x 15-3/4"
- For models K-5931, K-5932, K-5948

Part #	Mfg #	Description	Price
106661	K-6521-ST	For Models K-5931, K-5932, and K-5948	

### Efficiency™ Sink Rack for Left Bowl

- 14-1/4" x 17-1/2"

Part #	Mfg #	Overall Dimensions	Basin Depth	Holes	Color	Price
176731	K-6000-ST	For Model K-5948				

### Executive Chef™ Bottom Sink Rack for Models K-5931 and K-5932

- 17-5/8" x 14-1/4"

Part #	Mfg #	Description	Price
102212	K-6001-ST	For Left Bowl	

## Kitchen Cast Iron Sinks

### Galleon™ Hardwood Cutting Board

- Fits over:
  - Alcott™ kitchen sinks
  - K-6546 Dickinson® kitchen sink
  - K-6534 Hawthorne™ kitchen sink



Part #	Mfg #	Overall Dimensions	Basin Depth	Holes	Color	Price
056176	K-5984-NA	Hardwood Construction				

### Hartland® Stainless Steel Bottom Sink Rack with Rubber Feet for Model K-5818

- 12-1/4" x 16-3/4" ( **K-6016R-ST** model)
- 13-1/8" x 16-7/8" ( **K-5133-ST** & **K-5135-ST** models)

Part #	Mfg #	Overall Dimensions	Basin Depth	Holes	Color	Price
186214	K-5133-ST	Left Bowl				
177332	K-5135-ST	Right Bowl				

### Hartland® Stainless Steel Sink Basket for Left Bowl with Rubber Feet

- 17-1/8" x 12-5/8"

Part #	Mfg #	Overall Dimensions	Basin Depth	Holes	Color	Price
116719	K-6603L-ST	For Model K-5818				

### Indio® Colander for Model K-6411

- 14-3/8" x 8-7/16" x 4-3/8"
- Fits over Indio® kitchen sink



Part #	Mfg #	Overall Dimensions	Basin Depth	Holes	Color	Price
183093	K-6166-ST	Stainless Steel Mesh				

### Indio® Hardwood Cutting Board for Model K-6411

- 18-1/4" x 10-1/2"
- Fits over Indio® Smart Divide kitchen sink



Part #	Mfg #	Overall Dimensions	Basin Depth	Holes	Color	Price
183092	K-6165-NA	American Walnut				

### Iron/Tones® Sink Rack for K-6584 Kitchen Sink

- 13-3/8" x 14-5/8"
- Rack includes innovative wheels



Part #	Mfg #	Overall Dimensions	Basin Depth	Holes	Color	Price
174414	K-5184-ST	Stainless Steel				

## Kitchen Cast Iron Sinks

### Iron/Tones® Sink Rack for K-6625 Smart Divide® Kitchen Sink

- 8-1/4" x 14-3/8" (5139-ST)
- 18-1/4" x 14-3/8" (5139-ST)
- 17-1/2" x 14" (6058-ST)



Part #	Mfg #	Overall Dimensions	Basin Depth	Holes	Color	Price
181848	K-5137-ST	For Model K-6625 Large Bowl, Stainless Steel				
181849	K-5139-ST	For Model K-6625 Small Bowl, Stainless Steel				

### Kennon® Sink Rack for K-8185 Kitchen Sink

- 13-5/8" x 13-5/8"
- Rack includes innovative wheels
- Fits in the right bowl of the K-8185-1 and K-RH8185-1 Kennon kitchen sink



Part #	Mfg #	Overall Dimensions	Basin Depth	Holes	Color	Price
251262	K-5186-ST	Right Bowl, Stainless Steel				

### Lawnfield® Bottom Sink Rack for K-5841 Kitchen Sink

- 15-3/8" x 16-1/2" (6160-ST) or 15-1/2" x 9-3/8" (6162-ST)

Part #	Mfg #	Overall Dimensions	Basin Depth	Holes	Color	Price
169469	K-6160-ST	Left Bowl, Stainless Steel				
169470	K-6162-ST	Right Bowl, Stainless Steel				

### Octave® Sink Rack for K-3842 and K-3843 Kitchen Sinks

Part #	Mfg #	Overall Dimensions	Basin Depth	Holes	Color	Price
184801	K-6483-ST	Left Bowl, Stainless Steel				

### Riverby® Sink Rack for K-5871 Kitchen Sink with Rubber Feet

- 14-1/16" x 9-9/16"

Part #	Mfg #	Overall Dimensions	Basin Depth	Holes	Color	Price
164945	K-6255-ST	Left Bowl, Stainless Steel				

### Riverby® Hardwood Cutting Board for K-5871 and K-5872 Kitchen Sinks

Part #	Mfg #	Overall Dimensions	Basin Depth	Holes	Color	Price
164944	K-6246-NA	Maple Wood				

### Whitehaven® Stainless Steel Sink Rack with Left and Right Racks

- Durable, electro-polished stainless steel construction
- Includes rubber feet



Part #	Mfg #	Description	Price
157424	K-6638-ST	For K-6486 and K-6487, 30"	
141639	K-6639-ST	For K-6488 and K-6489, 36"	
169955	K-6449-ST	For K-5826 and K-5827	

## Kitchen Cast Iron Sinks

### Whitehaven® Sink Rack for K-6426 and K-6427 Kitchen Sinks

- 17-5/8" x 14-9/16" **(5828-ST)** or 14-1/2" x 9-1/8" **(5874-ST)**



Part #	Mfg #	Description	Price
164010	K-5828-ST	Large Rack, Stainless Steel	
164011	K-5874-ST	Small Rack, Stainless Steel	

### Woodfield™ Sink Rack for K-5839 Kitchen Sink

- 9-1/2" x 13" **(6021-ST)** or 13-3/4" x 15-3/4" **(6022-ST)**
- Model **(6021-ST)** is raised 2 inches for a shallow depth option



Part #	Mfg #	Description	Price
054721	K-6021-ST	Left Bowl, Stainless Steel	
054722	K-6022-ST	Right Bowl, Stainless Steel	

## Kitchen Fireclay Sinks

### Apron Front Kitchen Sinks

#### Alcott™ Under-Mount Apron Front Sink

- 25" x 22" Single bowl
- Center drain
- 27" Minimum apron sink base cabinet
- 5 Oversized faucet holes allow for easy installation
- Fireclay



Part #	Mfg #	Overall Dimensions	Basin Depth	Holes	Color	Price
069752	K-6573-5U-0	25" x 22"	8"	5U	White	
104325	K-6573-5U-47	25" x 22"	8"	5U	Almond	
091535	K-6573-5U-7	25" x 22"	8"	5U	Black	
059753	K-6573-5U-96	25" x 22"	8"	5U	Biscuit	

#### Evenweave® Design on Alcott™

- 25" x 22"
- Center drain
- Fits minimum 27" apron sink base cabinet
- Decorated with a textured woven pattern



Part #	Mfg #	Overall Dimensions	Basin Depth	Holes	Color	Price
168489	K-14572-T3-W2	25" x 22"	8"	5U	Earthen White	

**Kitchen Fireclay Sinks**

**Fine Fireclay Sinks**

**Explore™ Fine Fireclay Undermount Farm Apron Front Double Bowl Kitchen Sink**

- Gloss finish
- 10" High apron
- 1/4" Reveal
- Center drain



Part #	Mfg #	Overall Size	Bowl Sizes	Depth	Drain Opening	Min Sink Base	Color	Price
176045	SWUF32189BI	32-3/4" x 19-7/8"	N/A	9"	3-1/2"	36"	Biscuit	
176042	SWUF32189WH	32-3/4" x 19-7/8"	N/A	9"	3-1/2"	36"	White	

**Fireclay Farmhouse 60/40 Double Bowl Kitchen Sink with Aqua Divide**

- Porcelain glaze
- Center drain



Part #	Mfg #	Overall Size	Bowl Sizes	Depth	Drain Opening	Min Sink Base	Color	Price
238736	SWUF3320WH	33" x 20"	60/40	10-1/8"	3-1/2"	36"	White	



**Kitchen Composite Sinks**

**Self-Rimming/Drop-In E-Granite™ Sinks**

**Gourmet® E-Granite™ Dual-Mount Single Bowl Sink**

- Molded from E-Granite which is up to 80% natural quartz and acrylic resins
- Naturally sound deadened, heat resistant
- Can be mounted as top-mount or undermount
- 3/8" Rim height
- Drains not included



Part #	Mfg #	Overall Size	Holes	Depth	Drain Opening	Min Sink Base	Color	Price
121170	ELG1515MC0	16-5/8" x 16-5/8"	0	8"	3-1/2"	21"	Mocha	
242901	ELG1616GR0	15-3/4" x 15-3/4"	0	7-11/16"	3-1/2"	21"	Greige	
229399	ELG1616SD0	15-3/4" x 15-3/4"	0	7-11/16"	3-1/2"	21"	Sand	
228441	ELG1616WH0	15-3/4" x 15-3/4"	0	7-11/16"	3-1/2"	21"	White	

**Quartz Classic E-Granite™ Self-Rimming Single Bowl Sink**

- Molded from E-Granite which is up to 80% natural quartz and acrylic resins
- Non-porous and stain resistant
- Hard surface is scratch and chip resistant
- Naturally sound deadened and heat resistant
- Rim height: 3/8"
- 9-1/2" Bowl depth
- Drains not included



Part #	Mfg #	Overall Size	Holes	Depth	Drain Opening	Min Sink Base	Color	Price
108354	ELG2522BK0	25" x 22"	Prescored up to 5	9-1/2"	3-1/2"	30"	Black	
222124	ELG2522GR0	25" x 22"	Prescored up to 5	9-1/2"	3-1/2"	30"	Greige	
173325	ELG2522GY0	25" x 22"	Prescored up to 5	9-1/2"	3-1/2"	30"	Dusk Grey	
236502	ELG2522GS0	25" x 22"	Prescored up to 5	9-1/2"	3-1/2"	30"	Greystone	
245899	ELG2522SD0	25" x 22"	Prescored up to 5	9-1/2"	3-1/2"	30"	Sand	

**Gourmet® E-Granite™ Self-Rimming Single Bowl Kitchen Sink**

- Molded from up to 80% natural quartz and acrylic resins
- Naturally sound deadened, heat resistant
- Rear center drain location
- Drains not included



Part #	Mfg #	Overall Size	Bowl Sizes	Depth	Drain Opening	Min Sink Base	Color	Price
226421	ELGS2522SD0	25" x 22"	Pre-scored up to 2	8-1/2"	3-1/2"	30"	Sand	

**Kitchen Composite Sinks**

**Harmony® E-Granite™ Self-Rimming Double Bowl Sink with Aqua Divide and Deep Depth**

- Molded from E-Granite which is up to 80% natural quartz and acrylic resins
- Non-porous and stain resistant
- Hard surface is scratch and chip resistant
- Naturally sound deadened and heat resistant
- Rim height: 3/8"
- Aqua divide height: 5"
- Drains not included



Part #	Mfg #	Overall Size	Bowl Sizes	Depth	Drain Opening	Min Sink Base	Color	Price
227330	ELGDLB3322BQ0	33" x 22"	Pre-Scored up to 5	10"	3-1/2"	36"	Bisque	
224983	ELGDLB3322MC0	33" x 22"	Pre-Scored up to 5	10"	3-1/2"	36"	Mocha	
225486	ELGDLB3322SD0	33" x 22"	Pre-Scored up to 5	10"	3-1/2"	36"	Sand	

**Quartz Classic E-Granite™ Self-Rimming Double Bowl Sink**

- Molded from E-Granite which is up to 80% natural quartz and acrylic resins
- Non-porous and stain resistant
- Hard surface is scratch and chip resistant
- Naturally sound deadened and heat resistant
- Drains not included



ELG3322BK

Part #	Mfg #	Overall Size	Holes	Depth	Drain Opening	Min Sink Base	Color	Price
108350	ELG3322BK0	33" x 22"	Pre-scored up to 5	9-1/2"	3-1/2"	36"	Black	
108352	ELG3322BQ0	33" x 22"	Pre-scored up to 5	9-1/2"	3-1/2"	36"	Bisque	
189660	ELG3322GR0	33" x 22"	Pre-scored up to 5	9-1/2"	3-1/2"	36"	Greige	
238944	ELG3322GS0	33" x 22"	Pre-scored up to 5	9-1/2"	3-1/2"	36"	Greystone	
121419	ELG3322MC0	33" x 22"	Pre-scored up to 5	9-1/2"	3-1/2"	36"	Mocha	
250831	ELG3322PC0	33" x 22"	Pre-scored up to 5	9-1/2"	3-1/2"	36"	Pecan	
223425	ELG3322SD0	33" x 22"	Pre-scored up to 5	9-1/2"	3-1/2"	36"	Sand	
108353	ELG3322WH0	33" x 22"	Pre-scored up to 5	9-1/2"	3-1/2"	36"	White	

**E-Granite™ Quartz Classic Self-Rimming Double Bowl Sink with Aqua Divide**

- Molded from E-Granite which is up to 80% natural quartz and acrylic resins
- Non-porous and stain resistant
- Hard surface is scratch and chip resistant
- Naturally sound deadened and heat resistant
- Aqua divide height: 4"



Part #	Mfg #	Overall Size	Holes	Depth	Drain Opening	Min Sink Base	Color	Price
186758	ELGLBO3322BK0	33" x 22"	Pre-scored up to 3	9-1/2"	3-1/2"	36"	Black	
224537	ELGLBO3322GY0	33" x 22"	Pre-scored up to 3	9-1/2"	3-1/2"	36"	Dusk Gray	
245033	ELGLBO3322PT0	33" x 22"	Pre-scored up to 3	9-1/2"	3-1/2"	36"	Putty	

## Kitchen Composite Sinks

### E-Granite™ Quartz Classic Self-Rimming Double Bowl Sink

- Molded from E-Granite which is up to 80% natural quartz and acrylic resins
- Naturally sound deadened, heat resistant
- Top-mount
- Rim height: 3/8"
- Drains not included



ELG250RBK

Part #	Mfg #	Overall Size	Holes	Depth	Drain Opening	Min Sink Base	Color	Price
108347	ELG250RBK0	33" x 22"	0	9-1/2"	3-1/2"	36"	Black	
108348	ELG250RBQ0	33" x 22"	0	9-1/2"	3-1/2"	36"	Bisque	
237589	ELG250RGS0	33" x 22"	0	9-1/2"	3-1/2"	36"	Greystone	
174057	ELG250RGY0	33" x 22"	0	9-1/2"	3-1/2"	36"	Dusk Gray	
121420	ELG250RMC0	33" x 22"	0	9-1/2"	3-1/2"	36"	Mocha	
247658	ELG250RPC0	33" x 22"	0	9-1/2"	3-1/2"	36"	Pecan	
249439	ELG250RPT0	33" x 22"	0	9-1/2"	3-1/2"	36"	Putty	
244475	ELG250RSD0	33" x 22"	0	9-1/2"	3-1/2"	36"	Sand	
108349	ELG250RWHO	33" x 22"	0	9-1/2"	3-1/2"	36"	White	

### E-Granite™ Quartz Classic Self-Rimming Double Bowl Sink with Aqua Divide

- Molded from E-Granite which is up to 80% natural quartz and acrylic resins
- Non-porous and stain resistant
- Hard surface is scratch and chip resistant
- Naturally sound deadened and heat resistant
- Rim height: 3/8"
- Aqua divide height: 4"
- Drains not included



ELGLB3322BK0



ELG3322RGR

Part #	Mfg #	Overall Size	Holes	Depth	Drain Opening	Min Sink Base	Color	Price
122792	ELGLB3322BK0	33" x 22"	Pre-scored up to 5	9-1/2"	3-1/2"	36"	Black	
122793	ELGLB3322BQ0	33" x 22"	Pre-scored up to 5	9-1/2"	3-1/2"	36"	Bisque	
243401	ELGLB3322GR0	33" x 22"	Pre-scored up to 5	9-1/2"	3-1/2"	36"	Greige	
242286	ELGLB3322GS0	33" x 22"	Pre-scored up to 5	9-1/2"	3-1/2"	36"	Greystone	
160967	ELGLB3322GY0	33" x 22"	Pre-scored up to 5	9-1/2"	3-1/2"	36"	Dusk Gray	
122794	ELGLB3322MC0	33" x 22"	Pre-scored up to 5	9-1/2"	3-1/2"	36"	Mocha	

**Kitchen Composite Sinks**

**Harmony® E-Granite™ Self-Rimming Offset Double Bowl Sink with Aqua Divide**

- Molded from E-Granite which is up to 80% natural quartz and acrylic resins
- Non-porous and stain resistant
- Hard surface is scratch and chip resistant
- Naturally sound deadened and heat resistant
- Rim height: 3/8"
- Aqua divide height: 4"
- Drains not included



Part #	Mfg #	Overall Size	Holes	Depth	Drain Opening	Min Sink Base	Color	Price
189942	ELGH3322RGR0	33" x 22"	Pre-scored up to 4	10"	3-1/2"	36"	Greige	
225993	ELGH3322RGS0	33" x 22"	Pre-scored up to 4	10"	3-1/2"	36"	Graystone	
225621	ELGH3322RGY0	33" x 22"	Pre-scored up to 4	10"	3-1/2"	36"	Dusk Gray	
227033	ELGH3322RMC0	33" x 22"	Pre-scored up to 4	10"	3-1/2"	36"	Mocha	
227711	ELGH3322RSD0	33" x 22"	Pre-scored up to 4	10"	3-1/2"	36"	Sand	
237193	ELGH3322RBK0	33" x 22"	Pre-scored up to 4	10"	3-1/2"	36"	Black	

**Quartz Classic E-Granite™ Self-Rimming Single Bowl Kitchen Sink**

- Molded with 80% natural quartz and acrylic resins
- Non-porous and stain resistant
- Naturally sound deadening
- Drains not included



Part #	Mfg #	Overall Size	Holes	Depth	Drain Opening	Min Sink Base	Color	Price
185464	ELG13322BK0	33" x 22"	Pre-Scored up to 7	9-1/2"	3-1/2"	36"	Black	
189321	ELG13322GY0	33" x 22"	Pre-Scored up to 7	9-1/2"	3-1/2"	36"	Dusk Grey	
246578	ELG13322GS0	33" x 22"	Pre-Scored to 7	9-1/2"	3-1/2"	36"	Greystone	
252883	ELG13322PT0	33" x 22"	Pre-Scored to 7	9-1/2"	3-1/2"	36"	Putty	
189317	ELG13322WH0	33" x 22"	Pre-Scored up to 7	9-1/2"	3-1/2"	36"	White	
241096	ELGR13322BK0	33" x 20-7/8"	Pre-Scored up to 5	9-7/16"	3-1/2"	36"	Black	
239076	ELGR13322GS0	33" x 20-7/8"	Pre-Scored up to 5	9-7/16"	3-1/2"	36"	Putty	
223146	ELGR13322PT0	33" x 20-7/8"	Pre-Scored up to 5	9-7/16"	3-1/2"	36"	Putty	

**Quartz Luxe Self-Rimming Single Bowl Bar Sink**

- Molded from 80% natural quartz and acrylic resins
- Naturally sound deadening
- Rear center drain placement
- Drains not included



Part #	Mfg #	Overall Size	Bowl Sizes	Depth	Drain Opening	Min Sink Base	Color	Price
252393	ELX2522CA0	25" x 22"	Pre-Scored up to 5	9-1/2"	3-1/2"	30"	Caviar	
248851	ELX2522CH0	25" x 22"	Pre-Scored up to 5	9-1/2"	3-1/2"	30"	Charcoal	
252360	ELX3322CN0	25" x 22"	Pre-Scored up to 5	9-1/2"	3-1/2"	30"	Chestnut	

**Kitchen Composite Sinks**

**Self-Rimming/Drop-In E-Granite™ Sinks (Continued)**

**Quartz Luxe Self-Rimming Single Bowl Bar Sink**

Part #	Mfg #	Overall Size	Bowl Sizes	Depth	Drain Opening	Min Sink Base	Color	Price
240393	ELX2522PA0	25" x 22"	Pre-Scored up to 5	9-1/2"	3-1/2"	30"	Parchment	

**Quartz Luxe Self-Rimming Equal Double Bowl Kitchen Sink**

- Molded from 80% natural quartz and acrylic resins
- Naturally sound deadening
- Rear center drain placement
- Drains not included



Part #	Mfg #	Overall Size	Bowl Sizes	Depth	Drain Opening	Min Sink Base	Color	Price
250351	ELX3322CH0	33" x 22"	Pre-Scored up to 5	9-1/2"	3-1/2"	36"	Charcoal	

**Quartz Luxe Self-Rimming Offset Double Bowl Kitchen Sink**

- Molded from 80% natural quartz and acrylic resins
- Naturally sound deadening
- Rear center drain placement
- Drains not included



Part #	Mfg #	Overall Size	Bowl Sizes	Depth	Drain Opening	Min Sink Base	Color	Price
241257	ELX250RCN0	33" x 22"	Pre-Scored up to 4	9-1/2"	30"	Chestnut		

**Quartz Luxe Self-Rimming 60/40 Double Bowl Kitchen Sink with Aqua Divide**

- Molded from 80% natural quartz and acrylic resins
- Naturally sound deadening
- Rear center drain placement
- Drains not included



Part #	Mfg #	Overall Size	Bowl Sizes	Depth	Drain Opening	Min Sink Base	Color	Price
242466	ELXH3322RCN0	33" x 22"	Pre-Scored up to 4	10"	36"	Chestnut		
246630	ELXH3322RMA0	33" x 22"	Pre-Scored up to 4	10"	36"	Maraschino		
252800	ELXH3322RPA0	33" x 22"	Pre-Scored up to 4	10"	36"	Parchment		
247456	ELXH3322RRT0	33" x 22"	Pre-Scored up to 4	10"	36"	Ricotta		

**Kitchen Composite Sinks**

**Quartz Classic Self-Rimming Single Bowl Sink**

- Molded from up to 80% natural quartz and acrylic resins
- Naturally sound deadened, heat resistant
- 3/8" Rim height
- Drains not included



Part #	Mfg #	Overall Size	Bowl Sizes	Depth	Drain Opening	Min Sink Base	Color	Price
242495	ELGS3322RGS0	33" x 22"	Pre-scored up to 5	9-1/2"	3-1/2"	36"	Greystone	
122788	ELGS3322RMC0	33" x 22"	Pre-scored up to 5	9-1/2"	3-1/2"	36"	Mocha	
227343	ELGS3322RPC0	33" x 22"	Pre-scored up to 5	9-1/2"	3-1/2"	36"	Pecan	
127639	ELGS3322RWH0	33" x 22"	Pre-scored up to 5	9-1/2"	3-1/2"	36"	White	

**Under-Mount E-Granite™ Sinks**

**Fireclay Single Bowl Farmhouse Kitchen Sink**

- Molded from fireclay with porcelain glaze
- Reversible design
- Naturally sound deadening
- Center drain placement



Part #	Mfg #	Overall Size Color	Holes	Depth	Drain Opening	Min Sink Base	Price
241596	SWUF2520WH	24-3/8" x 19-5/8"	N/A	10-1/8"	27"	White	

**Quartz Classic Dual-Mount Single Bowl Bar Sink**

- Molded from 80% natural quartz and acrylic resins
- Naturally sound deadening
- Rear center drain placement
- Drains not included



Part #	Mfg #	Overall Size	Bowl Sizes	Depth	Drain Opening	Min Sink Base	Color	Price
173611	ELG16FBBK0	18-1/8" x 18-1/8"	N/A	7-1/2"	3-1/2"	21"	Black	
238765	ELG16FBGS0	18-1/8" x 18-1/8"	N/A	7-1/2"	3-1/2"	21"	Greystone	
242124	ELG16FBGY0	18-1/8" x 18-1/8"	N/A	7-1/2"	3-1/2"	21"	Dusk Grey	
217735	ELG16FBMC0	18-1/8" x 18-1/8"	N/A	7-1/2"	3-1/2"	21"	Mocha	



## Kitchen Composite Sinks

### Quartz Luxe Dual-Mount Single Bowl Bar Sink

- Molded from 80% natural quartz and acrylic resins
- Top mount or undermount installation
- Naturally sound deadening
- Rear center drain placement
- Drains not included



Part #	Mfg #	Overall Size	Bowl Sizes	Depth	Drain Opening	Min Sink Base	Color	Price
237315	ELX1616CH0	15-3/4" x 15-3/4"	N/A	7-11/16"	3-1/2"	21"	Charcoal	
240559	ELX1616MA0	15-3/4" x 15-3/4"	N/A	7-11/16"	3-1/2"	21"	Maraschino	
237314	ELX1616RT0	15-3/4" x 15-3/4"	N/A	7-11/16"	3-1/2"	21"	Ricotta	

### Quartz Classic Undermount Single Bowl Kitchen Sink

- Molded from up to 80% natural quartz and acrylic resins
- Naturally sound deadened, heat resistant
- Rear center drain location
- Drains not included



Part #	Mfg #	Overall Size	Bowl Sizes	Depth	Drain Opening	Min Sink Base	Color	Price
227496	ELGSU2522BK0	25" x 22"	N/A	8-1/2"	3-1/2"	30"	Black	
243857	ELGSU2522GR0	25" x 22"	N/A	8-1/2"	3-1/2"	30"	Greige	
250844	ELGSU2522PT0	25" x 22"	N/A	8-1/2"	3-1/2"	30"	Putty	
229486	ELGSU2522WH0	25" x 22"	N/A	8-1/2"	3-1/2"	30"	White	

### Quartz Luxe Undermount Single Bowl Kitchen Sink

- Molded from up to 80% natural quartz and acrylic resins
- Naturally sound deadened, heat resistant
- Rear center drain location
- Drains not included



Part #	Mfg #	Overall Size	Bowl Sizes	Depth	Drain Opening	Min Sink Base	Color	Price
240004	ELXSU2522CH0	25" x 22"	N/A	8-1/2"	3-1/2"	30"	Charcoal	

**Kitchen Composite Sinks**

**Quartz Luxe Undermount Single Bowl Apron-Front Sink**

- Farmhouse installation
- Organic fibers offer extra impact resistance
- Non-porous and stain resistant
- Hard surface is scratch and chip resistant
- Naturally sound deadened and heat resistant
- LKPDQ1CR Perfect Drain included



Part #	Mfg #	Overall Size	Holes	Depth	Drain Opening	Min Sink Base	Color	Price
237874	ELXUFP3620CA0	35-7/8" x 20-15/16"	N/A	9"	3-5/8"	36"	Caviar	
246618	ELXUFP3620CN0	35-7/8" x 20-15/16"	N/A	9"	3-5/8"	36"	Chestnut	
237312	ELXUFP3620RT0	35-7/8" x 20-15/16"	N/A	9"	3-5/8"	36"	Ricotta	

**Quartz Luxe Undermount Single Bowl Sink**

- Molded from E-Granite which is up to 80% natural quartz and high performance acrylic resins
- Organic fibers offer extra impact resistance
- Non-porous and stain resistant
- Hard surface is scratch and chip resistant
- Naturally sound deadened and heat resistant
- Drain not included



Part #	Mfg #	Overall Size	Holes	Depth	Drain Opening	Min Sink Base	Color	Price
244836	ELXU2522PA0	24-5/8" x 18-1/2"	N/A	9-1/2"	3-1/2"	30"	Parchment	

**Quartz Undermount Double Bowl Sink**

- Molded from E-Granite which is up to 80% natural quartz and high performance acrylic resins
- Non-porous and stain resistant
- Hard surface is scratch and chip resistant
- Naturally sound deadened and heat resistant
- Drains not included



**Quartz Classic**

Part #	Mfg #	Overall Size	Holes	Depth	Drain Opening	Min Sink Base	Color	Price
108360	ELGU250RBK0	33" x 20-1/2"	N/A	9-1/2"	3-1/2"	36"	Black	
108361	ELGU250RBQ0	33" x 20-1/2"	N/A	9-1/2"	3-1/2"	36"	Bisque	
247902	ELGU250RGR0	33" x 20-1/2"	N/A	9-1/2"	3-1/2"	36"	Greige	
223144	ELGU250RGS0	33" x 20-1/2"	N/A	9-1/2"	3-1/2"	36"	Greystone	
147723	ELGU250RGY0	33" x 20-1/2"	N/A	9-1/2"	3-1/2"	36"	Dusk Gray	
120802	ELGU250RMC0	33" x 20-1/2"	N/A	9-1/2"	3-1/2"	36"	Mocha	
225118	ELGU250RPT0	33" x 20-1/2"	N/A	9-1/2"	3-1/2"	36"	Putty	
108362	ELGU250RWH0	33" x 20-1/2"	N/A	9-1/2"	3-1/2"	36"	White	

## Kitchen Composite Sinks

### Quartz Luxe

Part #	Mfg #	Overall Size	Holes	Depth	Drain Opening	Min Sink Base	Color	Price
252639	ELXU250RCA0	33" x 20-1/2"	N/A	9-1/2"	3-1/2"	36"	Caviar	
241605	ELXU250RCH0	33" x 20-1/2"	N/A	9-1/2"	3-1/2"	36"	Charcoal	
249767	ELXU250RCN0	33" x 20-1/2"	N/A	9-1/2"	3-1/2"	36"	Chestnut	

### Gourmet® E-Granite™ Undermount Double Bowl Sink with Aqua Divide

- Molded from E-Granite™ which is up to 80% natural quartz and high performance acrylic resins
- Non-porous and stain resistant
- Hard surface is scratch and chip resistant
- Naturally sound deadened and heat resistant
- Drains not included



Part #	Mfg #	Overall Size	Holes	Depth	Drain Opening	Min Sink Base	Color	Price
181204	ELGULBO3322BK0	33" x 20-1/2"	N/A	9-1/2"	3-1/2"	36"	Black	
184850	ELGULBO3322BQ0	33" x 20-1/2"	N/A	9-1/2"	3-1/2"	36"	Bisque	
185402	ELGULBO3322GY0	33" x 20-1/2"	N/A	9-1/2"	3-1/2"	36"	Dusk Gray	
180485	ELGULBO3322MC0	33" x 20-1/2"	N/A	9-1/2"	3-1/2"	36"	Mocha	
223537	ELGULBO3322WH0	33" x 20-1/2"	N/A	9-1/2"	3-1/2"	36"	White	

### Quartz Classic E-Granite™ Undermount Offset Double Bowl Sink

- Molded from E-Granite™—up to 80% natural quartz and high performance acrylic resins
- Non-porous and stain resistant
- hard surface is scratch resistant
- Naturally sound deadening
- Drains not included



Part #	Mfg #	Overall Size	Holes	Depth	Drain Opening	Min Sink Base	Color	Price
225040	ELGOU3321LBK0	33" x 20-11/16"	N/A	9"	3-1/2"	36"	Black	
240811	ELGOU3321LBQ0	33" x 20-11/16"	N/A	9"	3-1/2"	36"	Bisque	
226150	ELGOU3321LGR0	33" x 20-11/16"	N/A	9"	3-1/2"	36"	Greige	
223948	ELGOU3321LGY0	33" x 20-11/16"	N/A	9"	3-1/2"	36"	Dusk Gray	
225645	ELGOU3321LMC0	33" x 20-11/16"	N/A	9"	3-1/2"	36"	Mocha	
239363	ELGOU3321LPT0	33" x 20-11/16"	N/A	9"	3-1/2"	36"	Putty	
244861	ELGOU3321LSD0	33" x 20-11/16"	N/A	9"	3-1/2"	36"	Sand	

**Kitchen Composite Sinks**

**Gourmet® E-Granite™ Undermount Double Equal Bowl Sink**

- Molded from E-Granite which is up to 80% natural quartz and high performance acrylic resins
- Non-porous and stain resistant
- Hard surface is scratch and chip resistant
- Naturally sound deadened and heat resistant
- Drains not included



ELGU3322BK

Part #	Mfg #	Overall Size Color	Bowl Sizes	Depth	Drain Opening	Min Sink Base	Price
108363	ELGU3322BK0	33" x 18-3/4"	N/A	9-1/2"	3-1/2"	36"	Black
108364	ELGU3322BQ0	33" x 18-3/4"	N/A	9-1/2"	3-1/2"	36"	Bisque
189887	ELGU3322GR0	33" x 18-3/4"	N/A	9-1/2"	3-1/2"	36"	Greige
223143	ELGU3322GS0	33" x 18-3/4"	N/A	9-1/2"	3-1/2"	36"	Greystone
146193	ELGU3322GY0	33" x 18-3/4"	N/A	9-1/2"	3-1/2"	36"	Dusk Gray
121425	ELGU3322MC0	33" x 18-3/4"	N/A	9-1/2"	3-1/2"	36"	Mocha
251011	ELGU3322PC0	33" x 18-3/4"	N/A	9-1/2"	3-1/2"	36"	Pecan
223456	ELGU3322SD0	33" x 18-3/4"	N/A	9-1/2"	3-1/2"	36"	Sand

**Gourmet® E-Granite™ Luxe Undermount Double Equal Bowl Sink**

- Proprietary manufacturing process —Combines natural quartz with high performance UV resins
- Patented webbing and embedded organic fibers
- Non-porous and stain resistant
- Hard surface is scratch and chip resistant
- Naturally sound deadened and heat resistant
- Drains not included



Part #	Mfg #	Overall Size Color	Bowl Sizes	Depth	Drain Opening	Min Sink Base	Price
227644	ELXU3322CN0	33" x 18-3/4"	N/A	9-1/2"	3-1/2"	36"	Chestnut

**Gourmet® E-Granite™ Luxe Undermount Offset Double Bowl Sink**

- Proprietary manufacturing process —Combines natural quartz with high performance UV resins
- Patented webbing and embedded organic fibers
- Non-porous and stain resistant
- Hard surface is scratch and chip resistant
- Naturally sound deadened and heat resistant
- Drains not included



Part #	Mfg #	Overall Size Color	Bowl Sizes	Depth	Drain Opening	Min Sink Base	Price
237134	ELXU250RPA0	33" x 20-1/2"	N/A	9-1/2"	3-1/2"	36"	

## Kitchen Composite Sinks

### Quartz Classic Undermount 60/40 Offset Double Bowl Sink

- Molded from E-Granite which is up to 80% natural quartz and acrylic resins
- Non-porous and stain resistant
- Hard surface is scratch and chip resistant
- Naturally sound deadened and heat resistant
- Rim height: 3/8"
- Aqua divide height: 4" (ELGHU3322R Models Only)
- Drains not included



Part #	Mfg #	Overall Size	Holes	Depth	Drain Opening	Min Sink Base	Color	Price
223424	ELGHU3220RBQ0	32-1/2" x 20"	N/A	10"	3-1/2"	36"	Bisque	
239481	ELGHU3220RGR0	32-1/2" x 20"	N/A	10"	3-1/2"	36"	Greige	
244647	ELGHU3220RMC0	32-1/2" x 20"	N/A	10"	3-1/2"	36"	Mocha	
226116	ELGHU3220RPT0	32-1/2" x 20"	N/A	10"	3-1/2"	36"	Putty	
237234	ELGHU3220RSD0	32-1/2" x 20"	N/A	10"	3-1/2"	36"	Sand	
237223	ELGHU3220RWH0	32-1/2" x 20"	N/A	10"	3-1/2"	36"	White	
226429	ELGHU3322RGY0	33" x 22"	N/A	10"	3-1/2"	36"	Graystone	
240455	ELGHU3322RBS0	33" x 22"	N/A	10"	3-1/2"	36"	Black Shale	
236656	ELGHU3322RBQ0	33" x 22"	N/A	10"	3-1/2"	36"	Bisque	

### Quartz Classic™ Undermount Offset 60/40 Double Bowl Sink

- Molded from E-Granite which is up to 80% natural quartz and acrylic resins
- Non-porous and stain resistant
- Hard surface is scratch and chip resistant
- Naturally sound deadened and heat resistant
- Aqua divide height: 4"
- Drains not included



Part #	Mfg #	Overall Size	Holes	Depth	Drain Opening	Min Sink Base	Color	Price
237560	ELGHU3322RGR0	33" x 22"	N/A	10"	3-1/2"	36"	Greige	
236979	ELGHU3322RSD0	33" x 22"	N/A	10"	3-1/2"	36"	Sand	

### Quartz Luxe™ Undermount Offset 60/40 Double Bowl Sink with Aqua Divide

- Molded from E-Granite which is up to 80% natural quartz and acrylic resins
- Non-porous and stain resistant
- Hard surface is scratch and chip resistant
- Naturally sound deadened and heat resistant
- Aqua divide height: 4"
- Drains not included



Part #	Mfg #	Overall Size	Holes	Depth	Drain Opening	Min Sink Base	Color	Price
240884	ELXHU3322CN0	33" x 22"	N/A	10"	3-1/2"	36"	Chestnut	
247531	ELXHU3322RCA0	33" x 22"	N/A	10"	3-1/2"	36"	Caviar	

**Kitchen Composite Sinks**

**Under-Mount E-Granite™ Sinks (Continued)**

**Quartz Luxe™ Undermount Offset 60/40 Double Bowl Sink with Aqua Divide**

Part #	Mfg #	Overall Size	Holes	Depth	Drain Opening	Min Sink Base	Color	Price
247821	ELXHU3322RCH0	33" x 22"	N/A	10"	3-1/2"	36"	Charcoal	
248774	ELXHU3322RPA0	33" x 22"	N/A	10"	3-1/2"	36"	Parchment	
242637	ELXHU3322RRT0	33" x 22"	N/A	10"	3-1/2"	36"	Ricotta	

**Harmony® E-Granite™ Undermount Double Bowl Sink with Aqua Divide**

- Molded from E-Granite which is up to 80% natural quartz and acrylic resins
- Non-porous and stain resistant
- Hard surface is scratch and chip resistant
- Naturally sound deadened and heat resistant
- Rim height: 3/8"
- Aqua divide height: 4"
- Drains not included



ELGULB3322BK

Part #	Mfg #	Overall Size	Bowl Sizes	Depth	Drain Opening	Min Sink Base	Color	Price
122795	ELGULB3322BK0	33" x 20"	N/A	9-1/2"	3-1/2"	36"	Black	
122796	ELGULB3322BQ0	33" x 20"	N/A	9-1/2"	3-1/2"	36"	Bisque	
223457	ELGULB3322GR0	33" x 20"	N/A	9-1/2"	3-1/2"	36"	Greige	
223145	ELGULB3322GS0	33" x 20"	N/A	9-1/2"	3-1/2"	36"	Greystone	
154713	ELGULB3322GY0	33" x 20"	N/A	9-1/2"	3-1/2"	36"	Dusk Gray	
122797	ELGULB3322MC0	33" x 20"	N/A	9-1/2"	3-1/2"	36"	Mocha	
131838	ELGULB3322WH0	33" x 20"	N/A	9-1/2"	3-1/2"	36"	White	

**Quartz E-Granite™ Undermount Double Bowl Sink with Aqua Divide and Deep Depth**

- Molded from E-Granite which is up to 80% natural quartz and acrylic resins
- Non-porous and stain resistant
- Hard surface is scratch and chip resistant
- Naturally sound deadened and heat resistant
- Rim height: 3/8"
- Aqua divide height: 5"
- Drains not included



**Quartz Classic**

Part #	Mfg #	Overall Size	Holes	Depth	Drain Opening	Min Sink Base	Color	Price
224441	ELGDULB3322BK0	33" x 19"	N/A	10"	3-1/2"	36"	Black	

**Quartz Luxe**

Part #	Mfg #	Overall Size	Holes	Depth	Drain Opening	Min Sink Base	Color	Price
237094	ELXDULB3322CA0	33" x 19"	N/A	10"	3-1/2"	36"	Caviar	
246676	ELXDULB3322CH0	33" x 19"	N/A	10"	3-1/2"	36"	Charcoal	
238957	ELXDULB3322CN0	33" x 19"	N/A	10"	3-1/2"	36"	Chestnut	



**Kitchen Composite Sinks**

**Under-Mount E-Granite™ Sinks (Continued)**

**Quartz E-Granite™ Undermount Double Bowl Sink with Aqua Divide and Deep Depth  
Quartz Luxe**

Part #	Mfg #	Overall Size	Holes	Depth	Drain Opening	Min Sink Base	Color	Price
247534	ELXDULB3322RT0	33" x 19"	N/A	10"	3-1/2"	36"	Ricotta	

**Quartz Luxe E-Granite™ Undermount Single Bowl Kitchen Sink**

- Molded with 80% natural quartz and acrylic resins
- Non-porous and stain resistant
- Naturally sound deadening
- Drains not included



Part #	Mfg #	Overall Size	Holes	Depth	Drain Opening	Min Sink Base	Color	Price
245203	ELXRU13322CH0	33" x 18-7/16"	N/A	9-7/16"	3-1/2"	36"	Charcoal	
247154	ELXRU13322PA0	33" x 18-7/16"	N/A	9-7/16"	3-1/2"	36"	Parchment	

**Quartz Classic E-Granite™ Undermount Single Bowl Kitchen Sink**

- Molded with 80% natural quartz and acrylic resins
- Non-porous and stain resistant
- Naturally sound deadening
- Drains not included



Part #	Mfg #	Overall Size	Holes	Depth	Drain Opening	Min Sink Base	Color	Price
250406	ELGRU13322BK0	33" x 18-7/16"	N/A	9-7/16"	3-1/2"	36"	Black	
247368	ELGRU13322BS0	33" x 18-7/16"	N/A	9-7/16"	3-1/2"	36"	Black Shale	
225671	ELGRU13322GS0	33" x 18-7/16"	N/A	9-7/16"	3-1/2"	36"	Graystone	
226410	ELGRU13322MC0	33" x 18-7/16"	N/A	9-7/16"	3-1/2"	36"	Mocha	
224612	ELGRU13322WH0	33" x 18-7/16"	N/A	9-7/16"	3-1/2"	36"	White	

**Quartz Classic E-Granite™ Undermount Single Bowl Kitchen Sink with Offset Drain**

- Molded from E-Granite which is up to 80% natural quartz and acrylic resins
- Naturally sound deadened and heat-resistant
- Drains not included



Part #	Mfg #	Overall Size	Holes	Depth	Drain Opening	Min Sink Base	Color	Price
186640	ELGU13322BK0	33" x 18-3/4"	N/A	9-1/2"	3-1/2"	36"	Black	
187879	ELGU13322GY0	33" x 18-3/4"	N/A	9-1/2"	3-1/2"	36"	Dusk Gray	
171950	ELGU13322MCO	33" x 18-3/4"	N/A	9-1/2"	3-1/2"	36"	Mocha	
249593	ELGU13322PT0	33" x 18-3/4"	N/A	9-1/2"	3-1/2"	36"	Putty	

## Kitchen Composite Sinks

### Under-Mount E-Granite™ Sinks (Continued)

#### Quartz Classic E-Granite™ Undermount Single Bowl Kitchen Sink with Offset Drain

Part #	Mfg #	Overall Size	Holes	Depth	Drain Opening	Min Sink Base	Color	Price
222801	ELGU13322WH0	33" x 18-3/4"	N/A	9-1/2"	3-1/2"	36"	White	
237418	ELGU13322GS0	33" x 18-3/4"	N/A	9-1/2"	3-1/2"	36"	Greystone	

#### Harmony® E-Granite™ Undermount Single Bowl Sink

- Molded from E-Granite which is up to 80% natural quartz and acrylic resins
- Naturally sound deadened, heat resistant
- 3/8" Rim height
- Drains not included



Part #	Mfg #	Overall Size	Bowl Size	Depth	Drain Opening	Min Sink Base	Color	Price
122789	ELGUS3322RBK0	33" x 20"	N/A	9-1/2"	3-1/2"	36"	Black	
252656	ELGUS3322RGS0	33" x 20"	N/A	9-1/2"	3-1/2"	36"	Greystone	
153305	ELGUS3322RGY0	33" x 20"	N/A	9-1/2"	3-1/2"	36"	Dusk Gray	
122791	ELGUS3322RMC0	33" x 20"	N/A	9-1/2"	3-1/2"	36"	Mocha	

#### Quartz Classic E-Granite™ Undermount Single Bowl Sink

- Molded from E-Granite which is up to 80% natural quartz and acrylic resins
- Naturally sound deadened and heat-resistant
- Drains not included unless stated in model number
- (-PD) Perfect drain and strainer included (LKPDPQ1CR)



Part #	Mfg #	Overall Size	Holes	Depth	Drain Opening	Min Sink Base	Color	Price
245261	ELGUAD2519PDM C0	25" x 18-1/2"	N/A	5-1/2"	3-1/2"	36"	Mocha	

#### Quartz Classic E-Granite™ Undermount Single Bowl Sink

- Molded from E-Granite which is up to 80% natural quartz and acrylic resins
- Naturally sound deadened and heat-resistant
- Drains not included



Part #	Mfg #	Overall Size	Holes	Depth	Drain Opening	Min Sink Base	Color	Price
108366	ELGU2522BK0	25" x 18-1/2"	N/A	9-1/2"	3-1/2"	30"	Black	
108367	ELGU2522BQ0	25" x 18-1/2"	N/A	9-1/2"	3-1/2"	30"	Bisque	
189667	ELGU2522GRO	25" x 18-1/2"	N/A	9-1/2"	3-1/2"	30"	Greige	
190084	ELGU2522GS0	25" x 18-1/2"	N/A	9-1/2"	3-1/2"	30"	Graystone	
149820	ELGU2522GY0	25" x 18-1/2"	N/A	9-1/2"	3-1/2"	30"	Dusk Gray	
121423	ELGU2522MC0	25" x 18-1/2"	N/A	9-1/2"	3-1/2"	30"	Mocha	
240336	ELGU2522PT0	25" x 18-1/2"	N/A	9-1/2"	3-1/2"	30"	Putty	

**Kitchen Composite Sinks**

**Under-Mount E-Granite™ Sinks (Continued)**

**Quartz Classic E-Granite™ Undermount Single Bowl Sink**

Part #	Mfg #	Overall Size	Holes	Depth	Drain Opening	Min Sink Base	Color	Price
108368	ELGU2522WH0	25" x 18-1/2"	N/A	9-1/2"	3-1/2"	30"	White	

**Quartz Luxe E-Granite™ Undermount Double Bowl Sink with Aqua Divide**

- Molded from E-Granite which is up to 80% natural quartz and acrylic resins
- Naturally sound deadened and heat-resistant
- Rear center drain placement
- Drains not included



Part #	Mfg #	Overall Size	Holes	Depth	Drain Opening	Min Sink Base	Color	Price
247276	ELXULB3322CA0	33" x 20"	N/A	9-1/2"	3-1/2"	36"	Caviar	
241839	ELXULB3322CH0	33" x 20"	N/A	9-1/2"	3-1/2"	36"	Charcoal	
238735	ELXULB3322CN0	33" x 20"	N/A	9-1/2"	3-1/2"	36"	Chestnut	
238122	ELXULB3322PA0	33" x 20"	N/A	9-1/2"	3-1/2"	36"	Parchment	

## Kitchen Composite Sinks

### Neoroc™ Composite Sinks

#### Cairn™ Neoroc® Under-Mount Single Bowl Bar Sink

- 18" minimum base cabinet
- No faucet holes
- Includes K-5658 bottom basin rack and cutout template
- Matte finish
- Heat resistant up to 750° F
- Scratch, stain, chip, and thermal-shock resistant

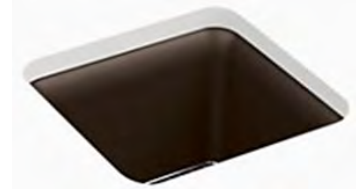

Part #	Mfg #	Overall Dimensions	Basin Depth	Holes	Color	Price
258120	K-8223-CM2	15-1/2" x 15-1/2"	9-1/2"	N/A	Matte Brown	
258122	K-8223-CM3	15-1/2" x 15-1/2"	9-1/2"	N/A	Matte Taupe	
258123	K-8223-CM6	15-1/2" x 15-1/2"	9-1/2"	N/A	Matte White	
258125	K-8223-CM7	15-1/2" x 15-1/2"	9-1/2"	N/A	Matte Graphite	

#### Cairn™ Under-Mount Double Bowl Kitchen Sink

- Versatile design allows large basin to be installed on left or right
- Slim divide creates more space in basins
- No faucet holes
- Includes K-5655 bottom basin rack and cutout template
- Neoroc™
- Matte finish
- Heat resistant up to 750° F
- Scratch, stain, chip, and thermal-shock resistant



**K-8204: Offset bowls**

**K-8199: Double equal bowls**

Part #	Mfg #	Overall Dimensions	Basin Depth	Holes	Color	Price
185391	K-8199-CM1	33-1/2" x 18-5/16"	9-1/2"	N/A	Matte Black	
185435	K-8199-CM2	33-1/2" x 18-5/16"	9-1/2"	N/A	Matte Brown	
256616	K-8199-CM3	33-1/2" x 18-5/16"	9-1/2"	N/A	Matte Taupe	
252067	K-8199-CM4	33-1/2" x 18-5/16"	9-1/2"	N/A	Matte Grey	
258129	K-8199-CM6	33-1/2" x 18-5/16"	9-1/2"	N/A	Matte White	
258130	K-8199-CM7	33-1/2" x 18-5/16"	9-1/2"	N/A	Matte Graphite	
178508	K-8204-CM1	33-1/2" x 18-1/4"	10"	N/A	Matte Black	
188253	K-8204-CM2	33-1/2" x 18-1/4"	10"	N/A	Matte Brown	
254205	K-8204-CM3	33-1/2" x 18-1/4"	10"	N/A	Matte Taupe	
258126	K-8204-CM4	33-1/2" x 18-1/4"	10"	N/A	Matte Grey	
258127	K-8204-CM6	33-1/2" x 18-1/4"	10"	N/A	Matte White	
258128	K-8204-CM7	33-1/2" x 18-1/4"	10"	N/A	Matte Graphite	

## Kitchen Composite Sinks

### Cairn™ Under-Mount Single Bowl Kitchen Sink

- 36" Minimum base cabinet
- No faucet holes
- Neoroc™
- Includes K-5196 bottom basin rack and cutout template
- Matte finish
- Heat resistant up to 750° F
- Scratch, stain, chip, and thermal-shock resistant



Part #	Mfg #	Overall Dimensions	Basin Depth	Holes	Color	Price
188254	K-8206-CM1	33-1/2" x 18-5/16"	10"	N/A	Matte Black	
188255	K-8206-CM2	33-1/2" x 18-5/16"	10"	N/A	Matte Brown	
258131	K-8206-CM3	33-1/2" x 18-5/16"	10"	N/A	Matte Taupe	
258132	K-8206-CM4	33-1/2" x 18-5/16"	10"	N/A	Matte Grey	
258133	K-8206-CM6	33-1/2" x 18-5/16"	10"	N/A	Matte White	
258084	K-8206-CM7	33-1/2" x 18-5/16"	10"	N/A	Matte Graphite	

### Cairn™ Neoroc® Under-Mount Single Bowl Kitchen Sink

- 27" Minimum base cabinet
- No faucet holes
- Includes K-80037 bottom basin rack
- Cutout templates and installation clips included
- Heat resistant up to 750° F
- Scratch, stain, chip, and thermal-shock resistant



Part #	Mfg #	Overall Dimensions	Basin Depth	Holes	Color	Price
252784	K-28001-CM1	24-1/2" x 18-5/16"	9-1/2"	N/A	Matte Black	

### Kennon® Neoroc® Dual-Mount Single Bowl Kitchen Sink

- 36" Minimum base cabinet
- Includes 1 faucet hole on rear deck
- Includes K-6109 bottom basin rack and cutout template
- Matte finish
- Heat resistant up to 750° F
- Scratch, stain, chip, and thermal-shock resistant



Part #	Mfg #	Overall Dimensions	Basin Depth	Holes	Color	Price
236777	K-8437-1-CM1	33" x 22"	9-1/2"	1	Matte Black	

---



---

## Kitchen Composite Sinks

---



---

### Kennon® Neoroc® Dual-Mount Double Bowl Kitchen Sink

- 36" Minimum base cabinet
- Top-mount or Under-mount installation
- Includes 1 faucet hole on rear deck
- Includes K-5662 bottom basin rack and cutout template
- Matte finish
- Heat resistant up to 750° F
- Scratch, stain, chip, and thermal-shock resistant



Part #	Mfg #	Overall Dimensions	Basin Depth	Holes	Color	Price
258334	K-8185-1-CM7	33" x 22"	9"	1	Matte Graphite	



## Kitchen Composite Sinks

### Drop-In or Dual-Mount Kitchen Sinks

#### QZAD Dual-Mount Large Single Ascend Bowl Granite Kitchen Sink

- Innovative raised platform with decorative channels is ideal for food prep, dishwashing and cleanup
- All the space of a larger single basin plus a smaller bowl for fast filling
- Made with 80% quartz stone-only a diamond is harder
- Virtually indestructible
- Offers design flexibility - installs as a drop-in or undermount
- 10" Deep bowl



Part #	Mfg #	Dimensions	Bowl	Mounting	Color	Price
103258	QZAD-3322-077	33" x 22"	Ascend	Drop-In/Undermount	Nero	

#### QZED Drop-In Double Bowl Granite Kitchen Sink

- Even, symmetrical double bowls
- Virtually indestructible
- Made with 80% actual quartz stone
- 9" Deep bowls



Part #	Mfg #	Width	Depth	Height	Color	Price
205860	QZED-3322-077	33" x 22"	Double	Drop-In	Nero	

#### QZDB Dual-Mount Double Bowl Granite Kitchen Sink

- Made with 80% quartz stone-only a diamond is harder
- Virtually indestructible
- Offers design flexibility - installs as a drop-in or undermount
- 9" Deep bowl



Part #	Mfg #	Dimensions	Bowl	Mounting	Color	Price
087023	QZDB-3322-077	33" x 22"	Double	Drop-In/Undermount	Nero	

#### QZLB Dual-Mount Double Bowl Granite Kitchen Sink

- Low divider allows large pans to fit into sink
- Made with 80% quartz stone-only a diamond is harder
- Virtually indestructible
- Offers design flexibility - installs as a drop-in or undermount
- 10" Deep large bowl, 6" deep small bowl



Part #	Mfg #	Dimensions	Bowl	Mounting	Color	Price
102675	QZLS-3322-077	33" x 22"	Double (Lrg/Sml)	Drop-In/Undermount	Nero	

## Kitchen Composite Sinks

### QZSB Dual-Mount Single Bowl Granite Kitchen Sink

- Offset drain
- Made with 80% quartz stone-only a diamond is harder
- Installs as drop-in or under-mount
- 9" Deep bowl



Part #	Mfg #	Width	Depth	Height	Color	Price
210964	QZSB-3322-170	33" x 22"x9"	Single	Drop-In/Undermount	Espresso	

### QZSB Dual-Mount Single Bowl Granite Kitchen Sink

- Low divider allows large pans to fit into sink
- Made with 80% quartz stone-only a diamond is harder
- Virtually indestructible
- Offers design flexibility - installs as a drop-in or undermount
- 10" Deep large bowl, 6" deep small bowl



Part #	Mfg #	Dimensions	Bowl	Mounting	Color	Price
090628	QZSB-2522-077	25" x 22"	Single	Drop-In/Undermount	Nero	

### QZBS Single Bowl Drop-In Bar Sink

- Contemporary design applied to classic sink features
- Virtually indestructible - will not damage from kitchen use
- Made with 80% actual quartz stone - only a diamond is harder
- 7.5" Deep bowls



Part #	Mfg #	Size	Bowl	Mounting	Color	Price
130611	QZBS-1816-077	18" x 16"	Single	Drop-In/Undermount	Nero	

## Under-Mount Kitchen Sinks

### QUAD Under-Mount Double Bowl Granite Kitchen Sink

- Contemporary design applied to classic sink features
- Virtually indestructible - will not damage from kitchen use
- Made with 80% actual quartz stone - only a diamond is harder
- 9" Deep bowls



Part #	Mfg #	Dimensions	Bowl	Mounting	Color	Price
105400	QUAD-3322-077	32" x 21"	Ascend	Undermount	Nero	
137109	QUAD-3322-170	32" x 21"	Ascend	Undermount	Espresso	

## Kitchen Composite Sinks

### QUDB Under-Mount Double Bowl Granite Kitchen Sink

- Contemporary design applied to classic sink features
- Virtually indestructible - will not damage from kitchen use
- Made with 80% actual quartz stone - only a diamond is harder
- 9" Deep bowls



Part #	Mfg #	Dimensions	Bowl	Mounting	Color	Price
099359	QUDB-3322-077	33" x 22"	Double	Undermount	Nero	
109792	QUDB-3322-076	33" x 22"	Double	Undermount	Granito	
131767	QUDB-3322-170	33" x 22"	Double	Undermount	Espresso	

### QULS Under-Mount Large/Small Bowl Granite Kitchen Sink

- Contemporary design applied to classic sink features
- Virtually indestructible - will not damage from kitchen use
- Made with 80% actual quartz stone - only a diamond is harder
- 10" Deep large bowl, 7" deep small bowl



Part #	Mfg #	Dimensions	Bowl	Mounting	Color	Price
102941	QULS-3322-077	33" x 22"	Double (Lrg/Sml)	Undermount	Nero	
131766	QULS-3322-170	33" x 22"	Double (Lrg/Sml)	Undermount	Espresso	

### KSDB-3322 Solid Surface Double Bowl Kitchen Sink

- Easily accommodates all faucet styles
- Renewable surface will not wear away
- Hot pots and boiling water will not harm it



Part #	Mfg #	Dimensions	Color	Price
031736	KSDB-3322-015	33" x 22" x 9"	Black Galaxy	
032764	KSDB-3322-051	33" x 22" x 9"	Tahiti Sand	
038003	KSDB-3322-011	33" x 22" x 9"	Tahiti White	
032623	KSDB-3322-059	33" x 22" x 9"	Tahiti Ivory	
010235	KSDB-3322-010	33" x 22" x 9"	White	

**Kitchen Composite Sinks**

**Top-Mount Single Bowl Kitchen Sinks**

**Diamond™ SILGRANIT® II Super Single Bowl Top-Mount Kitchen Sink**

- Versatile dual deck design can be installed as a drop-in or undermount
- Pre-drilled with 1 hole, 6 additional knockout hole locations
- Under-mount clips NOT included
- Cutout template included



Part #	Mfg#	Overall Dimensions	Bowl Depth	Cabinet Size	Color	Price
134046	440195	33-1/2" x 22"	9-1/2"	36"	White	
127504	440194	33-1/2" x 22"	9-1/2"	36"	Anthracite	
065937	440193	33-1/2" x 22"	9-1/2"	36"	Metallic Gray	
142021	440192	33-1/2" x 22"	9-1/2"	36"	Cafe Brown	
172001	440196	33-1/2" x 22"	9-1/2"	36"	Biscuit	
141599	441214	33-1/2" x 22"	9-1/2"	36"	Biscotti	
138256	441287	33-1/2" x 22"	9-1/2"	36"	Truffle	
163162	441467	33-1/2" x 22"	9-1/2"	36"	Cinder	

**Diamond™ SILGRANIT®II Single Bowl Top-Mount Sink**

- Versatile dual deck design can be installed as a drop-in or undermount
- Pre-drilled with 1 hole, 1 additional knockout hole location
- Cutout size: 24-1/4" x 21-1/4"
- Under-mount clips NOT included



Part #	Mfg#	Overall Dimensions	Bowl Depth	Cabinet Size	Color	Price
153471	440211	25" x 22"	10"	27"	White	
132113	440210	25" x 22"	10"	27"	Anthracite	
155775	440209	25" x 22"	10"	27"	Metallic Gray	
150501	440208	25" x 22"	10"	27"	Cafe Brown	
155152	440212	25" x 22"	10"	27"	Biscuit	
146876	441215	25" x 22"	10"	27"	Biscotti	
155058	441280	25" x 22"	10"	27"	Truffle	
189703	441463	25" x 22"	10"	27"	Cinder	

**Top-Mount Double Bowl Kitchen Sinks**

**Diamond™ SILGRANIT II® 1-3/4 Double Bowl Top-Mount Kitchen Sink**

- Versatile dual deck design can be installed as a drop-in or undermount
- Pre-drilled with 1 hole, 4 additional knockout hole locations
- Slim bowl divider
- Under-mount clips NOT included



Part #	Mfg#	Overall Dimensions	Bowl Depth	Cabinet Size	Color	Price
139085	440221	33" x 22"	9-1/2"	36"	White	
132112	440220	33" x 22"	9-1/2"	36"	Anthracite	

**Kitchen Composite Sinks**

**Top-Mount Double Bowl Kitchen Sinks (Continued)**

**Diamond™ SILGRANIT II® 1-3/4 Double Bowl Top-Mount Kitchen Sink**

Part #	Mfg#	Overall Dimensions	Bowl Depth	Cabinet Size	Color	Price
150251	440219	33" x 22"	9-1/2"	36"	Metallic Gray	
127173	440218	33" x 22"	9-1/2"	36"	Cafe Brown	
098630	440222	33" x 22"	9-1/2"	36"	Biscuit	
131540	441217	33" x 22"	9-1/2"	36"	Biscotti	
138254	441285	33" x 22"	9-1/2"	36"	Truffle	
158978	441466	33" x 22"	9-1/2"	36"	Cinder	

**Diamond™ SILGRANIT® II 1-3/4 Double Bowl Top-Mount Kitchen Sink**

- Versatile dual deck design can be installed as a drop-in or undermount
- Pre-drilled with 1 hole, 4 additional knockout hole locations
- Slim bowl divider
- Under-mount clips NOT included
- Cutout size 32-1/4" x 21-1/4"

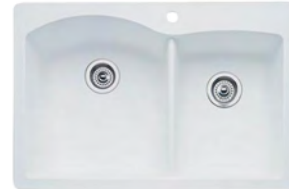

Part #	Mfg#	Overall Dimensions	Bowl Depth	Cabinet Size	Color	Price
138495	440216	33" x 22"	9-1/2" & 8"	36"	White	
062156	440215	33" x 22"	9-1/2" & 8"	36"	Anthraccite	
155995	440214	33" x 22"	9-1/2" & 8"	36"	Metallic Gray	
126560	440213	33" x 22"	9-1/2" & 8"	36"	Cafe Brown	
084557	440217	33" x 22"	9-1/2" & 8"	36"	Biscuit	
131538	441216	33" x 22"	9-1/2" & 8"	36"	Biscotti	
138252	441283	33" x 22"	9-1/2" & 8"	36"	Truffle	
158014	441465	33" x 22"	9-1/2" & 8"	36"	Cinder	

**Diamond™ SILGRANIT® II 1-1/2 Double Bowl Kitchen Sink**

- Versatile dual deck design can be installed as a drop-in or undermount
- Pre-drilled with 1 hole, 4 additional knockout hole locations
- Slim bowl divider
- Under-mount clips NOT included
- Cutout size 32-1/4" x 21-1/4"



Part #	Mfg#	Overall Dimensions	Bowl Depth	Cabinet Size	Color	Price
166164	440200	33" x 22"	9-1/2" & 8"	33"	White	
086308	440199	33" x 22"	9-1/2" & 8"	33"	Anthraccite	
138569	440198	33" x 22"	9-1/2" & 8"	33"	Metallic Gray	
144303	440197	33" x 22"	9-1/2" & 8"	33"	Cafe Brown	
151455	440201	33" x 22"	9-1/2" & 8"	33"	Biscuit	
149507	441221	33" x 22"	9-1/2" & 8"	33"	Biscotti	
158243	441282	33" x 22"	9-1/2" & 8"	33"	Truffle	
157912	441464	33" x 22"	9-1/2" & 8"	33"	Cinder	

**Kitchen Composite Sinks**

**Under-Mount Single Bowl Kitchen Sinks**

**Diamond™ Super Single Bowl Kitchen Sink**

- Cutout template included with 1/8" reveal
- Under-mount clips included



Part #	Mfg#	Overall Dimensions	Bowl Depth	Cabinet Size	Color	Price
176225	441764	33-1/2" x 18-1/2"	9-1/2"	36"	Cinder	
175391	441765	33-1/2" x 18-1/2"	9-1/2"	36"	Truffle	
181170	441767	33-1/2" x 18-1/2"	9-1/2"	36"	White	
180964	441768	33-1/2" x 18-1/2"	9-1/2"	36"	Anthracite	
180709	441769	33-1/2" x 18-1/2"	9-1/2"	36"	Biscuit	
188244	441766	33-1/2" x 18-1/2"	9-1/2"	36"	Biscotti	
180128	441770	33-1/2" x 18-1/2"	9-1/2"	36"	Metallic Gray	
186625	441771	33-1/2" x 18-1/2"	9-1/2"	36"	Cafe Brown	

**Ikon® SILGRANIT® Apron Front Single Bowl Kitchen Sink**

- Requires modified cabinet: 33" or 36"
- Heat resistant up to 536°
- Apron front is 10" high
- Rim width is 1-1/2"
- Undermount clips are not required



Part #	Mfg#	Overall Dimensions	Bowl Depth	Cabinet Size	Color	Price
187764	401733	30" x 19"	9-1/4"	33"	Cafe Brown	
189707	401734	30" x 19"	9-1/4"	33"	White	
189938	401732	30" x 19"	9-1/4"	33"	Anthracite	
244402	401779	30" x 19"	9-1/4"	33"	Cinder	
251260	401781	30" x 19"	9-1/4"	33"	Biscotti	
248020	401985	33 x 19"	9-1/4"	36"	Cinder	
241524	401988	33 x 19"	9-1/4"	36"	Truffle	
236745	401899	33" x 19"	9-1/4"	36"	White	

**Precis™ SILGRANIT® Single Bowl Under-Mount Kitchen Sink**

- Cutout template included with 1/8" reveal
- Under-mount clips included



Part #	Mfg#	Overall Dimensions	Bowl Depth	Cabinet Size	Color	Price
246332	442531	30" x 18"	9-1/2"	3-1/2"	Truffle	
249241	442533	30" x 18"	9-1/2"	3-1/2"	White	
248553	442537	30" x 18"	9-1/2"	3-1/2"	Cafe Brown	



**Kitchen Composite Sinks**

**Precis™ SILGRANIT® II Single Bowl Under-Mount Kitchen Sink**

- Cutout template included with 1/8" reveal
- Under-mount clips included



Part #	Mfg#	Overall Dimensions	Bowl Depth	Cabinet Size	Color	Price
170646	440150	32" x 19"	9-1/2"	3-1/2"	White	
106623	440149	32" x 19"	9-1/2"	3-1/2"	Anthracite	
154624	440148	32" x 19"	9-1/2"	3-1/2"	Metallic Gray	
119162	440147	32" x 19"	9-1/2"	3-1/2"	Cafe Brown	
149659	440151	32" x 19"	9-1/2"	3-1/2"	Biscuit	
138250	441299	32" x 19"	9-1/2"	3-1/2"	Biscotti	
138249	441297	32" x 19"	9-1/2"	3-1/2"	Truffle	
161001	441478	32" x 19"	9-1/2"	3-1/2"	Cinder	
240012	522414	23-1/2" x 17-3/4"	8-5/8"	3-1/2"	White	
250549	522416	23-1/2" x 17-3/4"	8-5/8"	3-1/2"	Biscotti	

**Precis™ SILGRANIT® II Cascade Super Single Bowl Under-Mount Kitchen Sink**

- Cutout template included with 1/8" reveal
- Under-mount clips included
- Integrated second level for drying, depositing, and draining
- Stainless steel mesh colander included



Part #	Mfg#	Overall Dimensions	Bowl Depth	Cabinet Size	Color	Price
159220	519450	28-3/4" x 18"	7-7/8" & 5-1/2"	33"	Anthracite	
246682	519451	28-3/4" x 18"	7-7/8" & 5-1/2"	33"	Cinder	
179361	519452	28-3/4" x 18"	7-7/8" & 5-1/2"	33"	Metallic Grey	
172630	519454	28-3/4" x 18"	7-7/8" & 5-1/2"	33"	Biscuit	
165876	519455	28-3/4" x 18"	7-7/8" & 5-1/2"	33"	Biscotti	
166975	519456	28-3/4" x 18"	7-7/8" & 5-1/2"	33"	Truffle	
174820	519457	28-3/4" x 18"	7-7/8" & 5-1/2"	33"	Cafe Brown	

**Performa® SILGRANIT® II Cascade Under-Mount Kitchen Sink**

- Raised ledge for placement of colander
- Cutout template included with 1/8" reveal
- Under-mount clips included



Part #	Mfg#	Overall Dimensions	Bowl Depth	Cabinet Size	Color	Price
150898	440066	32" x 19-1/2"	10" & 7-3/4"	36"	White	
132054	440064	32" x 19-1/2"	10" & 7-3/4"	36"	Anthracite	
153838	440067	32" x 19-1/2"	10" & 7-3/4"	36"	Metallic Gray	

**Kitchen Composite Sinks**

**Under-Mount Single Bowl Kitchen Sinks (Continued)**

**Performa® SILGRANIT® II Cascade Under-Mount Kitchen Sink**

Part #	Mfg#	Overall Dimensions	Bowl Depth	Cabinet Size	Color	Price
143331	440063	32" x 19-1/2"	10" & 7-3/4"	36"	Cafe Brown	
131215	440065	32" x 19-1/2"	10" & 7-3/4"	36"	Biscuit	
131543	441227	32" x 19-1/2"	10" & 7-3/4"	36"	Biscotti	
138248	441291	32" x 19-1/2"	10" & 7-3/4"	36"	Truffle	

**PROFINA™ Apron Front Single Bowl Kitchen Sink**

- Fireclay
- Required outside cabinet: 39"
- Cutting board included
- Center drain placement
- Features functional accessory ledge
- Apron front depth: 10"
- Sink walls: 3/4"
- Drain not included



Part #	Mfg#	Overall Dimensions	Bowl Depth	Cabinet Size	Color	Price
242690	523026	36" x 19"	9-1/4"	39"	White	

**Valea™ SILGRANIT™ Super Single Bowl Under-Mount Kitchen Sink**

- Template provided with approximate 1/8" reveal
- Under-mount clips included



Part #	Mfg#	Overall Dimensions	Bowl Depth	Cabinet Size	Color	Price
169815	441610	32-1/4" x 19-1/4"	9-1/2"	36"	Anthracite	
178309	441611	32-1/4" x 19-1/4"	9-1/2"	36"	Cinder	
174169	441612	32-1/4" x 19-1/4"	9-1/2"	36"	Biscotti	
181957	441613	32-1/4" x 19-1/4"	9-1/2"	36"	Cafe Brown	
185957	441772	32-1/4" x 19-1/4"	9-1/2"	36"	Truffle	
176735	441774	32-1/4" x 19-1/4"	9-1/2"	36"	Biscuit	
178319	441775	32-1/4" x 19-1/4"	9-1/2"	36"	Metallic Gray	

**Diamond™ SILGRANIT® II Single Bowl Under-Mount Sink**

- Cutout template included with 1/8" reveal
- Under-mount clips included



Part #	Mfg#	Overall Dimensions	Bowl Depth	Cabinet Size	Color	Price
153724	440175	24" x 20-13/16"	10"	27"	White	

**Kitchen Composite Sinks**

**Under-Mount Single Bowl Kitchen Sinks (Continued)**

**Diamond™ SILGRANIT® II Single Bowl Under-Mount Sink**

Part #	Mfg#	Overall Dimensions	Bowl Depth	Cabinet Size	Color	Price
101395	440174	24" x 20-13/16"	10"	27"	Anthracite	
141598	440173	24" x 20-13/16"	10"	27"	Metallic Gray	
127833	440172	24" x 20-13/16"	10"	27"	Cafe Brown	
167483	440176	24" x 20-13/16"	10"	27"	Biscuit	
131926	440220	24" x 20-13/16"	10"	27"	Biscotti	
138255	441281	24" x 20-13/16"	10"	27"	Truffle	
173453	441468	24" x 20-13/16"	10"	27"	Cinder	

**Under-Mount Double Bowl Kitchen Sinks**

**Diamond™ SILGRANIT® II 1-3/4 Bowl Under-Mount Sink With Low Divide**

- Low divide, 1-3/4 bowl
- Cutout template included with 1/8" reveal
- Under-mount clips included



Part #	Mfg#	Overall Dimensions	Bowl Depth	Cabinet Size	Color	Price
164423	441590	32" x 20-7/8"	9-1/2"	36"	Anthracite	
166082	441592	32" x 20-7/8"	9-1/2"	36"	Metallic Gray	
178180	441593	32" x 20-7/8"	9-1/2"	36"	White	
166083	441597	32" x 20-7/8"	9-1/2"	36"	Cafe Brown	
189706	441594	32" x 20-7/8"	9-1/2"	36"	Biscuit	
171118	441595	32" x 20-7/8"	9-1/2"	36"	Biscotti	
170520	441596	32" x 20-7/8"	9-1/2"	36"	Truffle	
169152	441591	32" x 20-7/8"	9-1/2"	36"	Cinder	

**Diamond™ SILGRANIT® II 1-3/4 Reverse Bowl Under-Mount Sink**

- Low divide, 1-3/4 reverse bowl
- Cutout template included with 1/8" reveal
- Under-mount clips included



Part #	Mfg#	Overall Dimensions	Bowl Depth	Cabinet Size	Color	Price
165344	441598	32" x 20-7/8"	9-1/2"	36"	Anthracite	
166084	441601	32" x 20-7/8"	9-1/2"	36"	Metallic Gray	
178394	441603	32" x 20-7/8"	9-1/2"	36"	White	
166085	441609	32" x 20-7/8"	9-1/2"	36"	Cafe Brown	
175892	441606	32" x 20-7/8"	9-1/2"	36"	Biscuit	
168756	441607	32" x 20-7/8"	9-1/2"	36"	Biscotti	
170219	441608	32" x 20-7/8"	9-1/2"	36"	Truffle	
165860	441600	32" x 20-7/8"	9-1/2"	36"	Cinder	

**Kitchen Composite Sinks**

**Diamond™ SILGRANIT® 1-3/4 Bowl Under-Mount Kitchen Sink**

- 1-3/4 Bowl sizes
- Cutout template included with 1/8" reveal
- Under-mount clips included



Part #	Mfg#	Overall Dimensions	Bowl Depth	Cabinet Size	Color	Price
108052	440180	32" x 20-27/32"	9-1/2" & 8"	36"	White	
090325	440179	32" x 20-27/32"	9-1/2" & 8"	36"	Anthracite	
109578	440178	32" x 20-27/32"	9-1/2" & 8"	36"	Metallic Gray	
113643	440177	32" x 20-27/32"	9-1/2" & 8"	36"	Cafe Brown	
129147	440181	32" x 20-27/32"	9-1/2" & 8"	36"	Biscuit	
131537	441222	32" x 20-27/32"	9-1/2" & 8"	36"	Biscotti	
138251	441284	32" x 20-27/32"	9-1/2" & 8"	36"	Truffle	
156802	441469	32" x 20-27/32"	9-1/2" & 8"	36"	Cinder	

**Diamond™ SILGRANIT® Equal Double Bowl Undermount Kitchen Sink**

- Double equal bowls
- Cutout template included with 1/8" reveal
- Under-mount clips included



Part #	Mfg#	Overall Dimensions	Bowl Depth	Cabinet Size	Color	Price
105692	440185	32" x 19-1/4"	9-1/2"	36"	White	
099090	440184	32" x 19-1/4"	9-1/2"	36"	Anthracite	
098765	440183	32" x 19-1/4"	9-1/2"	36"	Metallic Gray	
116705	440182	32" x 19-1/4"	9-1/2"	36"	Cafe Brown	
100782	440186	32" x 19-1/4"	9-1/2"	36"	Biscuit	
131539	441223	32" x 19-1/4"	9-1/2"	36"	Biscotti	
138253	441286	32" x 19-1/4"	9-1/2"	36"	Truffle	
157700	441470	32" x 19-1/4"	9-1/2"	36"	Cinder	

**Diamond™ SILGRANIT® Equal Double Bowl Undermount Kitchen Sink with Low-Divide**

Part #	Mfg#	Overall Dimensions	Bowl Depth	Cabinet Size	Color	Price
238517	442073	32" x 19-1/4"	9-1/2"	36"	Biscotti	
187796	442074	32" x 19-1/4"	9-1/2"	36"	White	
186738	442075	32" x 19-1/4"	9-1/2"	36"	Anthracite	
188356	442077	32" x 19-1/4"	9-1/2"	36"	Metallic Gray	
189931	442071	32" x 19-1/4"	9-1/2"	36"	Cinder	
226222	442072	32" x 19-1/4"	9-1/2"	36"	Truffle	
237755	442076	32" x 19-1/4"	9-1/2"	36"	Biscuit	

**Kitchen Composite Sinks**

**Precis™ SILGRANIT® II 1-3/4 Double Bowl Under-Mount Kitchen Sink**

- 1-3/4 Double bowl
- Cutout template included with 1/8" reveal
- Under-mount clips included



Part #	Mfg#	Overall Dimensions	Bowl Depth	Cabinet Size	Color	Price
145906	441125	33" x 18"	9-1/2"	36"	White	
130876	441128	33" x 18"	9-1/2"	36"	Anthracite	
148687	441130	33" x 18"	9-1/2"	36"	Metallic Gray	
136169	441129	33" x 18"	9-1/2"	36"	Cafe Brown	
136680	441127	33" x 18"	9-1/2"	36"	Biscuit	
150321	441298	33" x 18"	9-1/2"	36"	Biscotti	
146771	441296	33" x 18"	9-1/2"	36"	Truffle	
165935	441479	33" x 18"	9-1/2"	36"	Cinder	

**Precis™ SILGRANIT® II Equal Double Bowl Under-Mount Kitchen Sink**

- Equal double bowl
- Cutout template included with 1/8" reveal
- Under-mount clips included



Part #	Mfg#	Overall Dimensions	Bowl Depth	Cabinet Size	Color	Price
144370	516320	29-3/4" x 18-1/8"	8"	33"	White	
127059	516322	29-3/4" x 18-1/8"	8"	33"	Anthracite	
133886	516319	29-3/4" x 18-1/8"	8"	33"	Metallic Gray	
133906	516323	29-3/4" x 18-1/8"	8"	33"	Cafe Brown	
130920	516321	29-3/4" x 18-1/8"	8"	33"	Biscuit	
140421	517107	29-3/4" x 18-1/8"	8"	33"	Biscotti	
150673	517678	29-3/4" x 18-1/8"	8"	33"	Truffle	
162502	519050	29-3/4" x 18-1/8"	8"	33"	Cinder	

**Precis™ SILGRANIT® II 1-3/4 Multi-Level Under-Mount Kitchen Sink**

- Drainer board slopes 1/4" right to left
- Cutout template included with 1/8" reveal
- Under-mount clips included



Part #	Mfg#	Overall Dimensions	Bowl Depth	Cabinet Size	Color	Price
158463	440408	48" x 20"	9-1/2"	54"	Anthracite	
132915	440399	48" x 20"	9-1/2"	54"	Cafe Brown	
156602	440411	48" x 20"	9-1/2"	54"	Metallic Gray	

**Kitchen Composite Sinks**

**Under-Mount Double Bowl Kitchen Sinks (Continued)**

**Precis™ SILGRANIT® II 1-3/4 Multi-Level Under-Mount Kitchen Sink**

Part #	Mfg#	Overall Dimensions	Bowl Depth	Cabinet Size	Color	Price
159450	441471	48" x 20"	9-1/2"	54"	Cinder	

**Precis™ SILGRANIT® 1-3/4 Low Divide Under-Mount Kitchen Sink**

- 5-1/2" High low divide
- Cutout template included with 1/8" reveal
- Under-mount clips included



Part #	Mfg#	Overall Dimensions	Bowl Depth	Cabinet Size	Color	Price
248578	442521	33" x 18"	9-1/2"	36"	Cinder	
248549	442527	33" x 18"	9-1/2"	36"	Metallic Gray	

**Performa™ SILGRANIT® II 1-3/4 Double Bowl Under-Mount Kitchen Sink**

- 1-3/4 Double bowl
- Cutout template included with 1/8" reveal
- Under-mount clips included



Part #	Mfg#	Overall Dimensions	Bowl Depth	Cabinet Size	Color	Price
168279	441310	33" x 19"	10"	36"	White	
138243	441312	33" x 19"	10"	36"	Anthracite	
150264	441309	33" x 19"	10"	36"	Metallic Gray	
138246	441313	33" x 19"	10"	36"	Cafe Brown	
138245	441311	33" x 19"	10"	36"	Biscuit	
138242	441314	33" x 19"	10"	36"	Biscotti	
138241	441315	33" x 19"	10"	36"	Truffle	
165756	441474	33" x 19"	10"	36"	Cinder	

**Performa™ SILGRANIT II® Equal Double Bowl Under-Mount Kitchen Sink**

- Equal double bowl
- Cutout template included with 1/8" reveal
- Under-mount clips included



Part #	Mfg#	Overall Dimensions	Bowl Depth	Cabinet Size	Color	Price
161529	440071	33" x 20"	10"	36"	White	
149673	440069	33" x 20"	10"	36"	Anthracite	
149314	440072	33" x 20"	10"	36"	Metallic Gray	



**Kitchen Composite Sinks**

**Under-Mount Double Bowl Kitchen Sinks (Continued)**

**Performa™ SILGRANIT II® Equal Double Bowl Under-Mount Kitchen Sink**

Part #	Mfg#	Overall Dimensions	Bowl Depth	Cabinet Size	Color	Price
119794	440068	33" x 20"	10"	36"	Cafe Brown	
147178	440070	33" x 20"	10"	36"	Biscuit	
131542	441226	33" x 20"	10"	36"	Biscotti	
155140	441290	33" x 20"	10"	36"	Truffle	
164088	441473	33" x 20"	10"	36"	Cinder	

**Valea™ SILGRANIT® Equal Double Bowl Under-Mount Kitchen Sink**

- Equal double bowl
- Low 5-1/2" divide
- Cutout template included with 1/8" reveal
- Under-mount clips included



Part #	Mfg#	Overall Dimensions	Bowl Depth	Cabinet Size	Color	Price
241973	442197	32" x 19"	9-1/2"	36"	Truffle	
248787	442199	32" x 19"	9-1/2"	36"	White	
236610	442202	32" x 19"	9-1/2"	36"	Metallic Gray	
238807	442203	32" x 19"	9-1/2"	36"	Cafe Brown	

## Kitchen Sink Accessories

### Faucet Hole Covers

#### Faucet Solid Hole Cover

- 2" Diameter
- Solid top for covering unused hole in sink

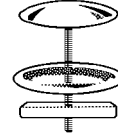

Part #	Mfg #	Finish	Price
059911	103/15S	Satin Nickel	

### Water Dispensers

#### Cold Water Dispenser Faucet

- Solid brass construction
- 4" Spout reach
- 6-1/4" Spout height at outlet
- Spout assembly with integral supply hoses
- 1/4" Turn washerless ceramic disc valve cartridge
- Maximum flow rate: 1.0 gpm



Part #	Mfg #	Holes	Reach	Spout Height	Handles	Finish	Price
092912	106C/26	1	4"	6-1/4"	1	Polished Chrome	

## Sink Accessories

### Sink Hole Covers



Part #	Mfg #	Finish	Price
096290	BTAPS50/BRN	Brushed Nickel	
101081	BTAPS50/BRS	Brushed Stainless	
101082	BTAPS50/PW	Polar White	
129339	BTAPS50/BL	Black	

### Miscellaneous Accessories

#### Extension Screw

- 3-1/2" Length
- For MT300, BWSTU, and BWSTUG



Part #	Mfg #	Size	Price
239524	BRBOLT/90	3-1/2"	

\*PVD Finish

**Sink Accessories**

**Sink Grids**

**Sink Grid for Blanco Ikon™ Single Bowl Sink**

- Durable stainless steel
- Protective feet and bumpers

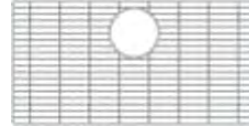

Part #	Mfg #	Description	Overall Size	Price
237046	235011	Blanco Ikon 33" Single Bowl Apron	13-3/4" x 22-7/8"	

**Sink Grid for BlancoDiamond™ Sink**

- Durable stainless steel
- Protective feet and side bumpers

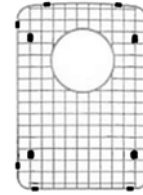

Part #	Mfg #	Description	Overall Size	Price
166290	231342	BlancoDiamond™ 1-3/4 Small Bowl	10-7/8" x 15-3/8"	
110666	220998	BlancoDiamond™ 1-3/4 Large Bowl	14-1/2" x 16-13/16"	
137369	221009	BlancoDiamond™ Double Equal Right Bowl	15-1/4" x 12-3/4"	
137368	221008	BlancoDiamond™ Double Equal Left Bowl	15-1/4" x 12-3/4"	

**Sink Grid for BlancoDiamond™ 1-3/4 Bowl Reverse Low Divide**

- Durable stainless steel
- Protective feet and side bumpers

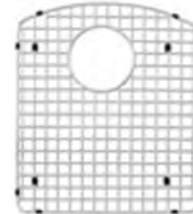

Part #	Mfg #	Description	Overall Size	Price
165345	231343	BlancoDiamond™ 1-3/4 Reverse Large Bowl	14-1/2" x 16-13/16"	

**Sink Grid for BlancoDiamond™ Super Single Bowl**

- Durable stainless steel
- Protective feet and side bumpers

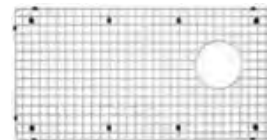

Part #	Mfg #	Description	Overall Size	Price
155590	221010	BlancoDiamond™ Super Single Bowl	28" x 14-1/4"	

**Sink Accessories**

**Sink Grid for BlancoPerforma™ Single Bowl Sink**

- *Stainless steel*
- *Protective bumpers and feet*

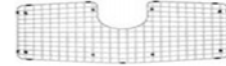

Part #	Mfg #	Description	Overall Size	Price
124192	220586	BlancoPerforma™ 440104	28-3/8" x 15-1/8"	

**Sink Grid for BlancoWave™ Plus**

- *Durable stainless steel*
- *Protective bumpers and feet*

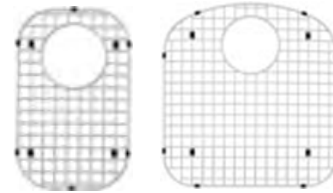

Part #	Mfg #	Description	Overall Size	Price
159253	220995	BlancoWave™ Plus Small Bowl	9" x 14-1/2"	

**Sink Grid for BlancoPerforma™ Equal Double Bowl**

- *Durable stainless steel*
- *Protective bumpers and feet*



Part #	Mfg #	Description	Overall Size	Price
161034	220577	BlancoPerfoma™ Left Bowl	13-3/8" x 15-5/8"	

**Sink Grid for BlancoPerforma™ 1-3/4 Bowl**

- *Durable stainless steel*
- *Protective bumpers and feet*

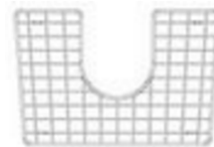

Part #	Mfg #	Description	Overall Size	Price
141355	226830	BlancoPerforma™ Right Bowl	12-15/16" x 12-3/4"	
141354	226828	BlancoPerforma™ Left Bowl	17-1/4" x 15-7/8"	

**Sink Accessories**

**Floating Sink Grid for BlancoSilgranit® Precis™ and Cascade™ Bowls**

- Durable stainless steel
- Protective bumpers and feet
- For BlancoSilgranit® Precis™ 1-3/4" equal double bowls
- For Cascade™ super single, large, 24" and 27" single bowls



Part #	Mfg #	Description	Overall Size	Price
250955	233542	BlancoPrecis Equal Double Bowl & Cascade Single Bowls	9-7/8" x 15-1/8"	

**Sink Grid for BlancoSilgranit® Precis™ 27" Single Bowl**

- Durable stainless steel
- Protective bumpers and feet

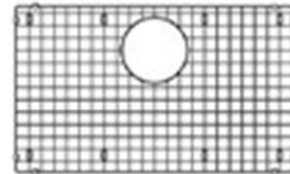

Part #	Mfg #	Description	Overall Size	Price
245850	234059	BlancoPrecis™ Single Bowl	22-11/16" x 13-9/16"	

**Sink Grid for BlancoPrecision™ and Precision16™ 1- 3/4 Bowl**

- Durable stainless steel
- Protective bumpers and feet

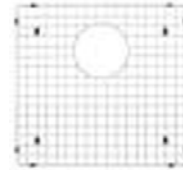

Part #	Mfg #	Description	Overall Size	Price
161021	516363	BlancoPrecis™ Equal Double Bowl	13-3/4" x 11-3/4"	
130878	516366	BlancoPrecis™ 1-3/4 Right Bowl	14-1/2" x 10-3/4"	
165515	223190	BlancoPrecision™ 1-3/4 Left Bowl	16-7/16" x 15-7/16"	
165516	223189	BlancoPrecision™ 1-3/4 Right Bowl	12-7/16" x 15-7/16"	
136269	516271	BlancoPrecision™ 16	19-1/2" x 15-1/2"	
130877	516364	BlancoPrecision™ 16 Left Bowl	14-1/2" x 14-3/4"	

**Sink Grid for BlancoStellar™ 1-3/4 Bowl Sink**

- Durable stainless steel
- Protective bumpers and feet

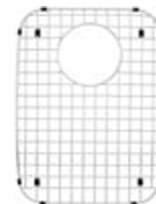

Part #	Mfg #	Description	Overall Size	Price
157857	515300	BlancoStellar™ 1-3/4 Large Bowl	17-1/8" x 13-5/8"	



**Sink Accessories**

**Sink Grids (Continued)**

**Sink Grid for BlancoStellar™ 1-3/4 Bowl Sink**

Part #	Mfg #	Description	Overall Size	Price
157859	515297	BlancoStellar™ 1-3/4 Small Bowl	13-1/2" x 15-1/2"	
240342	515299	BlancoStellar™ Medium Bowl	22-1/2" x 15-1/2"	
138424	515301	BlancoStellar™ Super Single Bowl	24-3/4" x 14-1/2"	

**Multi-Level Sink Grid for Blanco Quatrus™ Super Single Bowl**

- *Stainless steel*
- *15-3/8"L x 10-13/16"W x 4-5/8"H*
- *Protective bumpers and feet*



Part #	Mfg #	Description	Overall Size	Price
237949	231608	BlancoQuatrus™ Super Single Bowl	15-3/8" x 10-13/16" x 4-5/8"	

**Sink Grid for Blanco Quatrus™**

- *Stainless steel*
- *14-3/4"L x 14-9/16"W*
- *Protective bumpers and feet*
- *Fits Quatrus R15 model 519545 & Quatrus R0 518168*

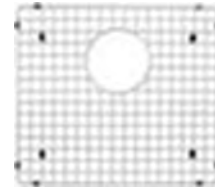

Part #	Mfg #	Description	Overall Size	Price
245102	223200	BlancoQuatrus™ Single Bowl	14-3/4 x 14-9/16"	

**Sink Grid for Blanco Quatrus™ Super Single Bowl & R15 Apron Front**

- *Stainless steel*
- *29-3/8"L x 15-3/8"W*
- *Protective bumpers and feet*

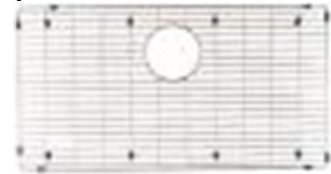

Part #	Mfg #	Description	Overall Size	Price
237948	231599	BlancoQuatrus™ Super Single Bowl	29-3/8" x 15-3/8"	

**Sink Grid for BlancoValea™ Super Single Bowl**

- *Durable stainless steel*
- *Protective bumpers and feet*



Part #	Mfg #	Description	Overall Size	Price
181663	230966	BlancoValea™ Super Single Bowl	27-3/8" x 15"	

**Sink Accessories**

**Cutting Boards**

**Blanco ONE Cutting Board for ONE Single Bowl**

- Ash compound
- 1/8" Reveal
- Durable rubber feet for countertop use



Part #	Mfg #	Description	Overall Size	Price
250761	230432	BlancoONE Medium Single Bowl	17-3/4" x 11-1/2"	

**Cutting Board for BlancoPerforma™ Silgranit II™ Equal Double Bowl Sinks**

- Walnut wood



Part #	Mfg #	Description	Overall Size	Price
161555	222587	BlancoPerforma™ Silgrant II	18-13/16" x 12-13/16"	

**Cutting Board for BlancoDiamond™ Double Bowl**

- Red alder wood
- Durable rubber feet for countertop use



Part #	Mfg #	Description	Overall Size	Price
155241	440229	BlancoDiamond™ Equal Double Bowl	18-1/4" x 12-5/8"	
138793	440227	BlancoDiamond™ 1-1/2 Double Bowl	19-3/4" x 12"	

**Cutting Board for all Blanco Sinks**

- 16" Bowls in depth
- Durable rubber feet for countertop use



Part #	Mfg #	Description	Overall Size	Price
237767	232002	Blanco	17-7/16" x 11-3/8"	

**Sink Accessories**

**Cutting Board for BlancoVale™ Super Single Bowl**



Part #	Mfg #	Description	Overall Size	Price
181664	230972	BlancoVale™ Super Single Bowl	20-3/4" x 11-3/4"	

**Cutting Board for Ikon 30" & 33"**

- Beechwood
- Rubber feet



Part #	Mfg #	Description	Overall Size	Price
236746	235010	Blanco Ikon 30"&33" Apron-Front	15-1/8" x 11"	

**Colanders**

**Stainless Steel Basket**

- Liven and Quatrus R15 laundry sinks



Part #	Mfg #	Description	Overall Size	Price
237182	234771	LIVEN and QUATRUS R15 Laundry Sinks	18-1/4" x 5-3/4"	

**Cleaners**



406214

406203

Part #	Mfg #	Description	Price
063266	406214	15 oz BlancoClean Stainless Steel Sink Cleaner	
118288	406203	15 oz BlancoClean SILGRANIT® II Sink Polish	

---

---

**Sink Accessories**

---

---

**Undermount Clips**

Part #	Mfg #	Material	Qty	Includes	Price
242645	212594	Stainless Steel	Set of 6	Clip, Screw , Insert	

## Kitchen Stainless Steel Sinks

### Stainless Steel Top-Mount Kitchen Sinks

#### Cadence™ Drop-In Double Bowl Kitchen Sink—33" x 22"

- 20 Gauge stainless steel
- SilentShield™ sound absorption technology



Part #	Mfg #	Overall Dimensions	Basin Depth	Holes	Bowls	Price
106227	K-3145-4-NA	33" x 22"	8"	4	Double Equal	

#### Octave® Drop-In Double Bowl Kitchen Sink—33" x 22"

- 18 Gauge stainless steel
- SilentShield™ sound absorption technology
- 36" Minimum base cabinet width
- Included bottom basin rack for left bowl, sponge caddy, and stainless-steel cleaner K-3844



Part #	Mfg #	Overall Dimensions	Basin Depth	Holes	Color	Price
158581	K-3842-1-NA	33" x 22"	9"	1	Double Equal	
168566	K-3842-4-NA	33" x 22"	9"	4	Double Equal	

#### Staccato™ Drop-In Double Bowl Kitchen Sink—33" x 22"

- 18 Gauge stainless steel
- SilentShield™ sound absorption
- Installation hardware included
- Faucet sold separately



Part #	Mfg #	Overall Dimensions	Basin Depth	Holes	Bowls	Price
065248	K-3361-1-NA	33" x 22"	8"	1	Large/Medium	
060281	K-3361-4-NA	33" x 22"	8"	4	Large/Medium	
073003	K-3369-1-NA	33" x 22"	8"	1	Double Equal	
061104	K-3369-3-NA	33" x 22"	8"	3	Double Equal	
061833	K-3369-4-NA	33" x 22"	8"	4	Double Equal	

#### Staccato™ Drop-In Single Bowl Kitchen Sink—25" x 22"

- 18-gauge stainless steel
- SilentShield® sound-absorption
- 27-inch minimum base cabinet width



Part #	Mfg #	Overall Dimensions	Basin Depth	Holes	Color	Price
069339	K-3362-4-NA	25" x 22"	8"	4	Single	

## Kitchen Stainless Steel Sinks

### Toccata™ Drop-In Double Equal Bowl Kitchen Sink—33" x 22"

- 18 Gauge stainless steel
- SilentShield™ sound absorption
- 36" Minimum cabinet base width



Part #	Mfg #	Overall Dimensions	Basin Depth	Holes	Color	Price
071972	K-3346-4-NA	33" x 22"	8"	4	Double Equal	
167656	K-3847-3-NA	33" x 22"	9-1/4"	3	Double Equal	
157135	K-3847-4-NA	33" x 22"	9-1/4"	4	Double Equal	
160916	K-4015-4-NA	33" x 22"	6"	4	Double Equal	

### Toccata™ Drop-In Single Bowl Kitchen Sink

- 19 Gauge stainless steel
- SilentShield™ sound absorption
- 27" Minimum cabinet base width



Part #	Mfg #	Overall Dimensions	Basin Depth	Holes	Color	Price
183567	K-4011-4-NA	25" x 22"	6"	4	Single	

### Toccata™ Drop-In Single Bowl Kitchen Sink

- 7" Depth
- 18 Gauge stainless steel
- SilentShield™ sound absorption
- 27" Minimum cabinet base width



Part #	Mfg #	Overall Dimensions	Basin Depth	Holes	Color	Price
059536	K-3348-3-NA	25" x 22"	7"	3	Single	
058455	K-3348-4-NA	25" x 22"	7"	4	Single	

### Vault™ Drop-In Apron Front Kitchen Sink

- 18 Gauge stainless steel
- SilentShield™ sound absorption
- Single bowl
- Installation hardware included



K-3935



K-3942



K-3944

Part #	Mfg #	Overall Dimensions	Basin Depth	Holes	Color	Price
163971	K-3935-1-NA	29-3/4" x 24-5/16"	9-5/16"	1	Single	
158080	K-3935-3-NA	29-3/4" x 24-5/16"	9-5/16"	3	Single	
170751	K-3935-4-NA	29-3/4" x 24-5/16"	9-5/16"	4	Single	
149052	K-3942-1-NA	35-3/4" x 24-5/16"	9-5/16"	1	Single	
149224	K-3942-3-NA	35-3/4" x 24-5/16"	9-5/16"	3	Single	
166149	K-3972-4-NA	35-3/4" x 24-5/16"	9-5/16"	4	Single	
160966	K-3944-1-NA	35-3/4" x 24-5/16"	9-5/16"	1	Double Equal	
175275	K-3944-3-NA	35-3/4" x 24-5/16"	9-5/16"	3	Double Equal	



## Kitchen Stainless Steel Sinks

### Stainless Steel Top-Mount Kitchen Sinks (Continued)

#### Vault™ Drop-In Apron Front Kitchen Sink

Part #	Mfg #	Overall Dimensions	Basin Depth	Holes	Color	Price
172610	K-3944-4-NA	35-3/4" x 24-5/16"	9-5/16"	4	Double Equal	

#### Verse™ Single-Bowl Drop-In Kitchen Sink — 33" x 22"

- 18 Gauge stainless steel
- SilentShield® sound-absorption technology
- 36" Minimum base cabinet width
- Includes installation hardware



Part #	Mfg #	Overall Dimensions	Basin Depth	Holes	Color	Price
227467	K-20060-1-NA	33" x 22"	9"	1	Single	
228892	K-20060-3-NA	33" x 22"	9"	3	Single	
238054	K-20060-4-NA	33" x 22"	9"	4	Single	

### Stainless Steel Dual-Mount Kitchen Sinks

#### Vault™ Dual-Mount Single Bowl Kitchen Sink

- 18 Gauge stainless steel
- Low profile: 1.25mm rim provides undercounter or flush mount
- SilentShield® sound-absorption technology
- Drains and sink racks not included



Part #	Mfg #	Overall Dimensions	Basin Depth	Holes	Color	Price
131051	K-3821-1-NA	33" x 22"	9"	1	Single	
134617	K-3821-3-NA	33" x 22"	9"	3	Single	
137068	K-3821-4-NA	33" x 22"	9"	4	Single	
183564	K-3894-4-NA	25" x 22"	6"	4	Single	

#### Vault™ Dual-Mount Double Bowl Kitchen Sink—33" x 22"

- 18 Gauge stainless steel
- Low-profile 1.25mm rim provides undercounter or flush mount
- Lowered saddle prevents water from overflowing
- Faucet sold separately



K-3823

K-3820

Part #	Mfg #	Overall Dimensions	Basin Depth	Holes	Color	Price
133964	K-3820-1-NA	33" x 22"	9"	1	Double Equal	
136935	K-3820-3-NA	33" x 22"	9"	3	Double Equal	
131035	K-3820-4-NA	33" x 22"	9"	4	Double Equal	
159070	K-3996-4-NA	33" x 22"	6"	4	Double Equal	
136196	K-3823-1-NA	33" x 22"	9"	1	Large/Medium	
141910	K-3823-3-NA	33" x 22"	9"	3	Large/Medium	
135808	K-3823-4-NA	33" x 22"	9"	4	Large/Medium	

## Kitchen Stainless Steel Sinks

### Vault™ Dual-Mount Double Bowl Kitchen Sink with SmartDivide® — 33" x 22"

- 18 Gauge stainless steel
- 9-inch depth
- Smart Divide® lowered divider
- SilentShield® sound-absorption
- 36-inch minimum base cabinet width
- Installation hardware and left side bottom bowl rack included



Part #	Mfg #	Overall Dimensions	Basin Depth	Holes	Color	Price
145795	K-3838-1-NA	33" x 22"	9"	1	Double Equal	
149391	K-3838-4-NA	33" x 22"	9"	4	Double Equal	
141028	K-3839-1-NA	33" x 22"	9"	1	Double Offset	
156031	K-3839-3-NA	33" x 22"	9"	3	Double Offset	
150438	K-3839-4-NA	33" x 22"	9"	4	Double Offset	

### Verse™ Double-Bowl Drop-In Kitchen Sink — 33" x 22"

- 18 Gauge stainless steel
- 9-inch depth
- SilentShield® sound-absorption
- Includes installation hardware
- 36-inch minimum base cabinet width



Part #	Mfg #	Overall Dimensions	Basin Depth	Holes	Color	Price
171394	K-5267-1-NA	33" x 22"	9"	1	Double Equal	
225967	K-5267-3-NA	33" x 22"	9"	3	Double Equal	
220795	K-5267-4-NA	33" x 22"	9"	4	Double Equal	
229053	K-75791-1-NA	33" x 22"	9"	1	Large/Medium	
254381	K-75791-3-NA	33" x 22"	9"	3	Large/Medium	
238578	K-75791-4-NA	33" x 22"	9"	4	Large/Medium	

## Stainless Steel Under-Mount Kitchen Sinks

### 8 Degree™ Offset Under-Mount Double Bowl Kitchen Sink

- 16 Gauge stainless steel
- Includes wine glass rack, bottom basin rack for each basin and installation hardware
- Racks not included



Part #	Mfg #	Overall Dimensions	Basin Depth	Holes	Bowls	Price
114845	K-3672-NA	31" x 16-1/2"	9-3/4"	Less Holes	Double Equal	

### 8 Degree™ Under-Mount Single Bowl Kitchen Sink

- 36-inch minimum base cabinet width
- 16-gauge stainless steel
- Includes installation hardware
- Includes wine glass rack and sink rack



Part #	Mfg #	Overall Dimensions	Basin Depth	Holes	Bowls	Price
116564	K-3673-NA	33" x 18"	9-3/4"	Less Holes	Single	

## Kitchen Stainless Steel Sinks

### Staccato™ Under-Mount Double Bowl Kitchen Sink

- 31-5/8" x 19-9/16"
- 18 Gauge stainless steel
- SilentShield® sound absorption technology
- Installation hardware included



Part #	Mfg #	Overall Dimensions	Basin Depth	Holes	Bowls	Price
130386	K-3899-NA	31-5/8" x 19-9/16"	8"	Less Holes	Double Equal	

### Octave® Under-Mount Double Bowl Kitchen Sink

- 33" x 20-1/4"
- 18 Gauge stainless steel
- SilentShield® sound absorption technology
- Includes 2 bottom basin racks, sponge caddy, and stainless-steel cleaner



Part #	Mfg #	Overall Dimensions	Basin Depth	Holes	Color	Price
151137	K-3843-NA	32" x 20-1/4"	9"	Less Holes	Double Equal	

### Poise® Under-Mount Single Bowl Kitchen Sink

- Part of K-3158-NA
- 33"L x 18"W
- Basin depth: 9"
- 16-gauge stainless steel
- SilentShield™ sound-absorption
- Please order the K-3158-NA sink which includes the following: sink and sink rack



Part #	Mfg #	Overall Dimensions	Basin Depth	Holes	Color	Price
085216	K-3387-NA	33" x 18"	9"	Less Holes	Single	

### Poise® Under-Mount Double Bowl Kitchen Sink

- 36" Minimum base cabinet width
- 16-Gauge stainless steel
- SilentShield® sound-absorption technology
- Strainer not included



Part #	Mfg #	Overall Dimensions	Basin Depth	Holes	Color	Price
073350	K-3159-NA	33" x 18"	9"	Less Holes	Double	

### Prolific™ Under-Mount Single Bowl Kitchen Sink

- 18 Gauge stainless steel
- SilentShield® sound absorption technology
- (3) Graduated ledges in basin
- Includes: bamboo cutting board, (2) multipurpose grated racks, colander, and wash bin and installation hardware



Part #	Mfg #	Overall Dimensions	Basin Depth	Holes	Color	Price
252781	K-23650-NA	23" x 17-3/4"	10-7/8"	Less Holes	Single	
242794	K-23651-NA	29" x 17-3/4"	10"	Less Holes	Single	

## Kitchen Stainless Steel Sinks

### Stainless Steel Under-Mount Kitchen Sinks (Continued)

#### Prolific™ Under-Mount Single Bowl Kitchen Sink

Part #	Mfg #	Overall Dimensions	Basin Depth	Holes	Color	Price
172615	K-5540-NA	33" x 17-3/4"	11"	Less Holes	Single	

#### Staccato™ Extra-Large/Medium Double Bowl Kitchen Sink — 31-5/8" x 19-9/16"

- 18 Gauge stainless steel
- SilentShield® sound absorption
- 36" Minimum base cabinet width
- Includes installation hardware



Part #	Mfg #	Overall Dimensions	Basin Depth	Holes	Bowls	Price
130385	K-3891-NA	31-5/8" x 19-9/16"	8"	Less Holes	Large/Medium	

#### Stages™ Under-Mount Single Bowl Kitchen Sink — 45" x 18-1/2"

- 16 Gauge stainless steel
- SilentShield® sound-absorption pads
- Single bowl with side platform
- 48" Minimum base cabinet width
- Includes:
  - Versatile flip trap
  - (6) Microwave and dishwasher-safe bowls
  - American walnut hardwood cutting board
  - Stainless steel accessory storage rack
  - Bottom bowl rack



Part #	Mfg #	Overall Dimensions	Basin Depth	Holes	Color	Price
130735	K-3761-NA	45" x 18-1/2"	9-1/2"	Less Holes	Single	

#### Strive™ Under-Mount Double Bowl Kitchen Sink

- 16 Gauge stainless steel
- SilentShield® sound absorption technology
- Includes divider dishcloth bar, divider utility shelf, and bottom basin rack
- 36" Minimum base cabinet width



Part #	Mfg #	Overall Dimensions	Basin Depth	Holes	Color	Price
159664	K-5281-NA	32" x 18-1/4"	9"	Less Holes	Double Equal	
169242	K-5282-NA	35-1/2" x 20-1/4"	9"	Less Holes	Extra-Large/Medium	

#### Strive™ Under-Mount Double Bowl Kitchen Sink with Smart Divide®

- 16 Gauge stainless steel
- SilentShield® sound absorption technology
- Includes sink bridge utility shelf with dishcloth bar and bottom basin rack
- 36" Minimum bas cabinet width



Part #	Mfg #	Overall Dimensions	Basin Depth	Holes	Color	Price
176419	K-5284-NA	32" x 18-5/16"	9"	Less Holes	Double Equal	

## Kitchen Stainless Steel Sinks

### Strive™ Under-Mount Single Bowl Kitchen Sink

- 16 Gauge stainless steel
- SilentShield® sound absorption technology
- Includes sink bridge utility shelf with dishcloth bar and bottom basin rack
- 36" Minimum base cabinet width



Part #	Mfg #	Overall Dimensions	Basin Depth	Holes	Color	Price
167294	K-5283-NA	35" x 18-5/16"	9"	Less Holes	Extra-Large Single	
160598	K-5285-NA	32" x 18-1/4"	9"	Less Holes	Single	
167652	K-5409-NA	29" x 18-5/16"	9"	Less Holes	Single	

### Strive™ Under-Mount Single Bowl Apron Front Sink — 35-1/2" x 21-1/4"

- 16 Gauge stainless steel
- SilentShield® sound absorption technology
- Includes bottom basin rack and installation hardware
- 36" Minimum base cabinet width
- 29-1/2" x 21-1/4" (5417-NA Only)



Part #	Mfg #	Overall Dimensions	Basin Depth	Holes	Color	Price
173738	K-5415-NA	35-1/2" x 21-1/4"	9"	Less Holes	Single	
177654	K-5416-NA	35-1/2" x 21-1/4"	9"	Less Holes	Double	
179825	K-5417-NA	29-1/2" x 21-1/4"	9"	Less Holes	Single	

### Undertone® Rounded Under-Mount Single Bowl Kitchen Sink

- 7-1/2-inch depth
- 18-gauge stainless steel
- SilentShield® sound-absorption technology
- Includes installation hardware
- 21-inch minimum base cabinet width



Part #	Mfg #	Overall Dimensions	Basin Depth	Holes	Color	Price
056356	K-3336-NA	15-1/2" x 17-1/8"	7-1/2"	Less holes	Single	

### Undertone® Extra-Large Rounded Under-Mount Single Bowl Kitchen Sink

- 9-1/2-inch depth
- 18-gauge stainless steel
- SilentShield® sound-absorption technology
- Includes installation hardware
- 24-inch minimum base cabinet width



Part #	Mfg #	Overall Dimensions	Basin Depth	Holes	Color	Price
057386	K-3335-NA	19-5/8" x 19-5/8"	9-1/2"	Less Holes	Single	



## Kitchen Stainless Steel Sinks

### Undertone® Medium Squared Under-Mount Single Bowl Kitchen Sink

- 18-gauge stainless steel
- Rear drain
- 9-1/2-inch depth
- 21-inch minimum base cabinet width
- SilentShield® sound-absorption technology
- Includes installation hardware



Part #	Mfg #	Overall Dimensions	Basin Depth	Holes	Color	Price
075316	K-3325-NA	23" x 17-1/2"	9-1/2"	Less Holes	Single	
064083	K-3330-NA	15-3/4" x 17-1/2"	9-1/2"	Less Holes	Single	

### Undertone® Small Squared Under-Mount Single Bowl Kitchen Sink

- 18-gauge stainless steel
- 5-1/2-inch depth
- SilentShield® sound-absorption technology
- 15-inch minimum base cabinet width
- Includes installation hardware



Part #	Mfg #	Overall Dimensions	Basin Depth	Holes	Color	Price
076121	K-3333-NA	10-3/4" x 17-1/2"	5-1/2"	Less Holes	Single	

### Undertone® Under-Mount Square Single Bowl Kitchen Sink — 15-3/4" x 20-3/8"

- 9-1/2-inch depth
- 18-gauge stainless steel
- SilentShield® sound-absorption
- Includes installation hardware
- 21-inch minimum base cabinet width



Part #	Mfg #	Overall Dimensions	Basin Depth	Holes	Color	Price
092075	K-3163-NA	15-3/4" x 20-3/8"	9-1/2"	Less Holes	Single	

### Undertone® Under-Mount Single Circular Bowl Kitchen Sink

- 5-1/4-inch depth
- 18-gauge stainless steel
- 18-inch minimum base cabinet width
- Includes installation hardware
- SilentShield® sound-absorption technology



Part #	Mfg #	Overall Dimensions	Basin Depth	Holes	Color	Price
066937	K-3339-NA	13-5/8" Diameter	5-1/4"	Less Holes	Single	



## Kitchen Stainless Steel Sinks

### Undertone™ Under-Mount Double Bowl Kitchen Sink with Rear Drain

- 18 Gauge stainless steel
- SilentShield® Plus sound absorption
- Installation hardware included
- Faucet sold separately



Part #	Mfg #	Overall Dimensions	Basin Depth	Holes	Bowls	Price
086135	K-3177-NA	29-1/4" x 18-5/8"	L 9-1/2", R 7-1/2"	Less Holes	Large/Medium/Square	
053331	K-3350-NA	29-1/4" x 15-3/4"	7-1/2"	Less Holes	Equal/Square	
053332	K-3351-NA	31-1/2" x 18"	L 9/12", R 7-1/2"	Less Holes	Equal/Square	
093255	K-3171-NA	31-1/2" x 18"	9-1/2"	Less Holes	Equal	
091716	K-3150-NA	31" x 20-1/8"	9-1/2"	Less Holes	Large/Medium/Round	

### Undertone® Preserve™ Under-Mount Double Bowl Kitchen Sink with Rear Drain

- 18 Gauge stainless steel sink
- SilentShield® sound absorption technology
- Premium stainless steel resists scratching
- Includes bottom basin rack and installation hardware
- 36" Minimum base cabinet width
- 31-1/2" x 18" (**3171-HCF-NA**) or 35-1/8" x 20-1/8" (**3356-HCF-NA**)



Part #	Mfg #	Overall Dimensions	Basin Depth	Holes	Color	Price
172790	K-3171-HCF-NA	31-1/2" x 18"	9-3/4"	Less Holes	Equal	
053471	K-3356-NA	35-1/8" x 20-1/8"	9-3/4"	Less Holes	Large/Medium	
173459	K-3356-HCF-NA	35-1/8" x 20-1/8"	9-3/4"	Less Holes	Large/Medium	

### Undertone® Preserve™ Under-Mount Single Bowl Kitchen Sink — 31-1/4" x 17-7/8"

- 18 Gauge stainless steel sink
- SilentShield® sound absorption technology
- Innovative Preserve™
- Includes bottom basin rack and installation hardware
- 36" Minimum base cabinet width



Part #	Mfg #	Overall Dimensions	Basin Depth	Holes	Color	Price
189374	K-5290-HCF-NA	31-1/4" x 17-7/8"	9-5/16"	Less Holes	Large	

### Undertone® Under-Mount Double Bowl Kitchen Sink — 31-3/4" x 18"

- 18-gauge stainless steel
- Large/small bowls with high/low design
- 5-1/2-inch left depth and 9-1/2-inch right depth
- SilentShield® sound-absorption
- Includes installation hardware
- 36" minimum base cabinet width



Part #	Mfg #	Overall Dimensions	Basin Depth	Holes	Color	Price
086961	K-3174-L-NA	31-3/4" x 18"	L5-1/2", R9-1/2"	Less Holes	High/Low	

## Kitchen Stainless Steel Sinks

### Undertone® Under Mount Single Bowl Kitchen Sink — 31-1/4" x 17-7/8"

- 18 Gauge stainless steel
- SilentShield® sound absorption technology
- Includes installation hardware
- 36" Minimum base cabinet width



Part #	Mfg #	Overall Dimensions	Basin Depth	Holes	Color	Price
189037	K-5290-NA	31-1/4" x 17-7/8"	9-5/16"	Less Holes	Large	

### Undertone® Under-Mount Single Bowl Kitchen Sink

- 18-gauge stainless steel
- 7-5/8-inch depth
- SilentShield® sound-absorption
- 21-inch minimum base cabinet width
- Includes installation hardware



Part #	Mfg #	Overall Dimensions	Basin Depth	Holes	Color	Price
080942	K-3184-NA	18-1/2" x 15-3/4"	7-5/8"	Less Holes	Single	

### Undertone® Under-Mount Triple Bowl Kitchen Sink — 41-5/8" x 20-1/8"

- 18-gauge stainless steel
- Double equal bowls with center disposal bowl
- 9-1/2-inch left depth, 5-1/2-inch center depth, and 7-1/2-inch right depth
- SilentShield® sound-absorption
- Includes installation hardware
- 45-inch minimum base cabinet width



Part #	Mfg #	Overall Dimensions	Basin Depth	Holes	Color	Price
091942	K-3166-NA	41-5/8" x 20-1/8"	L9-1/2", C5-1/2", R7-1/2"	Less Holes	Triple	

### Vault™ Under-Mount Apron Front Sink with Rear Drain — 35-1/2" x 21-1/4"

- 18 Gauge stainless steel
- SilentShield® sound absorption technology
- Shortened apron allows sink to be used in most standard cabinetry or retrofitted to existing standard cabinetry
- Self-trimming apron overlaps the cabinet face for easy installation
- Includes installation hardware and bottom basin rack
- 29-1/2" x 21-1/4" (**K-3943-NA Only**)



K-3936



K-3945

Part #	Mfg #	Overall Dimensions	Basin Depth	Holes	Color	Price
154322	K-3936-NA	29-1/2" x 21-1/4"	9"	Less Holes	Single	
142710	K-3943-NA	35-1/2" x 21-1/4"	9"	Less Holes	Single	
143391	K-3945-NA	35-1/2" x 21-1/4"	9"	Less Holes	Large/Medium	

## Kitchen Stainless Steel Sinks

### Stainless Steel Kitchen Sink Accessories

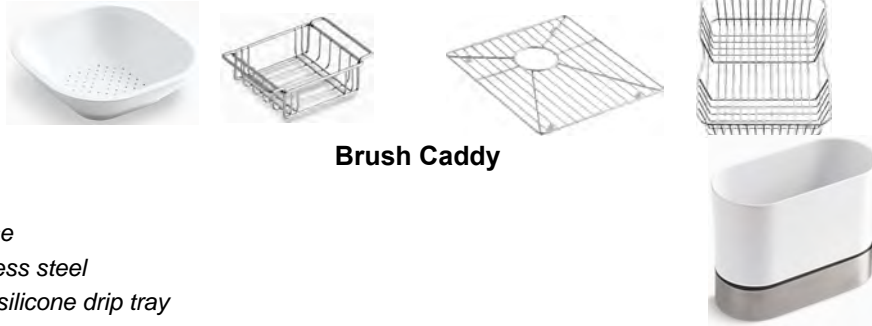

**Brush Caddy**

- Tip-resistant design
- Non slip silicone base
- Rust-resistant stainless steel
- Includes removable silicone drip tray

Part #	Mfg #	Overall Dimensions	Basin Depth	Holes	Color	Price
237751	K-SG6378-0	White				

### Cadence®/Toccata™ Sink Rack for K-3145 and K-3847 Kitchen Sinks

Part #	Mfg #	Overall Dimensions	Basin Depth	Holes	Color	Price
168002	K-6401-ST	12-1/4" x 13-1/4", Stainless Steel				

### Cairn™ Neoroc™ Basin Rack for K-8206 and K8207 Cairn™ Kitchen Sinks

Part #	Mfg #	Overall Dimensions	Basin Depth	Holes	Color	Price
188407	K-5192-ST	9-7/16" x 4", Stainless Steel				

### Cairn™ Sink Rack for K-8199 Cairn™ Kitchen Sink

Part #	Mfg #	Overall Dimensions	Basin Depth	Holes	Color	Price
188406	K-5656-ST	13-3/4" x 14", Stainless Steel				

### Deerfield ® Sink Rack for Left or Right Bowl

- Reversible design
- Dishwasher safe
- Rubber feet provide added protection



Part #	Mfg #	Overall Dimensions	Basin Depth	Holes	Color	Price
168424	K-6121-ST	12-7/8" x 15-3/8", Left Bowl, Stainless Steel				
168425	K-6122-ST	12-7/8" x 15-3/8", Right Bowl, Stainless Steel				

### Langlade® Smart Divide® Sink Rack for K-6626 Kitchen Sink

Part #	Mfg #	Overall Dimensions	Basin Depth	Holes	Color	Price
187222	K-5180-ST	13-1/2" x 15-1/4", Right Bowl, Stainless Steel				
187223	K-5182-ST	13-1/2" x 15-3/8", Left Bowl, Stainless Steel				

## Kitchen Stainless Steel Sinks

### Lift Dish Rack

- Rim lifts up to support large items; collapses for compact storage in a cabinet
- Wine glass rack folds upward for use; easily folds down when not in use
- Collapsible corner utensil band
- Stacks dishes front to back or side to side
- Drains over sink rim
- Open design promotes airflow
- Angled drain board and round corners prevent standing water
- Stands on end or side for easy storage under sink or in slim cabinets
- Removable grate is dishwasher safe

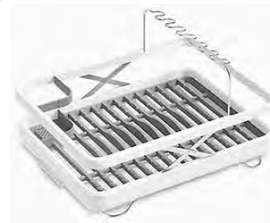

Part #	Mfg #	Length	Height	Width	Price
231016	K-8631-0	19"	10-1/2"	14-1/2"	

### Iron/Tones® Sink Rack

- Fits in the bowl of the K-5707 Iron/Tones® kitchen sink
- Stainless-steel construction
- Dishwasher safe
- Rubber feet provide added protection



Part #	Mfg #	Overall Dimensions	Basin Depth	Holes	Color	Price
258418	K-8342-ST	28-7/16" x 14-3/16", Stainless Steel				

### Kennon® Sink Rack

- Fits in the bowl of the K-8437-1 Kennon® kitchen sink
- Stainless-steel construction
- Dishwasher safe



Part #	Mfg #	Overall Dimensions	Basin Depth	Holes	Color	Price
258678	K-5376-ST	10-5/8" x 15-9/16", Stainless Steel				

### Poise® Sink Rack

- Fits in the bowl of the K-3158 Poise® kitchen sink
- Stainless-steel construction
- Dishwasher safe
- Rubber feet provide added protection



Part #	Mfg #	Overall Dimensions	Basin Depth	Holes	Color	Price
085217	K-3141-ST	28-3/16" x 13-3/16", Stainless Steel				

### Octave® Sink Rack

- For K-3844 and K-3855 Octave® kitchen sinks (K6484-ST)
- For K-3842 and K3843 Octave® kitchen sinks (K-6453-ST)

Part #	Mfg #	Overall Dimensions	Basin Depth	Holes	Color	Price
162276	K-6453-ST	14-1/4" x 17-5/8", Right Bowl, Stainless Steel				

## Kitchen Stainless Steel Sinks

### Staccato™ Sink Rack for K-3369 Staccato® Kitchen Sink

Part #	Mfg #	Overall Dimensions	Basin Depth	Holes	Color	Price
186452	K-5117-ST	13-1/4" x 15-7/8", Right Bowl, Stainless Steel				
186451	K-5119-ST	13" x 15-3/4", Left Bowl, Stainless Steel				

### Staccato™ Sink Rack for K-3361 Staccato® Kitchen Sink

- Innovative wheels
- Dishwasher safe



Part #	Mfg #	Overall Dimensions	Basin Depth	Holes	Color	Price
239196	K-5103-ST	16-5/8" x 15-7/8", Large Bowl, Stainless Steel				
245507	K-5111-ST	9-5/8" x 15-7/8", Small Bowl, Stainless Steel				

### Stainless Steel Sink Rack

- For Models:
  - Verse™ K-3373
  - Undertone® K-3183
  - Verity® K-3156, K-3157
- Dishwasher safe
- Stainless-steel construction
- Rubber feet provide added protection



Part #	Mfg #	Finish	Price
085099	K-3133-ST	13-3/4" x 27-1/2", Stainless Steel	

### Stainless Steel Sink Rack for K-8679 Riverby® Kitchen Sinks

- Comes included with K-8679 Riverby® sinks
- Dishwasher safe
- Rubber feet provide added protection



Part #	Mfg #	Overall Dimensions	Basin Depth	Holes	Color	Price
230864	K-9238-ST	12-7/8" x 14-5/16", Stainless Steel				

### Stainless Steel Sink Rack for K-5312 Iron/Tones® Smart Divide® Kitchen Sinks

- Fits in either bowl
- Dishwasher safe
- Innovative wheels
- Rubber feet provide added protection



Part #	Mfg #	Overall Dimensions	Basin Depth	Holes	Color	Price
251760	K-8339-ST	14-1/4" x 12-13/16", Stainless Steel				



## Kitchen Stainless Steel Sinks

### Tanager® Sink Rack for Right or Left Bowl

- 16-1/4" x 11-1/2"
- Stainless-steel construction
- Fits in the left bowl of the K-6491 Tanager® kitchen sink
- Dishwasher safe
- Rubber feet provide added protection

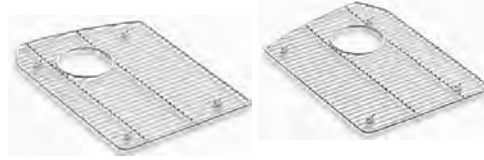

Part #	Mfg #	Overall Dimensions	Basin Depth	Holes	Color	Price
139990	K-6146-ST	Left Bowl, Stainless Steel				
139991	K-6147-ST	Right Bowl, Stainless Steel				

### Undertone™ Iron/Tones® Coated Sink Basket — 13-1/2" x 15-1/4"

- Fits the Iron/Tones™ K-6584 and 6585 Iron/Tones™ kitchen sinks
- Fits the K-3163, K-3168, K-3171, K-3174, K-3177, K-3330, K-3331, K-3332, K-3334, K-3350, K-3351, K-3352, K-3353, K-3325 Undertone™ kitchen sinks



Part #	Mfg #	Finish	Price
103842	K-3277-ST	Stainless Steel	

### Undertone™ Kitchen Wire Storage Basket

- For Models K-3154, K-3155, K-3156, and K-3157

Part #	Mfg #	Finish	Price
083452	K-3127-ST	Stainless Steel	

### Undertone™ Sink Rack

- For K-3356 and K-3356-HCF Undertone™ kitchen sinks (K-6389-ST & K-6390-ST)
- For K-3171 and K-3171-HCF Undertone™ kitchen sinks (K-6388-ST)

Part #	Mfg #	Overall Dimensions	Basin Depth	Holes	Color	Price
172722	K-6388-ST	For Models K-3171 and K-3171-HCF, Stainless Steel				
174210	K-6389-ST	For Models K-3356 and K-3356-HCF, LH Bowl, Stainless Steel				
172723	K-6390-ST	For Models K-3356 and K-3356-HCF, RH Bowl, Stainless Steel				

### Undertone® Sink Rack for Left Bowl

- Stainless-steel construction
- Dishwasher safe
- Fits in the left bowl of the K-3148 and K-3197 Undertone® kitchen sinks
- Rubber feet provide added protection



Part #	Mfg #	Overall Dimensions	Basin Depth	Holes	Color	Price
099032	K-2997-ST	14-1/4" x 14-3/4", Stainless Steel				



## Kitchen Stainless Steel Sinks

### Undertone® Stainless Steel Sink Rack

- 27-7/16" x 13-7/16"
- Dishwasher safe
- Innovative wheels
- Fits in the bowl of K-5290-NA Undertone® and K-5290-HCF-NA Undertone® Preserve™ sinks  
—Included with the model K-5290-HCF-NA



Part #	Mfg #	Overall Dimensions	Basin Depth	Holes	Color	Price	
239643	K-5474-ST	27-7/16" x 13-7/16", Stainless Steel					

### Utility Rack

- Fits K-3820, K-3821, K-3823, K-3838, K-3839, K-3935, K-3942, and K-3944 Vault™ kitchen sinks
- Comes included with the K-5285-NA, K-5283-NA, and 5409-NA Strive™ kitchen sinks



Part #	Mfg #	Overall Dimensions	Basin Depth	Holes	Color	Price	
172042	K-6429-ST	Stainless Steel					

### Vault™ Sink Rack

- For K-3944 Vault™ kitchen sink (K-6475-ST)
- For K-3820 and K-3838 Vault™ kitchen sinks (K-6475-ST)

Part #	Mfg #	Description	Price
138968	K-6641-ST	14" x 15-19/20", Stainless Steel	
179742	K-6475-ST	15-1/4" x 16-3/4" Stainless Steel	

### Vault™/Strive™ Sink Rack for Apron Front Sinks

- Fits in the Medium bowl of the K-3822 Vault™ and K-5417 Strive™ kitchen sinks (K-6645-ST)  
—For undermount single bowl apron-front sink
- Fits in the small bowl of the K-3945 Vault™ and K-5416 Strive™ kitchen sinks (K-6647-ST)  
—For 36" offset apron-front sink
- Fits in the rectangular bowl of the K-3943 Vault™ and K-5415 Strive™ kitchen sinks (K-6474-ST)  
—For 36" single bowl apron-front sink
- Fits in the rectangular bowl of the K-3936 Vault™ and K-5417 Strive™ kitchen sinks (K-6466-ST)  
—For 30" single bowl apron-front sink

Part #	Mfg #	Overall Dimensions	Basin Depth	Holes	Color	Price	
257516	K-6645-ST	15-15/16" x 21-1/4", Stainless Steel					
141042	K-6647-ST	11-1/8" x 16", Stainless Steel					
175216	K-6474-ST	32" x 16-3/4", Stainless Steel					
176498	K-6466-ST	26" x 16-3/4", Stainless Steel					

### Vault™/Strive™ Sink Rack for Right Basin — 11-1/4" x 16-3/4"

- Fits in the small right bowl of the K-3823 and K-3839 Vault™ kitchen sinks and K-5284 Strive™ kitchen sink

Part #	Mfg #	Overall Dimensions	Basin Depth	Holes	Color	Price	
141030	K-6477-ST	Stainless Steel					

## Kitchen Stainless Steel Sinks

### Vault™/Strive™ Saddle Towel Bar

- Fits K-3820, K-3823, K-3838, K-3839, K-3944, and K-3945 Vault™ kitchen sinks.
- Comes included with K-5281-NA and K-5282-NA Strive™ kitchen sinks.
- 13-9/16" Width

Part #	Mfg #	Overall Dimensions	Basin Depth	Holes	Color	Price
159662	K-6432	13-9/16 Width, Stainless Steel				

### Wheatland® Sink Rack for Left or Right Bowl

- Stainless-steel construction
- Fits in the left bowl of the K-5870 Wheatland® kitchen sink
- Dishwasher safe
- Rubber feet provide added protection



Part #	Mfg #	Overall Dimensions	Basin Depth	Holes	Color	Price
145450	K-6148-ST	9-1/8" x 14-3/8", Left Bowl, Stainless Steel				
145451	K-6159-ST	15-5/16" x 16-7/8", Right Bowl, Stainless Steel				

### Saddle Utility Rack

- Fits K-3820, K-3823, K-3838, K-3839, K-3944, and K-3945 Vault™ kitchen sinks.
- Comes included with K-5281-NA and K-5282-NA Strive™ kitchen sinks.



Part #	Mfg #	Overall Dimensions	Basin Depth	Holes	Color	Price
167838	K-6434-ST	Stainless Steel				

### Undertone™ Hardwood Cutting Board

- 15" x 14" x 10"
- Fits over:
  - Ravinia kitchen sinks: K-3222, K-3232, and K-3224
  - Undertone™ bar sink: K-14300
  - Undertone™ kitchen sinks: K-3150, K-3164, K-3165, K-3166, K-3336, K-3337, K-3354, K-3356, and K-3359



Part #	Mfg #	Overall Dimensions	Basin Depth	Holes	Color	Price
057026	K-3278-NA	Hardwood Construction				

### Vault™/Strive™ Wood Cutting Board

- For K-3820, K-3822, K-3823, K-3839, K-3894, K-3895, K-3942, K-3943, K-3944, K-3945, K-3996 Vault™ kitchen sinks
- K-5282, K-5285, and K-5286 Strive™ kitchen sinks.



Part #	Mfg #	Overall Dimensions	Basin Depth	Holes	Color	Price
164742	K-6667-NA	Hardwood				

### Poise® Sink Rack for K-3159 and K-3161 Poise® Kitchen Sinks

Part #	Mfg #	Overall Dimensions	Basin Depth	Holes	Color	Price
092812	K-3142-ST	13-1/4" x 13-1/4", Stainless Steel				

## Kitchen Stainless Steel Sinks

### Poise® Hardwood Cutting Board

- *Bamboo*
- *For Models K-3158, K-3159, K-3160, K-3161, K-3672, K-3673, and K-3671*



Part #	Mfg #	Overall Dimensions	Basin Depth	Holes	Color	Price
081504	K-3140-NA	Bamboo				

### Stages™ Hardwood Cutting Board for K-3760 and K-3761 Stages™ Kitchen Sinks

- *American walnut construction*



		Finish	
155164	K-6232-NA	Walnut, For Models K-3760 and K-3761	

## Kitchen Stainless Steel Sinks

### Stainless Steel Kitchen Sinks

#### Carthage® Undermount Single Bowl Kitchen Sink

- SilentShield® sound-absorption technology
- Undermount rimless design
- Installation hardware included



Part #	Mfg #	Overall Dimensions	Depth	Holes	Drain	Finish	Price
125000	11605-NA	32" x 18"	9"	Less Holes	3-5/8"	18ga Satin	

#### Carthage® Undermount Equal Double Bowl Kitchen Sink

- One-piece construction
- SilentShield® sound-absorption technology
- Undermount rimless design



Part #	Mfg #	Overall Dimensions	Depth	Holes	Drain	Finish	Price
129490	11445-NA	32" x 18"	8-1/4"	Less Holes	3-5/8"	18ga Satin	

#### Ludington™ Undermount Single Bowl Kitchen Sink

- SilentShield® sound-absorption technology
- Undermount rimless design
- Installation hardware included
- 3-3/4" Drain hole
- 18 Gauge stainless steel
- (-PC) models includes 7400 Duostrainer™ strainer & basin mat



Part #	Mfg #	Overall Dimensions	Depth	Holes	Min Base Cabinet	Finish	Price
236676	20022-NA	32" x 18-5/16"	9"	Less Holes	36"	Satin	
243529	20022-PC-NA	32" x 18-5/16"	9"	Less Holes	36"	Satin	
238412	20023-NA	24" x 18-1/4"	9"	Less Holes	27"	Satin	
243483	20023-PC-NA	24" x 18-1/4"	9"	Less Holes	27"	Satin	

#### McAllister® Undermount Single Bowl Kitchen Sink

- SilentShield™ sound deadening
- Installation hardware included
- Rimless design



Part #	Mfg #	Overall Dimensions	Depth	Holes	Drain	Gauge/Finish	Price
105392	11600-NA	30" x 18"	9"	Less Holes	3-5/8"	18ga Satin	
105391	11447-NA	24" x 18"	8"	Less Holes	3-5/8"	20ga Satin	

## Kitchen Stainless Steel Sinks

### McAllister® Undermount Double Bowl Kitchen Sink

- SilentShield™ sound deadening
- Installation hardware included
- Rimless design



Part #	Mfg #	Overall Dimensions	Depth	Holes	Drain	Gauge/Finish	Price
098433	11406-NA	32" x 18"	8"	Less Holes	3-5/8"	20ga Satin	
098379	11409-NA	31-3/4" x 20-3/4"	8"	Less Holes	3-3/4"	18ga Satin	
098380	11409-L-NA	31-3/4" x 18"/20-3/4"	8"	Less Holes	3-3/4"	18ga Satin	
111437	11444-NA	32" x 18"	8-1/4"	Less Holes	3-5/8"	18ga Satin	

### Middleton® Self-Rimming Double Bowl Kitchen Sink

- Top-Mount
- 3-5/8" Drain opening
- Luster finish
- SilentShield™ technology
- 20 Gauge stainless steel



Part #	Mfg #	Overall Dimensions	Depth	Holes	Drain	Gauge/Finish	Price
123757	14633-3-NA	33" x 22"	6-1/4"	3	3-5/8"	20ga Luster	

### Middleton® Self-Rimming Single Bowl Kitchen Sink

- 20 Gauge stainless steel with satin finish
- SilentShield™ sound deadening
- 1150001 Installation clips included



Part #	Mfg #	Overall Dimensions	Depth	Holes	Drain	Gauge/Finish	Price
242300	14710-3-NA	25" x 22"	7"	3	3-5/8"	20ga Satin	

### Southaven® Self-Rimming Single Bowl Kitchen Sink

- Ledge back
- Curved deck design
- Rolled rim
- SilentShield™ sound deadening



Part #	Mfg #	Overall Dimensions	Depth	Holes	Drain	Gauge/Finish	Price
136421	11878-3-NA	33" x 22"	9"	3	3-5/8"	19ga Satin	
189258	24912-4-NA	33" x 22"	8"	4	3-5/8"	20ga Satin	

### Southaven® Self-Rimming Double Bowl Kitchen Sink

- Ledge back
- Curved deck design
- Rolled rim
- SilentShield™ sound deadening



Part #	Mfg #	Overall Dimensions	Depth	Holes	Drain	Gauge/Finish	Price
084368	11400-3-NA	33" x 22"	6-1/2"	3	3-5/8"	22ga Satin	

**Kitchen Stainless Steel Sinks**

**Stainless Steel Kitchen Sinks (Continued)**

**Southhaven® Self-Rimming Double Bowl Kitchen Sink**

Part #	Mfg #	Overall Dimensions	Depth	Holes	Drain	Gauge/Finish	Price
074248	11400-4-NA	33" x 22"	6-1/2"	4	3-5/8"	22ga Satin	
085909	11402-3-NA	33" x 22"	8"	3	3-5/8"	20ga Satin	
085908	11402-4-NA	33" x 22"	8"	4	3-5/8"	20ga Satin	
115436	11850-3-NA	33" x 22"	8-1/2"	3	3-5/8"	18ga Satin	



## Kitchen Sink Accessories

### Stainless Steel Sink Accessories

#### Bottom Basin Rack

- Protects the kitchen sink from scratches or stains



Part #	Mfg #	Dimensions	For:	Price
121712	11862-ST	11-3/4" x 13-1/4"	Springdale® Single or McAllister® Double Sink (Smaller Basin)	
128645	11863-ST	11-7/8" x 16-1/4"	Springdale® Single or McAllister® Double Sink (Larger Basin)	

#### Ludington® Sink Mat

- Set of two
- Ash grey silicone
- Center drain hole
- For use with Ludington® sink 20022



Part #	Mfg #	Overall Dimensions	Holes	Finish	Price
242097	20285-ASH	Set Measures 16.3" x 30"	1	Stone Grey	

**Kitchen Stainless Steel Sinks**

**Undermount Single Bowl Stainless Steel Kitchen Sinks**

**One™ XL Single Bowl Undermount Kitchen Sink**

- 304 Series, 18 gauge stainless steel
- 18/10 Chrome/nickel content
- Satin polished finish
- Rear drain placement
- Sound deadening pads



Part #	Mfg #	Finish	Bowl Depth	Overall Size	Cabinet Size	Drain Dia	Price
169513	441588	Stainless Steel	9"	30" x 20"	33"	3-1/2"	

**One™ Medium Single Bowl Undermount Kitchen Sink Kit**

- 304 Series, 18 gauge stainless steel
- 18/10 Chrome/nickel content
- Satin polished finish
- Rear drain placement
- Sound deadening pads



Organized Model 441629: Medium Single Bowl + Grid + Magnetic Caddy  
 Safety Model 441631: Medium Single Bowl + Grid + Workstation  
 Prep Model 441630: Medium Single Bowl + Cutting Board + Magnetic Caddy  
 Culinary Model 441632: Medium Single Bowl + Cutting Board + Workstation

Part #	Mfg #	Finish	Bowl Depth	Overall Size	Cabinet Size	Drain Dia	Price
250760	441629	Stainless Steel	9"	25" x 18"	27"	3-1/2"	

**Precision™ Steelart™ R10 Super Single Bowl Undermount Kitchen Sink**

- 304 Series, 18 gauge stainless steel
- 18/10 Chrome/nickel content
- 10mm radius corners
- Satin polished finish
- Rear drain placement
- Sound deadening pads



Part #	Mfg #	Finish	Bowl Depth	Overall Size	Cabinet Size	Drain Dia	Price
114550	513686	Stainless Steel	10"	32" x 20"	36"	3-1/2"	

**Kitchen Stainless Steel Sinks**

**Precision™ Steelart™ Super Single Bowl Undermount Kitchen Sink**

- 304 Series, 18 gauge stainless steel
- 18/10 Chrome/nickel content
- Zero radius corners
- Satin polished finish
- Rear drain placement
- Sound deadening pads



Part #	Mfg #	Finish	Bowl Depth	Overall Size	Cabinet Size	Drain Dia	Price
126101	515820	Stainless Steel	10"	32" x 18"	36"	3-1/2"	
090953	512747	Stainless Steel	10"	32" x 19"	36"	3-1/2"	

**Quatrus™ Single Bowl Undermount Kitchen Sink**

- 304 Series, 18 gauge stainless steel
- 18/10 Chrome/nickel content
- Stain polish finish
- Rear drain placement
- Sound deadening coating



Part #	Mfg #	Finish	Bowl Depth	Overall Size	Cabinet Size	Drain Dia	Price
158553	518478	Stainless Steel	9"	22" x 18"	27"	3-1/2"	
173025	518171	Stainless Steel	9"	25" x 18"	30"	3-1/2"	

**Quatrus™ R15 Single Bowl Undermount Kitchen Sink**

- R15 Radius offers transitional yet geometric design
- 304 Series, 18 gauge stainless steel
- 18/10 Chrome/nickel content
- Satin finish
- Rear drain placement
- Sound deadening pads



Part #	Mfg #	Finish	Bowl Depth	Overall Size	Cabinet Size	Drain Dia	Price
174056	519546	Stainless Steel	9"	22" x 18"	27"	3-1/2"	
224564	519547	Stainless Steel	9"	25" x 18"	30"	3-1/2"	
175431	519548	Stainless Steel	9"	32" x 18"	36"	3-1/2"	

**Kitchen Stainless Steel Sinks**

**Stellar™ Medium Single Bowl Undermount Kitchen Sink**

- 304 Series, 18 gauge stainless steel
- 18/10 Chrome/nickel content
- Refined brushed finish
- Rear drain placement
- Sound deadening coating



Part #	Mfg #	Finish	Bowl Depth	Overall Size	Cabinet Size	Drain Dia	Price
123283	441025	Stainless Steel	8"	25" x 18"	27"	3-1/2"	

**Wave™ Small Single Bowl Undermount Kitchen Sink**

- 304 Series, 18 gauge stainless steel
- 18/10 Chrome/nickel content
- Stain polish finish
- Rear drain placement
- Sound deadening coating



Part #	Mfg #	Finish	Bowl Depth	Overall Size	Cabinet Size	Drain Dia	Price
153557	440248	Stainless Steel	8"	22-7/16" x 20-7/16"	27"	3-1/2"	
036830	440249	Stainless Steel	10"	22-7/16" x 20-7/16"	27"	3-1/2"	

**Undermount Double Bowl Stainless Steel Kitchen Sinks**

**Stellar™ Equal Double Bowl Undermount Kitchen Sink**

- 304 Series, 18 gauge stainless steel
- 18/10 Chrome/nickel content
- Refined brushed finish
- Rear drain placement



Part #	Mfg #	Finish	Bowl Depth	Overall Size	Cabinet Size	Drain Dia	Price
123276	441020	Stainless Steel	8"	33-1/3" x 18-1/2"	36"	3-1/2"	

**Stellar™ 1-3/4 Bowl Undermount Kitchen Sink**

- 304 Series, 18 gauge stainless steel
- 18/10 Chrome/nickel content
- Refined brushed finish
- Rear drain placement



Part #	Mfg #	Finish	Bowl Depth	Overall Size	Small Bowl	Cabinet Size	Drain Dia	Price
123279	441023	Stainless Steel	9" & 7"	32-1/3" x 20-1/2"	RH	36"	3-1/2"	
137735	441261	Stainless Steel	7" & 9"	32-3/8" x 20-1/2"	LH	36"	3-1/2"	

**Kitchen Stainless Steel Sinks**

**Stellar™ 1.6 Bowl Undermount Kitchen Sink**

- 304 Series, 18 gauge stainless steel
- 18/10 Chrome/nickel content
- Refined brush finish
- Rear drain placement
- Sound deadening pads



441262

441022

Part #	Mfg #	Finish	Bowl Depth	Overall Size	Cabinet Size	Drain Dia	Price
123278	441022	Stainless Steel	9" & 7"	31-3/4" x 20-1/2"	36"	3-1/2"	

**Supreme™ 1-1/2 Bowl Undermount Kitchen Sink**

- 304 Series, 18 gauge stainless steel
- 18/10 Chrome/nickel content
- Satin polished finish
- Rear drain placement
- Sound deadening pads



Part #	Mfg #	Finish	Bowl Depth	Overall Size	Cabinet Size	Drain Dia	Price
142624	440163	Stainless Steel	10"/6"	25-3/4" x 20-7/16"	30"	3-1/2"	

**Blanco Wave™ 1-1/2" Bowl Undermount Kitchen Sink**

- 304 Series, 18 gauge stainless steel
- 18/10 Chrome/nickel content
- Satin polish finish
- Rear drain placement
- Sound deadening pads



Part #	Mfg #	Finish	Bowl Depth	Overall Size	Cabinet Size	Drain Dia	Price
167785	440246	Stainless Steel	10" & 6"	32-3/32" x 20-7/8"	36"	3-1/2"	

**Quatrus™ Equal Double Bowl Undermount Kitchen Sink**

- 304 Series, 18 gauge stainless steel
- 18/10 Chrome/nickel content
- Stain finish
- Rear drain placement
- Sound deadening pads



Part #	Mfg #	Finish	Bowl Depth	Overall Size	Cabinet Size	Drain Dia	Price
165816	518170	Stainless Steel	9"	32" x 18"	36"	3-1/2"	

**Kitchen Stainless Steel Sinks**

**Quatrus™ 1-3/4 Bowl Undermount Kitchen Sink**

- 304 Series, 18 gauge stainless steel
- 18/10 Chrome/nickel content
- Satin finish
- Rear drain placement
- Sound deadening pads



Part #	Mfg #	Finish	Bowl Depth	Overall Size	Cabinet Size	Drain Dia	Price
170286	518169	Stainless Steel	9"	33" x 18"	36"	3-1/2"	
185583	519550	Stainless Steel	9"	33" x 18"	36"	3-1/2"	

**Quatrus™ R15 Equal Double Bowl Undermount Kitchen Sink**

- R15 radius offers transitional yet geometric design
- 304 Series, 18 gauge stainless steel
- 18/10 Chrome/nickel content
- Stain finish
- Rear drain placement
- Sound deadening pads



Part #	Mfg #	Finish	Bowl Depth	Overall Size	Cabinet Size	Drain Dia	Price
174568	519549	Stainless Steel	9"	32" x 18"	36"	3-1/2"	

**Precision™ 16" Equal Double Bowl Undermount Kitchen Sink**

- 304 Series, 18 gauge stainless steel
- 18/10 Chrome/nickel content
- Satin polished finish
- Rear drain placement
- Sound deadening pads



Part #	Mfg #	Finish	Bowl Depth	Overall Size	Cabinet Size	Drain Dia	Price
183262	516212	Stainless Steel	10"	37" x 18"	39"	3-1/2"	
224390	516211	Stainless Steel	10"	29" x 18"	33"	3-1/2"	

**Precision™ 16" 1-3/4 Bowl Undermount Kitchen Sink**

- 304 Series, 18 gauge stainless steel
- 18/10 Chrome/nickel content
- Satin polished finish
- Rear drain placement
- Sound deadening pads



Part #	Mfg #	Finish	Bowl Depth	Overall Size	Cabinet Size	Drain Dia	Price
224460	515821	Stainless Steel	10"	33" x 18"	36"	3-1/2"	



**Kitchen Stainless Steel Sinks**

**Precision™ 16"R10 Equal Double Bowl Undermount Kitchen Sink**

- 304 Series, 18 gauge stainless steel
- 18/10 Chrome/nickel content
- Satin polished finish
- Rear drain placement
- 10mm Radius corners
- Sound deadening pads



Part #	Mfg #	Finish	Bowl Depth	Overall Size	Cabinet Size	Drain Dia	Price
157352	516219	Stainless Steel	10"	37" x 18"	39"	3-1/2"	

**Precision™ 16"R10 1-3/4 Bowl Undermount Kitchen Sink**

- 304 Series, 18 gauge stainless steel
- 18/10 Chrome/nickel content
- Satin polished finish
- Rear drain placement
- 10mm Radius corners
- Sound deadening pads



Part #	Mfg #	Finish	Bowl Depth	Overall Size	Cabinet Size	Drain Dia	Price
167472	515824	Stainless Steel	10"	33" x 18"	36"	3-1/2"	

**Precision™ 16"R10 1-1/2 Bowl Undermount Kitchen Sink**

- 304 Series, 18 gauge stainless steel
- 18/10 Chrome/nickel content
- Satin polished finish
- Rear drain placement
- 10mm Radius corners
- Sound deadening pads



Part #	Mfg #	Finish	Bowl Depth	Overall Size	Cabinet Size	Drain Dia	Price
153853	516218	Stainless Steel	10" & 8"	33" x 18"	36"	3-1/2"	

**Kitchen Stainless Steel Sinks**

**Single Bowl Stainless Steel Kitchen Sinks**

**Avado® Undermount Stainless Steel Deep Single Bowl Sink**

- 16" Gauge
- Polished satin finish
- Sound guard undercoating



Part #	Mfg #	Overall Size	Holes	Depth	Drain Opening	Min Sink Base	Price
102476	EFU281610	30-1/2" x 18-1/2"	N/A	10"	3-1/2"	36"	

**Crosstown™ Apron Front SS Single Bowl Sink**

- 18" Gauge
- Polished satin finish
- Sound guard opening



Part #	Mfg #	Overall Size	Holes	Depth	Drain Opening	Min Sink Base	Price
174150	ECTRUF30179R	31-1/2" x 18-1/2"	N/A	9"	3-1/2"	36"	

**Crosstown™ Undermount SS Single Bowl Sink**

- 18" Gauge
- Polished satin finish
- Sound guard undercoating
- **(-RTC Models) include:**
  - Custom fit bottom grid
  - Deep strainer drain
  - Bar Keeper's friend cleanser
  - Microfiber towel



Part #	Mfg #	Overall Size	Holes	Depth	Drain Opening	Min Sink Base	Price
2601070	ECTRU24179RTC	25-1/2" x 18-1/2"	N/A	9"	3-1/2"	30"	
170596	ECTRU30179RT	31-1/2" x 18-1/2"	N/A	9"	3-1/2"	36"	
250520	ECTRU30179RTC	31-1/2" x 18-1/2"	N/A	9"	3-1/2"	36"	

**Crosstown™ Undermount SS Single Bowl Sink**

- 16" Gauge
- Polished satin finish
- Sound guard undercoating



Part #	Mfg #	Overall Size	Holes	Depth	Drain Opening	Min Sink Base	Price
250666	EFRU718T	10" x 20-1/2"	N/A	6"	3-1/2"	15"	

**Kitchen Stainless Steel Sinks**

**Crosstown™ Undermount SS Single Bowl Sink**

- 16" Gauge
- Polished satin finish
- Sound guard undercoating
- **(-OTC Models)** includes:
  - Custom fit bottom grid
  - Deep strainer drain
  - Bar keeper's friend
  - Microfiber towel



Part #	Mfg #	Overall Size	Holes	Depth	Drain Opening	Min Sink Base	Price
260981	EFU131610T	16" x 18-1/2"	N/A	10"	3-1/2"	21"	
250566	EFRU131610T	16" x 18-1/2"	N/A	10"	3-1/2"	21"	
251269	EFRU191610T	21-1/2" x 18-1/2"	N/A	10"	3-1/2"	27"	
250747	EFRU2115T	23-1/2" x 18-1/4"	N/A	8"	3-1/2"	27"	
254367	EFRU211510T	23-1/2" x 18-1/4"	N/A	10"	3-1/2"	27"	
249869	EFRU281610T	30-1/2" x 18-1/2"	N/A	10"	3-1/2"	36"	
252705	EFRU281610TC	30-1/2" x 18-1/2"	N/A	10"	3-1/2"	36"	
248655	EFRU2816T	30-1/2" x 18-1/2"	N/A	8"	3-1/2"	36"	
251273	EFRU311610T	32-1/2" x 18"	N/A	10"	3-1/2"	36"	
250452	EFRU311810T	30-3/4" x 18-1/2"	N/A	10"	3-1/2"	36"	
261034	EFRU311810TC	30-3/4" x 18-1/2"	N/A	10"	3-1/2"	36"	

**Crosstown™ Undermount SS Single Bowl Sink**

- 18" Gauge
- Polished satin finish
- Sound guard undercoating
- **(-OTC Models)** includes:
  - Custom fit bottom grid
  - Deep strainer drain
  - Bar keeper's friend
  - Microfiber towel



Part #	Mfg #	Overall Size	Holes	Depth	Drain Opening	Min Sink Base	Price
250622	ECTRU17179T	18-1/2" x 18-1/2"	N/A	9"	3-1/2"	24"	
250623	ECTRU21179T	22-1/2" x 18-1/2"	N/A	9"	3-1/2"	24"	
255543	ECTRU21179TC	22-1/2" x 18-1/2"	N/A	9"	3-1/2"	24"	

**Crosstown™ Dual Mount SS Single Bowl Sink**

- 18" Gauge
- Polished satin finish
- 1 2 FR2 MR2 3 4 5 faucet holes
- 1 2 FR2 ML2 MR2 3 4 5 faucet holes (ECTSRS33229BG Only)
- Sound guard opening
- Includes bottom grid (CTOBG2915SS)
- (-AD) ADA compliant



Part #	Mfg #	Overall Size	Holes	Depth	Drain Opening	Min Sink Base	Price
169562	ECTSRS33229BG1	33" x 22"	1	9"	3-1/2"	36"	

**Kitchen Stainless Steel Sinks**

**Single Bowl Stainless Steel Kitchen Sinks (Continued)**

**Crosstown™ Dual Mount SS Single Bowl Sink**

Part #	Mfg #	Overall Size	Holes	Depth	Drain Opening	Min Sink Base	Price
169968	ECTSRS33229BG2	33" x 22"	2	9"	3-1/2"	36"	
226681	ECTSRS33229BG3	33" x 22"	3	9"	3-1/2"	36"	
226240	ECTSRS33229BG4	33" x 22"	4	9"	3-1/2"	36"	
169810	ECTSRS33229BG5	33" x 22"	5	9"	3-1/2"	36"	

**Gourmet® Celebrity® Self-Rimming SS Single Bowl Sink**

- 20" Gauge
- Brushed satin finish
- 1 2 MR2 3 4 5 faucet holes
- Fully undercoated



Part #	Mfg #	Overall Size	Holes	Depth	Drain Opening	Min Sink Base	Price
131057	CR31221	31" x 22"	1	6-7/8"	3-1/2"	36"	

**Gourmet® Lustertone® SS Self-Rimming Single Bowl Sink**

- 18" Gauge
- Lustrous highlighted satin finish
- 1 2 MR2 3 4 5 faucet holes
- Fully undercoated
- AD models are ADA compliant



LR31221

Part #	Mfg #	Overall Size	Holes	Depth	Drain Opening	Min Sink Base	Price
237107	LRAD3122553	31" x 22"	3	5-1/2"	3-1/2"	36"	
186048	LRAD3122554	31" x 22"	4	5-1/2"	3-1/2"	36"	
169142	LRAD3122651	31" x 22"	1	6-1/2"	3-1/2"	36"	
158461	LRAD312265MR2	31" x 22"	MR2	6-1/2"	3-1/2"	36"	
119743	LRADQ3122653	31" x 22"	3	6-1/2"	3-1/2"	36"	
179992	LR31221	31" x 22"	1	7-5/8"	3-1/2"	36"	

**Gourmet® Lustertone® Self-Rimming SS Deep Bowl Sink**

- 18" Gauge
- Lustrous highlighted satin finish
- 1 2 MR2 3 4 5 faucet holes
- Fully undercoated
- (-PD) Includes one LKPD1 perfect drain & strainer



Part #	Mfg #	Overall Size	Holes	Depth	Drain Opening	Min Sink Base	Price
081756	DLR3122121	31" x 22"	1	11-5/8"	3-1/2"	36"	
104092	DLR3122123	31" x 22"	3	11-5/8"	3-1/2"	36"	
236870	DLR3122104	31" x 22"	4	10-1/8"	3-1/2"	36"	
257629	DLR312210PD2	31" x 22"	2	10-1/8"	3-1/2"	36"	
084847	DLRS3322103	33" x 22"	3	10-1/8"	3-1/2"	36"	
249144	DLRS332210MR2	33" x 22"	MR2	10-1/8"	3-1/2"	36"	

**Kitchen Stainless Steel Sinks**

**Single Bowl Stainless Steel Kitchen Sinks (Continued)**

**Gourmet® Lustertone® Self-Rimming SS Deep Bowl Sink**

Part #	Mfg #	Overall Size	Holes	Depth	Drain Opening	Min Sink Base	Price
173127	DLRS3322121	33" x 22"	1	12"	3-1/2"	36"	
162372	DLRS3322123	33" x 22"	3	12"	3-1/2"	36"	

**Gourmet® Lustertone® Self-Rimming Kitchen Sink with Countertop Ledge**

- 18" Gauge
- Lustrous highlighted satin finish
- 1 2 MR2 3 4 faucet holes
- Stainless Steel Material
- Single Bowl
- Fully undercoated



ILR4322RMR

ILR4322LMR

Part #	Mfg #	Overall Size	Holes	Depth	Drain Opening	Min Sink Base	Price
171109	ILR4322LMR2	43" x 22"	MR2	7-5/8"	3-1/2"	48"	
171840	ILR4322RMR2	43" x 22"	MR2	7-5/8"	3-1/2"	48"	

**Gourmet® Lustertone® Self-Rimming Single Bowl Kitchen Sink with Countertop Ledge**

- 18" Gauge
- Lustrous highlighted satin finish
- 1 2 MR2 3 4 5 faucet holes
- Fully undercoated



Part #	Mfg #	Overall Size	Holes	Depth	Drain Opening	Min Sink Base	Price
151173	ILR5422DD2	54" x 22"	2	7-5/8"	3-1/2"	57"	

**Gourmet® Lustertone® Undermount Farm Apron Front SS Single Bowl Sink**

- 18" Gauge
- Lustrous highlighted satin finish
- Sound guard undercoating
- DBG models include:
  - LKWOBG2816SS Bottom grid
  - LK99 Drain



Part #	Mfg #	Overall Size	Holes	Depth	Drain Opening	Min Sink Base	Price
075702	ELUHFS2816	33" x 20-1/2"	N/A	8"	3-1/2"	36"	
226049	ELUHFS2816DBG	33" x 20-1/2"	N/A	8"	3-1/2"	36"	

**Kitchen Stainless Steel Sinks**

**Lustertone® Classic Self-Rimming SS Single Bowl Sink with No Faucet Holes**

- 18" Gauge
- Lustrous satin finish
- Bottom pads only undercoating



Part #	Mfg #	Overall Size	Holes	Depth	Drain Opening	Min Sink Base	Price
252280	LFRAD251965	25" x 19-1/2"	N/A	6-1/2"	3-1/2"	30"	

**Lustertone® Classic Self-Rimming SS Single Bowl Sink**

- 18" Gauge
- Lustrous highlighted satin finish
- 1 2 MR2 3 faucet holes
- Bottom pads only undercoating



Part #	Mfg #	Overall Size	Holes	Depth	Drain Opening	Min Sink Base	Price
250441	LRAD1720553	17" x 20"	3	5-1/2"	3-1/2"	21"	
250868	LRAD2022653	19-1/2" x 22"	3	6-1/2"	3-1/2"	24"	

**Lustertone® Classic Undermount SS Single Bowl Sink**

- 18" Gauge
- Lustrous highlighted satin finish
- Sound guard undercoating
- AD models are ADA compliant
- **ELUH281610PDBG** Sink kit includes:
  - LKWOBG2816SS bottom grid
  - LKPD1 Perfect drain and strainer



ELUH281

Part #	Mfg #	Overall Size	Holes	Depth	Drain Opening	Min Sink Base	Price
105655	ELUH2816	30-1/2" x 18-1/2"	N/A	7-1/2"	3-1/2"	36"	
057696	ELUH281610	30-1/2" x 18-1/2"	N/A	10"	3-1/2"	36"	
249953	ELUH281610PDBG	30-1/2" x 18-1/2"	N/A	10"	3-1/2"	36"	
082719	ELUH281612	30-1/2" x 18-1/2"	N/A	11-1/2"	3-1/2"	36"	
185138	ELUHAD281645	30-1/2" x 18-1/2"	N/A	4-1/2"	3-1/2"	36"	



**Kitchen Stainless Steel Sinks**

**Lustertone™ Classic Dual Mount Slim Rim SS Single Bowl Sink**

- 18 Gauge
- Drop-in, undermount
- Lustrous satin finish
- Side and bottom pad undercoating
- (-R) Right drain
- (-L) Left drain
- (-PD) Perfect drain included



Part #	Mfg #	Overall Size	Holes	Depth	Drain Opening	Min Sink Base	Price
256643	DLSR2722101	27" x 22"	1	10"	3-1/2"	30"	

**Lustertone® Undermount SS Single Bowl Sink**

- 18 Gauge
- Lustrous highlighted satin finish
- Sound guard undercoating
- (-R) Right drain
- (-L) Left drain
- (-PD) Perfect drain included



Part #	Mfg #	Overall Size	Holes	Depth	Drain Opening	Min Sink Base	Price
249604	ELUH2317L	25-1/2" x 19-1/4"	N/A	8"	3-1/2"	27"	

**Pursuit™ Outdoor Undermount Stainless Steel Sink**

- 18" Gauge, type 316 stainless steel
- Lustrous highlighted satin finish
- Sound guard plus undercoating
- Drain not included



Part #	Mfg #	Overall Size	Holes	Depth	Drain Opening	Min Sink Base	Price
225572	PODUH2816	30-1/2" x 18-1/2"	N/A	7-7/8"	3-1/2"	36"	

**Kitchen Stainless Steel Sinks**

**Double Bowl Stainless Steel Kitchen Sinks**

**Crosstown® Undermount SS Double Bowl Sink**

- 16" Gauge
- Polished satin finish
- Sound guard undercoating
- 3219 model has reversible design
- **DBG** model includes:  
-LKOBG1316SS bottom grid  
-LK99 drain
- **RDBG** model includes:  
-EFRU312010R sink  
-(1) LKFOBG1418SS bottom grid  
-(1) LK99 drain



Part #	Mfg #	Overall Size	Holes	Depth	Drain Opening	Min Sink Base	Price
238916	EFRU311810	30-3/4" x 18-1/2"	N/A	10"	3-1/2"	36"	
167092	EFRU312010R	31-1/4" x 20-1/2"	N/A	10"	3-1/2"	36"	

**Crosstown™ Apron Front SS Double Bowl Sink**

- 18" Gauge
- Polished satin finish
- Sound guard opening
- **(-C Models)** include:  
-Custom fit bottom grid  
-Deep strainer drain  
-Bar Keeper's friend cleanser  
-Microfiber towel



ECTRUF32179  
60/40 Bowls



ECTRUF32179  
Equal Bowls w/ Aqua Divide

Part #	Mfg #	Overall Size	Holes	Depth	Drain Opening	Min Sink Base	Price
255317	ECTRUF32179C	35-7/8" x 20-1/4"	N/A	9"	3-1/2"	36"	
170170	ECTRUF32179R	35-7/8" x 20-1/4"	N/A	9"	3-1/2"	36"	
253424	ECTRUF32179RC	35-7/8" x 20-1/4"	N/A	9"	3-1/2"	36"	

**Crosstown™ Undermount SS Double Bowl Sink**

- 18" Gauge
- Polished satin finish
- Sound guard undercoating
- **RDBG** kit includes:  
-ECTRU32179R Sink  
-GFOBG1717SS bottom grid  
-GFOBG1217SS bottom grid  
-(2) LK35 drains
- **(-TC Models)** include:  
-Custom fit bottom grid  
-Deep strainer drain  
-Bar Keeper's friend cleanser  
-Microfiber towel



ECTRU32179R  
60/40 Bowls



ECTRU31179  
Equal Bowls

Part #	Mfg #	Overall Size	Holes	Depth	Drain Opening	Min Sink Base	Price
250746	ECTRU31179T	31-1/2" x 18-1/2"	N/A	9"	3-1/2"	36"	
253202	ECTRU31179TC	31-1/2" x 18-1/2"	N/A	9"	3-1/2"	36"	

**Kitchen Stainless Steel Sinks**

**Double Bowl Stainless Steel Kitchen Sinks (Continued)**

**Crosstown™ Undermount SS Double Bowl Sink**

Part #	Mfg #	Overall Size	Holes	Depth	Drain Opening	Min Sink Base	Price
240632	ECTRU32179L	31-1/2" x 18-1/2"	N/A	9"	3-1/2"	36"	
178574	ECTRU32179RT	31-1/2" x 18-1/2"	N/A	9"	3-1/2"	36"	
247485	ECTRU32179RDBG	31-1/2" x 18-1/2"	N/A	9"	3-1/2"	36"	

**Crosstown™ Undermount SS Offset Double Bowl Sink with Water Deck**

- 18" Gauge
- Polished satin finish
- Sound guard undercoating



Part #	Mfg #	Overall Size	Holes	Depth	Drain Opening	Min Sink Base	Price
249062	ECTRUD31199R1	32-1/2" x 20-1/2"	1	9"	3-1/2"	36"	
243609	ECTRUD31199R2	32-1/2" x 20-1/2"	2	9"	3-1/2"	36"	

**Crosstown® Dual-Mount SS Double Bowl Sink**

- 18" Gauge
- Polished satin finish
- 1 2 FR2 MR2 3 4 5 faucet holes
- Sound guard undercoating
- Includes **(CTOBG1315SS)** bottom grid
- AD models are ADA compliant



ECTSRO33229BG



ECTSR33229BG

Part #	Mfg #	Overall Size	Holes	Depth	Drain Opening	Min Sink Base	Price
180778	ECTSRAD33226BG0	33" x 22"	0	6"	3-1/2"	36"	
170950	ECTSR33229TBG1	33" x 22"	1	9"	3-1/2"	36"	
178017	ECTSR33229BG3	33" x 22"	3	9"	3-1/2"	36"	
226526	ECTSR33229BG5	33" x 22"	5	9"	3-1/2"	36"	
223610	ECTSR33229BGFR2	33" x 22"	FR2	9"	3-1/2"	36"	
180268	ECTSRO33229RBG1	33" x 22"	1	9"	3-1/2"	36"	
186546	ECTSRO33229RBG3	33" x 22"	3	9"	3-1/2"	36"	
174827	ECTSRO33229RBG5	33" x 22"	5	9"	3-1/2"	36"	
177161	ECTSRO33229RBGMR 2	33" x 22"	MR2	9"	3-1/2"	36"	

**Kitchen Stainless Steel Sinks**

**Crosstown® Dual-Mount SS Offset (60/40) Double Bowl Sink**

- 18" Gauge
- Polished satin finish
- Sound guard undercoating
- Includes **(CTOBG1515SS)** bottom grid (large bowl)



Part #	Mfg #	Overall Size	Holes	Depth	Drain Opening	Min Sink Base	Price
229447	ECTSRO33229RBG2	33" x 22"	2	9"	3-1/2"	36"	

**Gourmet® Celebrity® SS Self-Rimming Equal Double Bowl Sink**

- 20" Gauge
- Brushed satin finish
- Fully undercoated
- 1 2 MR2 3 4 5 faucet holes



Part #	Mfg #	Overall Size	Holes	Depth	Drain Opening	Min Sink Base	Price
006065	CR33213	33" x 21-1/4"	3	7"	3-1/2"	36"	
006066	CR33214	33" x 21-1/4"	4	7"	3-1/2"	36"	
027523	CR33221	33" x 22"	1	7"	3-1/2"	36"	
006067	CR33223	33" x 22"	3	7"	3-1/2"	36"	
006068	CR33224	33" x 22"	4	7"	3-1/2"	36"	
021600	CR43224	43" x 22"	4	6-7/8"	3-1/2"	48"	

**Gourmet® Celebrity® SS Self-Rimming Double Bowl Sink**

- 20" Gauge
- Brushed satin finish
- Fully undercoated
- 1 2 MR2 3 4 5 faucet holes



Part #	Mfg #	Overall Size	Holes	Depth	Drain Opening	Min Sink Base	Price
033771	GECECR33214	33" x 21-1/4"	4	5-3/8"	3-1/2"	36"	

**Gourmet® Lustertone® SS Self-Rimming Equal Double Bowl Sink**

- 18" Gauge
- Lustrous highlighted satin finish
- 1 2 MR2 3 4 5 faucet holes
- Sound guard undercoating
- **LR3322PD3** model includes:  
-Perfect Drain



Part #	Mfg #	Overall Size	Holes	Depth	Drain Opening	Min Sink Base	Price
118628	LR33191	33" x 19-1/2"	1	7-5/8"	3-1/2"	36"	
094201	LR33193	33" x 19-1/2"	3	7-5/8"	3-1/2"	36"	
108214	LR33194	33" x 19-1/2"	4	7-5/8"	3-1/2"	36"	
103606	LR33211	33" x 21-1/4"	1	7-7/8"	3-1/2"	36"	
102842	LR33213	33" x 21-1/4"	3	7-7/8"	3-1/2"	36"	

**Kitchen Stainless Steel Sinks**

**Double Bowl Stainless Steel Kitchen Sinks (Continued)**  
**Gourmet® Lustertone® SS Self-Rimming Equal Double Bowl Sink**

Part #	Mfg #	Overall Size	Holes	Depth	Drain Opening	Min Sink Base	Price
089176	LR33214	33" x 21-1/4"	4	7-7/8"	3-1/2"	36"	
101218	LR33223	33" x 22"	3	8-1/8"	3-1/2"	36"	
099176	LR33224	33" x 22"	4	8-1/8"	3-1/2"	36"	
095408	LR3322MR2	33" x 22"	MR2	8-1/8"	3-1/2"	36"	
179714	LR3322PD3	33" x 22"	3	8-1/8"	3-1/2"	36"	

**Lustertone® Classic SS Self-Rimming Equal Double Bowl Sink**

- 18" Gauge
- Lustrous highlighted satin finish
- 1 2 MR2 3 4 5 faucet holes
- Sound guard undercoating
- Fully undercoated



LRAD3322601



LRAD3319504

Part #	Mfg #	Overall Size	Holes	Depth	Drain Opening	Min Sink Base	Price
181976	LRAD3319503	33" x 19-1/2"	3	5"	3-1/2"	36"	
153643	LRAD3319504	33" x 19-1/2"	4	5"	3-1/2"	36"	
237514	LRAD3319553	33" x 19-1/2"	3	5-1/2"	3-1/2"	36"	
252793	LRAD3319554	33" x 19-1/2"	4	5-1/2"	3-1/2"	36"	
111517	LRAD3319603	33" x 19-1/2"	3	6"	3-1/2"	36"	
250293	LRAD3321554	33" x 21-1/4"	4	5-1/2"	3-1/2"	36"	
154314	LRAD3321604	33" x 21-1/4"	4	6"	3-1/2"	36"	
159986	LRAD332165MR2	33" x 21-1/4"	MR2	6-1/2"	3-1/2"	36"	
250600	LRAD3322503	33" x 22"	3	5"	3-1/2"	36"	
188925	LRAD3322554	33" x 22"	4	5-1/2"	3-1/2"	36"	
128418	LRAD3322601	33" x 22"	1	6"	3-1/2"	36"	
156923	LRAD3322652	33" x 22"	2	6-1/2"	3-1/2"	36"	
109553	LRAD3322654	33" x 22"	4	6-1/2"	3-1/2"	36"	
168266	LRADQ3319501	33" x 19-1/2"	1	5"	3-1/2"	36"	
179735	LRADQ3319601	33" x 19-1/2"	1	6"	3-1/2"	36"	
181410	LRADQ3321554	33" x 21-1/4"	4	5-1/2"	3-1/2"	36"	

**Lustertone® Classic SS Self-Rimming Equal Double Bowl Sink**

- 18" Gauge
- Lustrous highlighted satin finish
- 1 2 MR2 3 faucet holes
- Bottom only pads
- (-Q) Quick-clip mounting system
- (-PD) Includes two LKPD1 perfect drains and strainers



Part #	Mfg #	Overall Size	Holes	Depth	Drain Opening	Min Sink Base	Price
250450	LRADQ291865PD3	29" x 18"	3	6-1/2"	3-3/8"	33"	



**Kitchen Stainless Steel Sinks**

**Gourmet® Lustertone® Self-Rimming SS Deep Double Bowl Sink**

- 18" Gauge
- Lustrous highlighted satin finish
- 1 2 MR2 3 4 5 faucet holes
- Fully undercoated



DLR4322103



DLR3772210



DLR3319101

Part #	Mfg #	Overall Size	Holes	Depth	Drain Opening	Min Sink Base	Price
103554	DLR3319101	33" x 19-1/2"	1	10-1/8"	3-1/2"	36"	
089944	DLR3322103	33" x 22"	3	10-1/8"	3-1/2"	36"	
086752	DLR3322104	33" x 22"	4	10-1/8"	3-1/2"	36"	
084511	DLR3322123	33" x 22"	3	12-1/8"	3-1/2"	36"	
162379	DLR3722102	37" x 22"	2	10"	3-1/2"	42"	
222603	DLR3722103	37" x 22"	3	10"	3-1/2"	42"	
149622	DLR4322103	43" x 22"	3	10-1/8"	3-1/2"	48"	

**Gourmet® Lustertone® Self-Rimming Offset Double Bowl Sink**

- 18" Gauge
- Lustrous highlighted satin finish
- 1 2 S2 3 4 faucet holes
- Fully undercoated
- Sound guard undercoating ( **LR2503** only)
- AD models are ADA compliant



Part #	Mfg #	Overall Size	Holes	Depth	Drain Opening	Min Sink Base	Price
138481	LR2503	33" x 22"	3	7-7/8"	3-1/2"	36"	
047861	LR2504	33" x 22"	4	7-7/8"	3-1/2"	36"	

**Lustertone® SS Undermount Equal Double Bowl Sink**

- 18" Gauge
- Lustrous highlighted satin finish
- Sound guard undercoating
- **ELUH3118PD model** includes two perfect drain kits
- Drains not included unless **PD** exist in model number



ELUH311



ELUH311810PD



ELUH361710

Part #	Mfg #	Overall Sink Size	Left Bowl	Right Bowl	Depth	Drain Opening	Min Base	Price
020222	ELUH3118	30-3/4" x 18-1/2"	N/A	10"	3-1/2"	36"		
172772	ELUH311810L	30-3/4" x 18-1/2"	N/A	10"	3-1/2"	36"		
179739	ELUH311810PD	30-3/4" x 18-1/2"	N/A	10"	3-1/2"	36"		
117038	ELUH361710	35-3/4" x 18-1/2"	N/A	10"	3-1/2"	39"		



## Kitchen Stainless Steel Sinks

### Gourmet® Lustertone® SS Undermount Double Bowl Sink with Reversible Design

- 18" Gauge
- Lustrous highlighted satin finish
- Sound guard undercoating
- Drains not included
- (-DBG) Sink Kit includes:
  - ELUH3219 Sink
  - LKWBG2115SS Bottom grid
  - LK99 Drain



Part #	Mfg #	Overall Sink Size	Left Bowl	Right Bowl	Depth	Drain Opening	Min Base	Price
085128	ELUH3129	32-1/4" x 18-1/4"	N/A	7-3/4"	3-1/2"	36"		
245777	ELUH3219DBG	32-1/4" x 18-1/4"	N/A	7-3/4"	3-1/2"	36"		

### Gourmet® Lustertone® SS Undermount Offset Double Bowl Sink

- 18" Gauge
- Lustrous highlighted satin finish
- Sound guard undercoating
- **PD** includes two perfect drains
- **PBG** includes two perfect drain kits & bottom grid kit
- **PDK** includes two perfect drain kits & e-dock
- **LDBG** includes one perfect drain & bottom grid
- Drains not included unless stated through model number



ELUH3120L



ELUH3120

Part #	Mfg #	Overall Sink Size	Left Bowl	Right Bowl	Depth	Drain Opening	Min Base	Price
038604	ELUH3120L	31-1/4" x 20-1/2"	N/A	9-7/8"	3-1/2"	36"		
244770	ELUH3120LDBG	31-1/4" x 20-1/2"	N/A	9-7/8"	3-1/2"	36"		
177202	ELUH3120LPD	31-1/4" x 20-1/2"	N/A	9-7/8"	3-1/2"	36"		
186061	ELUH3120LPDBG	31-1/4" x 20-1/2"	N/A	9-7/8"	3-1/2"	36"		
182840	ELUH3120LPDK	31-1/4" x 20-1/2"	N/A	9-7/8"	3-1/2"	36"		
018512	ELUH3120R	31-1/4" x 20-1/2"	N/A	9-7/8"	3-1/2"	36"		
172758	ELUH3120RPD	31-1/4" x 20-1/2"	N/A	9-7/8"	3-1/2"	36"		

### Gourmet® Lustertone® SS Undermount Offset 60/40 Double Bowl Sink

- 18" Gauge
- Lustrous highlighted satin finish
- Sound guard undercoating
- Drains not included



Part #	Mfg #	Overall Sink Size	Left Bowl	Right Bowl	Depth	Drain Opening	Min Base	Price
085842	ELUH3520L	35-1/4" x 20-1/2"	N/A	9-7/8"	3-1/2"	39"		
081134	ELUH3520R	35-1/4" x 20-1/2"	N/A	9-7/8"	3-1/2"	39"		

**Kitchen Stainless Steel Sinks**

**Gourmet® Lustertone® SS Undermount Double Bowl Sink**

- 18" Gauge
- Lustrous highlighted satin finish
- Sound guard undercoating
- Fully undercoated with pad(s) ( **ELUHAD2316** model)
- **ELUHAD311855PD** includes two perfect drains
- Drains not included unless **PD** exist in model number



ELUHAD311845



ELUHAD311855PD

Part #	Mfg #	Overall Sink Size	Left Bowl	Right Bowl	Depth	Drain Opening	Min Base	Price
154507	ELUHAD311845	30-3/4" x 18-1/2"	N/A	4-1/2"	3-1/2"	36"		
181979	ELUHAD311845PD	30-3/4" x 18-1/2"	N/A	4-1/2"	3-1/2"	36"		
244066	ELUHAD311850PD	30-3/4" x 18-1/2"	N/A	4-7/8"	3-1/2"	36"		
175153	ELUHAD311855	30-3/4" x 18-1/2"	N/A	5-1/2"	3-1/2"	36"		
226195	ELUHAD311855PD	30-3/4" x 18-1/2"	N/A	5-1/2"	3-1/2"	36"		
159960	ELUHAD321650	31-3/4" x 16-1/2"	N/A	5"	3-1/2"	36"		

**Gourmet® Lustertone® Undermount SS Equal Double Bowl Corner Sink**

- 18" Gauge
- Lustrous highlighted satin finish
- Sound guard undercoating
- Drains not included



Part #	Mfg #	Overall Size	Holes	Depth	Drain Opening	Min Sink Base	Price
093856	ELUH3232	32" x 32"	N/A	7-7/8"	3-1/2"	36"	

**Gourmet® Lustertone® Undermount Farm Apron Front Double Bowl Sink**

- 18" Gauge
- Lustrous highlighted satin finish
- 8" High apron
- Sound guard undercoating
- DBG models include:  
-LKWOBG1316SS Bottom grid  
-LK99 Drain
- Drains included ONLY in DBG models



ELUHF332010DB



ELUHF332

Part #	Mfg #	Overall Size	Holes	Depth	Drain Opening	Min Sink Base	Price
082964	ELUHF3320	33" x 20-1/2"	N/A	7-7/8"	3-1/2"	36"	
225357	ELUHF332010	33" x 20-1/2"	N/A	10"	3-1/2"	36"	
227482	ELUHF332010DBG	33" x 20-1/2"	N/A	10"	3-1/2"	36"	
165329	ELUHF3320DBG	33" x 20-1/2"	N/A	7-7/8"	3-1/2"	36"	

## Kitchen Stainless Steel Sinks

### Gourmet® Pacemaker® SS Self-Rimming Equal Double Bowl Sink

- 20" Gauge
- Bright satin finish
- 1 2 MR2 3 4 5 faucet holes
- Fully undercoated
- Drains not included



PSR33191

Part #	Mfg #	Overall Size	Holes	Depth	Drain Opening	Min Sink Base	Price
120694	PSR33191	33" x 19-1/2"	1	7-1/8"	3-1/2"	36"	
171066	PSR33192	33" x 19-1/2"	2	7-1/8"	3-1/2"	36"	

### Lustertone® Undermount SS Double Bowl Sink

- 18" Gauge
- Lustrous highlighted satin finish
- Sound guard undercoating
- AQD models include high aqua divide  
-**ELUHAQD3218** 4-5/8" high aqua divide
- **ELUH322010PD** model includes:  
-Perfect drain
- Drains not included



Part #	Mfg #	Overall Size	Holes	Depth	Drain Opening	Min Sink Base	Price
155538	ELUH3121L	30-3/4" x 21"	N/A	9-7/8"	3-1/2"	36"	
134104	ELUH3220	31-1/4" x 20"	N/A	7-7/8"	3-1/2"	36"	
169877	ELUH322010PD	31-1/4" x 20"	N/A	9-7/8"	3-1/2"	36"	
144078	ELUHAQD3218	32-1/16" x 18-1/2"	N/A	8"	3-1/2"	36"	
141831	ELUHAQD32179	32-1/16" x 18-1/2"	N/A	9"	3-1/2"	36"	

### Gourmet® Undermount Stainless Steel Equal Double Bowl Sink with Aqua Divide

- 19" Gauge
- Bright highlighted satin finish
- 4-7/8" High aqua divide
- Fully undercoated with pad(s)
- Drains not included



Part #	Mfg #	Overall Size	Holes	Depth	Drain Opening	Min Sink Base	Price
129305	EAQDUH3118	32-1/2" x 18-1/8"	N/A	8"	3-1/2"	36"	

### Lustertone SS Self-Rimming Equal Double Bowl Kitchen Sink

- 18" Gauge
- Lustertone finish
- 1 2 MR2 3 4 5 faucet holes
- Bottom only pads
- Center drain placement



Part #	Mfg #	Overall Size	Holes	Depth	Drain Opening	Min Sink Base	Price
240712	LR4322-4	43" x 22"	4	7-5/8"	3-1/2"	48"	

**Kitchen Stainless Steel Sinks**

**Harmony™ Elumina Undermount SS Double Bowl Sink**

- 18" Gauge
- Soft highlighted satin finish
- Sound guard undercoating
- Drains not included



Part #	Mfg #	Overall Size	Holes	Depth	Drain Opening	Min Sink Base	Price
055152	ELUH3119R	31-1/4" x 20"	N/A	7-1/2"	3-1/2"	36"	

**Harmony™ Lustertone® Undermount SS Double Bowl Sink**

- 18" Gauge
- Lustrous highlighted satin finish
- Sound guard undercoating
- Drains not included



Part #	Mfg #	Overall Size	Holes	Depth	Drain Opening	Min Sink Base	Price
068543	ELUH311910R	31-1/4" x 20"	N/A	10"	3-1/2"	36"	

**Harmony™ Undermount SS Double Bowl Sink**

- 18" Gauge
- Lustrous highlighted satin finish
- Sound guard undercoating
- PD models include:  
-Two perfect drain kits



Part #	Mfg #	Overall Size	Holes	Depth	Drain Opening	Min Sink Base	Price
168914	ELUH31229RPD	32-3/4" x 21"	N/A	9"	3-1/2"	36"	

**Harmony™ Slim Rim Dual-Mount SS Double Bowl Sink**

- 18" Gauge
- Lustrous highlighted satin finish
- Sound guard undercoating
- 1 3 2L 2R faucet holes for self-rimming installation
- Includes:  
-Two perfect drain kits



Part #	Mfg #	Overall Size	Holes	Depth	Drain Opening	Min Sink Base	Price
155790	LKHSR2509RPD3	33" x 22"	3	9"	3-1/2"	36"	

**Lustertone® Self-Rimming SS Offset Double Bowl Sink**

- 18" Gauge
- Lustertone finish
- Sound guard undercoating
- 1 2 3 4 S2 faucet holes
- Rear center drain placement
- Drains not included



Part #	Mfg #	Overall Size	Holes	Depth	Drain Opening	Min Sink Base	Price
097706	LGR3322S2	33" x 22"	S2	10"	3-1/2"	36"	

## Kitchen Stainless Steel Sinks

### Lustertone® Undermount SS Equal Double Bowl Sink

- 18" Gauge
- Lustertone finish
- Bottom only pads
- Rear center drain placement



Part #	Mfg #	Overall Size	Holes	Depth	Drain Opening	Min Sink Base	Price
247225	ELUHAD421855	41-3/4" x 18-1/2"	N/A	5-3/8"	3-1/2"	45"	

### Triple Bowl Stainless Steel Kitchen Sinks

#### Lustertone® Classic Self-Rimming SS Triple Bowl Sink

- 18" Gauge
- Lustrous highlighted satin finish
- 3 4 6 8 Faucet holes
- Fully undercoated
- Drains not included



Part #	Mfg #	Overall Size	Holes	Depth	Drain Opening	Min Sink Base	Price
149561	LTR46220	46" x 22"	0	7-5/8"	3-1/2"	51"	
249153	LTR46222	46" x 22"	2	7-5/8"	3-1/2"	51"	
146917	LTR46223	46" x 22"	3	7-5/8"	3-1/2"	51"	
109648	LTR46226	46" x 22"	6	7-5/8"	3-1/2"	51"	
168113	LTR46228	46" x 22"	8	7-5/8"	3-1/2"	51"	
128311	LTR5422103	54" x 22"	3	10-1/8"	3-1/2"	57"	

### Harmony™ Lustertone® Undermount SS Triple Bowl Sink

- 18" Gauge
- Lustrous highlighted satin finish
- Sound guard undercoating
- Drains not included



Part #	Mfg #	Overall Size	Holes	Depth	Drain Opening	Min Sink Base	Price
043543	ELUH4020	40" x 20-1/2"	N/A	9-7/8"	3-1/2"	45"	

### Lustertone® Undermount SS Triple Bowl Sink Kit

- 18" Gauge
- Lustrous highlighted satin finish
- Sound guard undercoating
- Kit includes:
  - ELUH3920 sink
  - (2) LK99 drains
  - (1) LKWOBG1617SS bottom grid
  - (1) LKWOBG1115SS bottom grid



Part #	Mfg #	Overall Size	Holes	Depth	Drain Opening	Min Sink Base	Price
238754	ELUH3920DBG	39-1/2" x 20"	N/A	10"	3-1/2"	45"	



## Kitchen Stainless Steel Sinks

### Stainless Steel Sink Cleaners

### Sink Accessories

#### Bottom Grids

Part #	Mfg #	Overall Size	Holes	Depth	Drain Opening	Min Sink Base	Price
186065	CTOBG1215SS	Rear Center Drain Opening, Fits Crosstown™ Bowl Size 13-1/2" x 16-3/4"					
186378	CTOBG1315SS	Rear Center Drain Opening, Fits Crosstown™ Bowl Size 14-3/4" x 16-3/4"					
251086	CTXBG1214	Rear Center Drain Opening, Fits Crosstown™ Bowl Size 11-7/8" x 14-3/8"					
249606	CTXBG1316	Rear Center Drain Opening, Crosstown™ Overall Size 13" x 15-1/2"					
249246	CTXBG2815	Right Rear Corner Drain Opening, Crosstown™ Overall Size 28-1/2" x 15-1/2"					
251276	CTXBG2914	Rear Center Drain Opening, Fits Crosstown™ Overall Size 28-7/8" x 14-3/8"					
173331	GFOBG1217SS	Rear Center Drain Opening, Fits Crosstown™ Bowl Size 12" x 17"					
252091	GFOBG1619SS	Rear Center Drain Opening, Fits Crosstown™ Bowl Size 16" x 19"					
188296	GFOBG1717SS	Rear Center Drain Opening, Fits Crosstown™ Bowl Size 17" x 17"					
243191	GFOBG2117SS	Rear Center Drain Opening, Fits Crosstown™ Bowl Size 21" x 17"					
249778	GFOBG2417RSS	Right Rear Drain Opening, Fits Crosstown™ Bowl Size 24" x 17"					
165343	LKFOB1916SS	Rear Center Drain Opening, Fits Avado™ Bowl Size 19" x 16"					
240494	LKFOBG3116SS	Fits Bowl Size 30-1/2" x 16", Polished Stainless Steel					
167474	LKFOBG3218SS	Left Center Drain Opening, Fits Avado™ Bowl Size 32" x 18"					
225437	LKOBG1115SS	Rear Center Drain Opening, Fits Bowl Size 13-1/8" x 16-5/8"					
247070	LKOBG1216SS	Rear Center Drain Opening, Fits Bowl Size 16-1/2" x 16-1/2"					
247072	LKOBG1417LSS	Rear Center Drain Opening, Fits Bowl Size 15-3/16" x 17-7/8"					
247073	LKOBG1417RSS	Rear Center Drain Opening, Fits Bowl Size 15-3/16" x 17-7/8"					
247074	LKOBG1516SS	Rear Center Drain Opening, Fits Bowl Size 15-1/8" x 16-3/8" and 15-1/4" x 16-1/8"					
247075	LKOBG1518SS	Rear Center Drain Opening, Fits Bowl Size 15-1/8" x 18-1/8"					
251709	LKOBG1616SS	Rear Center Drain Opening, Fits Bowl Size 13-1/8" x 13-1/8"					
247071	LKOBG1718SS	Rear Center Drain Opening, Fits Bowl Size 16-1/2" x 16-1/2"					
247076	LKOBG2217SS	Rear Center Drain Opening, Fits Bowl Size 22-3/8" x 16-3/8"					
241472	LKOBG3014SS	Rear Center Drain Opening, Fits Bowl Size 14-7/16" x 29-15/16"					
247077	LKOBG3016RSS	Rear Right Drain Opening, Fits Bowl Size 30-5/16" x 16-13/32"					
247078	LKOBG3017RSS	Rear Right Drain Opening, Fits Bowl Size 30-5/16" x 17-7/8"					
240975	LKWBG1419SS	Center Drain Opening, Fits Bowl Size 13-7/16" x 18-9/16"					
186383	LKWBG1519SS	Center Drain Opening, Fits Bowl Size 15-3/8" x 18-1/8"					
240974	LKWBG1719SS	Center Drain Opening, Fits Bowl Size 17" x 18-9/16"					
168918	LKWOBG1118SS	Rear Center Drain Opening, Fits Bowl Size 11" x 17-11/16"					
100563	LKWOBG1316SS	Center Drain Opening, Fits Bowl Size 13-1/2" x 16"					
098158	LKWOBG1418SS	Rear Center Drain Opening, Fits Bowl Size 14" x 18"					
177773	LKWOBG1618SS	Rear Center Drain Opening, Fits Bowl Size 16" x 18"					
168916	LKWOBG1819SS	Rear Center Drain Opening, Fits Bowl Size 18" x 18-1/2"					
154525	LKWOBG2317SS	Rear Center Drain Opening, Fits Bowl Size 23" x 16-3/4"					
161793	LKWOBG2416SS	Rear Center Drain Opening, Fits Bowl Size 24" x 16"					
108131	LKWOBG2816SS	Rear Center Drain, Fits Bowl Size 28" x 16"					



**Kitchen Stainless Steel Sinks**

**Rinse Baskets**

Part #	Mfg #	Overall Size	Holes	Depth	Drain Opening	Min Sink Base	Price
185151	LKFRB1316SS	Fits Avado™ Bowl Size 13-1/2" x 16"					
170310	LKFRB1418SS	Fits Avado™ Bowl Size 14" x 18"					
169788	LKFRB2816SS	Fits Avado™ Bowl Sizes 28" x 16" and 30-1/2" x 16"					
157244	LKWRB1318SS	Fits Bowl Size 13-1/2" x 18"					
186256	LKWRB1716SS	Fits Bowl Size 16-1/2" x 16-1/2"					

**Cutting Boards**

Part #	Mfg #	Overall Size	Holes	Depth	Drain Opening	Min Sink Base	Price
167786	CB912	Fits Bowl Size 12" x 9-1/4", 12" x 10", and 12" x 12"					
185025	LKCB2317HW	Fits Bowl Sizes 23" x 16-3/4"					
175873	LKCBF17HW	Fits Crosstown™ Sink Models					

**SinkMate™ Kits**

**SinkMate™ Kit with Hook, Sponge Holder, and Ledge**

- *Stainless steel*
- *Includes:*
  - 17" Backing strip
  - Hook (LKEKHOOK)
  - Ledge (LKEKLEDGE)
  - Magnet (LKEKMAGNET)
  - Sponge holder (LKEKSPONGE)



Part #	Mfg #	Overall Size	Holes	Depth	Drain Opening	Min Sink Base	Price
182938	LKSMHSL	For Any Size Sink Bowl, 8" x 4-13/16" x 3-5/8"					

**Kitchen Stainless Steel Sinks**

**Dayton® Double Bowl Stainless Steel Sinks**

**Dayton® Elite Self-Rimming Double Bowl SS Sink**

- 20" Gauge
- Elite satin finish
- 1 2 MR2 3 4 5 faucet holes
- Fully undercoated
- Drains not included



DSE-23322-4

Part #	Mfg #	Overall Size	Holes	Depth	Drain Opening	Min Sink Base	Price
173233	DSE233222	33" x 22"	2	8-1/16"	3-1/2"	36"	
238274	DSE23322MR2	33" x 22"	MR2	8-1/16"	3-1/2"	36"	
041910	DSE233223	33" x 22"	3	8-1/16"	3-1/2"	36"	
049617	DSE233224	33" x 22"	4	8-1/16"	3-1/2"	36"	
175960	DSE233191	33" x 19"	1	8"	3-1/2"	36"	
163486	DSE233193	33" x 19"	3	8"	3-1/2"	36"	
187832	DSE23319MR2	33" x 19"	MR2	8"	3-1/2"	36"	
181900	DSE233214	33" x 21-1/4"	4	8-1/16"	3-1/2"	36"	

**Dayton® Premium Dual-Mount Double Bowl SS Sink**

- 18" Gauge
- Premium highlighted satin finish
- 1 2L 2R 3 faucet holes
- Slim Rim —ultra-thin edge virtually eliminates barrier between sink & countertop
- Fully undercoated
- R or L at end of model number indicates which side is larger on offset bowl
- Drains not included



Part #	Mfg #	Overall Size	Holes	Depth	Drain Opening	Min Sink Base	Price
166793	DPXSR2250R1	33" x 22"	1	8"	3-1/2"	36"	
177215	DPXSR2250R2R	33" x 22"	2R	8"	3-1/2"	36"	
169118	DPXSR233223	33" x 22"	3	8"	3-1/2"	36"	
160927	DPXSR233222R	33" x 22"	2R	8"	3-1/2"	36"	

**Dayton® Self-Rimming Equal Double Bowl SS Sink**

- 22" gauge
- Satin finish
- Undercoated on bottom of bowls
- 1 2 MR2 3 4 5 faucet holes
- 1 3 4 Faucet holes ( for model **22519** only)
- Drains not included



Part #	Mfg #	Overall Size	Holes	Depth	Drain Opening	Min Sink Base	Price
155039	D225191	25" x 19"	1	6-1/4"	3-1/2"	30"	
006082	D225193	25" x 19"	3	6-1/4"	3-1/2"	30"	
004174	D225194	25" x 19"	4	6-1/4"	3-1/2"	30"	

**Kitchen Stainless Steel Sinks**

**Dayton® Double Bowl Stainless Steel Sinks (Continued)**

**Dayton® Self-Rimming Equal Double Bowl SS Sink**

Part #	Mfg #	Overall Size	Holes	Depth	Drain Opening	Min Sink Base	Price
170370	D233191	33" x 19"	1	6-7/16"	3-1/2"	36"	
004175	D233193	33" x 19"	3	6-7/16"	3-1/2"	36"	
004176	D233194	33" x 19"	4	6-7/16"	3-1/2"	36"	
004177	D233213	33" x 21-1/4"	3	6-1/2"	3-1/2"	36"	
004178	D233214	33" x 21-1/4"	4	6-1/2"	3-1/2"	36"	
251082	D233215	33" x 21-1/4"	5	6-9/16"	3-1/2"	36"	
161612	D233221	33" x 22"	1	6-9/16"	3-1/2"	36"	
141784	D23322MR2	33" x 22"	MR2	6-9/16"	3-1/2"	36"	
004179	D233223	33" x 22"	3	6-9/16"	3-1/2"	36"	
004180	D233224	33" x 22"	4	6-9/16"	3-1/2"	36"	
156270	GE233223	33" x 22"	3	5-3/8"	3-1/2"	36"	
260299	K233221	33" x 22"	1	6-1/16"	3-1/2"	36"	

**Dayton® Self-Rimming Equal Double Bowl SS Kitchen Sink**

- 22" Gauge
- Satin finish
- 1 2 MR2 3 4 or 5 faucet holes
- Undercoated on bottom of bowls
- Drains not included



Part #	Mfg #	Overall Size	Holes	Depth	Drain Opening	Min Sink Base	Price
149510	DD233224	33" x 22"	1	7-1/16"	3-1/2"	36"	

**Dayton® DXR Series Self-Rimming Double Bowl SS Sink**

- 18 Gauge"
- Satin finish
- Fully undercoated
- 1 2 S2 3 4 faucet holes
- 1 2 MR2 3 4 5 faucet holes ( 3322 model only)
- Drains not included



Part #	Mfg #	Overall Size	Holes	Depth	Drain Opening	Min Sink Base	Price
160655	DXR250R2	33" x 22"	2	8-1/8"	3-1/2"	36"	
181323	DXR250R3	33" x 22"	3	8-1/8"	3-1/2"	36"	
155919	DXR250RS2	33" x 22"	S2	8-1/8"	3-1/2"	36"	
156083	DXR33221	33" x 22"	1	8-3/16"	3-1/2"	36"	
156711	DXR33223	33" x 22"	3	8-3/16"	3-1/2"	36"	
141488	DXR33224	33" x 22"	4	8-3/16"	3-1/2"	36"	
175408	DXR3322MR2	33" x 22"	MR2	8-3/16"	3-1/2"	36"	

**Kitchen Stainless Steel Sinks**

**Dayton® Undermount Double Bowl SS Sink**

- 18" Gauge
- Radiant satin finish
- Fully undercoated over pads
- Drains not included



Part #	Mfg #	Overall Size	Holes	Depth	Drain Opening	Min Sink Base	Price
123314	DXUH3118	31-3/4" x 18-1/4"	N/A	8"	3-1/2"	36"	

**Dayton® Undermount Offset Double Bowl SS Kitchen Sink**

- 18" Gauge
- Radiant satin finish
- Fully undercoated over pads
- L and R represents larger bowl
- Drains not included



Part #	Mfg #	Overall Size	Holes	Depth	Drain Opening	Min Sink Base	Price
146365	DXUH312010L	31-3/4" x 20-1/2"	N/A	10"	3-1/2"	36"	
140905	DXUH312010R	31-3/4" x 20-1/2"	N/A	10"	3-1/2"	36"	

**Dayton® Single Bowl Stainless Steel Sinks**

**Dayton® Elite Self-Rimming Single Bowl SS Kitchen Sink**

- 20" Gauge
- Elite satin finish
- 1 2 MR2 3 4 or 5 faucet holes
- Fully undercoated
- Drains not included



Part #	Mfg #	Overall Size	Holes	Depth	Drain Opening	Min Sink Base	Price
106282	DSE125222	25" x 22"	2	8-1/16"	3-1/2"	30"	
244828	DSE133224	33" x 22"	4	8-1/16"	3-1/2"	36"	

**Dayton® Kingsford Self-Rimming Single Bowl SS Sink**

- 23" Gauge
- Satin finish
- 1 2 MR2 3 4 or 5 faucet holes
- Undercoated on bottom of bowl
- Drains not included



Part #	Mfg #	Overall Size	Holes	Depth	Drain Opening	Min Sink Base	Price
221500	K125223	25" x 22"	3	6"	3-1/2"	30"	

## Kitchen Stainless Steel Sinks

### Dayton® Self-Rimming Single Bowl SS Sink

- 22" Gauge
- Satin finish
- 1 2 MR2 3 4 5 faucet holes
- Undercoated on bottom of bowl
- Drains not included



Part #	Mfg #	Overall Size	Holes	Depth	Drain Opening	Min Sink Base	Price
166276	D125211	25" x 21-1/4"	1	6-1/2"	3-1/2"	30"	
090995	D125212	25" x 21-1/4"	2	6-1/2"	3-1/2"	30"	
004171	D125214	25" x 21-1/4"	4	6-1/2"	3-1/2"	30"	
004172	D125223	25" x 22"	3	6-1/2"	3-1/2"	30"	
004173	D125224	25" x 22"	4	6-1/2"	3-1/2"	30"	
252482	D12522MR2	25" x 22"	MR2	6-9/16"	3-1/2"	30"	

### Dayton® Self-Rimming Single Bowl SS Bar Sink

- 22" Gauge
- 23" Gauge (*D11515 & D11516 models only*)
- Satin finish
- 1 2 3 Faucet holes
- Undercoated on bottom of bowl
- Drains not included



D11721



D115152



D117193

Part #	Mfg #	Overall Size	Holes	Depth	Drain Opening	Min Sink Base	Price
004169	D115152	15" x 15"	2	5-1/8"	2"	18"	
146719	D115163	15" x 15"	3	5-1/8"	3-1/2"	18"	
061808	D117192	17" x 19"	2	6-1/8"	3-1/2"	21"	
033360	D117193	17" x 19"	3	6-1/8"	3-1/2"	21"	
068528	D117212	17" x 21-1/4"	2	6-1/2"	3-1/2"	21"	
004170	D117213	17" x 21-1/4"	3	6-1/2"	3-1/2"	21"	

### Dayton® Elite Dual-Mount Single Bowl SS Sink

- 20" Gauge
- Elite satin finish
- 1 2 MR2 3 4 5 faucet holes
- Slim Rim
- Fully undercoated
- Drains not included



Part #	Mfg #	Overall Size	Holes	Depth	Drain Opening	Min Sink Base	Price
247256	DSESR127222	27" x 22"	2	8"	3-1/2"	30"	
172902	DSESR127224	27" x 22"	4	8"	3-1/2"	30"	
166175	DSESR12722MR 2	27" x 22"	MR2	8"	3-1/2"	30"	

**Kitchen Stainless Steel Sinks**

**Dayton® Premium Self-Rimming Single Bowl SS Sink**

- 20" Gauge
- Premium highlighted satin finish
- 1 2 MR2 3 4 5 faucet holes
- Fully undercoated
- Drains not included



Part #	Mfg #	Overall Size	Holes	Depth	Drain Opening	Min Sink Base	Price
160830	DPC12522101	25" x 22"	1	10"	3-1/2"	30"	
170391	DPC12522103	25" x 22"	3	10"	3-1/2"	30"	

**Dayton® Self-Rimming SS Single Bowl Sink**

- 18" Gauge
- Satin finish
- 1 2 MR2 3 4 5 faucet holes
- Side and bottom pads only
- Center drain placement
- Drains not included



Part #	Mfg #	Overall Size	Holes	Depth	Drain Opening	Min Sink Base	Price
247025	DXR2522MR2	25" x 22"	MR2	8-3/16"	3-1/2"	30"	

**Dayton® Self Rimming Single Bowl SS Sink**

- 22" Gauge
- Satin finish
- 1 2 MR2 3 4 5 faucet holes
- Drain opening in rear center (GE12521)
- Drain opening in right rear corner (GE12521R)
- Drain opening in left rear corner (GE12521L)
- Undercoated on bottom of bowl
- Drains not included



Part #	Mfg #	Overall Size	Holes	Depth	Drain Opening	Min Sink Base	Price
168552	GE125211	25" x 21-1/4"	1	5-3/8"	3-1/2"	30"	
247618	GE12521R4	25" x 21-1/4"	4	5-3/8"	3-1/2"	30"	
151039	GE125213	25" x 21-1/4"	3	5-3/8"	3-1/2"	30"	



**Kitchen Stainless Steel Sinks**

**Dayton® Self-Rimming SS Single Bowl Kitchen Sink**

- 22" Gauge
- Satin finish
- 1 2 MR2 3 4 5 faucet holes
- Drain opening in left rear corner (-L)
- Drain opening in right rear corner (-R)
- Drain opening in rear center (GE12522)
- Undercoated on bottom of bowl
- Drains not included



Part #	Mfg #	Overall Size	Holes	Depth	Drain Opening	Min Sink Base	Price
186996	GE12522RMR2	25" x 22"	MR2	5-3/8"	3-1/2"	30"	

**Dayton® Undermount SS Single Bowl Sink with Round Edges**

- 18" Gauge
- Radiant satin finish
- Fully undercoated with pad
- Drains not included



Part #	Mfg #	Overall Size	Holes	Depth	Drain Opening	Min Sink Base	Price
165803	DXUH2118	23-1/2" x 21-3/16"	N/A	8"	3-1/2"	27"	

**Dayton® Undermount SS Single Bowl Sink**

- 18" Gauge
- Radiant satin finish
- Fully undercoated over pad
- Drains not included



Part #	Mfg #	Overall Size	Holes	Depth	Drain Opening	Min Sink Base	Price
179775	DXUH1318	16" x 20-1/2"	N/A	8"	3-1/2"	21"	
120525	DXUH1618	16-1/2" x 18-1/4"	N/A	8"	3-1/2"	21"	
170263	DXUH2416	26-1/2" x 18-1/2"	N/A	8"	3-1/2"	30"	

**Dayton® Undermount SS Single Bowl Sink**

- 18" Gauge
- Soft satin finish
- Bottom only pads
- Drains not included



Part #	Mfg #	Overall Size	Holes	Depth	Drain Opening	Min Sink Base	Price
243055	DCFU2115	23-1/2" x 18-1/4"	N/A	8"	3-1/2"	27"	

---



---

**Kitchen Stainless Steel Sinks**

---



---

**Dayton® Sink Accessories****Bottom Grids**

		Size	Fits Bowl Sizes	Material
168887	GBG1318SS	DCFU2115		
177166	GBG1415SS	Fits Bowl Size 14" x 15-3/4"		

## Kitchen Stainless Steel Sinks

### Stainless Steel Kitchen Sinks

#### Double Bowl Undermount Stainless Steel Sink



Part #	Mfg #	Overall Dimensions	Basin Depth	Holes	Bowls	Price
159969	G20273	20" x 17"	7.5"	NA		
160126	G18256	29-1/4" x 18-1/2"	7"	NA		
164469	G18265	34-1/4" X 20"	8"	NA		
176356	G18264	34-1/4" x 20"	10,8	NA		

#### 1800 Single Bowl Stainless Steel Undermount Sink

- SoundSHIELD™
- Sink template included
- 18 Gauge stainless steel



Part #	Mfg #	Overall Dimensions	Basin Depth	Holes	Drain Placement	Price
250696	G18195L	18"X23"	5-1/2"	N/A	Left	
250697	G18443	16"x18"	8"	N/A	Center	
243428	G18110	31-1/4" x 18"	10"	N/A	Center	
164471	G18190	23" x 18"	10"	NA	Center	
173764	G18191	23" x 18"	8"	NA	Center	
240182	G18192B	23" x 18"	7"	N/A	Rear Center	
181993	G18185	22" x 20"	8-1/2"	NA	Center	
187631	G18442	16" x 18"	10"	NA	Center	

#### 2000 Single Bowl Stainless Steel Undermount Sinks

- 20 Gauge stainless steel
- Features SoundSHIELD™
- 3-1/2" Drain opening



Part #	Mfg #	Overall Dimensions	Basin Depth	Holes	Bowls	Price
225541	G20192	18" x 23"	7-1/2"	NA	Single	

## Kitchen Stainless Steel Sinks

### 1800 Undermount Stainless Steel Apron Front Sink

- 18 Gauge stainless steel
- Rear drain location
- Mounting brackets included, other standard mounting hardware and silicone sealant not included
- SoundSHIELD sound absorbing system
- Template number 22512



Part #	Mfg #	Overall Dimensions	Basin Depth	Holes	Bowls	Price
184851	G18121	30" x 21"	9"	NA	Single	
177121	G18220	30" x 21"	9"	NA	Double Equal	

### 2000 Double Bowl Drop In Stainless Steel Sink

- 20 Gauge stainless steel, brushed finish
- Rear drain, 3-5/8" opening
- U-channel mounting system, hardware included
- QuickMount™ installation included
- 7/8" Corner radius
- Includes SoundShield™ sound absorbing system



Part #	Mfg #	Overall Dimensions	Basin Depth	Holes	Bowls	Price
249394	G202173BQ	33" x 22"	5-1/2"	3	Double Equal	

### 2000 Double Bowl Drop In Stainless Steel Sink

- 22 Gauge stainless steel, brushed finish
- Center drain
- U-channel mounting system, hardware included
- Up to 1-1/8" max deck thickness
- Includes SoundShield sound absorbing system



Part #	Mfg #	Overall Dimensions	Basin Depth	Holes	Bowls	Price
184032	G222133	33" x 22"	8"	3	Double Equal	
170651	G222134	33" x 22"	8"	4	Double Equal	

### 2000 Single Bowl Stainless Steel Sink with Faucet

- 20 Gauge stainless steel
- Center drain
- U-Channel mounting system, hardware included
- SoundSHIELD sound absorbing system
- Sealite integrated drain assembly included
- Faucet sku #4904
- (-BQ) Includes faucet, drain, and strainer



Part #	Mfg #	Overall Dimensions	Basin Depth	Holes	Bowls	Price
245834	TG2045522BQ	16-5/8" x 17-5/16"	5.5"	2-H w/ Faucet, Drain, Strainer	Single	

## Kitchen Stainless Steel Sinks

### Stainless Steel Top-Mount Kitchen Sinks

#### Double Bowl Stainless Steel Sink

- 23 Gauge (-513)
- 20 Gauge (-5476)
- 304 Stainless steel
- 3-1/2" Drain opening
- Lustrous satin finish
- Fully coated underneath with heavy duty sound deadening pads
- Includes fasteners and instructions



Part #	Mfg #	Overall Dimensions	Basin Depth	Holes	Bowls	Price
186063	003-513	33" x 22"	6"	4	Double Equal	
186064	481-5476	33" x 22"	8"	4	Double Equal	

#### Top-Mount Double Bowl Stainless Steel Sink

- 20 Gauge (-0531)
- 23 Gauge (-1338)
- 304 Stainless steel
- 3-1/2" Drain opening
- Lustrous satin finish
- Full coated underneath with heavy duty sound deadening pads
- Includes fasteners and instructions
- Cutout template on box



Part #	Mfg #	Overall Dimensions	Basin Depth	Holes	Bowls	Price
186060	481-1338	33" x 22"	6"	3	Double Equal	
186062	481-0531	33" x 22"	8"	3	Double Equal	

#### Single Bowl Stainless Steel Sink

- 23 Gauge
- Premium grade 304 stainless steel
- 3-1/2" Drain opening
- Lustrous satin finish
- Full coated underneath with heavy duty sound deadening pad
- Includes fasteners and instructions
- Cutout template on box



Part #	Mfg #	Overall Dimensions	Basin Depth	Holes	Bowls	Price
186827	003-525	25" x 22"	6"	4	Single	
186536	004-136	15" x 15"	6"	2	Single	

## Kitchen Stainless Steel Sinks

### Gran-N-Go Single Bowl Stainless Steel Sink

- Includes: sink, faucet, and basket strainer
- 22 Gauge
- Lustrous satin
- 3-1/2" Drain opening
- Fully coated underneath with heavy duty sound deadening pad
- Includes fasteners and instructions
- Cutout template (DXF File Available)



Part #	Mfg #	Overall Dimensions	Basin Depth	Holes	Bowls	Price
235399	712-6027	25" x 22"	8"	4, Faucet Included	Single	

### Stainless Steel Under-Mount Kitchen Sinks

#### Single Bowl Stainless Steel Under-Mount Sink

- Premium Grade 18 gauge 304 Stainless Steel
- 9" Depth
- Lustrous Satin
- Highlighted Rim
- 3½" Drain Opening
- Fully Coated Underneath with Heavy Duty Sound Deadening Pad
- Supplied with Fasteners and Instructions
- Cutout Template (DXF File Available)
- Limited Lifetime Warranty



Part #	Mfg #	Overall Dimensions	Basin Depth	Holes	Bowls	Price
248263	481-1422	30" x 18"	9"	N/A	Single	



## Floor Sinks

### Cast Iron Floor Sinks

#### Deep Sanitary Floor Sink

- 12" Square top x 8" Deep sink
- Sink has white porcelain enamel-coated interior
- Loose set porcelain enamel-coated cast iron grate
- Aluminum dome strainer
- Options:
  - Suffix P = Push-on outlet
  - Suffix 22 = Less grate



Part #	Mfg #	Description	Price
097024	FS-744-P-22	For 4" Pipe	

#### Large Square Top Sanitary Floor Sink

- 12" Square top x 6" Deep sink
- Sink has white porcelain enamel-coated interior
- Loose set enamel-coated cast iron grate
- Aluminum dome bottom strainer
- Options:
  - Suffix P = Push-on outlet
  - Suffix 22 = Less grate



Part #	Mfg #	Description	Price
046245	FS-732-22	For 2" Pipe	
046242	FS-732-P-22	For 2" Pipe	
046246	FS-733-22	For 3" Pipe	
046243	FS733-P-22	For 3" Pipe	
046247	FS-734-22	For 4" Pipe	
046244	FS734-P-22	For 4" Pipe	

#### ProLine Square Top Floor Sink

- 12" Square x 6" Deep sink
- Aluminum dome bottom strainer
- White porcelain enamel-coated interior
- Loose set enamel-coated cast iron grate



Part #	Mfg #	Description	Price
245327	FS55-4NH	For 4" Pipe	

### Square Top Sanitary Floor Sink

- 8" Square top x 6" Deep sink
- Sink has white porcelain enamel-coated interior
- Loose set porcelain enamel-coated cast iron grate
- Aluminum dome bottom strainer
- Options:
  - Suffix P = Push-on outlet
  - Suffix 1 = Nickel bronze top
  - Suffix 22 = Less grate
  - Suffix 175 = 3/4" Grate
  - Suffix F = Flange with Weepholes
  - Suffix FC = Flange w/ Weepholes & Flashing Clamp



Part #	Mfg #	Description	Price
076231	FS-712-P-22	For 2" Pipe	
080485	FS-713-P-22	For 3" Pipe	
239399	FS-713-F-22	For 3" NH Pipe	
239387	FS-713-FC-1	For 3" NH Pipe	
239388	FS-714-FC-1	For 4" NH Pipe	

### Square Top Sanitary Floor Sink

- 12" Square x 6" deep
- No hub standard outlet
- Aluminum dome bottom strainer
- White porcelain enamel-coated interior
- Loose set porcelain enamel-coated cast iron grate
- Options:
  - Suffix 1 = Nickel bronze top
  - Suffix 175 = 3/4" Grate
  - Suffix FC = Flange with weepholes & flashing clamp



Part #	Mfg #	Description	Price
245258	FS-734-FC-1-17	For 4" Pipe	
	5		

### Stainless Steel Floor Sinks

#### Stainless Steel Square Top Sanitary Floor Sink

- 12 Square x 8" deep
- 14 Gauge, 304 stainless steel
- No hub standard outlet
- Dome bottom strainer
- Loose set cast stainless steel grate
- Options:
  - Suffix FC = Flange with weepholes & flashing clamp
  - Suffix 5 = Sediment bucket
  - Suffix 150 = 1/2" Grate



Part #	Mfg #	Description	Price
245328	FS-794	For 4" Pipe	

## Floor Sinks

### Stainless Steel Floor Sinks (Continued)

#### Stainless Steel Square Top Sanitary Floor Sink

Part #	Mfg #	Description	Price
245335	FS-794-FC-5-15	For 4" Pipe 0	

### Components for Floor Drains

#### Grate/Top Assembly

Part #	Mfg #	Description	Price
073688	FG-8NB	Full Grate, 8" x 8", NB	
082078	FG-12NB-1/2	8" sq NB 1/2 Grate Top Assembly for FS-710	
046248	FG-12	Full Grate, 12" x 12"	
046249	FG-12-1/2	1/2" Grate, 12" x 12"	
046250	FG-12-3/4	3/4" Grate, 12" x 12"	
063595	FS-DS	Dome Strainer	

## Mop & Utility Sinks

### Vitreous China

#### Camerton™ Wall-Mount Blow-Out Service Sink—25" x 21-1/2"

- No faucet holes
- Blow-out action flushing rim



Part #	Mfg #	Overall Dimensions	Bowl Depth	Holes	Color	Price
070981	K-12867-0	25" x 21-1/2"	-	-	White	

#### Gilford™ Wall-Mount Scrub-Up/ Plaster Utility Sink

- 30" x 22"
- Back drilled on 8" centers



Part #	Mfg #	Overall Dimensions	Bowl Depth	Holes	Color	Price
099693	K-12787-0	30" x 22"	8-5/8"	2	White	
055430	K-12700-0	30" x 22"	8-5/8"	2	White	
246282	K-12701-7	24" x 22"	8-5/8"	2	Black Black™	
063218	K-12701-0	24" x 22"	8-5/8"	24	White	

### Cast Iron Utility Sinks

#### Bannon™ Wall-Mounted or P-Trap Service Sink

- 22-1/4" x 18-1/4"
- (K-6716 & K-6719) 24" x 20-1/4"
- Without overflow
- Back drilled on 8" centers
- Includes rim guard for added durability
- Blank black included with (K-6718-0) model



Part #	Mfg #	Overall Dimensions	Bowl Depth	Holes	Color	Price
053193	K-6714-0	22-1/4" x 18-1/4"	12"	3	White	
059232	K-6716-0	24" x 20-1/4"	12"	3	White	
053473	K-6718-0	22-1/4" x 18-1/4"	12"	0	White	
059515	K-6719-0	24" x 20-1/4"	12"	0	White	

#### Brockway™ 3' Wall-Mounted Wash Sink

- Without overflow
- 36" x 17-1/2" x 15-5/8"
- Acid resistant enamel finish
- Drilled for three K-8892 Cannock™ faucets and two K-8880 soap dishes



Part #	Mfg #	Overall Dimensions	Bowl Depth	Holes	Color	Price
078907	K-3200-0	36" x 17-1/2"	7"	2	White	

\* Vibrant Limited Lifetime Warranty

[www.plumbsupply.com](http://www.plumbsupply.com) • Serving our Customers Since 1946 • [www.waterconcepts.net](http://www.waterconcepts.net)

## Mop & Utility Sinks

### Brockway™ 4' Wall-Mount Wash Sink

- Without overflow
- 48" x 17-1/2" x 15-5/8"
- Acid resistant enamel finish
- Drilled for three K-8892 Cannock™ faucets and two K-8880 soap dishes



Part #	Mfg #	Overall Dimensions	Bowl Depth	Holes	Color	Price
142733	K-3202-0	48" x 17-1/2"	7"	2	White	

### Brockway™ 5' Wall-Mounted Wash Sink

- Without overflow
- 60" x 17-1/2" x 15-5/8"
- Acid resistant enamel finish
- Drilled for three K-8892 Cannock™ faucets and two K-8880 soap dishes



Part #	Mfg #	Overall Dimensions	Bowl Depth	Holes	Color	Price
055217	K-3203-0	60" x 17-1/2"	7"	6	White	

### Park Falls™ Top-Mount/Under-Mount Utility Sink

- 22" x 10-1/2"
- Fits minimum 21-inch base cabinet if installed as top-mount.
- Fits minimum 24-inch base cabinet if installed as under-mount.
- 12-1/2-inch depth provides generous workspace.
- Small size fits compact spaces.



Part #	Mfg #	Overall Dimensions	Bowl Depth	Holes	Color	Price
178009	K-19022-1-0	22" x 10-1/2"	12-1/2"	1	White	
183494	K-19022-3-0	22"x 10-1/2"	12-1/2"	3	White	

### River Falls™ Top-Mount Utility Sink

- 25" x 22"
- 27" Minimum base cabinet width
- Available with 1, 2, 3, or 4 faucet holes
- Includes wire rack and soaking pan



Part #	Mfg #	Overall Dimensions	Bowl Depth	Holes	Color	Price
112532	K-6657-1-0	25" X 22"	14-1/4"	1	White	
145991	K-6657-1-96	25" X 22"	14-1/4"	1	Biscuit	
055713	K-6657-3-0	25" X 22"	14-1/4"	3	White	
090281	K-6657-3-47	25" X 22"	14-1/4"	3	Almond	
067756	K-6657-3-96	25" X 22"	14-1/4"	3	Biscuit	

\* Vibrant Limited Lifetime Warranty

[www.waterconcepts.net](http://www.waterconcepts.net) • Serving our Customers Since 1946 • [www.plumbsupply.com](http://www.plumbsupply.com)

## Mop & Utility Sinks

### River Falls™ Under-Mount Utility Sink

- 22" x 22"
- 27" Minimum base cabinet width
- 4 oversized faucet holes
- Includes white soaking pan and wire rack



Part #	Mfg #	Overall Dimensions	Bowl Depth	Holes	Color	Price
134385	K-6657-4U-0	25" X 22"	14-1/4"	4U	White	
153405	K-6657-4U-7	25" X 22"	14-1/4"	4U	Black	
154374	K-6657-4U-96	25" X 22"	14-1/4"	4U	Biscuit	

### Glen Falls™ Top-Mount Utility Sink

- 25" x 22"
- 27" Minimum base cabinet with
- Available with 1, 2, or 3 faucet holes



#### K-19017 Dual-Mount

Part #	Mfg #	Overall Dimensions	Bowl Depth	Holes	Color	Price
179617	K-19017-1-0	25" X 22"	13-5/8"	1	White	
224067	K-19017-3-0	25" X 22"	13-5/8"	3	White	
187475	K-19017-1-96	25" X 22"	13-5/8"	1	Biscuit	

### Harborview™ Top-Mount or Wall-Mount Utility Sink

- 48" x 28"
- 50" Minimum base cabinet width
- Available with 1,3, or 4 faucet holes
- Integral apron and backsplash
- Can be wall-mounted with K-6617 legs (sold separately)



Part #	Mfg #	Overall Dimensions	Bowl Depth	Holes	Color	Price
182865	K-6607-1-0	48" X 28"	10"	1	White	
102524	K-6607-1-47	48" X 28"	10"	1	Almond	
081328	K-6607-1-96	48" X 28"	10"	1	Biscuit	
082659	K-6607-4-0	48" X 28"	10"	4	White	

### Tyrell™ Floor-Mounted Siphon-jet Flushing Rim Service Sink

- 21" x 27-1/8"
- 2-1/2" Trapway
- Large basin allows placement of more volume
- 1-1/2" Top spud



Part #	Mfg #	Overall Dimensions	Bowl Depth	Holes	Color	Price
058657	K-6676-0	21" x 27-1/8"	20"	-	White	

\* Vibrant Limited Lifetime Warranty

[www.plumbsupply.com](http://www.plumbsupply.com) • Serving our Customers Since 1946 • [www.waterconcepts.net](http://www.waterconcepts.net)

## Mop & Utility Sinks

### Whitby™ Floor-Mounted Corner Service Sink

- 28" x 28"
- Without overflow
- Rim guard is not included
- Acid-resistant enamel finish



Part #	Mfg #	Overall Dimensions	Water Depth	Holes	Color	Price
060839	K-6710-0	28" x 28"	6-3/4"	Less Holes	White	

### Stainless Steel Utility Sinks

#### Ballad™ Top-Mount Utility Sink

- 25" x 22"
- 18 Gauge stainless steel
- SilentShield® sound-absorption technology
- 27" Minimum base cabinet width



Part #	Mfg #	Overall Dimensions	Bowl Depth	Holes	Color	Price
223325	K-5798-1-NA	25" x 22"	11-5/8"	1	Single	
185531	K-5798-3-NA	25" x 22"	11-5/8"	3	Single	

#### Undertone® Under-Mount Utility Sink

- 23" x 17-1/2"
- 18 Gauge stainless steel
- SilentShield® sound-absorption technology
- 27" Minimum base cabinet width



Part #	Mfg #	Overall Dimensions	Bowl Depth	Holes	Color	Price
119414	K-6661-NA	23" x 17-1/2"	11-1/4"	-	Single	

### Service Sink Drains

#### Adjustable Trap With Cleanout Plug and Strainer



Part #	Mfg #	Description
053474	K-6672-NA	Adjustable Trap for 2" Iron Pipe Connection
053194	K-6673-NA	Adjustable Trap for 3" Iron Pipe Connection

\* Vibrant Limited Lifetime Warranty



## Mop & Utility Sinks

### Mop and Utility Sink Accessories

#### Whitby™ Sink Rim Guard Coated Wire

- Durable coated wire construction
- For use with the K-6710 Whitby service sink



Part #	Mfg #	Overall Dimensions	Bowl Depth	Holes	Color	Price
078257	K-8940-NA	29-1/2" x 5-3/4"	3-7/16"	Wire		

#### Kitchen Sink Utility Rack

- Non slip coating
- Dishcloth rail
- Dishwasher safe
- Removable soaking cup
- Rust-resistant stainless steel
- Expands 3 inches to fit most sinks

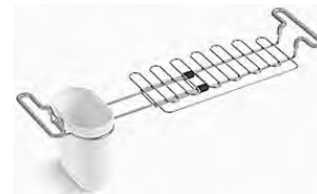

Part #	Mfg #	Description	Price
228562	K-5473-0	White	

\* Vibrant Limited Lifetime Warranty

[www.plumbsupply.com](http://www.plumbsupply.com) • Serving our Customers Since 1946 • [www.waterconcepts.net](http://www.waterconcepts.net)

## Mop & Utility Sinks

### Vikrell® Utility Sinks

- Compression molded from solid Vikrell™ material
- Double high gloss finish



#### Latitude® Self-Rimming Utility Sink

- Unique design features a quarter deck; perfect for cleaning smaller items
- Slight outside curves add a style dimension not found in other utility sinks
- Bond surface texture maintains a superior stain and scratch resistance
- Drill marks provided for drilling the faucet holes
- CSA Certified
- Faucet sold separately



Part #	Mfg #	Dimensions	Color	Price
102432	995-0	25" x 22" x 12"	White	
102434	995-96	25" x 22" x 12"	Biscuit	

#### Latitude® Self-Rimming/Undercounter Utility Sink with Stand

- Durable bond finish
- Gray powder-coated steel stand
- Includes foot levelers and wall brackets
- Lifetime limited warranty



Part #	Mfg #	Dimensions	Color	Price
112446	996-0	25" x 22" x 36"	White	
113845	996-96	25" x 22" x 36"	Biscuit	

**Mop & Utility Sinks**

**Stainless Steel Laundry Sinks**

**Essential™ Single Bowl Drop-In Laundry Sink**

- 304 Series, 18 gauge stainless steel
- 18/10 chrome/nickel content
- Brushed satin finish
- Sound deadening pads



Part #	Mfg #	Finish	Bowl Depth	Overall Size	Cabinet Size	Drain Dia	Price
151577	441078	Stainless Steel	1-Hole, 12"	25" x 22"	24"	3-1/2"	
158134	441400	Stainless Steel	3-Hole, 12"	25" x 22"	24"	3-1/2"	

**Stellar™ Single Bowl Undermount Laundry Sink**

- 304 Series, 18 gauge stainless steel
- 18/10 Chrome/nickel content
- Refined brushed finish
- Center drain placement
- Sound deadening insulation and pads
- Deep functional bowl design



Part #	Mfg #	Finish	Bowl Depth	Overall Size	Cabinet Size	Drain Dia	Price
160335	441398	Stainless Steel	12"	23" x 17-3/4"	27"	3-1/2"	

**Quatrus™ R15 Dual Mount Laundry Sink**

- 304 Series, 18 gauge stainless steel
- 18/10 Chrome/nickel content
- Drop-in or undermount installation
- Rear drain placement
- Sound deadening pads
- Required 27" outside cabinet



Part #	Mfg #	Finish	Bowl Depth	Overall Size	Cabinet Size	Drain Dia	Price
239348	522136	Satin	12"	25" x 22"	27"	3-1/2"	

**Mop & Utility Sinks**

**Composite Laundry Sinks**

**Silgranit® Blanco Liven™ Dual-Mount Laundry Sink**

- Versatile dual deck design
- Drop-in or undermount
- Heat resistant up to 536°F
- Template provided with approximate 1/8" reveal
- Drain not included



Part #	Mfg #	Finish	Bowl Depth	Overall Size	Cabinet Size	Drain Dia	Price
237957	401925	Biscuit	12"	25" x 22"	24"	3-1/2"	
235545	401924	Metallic Gray	12"	25" x 22"	24"	3-1/2"	

**Mop & Utility Sinks**

**Durastone® Laundry Tubs**

- Made with Durastone® - combination of fiberglass and crushed stone blended with special resins for extra strength and durability, marbled white

**10C Durastone® Countertop Utility Sink**

- 17 Gallon capacity
- 13-3/4" Extra deep self-rimming bowl
- Accommodates single or dual-handle faucet with 4" or 8" centers
- Hooks up to standard 1-1/2" P- or S-trap
- Stain resistant, semi-gloss, colorfast finish
- (10) Includes 1-1/2" drain assembly w/ stopper
- (10C) 3-1/2" Reinforced drain opening - fits standard basket drain assembly



Part #	Mfg #	Size	Holes	Capacity	Mounting	Price
007482	10	25"W x 22"L	2 (4"cc or 8"cc)	17 gal	Drop-In	
041226	10C	25"W x 22"L	2 (4"cc or 8"cc)	17 gal	Drop-In	

**Model 11 Durastone® Countertop Utility Sink**

- 9-1/2" Depth
- Self-rimming
- 3-1/2" Drain opening
- 1-1/2" P or S trap connection
- Mounting hardware included
- Stain resistant, semi-gloss, colorfast finish
- Accommodates single or dual-handle faucet with 4" or 8" centers



Part #	Mfg #	Description	Holes	Capacity	Mounting	Price
007484	11	17" x 20"	1, 2, or 3 (4"cc or 8"cc)	17 Gal	Drop-In	

**17F & 17W Utilatub® Durastone® Laundry Tub**

- Sturdy, 1-piece, extra deep molded tub
- 13" Deep
- Built in scrub board
- Leakproof, integrally molded-in drain with stopper
- Hooks up to standard 1-1/2" P- or S-trap
- Floor model includes adjustable leg levelers
- Wall model includes wall mounting bracket, side supports and hardware for securing tub to concrete or stud wall
- Smooth surface, rust resistant

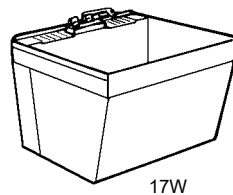

Part #	Mfg #	Size	Holes	Capacity	Mounting	Price
007493	17W	23"W x 23-1/2"L	(2) 4"cc	19 gal	Wall	
007492	17F	23"W x 23-1/2"L	(2) 4"cc	19 gal	Floor	

## Mop & Utility Sinks

### 18F & 18W Utilatub® Durastone® Laundry Tub

- Sturdy, 1-piece, extra deep molded tub
- 13" Deep with smooth surface
- Leakproof, integrally molded-in drain with stopper
- Hooks up to standard 1-1/2" P- or S-trap
- Floor model includes adjustable leg levelers
- Wall model includes wall mounting bracket, side supports and hardware for securing tub to concrete or stud wall



Part #	Mfg #	Size	Holes	Capacity	Mounting	Price
017774	18W	20"W x 24"L	(1 or 2) 4"cc or 8"cc	19 gal	Wall	
007496	18F	20"W x 24"L	(1 or 2) 4"cc or 8"cc	19 gal	Floor	

### 26F & 26W Utilatwin® Durastone® Laundry Tub

- Sturdy, 1-piece, extra deep molded tub
- Includes twin drain waste connector - joins drain assemblies, assures rapid and uniform discharge of waste water, washers, slip nuts and stoppers provided
- 13" Deep
- Hooks up to standard 1-1/2" P- or S-trap
- Floor model includes adjustable leg levelers
- Wall model includes wall mounting bracket, side supports and hardware for securing tub to concrete or stud wall
- Smooth surface, rust resistant



Part #	Mfg #	Size	Holes	Capacity	Mounting	Price
007501	26W	40"W x 24"L	(1 or 2) 4"cc or 8"cc	19 gal	Wall	
007500	26F	40"W x 24"L	(1 or 2) 4"cc or 8"cc	19 gal	Floor	

## Laundry & Utility Tubs

### 28CF BigTub™ Utilatub® Combo Utility Tub

- Molded 1-piece tub
- Impact-resistant polypropylene with heavy gauge steel legs
- Adjustable levelers
- Swivel faucet with 24" long pull-out spout and lever handles
- 1-1/2" P-trap with 12" tailpiece
- (2) 20" Flexible braided supply lines
- Drain stopper for 1-1/2" molded-in drain
- Large, self-draining back shelf
- Mold and mildew-resistant components
- Color-fast, stain-resistant white finish
- Inside dimensions: 36-1/2"W x 12-1/2"L x 17-1/2"D



Part #	Mfg #	Size	Mounting	Price
143590	28CF	40"W x 24"L	Floor	



## Mop & Utility Sinks

### Laundry Sinks

#### Large Utility Laundry Sink

- Swanstone® solid surface w/ no surface coating to chip or crack
- Will not mold or mildew
- Flat deck allows for variety of faucet applications
- Installs into countertop for an upgrade laundry room look
- 17-1/2" Gallon capacity
- 5 Pre-drilled starter holes



Part #	Mfg #	Size	Color	Price
179839	SSUS	25" x 22"	White	
179840	SSUSBI	25" x 22"	Biscuit	
179841	SSUSGG	25" x 22"	Gray Granite	
179842	SSUSMS	25" x 22"	Midnight Sparkle	

#### Small Utility Laundry Sink

- Swanstone® solid surface w/ no surface coating to chip or crack
- Will not mold or mildew
- Flat deck allows for variety of faucet applications
- Installs into countertop for an upgrade laundry room look
- 7" Gallon capacity
- 5 Pre-drilled starter holes



Part #	Mfg #	Size	Color	Price
179843	SSUSS	17-1/2" x 20"	White	
179844	SSUSSMS	17-1/2" x 20"	Midnight Sparkle	

### Mop Service Sinks

- Up to three times stronger than a molded stone type product
- Each unit includes a cast brass drain in either 2" or 3" IPS with a stainless steel dome strainer and lint basket



Part #	Mfg #	Size	Color	Price
023793	MS2424301 0	24" x 24"	White	

### Accessories

Part #	Mfg #	Description	Price
044027	MS-2410	3" to 2" Rubber Drain Adapter	

## Mop & Utility Sinks

### Laundry Tubs

#### Wall-Mount Serv-A-Sink® Laundry Tub

- Single compartment, molded-stone
- Heavy-gauge, galvanized wall bracket
- Side fillers white molded plastic polymers



Part #	Mfg #	Dimension	Holes	Capacity	Color	Price
035540	L-1	23"W x 22"D	(2) 4"cc	20 gal	White	

#### Floor-Mount Serv-A-Sink® Laundry Tub

- Single compartment, molded-stone
- White baked enamel legs and leveling feet



Part #	Mfg #	Dimension	Holes	Capacity	Color	Price
082152	FL-1	23"W x 22"D	(2) 4"cc	20 gal	White	

**Mop & Utility Sinks**

**Durastone® Mop Basins**

- White 1-piece molded construction
- Integrally molded drain with seal
- Model 65M has elevated self-draining shelf
- Meets or exceeds ANSI specifications Z124.2 and 124.6

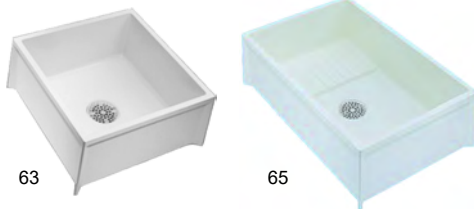

Part #	Mfg #	Size	IPS	Price
028428	63M	10"H x 24"W x 24"L	3"	
028429	65M	10"H x 36"W x 24"L	3"	

**Mop Basin Accessories**

Part #	Mfg #	Description	Price
028535	65.308	2" Drain Seal for 63M	

## Mop & Utility Sinks

### Mop Basins

#### Terrazzo Mop Service Basin

- Terrazzo is made of marble chips cast in grey portland cement



TSB-100

TSBC-1610

TSB-3000

Part #	Mfg #	Description	Price
004342	TSB-100	24" x 24" x 12" w/SS Caps on Curbs	
053122	TSBC-1610	24" x 24" x 12" w/6" Drop Front Neo-Corner	
096028	TSB-3000	24" x 24" x 12", 6" Drop Front w/SS Caps on Curbs	

#### Mop Service Basin

- Molded-Stone® product
- 10" High walls and not less than 1" wide shoulders
- Stainless steel drain body
- Stainless steel combination dome strainer and lint basket



Part #	Mfg #	Description	Price
139126	MSBID2424	24" x 24" x 10" w/Integral Drain	
035937	MSB3624	36" x 24" x 10"	

#### Mop Service Basin Optional Equipment

##### Bumper Guard

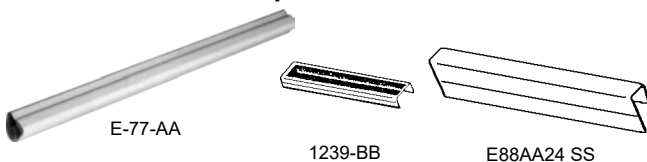

E-77-AA

1239-BB

E88AA24 SS

Part #	Mfg #	Description	Price
019904	E77AA-24	24" Vinyl Bumper Guard	
036477	E77AA-36	36" Vinyl Bumper Guard	
093129	1239BB24	24" Aluminum Bumper Guard	
032989	E88AA24 SS	24" Stainless Steel Bumper Guard	

### Wall Guard

- Stainless steel

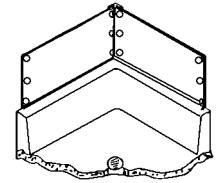

Part #	Mfg #	Description	Price
019906	MSG-2424	24" x 24" Wall Guards	
075666	MSG-3624	36" x 24" Wall Guards	

### Quick Drain Connector

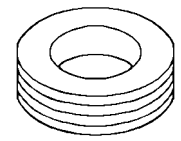

QDC-3-2

Part #	Mfg #	Description	Price
141765	QIC32	2"	
057001	QDC-3-2	Facilitates Connection of 2" Pipe to 3" Drain	
141767	QIC3SN	3", for Cast Iron Soil Pipe	

### Sealant

Part #	Mfg #	Description	Price
029794	833-AA	Silicone Sealant	

### Strainers

Part #	Mfg #	Description	Price
034416	1453-BB	Flat Strainer Plate	

### Deck Type Faucets

- 6-3/4" Threaded spout



Part #	Mfg #	Description	Price
040737	A-1	4" Centers	

### Service Faucet Accessories



832-AA

889-CC

Part #	Mfg #	Description	Price
019903	832-AA	Hose & Hose Bracket	

---



---

## Mop & Utility Sinks

---



---

### Service Faucet Accessories (Continued)

Part #	Mfg #	Description	Price
020373	889-CC	Mop Hanger Bracket	

### 830-AA Group Replacement Assembly Parts



Part #	Mfg #	Description	Price
104739	GRA-07	Vacuum Breaker & Disc Assembly	

**Mop & Utility Sinks**

**Stainless Steel Laundry Sinks**

**Gourmet® Lustertone® Self-Rimming Single Bowl SS Laundry Sink**

- 18" Gauge
- Lustrous highlighted satin finish
- 1 2 MR2 3 OS4 faucet holes
- Fully undercoated
- **DLR191910EK3** includes e-dock hook



Part #	Mfg #	Overall Size	Holes	Depth	Drain Opening	Min Sink	Price
150926	DLR1919101	19-1/2" x 19"	1	10-1/8"	3-1/2"	24"	
088763	DLR1919103	19-1/2" x 19"	3	10-1/8"	3-1/2"	24"	

**Gourmet® Celebrity Self-Rimming Stainless Steel Single Bowl Laundry Sink**

- 20" gauge
- Brushed satin finish
- 1 2 MR2 3 OS4 faucet holes
- Fully undercoated



Part #	Mfg #	Overall Size	Holes	Depth	Drain Opening	Min Sink	Price
118554	ESE2020101	20" x 20"	1	10-1/8"	3-1/2"	24"	

**Dayton® Premium Self-Rimming SS Single Bowl Laundry Sink**

- 20" Gauge
- Premium highlighted satin finish
- 1 2 MR2 3 OS4 faucet holes
- Fully undercoated
- Drains not included



Part #	Mfg #	Overall Size	Holes	Depth	Drain Opening	Min Sink	Price
168295	DPC12020101	20" x 20"	1	10"	3-1/2"	24"	
165034	DPC12020102	20" x 20"	2	10"	3-1/2"	24"	
179920	DPC12020103	20" x 20"	3	10"	3-1/2"	24"	



**Mop & Utility Sinks**

**Commercial Wash-Up SS Wall-Mount Lavatory Sink with Overflow**

- 18" Gauge
- Buffed satin
- 1 3 CS3 faucet holes
- 1-3/4" Coved corners
- 2-1/2" High backsplash & apron front and sides
- Front and side decks with raised rim
- Rear centered outlet
- Meets ADA requirements
- Sound absorbing pads



Part #	Mfg #	Overall Size	Holes	Depth	Drain Opening	Min Sink	Price
114286	ELV2219CS3	22" x 19"	CS3	5-1/2"	1-5/8"	N/A	

**Stainless Steel Service and Utility Scullery Sinks**

**Sturdibilt® Service and Utility SS Single Compartment Scullery Sink**

- 14" Gauge
- Lustrous satin finish
- Drain boards not included
- Square corner welded compartment construction
- Channel rim design with 2" apron
- Straight line styling
- 8" High, full length backsplash with 45° slope
- 14" Deep compartments
- Sink compartments pitched to drain
- Sink supported on (4) LK251 adjustable tubular legs
- 1-5/8" O.D. with up to 1" adjustable bullet shaped feet



Part #	Mfg #	Overall Size	Holes	Depth	Drain Opening	Min Sink	Price
156815	SS81362	27-1/2" x 39"	36"	14"	3-1/2"		

**Sturdibilt® Service and Utility SS Double Compartment Scullery Sink**

- 14" Gauge
- Lustrous satin finish
- Drain boards not included
- Square corner welded compartment construction
- Channel rim design with 2" apron
- Straight line styling
- 8" High, full length backsplash with 45° slope
- 14" Deep compartments
- Sink compartments pitched to drain
- Sink supported on (4) LK251 adjustable tubular legs
- 1-5/8" O.D. with up to 1" adjustable bullet shaped feet



Part #	Mfg #	Overall Size	Holes	Depth	Drain Opening	Min Sink	Price
173638	SS82362	39" x 27-1/2"	36"	14"	3-1/2"		

**Mop & Utility Sinks**

**Sturdibilt® Service and Utility SS Double Compartment Scullery Sink with Drain board**

- 14" Gauge
- Buffed satin finish
- Left or right drain board
- Drain board and sink compartments pitched to drain
- Square corner welded compartment construction
- Channel rim design with 2" apron
- Straight line styling
- 8" Backsplash with 45° slope
- Sink supported on (4) LK251 adjustable tubular legs
- 1-5/8" O.D. with up to 1" adjustable bullet shaped steel feet



Part #	Mfg #	Overall Size	Holes	Depth	Drain Opening	Min Sink	Price
173636	SS8236L2	61-1/2" x 27-1/2"	36"	14"	3-1/2"		

**Sturdibilt® Service and Utility SS Double Compartment Scullery Sink with Drain board**

- 14" Gauge
- Buffed satin finish
- Left and right drain board
- Drain board and sink compartments pitched to drain
- Square corner welded compartment construction
- Channel rim design with 2" apron
- Straight line styling
- 8" Backsplash with 45° slope
- Sink supported on (4) LK251 adjustable tubular legs
- 1-5/8" O.D. with up to 1" adjustable bullet shaped steel feet



Part #	Mfg #	Overall Size	Holes	Depth	Drain Opening	Min Sink	Price
173637	SS8260LR2	108" x 27-1/2"	36"	14"	3-1/2"		

**Commercial Foodservice Budget Series Utility SS Single Compartment Scullery Sink**

- 18" Gauge
- Welded construction
- 8" backsplash
- Drain boards not included
- 1-1/2" Edge rim design
- Basket strainers included with drain
- 1-5/8" galvanized legs with 1" adjustable feet



Part #	Mfg #	Overall Size	Holes	Depth	Drain Opening	Min Sink	Price
177850	B1C18X180X	21" x 21.5"	42"	12"	3-1/2"		
172990	B1C18X210X	21" x 24.5"	42"	12"	3-1/2"		
190455	B1C24X240X	27" x 27.5"	42"	12"	3-1/2"		

**Mop & Utility Sinks**

**Commercial Foodservice Utility SS Double Compartment Scullery Sink**

- 18" Gauge
- Welded construction
- Drain boards not included
- 8" Backsplash
- 1-1/2" Edge rim design
- Basket strainers included with drain
- 1-5/8" Galvanized legs with 1" adjustable feet



Part #	Mfg #	Overall Size	Holes	Depth	Drain Opening	Min Sink	Price
188327	B2C4X240X	51" x 27.5"	42"	12"	3-1/2"		

**Commercial Stainless Steel Wall Service Sinks**

**Commercial Stainless Steel Single Bowl Wall Service Sink with No Faucet Holes**

- 14" Gauge
- Buffed satin finish
- 1-3/4" Coved corners
- 1-1/2" Rolled rims
- 12" backsplash
- Includes wall hanger and stainless steel support brackets



Part #	Mfg #	Overall Size	Holes	Depth	Drain Opening	Min Sink	Price
176328	ESS25200	25" x 19-1/2"	12"	12"	3-1/2"		

**Commercial Stainless Steel Wall Service Sink**

- 14" Gauge
- Buffed satin finish
- 1-3/4" Coved corners
- 1-1/2" Rolled rims
- 12" High backsplash
- Includes wall hanger and stainless steel support brackets



Part #	Mfg #	Overall Size	Holes	Depth	Drain Opening	Min Sink	Price
087323	ESS23192	23" x 18-1/2"	2-Hole	20"	12"	3-1/2"	
098017	ESS25202	25" x 19-1/2"	2-Hole	22"	12"	3-1/2"	

**Mop & Utility Sinks**

**Commercial Stainless Steel Wall Service Sink—Lever Faucet Package**

- 14" Gauge
- Buffed satin finish
- 1-3/4" Coved corners
- 1-1/2" Rolled rims
- 12" High backsplash
- Includes wall hanger and stainless steel support brackets
- Model includes:
  - (LK940BR03L2H)** faucet
  - (LK173)** cast iron P-trap



Part #	Mfg #	Overall Size	Holes	Depth	Drain Opening	Min Sink	Price
036727	ESSB2520C	25" x 19-1/2"	1-Hole	22"	12"	3-1/2"	

**Adapters**

**Brass Compression Fittings**

**Brass Union (FIP x Comp) - Drill Through**



Part #	Mfg #	Size	Finish	Price
002645	10 C	3/8" x 3/8"	CP	
002657	12 C	1/2" x 3/8"	CP	

**Brass Union (Swt x Comp)**



Part #	Mfg #	Size	Finish	Price
002664	14C	1/2" x 3/8"	CP	

**Brass Compression Reducing Adapter  
Comp x MIP**

- No Tube Stop



Part #	Mfg #	Nom x OD	Finish	Price
002662	13XC	3/8" x 1/2"	Chrome	

---



---

## Closet Kits

---



---

### Closet Supply Kits

#### Angle Supply with Stop & Annealed Vertical Tube

- Sold individually
- Brass construction
- Compression valve
- Vertical metal supply tube
- Flange



Part #	Mfg #	Description	Price
068471	K-7637-AF	3/8" IPS, *French Gold	
109279	K-7637-BKB	3/8" IPS, Brushed Black	
056596	K-7637-BN	3/8" IPS, *Brushed Nickel	
070719	K-7637-BV	3/8" IPS, *Brushed Bronze	
069016	K-7637-CP	3/8" IPS, Polished Chrome	
076713	K-7637-G	3/8" IPS, Brushed Chrome	
089414	K-7637-PB	3/8" IPS, *Polished Brass	
139146	K-7637-SN	3/8" IPS, *Polished Nickel	
182518	K-7638-CP	1/2" NPT, Polished Chrome	

\* Vibrant Limited Lifetime Warranty

[www.waterconcepts.net](http://www.waterconcepts.net) • Serving our Customers Since 1946 • [www.plumbsupply.com](http://www.plumbsupply.com)



## Closet Kits

### Closet Supply Valves & Tubes

#### 5/8" OD Compression x 3/8" OD Compression Valve Kit

• Includes:

- (1) 5/8" OD Comp x 3/8" OD Comp angle valve (5812)
- (1) 20" Supply tube (772)
- (1) 5/8" OD Sure grip escutcheon (7463)



Part #	Mfg #	Finish	Price
115750	5812-72-ORB	Oil Rubbed Bronze	
115749	5812-72-SN	Satin Nickel	

#### 5/8" OD Compression x 3/8" OD Compression Valve Kit with Cover Tube & Bell Escutcheon

• Includes:

- (1) 5/8" OD Comp x 3/8" OD Comp angle valve (5812)
- (1) 20" Supply tube (772)
- (1) 5-1/4" Cover tube (579)
- (1) 11/16" Bell escutcheon (7116)



Part #	Mfg #	Finish	Price
141939	5812-72CT-ORB B	Oil Rubbed Bronze	



## Closet Supplies

### Closet Supply Tubes

#### Flexible Smooth Copper Supply Tube - 3/8" OD

- Use with 3/8" OD supply valves
- 662 & 663: Compliant with California's AB-1953 and Vermont's S152



Part #	Mfg #	Description	Price
115980	772-ORB	20", Oil Rubbed Bronze	
115975	772-SN	20", Satin Nickel	

**Closet Supplies**

**Closet Risers**

• *Suffix:*

- CP = Chrome plated bulk pack
- C2 = (1) Pair boxed
- PB = Polished brass
- RP = Rough /unplated bulk pack

**Closet Riser with Gasket Nosepiece**



Part #	Mfg #	OD x Length	Finish	Price
002651	1-12DL C	3/8" x 12"	CP	
002653	1-12DL PP	3/8" x 12"	PB	
002660	1-20DL C	3/8" x 20"	CP	

**Closet Riser with HD Rubber Nosepiece**



Part #	Mfg #	OD x Length	Finish	Price
002650	1-12DE C	3/8" x 12"	CP	
002659	1-20DE C	3/8" x 20"	CP	

**ProCoat® Pipe Connector  
(Fml Pipe Inlet x Fml Pipe Outlet)**

- 125 psi
- Coated stainless steel tube
- Integrated dielectric sleeve
- Used to connect water supply to water heater



Part #	Mfg #	FIP x FIP	Dia	Price
238353	SWB00-18N	3/4"	3/4"	

**Closet Supply Kits**

**Closet Angle Stop Supply Kit (Comp x Comp)**



Part #	Mfg #	Nom x OD x Lgth	Finish	Price
019939	OCR1912DLX	1/2" x 3/8" x 12"	CP	

## Closet Supplies

### Closet Supply Tubes

#### PEX Closet Supply Tube

- Molded head with bagged nylon ferrules



Part #	Mfg #	O.D. x PEX	Price
128319	287-12	3/8" x 12"	
034836	287-20	3/8" x 20"	

#### Nylon Supply Tube Ferrule

- Poly construction for PEX tubes

Part #	Mfg #	Description	Price
146598	285-100	3/8" Nominal	

### Anti-Siphon Ballcock

- 8½" Hoov-R-Line† Replacement
- Rebuild kit includes spare screw (reuse original brass screws when repairing)
- Conforms to ASSE 1002



490-1046

Part #	Mfg #	Assembly Size	Price
163061	490-10465	8-1/2"	

### Flappers

- Produced with high quality co-polymer vinyl or ABS materials
- Replacement flappers for most popular closet brands
- Chemical-resistant flappers prevent warping
- Stainless steel (Type 303) chains will not rust



490-10108

#### Chemical Resistant—Vinyl Resists Warping

Part #	Mfg #	Description	Price
183411	490-10108	Blue Vinyl with 9" Stainless Steel Chain and Hook	
183412	490-10112	Clear Vinyl with 9" Chain. 1.6 GPF with 4 Orifices	

### Replacement Flush Valve Tank Balls (For Douglas & Eljer Models)

Part #	Mfg #	Size	For:	Price
183413	490-10206	3"	Douglas	
183415	490-10211	N/A	Eljer	

### American Standard Flush Valve Disc

- With helmet  
—Snap-on or screw-on
- Without helmet  
—Genuine American standard – snap-on or screw-on  
—Model (490-10302) goes with A.S. #33643-07  
—Model (490-10312) goes with A.S. #73383-07



490-10312

#### Without Helmet

Part #	Mfg #	Attachment Method	Price
183417	490-10302	Snap-On	
183418	490-10312	Screw-On	

## Closet Supplies

### PRO Toilet Connectors

- Made of a tough polymer core covered in braided stainless steel wire
- Ample inside diameter for high flow capacity
- Won't kink or crease
- Exceeds all requirements for flexible water connectors as defined by ASME A112.18.6 and CSA B125
- 10-Year warranty

#### PRO Toilet Connector (Fem Comp x Fem Ballcock)



Part #	Mfg #	Length	Fittings	Price
108551	FLPRO1T06	6"	3/8" x 7/8"	
004367	PRO1T09	9"	3/8" x 7/8"	
004368	PRO1T12	12"	3/8" x 7/8"	
057209	PRO1T16	16"	3/8" x 7/8"	
004369	PRO1T20	20"	3/8" x 7/8"	
204868	FLPRO1T09 M	9"	3/8" x 7/8" w/ Nut	
204869	FLPRO1T12 M	12"	3/8" x 7/8" w/ Nut	
204870	FLPRO1T20 M	20"	3/8" x 7/8" w/ Nut	

### Click Seal® Toilet Connectors

#### Click Seal Toilet Connector (Fem Comp x Fem Ballcock)

- Technology you can trust
- CLICK SEAL® toilet connectors minimize cross threading and stripping
- No tools required for installation of CLICK SEAL® end
- Exceptional flexibility for fast, easy installation
- Won't kink or crease, even in the tightest of spaces
- Available in 9', 12' and 20' lengths



Part #	Mfg #	Description	Price
204904	FLB1T12CS	12" 3/8" x 7/8"	
207204	FLB1T20CS	20" 3/8" x 7/8"	

## Dishwasher Supply Hoses

### Speedi Plumb® Plus Braided Connectors

- Engineered polymer braid
- Chrome plated nuts and ferrules
- Tough inner core
- Large cone washer
- Unique flexibility



#### Dishwasher Connector Quick Connect

Part #	Mfg #	Description	Price
135403	B1-48DW	3/8" Comp x 3/8" Comp x 48"L	
135404	B1-60DW	3/8" Comp x 3/8" Comp x 60"L	
135405	B1-72DW	3/8" Comp x 3/8" Comp x 72"L	

### Garden Hose Elbow Dishwasher Fitting

- Swivel makes it easier to align
- 1-Piece forged fitting
- High temperature resistant washer
- For Whirlpool, Maytag, Amana, Kitchen Aid and Jenn-Air dishwashers manufactured after September 2009



Part #	Mfg #	Description	Price
129124	HES-6-12	3/8" OD Compression x 3/4" Garden Hose Swivel	



## Dishwasher Supply Hoses

### No-Burst® Braided Stainless Steel Appliance Water Supply Connectors

- Non-toxic polymer inner core surrounded by braided stainless steel
- Captured cone washers for perfect seal
- IAPMO Listed
- 10-Year warranty



#### Dishwasher Connector (Fem Comp x FIP)

- Includes elbow
- B Prefix: bulk packaging

Part #	Mfg #	Length	Fittings	Price
068907	B1W48	48"	3/8" x 1/2"	
034640	B1W60	60"	3/8" x 1/2"	

#### Dishwasher Connector (Fem Comp x Fem Comp)

- Includes elbow
- B Prefix: bulk packaging



Part #	Mfg #	Length	Fittings	Pkg	Price
004371	B6W48	48"	3/8" x 3/8"	Bulk	
056187	B6W60	60"	3/8" x 3/8"	Bulk	
056188	6W72	72"	3/8" x 3/8"	Carded	

### Dishwasher Supply Kit

- Machined brass and large inner diameter for better flow
- B Prefix: bulk packaging



Part #	Mfg #	Length	Fittings	Elbows	Price
140815	B6W48K	48"	3/8" x 3/8"	3/4" & 3/8"	
140816	B6W60K	60"	3/8" x 3/8"	3/4" & 3/8"	
140817	B6W72K	72"	3/8" x 3/8"	3/4" & 3/8"	

### Ice Maker Water Supply Connectors

#### Ice Maker Connectors (Comp x Comp)

- Sleeve packaged



Part #	Mfg #	Length	Fittings	Price
037754	12IM60	60"	1/4" x 1/4"	
055441	12IM84	84"	1/4" x 1/4"	
091625	12IM120	120"	1/4" x 1/4"	



## Dishwasher Supply Hoses

### Washing Machine Hoses



Part #	Mfg #	Description	Price
252020	093260	3/5" x 6'	
116669	093283	3/8" x 10' Braided Hose	

### Dishwasher Hoses

#### Reinforced Dishwasher Discharge Hose

- *Not recommended for use with PSI/temperature conditions beyond the safe working pressure*
- *Feature EPDM tubes and covers that have double-ply spiraled polyester reinforcements*
- *Burst pressure rating of 280 PSI (The safe working pressure is 80 PSI at 100°F)*



Part #	Mfg #	Description	Price
252100	093150	5/8" x 50'	
252099	093175	7/8" x 50'	

## Dishwasher Supply Hoses

### Hoses

#### Dishwasher Drain Hose

- 5/8" connects dishwasher pump to air gap inlet, directly to our long branch tailpiece or to a disposal tap-in- (with a connector kit)
- 7/8" connects the air gap outlet to branch tailpiece or disposal tap-in
- Maximum Temperature: 225°F at 20 PSI



Part #	Mfg #	Description	Price
224627	905	5/8" I.D. x 50 ft. Coil	

### Drain Connectors

#### Dishwasher Drain Connector

- Stainless steel hose clamps
- Slotted/hex screws included
- Ability to be cut for different size pipe and hose applications



Part #	Mfg #	Description	Price
104311	902	Black Elastomer Adapter	

**Escutcheons**

**Flanges**

**Low Pattern Flange**



Part #	Mfg #	Size	Finish	Price
003065	CS1097	3/8" OD	CP	
003076	CS1107C	5/8" OD for 1/2" Nom	CP	
003066	CS1098	1/2"OD for 3/8" Nom	CP	
003068	CS1099A	7/8"OD for 3/4" Nom	CP	
003067	CS1099B	5/8"OD for 1/2" Nom	CP	
003069	CS1100	3/8" NPT	CP	
003070	CS1101	1/2" NPT	CP	
003071	CS1101A	3/4" NPT	CP	
003072	CS1102	1-1/4"OD	CP	
003073	CS1104	1-1/2"OD	CP	
251850	CS1105	1-1/4" NPT	CP	
003074	CS1106	1-1/2" NPT	CP	
251851	CS1106A	2" NPT	CP	
252054	CS1106B	1-1/2" NPT	CP	

**High Pattern Flange**



Part #	Mfg #	Size	Finish	Price
003077	CS1109	3/8" IPS	CP	
003078	CS1110	1/2" IPS	CP	
003079	CS1114	1-1/4" OD	CP	
003080	CS1114A	1-1/4" IPS	CP	
003081	CS1115	1-1/2" OD	CP	

**Box Pattern Flange**



Part #	Mfg #	Size	Finish	Price
003083	CS1116	1-1/4" OD	CP	
003086	CS1117A	1-1/2" NPT	CP	
149701	DB1118	1-1/2" OD	CP	

**Box Pattern Flange - Tube In Flange Display Box**



Part #	Mfg #	Size	Finish	Price
003085	CS1117	1-1/2" OD	CP	

**Floor & Ceiling Plates**

**Heavy Grade Floor & Ceiling Plate with Spring**



Part #	Mfg #	Size	Price
252045	CS5340	1/2" Tube	
003173	CS5340H	1/2" CTS	
003174	CS5341H	3/4" CTS	
003175	CS5342H	1" CTS	
003176	CS5343H	1-1/4" CTS	
003177	CS5344H	1-1/2" CTS	
003178	CS5345H	2" CTS	
244155	CS5346H	2-1/2" CTS	
252039	CS5350H	3/8" IPS	
003180	CS5351H	1/2" IPS	
003181	CS5352H	3/4" IPS	
003182	CS5353H	1" IPS	
252041	CS5354H	1-1/4" IPS	
252040	CS5355H	1-1/2" IPS	
003185	CS5356H	2" IPS	
003186	CS5357H	2-1/2" IPS	
003187	CS5358H	3" IPS	
057644	CS5360H	4" IPS	

**Floor & Ceiling Plate with Spring**



Part #	Mfg #	Size	Price
003183	CS5354	1-1/4" IPS	
003184	CS5355	1-1/2" IPS	

---

---

## Escutcheons

---

---

### Plastic Split Flange

Part #	Mfg #	Size	Gauge	Price
253555	CS5351P	1/2" IPS		
026976	CS5340P	1/2" Nom		

**Escutcheons**

**Flanges & Ceiling Plates**

**Sure Grip Flange**

- Chrome-plated steel



Part #	Mfg #	IPS	CWT	Outside Diameter	Price
008031	1225	3/8"	--	2-1/2"	
008032	1226	1/2"	--	2-1/2"	
008033	1227	3/4"	--	2-1/2"	
008034	1230	--	1/2"	2-1/2"	
008035	1231	--	3/4"	2-1/2"	
127947	1241	1-1/4"	-	3"	

**Sure Grip Box Flange**

- Chrome-plated steel



Part #	Mfg #	IPS	CWT	Outside Diameter	Price
008036	1236	--	1-1/4"	3"	
008037	1237	--	1-1/2"	3"	

**Sure Grip Bell Flange**

- Chrome-plated steel



Part #	Mfg #	IPS	CWT	Tubular Diameter	Outside Diameter	Price
008090	2842	1/2"	--	--	2-1/2"	
056622	2845	-	1/2"	-	2-1/2"	
008091	2853	--	--	1-1/4"	3"	
008092	2854	--	--	1-1/2"	3"	

**Split-One™ Floor and Ceiling Plate**

- Simply bend and place around pipe
- Chrome or white finish
- 100% rustproof
- Non-corrosive - non-breakable



Part #	Mfg #	IPS	CWT	Outside Diameter	Price
059147	2856	1/2"	-	2-3/4"	
057215	2860	1-1/2"	-	4-1/4"	
057216	2861	2"	-	4-1/4"	
008093	2873	-	1/2"	2-1/2"	

**Sure Grip Floor and Ceiling Plate**

- Light pattern - no springs
- Chrome-plated steel



Part #	Mfg #	IPS	CWT	Outside Diameter	Price
008088	2821	-	1/2"	3"	
008089	2822	-	3/4"	2-3/4"	

**Floor and Ceiling Plate**

- Heavy pattern with springs
- Chrome-plated steel



Part #	Mfg #	IPS	CWT	Outside Diameter	Price
008094	2880	3/8"	-	2-1/4"	
008095	2881	1/2"	-	2-3/4"	
021288	2882	3/4"	-	2-3/4"	
021289	2883	1"	-	3-1/4"	
008096	2884	1-1/4"	-	3-1/2"	
008097	2885	1-1/2"	-	4"	
008098	2886	2"	-	4-1/2"	
091964	2895	-	2"	4-1/2"	



## Escutcheons

### Escutcheons

#### Trim Tite™ PVC Shallow/Deep Escutcheon

- Corrosion proof—will never rust or pit
- Will not come loose. molded-in “memory” retains a permanent grip on pipe or tube
- Will not scratch the tube and disrupt compression connections
- Low cost and attractive white color makes the TrimTite™ an excellent substitution for chrome-plated or stainless steel escutcheon's
- CTS and IPS available in a variety of sizes
- 1" through 2" IPS sizes have deluxe 3 1/2" O.D.
- Deep tubular escutcheon's are 3" deep and have an extra wide 4" base which are perfect for covering waste-arm adapters and pedestal lavatory installations



920-2W



922-5W

#### Shallow Escutcheon

Part #	Mfg #	Dia.	O.D.	Thickness	Price
065519	922-6W	1-1/2"	4"	3"	
027596	920-2W	1/2" CTS	2-1/2"	9/16"	
084391	920-3W	3/4" CTS	2-1/2"	9/16"	
184074	920-4W	1" CTS	3-1/2"	9/16"	
184075	921-3W	3/4" IPS	2-1/2"	1/2"	
029293	921-6W	1-1/2" IPS	3-1/2"	9/16"	
037168	921-7W	2" IPS	3-1/2"	9/16"	

#### Deep Tubular Escutcheon



Part #	Mfg #	Dia.	O.D.	Thickness	Price
146721	922-5W	1-1/4"	4"	3"	

#### Snap One™ Floor and Ceiling Plate

- Split for pre-piped jobs
- 100% rust proof
- 3/8" Thickness



926-2W

#### Chrome-Plated

Part #	Mfg #	Inner Dia.	Outer Dia.	Price
039233	926-2	1/2" CTS	2-1/2"	
087909	926-3	3/4" CTS	2-3/4"	
253388	926-4	1" CTS	3"	
184076	927-2	1/2" IPS	2-3/4"	
162604	927-3	3/4" IPS		
146517	927-4	1" IPS		
253406	927-5PK2	1-1/4" ABS		

### Escutcheons (Continued)

#### Snap One™ Floor and Ceiling Plate

##### Chrome-Plated

Part #	Mfg #	Inner Dia.	Outer Dia.	Price
035271	927-6	1-1/2" IPS	3-3/8"	
095737	927-7	2" IPS	4-3/8"	

##### White

Part #	Mfg #	Inner Dia.	Outer Dia.	Price
039234	926-2W	1/2" CTS	2-1/2"	
225731	926-3W	3/4" CTS	2-3/4"	
125029	926-4W	1" CTS	3"	
253408	926-6W	1-1/2" IPS	3"	
253401	927-7W	2" IPS	4"	
062623	927-8W	3" IPS	4"	

#### Dry Seal Pipe Collar™

- Creates a watertight seal around pipe or tube
- Thin, tapered design compresses tightly to wall
- Help keep moisture out of wall cavity which helps prevent mold growth



Part #	Mfg #	Description	Price
128259	928-2	1/2" CTS	

## Escutcheons

### Escutcheons

#### Low Pattern 5/8" OD Escutcheon

- Fits 1/2" copper
- Sure grip - no side set screw



Part #	Mfg #	Finish	Price
116149	7463-SC	Satin Chrome	
116150	7463-BKN	Black Nickel	
116151	7463-BU	Bronze Umber	
116152	7463-MBK	Matte Black	
116153	7463-ORB	Oil Rubbed Bronze	
116154	7463-PEW	Pewter	
116257	7463-PN	Pol Nickel	
116148	7463-SN	Satin Nickel	

#### Box Escutcheon

- 1-1/2" OD (Fits 1-1/2" "P" trap)
- 3" Diameter
- 1-3/4" High



Part #	Mfg #	Finish	Price
165292	767-ORB	Oil Rubbed Bronze	
238307	767-SG	Satin Gold	
155723	767-SN	Satin Nickel	

#### Multi-Fit Escutcheon

- Brass
- Decorative design
- Includes 3 o-rings to fit:
  - 1/2" IPS wall & ceiling drop nipples
  - 1/2" Showerarms
  - Cover tubes 578- & 579-, 629 & 631 series valves



Part #	Mfg #	Dia.	Finish	Price
245401	6010-PN	2-1/2"	Pol Nickel	
239281	6012-VB	3"	Vintage Bronze	

### Diameter Bell Escutcheon

- Sure grip - no side set screw



Part #	Mfg #	Finish	Price
116157	7158-SC	Satin Chrome	
116158	7158-BKN	Black Nickel	
116159	7158-BU	Bronze Umber	
116160	7158-MBK	Matte Black	
116161	7158-ORB	Oil Rubbed Bronze	
116162	7158-PEW	Pewter	
116255	7158-PN	Pol Nickel	
116156	7158-SN	Satin Nickel	

#### Escutcheon

- Cast with set screw
- For use with 1/2" IPS and 1/2" showerarms



Part #	Mfg #	Finish	Price
123369	6004-SN	Satin Nickel	

## Lavatory Kits

### Lavatory Supply Kits

#### Angle Supply with Stops - Pair

- Brass construction
- Annealed vertical tube
- Compression valve
- Flange



Part #	Mfg #	Description	Price
117725	K-7605-P-AF	3/8" NPT, *French Gold	
189570	K-7605-P-BKB	3/8" NPT, Brushed Black	
054474	K-7605-P-BN	3/8" NPT, *Brushed Nickel	
070716	K-7605-P-BV	3/8" NPT, *Brushed Bronze	
055575	K-7605-P-CP	3/8" NPT, Polished Chrome	
076716	K-7605-P-G	3/8" NPT, Brushed Chrome	
056527	K-7605-P-PB	3/8" NPT, *Polished Brass	
070690	K-7605-P-SN	3/8" NPT, *Polished Nickel	

#### Angle Supply with Stop (pair)

- Brass construction
- Compression valve
- Pair of angle supplies with stop
- Annealed vertical tub with union connection
- Loose key stop



Part #	Mfg #	Description	Price
182515	K-7608-CP	1/2" NPT, Polished Chrome	

### Sink Traps

#### Adjustable P-Trap with Tubing Outlet

- 1-1/2" x 1-1/2"
- Flange
- Cleanout plug
- Slip-joint inlet
- Cast solid brass construction
- Adjustable rotation on outlet tube



Part #	Mfg #	Description	Price
057668	K-9000-CP	Polished Chrome	

#### Contemporary Bottle Trap

- 1-1/4" x 1-1/4"
- Alternative to the traditional P-trap fitting
- Decorative solution for vessels and exposed plumbing applications



Part #	Mfg #	Description	Price
226609	K-9033-AF	*French Gold	
248107	K-9033-BL	Matte Black	
137293	K-9033-BN	*Brushed Nickel	
137426	K-9033-CP	Polished Chrome	
190535	K-9033-BV	*Brushed Bronze	
147073	K-9033-2BZ	Oil Rubbed Bronze	

#### Drain Tailpiece Shroud

- 1-5/8" x 4-7/8"
- Solid brass construction
- Installation hardware included
- Conceals drain in console table



Part #	Mfg #	Description	Price
248106	7709-BL	Matte Black	
083614	7709-BN	*Brushed Nickel	
243421	7709-SN	*Polished Nickel	

\* Vibrant Limited Lifetime Warranty

[www.plumbsupply.com](http://www.plumbsupply.com) • Serving our Customers Since 1946 • [www.waterconcepts.net](http://www.waterconcepts.net)

## Lavatory Kits

### P-Trap with Tubing Outlet

- 1-1/4" x 1-1/4"
- Adjustable rotation on outlet tube
- Slip- joint inlet
- Cleanout plug
- Brass construction



Part #	Mfg #	Description	Price
069041	K-8998-CP	Polished Chrome	

### P-Trap With Long Tubing Outlet

- 1-1/4" x 1-1/4" O.D inlet and outlet
- Adjustable rotation on outlet tube
- Cleanout plug, flange
- Extension and tubing outlet
- Brass construction
- Recommended for above-the-floor bidet and lavatory sink installations



Part #	Mfg #	Description	Price
062363	K-9018-BN	*Brushed Nickel	
083176	K-9018-PB	*Polished Brass	
189571	K-9018-2BZ	Oil Rubbed Bronze	

\* Vibrant Limited Lifetime Warranty

[www.waterconcepts.net](http://www.waterconcepts.net) • Serving our Customers Since 1946 • [www.plumbsupply.com](http://www.plumbsupply.com)

**Lavatory Kits**

**Lavatory/Sink Supply Kits**

**Lavatory Angle Stop Supply Kit (Comp x Comp)**

- SCR Has loose key handle



Part #	Mfg #	Nom x OD x Lgth	Desc	Price
019937	OCR1912AX C	1/2" x 3/8" x 12"	CP	
002620	SCR1912AX C	1/2" x 3/8" x 12"	CP Esc	



## Lavatory Kits

### Lavatory Supply Kits

#### 5/8" OD Compression x 3/8" OD Compression Valve Kit

• Includes:

- (2) 5/8" OD Comp x 3/8" OD Comp angle valves (5812)
- (2) 3/8" OD x 20" Supply tubes (662)
- 5/8" OD Sure grip escutcheons (7463)



Part #	Mfg #	Finish	Price
115742	5812-62-SN	Satin Nickel	

### Complete Faucet Supply Kit

• Kit contains:

- (2) 20" Copper supply tubes
- (2) Escutcheons
- (2) Cover tubes
- (2) Quarter turn angle pattern 5/8" O.D. compression (fits 1/2" copper) x 3/8" O.D. supply valve with contempo lever handle



Part #	Mfg #	Finish	Price
239584	621-2-62CT-MB K	Matte Black	
227629	621-2-62-CB	Caramel Bronze	



## Lavatory Supplies

### Lavatory/Sink Risers

- Actual riser length is length to connect less 1/2"
- Suffix:
  - CP = Chrome-plated bulk pack
  - RB = Rough brass

#### Lav/Sink Riser - 1-Piece with Insert



Part #	Mfg #	OD x Length	Finish	Price
002647	1-12A C	3/8" x 12"	CP	
002649	1-12A R	3/8" x 12"	RB	
002658	1-20A C	3/8" x 20"	CP	
022260	1-20A R	3/8" x 20"	RB	
190845	1-30A-C	3/8" x 30"	CP	
002663	1-36A C	3/8" x 36"	CP	

#### Lav/Sink Riser (Comp)



Part #	Mfg #	OD x Length	Finish	Price
002655	1-12KC C	3/8" x 12"	CP	
002656	1-20KC C	3/8" x 20"	CP	

### Faucet Connectors

#### Speedi Plumb® B1-A 3/8" Comp x 1/2" FIP

- No lead certified
- 125 PSI maximum
- Braided polymer tube
- 8-Sided pneumatic crimp
- Use with faucets with 1/2" MIP water connection; metal nut
- For use with potable water systems
- External & internal corrosion resistance



Part #	Mfg #	Length	Price
120210	B1-12AF	12"	

---

---

**Lavatory Supplies**

---

---

**Lavatory Supplies**

**Bottom Dome Strainer**

- *Aluminum*



Part #	Mfg #	Size	Price
238405	42754	2"	

## Lavatory Supplies

### Lavatory Supply Tubes

#### PEX Lav-Sink Supply Tube

- PEX tubes have molded head and include nylon ferrule



285-12

Part #	Mfg #	Size	Material	Price
128318	285-12	3/8" O.D. x 12"	PEX	
034834	285-20	3/8" O.D. x 20"	PEX	
034835	285-36	3/8" O.D. x 36"	PEX	

#### Supply Tube Connector

- Available in PEX or chrome-plated copper
- Copper closet supply tubes include rubber nose cone
- Copper lav supply tubes are one-piece with nylon insert
- PEX tubes have molded head and include nylon ferrule

#### Closet Supply Tubes

Part #	Mfg #	Size	Material	Price
243332	285-T241200	3/8" O.D. x 20"	PEX	
	0			

#### Soft Copper Supply Tube Extension Connectors

- Great for faucet change-outs or supply tube extensions

Part #	Mfg #	MSwt x FSwt	Length	Price
064542	289-12	3/8" O.D.	12"	



## Lavatory Supplies

### Lavatory Supply Tubes

#### Flexible Smooth Copper Supply Tube For 3/8" OD

- Use with 3/8" OD supply valves
- 662 & 663: Compliant with California's AB-1953 and Vermont's S152



Part #	Mfg #	Description	Price
115957	662-BU	20", Bronze Umber	
116263	662-ORB	20", Oil Rubbed Bronze	
244373	662-PB	20", Polished Brass	
115955	662-SN	20", Satin Nickel	

#### Flexible Smooth Copper Supply Tube for 1/2" OD

- Use with 1/2" OD supply valves
- 6620 is Compliant with California's AB-1953 and Vermont's S152



Part #	Mfg #	Description	Price
115969	6620-ORB	20", Oil Rubbed Bronze	
115965	6620-SN	20", Satin Nickel	

## Lavatory Supplies

### Faucet Water Supply Connectors

- Made of a tough polymer core covered with braided stainless steel wire
- Large inside diameter for higher flow capacity
- Won't kink or crease
- Heavy-duty brass hex nuts are easy to grip and nickel-plated for durability
- Exceeds all code requirements for flexible water connectors

#### Faucet Connector (Fem Comp x FIP Straight)

- B Prefix: bulk packaging



Part #	Mfg #	Length	Fittings	Price
047162	B1F09	9"	3/8" x 1/2"	

#### Faucet Connector (FIP Straight x FIP Straight)

- B Prefix: bulk packaging



Part #	Mfg #	Length	Fittings	Price
055109	B4F30	30"	1/2" x 1/2"	

#### Faucet Connector (Fem Comp x Fem Comp)

- B Prefix: bulk packaging



Part #	Mfg #	Length	Fittings	Price
061839	B6F16	16"	3/8" x 3/8"	

#### Faucet Connector (Fem Comp x OD Copper Tubing Coupling)

- B Prefix: bulk packaging



Part #	Mfg #	Length	Fittings	Price
039222	B8F16	16"	3/8" x 3/8"	

### Universal/Fits-All™ Faucet Connector

- Fits all Bathroom & Kitchen Faucets
- 3/8" Comp., 7/16" Comp., 1/2" Comp., or 1/2" F.I.P. x 1/2" F.I.P.
- Fits all Popular Shut Off Valves
- Exceptional flexibility for fast, easy installation
- 5-year Warranty
- Lead free
- Won't kink or crease, even in the tightest of spaces
- Heavy-duty brass hex nuts are easy to grip and nickel plated for durability
- Exceeds all code requirements for flexible water connectors



Part #	Mfg #	Length	Fittings	Price
194887	FL4F36CU	36"	Universal	

### PRO Faucet Connectors

- Made of a tough polymer core covered in braided stainless steel wire
- Ample inside diameter for high flow capacity
- Won't kink or crease
- Exceeds all requirements for flexible water connectors as defined by ASME A112.18.6 ad CSA B125
- 10-Year warranty

#### PRO Faucet Connector (Fem Comp x FIP Straight)



Part #	Mfg #	Length	Fittings	Price
004364	B1F12	12"	3/8" x 1/2"	
004365	B1F16	16"	3/8" x 1/2"	
004366	B1F20	20"	3/8" x 1/2"	
019833	B1F30	30"	3/8" x 1/2"	
228308	FLPRO3F20	20	1/2" x 1/2" (25)	



## Lavatory Supplies

### PRO Faucet Connector (FIP Straight x FIP Straight)



Part #	Mfg #	Length	Fittings	Price
042948	B4F12	12"	1/2" x 1/2"	
059323	B4F16	16"	1/2" x 1/2"	
042949	B4F20	20"	1/2" x 1/2"	

### PRO Faucet Connector (Fem Comp x Fem Comp)



Part #	Mfg #	Length	Fittings	Price
056587	B6F12	12"	3/8" x 3/8"	
051582	B6F20	20"	3/8" x 3/8"	

### PRO Faucet Connector (Fem Comp x OD Copper Tubing Coupling)



Part #	Mfg #	Length	Fittings	Price
004372	B8F12	12"	3/8" x 3/8"	
023095	B8F20	20"	3/8" x 3/8"	



**Nuts & Washers**

**Nuts**

Brass Nut (Comp)



Part #	Mfg #	Size	Finish	Price
002641	61-6-C	3/8" OD	CP	

**Compression Slip Nuts**



Part #	Mfg #	Nom x OD	Finish	Price
190852	90B	1-1/4"	CP	

**Washers**

Lavatory Riser Tube Component

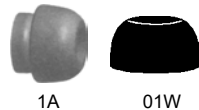

Part #	Mfg #	Description	Price
002644	1A	3/8" Lavatory Riser Nosepiece	

## Nuts & Washers

### Plumbing Washers

#### Cone Shaped Washer



Part #	Mfg #	Description	Price
006239	804	1/2" Red	

#### Step Style Washer

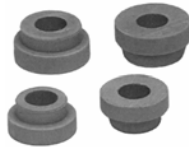

Part #	Mfg #	Size	Qty	Price
006237	802	3/8" x 3/4" x 3/8"	20	

## Stops - Angle

### Multi-Turn Angle Stop Valves

- Suffix after the space:  
- CP = Chrome-plated
- Suffix X before space is California lead-free

#### Angle Stop (Comp x Comp)



Part #	Mfg #	Nom x OD	Finish	Price
002578	OCR09XC	3/8" x 3/8"	CP	
036172	OCR09XC	1/2" x 1/4"	CP	
002596	OCR19XC	1/2" x 3/8"	CP	
002589	OCR39X	1/2" x 1/2"	CP	

#### Angle Stop (FIP x Comp)



Part #	Mfg #	Nom x OD	Finish	Price
002598	OR15X	3/8" x 3/8"	CP	
019935	OR17XC	1/2" x 3/8"	CP	

#### Angle Stop (Swt x Comp)

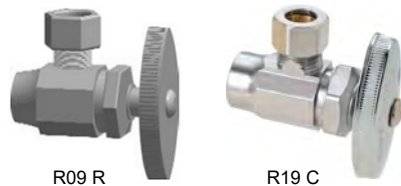

R09 R

R19 C

Part #	Mfg #	Nom x OD	Finish	Price
019080	R09XR	1/2" x 1/4"	RB	
025838	R09XC	1/2" x 1/4"	CP	
002610	R19XC	1/2" x 3/8"	CP	
002611	R19XR	1/2" x 3/8"	RB	

### Pushconnect Angle Stops

#### G2 Angle Stop (Push Connect x Comp)



Part #	Mfg #	Nom x OD	Finish	Price
158655	G2PS19X C	1/2" x 3/8"	CP	

#### G2 Angle Stop (Push Connect x Push Connect)



Part #	Mfg #	Nom x OD	Finish	Price
158657	G2QPS19X C	1/2" x 3/8"	CP	

### G2 Series Twist In 1/4-Turn Angle Stops

#### G2 Angle Stop (Cold Expansion Barb for PEX x Comp)



Part #	Mfg #	Nom x OD	Finish	Price
107384	G2CEPX19X C	1/2" x 3/8"	CP	

#### G2 Angle Stop (Comp x Comp)



Part #	Mfg #	Nom x OD	Finish	Price
162148	G2CR19X C	1/2" x 3/8"	CP	

#### G2 Angle Stop (FIP x Comp)



Part #	Mfg #	Nom x OD	Finish	Price
166382	G2R15X C	3/8" x 3/8"	CP	
190286	G2R17XC	1/2" x 3/8"	CP	

## Stops - Angle

### 1/4-Turn Ball Angle Stops

- PTFE Seats provide corrosion resistance and watertight seal
- Blow-out proof stem
- Plated stem
- 100% Leak tested
- Suffix after the space:  
- C is Chrome
- Suffix X before space is California lead-free

#### Angle Stop (Comp x Comp)



Part #	Mfg #	Nom x OD	Finish	Price
050641	KTCR19X C	1/2" x 3/8"	CP	

#### Angle Stop (FIP x Comp)



Part #	Mfg #	Nom x OD	Finish	Price
158741	KTR15X C1	3/8" x 3/8"	CP	
050649	KTR17X C	1/2" x 3/8"	CP	

#### Angle Stop (Swt x Comp)



Part #	Mfg #	Nom x OD	Finish	Price
050643	KTR19X C	1/2" x 3/8"	CP	

### Commercial Water Supplies

#### Angle Stop Valve with Loose Key - Regular Pattern (FIP)



Part #	Mfg #	Size	Finish	Price
002622	SR17X C	1/2" x 3/8"	CP	

### Angle Stop Valve with Loose Key (Swt x Comp)

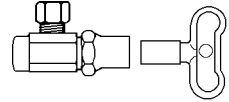

Part #	Mfg #	Size	Finish	Price
161876	SCR19X C	1/2" x 3/8"	CP	

## Stops - Angle

### Dual Outlet Stops

- Suffix after the space:
    - CP = Chrome plated
    - RB = Rough Brass
  - Suffix X before space is California lead-free
- Dual Outlet (Comp Inlet x Comp x Comp)**

- Suffix:
  - CRxxxxLR = neutral
  - C1 (chrome) and R1 (rough) are with window tray



Part #	Mfg #	Nom x OD x OD, Direction	Finish	Price
067556	CR1901LRXC	1/2" x 3/8" x 3/8"	CP	
002584	CR1901LRXR	1/2" x 3/8" x 3/8"	RB	

### Brass Valve Adapter (Comp)

- Suffix X is California lead-free



Part #	Mfg #	Size (OD Fem x OD x OD)	Price
135929	CT2-664X P	3/8" x 3/8" x 1/4"	
134129	CT2-666X P	3/8" x 3/8" x 3/8"	

### Dual Shut-Off Stops

- Suffix after the space:
  - RB = Rough Brass
- Suffix X before space is California lead-free

#### Dual Shut-Off Stop (Comp Inlet x Comp x Comp)

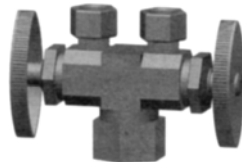

Part #	Mfg #	Nom x OD x OD	Finish	Price
110566	CR1901DV5XR	1/2" x 3/8" x 3/8"	RB	

### Stop Component Parts

#### Multi-Turn Stop Component

Part #	Mfg #	Description	Price
115113	S15-10C	Die Cast Zinc Loose Key Handle	

### Brass Compression Fittings

#### Brass Union (MIP x Comp) - Drill Through



Part #	Mfg #	Size	Finish	Price
002646	11C	3/8" x 3/8"	CP	

## Stops - Angle

### Supply Valves & Tubes

#### Angle Pattern 5/8" OD Compression x 3/8" OD Compression Valve

- All brass body and stem
- 5/8" OD Compression fits  
1/2" copper tubing



Part #	Mfg #	Finish	Price
115951	5812-ORB	Oil Rubbed Bronze	
115949	5812-SC	Satin Chrome	
115950	5812-SN	Satin Nickel	

#### Angle Pattern 3/8" IPS x 3/8" O/D. Supply Valve

- Oval handle
- All brass body and stem



Part #	Mfg #	Finish	Price
237215	585-PB	Polished Brass	

#### Cross Angle Pattern 5/8" OD Compression x 3/8" OD Compression Valve

- Brass button on handle matches finish  
on valve
- Handle options:
  - 621-8: Oval handle



Part #	Mfg #	Finish	Price
115929	621-8-BU	Bronze Umber	
115926	621-8-SN	Satin Nickel	



## Stops - Angle

### PRO-Stop Supply Stops - Angle Pattern

**PRO-Stop 7125 Angle Pattern 1/4-Turn Supply Stop (C x Comp)**



Part #	Mfg #	Size	Price
128954	7125A	1/2" Swt x 3/8" OD Comp	

**PRO-Stop 7145 Angle Pattern 1/4-Turn Supply Stop (Comp x Comp)**



Part #	Mfg #	Size	Price
136908	7145	5/8" OD x 1/4" OD Comp	
128951	7145A	5/8" OD x 3/8" OD Comp	

**PRO-Stop 7155A Angle Pattern 1/4-Turn Supply Stop (FIP x Comp)**



Part #	Mfg #	Size	Price
128952	ND617H5	3/8" FIP x 3/8" OD Comp	
128953	ND617H7	1/2" FIP x 3/8" OD Comp	

## Stops - Angle

### Mini-Ball™ Valves

#### 5000 Series Dual Shut-Off Valve

- With integral water hammer arrester
- Pattern: (2) straight with tee
- Operation: handle
- Chrome plated



Part #	Mfg #	Description	Price
086475	33-5001-WHA	5/8" OD Copper Comp x 3/8" OD Copper Comp	

#### 6000 Series Dual Shut-Off Valve

- With integral water hammer arrester
- Pattern: (1) straight, (1) angle with tee
- Operation: handle
- Chrome plated



Part #	Mfg #	Description	Price
086477	33-6001	5/8" OD Comp x 3/8" OD Comp x 3/8" OD Comp	

## Stops - Angle

### Angle Stops

#### PDQ™ Push Quarter-Turn Stop Valve—No Lead

- *Plumbing Done Quickly*
- *Easy & fast compliant plumbing solutions*
- *Universal: works with all CTS pipe types*
- *Removable, replaceable, reusable.*
- *Valves tested to 200 PSI at 200°F*



Part #	Mfg #	Push-Fit x O.D	Finish	Price
186105	648QG220A	1/2" x 3/8"	Chrome-Plated	

### Straight Stops

#### PDQ™ Push Quarter-Turn Stop Valve—No Lead

- *Plumbing Done Quickly*
- *Easy & fast compliant plumbing solutions*
- *Universal: works with all CTS pipe types*
- *Removable, replaceable, reusable.*
- *Valves tested to 200 PSI at 200°F*



Part #	Mfg #	Push-Fit x O.D	Finish	Price
186104	648QG220S	1/2" x 3/8"	Chrome-Plated	

#### Quarter-Turn Straight Supply Stop—No Lead

- *Bright, nickel-plated*
- *Quarter-turn positive on and off*
- *Individually bagged*



Part #	Mfg #	PEX x Compression	Price
247852	129-G2X0C	1/2" F1807 x 1/4"	

## Stops - Straight

### Multi-Turn Straight Stop Valves

- *Suffix after the space:*
  - CP = Chrome-plated
- *Suffix X before space is California lead-free*

#### Straight Stop (Swt x Comp)



Part #	Mfg #	Nom x OD	Finish	Price
002603	R14X C	1/2" x 3/8"	CP	

### G2 Series Twist In 1/4-Turn Straight Stops

#### G2 Straight Stop (Comp x Comp)



Part #	Mfg #	Nom x OD	Finish	Price
162147	G2CR14XCLF	1/2" x 3/8"	CP	

#### G2 Straight Stop (FIP x Comp)



Part #	Mfg #	Nom x OD	Finish	Price
166383	G2R10X C	3/8" x 3/8"	CP	

### G2 Series (Push Connect x Push Connect)



Part #	Mfg #	Nom x OD	Finish	Price
158656	G2QPS14X C	1/2" x 3/8"	CP	

### Commercial Straight Stops

#### Straight Stop Valve with Loose Key (Comp)

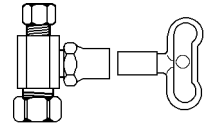

Part #	Mfg #	Nom Comp x OD	Finish	Price
031922	SCR14C	1/2" Comp x 3/8" OD	CP	

### Supply Kit Components

#### Brass Cover Tube

- *For 1/2" nominal copper tube*



Part #	Mfg #	Size	Finish	Price
002675	8491 C	36"	CP	

## Stops - Straight

### Pushconnect Straight Stops

#### Straight Stop (Pushconnect x Comp)

- Dual o-rings
- Pre-inserted tube stiffener
- Locking clip
- Suffix C1 - 20ct



Part #	Mfg #	Nom x OD	Finish	Price
158654	G2PS14XC	1/2" x 3/8"	CP	

### 1/4-Turn Ball Straight Stops

- PTFE Seats provide corrosion resistance and watertight seal
- Blow-out proof stem
- Plated stem
- 100% Leak tested
- Suffix after the space:
  - C is Chrome
- Suffix X before space is California lead-free

#### G2 Straight Stop

#### (Cold Expansion Barb for PEX x Comp)



Part #	Mfg #	Nom x OD	Finish	Price
107385	G2CEPX14XC	1/2" x 3/8"	CP	

### 1/4 Turn Straight Stop (Comp x Comp)



Part #	Mfg #	Nom x OD	Finish	Price
050642	KTCR14XC	1/2" x 3/8"	CP	
059129	KTCR11FC	3/8" Fe x 3/8"	CP	

### 1/4 Turn Straight Stop (FIP x Comp)

- Compatible with iron pipe
- For use in potable water systems
- Brass ball
- Temperature rating: 40° to 180°F
- Pressure rating: 125 PSI
- IAPMA and CSA listed to ASME A112.181.1/CSA B125.1



Part #	Mfg #	Nom x OD	Finish	Price
194831	KTR12XC	1/2" FIP x 3/8"	CP	

### Multi-Turn Straight Stop Valves

- Suffix after the space:
  - CP = Chrome-plated
- Suffix X before space is California lead-free

#### Straight Stop (FIP x Comp)



Part #	Mfg #	Nom x OD	Finish	Price
019932	OR10X	3/8" x 3/8"	CP	
019933	OR12X	1/2" x 3/8"	CP	

### Straight Stop (Comp x Comp)



Part #	Mfg #	Nom x OD	Finish	Price
002579	OCR11X	1/4" x 3/8"	CP	
161875	OCR14XC	1/2" x 3/8"	CP	
025026	OCR34XC	1/2" x 1/2"	CP	

## Stops - Straight

### PRO-Stop Supply Stops - Straight Pattern

**PRO-Stop 7120 Straight Pattern 1/4-Turn Supply Stop (C x Comp)**



Part #	Mfg #	Size	Price
128958	7120	1/2" C x 3/8" OD Comp	

**PRO-Stop 7140 Straight Pattern 1/4-Turn Supply Stop**



Part #	Mfg #	Size	Price
128955	ND60306	5/8" OD x 3/8" OD Comp	

**PRO-Stop 7140A Straight Pattern 1/4-Turn Supply Stop (Comp x Con)**



Part #	Mfg #	Size	Price
129859	ND613H4	3/8" OD x 3/8" OD Comp	

**PRO-Stop 7150 Straight Pattern 1/4-Turn Supply Stop**



Part #	Mfg #	Size	Price
128956	ND60605	3/8" FIP x 3/8" OD Comp	

**PRO-Stop 7150A Straight Pattern 1/4-Turn Supply Stop (FIP x Com)**

- Cold working pressure: 125 psi



Part #	Mfg #	Size	Price
128957	ND616H6	1/2" FIP x 3/8" OD Comp	





## Stops - Straight

### Straight Pattern Supply Valves

#### Straight Pattern 5/8" OD Compression x 3/8" OD Compression Valve

- 5/8" OD Compression fits 1/2" copper tubing
- Brass body and stem



Part #	Mfg #	Finish	Price
115946	581-ORB	Oil Rubbed Bronze	
115945	581-SN	Satin Nickel	

## Washing Machine Supply Hoses

### Washing Machine Connectors

- *Exceptional flexibility for fast, easy installation*
- *Heavy-duty brass hex nuts are easy to grip and nickel plated for durability*
- *High Efficiency Washing Machine Connector's wider inner diameter allow for faster filling and maximum energy efficiency*
- *Exceeds code requirements for flexible water connectors*

#### Washing Machine Connector (3/4" COMP x 3/4" COMP)



Part #	Mfg #	Length	Price
18168	B9WM48HE	48"	
4			
18168	B9WM60HE	60"	
5			
18168	B9WM72HE	72"	
6			

### Washing Machine Water Supply (Hose Fitting x Hose Fitting)

- *B Prefix: bulk packaging*



Part #	Mfg #	Length	Fittings	Price
00437	B9WM48	48"	3/4" x 3/4"	
3				
05544	B9WM60	60"	3/4" x 3/4"	
2				
05544	B9WM72	72"	3/4" x 3/4"	
3				

## Water Heater Supply Hoses

### Water Heater Supply Connectors

- Made of tough core covered with braided stainless steel wire
- Large inside diameter for higher flow capacity
- Won't kink or crease
- Heavy-duty brass hex nuts are easy to grip and nickel-plated for durability
- Exceeds all code requirements for flexible water connectors

#### Water Heater Connector (FIP x FIP)

- B Prefix: bulk packaging



Part #	Mfg #	Length	Fittings	Price
055640	B1H12	12"	3/4" x 3/4"	
055641	B1H18	18"	3/4" x 3/4"	
059321	B1H24	24"	3/4" x 3/4"	

#### Water Heater Connector (MIP x FIP)

- B Prefix: bulk packaging

Part #	Mfg #	Length	Fittings	Price
051579	B3H18	18"	3/4" x 3/4"	

#### Water Heater Connector (MIP x COMP)



Part #	Mfg #	Length	Fitting	Price
075080	FLB2H18	18"	3/4" x 3/4"	



## Water Heater Supply Hoses

### PEX Water Heater Fittings

#### Standard Water Heater Connector with Flexible FIP

- Full-flow, dielectric fitting - no flow restriction
- Brass FIP swivel nut includes gasket
- 3/4" FIP Branch for 2 gallon expansion tank
- Lead-free solder joint



Part #	Mfg #	Connection	Price
100810	634X418	(3/4") PEX x FIP Swivel	

## Bidet's & Bidet Faucets

### Horizontal Spray Bidet's

#### Amaretto® Horizontal Spray Bidet

- Vitreous china
- Drilled for fixture-mounted, single-hole, over-the-rim
- Included mounting hardware



Part #	Mfg #	Description	Rough-In	Color	Price
153702	K-4876-0	15-5/8"W x 24-3/8"L x 15"H	Above or Below the Floor	White	
139190	K-4876-47	15-5/8"W x 24-3/8"L x 15"H	Above or Below the Floor	Almond	
182459	K-4876-96	15-5/8"W x 24-3/8"L x 15"H	Above or Below the Floor	Biscuit	

### Vertical Spray Bidet's

#### Memoirs® Vertical Spray Bidet

- Vitreous China
- Drilled for fixture-mounted bidet faucet with vacuum breaker



Part #	Mfg #	Description	Rough-In	Color	Price
076952	K-4886-0	15-1/4"W x 25-9/16"L x 15"H	Above or Below the Floor	White	
122901	K-4886-47	15-1/4"W x 25-9/16"L x 15"H	Above or Below the Floor	Almond	
075863	K-4886-96	15-1/4"W x 25-9/16"L x 15"H	Above or Below the Floor	Biscuit	
159665	K-4886-G9	15-1/4"W x 25-9/16"L x 15"H	Above or Below the Floor	Sandbar	

#### San Tropez® Vertical Spray Bidet

- Vitreous china
- Drilled for fixture-mount bidet faucet and vacuum breaker
- (4) Faucet holes
- Front fill and vertical spray



Part #	Mfg #	Description	Rough-In	Color	Price
057459	K-4854-0	15-1/2"W x 24-3/8"L x 15-1/2"H	Above or Below the Floor	White	
104479	K-4854-47	15-1/2"W x 24-3/8"L x 15-1/2"H	Above or Below the Floor	Almond	
065592	K-4854-7	15-1/2"W x 24-3/8"L x 15-1/2"H	Above or Below the Floor	Black	
121286	K-4854-95	15-1/2"W x 24-3/8"L x 15-1/2"H	Above or Below the Floor	Ice Grey	
055764	K-4854-96	15-1/2"W x 24-3/8"L x 15-1/2"H	Above or Below the Floor	Biscuit	

\*Vibrant Limited Lifetime Finish

[www.plumbsupply.com](http://www.plumbsupply.com) • Serving our Customers Since 1946 • [www.waterconcepts.net](http://www.waterconcepts.net)

## Bidet's & Bidet Faucets

### Bidet Faucets

#### Artifacts® Vertical Spray Bidet Faucet

- Metal construction
- UltraGlide ceramic disc valves
- Fixture-mount vacuum breaker
- Pop-up drain with 1-1/4" tailpiece



Part #	Mfg #	Description	Finish
248731	K-72765-4-BN	Lever Handles, Vertical Spray	*Brushed Nickel

#### Bancroft® Vertical Spray Bidet Faucet

- Metal construction
- 1/4 Turn washerless ceramic disc valves
- Fixture-mount transfer valve/vacuum breaker
- Pop-up drain with lift rod and tailpiece



Part #	Mfg #	Description	Finish
236461	K-10586-4-CP	Lever Handles, Vertical Spray	Polished Chrome

#### Memoirs® Stately Vertical Spray Bidet Faucet

- Brass construction
- Fixture-mount transfer valve/vacuum breaker
- Pop-up drain with lift rod and tailpiece



Part #	Mfg #	Description	Finish
182456	K-470-4S-BN	Lever Handles, Vertical Spray	*Brushed Nickel
182457	K-470-4S-CP	Lever Handles, Vertical Spray	Polished Chrome

#### Purist® Vertical Spray Bidet Faucet

- Metal construction, brass valve bodies
- Fixture-mount transfer valve/vacuum breaker



Part #	Mfg #	Description	Finish
122759	K-14431-4-BN	Lever Handles, Vertical Spray	*Brushed Nickel
085045	K-14431-4-CP	Lever Handles, Vertical Spray	Polished Chrome

#### Refinia® Vertical Spray Bidet Faucet

- Metal construction
- Flexible connections
- Quarter-turn washerless ceramic disc valves
- Pop-up drain with lift rod and tailpiece



Part #	Mfg #	Description	Finish
183077	K-5329-4-BN	Lever Handles, Vertical Spray	*Brushed Nickel

\*Vibrant Limited Lifetime Finish

[www.waterconcepts.net](http://www.waterconcepts.net) • Serving our Customers Since 1946 • [www.plumbsupply.com](http://www.plumbsupply.com)



**Bidet's & Bidet Faucets**

**Bidet Faucets (Continued)**

**Refinia® Vertical Spray Bidet Faucet**

Part #	Mfg #	Description	Finish
149922	K-5329-4-CP	Lever Handles, Vertical Spray	Polished Chrome

**Revival® Horizontal Spray Bidet Faucet**

- 4" Centers
- 4-7/8" Swivel spray spout
- Brass construction, brass valve bodies
- Pop-up drain with lift rod and 1-1/4" tailpiece
- 1/4" Turn washerless ceramic disc valves



Part #	Mfg #	Description	Finish
247272	K-16131-4A-CP	Lever Handles, Horizontal Spray	Polished Chrome

\*Vibrant Limited Lifetime Finish

[www.plumbsupply.com](http://www.plumbsupply.com) • Serving our Customers Since 1946 • [www.waterconcepts.net](http://www.waterconcepts.net)



## Bolts & Caps

### Toilet Repair Parts & Fasteners

#### E-Z Snap Toilet Bolt Set

- Set contains:
  - (2) Toilet flange bolts
  - (2) Open acorn hex nuts
  - (2) Heavy NP washers
  - (2) Plastic retainers



Part #	Mfg #	Description	Price
017665	51076	Plumb Label, 1/4" x 2-1/4"	
017663	51176	Plumb Label, 5/16" x 2-1/4"	

#### Flange Bolt and Screw Set

- Set contains:
  - (2) Brass toilet flange bolts
  - (4) Open-end acorn nuts
  - (4) Heavy plated washers



Part #	Mfg #	Description	Price
017664	53046	Plumb Label, 1/4" x 2-1/4"	
042343	053065N	1/4" x 2-1/4"	
017666	53196	Plumb Label, 5/16" x 2-1/4"	

#### Brass Toilet Flange Bolt Set

- Contains:
  - (2) Brass toilet flange bolts
  - (2) Open acorn hex nuts
  - (2) Heavy NP washers
  - (2) Plastic speed nuts (optional)



Part #	Mfg #	Description	Price
058808	053125-N	1/4" x 3-1/2"	

#### Brass Toilet Flange Screw Set

- Contains:
  - (2) Brass toilet flange screws
  - (2) Closed brass NP acorn hex nuts
  - (2) Heavy NP washers



Part #	Mfg #	Description	Price
040968	059225	5/16" x 3-1/2"	
192930	059125	1/4" x 3-1/2"	

### Tank Bolt Kit

- Contains:
  - (2) 3" Brass tank bolts
  - (4) Rubber CI washers
  - (4) Heavy NP round washers
  - (4) Brass hex nuts OR
  - (2) Brass hex nuts and (2) wing nuts



Part #	Mfg #	Description	Price
033930	68022	Plumb Label Tank Bolt Kit	

### Sponge Rubber Gasket & Bolt Kit

- 3-1/4" OD x 2-1/8" ID x 9/16"
- Fits most close-coupled toilets
- Includes sponge rubber gasket with bolt kit (068025) and fiber washer (70045)



Part #	Mfg #	Description	Price
033931	072020	Plumb Label Tank Bolt Kit	

### Tank-To-Bowl Bolt Gasket & Washer

- Flexible non-wax gaskets
- Fits 3" and 4" waste lines

Part #	Mfg #	Description	Price
164388	072025	5/16" x 3"	

### Toilet Bolt Cap Set

- Cap snaps onto insert



Part #	Mfg #	Description	Price
005555	063065	White Plastic	

### Nipple Caddy

- Gray polyethelene
- Handle included
- 11"L x 7-5/8"W x 6-5/8"H



Part #	Mfg #	Size	Compartments	Price
239007	015610	1/2"	77	
239008	015615	3/4"	66	



---

---

## Bolts & Caps

---

---

### Gerber Toilet Bolt Caps

#### Bolt Cap

Part #	Mfg #	Description	Price
004844	99-287	Bolt Caps & Washer for Toilet, White	
164758	99-287-09	Bolt Caps & Washer for Toilet, Biscuit	

\*Physical Vapor Deposition (PVD) Limited Lifetime Finish

[www.plumbsupply.com](http://www.plumbsupply.com) • Serving our Customers Since 1946 • [www.waterconcepts.net](http://www.waterconcepts.net)

---

---

**Bolts & Caps**

---

---

**Bolt Caps**

**Plastic Bolt Caps**

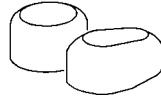

Part #	Mfg #	Size	Shape	Price
033750	917-PR	1/4-5/16"	Round Pair	

## Bolts & Caps

### Toilet Parts

#### Plumb Perfect™ Closet Bolt

- Tensile strength exceeds 1,100 lbs per bolt
- Redesigned threads provide increased strength and smoother, faster threading
- 100% corrosion proof nylon bolts are available in convenient 2-1/2" and 3-1/2" lengths
- Improved adaptability – open end nut now fits 1/2" sockets and fits under most bolt caps. Bolt base loads into any flange
- Unique design allows for quick and hassle free installation
- Pyramid base design keeps bolt upright and does not allow bolt to spin in flange, eliminating need to double nut bolt



Part #	Mfg #	Size	Price
009974	425-PB	2-1/2"	
064562	427-PB	3-1/2"	
204783	427-PBPK2	3-1/2"	

#### Solid Brass Closet Bolt

- Fastens a toilet bowl securely to the floor with a bolt, nut, and washer
- Available in 1/4" AND/or 5/16"
- Nickel-plated steel acorn nut and zinc-plated washer INCLUDED
- Acorn nuts and washers also available separately

#### Solid Brass Closet Bolt

Part #	Mfg #	Bolt Size	Price
009969	411-PB	1/4" x 20-3-1/2"	

#### Components

Part #	Mfg #	Description	Price
009971	417	1/4" x 20 -7/16" Hex, Nickel-Plated Steel Open End Nut	
009972	419	Closet Washer, Zinc Plated Steel, .042 Thick	

### Smart Cap™ Closet Bolt Cover Cap

- Taller cap eliminates the need to cut bolts
- Base creates a tight seal that helps provide a continuous sanitary seal between base and toilet
- Cap threads onto base and is less likely to get lost or knocked off
- Available with or without PlumbPerfect™ nylon closet bolts
- Model (440-2W) includes (425-PB) closet bolts

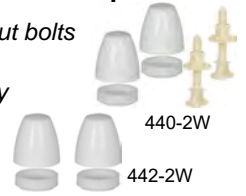

Part #	Mfg #	Color	Price
183409	440-2W	White	
121769	442-2W	White	

### Closet Bolt Cover Cap

- Polypropylene
- Snap on washer included



Part #	Mfg #	Color	Price
111541	SC49011240	White	

### Standard Tank Bolt Set

- Standard bolt set has 23/32" heads
- Plated hex nuts and wing nuts
- Cloth inserted washers and plated washers



Part #	Mfg #	Material	Price
183410	452-PB	Solid Brass	

### Wedge-It™ Multi-Purpose Stability Closet Wedge

- Corrosion proof
- Derivable stiff polypropylene
- Soft Rubber-Like PVC

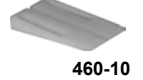

Part #	Mfg #	Material	Color	Price
029290	460-10	Polypro	Natural	
035407	460-20	PVC	White	



## Bolts & Caps

### Tank-to-Bowl Kit

- Gasket with deluxe tank-to-bowl bolts  
—Sponge rubber gasket
- Replaces worn tank-to-bowl gaskets and bolts
- Manufactured to same specifications as original parts
- Prevents leaks between the tank and the bowl



Part #	Mfg #	Brand	# of Bolts	Gasket	Price
183422	490-10555	Universal	2	3/4"	
152335	490-10572	Kohler	3	3/4"	



## Bolts & Caps

### Bolts & Caps

#### Harvey™ Bol-Bolts® Nylon Bolt Pack

- Corrosion proof
- 2 Bolts & 2 nuts per bag
- Eliminates need for two nuts
- Fits all flanges & material types
- Product must exceed 1,200lbs. tensile strength per bolt



Part #	Mfg #	Per Bag	Price
241889	051159	2 Bolts & Nuts	

#### Hercules® Johni-Bolts®

- Brass closet bolt
- Snap-off slot & captive washer



Part #	Mfg #	Diameter	Price
192903	90104	1/4 x 2-1/4"	
192904	90124	5/16" x 2-1/4"	
192905	90174	5/16" x 3-1/2"	

#### Hercules® Johni-Quick Bolts®

- Unique new bolting system for mounting toilets
- Fast and easy
- Just push down and twist to tighten in one quick motion
- Eliminates "fall-through" and wobble



Part #	Mfg #	Diameter	Price
139574	90-904	1/4"	
195044	90-905	5/16"	



## Bowl Wax

### PRO Series Bowl Wax Rings

- For floor outlet toilet bowls
- Fits 3" and 4" waste lines

#### PRO Bowl Wax Ring

Part #	Mfg #	Description	Price
145791	PRO700	Pro Series Wax Ring	

#### PRO Bowl Wax Ring with Flange



Part #	Mfg #	Description	Price
145792	PRO70F	Pro Series Wax Ring w/Flange	

#### PRO7530 – Better Than Wax® Wax-Free Seal

- No Wax, No Mess
- Can Be Repositioned and Double Stacked
- Plunging Won't Cause Leaks
- Bolt Holes for Easy Guide Installation
- Fits Any Drain, Any Toilet
- Will not melt



Part #	Mfg #	Description	Price
177741	FLPRO7530	Pro Series Wax-Free Seal	

#### Wax-Free™ Bowl Gasket

- Adapts to all types of flooring and drain pipes
- Eliminates the need for stacking multiple wax rings on new, raised flooring
- 10-Year warranty



Part #	Mfg #	Description	Price
055500	7504	4" Wax-Free™ Bowl Gasket	



## Bowl Wax

### Wax Toilet Bowl Gaskets

#### No-Seep No. 1 Wax Gasket

- With polyethylene flange
- Fits 3" and 4" lines
- For floor closet bowls only



Part #	Mfg #	Description	Price
017672	PL1NOSEEP	Plumb Label #1 Wax Gasket	

#### No-Seep No. 2 Specialty Urethane Wax Gasket

- Fits all wall closet bowls and carriers
- 10-Year guarantee



Part #	Mfg #	Description	Price
002560	BOWLWAX2NS	#2 Urethane	

#### No-Seep No. 3 Specialty Urethane Wax Gasket

- Fits 3" and 4" lines
- For floor and most wall bowls
- 10-Year guarantee



Part #	Mfg #	Description	Price
002561	BOWLWAX3NS	#3 Urethane	

#### No-Seep No. 5 4-in-1 Wax Gasket

- Polyethylene flange
- Fits 4" lines only



Part #	Mfg #	Description	Price
192916	BOWLWAX5NS	#5 Polyethylene Flange	

#### No-Seep No. 10 Extra Thick Wax Gasket

- With polyethylene flange
- Fits 3" and 4" lines
- 40% More wax for more positive seal



Part #	Mfg #	Description	Price
002559	BOWLWAX10	#10 Extra Thick	

### Bol-Wax No. 1 Standard Wax Gasket

- For floor closet bowls only

Part #	Mfg #	Description	Price
017762	PL1	Plumb Label 1 Bowl Wax	

### Bol-Wax No. 2 Economy Wax Gasket



Part #	Mfg #	Description	Price
192918	BOWLWAX2	#2 Economy	

### Bol-Wax No. 6 Specialty Urethane Wax Gasket

- Fits 2" outlet
- For urinals
- 10-Year guarantee



Part #	Mfg #	Description	Price
002562	BOWLWAX6	#6 Urinal Gasket	

### Bol-Wax No. 10 Extra Thick Wax Gasket

- For floor closet bowls only



Part #	Mfg #	Description	Price
119053	HV007400	#10 Extra Thick	

---

---

## Bowl Wax

---

---

### Wax Bowl Rings



Part #	Mfg #	Model	Description	Price
133296	82550	RWG1	Std Wax Gasket	

## Bowl Wax

### Bowl Rings Urinal Wax Ring

- Urethane sponge



Part #	Mfg #	Description	Price
121374	31187	Urinal Wax Ring	

### Heavy Duty Wax Bowl Ring w/ Sleeve

- 100% pure petroleum wax gasket for setting any floor type closet bowl
- Provides a permanent seal impervious to vermin, odors, gases and acids
- Polyethylene sleeve



Part #	Mfg #	Size	Price
189168	31194	3" or 4"	

### Hercules® Johni-Ring™ Wax Gasket for Back Outlet Toilets

- Packaged in a tray
- Hands stay clean; wax maintains shape

Part #	Mfg #	Size	Price
193641	90270	3" or 4"	

### Hercules® Johni-Ring®

- Includes clean-release tray
- For use on 3" and 4" waste lines



Part #	Mfg #	Waste Line	Price
192901	90210	3" or 4"	
192902	90220	3" or 4"	
063407	90241	3" or 4"	
063408	90243	3" or 4"	

### Hercules® Johni-Ring™ Wax Gasket for Wall Hung Urinals

- Packaged in a tray
- Hands stay clean
- Wax maintains shape



Part #	Mfg #	Waste Line	Price
193640	90260	3" or 4"	



## Closet Flanges, Spuds, & Flush Ells

### Toilet Flanges

#### Stainless Steel Toilet Mount Ring

- *Replaces damaged toilet flange ring*
- *Fits all closet hubs*
- *Will not rust or corrode*



Part #	Mfg #	Description	Price
059700	014710	Toilet Mount Ring	



---

---

## Closet Flanges, Spuds, & Flush Ells

---

---

### Closet Flanges

#### Closet Flange for Lead Flange



Part #	Mfg #	Size	Price
005875	CF-400	4" x 3"	

## Closet Flanges, Spuds, & Flush Ells

### Brass Closet Flush Elbows

- -1 Polished chrome



Part #	Mfg #	Size	Gauge	Price
003277	1032AD-1	2" x 5" x 7"	20ga	
003278	1033D-1	2" x 6" x 8"	20ga	

### Spud Washers

#### Closet Spud



Part #	Mfg #	Size	Price
003141	4029	1-1/4"	
003140	4028	1-1/2"	
003138	4025	2"	
003139	4026	2" x 1-1/2"	

#### Urinal Spud



Part #	Mfg #	Size	Price
003142	4030	1" x 3/4"	
003143	4031	1-1/4" x 3/4"	
084129	4032	1-1/2" x 3/4"	

### Closet Spud Washer



Part #	Mfg #	Size	Price
251827	7101	1-1/2"	
251828	7102	2"	
251830	7105	1" x 3/4"	

## Closet Flanges, Spuds, & Flush Ells

### Closet Flanges

#### Easy Tap® Closet Flange

- With test cap
- 3" or 4" flange solvent welds inside of 4" or over 3" Schedule 40 DWV pipe
- Built-in catch teeth prevents the test cap from falling down into the DWV line
- Four mounting slots for closet bolts
- Four countersunk holes for secure attachment to the floor



Part #	Mfg #	Size	Price
197460	OT43613	3" or 4" PVC w/ SS Ring	

#### Offset Level-Fit Closet Flange with Metal Ring

- The metal ring provides added strength and cracking resistance to the flange and can be rotated to allow precise alignment of bolts and screws
- Solvent welds inside of 4" or over 3" Sch 40 DWV pipe
- 2" Offset allows a margin of error for drain pipe/flange alignment



Part #	Mfg #	Description	Price
015447	43PDOCF	3" or 4" PVC	

#### Level-Fit Closet Flange with Metal Ring

- The metal ring provides added strength and cracking resistance to the flange and can be rotated to allow precise alignment of bolts and screws
- Solvent welds inside of 4" or over 3" Sch 40 DWV pipe



Part #	Mfg #	Description	Price
015446	43PDHCFMR	3" or 4" PVC	
015271	4PDHCFMR	4" PVC	
030381	43PDCFMRKO	3" or 4" PVC with Test Cap Also	

### Level-Fit Closet Flange

- 3" or 4" all plastic flange welds inside of 4" or over 3" Sch 40 DWV pipe
- 3" inside fit flange fits inside 3" Sch 40 DWV pipe
- (4) Mounting slots
- (4) Countersunk holes for secure attachment to the floor



43503

Part #	Mfg #	Description	Price
015444	43PDHCF	3" or 4" PVC less Test Cap	
015445	43PDHCFKO	3" or 4" PVC with Test Cap	
192790	OT43507	3" PVC w/Plastic Ring & Test Cap	
030382	3PDCF	3" PVC Inside Fit w/o Test Cap	
252126	OT43525	3" or 4" PVC Long Pattern Plastic Ring w/o Test Cap	

### Spigot Fit Closet Flange

- PVC w/ plastic ring
- For use in hub-end of fitting
- Fits on inside of fitting
- Eight countersunk holes and two closet bolt slots for secure attachment to the floor



Part #	Mfg #	Size	Price
252127	OT43585	3" PVC	

### 45° Swivel Closet Flange



Part #	Mfg #	Description	Price
049616	OT43816	4" x 3" PVC	

### Twist-N-Set™ Closet Flange

- Replaces broken cast iron closet flanges
- Installs easily without tools
- No need to tear up existing floor
- Smooth unrestricted flow design
- Gasket expands to fit service weight, heavy weight and no hub



Part #	Mfg #	Description	Price
075704	OT43654	3" PVC	
029792	OTTWISTNSET	4" PVC	

## Closet Flanges, Spuds, & Flush Ells

### Closet Flanges (Continued)

#### Twist-N-Set™ Closet Flange

Part #	Mfg #	Description	Price
049551	OT43653	4" Cast Iron	

#### Closet Flange Replacement

- Slides inside of 4" cast iron or Sch 40 DWV plastic pipe
- 3" Stainless steel bolts are tightened from the finished floor
- Compression joint allows up to 3" of adjustment to the riser
- No tear out or caulking required



Part #	Mfg #	Description	Price
040577	OT43539	4" PVC	

#### Cast Iron Closet Flange

- No caulking
- Use on plastic or heavy weight, no hub or service weight soil pipe
- Complete with body, brass ring, bolts and gasket



Part #	Mfg #	Description	Price
155787	OT42253	3" CI, w/o Test Cap	
149947	OT42255	4" CI, w/o Test Cap	
252187	OT42257	4" x 4" CI, w/o Test Cap	

#### Set-Rite® Closet Flange Extender Kit

- 1/4" - 3/8"



Part #	Mfg #	Size	Price
254172	OT43400	1/4" - 3/8"	

#### Closet Flange Spacer Kit

- For use when overlaying, replacing or tiling bathroom floors
- Kit includes gaskets, 1/2" spacer, closet bolts and shims



Part #	Mfg #	Size	Price
252111	OT43645	Spacer Kit	

#### Closet Flange Spacer

- Can be stacked to desired height



Part #	Mfg #	Description	Price
041344	OT43519	1/4" Flange Spacer for ABS or PVC Closet Flanges	
252122	OT43646	1/2"	

#### Set-Rite® Closet Flange Spacer



Part #	Mfg #	Size	Price
252115	OT43411	1/2"	

#### Stainless Steel Replacement Ring

- For use on 3" or 4" closet flanges
- Six countersunk holes and two closet bolt slots for secure attachment to the floor



Part #	Mfg #	Size	Price
252124	OT42778	3" or 4" SS Replacement Ring	

#### Moss Bay Replacement Flange

- Used for replacing rusted or corroded metal closet flange rings
- PVC or ABS closet flanges
- Includes closet bolts



Part #	Mfg #	Size	Price
173033	OT42777	PVC or ABS	

#### Galvanized Wood Support Kit

- For repairing wobbly toilets or loose closet flanges without replacing the floor
- Easy-to-use floor and flange support
- Use for holes cut too large, rotting floors or screws that pulled loose
- Includes two heavy gauge pre-slotted flange plates, six floor attaching screws and 4 large flathead flange assembly screws



Part #	Mfg #	Size	Price
251975	OT43555	Closet Repair Flange	

**Closeout Flanges, Spuds, & Flush Ells**

**PVC Closet Flanges**

**PVC Closet Flange (Hub)**



Part #	Size	Price
015261	4"	

**PVC Closet Flange with KO Test Plug (Hub)**

Part #	Size	Price
015272	4"	

**PVC Adj Closet Flange with Metal Ring (Hub)**



Part #	Size	Price
015271	4"	

**PVC Fitting Closet Flange (Spgt)**

Part #	Size	Price
015448	4" x 3"	

**PVC Adj Ftg Closet Flange with Metal Ring (Spgt)**

Part #	Size	Price
015449	4" x 3"	

**Closet Flanges, Spuds, & Flush Ells**

**Closet Flanges**

**Closet Quick Ring**

- Replaces any and all closet rings
- Unique screw tabs attach to wood or concrete
- Plastisol coat provides corrosion protection
- Slotted for 1/4" or 5/16" closet bolt

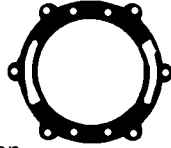

Part #	Mfg #	Description	Price
008019	21013	Quick Ring Closet Ring	

**Closet Spuds**

**Closet Spud**



Part #	Mfg #	Size	Locknut	Price
008121	959	1-1/2" x 1-1/2"	Brass	
008122	960	1-1/4" x 1-1/4"	Brass	

**Urinal Spud**



Part #	Mfg #	Size	Locknut	Price
008123	961	1" x 3/4"	Brass	



## Closet Flanges, Spuds, & Flush Ells

### Closet Flanges

#### TKO™ Total Knockout Closet Flange

- Knockout will not break apart and cannot fall down drain pipe
- Strong, corrosion-resistant stainless steel ring eliminates cracked flanges
- Easier installation, no need to hold knockout while hammering
- Holds five floors (22 psi) for head test
- Model (883-PTM) includes 1-3/4" long tailpiece



884-ATM

#### One-Piece Plastic Ring

Part #	Mfg #	Hub/Inside	Flush to Floor	Price
030421	883-PT	3"	4"	

#### Stainless Steel Swivel Ring

Part #	Mfg #	Hub/Inside	Flush to Floor	Price
035411	884-PTM	3"	4"	
105484	886-4PTM	4"	4"	
251688	886-4PTMSP K	4" (Spigot)	4"	
105483	886-PTMS	3" (Spigot)	4"	

#### Open Closet Flange

- **One-piece plastic ring**  
—Solid PVC or ABS
- **Stainless steel swivel ring**  
—Corrosion-resistant ring is engineered for maximum strength



887-PM



888-

#### One-Piece Plastic Ring: PVC

Part #	Mfg #	Hub/Inside	Flush to Floor	Price
035412	888-P	3" (Inside Fit)		

#### Stainless Steel Swivel Ring

Part #	Mfg #	Hub/Inside	Flush to Floor	Price
030422	887-PM	3"	4"	

### Push-Tite™ Gasketed Closet Flange

- Gasket seals inside DWV pipe
- Easy installation – simply push in and fasten to floor, perfect for replacement or new installations
- PushTite™ flanges have larger outlets than other gasketed closet flanges and smooth inner walls with no obstructions or ledges to cause clogs
- Swivel ring is stainless steel for durability



888-GPM



887-GPM



886-G

#### Inside 3" DWV Pipe

Part #	Mfg #	Ring	Connection	Price
101224	888-GPM	Plastic	4" Long Tailpiece	

#### Inside 4" DWV Pipe

Part #	Mfg #	Ring	Connection	Price
248702	886-GI	Cl flange	4" Long Tailpiece	
137027	886-GP	Plastic	4" Long Tailpiece	
073909	887-GPM	SS Swivel	Flush to Floor	

### Brass Closet Flange Ring

- Solid brass
- For use with lead pipe
- (-D) Deep seal model provides more surface area for better joint



890-4BPK



890-4BDPK

Part #	Mfg #	Size	Price
251889	890-4BDPK	Deep Seal Brass Flange Ring	
251887	890-4BPK	Brass Flange Ring	

### QuickSpacer™ Closet Flange Spacer Ring

- Fits under most closet flanges
- Each ring raises the flange 3/4" off the floor
- Use multiple rings for additional height



Part #	Mfg #	Size	Price
064362	886-ER	3/4"	

## Closet Flanges, Spuds, & Flush Ells

### Ringer™ Stainless Steel Closet Ring

- Strong corrosion-proof stainless steel
- Perfect for repairs - cups the damaged flange
- Mount around 3" or 4" pipe on concrete floors



Part #	Mfg #	Thickness	Price
078459	886-MR	Stainless Steel Closet Ring	

### Closet Flange Spacer Repair Ring Kit

- Two-piece, "Moss Bay" design for replacing broken or rusted swivel rings without removing flange
- Includes two-piece galvanized ring, closet bolts, nuts and washers



Part #	Mfg #	Pieces	Per	Price
176277	886-MRM	2	1	

### Raise-A-Ring™ Closet Flange Extension Ring

- Build up existing flange when added subfloor, etc. leaves flange at or below floor level
- Stack rings for additional height



Part #	Mfg #	Thickness	Price
034257	886-R	7/16"	
156865	886-RQ	1/4"	

### Spuds

#### Spud Gasket

- Installs on flush valve spud
- Seals brass spud to china
- Natural rubber



Part #	Mfg #	Size	Type	Price
183434	490-11520	1-1/4"	Urinal	
183435	490-11522	1-1/2"	Closet	
183437	490-11530	1" x 3/4"	Urinal	

### FullFlush™ Offset Open Closet Flange

- Full-flow, 3" I.D. throat – no restriction
- Allows for 1½" offset in any direction for closet bowl setting
- Corrosion-resistant 430 stainless steel swivel ring is engineered for maximum strength



Part #	Mfg #	Description	Price
249898	889-GPOM	Inside 4" Gasket Fit	
083332	889-POM	3" Hub/Inside 4", Flush-Floor	

### DropKick™ Offset Flange

- Full-flow, 3" I.D. throat – no restriction
- Solvent welds inside 3" Sch. 40 ftg hub
- Corrosion-resistant 430 stainless steel swivel ring is engineered for maximum strength



Part #	Mfg #	Hub/Inside	Flush to Floor	Price
085228	889-45PM	3" PVC	3"	

### Save-A-Flange™ Closet Flange Repair Kit

- 1/8" Stamped, zinc plated steel
- Kit Includes:
  - (1) Zinc-plated bar
  - (2) Plastic screw anchors
  - (2) 1-3/4" x 8" Phillips-head screws
  - (6) Poly spacer washers
  - (1) Instruction sheet



Part #	Mfg #	Description	Price
035408	490-11320	Save-A-Flange Repair Kit	

### Gaskets

#### Closet Bowl Cushion—Sponge Rubber Ring Type

- Wax-free Toilet Seal
- Excessive plunging will not cause leaks
- Pre-drilled holes on wide flange model hold bolts upright, eliminating need to double nut



Part #	Mfg #	O.D.	I.D.	Height	Price
183419	490-10542	5-3/8"	3-1/2"	3/4"	
252468	490-10547	6-3/4"	3-1/2"	3/4"	

#### Universal Tank-to-Bowl Gaskets

- Molded rubber



Part #	Mfg #	O.D.	I.D.	Height	Price
183425	490-10656	3-5/8"	2-1/4"	3/4"	

#### American Standard/Mansfield Tank-to-Bowl Gaskets

- Sponge material



Part #	Mfg #	O.D.	I.D.	Height	Price
183428	490-10661	3-1/2"	2-1/8"	1-1/8"	

## Closet Flanges, Spuds, & Flush Ells

### Gerber Tank-to-Bowl Gaskets

- *Sponge material*



Part #	Mfg #	O.D.	I.D.	Height	Price
183430	490-10666	3-1/4"	2-1/8"	1-3/16"	

### Kohler Tank-to-Bowl Gaskets

- *Sponge or molded rubber material*
- *3/4" Height*



490-1067

Part #	Mfg #	O.D.	I.D.	Material	Price
183431	490-10671	3-3/4"	2-1/2"	Rubber	
183432	490-10673	3-1/4"	2"	Sponge	

### Plastic Flush Valve

- *Complete replacement plastic flush valve with flapper*
- *Blue vinyl chemical-resistant flapper*
- *Stainless steel chain*

Part #	Mfg #	Description	Price
183433	490-11152	Gasket Only for 490-11150	

---



---

## Closet Flanges, Spuds, & Flush Ells

---



---

### Closet Flanges

#### Wax Free Toilet Seal

- *A strong and flexible to sustain a positive seal*
- *Ideal for wall carriers and floor mounts*
- *Accommodates floors raised above the toilet flange by up to 3/4"*
- *Maintains a gas tight seal even when minor movement occurs*



Part #	Mfg #	Size	Price
139045	FTS-3	3"	
167381	FTS-4	4"	



## Commercial Closets

### Commercial Spud Bowls

#### Wall-Mount Top Spud Bowl

- Elongated bowl
- 1-1/2" Spud for flushometer valve
- Wall waste outlet
- Siphon-jet
- Flush valve sold separately



Part #	Mfg #	Description	Rough-In	Color	Price
016283	25-030	Elongated Bowl	5-1/4" - 7-1/4"(ADA)	White	

#### North Point™ Wall-Mount Spud Bowl

- Elongated bowl
- 1-1/2" spud for flushometer valve
- siphon jet
- Top spud
- 1.28/1.6 gpf/4.8/6.0 Lpf high



Part #	Mfg #	Description	Rough-In	Color	Price
185772	25-033	Elongated Bowl	5-1/4" - 7-1/4"	White	

#### North Point™ ErgoHeight™ Elongated 1.28/1.6 gpf Top Spud Bowl

- Siphon jet
- 2" Glazed trapway
- 1-1/2" Spud for flushometer valve
- Flushometer valve not included
- Toilet seat not included



Part #	Mfg #	Description	Rough-In	Color	Price
168337	25-733	Elongated Bowl	10"	White	

#### North Point™ Round Front Washdown 1.28/1.6 gpf Back Spud Bowl

- Siphon jet
- Large trapway
- 2" x 1-1/2" Spud for flushometer valve
- Toilet seat not included



Part #	Mfg #	Description	Rough-In	Color	Price
238551	25-642-31	Round Front Bowl	10"	White	



## Commercial Closets

### Floor-Mount Top Spud Bowl

- Large trapway
- 1-1/2" Spud for flushometer valve
- Siphon-jet



Part #	Mfg #	Description	Rough-In	Color	Price
017712	25-830	Elongated Bowl	10"	White	
050466	25-870	Round Bowl, Eli Children's	10"	White	

### Floor-Mount ErgoHeight™ Top Spud Bowl

- Large trapway
- 1-1/2" Spud for flushometer valve
- Siphon-jet



Part #	Mfg #	Description	Rough-In	Color	Price
004647	25-730	ADA Elongated Bowl	10"	White	

### Floor-Mount Elongated 1.6 Back Outlet Spud Bowl

- Elongated bowl
- 4-1/4" Vertical rough in
- Fully glazed trapway
- 1-1/2" Back spud for flushometer valve
- Back outlet
- Siphon jet
- Toilet seat not included



Part #	Mfg #	Description	Rough-In	Color	Price
167101	25-874	Back outlet bowl	4-1/4" Vertical	White	

### Maxwell™ ErgoHeight Wall-Hung 2-Piece 1.28 Toilet

- 2" Glazed trapway for efficient waste removal
- 3" Flush valve for strong water flow and flushing power
- 4" Vertical rough-in
- Dual-fed siphon jet
- Pilot fill valve
- Seat sold separately



20-021 Combination: 21-970 Bowl, 28-970 Tank

Part #	Mfg #	Description	Rough-In	Color	Price
150801	20-021	21-970 ADA Wall-Hung Bowl, 28-970 Tank	4"	White	

## Commercial Closets

### Commercial Toilets

#### Anglesey™ Floor-Mounted Wall-Outlet Commercial 1.6 gpf Flushometer Valve

- 27-1/2" x 14-1/2" x 15"
- 1-1/2" top spud  
—1-1/2" Rear spud (K-4396-0)
- 15" Elongated bowl
- 4-1/2" rough-in
- Seat sold separately
- (K-4388 Models include integral seat)



Part #	Mfg #	Description	Rough-In	Color	Price
060200	K-4386-0	Elongated Bowl, 1-1/2" Top Spud	4-1/2"	White	
222090	K-4388-0	Elongated Bowl with Seat, 1-1/2" Top Spud	4-1/2"	White	
061742	K-4396-0	Elongated Bowl, 1-1/2" Rear Spud	4-1/2"	White	
093767	K-4398-0	Elongated Bowl, 1-1/2" Rear Spud	4-1/2"	White	

#### Anglesey™ Commercial Floor-Mounted 1.6 or 1.28 gpf Comfort Height® Bowl

- 31-1/2" x 14-7/8" x 17"
- Vitreous china
- Direct-fed siphon jet flushing
- Rear-outlet flushometer bowl
- 1-1/2" Top spud
- 4" Rough-in
- 2-1/8" Glazed trapway
- (-L) Bedpan lugs



Part #	Mfg #	Description	Rough-In	Color	Price
133057	K-4352-0	Elongated Bowl, 1-1/2" Top Spud	4"	White	
148226	K-4352-L-0	Elongated Bowl, 1-1/2" Top Spud	4"	White	

#### Barrington™ 2-Piece 1.0 gpf Toilet with Pressure Lite® Flushing Technology

- 31-1/2" L x 21-1/4" W x 31-1/4" H
- 4" Rough-in
- Includes left-hand trip lever
- Right-Hand Trip Lever (-RA)
- Rear outlet bowl



**K-3578 Combination: K-4305 Elongated Bowl, K-4484 Tank**

Part #	Mfg #	Description	Rough-In	Color	Price
138826	K-3578-0	ADA Elongated Complete, LH CP Trip	4"	White	
155830	K-3578-47	ADA Elongated Complete, LH CP Trip	4"	Almond	
174559	K-3578-RA-0	ADA Elongated Complete, RH CP Trip	4"	White	
225842	K-3652-0	Elongated Complete, LH Trip	4"	White	
165850	K-3652-7	Elongated Complete, LH Trip	4"	Black	

\*Vibrant Limited Lifetime Finish

**www.plumbsupply.com • Serving our Customers Since 1946 • www.waterconcepts.net**



## Commercial Closets

### Barrington™ Elongated Toilet with Pressure Lite® Flushing Technology

- Vitreous China
- Seat not included
- 4" Rough-In



Part #	Mfg #	Description	Rough-In	Color	Price
109852	K-3554-0	Elongated Complete, 1.6 GPF	4"	White	

### Highcliff™ Comfort Height® Commercial 1.1 to 1.6 gpf Toilet Bowl with Top Spud

- 26"L x 14-1/2"W x 17-1/2"H
- 10" or 12" Rough-in
- 1-1/2" Spud
- Seat sold separately



Part #	Mfg #	Description	Rough-In	Color	Price
234898	K-96057-0	ADA Elongated Bowl, 1-1/2" Top Spud	10" or 12"	White	
234908	K-96057-L-0	ADA Elongated Bowl, 1-1/2" Top Spud with Bedpan Lugs	10" or 12"	White	
234901	K-96057-96	ADA Elongated Bowl, 1-1/2" Top Spud	10" or 12"	Biscuit	
234902	K-96057-SS-0	ADA Elongated Bowl, 1-1/2" Top Spud with Antimicrobial Finish	10" or 12"	White	

### Highcliff™ Ultra Commercial Flushometer Bowl with Rear Spud

- Vitreous china
- 26-3/8"L x 14-5/8"W x 16-7/8"H
- 10" x 7" Water surface size
- 11" Rough-in
- 1-1/2" Rear spud
- ADA-compliant bowl height
- 2-1/8" Trap passageway
- WaterSense certified: 1.1, 1.28, and 1.6 gpf
- Seat sold separately
- Replaces Highcrest (K-4301) and Highcliff™ (K-4367) flushometer models
- (-L) Bedpan lugs



Part #	Mfg #	Description	Rough-In	Color	Price
240542	K-96058-0	ADA Elongated Bowl, 1-1/2" Rear Spud	11"	White	
240544	K-96058-L-0	ADA Elongated Bowl, 1-1/2" Rear Spud with Bedpan Lugs	11"	White	

\*Vibrant Limited Lifetime Finish

[www.waterconcepts.net](http://www.waterconcepts.net) • Serving our Customers Since 1946 • [www.plumbsupply.com](http://www.plumbsupply.com)

## Commercial Closets

### Juvenile™ 1.1-1.6 gpf Ultra Flushometer Toilet Bowl with Top Spud

- 25-15/16" L x 14-5/8" W x 13-3/4" H
- Vitreous china
- 10" or 12" Rough-in
- 1-1/2" Top spud
- 10" x 7" Water size
- Trap passageway 2-1/8"
- GPF range (1.1, 1.28, & 1.6 gpf)
- (-SS) Antimicrobial finish



Part #	Mfg #	Description	Rough-In	Color	Price
237911	K-96059-0	ADA Elongated Bowl, 1-1/2" Top Spud	10" or 12"	White	
259215	K-96059-SS-0	ADA Elongated Bowl, 1-1/2" Top Spud, Antimicrobial finish	10" or 12"	White	

### Kingston™ 2-Piece 1.28 gpf Comfort Height® Elongated Toilet with Class Five® Flushing Technology

- 29-3/4" L x 18-3/4" W x 31-1/2" H
- 29-7/8" L x 18-3/4" W x 29-1/2" H (Model K-25087)
- 12" Rough-in
- 2-1/8" Fully glazed trapway
- Includes left-hand trip lever
- Right-Hand Trip Lever (-RA)
- Rear outlet bowl
- Seat and supply line not included



K-25077 Combination: K-25076 Elongated Bowl, K-25100 Tank  
K-25087 Combination: K-25086 Elongated Bowl, K-25100 Tank

Part #	Mfg #	Description	Rough-In	Color	Price
255560	K-25077-0	ADA Elongated Complete, LH Trip Lever	12"	White	
255561	K-25087-0	ADA Elongated Complete, LH Trip Lever	12"	White	

### Kingston™ 2-Piece 1.28 gpf Round-Front Toilet with Class Five® Flushing Technology

- 29-7/8" L x 18-3/4" W x 29-1/2" H
- 12" Rough-in
- 2-1/8" Fully glazed trapway
- Includes left-hand trip lever
- Right-Hand Trip Lever (-RA)
- Rear outlet bowl
- Seat and supply line not included



K-25097 Combination: K-25096 Elongated Bowl, K-25100 Tank

Part #	Mfg #	Description	Rough-In	Color	Price
255562	K-25097-0	Round-Front Complete, LH Trip Lever	12"	White	

\*Vibrant Limited Lifetime Finish

[www.plumbsupply.com](http://www.plumbsupply.com) • Serving our Customers Since 1946 • [www.waterconcepts.net](http://www.waterconcepts.net)

## Commercial Closets

### Kingston™ Wall-Mounted 1.6 or 1.28 gpf Flushometer Valve Toilet Bowl with Top Inlet

- 17" - 19" High installation, floor to top of seat or installed with K-4679-CA toilet seat for ADA compliance
- Seat and flush valve sold separately
- -L Model includes bed pan plugs



Part #	Mfg #	Description	Color	Price
118238	K-4325-0	Elongated Bowl, Wall-Mount, 1-1/2" Rear Spud	White	
146599	K-4325-96	Elongated Bowl, Wall-Mount, 1-1/2" Rear Spud	Biscuit	
148195	K-4325-BA-0	Elongated Bowl, Wall-Mount, 1-1/2" Rear Spud	White	
183057	K-4325-L-0	Elongated Bowl, Wall-Mount 1-1/2" Rear Spud	White	
257237	K-4325-SS-0	Elongated Bowl, Wall-Mount, 1-1/2" Top Spud	White	

### Kingston™ Wall-Mounted 1.6 or 1.28 gpf Flushometer Valve Toilet Bowl with Rear Inlet

- 17" - 19" High installation, floor to top of seat or installed with K-4679-CA toilet seat for ADA compliance
- Seat sold separately



Part #	Mfg #	Description	Color	Price
130311	K-4323-0	Elongated Bowl, Wall-Mount, 1-1/2" Rear Spud	White	

### Primary™ Floor-Mount Flushometer Toilet Bowl

- 24-7/16"L x 13-1/8"W x 10-1/2"H
- Children's height bowl
- 1-7/8" Glazed trapway
- 10" or 12" Rough-in
- 1-1/2" Top spud
- 1.28 to 1.6 gpf flush range
- Replaces Primary™ K-4321 and K-4384
- Available with antimicrobial finish K-96064-SS
- Includes K-4686 toilet seat with scalloped handhold locations



Part #	Mfg #	Description	Rough-In	Color	Price
240839	K-96064-0	Elongated Bowl, Floor Mount, 1-1/2" Top Spud	10" or 12"	White	

### Stratton™ Wall-Mounted 3.5 gpf WaterGuard® Flushometer Valve Elongated Blow-Out Toilet Bowl

- 26" x 14" x 11-3/4"
- 1-1/2" Top spud
- Requires seat
- ADA-compliant when installed at required height of 17" - 19" from floor to top of seat



Part #	Mfg #	Description	Rough-In	Color	Price
062414	K-4450-C-0	Elongated Bowl, 1-1/2" Top Spud	-	White	

\*Vibrant Limited Lifetime Finish

[www.waterconcepts.net](http://www.waterconcepts.net) • Serving our Customers Since 1946 • [www.plumbsupply.com](http://www.plumbsupply.com)

**Commercial Closets**

**Wellcomme™ Ultra Flushometer Valve Toilet Bowl**

- 26-3/8" x 14-7/8" x 15-1/4"
- 10", 11", or 12" Rough-in
- 1-1/2" Top or rear spud
- 2-1/8" Glazed trapway



Part #	Mfg #	Description	Rough-In	Color	Price
235540	K-96053-0	Elongated Bowl, 1-1/2" Top Spud	10" or 12"	White	
245997	K-96053-SS-0	Elongated Bowl, 1-1/2" Top Spud, Antimicrobial Finish	10" or 12"	White	
252289	K-96054-0	Elongated Bowl, 1-1/2" Rear Spud	11"	White	

**Wellworth® Two-Piece 1.6 gpf Toilet with Pressure-Lite® Flushing Technology**

- Equipped with Sloan Flushmate™
- 15" High bowl with standard 12" rough-in
- Includes polished chrome trip lever
- Seat and supply sold separately



**K-3505 Combination: K-4303 Elongated Bowl, K-4645 Tank**

Part #	Mfg #	Description	Rough-In	Color	Price
086525	K-3505-0	Elongated Complete, LH CP Trip	12"	White	
086524	K-4303-0	Elongated Bowl Only	12"	White	

\*Vibrant Limited Lifetime Finish

[www.plumbsupply.com](http://www.plumbsupply.com) • Serving our Customers Since 1946 • [www.waterconcepts.net](http://www.waterconcepts.net)

**Commercial Closets**

**Commercial Toilets**

**ST-2029 & ST-2009 Floor Mount Top Spud Water Closet**

- Vitreous china
- Floor outlet
- Elongated bowl
- Integral flushing rim
- 1-1/2" I.P.S. top spud inlet
- Water spot area 10" x 7-1/2"
- 2 1/8" fully glazed trapway diameter
- Closet bolts and caps included
- Model (2102029) is ADA compliant when installed at 17" height (floor to top of fixture)



Part #	Mfg #	Description	Flow Rate (GPF)	Color
177498	2102009	Universal Elongated Bowl	1.1-1.6	White
171934	2102029	ADA Elongated Bowl	1.1-1.6	White

**ST-2459 Wall-Hung Top Spud Water Closet**

- Vitreous china
- Wall outlet
- Elongated bowl
- Integral flushing rim
- Siphon jet flushing action
- 2-1/8" fully glazed trapway
- 1-1/2" I.P.S. top spud inlet
- Water spot area 11-1/4" x 8-1/2"
- Toilet seat not included



Part #	Mfg #	Description	Flow Rate (GPF)	Color
186648	2102459	Elongated Bowl	1.1-1.6	White

## Closet Bowls

### Vitreous China Elongated Toilet Bowls

#### Archer® Comfort Height® 2-Piece Toilet Bowl

- 16-1/2" High bowl with 12" standard rough-in
- 2-1/8" Glazed trapway
- Seat and supply sold separately



**K-3551 Combination: K-4356 Elongated Bowl, K-4431 Tank**

Part #	Mfg #	Description	Rough-In	Color	Price
144888	K-4356-0	ADA Elongated Bowl	12"	White	
144063	K-4356-95	ADA Elongated Bowl	12"	Ice Grey	
144567	K-4356-K4	ADA Elongated Bowl	12"	Cashmere	
152287	K-4356-NY	ADA Elongated Bowl	12"	Dune	

#### Cimarron® Comfort Height® 2-Piece Toilet Bowl

- 16-1/2" High bowl with 12" standard rough-in
- Seat and supply sold separately



**K-3589 Combination: K-4309 Elongated Bowl, K-4418 Tank**

Part #	Mfg #	Description	Rough-In	Color	Price
116902	K-4309-0	ADA Elongated Bowl	12"	White	
117008	K-4309-47	ADA Elongated Bowl	12"	Almond	
125326	K-4309-7	ADA Elongated Bowl	12"	Black	
120793	K-4309-95	ADA Elongated Bowl	12"	Ice Grey	
116903	K-4309-96	ADA Elongated Bowl	12"	Biscuit	
129138	K-4309-G9	ADA Elongated Bowl	12"	Sandbar	

#### Cimarron® Comfort Height® 2-Piece Skirted Trapway Toilet Bowl

- 12" standard rough-in
- 2-1/8" Fully glazed trapway
- Seat and supply sold separately



**K-5310 Combination: K-5309 Elongated Bowl, K-4369 Tank**

Part #	Mfg #	Description	Rough-In	Color	Price
230302	K-5309-0	ADA Elongated Bowl	12"	White	
236957	K-5309-47	ADA Elongated Bowl	12"	Almond	
250812	K-5309-7	ADA Elongated Bowl	12"	Black	
241185	K-5309-95	ADA Elongated Bowl	12"	Ice Grey	
240786	K-5309-96	ADA Elongated Bowl	12"	Biscuit	
243013	K-5309-G9	ADA Elongated Bowl	12"	Sandbar	

\*Vibrant Limited Lifetime Finish

**www.plumbsupply.com • Serving our Customers Since 1946 • www.waterconcepts.net**

## Closet Bowls

### Vitreous China Elongated Toilet Bowls (Continued)

#### Cimarron® Comfort Height® 2-Piece Skirted Trapway Toilet Bowl

Part #	Mfg #	Description	Rough-In	Color	Price
243039	K-5309-NY	ADA Elongated Bowl	12"	Dune	

#### Corbelle™ Comfort Height® Elongated Toilet Bowl

- 12" Standard rough-in
- 2-1/8" Fully glazed trapway
- ReadyLock™ installation system
- Revolution 360™ swirl flushing technology



**K-3814 Combination: K-4144 Elongated Bowl, K-4143 Tank**

Part #	Mfg #	Description	Rough-In	Color	Price
237248	K-4144-0	ADA Elongated Bowl	12"	White	
250703	K-4144-95	ADA Elongated Bowl	12"	Ice Grey	
246066	K-4144-96	ADA Elongated Bowl	12"	Biscuit	
248447	K-4144-NY	ADA Elongated Bowl	12"	Dune	

#### Devonshire® Comfort Height® 2-Piece Toilet Bowl

- 16-1/2" High bowl with 12" standard rough-in
- 2-1/8" Glazed trapway
- Seat and supply sold separately



**K-3837 Combination: K-4397 Elongated Bowl, K-4438 Tank**

Part #	Mfg #	Description	Rough-In	Color	Price
141574	K-4397-0	ADA Compact Elongated Bowl	12"	White	
141581	K-4397-47	ADA Compact Elongated Bowl	12"	Almond	
141578	K-4397-96	ADA Compact Elongated Bowl	12"	Biscuit	

#### Highline® Comfort Height® 2-Piece Toilet Bowl

- 16-1/2" High bowl with 12" standard rough-in and 3 bolt installation
- 2-1/8" Glazed trapway
- Seat and supply sold separately



**K-3949 Combination: K-4199 Elongated Bowl, K-4841 Tank**

Part #	Mfg #	Description	Rough-In	Color	Price
134972	K-4199-0	ADA Elongated Bowl	12"	White	
138352	K-4199-47	ADA Elongated Bowl	12"	Almond	
140396	K-4199-7	ADA Elongated Bowl	12"	Black	
137503	K-4199-96	ADA Elongated Bowl	12"	Biscuit	

\*Vibrant Limited Lifetime Finish

[www.waterconcepts.net](http://www.waterconcepts.net) • Serving our Customers Since 1946 • [www.plumbsupply.com](http://www.plumbsupply.com)



## Closet Bowls

### Highline® Comfort Height® 2-Piece Toilet Bowl

- 16-1/2" High bowl with 10" standard rough-in and 3 bolt installation
- 2-1/8" Glazed trapway
- Seat and supply sold separately



**K-3889 Combination: K-4373 Elongated Bowl, K-4467 Tank**

Part #	Mfg #	Description	Rough-In	Color	Price
137504	K-4373-0	ADA Elongated Bowl	10"	White	
139803	K-4373-47	ADA Elongated Bowl	10"	Almond	
137505	K-4373-96	ADA Elongated Bowl	10"	Biscuit	

### Highline® Comfort Height® 2-Piece Toilet Bowl with Pressure Lite® Flushing Technology

- 17-1/8" High bowl with standard 12" rough-in
- Seat and supply sold separately
- (-SS) Antimicrobial finish



**K-3493 Combination: K-4304 Elongated Bowl, K-4645 Tank**

Part #	Mfg #	Description	Rough-In	Color	Price
086519	K-4304-0	ADA Elongated Bowl	12"	White	
257460	K-4304-SS-0	ADA Elongated Bowl	12"	White	
088818	K-4304-47	ADA Elongated Bowl	12"	Almond	

### Highline® Concealed Trapway Comfort Height® 2-Piece Elongated Toilet Bowl

- Clean Caps®
- 12" Rough-in and 3 bolt installation
- 2-1/8" Glazed trapway
- Seat and supply sold separately



**K-76301 Combination: K-80020 Elongated Bowl, K-5311 Tank**

Part #	Mfg #	Description	Rough-In	Color	Price
190440	K-80020-0	ADA Elongated Bowl	12"	White	
234333	K-80020-7	ADA Elongated Bowl	12"	Black	

\*Vibrant Limited Lifetime Finish

**www.plumbsupply.com • Serving our Customers Since 1946 • www.waterconcepts.net**

## Closet Bowls

### Kelston® Comfort Height® 2-Piece Toilet Bowl

- 16-1/2" High bowl with standard 12" rough-in
- 2-1/8" Glazed trapway
- Seat and supply sold separately



**K-3754 Combination: K-4306 Elongated Bowl, K-4474 LH Tank**

Part #	Mfg #	Description	Rough-In	Color	Price
128872	K-4306-0	ADA Elongated Bowl	12"	White	
134805	K-4306-95	ADA Elongated Bowl	12"	Ice Grey	
128873	K-4306-96	ADA Elongated Bowl	12"	Biscuit	
141836	K-4306-G9	ADA Elongated Bowl	12"	Sandbar	

### Kingston™ Comfort Height® 2-Piece Elongated Toilet Bowl

- 16-1/2" High bowl with standard 12" rough-in
- Three-bolt installation
- 2-1/8" Glazed trapway
- Seat and supply sold separately
- Combines with the K-25100, K-25100-RA, or K-25100-TR tank to create a K-25077, K25077-T, or K-25077-TR Kingston™ toilet



Part #	Mfg #	Description	Rough-In	Color	Price
255556	K-25076-0	ADA Elongated Bowl	12"	White	

### Kingston™ 2-Piece Elongated Toilet Bowl

- Standard 12" rough-in
- Three-bolt installation
- 2-1/8" Glazed trapway
- Seat and supply sold separately
- Combines with the K-25100, K-25100-RA, or K-25100-TR tank to create a K-25087, K25087-T, or K-25087-TR Kingston™ toilet



Part #	Mfg #	Description	Rough-In	Color	Price
255558	K-25086-0	Elongated Bowl	12"	White	

### Memoirs® Comfort Height® 2-Piece Toilet Bowl

- 16-1/2" High bowl with standard 12" rough-in
- 2-1/8" Glazed trapway
- Seat and supply sold separately



**K-3816 Combination: K-4380 Elongated Bowl, K-4433 Tank**

**K-3817 Combination: K-4380 Elongated Bowl, K-4434 Tank**

Part #	Mfg #	Description	Rough-In	Color	Price
138857	K-4380-0	ADA Elongated Bowl	12"	White	
143522	K-4380-47	ADA Elongated Bowl	12"	Almond	
153529	K-4380-95	ADA Elongated Bowl	12"	Ice Grey	

\*Vibrant Limited Lifetime Finish

[www.waterconcepts.net](http://www.waterconcepts.net) • Serving our Customers Since 1946 • [www.plumbsupply.com](http://www.plumbsupply.com)

## Closet Bowls

### Vitreous China Elongated Toilet Bowls (Continued)

#### Memoirs® Comfort Height® 2-Piece Toilet Bowl

Part #	Mfg #	Description	Rough-In	Color	Price
142402	K-4380-96	ADA Elongated Bowl	12"	Biscuit	
144486	K-4380-G9	ADA Elongated Bowl	12"	Sandbar	
151843	K-4380-NY	ADA Elongated Bowl	12"	Dune	

#### Memoirs® Comfort Height® Elongated 2-Piece Toilet Bowl with Concealed Trapway

- 12" Rough-in
- 2-1/8" Glazed trapway
- Clean Caps low-profile bolt caps
- Seat and supply sold separately



**K-6669 Combination: K-5626 Elongated Bowl, K-4434 Tank**

**K-6999 Combination: K-5626 Elongated Bowl, K-4433 Tank**

Part #	Mfg #	Description	Rough-In	Color	Price
177488	K-5626-0	ADA Elongated Bowl	12"	White	

#### Persuade® Comfort Height Elongated Bowl

- 12" Rough-in
- ReadyLock™ installation system
- Skirted trapway
- Seat and supply sold separately



**K-6355 Combination: K-4326 Elongated Bowl, K-3569 Tank**

**K-3815 Combination: K-4326 Elongated Bowl, K-7312 Tank**

**K-75790 Combination: K-4326 Elongated Bowl, K-19042 Tank**

Part #	Mfg #	Description	Rough-In	Color	Price
234648	4326-0	ADA Elongated Bowl	12"	White	

#### Tresham™ Comfort Height® 2-Piece Toilet Bowl

- 16-1/2" High bowl with standard 12" rough-in
- 2-1/8" Glazed trapway
- Seat and water supply sold separately



**K-3950 Combination: K-4799 Elongated Bowl, K-4899 Tank**

Part #	Mfg #	Description	Rough-In	Color	Price
143741	K-4799-0	ADA Elongated Bowl	12"	White	
154995	K-4799-47	ADA Elongated Bowl	12"	Almond	
173771	K-4799-58	ADA Elongated Bowl	12"	Thunder Grey	
144848	K-4799-96	ADA Elongated Bowl	12"	Biscuit	
156436	K-4799-G9	ADA Elongated Bowl	12"	Sandbar	

\*Vibrant Limited Lifetime Finish

**www.plumbsupply.com • Serving our Customers Since 1946 • www.waterconcepts.net**

## Closet Bowls

### Vitreous China Elongated Toilet Bowls (Continued)

#### Tresham™ Comfort Height® 2-Piece Toilet Bowl

Part #	Mfg #	Description	Rough-In	Color	Price
154947	K-4799-K4	ADA Elongated Bowl	12"	Cashmere	
151846	K-4799-NY	ADA Elongated Bowl	12"	Dune	

#### Wellworth® 2-Piece Toilet Bowl

- 14-1/2" Bowl height with standard 12" rough-in and 3-bolt installation
- 2-1/8" Glazed trapway
- Seat and supply sold separately



**K-3978 Combination: K-4198 Elongated Bowl, K-4468 Tank**

Part #	Mfg #	Description	Rough-In	Color	Price
130222	K-4198-0	Elongated Bowl	12"	White	
139927	K-4198-47	Elongated Bowl	12"	Almond	
139975	K-4198-7	Elongated Bowl	12"	Black	
137506	K-4198-96	Elongated Bowl	12"	Biscuit	

#### Veil™ One-Piece Elongated Dual-Flush Wall-Hung Toilet with Reveal® Quiet-Close™ Seat

- Compact elongated bowl
- Mounting hardware is completely concealed, giving Veil™ a sleek, seamless look that is easy to clean
- Includes Grip Tight Reveal® Q3 seat



**Requires: K-6284-NA or K-18829-NA In-Wall Tank and Carrier System**

Part #	Mfg #	Description	Rough-In	Color	Price
160478	K-6299-0	Wall-Mount Elongated Bowl	-	White	
183605	K-6299-7	Wall-Mount Elongated Bowl	-	Black	
173435	K-6299-96	Wall-Mount Elongated Bowl	-	Biscuit	

### Vitreous China Round Toilet Bowls

#### Cimarron® Comfort Height® Round-Front 2-Piece Toilet Bowl

- 2-1/8" Glazed trapway and 12" standard rough-in
- 16-1/2" High bowl is ADA compliant
- Seat and supply sold separately



**K-3887 Combination K-4347 Round Bowl, K-4166 Tank**  
**K-3851 Combination K-4829 Round Bowl, K-4166 Tank**

Part #	Mfg #	Description	Rough-In	Color	Price
142361	K-4347-0	ADA Round Bowl	12"	White	
145135	K-4347-47	ADA Round Bowl	12"	Almond	
142362	K-4347-96	ADA Round Bowl	12"	Biscuit	

\*Vibrant Limited Lifetime Finish

## Closet Bowls

### Vitreous China Round Toilet Bowls (Continued) Cimarron® Comfort Height® Round-Front 2-Piece Toilet Bowl

Part #	Mfg #	Description	Rough-In	Color	Price
167303	K-4347-NY	ADA Round Bowl	12"	Dune	
154822	K-4829-0	Round Bowl	10"	White	

### Highline® Comfort Height® Round-Front Toilet Bowl

- 12" Rough-in
- Three-bolt installation
- 2-1/8" fully glazed trapway
- Combines with a K-4467/-RA or K-4436/-RA tank to create a complete K-5481/-RA or 5296/-RA toilet



Part #	Mfg #	Description	Rough-In	Color	Price
227420	K-5393-0	Round Bowl	12"	White	
236554	K-5393-47	Round Bowl	12"	Almond	

### Kingston™ Round-Front Toilet Bowl

- Standard 12-inch rough-in
- Three-bolt installation
- 2-1/8" Fully glazed trapway
- Combines with the K-25100, K-25100-RA, or K-25100-TR tank to create a K-25097, K25097-T, or K-25097-TR Kingston™ toilet
- Seat sold separately



Part #	Mfg #	Description	Rough-In	Color	Price
255559	K-25096-0	Round Bowl	12"	White	

### Memoirs® Comfort Height® Round-Front Bowl

- Standard 12-inch rough-in
- Combines with the K-4433 or K-4434 tank to create a K-3986 Memoirs® Classic toilet or K-3933 Memoirs® Stately toilet
- Seat sold separately



Part #	Mfg #	Description	Rough-In	Color	Price
148308	K-4387-0	Round Bowl	12"	White	
148917	K-4387-96	Round Bowl	12"	Biscuit	
240498	K-4387-NY	Round Bowl	12"	Dune	

\*Vibrant Limited Lifetime Finish

[www.plumbsupply.com](http://www.plumbsupply.com) • Serving our Customers Since 1946 • [www.waterconcepts.net](http://www.waterconcepts.net)

---



---

## Closet Bowls

---



---

### Wellworth® 2-Piece Toilet Bowl

- 14-1/2" Bowl height with 12" standard rough-in
- 2-1/8" Glazed trapway
- Seat and supply sold separately



**K-3977 Combination: K-4197 Round Bowl, K-4468 Tank**

Part #	Mfg #	Description	Rough-In	Color	Price
130224	K-4197-0	Round Bowl	12"	White	
139929	K-4197-47	Round Bowl	12"	Almond	
145938	K-4197-7	Round Bowl	12"	Black	
134924	K-4197-96	Round Bowl	12"	Biscuit	

\*Vibrant Limited Lifetime Finish

<a href="http://www.waterconcepts.net">www.waterconcepts.net</a> • Serving our Customers Since 1946 • <a href="http://www.plumbsupply.com">www.plumbsupply.com</a>
--------------------------------------------------------------------------------------------------------------------------------------------------------------------



## Closest Bowls

### Vitreous China Toilet Bowls

#### Allerton™ ErgoHeight™ Toilet Bowl

- 17" Bowl height for accessible application
- 2" Glazed trapway
- Reverse trap
- Seat sold separately



Part #	Mfg #	Description	Rough-In	Color	Price
158265	HE-21-577	ADA Elongated Bowl	10"	White	

#### Avalanche™ Toilet Bowl

- 2" Fully-glazed trapway
- Seat sold separately



Part #	Mfg #	Description	Rough-In	Color	Price
161377	AV-21-852	Round Bowl	-	White	
161544	AV-21-852-09	Round Bowl	-	Biscuit	
161378	AV-21-862	Elongated Bowl	-	White	
126456	HE-21-852	Round Bowl	-	White	

#### Avalanche™ ErgoHeight™ Toilet Bowl

- 17" Bowl height for accessible application
- Glazed trapway
- Reverse trap
- Compatible with Slimline tank
- Seat sold separately
- 5-Year warranty



Part #	Mfg #	Description	Rough-In	Color	Price
161379	AV-21-828	ADA Elongated Bowl	-	White	
161546	AV-21-828-09	ADA Elongated Bowl	-	Biscuit	





## Closest Bowls

### Avalanche™ High Efficiency ErgoHeight™ Toilet Bowl

- 17" Bowl height for accessible application
- Glazed trapway
- Reverse trap
- (2) Bolt caps



Part #	Mfg #	Description	Rough-In	Color	Price
125896	HE-21-828	ADA Elongated Bowl	12"	White	
125902	HE-21-828-09	ADA Elongated Bowl	12"	Biscuit	

### Avalanche™ Concealed Trap ErgoHeight™ Toilet Bowl

Part #	Mfg #	Description	Rough-In	Color	Price
174321	21-832	ADA Elongated Bowl	-	White	

### Avalanche™ Elite™ Toilet Bowl

Part #	Mfg #	Description	Rough-In	Color	Price
246808	AB-21-852	ErgoHeight Round Bowl	-	White	
246810	AB-21-828	ErgoHeight Elongated Bowl	-	White	

### Maxwell® Toilet Bowl

- Glazed trapway
- Non-corrosive solid brass tank-to-bowl bolts
- Seat sold separately
- 5-Year warranty



Part #	Mfg #	Description	Rough-In	Color	Price
161412	21-952-09	Round Bowl	-	Biscuit	
247525	MX-21-952	Round Bowl	-	White	
138033	21-962	Elongated Bowl	-	White	
161424	21-962-09	Elongated Bowl	-	Biscuit	
247526	MX-21-962	Elongated Bowl	-	White	
130373	21-128	ADA Elongated Bowl	-	White	



## Closet Bowls

### Maxwell® ErgoHeight™ Toilet Bowl

- 17" Bowl height for accessible application
- Glazed trapway
- Non-corrosive solid brass tank-to-bowl bolts
- Seat sold separately
- 5-Year warranty



Part #	Mfg #	Description	Rough-In	Color	Price
138032	21-928	ADA Elongated Bowl	-	White	
247522	MX-21-928	ADA Elongated Bowl	-	White	
247523	MX-21-928-09	ADA Elongated Bowl	-	Biscuit	
161431	21-928-09	ADA Elongated Bowl	-	Biscuit	

### Maxwell® SE 1.28 Toilet Bowl

Part #	Mfg #	Description	Rough-In	Color	Price
130371	SE-21-152	Round Bowl	-	White	
004536	SE-21-162	Elongated Bowl	-	White	

### Maxwell® High Efficiency Compact ErgoHeight™ Toilet Bowl with Back Outlet

- Space saving compact design
- 2" Fully glazed trapway
- Seat sold separately



Part #	Mfg #	Description	Rough-In	Color	Price
149993	21-975	ADA Elongated Bowl	4-1/4" Vertical	White	

### Ultra Flush™ Pressure Assist Toilet Bowl

- Trapway averages over 3"
- Seat sold separately
- 10-Year limited warranty



Part #	Mfg #	Description	Rough-In	Color	Price
039791	21-342	Round Bowl	-	White	
039795	21-372	Elongated Bowl	-	White	
039797	21-372-09	Elongated Bowl	-	Biscuit	

\* With bedpan rim



## Closet Bowls

### Ultra Flush™ ErgoHeight™ Pressure Assist Toilet Bowl

- 17" Bowl height for accessible application
- Trapway averages over 3"
- Seat sold separately
- 10-Year limited warranty



Part #	Mfg #	Description	Rough-In	Color	Price
039798	21-377	ADA Elongated Bowl	-	White	
039800	21-377-09	ADA Elongated Bowl	-	Biscuit	

### Viper™ High Performance Toilet Bowl

- Glazed 2" trapway
- Dual feed siphon-jet
- Reverse trap
- Compatible with Slimline tank
- Seat sold separately
- 5-Year warranty



Part #	Mfg #	Description	Rough-In	Color	Price
161339	VP-21-552	Round Bowl	-	White	
161494	VP-21-552-09	Round Bowl	-	Biscuit	
165705	VP-21-552-25	Round Bowl	-	Bone	
161340	VP-21-562	Elongated Bowl	-	White	
161506	VP-21-562-09	Elongated Bowl	-	Biscuit	

### Viper™ ErgoHeight™ Toilet Bowl

- 17" Bowl height for accessible application
- Glazed 2" trapway
- Dual feed siphon-jet
- Reverse trap
- Compatible with Slimline tank
- Seat sold separately
- 5-Year warranty



Part #	Mfg #	Description	Rough-In	Color	Price
161341	VP-21-528	ADA Elongated Bowl	-	White	
161517	VP-21-528-09	ADA Elongated Bowl	-	Biscuit	
166620	VP-21-528-25	ADA Elongated Bowl	-	Bone	
152423	HE-21-872	ADA Compact Elongated Bowl	-	White	

## Closet Bowls

### Two-Piece Vitreous China Toilet Bowls

#### Karsten® Luxury Height® Toilet Bowl

- (2) Bolt installation
- 5-Year limited warranty



402087 Complete: 402086 Elongated Bowl, 402023 Tank

Part #	Mfg #	Description	Rough-In	Color	Price
135552	402086-0	Elongated Bowl	12"	White	
138448	402086-96	Elongated Bowl	12"	Biscuit	

#### Windham™/Riverton™ High-Efficiency Toilet Bowl

- Completely code approved
- (3) Bolt installation
- 2" Glazed trapway
- 8" x 9" Water area
- Seat and supply sold separately
- 5-Year limited warranty



403015



403215

402083 Complete: 403015 Round Bowl, 404552 Tank

402084 Complete: 403215 Elongated Bowl, 404552 Tank

Part #	Mfg #	Description	Rough-In	Color	Price
134274	403015-0	Round Bowl	12"	White	
134275	403015-96	Round Bowl	12"	Biscuit	
136949	403215-0	Elongated Bowl	12"	White	

#### Windham™ Toilet Bowl

- Completely code approved
- (2) Bolt installation
- Seat sold separately
- 5-Year warranty



402014 Complete: 403015 Round Bowl, 404514 Tank

402015 Complete: 403015 Round Bowl, 404515 Tank

402210 Complete: 404210 Elongated Bowl, 404515 Tank

Part #	Mfg #	Description	Rough-In	Color	Price
073992	404210-0	Elongated Bowl	10"	White	

**Closest Bowls**

**Windham™ Low Consumption Luxury Height® Toilet Bowl**

- 16-1/2" Bowl heights meets ADA requirements
- 2" Glazed trapway
- Seat and supply sold separately
- 8" x 9" Water area
- (3) Bolt, quick-connect installation system
- Meets EPA WaterSense® criteria
- 5-Year limited warranty



402082 Complete: 403315 Elongated Bowl, 404555 Tank

402082-RA Complete: 403315 Elongated Bowl, 404555-RA Tank

Part #	Mfg #	Description	Rough-In	Color	Price
135047	403315-0	ADA Elongated Bowl	12"	White	
131645	403315-96	ADA Elongated Bowl	12"	Biscuit	

**Stinson® Elongated Toilet Bowl**

- Elongated bowl only; pairs with Stinson toilet tank
- 12" Rough-in
- 1.28 gallons per flush
- Pro Force flushing technology



Part #	Mfg #	Description	Rough-In	Color	Price
136332	403070-0	ADA Elongated Bowl	12"	White	

## Closet Bowls

### Elongated Front Toilet Bowls

#### Alto Elongated Toilet Bowl

Part #	Mfg #	Color	Price
193101	135BI	Biscuit	
192316	135BN	Bone	
192317	135WH	White	
194485	138BI	Biscuit	
231794	138BN	Bone	
194484	138WH	White	

#### SmartHeight™ (ADA)

Part #	Mfg #	Color	Price
193635	137BI	Biscuit	
192320	137BN	Bone	
192319	137WH	White	
195142	139NSBI	Biscuit	
195755	139NSBN	Bone	
195141	139NSWH	White	

#### Barrett HET Elongated Toilet Bowl

#### SmartHeight™ (ADA)

Part #	Mfg #	Color	Price
197810	4115BI	Biscuit	
201339	4115BN	Bone	
197809	4115WH	White	

#### Brentwood Elongated Toilet Bowl

#### SmartHeight™ (ADA)

Part #	Mfg #	Color	Price
209886	4148WH	White	

#### Cascade Elongated Front Toilet Bowl

Part #	Mfg #	Color	Price
205816	4817WH	White	

#### Denali Elongated Toilet Bowl

#### SmartHeight™ (ADA)

Part #	Mfg #	Color	Price
225336	4977	White	

### Enso Elongated Front Toilet Bowl

#### SmartHeight™ (ADA)

Part #	Mfg #	Color	Price
200479	177WH	White	

#### Essence Bowl

Part #	Mfg #	Color	Price
210102	4184WH	White	

### Maverick Elongated Front Toilet Bowl

#### SmartHeight™ (ADA)

Part #	Mfg #	Color	Price
213162	1014WH	White	

### Montclair Elongated Front Toilet Bowl

#### SmartHeight™ (ADA)

Part #	Mfg #	Color	Price
197192	4107WH	White	

### Protector® No-Overflow Elongated Toilet Bowl

#### SmartHeight™ (ADA)

Part #	Mfg #	Color	Price
221509	1384WH	White	

### Quantum™ Elongated Toilet Bowl

Part #	Mfg #	Color	Price
193103	147WH	White	

#### SmartHeight™ (ADA)

Part #	Mfg #	Color	Price
209859	14810WH	White	
193102	148WH	White	

### Summit Elongated Front Toilet Bowl

#### SmartHeight™ (ADA)

Part #	Mfg #	Color	Price
195852	384BI	Biscuit	
197508	384BN	Bone	
195779	384WH	White	
219823	385BI	Biscuit	
229879	385BN	Bone	
219822	385WH	White	

## Closet Bowls

### Dual Flush

Part #	Mfg #	Color	Price
195318	382BI	Biscuit	
198243	382BN	Bone	
195316	382WH	White	

### Waverly Bowl

Part #	Mfg #	Color	Price
197558	4197WH	White	

### Round Front Toilet Bowls

#### Alto Round Toilet Bowl

Part #	Mfg #	Color	Price
192321	130BI	Biscuit	
192295	130BN	Bone	
192318	130WH	White	
192297	131BN	Bone	
192296	131WH	White	

### SmartHeight™

Part #	Mfg #	Color	Price
195486	117BI	Biscuit	
196715	117BN	Bone	
196329	117WH	White	

### Cascade Round Front Toilet Bowl

Part #	Mfg #	Color	Price
205815	4810WH	White	

### Quantum™ Round Front Toilet Bowl

Part #	Mfg #	Color	Price
220955	146BI	Biscuit	
195000	146BN	Bone	
194916	146WH	White	

### Summit Round Front Toilet Bowl

Part #	Mfg #	Color	Price
197195	380BI	Biscuit	
196071	380BN	Bone	
196233	380WH	White	

### SmartHeight™

Part #	Mfg #	Color	Price
210675	388BI	Biscuit	
234737	388BN	Bone	
210676	388WH	White	

### Elementary Juvenile Toilet Bowl

- 11-1/4" High bowl
- Includes SmartClose toilet seat
- 1.28 gpf

Part #	Mfg #	Color	Price
211488	5326WH	White	



**Closet Bowls**

**Two-Piece Vitreous China Toilet Bowls**

**Stealth® Ultra High-Efficiency Toilet Bowl**

- 8" x 6" Water surface area
- Seat sold separately
- 10-Year limited warranty



**N7716R Complete: N7716B Round Bowl, N7714T Tank**

Part #	Mfg #	Description	Rough-in	Color	Price
131373	N7716B	Round Bowl	12"	White	

## Closet Tanks

### Two-Piece Vitreous China Toilet Tanks

#### Archer® Comfort Height® 2-Piece 1.28 Toilet Tank with Chrome Trip Lever

- Class Five® flushing system
- Meets EPA WaterSense® criteria



**K-3551 Combination: K-4356 Elongated Bowl, K-4431 Tank**

Part #	Mfg #	Description	Rough-In	Color	Price
144889	K-4431-0	Tank, LH CP Trip	-	White	
144568	K-4431-K4	Tank, LH CP Trip	-	Cashmere	
152288	K-4431-NY	Tank, LH CP Trip	-	Dune	

#### Cimarron® Comfort Height® 2-Piece 1.28 Toilet Tank with Chrome Trip Lever

- AquaPiston® flush technology
- Meets EPA WaterSense® criteria
- (-RA) right-hand trip lever
- (-U) Insuliner® tank liner



**K-3887 Combination K-4347 Round Bowl, K-4166 Tank**

Part #	Mfg #	Description	Rough-In	Color	Price
142359	K-4166-0	Tank, LH CP Trip	-	White	
250258	K-4166-RA-0	Tank, RH CP Trip	-	White	
142360	K-4166-96	Tank, LH CP Trip	-	Biscuit	
151716	K-4166-U-0	Tank with Insuliner®, LH CP Trim	-	White	
249443	K-4166-U-47	Tank with Insuliner®, LH CP Trim	-	White	

#### Cimarron® 1.28 gpf High Efficiency Toilet Tank with AquaPiston® Flush Technology & Left-Hand Trip Lever

- DryLock™ System
- Meets EPA WaterSense® criteria
- Supply line not included
- (-RA) right-hand trip lever
- (-U) Insuliner® tank liner
- (-UT) Insuliner® tank liner and tank locks
- (-UR) Insuliner® tank liner with right-hand trip lever



**K-3609 Combination: K-4309 Elongated Bowl, K-4421 Tank**

**K-5310 Combination: K-5309 Elongated Bowl, K-4369 Tank**

Part #	Mfg #	Description	Rough-In	Color	Price
118679	K-4421-0	Tank, LH CP Trip	-	White	
154388	K-4421-95	Tank, RH CP Trip	-	Ice Grey	
122222	K-4421-96	Tank, LH CP Trip	-	Biscuit	
151731	K-4421-RA-0	Tank, RH CP Trip	-	White	
235531	K-4421-TR-0	Tank, RH CP Trip, with Tank Locks	-	White	

\*Vibrant Limited Lifetime Finish

**www.waterconcepts.net • Serving our Customers Since 1946 • www.plumbsupply.com**

## Closet Tanks

### Two-Piece Vitreous China Toilet Tanks (Continued)

#### Cimarron® 1.28 gpf High Efficiency Toilet Tank with AquaPiston® Flush Technology & Left-Hand Trip Lever

Part #	Mfg #	Description	Rough-In	Color	Price
155355	K-4421-U-0	Tank, LH CP Trip, with Insuliner®	-	White	
246598	K-4421-U-95	Tank, LH CP Trip, with Insuliner®	-	Ice Grey	
242618	K-4421-U-NY	Tank, LH CP Trip, with Insuliner®	-	Dune	
241610	K-4421-UT-0	Tank, LH CP Trip, with Insuliner® Tank Liner & Tank Locks	-	White	
155818	K-4421-UR-0	Tank, RH CP Trip, with Insuliner®	-	White	
250016	K-4421-UR-96	Tank, RH CP Trip, with Insuliner®	-	Biscuit	
233479	K-4369-0	Tank, LH CP Trip	-	White	
250813	K-4369-7	Tank, LH CP Trip	-	Black	
241186	K-4369-95	Tank, LH CP Trip	-	Ice Grey	
240787	K-4369-96	Tank, LH CP Trip	-	Biscuit	
243014	K-4369-G9	Tank, LH CP Trip	-	Sandbar	
243040	K-4369-NY	Tank, LH CP Trip	-	Dune	

#### Cimarron® 1.6 gpf Toilet Tank with AquaPiston® Flush Technology with Chrome Left-Hand Trip Lever

- Supply line not included
- (-RA) Right-hand trip lever



#### K-3589 Combination: K-4309 Elongated Bowl, K-4418 Tank

Part #	Mfg #	Description	Rough-In	Color	Price
116904	K-4418-0	Tank, LH Trip	-	White	
119007	K-4418-47	Tank, LH Trip	-	Almond	
125325	K-4418-7	Tank, LH Trip	-	Black	
120794	K-4418-95	Tank, LH Trip	-	Ice Grey	
116905	K-4418-96	Tank, LH Trip	-	Biscuit	
129139	K-4418-G9	Tank, LH Trip	-	Sandbar	
127768	K-4418-RA-0	Tank, RH Trip	-	White	

#### Cimarron® 1.6 gpf Toilet Tank with Polished Chrome Left-Hand Trip Lever

- DryLock™ System
- Meets EPA WaterSense® criteria



#### K-3888 Combination: K-4347 Round Bowl, K-4167 Tank

Part #	Mfg #	Description	Rough-In	Color	Price
147234	K-4167-0	Tank, LH CP Trip	-	White	
146873	K-4167-47	Tank, LH CP Trip	-	Almond	
146264	K-4167-96	Tank, LH CP Trip	-	Biscuit	

\*Vibrant Limited Lifetime Finish

[www.plumbsupply.com](http://www.plumbsupply.com) • Serving our Customers Since 1946 • [www.waterconcepts.net](http://www.waterconcepts.net)

## Closet Tanks

### Cimarron® 1.28 gpf Touchless Toilet Tank

- Powered by 4 AA batteries (included)
- Flush is activated by a no-touch sensor mounted inside the tank
- AquaPiston® canister
- Touchless has no impact on water usage
- Combines with the K-4309 bowl to create a complete K-6418 Cimarron® toilet



Part #	Mfg #	Description	Rough-In	Color	Price
167292	K-5692-0	Touchless Tank	-	White	
177070	K-5692-G9	Touchless Tank	-	Sandbar	

### Corbelle™ 1.28 gpf Toilet Tank with AquaPiston® Flushing Technology & Chrome Left-Hand Trip Lever

- AquaPiston® canister
- (K-5711) includes ContinuousClean™ System



**K-3814 Combination: K-4144 Round Bowl, K-4143 Tank**  
**K-5711 Combination: K-4144 Round Bowl, K-5709 Tank**

Part #	Mfg #	Description	Rough-In	Color	Price
237250	K-4143-0	Tank, LH CP Trip	-	White	
250704	K-4143-95	Tank, LH CP Trip	-	Ice Grey	
246067	K-4143-96	Tank, LH CP Trip	-	Biscuit	
251105	K-5711-0	Tank, LH CP Trip, ContinuousClean™	-	White	

### Devonshire® 1.28 gpf Toilet Tank with Class Five® Flushing Technology & Chrome Left-Hand Trip Lever

- Meets EPA WaterSense® criteria



**K-3837 Combination: K-4397 Elongated Bowl, K-4438 Tank**

Part #	Mfg #	Description	Rough-In	Color	Price
141573	K-4438-0	Tank, LH CP Trip	-	White	
141580	K-4438-47	Tank, LH CP Trip	-	Almond	
183570	K-4438-7	Tank, LH CP Trip	-	Black Black	
141577	K-4438-96	Tank, LH CP Trip	-	Biscuit	
183678	K-4438-G9	Tank, LH CP Trip	-	Sandbar	

\*Vibrant Limited Lifetime Finish

**www.waterconcepts.net • Serving our Customers Since 1946 • www.plumbsupply.com**

## Closet Tanks

### Wellworth® 1.6 gpf Toilet Tank with Class Five® Flushing Technology & Chrome Trip Lever

- Canister flush valve
- Supply not included
- (-R) Right-hand trip lever
- (-T) Tank locks
- Combines with the K-4199 bowl to create a complete K-3979 Highline toilet, combines with the K-4198 bowl to create a complete K-3978 Wellworth toilet, and combines with the K-4197 bowl to create a complete K-3977 Wellworth toilet



#### K-3979 Combination: K-4199 Elongated Bowl, K-4468 Tank

Part #	Mfg #	Description	Rough-In	Color	Price
137507	K-4468-0	LH CP Trip	-	White	
140397	K-4468-7	LH CP Trip	-	Black Black	
138353	K-4468-47	LH CP Trip	-	Almond	
137508	K-4468-96	LH CP Trip	-	Biscuit	
142859	K-4468-RA-0	RH CP Trip	-	White	
141866	K-4468-RA-96	RH CP Trip	-	Biscuit	
149478	K-4468-T-0	LH CP Trip , with Tank Locks	-	White	
248547	K-4468-T-47	LH CP Trip , with Tank Locks	-	Almond	
153821	K-4468-TR-0	RH CP Trip , with Tank Locks	-	White	

### Wellworth® 1.28 gpf Toilet Tank for Concealed Trapway Bowl

- Standard left-hand trip lever included
- Class Five® flushing technology
- Supply not included
- Combines with the K-80020 bowl to create K-76301 Highline® concealed trapway toilet



Part #	Mfg #	Description	Rough-In	Color	Price
190438	5311-0	LH CP Trip	-	White	
234332	5311-7	LH CP Trip	-	Black	

### Wellworth® Dual Flush Tank

- Left-hand nested trip lever offers a choice of 1.1 or 1.6 gallons per flush (gpf)
- Combines with the K-4197 or K-4198 bowl to create a complete K-3987 or K-3988 Wellworth toilet
- Combines with the K-4199 bowl to create a complete K-3989 Highline toilet

Part #	Mfg #	Description	Rough-In	Color	Price
159679	K-4458-0	LH CP Trip		White	

\*Vibrant Limited Lifetime Finish

[www.plumbsupply.com](http://www.plumbsupply.com) • Serving our Customers Since 1946 • [www.waterconcepts.net](http://www.waterconcepts.net)

## Closet Tanks

### Highline® Classic 2-Piece 1.6 gpf Toilet Tank

- Pressure Lite® flushing system
- (-R) right-hand trip lever
- (-T) Tank cover locks



**K-3493 Combination: K-4304 Elongated Bowl, K-4645 Tank**

Part #	Mfg #	Description	Rough-In	Color	Price
086518	K-4645-0	Tank, LH CP Trip	-	White	
090412	K-4645-RA-0	Tank, RH CP Trip	-	White	
162760	K-4645-RA-96	Tank, RH CP Trip	-	Biscuit	
090159	K-4645-T-0	Tank, LH CP Trip	-	White	
091896	K-4645-TR-0	Tank, RH CP Trip	-	White	

### Highline® Classic 1.0 gpf Toilet Tank with Left Hand Trip Lever

- Vitreous China
- (-RA) Right-hand trip lever
- (-T) Tank cover locks
- Combine with K-4303 or K-4303-L to create K-3531 Wellworth® Pressure Lite® 1.0 gpf toilet
- Combine with K-4304 or K-4304-L to create Highline® Pressure Lite® 1.0 gpf toilet



Part #	Mfg #	Description	Rough-In	Color	Price
103327	K-4484-0	Tank, LH CP Trip	-	White	
133865	K-4484-T-0	Tank, LH CP Trip	-	White	
106012	K-4484-RA-0	Tank, RH CP Trip	-	White	

### Kelston® 1.6 Toilet Tank with Left-Hand Trip Lever

- Class Five® flushing system



**K-3754 Combination: K-4306 Elongated Bowl, K-4474 LH Tank**

Part #	Mfg #	Description	Rough-In	Color	Price
128874	K-4474-0	Tank, LH CP Trip	-	White	
134804	K-4474-95	Tank, LH CP Trip	-	Ice Grey	
128875	K-4474-96	Tank, LH CP Trip	-	Biscuit	
141837	K-4474-G9	Tank, LH CP Trip	-	Sandbar	

### Kelston® 1.28 Toilet Tank with Left-Hand Trip Lever

- Class Five® flushing system
- Combines with the K-4306 bowl to create a complete K-3755 Kelston toilet



Part #	Mfg #	Description	Rough-In	Color	Price
132321	K-4469-0	Tank, LH CP Trip	-	White	

\*Vibrant Limited Lifetime Finish

[www.waterconcepts.net](http://www.waterconcepts.net) • Serving our Customers Since 1946 • [www.plumbsupply.com](http://www.plumbsupply.com)

## Closet Tanks

### Kingston® 1.28 Toilet Tank with Left-Hand Trip Lever

- Class Five® flushing system
- Combines with a K-25076 or K-25076-SS bowl to create a complete K-25077 or K-25077-SS Kingston two-piece toilet



Part #	Mfg #	Description	Rough-In	Color	Price
255555	K-25100-0	Tank, LH CP Trip	-	White	

### Memoirs® 1.28 gpf Toilet Tank with Chrome Left-hand Trip Lever

- Class Five® flushing technology
- Meets EPA WaterSense® criteria
- Supply line not included
- (-RA) Right-hand trip lever



K-4433



K-4434



**K-3816 Combination: K-4380 Elongated Bowl, K-4433 Tank**

**K-3817 Combination: K-4380 Elongated Bowl, K-4434 Tank**

Part #	Mfg #	Description	Rough-In	Color	Price
142688	K-4433-0	Classic Tank, LH CP Trip	-	White	
142689	K-4433-96	Classic Tank, LH CP Trip	-	Biscuit	
152497	K-4433-G9	Classic Tank, LH CP Trip	-	Sandbar	
226264	K-4433-RA-0	Classic Tank, RH CP Trip	-	White	
138858	K-4434-0	Stately Tank, LH CP Trip	-	White	
160613	K-4434-G9	Stately Tank, LH CP Trip	-	Sandbar	
151844	K-4434-NY	Stately Tank, LH CP Trip	-	Dune	
154371	K-4434-RA-0	Stately Tank, RH CP Trip	-	White	

### Memoirs® 1.6 gpf Toilet Tank with Chrome Left-Hand Trip Lever

- Class Five® flushing system
- Supply line not included



K-4641



K-4642

**K-3818 Combination: K-4380 Elongated Bowl, K-4641 LH Trip Classic Tank**

**K-3819 Combination: K-4380 Elongated Bowl, K-4642 LH Trip Stately Tank**

Part #	Mfg #	Description	Rough-In	Color	Price
142795	K-4641-0	Classic Tank, LH Trip	-	White	
154819	K-4641-47	Classic Tank, LH Trip	-	Almond	
183574	K-4641-7	Classic Tank, LH Trip	-	Black Black	
142403	K-4641-96	Classic Tank, LH Trip	-	Biscuit	
144631	K-4642-0	Stately Tank, LH Trip	-	White	

\*Vibrant Limited Lifetime Finish

[www.plumbsupply.com](http://www.plumbsupply.com) • Serving our Customers Since 1946 • [www.waterconcepts.net](http://www.waterconcepts.net)



## Closet Tanks

### Persuade® Curv Dual-Flush 1.6 or 1.0 gpf Toilet Tank

- Includes right-handed polished chrome dual flush trip lever
- Includes supply line
- Meets EPA WaterSense® criteria

**K-75790 Combination: K-4326 Elongated Bowl, K-19042 Tank**  
**K-75790-RA Combination: K-4326 Elongated Bowl, K-19042-RA Tank**



Part #	Mfg #	Description	Rough-In	Color	Price
248278	K-19042-0	LH Chrome Trip	-	White	
239798	K-19042-RA-0	RH Chrome Trip	-	White	

### Persuade® Curve Dual-Flush Tank

- Top-mount two-button flush offers choice of 1.0 or 1.6 gpf

**K-6355 Combination: K-4326 Elongated Bowl, K-3569 Tank**



Part #	Mfg #	Description	Rough-In	Color	Price
234660	K-3569-0	Top-Mount Dual-Flush	-	White	

### Wellworth® Classic 1.28 gpf Toilet Tank

- Class Five® flushing system
- Meets EPA WaterSense® criteria



Part #	Mfg #	Description	Rough-In	Color	Price
130221	K-4436-0	LH Chrome Trip	-	White	
150026	K-4436-47	LH Chrome Trip	-	Almond	
151969	K-4436-7	LH Chrome Trip	-	Black	
134923	K-4436-96	LH Chrome Trip	-	Biscuit	

### Tresham™ 1.28 gpf Toilet Tank with Chrome Left-hand Trip Lever

- Class Five® flushing system
- Meets EPA WaterSense® criteria
- Supply line not included

**K-3950 Combination: K-4799 Elongated Bowl, K-4899 Tank**



Part #	Mfg #	Description	Rough-In	Color	Price
143742	K-4899-0	Tank, LH CP Trip	-	White	
154994	K-4899-47	Tank, LH CP Trip	-	Almond	
173770	K-4899-58	Tank, LH CP Trip	-	Thunder Grey	

\*Vibrant Limited Lifetime Finish

**www.waterconcepts.net • Serving our Customers Since 1946 • www.plumbsupply.com**

## Closet Tanks

### Two-Piece Vitreous China Toilet Tanks (Continued) Tresham™ 1.28 gpf Toilet Tank with Chrome Left-hand Trip Lever

Part #	Mfg #	Description	Rough-In	Color	Price
145962	K-4899-96	Tank, LH CP Trip	-	Biscuit	
156437	K-4899-G9	Tank, LH CP Trip	-	Sandbar	
154948	K-4899-K4	Tank, LH CP Trip	-	Cashmere	
151847	K-4899-NY	Tank, LH CP Trip	-	Dune	
249505	K-4899-RA-0	Tank, RH CP Trip	-	White	

### Wellworth® 1.28 gpf Toilet Tank with Chrome-Plated Trip Lever & Class Five® Flush Technology

- Large 3-1/4" canister flush valve
- Qualifies as a HET (High-efficiency toilet)
- Meets EPA WaterSense® criteria
- (-R) right-hand trip lever
- (-U) Insuliner® tank liner
- (-T) Locks



- K-3948 Combination: K-4198 Elongated Bowl, K-4841 Tank**  
**K-3998 Combination: K-4198 Elongated Bowl, K-4467 Tank**  
**K-3889 Combination: K-4373 Elongated Bowl, K-4467 Tank**  
**K-3999 Combination: K-4199 Elongated Bowl, K-4467 Tank**  
**K-3999-U Combination: K-4199 Elongated Bowl, K-4467-U Tank**

Part #	Mfg #	Description	Rough-In	Color	Price
137509	K-4467-0	Tank, LH CP Trip	-	White	
139417	K-4467-47	Tank, LH CP Trip	-	Almond	
137510	K-4467-96	Tank, LH CP Trip	-	Biscuit	
153678	K-4467-RA-0	Tank, RH CP Trip	-	White	
146790	K-4467-RA-96	Tank, RH CP Trip	-	Biscuit	
149341	K-4467-T-0	Tank, LH CP Trip	-	White	
190453	K-4467-TR-0	Tank, RH CP Trip	-	White	
140988	K-4467-U-0	Tank, LH Trip Lever, with Insuliner®		White	
140989	K-4467-UR-0	Tank, RH Trip Lever, with Insuliner®		White	
137512	K-4841-0	Tank, LH CP Trip	14"	White	
137513	K-4841-96	Tank, LH CP Trip	14"	Biscuit	
181018	K-4841-U-O	Tank, LH CP Trip with Insuliner®	14"	White	
188274	K-4841-RA-0	Tank, RH CP Trip	14"	White	

\*Vibrant Limited Lifetime Finish

[www.plumbsupply.com](http://www.plumbsupply.com) • Serving our Customers Since 1946 • [www.waterconcepts.net](http://www.waterconcepts.net)

## Closet Tanks

### In-Wall Tank and Carrier System

- Robust steel tube frame
- Insulated tank to prevent sweating
- Large flush actuator plate
- Adjustable height
- Dual flush actuator offers a choice of 0.8 or 1.6 gpf
- Dual flush technology
- Supply line not included
- Works with K-6299 bowl as well as K-4177 and K-8857 flush actuator plates to create a complete solution



Part #	Mfg #	Description	Rough-In	Color	Price
177776	K-18829-NA	2'x4" In-Wall Tank and Carrier System	-	N/A	

### Veil® In-Wall Tank and Carrier System

- Robust steel tub frame
- Insulated tank to prevent sweating
- Large flush actuator plate opening can be removed for easy access to the inner tank
- Adjustable height allowing the bowl to be set anywhere from 15-3/8" to 28-1/2" from floor
- Dual flush actuator offers a choice of 0.8 or 1.6 gpf



Combines with the K-6299 bowl to create a complete K-6303 Veil toilet or with a K-6300 bowl to create a complete K-6304

Part #	Mfg #	Description	Rough-In	Color	Price
160477	K-6284-NA	2"x6" In-Wall Tank and Carrier System	-	N/A	

### Veil® In-Wall Tank and Carrier for K-76395 Veil® Intelligent Wall-Hung Toilet

- Robust steel tube frame
- Large flush actuator included
- Insulated tank to prevent sweating
- Dual-flush technology
- Supply line not included
- Adjustable height allows bowl to be set from 15"-23" from floor
- Steel frame carrier can be installed on 2" x 4" or 2" x 6" studs behind the wall
- WaterSense® certified: 0.8 or 1.6 gpf



Part #	Mfg #	Description	Rough-In	Color	Price
241354	K-18647-NA	2"x4" or 2"x6" In-Wall Tank and Carrier System	-	NA	

\*Vibrant Limited Lifetime Finish

[www.waterconcepts.net](http://www.waterconcepts.net) • Serving our Customers Since 1946 • [www.plumbsupply.com](http://www.plumbsupply.com)



## Closet Tanks

### Vitreous China Toilet Tanks

#### Avalanche™ 1.6 Toilet Tank

- Fluidmaster® fill valve
- Dual-fed siphon jet
- Color-matched tank lever



Part #	Mfg #	Description	Rough-In	Color	Price
161380	AV-28-895	Tank, Side Trip	10"	White	
161381	AV-28-890	Tank, Side Trip	12"	White	
161548	AV-28-890-09	Slimline Tank, Side Trip	12"	Biscuit	

#### Avalanche™ High Efficiency Gravity Fed 1.28 Toilet Tank

- 3" Flush valve
- Fluidmaster® fill valve
- Dual-feed jet
- Side tank lever
- Meets EPA WaterSense® criteria



Part #	Mfg #	Description	Rough-In	Color	Price
161394	WS-28-890	Tank, Side Trip	12"	White	
161565	WS-28-890-09	Tank, Side Trip	12"	Biscuit	
161393	WS-28-895	Tank	10"	White	

#### Avalanche Elite™ Toilet Tank

- Chrome, metal side tank lever
- 3" Flush valve
- Corrosion resistant Fluidmaster flapper
- Double nut, multi-point tank-to-bowl mounting system
- Best-in-class Fluidmaster 400A fill valve

Part #	Mfg #	Description	Rough-In	Color	Price
246816	AH-28-890	Tank, 1.28 gpf	12"	White	
246811	AL-28-890	Tank, 1.6 gpf	12"	White	

#### Avalanche™ .28 Tank

Part #	Mfg #	Description	Rough-In	Color	Price
125897	HE-28-890	Tank	12"	White	



## Closet Tanks

### Hinsdale™ 1.28 Toilet Tank

- Extra-large dual fed siphon jets
- Best-In-Class Fluidmaster 400A fill valve
- Double nut, multi-point tank-to-bowl mounting system

Part #	Mfg #	Description	Rough-In	Color	Price
242068	28-181	Tank	12"	White	

### Logan Square™ 1.6 Toilet Tank

- Gerber® XP-3 technology
- 3" Flush valve
- Fluidmaster® fill valve
- Dual-feed jet
- Side tank lever



Part #	Mfg #	Description	Rough-In	Color	Price
126922	28-530	Tank	12"	White	

### Logan Square™ ErgoHeight™ 1.6 Toilet Tank

- Gerber® XP-3 technology
- 3" Flush valve
- Fluidmaster® fill valve
- Dual-feed jet
- Side tank lever



Part #	Mfg #	Description	Rough-In	Color	Price
119892	28-535	Tank	10"	White	

### Maxwell™ Gravity Fed 1.6 Toilet Tank

- Non-corrosive solid brass tank-to-bowl bolts
- 5-Year warranty



Part #	Mfg #	Description	Rough-In	Color	Price
161308	MX-28-990	Tank, LH Trip	12"	White	
161414	MX-28-990-09	Tank, LH Trip	12"	Biscuit	
170306	MX-28-990-25	Tank, LH Trip	12"	Bone	
167299	MX-28-990-97	Tank, RH Trip	12"	White	
161309	MX-28-994	Tank, LH Trip	14"	White	



## Closet Tanks

### Vitreous China Toilet Tanks (Continued)

#### Maxwell™ Gravity Fed 1.6 Toilet Tank

Part #	Mfg #	Description	Rough-In	Color	Price
161307	MX-28-995	Tank, LH Trip	10"	White	
252473	MX-28-995-25	Tank, LH Trip	10"	Bone	

#### Maxwell® High Efficiency 1.28 Toilet Tank

- Dual-fed siphon jet
- Pilot fill valve
- 3" Flush valve
- Color-matched front tank lever



Part #	Mfg #	Description	Rough-In	Color	Price
138035	28-990	Tank	12"	White	

#### Maxwell® High Efficiency Compact ErgoHeight™ 1.28 Toilet Tank

- 3" Flush valve
- Dual-fed siphon jet
- Pilot fill valve
- Color-matched front tank lever



Part #	Mfg #	Description	Rough-In	Color	Price
150550	28-980	Tank	4-1/4" Vertical	White	

#### Maxwell® SE 1.6 gpf Toilet Tank

- 2" Flush valve
- Color-matched, front mounted tank lever

Part #	Mfg #	Description	Rough-In	Color	Price
241773	28-175	Tank	10"	White	

#### Maxwell® 1.1/1.6 gpf Dual Flush Tank

Part #	Mfg #	Description	Rough-In	Color	Price
135971	DF-28-190	Dual Flush Tank	12"	White	
161324	DF-28-990	Dual Flush Tank	12"	White	



## Closet Tanks

### Ultra Flush™ Pressure Assist 1.6 Toilet Tank

- Sloan Flushmate pressure vessel
- Insulated non-sweating tank
- 10-Year limited warranty



Part #	Mfg #	Description	Rough-In	Color	Price
039785	28-380	Tank, LH Trip	12"	White	
039787	28-380-09	Tank, LH Trip	12"	Biscuit	
058856	28-380-97	Tank, RH Trip	12"	White	
039788	28-384	Tank, LH Trip	14"	White	
039780	28-385	Tank, LH Trip	10"	White	

### Ultra Flush™ Dual-Flush Pressure Assist 1.1/1.6 Toilet Tank

- HET High efficiency toilet
- Meets EPA WaterSense® criteria
- Non-corrosive solid brass tank-to-bowl bolts



Part #	Mfg #	Description	Rough-In	Color	Price
091666	DF-28-380	Tank, LH Trip	12"	White	
118354	DF-28-380-97	Tank, RH Trip	12"	White	

### Ultra Flush™ ErgoHeight™ Pressure Assist High Efficiency 1.1 Toilet Tank

- 17" Bowl height for accessible application
- Non-corrosive solid brass tank-to-bowl bolts
- Meets EPA WaterSense® criteria



Part #	Mfg #	Description	Rough-In	Color	Price
136315	EF-28-380	Tank, LH Trip	12"	White	





## Closet Tanks

### Viper™ High Performance Gravity Fed 1.6 Toilet Tank

- HP2 Flushing technology
- Fluidmaster® fill valve
- Dual-feed siphon-jet
- 5-Year warranty



Part #	Mfg #	Description	Rough-In	Color	Price
161335	VP-28-595	Tank, LH Trip	10"	White	
161495	VP-28-595-09	Tank, LH Trip	10"	Biscuit	
161336	VP-28-590	Tank, LH Trip	12"	White	
161500	VP-28-590-09	Tank, LH Trip	12"	Biscuit	
165706	VP-28-590-25	Tank, LH Trip	12"	Bone	
166182	VP-28-590-97	Tank, RH Trip	12"	White	
166185	VP-28-592	Insulated Tank, LH Trip, For 21-518 Series	12"	White	
161337	VP-28-594	Tank, LH Trip	14"	White	
161504	VP-28-594-09	Tank, LH Trip	14"	Biscuit	

### Viper™ 1.28 Toilet Tank

- Color-matched, metal tank lever
- 3" Flush valve
- Best-in-class Fluidmaster 400A fill valve
- Double nut, multi-point tank-to-bowl mounting system

Part #	Mfg #	Description	Rough-In	Color	Price
161366	WS-28-590	Tank	12"	White	
161525	WS-28-590-09	Tank	12"	Biscuit	
152424	HE-28-570	Tank	12"	White	
156039	HE-28-570-09	Tank	12"	Biscuit	

**Closest Tanks**

**Two-Piece Vitreous China Toilet Tanks**  
**Windham™ Low Consumption 1.6 Toilet Tank**

- Completely code approved
- One flush performance limited guarantee
- Meets EPA WaterSense® criteria
- 5-Year warranty



**402015 Complete: 403015 Round Bowl, 404515 Tank**  
**402210 Complete: 404210 Elongated Bowl, 404515 Tank**  
**402215 Complete: 403215 Elongated Bowl, 404515 Tank**

Part #	Mfg #	Description	Rough-In	Color	Price
074000	404515-0	Tank with LH Trip, Lid & Trim	-	White	
074002	404515-96	Tank with LH Trip, Lid & Trim	-	Biscuit	

**Stinson® Toilet Tank**

- Tank only: pairs with Stinson toilet bowl
- 1.28 gallons per flush
- Pro Force flushing technology



Part #	Mfg #	Description	Rough-In	Color	Price
136333	402091-0	Tank with LH Trip, Lid & Trim	-	White	

## Closet Tanks

### Closet Tanks

#### Barrett Tank

Part #	Mfg #	Color	Price
197811	106BI	Biscuit	
201340	106BN	Bone	
196426	106WH	White	

#### Alto Tank

Part #	Mfg #	Color	Price
194483	125BI	Biscuit	
194482	125BN	Bone	
194481	125WH	White	
193100	160BI	Biscuit	
192302	160BN	Bone	
192300	160RHWH	White	
192301	160WH	White	
194467	180BI	Biscuit	
194466	180BN	Bone	
194465	180WH	White	
248721	3173WH	White	

#### Quantum Tank

Part #	Mfg #	Color	Price
214183	155WH	White	

#### Enso Tank

Part #	Mfg #	Color	Price
200480	178WH	White	

#### Montclair HET Tank

Part #	Mfg #	Color	Price
197193	3108WH	White	

#### Brentwood Tank

Part #	Mfg #	Color	Price
211777	3147BI	Biscuit	
209887	3147WH	White	
251000	3148WH	White	

#### Essence HET Tank

Part #	Mfg #	Color	Price
210101	3185WH	White	

### Waverly HET Tank

Part #	Mfg #	Color	Price
197559	3195WH	White	

### Summit Dual Flush Tank

Part #	Mfg #	Color	Price
204258	3386BI	Biscuit	
204257	3386WH	White	

### Cascade Toilet Tank

Part #	Mfg #	Color	Price
205817	3816WH	White	

### Summit Toilet Tank

Part #	Mfg #	Color	Price
195319	386BI	Biscuit	
196070	386BN	Bone	
195317	386WH	White	
215411	386LTBN	Bone	
236341	386LTWH	White	
208443	386RHWH	White	
211080	387BI	Biscuit	
238036	387RHWH	White	
211079	387WH	White	

### Denali Tank

Part #	Mfg #	Color	Price
225337	3916	White	

### Vanquish Tank

Part #	Mfg #	Color	Price
246996	398710WH	White	

### Protector® No-Overflow Tank

Part #	Mfg #	Color	Price
221508	1386WH	White	

### Elementary Tank

Part #	Mfg #	Color	Price
211487	4320WH	White	

---

---

## Closet Tanks

---

---

### Toilet Tank Lids

#### Alto Tank Lid Only

Part #	Mfg #	Color	Price
204113	160LBI	Biscuit	
204970	160LBN	Bone	
193120	160LWH	White	

#### Summit Tank Lid Only

Part #	Mfg #	Color	Price
220758	386LIDWHT	White	

**Closet Tanks**

**Two-Piece Vitreous China Toilet Tanks**

**Stealth® Ultra High-Efficiency 2-Piece 0.80 Toilet Tank**

- Quiet siphonic flushing
- Patented flush chamber and air transfer system
- Polished chrome top-mount flush actuator
- 10-Year limited warranty
- Meets EPA WaterSense® criteria



**N7716R Complete: N7716B Round Bowl, N7714T Tank**

Part #	Mfg #	Description	Rough-in	Color	Price
131374	N7714T	Tank	12"	White	

## Elongated Closets

### Two-Piece Vitreous China Toilets

#### Archer® Comfort Height® 2-Piece 1.28 gpf Toilet with AquaPiston® Flushing Technology

- 2-1/8" Glazed trapway
- Includes left-hand trip lever
- Seat and supply sold separately
- Meets EPA WaterSense® criteria



**K-3551 Combination: K-4356 Elongated Bowl, K-4431 Tank**

Part #	Mfg #	Description	Rough-In	Color	Price
144891	K-3551-0	ADA Elongated Complete	12"	White	
175354	K-3551-47	ADA Elongated Complete	12"	Almond	
166339	K-3551-58	ADA Elongated Complete	12"	Thunder Grey	
174538	K-3551-7	ADA Elongated Complete	12"	Black	
144065	K-3551-95	ADA Elongated Complete	12"	Ice Grey	
148497	K-3551-96	ADA Elongated Complete	12"	Biscuit	
146027	K-3551-G9	ADA Elongated Complete	12"	Sandbar	
144569	K-3551-K4	ADA Elongated Complete	12"	Cashmere	
152289	K-3551-NY	ADA Elongated Complete	12"	Dune	

#### Cimarron® Comfort Height® 2-Piece 1.6 Toilet with Left-Hand Trip Lever

- AquaPiston® flushing system
- Seat and supply sold separately
- (-RA) Right-hand trip lever



**K-3589 Combination: K-4309 Elongated Bowl, K-4418 Tank**

Part #	Mfg #	Description	Rough-In	Color	Price
116908	K-3589-0	ADA Elongated Complete	12"	White	
119008	K-3589-47	ADA Elongated Complete	12"	Almond	
125327	K-3589-7	ADA Elongated Complete	12"	Black	
120795	K-3589-95	ADA Elongated Complete	12"	Ice Grey	
116909	K-3589-96	ADA Elongated Complete	12"	Biscuit	
129140	K-3589-G9	ADA Elongated Complete	12"	Sandbar	
157442	K-3589-NY	ADA Elongated Complete	12"	Dune	
127769	K-3589-RA-0	ADA Elongated Complete, RH Trip	12"	White	
174416	K-3589-RA-96	ADA Elongated Complete, RH Trip	12"	Biscuit	

\*Vibrant Limited Lifetime Finish

**www.waterconcepts.net • Serving our Customers Since 1946 • www.plumbsupply.com**

## Elongated Closets

### Cimarron® Comfort Height® 2-Piece 1.28 Toilet with AquaPiston® Flush Technology & Left-Hand Trip Lever

- 2-1/8" Fully glazed trapway
- Seat and supply sold separately
- (-RA) Right-hand trip lever
- (-U) Insuliner® tank liner
- (-T) Tank cover locks



**K-3906 Combination: K-4309 Elongated Bowl, K-4421 Tank**

Part #	Mfg #	Description	Rough-In	Color	Price
119584	K-3609-0	ADA Elongated Complete, LH CP Trip	12"	White	
134220	K-3609-47	ADA Elongated Complete, LH CP Trip	12"	Almond	
150307	K-3609-7	ADA Elongated Complete, LH CP Trip	12"	Black	
154389	K-3609-95	ADA Elongated Complete, LH CP Trip	12"	Ice Grey	
122223	K-3609-96	ADA Elongated Complete, LH CP Trip	12"	Biscuit	
149750	K-3609-G9	ADA Elongated Complete, LH CP Trip	12"	Sandbar	
171312	K-3609-RA-0	ADA Elongated Complete, RH CP Trip	12"	White	
245131	K-3609-T-0	ADA Elongated Complete, LH CP Trip, Cover Locks	12"	White	
156508	K-3609-U-0	ADA Elongated Complete with Tank Insuliner, LH CP Trip	12"	White	
246599	K-3609-U-95	ADA Elongated Complete with Tank Insuliner, LH CP Trip	12"	Ice Grey	
150539	K-3609-U-96	ADA Elongated Complete with Tank Insuliner, LH CP Trip	12"	Biscuit	
242619	K-3609-U-NY	ADA Elongated Complete with Tank Insuliner, LH CP Trip	12"	Dune	

### Cimarron® Touchless Comfort Height® 2-Piece 1.28 Toilet with AquaPiston® Flushing Technology

- Flush is activated by a no-touch sensor mounted inside the tank
- Powered by (4) AA batteries (included)
- 2-1/8" Fully glazed trapway
- Seat and supply sold separately



**K-6418 Combination: K-4309 Elongated Bowl, K-5692 Tank**

Part #	Mfg #	Description	Rough-In	Color	Price
169314	K-6418-0	Elongated Complete, No-Touch Flush	12"	White	
176504	K-6418-47	Elongated Complete, No-Touch Flush	12"	Almond	
190213	K-6418-95	Elongated Complete, No-Touch Flush	12"	Ice Grey	
168743	K-6418-96	Elongated Complete, No-Touch Flush	12"	Biscuit	
177069	K-6418-G9	Elongated Complete, No-Touch Flush	12"	Sandbar	
170167	K-6418-NY	Elongated Complete, No-Touch Flush	12"	Dune	

\*Vibrant Limited Lifetime Finish

[www.plumbsupply.com](http://www.plumbsupply.com) • Serving our Customers Since 1946 • [www.waterconcepts.net](http://www.waterconcepts.net)



## Elongated Closets

### Cimarron® Comfort Height® 2-Piece 1.28 Toilet with Skirted Trapway

- AquaPiston® flushing system
- Patented ReadyLock™ installation
- Floor mount / floor outlet
- Left-hand polished chrome trip lever included
- 2-1/8" Fully glazed trapway
- Seat and supply sold separately



**K-5310 Combination: K-5309 Elongated Bowl, K-4369 Tank**

Part #	Mfg #	Description	Rough-In	Color	Price
234987	K-5310-0	Elongated Complete, LH CP Trip	12"	White	
258548	K-5310-47	Elongated Complete, LH CP Trip	12"	Almond	
250847	K-5310-7	Elongated Complete, LH CP Trip	12"	Black	
241187	K-5310-95	Elongated Complete, LH CP Trip	12"	Ice Grey	
240789	K-5310-96	Elongated Complete, LH CP Trip	12"	Biscuit	
246375	K-5310-NY	Elongated Complete, LH CP Trip	12"	Dune	

### Corbelle™ Comfort Height® Skirted Trapway 2-Piece 1.28 gpf Toilet

- Revolution360™ Swirl flushing technology
- ReadyLock™ installation
- CleanCoat® surface coating
- 2-1/8" Fully glazed trapway
- Includes left-hand trip lever
- Seat and supply sold separately



**K-3814 Combination: K-4144 Elongated Bowl, K-4143 Tank**

Part #	Mfg #	Description	Rough-In	Color	Price
237251	K-3814-0	ADA Elongated Complete, LH Trip	12"	White	
250705	K-3814-95	ADA Elongated Complete, LH Trip	12"	Ice Grey	
246068	K-3814-96	ADA Elongated Complete, LH Trip	12"	Biscuit	

### Corbelle™ Comfort Height® ContinuousClean™ 2-Piece 1.28 gpf Toilet

- Revolution360™ Swirl flushing technology
- ReadyLock™ installation
- CleanCoat® surface coating
- 2-1/8" Fully glazed trapway
- Includes left-hand trip lever
- Seat and supply sold separately



**K-5709 Combination: K-4144 Elongated Skirted Bowl, K-5711 Tank**

Part #	Mfg #	Description	Rough-In	Color	Price
251103	K-5709-0	ADA Elongated Complete, LH Trip	12"	White	

\*Vibrant Limited Lifetime Finish

**www.waterconcepts.net • Serving our Customers Since 1946 • www.plumbsupply.com**

## Elongated Closets

### Devonshire® Comfort Height® 2-Piece 1.28 gpf Toilet with AquaPiston® Flushing Technology

- 2-1/8" Fully glazed trapway
- Includes left-hand trip lever
- Seat and supply sold separately



**K-3837 Combination: K-4397 Elongated Bowl, K-4438 Tank**

Part #	Mfg #	Description	Rough-In	Color	Price
141575	K-3837-0	ADA Elongated Complete, LH Trip	12"	White	
141582	K-3837-47	ADA Elongated Complete, LH Trip	12"	Almond	
234386	K-3837-7	ADA Elongated Complete, LH Trip	12"	Black	
141369	K-3837-95	ADA Elongated Complete, LH Trip	12"	Ice Grey	
141579	K-3837-96	ADA Elongated Complete, LH Trip	12"	Biscuit	
243511	K-3837-G9	ADA Elongated Complete, LH Trip	12"	Sandbar	
177204	K-3837-K4	ADA Elongated Complete, LH Trip	12"	Cashmere	
154858	K-3837-NY	ADA Elongated Complete, LH Trip	12"	Dune	

### Elliston® The Complete Solution® Comfort Height® 2-Piece 1.28 gpf Toilet

- 2-1/8" Glazed trapway
- Quick-Release™ hinges
- Class Five® flushing technology
- Floor mount/floor outlet
- Supply line not included
- Standard left-hand polished chrome trip lever included
- Includes (K-4774) toilet seat



Part #	Mfg #	Description	Rough-In	Color	Price
244754	12767-96	ADA Elongated Complete LH Trip	12"	Biscuit	

### Wellworth® 2-Piece 1.6 gpf Toilet with Class Five® Flush Technology and Left-Hand Trip Lever

- 12" Standard rough-in and 3-bolt installation
- 2" Glazed trapway
- Seat and supply sold separately



**K-3979 Combination: K-4199 ADA Bowl, K-4468 Tank**

**K-3978 Combination: K-4198 Elongated Bowl, K-4468 Tank**

Part #	Mfg #	Description	Rough-In	Color	Price
137522	K-3978-0	Elongated Complete, LH CP Trip	12"	White	

\*Vibrant Limited Lifetime Finish

**www.plumbsupply.com • Serving our Customers Since 1946 • www.waterconcepts.net**

## Elongated Closets

### Highline® Comfort Height® 2-Piece 1.6 gpf Toilet with Class Five® Flush Technology & Left-Hand Trip Lever

- 2" Glazed trapway
- 12" Standard rough-in and 3-bolt installation
- Seat and supply sold separately
- (-RA) Right-hand trip lever
- (-T) Tank cover locks



**K-3979 Combination: K-4199 ADA Bowl, K-4468 Tank**

**K-3978 Combination: K-4198 Elongated Bowl, K-4468 Tank**

Part #	Mfg #	Description	Rough-In	Color	Price
137514	K-3979-0	ADA Elongated Complete, LH CP Trip	12"	White	
138354	K-3979-47	ADA Elongated Complete, LH CP Trip	12"	Almond	
140398	K-3979-7	ADA Elongated Complete, LH CP Trip	12"	Black	
137515	K-3979-96	ADA Elongated Complete, LH CP Trip	12"	Biscuit	
142860	K-3979-RA-0	ADA Elongated Complete, RH CP Trip	12"	White	
144720	K-3979-RA-47	ADA Elongated Complete, RH CP Trip	12"	Almond	
141867	K-3979-RA-96	ADA Elongated Complete, RH CP Trip	12"	Biscuit	
149479	K-3979-T-0	ADA Elongated Complete, LH CP Trip, with Locks	12"	White	

### Highline® Comfort Height® 2-Piece 1.28 gpf Toilet with Class Five® flush technology & Left-Hand Trip Lever

- 2-1/8" Glazed trapway
- 3-bolt installation
- Seat and supply sold separately
- Meets EPA WaterSense® criteria
- (-RA) Right-hand trip lever
- (-U) Insuliner® tank liner



Part #	Mfg #	Description	Rough-In	Color	Price
137520	K-3889-0	ADA Elongated Complete, LH CP Trip Lever	10"	White	
139804	K-3889-47	ADA Elongated Complete, LH CP Trip Lever	10"	Almond	
142662	K-3889-7	ADA Elongated Complete, LH CP Trip Lever	10"	Black	
137521	K-3889-96	ADA Elongated Complete, LH CP Trip Lever	10"	Biscuit	
170050	K-3889-RA-0	ADA Elongated Complete, RH CP Trip Lever	10"	White	
151833	K-3889-U-96	ADA Elongated Complete with Insuliner® Tank, LH CP Trip	10"	Biscuit	
137516	K-3999-0	ADA Elongated Complete, LH CP Trip Lever	12"	White	
139453	K-3999-47	ADA Elongated Complete, LH CP Trip Lever	12"	Almond	
157547	K-3999-7	ADA Elongated Complete, LH CP Trip Lever	12"	Black	
137517	K-3999-96	ADA Elongated Complete, LH CP Trip Lever	12"	Biscuit	
159525	K-3999-RA-0	ADA Elongated Complete, RH CP Trip Lever	12"	White	
146791	K-3999-RA-96	ADA Elongated Complete, RH CP Trip Lever	12"	Biscuit	
140990	K-3999-U-0	ADA Elongated Complete, LH CP Trip Lever, w/Insuliner®	12"	White	

\*Vibrant Limited Lifetime Finish

**www.waterconcepts.net • Serving our Customers Since 1946 • www.plumbsupply.com**

## Elongated Closets

### Two-Piece Vitreous China Toilets (Continued)

#### Highline® Comfort Height® 2-Piece 1.28 gpf Toilet with Class Five® flush technology & Left-Hand Trip Lever

Part #	Mfg #	Description	Rough-In	Color	Price
140991	K-3999-UR-0	ADA Elongated Complete, RH CP Trip Lever, w/Insuliner®	12"	White	
137518	K-3949-0	ADA Elongated Complete	14"	White	
137519	K-3949-96	ADA Elongated Complete	14"	Biscuit	

#### Highline® Concealed Trapway Comfort Height® 1.28 gpf 2-Piece Toilet with Class Five® flush technology

- 2-1/8" Glazed trapway
- Includes polished chrome left-hand trip lever
- Standard 12" Rough-in with 3-bolt installation
- Seat and supply sold separately
- Meets EPA WaterSense® criteria



Combination: K-80020 ADA Bowl, K-5311 Tank

Part #	Mfg #	Description	Rough-In	Color	Price
190442	K-76301-0	ADA Elongated Complete, LH CP Trip Lever, Concealed Trap	12"	White	
228161	K-76301-47	ADA Elongated Complete, LH CP Trip Lever, Concealed Trap	12"	Almond	
190443	K-76301-96	ADA Elongated Complete, LH CP Trip Lever, Concealed Trap	12"	Biscuit	

#### Highline® Classic Comfort Height® 1.28 gpf 2-Piece Toilet with Class Five® Flush & Left Hand Trip Lever

- 2-1/8" Fully glazed trapway
- Seat and supply sold separately
- Meets EPA Watersense® criteria
- (-RA) Right-hand trip lever



K-3658 Combination: K-4199 Elongated Bowl, K-4436 Tank

K-3713 Combination: K-4373 Elongated Bowl, K-4436 Tank

Part #	Mfg #	Description	Rough-In	Color	Price
134973	K-3658-0	ADA Elongated Complete, LH CP Trip	12"	White	
175505	K-3658-96	ADA Elongated Complete, LH CP Trip	12"	Biscuit	
139709	K-3658-RA-0	ADA Elongated Complete, RH CP Trip	12"	White	
138445	K-3713-0	ADA Elongated Complete, LH CP Trip	10"	White	
151970	K-3713-7	ADA Elongated Complete, LH CP Trip	10"	Black	
153309	K-3713-96	ADA Elongated Complete, LH CP Trip	10"	Biscuit	

\*Vibrant Limited Lifetime Finish

[www.plumbsupply.com](http://www.plumbsupply.com) • Serving our Customers Since 1946 • [www.waterconcepts.net](http://www.waterconcepts.net)

## Elongated Closets

### Highline® Classic Comfort Height® 1.6 gpf 2-Piece Elongated Toilet with PressureLite® Flush Technology



- 30-1/8"L x 21-1/4"W x 31-1/4"H
- Seat and supply sold separately
- 12" Rough-in
- Includes left hand trip lever  
—(-RA) Right-hand trip lever

**K-3493 Combination: K-4304 Elongated Bowl, K-4645 Tank**

Part #	Mfg #	Description	Rough-In	Color	Price
086520	K-3493-0	ADA Elongated Complete, LH Trip	12"	White	
088820	K-3493-47	ADA Elongated Complete, LH Trip	12"	Almond	
086523	K-3493-96	ADA Elongated Complete, LH Trip	12"	Biscuit	
090414	K-3493-RA-0	ADA Elongated Complete, RH Trip	12"	White	
180505	K-3493-RA-96	ADA Elongated Complete, RH Trip	12"	Biscuit	
257461	K-3493-SS-0	ADA Elongated Complete, LH Trip	12"	White	
090163	K-3493-T-0	ADA Elongated Complete, LH Trip and Tank Cover Locks	12"	White	
091897	K-3493-TR-0	ADA Elongated Complete, RH Trip and Tank Cover Locks	12"	White	

### Highline® Classic Comfort Height® 1.0 gpf 2-Piece Elongated Toilet with PressureLite® Flush Technology



- Pressure assisted flushing system
- 2-1/4" Glazed trapway
- Seat and supply sold separately
- WaterSense® certified product
- Includes left hand trip lever  
—(-RA) Right-hand trip lever

Part #	Mfg #	Description	Rough-In	Color	Price
103513	K-3519-0	ADA Elongated Complete, LH CP Trip	12"	White	
115015	K-3519-7	ADA Elongated Complete, LH CP Trip	12"	Black	
146024	K-3519-96	ADA Elongated Complete, LH CP Trip	12"	Biscuit	
106013	K-3519-RA-0	ADA Elongated Complete, RH CP Trip	12"	White	
143297	K-3519-T-0	ADA Elongated Complete, LH CP Trip with Tank Cover Locks	12"	White	
133866	K-3519-TR-0	ADA Elongated Complete, RH CP Trip with Tank Cover Locks	12"	White	

\*Vibrant Limited Lifetime Finish

[www.waterconcepts.net](http://www.waterconcepts.net) • Serving our Customers Since 1946 • [www.plumbsupply.com](http://www.plumbsupply.com)

## Elongated Closets

### Kelston® Comfort Height® 1.6 gpf 2-Piece Elongated Toilet with AquaPiston® Flush & Left-Hand Trip Lever

- 2-1/8" Glazed trapway
- DryLock™ system
- Seat and supply sold separately



K-3754 Combination: K-4306 Elongated Bowl, K-4474 LH Tank

Part #	Mfg #	Description	Rough-In	Color	Price
128876	K-3754-0	ADA Elongated Complete, LH CP Trip	12"	White	
128944	K-3754-47	ADA Elongated Complete, LH CP Trip	12"	Almond	
132278	K-3754-7	ADA Elongated Complete, LH CP Trip	12"	Black	
128877	K-3754-96	ADA Elongated Complete, LH CP Trip	12"	Biscuit	
141838	K-3754-G9	ADA Elongated Complete, LH CP Trip	12"	Sandbar	
157917	K-3754-NY	ADA Elongated Complete, LH CP Trip	12"	Dune	

### Kelston® Comfort Height® 2-Piece Elongated 1.28 gpf Toilet with AquaPiston® Flush & Left-Hand Trip Lever

- 2-1/8" Glazed trapway
- DryLock™ system
- Seat and supply sold separately



K-3755 Combination: K-4306 Elongated Bowl, K-4469 LH Tank

Part #	Mfg #	Description	Rough-In	Color	Price
132322	K-3755-0	ADA Elongated Complete	12"	White	
175621	K-3755-47	ADA Elongated Complete	12"	Almond	
226008	K-3755-95	ADA Elongated Complete	12"	Ice Grey	
172138	K-3755-G9	ADA Elongated Complete	12"	Sandbar	

### Memoirs® Comfort Height® 2-Piece Elongated 1.6 gpf Toilet with AquaPiston® Flush Technology

- 12" Rough-in
- Includes left-hand polished chrome trip lever
- Seat and supply sold separately



Classic

Stately

K-3818 Combination: K-4380 Elongated Bowl, K-4641 LH Trip Classic Tank

K-3819 Combination: K-4380 Elongated Bowl, K-4642 LH Trip Stately Tank

Part #	Mfg #	Description	Rough-In	Color	Price
142797	K-3818-0	ADA Classic Elongated Complete	12"	White	
154820	K-3818-47	ADA Classic Elongated Complete	12"	Almond	
167047	K-3818-95	ADA Classic Elongated Complete	12"	Ice Grey	
142404	K-3818-96	ADA Classic Elongated Complete	12"	Biscuit	

\*Vibrant Limited Lifetime Finish

[www.plumbsupply.com](http://www.plumbsupply.com) • Serving our Customers Since 1946 • [www.waterconcepts.net](http://www.waterconcepts.net)



## Elongated Closets

### Two-Piece Vitreous China Toilets (Continued)

#### Memoirs® Comfort Height® 2-Piece Elongated 1.6 gpf Toilet with AquaPiston® Flush Technology

Part #	Mfg #	Description	Rough-In	Color	Price
144488	K-3818-G9	ADA Classic Elongated Complete	12"	Sandbar	
144633	K-3819-0	ADA Stately Elongated Complete	12"	White	
145322	K-3819-47	ADA Stately Elongated Complete	12"	Almond	
162018	K-3819-95	ADA Stately Elongated Complete	12"	Ice Grey	
156881	K-3819-96	ADA Stately Elongated Complete	12"	Biscuit	
153191	K-3819-G9	ADA Stately Elongated Complete	12"	Sandbar	

#### Memoirs® Comfort Height® 2-Piece Elongated 1.28 gpf Toilet with Left-Hand Trio Lever

- AquaPiston® flushing technology
- 2-1/8" Glazed trapway
- Seat and supply sold separately
- Meets EPA WaterSense® criteria



**K-3816 Combination: K-4380 Elongated Bowl, K-4433 Tank**

Part #	Mfg #	Description	Rough-In	Color	Price
143308	K-3816-0	ADA Classic Elongated Complete, LH Trip	12"	White	
153531	K-3816-95	ADA Classic Elongated Complete, LH Trip	12"	Ice Grey	
143143	K-3816-96	ADA Classic Elongated Complete, LH Trip	12"	Biscuit	
152496	K-3816-G9	ADA Classic Elongated Complete, LH Trip	12"	Sandbar	
165403	K-3816-NY	ADA Classic Elongated Complete, LH Trip	12"	Dune	
223613	K-3816-U-0	ADA Classic Elongated Complete, LH Trip & Tank Liner	12"	White	
138859	K-3817-0	ADA Stately Elongated Complete, LH Trip	12"	White	
230602	K-3817-7	ADA Stately Elongated Complete, LH Trip	12"	Black	
155040	K-3817-96	ADA Stately Elongated Complete, LH Trip	12"	Biscuit	
143524	K-3817-47	ADA Stately Elongated Complete, LH Trip	12"	Almond	
160614	K-3817-G9	ADA Stately Elongated Complete, LH Trip	12"	Sandbar	
151845	K-3817-NY	ADA Stately Elongated Complete, LH Trip	12"	Dune	

#### With Concealed Trapway and Clean Caps®

Part #	Mfg #	Description	Rough-In	Color	Price
177489	K-6669-0	ADA Stately Elongated Complete, LH Trip Concealed Trapway		12" White	
184224	K-6669-47	ADA Stately Elongated Complete, LH Trip Concealed Trapway		12" Almond	
185578	K-6669-95	ADA Stately Elongated Complete, LH Trip Concealed Trapway		12" Ice Grey	
180836	K-6669-96	ADA Stately Elongated Complete, LH Trip Concealed Trapway		12" Biscuit	
188480	K-6669-NY	ADA Stately Elongated Complete, LH Trip Concealed Trapway		12" Dune	
186848	K-6999-0	ADA Classic Elongated Complete, LH Trip Concealed Trapway		12" White	
250397	K-6999-47	ADA Classic Elongated Complete, LH Trip Concealed Trapway		12" Almond	
185574	K-6999-96	ADA Classic Elongated Complete, LH Trp Concealed Trapway	12"	Biscuit	
258514	K-6999-G9	ADA Classic Elongated Complete, LH Trp Concealed Trapway	12"	Sandbar	

\*Vibrant Limited Lifetime Finish

[www.waterconcepts.net](http://www.waterconcepts.net) • Serving our Customers Since 1946 • [www.plumbsupply.com](http://www.plumbsupply.com)



## Elongated Closets

### Persuade® Curv Comfort Height® 2-Piece Dual Flush 1.6/1.0 Toilet

- Includes 2-button actuator that provides easy-to-use flushing options
- Skirted trapway
- Supply line included
- Seat sold separately
- Meets EPA WaterSense® criteria



**K-3723 Combination: K-4353 Elongated Bowl, K-4441 Tank**

Part #	Mfg #	Description	Rough-In	Color	Price
234677	K-6355-0	ADA Elongated Complete	12"	White	
234681	K-6355-47	ADA Elongated Complete	12"	Almond	
234680	K-6355-96	ADA Elongated Complete	12"	Biscuit	
234678	K-6355-NY	ADA Elongated Complete	12"	Dune	
234682	K-6355-7	ADA Elongated Complete	12"	Black	

### Persuade® Curv Comfort Height® 2-Piece Dual Flush Toilet

- ReadyLock™ installation
- Includes left or right trip lever  
—1.0 or 1.6 gpf
- Skirted trapway
- Supply line included
- Seat sold separately
- Meets EPA WaterSense® criteria
- (-RA) right hand trip lever



**K-75790-RA-0 Combination: K-4326 Bowl, K-19042-RA Tank**

Part #	Mfg #	Description	Rough-In	Color	Price
248279	K-75790-0	ADA Elongated Complete, LH Trip Lever	12"	White	
239799	K-75790-RA-0	ADA Elongated Complete, RH Trip Lever	12"	White	

### Persuade® Circ Comfort Height® 2-Piece Dual Flush 1.6/1.0 Toilet

- Includes top-mount dual flush trip lever
- Skirted trapway
- Supply line included



**K-3753 Combination: K-4353 Elongated Bowl, K-4442 DF Tank**

Part #	Mfg #	Description	Rough-In	Color	Price
234683	K-3815-0	ADA Elongated Complete	12"	White	

\*Vibrant Limited Lifetime Finish

[www.plumbsupply.com](http://www.plumbsupply.com) • Serving our Customers Since 1946 • [www.waterconcepts.net](http://www.waterconcepts.net)

## Elongated Closets

### Two-Piece Vitreous China Toilets (Continued)

#### Persuade® Circ Comfort Height® 2-Piece Dual Flush 1.6/1.0 Toilet

Part #	Mfg #	Description	Rough-In	Color	Price
234689	K-3815-47	ADA Elongated Complete	12"	Almond	
234690	K-3815-7	ADA Elongated Complete	12"	Black	
234687	K-3815-95	ADA Elongated Complete	12"	Ice Grey	
234686	K-3815-96	ADA Elongated Complete	12"	Biscuit	

#### Tresham™ Comfort Height® 2-Piece Elongated 1.28 Toilet with AquaPiston® Flush Technology

- 2-1/8" Glazed trapway
- Includes left-hand polished chrome trip lever
- Seat and water supply sold separately
- Meets EPA WaterSense® criteria



**K-3950 Combination: K-4799 Elongated Bowl, K-4899 Tank**

Part #	Mfg #	Description	Rough-In	Color	Price
143743	K-3950-0	ADA Elongated Toilet Complete	12"	White	
154996	K-3950-47	ADA Elongated Toilet Complete	12"	Almond	
173772	K-3950-58	ADA Elongated Toilet Complete	12"	Thunder Grey	
181231	K-3950-7	ADA Elongated Toilet Complete	12"	Black	
145963	K-3950-96	ADA Elongated Toilet Complete	12"	Biscuit	
156438	K-3950-G9	ADA Elongated Toilet Complete	12"	Sandbar	
154949	K-3950-K4	ADA Elongated Toilet Complete	12"	Cashmere	
151848	K-3950-NY	ADA Elongated Toilet Complete	12"	Dune	

#### Wellworth® Classic Elongated 2-Piece 1.6 Pressure Lite™ Toilet

- Pressure assist flushing technology
- Equipped with Sloan FLUSHMATE® - Sloan® Valve Company
- Polished Chrome Trip Lever
- Less seat and supply



Part #	Mfg #	Description	Rough-In	Color	Price
183050	K-3505-RA-0	ADA Elongated Toilet Complete, RH Trip Lever	12"	White	

\*Vibrant Limited Lifetime Finish

[www.waterconcepts.net](http://www.waterconcepts.net) • Serving our Customers Since 1946 • [www.plumbsupply.com](http://www.plumbsupply.com)

## Elongated Closets

### Wellworth® Classic 2-Piece Elongated 1.28 Toilet with Class Five® Flush Technology & Left-Hand Trip Lever

- 2-1/8" Glazed trapway
- Large 3-1/4" canister flush valve
- Seat and supply sold separately
- Meets EPA WaterSense® criteria



Part #	Mfg #	Description	Rough-In	Color	Price
130223	K-3575-0	Elongated Complete	12"	White	
171499	K-3575-47	Elongated Complete	12"	Almond	

### Wellworth® 2-Piece Elongated 1.28 gpf Toilet with Class Five® Flush Technology

- 2-1/8" Glazed trapway
- Large 3-1/4" canister flush valve
- Left-hand chrome-plated trip lever
- Seat and supply sold separately
- Meets EPA WaterSense® criteria



K-3948 Combination: K-4198 Elongated Bowl, K-4841 Tank

K-3998 Combination: K-4198 Elongated Bowl, K-4467 Tank

Part #	Mfg #	Description	Rough-In	Color	Price
137526	K-3948-0	Elongated Complete	14"	White	
171446	K-3948-47	Elongated Complete	14"	Almond	
137524	K-3998-0	Elongated Complete	12"	White	

### Wellworth® 2-Piece Elongated Dual-Flush Toilet with Left-Hand Trip Lever

- Dual-flush offers 1.1 gpf or 1.6 gpf flush options
- 2-1/8" Glazed trapway
- 3-Bolt installation
- Seat and supply sold separately
- Meets EPA WaterSense® criteria



K-3988 Combination: K-4198 Elongated Bowl, K-4458 Tank

Part #	Mfg #	Description	Rough-In	Color	Price
159681	K-3988-0	Elongated Complete, LH Trip	12"	White	
171449	K-3988-47	Elongated Complete, LH Trip	12"	Almond	
188193	K-3988-96	Elongated Complete, LH Trip	12"	Biscuit	

\*Vibrant Limited Lifetime Finish

[www.plumbsupply.com](http://www.plumbsupply.com) • Serving our Customers Since 1946 • [www.waterconcepts.net](http://www.waterconcepts.net)

## Elongated Closets

### Highline® Comfort Height® 2-Piece Elongated Dual-Flush Toilet with Class Five® Flush Technology

- Dual-flush offers 1.1 gpf or 1.6 gpf flush options
- 2-1/8" Glazed trapway
- 3-Bolt installation
- Includes left-hand trip lever  
—(-RA) right-hand trip lever
- Seat and supply sold separately
- Meets EPA WaterSense® criteria



**K-3989 Combination: K-4199 Elongated Bowl, K-4458 Tank**  
**K-6393 Combination: K-4373 Elongated Bowl, K-4458-RA Tank**

Part #	Mfg #	Description	Rough-In	Color	Price
160279	K-3989-0	ADA Elongated Complete, LH Trip	12"	White	
249485	K-3989-47	ADA Elongated Complete, LH Trip	12"	Almond	
160281	K-3989-96	ADA Elongated Complete, LH Trip	12"	Biscuit	
185409	K-6393-0	ADA Elongated Complete, LH Trip	10"	White	
181254	K-6393-RA-0	ADA Elongated Complete, RH Trip	10"	White	

\*Vibrant Limited Lifetime Finish

[www.waterconcepts.net](http://www.waterconcepts.net) • Serving our Customers Since 1946 • [www.plumbsupply.com](http://www.plumbsupply.com)



## Elongated Closets

### Two-Piece Elongated Vitreous China Toilets

#### Allerton™ 2-Piece 1.28gpf Toilet

- 3" flush valve with Fluidmaster® pilot valve for quiet fill
- Elongated ErgoHeight™ bowl
- Dual-fed siphon jet action bowl (no splashing)
- 2" fully glazed trapway for effective waste removal
- Side tank lever
- 6 point tank to bowl connection for tank stability
- Sanitary bead for easy cleaning
- Color matched bolt caps included
- Toilet seat not included



**HE-20-007 Combination: HE-21-577 Bowl, HE-28-580 Tank**

Part #	Mfg #	Description	Rough-In	Color	Price
177840	HE-20-007	HE-20-007 Combination: HE-21-577 Bowl, HE-28-580 Tank	12"	White	

#### Avalanche™ 2-Piece 1.6gpf Toilet

- Fluidmaster® fill valve
- 2" Glazed trapway
- Side, color matched tank lever
- Seat sold separately



#### Elongated, Standard Height

**AV-21-810 Combination: AV-21-862 Elong Bowl, AV-28-895 Tank**

**AV-21-812 Combination: AV-21-862 Elong Bowl, AV-28-890 Tank**

**AV-21-814 Combination: AV-21-862 Elong Bowl, AV-28-894 Tank**

Part #	Mfg #	Description	Rough-In	Color	Price
161386	AV-21-810	AV-21-862 Elong Bowl, AV-28-895 Tank	10"	White	
161556	AV-21-810-09	AV-21-862-09 Elong Bowl, AV-28-895-09 Tank	10"	Biscuit	
161387	AV-21-812	AV-21-862 Elong Bowl, AV-28-890 Tank	12"	White	
161557	AV-21-812-09	AV-21-862-09 Elong Bowl, AV-28-890-09 Tank	12"	Biscuit	
161389	AV-21-814	AV-21-862 Elong Bowl, AV-28-894 Tank	14"	White	
161559	AV-21-814-09	AV-21-862-09 Elong Bowl, AV-28-894-09 Tank	14"	Biscuit	

#### ErgoHeight (ADA)

**AV-21-817 Combination: AV-21-828 ADA Bowl, AV-28-895 Tank**

**AV-21-818 Combination: AV-21-828 ADA Bowl, AV-28-890 Tank**

**AV-21-824 Combination: AV-21-828 ADA Bowl, AV-28-894 Tank**

Part #	Mfg #	Description	Rough-In	Color	Price
161390	AV-21-817	AV-21-828 ADA Bowl, AV-28-895 Tank	10"	White	
161561	AV-21-817-09	AV-21-828-09 ADA Bowl, AV-28-895-09 Tank	10"	Biscuit	
161391	AV-21-818	AV-21-828 ADA Bowl, AV-28-890 Tank	12"	White	
161562	AV-21-818-09	AV-21-828-09 ADA Bowl, AV-28-890-09 Tank	12"	Biscuit	
166257	AV-21-818-25	AV-21-828-25 ADA Bowl, AV-28-890-25 Tank	12"	Bone/Wheat	



## Elongated Closets

### Two-Piece Elongated Vitreous China Toilets (Continued)

#### Avalanche™ 2-Piece 1.6gpf Toilet ErgoHeight (ADA)

Part #	Mfg #	Description	Rough-In	Color	Price
161392	AV-21-824	AV-21-828 ADA Bowl, AV-28-894 Tank	14"	White	
161563	AV-21-824-09	AV-21-828-09 ADA Bowl, AV-28-89-094 Tank	14"	Biscuit	

#### Avalanche™ 2-Piece 1.28gpf Toilet

- Fluidmaster® fill valve
- 2" Glazed trapway
- Side, color matched tank lever
- Seat sold separately



#### Elongated, Standard Height

- WS-21-810 Combination: AV-21-862 Elong Bowl, WS-28-895 Tank**  
**WS-21-812 Combination: AV-21-862 Elong Bowl, WS-28-890 Tank**  
**WS-21-814 Combination: AV-21-862 Elong Bowl, WS-28-894 Tank**

Part #	Mfg #	Description	Rough-In	Color	Price
161401	WS-21-810	AV-21-862 Elong Bowl, WS-28-895 Tank	10"	White	
161572	WS-21-810-09	AV-21-862-09 Elong Bowl, WS-28-895-09 Tank	10"	Biscuit	
161402	WS-21-812	AV-21-862 Elong Bowl, WS-28-890 Tank	12"	White	
161573	WS-21-812-09	AV-21-862-09 Elong Bowl, WS-28-890-09 Tank	12"	Biscuit	
161403	WS-21-814	AV-21-862 Elong Bowl, WS-28-894 Tank	14"	White	
161575	WS-21-814-09	AV-21-862-09 Elong Bowl, WS-28-894-09 Tank	14"	Biscuit	

#### ErgoHeight (ADA)

- WS-21-817 Combination: AV-21-828 ADA Bowl, WS-28-895 Tank**  
**WS-21-818 Combination: AV-21-828 ADA Bowl, WS-28-890 Tank**  
**WS-21-824 Combination: AV-21-828 ADA Bowl, WS-28-894 Tank**

Part #	Mfg #	Description	Rough-In	Color	Price
161404	WS-21-817	AV-21-828 ADA Bowl, WS-28-895 Tank	10"	White	
161576	WS-21-817-09	AV-21-828-09 ADA Bowl, WS-28-895-09 Tank	10"	Biscuit	
161405	WS-21-818	AV-21-828 ADA Bowl, WS-28-890 Tank	12"	White	
161577	WS-21-818-09	AV-21-828-09 ADA Bowl, WS-28-890-09 Tank	12"	Biscuit	
161407	WS-21-824	AV-21-828 ADA Bowl, WS-28-894 Tank	14"	White	
161578	WS-21-824-09	AV-21-828-09 ADA Bowl, WS-28-894-09 Tank	14"	Biscuit	



## Elongated Closets

### Avalanche™ 2-Piece 1.28gpf Toilet with Concealed Trapway

- Two piece toilet with concealed trapway for superior look
- Elongated bowl
- Single flush 1.28 HET provides for maximum performance at optimal water savings
- Fluidmaster Fill Valve
- 3" flush valve
- Color-matched cover plates included
- Toilet seat not included



**20-832 Combination: 21-832 ADA Bowl, 28-830 Tank**

Part #	Mfg #	Description	Rough-In	Color	Price
174323	20-832	21-832 ADA Bowl, 28-830 Tank	12"	White	

### Avalanche™ Elite™ 2-Piece 1.6gpf ErgoHeight™ Toilet

- 17" Tall ErgoHeight™ bowl
- Fluidmaster® 400A fill valve
- PowerClean Flush System
- 2-1/8" Glazed trapway
- 3" Flush valve
- Dual fed siphon jets
- Side, color matched tank lever
- Corrosion resistant FluidMaster® flapper
- Double nut, multi-point tank-to-bowl mounting system
- Seat sold separately



**AV-20-828 Combination: AB-21-828 ADA Bowl, AL-28-890 Tank**

Part #	Mfg #	Description	Rough-In	Color	Price
246820	AV-20-828	AB-21-828 ADA Bowl, AL-28-890 Tank	12"	White	





## Elongated Closets

### Avalanche™ Elite™ 2-Piece 1.28gpf ErgoHeight™ Toilet

- 17" Tall ErgoHeight™ bowl
- Fluidmaster® 400A fill valve
- PowerClean Flush System
- 2-1/8" Glazed trapway
- 3" Flush valve
- Dual fed siphon jets
- Side, color matched tank lever
- Corrosion resistant FluidMaster® flapper
- Double nut, multi-point tank-to-bowl mounting system
- Seat sold separately



WS-20-828 Combination: AB-21-828 ADA Bowl, AH-28-890 Tank

Part #	Mfg #	Description	Rough-In	Color	Price
246826	WS-20-828	AB-21-828 ADA Bowl, AH-28-890	12"	White	

### Blaze™ 2-Piece 1.28gpf Toilet

- 3" Flush valve
- Fluidmaster 400A fill valve
- Color-matched flush lever
- Double nut, multi-point tank-to-bowl mounting system for easy tool-free installation
- XL dual fed siphon jets increases the force of the flush, clearing the bowl effectively
- Large water surface to thoroughly rinse bowl with each flush
- Large, 2" fully glazed trapway for clog-free waste removal
- Toilet seat not included
- WaterSense® certified
- 10 Year warranty



20-023 Combination: 21-187 ADA Bowl, 28-187 Tank

Part #	Mfg #	Description	Rough-In	Color	Price
180963	20-023	21-187 ADA Bowl, 28-187 Tank	12"	White	
222328	20-023-09	21-187-09 ADA Bowl, 28-187-09 Tank	12"	Biscuit	



## Elongated Closets

### Brianne™ Elongated ErgoHeight™ 2-Piece 1.28gpf Toilet

- 3" flush valve with Fluidmaster® pilot valve for quiet fill
- Compact Elongated ErgoHeight™ bowl, ADA Compliant
- Dual-fed siphon jet action bowl (no splashing)
- 2" fully glazed trapway for effective waste removal
- Side tank lever
- 6 point tank to bowl connection for tank stability
- Color matched bolt caps included
- Toilet seat not included



HE-20-013 Combination: HE-21-183 ADA Bowl, HE-28-183 Tank

Part #	Mfg #	Description	Rough-In	Color	Price
174706	HE-20-013	HE-21-183 ADA Bowl, HE-28-183 Tank	12"	White	

### Hinsdale™ Elongated ErgoHeight™ 1.28gpf Toilet

- 3" Flush valve
- QuietClean flush system
- Fluidmaster® 400A fill valve
- Extra-large dual fed siphon jets
- Double nut, multi-point tan-to-bowl mounting system
- Toilet seat not included



20-181 Combination: 21-181 Bowl, 28-181 Tank

Part #	Mfg #	Description	Rough-In	Color	Price
242069	20-181	21-181 Bowl, 28-181 Tank	12"	White	

### Logan Square ErgoHeight™ Elongated 1.28 gpf

- 3" Flush valve
- Dual fed siphon jet
- Fluidmaster fill valve
- 2" Glazed trapway
- Toilet seat not included



HE-20-018 Combination: HE-21-538 Bowl, HE-28-530 Tank

Part #	Mfg #	Description	Rough-In	Color	Price
153809	HE-20-018	HE-21-538 ADA Bowl, HE-28-530 Tank	12"	White	
156748	HE-20-018-09	HE-21-538 ADA Bowl, HE-28-530 Tank	12"	Biscuit	



## Elongated Closets

### Logan Square 2-Piece Dual Flush 1.1/1.6 gpf Toilet

- ErgoHeight® ADA Elongated Bowl
- Fully Glazed Trapway
- Top mounted, two-button actuator
- Syphonic flush action
- Toilet seat not included
- Color matched bolt caps included
- HET High Efficiency Toilet



DF-20-018 Combination: HE-21-538 Bowl, DF-28-530 Tank

Part #	Mfg #	Description	Rough-In	Color	Price
168716	DF-20-018	HE-21-538 ADA Bowl, DF-28-530 Dual Flush Tank	12"	White	

### Maxwell™ 2-Piece 1.6gpf Toilet

- 3" Flush valve
- 2" Glazed trapway
- Front, color matched tank lever
- Dual-fed siphon jet
- Seat sold separately



MX-20-910 Combination: MX-21-962 Elong Bowl, MX-28-995 Tank  
 MX-20-912 Combination: MX-21-962 Elong Bowl, MX-28-990 Tank  
 MX-20-914 Combination: MX-21-962 Elong Bowl, MX-28-994 Tank  
 MX-21-410 Combination: 21-962 Elong Bowl, MX-28-995 Tank  
 MX-21-412 Combination: 21-962 Elong Bowl, MX-28-990 Tank  
 MX-21-414 Combination: 21-962 Elong Bowl, MX-28-994 Tank

### Elongated, Standard Height

Part #	Mfg #	Description	Rough-In	Color	Price
247576	MX-20-910	MX-21-962 Elong Bowl, MX-28-995 Tank	10"	White	
247577	MX-20-910-09	MX-21-962-09 Elong Bowl, MX-28-995-09 Tank	10"	Biscuit	
247579	MX-20-912	MX-21-962 Elong Bowl, MX-28-990 Tank	12"	White	
247580	MX-20-912-09	MX-21-962-09 Elong Bowl, MX-28-990-09 Tank	12"	Biscuit	
247582	MX-20-914	MX-21-962 Elong Bowl, MX-28-994 Tank	14"	White	
161313	MX-21-410	21-962 Elong Bowl, MX-28-995 Tank	10"	White	
161427	MX-21-410-09	21-962-09 Elong Bowl, MX-28-995-09 Tank	10"	Biscuit	
161314	MX-21-412	21-962 Elong Bowl MX-28-990 Tank	12"	White	
161428	MX-21-412-09	21-962-09 Elong Bowl, MX-28-990-09 Tank	12"	Biscuit	
161315	MX-21-414	21-962 Elong Bowl, MX-28-994 Tank	14"	White	
161429	MX-21-414-09	21-962-09 Elong Bowl, MX-28-994-09 Tank	14"	Biscuit	



## Elongated Closets

### ErgoHeight (ADA)

**MX-20-917 Combination: MX-21-928 ADA Bowl, MX-28-995 Tank**  
**MX-20-918 Combination: MX-21-928 ADA Bowl, MX-28-990 Tank**  
**MX-20-924 Combination: MX-21-928 ADA Bowl, MX-28-994 Tank**  
**MX-21-417 Combination: 21-928 ADA Bowl, MX-28-995 Tank**  
**MX-21-418 Combination: 21-928 ADA Bowl, MX-28-990 Tank**  
**MX-21-424 Combination: 21-928 ADA Bowl, MX-28-994 Tank**

Part #	Mfg #	Description	Rough-In	Color	Price
247583	MX-20-917	MX-21-928 ADA Bowl, MX-28-995 Tank	10"	White	
247584	MX-20-917-09	MX-21-928-09 ADA Bowl, MX-28-995-09 Tank	10"	Biscuit	
247585	MX-20-918	MX-21-928 ADA Bowl, MX-28-990 Tank	12"	White	
247586	MX-20-918-09	MX-21-928-09 ADA Bowl, MX-28-990-09 Tank	12"	Biscuit	
247587	MX-20-918-25	MX-21-928-25 ADA Bowl, MX-28-990-25 Tank	12"	Bone	
247588	MX-20-924	MX-21-928 ADA Bowl, MX-28-994 Tank	14"	White	
161316	MX-21-417	21-928 ADA Bowl, MX-28-995 Tank	10"	White	
161432	MX-21-417-09	21-928-09 ADA Bowl, MX-28-995-09 Tank	10"	Biscuit	
161317	MX-21-418	21-928 ADA Bowl, MX-28-990 Tank	12"	White	
161433	MX-21-418-09	21-928-09 ADA Bowl, MX-28-990-09 Tank	12"	Biscuit	
246532	MX-21-418-25	21-928-25 ADA Bowl, MX-28-990-25 Tank	12"	Bone	
161318	MX-21-424	21-928 ADA Bowl, MX-28-994 Tank	14"	White	
161434	MX-21-424-09	21-928-09 ADA Bowl, MX-28-994-09 Tank	14"	Biscuit	

### Maxwell™ SE 2-Piece 1.6gpf Toilet

- 2" Flush valve
- 2" Glazed trapway
- Dual-fed siphon jet
- Front, color matched tank lever
- Seat sold separately



### Elongated, Standard Height

**SE-21-110 Combination: 21-162 Elong Bowl, 28-175 Tank**  
**SE-21-112 Combination: 21-162 Elong Bowl, 28-170 Tank**  
**SE-21-114 Combination: 21-162 Elong Bowl, 28-174 Tank**

Part #	Mfg #	Description	Rough-In	Color	Price
241842	SE-21-110	21-162 Elongated Bowl, 28-175 Tank	10"	White	
241776	SE-21-112	21-162 Elongated Bowl, 28-170 Tank	12"	White	
241843	SE-21-114	21-162 Elongated Bowl, 28-174 Tank	14"	White	

### ErgoHeight™ (ADA)

**SE-21-117 Combination: 21-128 ADA Bowl, 28-175 Tank**  
**SE-21-118 Combination: 21-128 ADA Bowl, 28-170 Tank**  
**SE-21-124 Combination: 21-128 ADA Bowl, 28-174 Tank**

Part #	Mfg #	Description	Rough-In	Color	Price
241845	SE-21-117	21-128 ADA Bowl, 28-175 Tank	10"	White	
241844	SE-21-118	21-128 ADA Bowl, 28-170 Tank	12"	White	



## Elongated Closets

### Two-Piece Elongated Vitreous China Toilets (Continued)

#### Maxwell™ SE 2-Piece 1.6gpf Toilet ErgoHeight™ (ADA)

Part #	Mfg #	Description	Rough-In	Color	Price
241846	SE-21-124	21-128 ADA Bowl, 28-174 Tank	14"	White	

#### Maxwell™ 2-Piece 1.28gpf Toilet

- 3" Flush valve
- 2" Glazed trapway
- Front, color matched tank lever
- Seat sold separately



#### Elongated, Standard Height

**SE-21-912 Combination: 21-962 Elong Bowl, 28-990 Tank**

Part #	Mfg #	Description	Rough-In	Color	Price
138037	21-912	21-962 Elong Bowl, 28-990 Tank	12"	White	

#### ErgoHeight (ADA)

**21-917 Combination: 21-928 Elong Bowl, 28-995 Tank**  
**21-918 Combination: 21-928 Elong Bowl, 28-990 Tank**

Part #	Mfg #	Description	Rough-In	Color	Price
246268	21-917	21-928 Elong Bowl, 28-995 Tank	10"	White	
138038	21-918	21-928 ADA Bowl, 28-990 Tank	12"	White	

#### Maxwell™ 2-Piece 1.28gpf Toilet

- 3" Flush valve
- 2" Glazed trapway
- Front, color matched tank lever
- Seat sold separately



#### Elongated, Standard Height

**WS- 20-912 Combination: MX-21-962 Elong Bowl, 28-990 Tank**

Part #	Mfg #	Description	Rough-In	Color	Price
247565	WS-20-912	MX-21-962 Elong Bowl, 28-990 Tank	12"	White	
247567	WS-20-912-09	MX-21-962-09 Elong Bowl, 28-990-09 Tank	12"	Biscuit	



## Elongated Closets

### ErgoHeight (ADA)

**WS- 20-917 Combination: MX-21-928 Elong Bowl, 28-995 Tank**

**WS- 20-918 Combination: MX-21-928 Elong Bowl, 28-990 Tank**

Part #	Mfg #	Description	Rough-In	Color	Price
247568	WS-20-917	MX-21-928 ADA Bowl, 28-995 Tank	10"	White	
247569	WS-20-918	MX-21-928 ADA Bowl, 28-990 Tank	12"	White	

### Maxwell™ 2-Piece Dual Flush 1.1/1.6 gpf Toilet

- Front jet flushing action
- Glazed trapway
- Top button actuator
- Seat sold separately



### Elongated, Standard Height

**DF- 21-910 Combination: 21-962 Elong Bowl, DF-28-995 Tank**

**DF- 21-912 Combination: 21-962 Elong Bowl, DF-28-990 Tank**

**DF- 21-914 Combination: 21-962 Elong Bowl, DF-28-994 Tank**

Part #	Mfg #	Description	Rough-In	Color	Price
161329	DF-21-910	21-962 Elong Bowl, DF-28-995 Tank	10"	White	
161330	DF-21-912	21-962 Elong Bowl, DF-28-990 Tank	12"	White	
161444	DF-21-912-09	21-962-09 Elong Bowl, DF-28-990-09 Tank	12"	Biscuit	
161331	DF-21-914	21-962 Elong Bowl, DF-28-994 Tank	14"	White	

### ErgoHeight (ADA)

**DF- 21-917 Combination: 21-928 ADA Bowl, DF-28-995 Tank**

**DF- 21-918 Combination: 21-928 ADA Bowl, DF-28-990 Tank**

**DF- 21-924 Combination: 21-928 ADA Bowl, DF-28-994 Tank**

Part #	Mfg #	Description	Rough-In	Color	Price
161332	DF-21-917	21-928 ADA Bowl, DF-28-995 Tank	10"	White	
161333	DF-21-918	21-928 ADA Bowl, DF-28-990 Tank	12"	White	
161448	DF-21-918-09	21-928-09 ADA Bowl, DF-28-990-09 Tank	12"	Biscuit	
161334	DF-21-924	21-928 ADA Bowl, DF-28-994 Tank	14"	White	





## Elongated Closets

### Maxwell™ Compact Elongated ErgoHeight™ 2-Piece 1.28gpf Toilet with Back Outlet

- Space saving compact design
- 3" Flush valve
- Dual-fed siphon jet
- 2" Glazed trapway
- Front, color matched tank lever
- Seat sold separately



**20-022 Combination: 21-975 ADA Bowl, 28-980 Tank**

Part #	Mfg #	Description	Rough-In	Color	Price
149994	20-022	21-975 ADA Bowl, 28-980 Tank	4-1/4" Vertical	White	

### Viper™ Gravity Fed 2-Piece 1.6 Toilet

- HP2 Flushing technology
- Fluidmaster® fill valve
- 2" Glazed trapway
- Dual feed siphon-jet
- Color matched tank lever for white, bone and biscuit
- Seat sold separately



#### Elongated, Standard Height

**VP-21-510 Combination: VP-21-562 Elong Bowl, VP-28-595 Tank**  
**VP-21-512 Combination: VP-21-562 Elong Bowl, VP-28-590 Tank**  
**VP-21-514 Combination: VP-21-562 Elong Bowl, VP-28-594 Tank**

Part #	Mfg #	Description	Rough-In	Color	Price
161353	VP-21-510	VP-21-562 Elong Bowl, VP-28-595 Tank	10"	White	
161509	VP-21-510-09	VP-21-562-09 Elong Bowl, VP-28-595-09 Tank	10"	Biscuit	
161354	VP-21-512	VP-21-562 Elong Bowl, VP-28-590 Tank	12"	White	
161512	VP-21-512-09	VP-21-562-09 Elong Bowl, VP-28-590-09 Tank	12"	Biscuit	
161355	VP-21-514	VP-21-562 Elong Bowl, VP-28-594 Tank	14"	White	
161515	VP-21-514-09	VP-21-562-09 Elong Bowl, VP-28-594-09 Tank	14"	Biscuit	

#### ErgoHeight (ADA)

**VP-21-517 Combination: VP-21-528 ADA Bowl, VP-28-595 Tank**  
**VP-21-518 Combination: VP-21-528 ADA Bowl, VP-28-590 Tank**  
**VP-21-524 Combination: VP-21-528 ADA Bowl, VP-28-594 Tank**

Part #	Mfg #	Description	Rough-In	Color	Price
161356	VP-21-517	VP-21-528 ADA Bowl, VP-28-595 Tank	10"	White	
161519	VP-21-517-09	VP-21-528-09 ADA Bowl, VP-28-595-09 Tank	10"	Biscuit	
161358	VP-21-518	VP-21-528 ADA Bowl, VP-28-590 Tank	12"	White	
161520	VP-21-518-09	VP-21-528-09 ADA Bowl, VP-28-590-09 Tank	12"	Biscuit	
166621	VP-21-518-25	VP-21-528-25 ADA Bowl, VP-28-590-25 Tank	12"	Bone/Wheat	
161359	VP-21-524	VP-21-528 ADA Bowl, VP-28-594 Tank	14"	White	
161522	VP-21-524-09	VP-21-528-09 ADA Bowl, VP-28-594-09 Tank	14"	Biscuit	





## Elongated Closets

### Viper™ Gravity Fed 2-Piece 1.28gpf Toilet

- Fluidmaster® fill valve
- Dual-fed siphon jet
- 3" Flush valve
- 2" Glazed trapway
- Color matched front tank lever
- Seat sold separately



#### Elongated, Standard Height

**WS-21-510 Combination: VP-21-562 Elong Bowl, WS-28-595 Tank**

**WS-21-512 Combination: VP-21-562 Elong Bowl, WS-28-590 Tank**

**WS-21-514 Combination: VP-21-562 Elong Bowl, WS-28-594 Tank**

Part #	Mfg #	Description	Rough-In	Color	Price
161371	WS-21-510	VP-21-562 Elong Bowl, WS-28-595 Tank	10"	White	
161536	WS-21-510-09	VP-21-562-09 Elong Bowl, WS-28-595-09 Tank	10"	Biscuit	
161372	WS-21-512	VP-21-562 Elong Bowl, WS-28-590 Tank	12"	White	
161538	WS-21-512-09	VP-21-562-09 Elong Bowl, WS-28-590-09 Tank	12"	Biscuit	
161373	WS-21-514	VP-21-562 Elong Bowl, WS-28-594 Tank	14"	White	
161539	WS-21-514-09	VP-21-562-09 Elong Bowl, WS-28-594-09 Tank	14"	Biscuit	

#### ErgoHeight (ADA)

**WS-21-517 Combination: VP-21-528 ADA Bowl, WS-28-595 Tank**

**WS-21-518 Combination: VP-21-528 Elong Bowl, WS-28-590 Tank**

**WS-21-514 Combination: VP-21-562 Elong Bowl, WS-28-594 Tank**

Part #	Mfg #	Description	Rough-In	Color	Price
161374	WS-21-517	VP-21-528 ADA Bowl, WS-28-595 Tank	10"	White	
161540	WS-51-517-09	VP-21-528-09 ADA Bowl, WS-28-595-09 Tank	10"	Biscuit	
161375	WS-21-518	VP-21-528 ADA Bowl, WS-58-590 Tank	12"	White	
161542	WS-21-518-09	VP-21-528-09 ADA Bowl, WS-28-590-09 Tank	12"	Biscuit	
161376	WS-21-524	VP-21-528 ADA Bowl, WS-58-594 Tank	14"	White	
161543	WS-21-524-09	VP-21-528-09 ADA Bowl, WS-58-594-09 Tank	14"	Biscuit	

### Viper™ 2-Piece Compact ErgoHeight 1.6 Toilet

- Compact design fits in round front space
- 3" flush valve
- 2" glazed trapway
- Color matched tank lever
- 2 bolt caps



**VP-21-519 Combination: HE-21-872 ADA Bowl, VP-28-595 Tank**

Part #	Mfg #	Description	Rough-In	Color	Price
175564	VP-21-519	HE-21-872 ADA Bowl, VP-28-595 Tank	12"	White	
177281	VP-21-519-25	HE-21-872-25 ADA Bowl, VP-28-595-25 Tank	12"	Bone	



## Elongated Closets

### Viper™ 2-Piece Compact ErgoHeight 1.28 Toilet

- Space saving compact elongated design
- Fluidmaster® fill valve
- Dual-fed siphon jet
- 3" Flush valve
- 2" Glazed trapway
- Color matched front tank lever
- Seat sold separately



HE-21-519 Combination: HE-21-872 Compact Elong Bowl, HE-28-570 Tank

Part #	Mfg #	Description	Rough-In	Color	Price
152425	HE-21-519	HE-21-872 Compact Elong Bowl, HE-28-570 Tank	12"	White	
156040	HE-21-519-09	HE-21-872-09 Compact Elong Bowl, HE-28-570-09 Tank	12"	Biscuit	
172163	HE-21-519-25	HE-21-872-25 Compact Elong Bowl, HE-28-570-25 Tank	12"	Bone/Wheat	
159343	HE-21-519-21	HE-21-872-21 Compact Elong Bowl, HE-28-570-21 Tank	12"	Bahama Pink	
156814	HE-21-519-29	HE-21-872-29 Compact Elong Bowl, HE-28-570-29 Tank	12"	Dawn Blue	

### Viper® ErgoHeight™ 2-Piece Dual Flush .9/1.1 gpf Toilet

- 2" Glazed trapway
- 3" Flush valve
- 12" Rough-in
- Large dual fed siphon jet
- Top mount, 2 button flush actuator: large/small flush
- Double nut, multi-point tank-to-bowl mounting system
- WaterSense® certified
- Seat sold separately



DF-20-521 Combination: WS-21-521 ADA Bowl, DF-28-591 Tank

Part #	Mfg #	Description	Rough-In	Color	Price
241409	DF-20-521	WS-21-521 ADA Elongated Bowl, DF-28-591 Tank	12"	White	

### Ultra Flush™ Pressure Assist 2-Piece 1.6 Toilet

- Sloan flushmate pressure vessel
- Over 3" average trapway
- Insulated non-sweating tank
- Seat sold separately



Elongated, Standard Height

21-311 Combination: 21-372 Elong Bowl, 28-385 Tank

21-312 Combination: 21-372 Elong Bowl, 28-380 Tank

21-314 Combination: 21-372 Elong Bowl, 28-384 Tank

Part #	Mfg #	Description	Rough-In	Color	Price
039813	21-311	21-372 Elong Bowl, 28-385 Tank	10"	White	



## Elongated Closets

### Two-Piece Elongated Vitreous China Toilets (Continued)

#### Ultra Flush™ Pressure Assist 2-Piece 1.6 Toilet

##### Elongated, Standard Height

Part #	Mfg #	Description	Rough-In	Color	Price
039816	21-312	21-372 Elong Bowl, 28-380 Tank	12"	White	
039818	21-312-09	21-372-09 Elong Bowl, 28-380-09 Tank	12"	Biscuit	
039820	21-314	21-372 Elong Bowl, 28-384 Tank	14"	White	

##### ErgoHeight (ADA)

21-317 Combination: 21-377 ADA Bowl, 28-385 Tank

21-318 Combination: 21-377 ADA Bowl, 28-380 Tank

21-324 Combination: 21-377 ADA Bowl, 28-384 Tank

Part #	Mfg #	Description	Rough-In	Color	Price
039822	21-317	21-377 ADA Bowl, 28-385 Tank	10"	White	
051978	21-317-09	21-377-09 ADA Bowl, 28-385-09 Tank	10"	Biscuit	
039825	21-318	21-377 ADA Bowl, 28-380 Tank	12"	White	
039827	21-318-09	21-377-09 ADA Bowl, 28-380-09 Tank	12"	Biscuit	
039826	21-318-25	21-377-09 ADA Bowl, 28-380-09 Tank	12"	Bone	
238767	HE-21-318-09	HE-21-377-09 ADA Bowl, HE-28-380-09 Tank	12"	Biscuit	
039828	21-324	21-377 ADA Bowl, 28-384 Tank	14"	White	
039830	21-324-09	21-377-09 ADA Bowl, 28-384-09 Tank	14"	Biscuit	

#### Ultra Flush™ Dual-Flush Pressure Assist 2-Piece 1.1/1.6 Toilet

- Dual flush pressure vessel
- Over 3" average trapway
- Insulated non-sweating tank
- Non-corrosive solid brass tank-to-bowl bolts
- Seat sold separately



##### Elongated, Standard Height

DF-21-312 Combination: 21-372 Elong Bowl, DF-28-385 Tank

Part #	Mfg #	Description	Rough-In	Color	Price
091844	DF-21-312	21-372 Elong Bowl, DF-28-380 Tank	12"	White	

##### ErgoHeight (ADA)

DF-21-318 Combination: 21-377 ADA Bowl, DF-28-380 Tank

DF-21-324 Combination: 21-377 ADA Bowl, DF-28-384 Tank

Part #	Mfg #	Description	Rough-In	Color	Price
091849	DF-21-318	21-377 ADA Bowl, DF-28-380 Tank	12"	White	
091851	DF-21-318-09	21-377-09 ADA Bowl, DF-28-380-09 Tank	12"	Biscuit	



## Elongated Closets

### Ultra Flush™ Pressure Assist 2-Piece Toilet with Back Outlet

- Low Consumption 1.6 gpf (6.0 Lpf)
- Elongated bowl
- Wall waste outlet
- Pressurized flushing action
- Close coupled flushometer tank
- Optional right-handed trip lever available
- Siphon jet
- Front tank lever
- 2 Bolt caps



#### Elongated, Standard Height

21-310 Combination: 21-374 Bowl, 28-380 Tank

Part #	Mfg #	Description	Rough-In	Color	Price
019214	21-310	21-374 Bowl, 28-380 Tank	4-1/4" (Vertical)	White	

#### ErgoHeight (ADA)

21-325 Combination: 21-375 Bowl, 28-380 Tank

Part #	Mfg #	Description	Rough-In	Color	Price
050470	21-325	21-325 Bowl, 28-380 Tank	4-1/4" (Vertical)	White	

### Wicker Park™ 2-Piece 1.28 Toilet

- XP-3 Technology
- 3" Flush valve
- Fluidmaster® Fill valve
- Glazed trapway
- Dual feed jet
- Soft close toilet seat included
- Side tank lever



20-020 Combination: 21-186 Bowl, DF-28-186 Tank

Part #	Mfg #	Description	Rough-In	Color	Price
151934	20-020	21-186 Bowl, 28-186 Tank	12"	White	

## Elongated Closets

### Two-Piece Elongated Toilets

#### Karsten® Dual Force® 2-Piece Toilet

- Dual Force® flushing system with choice of full flush 1.6 gallons or half flush 0.8 gallons
- One flush performance
- (2) Bolt installation
- Meets EPA WaterSense® criteria
- 5-Year limited warranty



402087 Complete: 402086 Elongated Bowl, 402023 Tank

Luxury Height

402077 Complete: 403370 ADA Elongated Bowl, 402091 Tank

Part #	Mfg #	Description	Rough-In	Color	Price
136928	402087-0	Elongated Complete	12"	White	
138449	402087-96	Elongated Complete	12"	Biscuit	

#### Rockton™ Dual Force® 2-Piece Toilet

- Dual-Force® technology uses 1.6 gpf (6 lpf) flush for solid waste
- and .8 gpf (3 lpf) for liquid waste
- 2" Fully glazed trapway
- Two-button actuator
- 5-Year limited warranty



402088 Complete: 402086 Elongated Bowl, 402022 Tank

Luxury Height

402077 Complete: 403370 ADA Elongated Bowl, 402091 Tank

Part #	Mfg #	Description	Rough-In	Color	Price
137769	402088-0	ADA Elongated Complete	12"	White	
139566	402088-96	ADA Elongated Complete	12"	Biscuit	

#### Stinson® Pro Force® 1.28 2-Piece Toilet

- Pro Force® flushing technology
- 2" Fully glazed trapway
- WaterSense® certified: 1.28 gpf
- 5-Year limited warranty



Standard Height

402076 Complete: 403070 Elongated Bowl, 402091 Tank

Part #	Mfg #	Description	Rough-In	Color	Price
136334	402076-0	Elongated Complete	12"	White	

## Elongated Closets

### Luxury Height

**402077 Complete: 403370 ADA Elongated Bowl, 402091 Tank**

Part #	Mfg #	Description	Rough-In	Color	Price
140017	402077-0	ADA Elongated Complete	12"	White	
142137	402077-96	ADA Elongated Complete	12"	Biscuit	

### Windham™ 2-Piece 1.28 Toilet

- 16-1/2" Bowl heights meets ADA requirements
- 2" Glazed trapway
- One flush performance limited guarantee
- (3) Bolt, quick-connect installation system
- WaterSense® certified: 1.28 gpf
- 5-Year limited warranty



**403082 Complete: 403315 ADA Elongated Bowl, 404551 Tank**

### Luxury Height

**402077 Complete: 403370 ADA Elongated Bowl, 402091 Tank**

Part #	Mfg #	Description	Rough-In	Color	Price
170955	403082-0	ADA Elongated Complete	12"	White	
170957	403082-96	ADA Elongated Complete	12"	Biscuit	

### Windham™ 2-Piece 1.6 Toilet with Pro Force® Technology

- 15" Bowl height
- 8" x 9" Water surface
- 2" Fully glazed trapway
- Includes left-hand polished chrome trip lever
- Less seat and supply



**402215 Complete: 403215 Elongated Bowl, 404515 Tank**

**402315 Complete: 403315 ADA Elongated Bowl, 404515 Tank**

### Standard Height

Part #	Mfg #	Description	Rough-In	Color	Price
074006	402210-0	Elongated Complete	10"	White	
074011	402210-96	Elongated Complete	10"	Biscuit	
155235	402215-0	Elongated Complete	12"	White	
074011	402210-96	Elongated Complete	12"	Biscuit	

### Luxury Height

**402077 Complete: 403370 ADA Elongated Bowl, 402091 Tank**

Part #	Mfg #	Description	Rough-In	Color	Price
074008	402315-0	ADA Elongated Complete	12"	White	
074013	402315-96	ADA Elongated Complete	12"	Biscuit	



## Elongated Closets

### Two-Piece Standard Height

#### Alto™ 2-Piece 1.6gpf Toilet

- Elongated front
- 1.6 Gpf / 6.0 Lpf
- 2 " Glazed trapway
- Anti-siphon ballcock provides efficient toilet tank operation at high or low water pressures
- Three-point cushioned tank-to-bowl connection assures perfect tank alignment and leak proof connections.



Part #	Mfg #	Description	Rough-In	Color	Price
194501	135125WH	Elongated Complete, Trip Lever	14"	White	
194503	135125BI	Elongated Complete, Trip Lever	14"	Biscuit	
194502	135125BN	Elongated Complete, Trip Lever	14"	Bone	
192308	135160WH	Elongated Complete, Trip Lever	12"	White	
192315	135160BI	Elongated Complete, Trip Lever	12"	Biscuit	
192307	135160BN	Elongated Complete, Trip Lever	12"	Bone	
194471	135180WH	Elongated Complete, Trip Lever	12"	White	
194473	135180BI	Elongated Complete, Trip Lever	12"	Biscuit	
194472	135180BN	Elongated Complete, Trip Lever	12"	Bone	

#### Alto® 2-Piece 1.28gpf Complete Toilet Kit

- Elongated front bowl
- WaterSense® certified: 1.28 gpf / 4.86 Lpf
- 2" Glazed trapway
- 3" Hybrid flush valve
- Pilot operated flush valve
- 3 Bolt tank-to-bowl connection
- Color-match trip lever
- Kit includes: toilet seat, tank and bowl, flange bolts, wax ring with polyethylene flange and instructions



Part #	Mfg #	Description	Rough-In	Color	Price
247185	4135CTKWH	Elongated Complete Kit, Trip Lever	12"	White	

#### ProFit®2 2-Piece 1.6gpf Complete Toilet Kit

- 1.6 Gpf / 6.0 Lpf
- Elongated front bowl
- 3 Bolt tank-to-bowl connection
- Anti-siphon ballcock
- 2" Flush tower
- 2-1/8" Glazed trapway
- Chrome trip lever
- Kit includes: toilet seat, wax ring, floor bolts, caps, and installation instructions
- Water supply hardware not included



Part #	Mfg #	Description	Rough-In	Color	Price
247186	135CTKWH	Elongated Complete, CP Trip Lever	12"	White	

\*Vibrant Limited Lifetime Finish

**www.plumbsupply.com • Serving our Customers Since 1946 • www.waterconcepts.net**



## Elongated Closets

### Quantum™ 2-Piece 1.6gpf Toilet

- 1.6 Gpf / 6.0 Lpf
- Elongated front
- Pressure-assist, Sloan Flushmate™ flushing system
- Water usage: 1.6 gpf / 6.0 lpf
- Trap diameter: 2-1/8" glazed



Part #	Mfg #	Description	Rough-In	Color	Price
214519	147123WH	Elongated Complete	12"	White	

### Summit 2-Piece Dual Flush 1.1/1.6gpf Toilet

- Elongated front
- 2" Glazed trap
- Dual flush technology with 3" tower
- 1.1 Gpf / 1.6 Gpf (4.0 Lpf / 6.0 Lpf)
- Pilot operated anti-siphon fill valve
- SmartFasten 3-bolt tank-to-bowl connection
- PuraClean easy-to-clean glaze



Part #	Mfg #	Description	Rough-In	Color	Price
204262	3823386WH	Elongated Complete, CP Dual Flush Actuator	12"	White	
204263	3823386BI	Elongated Complete, CP Dual Flush Actuator	12"	White	

### Summit EL 2-Piece 1.6gpf Toilet

- Elongated bowl
- 1.6 Gpf / 6.0 Lpf
- PuraClean™ easy-to-clean glaze
- MagnaFlush™ flushing technology
- SmartFasten™ 3-bolt tank-to-bowl connection
- Pilot operated anti-siphon fill valve
- 3" Flush valve
- 2" Glazed trapway
- Decorative metal trip lever
- Model (382CTK) includes completed toilet kit: Slow close toilet seat, tank and bowl, flange bolts, wax ring with polyethylene flange and instructions



Part #	Mfg #	Description	Rough-In	Color	Price
198186	382386WH	Elongated Complete, Trip Lever	12"	White	
198185	382386BI	Elongated Complete, Trip Lever	12"	Biscuit	
198431	382386BN	Elongated Complete, Trip Lever	12"	Bone	
247189	382CTKWH	Elongated Complete Kit, CP Trip Lever	12"	White	

\*Vibrant Limited Lifetime Finish

[www.waterconcepts.net](http://www.waterconcepts.net) • Serving our Customers Since 1946 • [www.plumbsupply.com](http://www.plumbsupply.com)

## Elongated Closets

### Two-Piece Comfort Height Toilets

#### Alto™ Smart Height® 2-Piece 1.6gpf Toilet

- 1.6 Gpf / 6.0 Lpf
- 2" Glazed trap
- Elongated front, SmartHeight bowl
- Chair height for maximum comfort
- Anti-siphon ballcock provides efficient toilet tank operation at high or low water pressures



Part #	Mfg #	Description	Rough-In	Color	Price
193490	137160RHWH	ADA Complete, RH Trip Lever	12"	White	
195143	139NS160WH	ADA Complete, No Seat	10"	White	
195144	139NS160BI	ADA Complete, No Seat	10"	White	
194504	137125WH	ADA Complete, Trip Lever	14"	White	
194506	137125BI	ADA Complete, Trip Lever	14"	Biscuit	
194505	137125BN	ADA Complete, Trip Lever	14"	Bone	
192310	137160WH	ADA Complete, Trip Lever	12"	White	
193636	137160BI	ADA Complete, Trip Lever	12"	Biscuit	
192311	137160BN	ADA Complete, Trip Lever	12"	Bone	
194536	137180WH	ADA Complete, Trip Lever	12"	White	

#### Alto® ProFit® SmartHeight™ 2-Piece 1.28gpf Complete Toilet Kit

- Elongated front, SmartHeight™ 16-1/2" high bowl
- WaterSense® certified: 1.28 gpf / 4.86 Lpf
- 2" Glazed trapway
- 3" Hybrid flush valve
- Pilot operated flush valve
- 3 Bolt tank-to-bowl connection
- Color-match trip lever
- Kit includes: toilet seat, tank and bowl, flange bolts, wax ring with polyethylene flange and instructions



Part #	Mfg #	Description	Rough-In	Color	Price
247187	4137CTK	ADA Complete Kit, Trip Lever	12"	White	

#### Barrett 2-Piece Smarheight™ 1.6gpf Toilet

- Traditional style
- Elongated front, SmartHeight™ chair height for maximum comfort
- 1.6 Gpf / 6.0 Lpf
- Concealed trapway for easier cleaning
- High performance MagnaFlush™ flushing system with 3" flush valve virtually eliminates clogging



Part #	Mfg #	Description	Rough-In	Color	Price
197812	115106WH	ADA Complete, Trip Lever	14"	White	
197813	115106BI	ADA Complete, Trip Lever	14"	Biscuit	

\*Vibrant Limited Lifetime Finish

[www.plumbsupply.com](http://www.plumbsupply.com) • Serving our Customers Since 1946 • [www.waterconcepts.net](http://www.waterconcepts.net)

## Elongated Closets

### Cascade™ SmartHeight 2-Piece 1.28gpf Toilet

- Unique rimless bowl design
- Elongated ADA front
- Gravity fed
- Strong swirling action
- 1.28 Gpf / 4.86 Lpf
- HET uses 20% less water than conventional toilets
- 3" Flush Valve
- Pilot operated fill valve
- Glazed trapway
- Chrome trip lever



Part #	Mfg #	Description	Rough-In	Color	Price
205819	48173816 WH	ADA Complete, Trip Lever	12"	White	

### Quantum™ Smart Height® 2-Piece 1.6gpf Toilet

- Powerful "one flush" performance.
- Elongated front, SmartHeight™
- Chair height for maximum comfort
- Pressure-assist, Sloan Flushmate™ flushing system
- Colors: white and standard colors: biscuit and bone
- Water usage: 1.6 gpf / 6.0 lpf
- Trap diameter: 2-1/8" glazed
- Trap seal: 3"



Part #	Mfg #	Description	Rough-In	Color	Price
192304	148123-WH	Elongated Complete, ADA	12"	White	

### Summit SmartHeight™ 2-Piece 1.1 1.6gpf Dual Flush Toilet

- Elongated front SmartHeight bowl
- Dual flush technology with 3" tower
- 1.1 Gpf / 1.6 Gpf (4.0 Lpf / 6.0 Lpf)
- Pilot operated anti-siphon fill valve
- SmartFasten 3-bolt tank-to-bowl connection
- PuraClean easy-to-clean glaze
- Chrome push button actuator



Part #	Mfg #	Description	Rough-In	Color	Price
204264	3843386WH	Elongated Complete, ADA, Trip Lever	12"	White	
204265	3843386BI	Elongated Complete, ADA, Trip Lever	12"	Biscuit	

\*Vibrant Limited Lifetime Finish

[www.waterconcepts.net](http://www.waterconcepts.net) • Serving our Customers Since 1946 • [www.plumbsupply.com](http://www.plumbsupply.com)

## Elongated Closets

### Summit ADA SmartHeight™ 2-Piece 1.6gpf Toilet

- Elongated front 16-1/2" SmartHeight™ bowl
- ADA compliant
- 1.6 Gpf / 6.0 Lpf
- PuraClean™ easy-to-clean glaze
- MagnaFlush™ flushing technology
- SmartFasten™ 3-bolt tank-to-bowl connection
- Pilot operated anti-siphon fill valve
- 3" Flush valve
- 2" Glazed trapway
- Decorative metal trip lever
- Model (384CTK) includes complete kit: slow close toilet seat, tank and bowl, flange bolts, wax ring with polyethylene flange, and instructions



Part #	Mfg #	Description	Rough-In	Color	Price
198184	384386WH	Elongated Complete, ADA	12"	White	
198183	384386BI	Elongated Complete, ADA	12"	Biscuit	
198430	384386BN	Elongated Complete, ADA	12"	Bone	
247190	384CTK	Elongated Complete Kit, ADA	12"	White	
219824	385386WH	Elongated Complete, ADA	10"	White	
219825	385386BI	Elongated Complete, ADA	10"	Biscuit	

### Vanquish™ ADA SmartHeight™ 2-Piece 1.6gpf Toilet

- Elongated front 17" SmartHeight™ bowl
- 1.6 Gpf / 6.0 Lpf
- PuraClean® easy-to-clean glaze
- SmartFasten™ 2-bolt tank-to-bowl connection
- Fluidmaster® pilot operated anti-siphon fill valve
- 3" Rigid flapper flush valve
- 2" Glazed trapway
- Model 39 Decorative metal trip lever
- Seat included



**Combination: 4987-10 Bowl and Seat, 3987-10 Tank**

Part #	Mfg #	Description	Rough-In	Color	Price
246998	4987-3987	Elongated Complete, ADA, Trip Lever	12"	White	

\*Vibrant Limited Lifetime Finish

[www.plumbsupply.com](http://www.plumbsupply.com) • Serving our Customers Since 1946 • [www.waterconcepts.net](http://www.waterconcepts.net)

## Elongated Closets

### Two-Piece Elongated Toilets

#### Grab-N-Go Elongated Front Toilet

- Includes:
  - Tank & bowl
  - Toilet seat
  - Wax ring w/ sleeve
  - (2) Bolt caps
  - (2) Flange bolts
- 3" High performance flushing system
- Large water surface
- 2-1/8" Wide fully glazed trapway
- 1.28 GPF Siphon jet flush
- MaP score: 800 Grams



Part #	Mfg #	Description	Rough-In	Color	Price
235398	572-5835	ADA Elongated Complete	12"	White	



## Gaskets

### Toilet Bowl Fittings

#### Bolt & Gasket

- Durable solid brass bolts and universal gasket
- Sponge rubber gasket fits most close-coupled toilets with both round and hex-shaped flush valve nuts
- Includes bolts with washers and wing nuts



6106

Part #	Mfg #	Description	Price
073270	6102	(2) Closet Bolts & Gasket	
062252	6106	(3) Closet Bolts & Gasket	



## Gaskets

### Gerber Toilet Gaskets

#### Gasket



99-591



99-582

Part #	Mfg #	Description	Price
084274	99-591	Tank Bowl Gasket	
004852	99-582	Tank-to-Bowl Gasket, Black (28-190/196/290/590/790/794/ 795)	

\*Physical Vapor Deposition (PVD) Limited Lifetime Finish

[www.waterconcepts.net](http://www.waterconcepts.net) • Serving our Customers Since 1946 • [www.plumbsupply.com](http://www.plumbsupply.com)





## Gaskets

### Toilet Repair

#### Tank-To-Bowl Kit for American Standard

- Kit includes:
  - (2) Tank bolts with washers and nuts
  - (1) Sponge rubber spud gasket
- Bolt size: 5/16" x 2-1/2"



Part #	Mfg #	Description	Price
097904	88191	Complete Kit for Plebe	

#### Tank-To-Bowl Kit for Mansfield

- Kit includes:
  - (3) Tank bolts with washers and nuts
  - (1) Sponge rubber spud gasket
- Bolt size: 5/16" x 2-1/2"

Part #	Mfg #	Description	Price
097905	88913	Complete Kit	

#### Tank-To-Bolt Kit for Crane

- Kit includes:
  - (2) Tank bolts with washers and nuts
  - (1) Sponge rubber spud gasket
- Bolt size: 5/16" x 3"

Part #	Mfg #	Description	Price
097906	81257	Complete Kit for Neuday	

### Toilet Tank Repair

#### Toilet Repair Parts



Part #	Mfg #	Description	Price
101414	40008	Flush Unit Ball and Chain	

## Gaskets

### Spud Washers

#### Flanged Spud Washer

- *Black synthetic rubber washer for closet spuds*
- *Box of 25 washers*



Part #	Mfg #	Size	Trade Size	Price
006211	465	1-1/4" x 2" x 1/2"	1"	
006212	466	1-21/32" x 2-1/2" x 5/8"	1-1/4"	
006213	467	1-7/8" x 2-11/16" x 5/8"	1-1/2"	

### Gaskets

#### Close Coupled Tank Gasket

- *Solid rubber*



Part #	Mfg #	Description	Price
006208	459	Box of 25 Close Coupled Gaskets, 2-3/16" x 3-1/4" x 9/16"	

#### Tank to Bowl Gasket

- *Sponge rubber*



Part #	Mfg #	Description	Price
006209	460	Gerber Type, 1-3/16" Thick	
019048	462	2-1/8" x 3-31/64" x 1-1/4" Recessed Box of 10 Fits American Standard®	



---

---

## Gaskets

---

---

### Carrier Systems

#### Closet Carrier Parts



Part #	Mfg #	Description	Price
094174	Z-1210-57	4" Bonded "Neo-Seal" Closet Gasket Kit	

## Macerating Toilet Systems

### Macerating Toilet Systems

**Macerating Toilets Work as a System and May be Purchased Separately**

- *Systems require:*
  - 003 Round front back discharge bowl or 007 Elongated back discharge ADA bowl
  - 005 Toilet tank

#### Saniplus® Macerating Toilet System

- *Used to install a complete Residential bathroom up to 15' below the sewer line or even up to 150' away from a soil stack without breaking the concrete*
- *Discharge rate @ 15': 17 gpm*
- *Discharge pipe diameter: 3/4"*
- *Electrical: 115V, 60Hz, 4.5A*
- *Motor: 0.5 hp*
- *Includes:*
  - 10-5/8"H x 20"W x 7"D Macerating pump
  - Toilet tank
  - Toilet bowl



Part #	Mfg #	Description	Color	Price
139770	0235	Round Front System	White	
139772	0275	Elongated System	White	

#### Saniplus® Components



Part #	Mfg #	Description	Price
139771	002	Macerating Pump Only	

#### Sanibest® Pro Macerating Toilet System

- *Ideal for guest bathrooms, rental units or office buildings where you do not control usage*
- *Vertical pumping up to 25' and 150' horizontally*
- *Discharge rate @ 15': 19 gpm*
- *Discharge pipe diameter: 3/4"*
- *Electrical: 115V, 60Hz, 9.0A*
- *Motor: 0.5 hp*
- *Includes:*
  - 10-1/2"H x 20-5/16"W x 8"D Macerating pump
  - Toilet tank
  - Bowl



Part #	Mfg #	Description	Color	Price
139768	1335	Round Front	White	

### Macerating Toilet Systems (Continued)

#### Sanibest® Pro Macerating Toilet System

Part #	Mfg #	Description	Color	Price
139769	1375	Elongated	White	

#### Sanibest® Components



Part #	Mfg #	Description	Price
134502	013	Grinder Pump Only	

#### Sanicondens® Condensate Pump

- *Possible connections:*
  - Tankless water heater
  - Boiler
  - Air conditioning unit
- *Vertical and horizontal discharges*
  - 15 ft vertical
  - 150 ft horizontal



Part #	Mfg #	Description	Color	Price
224975	40	Pump Case Only		
224977	41	Sanicondens 'Best' Pump Case Only		
224978	42	Sanineutral w/ Starter Neutralizing agent		

### System Components

Part #	Mfg #	Description	Price
134503	003	Round Front Toilet Bowl, White	
139759	007	ADA Elongated Front Toilet Bowl, White	
134505	005	Toilet Tank Only, White	

#### PVC Pipe

Part #	Mfg #	Description	Price
134506	030	4" x 16" PVC Extension Pipe with Flexible Rubber Seal & Bell Housing	

---

---

## Macerating Toilet Systems

---

---

### Accessories

#### Descaler

- *Specifically created for use with Saniflo products*
- *Laboratory formulated with phosphoric acid*
- *Concentrated solution for optimum cleaning and disinfecting*
- *Regular usage prolongs unit life and maintains efficiency*
- *Harmless to septic tank operation*

Part #	Mfg #	Description	Price
145660	052	1.5 gal Descaler Solution	

## One-Piece Closets

### One-Piece Vitreous China Toilets

#### Adair® Comfort Height® 1-Piece 1.28 gpf Toilet with AquaPiston® Flush Technology & Left-Hand Trip Lever

- 2-1/8" Glazed trapway
- 16-1/2" High bowl is ADA compliant
- Supply sold separately
- (-RA) right-hand trip lever



Part #	Mfg #	Description	Rough-In	Color	Price
156087	K-3946-0	ADA Elongated Complete, LH CP Trip	12"	White	
239364	K-3946-47	ADA Elongated Complete, LH CP Trip	12"	Almond	
164679	K-3946-58	ADA Elongated Complete, LH CP Trip	12"	Thunder Grey	
181754	K-3946-7	ADA Elongated Complete, LH CP Trip	12"	Black	
169401	K-3946-95	ADA Elongated Complete, LH CP Trip	12"	Ice Grey	
164047	K-3946-96	ADA Elongated Complete, LH CP Trip	12"	Biscuit	
181753	K-3946-G9	ADA Elongated Complete, LH CP Trip	12"	Sandbar	
228816	K-3946-K4	ADA Elongated Complete, LH CP Trip	12"	Cashmere	
173588	K-3946-RA-0	ADA Elongated Complete, RH CP Trip	12"	White	

#### Archer® Elongated 1-Piece 1.28 gpf Toilet with AquaPiston® Flush Technology & Left-Hand Trip Lever

- 2-1/8" Glazed trapway
- 14-11/16" High bowl
- Includes seat and cover
- Supply sold separately



Part #	Mfg #	Description	Rough-In	Color	Price
128583	K-3639-0	Elongated Complete, LH CP Trip	12"	White	
133134	K-3639-47	Elongated Complete, LH CP Trip	12"	Almond	
167300	K-3639-58	Elongated Complete, LH CP Trip	12"	Thunder Grey	
138435	K-3639-96	Elongated Complete, LH CP Trip	12"	Biscuit	

\*Vibrant Limited Lifetime Finish

[www.waterconcepts.net](http://www.waterconcepts.net) • Serving our Customers Since 1946 • [www.plumbsupply.com](http://www.plumbsupply.com)

## One-Piece Closets

### Cimarron® Comfort Height® 1-Piece 1.28 Toilet with AquaPiston® Flush Technology & Left-Hand Trip Lever

- 2-1/8" Glazed trapway
- 16-1/2" High bowl is ADA compliant
- Includes Reveal® Quiet-Close™ with Grip-Tight seat.
- Supply sold separately



#### With Concealed Trapway and Clean Caps®

Part #	Mfg #	Description	Rough-In	Color	Price
187224	K-3619-0	ADA Elongated Compete, LH CP Trip w/ Concealed Trapway	12"	White	
223712	K-3619-47	ADA Elongated Compete, LH CP Trip w/ Concealed Trapway	12"	Almond	
260917	K-3619-58	ADA Elongated Compete, LH CP Trip w/ Concealed Trapway	12"	Thunder Grey	
226789	K-3619-96	ADA Elongated Compete, LH CP Trip w/ Concealed Trapway	12"	Biscuit	
232060	K-3619-G9	ADA Elongated Compete, LH CP Trip w/ Concealed Trapway	12"	Sandbar	
247043	K-3619-NY	ADA Elongated Compete, LH CP Trip w/ Concealed Trapway	12"	Dune	

#### Without Concealed Trapway

Part #	Mfg #	Description	Rough-In	Color	Price
144849	K-3828-0	ADA Elongated Complete, LH CP Trip	12"	White	
150479	K-3828-47	ADA Elongated Complete, LH CP Trip	12"	Almond	
154068	K-3828-58	ADA Elongated Complete, LH CP Trip	12"	Thunder Grey	
159676	K-3828-7	ADA Elongated Complete, LH CP Trip	12"	Black	
150000	K-3828-95	ADA Elongated Complete, LH CP Trip	12"	Ice Grey	
149842	K-3828-96	ADA Elongated Complete, LH CP Trip	12"	Biscuit	
153135	K-3828-G9	ADA Elongated Complete, LH CP Trip	12"	Sandbar	
151874	K-3828-K4	ADA Elongated Complete, LH CP Trip	12"	Cashmere	
175365	K-3828-NY	ADA Elongated Complete, LH CP Trip	12"	Dune	

### Gabrielle™ Comfort Height® 1-Piece 1.28 Toilet with Class Five® Flush Technology & Left-Hand Trip Lever

- 16-1/4" High bowl is ADA compliant
- Includes Reveal® Quiet-Close™ with Grip-Tight seat
- Meets EPA WaterSense® criteria
- Supply line not included



Part #	Mfg #	Description	Rough-In	Color	Price
143733	K-3615-0	ADA Elongated Complete, LH Trip, Q3 Advantage Seat	12"	White	
146071	K-3615-47	ADA Elongated Complete, LH Trip, Q3 Advantage Seat	12"	Almond	
157662	K-3615-95	ADA Elongated Complete, LH Trip, Q3 Advantage Seat	12"	Ice Grey	
148371	K-3615-96	ADA Elongated Complete, LH Trip, Q3 Advantage Seat	12"	Biscuit	
146066	K-3615-G9	ADA Elongated Complete, LH Trip, Q3 Advantage Seat	12"	Sandbar	
184228	K-3615-K4	ADA Elongated Complete, LH Trip, Q3 Advantage Seat	12"	Cashmere	

\*Vibrant Limited Lifetime Finish

[www.plumbsupply.com](http://www.plumbsupply.com) • Serving our Customers Since 1946 • [www.waterconcepts.net](http://www.waterconcepts.net)



**One-Piece Closets**

**One-Piece Vitreous China Toilets (Continued)**

**Gabrielle™ Comfort Height® 1-Piece 1.28 Toilet with Class Five® Flush Technology & Left-Hand Trip Lever**

Part #	Mfg #	Description	Rough-In	Color	Price
183563	K-3615-NY	ADA Elongated Complete, LH Trip, Q3 Advantage Seat	12"	Dune	

**Karing™ Intelligent Skirted 1-Piece 1.28 Toilet**

- Compact toilet with integrated bidet with self-cleaning wand, precision air dryer and deodorizer
- Sleek tankless design with skirted trapway
- Intuitive touch screen remote
- Motion-activated flush utilizing Pure Lite technology
- LED light illuminated bowl



Part #	Mfg #	Description	Rough-In	Color	Price
177490	K-4026-0	ADA Compact Elongated, Bidet Seat with Remote	12"	White	

**Kathryn® Comfort Height® Compact 1-Piece 1.28 Toilet with AquaPiston® Flush Technology**

- 16-3/8" High bowl is ADA compliant
- Includes left-hand trip lever
- Glenbury™ Quiet-Close™ seat with Quick-Release™
- Concealed trapway and Clean Caps®
- Supply line not included



Part #	Mfg #	Description	Rough-In	Color	Price
161812	K-3940-0	ADA Elongated Complete, LH Trip, Glenbury Seat	12"	White	
226151	K-3940-47	ADA Elongated Complete, LH Trip, Glenbury Seat	12"	Almond	
173488	K-3940-96	ADA Elongated Complete, LH Trip, Glenbury Seat	12"	Biscuit	
226392	K-3940-K4	ADA Elongated Complete, LH Trip, Glenbury Seat	12"	Cashmere	

\*Vibrant Limited Lifetime Finish

[www.waterconcepts.net](http://www.waterconcepts.net) • Serving our Customers Since 1946 • [www.plumbsupply.com](http://www.plumbsupply.com)

## One-Piece Closets

### Memoirs® Classic Comfort Height® 1-Piece 1.28 Toilet with AquaPiston® Flush Technology

- 16-1/4" High bowl is ADA compliant
- Glenbury™ Quiet-Close™ with Grip-Tight seat
- 2-1/8" Fully glazed trapway
- Includes left-hand trip lever
- WaterSense® certified product: 1.28 gpf



K-3812



K-6424

Part #	Mfg #	Description	Rough-In	Color	Price
141727	K-3812-0	ADA Elongated Complete, LH Trip, Glenbury Seat	12"	White	
183054	K-3812-47	ADA Elongated Complete, LH Trip, Glenbury Seat	12"	Almond	
139345	K-3812-96	ADA Elongated Complete, LH Trip, Glenbury Seat	12"	Biscuit	
183053	K-3812-G9	ADA Elongated Complete, LH Trip, Glenbury Seat	12"	Sandbar	
227063	K-3812-K4	ADA Elongated Complete, LH Trip, Glenbury Seat	12"	Cashmere	
227991	K-6424-0	Skirted ADA Elongated Complete, LH Trip, Glenbury Seat	12"	White	

### Memoirs® Stately Comfort Height® 1-Piece 1.28 Toilet with AquaPiston® Flush Technology

- 16-1/4" High bowl is ADA compliant
- Includes left-hand trip lever  
—(-RA) right-hand trip lever
- 2-18" Glazed trapway
- Glenbury™ Quiet-Close™ with Grip-Tight seat
- Supply line not included



Part #	Mfg #	Description	Rough-In	Color	Price
145886	K-3813-0	ADA Elongated Complete, LH Trip, Glenbury Seat	12"	White	
146194	K-3813-47	ADA Elongated Complete, LH Trip, Glenbury Seat	12"	Almond	
150693	K-3813-58	ADA Elongated Complete, LH Trip, Glenbury Seat	12"	Thunder Grey	
159200	K-3813-96	ADA Elongated Complete, LH Trip, Glenbury Seat	12"	Biscuit	
183055	K-3813-K4	ADA Elongated Complete, LH Trip, Glenbury Seat	12"	Cashmere	
164395	K-3813-RA-0	ADA Elongated Complete, RH Trip, Glenbury Seat	12"	White	

\*Vibrant Limited Lifetime Finish

[www.plumbsupply.com](http://www.plumbsupply.com) • Serving our Customers Since 1946 • [www.waterconcepts.net](http://www.waterconcepts.net)

## One-Piece Closets

### Memoirs® Stately Comfort Height® 1-Piece 1.28 Toilet with Concealed Trap

- Compact elongated
- AquaPiston® flushing system
- 16-1/2" High bowl
- Includes seat and cover
- 2-1/8" Plastic trapway
- 9-5/8" Water area



Part #	Mfg #	Description	Rough-In	Color	Price
189749	K-6428-0	Compact Elongated, LH Trip, Glenbury Seat	12"	White	
223389	K-6428-7	Compact Elongated, LH Trip, Glenbury Seat	12"	Black	
232623	K-6428-96	Compact Elongated, LH Trip, Glenbury Seat	12"	Biscuit	

### Portrait® Comfort Height® 1-Piece Compact 1.28 gpf Toilet with Concealed Trapway & Lift Knob Actuator

- 16-1/2" High bowl
- AquaPiston® flush technology
- Clean Caps®
- Glenbury™ Quiet-Close™ seat with Quick-Release™
- 21/8" glazed trapway
- Includes polished chrome lift knob
- WaterSense® certified product
- Supply line not included



Part #	Mfg #	Description	Rough-In	Color	Price
174458	K-3826-0	Compact Elongated, Lift Knob Actuator	12"	White	
235944	K-3826-47	Compact Elongated, Lift Knob Actuator	12"	Almond	
181929	K-3826-96	Compact Elongated, Lift Knob Actuator	12"	Biscuit	
175102	K-3826-K4	Compact Elongated, Lift Knob Actuator	12"	Cashmere	
236861	K-3826-NY	Compact Elongated, Lift Knob Actuator	12"	Dune	

### Reve® 1-Piece Comfort Height® Dual Flush Toilet

- 16-1/8" High bowl
- Seat and lid included
- Polished Chrome top-mount flush actuator
- Supply line sold separately
- Skirted trapway
- WaterSense® certified product: 0.8gpf/1.6gpf



Part #	Mfg #	Description	Rough-In	Color	Price
133401	K-3797-0	Elongated Complete, Dual Flush Chrome Actuator	12"	White	

\*Vibrant Limited Lifetime Finish

[www.waterconcepts.net](http://www.waterconcepts.net) • Serving our Customers Since 1946 • [www.plumbsupply.com](http://www.plumbsupply.com)

## One-Piece Closets

### Saile® Skirted 1-Piece Dual-Flush Toilet with Top Actuator and Saile Quiet-Close® Seat with Quick-Release™

- High efficiency 1.6gpf or 0.8 gpf
- 2-1/8" Fully glazed trapway
- Supply line not included



Part #	Mfg #	Description	Rough-In	Color	Price
121016	K-3564-0	Compact Elongated, Skirted Trapway	12"	White	
183051	K-3564-47	Compact Elongated, Skirted Trapway	12"	Almond	
132139	K-3564-96	Compact Elongated, Skirted Trapway	12"	Biscuit	

### San Raphael® 1-Piece Comfort Height® 1.0 gpf Toilet with Pressure Lite® Flush Technology

- 16-1/2" High bowl
- Seat and lid included
- Left-hand trip lever
- Supply line sold separately
- Sloan Flushmate® pressure vessel
- WaterSense® certified product: 1.0 gpf



Part #	Mfg #	Description	Rough-In	Color	Price
118243	K-3597-0	Elongated Complete, LH CP Trip	12"	White	
120087	K-3597-47	Elongated Complete, LH CP Trip	12"	Almond	
126040	K-3597-7	Elongated Complete, LH CP Trip	12"	Black	
165526	K-3597-95	Elongated Complete, LH CP Trip	12"	Ice Grey	
114809	K-3597-96	Elongated Complete, LH CP Trip	12"	Biscuit	
228300	K-3597-G9	Elongated Complete, LH CP Trip	12"	Sandbar	

### San Raphael® 1-Piece Comfort Height® 1.28 Toilet

- Elongated bowl
- Skirted trapway
- Includes seat, cover and left-hand polished chrome trip lever
- Single-flush gravity uses the force of gravity and a precision-engineered tank, bowl, and trapway to create a siphon during flushing
- Quiet-Close™ seat and lid included
- WaterSense® certified



Part #	Mfg #	Description	Rough-In	Color	Price
172613	K-3722-0	Elongated Complete, LH CP Trip	12"	White	

\*Vibrant Limited Lifetime Finish

[www.plumbsupply.com](http://www.plumbsupply.com) • Serving our Customers Since 1946 • [www.waterconcepts.net](http://www.waterconcepts.net)

## One-Piece Closets

### Santa Rosa™ Comfort Height® Compact 1-Piece 1.6 Toilet with AquaPiston® Flush Technology

- 16-1/2" High bowl is ADA compliant
- Seat and cover included
- Supply sold separately
- 2-1/8" glazed trapway
- Left-hand trip lever
- Includes Brevia™ with Quick-Release™ seat



Part #	Mfg #	Description	Rough-In	Color	Price
142214	K-3811-0	Elongated Complete, LH CP Trip	12"	White	
149680	K-3811-47	Elongated Complete, LH CP Trip	12"	Almond	
152734	K-3811-7	Elongated Complete, LH CP Trip	12"	Black	
150148	K-3811-95	Elongated Complete, LH CP Trip	12"	Ice Grey	
144409	K-3811-96	Elongated Complete, LH CP Trip	12"	Biscuit	
157648	K-3811-G9	Elongated Complete, LH CP Trip	12"	Sandbar	
174335	K-3811-NY	Elongated Complete, LH CP Trip	12"	Dune	

### Santa Rosa™ Comfort Height® 1-Piece Compact 1.28 Toilet with AquaPiston® Flush Technology

- 16-1/2" High bowl is ADA compliant
- 2-1/8" Glazed trapway
- Includes seat and cover
- Supply sold separately
- Standard left-hand trip lever  
-(-RA) Models right-hand trip lever
- Meets EPA WaterSense® criteria



Part #	Mfg #	Description	Rough-In	Color	Price
139879	K-3810-0	ADA Elongated Compact Complete, LH CP Trip	12"	White	
183052	K-3810-47	ADA Elongated Compact Complete, LH CP Trip	12"	Almond	
154293	K-3810-7	ADA Elongated Compact Complete, LH CP Trip	12"	Black	
142342	K-3810-95	ADA Elongated Compact Complete, LH CP Trip	12"	Ice Grey	
142327	K-3810-96	ADA Elongated Compact Complete, LH CP Trip	12"	Biscuit	
150223	K-3810-G9	ADA Elongated Compact Complete, LH CP Trip	12"	Sandbar	
176495	K-3810-NY	ADA Elongated Compact Complete, LH CP Trip	12"	Dune	
249102	K-3810-RA-0	ADA Elongated Compact Complete, RH CP Trip	12"	White	

\*Vibrant Limited Lifetime Finish

[www.waterconcepts.net](http://www.waterconcepts.net) • Serving our Customers Since 1946 • [www.plumbsupply.com](http://www.plumbsupply.com)

## One-Piece Closets

### San Souci® Comfort Height® 1-Piece Compact Elongated 1.28 gpf Touchless Toilet

- Low-profile design
- DryLock™ System
- 12" Rough-in
- AquaPiston® flushing system
- Powered by 4 AA batteries (included)
- Concealed trapway and Clean Caps®
- 2-1/8" Fully glazed trapway
- Includes K-4008 Reveal® Quiet-Close™ with Grip-Tight seat
- Supply line not included



Part #	Mfg #	Description	Rough-In	Color	Price
170468	K-4000-0	Elongated Front Complete, LH CP Trip	12"	White	
240806	K-4000-47	Elongated Front Complete, LH CP Trip	12"	Almond	
225958	K-4000-95	Elongated Front Complete, LH CP Trip	12"	Ice Grey	
185473	K-4000-96	Elongated Front Complete, LH CP Trip	12"	Biscuit	
183565	K-4000-NY	Elongated Front Complete, LH CP Trip	12"	Dune	

### San Souci® 1-Piece Round-Front 1.28 gpf Toilet with AquaPiston® Flush Technology

- Low-profile design
- Includes standard left-hand trip lever
- Supply line not included
- **(K-4008)** Reveal® Quiet-Close™ with Grip-Tight seat included



Part #	Mfg #	Description	Rough-In	Color	Price
177855	K-4007-0	Round Front Complete, LH CP Trip	12"	White	
176792	K-4007-95	Round Front Complete, LH CP Trip	12"	Ice Grey	
224875	K-4007-G9	Round Front Complete, LH CP Trip	12"	Sandbar	

### San Souci® Comfort Height® 1-Piece Compact Elongated 1.28 gpf Toilet w/ Concealed Trapway Clean Caps®

- Low-profile design
- 12" Rough-in
- Includes standard left-hand polished chrome trip lever
- AquaPiston® flushing system
- 2-1/8" Fully glazed trapway
- Includes K-4008 Reveal® Quiet-Close™ with Grip-Tight seat
- Supply line not included
- (-RA) Right-hand trip lever



Part #	Mfg #	Description	Rough-In	Color	Price
174349	K-5172-0	Compact Elongated Front, LH CP Trip	12"	White	
243622	K-5172-RA-0	Compact Elongated Front, RH CP Trip	12"	White	
221796	K-5172-47	Compact Elongated Front, LH Trip	12"	Almond	

\*Vibrant Limited Lifetime Finish

[www.plumbsupply.com](http://www.plumbsupply.com) • Serving our Customers Since 1946 • [www.waterconcepts.net](http://www.waterconcepts.net)



## One-Piece Closets

### One-Piece Vitreous China Toilets (Continued)

#### San Souci® Comfort Height® 1-Piece Compact Elongated 1.28 gpf Toilet w/ Concealed Trapway Clean Caps®

Part #	Mfg #	Description	Rough-In	Color	Price
242788	K-5172-58	Compact Elongated Front, LH Trip	12"	Thunder Grey	
188443	K-5172-7	Compact Elongated Front, LH CP Trip	12"	Black Black	
226435	K-5172-95	Compact Elongated Front, LH CP Trip	12"	Ice Grey	
185421	K-5172-96	Compact Elongated Front, LH CP Trip	12"	Biscuit	
236809	5172-G9	Compact Elongated Front, LH CP Trip	12"	Dune	
188542	K-5172-K4	Compact Elongated Front, LH CP Trip	12"	Cashmere	
229086	K-5172-NY	Compact Elongated Front, LH Trip	12"	Dune	

#### San Souci™ Comfort Height® 1-Piece 1.28 Toilet

- AquaPiston® flushing technology
- Touchless with Purefresh™
- Concealed trapway and Clean Caps™
- 16-1/2" High bowl is ADA compliant
- 2-1/8" Fully glazed concealed trapway
- Includes K-5588 Purefresh™ toilet seat



Part #	Mfg #	Description	Rough-In	Color	Price
186897	K-8687-0	Compact Elongated Bowl, Touchless	12"	White	

#### Tresham™ Comfort Height Skirted 1-Piece 1.28 Toilet

- Compact elongated bowl
- AquaPiston® flushing system
- 16-1/2" High bowl is ADA compliant
- Includes Glenbury™ Q3 seat
- Skirted trapway
- 2-1/8" plastic trapway



Part #	Mfg #	Description	Rough-In	Color	Price
180164	K-3981-0	ADA Compact Elongated Complete, LH CP Trip	12"	White	
222408	K-3981-7	ADA Compact Elongated Complete, LH CP Trip	12"	Black	
231784	K-3981-96	ADA Compact Elongated Complete, LH CP Trip	12"	Biscuit	
244341	K-3981-K4	ADA Compact Elongated Complete, LH CP Trip	12"	Cashmere	
221313	K-3981-NY	ADA Compact Elongated Complete, LH CP Trip	12"	Dune	

\*Vibrant Limited Lifetime Finish

www.waterconcepts.net • Serving our Customers Since 1946 • www.plumbsupply.com



## One-Piece Closets

### Veil® Intelligent Wall-Hung One-Piece Toilet

- Elongated bowl offers added room and comfort
- Dual flush offers a choice of 0.8 or 1.28 gallon per flush (gpf).
- Stainless steel wand offers adjustable spray shape, position, water pressure, temperature, pulsate, and oscillate functions
- Front and rear wash modes provide warm water for cleansing
- Self-cleaning function uses UV light and electrolyzed water systems
- Warm-air drying system with adjustable temperature settings
- Automatic deodorization system
- Touchscreen LCD remote
- Heated seat with adjustable temperature settings
- Motion-activated, hands-free opening/closing of seat and cover
- LED lighting illuminates the bowl to serve as a night-light
- English-language touchscreen LCD remote control
- WaterSense® certified



Part #	Mfg #	Description	Rough-In	Color	Price
241740	K-5402-0	Elongated Complete	-	White	

### Veil® Intelligent Skirted One-Piece Elongated Dual-Flush Toilet

- Compact, streamlined one-piece toilet with integrated cleansing
- Elongated bowl offers added room and comfort
- Tankless design with direct water supply
- Dual flush offers a choice of 0.8 or 1.28 gallon per flush (gpf).
- Stainless steel wand offers adjustable spray shape, position, water pressure, temperature, pulsate, and oscillate functions
- Front and rear wash modes provide warm water for cleansing
- Self-cleaning function uses UV light and electrolyzed water systems to sanitize the wand surfaces
- Warm-air drying system with adjustable temperature settings
- Automatic deodorization system
- Heated seat with adjustable temperature settings
- Motion-activated, hands-free opening/closing of seat and cover
- Quiet-Close™ lid closes slowly and quietly without slamming
- LED lighting illuminates the bowl to serve as a night-light
- English-language touchscreen LCD remote control
- Emergency flush feature for power outages
- (-PA) Pump-assisted flushing



Part #	Mfg #	Description	Rough-In	Color	Price
222148	K-5401-0	ADA Skirted w/ Bidet Functionality Seat	12"	White	
258155	K-5401-PA-0	ADA Skirted w/ Bidet Functionality Seat, Pump-Assisted	12"	White	

\*Vibrant Limited Lifetime Finish

[www.plumbsupply.com](http://www.plumbsupply.com) • Serving our Customers Since 1946 • [www.waterconcepts.net](http://www.waterconcepts.net)

---



---

## One-Piece Closets

---



---

### Veil® Intelligent Wall-Hung Toilet and Actuator Plate — Less In-Wall Tank

- *Elongated bowl*
- *LED lighting*
- *Dual flush technology*
- *Concealed mounting hardware*
- *Front and rear wash modes*
- *Automatic deodorization system*
- *Integrated self-cleaning function*
- *Automatically flushing toilet after use*
- *Touchless actuator plate in honed white*
- *English-language touchscreen LCD remote control*
- *Heated seat with adjustable temperature settings*
- *Motion-activated, hands free opening/closing of cover*
- *Warm-air drying system with adjustable temperature settings*
- *Stainless steel wand offers adjustable spray shape, position, water pressure, temperature, pulsate, and oscillate functions*
- *WaterSense® certified: 0.8 or 1.6 gpf*



**Requires K-18647 In-wall tank and carrier**

Part #	Mfg #	Description	Rough-In	Color	Price
241353	K-76395-0	Elongated Toilet Complete	-	White	

\*Vibrant Limited Lifetime Finish

[www.waterconcepts.net](http://www.waterconcepts.net) • **Serving our Customers Since 1946** • [www.plumbsupply.com](http://www.plumbsupply.com)



## One-Piece Closets

### One-Piece Elongated Vitreous China Toilets

#### Avalanche™ One-Piece ErgoHeight™ 1.28 Toilet

- Elongated, ErgoHeight™ bowl
- Compact design fits in round front space
- Dual-fed siphon jet
- Fluidmaster™ fill valve
- 3" Flush valve with XP3 flushing technology
- 2" Glazed trapway
- Color matched side tank lever
- Toilet seat included



Part #	Mfg #	Description	Rough-In	Color	Price
135189	21-014	One-Piece, Seat Included	12"	White	

#### Avalanche™ One-Piece ErgoHeight™ 1.28 Toilet with Concealed Trapway

- Fluidmaster® Fill valve WDI 3" flush valve
- Front mount tank lever
- Soft-closing seat cover included
- Matching color ceramic floor bolt cover plates included



Part #	Mfg #	Description	Rough-In	Color	Price
168544	21-019	One-Piece w/ Concealed Trap, Seat Included	12"	White	

#### Wicker Park™ One-Piece Elongated ErgoHeight™ Toilet

- 3" Flush valve
- 12" Rough-in
- Toilet seat included
- 2" Fully glazed trapway
- Extra-large dual fed siphon jets
- WaterSense® certified product: 1.28 gpf

Part #	Mfg #	Description	Rough-In	Color	Price
237774	21-221	One-Piece, Seat Included	12"	White	

## Round Front Closets

### Two-Piece Round Vitreous China Toilets

#### Cimarron® Comfort Height® 2-Piece Round-Front 1.6 gpf Toilet with AquaPiston® Flush Technology

- 2-1/8" Glazed trapway
- 16-1/2" High bowl is ADA compliant
- DryLock™ System
- Seat and supply sold separately
- Left-hand polished chrome trip lever included  
—(-RA) right-hand trip lever
- Meets EPA WaterSense® criteria



**K-3888 Combination: K-4347 Round Bowl, K-4167 Tank**

Part #	Mfg #	Description	Rough-In	Color	Price
147235	K-3888-0	Round Complete, Trapway less Supply, LH CP Trip	12"	White	
147651	K-3888-47	Round Complete, Trapway less Supply, LH CP Trip	12"	Almond	
157181	K-3888-7	Round Complete, Trapway less Supply, LH CP Trip	12"	Black	
145421	K-3888-95	Round Complete, Trapway less Supply, LH CP Trip	12"	Ice Grey	
146265	K-3888-96	Round Complete, Trapway less Supply, LH CP Trip	12"	Biscuit	
146333	K-3888-G9	Round Complete, Trapway less Supply, LH CP Trip	12"	Sandbar	
167305	K-3888-NY	Round Complete, Trapway less Supply, LH CP Trip	12"	Dune	
145596	K-3888-RA-0	Round Complete, Trapway less Supply, RH CP Trip	12"	White	
169277	K-3888-RA-47	Round Complete, Trapway less Supply, RH CP Trip	12"	Almond	

#### Cimarron® Comfort Height® 2-Piece Round-Front 1.28 gpf Toilet with AquaPiston® Flush Technology

- DryLock™ System
- 2-1/8" Glazed trapway
- Includes left-hand chrome trip lever
- 16-1/2" High bowl is ADA compliant
- Seat and supply sold separately
- Meets EPA WaterSense® criteria
- (-RA) right-hand trip lever
- (-U) Insuliner® tank liner



**K-3887 Combination K-4347 Round Bowl, K-4166 Tank**

**K-3851 Combination K-4829 Round Bowl, K-4166 Tank**

Part #	Mfg #	Description	Rough-In	Color	Price
154825	K-3851-0	Round Complete, LH CP Trip	10"	White	
171868	K-3851-47	Round Complete, LH CP Trip	10"	Almond	
176456	K-3851-96	Round Complete, LH CP Trip	10"	Biscuit	
142363	K-3887-0	Round Complete, LH CP Trip	12"	White	
145136	K-3887-47	Round Complete, LH CP Trip	12"	Almond	
176658	K-3887-7	Round Complete, LH CP Trip	12"	Black	
146660	K-3887-95	Round Complete, LH CP Trip	12"	Ice Grey	
142364	K-3887-96	Round Complete, LH CP Trip	12"	Biscuit	
145755	K-3887-G9	Round Complete, LH CP Trip	12"	Sandbar	
236607	K-3887-NY	Round Complete, LH CP Trip	12"	Dune	

\*Vibrant Limited Lifetime Finish

[www.waterconcepts.net](http://www.waterconcepts.net) • Serving our Customers Since 1946 • [www.plumbsupply.com](http://www.plumbsupply.com)

## Round Front Closets

### Two-Piece Round Vitreous China Toilets (Continued)

#### Cimarron® Comfort Height® 2-Piece Round-Front 1.28 gpf Toilet with AquaPiston® Flush Technology

Part #	Mfg #	Description	Rough-In	Color	Price
151717	K-3887-U-0	Round Complete with Insuliner® Tank, LH CP Trip	12"	White	
249444	K-3887-U-47	Round Complete with Insuliner® Tank, LH CP Trip	12"	Almond	
167103	K-3887-U-96	Round Complete with Insuliner® Tank, LH CP Trip	12"	Biscuit	

#### Cimarron® Touchless Comfort Height® 2-Piece 1.28 Toilet

- Flush is activated by a no-touch sensor mounted inside the tank
- Powered by 4 (AA) batteries
- AquaPiston® flushing system
- 2-1/8" Glazed trapway
- 12" Rough-in
- 16-1/2" High bowl is ADA compliant
- Seat and supply sold separately
- WaterSense® certified product



Part #	Mfg #	Description	Rough-In	Color	Price
171393	K-6419-0	Round Complete, Touchless Flush	12"	White	
190204	K-6419-95	Round Complete, Touchless Flush	12"	Ice Grey	
174046	K-6419-96	Round Complete, Touchless Flush	12"	Biscuit	

#### Highline® Classic Comfort Height® 2-Piece Round-Front 1.28 gpf Toilet with Class Five® Flush Technology

- 2-1/8" Fully glazed trapway
- Floor mount / Floor outlet
- 10.5" x 8.25" Water area
- Left-hand polished chrome trip lever
- Seat and supplies not included
- WaterSense® certified product



Part #	Mfg #	Description	Rough-In	Color	Price
232564	K-5296-0	Round Complete, LH Trip	12"	White	

#### Highline® Comfort Height® 2-Piece Round-Front 1.28 gpf Toilet with Class Five® Flush Technology

- 2-1/8" Fully glazed trapway
- Floor mount / Floor outlet
- Three-bolt installation
- Left-hand polished chrome trip lever included
- Seat and supply line not included
- WaterSense® certified product



Part #	Mfg #	Description	Rough-In	Color	Price
230301	K-5481-0	Round Complete, LH Trip	12"	White	
236555	K-5481-47	Round Complete, LH Trip	12"	Almond	

\*Vibrant Limited Lifetime Finish

[www.plumbsupply.com](http://www.plumbsupply.com) • Serving our Customers Since 1946 • [www.waterconcepts.net](http://www.waterconcepts.net)

## Round Front Closets

### Memoirs® Comfort Height® 2-Piece Round-Front 1.28 gpf Toilet with AquaPiston® Flush Technology

- 2-1/8" Glazed trapway
- Includes chrome left-hand trip lever
- Seat and supply sold separately
- Meets EPA WaterSense® criteria
- (-RA) right-hand trip lever
- (-U) Insuliner® tank liner



Stately Design



Classic Design

#### Stately Design

Part #	Mfg #	Description	Rough-In	Color	Price
148309	K-3933-0	Round Complete, LH Trip	12"	White	
152441	K-3933-47	Round Complete, LH Trip	12"	Almond	
163125	K-3933-96	Round Complete, LH Trip	12"	Biscuit	
172235	K-3933-G9	Round Complete, LH Trip	12"	Sandbar	

#### Classic Design

Part #	Mfg #	Description	Rough-In	Color	Price
149039	K-3986-0	Round Complete, LH Trip	12"	White	
149299	K-3986-47	Round Complete, LH Trip	12"	Almond	
148918	K-3986-96	Round Complete, LH Trip	12"	Biscuit	
158602	K-3986-G9	Round Complete, LH Trip	12"	Sandbar	
226265	K-3986-RA-0	Round Complete, RH Trip	12"	White	
150837	K-3986-U-0	Round Complete, LH Trip w/ Insuliner® Tank	12"	White	

### Wellworth® 2-Piece Round-Front 1.28 gpf Toilet with Class Five® Flush Technology & Left-Hand Trip Lever

- 2-1/8" Glazed trapway
- Large 3-1/4" canister flush valve
- Seat and supply sold separately
- Meets EPA WaterSense® criteria
- (-RA) right-hand trip lever



K-3947 Combination: K-4197 Round Bowl, K-4841 Tank

K-3997 Combination: K-4197 Round Bowl, K-4467 Tank

Part #	Mfg #	Description	Rough-In	Color	Price
137532	K-3947-0	Round Complete	14"	White	
137530	K-3997-0	Round Complete	12"	White	
160751	K-3997-RA-0	Round Complete, RH Trip	12"	White	

\*Vibrant Limited Lifetime Finish

[www.waterconcepts.net](http://www.waterconcepts.net) • Serving our Customers Since 1946 • [www.plumbsupply.com](http://www.plumbsupply.com)



## Round Front Closets

### Wellworth® 2-Piece Round-Front 1.6 gpf Toilet with Class Five® Flush Technology & Left-Hand Trip Lever

- 14-1/2" Bowl height
- 2-1/8" Glazed trapway
- Seat and supply sold separately

K-3977 Combination: K-4197 Round Bowl, K-4468 Tank



Part #	Mfg #	Description	Rough-In	Color	Price
137528	K-3977-0	Round Complete, LH CP Trip	12"	White	
145939	K-3977-7	Round Complete, LH CP Trip	12"	Black	

### Wellworth® 2-Piece Dual-Flush Toilet with Class Five® Flushing Technology & Left-hand Trip Lever

- 14-1/2" Bowl height
- 2-1/8" Glazed trapway
- 12" Rough-in and 3-bolt installation
- Seat and supply sold separately
- 1.1 or 1.6 gpf

K-3987 Combination: K-4197 Round Bowl, K-4458 Tank



Part #	Mfg #	Description	Rough-In	Color	Price
166486	K-3987-0	Round Complete, LH CP Trip	12"	White	
171448	K-3987-47	Round Complete, LH CP Trip	12"	Almond	
168119	K-3987-7	Round Complete, LH CP Trip	12"	Black	

### Wellworth® Classic 2-Piece 1.28 gpf Toilet Class Five® Flush Technology & Left-hand Trip Lever

- 2-1/8" Glazed trapway
- Left-hand polished chrome trip lever
- Seat and supply sold separately
- Meets EPA WaterSense® criteria



Part #	Mfg #	Description	Rough-In	Color	Price
130225	K-3577-0	Round Complete, LH CP Trip	12"	White	
167940	K-3577-47	Round Complete, LH CP Trip	12"	Almond	
165746	K-3577-7	Round Complete, LH CP Trip	12"	Black	
134925	K-3577-96	Round Complete, LH CP Trip	12"	Biscuit	

\*Vibrant Limited Lifetime Finish

[www.plumbsupply.com](http://www.plumbsupply.com) • Serving our Customers Since 1946 • [www.waterconcepts.net](http://www.waterconcepts.net)



**Round Front Closets**

**Two-Piece Round Vitreous China Toilets**

**Karsten® Dual-Force® 2-Piece 1.6/.8 gpf Toilet**

- One flush cleansing performance
- (2) Bolt installation
- 2-1/2" Glazed trapway
- Dual Force® flushing system
- WaterSense® certified: 1.6 gpf/.08 gpf
- 5-Year warranty



402025 Complete: 402021 Round Bowl, 402023 Tank

Part #	Mfg #	Description	Rough-In	Color	Price
099377	402025-0	Round Complete	12"	White	
120969	402025-96	Round Complete	12"	Biscuit	

**Rockton™ Dual Force® 2-Piece 1.6/.8 gpf Toilet**

- One flush cleansing performance
- (2) Bolt installation
- 2-1/2" (64 mm) glazed trapway
- Dual Force® flushing system
- WaterSense® certified: 1.6gpf/.08gpf
- 5-Year warranty



402024 Complete: 402021 Round Bowl, 402022 Tank

Part #	Mfg #	Description	Rough-In	Color	Price
081316	402024-0	Round Complete	12"	White	
081320	402024-96	Round Complete	12"	Biscuit	

**Windham™ Pro Force® 2-Piece Toilet**

- Completely code approved
- 12" Rough-in
- (3) Bolt installation
- Fully-glazed 2" trapway
- One flush performance limited guarantee
- Seat and supply sold separately
- Includes left-hand polished chrome trip lever



402015 Complete: 403015 Round Bowl, 404515 Tank

403080 Complete: 403015 Round Bowl, 404551 Tank

Part #	Mfg #	Description	Rough-In	Color	Price
137389	402015-0	Round Complete, 1.6 gpf	12"	White	
074009	402015-96	Round Complete, 1.6 gpf	12"	Biscuit	
238146	403080-0	Round Complete, 1.28 gpf	12"	White	

## Round Front Closets

### Two-Piece Vitreous China Toilets

#### Stealth® Ultra High-Efficiency 2-Piece 0.80 Toilet

- *Seat sold separately*
- *Quiet siphonic flushing*
- *Patented flush chamber and air transfer system*
- *28-7/8" x 18-3/4" x 31"*
- *8" x 6" Water surface area*
- *Polished chrome top-mount flush actuator*
- *10-Year limited warranty*



**N7716R Complete: N7716B Round Bowl, N7714T Tank**

Part #	Mfg #	Description	Rough-in	Color	Price
131375	N7716R	Round Compete	12"	White	



## Round Front Closets

### Two-Piece Round Vitreous China Toilets

#### Allerton 2-Piece 1.28gpf Toilet

- Fluidmaster® fill valve
- Dual fed siphon jet
- 3" Flush valve
- 2" Glazed trapway
- Side tank lever
- Seat sold separately



HE-20-001 Combination: HE-21-542 Round Bowl, HE-28-580 Tank

Part #	Mfg #	Description	Rough-In	Color	Price
159209	HE-20-001	HE-21-542 Round Bowl, HE-28-580 Tank	12"	White	

#### Avalanche™ 2-Piece 1.28gpf Toilet

- Fluidmaster® fill valve
- Dual-fed siphon jet
- 3" Flush valve
- Glazed trapway
- Color matched, side tank lever
- Seat sold separately



WS-21-800 Combination: WS-21-852 Round Bowl, WS-21-895 Tank  
 WS-21-802 Combination: WS-21-852 Round Bowl, WS-21-890 Tank  
 WS-21-804 Combination: WS-21-852 Round Bowl, WS-21-894 Tank

Part #	Mfg #	Description	Rough-In	Color	Price
161398	WS-21-800	WS-21-852 Round Bowl, WS-21-895 Tank	10"	White	
161567	WS-21-800-09	WS-21-852-09 Round Bowl, WS-21-895-09 Tank	10"	Biscuit	
161399	WS-21-802	WS-21-852 Round Bowl, WS-21-890 Tank	12"	White	
161570	WS-21-802-09	WS-21-852-09 Round Bowl, WS-21-890-09 Tank	12"	Biscuit	
161400	WS-21-804	WS-21-852 Round Bowl, WS-28-894 Tank	14"	White	
161571	WS-21-804-09	WS-21-852-09 Round Bowl, WS-28-894-09 Tank	14"	Biscuit	

#### Avalanche™ 2-Piece 1.6gpf Toilet

- Fluidmaster® fill valve
- Dual-fed siphon jet
- 2" Fully-glazed trapway
- Color matched, side tank lever
- Seat sold separately



AV-21-800 Combination: AV-21-852 Round Bowl, AV-28-895 Tank  
 AV-21-802 Combination: AV-21-852 Round Bowl, AV-28-890 Tank  
 AV-21-804 Combination: AV-21-852 Round Bowl, AV-28-894 Tank

Part #	Mfg #	Description	Rough-In	Color	Price
161383	AV-21-800	AV-21-852 Round Bowl, AV-28-895 Tank	10"	White	
161550	AV-21-800-09	AV-21-852-09 Round Bowl, AV-28-895-09 Tank	10"	Biscuit	



## Round Front Closets

### Two-Piece Round Vitreous China Toilets (Continued)

#### Avalanche™ 2-Piece 1.6gpf Toilet

Part #	Mfg #	Description	Rough-In	Color	Price
161384	AV-21-802	AV-21-852 Round Bowl, AV-28-890 Tank	12"	White	
161552	AV-21-802-09	AV-21-852-09 Round Bowl, AV-28-890-09 Tank	12"	Biscuit	
165710	AV-21-802-25	AV-21-852-25 Round Bowl, AV-28-890-25 Tank	12"	Bone/Wheat	
161385	AV-21-804	AV-21-852 Round Bowl, AV-28-894 Tank	14"	White	
161554	AV-21-804-09	AV-21-852-09 Round Bowl, AV-28-894-09 Tank	14"	Biscuit	

#### Avalanche™ Elite™ 2-Piece ErgoHeight™ 1.6gpf Toilet

- Corrosion resistant Fluidmaster® flapper
- Fluidmaster® 400A fill valve
- PowerClean flush system
- Dual-fed siphon jet
- 2-1/8" Fully-glazed trapway
- 3" Flush valve
- Color matched, side tank lever
- Double nut, multi-point tank-to-bowl mounting system
- Seat sold separately



#### AV-20-852 Combination: AB-21-852 Round Bowl, AL-28-890 Tank

Part #	Mfg #	Description	Rough-In	Color	Price
246817	AV-20-852	AB-21-852 Round Bowl, AL-28-890 Tank	12"	White	

#### Avalanche™ Elite™ 2-Piece ErgoHeight™ 1.28gpf Toilet

- Corrosion resistant Fluidmaster® flapper
- Fluidmaster® 400A fill valve
- PowerClean flush system
- Dual-fed siphon jet
- 2-1/8" Fully-glazed trapway
- 3" Flush valve
- Color matched, side tank lever
- Double nut, multi-point tank-to-bowl mounting system
- Seat sold separately



#### WS-20-852 Combination: AB-21-852 Round bowl, AH-28-890 tank

Part #	Mfg #	Description	Rough-In	Color	Price
246822	WS-20-852	AB-21-852 Round Bowl, AH-28-890 Tank	12"	White	



## Round Front Closets

### Maxwell™ 2-Piece 1.28gpf Toilet

- Pilot fill valve
- Dual-fed siphon jet
- 3" Flush valve
- 2" Glazed trapway
- Color matched front tank lever
- Seat sold separately



21-902 Combination: 21-952 Round Bowl, 28-990 Tank

Part #	Mfg #	Description	Rough-In	Color	Price
138036	21-902	21-952 Round Bowl, 28-990 Tank	12"	White	

### Maxwell™ 2-Piece 1.6gpf Toilet

- Siphon jet action
- 2" Glazed trapway
- 3" Flush valve
- Pilot fill valve
- Color matched front tank lever
- Seat sold separately
- Double nut, multi-point tank-to-bowl mounting system



MX-21-400 Combination: 21-952 Round Bowl, MX-28-995 Tank

MX-21-402 Combination: 21-952 Round Bowl, MX-28-990 Tank

MX-21-404 Combination: 21-952 Round Bowl, MX-28-994 Tank

Part #	Mfg #	Description	Rough-In	Color	Price
161310	MX-21-400	21-952 Round Bowl, MX-28-995 Tank	10"	White	
161413	MX-21-400-09	21-952-09 Round Bowl, MX-28-995-09 Tank	10"	Biscuit	
161311	MX-21-402	21-952 Round Bowl, MX-28-990 Tank	12"	White	
161421	MX-21-402-09	21-952-09 Round Bowl, MX-28-990-09 Tank	12"	Biscuit	
170307	MX-21-402-25	21-952-25 Round Bowl, MX-28-990-25 Tank	12"	Bone/Wheat	
161312	MX-21-404	21-952 Round Bowl, MX-28-994 Tank	14"	White	
161423	MX-21-404-09	21-952-09 Round Bowl, MX-28-994-09 Tank	14"	Biscuit	



## Round Front Closets

### Maxwell™ 2-Piece 1.6gpf Toilet

- 2" Glazed trapway
- 3" Flush valve
- Pilot fill valve
- Dual fed siphon jets
- Color matched tank lever
- Color matched metal tank lever
- Double nut, multi-point tank-to-bowl mounting system
- Seat sold separately

**MX-20-900 Combination: MX-21-952 Round Bowl, MX-28-995 Tank**

**MX-20-902 Combination: MX-21-952 Round Bowl, MX-28-990 Tank**

Part #	Mfg #	Description	Rough-In	Color	Price
247570	MX-20-900	MX-21-952 Round Bowl, MX-28-995 Tank	10"	White	
247572	MX-20-900-09	MX-21-952-09 Round Bowl, MX-28-995-09 Tank	10"	Biscuit	
247573	MX-20-902	MX-21-952 Round Bowl, MX-28-990 Tank	12"	White	
247574	MX-20-902-09	MX-21-952-09 Round Bowl, MX-28-990-09 Tank	12"	Biscuit	

### Maxwell™ 2-Piece 1.6gpf Toilet

- 2" Glazed trapway
- 2" Flush valve
- Color matched front tank lever
- Seat sold separately



**SE-21-100 Combination: 21-152 Round Bowl, 28-175 Tank**

**SE-21-102 Combination: 21-152 Round Bowl, 28-170 Tank**

**SE-21-104 Combination: 21-152 Round Bowl, 28-174 Tank**

Part #	Mfg #	Description	Rough-In	Color	Price
241774	SE-21-100	21-152 Round Bowl, 28-175 Tank	10"	White	
130372	SE-21-102	21-152 Round Bowl, 28-170 Tank	12"	White	
241772	SE-21-104	21-152 Round Bowl, 28-174 Tank	14"	White	

### Maxwell™ 2-Piece 1.28gpf Toilet

- 2" Glazed trapway
- 3" Flush valve
- Pilot fill valve
- Dual fed siphon jets
- Color matched tank lever (white only)
- Optional right-handed trip lever
- Double nut, multi-point tank-to-bowl mounting system
- Two bolt caps included
- Seat sold separately



**WS-20-902 Combination: MX-21-952 Round Bowl, 28-990 Tank**

Part #	Mfg #	Description	Rough-In	Color	Price
247562	WS-20-902	MX-21-952 Round Bowl, 28-990 Tank	12"	White	



## Round Front Closets

### Two-Piece Round Vitreous China Toilets (Continued)

#### Maxwell™ 2-Piece 1.28gpf Toilet

Part #	Mfg #	Description	Rough-In	Color	Price
247563	WS-20-902-09	MX-21-952 Round Bowl, 28-990 Tank	12"	Biscuit	

#### Maxwell™ 2-Piece Dual Flush 1.1/1.6gpf Toilet

- Front jet flushing action
- Glazed trapway
- Top button actuator
- Seat sold separately



DF-21-900 Combination: 21-952 Round Bowl, DF-28-995 Tank  
 DF-21-902 Combination: 21-952 Round Bowl, DF-28-990 Tank  
 DF-21-904 Combination: 21-952 Round Bowl, DF-28-994 Tank

Part #	Mfg #	Description	Rough-In	Color	Price
161326	DF-21-900	21-952 Round Bowl, DF-28-995 Tank	10"	White	
161327	DF-21-902	21-952 Round Bowl, DF-28-990 Tank	12"	White	
161438	DF-21-902-09	21-952-09 Round Bowl, DF-28-990-09 Tank	12"	Biscuit	
161328	DF-21-904	21-952 Round Bowl, DF-28-994 Tank	14"	White	

#### Viper™ 2-Piece 1.28gpf Toilet

- Fluidmaster® fill valve
- Dual-fed siphon jet
- 3" Flush valve
- 2" Glazed trapway
- Color matched, side tank lever
- Seat sold separately



WS-21-500 Combination: VP-21-552 Round Bowl, WS-28-595 Tank  
 WS-21-502 Combination: VP-21-552 Round Bowl, WS-28-590 Tank  
 WS-21-504 Combination: VP-21-552 Round Bowl, WS-28-594 Tank

Part #	Mfg #	Description	Rough-In	Color	Price
161368	WS-21-500	VP-21-552 Round Bowl, WS-28-595 Tank	10"	White	
161527	WS-21-500-09	VP-21-552-09 Round Bowl, WS-28-595-09 Tank	10"	Biscuit	
161369	WS-21-502	VP-21-552 Round Bowl, WS-28-590 Tank	12"	White	
161533	WS-21-502-09	VP-21-552-09 Round Bowl, WS-28-590-09 Tank	12"	Biscuit	
161370	WS-21-504	VP-21-552 Round Bowl, WS-28-594 Tank	14"	White	
161535	WS-21-504-09	VP-21-552-09 Round Bowl, WS-28-594-09 Tank	14'	Biscuit	





## Round Front Closets

### Viper™ 2-Piece 1.6gpf Toilet

- HP2 Flushing technology
- Fluidmaster® fill valve
- Glazed 2" trapway
- Dual feed siphon-jet
- Color matched tank lever for white, bone and biscuit
- Seat sold separately



VP-21-500 Combination: VP-21-552 Round Bowl, VP-28-595 Tank

VP-21-502 Combination: VP-21-552 Round Bowl, VP-28-590 Tank

VP-21-504 Combination: VP-21-552 Round Bowl, VP-28-594 Tank

Part #	Mfg #	Description	Rough-In	Color	Price
161350	VP-21-500	VP-21-552 Round Bowl, VP-28-595 Tank	10"	White	
161497	VP-21-500-09	VP-21-552-09 Round Bowl, VP-28-595-09 Tank	10"	Biscuit	
161351	VP-21-502	VP-21-552 Round Bowl, VP-28-590 Tank	12"	White	
161503	VP-20-502-09	VP-21-552-09 Round Bowl, VP-28-590-09 Tank	12"	Biscuit	
165707	VP-21-502-25	VP-21-552-09 Round Bowl, VP-28-590-09 Tank	12"	Bone	
161352	VP-21-504	VP-21-552 Round Bowl, VP-28-594 Tank	14"	White	
161505	VP-21-504-09	VP-21-552-09 Round Bowl, VP-28-594-09 Tank	14"	Biscuit	

### Ultra Flush™ Dual-Flush Pressure Assist 2-Piece 1.1/1.6gpf Toilet

- HET High efficiency toilet
- 2-Piece toilet
- Meet EPA WaterSense® criteria
- Non-corrosive solid brass tank-to-bowl bolts
- Seat sold separately



DF-21-302 Combination: 21-342 Round Bowl, DF-28-380 Tank

Part #	Mfg #	Description	Rough-In	Color	Price
091838	DF-21-302	21-342 Round Bowl, DF-28-380 Tank	12"	White	

### Ultra Flush™ Pressure Assist 2-Piece 1.6gpf Toilet

- Sloan Flushmate pressure vessel
- Trapway averages over 3"
- Insulated non-sweating tank
- Seat sold separately



21-300 Combination: 21-342 Round Bowl, 28-385 Tank

21-302 Combination: 21-342 Round Bowl, 28-380 Tank

21-304 Combination: 21-342 Round Bowl, 28-384 Tank

Part #	Mfg #	Description	Rough-In	Color	Price
039803	21-300	21-342 Round Bowl, 28-385 Tank	10"	White	
039808	21-302	21-342 Round Bowl, 28-380 Tank	12"	White	
039810	21-302-09	21-342-09 Round Bowl, 28-380-09 Tank	12"	Biscuit	
039811	21-304	21-342 Round Bowl, 28-384 Tank	14"	White	



## Round Front Closets

### PeeWee™ Children's Gravity Fed 2-Piece 1.28 Toilet

- Dimensions: 25"H x 16"W x 23-3/4"D
- Ready to install
- Siphon-jet
- Fluidmaster® fill valve
- WaterSense® certified
- Includes tank, toilet bowl, toilet seat, wax rings, and floor bolts



Part #	Mfg #	Description	Rough-In	Color	Price
189945	HE-20-601	Round Complete, Toilet-In-A-Box	10"	White	

## Round Front Closets

### Two-Piece Standard Height

#### Alto™ 2-Piece 1.6gpf Toilet

- 1.6 Gpf / 6.0 Lpf
- Round front bowl
- 2" Glazed trapway
- Anti-siphon ballcock provides efficient toilet tank operation at high or low water pressures
- Three-point cushioned tank-to-bowl connection assures perfect tank alignment and leak proof connections.



Part #	Mfg #	Description	Rough-In	Color	Price
194498	130125WH	Round Complete	14"	White	
194500	130125BI	Round Complete	14"	Biscuit	
194499	130125BN	Round Complete	14"	Bone	
192306	130160WH	Round Complete	12"	White	
192314	130160BI	Round Complete	12"	Biscuit	
192305	130160BN	Round Complete	12"	Bone	
194468	13018WH	Round Complete	12"	White	
194469	130180BI	Round Complete	12"	Biscuit	
194470	130180BN	Round Complete	12"	Bone	
192312	131160WH	Round Complete	12"	White	
192313	131160BN	Round Complete	12"	Bone	

#### Alto™ 2-Piece 1.28gpf Complete Toilet Kit

- WaterSense® certified: 1.28 Gpf / 4.86 Lpf
- Round front bowl
- 2" Glazed trapway
- 3" Hybrid flush valve
- Pilot operated fill valve
- 3 Bolt tank-to-bowl connection
- Color-match trip lever
- Kit includes: toilet seat, tank and bowl, flange bolts, wax ring with polyethylene flange and instructions



Part #	Mfg #	Description	Rough-In	Color	Price
247184	4130CTK	Round Complete Kit	12"	White	

\*Vibrant Limited Lifetime Finish

[www.plumbsupply.com](http://www.plumbsupply.com) • Serving our Customers Since 1946 • [www.waterconcepts.net](http://www.waterconcepts.net)

## Round Front Closets

### Cascade™ 2-Piece 1.28gpf Toilet

- Gravity fed
- Unique rimless bowl design
- 3" Flush valve
- Pilot operated fill valve
- Glazed trapway
- WaterSense Certified®: 1.28 gpf



**4810-3816 Combination: 4810 Bowl, 3816 Tank**

Part #	Mfg #	Description	Rough-In	Color	Price
205818	48103816	Round Complete, LH CP Trip	12"	White	

### Summit™ 2-Piece Dual Flush 1.1/1.6gpf Toilet

- Round front
- Dual flush technology with 3" tower
- 1.1 Gpf / 1.6 Gpf (4.0 Lpf / 6.0 Lpf)
- Pilot operated anti-siphon fill valve
- SmartFasten 3-bolt tank-to-bowl connection
- PuraClean easy-to-clean glaze



Part #	Mfg #	Description	Rough-In	Color	Price
204260	3803386WH	Round Complete Dual Flush	12"	White	
204261	3803386BI	Round Complete Dual Flush	12"	Bone	

### Summit™ 2-Piece 1.6gpf Toilet

- Round front bowl
- 1.6 Gpf / 6.0 Lpf
- PuraClean™ easy-to-clean glaze
- MagnaFlush™ flushing technology
- SmartFasten™ 3-bolt tank-to-bowl connection
- Pilot operated anti-siphon fill valve
- 3" Flush valve
- 2" Glazed trapway
- Decorative metal trip lever
- Model **(380CTK)** includes completed kit: slow close toilet seat, tank and bowl, flange bolts, wax ring with polyethylene flange and instructions



Part #	Mfg #	Description	Rough-In	Color	Price
198188	380386WH	Round Complete	12"	White	
198187	380386BI	Round Complete	12"	Biscuit	
198432	380386BN	Round Complete	12"	Bone	
247191	380CTK	Round Complete Kit	12"	White	

\*Vibrant Limited Lifetime Finish

**www.waterconcepts.net • Serving our Customers Since 1946 • www.plumbsupply.com**

## Round Front Closets

### Two Piece Smartheight™

#### ProFit® 2-Piece 1.6 gpf Smartheight™ Complete Toilet Kit

- Round front SmarHeight™ (16-1/2") bowl
- ADA compliant
- 1.6 gpf / 6.0 lpf
- 3 bolt tank-to-bowl connection
- 2" Flush tower
- 2" Glazed trapway
- Chrome trip lever
- Anti-siphon ballcock
- Kit includes: toilet seat, wax ring, floor bolts, caps, and installation instructions
- Water supply hardware not included



Part #	Mfg #	Description	Rough-In	Color	Price
247188	117CTKWH	Round Complete ADA Smartheight	12"	White	

#### Summit™ 2-Piece 1.6gpf Smartheight™ Toilet

- Round front SmarHeight bowl
- ADA compliant
- 1.6 Gpf / 6.0 Lpf
- PuraClean easy-to-clean glaze
- Pilot operated anti-siphon fill valve
- 3" Flush valve
- SmartFasten 3-bolt tank-to-bowl connection
- Decorative metal trip lever



Part #	Mfg #	Description	Rough-In	Color	Price
210677	388386WH	Round Complete ADA Smartheight	12"	White	
210678	388386BI	Round Complete ADA Smartheight	12"	Biscuit	

### Two Piece Elementary

#### Elementary 2-Piece 1.28gpf Toilet

- Juvenile toilet (11-1/4" high bowl)
- Includes a SmartClose toilet seat
- Includes cover lock
- 1.28 gpf / 4.86 lpf low water consumption
- Round front bowl
- High efficiency toilet
- 2" Flapper flush valve
- Pilot operated anti-siphon fill valve
- Chrome-plated trip lever



Part #	Mfg #	Description	Rough-In	Color	Price
211489	53264320WH	Round Complete	Juvenile	12" White	

\*Vibrant Limited Lifetime Finish

**www.plumbsupply.com • Serving our Customers Since 1946 • www.waterconcepts.net**

## Round Front Closets

### Two-Piece Round Front Toilets

#### Grab-N-Go Round Front Toilet

- Includes:
  - Tank & bowl
  - Toilet seat
  - Wax ring w/ sleeve
  - (2) Bolt caps
  - (2) Flange bolts
- 3" High performace flushing system
- Large water surface
- 2-1/8" Wide fully glazed trapway
- 1.28 GPF Siphon jet flush
- MaP score: 800 Grams



Part #	Mfg #	Description	Rough-In	Color	Price
235395	572-5833	Round Front Complete	12"	White	

## Tank Parts

### Flush Actuators

#### Bevel® Flush Actuator Plate

- For 2"x4" in-wall tank and carrier system



For use with K-18829-NA

Part #	Mfg #	Description	Price
177777	K-8857-CP	Polished Chrome	

#### Portrait® Lift Knob Flush Actuator

- For K-3826 Toilet



Part #	Mfg #	Description	Price
175103	K-7677-BV	*Brushed Bronze	
183655	K-7677-SN	*Polished Nickel	
182407	K-7677-2BZ	Oil Rubbed Bronze	

#### Persuade® Dual Flush Actuator

- Large top-mount buttons
- Spring-loaded buttons
- For use with k-3753 Persuade® Circ and Persuade® Curv toilets



Part #	Mfg #	Description	Price
189130	K-186-BN	*Brushed Nickel	
190296	K-186-BV	*Brushed Bronze	

#### Dual Flush Actuator

- Premium metal construction
- For use with Reve™, Saile®, Escale®, Strela™ and Persuade® dual-flush toilets



Part #	Mfg #	Finish	Price
120856	K-9384-BN	*Brushed Nickel	
132498	K-9384-BV	*Brushed Bronze	
224589	K-9384-SN	*Polished Nickel	

### Droplet® Flush Actuator Plate

- For use with k-18829 2"x4" in-wall tank and carrier system
- WaterSense® certified 0.8/1.6 gpf
- Plate can be removed for access to inner tank.



Part #	Mfg #	Description	Price
189339	K-4177-CP	Polished Chrome	

### Lynk™ Dual Flush Actuator Plate

- For use with k-18829 2"x4" in-wall tank and carrier system
- WaterSense® certified 0.8/1.6 gpf
- Plate can be removed for access to inner tank.



Part #	Mfg #	Description	Price
253895	75890-0	White	

### Note™ Dual Flush Actuator Plate

- For use with K-18829-NA 2" x 4" in-wall tank and carrier system
- WaterSense® certified: 0.8 or 1.6 gpf



Part #	Mfg #	Description	Price
241850	75891-CP	Polished Chrome	

### Veil® Flush Actuator Plate

- For 2"x6" in-wall tank and carrier system
- WaterSense® certified: 0.8/1.6 gpf
- Large flush actuator plate opening can be removed for easy access to inner tank



Part #	Mfg #	Description	Price
161708	K-6298-BN	*Brushed Nickel	
244709	K-6298-BV	*Brushed Bronze	
181616	K-6298-CP	Polished Chrome	
183604	K-6298-SN	*Polished Nickel	
183644	K-6298-0	White	
180079	K-6298-2BZ	Oil Rubbed Bronze	
162487	K-6298-7	Black Black	

\* Vibrant Limited Lifetime Warranty

www.plumbsupply.com • Serving our Customers Since 1946 • www.waterconcepts.net



## Tank Parts

### Veil® 2"x6" Wall-Hung Cast Iron Waste Pipe

- For use with K-6284 in-wall tank and carrier system



Part #	Mfg #	Description	Price
174219	K-6291-NA	Cast Iron, 2"x6"	

### Trip Levers

#### Archer® Toilet Trip Lever



Part #	Mfg #	Finish	Price
105644	K-11069-BN	*Brushed Nickel	
107125	K-11069-BV	*Brushed Bronze	
108320	K-11069-G	Brushed Chrome	
130755	K-11069-PB	*Polished Brass	
137618	K-11069-SN	*Polished Nickel	
155674	K-11069-2BZ	Oil Rubbed Bronze	

#### Bancroft™ Toilet Trip Lever



Part #	Mfg #	Finish	Price
089966	K-9475-BN	*Brushed Nickel	
111085	K-9475-BV	*Brushed Bronze	
102771	K-9475-PB	*Polished Brass	
122118	K-9475-SN	*Polished Nickel	
153291	K-9475-2BZ	Oil Rubbed Bronze	

#### Cimarron™ Toilet Trip Lever

- K-9470 Blade style
- (L) left hand
- (R) right hand



Part #	Mfg #	Description	Price
086975	K-9466-L-AF	Left Hand, *French Gold	
189575	K-9466-L-BGD	Left Hand, *Moderne Br Gld	
249331	K-9466-L-BL	Left Hand, Matte Black	
077088	K-9466-L-BN	Left Hand, *Brushed Nickel	
080986	K-9466-L-BV	Left Hand, *Brushed Bronze	

### Trip Levers (Continued)

#### Cimarron™ Toilet Trip Lever

Part #	Mfg #	Description	Price
079879	K-9466-L-G	Left Hand, Brushed Chrome	
078886	K-9466-L-PB	Left Hand, *Polished Brass	
254522	K-9466-L-RGD	Left Hand, *Rose Gold	
090276	K-9466-L-SN	Left Hand, *Polished Nickel	
147101	K-9466-L-2BZ	Left Hand, Oil Rubbed Bronze	
106220	K-9470-L-CP	Left Hand, Pol Chrome	
147103	K-9470-L-2BZ	Left Hand, Oil Rubbed Bronze	

#### Corbelle™ Toilet Trip Lever

- For use with the (K-3814) toilet



Part #	Mfg #	Description	Price
244736	20120-L-BN	Left Hand, *Brushed Nickel	
251824	20120-LF2-SN	Left Hand, *Polished Nickel	
255692	20120-LF2-2BZ	Left Hand, Oil Rubbed Brz	

#### Devonshire®/Memoirs® Toilet Trip Lever



Part #	Mfg #	Description	Price
060522	K-484-BN	*Brushed Nickel	
076104	K-484-BV	*Brushed Bronze	
066973	K-484-CP	Polished Chrome	
253732	K-484-VNT	Vintage Nickel	
170636	K-484-2BZ	Oil Rubbed Bronze	

#### Dual-Flush Left Hand Trip Lever

For use with: K-3987, K-3988, and K-3989 Dual-Flush Toilets



Part #	Mfg #	Description	Price
161858	K-9237-BN	*Brushed Nickel	
173581	K-9237-CP	Polished Chrome	
170293	K-9237-2BZ	Oil Rubbed Bronze	

\* Vibrant Limited Lifetime Warranty

[www.waterconcepts.net](http://www.waterconcepts.net) • Serving our Customers Since 1946 • [www.plumbsupply.com](http://www.plumbsupply.com)

## Tank Parts

### Gabrielle™ Left Hand Toilet Trip Lever



Part #	Mfg #	Description	Price
078628	K-9464-L-BN	Left Hand, *Brushed Nickel	
079883	K-9464-L-BV	Left Hand, *Brushed Bronze	
176948	K-9464-L-2BZ	Left Hand, Oil Rubbed Bronze	

### Memoirs® Toilet Trip Lever

- Solid-brass construction
- For use with Memoirs® one-piece toilets



Part #	Mfg #	Description	Price
137988	502-SN	*Polished Nickel	

### Wellworth® Trip Lever

- Metal construction
- For use with the Wellworth® and Highline™ 2-piece toilets
- Can be used for left and right-hand tank configurations



Part #	Mfg #	Finish	Price
140290	K-9379-0	White	
142043	K-9379-AF	*French Gold	
137744	K-9379-BN	*Brushed Nickel	
144797	K-9379-BV	*Brushed Bronze	
142519	K-9379-PB	*Polished Brass	
141421	K-9379-SN	*Polished Nickel	
152245	K-9379-2BZ	Oil Rubbed Bronze	

### Kathryn® Toilet Trip Lever



Part #	Mfg #	Finish	Price
067100	K-9451-BN	*Brushed Nickel	
075018	K-9451-BV	*Brushed Bronze	
057081	K-9451-CP	Polished Chrome	
253729	K-9451-VNT	Vintage Nickel	
147097	K-9451-2BZ	Oil Rubbed Bronze	

### Kathryn® Vertical Trip Lever

- For K-3940 and K-3324



Part #	Mfg #	Description	Price
226152	K-9131-AF	*French Gold	
163165	K-9131-BN	*Brushed Nickel	
181437	K-9131-2BZ	Oil Rubbed Bronze	

### Kelston™ Left Hand Toilet Trip Lever



Part #	Mfg #	Description	Price
120945	K-9385-BN	Left Hand, *Brushed Nickel	
128947	K-9385-BV	Left Hand, *Brushed Bronze	
189125	K-9385-G	Left Hand, Brushed Chrome	
147092	K-9385-2BZ	Left Hand, Oil Rubbed Brz	

### Toilet Trip Lever

- Metal construction
- Corrosion and tarnish resistant finish
- For use with the Memoirs® Comfort Height® toilet



Part #	Mfg #	Description	Price
183160	K-9167-L-AF	Left Hand, *French Gold	
142794	K-9167-L-BN	Left Hand, *Brushed Nickel	
147590	K-9167-L-BV	Left Hand, *Brushed Bronze	
159522	K-9167-L-G	Left Hand, Brushed Chrome	
146195	K-9167-L-PB	Left Hand, *Polished Brass	
152150	K-9167-L-SN	Left Hand, *Polished Nickel	
223891	K-9167-L-VNT	Left Hand, Vintage Nickel	
143235	K-9167-L-2BZ	Left Hand, Oil Rubbed Brz	
154373	K-9167-R-BN	Right Hand, *Br Nickel	
164396	K-9167-R-PB	Right Hand, *Pol Brass	

\* Vibrant Limited Lifetime Warranty

[www.plumbsupply.com](http://www.plumbsupply.com) • Serving our Customers Since 1946 • [www.waterconcepts.net](http://www.waterconcepts.net)

## Tank Parts

### Memoirs® Toilet Trip Lever

Part #	Mfg #	Description	Price
095314	K-9477-BN	*Brushed Nickel	

### Tresham® Toilet Trip Lever

- Metal construction
- For use with K-3950 Tresham® two-piece toilet



Part #	Mfg #	Description	Price
163228	K-9375-AF	Left Hand, *French Gold	
149432	K-9375-BN	Left Hand, *Brushed Nickel	
153589	K-9375-BV	Left Hand, *Brushed Bronze	
172166	K-9375-SN	Left Hand, *Polished Nickel	
188090	K-9375-VNT	Left Hand, Vintage Nickel	
147077	K-9375-2BZ	Left Hand, Oil Rubbed Brz	

### Santa Rosa™ Left Hand Toilet Trip Lever



Part #	Mfg #	Description	Price
144410	K-9169-L-BN	Left Hand, *Brushed Nickel	
146206	K-9169-L-BV	Left Hand, *Brushed Bronze	
171439	K-9169-L-PB	Left Hand, Polished Brass	
243147	K-9169-L-SN	Left Hand, *Polished Nickel	
242555	K-9169-L-TT	Left Hand, *Titanium	
147332	K-9169-L-2BZ	Left Hand, Oil Rubbed Brz	

### San Souci™ Toilet Trip Lever

- For use with the K-5172 or K-5172-RA San Souci toilet
- (-L) Left hand or (-R) right hand



Part #	Mfg #	Description	Price
223735	K-9171-L-AF	Left, *French Gold	
174481	K-9171-L-BN	Left, *Brushed Nickel	
221797	K-9171-L-BV	Left, *Brushed Bronze	
226939	K-9171-L-PB	Left, Polished Brass	
229493	K-9171-L-SN	Left, *Polished Nickel	

### Trip Levers (Continued)

#### San Souci™ Toilet Trip Lever

Part #	Mfg #	Description	Price
187038	K-9171-L-2BZ	Left, Oil Rubbed Bronze	
243624	K-9171-R-BN	Right, *Brushed Nickel	

#### San Souci™ Toilet Trip Lever

- For use with the K-4007 San Souci toilet



Part #	Mfg #	Description	Price
248656	K-9176-BGD	Left Hand, *Moderne Brushed Gold	
258421	K-9176-BN	Left Hand, *Brushed Nickel	
224877	K-9176-2BZ	Left Hand, Oil-Rbbrd Bronze	

#### Wellworth® Left-Hand Trip Lever

- Solid brass construction
- For use with K-3575 and K-3577 Wellworth® classic toilets



Part #	Mfg #	Description	Price
176656	K-9380-L-0	Left Hand, White	
152209	K-9380-L-BN	Left Hand, *Brushed Nickel	
144857	K-9380-L-BV	Left Hand, *Brushed Bronze	
147720	K-9380-L-PB	Left Hand, Polished Brass	
147090	K-9380-L-2BZ	Left Hand, Oil Rubbed Brz	

#### Wellworth®/Barrington™/Highline™ Pressure Lite Toilet Trip Lever

- Solid brass construction



Part #	Mfg #	Description	Price
097031	K-9481-L-BN	Left Hand, *Brushed Nickel	
094654	K-9481-L-G	Left Hand, Brushed Chrome	
147106	K-9481-L-2BZ	Left Hand, Oil Rubbed Brz	

#### Wellworth® Left Hand Trip Lever

- Solid brass construction
- For Wellworth® & Highline™ toilets



Part #	Mfg #	Description	Price
057230	K-9404-L-0	Left Hand, White	
056233	K-9404-L-BN	Left Hand, *Brushed Nickel	

\* Vibrant Limited Lifetime Warranty

[www.waterconcepts.net](http://www.waterconcepts.net) • Serving our Customers Since 1946 • [www.plumbsupply.com](http://www.plumbsupply.com)

## Tank Parts

### Toilet Trip Lever and Nut

- For model K-3520



Part #	Mfg #	Description	Price
058705	30324-VF	Left Hand, Polished Brass	
055299	GP30324-CP	Left Hand, Pol Chrome	

### Flush Kits

#### Flush Valve Service Kit



Part #	Mfg #	Description	Price
105969	1013944	Flush Valve Service Kit	

#### Canister Valve Assembly for Single Flush Toilets

- Canister flapper for toilets
- Gaskets included



Part #	Mfg #	Description	Price
121408	1069722	Canister Flapper Assy Kit	
164476	1216610	Canister Valve Assy	
247312	1216619	Canister Valve Assy	
176536	1216614	Canister Valve Assy	
178033	GP1229656	Canister Repair Kit	

### Flappers

#### Flapper



Part #	Mfg #	Description	Price
105337	GP1039444	Flapper for 1-Piece Toilets	
122919	GP1060740	Flapper for 1-Piece Toilets	
120115	GP1078440	Flapper for 1-Piece Toilets	
119016	GP1078441	Flapper for 2-Piece Toilets	

### Flappers (Continued)

#### Flapper

Part #	Mfg #	Description	Price
051340	GP83064	2" Flapper for 1-Piece Toilet	
055313	GP84995	2"Hinge Flapper for 1-Piece	
055291	GP85160	Flapper, Blue with Float	
055289	GP87449	Flapper, Blue less Float	
093108	GP89825	Flapper Assembly	

#### Trip Lever Service Kit



Part #	Mfg #	Description	Price
152893	30324-BRZ	Trip Lever & Nut	
055221	500189-CP	Trip Lever Assy	
160784	55335	Trip Lever	
182657	55615-CP	Trip Lever Assy, Chrome	
182658	55615-G	Trip Lever Assy, Br Chrome	
183340	55615-VF	Trip Lever Assy, *Pol Brass	
247087	77940-CP	Trip Lever Assy, Chrome	
251583	77940-VF	Trip Lever Assy, *Pol Brass	
073316	78423-CP	Trip Lever Assy, Chrome	
160885	81609-CP	Trip Lever, Chrome	
182736	81610-CP	Trip Lever Kit, Chrome	
182936	81610-VF	Trip Lever Kit, *Pol Brass	
182937	81611-VF	Trip Lever Kit, *Pol Brass	
186800	84874-BN	Trip Lever Kit, *Br Nickel	
175334	84874-CP	Trip Lever Kit, Chrome	
183346	85084-BRZ	Trip Lever Assy, Oil-Rd Brz	
153353	85084-CP	Trip Lever Assy, Chrome	
182939	85085-BN	Trip Lever Assy, *Br Nickel	
088518	85114-CP	Trip Lever Assy, Chrome	
241527	87114-VF	Trip Lever Assy, *Pol Brass	
186772	87115-BN	Trip Lever Assy, *Br Nickel	
101025	87115-CP	Trip Lever Assy, *Chrome	
120180	1034693-AF	Cimarron® Trip Lever, *French Gold	
120176	1034693-BRZ	Trip Lever Kit, Oil-Rbld Brz	
120178	1034693-BV	Cimarron® Trip Lever, *Brushed Bronze	
183190	1034693-VF	Trip Lever Kit, *Pol Brass	

\* Vibrant Limited Lifetime Warranty

**www.plumbsupply.com • Serving our Customers Since 1946 • www.waterconcepts.net**

## Tank Parts

### Flappers (Continued)

#### Trip Lever Service Kit

Part #	Mfg #	Description	Price
162928	1042212-CP	Trip Lever Kit, Chrome	
248081	1043340-CP	Trip Lever Assy, Chrome	
183202	1045276-BRZ	Trip Lever Kit, Oil-Rubbed Brz	
236965	1067577-BN	Archer® Trip Lever Kit for 3639, 3551, 3517, *Br. Nkl	
149968	1067577-CP	Archer® Trip Lever Kit for 3639, 3551, 3517, Chrome	
131211	1069723-CP	Wellworth Trip Lever Kit with Nut, Chrome	
167527	1069724-BN	Trip Lever Kit, *Br Nickel	
136836	1075394-BRZ	Trip Lever Kit, Oil-Rubbed Brz	
161451	1075394-CP	Trip Lever Kit, Chrome	
183233	1089001-CP	Trip Lever Kit, Chrome	
228206	1117207-CP	Trip Lever Kit, Chrome	
150879	1133133-CP	Trip Lever Kit, Chrome	
150290	1142713-CP	Trip Lever Kit, Chrome	
243176	1158701-CP	Santa Rosa 3810 & 10491 Trip Lever Kit, Chrome	
256011	1161319-CP	Trip Lever Kit, Chrome	
254452	1219665-CP	Lift Trip Lever Kit, Chrome	
120177	GP1034693-CP	Cimarron® Trip Lever, Polished Chrome	

#### Memoirs® Trip Lever Service Kit

- For 3812, 3816, 3532, 3542, 11461, 3509, 3515, 3813, 10494

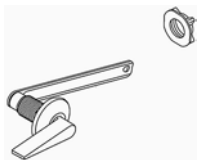

Part #	Mfg #	Description	Price
243949	1160316-BN	Trip Lever Service Kit, Brushed Nickel	
183699	1160316-BRZ	Trip Lever Service Kit, ORB	
183701	1160316-CP	Trip Lever Service Kit, Chr	

### Flush Valve Seal



Part #	Mfg #	Description	Price
055361	GP83888	Flush Valve Seal	
116169	GP1059291	Flush Valve Seal Kit	

### Tank Cover



1086929

Part #	Mfg #	Description	Price
159633	1000401-BC	Bright Chrome	
103049	1015867-0	White, Close Coupled	
111478	1036375-0	White	
167048	1046467-0	White, Kelston	
165618	1052861-96	Biscuit, Memoirs	
166880	1052862-0	White, Memoirs Stately	
167170	1055954-0	White, Tank Lid	
170793	1055954-96	Biscuit, Tank Lid	
156049	1070414-47	Almond	
170734	1086929-0	White, Close Coupled	
162684	1086929-7	Black, Black Close Coupled	
125084	1086929-96	Biscuit, Close Coupled	
153988	1138565-0	White	
169716	1138565-96	Biscuit	
166928	1145223-0	White	
242567	1223375-96	Biscuit	
244995	1138565-T-0	White	
182735	81509-33	Mexican Sand	
222951	84252-0	White	
081116	84591-0	White	
153399	84591-47	Almond	
183715	88497-NY	Dune	

\* Vibrant Limited Lifetime Warranty

[www.waterconcepts.net](http://www.waterconcepts.net) • Serving our Customers Since 1946 • [www.plumbsupply.com](http://www.plumbsupply.com)



## Tank Parts

### Fill Valves

#### Fill Valve



Part #	Mfg #	Description	Price
086318	1007488	Fill Valve Assy	
122780	1013282	Fill Valve Assy	
136555	1043213	Fill Valve Assy	
112635	1068031	Fill Valve Assy for 1-Piece Toilets w/ Brass Shank	
177990	1069398	Fill Valve Assy	
183238	1097230	Fill Valve Kit	
108373	GP1068030	Fill Valve Assy	
134063	GP1138930	Float Valve Kit	
055343	30668	Fill/Flush Valve Kit	
067046	30669	Fill/Flush Valve Kit	

#### Valve



Part #	Mfg #	Description	Price
181498	83093	Flush Valve Kit	
123254	83095	Flush Valve Kit	
242103	84284	Flush Valve Kit	
160713	84996	Flush Valve Kit	
095560	85406	Flush Valve	
158343	87373	Flush Valve Kit	
110860	87998	Flush Valve Kit	
182949	89827	Flush Valve Assy	
095558	1003068	Flush Valve Kit	
158795	1007489	Fill Valve Assy	
182878	1016123	Flush Valve Kit	
078121	1024385	Cimarron® Flush Valve Kit w/ 3-1/4" Flapper	
183189	1032640	Flush Valve Kit	
182849	1042499	Flush Valve Kit	
177989	1058776	Flush Valve Kit	

### Fill Valves (Continued)

#### Valve

Part #	Mfg #	Description	Price
183219	1060862	Flush Valve Kit	
154341	1080961	Valve Assembly Kit	
183239	1097231	Flush Valve Kit	
219442	1117210	1.28 gpf Flush Valve Kit	
175065	1132466	Flush Valve	
183332	1145275	Flush Valve	
153142	1145365	Flush Valve Kit	
168700	1151862	Flush Valve Kit	
160353	1152349	Valve Assembly	
158438	1188998	Flush Valve Kit	
183708	1188999	Flush Valve Kit	
183709	1189000	Flush Valve Kit	
158264	1189001	Flush Valve Kit	
163314	1216612	Canister Valve Assy	

### Miscellaneous Tank Parts

#### Toilet Tank Gasket



Part #	Mfg #	Description	Price
074165	84460	Tank Gasket	
123062	GP1018165-F	Drylock Tank Gasket	
155255	GP1112256	2" Seal for drylock	

#### Clean Caps® Low-Profile Toilet Bolt Caps

- Conceals floor bolts on toilets
- No bolt cutting required
- Comes standard with all concealed toilets



Part #	Mfg #	Finish	Price
240497	5420-NY	Dune	

\* Vibrant Limited Lifetime Warranty

[www.plumbsupply.com](http://www.plumbsupply.com) • Serving our Customers Since 1946 • [www.waterconcepts.net](http://www.waterconcepts.net)

## Tank Parts

### Trip Levers

#### Addison™ Trip Lever



Part #	Mfg #	Description	Price
167409	79260	Chrome	
166033	79260-CZ	Champagne Bronze™	
164375	79260-RB	Venetian Bronze®	
160249	79260-SS	Stainless*	

#### Arzo™ Trip Lever



Part #	Mfg #	Description	Price
173887	77560	Chrome	
234735	77560-BL	Matte Black	
163956	77560-SS	Stainless*	

#### Cassidy™ Trip Lever



Part #	Mfg #	Description	Price
156849	79760	Chrome	
175411	79760-CZ	Champagne Bronze™	
161212	79760-PN	Polished Nickel	
165819	79760-SS	Stainless*	
150962	79760-RB	Venetian Bronze®	

#### Cassidy™ French Curve Trip Lever



Part #	Mfg #	Description	Price
173527	79860	Chrome	
154522	79860-CZ	Champagne Bronze™	
161717	79860-PN	Polished Nickel	
165130	79860-RB	Venetian Bronze®	
176750	79860-SS	Stainless*	

#### Compel Trip Lever



Part #	Mfg #	Description	Price
175419	77160	Chrome	
159647	77160-SS	Stainless*	

#### Dryden™ Trip Lever



Part #	Mfg #	Description	Price
178513	75160	Chrome	
163315	75160-CZ	Champagne Bronze™	
181349	75160-PN	Polished Nickel*	
162281	75160-RB	Venetian Bronze®	
159517	75160-SS	Stainless*	

#### Pivotal™ Trip Lever



Part #	Mfg #	Description	Price
244512	79960	Chrome	
251680	79960-BL	Matte Black	

#### Trinsic™ Trip Lever



Part #	Mfg #	Description	Price
237950	75960-BL	Matte Black	
179762	75960-CZ	Champagne Bronze™	
159098	75960-RB	Venetian Bronze®	
161610	75960-SS	Stainless*	

#### Victorian® Trip Lever



Part #	Mfg #	Finish	Price
059730	75060	Chrome	

\* Brilliance® Anti-Tarnish Lifetime Finishes



## Tank Parts

### Trip Levers (Continued)

#### Victorian® Trip Lever

Part #	Mfg #	Finish	Price
166041	75060-CZ	Champagne Bronze™	
057187	75060-PB	Polished Brass*	
073502	75060-SS	Stainless*	
055721	75060-RB	Venetian Bronze®	

#### Vero™ Trip Lever



Part #	Mfg #	Description	Price
175420	77760	Chrome	
255064	77760-CZ	Champagne Bronze™	
167402	77760-RB	Venetian Bronze®	
166562	77760-SS	Stainless*	

#### Brizo Trip Levers

##### Charlotte™ Front-Mount Trip Lever



Part #	Mfg #	Description	Price
180677	696085-BN	Brushed Nickel*	
190411	696085-PN	Polished Nickel*	

##### Charlotte™ Side-Mount Trip Lever



Part #	Mfg #	Description	Price
163774	696285-PNC O	Cocoa Bronze & Pol Nickel	

#### Litze™ Universal Trip Lever



Part #	Mfg #	Description	Price
238667	696335-GL	Luxe Gold	
255162	696335-PC	Chrome	

#### Odin Front-Mount Trip Lever



Part #	Mfg #	Description	Price
225075	696075-BN	Brushed Nickel*	
226107	696075-BL	Matte Black	
257827	696075-GL	Luxe Gold	

#### Odin Side-Mount Trip Lever



Part #	Mfg #	Description	Price
244601	696275-BL	Matte Black	

#### Rook Universal Trip Lever



Part #	Mfg #	Description	Price
185806	696361-NK	Luxe Nickel*	

#### RSVP® Trip Lever



Part #	Mfg #	Description	Price
114792	69960-BN	Brushed Nickel*	
173645	69960-PC	Chrome	

\* Brilliance® Anti-Tarnish Lifetime Finishes

## Tank Parts

### RSVP® Side-Mount Trip Lever



Part #	Mfg #	Description	Price
145031	69962-BN	Brushed Nickel*	
181896	69962-PC	Chrome	

### Virage® Trip Lever



Part #	Mfg #	Description	Price
138713	696230-BZ	Brushed Bronze*	
168462	696230-RB	Venetian Bronze®	

### Siderna® Trip Lever



Part #	Mfg #	Description	Price
188614	696080-BL	Matte Black	
171847	696080-PC	Chrome	

### Vesi® Channel Trip Lever



Part #	Mfg #	Description	Price
162266	696340-BN	Brushed Nickel*	

### Siderna Side-Mount Trip Lever



Part #	Mfg #	Description	Price
178523	696280-BN	Brushed Nickel*	

### Virage® Trip Lever



Part #	Mfg #	Description	Price
158970	696030-BN	Brushed Nickel*	
170232	696030-RB	Venetian Bronze®	

### Sotria Trip Lever



Part #	Mfg #	Description	Price
181334	696050-NK	Luxe Nickel*	

### Traditional Trip Lever

- Front mount



Part #	Mfg #	Description	Price
117007	69561-BZ	Brushed Bronze*	
144012	69561-PC	Chrome	
085403	69561-RB	Venetian Bronze®	

\* Brilliance® Anti-Tarnish Lifetime Finishes

## Tank Parts

### Tank Levers

#### Belfield™ Tank Lever



Part #	Mfg #	Finish	Price
252702	YB6401CH	Chrome	
252695	YB6401ORB	Oil Rubbed Bronze	

#### Brantford™ Tank Lever



Part #	Mfg #	Finish	Price
102299	YB2201ORB	Oil Rubbed Bronze	
103429	YB2201BN	Brushed Nickel	

#### Eva™ Tank Lever



Part #	Mfg #	Finish	Price
097222	YB2801BN	Brushed Nickel	
109978	YB2801CH	Chrome	

#### Dartmoor Tank Lever



Part #	Mfg #	Finish	Price
250757	YB2101ORB	Oil Rubbed Bronze	

#### Kingsley™ Tank Lever



Part #	Mfg #	Finish	Price
083456	YB5401ORB	Oil Rubbed Bronze	

#### Icon™ Tank Lever



Part #	Mfg #	Finish	Price
101731	YB5801CH	Chrome	

#### Method™ Tank Lever



Part #	Mfg #	Finish	Price
238060	YB2401CH	Chrome	

#### Voss™ Tank Lever



Part #	Mfg #	Finish	Price
153124	YB5101BN	Brushed Nickel	
157526	YB5101CH	Chrome	
162351	YB5101ORB	Oil Rubbed Bronze	

#### Waterhill® Tank Lever



Part #	Mfg #	Finish	Price
172077	YB9801NL	Polished Nickel	
123964	YB9801ORB	Oil Rubbed Bronze	

#### Weymouth® Tank Lever



Part #	Mfg #	Finish	Price
183891	YB8401CH	Chrome	
152843	YB8401NL	Polished Nickel	

## Tank Parts

### Wynford Tank Lever



Part #	Mfg #	Finish	Price
240314	YB5201BN	Brushed Nickel	
238815	YB5201ORB	Oil Rubbed Bronze	

### Toilet Seats

#### Home Care Glacier Elevated Toilet Seat

- Plastic
- Round front



Part #	Mfg #	Finish	Price
243872	DN7020	White	



## Tank Parts

### Gerber® Toilet Tank Parts

#### Flapper

Part #	Mfg #	Description	Price
063847	99-644	2" Rigid Flapper Assembly for Black Pedestal Flush Valve	
084363	99-647	1.6 gpm Flapper	
105004	99-770	1.6 gpm Flapper for 3" Flush Valves	
227859	99-014	1.6 gpm Flapper 3" for Avalanche Tank AV2889X	

#### Tank Lid

Part #	Mfg #	Description	Price
107949	TC-28-590	Tank Lid for Viper Toilets, White	
097776	TC-28-601	Tank Lid for PeeWee Children's Gravity Fed Toilets, White	
122060	TC-28-595	Tank Lid for 10" Viper, White	
154859	TC-28-890	Tank Lid for 12" Avalanche, Wht	
166514	TC-28-990	Tank Lid for 1.28gpf 12" Maxwell Tanks, White	
166520	TC-HE-590	Tank Lid for 1.28gpf 12" Viper Tanks, White	

#### Trip Lever

Part #	Mfg #	Description	Price
092083	99-171-KT	Flushmate LH Trip Lever for 503 Series & 21-012 Toilets	
028802	99-586	Tank Lever, All Gravity Tanks, White Plastic	
038088	99-571KT	Tank Lever, Chrome	
056279	99571RHK	RH Actuator Rod Kit ONLY for Ultra Flush Tanks	
104778	99-588	Chrome, Metal Tank Lever for Aqua Saver™ & Maxwell®	
112219	99-685	Tank Lever for Gravity Fed Toilets, Chrome	
109977	99-656-09	Tank Lever for Viper Gravity Fed Toilets, Biscuit	
110648	99-656-WH	LH Trip Lever for Viper Tank, White	
166524	99-659-WH	LH Trip Lever for 10" RI Avalanche Tank	
222877	99-001-09	LH Trip Lever for Viper Tank, Biscui	

### Gerber® Toilet Tank Parts (Continued)

#### Trip Lever

Part #	Mfg #	Description	Price
166525	99-001-WH	LH Trip Lever for Viper Tank, White	
166522	99-840	LH Plastic Trip Lever for Maxwell HET Tanks, White	
060279	N9-571	Trip Lever for FMIII 2-Pc Units, Brushed Nickel	
076134	WH571	Metal Trip Lever for FM III 2-Pc Units, White	

#### Flush Valves

Part #	Mfg #	Description	Price
037484	99-403	Flush Valve Cartridge	
101980	99-648	Viper Flush Valve	
105003	99-780	1.6 gpf 3" Flush Valve for Picturesque, Brianne, Logan Square, and Avalanche	

#### Washers

Part #	Mfg #	Description	Price
004790	90-940	Washer	
004795	91-150	Beveled Washer for Bath waste Head	
026026	91-260	Washer	

\*Physical Vapor Deposition (PVD) Limited Lifetime Finish

[www.plumbsupply.com](http://www.plumbsupply.com) • Serving our Customers Since 1946 • [www.waterconcepts.net](http://www.waterconcepts.net)

## Tank Parts

### Toilet Tank Fill Valves

- Fits most toilet tanks
- Saves water
- Easy to install
- Replaces old-fashioned units
- Corrosion-resistant materials

#### PRO45 Fill Valve

- Ultra-quiet operation
- Minimal water hammer
- Code approved



Part #	Mfg #	Description	Price
096993	PRO45	Fill Valve	

#### PRO45U Universal Fill Valve

- For all two-piece toilets and most one-piece toilets
- Refill diverter inserts and roller clamp refill adjuster allow PRO45U to set toilet to factory specifications for bowl refill
- Ultra-quiet operation
- Minimal water hammer
- Code approved



Part #	Mfg #	Description	Price
145790	PRO45U	Universal Fill Valve	

#### Pro Series® Fill Valve

- Heavy-duty shank manages water flow, eliminating water hammer by 99% and delivering tank refill at half the noise level of other valves
- Adjustable height for a universal fit and a float screw for fine tuning
- Extremely durable



Part #	Mfg #	Description	Price
096995	PRO45B	Anti-Siphon Fill Valve w/Brass Shank	
097287	PRO45C	Anti-Siphon Fill Valve w/Adj Flapper	
096994	PRO45K	Complete Kit Includes Fill Valve, Flush Valve, Bowl Gasket, Bolts, and Tank Lever	

### Performax® Fill Valve

- Easy to install
- Quietest and Most Powerful Solution
- Features Ultra Quiet Fill
- 2X greater refill rate than standard fill valves
- Height adjusts 10" to 15"
- Helps prevent excessive or inadequate bowl fill level
- Some toilet models not supported: Flapperless, One Piece Toilets and Side Entry Valves



Part #	Mfg #	Description	Price
243335	400ARHR	Ultra Quiet Fill Valve	

#### 400LS – Universal Fill Valve, Leak Sentry®

- Prevents automatic refill of water when flapper is worn and water is draining out
- Code approved
- Anti-Siphon design – Won't contaminate fresh water supply
- Also replaces 400LG Leak Guard Valve



Part #	Mfg #	Description	Price
035212	FL400LS	Universal 3.5 - 7 gpf	

#### Fill Valve and Flapper Value Pack

- 400A Anti-Siphon Fill Valve
- 504 Sure-Fit® Super Flapper



Part #	Mfg #	Description	Price
089222	400AW504	Fill Valve and Flapper	

### Fill Valve Repair Parts

#### Replacement Seal

- Easy repair, extends valve life



Part #	Mfg #	Description	Price
004376	242	For 200A & 400A Fill Valves	



## Tank Parts

### Fill Valve Repair Parts (Continued)

#### Replacement Seal

Part #	Mfg #	Description	Price
004370	B212	Replacement Seal, Bulk	

### Flush Valves

#### 507AK Complete Toilet Bowl Gasket

- Saves water, stops leaks at the drain
- Includes proven Adjust-A-Flush™ flapper that dials to adjust water volume for a custom flush
- Fits most 2- and 3-bolt tanks, including 1.6 gallon models
- Easy to install
- Universal gasket fits most close-coupled toilets
- 5-Year warranty



Part #	Mfg #	Description	Price
062253	507AK	Flush Valve, Bolts & Gasket	

#### 540AKR Complete 3" Toilet Flush Valve Kit

- Fixes leaks between tank and bowl
- Easy adjustable overflow tube
- Adjustable flapper to maximize water savings
- Chlorine resistant silicone flapper seal
- Includes:
  - Gasket
  - Bolts
  - Washers
  - Nuts



Part #	Mfg #	Description	Price
169180	540AKRP5	Universal Flush Valve, 3"	

#### PRO57 Flush Valve

- Longer-life, kink-free stainless steel chain
- Corrosion-resistant materials withstand constant use
- Adjustable float controls water in tank for optimal flush
- Universal-fit, chlorine-resistant flapper that fits most toilets
- 5-Year warranty



Part #	Mfg #	Description	Price
096996	PRO57	Flush Valve	

### Flush Valves (Continued)

#### PRO57 Flush Valve

Part #	Mfg #	Description	Price
097290	PRO57K	Flush Valve w/PRO55 Flapper	

### Flappers

#### PRO53 Flapper

- Professional grade material
- Kink-free heavy-duty metal chain
- Replaces most worn flapper or tank ball units



Part #	Mfg #	Description	Price
096997	PRO53	Heavy-Duty Flapper	

#### PRO54 Chemical-Resistant Flapper

- Universal fit flapper
- Fits flush valves with and without mounting ears and American Standard actuator units
- Strong, kink-free metal chain
- Durable material resists chemicals and hard water
- 5-Year warranty



Part #	Mfg #	Description	Price
096998	PRO54	Chemical-Resistant Flapper	

#### PRO55 Flapper

- Adjustable volume for optimal flushes every time
- Chlorine resistant
- Heavy-duty metal chain with float
- Fits most flapper or tank ball units



Part #	Mfg #	Description	Price
097288	PRO55	Flapper w/Adjustable Float	



## Tank Parts

### Pro Series Universal Adjustable Flapper

- Adjustable dial
- Chlorine and hard water resistant
- Solid frame for the best seal every time – no twisting
- Fits most 2" flush valves
- Built-in Microban®



Part #	Mfg #	Description	Price
165929	PRO56	1.28 to 3.5+ gpf	

### 502 – Performax® Adjustable 2" Flapper

- Fits most 2" flush valves
- Adjustable dial for maximum performance and water savings
- Chlorine and hard water resistant
- Solid frame for the best seal every time – no twisting
- Built-in Microban®



Part #	Mfg #	Description	Price
056444	FL502	2", 1.28 – 3.5+ gpf	

### PRO58 Universal 3" Adjustable Flapper

- Adjustable float cup for maximum performance and water savings
- Chlorine and hard water resistant
- Solid frame for the best seal every time – no twisting
- Adjustable mounting arms – fits all 3" flush valves
- Long lasting silicone seal



Part #	Mfg #	Description	Price
165930	FLPRO58	3", 1.6 gpf	

### 500 – Universal Solid Frame 2" Flapper

- Fits most 2" flush valves
- Solid frame for the best seal every time – no twisting
- Built-in Microban®



Part #	Mfg #	Description	Price
004378	FL500	2", 3.5+ gpf	

### Bull's Eye® Super Flapper

- Chlorine-resistant for harsh water regions
- Outlasts vinyl or rubber
- Ends leaks at the tank drain
- Rigid frame precisely aligns flapper on drain
- 5-Year warranty



Part #	Mfg #	Description	Price
035805	501	Fits Most Tanks	

### 503 – Universal Flexible Frame 2" Flapper

- Flexible design – fits on flush valves with or without mounting ears
- Fits most 2" flush valves
- Built-in Microban®



Part #	Mfg #	Description	Price
066216	FL503	2", 3.5+ gpf	

### 504 – Universal Flexible Frame 2" Red Flapper

- Flexible design – fits on flush valves with or without mounting ears
- Fits most 2" flush valves
- Built-in Microban®
- Chlorine and hard water resistant



Part #	Mfg #	Description	Price
066215	FL504	2", 3.5+ gpf	

### 3" Universal Water Saving Long Life Toilet Flapper

- Fits all 3" flapper toilets currently on the market
- Fits toilets in three easy adjustments
- Included guide tells you what settings you need for the most popular toilets
- Silicone seal lasts up to ten times longer than a regular flapper
- 10-Year warranty



Part #	Mfg #	Description	Price
120028	5403	3" Universal Flapper	

## Tank Parts

### Five Minute Flush Valve Repair Kit

- True universal flapper
- Provides new drain seat for damaged flush valves
- Works on most toilets
- Chlorine-resistant, rigid frame flapper
- Adjustable timing cup for most efficient flush
- 5-Year warranty



Part #	Mfg #	Description	Price
004380	555CRP8	Fits Most Tanks	

### Tank Levers

#### Sure-Fit® Tank Lever

- Trims/bends to fit most front, side and angle-mounted tanks
- No pre-measuring required
- Easy to install
- Self-tightening lock-nut won't loosen over time
- Durable, non-corroding plastic
- Fits most American Standard®, Eljer®, Kohler® Wellworth® brand toilets and more



Part #	Mfg #	Description	Price
004382	680	White	
004383	681	Chrome	

#### Sure-Fit® Metal-Arm Tank Lever

- Trims/bends to fit most front, side and angle-mounted tanks
- Easy to install
- Self-tightening lock-nut won't loosen over time
- Fits most American Standard®, Eljer®, Kohler® Wellworth® brand toilets and more



Part #	Mfg #	Description	Price
064603	683	White	
064606	686	Platinum	
117322	687	Oil Rubbed Bronze	

### Perfect Fit™ Tank Lever

- Universal: Fits most toilets with a Front, Side, Angle or Right mount
- Simple and easy to install
- Simple to adjust the length and angle for a proper fit.
- Direct Replacement for Mansfield®, Kohler Wellworth®, Eljer®, and American Standard®
- 3- Year Warranty



Part #	Mfg #	Description	Price
241786	641	Chrome	
241787	642	Brushed Nickel	

### 682 – Triangular Tank Lever Brass Finish

- Lifetime polished brass finish
- Trims/bends to fit most front, side and angle mount tanks
- 1-year warranty
- Easy to install
- Self-tightening locknut wont loosen over time



Part #	Mfg #	Description	Price
004384	FL682	Brass	

### 685 – Curved Tank Lever Brass Finish

- Lifetime polished brass finish
- Durable metal arm
- Trims/bends to fit most front, side and angle mount tanks
- 3-year warranty



Part #	Mfg #	Description	Price
064605	FL685	Brass	

### 693 – Premium Lever Oil Rubbed Bronze



Part #	Mfg #	Description	Price
233205	FL693	Oil Rubbed Bronze	



## Tank Parts

### PRO61 Tank Lever

- Direct replacement tank lever
- Chrome finished handle
- Self-tightening lock nut
- Fits most Eljer®, American Standard®, Kohler® Wellworth®, and Mansfield® toilets



Part #	Mfg #	Description	Price
096999	PRO61	Tank Lever w/Chrome Handle	

### PRO64 Tank Lever

- Direct replacement tank lever
- European style chrome finished handle
- Self-tightening lock nut (won't loosen over time)
- Fits most Eljer®, American Standard®, Kohler® Wellworth®, and Mansfield® toilets



Part #	Mfg #	Description	Price
097000	PRO64	Euro Style, Chrome	

## Flush Valve-Related Products

### American Standard™ Seat Disc

- Fits all American Standard actuator flush valves
- For snap-on or thread-type actuators
- Chlorine resistant



Part #	Mfg #	Description	Price
051580	5103	American Standard™ Seat Disc	

### PROS3KP15 Replacement Flush Valve Seals

- Fits Kohler AquaPiston Flush Valves and American Standard Champion 3 Flush



Part #	Mfg #	Description	Price
185588	FLPROS3KP15	Replacement Valve Seals	

### PROS3MAP15 Replacement Flush Valve Seals

- Fits Mansfield #210 & 211 Flush Valves



Part #	Mfg #	Description	Price
185589	FLPROS3MAP1	Replacement Valve Seals	
	5		

## Tank Parts

### Closet Tank Parts

#### Douglas Flush Valve

- Rubber washer
- Solid ring guide
- Locknut
- Overflow tube



Part #	Mfg #	Description	Price
008025	1029	White Plastic Flush Valve, w/Flapper	

#### Anti-Siphon Ballcock

- Brass float rod
- Adjustment screw



Part #	Mfg #	Description	Price
008021	1015N	Diaphragm and Adjustable Screw	

#### Lift Wire - Brass



Part #	Mfg #	Description	Price
008111	856	9" Upper Lift Wire	

#### Tank Float

- Oval, 4"x5"

Part #	Mfg #	Description	Price
008027	1073	4"x 5" Oval Plastic	



---

---

## Tank Parts

---

---

### Tank Replacement Parts

#### Replacement Seal

Part #	Mfg #	Description	Price
108423	090735	208/209, Black	

## Tank Parts

### Toilet Flappers

- *Guaranteed chemical resistant for 6 years*



Part #	Mfg #	Description	Price
076236	16BP	Korky 1.6 Adj Replacement Flapper	
193797	50BP	Korky 5&7 gal, 2" Opening	
043277	52P	Economy Blue Vinyl 2" Opening	
006219	54BP	Korky® "Original" Universal	
006221	58BP	Kohler® Red Flush Ball	
006201	2001BP	Red Korky® Plus	
137329	2004BP	Korky® Plus Premium Adjustable For Kohler & American Standard 2-Piece Toilets	
136414	2021BP	Korky® Red 3" G-Max	

### Miscellaneous Parts

Part #	Mfg #	Description	Price
162204	427BP	Mansfield® 210/211 Valve Seal	

## Tank Parts

### Toilet Tank Parts

#### Triple Seal® Tank Ball



B-251-12

B-252

Part #	Mfg #	Description	Price
008850	B-251-12	2-5/8" Standard, 12/Pk	
008851	B-252	3" Standard	

#### TITE-SEAL® Tank Ball

- *Designed to fit the curvature of all flush valves*



Part #	Mfg #	Description	Price
008852	B-254-12	Standard, 12/Pk	





## Tank Parts

### Toilet Trip Levers

#### Universal Trip Lever

- Fits most standard old style 2-piece toilets
- Front-mount



Part #	Mfg #	Finish	Price
147373	934-ORB	Oil Rubbed Bronze	

## Tank Parts

### Trip Levers

#### 46 Trip Lever

- Fits tank number: 120, 121, 700, 702, 705, 707



Part #	Mfg #	Description	Price
239635	46CH	Chrome	

#### 41 Trip Lever

- Left hand, front mount

Part #	Mfg #	Description	Price
192277	41CH-P	Chrome	

#### 40 Trip Lever

- Left hand, front mount

Part #	Mfg #	Description	Price
192338	40CH-P-20	Chrome	

### Flush Valves

Part #	Mfg #	Description	Price
242537	2036-1212	1.28 GPF Flush Valve	
242538	2037-1212	1.6 GPF Flush Valve	

#### Tank Number 700 Flush Valve



Part #	Mfg #	Description	Price
239634	212-1034	Flush Valve	
192284	210-1112	11-1/2" Flush Valve	

#### Flush Valve Seal Servive Kit

- For 210 & 211 flush valves



Part #	Mfg #	Color	Price
192348	630-0030	Red	

### Flush Valve Seal



Part #	Mfg #	Description	Price
192292	630-4837	For 208/209 Flush Valves	

### Flush Valve Stop Cap

- For use with 210 or 211 flush valves



Part #	Mfg #	Description	Price
240300	630-5907	Cap for 210/211 Flush Valves	
193242	225-5907-20	Cap for 210/211 Flush Valves	

### Flappers

#### Mansfield Flapper

- 4 inserts
- Chart telling which insert fits which model



Part #	Mfg #	Description	Price
196159	630-0207	3" Large Flapper	

### Miscellaneous Parts

#### SmartFasten Tank-to-Bowl Kit



Part #	Mfg #	Description	Price
192286	630-0204	2"	

## Tank Parts

### Miscellaneous Tank Parts

Part #	Mfg #	Description	Price
254318	1304525	Seal for Mansfield 210 Flush Vlvs	
192352	CD301	Replacement Diaphragm Flushboy	
215444	CD403	Drop-In Rebuild Kit for Flushboy	

### Trip Levers

#### Accent Single Action Tank Lever



Part #	Mfg #	Description	Price
030041	1317004	Chrome Trip Lever	

### Flush Valves

#### Flush Valve for Mansfield 210

- 3-1/2 Gallon tanks
- 10-3/4" Length



Part #	Mfg #	Description	Price
254316	1360100	Fits Mansfield 210	

## Commercial Toilet Seats

### Commercial Toilet Seats

#### Lustra™ Commercial Open Front Seat

- Solid polypropylene plastic resistant to staining, fading, chipping peeling
- Open front with check hinge
- Without cover
- C = Check hinge
- SC = Self-sustaining check hinge
- A = Anti-microbial



Part #	Mfg #	Style	Color	Price
060424	K-4670-C-47	Elongated	Almond	
058174	K-4670-C-95	Elongated	Ice Grey™	
078340	K-4670-C-K4	Elongated	Cashmere	
065583	K-4670-CA-0	Elongated	White	
053392	K-4670-SC-0	Elongated	White	
060836	K-4679-CA-0	1" Bumpers	White	

#### Lustra™ Commercial Open Front Seat

- Solid polypropylene plastic
- Without cover
- Self-raising hinge
- Stainless steel mounting bolts



Part #	Mfg #	Style	Color	Price
154497	K-4672-0	Elongated	White	

#### Lustra™ Commercial Open Front Seat with Check Hinge

- Solid polypropylene plastic
- Without cover
- Stainless steel mounting bolts



Part #	Mfg #	Style	Color	Price
156564	K-4667-C-7	Elongated	Black	

### Stronghold® Commercial Open Front Seat

- Solid polypropylene plastic resistant to staining, fading, chipping, peeling
- Integrated handle allows user to easily raise and lower the ring
- Check hinge stops seat from leaning back and applying pressure on tank/flushometer
- Cover sold separately
- C = Check hinge
- GC = Quiet-Close™ check hinge
- SC = Self-sustaining check hinge
- CA = Check hinge and Anti-Microbial



Part #	Mfg #	Style	Color	Price
103331	K-4731-C-0	Elongated	White	
156010	K-4731-C-47	Elongated	Almond	
118166	K-4731-C-7	Elongated	Black Black™	
133529	K-4731-C-96	Elongated	Biscuit	
129852	K-4731-GC-0	Elongated	White	
103329	K-4731-SC-0	Elongated	White	
246803	K-4731-SC-7	Elongated	Black Black™	
183072	K-4731-CA-0	Elongated	White	

### Triko™ Open Front Toilet Seat

- Molded wood
- Polished chrome hinges



Part #	Mfg #	Style	Color	Price
182458	K-4710-GS-0	Elongated	White	

\*Vibrant Limited Lifetime Finish

[www.waterconcepts.net](http://www.waterconcepts.net) • Serving our Customers Since 1946 • [www.plumbsupply.com](http://www.plumbsupply.com)

## Commercial Toilet Seats

### Commercial Plastic Toilet Seats

#### 9400SSCT Commercial Open Front Plastic Seat

- Heavyweight injection molded solid plastic
- Self-sustaining check hinges with non-corrosive 300 stainless steel posts and pintles
- Sta-Tite® commercial fastening system™
- Cover sold separately



Part #	Mfg #	Style	Color	Price
002394	9400SSCT-000	Elongated	White	

#### 1655CT Commercial Open Front Plastic Seat

- Extra heavyweight contoured seat
- Sta-Tite® Commercial fastening System™
- External check hinges with 300 Series stainless steel posts and pintles that stop seat 11° beyond vertical
- Cover sold separately



Part #	Mfg #	Style	Color	Price
002354	1655SSCT	Elongated	White/SS	
118923	1655CT-000	Elongated	White	

#### 1955SSC Commercial Open Front Plastic Seat

- Heavyweight
- Self-sustaining and external check hinge
- Cover sold separately



Part #	Mfg #	Style	Color	Price
002361	1955SSC-000	Elongated	White	
002362	1955SSC-047	Elongated	Black	

#### 1955SSTFR Commercial Fire Retardant Plastic Seat

- Heavy duty
- Plastic check hinge
- Bolt to seat front: 18-3/8"
- Firepro® fire-retardant material
- Sta-Tite® commercial fastening system
- 300 Series stainless steel posts and pintles
- Cover sold separately



Part #	Mfg #	Style	Color	Price
163537	1955SSTFR-000	Elongated	White	

#### 955CT/1955CT Commercial Open Front Plastic Seat

- Extra heavyweight contoured seat
- Sta-Tite® Commercial fastening System™
- External check hinges with 300 Series stainless steel posts and pintles that stop seat 11° beyond vertical
- Cover sold separately



1955CT

Part #	Mfg #	Style	Color	Price
002395	955CT-000	Round	White	
002359	1955CT-000	Elongated	White	
002360	1955CT-047	Elongated	Black	

#### 955SSCT Commercial Open Front Plastic Seat

- Extra heavyweight contoured seat
- Sta-Tite® Commercial fastening System™
- External check hinges with 300 Series stainless steel posts and pintles that stop seat 11° beyond vertical
- Cover sold separately



Part #	Mfg #	Style	Color	Price
002397	955SSCT-000	Round	White	

## Commercial Toilet Seats

### 1900SS Commercial Plastic Seat with Cover

- Heavyweight
- Self-sustaining hinge
- Closed front
- 300 Series stainless steel hardware



Part #	Mfg #	Style	Color	Price
027186	1900SS-000	Elongated	White	

### 1950 Commercial Open Front Plastic Seat with Cover

- Commercial weight
- Top-Tite® hinge



Part #	Mfg #	Style	Color	Price
002356	1950-000	Elongated	White	
002358	1950SS	Elongated	White/SS	

### 3L2050T Open Front Plastic Seat with Cover

- STA-TITE® commercial fastening system
- DuraGuard® Antimicrobial
- 3" Lift hinges and bumpers



Part #	Mfg #	Style	Color	Price
169461	3L2050T	Elongated	White	

### 2155C Commercial Open Front Plastic Seat

- Duraguard® anti-microbial agent
- Heavyweight
- External check hinge with stainless steel post
- Cover sold separately
- Hinges:
  - 2155C - Check hinge
  - 2155SSC - Has self-sustaining hinge



Part #	Mfg #	Style	Color	Price
070728	2155C-000	Elongated	White	
030385	2155SSC-000	Elongated	White	

### 3155C Commercial Open Front Extra Heavy Plastic Seat

- Duraguard® anti-microbial agent
- Heavyweight
- External check hinge with stainless steel post
- Cover sold separately
- Hinges:
  - 3155C - Check hinge
  - 3155SSC - Has self-sustaining hinge



Part #	Mfg #	Style	Color	Price
030638	3155SSC-000	Elongated	White	

### 3155CT Commercial Open Front Extra Heavy Plastic Seat

- Duraguard® anti-microbial agent
- Heavyweight
- External check hinge with stainless steel post
- Cover sold separately



Part #	Mfg #	Style	Color	Price
118925	3155CT-000	Elongated	White	

### Medic-Aid® Heavy Duty Commercial Plastic Toilet Seat

- STA-TITE® Commercial fastening system
- Heavy-Weight plastic
- 3" Lifts
- 300 Series Stainless steel posts and pintles



(3L2150T) - Includes Cover

Part #	Mfg #	Style	Color	Price
132585	3L2155T	Elongated	White	
147196	3L2150T	Elongated	White	





## Commercial Toilet Seats

### Commercial Plastic Toilet Seats

#### 1580CT Commercial Open Front Plastic Seat

- Check Hinge
- STA-TITE® Commercial Fastening System™
- Designed to Fit Baby Bowls
- DuraGuard® Antimicrobial Built-In Seat Protection™



Part #	Mfg #	Style	Color	Price
192350	1580CT000	Toddler/Baby	White	

#### 255 Commercial Open Front Plastic Seat

- Check Hinge
- Non-Corrosive Hardware



Part #	Mfg #	Style	Color	Price
203971	255	Elongated	White	

#### 293SS Commercial Open Front with Cover Plastic Seat

- Metal Hinge
- 300 Series Stainless Hardware
- Self-Sustaining Hinge



Part #	Mfg #	Style	Color	Price
194036	293SS	Elongated	White	

#### 295CT Commercial Open Front Plastic Seat

- Check Hinge
- Non-Corrosive 300 Series Stainless Steel Posts
- STA-TITE® Commercial Fastening System™



Part #	Mfg #	Style	Color	Price
218552	295CT	Elongated	White	

#### 295SSCT Commercial Open Front Plastic Seat

- Check Hinge
- Self-Sustaining Hinge
- 300 Series Stainless Hardware
- STA-TITE®



Part #	Mfg #	Style	Color	Price
193197	295SSCT	Elongated	Black	
193196	295SSCT	Elongated	White	

#### 397SSCT Commercial Open Front Plastic Seat

- Self-Sustaining Hinge
- 300 Series Stainless Hardware
- STA-TITE®
- STA-TITE® Commercial Fastening System™
- Non-Corrosive 300 Series Stainless Steel Posts



Part #	Mfg #	Style	Color	Price
193201	397SSCT	Round	White	

#### 9500CT Commercial Open Front Plastic Seat

- Check Hinge
- Non-Corrosive 300 Series Stainless Steel Posts
- STA-TITE® Commercial Fastening System™



Part #	Mfg #	Style	Color	Price
221877	9500CT	Elongated	White	

#### 9500SSCT Commercial Open Front Plastic Seat

- Check Hinge
- Self-Sustaining Hinge
- Non-Corrosive 300 Series Stainless Steel Posts
- STA-TITE®



Part #	Mfg #	Style	Color	Price
193205	9500SSCT	Elongated	White	



## Commercial Toilet Seats

### 7650T Hospitality Open Front with Cover Plastic Seat

- Non-Corrosive 300 Series Stainless Steel Posts
- STA-TITE® Commercial Fastening System™



Part #	Mfg #	Style	Color	Price
193568	7650T	Elongated	White	

### 3L2150T Medic-Aid® Open Front with Cover Plastic Toilet Seat

- Non-Corrosive 300 Series Stainless Steel Posts
- STA-TITE® Commercial Fastening System™
- DuraGuard® Antimicrobial Built-In Seat Protection™
- 3" Lift Hinges and Bumpers



Part #	Mfg #	Style	Color	Price
202530	3L2150T	Elongated	White	

### 7300SL Hospitality Toilet Seat

- Closed front with cover
- Whisper-Close™ hinges
- Includes four molded-in bumpers
- STA-TITE® Seat Fastening System™



Part #	Mfg #	Style	Color	Price
244199	7300SL	Elongated	White	

**Plastic Toilet Seats**

**Residential Plastic Elongated Toilet Seats**

**Bancroft™ Residential Closed Front Plastic Seat with Cover**

- Solid polypropylene plastic resistant to staining, fading, chipping peeling
- -CP - Polished chrome hinges
- -BN - \*Brushed nickel hinges
- (K-4659-0) includes Quick-Release™ plastic hinges



K-4659



K-4685

Part #	Mfg #	Style	Color	Price
087315	K-4685-CP-0	Elongated	White	
108566	K-4685-BN-47	Elongated	Almond	

**Brevia™ Q2 Advantage™ Residential Closed Front Plastic Seat with Cover**

- Quick-Attach™ hardware for a fast and secure installation
- Quick-Release™ hinges allow the seats to be easily removed for cleaning
- Fits one- and two-piece toilets
- Made of solid polypropylene plastic and is resistant to staining, fading, chipping and peeling
- Contoured seat for user comfort



Part #	Mfg #	Style	Color	Price
140965	K-4774-0	Elongated	White	
142394	K-4774-7	Elongated	Black Black	
141902	K-4774-47	Elongated	Almond	
140966	K-4774-96	Elongated	Biscuit	

**Cachet® Quick-Release™ Hinges with Grip-Tight Toilet Seat**

- Quick-Attach® hardware
- Grip-tight bumpers



Part #	Mfg #	Style	Color	Price
185955	K-7315-0	Elongated	White	
224559	K-7315-96	Elongated	Biscuit	

**Cachet® Nightlight Quiet-Close™ Residential Closed Front Seat with Cover**

- Light intensity designed to provide enough light to see toilet w/o disrupting nighttime vision
- Dual LED lighting
- Illumination cycle with automatic 7-hour nightlight
- Battery-operated (4) AA
- Up to 6 months of battery life
- Grip-tight bumpers
- Quick-Release™ hinges
- Quick-Attach® hardware



Part #	Mfg #	Style	Color	Price
180697	K-75796-0	Elongated	White	
167629	K-75796-47	Elongated	Almond	
188957	K-75796-95	Elongated	Ice Grey	
179826	K-75796-96	Elongated	Biscuit	
251467	K-75796-NY	Elongated	Dune	

**Cachet® Quiet-Close™ Residential Closed Front Plastic Seat with Cover**

- Solid polypropylene plastic
- Contoured seat for user comfort
- Quiet-Close™ lid and ring prevents slamming
- Quick-Release™ hinge caps snap open and seat pulls forward for removal
- Quick-Attach™ stainless steel fastener allows for top-mount screwdriver only install
- Slip resistant bumpers hold seat firmly in place
- Fits one- and two-piece toilets



Part #	Mfg #	Style	Color	Price
076739	K-4636-0	Elongated	White	
079973	K-4636-47	Elongated	Almond	
115339	K-4636-58	Elongated	Thunder Grey	
083221	K-4636-7	Elongated	Black Black	
094218	K-4636-95	Elongated	Ice Grey	
076740	K-4636-96	Elongated	Biscuit	
079971	K-4636-G9	Elongated	Sandbar	
148140	K-4636-NY	Elongated	Dune	
083597	K-4636-K4	Elongated	Cashmere	

\*Vibrant Limited Lifetime Finish

[www.plumbsupply.com](http://www.plumbsupply.com) • Serving our Customers Since 1946 • [www.waterconcepts.net](http://www.waterconcepts.net)

**Plastic Toilet Seats**

**Cachet® Quiet-Close™ Residential Closed Front Plastic Seat with Cover with Grip-Tight**

- Solid polypropylene plastic
- Quiet-Close™ lid and ring prevents slamming
- Hardware kit included
- Quick-Attach™ hardware
- Slip resistant bumpers hold seat firmly in place



Part #	Mfg #	Style	Color	Price
241732	K-7671-0	Elongated	White	

**Escale® Residential Closed Front Seat**

- Metal hinges



Part #	Mfg #	Style	Color	Price
251052	K-E70004-0	Elongated	White	

**French Curve® Grip-Tight Residential Seat**

- Solid polypropylene plastic
- Quiet-Close™ lid and ring prevents slamming
- Quick-Release™ hinges for easy removal for cleaning
- Quick-Attach® hardware for fast and secure installation



Part #	Mfg #	Style	Color	Price
097440	K-4713-0	Elongated	White	
150689	K-4713-58	Elongated	Thunder Grey	
126694	K-4713-7	Elongated	Black	
153532	K-4713-95	Elongated	Ice Grey	
099814	K-4713-96	Elongated	Biscuit	
101628	K-4713-G9	Elongated	Sandbar	
120212	K-4713-K4	Elongated	Cashmere	
244932	K-4713-NY	Elongated	Dune	

**Glenbury™ Quiet-Close™ Residential Grip-Tight Closed Front Plastic Seat with Cover**

- Solid polypropylene plastic resistant to staining, fading, chipping peeling
- Ergonomically contoured seat and cover
- Bumpers molded in, seat will not detach



Part #	Mfg #	Style	Color	Price
103463	K-4733-0	Elongated	White	

**Residential Plastic Elongated Toilet Seats (Continued)**

**Glenbury™ Quiet-Close™ Residential Grip-Tight Closed Front Plastic Seat with Cover**

Part #	Mfg #	Style	Color	Price
104660	K-4733-47	Elongated	Almond	
183073	K-4733-58	Elongated	Thunder Grey	
108853	K-4733-95	Elongated	Ice Grey	
104661	K-4733-96	Elongated	Biscuit	
107025	K-4733-G9	Elongated	Sandbar	

**Lustra™ Open Front Plastic Seat with Cover**

- Color-matched plastic hinges
- Stainless-steel mounting bolts



Part #	Mfg #	Style	Color	Price
056626	K-4650-0	Elongated	White	
080331	K-4650-47	Elongated	Almond	
124756	K-4650-7	Elongated	Black	
145224	K-4650-95	Elongated	Ice Grey	
064152	K-4650-96	Elongated	Biscuit	

**Lustra™ Open Front Plastic Seat with Cover and Anti-Microbial Agent**

- Color-matched plastic hinges
- Stainless-steel mounting bolts
- Includes an antimicrobial agent



Part #	Mfg #	Style	Color	Price
182453	K-4650-A-0	Elongated	White	

**Lustra™ with Quick-Release™ Hinges**

- Sturdy, chip-resistant polypropylene
- Finish will not stain or peel



Part #	Mfg #	Style	Color	Price
053380	K-4652-0	Elongated	White	
054874	K-4652-47	Elongated	Almond	
063230	K-4652-58	Elongated	Thunder Grey	
055922	K-4652-7	Elongated	Black	
056934	K-4652-95	Elongated	Ice Grey	

\*Vibrant Limited Lifetime Finish

## Plastic Toilet Seats

### Residential Plastic Elongated Toilet Seats (Continued)

#### Lustra™ with Quick-Release™ Hinges

Part #	Mfg #	Style	Color	Price
053383	K-4652-96	Elongated	Biscuit	
056735	K-4652-G9	Elongated	Sandbar	
089948	K-4652-K4	Elongated	Cashmere	
167790	K-4652-NY	Elongated	Dune	
082843	K-4652-W2	Elongated	Earthen White	

#### Lustra™ with Quick-Release™ Hinges

- Sturdy, chip-resistant polypropylene
- Finish will not stain or peel
- Stainless steel support arms
- Anti-microbial agent



Part #	Mfg #	Style	Color	Price
066940	K-4652-A-0	Elongated	White	

#### Lustra™ Residential Open Front Extra Heavy Plastic Seat

- Extra-heavy solid polypropylene plastic with check hinge
- -C - Check hinge
- -SC - Self-sustaining check hinge
- Cover sold separately



Part #	Mfg #	Style	Color	Price
077940	K-4666-C-0	Elongated	White	
084236	K-4666-SC-0	Elongated	White	

#### Purefresh™ Elongated Toilet Seat

- Contoured seat for user comfort
- Deodorizing system
- Dual LED night light
- Battery operated (2 D)



Part #	Mfg #	Style	Color	Price
172614	K-5588-0	Elongated	White	
185475	K-5588-96	Elongated	Biscuit	
183389	K-7729-NA	Garden Waterfall Refill Scent for K-5588 or K-5589		
183390	K-7774-NA	Carbon Filter Refill		

#### PureWarmth™ Heated Elongated Toilet Seat

- 3 Adjustable warmth settings
- Quiet-Close™ lid
- Quick-Release™ hinges
- Grip-tight bumpers
- Color matched plastic hinge
- Dual LED night light
- Compatible with KOHLER® PureWarmth™ app to adjust seat warmth and lighting



Part #	Mfg #	Style	Color	Price
258904	K-10349-0	Elongated	White	

#### PureTide™ Manual Cleansing Toilet Seat

- Single wand
- Side handle adjusts water spray position and pressure
- Quiet-Close™
- Quick-Release™ hinges
- Quick-Attach® hardware
- Grip-tight bumpers



Part #	Mfg #	Style	Color	Price
188675	K-5724-0	Elongated	White	

#### Reveal® Quiet-Close™ Toilet Seat with Grip-Tight

- Quiet-close™ lid and ring prevents slamming
- Quick-Release™ hinge caps snap open and seat pulls forward for removal
- Quick-Attach™ stainless steel fastener allows for top-mount screwdriver only installation
- Grip-Tight bumpers



Part #	Mfg #	Style	Color	Price
156172	K-4008-0	Elongated	White	
164439	K-4008-47	Elongated	Almond	
162486	K-4008-58	Elongated	Thunder Grey	
234375	K-4008-7	Elongated	Black	
177806	K-4008-95	Elongated	Ice Grey	
162265	K-4008-96	Elongated	Biscuit	
162183	K-4008-G9	Elongated	Sandbar	
171302	K-4008-K4	Elongated	Cashmere	
239012	K-4008-NY	Elongated	Dune	

\*Vibrant Limited Lifetime Finish

[www.plumbsupply.com](http://www.plumbsupply.com) • Serving our Customers Since 1946 • [www.waterconcepts.net](http://www.waterconcepts.net)

## Plastic Toilet Seats

### Reveal® Nightlight Quiet-Close™ with Grip-Tight Toilet Seat

- Light intensity designed to provide enough light to see the toilet without disrupting nighttime vision
- Dual LED lighting includes guiding light when lid is down
- Illumination cycle with automatic 7-hour nightlight
- Up to 6 months of battery life (4) AA
- Quick-Release™ hinges
- Quick-Attach® hardware



Part #	Mfg #	Style	Color	Price
181506	K-75792-0	Elongated	White	
176506	K-75792-47	Elongated	Almond	
244789	K-75792-7	Elongated	Black	
168104	K-75792-96	Elongated	Biscuit	

### Saile® Quiet-Close™ Residential Closed Front Plastic Seat with Cover

- Slow-closing lid and ring
- Hydraulic slow-closing device
- Ergonomically contoured seat
- Solid polypropylene plastic
- Quick-release hinges



Part #	Mfg #	Style	Color	Price
119902	K-4748-0	Elongated	White	
134913	K-4748-96	Elongated	Biscuit	

### Transitions® Nightlight Quiet-Close™ Toilet Seat with Grip-Tight

- Made of solid polypropylene
- Quiet-close child ring and adult ring
- Quick-release hinges



Part #	Mfg #	Style	Color	Price
182488	K-2599-0	Elongated	White	
103670	K-2599-47	Elongated	Almond	
095396	K-2599-96	Elongated	Biscuit	

### Residential Plastic Round Toilet Seats

#### Brevia™ Toilet Seat with Quick-Release™ Hinges

- Quick-Attach™ hardware for a fast and secure installation
- Fits one- and two-piece toilets
- Polypropylene
- Contoured seat for user comfort



Part #	Mfg #	Style	Color	Price
141901	K-4775-0	Round	White	
142951	K-4775-47	Round	Almond	
142518	K-4775-96	Round	Biscuit	

#### Cachet® Residential Closed Front Seat with Cover

- Quiet-close™ lid
- Grip-Tight bumpers
- Quick-Attach™ system



Part #	Mfg #	Style	Color	Price
179654	K-7673-0	Round	White	

#### Cachet® Quiet-Close™ Toilet Seat with Grip-Tight

- Solid polypropylene plastic
- Contoured seat for user comfort
- Quick-Release™ hinges
- Fits one- and two-piece toilets
- Quick-Attach™ stainless steel fastener
- Slip resistant bumpers hold seat firmly in place



Part #	Mfg #	Style	Color	Price
077571	K-4639-0	Round	White	
092023	K-4639-47	Round	Almond	
087785	K-4639-7	Round	Black	
100748	K-4639-95	Round	Ice Grey	
079212	K-4639-96	Round	Biscuit	
087783	K-4639-G9	Round	Sandbar	
152705	K-4639-K4	Round	Cashmere	
175530	K-4639-NY	Round	Dune	

\*Vibrant Limited Lifetime Finish

[www.waterconcepts.net](http://www.waterconcepts.net) • Serving our Customers Since 1946 • [www.plumbsupply.com](http://www.plumbsupply.com)



## Plastic Toilet Seats

### Cachet® Quiet-Close™ with Grip-Tight and Nightlight Technology

- Dual LED lighting includes guiding light when lid is down and task light when lid is lifted
- Illumination cycle with automatic 7-Hour nightlight
- Battery-operated - no cords required
- (4) AA batteries, not included



Part #	Mfg #	Style	Color	Price
181507	K-75758-0	Round	White	

### Cachet® Quick-Release™ Hinges with Grip-Tight Round-Front Toilet Seat

- Grip-tight bumpers
- Quick-Attach® hardware
- Color-matched plastic hinges



Part #	Mfg #	Style	Color	Price
252414	K-7316-47	Round	Almond	

### French Curve® with Quick-Release™ Hinges

- Quick-Attach® hardware
- Color-matched plastic hinges



Part #	Mfg #	Style	Color	Price
062923	K-4663-0	Round	White	

### Lustra® with Quick-Release™ Hinges

- Quick-Attach® hardware
- Color-matched plastic hinges



Part #	Mfg #	Style	Color	Price
061925	K-4662-7	Round	Black	
054754	K-4662-95	Round	Ice Grey	

### Purefresh™ Quiet-Close™ Front Toilet Seat

- Neutralizes odors continuously for up to 6 months
- Integrated freshener fills air with a light
- 8-Hour dual LED nightlight
- Battery-operated
- Grip-Tight bumpers
- Quick-Attach® hardware



Part #	Mfg #	Style	Color	Price
173391	K-5589-0	Round	White	

### Reveal® Quiet-Close™ with Grip-Tight

- Quick-Release™ hinges
- Quick-Attach® hardware
- Color-matched plastic hinges



Part #	Mfg #	Style	Color	Price
180562	K-4009-0	Round	White	
231641	K-4009-47	Round	Almond	
162687	K-4009-7	Round	Black	
183566	K-4009-96	Round	Biscuit	
247894	K-4009-G9	Round	Sandbar	

### Reveal® Nightlight Quiet-Close™ with Grip-Tight round-front Toilet Seat

- Dual LED lighting includes guiding light when lid is down and task light when lid is lifted
- Illumination cycle with automatic 7-Hour nightlight
- (4) AA batteries, not included



Part #	Mfg #	Style	Color	Price
171195	K-75793-0	Round	White	
188510	K-75793-96	Round	Biscuit	

### Rutledge® Quiet-Close™ Round-Front Toilet Seat

- Contoured seat
- Grip-Tight bumpers
- Quick-Release™ hinges
- Quick-Attach™ hardware



Part #	Mfg #	Style	Color	Price
246461	K-78052-0	Round	White	

\*Vibrant Limited Lifetime Finish

[www.plumbsupply.com](http://www.plumbsupply.com) • Serving our Customers Since 1946 • [www.waterconcepts.net](http://www.waterconcepts.net)

**Plastic Toilet Seats**

**Rutledge® Nightlight Quiet-Close™ Round-Front Toilet Seat**

- Dual LED lighting
- 3 Brightness levels
- Battery operated
- Contoured seat
- Grip-Tight bumpers
- Quick-Release™ hinges
- Quick-Attach™ hardware
- Illumination cycle - automatic 10-hour nightlight



Part #	Mfg #	Style	Color	Price
247113	K-78059-0	Round	White	

**Bidet Toilet Seats**

**C3®-050 Elongated Cleansing Bidet Toilet Seat**

- Hybrid heater provides continuously heated water for consistent comfort
- Stainless steel wand with automatic UV-light self-sanitization
- Front and rear wash modes provide warm water for cleansing
- Adjustable water temperature and water pressure
- Quiet-Close™ lid
- Quick-Release™ hinges



Part #	Mfg #	Style	Color	Price
232249	K-18751-0	Elongated	White	
251372	K-18751-96	Elongated	Biscuit	

**C3®-125 Elongated Cleansing Bidet Toilet Seat**

- Tank heater
- Automatic LED lighting
- Automatic deodorization function
- Warm-air drying system
- Quiet-Close™
- Quick-Release™ hinges
- Grip-Tight bumpers
- Front and rear wash modes
- Side seat controls for convenient access
- Adjustable water temperature and water pressure.
- Heated seat with adjustable temperature settings.



Part #	Mfg #	Style	Color	Price
132513	K-4737-0	Elongated	White	
132037	K-4737-96	Elongated	Biscuit	

**C3®-155 Elongated Cleansing Bidet Toilet Seat**

- Hybrid heater provides continuously heated water for consistent comfort
- Heated seat with 5 temperature settings
- Stainless steel wand with automatic UV-light self-sanitization
- LED lighting illuminates the bowl to serve as a night-light
- Ergonomically designed side panel offers larger control buttons for comfortable control
- Front and rear wash modes provide warm water for cleansing
- Adjustable water temperature and water pressure
- Choose oscillating or pulsating spray
- Warm-air drying system with adjustable air speed and temperature
- Automatic deodorization with carbon filter for odor control



Part #	Mfg #	Style	Color	Price
234867	K-8298-0	Elongated	White	
258497	K-8298-96	Elongated	Biscuit	

**C3®-200 Elongated Cleansing Bidet Toilet Seat**

- In-line heater
- Automatic LED lighting
- Automatic deodorization function
- Warm-air drying system
- Quiet-Close™
- Quick-Release™ hinges
- Grip-Tight bumpers
- Front and rear wash modes
- Adjustable water temperature and water pressure.
- Remote control with 2 programmable user presets
- Heated seat with five temperature settings.



Part #	Mfg #	Style	Color	Price
098585	K-4709-0	Elongated	White	

\*Vibrant Limited Lifetime Finish

[www.waterconcepts.net](http://www.waterconcepts.net) • Serving our Customers Since 1946 • [www.plumbsupply.com](http://www.plumbsupply.com)



**Plastic Toilet Seats**

**C3® 230 Elongated Bidet Toilet Seat**

- In-line heater provides continuously heated water for consistent comfort.
- Anterior and posterior nozzles provide warm, aerated water for cleansing.
- Adjustable water temperature and water pressure.
- Choose oscillating or pulsating spray.
- Touchscreen remote control with two programmable user presets.
- Stainless steel wand with UV-light self-sanitization.
- Heated seat with five temperature settings.
- LED lighting illuminates the bowl to serve as a night-light.
- Warm-air drying system with adjustable air speed and temperature.
- Carbon filter for odor control.
- Quiet-Close™ lid closes slowly and quietly without slamming.
- Quick-Release™ hinges allow seat to be unlatched from toilet for easy removal and convenient cleaning; no tools required.



Part #	Mfg #	Style	Color	Price
171896	K-4108-0	Elongated	White	
233574	K-4108-96	Elongated	Biscuit	

**C3®-455 Elongated Cleansing Bidet Toilet Seat**

- Hybrid heater provides continuously heated water for consistent comfort
- Heated seat with 5 temperature settings
- Stainless steel wand with automatic UV-light self-sanitization
- LED lighting illuminates the bowl to serve as a night-light
- Sleek, handheld remote control with two programmable user presets
- Front and rear wash modes provide warm water for cleansing
- Adjustable water temperature and water pressure
- Choose oscillating or pulsating spray
- Warm-air drying system with adjustable air speed and temperature
- Automatic deodorization with carbon filter for odor control



Part #	Mfg #	Style	Color	Price
254799	K-8298-CR-0	Elongated	White	

\*Vibrant Limited Lifetime Finish

[www.plumbsupply.com](http://www.plumbsupply.com) • Serving our Customers Since 1946 • [www.waterconcepts.net](http://www.waterconcepts.net)

## Plastic Toilet Seats

### Residential Plastic Elongated Toilet Seats

#### 113EC Closed Front Padded Toilet Seat

- Easy•Clean & Change®
- Soft Seat with Molded Wood Core
- Non-Corrosive Hardware



Part #	Mfg #	Style	Color	Price
258707	113ECWH	Elongated	White	

#### 170 Closed Front Plastic Seat with Cover

- Standard weight
- Molded-in bumpers
- Color-matched Top-Tite® hinges with non-corrosive top-tightening bolts and wing nuts
- Ring thickness is 3/8"
- Height of seat with cover is 1-1/2"



Part #	Mfg #	Style	Color	Price
107973	170-000	Elongated	White	

#### Affinity™ Closed Front Plastic Toilet Seat

- STA-TITE®
- Easy•Clean & Change®
- Whisper•Close®
- Precision Seat Fit™
- Super Grip Bumpers™



Part #	Mfg #	Style	Color	Price
254646	1200E4 000	Elongated	White	
256966	1200E4 346	Elongated	Biscuit	
255892	1200E4 006	Elongated	Bone	

#### 1800EC Easy-Clean and Change™ Closed Front Plastic Seat

- Lifts off for easy cleaning - twist hinge to unlock
- Color-matched Easy-Clean & Change™ hinges with stainless steel pintles
- Lift-Off™ top-tightening bolts, wing nuts, and no-slip washers



Part #	Mfg #	Style	Color	Price
103929	1800EC-000	Elongated	White	
131238	1800EC-346	Elongated	Biscuit	

### Residential Plastic Elongated Toilet Seats (Continued)

#### 1800EC Easy-Clean and Change™ Closed Front Plastic Seat

Part #	Mfg #	Style	Color	Price
127467	1800EC-006	Elongated	Bone	

#### NextStep® Built-In Potty Seat™

- Whisper-Close™
- Easy Clean & Change™ Hinges
- STA-TITE® Seat Fastening System



Part #	Mfg #	Style	Color	Price
180489	1483SLOW	Elongated	White	
186531	1483SLOW-346	Elongated	Biscuit	

### Residential Plastic Round Toilet Seats

#### Plastic Toilet Seat

- Easy Clean & Change®
- Non-corrosive bolts and wing nuts
- Closed front, includes cover



Part #	Mfg #	Style	Color	Price
002331	100EC	Round	Elongated	

#### Affinity™ Whisper-Close™ Residential Closed Front Plastic Seat with Cover

- Heavy-weight solid plastic
- Easy-Clean and Change™ hinge



Part #	Mfg #	Style	Color	Price
190419	200E3-346	Round	Biscuit	

## Plastic Toilet Seats

### Affinity™ Toilet Seat

- STA-TITE® Seat Fastening System™
- Easy Clean & Change®
- Whisper Close®
- Precision Seat Fit™  
1/2" front-to-back adjustability
- Super Grip Bumpers™  
provides greater stability



Part #	Mfg #	Style	Color	Price
254647	200E4	Round	White	

### NextStep® Built-In Potty Seat™

- Whisper-Close™
- Easy Clean & Change™ Hinges
- STA-TITE® Seat Fastening System



Part #	Mfg #	Style	Color	Price
139587	483SLOW	Round	White	

### 730SL Hospitality Toilet Seat

- Round closed front with cover
- Whisper-Close™ hinges
- Includes four molded-in bumpers
- STA-TITE® Seat Fastening System™



Part #	Mfg #	Style	Color	Price
244200	730SL	Round	White	

### 800EC Easy-Clean and Change™ Closed Front Plastic Seat

- Lifts off for easy cleaning - twist hinge to unlock
- Color-matched Easy-Clean & Change™ hinges with stainless steel pintles
- Lift-Off™ top-tightening bolts, wing nuts, and no-slip washers



Part #	Mfg #	Style	Color	Price
105555	800EC-000	Round	White	
002391	800EC-006	Round	Bone	

### 200TCA Closed Front Plastic Seat with Cover

- Heavy-weight and injection molded of solid plastic
- Features large molded-in bumpers
- Color-matched Top-Tite® hinges
- Closed front, includes cover
- Non-corrosive top-tightening bolts and wing nuts



Part #	Mfg #	Style	Color	Price
002365	200TCA	Round	White	

## Plastic Toilet Seats

### Residential Plastic Elongated Toilet Seats

#### Affinity™ 300E4 Residential Plastic Toilet Seat

- Closed front
- STA-TITE® Seat fastening system
- Easy Clean & Change®
- Whisper Close®
- Super Grip Bumpers™
- Precision Seat Fit™  
1/2" front-to-back adjustability for perfect bowl fit



Part #	Mfg #	Style	Color	Price
254618	380E4 000	Elongated	White	
254619	380E4 346	Elongated	Biscuit	

#### 130EC Residential Closed Front Plastic Seat

- Easy•Clean & Change®
- Non-Corrosive Hardware



Part #	Mfg #	Style	Color	Price
193204	130EC	Elongated	White	
194128	130EC	Elongated	Biscuit	
193514	130EC	Elongated	Bone	

#### 380SLOWT Residential Closed Front Plastic Seat

- Closed front with cover, elongated, injection molded solid plastic toilet seat.
- Features four molded-in bumpers, color-matched Whisper•Close®
- Easy•Clean & Change® hinges with STA-TITE® Seat Fastening System™.



Part #	Mfg #	Style	Color	Price
228429	380E3BI	Elongated	Biscuit	

### 380TCA Residential Closed Front Plastic Seat

- Top-Tite® Hinges
- Non-Corrosive Hex-Tite™ Bolts and Wing Nuts



Part #	Mfg #	Style	Color	Price
203128	380TCA	Elongated	White	

#### 7200SLEC Residential Plastic Toilet Seat

- Closed front with cover
- Includes four molded-in bumpers
- Whisper•Close®
- Easy•Clean & Change®
- Non-Corrosive Hardware



Part #	Mfg #	Style	Color	Price
244198	7200SLEC-BI	Elongated	Biscuit	
247022	7200SLEC-WH	Elongated	White	

### Residential Plastic Round Toilet Seats

#### Affinity™ 300E4 Residential Plastic Toilet Seat

- Closed front
- STA-TITE® Seat fastening system
- Easy Clean & Change®
- Whisper Close®
- Super Grip Bumpers™
- Precision Seat Fit™  
1/2" front-to-back adjustability for perfect bowl fit



Part #	Mfg #	Style	Color	Price
254616	300E4 000	Round	White	
254617	300E4 006	Round	Bone	

## Plastic Toilet Seats

### 300SLOWT Residential Closed Front Plastic Seat

- Closed front with cover, round, injection molded solid plastic toilet seat.
- Features four molded-in bumpers, color-matched Whisper•Close®
- Easy•Clean & Change® hinges with STA-TITE® Seat Fastening System



Part #	Mfg #	Style	Color	Price
228426	300E3BN	Round	Bone	

### 3EC Residential Closed Front Plastic Seat

- Easy•Clean & Change®
- Non-Corrosive Hardware



Part #	Mfg #	Style	Color	Price
193513	3EC	Round	White	

### 720SLEC Residential Plastic Toilet Seat

- Closed front with cover
- Includes four molded-in bumpers
- Whisper•Close®
- Easy•Clean & Change®
- Non-Corrosive Hardware



Part #	Mfg #	Style	Color	Price
244201	720SLEC-BI	Round	Biscuit	
247023	720SLEC-WHT	Round	White	



## Residential Plastic Toilet Seats

### Residential Plastic Elongated Toilet Seats

#### Adjustable Slow Close Elongated Toilet Seat



Part #	Mfg #	Description	Price
159359	99-213	White	
159414	99-213-09	Biscuit	

#### Open Front Toilet Seat for Children's PeeWee™ and Eli™ Toilet Bowls



Part #	Mfg #	Description	Price
239116	GC550119 43-GEG1	White	

#### Adjustable Slow Close Elongated Toilet Seat with Cover

- *Designed to fit the Avalanche 21-019 and 20-832 toilets*



Part #	Mfg #	Description	Price
236383	99-849	White	

\*Physical Vapor Deposition (PVD) Limited Lifetime Finish

[www.waterconcepts.net](http://www.waterconcepts.net) • Serving our Customers Since 1946 • [www.plumbsupply.com](http://www.plumbsupply.com)



## Wood Toilet Seats

### Residential Elongated Wood Toilet Seats

#### Avantis® Quiet-Close™ with Grip-Tight

- Quick-Release™ hinges
- Solid wood



Part #	Mfg #	Color	Price
183074	K-4761-BN-LAW	Light Antique Walnut	
108713	K-4761-CP-DAW	Dark Antique Walnut	

#### Kathryn® Elongated Seat

- Molded wood
- Exclusive seat for Kathryn K-3324 and K-4384 toilets
- -AF: Vibrant® french gold hinges
- -BN: Vibrant brushed nickel hinges
- -CP: polished chrome hinges
- -SN: Vibrant polished nickel hinges



Part #	Mfg #	Color	Price
179900	K-4701-AF-0	White	
086170	K-4701-BN-0	White	
182861	K-4701-CP-96	Biscuit	
242406	K-4701-SN-NY	Dune	
242404	K-4701-SN-96	Biscuit	

#### Ridgewood® Elongated Seat

- Made of compression molded wood
- Color matched polypropylene hinges



Part #	Mfg #	Color	Price
111833	K-4694-0	White	
131669	K-4694-96	Biscuit	

#### Stonewood® Elongated Seat

- Made of compression molded wood
- Color matched plastic hinges



Part #	Mfg #	Color	Price
108295	K-4647-0	White	
099425	K-4647-47	Almond	
108297	K-4647-96	Biscuit	

#### Stonewood® Quiet-Close™ Elongated Seat

- Made of compression molded wood
- Color-matched plastic hinges



Part #	Mfg #	Color	Price
253089	K-20466-0	White	

#### Stonewood® Seat with Quick-Release Hinges

- Made of compression molded wood
- Quick-Attach® hardware



Part #	Mfg #	Color	Price
183575	K-4814-0	White	
156590	K-4814-47	Almond	
189568	K-4814-96	Biscuit	

#### Triko™ Elongated Seat with Chrome Hinges

- Molded wood



Part #	Mfg #	Color	Price
127805	K-4722-T-0	White	
156595	K-4722-T-47	Almond	

#### Triko™ Elongated Seat

- Molded wood
- Color-matched plastic hinges



Part #	Mfg #	Color	Price
053398	K-4712-T-0	White	
053399	K-4712-T-47	Almond	
104445	K-4712-T-95	Ice Grey	
053400	K-4712-T-96	Biscuit	

\*Vibrant Limited Lifetime Finish

[www.plumbsupply.com](http://www.plumbsupply.com) • Serving our Customers Since 1946 • [www.waterconcepts.net](http://www.waterconcepts.net)



## Wood Toilet Seats

### Residential Round Wood Toilet Seats

#### Ridgewood® Round Seat

- Compression molded wood
- Color matched plastic hinges



Part #	Mfg #	Color	Price
166551	K-4695-47	Almond	

#### Stonewood® Round Seat

- Compression molded wood
- Color matched polypropylene hinges



Part #	Mfg #	Color	Price
108298	K-4648-0	White	
109682	K-4648-47	Almond	
108299	K-4648-96	Biscuit	

#### Stonewood® Quiet-Close™ Round Seat

- Made of compression molded wood
- Color-matched plastic hinges



Part #	Mfg #	Color	Price
259324	K-20467-0	White	

#### Stonewood® Toilet Seat with Quick-Release™ Color Matched Plastic Hinges

- Compression molded wood
- Quick-Attach® hardware



Part #	Mfg #	Color	Price
157867	K-4816-0	White	
222985	K-4816-47	Almond	

### Triko™ Round Seat

- Hardwood fibers molded with phenolic resins
- Durable baked enamel finish
- Plastic hinges



Part #	Mfg #	Color	Price
053394	K-4716-T-0	White	
053395	K-4716-T-47	Almond	
058719	K-4716-T-95	Ice Grey	
053396	K-4716-T-96	Biscuit	

### Triko™ Round Seat with Chrome Hinges

- Molded wood
- Polished Chrome Hinges



Part #	Mfg #	Color	Price
061514	K-4726-T-0	White	
156594	K-4726-T-47	Almond	

\*Vibrant Limited Lifetime Finish

[www.waterconcepts.net](http://www.waterconcepts.net) • Serving our Customers Since 1946 • [www.plumbsupply.com](http://www.plumbsupply.com)

## Wood Elongated Toilet Seats

### Residential Wood Elongated Toilet Seats

#### 1500EC Easy-Clean and Change™ Closed Front Molded Wood Seat

- Lifts off for easy cleaning - twist hinge to unlock
- Color-matched Easy-Clean & Change™ bumpers and hinges
- Lift-Off™ top-tightening bolts, wing nuts, and no-slip washers



Part #	Mfg #	Style	Color	Price
102035	1500EC	Elongated	White	
098010	1500EC-006	Elongated	Bone	
098014	1500EC-146	Elongated	Almond	
100455	1500EC-346	Elongated	Biscuit	

#### 1600E2 Easy-Clean and Change™ Closed Front Molded Wood Seat with Cover

- Molded wood with multi-coat enamel finish
- Color-matched bumpers
- Whisper-Close® lid
- Easy-Clean & Change™ hinges
- Non-corrosive, top-tightening bolts and wing nuts



Part #	Mfg #	Style	Color	Price
101794	1600E3	Elongated	White	
145184	1600E3-346	Elongated	Biscuit	

#### 1550PRO Proline™/Proseat™ Toilet Seat

- Open front with cover
- Plastic Top-Tite® hinges
- Non-Corrosive Hex-Tite™ bolts and wing nuts



Part #	Mfg #	Style	Color	Price
067665	1550PRO	Elongated	White	

### High Density™ Whisper Close® Molded Wood Seat

- Whisper Close™
- Easy Clean & Change®
- STA-TITE® Seat Fastening System



Part #	Mfg #	Style	Color	Price
138297	19170CHSL	Elongated	White	

### Residential Wood Round Toilet Seats

#### 500EC Easy-Clean and Change™ Closed Front Molded Wood Seat

- Lifts off for easy cleaning - twist hinge to unlock
- Color-matched Easy Clean & Change™ bumpers and hinges
- Lift-Off™ top-tightening bolts, wing nuts, and no-slip washers



Part #	Mfg #	Style	Color	Price
102033	500EC	Round	White	
100501	500EC-006	Round	Bone	
100223	500EC-146	Round	Almond	
100454	500EC-346	Round	Biscuit	

#### 600E2 Closed Front Molded Wood Seat with Cover

- Molded wood with multi-coat enamel finish
- Color-matched bumpers
- Whisper-Close® lid
- Easy-Clean & Change™ hinges
- Non-corrosive, top-tightening bolts and wing nuts



Part #	Mfg #	Style	Color	Price
101796	600E3-000	Round	White	
172118	600E3-346	Round	Biscuit	

---

---

## Wood Elongated Toilet Seats

---

---

### High Density™ Whisper Close® Molded Wood Seat

- *Whisper Close™*
- *Easy Clean & Change®*
- *STA-TITE® Seat Fastening System*



Part #	Mfg #	Style	Color	Price
179647	9170CHSL	Round	White	



## Wood Toilet Seats

### Residential Molded Wood Toilet Seats

#### 540EC Residential Closed Front Molded Wood Seat

- Easy•Clean & Change®
- Non-Corrosive Hardware



Part #	Mfg #	Style	Color	Price
198066	540EC-000	Round	White	
198067	540EC-006	Round	Bone	
198068	540EC-346	Round	Biscuit	

#### 540TTT Residential Closed Front Molded Wood Seat

- Non-Corrosive Hardware
- STA-TITE® Residential Fastening System™
- Adjustable Hinges



Part #	Mfg #	Style	Color	Price
212112	540TTT	Round	White	

#### 585EC Residential Closed Front Molded Wood Seat

- Easy•Clean & Change®
- Non-Corrosive Hardware



Part #	Mfg #	Style	Color	Price
198069	585EC-000	Elongated	White	
198070	585EC-006	Elongated	Bone	
198071	585EC-346	Elongated	Biscuit	

#### 585TTT Residential Closed Front Molded Wood Seat

- Non-Corrosive Hardware
- STA-TITE® Residential Fastening System™
- Adjustable Hinges



Part #	Mfg #	Style	Color	Price
212111	585TTT	Elongated	White	

#### 640E3 Residential Closed Front Molded Wood Seat

- Easy•Clean & Change®
- Whisper•Close®
- STA-TITE® Residential Fastening System™
- Adjustable Hinges



Part #	Mfg #	Style	Color	Price
202864	640E3-000	Round	White	

#### 685E3 Residential Closed Front Molded Wood Seat

- Easy•Clean & Change®
- Whisper•Close®
- STA-TITE® Residential Fastening System™
- Adjustable Hinges



Part #	Mfg #	Style	Color	Price
205557	685E3-000	Elongated	White	
203428	685E3-346	Elongated	Biscuit	



## Drill Bits

### Shockwave® Driver Bit Sets

#### SHOCKWAVE™ 9PC 1/2" Deep Well Socket Set

• Includes:

- (1) 3/8" SHOCKWAVE impact socket
- (1) 7/16" SHOCKWAVE impact socket
- (1) 1/2" SHOCKWAVE impact socket
- (1) 9/16" SHOCKWAVE impact socket
- (1) 5/8" SHOCKWAVE impact socket
- (1) 11/16" SHOCKWAVE impact socket
- (1) 3/4" SHOCKWAVE impact socket
- (1) 7/8" SHOCKWAVE impact socket
- (1) 1/4" Hex to 1/2" square adapter



Part #	Mfg #	Description	Price
160302	49-66-4484	SHOCKWAVE™ 1/2" Deep Well Socket Set (9 PC)	

#### Shockwave™ 12PC Impact Drive Guide Set

• Includes:

- (1) ECX™ Bit 1" #1
- (1) ECX™ Bit 1" #2
- (2) Phillips Bit 1" P2
- (1) Phillips Bit 1" P3
- (1) Slotted Bit 1" SL 1/4"
- (1) Slotted Bit 1" SL 3/16"
- (1) Square Bit 1" SQ2
- (1) TORX® Bit 1" T15
- (1) TORX® Bit 1" T20
- (1) TORX® Bit 1" T25
- (1) SHOCKWAVE™ 3 Magnetic bit tip holder



Part #	Mfg #	Description	Price
164158	48-32-4507	12PC Impact Drive Guide Set	

#### 18PC Shockwave™ Driver Bit Set

• Includes:

- (1) Phillips bit 1" P1
- (1) Phillips bit 1" P2
- (1) Phillips bit 1" P3
- (1) Slotted bit 1" SL 1/4"
- (1) Slotted bit 1" SL 3/16"
- (1) Square bit 1" SQ1
- (1) Square bit 1" SQ2
- (2) Phillips bit 2" P2
- (1) Phillips bit 2" P3
- (2) Square bit 2" SQ2
- (1) Square bit 2" SQ3
- (1) TORX® 2" T15
- (1) TORX® bit 2" T20
- (1) 3 1/2" Phillips #2
- (1) 3 1/2" Square drive #2
- (1) Case with bulk storage container
- (1) SHOCKWAVE™ magnetic bit holder



Part #	Mfg #	Description	Price
161626	48-32-4403	18-Pc Driver Bit Set	

#### 29-Piece Shockwave® Impact Duty™ Driver Bit Set

• Includes:

- Phillips bits:
  - 1" - (1) P1, (7) P2, (2) P3;
  - 2" Power - (2) P2, (1) P3
- Square bits:
  - 1" - (1) SQ1, (4) SQ2, (1) SQ3
  - 2" Power - (2) SQ2
- Torx® bits:
  - 1" - (1) T15, (1) T20, (1) T25
- Magnetic nut drivers: (1) 1/4" red, (1) 5/16" amber, (1) 3/8" blue
- (1) Magnetic bit holder
- (1) Case with bulk storage container



Part #	Mfg #	Description	Price
137578	48-32-4401	29-Pc Driver Bit Set	

#### 26-Piece Shockwave™ Drive and Fasten Set

• Includes:

- Phillips bits:
  - 1" - (1) P1, (1) P2, (3) P3
  - 2" - (1) P2
- Square bits:
  - 1" - (1) SQ1, (2) SQ2, (1) SQ3
  - 2" - (1) SQ2
- Torx® bits:
  - 1" - (2) T20, (2) T25, (1) T30
  - 2" - (1) T20, (1) T25
- 1/4" Hex to 3/8" square adapter (1)
- 1/4" Magnetic nut driver (1)
- Slotted bit 1" SL 3/16" (1)
- Drive Sockets:
  - (1) 3/8" Drive: 1/2" Socket,
  - (1) 3/8" Drive: 9/16" Socket
- Magnetic nut drivers:
  - (1) 3/8" Magnetic nut driver,
  - (1) 5/16" Magnetic nut driver
- (1) Shockwave™ compact magnetic bit holder



Part #	Mfg #	Description	Price
173708	48-32-4408	26-Pc Drive and Fasten Set	



## Drill Bits

### 32-Piece Shockwave™ Driver Bit Set

- Includes:
- Magnetic nut driver:  
(1) 1/4", (1) 5/16"
- Phillips bits:  
1" (1) P1, (4) P2, (1) P3  
2" (2) P2
- Phillips reduced 1" PR2 bit
- Slotted:  
1" (1) #8, (1) #10  
2" (1) #10
- Square bits:  
1" (1) SQ1, (3) SQ2, (1) SQ3  
2" (1) SQ2
- Torx® bits:  
1" (1) T15, (2) T20, (2) T25, (1) T30  
2" (1) T20, (1) T25



Part #	Mfg #	Description	Price
173709	48-32-4004	32-Pc Driver Bit Set	

### 35-Piece Shockwave® Impact Duty™ Driver Bit Set

- Includes:
- ECX™: 1" - (1) ECX1, (1) ECX2
- Phillips bits:  
1" (1) Ps, (2) P2, (1) P3;  
2" Power: (1) P1, (1) P2  
3-1/2" Power: (1) P2
- Square bits:  
1" (1) SQ1, (2) SQ2, (1) SQ3  
2" Power: (1) SQ1, (1) SQ2, (1) SQ3  
3-1/2" Power: (1) SQ2
- Torx® bits:  
2" Power: (1) T15, (1) T20, (1) T25, (1) T30
- Slotted bits:  
2" Power: (1) SL1/8", (1) SL3/16", (1) SL1/4"
- Magnetic nut drivers: (1) 1/4" red, (1) 5/16" amber,  
(1) 3/8" blue
- Hex Shank Drill Bits:  
1/4" (1) 1/8", (1) 5/32", (1) 3/16", (1) 7/32", (1) 1/4"
- Socket adapters: (1) 1/4" hex shank to 3/8" square  
(1) 1/4" hex shank to 1/2" square
- (1) Magnetic bit holder
- (1) Case with bulk storage container



Part #	Mfg #	Description	Price
140584	48-32-4402	35-Pc M/E Drill & Drive Set	

### 40-PC Shockwave™ Drill & Drive Set

- Includes:
- (1) 1/2" Socket adapter
- (1) 1/4" Magnetic nut driver
- (1) 1/4" Shockwave Hex drive bit
- (1) 1/8" Drill bit
- (1) 3/16" Shockwave Hex drive bit
- (1) 3/8" Magnetic nut driver
- (1) 3/8" Socket adapter
- (1) 5/16" Magnetic nut driver
- (1) Shockwave™ Compact magnetic bit holder
- Hex bits:  
1" (1) 1/4", (1) 1/8", (1) 3/16", (1) 5/32"
- Phillips bits:  
1" (1) P1, (2) P2, (1) P3  
2" (4) P2, (1) P3
- (1) Phillips reduced 1" PR2 bit
- Slotted bits:  
1" (1) #10, (1) #8  
2" (1) #10
- Square bits:  
1" (1) SQ1, (2) SQ2, (1) SQ3  
2" (1) SQ2, (1) SQ3
- TORX® BITS:  
1" (1) T15, (1) T20, (2) T25  
2" (1) T20, (2) T25



Part #	Mfg #	Description	Price
173711	48-32-4006	40-Pc Driver Bit Set	

### SHOCKWAVE™ Impact Security Insert Bit Set - 9PC

- Includes:
- (1) T20 Security Insert Bit
- (2) T25 Security Insert Bit
- (1) T30 Security Insert Bit
- (1) Hex Bit 1" 1/8"
- (1) Hex Bit 1" 5/32"
- (1) Spanner Bit 1" #10
- (1) Clutch G Bit 1" 3/16"
- (1) Clutch G Bit 1" 5/32"



Part #	Mfg #	Description	Price
237358	48-32-4620	9-Pc Incert Bit Set	

## Drill Bits

### 10-PC SHOCKWAVE™ Torx® Security Insert Bit Set

- Includes:
- (1) T7 Security Insert Bit
- (1) T8 Security Insert Bit
- (1) T9 Security Insert Bit
- (1) T10 Security Insert Bit
- (1) T15 Security Insert Bit
- (1) T20 Security Insert Bit
- (1) T25 Security Insert Bit
- (1) T30 Security Insert Bit
- (1) T40 Security Insert Bit



Part #	Mfg #	Description	Price
237356	48-32-4618	10-Pc Insert Bit Set	

### 36-Piece Shockwave™ Driver Bit Set

- Includes:
- (1) 1/4" Insert magnetic nut driver
- (1) 3/8" Socket adapter
- (1) 5/16" Insert magnetic nut driver
- (1) Shockwave™ 6" Magnetic bit tip holder
- (1) Shockwave™ Compact magnetic bit holder
- Hex bits:
- 1" (1) 1/4", (1) 1/8", (1) 3/16", (1) 3/32", (1) 5/32", (1) 5/64", (1) 7/64", (1) 9/64"
- Phillips bits:
- 1" (1) P1, (3) P2, (1) P3
- (1) Phillips reduced 1" PR2 bit
- Slotted bits:
- 1" (2) #10, (1) #12, (1) #8
- Square bits:
- 1" (1) SQ1, (1) SQ3
- Torx® bits:
- 1" (1) T10, (1) T15, (2) T20, (2) T25, (1) T27, (1) T30, (1) T40



Part #	Mfg #	Description	Price
173710	48-32-4005	36-Pc Driver Bit Set	

### 10-Piece SHOCKWAVE™ Hex Bit Set



Part #	Mfg #	Description	Price
164160	48-89-4445	10-Pc Hex Bit Set	

### 10-Piece SHOCKWAVE™ RED HELIX™ Titanium Drill Bit Set

- Includes:
- (1) 1/8" Titanium SHOCKWAVE™ (48-89-4605)
- (1) 9/64" Titanium SHOCKWAVE™ (48-89-4606)
- (1) 5/32" Titanium SHOCKWAVE™ (48-89-4607)
- (1) 11/64" Titanium SHOCKWAVE™ (48-89-4608)
- (1) 3/16" Titanium SHOCKWAVE™ (48-89-4609)
- (1) 7/32" Titanium SHOCKWAVE™ (48-89-4611)
- (1) 1/4" Titanium SHOCKWAVE™ (48-89-4613)
- (1) 5/16" Titanium SHOCKWAVE™ (48-89-4617)
- (1) 3/8" Titanium SHOCKWAVE™ (48-89-4621)



Part #	Mfg #	Description	Price
242614	48-89-4633	10Pc RED HELIX™	

### 23-Piece SHOCKWAVE™ RED HELIX™ Titanium Drill Bit Set

- Includes:
- (1) 9/64" Titanium SHOCKWAVE™ (48-89-4606)
- (2) 7/64" Titanium SHOCKWAVE™ (48-89-4604)
- (1) 7/32" Titanium SHOCKWAVE™ (48-89-4611)
- (2) 5/64" Titanium SHOCKWAVE™ (48-89-4602)
- (2) 5/32" Titanium SHOCKWAVE™ (48-89-4607)
- (1) 5/16" Titanium SHOCKWAVE™ (48-89-4617)
- (1) 3/8" Titanium SHOCKWAVE™ (48-89-4621)
- (1) 3/32" Titanium SHOCKWAVE™ (48-89-4603)
- (2) 3/16" Titanium SHOCKWAVE™ (48-89-4609)
- (1) 13/64" Titanium SHOCKWAVE™ (48-89-4610)
- (1) 11/64" Titanium SHOCKWAVE™ (48-89-4608)
- (2) 1/8" Titanium SHOCKWAVE™ (48-89-4605)
- (2) 1/4" Titanium SHOCKWAVE™ (48-89-4613)
- (1) 1/2" Titanium SHOCKWAVE™ (48-89-4629)
- (2) 1/16" Titanium SHOCKWAVE™ (48-89-4601)



Part #	Mfg #	Description	Price
219061	48-89-4631	23Pc RED HELIX™	



## Drill Bits

### SHOCKWAVE™ Impact Deep Well Sockets

- 6 point deep wells for unyielding bit engagement
- Proprietary steel and heat treat process for maximum strength and durability
- Thin wall construction



Part #	Mfg #	Length	Size	Price
235692	49-66-4463	3"	1/2"	
235696	49-66-4467	3"	3/4"	
235701	49-66-4473	3"	1-1/8"	

### SHOCKWAVE™ Impact Hex Drill Bit

- Extreme durability
- Fast, accurate drilling
- Corrosion resistant
- 1/4" Hex power groove shank offers quick bit changes



Part#	Mfg#	Length	Diameter	Price
164179	48-89-4405	2.62"	1/8"	
164180	48-89-4407	2.72"	5/32"	
164181	48-89-4409	2.80"	3/16"	
164182	48-89-4411	2.90"	7/32"	
164183	48-89-4413	3.00"	1/4"	
164184	48-89-4414		5/16"	

### SHOCKWAVE™ Magnetic Bit Tip Holder



Part #	Mfg #	Size	Price
141230	48-32-4503	3"	
169681	48-32-4508	3" (Guide Sleeve w/ C-Ring)	
188311	48-32-4511	6"	

### Titanium SHOCKWAVE™ Drill Bit

- RED HELIX™
- Titanium coating
- 135° Split point
- 1/4" Hex



Part#	Mfg#	Length	Diameter	Price
237346	48-89-4601	2-1/4"	1/16"	
237348	48-89-4606	2.63"	9/64"	
237347	48-89-4603	2.38"	3/32"	
253473	48-89-4613	4.13"	1/4"	
237349	48-89-4621	4.65"	3/8"	
237350	48-89-4629	5.12"	1/2"	

### 15-Pc Titanium SHOCKWAVE™ Drill Bit Kit

- (1) 1/16" Titanium SHOCKWAVE™ (48-89-4601)
- (1) 5/64" Titanium SHOCKWAVE™ (48-89-4602)
- (1) 3/32" Titanium SHOCKWAVE™ (48-89-4603)
- (1) 7/64" Titanium SHOCKWAVE™ (48-89-4604)
- (2) 1/8" Titanium SHOCKWAVE™ (48-89-4605)
- (1) 9/64" Titanium SHOCKWAVE™ (48-89-4606)
- (1) 5/32" Titanium SHOCKWAVE™ (48-89-4607)
- (2) 3/16" Titanium SHOCKWAVE™ (48-89-4609)
- (1) 7/32" Titanium SHOCKWAVE™ (48-89-4611)
- (1) 1/4" Titanium SHOCKWAVE™ (48-89-4613)
- (1) 5/16" Titanium SHOCKWAVE™ (48-89-4617)
- (1) 3/8" Titanium SHOCKWAVE™ (48-89-4621)
- (1) 1/2" Titanium SHOCKWAVE™ (48-89-4629)



Part #	Mfg #	Description	Price
219060	48-89-4630	15-Piece Kit	

### Thunderbolt® Bits

#### Thunderbolt® Drill Bit Set



Part #	Mfg #	Description	Price
137838	48-89-2803	15-Pc Black Oxide Bit Set	
154239	48-89-2801	21-Pc Black Oxide Bit Set	

## Drill Bits

### 20-Pc Thunderbolt® Titanium Drill Bit Set

- Includes:
- (2) 1/16" Titanium Coated Drill Bit (48-89-2201)
- (2) 5/64" Titanium Coated Drill Bit (48-89-2202)
- (2) 3/32" Titanium Coated Drill Bit (48-89-2203)
- (2) 7/64" Titanium Coated Drill Bit (48-89-2204)
- (2) 1/8" Titanium Coated Drill Bit (48-89-2205)
- (1) 9/64" Titanium Coated Drill Bit (48-89-2206)
- (1) 5/32" Titanium Coated Drill Bit (48-89-2207)
- (1) 11/64" Titanium Coated Drill Bit (48-89-2208)
- (1) 3/16" Titanium Coated Drill Bit (48-89-2209)
- (1) 13/64" Titanium Coated Drill Bit (48-89-2210)
- (1) 7/32" Titanium Coated Drill Bit (48-89-2211)
- (1) 1/4" Titanium Coated Drill Bit (48-89-2213)
- (1) 5/16" Titanium Coated Drill Bit (48-89-2217)
- (1) 3/8" Titanium Coated Drill Bit (48-89-2221)
- (1) 1/2" Titanium Coated Drill Bit (48-89-2229)



Part #	Mfg #	Description	Price
185383	48-89-1105	20-Pc Titanium Bit Set	

### 14-Pc Thunderbolt® Titanium Drill Bit Set

- Includes:
- (1) 1/16" Thunderbolt® Titanium Drill Bit (48-89-2201)
- (1) 5/64" Thunderbolt® Titanium Drill Bit (48-89-2202)
- (1) 3/32" Thunderbolt® Titanium Drill Bit (48-89-2203)
- (1) 7/64" Thunderbolt® Titanium Drill Bit (48-89-2204)
- (2) 1/8" Thunderbolt® Titanium Drill Bit (48-89-2205)
- (1) 9/64" Thunderbolt® Titanium Drill Bit (48-89-2206)
- (1) 5/32" Thunderbolt® Titanium Drill Bit (48-89-2207)
- (1) 3/16" Thunderbolt® Titanium Drill Bit (48-89-2209)
- (1) 7/32" Thunderbolt® Titanium Drill Bit (48-89-2211)
- (1) 1/4" Thunderbolt® Titanium Drill Bit (48-89-2213)
- (1) 5/16" Thunderbolt® Titanium Drill Bit (48-89-2217)
- (1) 3/8" Thunderbolt® Titanium Drill Bit (48-89-2221)
- (1) 1/2" Thunderbolt® Titanium Drill Bit (48-89-2229)



Part #	Mfg #	Description	Price
146916	48-89-0011	14-Pc Titanium Bit Set	

### 29-Pc Thunderbolt® Titanium Drill Bit Set

- (1) 1/16" Thunderbolt® Titanium Drill Bit (48-89-2201)
- (1) 5/64" Thunderbolt® Titanium Drill Bit (48-89-2202)
- (1) 3/32" Thunderbolt® Titanium Drill Bit (48-89-2203)
- (1) 7/64" Thunderbolt® Titanium Drill Bit (48-89-2204)
- (1) 1/8" Thunderbolt® Titanium Drill Bit (48-89-2205)
- (1) 9/64" Thunderbolt® Titanium Drill Bit (48-89-2206)
- (1) 5/32" Thunderbolt® Titanium Drill Bit (48-89-2207)
- (1) 11/64" Thunderbolt® Titanium Drill Bit (48-89-2208)
- (1) 3/16" Thunderbolt® Titanium Drill Bit (48-89-2209)
- (1) 13/64" Thunderbolt® Titanium Drill Bit (48-89-2210)
- (1) 7/32" Thunderbolt® Titanium Drill Bit (48-89-2211)
- (1) 15/64" Thunderbolt® Titanium Drill Bit (48-89-2212)
- (1) 1/4" Thunderbolt® Titanium Drill Bit (48-89-2213)
- (1) 17/64" Thunderbolt® Titanium Drill Bit (48-89-2214)
- (1) 9/32" Thunderbolt® Titanium Drill Bit (48-89-2215)
- (1) 19/64" Thunderbolt® Titanium Drill Bit (48-89-2216)
- (1) 5/16" Thunderbolt® Titanium Drill Bit (48-89-2217)
- (1) 21/64" Thunderbolt® Titanium Drill Bit (48-89-2218)
- (1) 11/32" Thunderbolt® Titanium Drill Bit (48-89-2219)
- (1) 23/64" Thunderbolt® Titanium Drill Bit (48-89-2220)
- (1) 3/8" Thunderbolt® Titanium Drill Bit (48-89-2221)
- (1) 25/64" Thunderbolt® Titanium Drill Bit (48-89-2222)
- (1) 13/32" Thunderbolt® Titanium Drill Bit (48-89-2223)
- (1) 27/64" Thunderbolt® Titanium Drill Bit (48-89-2224)
- (1) 7/16" Thunderbolt® Titanium Drill Bit (48-89-2225)
- (1) 29/64" Thunderbolt® Titanium Drill Bit (48-89-2226)
- (1) 15/32" Thunderbolt® Titanium Drill Bit (48-89-2227)
- (1) 31/64" Thunderbolt® Titanium Drill Bit (48-89-2228)
- (1) 1/2" Thunderbolt® Titanium Drill Bit (48-89-2229)



Part #	Mfg #	Description	Price
161240	48-89-0012	29-Pc Titanium Bit Set	

## Drill Bits

### Thunderbolt® Black Oxide Drill Bit

- Provides longer life and faster drill times
- Parabolic flute clears chips faster
- 135° Split point, precision start no walking



Part #	Mfg #	Diameter	Price
137807	48-89-2710	1/16"	
137808	48-89-2711	5/64"	
137809	48-89-2712	3/32"	
137810	48-89-2713	7/64"	
137812	48-89-2714	1/8"	
137813	48-89-2715	9/64"	
137815	48-89-2716	5/32"	
137816	48-89-2717	11/64"	
137817	48-89-2718	3/16"	
137818	48-89-2719	13/64"	
137819	48-89-2720	7/32"	
137820	48-89-2721	15/64"	
137821	48-89-2722	1/4"	
137822	48-89-2723	17/64"	
137823	48-89-2724	9/32"	
137824	48-89-2725	19/64"	
137825	48-89-2726	5/16"	
137826	48-89-2727	21/64"	
137827	48-89-2728	11/32"	
137828	48-89-2729	23/64"	
137829	48-89-2730	3/8"	
137830	48-89-2731	25/64"	
137831	48-89-2732	13/32"	
137832	48-89-2733	27/64"	
137833	48-89-2734	7/16"	
137834	48-89-2735	29/64"	
137835	48-89-2736	15/32"	
137836	48-89-2737	31/64"	
137837	48-89-2738	1/2"	

### Thunderbolt® Aircraft Length Black Oxide Drill Bit

- Provides longer life and faster drill times
- Parabolic flute clears chips faster
- 135° Split point, precision start no walking

Part #	Mfg #	Diameter	Price
138278	48-89-2772	1/4" x 12"	

### Bits & Accessories

#### Flat Boring Bit

- Fluted bit clears chips
- Bores cleaner and faster
- Furnished with hole for use in wire pulling
- Flats for secure chuck grip
- Precision made of high carbon steel



Part #	Mfg #	Description	Price
006918	48-27-0371	3/8" x 6" Flat Boring Bit	
006920	48-27-0501	1/2" x 6" Flat Boring Bit	
006921	48-27-0561	9/16" x 6" Flat Boring Bit	
170327	48-27-0621	5/8" x 6" Flat Boring Bit	
006922	48-27-0751	3/4" x 6" Flat Boring Bit	
006923	48-27-0811	13/16" x 6" Flat Boring Bit	
006924	48-27-0871	7/8" x 6" Flat Boring Bit	
006925	48-27-1001	1" x 6" Flat Boring Bit	
170328	48-27-1121	1-1/8" x 6" Flat Boring Bit	
170329	48-27-1251	1-1/4" x 6" Flat Boring Bit	
170330	48-27-1371	1-3/8" x 6" Flat Boring Bit	
170331	48-27-1501	1-1/2" x 6" Flat Boring Bit	
243046	48-27-0170	3/8" x 16" Flat Boring Bit	

#### Bull Point SDS Plus Demolition Steel

- Carbide bits/masonry drill bits
- Bull point
- SDS-PLUS shank
- Made from forged high grade steel



Part #	Mfg #	Description	Price
178594	48-62-6010	10"	

#### Speed Feed Wood Bit

- Up to 10x faster drilling than flat boring bits
- Fast chip removal
- Clean holes
- 1/4" power groove shank fits all 1/4" extensions



Part #	Mfg #	Description	Price
170321	48-13-0048	1/2" x 6" Speed Feed Wood Bit	
170322	48-13-0058	5/8" x 6" Speed Feed Wood Bit	
170323	48-13-0068	3/4" x 6" Speed Feed Wood Bit	

## Drill Bits

### Bits & Accessories (Continued)

#### Speed Feed Wood Bit

Part #	Mfg #	Description	Price
170324	48-13-0078	7/8" x 6" Speed Feed Wood Bit	
170325	48-13-0088	1" x 6" Speed Feed Wood Bit	
170326	48-13-0108	1-1/4x6" Speed Feed Wood Bit	
146745	48-13-0400	6-1/2" (4 Pc)	

#### SHOCKWAVE™ Impact Torx Bits



Part #	Mfg #	Description	Price
164169	48-32-4685	2" T25 (5/Pk)	
247233	48-32-4846	6" T25 (10/Pk)	
219271	48-32-4414	1" T20 (2/Pk)	

#### SHOCKWAVE™ Lineman's Impact Socket Adapter

- Pin detent design
- Optimized shock zone
- Custom alloy 76 steel
- Fits all 1/2" drive accessories
- Use with Shockwave™ Lineman's 3 in 1 utility sockets



Part #	Mfg #	Size	Price
241167	48-32-5100	7/16" Hex to 1/2" Square Adapter	

#### Ship Auger Bit

- Hardened, one-face 20° rake angle design
- Nonstick, polished and coated flutes
- Impact-rated shank: Strong enough to use with an impact wrench
- One line of Milwaukee® auger bits covers all applications and tools



Part#	Mfg#	Size	Price
175884	48-13-0683	11/16" x 6"	
169686	48-13-0753	3/4" x 6"	
144979	48-13-0873	7/8" x 6"	
169687	48-13-1003	1" x 6"	

### Bits & Accessories (Continued)

#### Ship Auger Bit

Part#	Mfg#	Size	Price
144980	48-13-1123	1-1/8" x 6"	
221628	48-13-1503	1-1/2" x 6"	
169688	48-13-1253	1-1/4" x 6"	
169693	48-13-6250	1-1/4" x 18"	
144861	48-13-1373	1-3/8" x 6"	

#### Spur Auger Bit

- Double wing spurs: Allow for fast, clean hole cutting
- Fast chip removal: Nonstick, polished and coated flutes eliminate costly cleaning time
- Impact-rated shank: Strong enough to use with an impact wrench
- One line of auger bits covers all applications and tools



Part#	Mfg#	Size	Price
253472	48-13-0750	3/4" x 6-1/2"	
248133	48-13-0870	7/8" x 6-1/2"	
175885	48-13-1000	1" x 6-1/2"	
145684	48-13-1250	1-1/4" x 6-1/2"	
232417	48-13-1500	1-1/2" x 6-1/2"	

### Boring Bit Sets

#### 8-Piece Universal Quik-Lok™ Flat Boring Bit Set

- Includes the Universal Quik-Lok™
- Double wing spurs
- 1/4" Quick change hex shank



Part #	Mfg #	Description	Price
137800	49-22-0175	8-Pc with 6" Extension	

#### Flat Boring Bit Kit

- Contains (6) popular size flat boring bits in heavy protective plastic
- In pockets for orderly storage and easy size selection



Part #	Mfg #	Sizes Include:	Price
006980	49-22-0071	3/8", 1/2", 5/8", 3/4", 7/8" & 1"	



## Drill Bits

### 6-Piece SPEED FEED Wood Bit Set



Part #	Mfg #	Description	Price
170791	48-13-0600	6-1/2"	

### Bit Kits

#### Contractor's Selffeed Bit Kit

- Includes:
- (1) Extension
- (1) 1" Selffeed Bit
- (1) 1-1/8" Selffeed Bit
- (1) 1-1/4" Selffeed Bit
- (1) 1-1/2" Selffeed Bit
- (1) 1-3/4" Selffeed Bit
- (1) 2-1/8" Selffeed Bit
- (1) 2-9/16" Selffeed Bit
- (1) 5-1/2" One-Piece Shank and Coupling
- (1) Carrying Case



Part #	Mfg #	Description	Price
006981	49-22-0130	7-Pc Kit	

#### Ship Auger Bit 18" Set - 3 PC

- Includes:
- (1) Carrying case
- (1) 3/4" Ship Auger bit
- (1) 1/2" Ship Auger bit
- (1) 1" Ship Auger bit



Part #	Mfg #	Description	Price
175883	48-13-1000	3-Pc Kit	

#### Spur Auger Bit 6-1/2" Set - 4PC

- Includes
- (1) 1" Spur Auger bit
- (1) 1/2" Spur Auger bit
- (1) 3/4" Spur Auger bit
- (1) 7/8" Spur Auger bit



Part #	Mfg #	Description	Price
232418	48-13-4000	4-Pc Kit	

### Contractors' Bit Kit

- Assortment of self-feed bits for big hole drilling
- Includes impact resistant carrying case



Part #	Mfg #	Description	Price
006982	49-22-0135	1-3/8", 1-1/2", 2-1/8", 2-9/16"	

### Plumbers' Bit Kit

- Includes 5-1/2" 1-piece shank and coupling extension and carrying case
- Includes:
  - Self-feed bits: 1-3/4", 2-1/8" & 2-9/16"
  - Auger bits: 7/8", 1-1/8", 1-1/4" & 1-1/2"



Part #	Mfg #	Sizes Include:	Price
140832	49-22-0065	Auger Bits & Self-feed Bits	

### 15 Piece Cobalt RED HELIX™ Kit

- 135° split point for precision start
- RED HELIX™ Design for Rapid Chip Removal™
- Secure Grip™
- Includes:
  - (1) 9/64" COBALT RED HELIX™ Drill Bit (48-89-2306)
  - (1) 7/64" COBALT RED HELIX™ Drill Bit (48-89-2304)
  - (1) 7/32" COBALT RED HELIX™ Drill Bit (48-89-2311)
  - (1) 5/64" COBALT RED HELIX™ Drill Bit (48-89-2302)
  - (1) 5/32" COBALT RED HELIX™ Drill Bit (48-89-2307)
  - (1) 5/16" COBALT RED HELIX™ Drill Bit (48-89-2317)
  - (1) 3/8" COBALT RED HELIX™ Drill Bit (48-89-2321)
  - (1) 3/32" COBALT RED HELIX™ Drill Bit (48-89-2303)
  - (1) 3/16" COBALT RED HELIX™ Drill Bit (48-89-2309)
  - (2) 1/8" COBALT RED HELIX™ Drill Bit (48-89-2305)
  - (2) 1/4" COBALT RED HELIX™ Drill Bit (48-89-2313)
  - (1) 1/2" COBALT RED HELIX™ Drill Bit (48-89-2329)
  - (1) 1/16" COBALT RED HELIX™ Drill Bit (48-89-2301)



Part #	Mfg #	Description	Price
224696	48-89-2331	15-Pc Cobalt Red Helix	

## Drill Bits

### 42-PC Driver Bit Set

- TORX® Bit  
(1) 2" T25, (1) 2" T20, (1) 1" T30, (1) 1" T25, (1) 1" T20  
(1) 1" T15, (1) 1" T10, (1) 2" T15
- Square Bit  
(1) 3-1/2" SQ2, (1) 2" SQ3, (1) 2" SQ2, (1) 1" SQ3  
(6) 1" SQ2, (2) 1" SQ1
- Slotted Bit  
(1) SL 2" 1/4", (1) 2" SL 3/16", (1) 1" SL 3/16",  
(1) 1" SL 1/8", (1) 1" SL 1/4"
- Phillips Bit  
(1) 3-1/2" P2, (1) 2" P3, (1) 2" P2,  
(1) 1" P3, (6) 1" P2, (2) 1" PR2
- HEX Bit  
(1) 1" 3/16", (1) 1" 1/4"
- Magnetic drive guide



### 95-PC Drill & Drive Set

- Includes:
  - (1) 1/16" Thunderbolt Black Oxide Drill Bit
  - (1) 1/4" Magnetic Nut Driver
  - (1) 1/4" Thunderbolt Black Oxide Drill Bit
  - (1) 1/8" Thunderbolt Black Oxide Drill Bit
  - (1) 3/16" Thunderbolt Black Oxide Drill Bit
  - (1) 3/32" Thunderbolt Black Oxide Drill Bit
  - (1) 5/16" Magnetic Nut Driver
  - (1) 5/32" Thunderbolt Black Oxide Drill Bit
  - (1) 5/64" Thunderbolt® Black Oxide Drill Bit
  - (1) 7/64" Thunderbolt Black Oxide Drill Bit
  - (2) Hex Bit 1" 1/16"
  - (2) Hex Bit 1" 1/4"
  - (2) Hex Bit 1" 3/16"
  - (1) Hex Bit 1" 5/32"
  - (1) Hex Bit 1" 9/64"
  - (2) Hex Bit 1" 1/8"
  - (2) Hex Bit 1" 3/32"
  - (2) Hex Bit 1" 5/64"
  - (2) Hex Bit 1" 7/64"
  - (1) Magnetic Drive Guide
  - (3) Phillips Bit 1" P1
  - (10) Phillips Bit 1" P2
  - (4) Phillips Bit 1" P3
  - (3) Phillips Bit 1" PR2
  - (1) Phillips Bit 2" P2
  - (1) Pozidrive Bit 1" P2
  - (1) Pozidrive Bit 1" P2
  - (2) Slotted Bit 1" SL 1/4"
  - (2) Slotted Bit 1" SL 1/8"
  - (2) Slotted Bit 1" SL 3/16"
  - (2) Slotted Bit 1" SL 7/64"
  - (1) Slotted Bit 1" SL 9/32"
  - (1) Slotted Bit 2" SL 3/16"
  - (3) Square Bit 1" SQ1
  - (8) Square Bit 1" SQ2
  - (3) Square Bit 1" SQ3
  - (1) Square Bit 2" SQ2
  - (2) TORX® Bit 1"
  - x10(2) TORX® Bit 1" T15
  - (3) TORX® Bit 1" T20
  - (3) TORX® Bit 1" T25
  - (2) TORX® Bit 1" T27
  - (2) TORX® Bit 1" T30
  - (2) TORX® Bit 1" T40
  - (2) TORX® Bit 1" T9
  - (1) TORX® Bit 2" T20
  - (1) TORX® Bit 2" T25



Part #	Mfg #	Description	Price
219316	48-32-1551	42-Pc Driver Bit Set	

Part #	Mfg #	Description	Price
219317	48-89-1561	95-Pc Drill and Drive Set	

## Drill Bits

### Drill Accessories

#### Bellhanger Bit

- Aggressive tip geometry for faster drilling
- Coated flutes for fast chip removal
- Wire pulling hole
- 3-Flat shank



Part #	Mfg #	Dia	OAL	Price
138408	48-13-7125	1/4"	12"	
140014	48-13-7225	1/4"	18"	
169696	48-13-7237	3/8"	18"	
169821	48-13-7231	5/16"	18"	
138666	48-13-7325	1/4"	24"	
153612	48-13-7337	3/8"	24"	

#### Centering Bit

- Use with SDS-MAX and spline 1-Pc core bits to start drilling
- Centering tip to reduce bit walking and create exact spot drilling



Part #	Mfg #	Description	Price
189747	48-20-5495	For 1Pc Core Bits	

### Hole Saw Accessories

#### Rotary Hammer Bit

- SDS Shank



Part #	Mfg #	Size	Price
240801	48-20-7400	5/32" x 2" x 4"	
137647	48-20-7410	3/16" x 2" x 4"	
137648	48-20-7411	3/16" x 4" x 6"	
137649	48-20-7430	1/4" x 2" x 4"	
137650	48-20-7431	1/4" x 4" x 6"	
137651	48-20-7441	5/16" x 4" x 6"	
137652	48-20-7451	3/8" x 4" x 6"	
137653	48-20-7471	1/2" x 4" x 6"	

#### Switchblade™ Selffeed Bit



Part #	Mfg #	Description	Price
235679	48-25-5125	1-1/2"	
235680	48-25-5135	2"	

### Selffeed Bit

- Faster, more accurate drilling
- Clean holes
- Long-lasting performance



Part #	Mfg #	Description	Price
169683	48-25-1502	Selffeed Bit 1-1/2"	
169684	48-25-2122	Selffeed Bit 2-1/8"	
006904	48-25-1002	Selffeed Bit, 1"	
006905	48-25-1122	Selffeed Bit 1-1/8"	
006906	48-25-1252	Selffeed Bit 1-1/4"	
181958	48-25-1752	Selffeed Bit 1-3/4"	
006910	48-25-2002	Selffeed Bit 2"	
144970	48-25-2252	Selffeed Bit 2-1/4"	
006913	48-25-2562	Selffeed Bit 2-9/16"	
144171	48-25-5120	Selffeed Bit 1-3/8"	
144172	48-25-5140	Selffeed Bit 2-1/8"	
144174	48-25-5150	Selffeed Bit 2-9/16"	
006914	48-25-3621	Selffeed Bit 3-5/8"	
006915	48-25-4621	Selffeed Bit, 4-5/8"	

### For 1/2" D-Handle & Larger Model Drill



Part #	Mfg #	Dia	Shank Type	Price
006907	48-25-1371	1-3/8"	7/16" Hex	
006911	48-25-2121	2-1/8"	7/16" Hex	

### For 1/2" D-Handle & Larger Model Drill Except 1001-1 & 1007-1

Part #	Mfg #	Dia	Shank Type	Price
006912	48-25-2561	2-9/16"	7/16" Hex	

### Diamond Core Bit Pre-Stress

- Maximum speed
- High quality
- Versatile



Part #	Mfg #	Description	Price
159936	48-17-1060	6" Diamond Core Bit	
246058	48-17-2025	2-1/2" Diamond Wet Core Bit	
246059	48-17-2040	4" Diamond Wet Core Bit	





## Drill Bits

### Switchblade™ 5-Piece Plumbers' Kit

- Includes:
  - (4) Switchblade™ self-feed bit blades - 1-3/8", 1-1/2", 2-1/8" and 2-9/16"
  - (1) Universal Quik-Lok® extension - 5-1/2" x 7/16"
  - (1) Each replacement blades - 1-3/8", 1-1/2", 2-1/8", and 2-9/16"
  - (4) Feed screws
  - (4) Set screws
  - (1) Hex wrench
  - Removable storage case
  - Compact carrying case with handle



Part #	Mfg #	Description	Price
149390	49-22-5100	5-Pc Switchblade Plumbers Kit	

### Replacement Switchblades



Part #	Mfg #	Description	Price
170832	48-25-5225	3-Pk, 1-1/2" Diameter	
235681	48-25-5325	10-Pk, 1-1/2" Diameter	
144551	48-25-5420	Single Blade, 1-3/8" Diameter	
179631	48-25-5220	3-Pk, 1-3/8" Diameter	
169678	48-25-5320	10-Pk, 1-3/8" Diameter	
144552	48-25-5440	Single Blade, 2-1/8" Diameter	
146743	48-25-5240	3-Pk, 2-1/8" Diameter	
169549	48-25-5540	3-Pk, 2-1/8" Diameter	
169679	48-25-5340	10-Pk, 2-1/8" Diameter	
245442	48-25-5543	3-Pk, 2-1/4" Diameter	
169680	48-25-5350	10-Pk, 2-9/16" Diameter	
146744	48-25-5250	3-Pk, 2-9/16" Diameter	
169548	48-25-5550	3-Pk, 2-9/16" Diameter	
147445	48-25-5450	Single Blade, 2-9/16" Diameter	

### Replacement Feed Screw Kit

- For Switchblade™ selffeed bits
- Up to 2-9/16"
- Faster, more accurate drilling



Part #	Mfg #	Description	Price
150897	48-25-5275	Replacement Feed Screw Kit	

### SWITCHBLADE™ Replacement Feed Screw Kit

- For SwitchBlade™ selffeed bits up to 2-9/16"
- Faster, more accurate drilling



Part #	Mfg #	Description	Price
160788	48-25-5280	Replacement Feed Screw Kit	

### Step Drill Bits

#### High Speed Steel Step Drill Bit

- Jam-Free performance
- Rapid Strike™ Tip
- Up to 4X longer bit life
- Up to 50% more holes per battery charge
- Laser-engraved reference marks
- 3-Flat Secure-Grip™ shanks



Part #	Mfg #	Size	# of Steps	Price
169382	48-89-9207	7/8" x 3/8"	1	
169191	48-89-9201	1/8"-1/2" x 1/32"	13	
169381	48-89-9202	3/16" - 1/2" x 1/16"	6	
169186	48-89-9203	1/4" - 3/4" x 1/16"	9	
169187	48-89-9204	3/16" - 7/8" x 1/16"	12	
169351	48-89-9205	1/4" - 1-3/8"	10	
169188	48-89-9206	3/8" - 1/2" x 1/16"	2	
169189	48-89-9208	7/8" - 1-1/8" x 3/8"	9	
169190	48-89-9209	7/8" - 1-1/8"	2	
169383	48-89-9211	7/8" - 1-7/32" x 3/8"	13	
169384	48-89-9212	7/8" - 1-3/8" x 3/8"	5	

## Drill Bits

### SHOCKWAVE™ Impact Duty™ Step Bit

- The Rapid Strike Tip™
- The optimized SHOCKZONE™
- Titanium Aluminum Nitride (TiAlN) coating



Part #	Mfg #	Size	# of Steps	Price
256703	48-89-9249	7/8" - 1-1/8"	13	

### 2-Piece Step Drill Bit Set

- Includes:
  - (1) 13-Hole bit (48-89-9100)
  - (1) 9-Hole bit (48-89-9105)



Part #	Mfg #	Description	Price
145131	48-89-9050	2-Pc Step Drill Bit Set	

### 2-Piece #4 Step Drill Bit Set

- (2) #4 Step Drill Bit, 3/16" - 7/8" by 1/16" (48-89-9204)



Part #	Mfg #	Description	Price
178317	48-89-9234	2-Pc Step Drill Bit Set	

### 2-Piece #9 Step Drill Bit Set

- (2) #9 Step Drill Bit, 7/8" & 1-1/8" (48-89-9209)



Part #	Mfg #	Description	Price
178318	48-89-9239	2-Pc Step Drill Bit Set	

### 3-Piece Step Drill Bit Set

- Includes:
  - (1) 6-Hole bit (48-89-8955)
  - (1) 9-Hole bit (48-89-9105)
  - (1) 13-Hole bit (48-89-9100)



Part #	Mfg #	Description	Price
145130	48-89-8990	3-Pc Step Drill Bit Set	

### 6-Piece Step Drill Bit Set

- Includes:
  - (1) #9 Step Drill Bit, 7/8" & 1-1/8" (48-89-9209)
  - (1) #8 Step Drill Bit, 1/2" - 1" by 1/16" (48-89-9208)
  - (1) #7 Step Drill Bit, 7/8" Single Hole (48-89-9207)
  - (1) #6 Step Drill Bit, 3/8" & 1/2" by 1/16" (48-89-9206)
  - (1) #4 Step Drill Bit, 3/16" - 7/8" by 1/16" (48-89-9204)
  - (1) #1 Step Drill Bit, 1/8" - 1/2" by 1/32" (48-89-9201)
  - (1) Carrying Case



Part #	Mfg #	Description	Price
258302	48-89-9224	6-Pc Step Drill Bit Set	

### SHOCKWAVE™ Impact Duty™ ELECTRICAL KIT (#1, #4, #9)

- Electrical step bits
- Titanium Aluminum Nitride (TiAlN) coating
- A dual spiral flute combined with the Rapid Strike Tip™



Part #	Mfg #	Description	Price
255240	48-89-9257	3-Pc Step Drill Bit Set	

### SDS Bits and Accessories

#### One Piece SDS-MAX Core Bit



Part #	Mfg #	Size	Price
242436	48-20-5412	2-5/8" x 11-3/8"	
243816	48-20-5470	3-1/8" x 11-3/8"	
243817	48-20-5482	4" x 11-3/8"	

## Drill Bits

### SDS Bits and Accessories (Continued)

#### One Piece SDS-MAX Core Bit

Part #	Mfg #	Size	Price
243819	48-20-5490	6" x 22"	

#### One Piece SDS-MAX Tunnel Bit

- Centering tip
- Chisel and raker teeth
- Land and core thickness



Part #	Mfg #	Size	Price
244755	48-20-5312	2-1/8" x 22"	
244756	48-20-5318	2-1/2" x 22"	

#### Core Bit With Center Bit

- Abrasion-resistant carbide teeth
- Centering bit eliminates slipping
- Use with 11" extension for extra-deep drilling
- Multipurpose SDS-MAX or spline shank: Interchangeable with a variety of drilling heads from 1-1/2" to 5"



Part #	Mfg #	Description	Price
166215	48-20-5092	2-1/8" Core Bit With Center Bit	

#### SDS-PLUS Thin Wall Carbide Tipped Core Bit

- Thin wall design
- 2" Diameter
- Usable cutting depth 2-13/16"
- Use with 8" or 12" SDS PLUS adapter shanks (48-03-3555, 48-03-3561)
- Use with 7-1/2" extensions 48-95-6075
- Includes core body with guide plate & centering pin



Part #	Mfg #	Description	Price
163505	48-20-5035	SDS-PLUS Thin Wall Carbide Tipped Core Bit 2"	
163506	48-20-5050	SDS-PLUS Thin Wall Carbide Tipped Core Bit 3-1/2"	

### SDS PLUS Core Bits

- Asymmetrical carbide teeth for up to 20% faster drilling
- 2" Depth



Part #	Mfg #	Size	Price
247470	48-20-5230	2-9/16"	
254803	48-20-5225	2"	
252463	48-20-5240	3-9/16"	
254804	48-20-5245	4"	

#### SDS-Max and SPLINE Thick Wall Carbide Tipped Core Bit

- Thick Wall Design
- Use with 12" or 18" SPLINE adapter shanks (48-00-3564, 48-03-3565) and 12" or 18" SDS-Max adapter shanks (48-03-3572, 48-03-3573)
- Use with 7-1/2" extension 48-95-6085
- Includes core body with guide plate & centering pin



Part #	Mfg #	Description	Price
164477	48-20-5130	1-3/4"	
159714	48-20-5140	2-1/2"	
254362	48-20-5145	3"	
155357	48-20-5150	3-1/2"	
162578	48-20-5155	4"	

#### SDS-Max 4-CUTTER Bit

- SDS-Max shank
- 4-Cutter head
- Highest quality carbide
- Optimized flutes provide fastest debris extraction for faster drilling



Part #	Mfg #	Description	Price
248864	48-20-3916	SDS-Max Bit 5/8" x 7" x 13"	
154017	48-20-3918	SDS-Max Bit 5/8" x 15" x 21"	
220742	48-20-3930	SDS-Max Bit 3/4" x 7" x 13"	
259830	48-20-3953	SDS-Max Bit 1" x 12" x 17"	
220743	48-20-3964	SDS-Max Bit 1-1/8" x 12" x 17"	
232587	48-20-3966	SDS-Max Bit 1-1/8" x 16" x 21"	
247447	48-20-3990	SDS-Max Bit 1-9/16" x 18" x 23"	

## Drill Bits

### SDS Bits and Accessories (Continued)

#### SDS-Max 4-CUTTER Bit

Part #	Mfg #	Description	Price
236941	48-20-3992	SDS-Max Bit 1-3/4" x 18" x 23"	

#### SDS-Plus 2CT Bit

- Enhanced rebar guards 
- Breaker points lead to faster drilling speeds
- Variable flute for 20% more holes per charge
- Centering tip for exact spot drilling
- Wear mark indicators
- Reinforced flutes for minimized vibration & max durability

Part #	Mfg #	Description	Price
170315	48-20-7432	SDS-Plus 2CT 1/4" x 6" x 8"	
170316	48-20-7452	SDS-Plus 2CT 3/8" x 6" x 8"	
167611	48-20-7459	SDS-Plus 2CT 3/8" x 22" x 24"	
179485	48-20-7473	SDS-Plus 2CT 1/2" x 8" x 10"	
170317	48-20-7474	SDS-Plus 2CT 1/2" x 10" x 12"	
170318	48-20-7481	SDS-Plus 2CT 9/16" x 4" x 6"	
170319	48-20-7601	SDS-Plus 2CT 5/8" x 4" x 6"	
170320	48-20-7604	SDS-Plus 2CT 5/8" x 10" x 12"	
153951	48-20-7061	SDS-Plus 2CT 3/4" x 6" x 8"	
170314	48-20-7065	SDS-Plus 2CT 3/4" x 10" x 12"	
247469	48-20-7066	SDS-PLUS 2CT 3/4" X 16" X 18"	
142705	48-20-7454	SDS-Plus 2CT 3/8" x 10" x 12"	
247468	48-20-7477	SDS-PLUS 2CT 1/2" X 16" X 18"	

#### SDS-Plus 4CT MX4™ Bit

- Enhanced rebar guards provide increased durability 
- Breaker points lead to faster drilling speeds
- Variable flute for up to 20% more holes per charge in rotary hammers
- Centering tip for exact spot drilling
- Wear mark indicators to show end of life and when bit no longer meets the ANSI requirement
- Reinforced flutes for minimized vibration and maximum durability

Part #	Mfg #	Description	Price
152697	48-20-7206	5/8" x 16" x 18"	
255868	48-20-7246	1" x 16" x 18"	

#### SDS Bit Assortment

- Includes:
  - 3/16" x 4-1/2"
  - 1/4" x 6"
  - 5/16" x 6"
  - 3/8" x 6"
  - 1/2" x 6"
- SDS Shank
- Carbide



Part #	Mfg #	Description	Price
137655	48-20-7490	5-Pc SDS Bit Set	

#### SDS Bit - 44 Magnum™ Series

- 4-Fluted spiral shaft 

Part #	Mfg #	Bit Dia	Overall Length	Drilling Depth	Price
137646	48-20-7401	5/32"	4"	6"	
137657	48-20-7602	5/8"	6"	8"	

#### SDS Bit with 1/4" Hex

- 2-Cutter head 
- SDS Shank w/ hex shoulder for Tap-Con screw system

Part #	Mfg #	Bit Dia	Overall Length	Drilling Depth	Price
137644	48-20-7091	5/32"	7"	4"	
137645	48-20-7092	3/16"	7"	4"	





## Drill Bits

### Stop Bit SDS-PLUS

- For use with drop-in anchors
- Stopping shoulder to drill accurate depths repeatedly
- Patented flute geometry to remove debris rapidly and maximize impact energy
- Centering tip to reduce bit walking and create exact spot drilling



Part #	Mfg #	Description	Price
171096	48-20-7651	3/8" x 1-1/16" Stop Bit	
171101	48-20-7653	1/2" x 1-11/16" Stop Bit	
171103	48-20-7655	5/8" x 2-1/16" Stop Bit	
242646	48-20-7652	1/2" x 13/16" Stop Bit	

### Spline to SDS-Plus Adapter

- Allows the use of SDS-Max shank accessories in a spline shank rotary hammer



Part #	Mfg #	Description	Price
193588	48-03-3015	Adapter	

### SDS-MAX to Spline Adapter

- Allows the use of SPLINE shank accessories in a SDS-Max shank rotary hammer



Part #	Mfg #	Description	Price
238466	48-03-3012	SDS-MAX to Spline Adapter	

### Hammer Drill Bits

#### Carbide-Tip Hammer Drill Bit

Part #	Mfg #	Description	Price
137662	48-20-8810	1/4" x 2" x 4" with Hex Shank	

#### Three-Flat Secure-Grip™ Hammer Drill Bit

- Fast drilling, long life
- 3-Flat Secure-Grip™ prevents bit from slipping in the chuck



Part #	Mfg #	Size	Price
137665	48-20-8821	3/8" x 4" x 6"	
137658	48-20-8800	1/8" x 1-1/2" x 3"	
137663	48-20-8811	1/4" x 4" x 6"	
137659	48-20-8801	5/32" x 4" x 6"	
137660	48-20-8805	3/16" x 2" x 4"	
137661	48-20-8806	3/16" x 4" x 6"	
137664	48-20-8816	5/16" x 4" x 6"	
137666	48-20-8830	1/2" x 4" x 6"	

### Hammer Drill Bits (Continued)

#### Three-Flat Secure-Grip™ Hammer Drill Bit

Part #	Mfg #	Size	Price
235675	48-20-8840	5/8" x 4" x 6"	
184757	48-20-8812	1/4" x 10" x 12"	

#### Spline 2 Cutter Drill Bit

- 2-Cutter Head
- Spline Shank



Part #	Mfg #	Bit Drilling Dia Depth	Overall Length	Price
256543	48-20-4064	5/8" 22"	17"	
256546	48-20-4101	1" 22"	17"	

#### Spline 4 Cutter Drill Bit

- 4-Cutter 4x90° tip geometry
- Spline shank



Part #	Mfg #	Bit Dia	Overall Length	Drilling Depth	Price
189727	48-20-4335	3/4"	16"	11"	
236911	48-20-4400	1-1/4"	22"	17"	
249029	48-20-4419	2"	18"	23"	

#### 5-Piece, 3-Flat Secure-Grip™ Hammer-Drill Bit Set

- Comprehensive offering with diameters from 1/8" to 1" with lengths up to 18"



Part #	Mfg #	Description	Price
137667	48-20-8851	Bit Hammer-Drill Kit 5-Pc	

## Drill Bits

### 3-Flat Secure-Grip™ Hammer Drill Bit Set (7 PC)

- 3-Flat Secure-Grip™ shank
- Includes:
  - (1) 1/8" x 3" 3-Flat Secure-Grip Hammer Drill Bit
  - (1) 5/32" x 6" 3-Flat Secure-Grip Hammer Drill Bit
  - (1) 3/16" x 6" 3-Flat Secure-Grip Hammer Drill Bit
  - (1) 1/4" x 6" 3-Flat Secure-Grip Hammer Drill Bit
  - (1) 5/16" x 6" 3-Flat Secure-Grip Hammer Drill Bit
  - (1) 3/8" x 6" 3-Flat Secure-Grip Hammer Drill Bit
  - (1) 1/2" x 6" 3-Flat Secure-Grip Hammer Drill Bit



Part #	Mfg #	Description	Price
247468	48-20-7477	Bit Hammer-Drill Kit 7-Pc	

### Miscellaneous

#### Diamond Premium Segmented Wheel

- Extended Life
- Fast Cutting
- Designed to be used Wet or Dry



Part #	Mfg #	Description	Price
186478	49-93-7005	4-1/2", Arbor: 7/8", 20mm, 5/8"	

#### Scraping Chisel

- Made from forged high grade steel



Part #	Mfg #	Description	Price
172488	48-62-2065	2" Scraping Chisel	

#### SDS Demo Flat Chisel



Part #	Mfg #	Description	Price
151866	48-62-6015	SDSPlus 3/4" x 10"	
167377	48-62-4079	SDSMAX Demo 12" Flat Chisel	
186711	48-62-6020	1/2" x 10" Scaling Chisel	
186712	48-62-6030	9-1/2" Tile Chisel	
186713	48-62-6035	9/16" x 7" Mortar Scraper	

### SDS MAX Clay Spade Chisels

- Highest quality carbide maximizes material pulverization
- Optimized flutes provide fastest debris extraction for faster drilling



Part #	Mfg #	Size	Price
248863	48-62-4094	4-1/2" x 16-5/8"	

### SDS MAX Scaling Chisel

- 1-1/2 inch width x 12 inch overall length
- SDS-Max Shank
- Made from forged high grade steel



Part #	Mfg #	Description	Price
247448	48-62-4082	1-1/2" x 12" Scaling Chisel	

### SDS MAX Bull Point Chisel 12"

- Bull Point
- SDS-Max Shank
- 12" overall length
- Made from forged high grade steel



Part #	Mfg #	Description	Price
247449	48-62-4075	Bull Point Chisel 12"	

### SPL/RDHEX Demo Flat Chisel

- Cold Chisel
- Carbide Bits/Masonry Drill Bits



Part #	Mfg #	Description	Price
248633	48-62-2020	1" x 12"	
226835	48-62-2130	1" x 18"	



## Drill Bits

### M12™ Soldering Iron Pointed Tip

- Conical tip, .02" width
- Tip length: 1.55"
- Copper core, nickle and iron Coated
- For use with M12™ soldering iron



Part #	Mfg #	Description	Price
253711	49-80-0400	Soldering Iron Pointed Tip	

### M12™ Soldering Iron Chisel Tip

- Conical tip, .02" width
- Tip length: 1.55"
- Copper core, nickle and iron coated
- For use with M12™ soldering iron



Part #	Mfg #	Description	Price
253710	49-80-0401	Soldering Iron Chisel Tip	

### Feed and Set Screw Accessory Set

- Includes:
- (5) Feed Screws
- (1) Hex Key
- (3) Set Screws



Part #	Mfg #	Description	Price
169682	48-25-6000	8 Pc Set	

### 12-Piece 3/8" Drive SAE Socket Set

- Includes:
- (1) 3/8" Drive Roto Ratchet
- (1) 3/8" Deep Well Socket
- (1) 7/16" Deep Well Socket
- (1) 1/2" Deep Well Socket
- (1) 9/16" Deep Well Socket
- (1) 5/8" Deep Well Socket
- (1) 11/16" Deep Well Socket
- (1) 3/4" Deep Well Socket
- (1) 6" Extension
- (1) 3/8" to 1/4" Drive Adaptor
- (1) 3/8" to Hex Adaptor
- (1) Carrying Case



Part #	Mfg #	Description	Price
232445	48-22-9000	12 Pc, 3/8"	

### 12-Piece 3/8" Drive Metric Socket Set

- Includes:
- (1) 3/8" Drive Roto Ratchet
- (1) 10mm Deep Well Socket
- (1) 12mm Deep Well Socket
- (1) 13mm Deep Well Socket
- (1) 14mm Deep Well Socket
- (1) 15mm Deep Well Socket
- (1) 17mm Deep Well Socket
- (1) 18mm Deep Well Socket
- (1) 19mm Deep Well Socket
- (1) 6" Extension
- (1) 3/8" to 1/4" Drive Adaptor
- (1) 3/8" to Hex Adaptor
- (1) Carrying Case



Part #	Mfg #	Description	Price
232446	48-22-9001	12 Pc, 3/8"	



---

---

## Drill Bits

---

---

### Drill Bits

#### Polished Double Enders Drill Bit

- Punch style length
- Bit at each end
- 135° Split point
- For use on sheet metal



Part #	Mfg #	Bit Dia	O/A Length	Price
006385	DE1/8	1/8"	2"	
006384	DE1/4	1/4"	2-1/2"	

---

---

**Flaring Tools**

---

---

**Flaring Tools**

**Pro-Set® Flaring Tool**



- For use on the following tube materials:
  - Copper
  - Aluminum
  - Brass
  - Thin-Wall Steel

Part #	Mfg #	Description	Price
134798	87-FT800FN	R-410A Imperial Block 3/16", 1/4", 5/16", 3/8", 1/2", 5/8", 3/4" with Ratchet	

## Flaring Tools

### Flaring Tools

#### Ratchet Flaring Tool

- Ratcheting feed screw handle
- Hardened steel flaring cone, eccentrically mounted in needle bearings



Part #	Mfg #	Model	Type	Sizes	Price
045766	83037	458R	45° SAE Flares	1/8", 3/16", 1/4", 5/16", 3/8", 1/2", 5/8", 3/4"	

#### Flaring Tool

- Precision designed tool for producing 45° flares in soft copper, brass, aluminum, and mild steel (JIC and Bundy) tubing
- A hardened, smooth cone provides fast, 45° flares either single or double lap
- A single clamp screw provides for easy clamping and removal of tubing



Part #	Mfg #	Model	Type	Sizes	Price
008721	23332	345	45° SAE Flares	3/16", 1/4", 5/16", 3/8", 7/16", 1/2", 5/8"	

#### Hammer-Type Flaring Tool

- Made of high-grade hardened steel
- Long nose guide that centers tools for smooth, 45° uniform flares



Part #	Mfg #	Model	Water Tube Size	Price
067998	41320	E-45	1/2"	
008618	41330	E-47	3/4"	
008625	41335	E-52	1"	
025807	41345	E-63	1-1/2"	
022441	41350	E-64	2"	

## Flaring Tools

### Flaring Tools

#### Deluxe 45° Flaring Tool

- Easy-to-use with four basic steps
- Designed with the new R-410A system
- Automatic tube height gauge
- Multi-faceted burnishing cone produces a burnished flare seat for a positive seal
- Self-centering yoke grips without marring or constricting tube



Part #	Mfg #	For:	Price
182105	60278	1/8"-3/4" O.D.	

#### Eccentric Cone Flaring Tool

- Large feed screw handle
- Black oxide-finished steel flaring bars are heat-treated
- Recommended for soft materials such as copper and aluminum
- Built-in clutch release to prevent over-torquing



Part #	Mfg #	For:	Price
182107	60295	3/16"-3/4" O.D.	

#### 45° Small Flaring Tool

- Chrome finish
- Forged steel yoke
- Hardened steel flaring bar
- Threaded feed screw and long handle



Part #	Mfg #	For:	Price
238075	60230	1/2"-3/4" O.D.	

#### Punch-Type Swaging Tool

- Expands one end of copper tubing for connecting same size tubes
- Heat-treated and plated alloy steel
- Made in the USA



Part #	Mfg #	Size	Price
182156	60466	3/8" O.D.	
182158	60469	3/4" O.D.	
182159	60470	7/8" O.D.	

#### Complete Tubing Expander/Swager Kit

- Heat treated handles and expanding pin
- Use on 0.063" wall soft copper and aluminum to 1-5/8" O.D.
- Use on 0.047" wall soft steel to 7/8" O.D.
- Kit includes six expander heads; three optional sizes sold separately



Part #	Mfg #	Heads For:	Price
182147	60407	3/8", 1/2", 5/8", 3/4", 7/8", 1-1/8" O.D.	

#### Complete Swage and 45° Flare Kit

- Kit includes:
  - Yoke
  - Deluxe case
  - 6 Swage adapters
  - Flaring cone
  - 2 Flaring bars
- Deeply knurled adapters
- Six hardened and plated alloy steel adapters are interchangeable
- Slip-on self-centering steel yoke has a feed screw with extra long handle
- Flaring bars are hardened and chrome plated



Part #	Mfg #	Description	Price
182152	60440	3/16"-3/4" O.D.	

## Work Lights

### M12™ Work Lights

#### M12™ Work Light

- REDLITHIUM™ battery technology
- Compact design
- 90° rotating head
- Integrated magnet



Part #	Mfg #	Length	Voltage	Price
164019	49-24-0145	7"	12V	

#### M12™ LED Work Light

- REDLITHIUM™ Battery technology
- Sealed aluminum head
- 90° Rotating head
- Magnetic back



Part #	Mfg #	Length	Voltage	Price
137576	49-24-0146	7"	12V	

#### M12™ TRUEVIEW™ LED Spotlight

- Up to 700 yard beam distance
- 3 Light output modes for distance, clarity, and safety
- High: 750 lumens
- Low: 400 lumens
- Strobe: 800 lumens
- Impact and moisture resistant



Part #	Mfg #	Length	Voltage	Price
181689	2353-20	6.5"	12V	

#### M12™ LED Lantern/Flood Light

- TRUEVIEW™: High definition lighting technology
- 180° - 360° Adjustable beam
- 2.1A USB Charger
- Rugged design
- Four light settings: High, medium, low, strobe
- Two stainless steel hooks



Part #	Mfg #	Length	Voltage	Price
171826	2362-20	10.6"	12V	

### M12™ LED Stick Light (Bare Tool)

- TRUEVIEW™ High definition lighting technology
- Powerful 3-LED design
- Multi-position stainless steel hook
- Over 4+ hours of run-time
- Bright, smooth, even beam pattern
- Impact resistant/replaceable lens



49-24-2351

Part #	Mfg #	Length	Voltage	Price
158985	2351-20	9-1/4"	12V	
158986	49-24-2351	1-3/4"	N/A	

### M12™ Compact Flood Light

- High mode: 1,000 Lumens 3.5hrs
- Low mode: 200 Lumens 15hrs



Part #	Mfg #	Length	Voltage	Price
225830	2364-20	7.5"	12V	

### M12™ ROCKET™ Dual Power Tower Light

- Light head rotates 210° and pivots 270° for light in any direction
- Collapses down to 31" with three side handles for easy transportation and storage
- 45% smaller footprint than M18™ ROCKET™ tower lights
- Impact resistant, reinforced legs
- Dual Power: Powered by M12 or Extension Cord
- Low battery indicator flashes when battery pack is low
- Protective guard secures head during transport and storage



Part #	Mfg #	Height	Voltage	Price
252843	2132-20	2.7"-5'8"	12V	

## Work Lights

### M12™ LED Underhood Light

- 1,350 Lumens of TRUEVIEW™ High Definition Output
- FINISHGUARD™ hooks provide lasting protection against scratches to a vehicle's finish
- 2x more gripping surface for maximum hold
- Rotate, slide, remove and hang light bar for added flexibility and versatility
- Mounting Hooks Extend up to 7' on cars and trucks
- Light bar with SS hook
- Sturdy aircraft aluminum frame
- Impact and chemical resistant lens
- 5 Year Tool Warranty



Part #	Mfg #	Description	Price
234818	2125-20	Bare Tool	

### M12™ LED Metal Flashlight

- High mode: 800 Lumens, 5 Hrs
- Low mode: 325 Lumens, 7 Hrs



Part #	Mfg #	Description	Price
222067	2355-20	Bare Tool	
222068	2355-21	Kit	

### M18™ Work Lights

#### M18™ Search Light

- 1250 Lumens with 700 yard beam distance
- 198° Head rotation
- Modes: Spot, Flood, Spot/Flood, & Strobe



Part #	Mfg #	Length	Voltage	Price
226122	2354-20	Bare Tool		
226123	2354-21	Kit		

### M18™ Cordless LED Work Light

- Sealed, aluminum head
- 160 Lumen LED
- Lasts up to 12 hours on one charge
- Integrated hook
- 135° Rotating head



Part #	Mfg #	Length	Voltage	Price
137577	2735-20	8.5"	18V	

### M18™ ROVER™ LED Flood Light

- Trueview: High definition lighting technology
- Up to 30% brighter than corded 250 halogen lights
- Up to 8 hours of run-time
- Innovative roll cage design
- Multiple hanging features: emt hanger, key hole hanger, cross bar hanger, handle hanger



Part #	Mfg #	Length	Voltage	Price
161982	2361-20	8-3/4"	18V	

### M18™ ROVER™ Mounting Flood Light

- 1500 lumens up to 20 hours of runtime
- Magnets, 2" spring loaded clamp, & folding rotating light head design
- 3 output modes for optimal brightness and runtime



Part #	Mfg #	Description	Price
240424	2365-20	Bare Tool	

### M18™ RADIUS™ Compact Site Light

- Flood mode
- 4-1/4" Hanging hook
- AC inlet for all day runtime
- 3 Area and task output modes
- Dual function: 360° area lighting, 90° flood lighting



Part #	Mfg #	Length	Voltage	Price
244930	2144-20	8"	18V	



## Work Lights

### M18™ RADIUS™ Site Light with ONE-KEY™

- Low battery indicator
- Plug-in and daisy chain
- Program automatic schedules
- Optimize brightness and runtime
- Set light remotely from up to 100ft
- Integrated two-bay sequential charger
- Integrated tool tracking and security
- 180° and 360° electronic light control



Part #	Mfg #	Description	Price
239064	2150-20	18V	

### M18™ ROCKET™ LED Tower Light/Charger

- 5 Second setup, 7 foot extension
- 3,000 Lumens of multidirectional light
- Impact resistant, reinforced legs
- Built in M18™ charger
- Covered AC Plug-in
- 3 Independently pivoting light heads
- Protective guard to secure head and lens during transport and storage
- Compact footprint, low center of gravity
- Low battery indicator



Part #	Mfg #	Height	Voltage	Price
226119	2135-20	4-7 Ft	18V	
226121	2135-21HD	4-7 Ft	18V	

### M18™ ROCKET™ LED Tower Light

- 7ft Max extension
- Rotating and pivoting head is extendable from 4-7ft
- Compact 26" footprint w/ low center of gravity
- Three light output modes
  - High: 2,000 lumens
  - Medium: 1,300 lumens
  - Low: 850 lumens
- Impact resistant, reinforced legs



Part #	Mfg #	Height	Voltage	Price
181687	2130-20	4-7 Ft	18V	

### M18™ ROCKET™ Dual Pack Tower Light w/ One Key

- 5400 Lumens up to 26 hrs runtime
- 5'5" Extension, collapses to 22"
- Waterproof and dustproof
- Dual batter design: use one or two batteries
- 3 Leg positions
- One key capable
- 3 Output modes
  - High: 5400 Lumens
  - Medium: 3100 Lumens
  - Low: 1600 Lumens
- -HD model includes: 9.0 battery w/ rapid charger



Part #	Mfg #	Height	Voltage	Price
238902	2120-20	22"-65"	18V	
238905	2120-22HD	22"-65"	18V	

### M18™ ROCKET™ Dual Power Tower Light

- 5 Second setup, 7ft extension
- 2,500 Lumens of TRUEVIEW™ high definition output
- Impact resistant reinforced legs
- Dual Power: powered by M18 or extension cord
- Impact resistant, adjustable light head
- Protective light head guard when stored or in transportation
- Low battery indicator



Part #	Mfg #	Height	Voltage	Price
251797	2131-20	4-7 FT	18V	

## Work Lights

### M18™ Rover™ LED Dual Power Flood Light

- Three light output modes
- Medium Mode: 1,500 lumens for up to 4 hours with M18™ XC 5.0 Pack
- High Mode: 3,000 lumens for up to 2 hours with M18™ XC 5.0 Pack
- Low Mode: 650 lumens for up to 8 hours with M18™ XC 5.0 Pack
- High Definition Output with true color, even beam, and natural light
- Dual Power Source: M18™ or Corded
- Light Head rotates 240° with positive stops
- (3) integrated keyholes for hanging horizontally or vertically
- Durable Roll Cage protects light head



Part #	Mfg #	Length	Voltage	Price
181688	2360-20		18V	

### M18™ RADIUS™ LED Compact Site Light w/ ONE-KEY™

- Set light remotely from 50ft
- Optimize brightness and runtime
- Program automatic schedule
- Lighting for task, area, and overhead
- High impact polycarbonate lens
- 4,400 Lumens for maximum coverage
- AC in and out: string up to 10 together
- Protected AC plugs self-centering hang hook
- Reinforced hang hole
- 180 and 360 electronic: light control
- Low battery indicator



Part #	Mfg #	Length	Voltage	Price
222799	2146-20		18V	

### M18™ LED Stick Light

- TRUEVIEW: High definition lighting technology
- Forward and backward pivoting head
- Rugged design: replaceable lens plate and chemical resistant body
- Two adjustable metal hooks
- Compact design



Part #	Mfg #	Length	Voltage	Price
172034	2352-20	11.6"	18V	

### M18™ RADIUS™ LED Compact Site Light



Part #	Mfg #	Length	Voltage	Price
222798	2145-20		18V	

### M18™ LED Lantern/Flood Light

- TRUEVIEW: High definition lighting technology
- 180° - 360° Adjustable beam
- 2.1A USB Charger
- Rugged design
- Four light settings: High, medium, low, strobe
- Two stainless steel hooks



Part #	Mfg #	Length	Voltage	Price
171827	2363-20	11.5"	18V	

### Complete Flashlights

#### Headlamp

- Wide flood beam pattern
- High, medium, and low mode
- 7-Position tilting light head
- Includes (3) AAA batteries
- 3 Light output modes for optimal brightness & runtime



Part #	Mfg #	Description	Price
238980	2106	Headlamp	

## Work Lights

### Penlight

- 6000 Series aircraft aluminum body
- Over 3 hours continuous runtime
- Removable metal clip on/off
- Momentary-on button
- 43 Meter beam distance
- Includes (2) AAA batteries



Part #	Mfg #	Description	Price
238979	2105	Penlight	

### 325L Focusing Flashlight

- Two light output modes:  
High mode: 325 lumens- 5 hours  
Low mode: 25 lumens- 18 hours
- 115m (377 ft) beam distance
- Hard anodized, structural grade aluminum body
- Powered by (3) AAA batteries (Included)
- Kit includes:  
- Holster



Part #	Mfg #	Description	Price
253813	2107	Bare Tool	
253814	2107S	Kit	

### USB Rechargeable Hard Hat Headlamp

- REDLITHIUM™
- LED fuel gauge
- 2FT Micro-USB braided cord
- 7-Position tilting light head
- Flood, spot, & spot/flood beam patterns  
—Low, medium, and high modes
- 475 Lumens of TRUEVIEW™ high definition output
- 5 Light output modes for optimal brightness & runtime
- Clips & rubber grips included for hard hat attachment



Part #	Mfg #	Description	Price
238968	2111-21	Hard Hat Headlamp	

### USB Rechargeable Flashlight

- REDLITHIUM™
- LED fuel gauge
- 2' heavy duty USB cord
- Removable metal cord
- 155 Meter beam distance
- Spot-flood sliding beam adjustment
- 6,000 Series aircraft aluminum body
- 3 Light output modes: high, low, & strobe
- 700 Lumens of TRUEVIEW™ high definition output



Part #	Mfg #	Description	Price
238967	2110-21	USB Rechargeable 700L Light	

### USB Rechargeable Pivoting Flashlight

- REDLITHIUM™
- Fuel gauge
- Three light output modes:  
Spot high mode: 500 lumens- 2.5 hours  
Flood high mode: 400 lumens- 3 hours  
Flood low mode: 100 lumens- 10 hours
- Metal pocket clip
- 2 ft. braided micro-USB cable



Part #	Mfg #	Description	Price
253813	2113-21	USB Rechargeable Pivoting Light	

### USB Rechargeable ROVER™ Pocket Flood Light

- REDLITHIUM™
- LED fuel gauge
- Dual magnet clip
- 2FT Micro-USB braided cord
- 2 Light output modes for max brightness or run time
- Lumens of TRUEVIEW™ high definition output  
—High (445) and Low (100) modes



Part #	Mfg #	Description	Price
238969	2112-21	Pocket Flood Light	

## Work Lights

### USB Rechargeable ROVER™ Pivoting Flood Light

- REDLITHIUM™
- Fuel gauge
- Built-in carbiner clip
- Three light output modes:  
*High mode: 550 lumens- 2.0 hours*  
*Medium mode: 250 lumens- 4.5 hours*  
*Low mode: 100 lumens- 11.5 hours*
- 2 ft braided micro-USB cable



Part #	Mfg #	Description	Price
253817	2114-21	USB Rechargeable Pivoting Flood Light	

### Replacement Bulbs



49-81-0030



49-81-0090

Part #	Mfg #	Description	Price
141993	49-81-0030	Bulbs for 18V Work Light, 2/Pk	
138845	49-81-0090	LED Upgrade Work Lights	

---

---

## Flashlights

---

---

### LED Flashlights

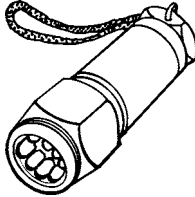

Part #	Mfg #	Description	Price
136007	R319350	Pocket LED Lightstick	

## Hammers

### Hammers

#### Smooth Face Framing Hammer

- Shockshield™ Handle
- Most Durable Grip Construction
- Magnetic Nail Set
- I-Beam Handle Construction
- Anti-Ring Claw
- Smooth Face
- Straight Claw



Part #	Mfg #	Size	Price
232892	48-22-9017	16-1/8"L x 5-3/4"W	
232894	48-22-9023	15"L x 6-1/8"W	

#### Hickory Handle Framing Hammer

- Shock absorbing American hickory
- Axe style curved claw
- Precision balanced design
- Magnetic nail set
- Anti-ring claw design



Part #	Mfg #	Size	Price
253604	48-22-9419	19oz Milled Face	
253605	48-22-9519	19oz Smooth Face	

#### Smooth Face Poly/Fiberglass Handle Hammer

- Most Durable Fiberglass Handle
- Magnetic Nail Set
- Asymmetrical Anti-Ring Claw
- Smooth Face
- Straight Claw



Part #	Mfg #	Size	Price
232895	48-22-9316	15-1/4"L x 5-5/8"	

#### Milled Face Framing Hammer

- Shockshield™ Handle
- Most Durable Grip Construction
- Magnetic Nail Set
- I-Beam Handle Construction
- Asymmetrical Anti-Ring Claw
- Milled Face
- Straight Claw



Part #	Mfg #	Size	Price
232893	48-22-9022	22oz	
232891	48-22-9016	17oz	



## Hammers

### Hammers

#### Sheet Metal Hammer - Riveting

- Polished finish



Part #	Mfg #	Size	Handle	Head Weight	Price
006477	RH4	4-7/8"	Leather	12 oz	

#### Sheet Metal Hammer - Setting

- Polished finish



Part #	Mfg #	Size	Handle	Head Weight	Price
006482	SH3	5-1/2"	Leather	18 oz	

**Hammers**

**Hammers**

**Hammer**



Ball Pein



Ripping Claw



Part #	Mfg #	Model	Description	Head Weight	Overall Length	Price
008654	52455	016	Ball Pein	16 oz	14"	
008705	52485	216	Ripping Claw	16 oz	13-1/4"	

## Hole Saws

### Hole Cutter Kits

#### Big Hawg® Hole Cutter Kit

- 50X Life in nail embedded wood & abrasive material applications
- 5X Faster cuts
- Thicker backer for extreme life in demanding applications
- Enlarged braze surface for stronger bond to the carbide teeth
- (3) Tooth design for fast aggressive cuts
- Cuts 1000+ more nails
- 10X Larger carbide teeth
- Carbide tipped multi-material pilot bit for increased material versatility
- Cuts wood, nails, shingles, cement board, plaster and more
- Includes:
  - 2-1/8" BIG HAWG™ with Carbide Teeth
  - (1) 2-9/16" BIG HAWG™ with Carbide Teeth
  - (1) 3-5/8" BIG HAWG™ with Carbide Teeth
  - (2) BIG HAWG™ with Carbide Teeth Pilot Bit (49-56-9300)
  - (1) BIG HAWG™ with Carbide Teeth Arbor (49-56-9305)
  - (1) BIG HAWG™ with Carbide Teeth Diamond File (48-09-5055)



Part #	Mfg #	Description	Price
249929	49-56-9280	7-Piece	

#### Big Hawg® Hole Cutter Kit

- Includes:
  - (1) 2-1/8" BIG HAWG™ with Carbide Teeth
  - (1) 2-9/16" BIG HAWG™ with Carbide Teeth
  - (1) 3-5/8" BIG HAWG™ with Carbide Teeth
  - (1) 4-5/8" BIG HAWG™ with Carbide Teeth
  - (2) BIG HAWG™ with Carbide Teeth Pilot Bit (49-56-9300)
  - (1) BIG HAWG™ with Carbide Teeth Arbor (49-56-9305)
  - (1) BIG HAWG™ with Carbide Teeth Diamond File (48-09-5055)



Part #	Mfg #	Description	Price
248848	49-56-9285	8-Piece	

### Big Hawg® Hole Cutter Kit

- Kit Includes:
  - (1) 2-1/8" BIG HAWG™ with Carbide Teeth
  - (1) 2-1/4" BIG HAWG™ with Carbide Teeth
  - (1) 2-9/16" BIG HAWG™ with Carbide Teeth
  - (1) 3" BIG HAWG™ with Carbide Teeth
  - (1) 3-5/8" BIG HAWG™ with Carbide Teeth
  - (1) 4-1/4" BIG HAWG™ with Carbide Teeth
  - (2) BIG HAWG™ with Carbide Teeth Pilot Bit (49-56-9300)
  - (1) BIG HAWG™ with Carbide Teeth Arbor (49-56-9305)
  - (1) BIG HAWG™ with Carbide Teeth Diamond File (48-09-5055)



Part #	Mfg #	Description	Price
249930	49-56-9290	10-Piece	

### Hole Saw Kits

#### Ice Hardened™ Hole Saw Kit

- Ice Hardened™ for up to 50% longer life
- Includes:
  - (5) Hole saws: 3/4", 7/8", 1", 1-1/8", 1-1/2"
  - Twist-Release™ arbor with pilot bit: 49-56-7210
  - Additional pilot bit: 49-56-8010
  - 1/8" Hex Key
  - Adapter: 49-56-6560



Part #	Mfg #	Description	Price
150075	49-22-4005	8-Piece	

#### Plumber's Ice Hardened™ Hole Saw Kit

- Includes:
  - (6) Hole saws: 3/4", 7/8", 1-1/8", 1-1/2", 1-3/4", 2-1/4"
  - (2) Arbors with pilot bits (49-56-7010 and 49-56-9100)
  - (2) Additional pilot bits (49-56-8010)
  - (1) Adapter (49-56-6560)
  - (1) Spacer (49-67-0120)



Part #	Mfg #	Description	Price
139022	49-22-4145	10-Piece	

## Hole Saws

### 18-Piece Master Plumbers Ice Hardened™ Hole Saw Kit

- Cryogenically treated
- Optimized tooth form for up to 2 times faster cutting
- Wide, angled and offset slots
- Includes:
  - (13) Hole saws - 3/4", 7/8", 1-1/8", 1-3/8", 1-1/2", 1-3/4", 2-1/4", 2-5/8", 3", 3-1/2", 4", 4-1/4", and 4-1/2"
  - (2) Arbors with pilot bits (49-56-7010 and 49-56-9100)
  - (3) Additional pilot bits (49-56-6560)
  - (1) Spacer (49-67-0120)



Part #	Mfg #	Description	Price
139021	49-22-4155	18-Piece	

### All Purpose Professional Hole Dozer™ Hole Saw Kit

- Rip Guard™, the strongest tooth form in the industry
- Rip Guard™ limited lifetime tooth break warranty
- Plug Jack™, an all access slot design for fast plug removal
- Bi-metal construction with 8% cobalt for increased wear resistance



49-22-4185

Part #	Mfg #	Description	Price
249351	49-22-4006	9- Piece	
173237	49-22-4142	12-Piece	
144971	49-22-4025	13-Piece	
227494	49-22-4175	15-Piece	
154644	49-22-4185	28-Piece	

### 8 Pc Refrigeration Hole Dozer™ Hole Saw Kit

- Rip Guard™, strongest tooth form
- Rip Guard™ limited lifetime tooth break warranty
- Plug Jack™ all access slot design for fast plug removal
- Bi-metal construction with 8% cobalt for increased wear resistance



Part #	Mfg #	Description	Price
246026	49-22-4079	8-Piece	

### 10 Pc Hole Dozer BiMetal Hole Saw Packout Kit

- Equipped with plug jack
- Backed by RipGuard™ limited lifetime tooth break warranty
- Includes PACKOUT(tm) Compact Organizer
- Bi-metal construction with 8% cobalt for increased wear resistance



Part #	Mfg #	Description	Price
258422	49-22-5606	10-Piece	

### SHOCKWAVE™ Impact Hole Saw Kit

- 1/4" Quick change hex shank for use with impact drivers
- Thin wall 8 TPI design
- Stop shoulder design prevents over-drilling and damaging components
- Ejection spring automatically removes slugs



Part #	Mfg #	Description	Price
169267	49-22-4800	3-Piece	

## Hole Cutters

### Big Hawk® Hole Cutter with Carbide Teeth

- 5X Faster cuts
- 3 Tooth design for aggressive cuts
- Thicker backer for extreme life
- Enlarged braze surface for stronger bond to the carbide teeth
- Cuts 1000+ nails
- 10X Larger carbide teeth
- Cuts wood, nails, shingles, cement board, plaster and more



Part #	Mfg #	Diameter	Price
249926	49-56-9200	1-3/8"	
246974	49-56-9210	2-1/8"	
249927	49-56-9215	2-1/4"	
246976	49-56-9220	2-9/16"	
246977	49-56-9225	2-3/4"	
246978	49-56-9230	3"	
246979	49-56-9240	3-5/8"	
246980	49-56-9255	4-1/4"	
249861	49-56-9265	4-5/8"	
249928	49-56-9270	5-1/4"	
249862	49-56-9275	6-1/4"	

## Hole Saws

### Hole Saws

#### Carbide Tipped Hole Saws

- Tungsten carbide tipped for long life
- Aggressive tooth form for fast cutting
- Wide, angled & offset slots for easy plug access



Part #	Mfg #	Diameter	Price
165182	49-56-0623	5/8"	
165184	49-56-0873	7/8"	
165186	49-56-1123	1-1/8"	
165189	49-56-1503	1-1/2"	
165190	49-56-1623	1-5/8"	
141827	49-56-1873	1-7/8"	
165196	49-56-2503	2-1/2"	
165202	49-56-2623	2-5/8"	
165205	49-56-3003	3"	
165207	49-56-3503	3-1/2"	
144973	49-56-3623	3-5/8"	
154873	49-56-4003	4"	

#### Hole Dozer™ with Carbide Teeth



Part #	Mfg #	Hole Dia	Price
246983	49-56-0702	3/4"	
246984	49-56-0704	7/8"	
249969	49-56-0707	1"	
246985	49-56-0708	1-1/8"	
249970	49-56-0710	1-1/4"	
249971	49-56-0712	1-3/8"	
246986	49-56-0713	1-1/2"	
246987	49-56-0717	1-3/4"	
249972	49-56-0719	1-7/8"	
249973	49-56-0720	2"	
165193	49-56-2123	2-1/8"	
246988	49-56-0724	2-1/4"	
249974	49-56-0726	2-3/8"	
249975	49-56-0727	2-1/2"	
246989	49-56-0729	2-5/8"	

### Hole Saws (Continued)

#### Hole Dozer™ with Carbide Teeth

Part #	Mfg #	Hole Dia	Price
165203	49-56-2753	2-3/4"	
165204	49-56-2873	2-7/8"	
246990	49-56-0734	3"	
165206	49-56-3253	3-1/4"	
249976	49-56-0738	3-1/2"	
249977	49-56-0739	3-5/8"	
165208	49-56-3753	3-3/4"	
249978	49-56-0742	4"	
246991	49-56-0744	4-1/4"	
249979	49-56-0746	4-1/2"	
165210	49-56-5003	5"	
165211	49-56-6003	6"	

#### Hole Dozer™ Hole Saw

- Rip Guard™, the strongest tooth form in the industry
- Plug Jack™, an all access slot design for fast plug removal
- Bi-metal construction for increased wear resistance



Part #	Mfg #	Hole Dia	Price
165164	49-56-0012	5/8"	
152110	49-56-0023	3/4"	
152111	49-56-0032	7/8"	
165165	49-56-0017	11/16"	
152112	49-56-0043	1"	
165166	49-56-0047	1-1/16"	
152113	49-56-0052	1-1/8"	
152114	49-56-0062	1-1/4"	
152115	49-56-0072	1-3/8"	
152116	49-56-0082	1-1/2"	
165167	49-56-0092	1-5/8"	
165178	49-56-0112	1-7/8"	
152119	49-56-0132	2-1/4"	
152117	49-56-0127	2-1/8"	
163909	49-56-0142	2-3/8"	
165168	49-56-0153	2-9/16"	
153383	49-56-0163	2-3/4"	
165170	49-56-0167	2-7/8"	
165171	49-56-0177	3-1/8"	
165172	49-56-0183	3-1/4"	





## Hole Saws

### Hole Saws (Continued)

#### Hole Dozer™ Hole Saw

Part #	Mfg #	Hole Dia	Price
165173	49-56-0203	3-3/4"	
152120	49-56-0213	4"	
165174	49-56-0217	4-1/8"	
165175	49-56-0223	4-1/4"	
165176	49-56-0237	4-3/4"	
247209	49-56-9654	5-1/2"	
165177	49-56-0253	6"	
219363	49-56-9656	6"	

#### Ice Hardened™ Hole Saw

- Ice Hardened™ for up to 50% longer life



Part #	Mfg #	Size	Price
143992	49-56-0102	1-3/4"	
144015	49-56-0117	2"	
144016	49-56-0147	2-1/2"	
150074	49-56-0158	2-5/8"	
144017	49-56-0173	3"	
251763	49-56-0187	3-3/8"	
148183	49-56-0193	3-1/2"	
144018	49-56-0197	3-5/8"	
144019	49-56-0233	4-1/2"	
142700	49-56-0243	5"	
240086	49-56-0247	5-1/2"	

#### Carbide Grit Hole Saws

- Tungsten carbide grit edge
- Coarse grit & segmented edge
- Includes carbide tipped pilot bit
- Wide, angled & offset slots for easy plug access



Part #	Mfg #	Description	Price
173245	49-56-0426	1-3/8"	

#### Diamond Plus™ Hole Saw

- Diamond Plus™ greater durability and toughness delivers up to 10X longer life
- Higher grade diamonds and improved braze: Provides best-in-class performance
- Large slug ejection slot
- Versatile: Ideal for cutting anchoring and clearance holes in all tile, stone and glass



Part #	Mfg #	Size	Price
170733	49-56-0503	3/16"	
173242	49-56-0505	1/4"	
173243	49-56-0507	5/16"	
233568	49-56-0509	3/8"	
234018	49-56-0511	1/2"	
234019	49-56-0513	5/8"	
173244	49-56-0515	3/4"	
222523	49-56-5625	1-3/8"	
254780	49-56-5660	2-1/2"	

#### Thin Wall Hole Saw

- 1/4" Quick change hex shank for use with impact drivers
- Thin wall 8 TPI design for 40% faster cuts than standard bi-metal hole saws
- Stop shoulder design prevents over drilling and damaging components
- Ejection spring automatically removes slugs



Part #	Mfg #	Size	Price
169268	49-56-9805	3/4"	
169269	49-56-9810	7/8"	
169270	49-56-9815	1"	
169271	49-56-9820	1-1/8"	
169272	49-56-9825	1-1/4"	
169273	49-56-9830	1-3/8"	
169274	49-56-9835	1-1/2"	



## Hole Saws

### Adjustable Hole Cutter

- Quik-Lok™ Arbor
- 2" through 7" Diameters with 1/4" Increments
- Black Oxide Coated with Laser Etched Size Indicators
- Durable debris shield



Part #	Mfg #	Description	Price
173825	49-56-0320	Depth of cut: 1"	

### Quick Change Steel Plate Carbide Cutter

- For use with quick change arbor 49-57-0035
- 1/2" cutting depth



Part#	Mfg#	Diameter	Price
253374	49-57-8207	7/8"	
253375	49-57-8215	1-1/8"	
253376	49-57-8223	1-3/8"	

### Arbors

#### Small Arbor

- Durable hardened steel construction



Part #	Mfg #	Size Range	Shank Size	Price
007020	49-56-6950	Up to 1-3/16"	1/4"	
007021	49-56-7000	Up to 1-3/16"	7/16"	
144976	49-56-7010	Up to 1-3/16"	3/8"	

#### Big Hawg® Arbor

- Standard 5/8"-18 thread fits all hole saws or hole cutters 1-1/4" through 6-1/4"
- Includes:
  - (1) Flat boring pilot bit
  - (1) Big Hawg® Arbor
  - (1) 7/16" Quick change shank



Part #	Mfg #	Description	Price
137895	49-56-9105	Big Hawg® Arbor	

### Large Quick Change Arbor

- Tool-free operation
- Universal, quick change with all brands of hole saws
- No adapters required
- Hardened steel construction
- Fits all hole saws 1-1/4" and larger
- Fits all drill chucks 3/8" and larger



Part #	Mfg #	Size Range	Shank Size	Price
144975	49-56-7250	1-1/4"+	3/8"	
149219	49-56-9100	1-1/4"+	7/16" No Wobble	
007022	49-56-7055	1-1/4" +	7/16"	

### Pilot Drill Bits

#### Big Hawg® Hole Cutter Pilot Bit

- Machined cutting edge for increased cutting speed
- Exclusive bit geometry aids plug removal



Part #	Mfg #	Description	Price
137898	48-27-1401	Big Hawg® Center Spade Bit	

#### Big Hawg® with Carbide Teeth Pilot Bit

- 50X Life in nail embedded wood & abrasive material applications
- Cuts 1000+ more nails
- 5x Faster cuts
- 5/16" Multi material pilot bit
- Carbide tipped for fast drilling in nail embedded wood and abrasive materials
- Exclusive bit geometry aids in plug removal



Part #	Mfg #	Description	Price
246981	49-56-9300	5/16" Multi-Material	



## Hole Saws

### High Speed Steel Pilot Bit

- Thunderbolt® tapered web for added durability
- 135° split point provides accurate hole placement
- 3-Flat shank won't slip in arbor or chuck
- Parabolic flute clears chips faster
- 12/Pk



Part #	Mfg #	Size	Price
007024	49-56-8000	1/4" x 4"	
152121	49-56-8010	1/4" X 3-1/2"	

### Carbide Tipped Pilot Bit

- Tungsten carbide tipped for long life
- Fits all hole saw sizes



Part #	Mfg #	Size	Price
007025	49-56-8005	1/4" x 4"	

### Hole Saw Accessories

#### Big Hawg® Arbor with Carbide Teeth

- Exclusive bit geometry aids in plug removal
- Cuts 1000+ more nails
- Carbide tipped for fast drilling in nail embedded wood and abrasive materials
- 50X Life in nail embedded wood and abrasive material applications
- 5X faster cuts



Part #	Mfg #	Description	Price
246982	49-56-9305	7/16" Quick Change	

#### Universal Quik-Lok™ Extension

- Accepts all 7/16" shanks
- No tools required for bit change
- Impact rated



Part #	Mfg #	Size	Price
144978	48-28-1000	3" x 1/4"	
152998	48-28-1030	5-1/2" x 7/16"	
147701	48-28-1040	12" x 7/16"	
170804	48-28-1050	18" x 7/16"	
241570	48-28-1060	24" x 7/16"	

### Hex-Wrench Bit Extension

- Accepts all 7/16" hex shanks
- For selffeed bits, auger bits and hole saw 1" diameter and larger



Part #	Mfg #	Size	Price
238663	48-28-4016	24" Length	
006928	48-28-4006	12" Length	
177316	48-28-4001	5-1/2" Length	

### Hex Extension

Part#	Mfg #	Description	Price
138372	48-28-1010	6" Hex Extension	
138373	48-28-1020	12" Hex Extension	

### Right Angle Attachment

- Rated up to 235 in/lbs torque
- Accepts standard 1/4" hex shank bits



Part #	Mfg #	Description	Price
149497	49-22-8510	Right Angle Attachment	

### Files

#### Big Hawg® Diamond File

- Easy re-sharpening on job site



Part #	Mfg #	Description	Price
137897	48-95-5055	Big Hawg® Diamond File	

**HVAC Testing Tools**

**Motor Testers**

**TECMate Pro ECM Motor Tester**

- Analyze ECM motors independent of the HVAC system
- Operates in the basic HVAC settings of fan-only, heating, cooling and de-humidification
- Designed to detect and isolate motor failures from other HVAC system failures



Part #	Mfg #	Description	Price
153548	PD510009	TECMate Pro Motor Tester	

**Test Connector**

Part #	Mfg #	Description	Price
031520	45-24318-0	Test Connector	
	1		

**Circuit Protection Products**

**ZBreaker Circuit Breaker Set**



Part #	Mfg #	Description	Price
141508	ZK005	5 Amp	

**Short-Pro Tool™**

- Finds 24 volt system shorts
- Automatically resets the breaker
- (2) 18" Leads



Part #	Mfg #	Description	Price
140758	ZSPRT	Short-Finder	

**Safety Power Adapters**

**Zebra'Dapter Fused Power Tap Cord**

- Lighted to show voltage level of plug
- Safe way to obtain 120V power to vacuum pumps, charging scales, drop lights, etc.



Part #	Mfg #	Description	Price
140729	ZD002	2' Lighted Female Cordset Blue	
140728	ZD001	2' Lighted Male Cordset Yellow	

**Smoke Detector & Accessories**

**SL-2000 Duct Smoke Detector**

- Hi-Temp
- Low-Flow
- No Tools



Part #	Mfg #	Description	Price
118470	SL-2000-N	4-Wire Ionization	

**Sampling Tube for SL-2000 & RT-3000 Series**



Part #	Mfg #	Description	Price
118471	STN-2.5	12" to 3.0'	

**HVAC Testing Tools**

**Meters**

**Thermo-Psychrometer**

- Large storage area for probes
- TM350 Includes:
  - (1) TMX2A 15' Air probe
  - (1) TMX2G 15' General purpose
  - (1) TMX2S 15' Surface probe



Part #	Mfg #	Description	Price
143080	87-TM350	Four Remote Stations	

**Probe for TM350 Thermo-Psychrometer**



TMX2S

Part #	Mfg #	Description	Price
143081	87-TMX2C	Clamp-On	
143082	87-TMX2P	Puncture	
143083	87-TMX2S	Surface	

**Hardware**

**Alligator Clip**

Part #	Mfg #	Description	Price
140494	455055	1" Black, 6/Pk	
140495	455056	1" Red, 6/Pk	
140496	455057	Alligator Clips with 18 AWG - 36" Test Leads	

**Test Lead**

Part #	Mfg #	Description	Price
140609	455150	10 AWG, 36" with 10A Clip	

**Combustion Analyzer Kits**

**Testo Residential Combustion Analyzer Kit**

- Fast 30-second startup
- Sensor technology
- Integrated probe hose
- Use for:
  - Boiler tuning
  - Checking furnace efficiency
  - Water heater checks
- Measures:
  - Ambient CO
  - Undiluted CO (CO air free)
  - O<sub>2</sub>, CO (with built-in NO<sub>x</sub> filter), CO<sub>2</sub>
  - Draft & pressure temperature
  - Combustion/flue gas efficiency & excess air



Part #	Mfg #	# of Fuels	Price
181036	PD875492	5	

## HVAC Testing Tools

### Voltage Detectors

#### Voltage Detector with LED

- Safety rating: CAT IV 1,000V
- Green power on indicator light
- Pocket clip
- Requires (2) AA batteries (included)



Part #	Mfg #	Voltage Range	Price
137565	2202-20	50 to 1,000 AC	

#### Dual Range Voltage Detector

- Different colors identify voltage range
- Built-in LED work light
- Auto-off
- Pocket clip
- Blade-tip for checking outlets
- Constant power ON LED indicator



Part #	Mfg #	Voltage Range	Price
168492	2203-20	10-1,000 V	

### Test & Measurement Tools

#### Fork Meter for HVAC/R

- Heavy-duty True-RMS electrical tester for professional residential, commercial and industrial applications
- High contrast white-on-black display
- Five tools in one:
  - Current measurement
  - Temperature measurement
  - Voltage measurement
  - Voltage detection
  - Task lighting - LED work light
- Includes:
  - Fork clamp
  - Test leads
  - Dual banana thermocouple
  - (2) AA Batteries
  - Manual
- 5-Year warranty



Part #	Mfg #	Description	Price
137566	2206-20	8" Length, 200A Current AC	

### Tru RMS Digital Multimeter

- Wide voltage range to 600VAC/DC
- Auto range to millivolts
- True-RMS for accurate measurement in all applications
- Lo-Z measurement to eliminate ghost voltage
- Frequency measurements from 10Hz to 50kHz
- Contact temperature measurement: -40° to 752°F
- Current measurement to 10AAC/DC
- High contrast white on black display with back light
- Rugged over-molding increases durability and grip
- 5-Year warranty
- Includes:
  - Multimeter
  - Test leads
  - Dual banana thermocouple
  - (2) AA Batteries
  - Manual



Part #	Mfg #	Description	Price
136067	2217-20	6-1/2" L, 10.00A Current AC/DC	

#### Clamp Meter for HVAC/R

- Electrical current tester for professional residential, commercial and industrial applications
- 1.3" Jaw opening to easily handle large conductors
- White-on-black display
- LED Work light
- Includes:
  - Clamp
  - Test leads
  - Dual banana thermocouple
  - (2) AA Batteries
  - Manual
- 5-Year warranty



Part #	Mfg #	Description	Price
137567	2236-20	9-1/2" Length, 600A Current AC	

#### Electrical Test Lead Set

- Works on all digital multimeters, clamp meters and fork meters
- Measures up to 1000 volts and 10amps



Part #	Mfg #	Description	Price
153226	49-77-100	Electrical Test Lead	1



## HVAC Testing Tools

### Detectors

#### Dust Smoke Detector

- Ionization



Part #	Mfg #	Description	Price
118470	849046	Dust Smoke Detector	

#### Air Products Sampling Tube

- For SL-2000

Part #	Mfg #	Model #	Size	Price
118471	849051	STN-2.5	2-1/2" ft	

### Meters & Testers

#### Vane Anemometer

- Air humidity meter with temperature measurement
- Integrated measurement with 1.5 in. vane
- Timed mean value calculation
- Hold function and max./min. values
- Wind chill calculation for outside areas (perceived temperature)
- Back lit display
- Air humidity measurement with long-term stable Testo humidity sensor
- Incl. dewpoint calculation and wet bulb
- Includes:
  - Integrated humidity measurement and NTC air thermometer
  - Protective cap for safe storage
  - Wrist strap and belt clip
  - (2) Type AAA batteries, 60 hour life
  - Calibration certificate



Part #	Mfg #	Description	Price
143078	875043	Vane Anemometer with Integrated Humidity & NTC Air Thermometer	

### Carbon Monoxide Stick Meter

- Detects presence of carbon monoxide in ambient air from gas furnaces, water heaters, and other appliances or equipment
- Visual and audio warnings, adjustable alarm threshold
- No zero phase, instrument can be used immediately
- CO Zeroing on-site
- Self test function



Part #	Mfg #	Description	Price
143084	875036	Includes Leather Holster w/Belt Strap, Earphone, Wrist Strap	

### Humidity and Temperature Meter

- Long-term, stable Testo humidity sensor
- +/-2.5 %RH Accuracy
- Hold function and max/min values
- Includes:
  - Protective cap for safe storage
  - Batteries
  - Calibration certificate



Part #	Mfg #	Description	Price
143079	875042	Dewpoint & Wet Bulb Meter	

### Electrical

Part #	Mfg #	Description	Price
141560	86-22510	Test Leads	



## HVAC Testing Tools

### Clamp-On Digital Multimeters

#### DL389 G2 Phoenix Pro+ Clamp-On Multimeter

- Dual display and low battery display lock
- Test lead storage and holder on clamp head
- Auto off
- Input jack lock
- Detachable clamp head
- Worklight
- Magnetic mount
- User temperature calibration
- EasyView high contrast backlight display
- Compatible with common industry accessories heads
- Safety compliance CAT III 600V, CAT II 1000V
- Includes:
  - Test leads
  - K-Type probe (no adapter required)
  - Zippered case
  - (2) AAA Batteries
- 3-Year limited warranty



Part #	Mfg #	Description	Price
128764	DL389	12 Functions Including TRUE-RMS (AC Volts & Amps)	

### Thermometers

#### 550B Digital Pocket Thermometer

- Water resistant
- Records minimum & maximum temperatures
- Protective boot
- Magnetic mount
- HOLD freezes the current temp reading
- Auto power off
- Ergonomic designed head
- 3-Year limited warranty



Part #	Mfg #	Description	Price
069651	550B	-58° to 572°F Range	

### Digital Thermometer

- Waterproof
- Built-in magnetic mount
- Records minimum & maximum temperatures
- Data hold
- Auto power off
- Easy access battery compartment
- Enhanced accuracy of digital circuitry
- Includes battery & multipurpose probe
- -58° to 572°F Range
- 3-Year limited warranty

PDT550



PDT650



Part #	Mfg #	Description	Price
082376	PDT550	Pen Type	
153228	PDT650	Folding Type	

### CO Detectors

#### CO71 "The CO Detective" Carbon Monoxide Monitor

- Tri-color LED indicates concentrations at 3 levels complying with residential and work place standards
- Audible alert triggers at 35 ppm indicating the threshold of dangerous concentration
- Backlight display
- Operating temperature: 32° to 104°F
- MAX Continually updates to provide recall of highest CO reading
- Auto zero activates upon turn on
- 9V Battery operated
- 3-Year limited warranty



Part #	Mfg #	Description	Price
051760	CO71	Displays 0 to 999 ppm CO Level in Ambient Air	

**HVAC Testing Tools**

**Leak Detectors**

**CD100A Combustible Gas Leak Detector**

- Long 18" gooseneck for hard to reach areas
- Tip light in sensor cap illuminates search area
- Probe cage protects sensor
- Audio and visual tic rate fully adjustable
- Headphone jack
- Includes:
  - Sensor and cap
  - 9V Battery
- 1-Year limited warranty



Part #	Mfg #	Description	Price
038331	CD100A	50 ppm Minimum Detection	

**Manometers**

**EM151 Digital Electronic Manometer**

- Single input measurement to  $\pm 20"$  wg
- Integral protective boot w/magnet
- Simple two-button operation
- Measures in inches water gauge and Mbar
- Automatic after 5 minutes of inactivity and manual power-off
- Includes:
  - (1) Pressure tubes with brass fitting connector
  - (1) Std 9V battery
  - Manual
- 1-Year limited warranty



Part #	Mfg #	Description	Price
126553	EM151	Single Input Electronic Manometer	

**SSM1 Super Heat/Sub Cool Meter**

- Measures:
  - Pressure from 0 - 500 psia
  - Temperature from -40° to 400°F
- Calculates:
  - Superheat for low side
  - Subcool for high side (TXV systems)
- Refrigerants included for calculations: R-22, R-134a, R-404A, and R-410A
- 1-Year limited warranty



Part #	Mfg #	Description	Price
133479	SSM1	Super Heat/Sub Cool Meter	

**Static Pressure Kit**

- Dynamic Min/Max value capture
- Data hold
- Backlit display
- Ruggedized, including rubber boot with integral magnet
- Auto power off
- 3-Year limited warranty



Part #	Mfg #	Description	Price
161833	EM201SPKIT	Dual input differential measurement to $\pm 60$ InWC	

**Electrical Testers**

**PET1 Pocket Electrical Tester**

The PET1 features:

- Worklight
- Non-contact AC voltage test from 12-600VAC (with adjustable sensitivity)
- Detects high and low AC voltage
- Continuity check: 0-80 megohms
- Audible/visual indicators
- 3-Year limited warranty



Part #	Mfg #	Description	Price
083035	PET1	Volt Tester w/Light	

**Probes**

**ATL5 Modular Test Lead Tip**

- Back probe



Part #	Mfg #	Description	Price
237035	ATL-5	Modular Test Lead Tip	



## HVAC Testing Tools

### Meters

#### TurboMeter™

Part #	Mfg #	Description	Price
106684	439103	Air Velocity Meter	

#### Differential Pressure Meter

- Includes protective cap, batteries and calibration certificate
- Display in Pascal optional over entire measurement range
- Temperature compensation
- Magnetic back permits free-hand work
- Accuracy:  $\pm 0.01$  "H<sub>2</sub>O (0 to 0.12 "H<sub>2</sub>O) /  $\pm 0.02$  "H<sub>2</sub>O (0.13 to 0.4 "H<sub>2</sub>O)
- Flow velocity measurement with Pilot tube (Pilot tube not included in delivery)
- Air density compensation
- Includes:
  - Protective cap for safe storage
  - (2) Type AAA Batteries, 50 hour life
  - Including wrist strap and belt clip



Part #	Mfg #	Description	Price
142784	875044	Digital Differential Pressure Meter	

#### Smartphone Static Pressure Meter

- Automatically imports local weather data based on GPS location
- Easily emails professional, detailed reports
- Rugged, weather resistant housing with hands-free magnetic holder



Part #	Mfg #	Description	Price
180508	SPM-100	Dual Port Manometer Accessory	

## HVAC Testing Tools

### Meters

#### Economy Auto-Ranging Clamp-On Meter

- Reads volts, amps and ohms
- Data hold and continuity buzzer
- CAT II
- Includes carrying case



Part #	Mfg #	Description	Price
111388	MA-600CF	Temp Range: -38° to 1,750°F	

#### Oil & Glycol Refractometer



Part #	Mfg #	Description	Price
111392	MA-REF401F	Glycol Fahrenheit Refractor	

#### Torsion Mounting Bracket

- 5.5"

Part #	Mfg #	Description	Price
197937	MA-FM55	Mounting Bracket Motor	

## HVAC Testing Tools

### Meters & Testers

#### Digital Psychrometer

- Data hold
- Auto power off
- °F/°C switchable
- Power: 2 AAA batteries
- Dimensions: 7" x 1-7/8" x 1"
- Operating temperature range: 4° to 122°F
- Response time of 60 seconds to changes in humidity
- Display relative humidity & temperature simultaneously



Part #	Mfg #	Description	Price
182260	69008	Digital Psychrometer	

#### Gas Pressure Test Kit

- Helps to accurately set manifold pressure natural or L.P. gas
- Two gauge ranges available
- single bellows on brass plate design
- Sensitive diaphragm gauge calibrated in inches of water column and ounces per square inch
- Tube nipple for easy connection to system manifold



Part #	Mfg #	Description	Price
182330	78060	Gas Pressure Test Kit	

### Manometers

#### Dual Port Manometer

- Auto power-off
- 9V Battery required
- Single button operation
- Measures gas pressure, static pressure, & pressure differential
- Measures pressure between -19.95 and 19.95inWC (inches of water column)
- Includes a easy to use zero function
- Designed for HVACR field service technicians
- Measures pressure drop directly across two points such as filter pressure drop or flow volumes
- Positive and negative pressures can be read directly if measured on the appropriate input
- Kit includes: 30" tubing, clear hose, tube splice and 1/8" NPT brass fitting.



Part #	Mfg #	Description	Price
240354	78052	Dual Port Manometer	

### Water-Type Manometer

- Plastic tubing with fitting
- Set manifold pressure for natural gas or L.P. gas
- Strong magnet holds manometer in upright position



Part #	Mfg #	Description	Price
182335	78075	0-15" Water-Type Manometer	

### Detectors

#### AccuProbe™ UV Leak Detector

- Low battery indicator
- True mechanical pump
- 17" Probe length
- Instantaneous response time
- Power: 4 AA alkaline batteries
- SmartAlarm™ leak size indicator
- 3 selectable sensitivity level settings
- Long life, stable electrolyte sensor
- Humidity: 0 to 95% RH non-condensing
- Operating temperature range: 24° to 125°F
- Automatic calibration and reset to environment
- Clears in 12 seconds or less after exposure to a 1.75 oz (50 g)/year leak
- Sensitivity: HFC – 0.06 oz. (1.7 g)/year; HCFC – 0.03 oz. (0.9 g)/year; HFO – 0.15 oz. (4.3 g)/year



Part #	Mfg #	Description	Price
182305	69336	AccuProbe Leak Detector	

#### AccuProbe™ II Leak Detector

- Low battery indicator
- True mechanical pump
- 17" Probe length
- Instantaneous response time
- Power: 4 AA alkaline batteries
- SmartAlarm™ leak size indicator
- 3 selectable sensitivity level settings
- Long life, stable electrolyte sensor
- Humidity: 0 to 95% RH non-condensing
- Operating temperature range: 24° to 125°F
- Automatic calibration and reset to environment
- Clears in 12 seconds or less after exposure to a 1.75 oz (50 g)/year leak
- Sensitivity: HFC – 0.06 oz. (1.7 g)/year; HCFC – 0.03 oz. (0.9 g)/year; HFO – 0.15 oz. (4.3 g)/year



Part #	Mfg #	Description	Price
182306	69354	AccuProbe II Leak Detector	



## HVAC Testing Tools

### Combustible Gas Detector

- Probe length: 17"
- Sensor life: 500 hours
- Automatic calibration
- 25 second warm up time
- Instantaneous response time
- Power battery: 4 AA alkaline batteries
- Operating temperature range: 32° to 110°F
- Sensitivity: 5 ppm methane or better 2 ppm propane



Part #	Mfg #	Description	Price
182308	69373	Combustible Gas Detector	

### Parts & Accessories

Part #	Mfg #	Description	Price
182311	69384	AccuProbe Replacement Sensor & Filter	
182312	69385	AccuProbe Sensor Filters-5Pk	
182331	78062	Hose w/ Nipple for 78055/60	
182332	78064	Brass Barb Ftg For 78055/60	
182333	78065	Rubber Nipple for 78055/60	



## Knives & Replacement Blades

### Utility Knives and Knife Blades

#### Quick Open Utility Knife

- Retractable blade
- Integrated hinge



Part #	Mfg #	Description	Price
048168	9PK	3-Position	

#### Top Button Action Utility Knife

- Safe, easy to operate thumb action mechanism on top



Part #	Mfg #	Description	Price
006528	4PK	3-Position	

## Knives & Replacement Blades

### Utility Knives

#### Fastback Compact Flip Utility Knife

- Press and flip opening
- Compact size
- Quick blade change
- Belt clip
- Lanyard hole



Part #	Mfg #	Length	Price
188651	48-22-1906	6.2"	

#### Sliding Utility Knife

- Side slide activated blade
- Rubber over mold hand grip
- On board blade storage
- Tool-free blade change
- Integrated gut hook and wire stripper



Part #	Mfg #	Length	Price
137585	48-22-1910	7-1/4"	

#### 18mm Snap Off Knife

- Durable lock- up to 2x longer life
- Speed thread- 2x faster blade adjustment
- Microcarbide blade- up to 2x longer blade life
- Acetone resistant
- 8 Point blade



Part #	Mfg #	Length	Price
163299	48-22-1964	6"	

#### Fastback™ Utility Knife

- One-handed blade opening
- Tool-free blade change
- Wire stripper
- Integrated gut hook
- Thin body design



Part #	Mfg #	Length	Price
137584	48-22-1901	7-1/4"	
225380	48-22-1903	6-3/4"	

#### HARDLINE™ Smooth Blade Pocket Knife

- Drop point smooth blade
- Flipper with bearing system
- Opening steel frame lock
- Glass filled nylon handle with stainless steel back
- Stone washed black oxide finish
- Reversible tip up belt clip
- Lanyard hole



Part #	Mfg #	Length	Price
243683	48-22-1928	10.3"	
222817	48-22-1994	6.9"	
222819	48-22-1999	8.2"	

### Multi-Purpose Knives

#### FASTBACK™ Smooth Folding Pocket Knife

- Press and flip operation: Permits one-handed opening
- Stainless steel drop-point blade: resharpenable edge for long lasting use
- Liner lock
- Slim, compact body: stores easily yet withstands job site abuse
- Piercing tip: allows controlled piercing and smooth cutting
- Lanyard hole
- Reversible wire-form belt clip



Part #	Mfg #	Length	Price
163301	48-22-1990	7-3/4"	

#### FASTBACK™ Spring Assisted Serrated Knife

- Spring-assisted opening: Permits one-handed operation
- Black oxide-coated stainless steel serrated blade: Maintains long-lasting sharp edge
- Liner lock
- Serrated blade: Ideal for tearing through material, Tanto tip: Ideal for piercing material
- Slim, compact body: Stores easily yet withstands job site abuse
- Reversible wire-form belt clip



Part #	Mfg #	Length	Price
162813	48-22-1995	8-1/4"	

## Knives & Replacement Blades

### FASTBACK™ Hawk Bill Folding Knife

- Press-and-flip operation: permits one handed opening
- Stainless steel curved blade
- Liner lock
- Slim, compact body
- Piercing tip: allows controlled piercing and smooth cutting
- Lanyard hole
- Reversible wire-form belt clip



Part #	Mfg #	Length	Price
170008	48-22-1985	7-1/4"	

### FASTBACK™ Spring Assisted Knife

- Spring Assisted Open for fast one-handed opening
- Black Oxide Stainless Steel Blade
- Liner Lock
- Reversible Wire Form Belt Clip



Part #	Mfg #	Length	Price
180512	48-22-1996	Realtree Xtra® Camo	

### Tradesman Fixed Blade Knife

- Stays sharper longer
- Full tang
- 4" Drop point blade
- 9-1/2" Overall length
- Lanyard hole
- Stainless steel blade



Part #	Mfg #	Description	Price
240552	48-22-1926	9-1/2"	

### HARDLINE™ Pocket Knife

- Drop Point Smooth Blade
- Flipper with Bearing System
- Opening Steel Frame Lock
- Glass Filled Nylon Handle with SS Back
- Stone Washed Black Oxide Finish
- Reversible Tip Up Belt Clip
- Lanyard Hole



Part #	Mfg #	Description	Price
222816	48-22-1997	2.5", Smooth Blade	
222818	48-22-1998	3", Serrated Blade	

### Duct Knife

- Stainless steel blade
- Full tang for tough cuts
- Double edged blade
- Durable sheath with belt clip
- Lanyard hole



Part #	Mfg #	Description	Price
181527	48-22-1920	Includes Sheath	

### Insulation Knife

- Stainless steel blade
- Full tang for tough cuts
- Rounded handle for smoothing applications
- Durable blade cover for storage
- Lanyard hole



Part #	Mfg #	Description	Price
181528	48-22-1921	Smooth Blade	
181529	48-22-1922	Serrated Blade	

## Replacement Blades

### 50 PC General Purpose Utility Blades w/ Dispenser

- Micro carbide deposited metal delivers up to 3X longer life than standard carbon blades
- Precision grind process removes the burr from cutting edge for cleaner cuts
- Optimized grind angles deliver improved sharpness for less repeat cuts
- Made in the USA



Part #	Mfg #	Description	Price
163303	48-22-1950	50 PC General Purpose Utility Blades w/ Dispenser	

### General Purpose Utility Blades

- Micro carbide dispersed metal
- Precision grind process removes the burr from cutting edge for cleaner cuts
- Optimized grind angles deliver improved sharpness for less repeat cuts



Part #	Mfg #	Description	Price
233562	48-22-1905	5 Pc	



---

---

## Knives & Replacement Blades

---

---

### Replacement Blades (Continued)

#### General Purpose Utility Blades

Part #	Mfg #	Description	Price
246449	48-22-1900	100 Pc	
219300	48-22-1934	5 Pc, Round Point	



---

---

## Knives & Replacement Blades

---

---

### Utility Knives and Blades

#### #82 Safety Nose Retractable Blade Knife

Part #	Mfg #	Description	Price
036760	38205	Heavy-Duty Red	

**Levels**

**Levels**

**Torpedo Level**

- Ideal for general use and work in tight places
- Three vials for plumb, level and 45° miter
- Full length strong magnetic edge
- V-Grooved edge for pipe and conduit work
- Large top read level vial



Part #	Mfg #	Model	Description	Price
051918	20233	395	9" Nightshade Level	



## Levels

### Empire Levels

#### TRUE BLUE® Magnetic DUAL-PITCH™ Torpedo Level

- Powerful rare earth magnets provide superior holding strength
- All aluminum frame with top read window
- V-Groove working edge for accurate alignment on pipe or conduit
- Ruler Groove compatible with most straight edges for extended measuring and marking
- Surface grip surrounds level vial for increased stability



Part #	Mfg #	Size	Price
232260	EM75.10	10"	

#### TRUE BLUE® Magnetic Billet Torpedo Level

- Powerful rare earth magnets provide superior holding strength
- High contrast e-BAND™ vials highlight the edge of the bubble
- VARI-PITCH™ vial reads slope at 1/8", 1/4", 3/8", or 1/2" per foot of horizontal run
- V-Groove working edge for accurate alignment on pipe or conduit
- Top read window provides clear overhead viewing
- Laser etched ruled edge allows for quick measurements on working material
- Tapered design for easy in and out of pocket
- Billet aluminum frame for superior durability



Part #	Mfg #	Size	Price
187324	EM71.8	8"	

#### Magnetic Torpedo Level

- High contrast e-BAND™ vials highlight the edge of the bubble
- High contrast vial surrounds improve vial visibility
- 3 vials - plumb, level and 45°
- V-Groove working edge for accurate alignment on pipe or conduit
- Aluminum frame with top read window
- Strong magnetic edge



Part #	Mfg #	Size	Price
218536	EM81.9	9"	
218537	EM81.12	12"	
173520	EM81.24	24"	
174326	EM81.48	48"	

### TRUE BLUE® Box Level

- Surface grippers
- e-BAND™ vials
- Precision milled edge
- Hang hole for ease of storage
- 300° Viewing Window maximizes range of view



Part #	Mfg #	Size	Price
173522	E75.24	24"	

#### TRUE BLUE® ULTRAVIEW™ LED Magnetic Box Level

- Surface grippers
- e-BAND™ vials made in the USA
- 2 minute auto shut-off or press and hold to turn off
- Hang hole for ease of storage
- Limited lifetime warranty on frame and vials. 1 year warranty on electronics
- 2 (AA) batteries included



Part #	Mfg #	Size	Price
224519	EM95.24	24"	
237855	EM95.10	10"	

### I-Beam Magnetic Level

- Top read window
- Ergonomic, grip zones
- All metal, anodized I-Beam frame
- High-strength magnetic edge
- Hang hole for ease of storage



Part #	Mfg #	Size	Price
189806	EM55.48	48"	

### Levels

#### Die Cast Torpedo Level w/ 360° Locking Vial



Part #	Mfg #	Size	Price
240706	48-22-5210	10"	

#### Compact Billet Torpedo Level

- Amplified rare earth magnets
- Maximized viewing area



Part #	Mfg #	Size	Price
226658	48-22-5107	Billet Torpedo	



## Levels

### Torpedo Level Starter Kit

- Includes: (1) 24" Milwaukee Box
- Tough, water resistant nylon
- All metal hardware
- Durable zipper closure
- Two Integrated carrying or hanging handles
- Integrated external tool loops for additional tool storage
- Two debris vent to prevent dust, dirt and/or water build up



Part #	Mfg #	Size	Price
243836	MLBXC48	Includes Bag, 48" Level, 24" Level	

### 24" / 48" REDSTICK™ Box Level Set

- ALL-METAL BACKBONE™
- SHARPSITE™ Vial technology
- High density, removable end-caps protect frame and provide access in tight spaces
- Wide, durable handles for comfort and portability
- Precision milled measuring surface guarantees accuracy in all working positions
- Overmolded, non-slip grips stick to the wall and prevent sliding
- Durable, all-metal hang hole for storage



Part #	Mfg #	Size	Price
234217	MLBXS48	24" & 48"	

### 24" / 48" REDSTICK™ Magnetic Box Level Set

- ALL-METAL BACKBONE™
- SHARPSITE™ Vial technology
- High Density, removable end-caps protect frame and provide access in tight spaces
- Wide, durable handles for comfort and portability
- Precision milled measuring surface guarantees accuracy in all working positions
- Overmolded, non-slip grips stick to the wall and prevent sliding
- Durable, all-metal hang hole for storage
- Includes:
  - (1) 24" REDSTICK™ Magnetic Box Level (MLBXM24)
  - (1) 48" REDSTICK™ Magnetic Box Level (MLBXM48)



Part #	Mfg #	Size	Price
240501	MLBXS48	24" & 48"	

### 24" REDSTICK™ Box Level

- SHARPSITE Vial technology
- Durable, all-metal hang hole for storage
- Guaranteed lifetime accuracy - accurate to .029°
- High density, removable end-caps
- Wide, durable handles for comfort and portability



Part #	Mfg #	Size	Price
252641	MLCMM24	24" Magnetic Compact	

### 48" REDSTICK™ Box Level

- ALL-METAL BACKBONE™
- SHARPSITE™ Vial technology
- Guaranteed lifetime accuracy: accurate to .029°
- High contrast vial system is easy to clean and optimizes visibility
- High density, removable end-caps protect frame and provide access in tight spaces
- Wide, durable handles for comfort and portability



Part #	Mfg #	Size	Price
245215	MLBX48	48"	
245217	MLCM48	48" Compact	
245218	MLCMM48	48" Magnetic Compact	

### REDSTICK Concrete Levels

- Ergonomic keyhole frame
- Magnesium base for screeding
- Dedicated concrete working edges
- Sharpsite pitch vial for easily reading 1/8" and 1/4" pitches



Part #	Mfg #	Size	Price
253268	MLCON48	48"	
261434	MLCON72	72"	

---



---

## Miscellaneous Tools

---



---

### Maxstraps

#### The Original 1" Polypropylene Cam Tiedown

- Ideal for lumber, pipe, ladders, and outdoor gear
- Weather and sunlight resistant
- 750 lb Test
- Rustproof cam buckle
- Easy thumb release



Part #	Mfg #	Description	Price
053091	00216	2' Black	
053093	00411	4' Red	
053094	00612	6' Yellow	
053095	00813	8' Green	
053096	01014	10' Blue	

## Miscellaneous Tools

### Utility Strap

#### Rubber Tie Down Strap

- Stretches to double its length
- Extra heavy steel S-hooks on each end



Part #	Mfg #	Description	Price
002270	540-31	31" Rubber Strap	

#### Ratchet Strap

- Easy ratcheting permits tie-down of appliances securely.
- An innovative latch and a fast release cam reduces socket wear.
- Cadmium-plated steel buckle has a positive lock that eliminates release due to vibration.
- When closed, the handle locks the latch into the sprocket to prevent inadvertent release. 16 foot nylon webbing rated at 3000 PSI tensile.
- Vinyl coated end hooks rated at 1200 PSI tensile.



Part #	Mfg #	Description	Price
192407	HS-192	16 ft	

#### Hanging Strap

- Strong, versatile, easy way to secure loose gear safely
- 1 in. polypropylene webbing
- Spring loaded adjustable buckle
- Easy to get firm tension with no slipping
- Make an endless length by connecting 2 or more together



Part #	Mfg #	Description	Price
046209	HS-30	30"	
049072	HS-60	60"	

#### Strapping Hanger Iron

- Galvanized 3/4in. vent strapping, hanger iron, plumber's tape, pipe hanger tape and many other uses
- 1/4in. centers for bolts or nails.



Part #	Mfg #	Description	Price
194311	710-A16100	3/4" x 100'	

### Woven Polypropylene Duct Strap

- Webbed duct strap processing high tensile and abrasion resistance.
- This can be used for flex duct as it is easy to cut and staple to joists.
- The product is chemical resistant and tested to meet UL Standard 2043.



Part #	Mfg #	Description	Price
192065	710-100	1-3/4" x 100 Yards	
137962	710-102	3" x 100 Yards	

### Metallic Duct Strap

- Galvanized duct strap in a convenient cardboard dispenser is not only easy to drill or nail, but also solid strapping.
- Plenum rated.



Part #	Mfg #	Description	Price
192070	710-001	26 Gauge, 1" x 100'	
194518	710-003	30 Gauge 1-1/2" x 100'	

### Miscellaneous Tools

#### Fin Whisk

- Plastic handled whisk for cleaning condenser and evaporator fins



Part #	Mfg #	Description	Price
141528	B-26	Fin Whisk Brush	

#### Chip Brush

- 100% pure bristle
- Wood handle
- Poly sleeve over bristles
- Use once and throw away



Part #	Mfg #	Description	Price
195230	B-504	2-1/2" Chip Brush	

## Miscellaneous Tools

### SuperComb

- Easier to grip, easier to use tool for straightening condenser and evaporator fins.
- Straightens 50% more fins in one stroke.
- Keeps hands a safe distance from fins.
- Easy to grip, strong, durable, heavy duty nylon.
- Color coded for easy identification.
- 6 per set.



Part #	Mfg #	Description	Price
143979	T-400	6 Pack	

### Multi-Head Fin-Tool

- Conveniently straightens and cleans condenser and evaporator fins.
- Each nylon head slides into the master handle and tightens in place.
- Heads are designed to fit units with fin spacing of 4–24 fins per inch.
- Each head is engraved with its own size and is color coded for fast identification.
- Heads are angled so that when inserted in the handle, the hand is a safe distance from the sharp fins.
- Heads may also be reversed in the handle so that combing with an upward stroke (recommended method) may be done easily with proper leverage.
- The master handle rests comfortably in a man-size grip, is rigid and long lasting.



Part #	Mfg #	Description	Price
192409	T-100	6 Heads, 1 Handle	



## Miscellaneous Tools

### Telescoping Tools

#### Telescopic Inspection Mirror

- American made
- Double ball joint links swivel mirrors for viewing to 360°



Part #	Mfg #	Description	Price
192406	M-2	2-1/4" Circular Extends 10-14"	
002322	M-5	1" x 2" Oval Extends 8-1/2"	

### Refrigeration Tools

#### Nitrogen Purge Tool

- Adjustable dial
- Quickly switch between braze, purge or off
- Accurately regulates flow and volume for purging or brazing



Part #	Mfg #	Description	Price
234800	DP-1	Adjustable Dial	

#### Access Fittings

- May be installed in any position on either high or low side for charging, purging, quick testing, or pressure checking



Part #	Mfg #	Description	Price
192402	VC-4	Flare Cap, 1/4" SAE Male	
193548	VVC-1	Valve Core	
195766	VST-44	Swivel Tee	
195768	VTS-68	Solder Tee 3/8"	
195769	VTS-12	Solder Tee 3/4"	

#### Extended Copper Tube

- For refrigeration servicing
- May be installed in any position
- 1/4" SAE male flare access ports
- Includes
  - Quick seal cap
  - Stainless and brass special refrigerant valve core



Part #	Mfg #	Description	Price
192416	VAX-2	Extended Copper Tube, 1/8"O	
192415	VAX-3	3/16" O.D. x 1/8" I.D.	
224361	VAX-4	Ext Copper Tube, 1/4"ODx3/16"ID	

### Cop Cap™ Locking Valve Cover

- Includes 2 caps, 1 wrench



Part #	Mfg #	Description	Price
204182	VVC-4	2 Caps and 1 Wrench	

### Copper Saddle Valve

- For copper-to-copper brazing.
- Penetrates line in one easy operation with no holes to drill.
- Steel pin with valve core pierces line and is locked into valve body by tightening cap.
- Teflon ring assures positive seal.
- Available in sizes from 1/4in. to 1-1/8in..



Part #	Mfg #	Description	Price
192413	VLC10	5/8in. O.D. Tube Size, Pack of 3	
192414	VLC12	3/4in. O.D. Tube Size, Pack of 2	
194230	VLC-6	3/8in. O.D. Tube Size, Pack of 6	
196482	VLC-8	1/2in. O.D. Tube Size, Pack of 4	
196181	VLC-4	1/4in. O.D. Tube Size, Pack of 6	

### Core Storer

- All steel valve core remover and storage container.
- Completely knurled for easier grip, eliminating slippage when using with oily or greasy hands.
- Core Storer features a compartment for storing extra valve cores.
- Four replacement cores are included with each tool.



Part #	Mfg #	Description	Price
192398	VCR-1	Core Remover and Store	



## Miscellaneous Tools

### Staple Guns

#### T-50 Series Staples

- Used extensively by building contractors, home do-it-yourselfers and specialty trade applications for tacking insulation, ceiling tile, window screening, cornerite, and 1001 other jobs ranging from light to heavy duty work.
- The T-50 Outward Clinch Staple Gun is ideal for fiberglass ductwork.



Part #	Mfg #	Description	Price
196495	540-509	9/16" Staples for T50 Staple Guns	

### Miscellaneous

#### Surge Trap® STXH Series

- TPMOV® technology
- 1/2"-14 threaded hub
- LED status indicator
- Frequency: 50-60 Hz
- Pre-wired 18" 10AWG
- -40°C to +85°C Temperature
- Volts: 120/240VAC split phase
- Surge capacity: 50kA
- Nominal discharge current rating: 20kA
- Short-circuit current rating: 200kA
- Includes sealing locking washer
- Compact footprint designed to mate with AC disconnect switches
- 3 Modes of protection (L-N, L-L)
- Fits 1/2" knockouts with 18" leads
- NEMA 4X enclosure for outdoor or indoor use
- For use in ANSI/UL Type 1 or 2 SPD installations



Part #	Mfg #	Description	Price
245751	STXH240S05	120/240VAC Split Phase	

**Miscellaneous Tools**

**Tools**

**Pro-Set® Inspection Mirror**



Part #	Mfg #	Description	Price
098914	87-TLMIR3	3.5" x 2.12" Rectangular Telescoping Mirror	

**Batteries**

**Batteries - Alkaline**

- Batteries all alkaline
- Attractive retail-type packaging



Part #	Mfg #	Description	Price
180520	BV900243	AA - 18 PK	
180522	BV900244	AAA - 18 PK	
180521	BV900245	9V - 4PK	
180523	BV900269	C - 2PK	
180524	BV900270	D - 2PK	

## Miscellaneous Tools

### Flue and Boiler Tube Brushes

#### Fine-Wire Single Spiral Brush

- For small boilers, burners, nozzles and fans
- 3" Brush lengths

Part #	Mfg #	Description	Price
007444	01216	3/4" Dia, 24" OAL 4" Loop, Carbon Steel	

### Tool Cases

#### Stackable Utility Case

- Tough, durable, double-lock catch, 12" x 6" x 6"
- Lifetime guarantee

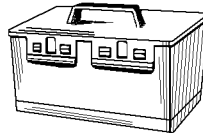

Part #	Mfg #	Description	Price
007462	75600	Tote Box - Carton	

### Lock 'N Load Heavy-Duty Drybox

- Locks out moisture as well as dirt and grime
- (3) Compartments store and organize tools and accessories
- Easy access top compartment is ideal for small tools and parts
- Dimensions: 15" x 8" x 10"



Part #	Mfg #	Description	Price
061933	75605	Lock 'N Load Drybox, Carton	

### Tube Cleaning Brushes

#### #6200 Series Power Tube Cleaning Brush

- Use for solder or brazed fittings
- Carded 1/4" hex-shank tube cleaning brushes
- Point-of-purchase display

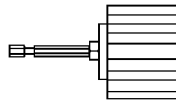

Part #	Mfg #	Description	Price
007454	62350	1/2" Bagged	
007455	62370	3/4" Bagged	

### Toilet Bolts



Part #	Mfg #	Description	Price
169958	73065	5/16" x 2-1/4"	
235895	73070	5/16" x 3-1/2"	



---

---

## Miscellaneous Tools

---

---

### Chemicals

#### Insecticide

Part #	Mfg #	Description	Price
140752	85-200	Bee/Wasp Spray	
189900	4292-75	Nu-Kill II Aerosol - 14oz	

---

---

**Miscellaneous Tools**

---

---

**Cases & Carriers**

**Nipple Box**

- Holds 1/2" CL through 6" nipples
- Fold away handle
- Epoxy coated steel

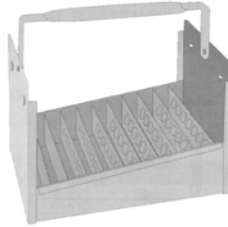

Part #	Mfg #	Size	Holds	Price
013210	3080	1/2"	77	

**Miscellaneous Tools**

**Nipple Boxes**

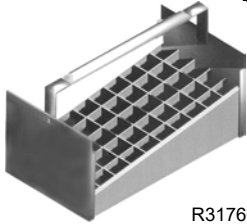

R317600

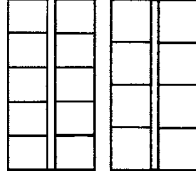

R318410

Part #	Mfg #	Description	Price
014776	R317600	E-51-R 3/4"	
080438	R318410	Galvanized Fitting Tray	

**Plumb Bob Red Bucket**

Part #	Mfg #	Description	Price
226028	PLUMBBOBBUCKE T	5 Gallon Bucket	
226029	PLUMBBOBLID	Lid for 5 Gallon Bucket	



## Miscellaneous Tools

### Radios/Speakers

#### M18™/M12™ Wireless Jobsite Speaker

- AC adapter
- Impact resistant roll cage
- Stream high definition music from over 100ft.



Part #	Mfg #	Description	Price
229138	2891-20	12V and 18V	

#### M18™ Jobsite Radio

- Customizable EQ
- 2.1A USB charger
- 10 station presets
- 3.5mm Aux In Port
- Powered by all M18™ Batteries or A/C outlet —(battery not included)
- Weather sealed auxiliary compartment
- Up to 12hrs run time with an M18™ 5.0Ah battery



Part #	Mfg #	Description	Price
185219	2890-20	M18™ Job Site Radio	

#### M18™ Job site Radio/Charger

- Built-in charger
- Digital Bluetooth® receiver
- USB power port
- 40-watt amplifier
- Customizable equalizer
- 10-station preset
- Reinforced roll cage and metal handles
- Weather-sealed compartment
- On-board bottle opener
- Includes:
  - (1) M18™ Job site radio/charger (2792-20)
  - (1) 16" Auxiliary input cord
  - (2) AAA batteries



Part #	Mfg #	Description	Price
163377	2792-20	M18™ Job Site Radio/Charger	

#### M12™ Job site Radio

- Digital reception with signal processor
- 1/8" Stereo jack auxiliary input



Part #	Mfg #	Description	Price
139355	2590-20	Bare Tool	

### M12™ Wireless Jobsite Radio

- Bluetooth® Connectivity with portable electronic devices up to 30ft away
- Premium Speaker with integrated Bass Port delivers loud, clear sound at all volumes
- Jobsite Durability
- 2.1A USB Charger electronic devices
- 3.5mm Aux In Port for wired playback (cable not included)
- Integrated Loop for easy hanging and transport



Part #	Mfg #	Description	Price
172937	2592-20	Bare Tool	
181843	2592-21	Kit	

### Carrying Cases and Bags

#### Zipper Pouch

- Hang loop
- Rugged metal zipper
- Heavy duty No. 10 canvas
- Water resistant stand-up base



Part #	Mfg #	Description	Price
170552	48-22-8180	Zipper Pouch	

#### 3 PK Zipper Pouches

- Hang loop
- Rugged metal zipper
- Water resistant stand-up base
- Heavy duty No. 10 canvas



Part #	Mfg #	Description	Price
170554	48-22-8193	3 Pk Zipper Pouches	

## Miscellaneous Tools

### Meter Case

- Rugged nylon
- Three sided zipper closure
- One inside pocket, one compartment
- Strong nylon strap with snap closure
- The following Milwaukee meters fit this case:
  - 2205-20 Fork meter
  - 2206-20 Fork meter for HVAC/R
  - 2216-20 Digital multimeter
  - 2217-20 Digital multimeter
  - 2235-20 400amp clamp meter
  - 2265-20 Laser temp-gun
  - 2266-20 Laser temp-gun



Part #	Mfg #	Description	Price
164509	48-55-0175	Meter Case	
164510	48-55-0180	Large Meter Case	

### Job Site Organizer

- Mountable bins
- Full access when stacked
- 20% More capacity
- Weather seal
- No-travel bins seals



Part #	Mfg #	Size	Price
176587	48-22-8030	14" x 18" x 5"	

### Jobsite Cooler

- 2X the insulation
- Food grade leak proof liner
- 1680D ballistic material
- Holds ice for 24 hours
- Heavy duty metal zippers
- Padded shoulder strap
- Tape measure clip w/ bottle opener
- Tech Pocket for storing tablets and electronic devices
- Dry storage compartment
- No sweat exterior
- 3 Total pockets inside and 5 pockets outside
- Holds 21.65 liquid quarts



Part #	Mfg #	Description	Price
239938	48-22-8250	11.1"L x 13.77"W x 14.96"H	

### Organizer Bag



Part #	Mfg #	Use with:	Price
145691	49-17-0110	Contractor Parts Organizer	

### Job Site Backpack

- 35 Pockets for organizing tools
- Bulk pocket
- Impact resistant molded base
- 1680 Ballistic material
- Load-bearing harness
- 15.6" Laptop sleeve
- Attachment strap



Part #	Mfg #	Description	Price
170551	48-22-8200	Job Site Backpack	

### Ultimate Jobsite Backpack

- 48 Pockets, 2 external
- 1680D Ballistic material
- Impact resistant base
- Sternum strap
- Tape measure clip
- Rugged metal zippers
- Attachment strap for dolly's
- Loaded-bearing harness
- Hardshell protected electronic & equipment pockets



Part #	Mfg #	Description	Price
238907	48-22-8201	Ultimate Job Site Backpack	

## Miscellaneous Tools

### Low-Profile Job Site Backpack

- 22 Pockets, 4 external
- 1680D Ballistic material
- Reinforced base
- Sternum strap
- Tape measure clip
- Rugged metal zippers
- Attachment strap for dolly's
- Padded electronics sleeve



Part #	Mfg #	Description	Price
238908	48-22-8202	Low-Profile Jobsite Backpack	

### PACKOUT™ Backpack

- 48 Total pockets
- 1680D Ballistic material
- Impact resistant polymer base
- All-metal hardware
- Tape measure clip
- Daisy chains for additional storage
- Plastic reinforced jab saw pocket
- Load bearing harness with sternum strap
- Hardshell electronics & equipment pocket
- Part of the PACKOUT™ modular storage system



Part #	Mfg #	Description	Price
255404	48-22-8301	PACKOUT™ Backpack	

### Jobsite Tech Bag

- Impact resistant molded base
- 1680D ballistic material construction
- Integrated rain fly
- Protected tech pocket
- 53 Total pockets



Part #	Mfg #	Description	Price
188643	48-22-8210	Tech Jobsite Bag	

### Contractor Bag

- Tough, water resistant 600 denier material
- Shoulder strap or dual handle straps for easy carrying
- Durable zipper closure
- Ideal for tool and accessory storage



Part #	Mfg #	Description	Price
140379	48-55-3500	20-1/2"L x 9"W x 8"H	
140378	48-55-3510	18"L x 11"W x 10"H	

### Carrying Cases and Bags (Continued)

#### Contractor Bag

Part #	Mfg #	Description	Price
225575	48-55-3490	17"L x 9"W x 10"H	
140377	48-55-3530	26-1/2"L x 13"W x 14"H	

#### Contractor Work Belt w/ Suspension Rig

- 24 Pockets
- 1680D Nylon construction
- Riveted seams
- All metal hardware
- Integrated carry handles
- Puncture resistant pocket
- Padded work belt- Fits 30" to 53" waists



Part #	Mfg #	Description	Price
170550	48-22-8120	Includes Suspension Ring	

#### Electricians Work Pouch w/ Quick Adjust Belt

- 15 Pockets
- 1680D Nylon construction
- Riveted seams
- All metal hardware
- Integrated carry handle
- Stable base
- Puncture resistant pocket
- Tape measure clip
- Belt slot- fits up to a 3" work belt
- Quick adjust belt



Part #	Mfg #	Description	Price
170548	48-22-8100	Work Pouch w/ Adjustable Belt	

#### Electricians Work Belt

- 29 Pockets
- 1680D nylon construction
- Riveted seams
- All metal hardware
- Integrated carry handles
- Stable base
- Puncture resistant pocket
- Tape measure clip
- Belt slot- Fits up to a 3" work belt



Part #	Mfg #	Description	Price
170549	48-22-8110	Electricians Work Belt	



## Miscellaneous Tools

### Packout™ Tote

- All metal hardware
- Padded shoulder strap
- Durable overmolded handle
- Impact resistant molded base
- 1680 Ballistic material construction
- Part of the PACKOUT™ modular storage system



Part #	Mfg #	Tote Size	Pockets	Price
237607	48-22-8310	10"	28	
237606	48-22-8315	15"	31	
237605	48-22-8320	20"	32	

### Parachute Organizer Bag

- Stand up, stay open design
- Stackable
- Reinforced water resistant base
- External zipper pocket storage



Part #	Mfg #	Description	Price
221399	48-22-8170	11.81"L x 11.02"H	

### Bucket-Less Tool Organizer

- Padded handles
- 50 total pockets
- Heavy-duty water resistant 600 Denier Ripstop Polyester Material
- Internal hammer loop keeps hammer easily accessible



Part #	Mfg #	Description	Price
138843	49-17-0180	50 Pockets	

### Bucket Organizer Bag

- Open Bucket Design - Allows full access and use of the interior of the bucket
- 2 Exterior Zipper Pockets
- 1680D Ballistic Material Construction
- 32 Exterior Pockets



Part #	Mfg #	Description	Price
221400	48-22-8175	10.04"L x 2.17"W x 13.39"H	

### 15" PACKOUT™ Tool Bag

- Tear-resistant 1680D ballistic material
- Heavy duty zippers
- All-metal hardware
- 2 Exterior pockets for quick access
- Impact resistant polymer base
- Included shoulder strap
- Daisy chains for additional storage



Part #	Mfg #	Description	Price
253971	48-22-8321	15"L x 9.6"W x 12.2"H	

### 20" PACKOUT™ Tool Bag

- Tear-resistant 1680D ballistic material
- Heavy duty zippers
- All-metal hardware
- 2 Exterior pockets for quick access
- 6 interior pockets for organization
- Impact resistant polymer base
- Included shoulder strap
- Daisy chains for additional storage



Part #	Mfg #	Description	Price
253972	48-22-8322	20"L x 12.2"W x 13.8"H	

### 18" Jobsite Rolling Bag

- 6" All-Terrain Metal Rim Wheels
- Industry's Strongest Extendable Handle
- All Metal Skid Plates
- Full Length Metal Axle
- 200 lbs Weight Capacity
- Wide Grip Handle
- Fold Down Front Panel
- 1680D Ballistic Material Construction
- Integrated Tablet Sleeve
- 66 Total Pockets



Part #	Mfg #	Description	Price
233580	48-22-8221	19-1/2"W x 16"L x 21"H	

## Miscellaneous Tools

### 24" Hardtop Rolling Bag

- Designed for stacking
- 6" All-terrain metal rim wheels
- Strongest extendable handle
- 250 lbs Weight capacity
- Wide grip handle
- Fold down front panel
- 1680D Ballistic material
- Integrated tablet sleeve
- 53 Total pockets



Part #	Mfg #	Description	Price
230510	48-22-8220	25"W x 16"L x 21"H	

### Packout™ Rolling Tool Box

- 9" All-terrain wheels
- Interior organizer tray
- 250lbs weight capacity
- IP65 Rated weather seal
- Industrial grade extension handle
- Metal reinforced corners & locking point
- Constructed with impact resistant polymers
- Mounting Location for the ONE-KEY™ TICK™
- Part of the PACKOUT™ modular storage system



Part #	Mfg #	Description	Price
237609	48-22-8426	Packout Rolling Tool Box	

### Packout™ Tool Box

- Interior organizer tray
- IP65 Rated weather seal
- Impact resistant polymers
- Metal reinforced corners, locking point, & top handle
- Mounting Location for the ONE-KEY™ TICK™
- Part of the PACKOUT™ modular storage system



Part #	Mfg #	Description	Price
237611	48-22-8424	75lbs Capacity, W/O Handle	
237610	48-22-8425	Large Box, 100lbs Capacity	

### PACKOUT™ Tool Case W/ Customizable Insert

- IP65 rated weather seal
- 75lbs Weight capacity
- Included customizable foam insert
- Mounting location for the ONE-KEY™ TICK™ Tool and equipment tracker
- Part of the PACKOUT™ modular storage system



Part #	Mfg #	Description	Price
257192	48-22-8450	Tool Case W/ Customizable Insert	

### Customizable Foam Insert

- Layered Foam for easy customization
- Designed to fit all PACKOUT™ tool boxes and tool cases (48-22-8424, 48-22-8425, 48-22-8450)



Part #	Mfg #	Description	Price
257679	48-22-8451	PACKOUT FOAM INSERT	

### Packout™ Compact Organizer

- IP65 Rated weather seal
- 5 Removable & mountable bins
- Impact resistant polymers
- No-travel bins seal prevent small part migration between Bins
- Part of the PACKOUT™ modular storage system



Part #	Mfg #	Description	Price
237613	48-22-8435	Compact Organizer	

### PACKOUT™ Compact Low-Profile Organizer

- IP65 Rated weather seal
- 4 small and 1 large removable bins
- No-travel bins seal prevent small part migration between bins
- Slim design for organization of small Items



Part #	Mfg #	Description	Price
253970	48-22-8436	Compact Low-Profile Organizer	

## Miscellaneous Tools

### PACKOUT™ Organizer

- IP65 Rated weather seal
- 10 Removable & mountable bins
- Impact resistant polymers
- No-travel bins seal prevent small part migration between Bins
- Part of the PACKOUT™ modular storage system



Part #	Mfg #	Description	Price
237612	48-22-8430	Packout Organizer	

### PACKOUT™ Low-Profile Organizer

- IP65 Rated weather seal
- 8 small and 2 large removable bins
- Slim design for organization of small items
- Integrated center slot for long bits and blades
- No-travel bins seal prevent small part migration between bins



Part #	Mfg #	Description	Price
253969	48-22-8431	Low-Profile Organizer	

### 48" Level Bag

- Tough, water resistant nylon construction
- All metal hardware to ensure ultimate durability
- Durable zipper closure
- Two integrated carrying or hanging handles
- Integrated external tool loops for additional tool storage
- Two debris vent to prevent dust, dirt and/or water build up



Part #	Mfg #	Description	Price
243112	MLSB48	48" Level Bag	

### M12™ Tool Holster

- Heavy duty nylon material
- Easy snap-on
- On board bit storage
- Compatible with most M12™ drilling & fastening tools



Part #	Mfg #	Description	Price
151175	2335-20	Tool Holster	

### 13" Job Site Work Box

- Impact resistant construction
- Vertical tool storage tray
- 16" Seat height
- Cut groove
- Wide grip locking handle
- Drip ledge lid
- Indexing square
- Made in USA



Part #	Mfg #	Description	Price
170620	48-22-8010	13" Job Site Work Box	

### 26" Job Site Work Box

- Impact resistant construction
- Buttressed hinges
- Protected recessed latches
- Reinforced corners
- Integrated weather seal
- Clamping cut groove
- Over molded wide grip handle
- Pass through side grips
- Integrated screw mounting bosses
- Corner pocket storage
- Space for long and bulky tools
- Indexing square
- Made in USA



Part #	Mfg #	Description	Price
170622	48-22-8020	26" Job Site Work Box	

### TRAPSAKE TOILET AUGER CASE

- 2 Handles
- Vent holes
- 1680D Ballistic material



Part #	Mfg #	Description	Price
256440	48-22-2576	Toilet Auger Case	

### Belt Clip

Part #	Mfg #	Description	Price
164935	42-70-2653	Assembly	



## Miscellaneous Tools

### Milwaukee® Markers

#### INKZALL® Marker

- Clog resistant marker tip
- Writes through dusty, wet and oily surfaces
- Write on concrete, OSB and rough surfaces
- Built-In hard hat storage clip
- Fine point
- Ink dries in seconds
- Lanyard hole
- Anti-roll body design
- Non-toxic ink



Part#	Mfg#	Color	Point	Pk
165641	48-22-3100	Black	Fine	1
171184	48-22-3105	Black	Fine	2
166905	48-22-3104	Black	Fine	4
175754	48-22-3102	Black	Medium	2
186547	48-22-3170	Red	Fine	1
186548	48-22-3180	Blue	Fine	1
186549	48-22-3190	Green	Fine	1
189841	48-22-3121	Silver	Fine	2
189843	48-22-3123	Silver/Gold	Fine	2
226974	48-22-3107	Multi	Fine	8

#### INKZALL® Paint Marker

- Writes on dirtiest, hottest, roughest surfaces
- Durable acrylic nib
- Water & UV resistant markings
- 10 second dry time
- Marks on surfaces up to 300F
- Valve action marker



Part#	Mfg#	Color	Point	Pk
189845	48-22-3711	White	Paint	1
189844	48-22-3712	White	Paint	1
189848	48-22-3721	Yellow	Paint	1
189567	48-22-3722	Yellow	Paint	1
189854	48-22-3771	Orange	Paint	1
189851	48-22-3741	Red	Paint	1
189849	48-22-3731	Black	Paint	1
189852	48-22-3751	Green	Paint	1
189853	48-22-3761	Blue	Paint	1

### 1PK Medium Chisel Black Marker

- Clog resistant chisel tip marker
- Built-in hard hat storage clip
- Writes through dusty, wet, and oily surfaces
- Writes on concrete, OSB, and rough surfaces



Part#	Mfg#	Color	Point
171183	48-22-3103	Black	Med Chisel

### INKZALL® Stylus & Fine Point Black Marker

- Conductive stylus tip
- Clog resistant marker tip
- Writes through dusty, wet and oily surfaces
- Writes on concrete, OSB and rough surfaces
- Built-In hard hat storage clip
- Ink dries in seconds
- Lanyard hole
- Anti-roll body design
- Non-toxic ink



Part #	Mfg #	Description	Price
165228	48-22-3101	Stylus & Black Marker	

### 4-PK Fine Point Colored Markers

- Clog resistant marker tip
- Built-in hard hat storage clip
- Writes through dusty, wet, and oily surfaces
- Writing on concrete, OSB, and rough surfaces



Part #	Mfg #	Description	Price
171185	48-22-3106	4-PK Colored Markers	

### Reaming Pen

- Pen provides easy deburring of copper tubing and PVC
- all-metal design for durability
- The blade is heat treated and black oxide coated for extended life
- A slide resistant clip allows easy storage



Part #	Mfg #	Description	Price
186221	48-22-4255	5.5" Length	



## Miscellaneous Tools

### Measuring Tools

#### Auto Lock Tape Measure

- Auto Lock brake
- Nylon bond blade protection
- 5-Point reinforced frame
- Fractional scale
- Optimized hook designed for scoring
- Stamped steel belt clip
- Lanyard ready



Part #	Mfg #	Description	Price
252026	48-22-6816	16'	
248194	48-22-6825	25'	

#### Compact Tape Measure

- Nylon bond blade protection
- 5-point reinforced frame
- Stamped steel belt clip
- Lanyard read
- Optimized hook designed for scoring



Part #	Mfg #	Size	Price
236370	48-22-6616	16'	
230575	48-22-6625	25'	

#### Tape Measure

- Nylon bond blade protection
- 5-Point reinforced frame
- Finger stop
- Wire form belt clip
- 2-Sided printing
- Up to 9' standout
- 360° hook attachment
- Blueprint scale- Calculated 1/4" and 1/8" drawings



Part #	Mfg #	Size	Price
168290	48-22-5117	16'	
168291	48-22-5126	25'	
168292	48-22-5131	30'	
169837	48-22-5136	35'	
173931	48-22-5525	25'	

### Magnetic Tape Measure

- Nylon bond blade protection
- 5-point reinforced frame
- Finger stop
- Dual magnets
- Wire form belt clip
- 2 Sided printing
- 360° hook attachment
- Blueprint scales- calculates 1/4" and 1/8" drawings



Part #	Mfg #	Size	Price
159975	48-22-5116	16'	
159976	48-22-5125	25'	
226323	48-22-7125	25' (2Pk) G	
227233	48-22-7130	30'	
185179	48-22-7135	35'	

### STUD™ Tape Measure

- EXO360™ Blade technology delivers the longest lasting, rip and wear resistant tape measure blade
- Fully reinforced body, impact resistant frame survives up to 80 foot drop\*
- Up to 10' tape standout
- Wire form belt clip
- Zero tolerance hook
- Lanyard ready
- Finger stop delivers tape retraction control



Part #	Mfg #	Description	Price
253469	48-22-9916	16'	
253470	48-22-9925	25'	

### Key chain Tape Measure

- 6'/2m



Part #	Mfg #	Size	Price
186517	48-22-5506	6'	

## Miscellaneous Tools

### Composite Folding Rule

- Most durable markings and blades
- Heat stamped markings
- Wear and scratch resistant laminate
- Corrosion-free embedded joints



Part #	Mfg #	Description	Price
183684	48-22-3801	9-1/4" x 1-3/8"	

### Closed Reel Long Tape Measure

- Grime Guard™
- Heavy duty metal frame
- Nylon coated steel blade
- 100ft Folding hook



Part #	Mfg #	Blade Length	Price
238210	48-22-5101	100 Foot	

### Open Reel Long Tape

- Grime Guard™
- 3:1 Metal planetary gears
- 3/8" Nylon bond steel blade
- Metal reinforced handle



Part #	Mfg #	Description	Price
248643	48-22-5230	300 Foot	

### 12" Measuring Wheel

- Top Break Function
- Reinforced Locking Pivot Point
- Kickstand
- Top Handle Clearing Function
- Wheel Debris Cleaning Flap
- Zero Point Indicator



Part #	Mfg #	Description	Price
227767	48-22-5012	12"	

### Laser Distance Meter

- +/- 1/16" Accuracy
- Side-shot button
- Digital auto-level
- Backlit color screen
- Simplified user interface



Part #	Mfg #	Size	Price
233153	48-22-9802	150'	
241057	48-22-9803	330'	

### 100' Precision Line Chalk Reel

- StripGuard™ Clutch
- Planetary Gear System
- 6:1 Gear Retraction Ratio
- Low spillage line
- All metal body



Part #	Mfg #	Description	Price
188278	48-22-3992	Kit with Red Chalk	

### 100' Bold Line Chalk Reel

- StripGuard™ Clutch
- Planetary Gear System
- 6:1 Gear Retraction Ratio
- Flush Handle Storage
- Rubber Overmold



Part #	Mfg #	Description	Price
188283	48-22-3980	Reel Only	
188280	48-22-3982	Kit with Blue Chalk	
188281	48-22-3986	Kit with Red Chalk	

### Replacement Line

- 1.5mm Replacement Line
- High Strength Braided Line
- 100ft



Part #	Mfg #	Description	Price
188285	48-22-3989	Bold Line	

## Miscellaneous Tools

### Miscellaneous

#### TICK™ Tool and Equipment Tracker

- Allows you to track the location of any item in your inventory
- The app will automatically store the last time any ONE-KEY™ app was within the 100 ft Bluetooth® range of your TICK™. Check your app to easily pinpoint the last seen date, time and location to find leave-behinds, view equipment deployment, and help find missing equipment



Part #	Mfg #	Description	Price
232950	48-21-2000	3V Lithium-Ion Coin Cell	
232951	48-21-2004	3V Lithium-Ion Coin Cell 4-PK	
232952	48-21-2010	3V Lithium-Ion Coin Cell 10-PK	
232953	48-21-2050	3V Lithium-Ion Coin Cell 50-PK	

#### +Stop Lock Hand Clamp

- +STOP LOCK™ Mechanism
- Optimized pad geometry for more secure clamping
- Hex Release Mechanism
- Riveted Pivoting Clamp Pads
- High Grade Resin
- Rust protection



Part#	Mfg#	Size	Price
221198	48-22-3002	2"	
221199	48-22-3004	4"	

#### Staple & Nail Gun

- Up to 75% More Driving Power
- Hi/Low power switch for driving control
- Tilt & Fire Mechanism  
-Fully drive staples at an angle
- Integrated Stapler Puller
- All Metal Jam Free Magazine
- Stapler Flush Drive Surface
- Belt Clip
- Compatible with Arrow t50® staples sizes - 9/16", 1/2", 3/8", 5/16", 1/4"
- Compatible with 5/8" & 1/2" 18ga brad nails



Part #	Mfg #	Description	Price
181710	48-22-1010	7-1/2"	

### Bottle Opener

- Wire Stripper - Up to 12ga
- Chrome Plated Rust Protection
- Hardened Steel for Durability
- Cushion Grip Handle
- Rear Cap ID Marking



Part #	Mfg #	Description	Price
165227	48-22-2000	6-3/5" Length	

### Hook and Pick Set

- All-metal core
- Comfort grip handle
- Knurling
- Includes:
  - Hook
  - 90° Hook
  - Offset hook
  - Straight pick



Part #	Mfg #	Description	Price
239632	48-22-9215	4-Piece Hook and Pick Set	

### Water Tank

- 3-1/2 Gallon poly tank
- For use when regular tap water is not available



Part #	Mfg #	Description	Price
255319	49-76-0055	3-1/2 Gallon Water Tank	

### Inner Core Bulb Head Cable

- RUST GUARD™



Part #	Mfg #	Size	Price
238927	48-53-2563	1/4" x 25'	



## Miscellaneous Tools

### Inner Core Drop Head Cable

- RUST GUARD™



Part #	Mfg #	Size	Price
238929	48-53-2561	5/16" x 25'	
238930	48-53-2562	5/16" x 25'	
238928	48-53-2564	1/4" x 25'	

### Inner Core Coupling Cable

- RUST GUARD™



Part #	Mfg #	Size	Price
238932	48-53-2675	3/8" x 35'	
238937	48-53-2773	3/8" x 50'	
238936	48-53-2774	1/2" x 50'	
242542	48-53-2775	5/8" x 50'	

### Inner Core Bulb Head Cable

- Solid polymer core
- Carries power through end of cable
- Maneuvers the tightest bends
- Corrosion resistant core
- End of cable indicator: approximately 3' from back end of cable



Part #	Mfg #	Size	Price
188683	48-53-2571	5/16" x 25'	
242348	48-53-2673	5/16" x 35'	
247628	48-53-2674	5/16" x 50'	
188687	48-53-2581	5/16" x 25' w/ Drum	

### Drop Head Cable

- Solid polymer core
- End of cable indicator
- Carries power through end of cable
- Corrosion resistant core



Part #	Mfg #	Size	Price
188686	48-53-2574	1/4" x 25'	

### Inner Core Drop Head Cable w/ Drum



Part #	Mfg #	Size	Price
188688	48-53-2582	5/16" x 25' w/ Drum	

### Small Drop Head Attachment

- RUST GUARD™ Plating



Part #	Mfg #	Description	Price
250038	48-53-2682	Small Drop Head Attachment	

### 5-PC Drain Line Kit

- RUST GUARD™



Part #	Mfg #	Size	Price
238933	48-53-2685	Small	
238934	48-53-2790	Medium	

### TRAPSAKE™ Manual Toilet Auger

- Powers through tough clogs and retrieve with control
- Integrated locking mechanism which holds the cable in place for easy telescoping extension and retraction
- Fixed Rubber Boot: Prevents porcelain scratches throughout the life of the tool
- Industry's first replaceable cables



Part #	Mfg #	Description	Price
230884	49-16-2576	6' x 1/2" Cable Size	
230886	49-16-2574	4' x 3/8" Cable Size	



---

---

## Miscellaneous Tools

---

---

### TRAPSAKE™ Toilet Auger Replacement Cable



Part #	Mfg #	Description	Price
230887	48-53-2576	6'	



## Miscellaneous Tools

### Miscellaneous Tools

#### Fin Straightener

- Long comfort-grip handle
- Adjustable straightening wire tension
- Accommodates various fin types
- Wires held by a sturdy metal body



Part #	Mfg #	Description	Price
182251	61170	Fin Straightener	

#### Tube Deburring Tool



Part #	Mfg #	Description	Price
237074	60163	Deburring Tool	

**Miscellaneous Tools**

**Bucket Organizers**

- High-impact plastic pail
- Storage trays fit snugly inside
- Easy on/off lid



Part #	Mfg #	Bucket	Trays:	Price
008175	502	5 gal	2 Large & 2 Small	

**Bucket Organizer Pail Lid**

- Fits both 3.5 and 5 gallon pails

Part #	Mfg #	Description	Price
059482	001	Lid Only	

## Miscellaneous Tools

### Tie Downs

#### EPDM Tie-Down Strap

- Super-strong 100% EPDM material with 2-1/2" galvanized S hooks



Part #	Mfg #	Max Length	Length	Price
183405	319-15	22"	15"	
183406	319-20	30"	20"	
183407	319-31	45"	31"	

#### Extendable Inspection Mirror with Angle Ball Joint

- Pocket clasp included
- Powerful long life magnetic tip



Part #	Mfg #	Size	Extension	Price
156742	390-50115	1" x 2"	5-5/8"-18-3/4"	

## Miscellaneous Tools

### PowerPEX® F1807 Tools & Miscellaneous

#### PowerPEX® F1807 Stainless Compression Tool

- Steel handle
- Exclusively for installing Sioux-Chief's **305-83TX** V-Sleeve™ stainless steel PEX compression system
- PowerPEX® tools by Tomahawk™



Part #	Mfg #	Size	Price
165320	305-82TX	1/2"	
165321	305-83TX	3/4"	
165322	305-84TX	1"	

#### PowerPEX® F1807 PEX Crimp Ring Removal Tool

- Allows fitting recovery without damaging the sealing surfaces of the fitting
- Do not use on Copper F1807 PEX or AccuCrimp™ fittings
- Two cuts on copper ring allows user to reclaim fitting
- Cutting blade only penetrates the copper ring and pipe
- Suitable for use on 1/2" through 1" PEX pipe sizes
- PowerPEX™ tools by Tomahawk™



Part #	Mfg #	Description	Price
165518	305-99	Crimp Ring Removal Tool	

## Pipe Cutters - Copper

### Tubing Cutters

#### Close Quarters Tubing Cutter

- Use in restricted spaces on small diameter, hard and soft copper, aluminum, brass and plastic tubing
- Large knurled feed screw knob



Part #	Mfg #	Model	Capacity	Description	Std Wheel	Price
008656	40617	101	1/4" - 1-1/8"	Cutter	E-3469	
008659	32975	103	1/8" - 5/8"	Cutter	E-3469	
008660	32985	104	3/16" - 15/16"	Cutter	E-3469	
067702	97787	117	3/16" - 15/16"	Quick-Feed Cutter	E-3469	
051432	86127	118	1/4" - 1-1/8"	Quick-Feed Cutter	E-3469	

#### Constant Swing Cutter with X-CEL

- Features an enclosed feed screw to eliminate clogging and jamming, grooved rolls for close-to-flare cuts, and a fold-away reamer
- Made from high-strength aluminum alloy



Part #	Mfg #	Model	Capacity	Description	Std Wheel	Price
008687	31622	150	1/8" - 1-1/8"	Feed Cutter	E-3469	
008688	31627	150	1/8" - 1-1/8"	Feed Cutter with HD Wheel(s)	E-4546	

#### Tubing and Conduit Cutter with X-CEL

- Clean, square cuts on copper, brass, aluminum, and thin-wall conduit



Part #	Mfg #	Model	Capacity	Description	Std Wheel	Price
008655	32910	10	1/8" - 1"	Screw Feed Cutter	F-158	
008648	32920	15	3/16" - 1-1/8"	Screw Feed Cutter, Fold-Away Reamer	F-158	
008703	32930	20	5/8" - 2-1/8"	Screw Feed Cutter, Fold-Away Reamer	F-158	
008713	32940	30	1" - 3-1/8"	Screw Feed Cutter f/Lg Dia Steel & SS Tube	F-158	

#### Quick-Acting Tubing Cutter with X-CEL

- I-Beam construction, hardened wear surfaces and bearing side assemblies for smooth operation
- Plastic cutters include spare cutting wheel for cutting copper

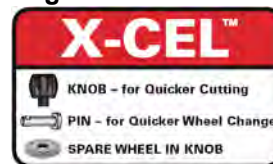

Part #	Mfg #	Model	Capacity	Description	Std Wheel	Price
008689	31632	151	1/4" - 1-5/8"	Quick-Acting, Fold-Away Reamer	E-3469	
008690	31642	152	1/4" - 2-5/8"	Quick-Acting, Fold-Away Reamer	E-3469	
008691	31652	154	1-7/8" - 4-1/2"	Quick-Acting Tubing Cutter	E-2558	

## Pipe Cutters - Copper

### Internal Tubing Cutter

- For trimming tubing below floor level for shower and floor drain installations, or above the ceiling for sprinkler head installations



Part #	Mfg #	Model	Capacity Nom / Depth	Description	Std Wheel	Price
018338	33005	106	2" - 3" / 1/4" - 2-5/8"	Internal, Steel & Aluminum Body	E-2558	

### Tubing Cutter Wheel



Part #	Mfg #	Model	Blade Exp	Application	For Model	Price
008575	33165	E-1240	.162	Steel - SS	10, 15, 15-SI	
008596	33175	E-2191	.292	HD Steel Tubing	30, 40, 122, 122XL, 133, 154, 156	
008599	33170	E-2558	.220	Aluminum & Copper	30, 40, 108, 109P, 133, 154, 156	
023461	34695	E-3495	.290	Aluminum	151, 152, 153, 205	
008617	33190	E-4546	.162	Steel - SS	151, 152, 153, 205	
008606	33185	E-3469	.149	Copper, Aluminum, Brass & Plastic	101, 103, 104, 117, 118, 150, 151, 152, 153, 205	
008636	33160	F-158	.149	Aluminum & Copper	10, 15, 20	

### Tubing Cutter Parts

Part #	Mfg #	Description	For Model	Price
129719	34620	Roll Housing Screw	20	
024438	42327	Retaining Ring	101, 103, 104, 117 & 118	

### Tubing Tools

#### 456 Tri-Bender

- Ideal for plumbing and HVAC applications
- 90° Start angle minimizes effort required to form a bend
- Handy reference marks indicate the angle for quick bends through 90°



Part #	Mfg #	Model	Capacity	Price
008738	44852	456	1/4", 5/16", 3/8"	

### Spring-Type Tube Bender

- Fast, free-form bending of soft copper and aluminum tube



Part #	Mfg #	Model	Length	Tube OD	Price
008563	35255	D-1377	10"	3/8"	



## Pipe Cutters - Copper

### Copper Tubing Cutters

#### Close Quarters Tubing Cutter

- Most compact
- Longest life
- Chrome rollers
- Weep holes
- Directional grip
- Replaceable blade



Part #	Mfg #	Size	Price
225206	48-22-4260	1/2"	
225207	48-22-4261	3/4"	
225208	48-22-4262	1"	

#### Mini Copper Tubing Cutter

- Proprietary adjustment mechanism
- Chrome Rollers
- Easy Grip Knob



Part #	Mfg #	Size	Price
188005	48-22-4250	1/2"	
229533	48-22-4258	3/4"	
188006	48-22-4251	1"	

#### Constant Swing Copper Tubing Cutter

- 4 Roller design
- Chrome rollers
- Smooth adjustment mechanism
- On-Board reamer



Part #	Mfg #	Size	Price
234876	48-22-4259	1"	
188007	48-22-4252	1-1/2"	

#### Quick Adjust Copper Tubing Cutter

- 4 Roller design
- Chrome rollers
- Quick adjustment mechanism
- Tool-free blade change
- Extra blade included



Part #	Mfg #	Size	Price
234288	48-22-4253	2-1/2"	
234872	48-22-4254	3-1/2"	

### 3 Piece Close Quarters Tubing Cutter Set

- Most compact
- Longest life
- Chrome rollers
- Weep holes
- Directional grip
- Replaceable blade
- Includes:
  - (1) 1/2" Close quarters tubing cutter (48-22-4260)
  - (1) 3/4" Close quarters tubing cutter (48-22-4261)
  - (1) 1" Close quarters tubing cutter (48-22-4262)



Part #	Mfg #	Size	Price
225209	48-22-4263	1/2", 3/4" & 1"	

### 2 Piece Close Quarters Cutter Replacement Blades

- Replacement cutter wheels
- Designed for use with Milwaukee® close quarters tubing cutters
- Two pack
- High carbon steel blades
- Precision machined
- Optimized for copper



Part #	Mfg #	Description	Price
225210	48-22-4266	2/Pk	

### Copper Cutter Wheels

- Hardened steel with black oxide
- Convex blade design
- For use with Milwaukee® 12V copper cutter (2471)



Part #	Mfg #	Description	Price
138792	48-38-0010	2/Pk	

### 2Pc Replacement Cutter Wheels

- Designed for use with Milwaukee Mini and Constant Swing Copper Tubing Cutters
- Two Pack
- High Carbon Steel Blades
- Optimized for Copper



Part #	Mfg #	Description	Price
188008	48-22-4256	2/Pk	



## Pipe Cutters - Copper

### 3 Pc Replacement Reaming Blades

- Designed for use with Milwaukee Constant Swing Copper Tubing Cutters
- Heat Treated
- Black Oxide Blade



Part #	Mfg #	Description	Price
188009	48-22-4257	3 Pack	

### M12™ Cordless Copper Tubing Cutter

- Close quarter rotating cutting head
- Automatic adjustment from 3/8" to 1" tubing
- Auto locking mechanism
- Water resistant sealed metal cutter head
- Battery fuel gauge displays remaining run time
- Built-in LED light illuminates line of cut
- No load speed: 500 rpm
- Capacity: 1/2" to 1-1/8" OD
- Kit includes:
  - Tubing cutter (2471-20)
  - (2) 12V Lithium-Ion battery (2471-21 is single battery kit)
  - 30-Minute charger
  - Carrying case
- 5-Year warranty



Part #	Mfg #	Size	Price
148546	2471-20	3/8"-1" 1/2"-1-1/8OD	
137554	2471-21	3/8"-1"	



## Pipe Cutters - Copper

### Autocut™ Copper Tubing Cutters



ATC



RH

Part #	Mfg #	Description	Price
031428	ATC12	For 1/2" Tubing	
031429	ATC34	For 3/4" Tubing	
073599	ATC100	For 1" Tubing	
031674	RH12	Ratchet Handle for ATC12	
031675	RH34	Ratchet Handle for ATC34	
031430	ATCW	Replacement Cutter Wheels	

---



---

## Pipe Cutters - Copper

---



---

### Tube Benders

#### Tri-Tube Bender

- Indicators on handle help identify tube sizes
- Color-coded to help spot the right tube size
- Indicators on side help measure the bend radius, up to 180°



Part #	Mfg #	Description	Price
167766	1839026	1/4", 5/16", 3/8"	
171454	1839027	1/4", 3/8", 1/2"	

## Pipe Cutters - Copper

### Copper Tubing Cutters

#### Heavy Duty Mini Cutter

- Large rollers
- Flare cut-off groove



Part #	Mfg #	Cuts From:	Price
182094	60121	1/4"-7/8" O.D.	

#### Premium Tube Cutter

- Textured finish
- Wide rollers with flare cut-off groove
- Wheel retracts into cutter body to save 1" in cutting radius
- Fold away steel reamer with turned cutting edge for deburring
- Textured corrosion-resistant finish on lightweight aluminum frame
- Wheels are pinned to rotate in either direction without the screw backing out



Part #	Mfg #	Size	For:	Price
182092	60101	Small	1/8"-1-1/8" O.D.	
182093	60102	Large	1/4"-1-5/8" O.D.	

#### Ratchet Hand Bender Kit

- Index marks to locate bends
- Trouble free ratchet mechanism
- Without reverse bending mandrel
- Kit includes all items required to bend; 1/4", 5/16", 3/8", 1/2", 5/8", 3/4" and 7/8" tubing
- Hard copper must be annealed before bending



Part #	Mfg #	Description	Price
182133	60331	Ratchet Hand Bender Kit	

#### Spring Tube Bender

Part #	Mfg #	Description	Price
251479	60353	Set-1/2", 5/8", 3/4" and 7/8" O.D.	
246907	60358	1/2" O.D.	

### Parts & Accessories

Part #	Mfg #	Description	Price
238178	60094	Pin Clips, 5 Pack	
182091	60100	Copper Cutter Wheel	

### Replacement Parts for 60331 and 60325

- 60331 Basic ratchet hand bender kit
- 60325 Deluxe ratchet hand bender kit

Part #	Mfg #	Description	Price
182132	60329	3/4"-7/8" Crossbar Assy	
182136	60336	7/8" O.D. Bending Mandrel	
236600	60340	Ratchet Bar 9' for Bender	
182138	60342	Reverse Bending Mandrel	
182140	60348	Wing Nut Screw (8, 11)	



## Pipe Cutters - PEX

### Tubing Cutters

#### ProPEX®/Tubing Cutter

- Replaceable blades
- Double ground steel V-shaped blade
- Metal core - indestructible frame
- Rework groove
- One-handed locking mechanism
- Rust protection



48-22-4200



48-22-4202

### Cutter Wheel for PVC and PEX

- Cuts PVC, CPVC, ABS, and PEX
- For use with Milwaukee® quick adjust tubing cutters
- Cuts up to 2 in. plastic pipe with the 48-22-4253 quick adjust cutter
- Cuts up to 3 in. pipe with the 48-22-4254 quick adjust cutter
- High carbon steel
- .4" Max wall thickness
- 1.3" Diameter



Part #	Mfg #	Jaw Capacity	
143343	48-22-4200	1"	
184107	48-22-4202	1"	

Part #	Mfg #	Description	Price
234878	48-22-4206	PEX Cutter Wheel	

### Ratcheting Pipe Cutter

- Pierce Point Blade Durable Stainless Steel Blade
- Ergonomic Handle Design
- Integrated Lanyard Hole
- Limited Lifetime Warranty



Part #	Mfg #	Jaw Capacity	
236683	48-22-4210	1-5/8"	
236684	48-22-4215	2-3/8"	

### Replacement Blades and Accessories

#### ProPEX®/Tubing Cutter Replacement Blade

- Double-Ground V-Shaped Blade - Cleaner Cuts on 1" rubber and plastic tubing/PEX-a tubing
- Rust protection - stainless design for increased tool life and corrosion resistance



Fits 48-22-4200 and 48-22-4202 Milwaukee® Tubing Cutters

Part #	Mfg #	Description	Price
170838	48-22-4203	Blades Only	

#### Ratcheting Pipe Cutter Replacement Blade

For use with 48-22-4210 pipe cutter

- 1-5/8" max capacity
- Heat treated
- Precision ground edge
- Pierce point blade durable stainless steel



Part #	Mfg #	Description	Price
236685	48-22-4211	Blade Only, 1-5/8"	
236686	48-22-4216	Blade Only, 2-3/8"	



## Pipe Cutters - Plastic

### Plastic Tubing Cutters

#### Quick-Acting CSST Cutter

- I-Beam frame
- Cuts corrugated gas tubing 3/8" - 1"
- Two sets of split-floating guide wheels
- Ergonomic knob
- Full lifetime warranty



Part #	Mfg #	Model	Capacity	Description	Std Wheel	Price
122158	32078	151 CSST	3/8" - 1"	Quick-Acting CSST Cutter	33190	

### Plastic Pipe Tubing Cutter

- Designed for quick, clean cuts through plastic pipe and tube



Part #	Mfg #	Model	Capacity	Description	Std Wheel	Price
104549	23493	PC-1375	1/8" - 1"	Single Stroke Plastic Pipe & Tubing Cutter	X-CEL™ PCB-1375	
108391	23498	RC-1625	1/2" - 1-5/8"	Ratchet Action Plastic Pipe & Tubing Cutter, Erg Grip	27858	
119754	30088	RC-2375	1/2" - 2-3/8"	Ratchet Action Plastic Pipe & Tubing Cutter, Erg Grip	30093	

### Cutter Replacement Blade

Part #	Mfg #	Model	Description	Price
008706	22086	1493	Replacement Blade with Clip	
104550	25588	PCB-1375	X-CEL™ Replacement Blade	
132081	27858	RCB-1625	Replacement Blade for RC-1625	
123436	30093	RCB-2375	Replacement Blade for RC-2375	
008565	92170	138	Replacement Blade for 91125	

### Plastic Tubing Cutter Wheel



Part #	Mfg #	Model	Blade Exp	Application	For Model	Price
008626	33195	E-5272	.290	PVC, ABS, Standard Wall	151-P, 152-P	
008627	33180	E-5299	.412	PVC, ABS, Standard Wall	30P - 133P, 106, 108, 109P, 154-P, 156-P	

---



---

**Pipe Cutters - Plastic**

---



---

**Big Nipper™**

- Cuts hose and tubing up to 2-1/2" ID, polyethylene up to 1-1/2" ID, and PVC up to 1-1/2" ID



- Excellent for cutting tubing insulation
- Replaceable stainless steel blade
- Clean cut - no burrs or sawdust replaceable blades

Part #	Mfg #	Description	Price
112016	16368	Big Nipper Cutter	

**Li'l Nipper™**

- Cuts up to 1-1/4" polyethylene, PVC, ABS, and rubber hose
- Cutters are light and can be handily carried in back pocket or tool pouch
- Strong nylon handle with replaceable blades
- Cutters do not distort pipe



Part #	Mfg #	Description	Price
002266	0125	Li'l Nipper™ Cutter	
026128	0127	2 Replacement Blades	

## Pipe Cutters - Plastic

### Tube and Pipe Cutters

#### Inside Pipe Cutter

- Steel blade for plastic pipe
- Abrasive disc for plastic or steel pipe



390-5016

Part #	Mfg #	Steel Blade Size	Price
035402	390-50163	1-1/4"	
035403	390-50164	1-1/4" Hardened	

#### PowerPEX Crimp Tools (Complete Line of ASTM F1807 Options)

- Complete line of F1807 crimp tool options below:
- Steel or composite handles
- Composite handles are strong and durable, yet lightweight
- Compact tools allow one-hand crimping
- Combo tool for the most common crimp connections and added cost savings
- Free Go/No-Go gauge provided with every model
- Also work on PB 1380 tube and fittings



305-23CP

#### Composite Handle

Part #	Mfg #	Description	Length	Price
183403	305-23CPK	1/2"Over-3/4" Combo	14"	

#### Plactic Tube and Hose Cutter

- Quickly cut PEX, PVC, CPVC and other poly pipe or non-metallic hose
- For 1 1/8" O.D. tube or smaller



304-08

Part #	Mfg #	Blade Length	Price
160228	304-08	2-1/4"	

**Pipe Cutters - Soil Pipe**

**Soil Pipe Cutters**

- Provides 1-stroke cutting of 1-1/2" to 6" service weight, No-Hub® soil pipe, clay, asbestos and cement pipe



Part #	Mfg #	Model	Pipe Capacity	Description	Price
008709	32900	246	1-1/2" - 6"	Cuts Clay, Cast Iron, Cement Pipe, 4" Class 22 Water Main	

## Pipe Cutters - Steel

### Pipe Cutters

#### Heavy-Duty Pipe Cutter

- Fast, clean pipe cutting by hand or power
- Extra-long shank protects adjustment threads, while an extra-large handle is provided for quick, easy adjustment
- Can be converted to 3-wheel cutter by replacing rollers with cutter wheel



Part #	Mfg #	Model	Pipe Capacity	Description	Price
008701	32820	2-A	1/8" - 2"	Heavy-Duty Pipe Cutter	

#### Pipe Cutter Replacement Wheel



Part #	Mfg #	Model	Blade Exp	Application	For Model	Price
008732	44185	E-1032	.450	Steel & Ductile Iron	202, 360, 732, 820/364	
008641	33105	F-3	.312	Steel & Ductile Iron	1A, 2A, 42A, 202, 360, 732, 820/364	
008637	33125	F-229	.411	Steel & Ductile Iron	3S, 4S, 44S, 466C/S/HWS, 468C/S/HWS, 472C/S/HWS, 764	
008643	33100	F-514	.312	Steel & Ductile Iron	1A, 2A, 42A, 202, 360, 732, 820/364	

#### Pipe Cutter Parts



Part #	Mfg #	Model	Description	For Model	Price
008664	30118	E-3055X	Ratchet with Handle	12-R	
008720	32142		Wheel Pins with Clip, 5/Pk	151-P, 152, 152-P, 152-PVC, 153, 153-P	
008574	33970	E-1189X	Rings with Pin, 5/Pk	101, 103, 104	
008590	34325	E-1948	Screws, 10/Pk	10, 15, 15-SI	
008638	34805	F-255	Roller, 5/Pk	15	
129720	34825	F-266	Roller, 5/Pk	20	



---

---

## Pipe Taps

---

---

### Machine Screw Tap - Plug Style



Part #	Mfg #	Description	Price
141468	R305100	WC10 1/4-20 N.C.	



## Pipe Threaders

### Pipe Tools

#### Pipe Reamer

- All reamers include handles



Part #	Mfg #	Model	Capacity	Description	Price
008702	34955	2-S	1/4" - 2"	Spiral Ratchet	

#### Inner-Outer Reamer

- Plastic construction with long-wearing alloy steel blades

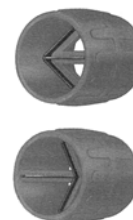

Part #	Mfg #	Model	Description	Construction	Price
017583	34965	127	1/4" - 1-1/2" Nominal Water Tube	Plastic	

#### Hardened Steel Inner-Outer Reamer

- Hardened steel construction
- 46 Cutting edges on interior cone
- For fast, clean, inner reaming and outer deburring/beveling of 1/2"-2" copper and stainless steel tubing



Part #	Mfg #	Model	Description	Construction	Price
111700	29993	227S	1/2" - 2" Copper & SS Tubing	Hardened Steel	

#### Deburring Tool

- For plastic pipe and tubing
- Made of high-grade steel with long-lasting cutting edges
- Ideal for removing outside ridges and inside burrs on plastic pipe and tubing



Part #	Mfg #	Model	Capacity	Plastic Cap ID	Price
033796	64967	74	4"	--	

#### Individual Pipe Extractor

- Easily removes broken threaded ends of pipe, pipe plugs and fittings
- Each is plainly marked showing drill size used when solid ends of plugs and fittings must be drilled to receive extractor



Part #	Mfg #	Model	Pipe Size	Length Overall	Use Drill	Price
120553	35610	83	1/2"	3"	5/8"	

## Pipe Threaders

### Manual Threaders

#### Manual Threader Die Head

- North American standards



Part #	Mfg #	Model	Description	Nominal Pipe Capacity	Price
008661	37040	11-R	Alloy RH	1/2"	
008672	37390	12-R	Alloy RH	1/2"	
008679	37395	12-R	Alloy RH	3/4"	
008666	37400	12-R	Alloy RH	1"	
008668	37410	12-R	Alloy RH	1-1/2"	
008677	37415	12-R	Alloy RH	2"	

#### Pipe Die - National Pipe Taper NPT



Part #	Mfg #	Model	Description	Nominal Pipe Capacity	Price
008671	37825	12-R	Alloy RH	1/2" - 14	
008678	37830	12-R	Alloy RH	3/4" - 14	
008665	37835	12-R	Alloy RH	1" - 11-1/2	
008669	37840	12-R	Alloy RH	1-1/4" - 11-1/2	
008667	37845	12-R	Alloy RH	1-1/2" - 11-1/2	
008676	37850	12-R	Alloy RH	2" - 11-1/2	
008724	37920	12-R	High Speed SS RH	3/4" - 14	
008725	37925	12-R	High Speed SS RH	1" - 11-1/2	

### Power Threading Equipment

#### Model 300 Power Drive Complete

- RIDGID® speed chuck
- Reversible 1/2 HP universal motor
- Ideal for use with RIDGID roll groovers
- Heavy-duty forward/off/reverse and integral foot switch
- Speed chuck with replaceable rocker-action jaws
- Cam-action turns with chuck
- Heavy-duty support bar



Part #	Mfg #	Model	Description	Price
022267	15682	300 Complete	115V, 25-60 Hz (NPT)	

**Pipe Threaders**

Pipe Die for Machine Die Heads



Pipe Die for 504A, 711, 731, 811A, 815A and 842

Part #	Mfg #	Die Material or Type	(NPT) Nominal Pipe Size Threads Per Inch	Price
008747	47745	Alloy RH NPT	1/2"-3/4" - 14	
008748	47750	Alloy RH NPT	1"-2" - 11-1/2	



---

---

## Pipe Threaders

---

---

### Golden Tool™ Pipe Threaders Golden Pipe Shredder™ Kit

- 4 Shredder tools: 1-1/2", 2", 3", 4"
- 1/2" Arbor size



Part #	Mfg #	Size	Qty	Price
143396	98040	1-1/2"	4	
143394	98041	2"	4	

## Pliers & Wire Strippers

### Pliers

#### 6-in-1 Long Nose Pliers

- Integrated reaming head to smooth-out rough edges of metal pipe
- High-leverage design
- (6) Applications:
  - Reaming
  - Wire stripping
  - Nail/wire cutting
  - Nail pulling
  - Pliers
  - Loop maker



Part #	Mfg #	Overall Length	Price
150218	48-22-3068	8"	

#### Long Nose Pliers

- 2" Gripping nose reaming head design - Up to 1"
- On-Board fish tape puller
- Comfort grips will not peel
- Forged design for added strength
- Rust resistance



Part #	Mfg #	Overall Length	Price
175004	48-22-6101	8"	

#### 6-in-1 Combination Pliers

- Integrated reaming head
- High-leverage design
- (6) Applications:
  - Reaming
  - Wire stripping
  - Bolt cutter
  - Wire cutting
  - Pliers
  - Loop maker



Part #	Mfg #	Overall Length	Price
149136	48-22-3069	7-1/2"	

### Cable Cutting Pliers

- Rust resistant
- Comfort grips
- Beveled jaw head
- Optimized blade angle
- Forged strength design
- Ergonomic handle design
- 2/0 Copper max capacity
- 4/0 Aluminum max capacity



Part #	Mfg #	Jaw Length	Price
241143	48-22-6104	2.13"	

### PVC/Oil Filter Pliers

- Comfort grips will not peel or dig into hands during extended use
- Rust resistant
- Forged strength design



Part #	Mfg #	Jaw Length	Price
185825	48-22-6321	3.5"	

### Combination Wire Pliers

- Reaming head design
- Bolt cutter - thread and cut #6 and #8 bolts
- Wire stripper
- One-handed swing lock
- Curved cutting blade
- Ruse protection
- Tether-ready handle loops



Part #	Mfg #	Overall Length	Price
190123	48-22-3079	7.75"	

### Comfort Grip Crimping Pliers

- Crimping head for INS and NON-INS terminals, 10-22AWG
- Integrated reaming head
- Integrated wire cutting for 8-28AWG
- Comfort grips will not peel
- Rust resistant



Part #	Mfg #	Overall Length	Price
189200	48-22-6103	9"	



## Pliers & Wire Strippers

### 6-In-1 Diagonal Pliers

- Reaming head design
- Bolt cutter
- High-leverage design
- Laser hardened cutting edges
- Offset head design - 15 degree offset head for easier and quicker prying and pulling (Patent Pending)
- Rust protection



Part #	Mfg #	Overall Length	Price
175105	48-22-6107	7"	

### Diagonal Cutting Pliers

- Reaming head design
- Flush cutting blades
- On-board fish tape puller
- Comfort grips
- Forged design for added strength
- Rust resistance



Part #	Mfg #	Overall Length	Price
175106	48-22-6106	6"	
175005	48-22-6108	8"	

### Tongue & Groove Pliers

- Reaming head design
- Forged alloy steel for maximum tool strength
- Induction hardened jaws
- Smooth transition grips minimize wear tear and improve punchability
- Rust protection increases tool life by reducing corrosion



Part #	Mfg #	Overall Length	Price
143342	48-22-3210	10"	
150217	48-22-3212	12"	

### 12" Smooth Jaw Pliers

- Ergonomic handles with dipped grips
- Reaming head
- Smooth jaw
- Rust protection



Part #	Mfg #	Overall Length	Price
255002	48-22-6552	12"	

### Straight-Jaw Pliers

- REAM & PUNCH™ handles
- Hardened teeth for long gripping life
- Comfort grips
- Rust resistant
- Forged design for added strength



Part #	Mfg #	Overall Length	Price
175007	48-22-6306	6"	
175008	48-22-6310	10"	
175009	48-22-6312	12"	
175010	48-22-6316	16"	
175110	48-22-6320	20"	
175006	48-22-6330	6" & 10" (2Pk)	

### Hex-Jaw Pliers

- Hex-Jaw design for hex bolts
- All-Metal quick adjustment mechanism
- REAM & PUNCH™ Handles
- Slim head design comfort grips
- Rust resistant



Part #	Mfg #	Overall Length	Price
175109	48-22-6208	8"	
175108	48-22-6210	10"	
175107	48-22-6212	12"	

### 3 Pc Pliers Kit

- Includes:
  - (1) 8" Long Nose Pliers (48-22-6101)
  - (1) 7" Diagonal Cutting Pliers (48-22-6107)
  - (1) 10" Straight-Jaw Pliers (48-22-6310)



Part #	Mfg #	Description	Price
189817	48-22-6331	Multi-Use	

### 2 Pc Locking Pliers Set

- Includes:
  - (1) 10" Torque Lock™ Curved Jaw Locking Pliers (48-22-3420)
  - (1) 6" Long Nose (48-22-3506)



Part #	Mfg #	Overall Length	Price
226918	48-22-3602	6" & 10"	



## Pliers & Wire Strippers

### Maxbite Curved Jaw Locking Pliers

- MAXBITE JAW DESIGN 3X GRIPPING FORCE
- Torque lock faster setup and more force for locking tools
- MAXBITE jaw maximizes pressure points for round pipe, hex bolts, and many other locking tool applications
- Control release fast, easy, one-handed release
- Hardened jaws better grip force on jobsite material
- Forged alloy steel for maximum tool strength and durability



Part #	Mfg #	Overall Length	Price
221689	48-22-3610	10"	

### High Leverage Lineman's Pliers w/ Crimper

- Iron carbide edge cutting edge hardened blades
- Reaming head design - up to 1 1/2" (patent pending)
- Integrated crimper for INS and NON INS terminals
- On-Board fish tape puller
- Comfort grips will not peel
- Forged design for added strength
- Rust resistance



Part #	Mfg #	Overall Length	Price
175003	48-22-6100	9"	

### 6-in-1 Lineman's Pliers

- Integrated reaming head
- High-leverage design
- (6) Applications:
  - Reaming
  - Bolt cutter
  - Wire cutter
  - Nail pulling
  - Pliers
  - Fish tape puller



Part #	Mfg #	Overall Length	Price
149137	48-22-3309	9"	

### Lineman's Crimper w/ Fixed BG

- Contoured rubberized grip
- Fiberglass core
- Accepts W style crimping dies
- Integrated carabineer loops



Part #	Mfg #	Overall Length	Price
256101	49-16-2601	Crimper	

### Multi-Purpose Wire Stripper with Crimper

- Spring assisted
- Ergonomic Handles with Dipped Grips
- Shears Bolts for 4-40, 5-40, 10-32 & 10-24
- Crimper for Insulated and Noninsulated Terminals
- Strips 10-20awg solid wire and 12-22awg stranded wire



Part #	Mfg #	Overall Length	Price
257547	48-22-6579	Wire Stripper	

### TORQUE LOCK Pliers

#### TORQUE LOCK™ Curved Jaw Locking Pliers with Durable Grip

- TORQUE LOCK™ Faster setup and easy release
- Curved Jaw: Maximizes pressure points for any bolt, nut or locking tool application
- Hardened Jaws: Better grip force on job site material
- Rust Protection: Increases tool life by reducing corrosion
- Overmold Grips: Durable and comfortable



Part #	Mfg #	Overall Length	Price
168835	48-22-3405	5"	
168834	48-22-3407	7"	
168827	48-22-3410	10"	

#### TORQUE LOCK™ Long Nose Locking Pliers With Durable Grip

- TORQUE LOCK™ Faster setup and easy release
- Curved Jaw: Maximizes pressure points for any bolt, nut or locking tool application
- Hardened Jaws: Better grip force on job site material
- Rust Protection: Increases tool life by reducing corrosion
- Overmold Grips: Durable and comfortable



Part #	Mfg #	Overall Length	Price
168838	48-22-3406	6"	
168837	48-22-3409	9"	

## Pliers & Wire Strippers

### TORQUE LOCK™ Straight Jaw Locking Pliers

- *TORQUE LOCK™: Faster setup and easy release*
- *Straight Jaw: Maximizes contact points on job site work surfaces*
- *Hardened Jaws: Better grip force on job site material*
- *Forged Alloy Steel: For maximum tool strength and durability*
- *Rust Protection: Increases tool life by reducing corrosion*



Part #	Mfg #	Overall Length	Price
168826	48-22-3507	7"	
168825	48-22-3510	10"	

### TORQUE LOCK™ Curved Jaw Locking Pliers

- *TORQUE LOCK™: Faster setup and easy release*
- *Curved Jaw: Maximizes pressure points for any bolt, nut or locking tool application*
- *Hardened Jaws: Better grip force on job site material*
- *Forged Alloy Steel: For maximum tool strength and durability*
- *Rust Protection: Increases tool life by reducing corrosion*



Part #	Mfg #	Overall Length	Price
221690	48-22-3607	7"	
168824	48-22-3420	10"	

### TORQUE LOCK™ Curved Jaw Locking Pliers Set

- *Includes:*  
 (1) 7" TORQUE LOCK Curved Jaw Locking Pliers (48-22-3407)  
 (1) 10" TORQUE LOCK™ Curved Jaw Locking Pliers (48-22-3410)



Part #	Mfg #	Overall Length	Price
168839	48-22-3402	7" & 10"	

## Pliers & Wire Strippers

### Pliers

#### Water Pump Pliers

- *Hardened and tempered for durability*



Part #	Mfg #	Model	Description	Length	Price
008764	80475	734	2" Capacity	10"	



## Pliers & Wire Strippers

### Milled Jaw Slip-Joint Pliers

- Nickel-plated finish with plastic grips
- Angle-nose pliers have grip tight clip



306-10

Part #	Mfg #	Type	Size	Max	Price
113964	306-10	10"	Angle Nose	1-1/2"	

## Pliers & Wire Strippers

### Pliers **CHANNEL LOCK**

- Undercut tongue and groove design won't slip
- Patented reinforcing edge minimizes stress breakage
- CHANNELLOCK BLUE® grips for comfort

#### Straight Jaw Tongue & Groove Pliers

- High-carbon C1080 steel for superior performance on the job and electronic coating for ultimate rust prevention
- Right-angle, laser-heat treated teeth grip better and last longer
- PermaLock® fastener eliminates nut and bolt failure



Part #	Mfg #	Length	Capacity	Price
076358	R117200	6-1/2"	7/8"	
008905	R117400	9-1/2"	1-1/2"	
008907	R117600	10"	2"	
008908	R117800	12"	2-1/4"	
109928	R117900	16-1/2"	4-1/4"	

#### V-Jaw Tongue & Groove Pliers

- High-carbon C1080 steel for superior performance on the job and electronic coating for ultimate rust prevention
- Right-angle, laser heat-treated teeth grip better and last longer
- V-Jaws give you more points of contact on round stock and tubing
- PermaLock® fastener eliminates nut and bolt failure



Part #	Mfg #	Length	Capacity	Price
008906	R118300	9-1/2"	1-1/2"	

## Pliers & Wire Strippers

### Wire Strippers

#### 7" Wire Stripper

- *Comfortable grip*
- *Quick ID with easy-to-read size markings*



Part #	Mfg #	Description	Price
174618	1885426	7" Wire Strippers	

### Pliers

#### Quick-Adjusting Tongue & Groove Pliers

- *Comfortable grip*
- *Push button allows for quick adjustments while multiple grooves guarantee precise positioning*
- *Machined jaws increase grip on the material*



Part #	Mfg #	Description	Price
174615	1890996	8" Pliers	
174616	1890997	10" Pliers	



## Power Tools - M12 and Misc

### M12™ Cordless Tools

#### M12™ Cordless 3/8" Right Angle Drill Driver

- No load speed: 0 to 800 rpm
- Clutch settings: 11+ Drill
- Chuck type: 3/8" single sleeve
- Head length/weight: 3-3/4"/2.4 lbs
- Kit Includes:
  - M12™ 3/8" Right angle drill driver
  - M12™ Lithium-Ion battery
  - 30-Minute charger
  - Soft carrying case



Part #	Mfg #	Description	Price
160481	2415-20	Bare Tool	
137547	2415-21	Tool Kit	

#### M12™ Cordless Lithium-Ion No-Hub Driver

- 0-750 RPM Drill Mode
- 12-volt motor
- Kit Includes:
  - (1) M12™ Cordless No-Hub Driver (2455-20)
  - (2) M12™ REDLITHIUM™ battery (48-11-2401)
  - (1) M12™ Lithium-ion battery charger (48-59-2401)
  - (1) SHOCKWAVE™ 1-7/8" MAG NUTDRIVER 1/4" (49-66-4502)
  - (1) SHOCKWAVE™ 1-7/8" MAG NUTDRIVER 5/16" (49-66-4503)
  - (1) SHOCKWAVE™ 1-7/8" MAG NUTDRIVER 3/8" (49-66-4505)
  - (1) Carrying Case
  - (3) SHOCKWAVE™ Sockets



Part #	Mfg #	Description	Price
225358	2455-20	Bare Tool	
137555	2455-22	Kit	

### M12™ 3/8" Hammer Drill/Driver Kit

- Delivers up to 275 in lbs of Torque
- On-board battery fuel gauge displays remaining run time
- New ergonomic handle design for increased comfort
- Metal ratcheting chuck for maximum durability
- Includes:
  - (1) M12™ 3/8" Hammer drill/driver (Bare Tool) (2408-20)
  - (2) M12™ REDLITHIUM™ battery (48-11-2401)
  - (1) M12™ Lithium-ion battery charger (48-59-2401)
  - (1) Belt clip
  - (1) Carrying case



Part #	Mfg #	Description	Price
162002	2408-20	Bare Tool	
161649	2408-22	Kit	

### M12™ 3/8" Drill/Driver

- Delivers up to 275 in-lbs of torque
- On-board battery fuel gauge displays remaining run time
- Metal ratcheting chuck for maximum durability
- Kit Includes:
  - (1) M12™ 3/8" Drill/Driver (bare tool) (2407-20)
  - (1) M12™ REDLITHIUM Battery (48-11-2401)
  - (1) M12™ Lithium-ion battery charger (48-59-2401)
  - (1) Belt clip
  - (1) Carrying case



Part #	Mfg #	Description	Price
162001	2407-20	Bare Tool	
162000	2407-22	Kit	

## Power Tools - M12 and Misc

### M12 FUEL™ 1/2" Drill/Driver

- POWERSTATE™ Brushless motor
- REDLITHIUM™ Battery technology
- REDLINK Plus™ Intelligence
- Kit Includes:
  - (1) M12 FUEL™ 1/2" Drill/Driver (2403-20)
  - (1) M12 REDLITHIUM™ 2.0 Compact battery pack (48-11-2420)
  - (1) M12™ REDLITHIUM™ XC 4.0 extended capacity battery pack (48-11-2440)
  - (1) M12™ Lithium-ion battery charger (48-59-2401)
  - (1) Belt clip
  - (1) Carrying case



Part #	Mfg #	Description	Price
172508	2403-20	Bare Tool	
165720	2403-22	Kit	

### M12™ Cordless Rotary Tool

- Kit Includes:
  - M12™ Rotary tool (2460-20)
  - (1) REDLITHIUM™ Battery (48-11-2401)
  - (5) Cutting wheels, mandrel
  - Wrench
  - 30-Minute charger



Part #	Mfg #	Description	Price
162782	2460-20	Bare Tool	
144497	2460-21	Kit	

### M12™ 1/4" Hex 2-Speed Screwdriver

- Delivers up to 275 in-lbs of torque
- On-board battery fuel gauge displays remaining run time
- New ergonomic handle design for increased comfort
- 1/4" Hex quick change chuck for one-handed bit changes
- Kit Includes:
  - (1) M12™ 1/4" Hex 2-speed screwdriver (2406-20)
  - (2) M12™ REDLITHIUM™ battery (48-11-2401)
  - (1) M12™ Lithium-ion battery charger (48-59-2401)
  - (1) Belt clip
  - (1) Carrying case



Part #	Mfg #	Description	Price
162004	2406-20	Bare Tool	
162003	2406-22	Kit	

### M12 FUEL™ 1/4" Hex 2-Speed Screwdriver

- POWERSTATE™ Brushless motor
- REDLITHIUM™ Battery technology
- REDLINK Plus™ Intelligence



Part #	Mfg #	Description	Price
165722	2402-22	Kit	

### M12™ 1/4" Hex Screwdriver

- Quick one-handed bit-loading
- Variable speed trigger
- No load speed: 0 to 500 rpm
- Kit Includes:
  - M12™ Screwdriver (2401-20)
  - (2) 12V Lithium-Ion batteries
  - 12V Charger
  - Compact driver storage bag
- 5-Year warranty



Part #	Mfg #	Description	Price
235862	2401-20	Bare Tool	
137546	2401-22	Kit	

### M12™ 1/4" Hex Impact Driver

- 1,000 in-lbs of torque
- 0-2,500 RPM
- On-board battery fuel gauge
- Kit Includes:
  - (1) M12™ 1/4" Hex impact driver (2462-20)
  - (1) M12™ REDLITHIUM™ battery (48-11-2401)
  - (1) M12™ Lithium-ion battery charger (48-59-2401)
  - (1) Belt clip
  - (1) Carrying case



Part #	Mfg #	Description	Price
160215	2462-20	Bare Tool	
160216	2462-22	Kit	

## Power Tools - M12 and Misc

### M12™ 1/4" Hex Right Angle Impact Driver

- Offers users maximum access for hard-to-reach fastener
- Provides the most power and highest RPM in its class
- Part of the M12 System, featuring over 70 tools
- Best-in-class power and speed with 600 in. lbs. of torque and 0 - 2,150 RPM
- Variable speeds provides maximum control for any job
- Extended paddle switch for multiplk



Part #	Mfg #	Description	Price
188323	2467-20	Bare Tool	
219059	2467-21	Kit	

### M12™ 1/4" Impact Wrench

- Lightweight, compact design
- On-board battery fuel gauge
- 1/4" anvil with friction ring



- Kit Includes:
  - (1) M12™ 1/4" Impact wrench (2461-20)
  - (2) M12™ REDLITHIUM™ battery (48-11-2401)
  - (1) M12™ Lithium-ion battery charger (48-59-2401)
  - (1) Belt clip
  - (1) Carrying case

Part #	Mfg #	Description	Price
162010	2461-20	Bare Tool	
162009	2461-22	Kit	

### M12™ FUEL™ 1/4" Impact Wrench

- POWERSTATE™ Brushless motor
- REDLITHIUM™ 2.0 Battery REDLINK Plus™ Intelligence
- DRIVE CONTROL™



- Kit Includes:
  - (1) M12 FUEL™ 1/4" Impact wrench (2452-20)
  - (2) M12 REDLITHIUM™ 2.0 Compact battery pack (48-11-2420)
  - (1) M12™ Lithium-ion battery charger (48-59-2401)
  - (1) Belt clip
  - (1) Carrying case

Part #	Mfg #	Description	Price
165719	2452-22	Kit	

### M12™ FUEL™ 3/8" Impact Wrench

- POWERSTATE™ Brushless motor
- REDLITHIUM™ 2.0 Battery REDLINK Plus™ Intelligence
- DRIVE CONTROL™



Part #	Mfg #	Description	Price
238273	2454-20	Bare Tool	
165718	2454-22	Kit	

### M12 FUEL 1/2" Stubby Impact Wrench

- POWERSTATE™ Brushless motor
- Up to 250 ft.-lbs. of nut-busting torque
- REDLINK PLUS™ Electronic intelligence
- Most Compact. Greatest access in tight spaces at 4.9" in length



Part #	Mfg #	Description	Price
255262	2555-20	Bare Tool	

### M12™ FUEL™ 3/8" Stubby Impact Wrench

- POWERSTATE™ brushless motor
- Up to 250 ft.-lbs. of nut-busting torque
- REDLINK Plus™ intelligence
- 4-Mode drive control
- Most compact. Greatest access in tight spaces at 4.8" in length
- Kit Includes
  - (1) M12 FUEL 3/8" Stubby Impact Wrench (2554-20)
  - (1) M12™ REDLITHIUM™ CP2.0 battery (48-11-2420)
  - (1) M12™ REDLITHIUM™ XC 4.0 extended capacity battery pack (48-11-2440)
  - (1) M12™ Lithium-ion battery charger (48-59-2401)
  - (1) Belt clip
  - (1) Carrying case



Part #	Mfg #	Description	Price
253316	2554-20	Bare Tool	
253636	2554-22	Kit	

## Power Tools - M12 and Misc

### M12™ 3/8" Impact Wrench Kit

- 1,200 in-lbs of torque
- On-board battery fuel gauge
- 3/8" anvil with friction ring
- Kit Includes:
  - (1) M12™ 3/8" Impact wrench (2463-20)
  - (2) M12™ REDLITHIUM™ battery (48-11-2401)
  - (1) M12™ Lithium-ion battery charger (48-59-2401)
  - (1) Belt clip
  - (1) Carrying case



Part #	Mfg #	Description	Price
162008	2463-20	Bare Tool	
162006	2463-22	Kit	

### M12 FUEL™ 5/8" SDS Plus Rotary Hammer Kit

- REDLINK™ Intelligence
- REDLITHIUM™ Battery technology
- Electro pneumatic mechanism
- Delivers 0-900 RPM and 0-6,200 BPM for superior performance
- Compact, lightweight design
- 2-Mode operation
- LED light: Illuminates the work surface



Part #	Mfg #	Description	Price
228736	2416-20	Bare Tool	
165721	2416-22X	Kit	
	C		

### M12™ Cordless Ratchet

- Torque: 30 ft-lbs
- Speed: 250 rpm
- Anvil: 1/4" ball detent
- Kit includes:
  - M12™ Ratchet
  - (1) M12™ REDLITHIUM™ battery
  - 30-Minute charger
  - Carrying case



Part #	Mfg #	Description	Size	Price
143704	2456-20	Bare Tool	1/4"	
143703	2456-21	Kit	1/4"	
143706	2457-20	Bare Tool	3/8"	
143705	2457-21	Kit	3/8"	

### M12™ Hackzall™ Cordless Reciprocating Saw

- 11" Long and 2.6 lbs for cutting in tight spaces
- 1/2" Stroke, 0 to 3,000 strokes per minute
- All-metal gear case
- Variable speed trigger
- Battery fuel gauge
- QUIK-LOK™ blade clamp
- Built-in LED light illuminates work surface
- Accepts both Hackzall™ and Sawzall® style blades
- Kit includes:
  - Hackzall™ (2420-20)
  - 30-Minute charger
  - (2) Hackzall™ blades
  - Carrying case



Part #	Mfg #	Description	Price
146874	2420-20	Bare Tool	
137550	2420-21	Kit	

### M12™ Cordless PVC Shear Kit

- Ultra sharp blade with pierce point
- Offset blade cuts PVC/PEX in-wall, in-ground, or close to wall
- Quick return blade
- All metal planetary drive
- Stainless steel blade and aluminum jaw
- Variable speed trigger
- Impact, water and rust resistant
- On board fuel gauge - displays remaining run-time
- Torque: 1,900 in-lbs
- Kit Includes:
  - M12™ Cordless PVC shear (2470-20)
  - (1) Lithium-Ion battery
  - 30-Minute charger
  - Carrying case



Part #	Mfg #	Description	Price
152547	2470-20	Bare Tool	
137552	2470-21	Kit	



## Power Tools - M12 and Misc

### M12™ Cordless Grease Gun

- Maximum operating pressure: 8,000 psi
- Grease capacity: 14 oz cartridge/16 oz bulk
- Kit Includes:
  - M12™ Grease gun (2446-20)
  - M12™ XC REDLITHIUM™ battery
  - 60-Minute charger
  - 36" High pressure flex hose with spring guard
  - Grease coupler
  - Carrying case



Part #	Mfg #	Description	Price
224896	2446-20	Bare Tool	
141426	2446-21X C	Kit	

### M12™ Cordless Multi-Tool

- Cuts, grinds, sands and scrapes
- Variable speed dial
- On board fuel gauge displays run time
- Runs 5,000 to 20,000 OPM
- Kit Includes:
  - Cordless multi-tool
  - Accessory adapter
  - Wood cutting blade
  - Sanding pad
  - (5) Assorted sanding sheets
  - (2) REDLITHIUM™ batteries
  - 30-Minute charger
  - Contractor bag



Part #	Mfg #	Description	Price
139011	2426-22	Kit	

### M12™ 600 MCM Cable Cutter Kit

- Powerful open jaws: Cut effortlessly through 600 MCM copper and 750 MCM aluminum
- REDLITHIUM™ Battery technology:
- Auto release lever: Cut, reload and quickly repeat for maximum productivity
- 2-Speed gear box:
- Built-in LED light: Illuminates the line of cut



Part #	Mfg #	Description	Price
177727	2472-21X C	Kit	

### M12™ Soldering Iron Kit

- 18 Second heat up time
- LED work light
- 3-Stop pivoting head
- 750° Max temperature
- 90W heater
- Kit includes
  - Pointed tip
  - Chisel tip
  - M12™ Soldering iron (2488-20)
  - M12 Charger and carrying case
  - M12™ REDLITHIUM compact battery pack



Part #	Mfg #	Description	Price
241854	2488-21	Kit	
244358	2488-20	Bare Tool	

### M12™ Cordless LITHIUM-ION Multi-Tool

- Cuts, grinds, sands and scrapes
- Variable speed dial
- On board fuel gauge displays run time
- Runs 5,000 to 20,000 OPM
- Kit includes:
  - Cordless multi-tool
  - Accessory adapter
  - Wood cutting blade
  - (1) REDLITHIUM™ battery
  - 30-Minute charger
  - Contractor bag



Part #	Mfg #	Description	Price
150059	2426-20	Bare Tool	
143165	2426-21	Kit	

### M12™ Cordless 2-Tool Combo Kit

- 1/4" Hex screwdriver delivers 150 in-lbs of torque, 15 position clutch, and 0 to 500 rpm
- Hackzall™ reciprocating saw delivers 0 to 3000 spm
- Kit includes:
  - Screwdriver (2401-20)
  - Hackzall™ Reciprocating saw (2420-20)
  - (2) M12™ Lithium-Ion batteries
  - 30-Minute charger
  - (2) Hackzall™ blades
  - Contractor bag



Part #	Mfg #	Description	Price
137556	2490-22	Combo Kit	

## Power Tools - M12 and Misc

### M12 FUEL™ 2-Tool Combo Kit

- Kit includes:
- (1) M12 FUEL™ 1/2" Drill/Driver (2403-20)
- (1) M12 FUEL™ 1/4" Hex Impact Driver (2453-20)
- (1) M12 REDLITHIUM™ 2.0 Battery (48-11-2420)
- (1) M12™ REDLITHIUM™ XC 4.0 Extended Capacity Battery Pack (48-11-2440)
- (1) M12™ Lithium-ion Battery Charger (48-59-2401)
- (2) Belt Clip
- (1) Carrying Case



Part #	Mfg #	Description	Price
186086	2594-22	Combo Kit	

### M12 FUEL™ 2-Tool Combo Kit (1/2" Hammer Drill, 1/4" Hex Impact Driver)

- Kit includes:
- (1) M12 FUEL™ 1/2" Drill/Driver (2503-20)
- (1) M12 FUEL™ 1/4" Hex Impact Driver
- (1) M12 REDLITHIUM™ Battery
- (2) Belt Clip
- (1) Contractor Bag



Part #	Mfg #	Description	Price
244456	2598-22	Combo Kit	

### M12™ Cordless LITHIUM-ION 2-Tool Combo Kit

- Kit Includes:
- M12™ 3/8" Hammer Drill/Driver
- M12™ 1/4" Hex Impact Driver
- REDLITHIUM Battery



Part #	Mfg #	Description	Price
163696	2497-22	Kit	

### M12™ Cordless 4-Tool Combo Kit

- Hackzall™ reciprocating saw delivers 0 to 3000 spm
- Copper tubing cutter adjusts to cut 3/8" to 1" copper
- Work light illuminates large work area with 90° rotating head and integrated m:



- Kit Includes:
- Screwdriver (2401-20)
- Hackzall™ reciprocating saw (2420-20)
- Copper tubing cutter (2471-20)
- Work light (49-24-0145)
- (2) 12V Lithium-Ion battery packs
- 30-Minute charger
- (2) Hackzall™ blades
- Contractor bag

Part #	Mfg #	Description	Price
138377	2490-24	Combo Kit	

### M12™ Cordless 2-Tool Combo Kit (1)

- Kit Includes:
- 1/4" Hex Impact driver (2450-20)
- Hackzall™ Reciprocating saw (2420-20)
- (2) Lithium-Ion batteries
- 30-Minute charger
- Contractor bag



Part #	Mfg #	Description	Price
139268	2491-22	Combo Kit	

### M12™ Cordless 2-Tool Combo Kit

- Kit Includes:
- 3/8" Drill driver (2410-20)
- 1/4" Hex impact driver (2450-20)
- (2) M12™ REDLITHIUM™ Batteries (48-11-2401)
- 30-Minute charger (48-59-2401)
- Contractor bag



Part #	Mfg #	Description	Price
137558	2494-22	Combo Kit	



## Power Tools - M12 and Misc

### M12 Fuel™ Cordless Tools

#### M12™ FUEL 1/2" Drill/Driver

- Most capable, lightest weight, most compact
- 1/2" All metal chuck for maximum grip and bit retention
- E-Clutch for consistent repeatability
- 1700 RPMs for faster drilling speeds
- 350 in lbs of peak torque



Part #	Mfg #	Description	Price
244564	2503-20	Bare Tool	
244562	2503-22	Kit	

#### M12 FUEL™ 1/2" Hammer Drill Kit

- Most capable, lightest weight, most compact
- 1/2" All metal chuck for maximum grip and bit retention
- E-Clutch for consistent repeatability
- 1700 RPMs for faster drilling speeds
- 350 in lbs of peak torque



Part #	Mfg #	Description	Price
244567	2504-20	Bare Tool	
244566	2504-22	Kit	

#### M12 FUEL™ 1/2" Hammer Drill/Driver Kit

- POWERSTATE™ Brushless motor
- REDLINK Plus™ Intelligence
- REDLITHIUM™ Battery technology
- Kit Includes:
  - (1) M12 FUEL™ 1/2" hammer drill/driver (2404-20)
  - (1) M12 REDLITHIUM™ 2.0 compact battery pack (48-11-2420)
  - (1) M12™ REDLITHIUM™ XC 4.0 extended capacity battery pack (48-11-2440)
  - (1) M12™ Lithium-ion battery charger (48-59-2401)
  - (1) Belt clip
  - (1) Carrying case



Part #	Mfg #	Description	Price
154724	2404-22	Kit	

### M12 FUEL™ 1/4" Hex Impact Driver Kit

- Most Compact
- 4-Mode Drive Control
- POWERSTATE brushless motor
- REDLINK PLUS intelligence
- REDLITHIUM batteries
- 4-mode drive control provides greater control over output speed and power



Part #	Mfg #	Description	Price
244569	2553-20	Bare Tool	
244568	2553-22	Kit	

### M12 FUEL™ 1/4" Hex Impact Driver

- POWERSTATE™ Brushless motor
- REDLITHIUM™ 2.0 Battery technology
- REDLINK Plus™ Intelligence
- DRIVE CONTROL™
- Kit Includes:
  - (1) M12 FUEL™ 1/4" hex impact driver (2453-20)
  - (2) M12 REDLITHIUM™ 2.0 compact battery pack (48-11-2420)
  - (1) M12™ Lithium-ion battery charger (48-59-2401)
  - (1) Belt clip
  - (1) Carrying case



Part #	Mfg #	Description	Price
159974	2453-20	Bare Tool	
154725	2453-22	Kit	

### M12 FUEL™ 2-Tool Combo Kit: 1/2" Drill Driver and 1/4" Hex Impact Driver

- Most Capable 12V Drill
- Lightest Weight in its class
- Most Compact in its class
- 1/2" All Metal chuck for maximum grip and bit retention
- E-Clutch for consistent repeatability in driving applications
- 1700 RPMs for faster drilling speeds
- 350 in.lbs of peak torque



Part #	Mfg #	Description	Price
244570	2596-22	Kit	

## Power Tools - M12 and Misc

### M12 FUEL™ HACKZALL® Recip Saw Kit

- One-handed design
- Compact size
- POWERSTATE™ brushless motor
- REDLINK PLUS™ Intelligence
- REDLITHIUM™ XC 4.0 Battery pack



Part #	Mfg #	Description	Price
166203	2520-20	Bare Tool	
166202	2520-21X C	Kit	

### M12 FUEL™ Circular Saw



Part #	Mfg #	Description	Price
220202	2530-20	Bare Tool, 5-3/8"	
185807	2530-21X C	Kit, 5-3/8"	

### M12™ Cordless LITHIUM-ION 4-Tool Combo Kit

- Kit Includes:
  - (1) M12™ 3/8" Drill/Driver (bare tool) (2407-20)
  - (1) M12™ HACKZALL® Recip saw (bare tool) (2420-20)
  - (1) M12™ 1/4" Hex impact driver (bare tool) (2462-20)
  - (2) M12™ REDLITHIUM™ Battery (48-11-2401)
  - (1) M12™ Lithium-ion battery charger (48-59-2401)
  - (1) M12™ Work light (49-24-0145)
  - (1) Contractor bag



Part #	Mfg #	Description	Price
159666	2498-24	Combo Kit	

### M12 FUEL™ 1/4" Ratchet Tool

- Torque: 40ft-lbs
- Recessed head profile
- Pneumatic ratchet performance
- Delivers 250 RPM
- REDLINK PLUS™
- REDLITHIUM™ Battery
- Variable speed metal trigger
- LED light illuminates the work area



Part #	Mfg #	Description	Price
240413	2556-20	Bare Tool	1/4"
240414	2556-22	Kit	1/4"

### M12™ Fuel Cordless Ratchet

- Torque: 55ft-lbs
- Speed: 250 rpm
- LED light
- REDLINK PLUS™
- REDLITHIUM™ batteries
- POWERSTATE™ brushless motor



Part #	Mfg #	Description	Size	Price
241820	2557-20	Bare Tool	3/8"	
240746	2557-22	Kit	3/8"	

### M12™ Rivet Tool

- Pull Up to 3/16" Stainless Steel Rivets
- 450 1/8" Steel Rivets per charge
- Aluminum, Steel, Stainless Steel - Capacity
- Part of 90+ Solutions on the M12 Platform
- 450 1/8" Steel Rivets per charge
- Pull 3/32", 1/8", 5/32", 3/16" Rivet
- 0.8" Stroke Length
- 2,000 lbs. pulls force
- Tool holds rivet in any orientation



Part #	Mfg #	Description	Price
247116	2550-20	Bare Tool	
247118	2550-22	Kit	

## Power Tools - M12 and Misc

### M12™ Miscellaneous Tools

#### M12™ Caulk and Adhesive Gun

- 30 Minutes charge time
- Kit includes:
  - (1) M12™ 10oz. Caulk and Adhesive Gun (Bare Tool) (2441-20)
  - (1) 3/8" Hollow Shaft Nut Driver (48-22-2424)
  - (1) 3/8" Hollow Shaft Nut Driver (48-22-2424)



Part #	Mfg #	Description	Price
158760	2441-20	Bare Tool	
232433	2441-21	Kit	

#### M12™ Quart Caulk and Adhesive Gun

- 30 Minutes charge time
- For use with 29 oz. quart cartridge style caulk tubes
- Will dispense up to 150 10 oz. tubes of sealant on one charge
- Kit includes:
  - (1) M12™ Quart Conversion Kit (48-08-0910)
  - (1) M12™ Lithium-ion Battery Charger (48-59-2401)
  - (1) M12™ REDLITHIUM™ CP1.5 Battery Pack (48-11-2401)



Part #	Mfg #	Description	Price
252659	2444-21	Kit	

#### M12™ Sausage Style Caulk and Adhesive Gun

- 20 oz Aluminum barrel
- Kit Includes:
  - 12V 20oz Sausage conversion kit (48-08-0905)
  - M12 Lithium-ion battery charger (48-59-2401)
  - M12 REDLITHIUM Battery (48-11-2401)



Part #	Mfg #	Description	Price
243478	2442-21	Kit	

#### M12™ Cordless Palm Nailer

- 12V
- REDLITHIUM™ technology
- REDLINK™ Intelligence
- On-board fuel gauge
- Build-in LED light
- Industrial-duty collet: 6D-16D magnetic collet provides secure hold for one-handed tool use



Part #	Mfg #	Description	Price
242609	2458-20	Bare Tool	

### M12™ Compact Inflator

- Includes: Ball inflation needle, Presta chuck, Schrader chuck, Inflator nozzle
- TrueFill™ auto shut-off technology increases accuracy, protects from over-temp and over-fill
- Illuminated digital gauge with target and current pressure reading
- Inflates car, LT truck, and compact equipment tires
- High efficiency pump & motor for true 120PSI capability



Part #	Mfg #	Description	Price
245947	2475-20	Bare Tool	
246162	2475-21X	Kit	
	C		

### M12™ Crown Stapler

- Kit includes:
  - (1) M12 3/8" Crown Stapler (2447-20)
  - (1) M12™ REDLITHIUM™ Battery (48-11-2401)
  - (1) M12™ Lithium-ion Battery Charger (48-59-2401)



Part #	Mfg #	Description	Price
238190	2447-20	Bare Tool	
238191	2447-21	Kit	

## Power Tools - M12 and Misc

### M12™ 160 x 120 Thermal Imager Kit

- 30-Minute charge time
- 4-Hour battery life
- Knurled focus ring
- 3.5" High resolution LCD
- 4" Minimum focus distance
- Hinged camera style lens
- Raised corners protect the LCD and thermal engine if dropped
- Complete report software
- Broader temperature range —14 to 662°F
- REDLITHIUM™ batteries
- Built-in visual camera & flashlight
- Auto and manual ranging
- Iron, rainbow, and gray color pallets
- Data storage: 2GB SD card
- All thermal and visual images use standard JPEG format for use in any program



### M12™ M-Spector 360™ Rotating Inspection Scope

- Rotating display allows user to o. without having to fight the cable
- 640 x 480 Digital image sensor
- (4) LED lights
- Display: 2.7" LCD
- 9mm Aluminum head
- 3' Cable
- Kit Includes:
  - M-Spector 360™ console
  - M12™ REDLITHIUM™ battery
  - 30 Minute charger
  - Hook, magnet and mirror attachments
  - Carrying case



Part #	Mfg #	Display Resolution	Price
144777	2260-21	160 x 120 Pixels	

### M-Spector™ Inspection Scope Kit

- 2.7" LCD display
- Four surround LED lights
- 3 ft enhanced cable
- Kit Includes:
  - (1) M-Spector™ Scope Kit
  - (1) Pipe guide attachment
  - (1) 9V Battery
  - (1) Carrying case



Part #	Mfg #	Description	Price
229565	2309-20	Kit	

### M12™ M-Spector Flex™ 9FT Inspection Camera Cable Kit

- Kit Includes:
  - (1) M12™ M-SPECTOR FLEX™ 9' FT Inspection Camera
  - (1) M12™ REDLITHIUM™ CP1.5 Battery Pack (48-11-2401)
  - (1) M12™ Lithium-ion Battery Charger (48-59-2401)
  - (1) USB Cable
  - (1) SD Card
  - (1) Carrying Case



Part #	Mfg #	Description	Price
228027	2316-21	Kit	

### SUB-SCANNER™ M12™ Detection Tool

- Measures depth and location of Rebar up to 6" through concrete
- Detects location of wood and metal studs
- Differentiates between steel and copper or aluminum metals
- Intuitive user interface displays stud centers and edges
- High contrast white on black display and back light for easy reading
- Rugged over-molding improves durability and user grip
- One button calibration for all surfaces



Part #	Mfg #	Description	Price
153058	2291-20	Bare Tool	



## Power Tools - M12 and Misc

### Drills

#### 3/8" Pistol Drill

- 8 Amp motor
- 120VAC Only
- Keyless, metal chuck type
- All metal gear case
- Soft grip handle and 2-finger trigger
- 8' Cord
- Kit Includes:
  - 3/8" Drill
  - Side handle



Part #	Mfg #	No Load RPM	Price
139060	0240-20	0 - 2,800	

#### SDS Plus Rotary Hammer Kit



Part#	Mfg#	Description	Size	Price
164855	5263-21	Kit	5/8"	
151555	5262-21	Kit	1"	
219770	5268-21	Kit	1-1/8"	

#### 1-9/16" Spline Rotary Hammer

- Powerful 10.5 amp motor: Delivers 450RPM and 3,000 BPM
- Powerful hammer mechanism
- CPT™- Constant power technology
- Mechanical clutch
- 2-Mode operation: Rotary hammer and hammer only
- 12-Position chipping adjustment



Part #	Mfg #	Description	Price
153749	5316-21	Kit	

#### 1-9/16" SDS Max Rotary Hammer

- Powerful 10.5 Amp motor: Delivers 450 RPM and 3,000BPM
- Powerful hammer mechanism
- CPT™- Constant power technology
- Mechanical clutch
- 2-mode operation: Rotary hammer and hammer only
- 12-Position chipping adjustment: Allows the user to maintain the desired hammer position while chipping in any orientation



Part #	Mfg #	Description	Price
159786	5317-21	Kit	

#### 1/2" D-Handle Drill

- 0-500 RPM
- 7.0 Amp motor
- Torque: Offers 1/2" capacity in steel
- Heavy-Duty keyed chuck w/ holder
- QUIK-LOK® Cord: 8ft, 3-wire ground rubber cord



Part #	Mfg #	No Load RPM	Price
242791	1107-6	0-500	

#### 2" SDS Max Rotary Hammer

- 15-Amp motor, 120V AC
- 19.9 ft-lbs of blow energy
- D-handle style
- Variable-speed dial
- Service reminder light
- Double insulated cord type
- Vibration isolation system
- No load speed: 125-250
- No load BPM: 975-1,950
- 6" Thick wall core bit capacity
- Drilling mode: Rotary hammer & hammer only



Part #	Mfg #	No Load RPM	Price
221333	5342-21	125-250	



## Power Tools - M12 and Misc

### SDS Demolition Hammer

- 14 Amp motor
- Heavy-duty construction
- Variable-speed dial
- AVS Anti-Vibration system
- Service reminder light
- Lock-on trigger
- Kit includes:
  - (1) 2" SDS Max Demo Hammer
  - (2) Auxiliary handle
  - (1) Carrying case



Part #	Mfg #	Description	Price
237268	5339-21	Kit	

### 1/2" Hole Hawg® Drill 900 RPM

- Powerful 7.5-amp motor: Delivers 900 RPM with reverse
- Selffeed bit capacity: Handles up to a 2-9/16"
- Reinforced nylon resin casing
- Kit Includes:
  - (1) 1/2" Hole Hawg® Drill 900RPM (1670-1)
  - (1) Pipe handle



Part #	Mfg #	Description	Price
224919	1670-1	Kit	

### 3/4" Large Drill, 350 RPM

- Powerful 10.0-amp motor. Delivers up to 350RPM with reverse
- Torque: Offers 3/4" capacity in steel
- Heat-treated gears: Helical-cut for quiet performance
- 8-ft fixed rubber cord
- Includes:
  - (1) 3/4" Large Drill (1854-1)
  - (1) Pipe Handle



Part #	Mfg #	Description	Price
151479	1854-1	1854-1 3/4" 120V 350RP Drill	

### 1/2" Magnum® Drill

- Motor: 120VAC 8A
- 360° Locking side handle
- Chuck key with holder
- 8' Cord



Part #	Mfg #	No Load RPM	Price
139067	0299-20	0 - 850	
184121	0300-20	0-850	

### Right Angle Drill Kits

#### 1/2" Reversing Right Angle Drill Kit

- 120VAC, 7.0A R.A.D.
- 1/2" Trigger speed control reversing
- Use with up to 4-5/8" self-feed bits
- Head and handle swivel 360°
- Allow 5-1/2" for right angle drill head and chuck
- Kit Includes:
  - Chuck key and rubber flex key holder
  - Right angle drive
  - 9/16" Open end wrench
  - 3/16" Socket wrench
  - Chuck remover bar
  - Side handle
  - Steel carrying case
  - 8' 3-Wire Quik-Lok® cord set



Part #	Mfg #	Kit Type	Drill RPM	Amps	Price
137799	3107-6	Variable	0-500	7.0	

### Super Hawg™ Drills

#### Super Hawg™ 1/2" Drill

- Clutch in low speed
- High operating speeds for maximum productivity
- 90° Left-right, Roto-Lok® handle
- Comfort grip switch handle and gear case with front T-bar handle
- Includes side handle
- 1680-21 Includes carrying case
- 5-Year warranty



Part #	Mfg #	No Load RPM	Steel Capacity	Price
148643	1680-20	450/1,750	1/2"	
137572	1680-21	450/1,750	1/2"	



## Power Tools - M12 and Misc

### Hole-Hawg®

#### Hole-Hawg® Drill

- 120VAC, 7.5A
- Compact design
- Triple reduction gearing
- 2-Position pipe handle
- 3-Position spade handle
- 2-Speed gear shift
- External brush caps
- Includes steel carrying case



Part #	Mfg #	No Load RPM	Price
144516	1676-6	300/1,200	

### Miter Saws

#### Dual-Bevel Sliding Compound Miter Saw

- Angle digital readout
- Angle fine adjust w/ detent override
- Dual integral jobsite lights
- Powerful 15.0 amp, 3.3 Max HP direct drive motor
- Constant Power Technology with Soft Start
- Integral dust channel
- Dual horizontal steel railers
- Oversized single lever bevel adjustment



Part #	Mfg #	Description	Price
242515	6955-20	12", Bare Tool	

### Circular Saws

#### TILT-LOK™ 7-1/4" Circular Saw with Case

- New exclusive TILT-LOK™ main handle adjusts to the work or most comfortable work position
- 10.4 pounds net weight
- 15 amp, 3.25 peak horsepower
- Wide, clear sight line
- Kit Includes:
  - (1) TILT-LOK™ 7-1/4" Circular Saw with case (6390-21)
  - (1) Blade wrench
  - (1) Carrying case
  - (1) Circular saw blade



Part #	Mfg #	Description	Price
154578	6390-21	Kit	

### 8" Metal Cutting Saw Kit

- Dry-cut technology
- Durable blade shields with integral chiptank deflects/collects hot chips and sparks
- Plunge lever for fast, effective plunge cuts
- Exclusive quick-release shield latch
- 2-9/16 in cut depth for one-pass cuts through most common materials
- Powerful 13.0 amp, 3,700 rpm motor
- Premium cement-tipped blades cut faster, cleaner, and longer than other carbide-tipped or friction blades



Part #	Mfg #	Description	Price
243054	6370-20	Bare Tool	
161013	6370-21	Kit	

### Sawzall® Reciprocating Saws

#### 15 Amp Super Sawzall® Reciprocating Saw

- Constant Power Technology™
- Gear Protecting Clutch
- Counter Balanced Mechanism
- Variable Speed trigger and drill speed control
- Quick-Lok™ blade clamp system
- Includes carrying case



Part #	Mfg #	Length of Stroke	Strokes Per Minute	Price
227013	6538-21	1-1/4"	0-2,800	

#### 13 Amp Orbital Super Sawzall® with Case

- Orbital cutting action
- Variable speed trigger
- Quik-Lok™ blade clamp
- 8' Cord
- 5-Year warranty



Part #	Mfg #	Length of Stroke	Strokes Per Minute	Price
148168	6536-21	1-1/4"	0 - 3,000	

## Power Tools - M12 and Misc

### 12 Amp Sawzall® Reciprocating Saw

- Quik-Lok™ blade clamp
- Gear protecting clutch
- Counter weighted mechanism
- Includes:
  - (1) Sawzall® Recip Saw
  - Carrying case



Part #	Mfg #	Length of Stroke	Strokes Per Minute	Price
137571	6509-31	3/4"	0 - 3,000	
219154	6519-31	1-1/8"	0-3,000	

### 360° Rotating Handle Orbital Super Sawzall® Reciprocating Saw

- 360° Rotating handle
- 13 Amp Milwaukee built motor
- Orbital cutting action
- Variable speed trigger, 0-3000 SPM
- 1-1/4in stroke
- Counter balanced/gear protection systems
- Speed dial
- QUIK-LOK™ blade clamp
- QUIK-LOK® cord
- Includes:
  - (1) 360° Rotating handle orbital super Sawzall® recip saw (6523-21)
  - (1) Carrying case



Part #	Mfg #	Description	Price
154278	6523-21	Kit	

## Band Saws

### M12™ Sub-Compact Band Saw

- One-Handed Cuts
- Cuts 3/4" EMT in 3 seconds  
1-5/8" Cut Capacity
- LED Light
- Blade tension adjustment
- Kit Includes:
  - (1) 18 TPI Sub-Compact Band Saw Blade
  - (1) M12™ Sub-Compact Band Saw (Bare Tool) (2429-20)
  - (1) M12™ XC High Capacity REDLITHIUM™ Battery (48-11-2402)
  - (1) M12™ Lithium-ion Battery Charger (48-59-2401)
  - (1) Carrying Case



Part #	Mfg #	Description	Price
172509	2429-20	Bare Tool	

### Band Saws (Continued)

#### M12™ Sub-Compact Band Saw

Part #	Mfg #	Description	Price
150209	2429-21X C	Kit	

#### Compact Band Saw

- 120VAC
- 7.0A Motor, 3-wire, 8' cord
- LED Work light
- Blade ejection system
- Drop-resistant pulley guard
- Cast aluminum gear case
- Adjustable material guide
- Maximum rectangular capacity: 3-1/4" x 3-1/4"
- Maximum round capacity: 3-1/4"
- Kit Includes:
  - Band saw
  - Case



Part #	Mfg #	No Load SFPM	Price
142295	6242-6	200 - 300	

#### Deep Cut Variable Speed Band Saw

- Powerful 11 amp motor w/ CPT™
- All metal direct drive
- LED Light
- Job Site Armor™ technology
- Gear protecting clutch
- Revolutionary cut visibility
- Tool-free locking adjustable shoe
- Debris protection system
- Kit includes:
  - (1) Deep Cut Variable Speed Band Saw (6232-20)
  - (1) Carrying Case



Part #	Mfg #	Description	Price
138406	6232-20	Bare Tool	
151865	6232-21	Kit	

## Power Tools - M12 and Misc

### Jig Saws

#### M12™ High Performance Jig Saw

- 3/4" Stroke length & 0-2,800 SPM
- Hybrid Grip™
- LED Light and fuel gauge
- Quik-Lok™ T-Shank blade clamp and tool-free 450 bevel capability with positive lock at 900
- Kit includes:
  - (1) M12™ High Performance Jig Saw (Tool Only) (2445-20)
  - (1) M12™ Lithium-ion battery charger (48-59-2401)
  - (1) M12™ REDLITHIUM™ CP1.5 Battery pack (48-11-2401)
  - (1) Contractor bag



Part #	Mfg #	Description	Price
230116	2445-20	Bare Tool	
148167	2445-21	Kit	

### Abrasive Cut-Off Machines

#### 14" Abrasive Cut-Off Machine

- Cuts up to 5" pipe
- Oversized wheel guards
- Miter capacity: 45° with adjustable fence
- Large spindle lock button
- Kit Includes:
  - Vise
  - Abrasive wheel
  - Hex wrench



Part #	Mfg #	Description	Price
142284	6177-20	120VAC/DC, 15 Amps	

#### 14" Hand Held Cut-Off Machine

- Powerful 15-amp, 4.8 maximum horsepower motor
- 20-amp overload protection switch
- Downward cutting rotation
- Externally accessible brushes | and brush cutoff feature
- Kit Includes:
  - (1) 14" Abrasive Cut-Off Machine (6177-20)
  - (1) Abrasive Wheel
  - (1) Hex Wrench
  - (1) Vise



Part #	Mfg #	Description	Price
161844	6185-20	Kit	

### M12 FUEL™ 3" Compact Cut Off Tool

- 20,000 RPM for fast and accurate cutting performance
- REDLINK PLUS™ intelligence provides optimized performance and overload protection
- Reversible blade rotation
- LED light for improved visibility
- Compatible with common 3" cut off wheels with 3/8" arbor
- Tool includes:
  - (1) M12 FUEL™ 3" Compact Cut Off Tool (2522-20)
  - (1) 3" Carbide Abrasive Blade (49-94-3005)
  - (1) 3" Diamond Tile Blade (49-94-3010)
  - (1) Blade Wrench
  - (1) Metal Cut Off Wheel
  - (1) 7/16" Flange Adapter
  - (1) Shoe Guard
- Kit also includes:
  - (1) M12™ REDLITHIUM™ XC 4.0 Extended Capacity Battery Pack (48-11-2440)
  - (1) M12™ Lithium-ion Battery Charger (48-59-2401)



Part #	Mfg #	Description	Price
251833	2522-20	Bare Tool	
251834	2522-21X	Kit	
	C		

### Sanders

#### 5" Random Orbit Palm Sander

- 3 Amp permanent magnet motor
- Variable speed dial
- Kit Includes:
  - (1) 5" Random Orbit Palm Sander (6034-21)
  - (2) 80 Grit Sandpaper
  - (1) Plastic Dust Canister
  - (1) Universal Vac Hose Adapter
  - (1) Contractor Bag



Part #	Mfg #	Description	Price
231354	6034-21	Kit	

## Power Tools - M12 and Misc

### 1/4-Sheet Palm Sander

- 3.0 Amp permanent magnet motor with 14,000 orbits per minute
- Fits 1-1/4" or 2-1/4" hoses for efficient dust removal
- Ergonomic design
- Includes:
  - (1) 1/4-Sheet Palm Sander (6033-21)
  - (1) Plastic Dust Canister
  - (1) Paper Punch
  - (1) 150 Grit Sandpaper
  - (1) 100 Grit Sandpaper



Part #	Mfg #	Description	Price
187918	6033-21	1/4 Sheet Sander	

### 3.5 Max HP Sander

- 7" / 9"
- 6000 RPM



Part #	Mfg #	Speed RPM	Disc Dia	Price
237737	6066-6	6,000	7" / 9"	

### M12™ Variable Speed Polisher/Sander

- Variable speed trigger
- 5-Pc Accessory pack
  - 3" Polishing backing pad
  - 2" Sanding backing pad
  - Wool pad
  - Yellow foam pad
  - White foam pad



2438-22X

Part #	Mfg #	Description	Price
229843	2438-22X	Kit	

### Grinders

#### 11 AMP 4-1/2" Small Angle Grinder Paddle, Lock-On

- Powerful 11 AMP, 11,000 RPM motor
- Overload Protection
- Electronic Clutch
- Tool-Free accessory change
- Tool-Free adjustable guard
- Advanced airflow system
- Debris baffles



- Includes:
  - (1) 11 Amp 4-1/2" small angle grinder paddle, lock-on (6146-30)
  - (1) Contractor bag
  - (1) Flange
  - (1) Grinding wheel
  - (1) Side handle
  - (1) Spanner wrench
  - (1) Type 27 guard

Part #	Mfg #	Description	Price
240167	6141-30	Kit	
158930	6146-30	Kit	

#### 11 Amp Corded 4-1/2 in. Small Angle Grinder Paddle No-lock

- Powerful 11 Amp, 11,000 RPM motor
- Tool-free adjustable guard
- Debris baffles
- Tool-free accessory change
- Advanced airflow system



- Includes:
  - (1) 11 Amp Corded 4-1/2 in. Small Angle Grinder Paddle Lock-On (6141-30)
  - (1) Type 27 Guard
  - (1) Spanner Wrench
  - (1) Side Handle
  - (1) Flanges

Part #	Mfg #	Description	Price
248388	6142-31	Kit	



## Power Tools - M12 and Misc

### 7 AMP 4-1/2" Small Angle Grinder

- Compact, Lightweight Design: At 10.2" long and 3.5 lbs
- Debris Baffles- protect internal components by deflecting damaging debris out of the airflow at the intake vents
- Multi-Port Exhaust-reduces motor burn-up
- Tool Free, Burst Resistant Guard



Part #	Mfg #	Description	Price
150013	6130-33	7 AMP 750 MWO Motor	

### M28™ Cordless Grinder / Cut-Off Tool

- 28V motor delivers 8000 RPM no load speed
- Tool free guard
- Fuel gauge
- Overload protection
- Large spindle lock
- Slide on switch



Part #	Mfg #	Description	Price
256259	0725-20	Bare Tool	

### Misc. Tools

#### M12™ HAMMERVAC Universal Dust Extractor

- Auto-on mode allows extractor to turn it on and off
- Provides filtration up to 160 holes on a single charge
- Part of the M12 System, featuring over 70 tools
- Universal handle system- compatible with most SDS plus rotary hammers and some AC and DC hammer drills
- Self-powered by M12 red lithium battery pack
- Replaceable HEPA filter-highest quality debris filtration and lowest cost of ownership



Part #	Mfg #	Description	Price
172810	2306-20	Bare Tool	
186658	2306-22	Kit	

#### Accessories

Part #	Mfg #	Description	Price
241576	49-90-230	M12™ HAMMERVAC™ Dust Extractor Nozzle	
	1		

### 8 Gallon Dust Extractor

- 2 Step filtration system
- On-board tool activated plug
- Quiet operation: 69dB
- Suction control dial
- 13 Ft Anti-static hose
- Large wheels, locking swivel casters for jobsite durability
- Water level float valve shuts off suction when tank is full



Part #	Mfg #	Description	Price
242452	8960-20	Bare Tool	

#### Accessories

Part #	Mfg #	Description	Price
249514	49-90-195	Main Filter	
	3		

### Diamond Coring Rig w/ Large Base Stand, Vac-U-Rig® Kit, Meter Box and Diamond Coring Motor

- Kit Includes:
  - Diamond coring large base stand
  - Diamond coring motor
  - Large base stand
  - Vac-U-Rig® kit
  - Diamond coring rig
  - Meter box



Part #	Mfg #	Description	Price
244274	4120-22	Kit	

### Vacuum Pump Assembly

- 1/3 max HP
- Recommended for use with 49-22-7100 pad only



Part #	Mfg #	Description	Price
255320	49-50-020	Bare Tool	
	0		

## Power Tools - M12 and Misc

### 1 Ton Electric Chain Hoist

- 1 ton rated load,
- 10 ft. lift height
- 16 ft./min. lifting speed
- 115/230 voltage (AC), 16.0 amps at low voltage
- Built-in, multiple-disc, magnetic brake
- Adjustable upper and lower limit switches



Part #	Mfg #	Description	Price
253643	9568	Chain Hoist	

### 2 Ton Electric Chain Hoist

- 2 Ton rated load
- 10 ft. lift height
- 8 ft./min. lifting speed
- Single-phase, 115/230 voltage (AC), 16.0 amps at low voltage
- Built-in, multiple-disc, magnetic brake
- Adjustable upper and lower limit switches



Part #	Mfg #	Description	Price
253644	9573	Chain Hoist	

### Fixed-Base Production Router

- 15 Amps
- 8' Fixed cord
- 120V AC
- Double insulated
- 36-Position speed dial
- 10,000-22,000 No load rpm
- Kit includes:
  - 1/2" Collet
  - 2-1/2" Sub-base
  - 1-1/8" Collet wrenches
  - T-handle wrench



Part #	Mfg #	Description	Price
241914	5625-20	3-1/2" MAX HP	

### Milner Saw Stand

- Material supports with steel rollers extend to 9.5' for maximum work piece support
- 550 lbs table area weight capacity
- Rubber wheels for max portability
- Adjustable leg provides stability on uneven surfaces
- Collapsible legs for compact storage



Part #	Mfg #	Description	Price
227452	48-08-055	55"(119" Fully Extended) x 39-1/2"H	
	0		

### Folding Miter Saw Stand

- Mounting brackets work with all brands of miter saws
- Light weight aluminum construction for easy portability
- Compact folding design for easy storage
- Supports up to 500 lbs off main beam
- Adjustable foot for leveling on uneven surfaces
- Extends to a maximum of 100" to pieces
- Quick and easy adjustments for fast setup and tear down



Part #	Mfg #	Description	Price
239095	48-08-055	43-1/2"-100"L x 27"W x 32"H	
	1		

### Folding Table Saw Stand

- Adjustable foot for cutting on uneven surfaces
- Compact design for easy storage
- Quick attach latching system
- Only 15 lbs
- All steel construction



Part #	Mfg #	Description	Price
248729	48-08-056	17-3/4"L x 23"W x 20-1/2"H	
	1		

### 14 Gauge Shear

- 5 amps, 4,000 SPM
- Clear unobstructed visibility
- Cuts close curves either left or right
- Blade design eliminates jamming



Part #	Mfg #	Description	Price
176044	6815	14 Gauge Shear	



## Power Tools - M12 and Misc

### 10 Gauge Nibbler

- 4.0 amp, 1,000 SPM
- Cuts up to 8.75ft per minute
- 1.65 in. starting hole required
- AC-DC toggle switch allows for two-handed operation



Part #	Mfg #	Description	Price
176046	6880	10 Gauge Nibbler	

### M12™ TRAPSSNAKE™ Toilet Auger

- 6'
- Kit includes:
  - (1) M12™ TRAPSSNAKE™ 6' Toilet Auger (Tool Only) (2576-20)
  - (1) M12™ REDLITHIUM™ Battery (48-11-2401)
  - (1) M12™ Lithium-ion Battery Charger (48-59-2401)



Part #	Mfg #	Description	Price
230879	2576-20	Bare Tool	
230877	2576-21	Kit	

### M12™ TRAPSSNAKE™ 2-Tool Combo Kit

- Kit includes:
  - (1) M12™ TRAPSSNAKE™ 4' Urinal Auger (Tool Only) (2574-20)
  - (1) M12™ TRAPSSNAKE™ 6' Toilet Auger (Tool Only) (2576-20)
  - (1) M12™ REDLITHIUM™ Battery (48-11-2401)
  - (1) M12™ Lithium-ion Battery Charger (48-59-2401)



Part #	Mfg #	Description	Price
230883	2577-21	Kit	

### M12™ TRAPSSNAKE™ Urinal Auger

- Maneuvers traps faster and protects porcelain, compatible with all TRAPSSNAKE™ Augers
- Fixed rubber boot: Prevents porcelain scratches throughout the life of the tool
- Integrated locking mechanism which holds the cable in place for easy telescoping extension and retraction



Part #	Mfg #	Description	Price
230882	2574-20	Bare Tool	
230881	2574-21	Kit	

### TRAPSSNAKE™ Accessories

Part #	Mfg #	Description	Price
230888	48-53-257 7	4' Urinal Auger Replacement Cable	

### M12 AIRSSNAKE™ Drain Cleaning Air Gun Kit

- Up to 50 PSI
- 25+ pressure cycles
- Includes:
  - (3) Drain plug attachments
  - Straight connector
  - 15° offset connector
  - Carrying case
  - Drain shroud attachment
  - M12 Lithium-ion battery charger
  - M12 REDLITHIUM™ battery pack



Part #	Mfg #	Description	Price
238926	2572A-21	12V	
240438	2572B-21	12V	

### Airsnake™ Accessories

Part #	Mfg #	Description	Price
242106	48-53-257 0	10" Extension	

## Power Tools - M12 and Misc

### M12™ Drain Snake Kit

- 1) M12™ Drain Snake (2571-20)
- (1) 5/16"X25' BULB CABLE W/DRUM (48-53-2581)
- (1) 5 Gallon Storage Bucket
- (1) M12™ REDLITHIUM™ Battery (48-11-2401)
- (1) M12™ Lithium-ion Battery Charger (48-59-2401)



Part #	Mfg #	Description	Price
188681	2571-20	Bare Tool	
188682	2571-21	25' of 1/4" or 5/16" Inner Core Cable	

### 1-Stage Wet/Dry Vacuum Cleaner

- 10 gal, 1-1/8 bu. recovery capacity, 8.0 amp motor
- Positive water shut-off
- Can be used as a blower
- One-stage bypass motor for wet/dry operation



Part #	Mfg #	Description	Price
176821	8955	1-Stage Wet/Dry Vacuum Cleaner	
142565	49-90-190	Filter, 8950,8955,8936-20, 8938-20	

### M12™ Compact Vacuum

- 33CFM for use on wide range of materials
- Up to 29 minutes\* on a single charge using REDLITHIUM™ XC4.0 batteries
- Versatile attachments
- Clear viewing window
- Reusable 42 pleat filter
- Lock-on switch reduces



Part #	Mfg #	Description	Price
173344	0850-20	Bare Tool	
178389	49-90-195	Vacuum Filter	

### M4™ 1/4" Hex Screwdriver

- 21-Position clutch setting with auto shut-off
- 2-Speed gearbox: 200/600 RPM
- 44 Inch-pounds of torque



### M4™ 1/4" Hex Screwdriver Kit

- Includes:
  - (1) M4™ 1/4" Hex Screwdriver (Tool Only) (2101-20)
  - (1) M4™ Charger (48-59-2001)
  - (1) M4™ 2.0 Battery (48-11-2001)

Part #	Mfg #	Description	Price
222007	2101-21	Kit	

### M4™ 1/4" Hex Screwdriver Kit (2 batteries)

- Includes:
  - (1) M4™ 1/4" Hex Screwdriver (Tool Only) (2101-20)
  - (1) M4™ Charger (48-59-2001)
  - (2) M4™ 2.0 Battery (48-11-2001)

Part #	Mfg #	Description	Price
240422	2101-22	Kit	

## Temperature Guns

### Infrared Laser TEMP-GUN™ Thermometer Kit

- Basic accuracy: 1.50%
- Distance to spot: 12 to 1
- Includes:
  - Laser TEMP-GUN™ thermometer
  - (3) AA Alkaline batteries
  - K-Type thermocouple
  - Slide rail system
- 5-Year warranty



Part #	Mfg #	Temperature Range	Price
137568	2266-20	-20° to 932°F	
228847	2268-20	-22°F to 1022°F	

## Power Tools - M12 and Misc

### Laser TEMP-GUN™ M12™ Cordless Lithium-Ion Thermometer for HVAC/R

- Infrared surface temperature measurement from -22 to 1472° F (-30 to 800° C)
- Contact surface temperature measurement from -40 to 1022° F (-40 to 550° C)
- 40:1 Distance to spot ratio
- Measure ambient humidity and dew point
- Adjustable emissivity from 0.10 to 1.00 for increased accuracy
- Unit memory stores up to 20 temperature values



Part #	Mfg #	Temperature Range	Price
180839	2277-20	-22 to 1472° F	

### M12™ Infrared Temp-Gun™

- 12:1 distance-to-spot ratio
- 6' Drop test
- Trigger lock
- Laser on/off
- 0.95 Fixed emissivity
- Premium LCD display
- Fully bumpered nose
- High/Low temperature alert
- Hold, max, min, avg, diff modes
- M12™ 12V Lithium-ion battery
- Clear button functions with rubber overmolded grip



Part #	Mfg #	Surface Temperature	Price
223515	2278-20	-22°F to 1022°F	

### Spot Infrared Imager

- Measurements from long range or up close with 56:1 distance-to-spot performance
- Powered by standard 9V Alkaline battery
- DUAL SENSE™ pixels are ultra-responsive
- Ironbow color palette allows easy differentiation between hot and cold areas
- Toggle between °F and °C measurements with switch in the battery compartment



Part #	Mfg #	Surface Temperature	Price
240565	2257-20	14°F - 626°F	

### M12™ 102 X77 Infrared Camera

- 7,854 (102 x 77) pixel resolution captures highest resolution image in it's class
- DUAL SENSE™ pixels are ultra-responsive, adjusting individually to eliminate blurring of hot and cold details
- Measure surface temperatures 14°F to 626°F degrees for images spanning wide ranges
- 2-Stage trigger activates lasers for easy scanning or quickly captures images
- Dual lasers frame on-screen temperature area
- Multiple color palettes available: rainbow, grayscale and ironbow
- Automatically locates highest and lowest temperatures
- Fully compatible with Milwaukee® thermal imager reporting software available at Milwaukeeeetool.com
- Compatible with over 70+ M12™ tools



Part #	Mfg #	Description	Price
185579	2258-21	102 X 77 Infrared Camera	

### Heat Guns

#### Variable Temperature Heat Gun

- Variable temperature 100 to 1,040°F, 11.6 amp tool
- Unique impact resistant heating element
- Dial control to select temperature



Part #	Mfg #	Description	Price
257726	8977-20	Heat Gun	

#### Dual Temperature Heat Gun

- Dual temperature 570 and 1000 degrees F, 11.6 amp motor
- Unique impact resistant heating element
- Three position rock switch - off, high and low



Part #	Mfg #	Description	Price
161906	8975-6	Heat Gun	



## Power Tools - M12 and Misc

### Heat Gun Accessory Assortment

- Use with any Milwaukee Heat Gun
- Includes
  - 49-80-0292 Hook Nozzle
  - 49-80-0293 Deflector Nozzle
  - 49-80-0294 Air Spreader Nozzle
  - 49-80-0297 Air Reduction Nozzle



Part #	Mfg #	Description	Price
253861	49-80-030	Heat Gun Accessories	0

## Power Tools

### M18™ Cordless Drills

#### M18™ Cordless Right Angle Drill

- No load speed: 0 to 1550 rpm
- Torque: 125 in-lbs
- Chuck type: 3/8" single sleeve ratcheting
- Includes:
  - M18™ Right angle drill (2615-20)
  - M18™ REDLITHIUM™ XC High capacity battery
  - 1-Hour charger
  - Carrying case



Part #	Mfg #	Description	Price
162304	2615-20	Bare Tool	
142940	2615-21	Kit	

#### Kit Includes:

- (1) M18™ Cordless Right Angle Drill (Tool Only) (2615-20)
- (1) M18™ & M12™ Multi-voltage charger (48-59-1812)
- (1) M18™ Compact REDLITHIUM™ battery (48-11-1815)
- (1) Carrying case

Part #	Mfg #	Description	Price
257846	2615-21CT	Kit	

#### M18™ Cordless 2-Speed 1/4" Right Angle Impact Driver

- No Load RPM:
  - 0-1,500 (mode 1) 0-2,250 (mode 2)
- 2-Speed Drive-Control™
- 1/4" hex drive with 1" bit acceptance
- Extended paddle switch for multiple grip options



Part #	Mfg #	Description	Price
180431	2667-20	Bare Tool	

#### M18™ 1/2" High Performance Hammer/Drill Driver

- 4-Pole frameless motor
- 1/2" Single-sleeve ratcheting metal chuck with carbide jaws
- Battery fuel gauge displays remaining run-time
- Built-in LED light illuminates work sur
- Variable speed trigger
- No load speed: 0 to 1,800 rpm
- No load BPM: 0 to 28,000 BPM
- Includes:
  - (2) M18™ 18V XC Lithium-Ion batteries
  - 18V Charger
  - Side handle
  - Carrying case
- 5-Year warranty



Part #	Mfg #	Description	Price
139122	2611-24	650 in-lbs Torque	

#### M18™ Compact Drill Driver

- Built-in LED light
- 18V DC
- No load speed: 350 to 1,400 rpm
- Torque: 425 in-lbs
- Kit includes:
  - M18™ Compact drill driver (2601-20)
  - (2) 18V Lithium-Ion batteries
  - 18V Lithium-Ion charger
  - 1/2" 3-Jaw keyless chuck
- 5-Year warranty



Part #	Mfg #	Description	Price
137559	2601-22	Kit	



## Power Tools

### M18™ Compact 1/2" Drill Driver

- Milwaukee® 4-pole frameless motor
- All-Metal gear case and chuck
- Compact design
- REDLINK™ intelligence



- Kit includes:
  - (1) M18™ Compact 1/2" Drill Driver (Tool Only) (2606-20)
  - (1) M18™ & M12™ Multi-voltage charger (48-59-1812)
  - (2) M18™ Compact REDLITHIUM™ battery (48-11-1815)
  - (1) Carrying case

Part #	Mfg #	Description	Price
188021	2606-20	Bare Tool	
253217	2606-21CT	Kit	

### M18 Compact Brushless 1/2" Drill Driver

- Milwaukee brushless motor
- Compact design
- REDLINK™ intelligence
- Belt clip
- All-metal gear case and 1/2 in. metal chuck



- Kit includes:
  - (1) M18 Compact Brushless 1/2" Drill Driver Bare Tool (2801-20)
  - (2) M18™ REDLITHIUM™ CP2.0 battery (48-11-1820)
  - (1) M18™ & M12™ Multi-voltage charger (48-59-1812)
  - (1) Carrying case

Part #	Mfg #	Description	Price
251013	2801-20	Bare Tool	
251014	2801-22CT	Kit	

### M18™ FUEL™ 1/2" Drill/Driver

- POWERSTATE™ Brushless motor
- REDLINK PLUS™ Intelligence



- Kit Includes:
  - (1) M18 FUEL™ 1/2" Drill/Driver (Bare Tool) (2703-20)
  - (2) M18™ REDLITHIUM™ XC5.0 Extended Capacity Battery Pack (48-11-1850)
  - (1) M18™ & M12™ Multi-Voltage Charger (48-59-1812)
  - (1) Belt Clip
  - (1) Bit Holder
  - (1) Side Handle
  - (1) Carrying Case

Part #	Mfg #	Description	Price
179571	2703-20	Bare Tool	
179572	2703-22	Kit	

### M18™ FUEL™ 1/2" Drill Driver

- Up To 60% More Power: 1,200 in-lbs of torque
- LED on foot of tool for better lighting in dark spaces
- POWERSTATE™ Brushless Motor
- REDLINK PLUS™ Intelligence
- Kit includes:
  - (1) M18 FUEL™ 1/2" Drill Driver (Tool Only) (2803-20)
  - (2) M18™ REDLITHIUM™ XC5.0 Extended Capacity Battery Pack (48-11-1850)
  - (1) M18™ & M12™ Multi-Voltage Charger (48-59-1812)
  - (1) Carrying Case
  - (1) Side Handle
  - (1) Belt Clip
  - (1) Bit Holder



Part #	Mfg #	Description	Price
248755	2803-20	Bare Tool	
248756	2803-22	Kit	

### M18 FUEL™ 1/2" Drill/Driver w/ ONE-KEY™

- POWERSTATE™ Brushless motor
- Anti-kickback technology
- REDLINK PLUS™ Intelligence
- ONE-KEY™ Compatible
- Up To 60% more power: 1,200 in-lbs of torque
- LED on foot of tool for better lighting in dark spaces
- Kit includes:
  - (1) M18 FUEL™ 1/2" Drill/Driver w/ ONE-KEY™ (2805-20)
  - (2) M18™ REDLITHIUM™ XC5.0 Extended Capacity Battery Pack (48-11-1850)
  - (1) Belt Clip
  - (1) Bit Holder
  - (1) Side Handle



Part #	Mfg #	Description	Price
254436	2805-20	Bare Tool	
254437	2805-22	Kit	



## Power Tools

### M18™ FUEL™ 1/2" Hammer Drill/Driver

- Up To 60% More Power: 1,200 in-lbs of torque
- LED on foot of tool for better lighting in dark spaces
- POWERSTATE™ Brushless motor
- REDLINK PLUS™ Intelligence
- Kit includes:
  - (1) M18 FUEL™ 1/2" Hammer Drill/Driver (Tool Only) (2804-20)
  - (2) M18™ REDLITHIUM™ XC5.0 Extended capacity battery pack (48-11-1850)
  - (1) M18™ & M12™ Multi-voltage charger (48-59-1812)
  - (1) Belt clip
  - (1) Bit holder
  - (1) Carrying case
  - (1) Side handle



Part #	Mfg #	Description	Price
248757	2804-20	Bare Tool	
248759	2804-22	Kit	

### M18 FUEL™ 1/2" Hammer Drill w/ ONE-KEY™

- Up To 60% more power: 1,200 in-lbs of torque
- LED on foot of tool for better lighting in dark spaces
- REDLINK PLUS™ Intelligence
- ONE-KEY™ Compatible
- Kit includes:
  - (1) M18 FUEL™ 1/2" Hammer Drill w/ ONE-KEY™ (2806-20)
  - (2) M18™ REDLITHIUM™ XC5.0 Extended capacity battery pack (48-11-1850)
  - (1) M18™ & M12™ Multi-voltage charger (48-59-1812)
  - (1) Belt clip
  - (1) Bit holder
  - (1) Side handle



Part #	Mfg #	Description	Price
254438	2806-20	Bare Tool	
254439	2806-22	Kit	

### M18™ FUEL™ HOLE HAWG® 1/2" Right Angle Drill

- POWERSTATE™ Brushless motor
- All-metal keyed chuck
- On-board chuck key holder
- Kit Includes:
  - (1) M18 FUEL™ HOLE HAWG® 1/2" right angle drill (Tool Only) (2707-20)
  - (1) Contractor bag
  - (1) Chuck key
  - (2) M18™ REDLITHIUM™ XC5.0 extended capacity battery pack (48-11-1850)
  - (-22 Model) - (1) Multi-voltage charger (48-59-1812)
  - (-22HD Model)- (1) Rapid charger (48-59-1808)



Part #	Mfg #	Description	Price
170226	2707-20	Bare Tool	
170227	2707-22	Kit	
234423	2707-22HD	High Demand Kit	

### M18™ FUEL™ Hole Hawg™ Right Angle Drill with QUIK-LOK™

- POWERSTATE™ brushless motor
- REDLINK™ PLUS
- Kit Includes:
  - M18™ FUEL™ 1/2" Right angle drill
  - M18™ REDLITHIUM™ battery pack
  - M18™&M12™ multi-voltage charger
  - Contractor bag



Part #	Mfg #	Description	Price
171055	2708-20	Bare Tool	
171056	2708-22	Kit	

#### High Demand

Part #	Mfg #	Description	Price
227455	2708-22HD	Kit	



## Power Tools

### M18™ FUEL™ Super Hawg™ 1/2" Right Angle Drill Kit

- POWERSTATE™ brushless motor
- REDLINK™ PLUS intelligence ensures optimal performance and overload protection
- Kit Includes:
  - M18™ FUEL™ 1/2" Right Angle Drill
  - M18™ REDLITHIUM™ battery pack (-HD models: REDLITHIUM™ HIGH DEMAND™ battery)
  - M18™&M12™ rapid charger
  - Chuck key
  - Side handle
  - Contractor bag



Part #	Mfg #	Description	Price
181106	2709-20	Bare Tool	
181107	2709-22	Kit	
230567	2709-22HD	High Demand Kit	

### M18™ FUEL™ Super Hawg™ Right Angle Drill with Quick-Lok™

- POWERSTATE™ Brushless motor
- REDLINK™ PLUS Intelligence
- Includes:
  - (1) (Bare Tool) (2711-20)
  - (2) 9.0 Battery Pack (48-11-1890)
  - (1) Rapid Charger (48-59-1808)
  - (1) Side Handle
  - (1) Contractor Bag



Part #	Mfg #	Description	Price
181108	2711-20	Bare Tool	
226174	2711-22HD	Kit, Heavy Duty	
181109	2711-22	Kit	

### M18™ Compact 1/2" Hammer Drill/Driver

- 4-Pole Frameless Motor: Features a robust design combined with rare-earth magnets for longer life, best-in-class 500 in-lbs of torque and 0-400/0-
- All-Metal gear case and chuck
- REDLINK™ Intelligence



Part #	Mfg #	Description	Price
170819	2607-20	Bare Tool	

### M18™ Cordless Drills (Continued)

#### M18™ Compact 1/2" Hammer Drill/Driver

Part #	Mfg #	Description	Price
166993	2607-22	Kit	

#### M18™ Compact Hammer Drill Driver

- 4-Pole frameless motor
- 1/2" Single-sleeve ratcheting metal chuck
- Variable speed trigger
- No load speed: 0 to 1,700 rpm
- No load BPM: 0 to 29,000 BPM
- Torque: 550 in-lbs
- Kit includes:
  - M18™ Hammer-drill driver (2602-22)
  - (2) 18V XC Lithium-Ion batteries
  - 1-Hour 18V charger
  - Carrying case
- 5-Year warranty



Part #	Mfg #	Description	Price
143056	2602-20	Bare Tool	
137560	2602-22	Kit	

#### M18™ FUEL™ 1/2" Hammer Drill/Driver Kit

- 2-Speed Powerstate™ brushless motor
- Redlink PLUS™ Intelligence system communications with overload protection
- No load speed: 0 to 500/0 to 1850 rpm
- Kit Includes:
  - 1/2" Drill/driver
  - (2) 18V Compact REDLITHIUM™ batteries
  - Multi-voltage charger
  - Locking chuck
  - LED Light
- 5-Year warranty



Part #	Mfg #	Description	Price
179573	2704-20	Bare Tool	
179574	2704-22	Kit	

## Power Tools

### M18™ FUEL™ 1-9/16" SDS Max Hammer Drill

- POWERSTATE™ brushless motor
- REDLITHIUM™ battery pack
- REDLINK PLUS™ intelligence



Part #	Mfg #	Description	Price
226124	2717-20	Bare Tool	
226125	2717-21HD	Kit	
226126	2717-22HD	Kit	

### M18™ FUEL™ with ONE-KEY™ 1/2" Hammer Drill/Driver Kit

- Kit includes:
  - (1) M18 FUEL™ with ONE-KEY™ 1/2" Hammer Drill/Driver (Tool Only) (2706-20)
  - (2) M18™ REDLITHIUM™ XC5.0 Extended Capacity Battery Pack (48-11-1850)
  - (1) M18™ & M12™ Multi-Voltage Charger (48-59-1812)
  - (1) Belt Clip
  - (1) Bit Holder
  - (1) Side Handle
  - (1) Carrying Case



Part #	Mfg #	Description	Price
223514	2706-20	Bare Tool	
230428	2706-22	Kit	

### M18™ 1/4" Hex Compact Impact Driver

- 1/4" Hex quick change chuck
- 4-Pole frameless motor
- Battery fuel gauge displays remaining run-time
- No load speed: 0 to 2,200 rpm
- No load IPM: 0 to 3,200 IPM
- Variable speed trigger
- Built-in LED light illuminates work surface
- 18V
- Includes:
  - M18™ Impact driver (2650-20)
  - (2) M18™ REDLITHIUM™ XC high capacity batteries
  - Battery charger
  - Belt clip
  - Carrying case
- 5-Year warranty



Part #	Mfg #	Description	Price
144367	2650-20	Bare Tool	
137562	2650-22	Kit	

### M18™ 1/4" Hex Impact Driver

- Milwaukee® 4-Pole frameless motor
- Delivers maximum power and application speed for greater efficiency on the job
- REDLINK™ Intelligence
- 2-Mode DRIVE CONTROL™
- 1/4" Hex quick- connect chuck
- REDLITHIUM™ Battery
- Kit Includes:
  - (1) M18 2-Speed 1/4" hex impact driver (Bare tool)
  - (2) M18™ Compact REDLITHIUM™ battery (48-11-1815)
  - (1) M18™ & M12™ Multi-voltage charger (48-59-1812)
  - (1) Belt clip
  - (1) Carrying case



Part #	Mfg #	Description	Price
164016	2657-20	Bare Tool (2-Speed)	
179431	2656-20	Bare Tool	



## Power Tools

### M18 1/4" Hex Impact Driver

- Compact design
- REDLINK™ Intelligence
- Milwaukee brushless motor
- RPM: 0-3,400
- IPM: 0-4,200
- Kit includes:
  - (1) M18 1/4" Hex Impact Driver Bare Tool (2850-20)
  - (2) M18™ REDLITHIUM™ CP2.0 battery (48-11-1820)
  - (1) M18™ & M12™ Multi-voltage charger (48-59-1812)
  - (1) Carrying case
  - (1) Belt clip



Part #	Mfg #	Description	Price
251015	2850-20	Bare Tool	
251016	2850-22CT	Kit	
251020	2851-20	Bare Tool (3-Speed)	

### M18 FUEL™ 1/4" Hex Impact Driver

- POWERSTATE™ Brushless motor
- Torque: 1,800 in-lbs
- 4-Mode DRIVE CONTROL™
- Kit includes:
  - M18 FUEL™ 1/4" Hex Impact Driver (Tool Only) (2753-20)
  - M18™ REDLITHIUM™ XC5.0 Extended capacity battery pack (48-11-1850)
  - M18™ & M12™ Multi-voltage charger (48-59-1812)



Part #	Mfg #	Description	Price
179575	2753-20	Bare Tool	
179576	2753-22	Kit	

### M18™ FUEL™ 1/4" Hex Impact Driver

- POWERSTATE™ Brushless motor
- Torque: 2,000 in-lbs
- 4-Mode drive control
- Self-tapping screw mode
- Single handed bit insertion
- LED light to illuminate work area
- Kit includes:
  - (1) M18 FUEL™ 1/4" Hex Impact Driver (Tool Only) (2853-20)
  - (2) M18™ REDLITHIUM™ XC5.0 extended capacity battery pack (48-11-1850)
  - (1) M18™ & M12™ Multi-voltage charger (48-59-1812)
  - (1) Belt clip
  - (1) Bit holder
  - (1) Carrying case



Part #	Mfg #	Description	Price
248760	2853-20	Bare Tool	
248762	2853-22	Kit	
248761	2853-22CT	Kit	

### M18 FUEL™ 1/4" Hex Impact Driver w/ ONE-KEY™

- POWERSTATE™ Brushless motor
- REDLINK PLUS™ Intelligence
- Torque: 2,000 in-lb
- ONE-KEY™ Compatible
- LED light
- Select between four custom drive control modes
- Kit includes:
  - (1) M18 FUEL™ 1/4" Hex Impact Driver w/ ONE-KEY™ XC Kit (2857-22)
  - (2) M18™ REDLITHIUM™ XC5.0 Extended Capacity Battery Pack (48-11-1850)
  - (1) M18™ & M12™ Multi-Voltage Charger (48-59-1812)
  - (1) Belt Clip
  - (1) Bit Holder
  - (1) Carrying Case
  - (1) Side Handle



Part #	Mfg #	Description	Price
254440	2857-20	Bare Tool	
254442	2857-22	Kit	
254441	2857-22CT	Kit	



## Power Tools

### M18™ 1/4" Hex Brushless Impact Driver

- Compact Design
- REDLINK™ Intelligence
- REDLITHIUM™ Battery

**Kit Includes:**

- (1) M18™ 1/4" Hex Brushless Impact Driver (2750-20)
- (1) M18™ & M12™ Multi-Voltage Charger (48-59-1812)
- (2) M18™ REDLITHIUM™ CP2.0 Battery Pack (48-11-1820)
- (1) Carrying Case

Part #	Mfg #	Description	Price
173942	2750-22CT	Kit	

### M18™ FUEL™ SURGE™ 1/4" Hex Hydraulic Driver

- Kit includes:
  - (1) 1/4" Hex Hydraulic Driver (Tool Only) (2760-20)
  - (2) M18™ REDLITHIUM™ XC5.0 (48-11-1850)
- (1) M18™ & M12™ Multi-Voltage Charger (48-59-1812)
- (1) Belt Clip
- (1) Bit Holder
- (1) Carrying Case



Part #	Mfg #	Description	Price
231122	2760-20	Bare Tool	
231123	2760-22	Kit	
248572	2760-22CT	Kit	

### M18™ FUEL™ High Torque 1/2" Impact Wrench w/ Pin Detent

- 8.1" in length
- Bolt removal mode
- REDLINK PLUS™ intelligence
- REDLITHIUM™ batteries
- Features a pin detent design for maximum socket retention
- Premium rubber overmold
- Reduced user fatigue at only 7.1lbs w/ battery
- LED light to illuminate the work area



Part #	Mfg #	Description	Price
245924	2766-22	Kit	

### M18™ FUEL™ 3/8" Compact Impact Wrench with Friction Ring Kit

- Kit Includes:
  - (1) M18 FUEL™ 3/8" Compact Impact Wrench w/ Friction Ring (Bare Tool) (2754-20)
  - (2) M18™ REDLITHIUM™ XC5.0 Ext Capacity Batteries(48-11-1850)
  - (1) M18™ & M12™ Multi-Voltage charger (48-59-1812)
  - (1) Belt Clip
  - (1) Carrying Case



Part #	Mfg #	Description	Price
222174	2754-20	Bare Tool	
181171	2754-20	Kit	

### With ONE-KEY™

Part #	Mfg #	Description	Price
245791	2758-22	Kit	

### M18™ 3/8" Impact Wrench Kit with Friction Ring

- 3/8" Anvil with friction ring
- Kit Includes:
  - (1) M18™ 3/8" Impact wrench with friction ring (bare tool) (2658-20)
  - (2) M18™ REDLITHIUM™ XC battery (48-11-1828)
  - (1) M18™ & M12™ Multi-voltage charger (48-59-1812)
  - (1) Belt clip
  - (1) Carrying case



Part #	Mfg #	Description	Price
166198	2658-22	Kit	

### M18 FUEL™ 3/8" Mid-Torque Impact Wrench w/ Friction Ring

- POWERSTATE™ brushless motor
- 3-Mode DRIVE CONTROL™
- REDLINK PLUS™ intelligence
- Features a friction ring design
- LED light
- Belt Clip



Part #	Mfg #	Description	Price
255838	2852-20	Bare Tool	

## Power Tools

### M18™ FUEL™ 1/2" Compact Impact Wrench with Friction Ring Kit

- Kit Includes:
- (1) M18 FUEL™ 1/2" Compact Impact Wrench w/ Friction Ring (Bare Tool) (2755B-20)
- (2) M18™ REDLITHIUM™ XC5.0 Extended Capacity Battery Pack (48-11-1850)
- (1) M18™ & M12™ Multi-Voltage Charger (48-59-1812)
- (1) Belt Clip
- (1) Carrying Case



Part #	Mfg #	Description	Price
228402	2755B-20	Bare Tool	
226462	2755B-22	Kit	

### M18™ FUEL™ 1/2" High Torque Impact Wrench with Pin Detent

- Kit includes:
- (1) M18 FUEL™ 1/2" High Torque Impact Wrench (2762-20)
- (1) M18™ & M12™ Multi-Voltage Charger (48-59-1812)
- (2) M18™ REDLITHIUM™ XC5.0 Ext Capacity Battery (48-11-1850)
- (1) Carrying Case



Part #	Mfg #	Description	Price
221607	2762-20	Bare Tool	
166737	2762-22	Kit	

### M18™ FUEL™ 1/2" Mid-Torque Impact Wrench with Pin Detent

- POWERSTATE™ Brushless motor
- 3-Mode DRIVE CONTROL™
- Up to 600 ft-lbs of nut-busting torque
- Up to 450 ft-lbs of fastening torque
- Kit Includes:
- (1) M18 FUEL™ 1/2" Mid-Torque Impact Wrench with pin detent (tool only) (2860-20)
- (2) M18™ REDLITHIUM™ XC5.0 Extended capacity battery pack (48-11-1850)
- (1) M18™ & M12™ Multi-voltage charger (48-59-1812)
- (1) Carrying case
- (1) Belt clip



Part #	Mfg #	Description	Price
247481	2860-20	Bare Tool	
234481	2860-22	Kit	

### M18™ FUEL™ 1/2" High Torque Impact Wrench with Friction Ring Kit

- Delivers up to 700 ft-lbs of maximum fastening torque, up to 1,100 ft-lbs of nut-busting torque and up to 2X more runtime
- POWERSTATE™ Brushless Motor
- REDLINK PLUS™ Intelligence



- Kit Includes**
- (1) M18 FUEL™ 1/2" High Torque Impact Wrench with Friction Ring (Bare Tool) (2763-20)
  - (2) M18™ REDLITHIUM™ XC5.0 Extended Capacity Battery Pack (48-11-1850)
  - (1) M18™ & M12™ Rapid Charger (48-59-1808)

Part #	Mfg #	Description	Price
165987	2763-22	Kit	

### M18™ FUEL™ 1/2" Mid-Torque Impact Wrench with Friction Ring

- LED light
- Delivers up to 450 ft-lbs of fastening torque
- Delivers up to 600 ft-lbs of nut-busting torque
- REDLINK PLUS™
- REDLITHIUM™ batteries
- POWERSTATE™ brushless motor
- Utilizes a friction ring design to ensure quick & easy socket changes



Part #	Mfg #	Description	Price
243289	2861-20	Bare Tool	

### M18™ FUEL™ 1/2" High Torque Impact Wrench with Friction Ring

- LED light
- Bolt removal mode
- Rubber overmold
- REDLINK PLUS™
- REDLITHIUM™ batteries
- POWERSTATE™ brushless motor



Part #	Mfg #	Description	Price
239311	2767-20	Bare Tool	
238946	2767-22	Kit	



## Power Tools

### M18™ 1/2" Impact Wrench with Pin Detent

- Kit includes:
  - (1) M18™ 1/2" Impact Wrench w/ Pin Detent (2659-20)
  - (2) M18™ REDLITHIUM™ XC Extended Capacity Battery (48-11-1828)
  - (1) M18™ & M12™ Multi-Voltage Charger (48-59-1812)
  - (1) Belt Clip
  - (1) Carrying Case



Part #	Mfg #	Description	Price
167795	2659-20	Bare Tool	
228550	2659-22	Kit	

### M18™ 1/2" High-Torque Impact Wrench with Friction Ring Kit

- Milwaukee® 4-pole frameless motor
- REDLITHIUM™ battery technology
- REDLINK™ intelligence
- Includes:
  - (1) M18™ 1/2" high-torque impact wrench with friction ring (2663-20)
  - (2) M18™ REDLITHIUM™ XC extended capacity battery (48-11-1828)
  - (1) M18™ & M12™ Multi-voltage charger (48-59-1812)
  - (1) Carrying case



Part #	Mfg #	Description	Price
152298	2663-22	Kit	

### M18™ FUEL 1/2" Compact Impact Wrench with Pin Detent

- POWERSTATE™ Brushless motor
- 4-Mode DRIVE CONTROL™
- Utilizes a pin detent design for maximum socket retention
- Kit Includes:
  - (1) M18 FUEL™ 1/2" Compact Impact Wrench w/ Pin Detent (2755-20)
  - (2) M18™ REDLITHIUM™ XC5.0 Battery Pack (48-11-1850)
  - (1) M18™ & M12™ Multi-Voltage Charger (48-59-1812)
  - (1) Belt Clip
  - (1) Carrying Case



Part #	Mfg #	Description	Price
179579	2755-20	Bare Tool	
179580	2755-22	Kit	

### M18 FUEL™ w/ ONE-KEY™ High Torque Impact Wrench 1/2" Friction Ring

- POWERSTATE™ brushless motor
- Up to 1400 ft-lbs nut-busting torque
- REDLINK PLUS™ intelligence
- M18 FUEL with ONEKEY™ technology
- Features a friction ring design
- Kit includes:
  - (1) M18 FUEL™ w/ ONE-KEY™ High Torque Impact Wrench 1/2" Friction Ring (2863-20)
  - (2) M18™ REDLITHIUM™ XC5.0 Extended Capacity Battery Pack (48-11-1850)
  - (1) M18™ & M12™ Multi-Voltage Charger (48-59-1812)
  - (1) Carrying Case



Part #	Mfg #	Description	Price
254380	2863-20	Bare Tool	
258656	2863-22	Kit	

### M18 FUEL™ w/ ONE-KEY™ High Torque Impact Wrench 1/2" Pin Detent

- POWERSTATE™ Brushless motor
- Compatible with ONE-KEY™
- REDLINK PLUS™ intelligence
- Delivers up to 750ft-lbs of fastening torque and 1100ft-lbs of nut-busting torque



Part #	Mfg #	Description	Price
255972	2862-20	Bare Tool	

### M18 FUEL™ 3/4" w/ ONE-KEY™ High Torque Impact Wrench Friction Ring

- POWERSTATE™ brushless motor delivers up to 1200ft-lbs of fastening torque and 1500ft-lbs of nut-busting torque
- ONE-KEY™ Compatible
- Features a friction ring with thru-hole design to ensure quick and easy socket changes



Part #	Mfg #	Description	Price
250927	2864-20	Bare Tool	

## Power Tools

### M18™ Cordless 2-Speed 3/8" Right Angle Impact Wrench

- 2-Speed Drive-Control™ offers greater control over applications
- 3/8" Anvil with friction ring for fast, easy socket change
- 1.4" Head



Part #	Mfg #	Description	Price
223133	2668-20	Bare Tool	

### M18™ Cordless 5/8" SDS Plus Rotary Hammer Kit

- REDLITHIUM™ battery technology: superior pack construction, electronics, and performance deliver more work per charge and more work over pack life than any battery on the market
- Powerful 18-volt motor: delivers 0-1,300 RPM and 0-7,000 BPM
- 2-Mode operation: choose rotary hammer or rotation only for added versatility
- LED light: illuminates dark work spaces



Part #	Mfg #	Description	Price
244697	2612-20	Bare Tool	
166128	2612-21	Kit	

### M18™ FUEL™ SDS Plus Rotary Hammer

- POWERSTATE™ brushless motor
- REDLINK PLUS™
- REDLITHIUM™ battery
- AVS system



Part #	Mfg #	Description	Price
227454	2712-22HD	High Demand Kit, 1"	
173340	2712-22	Kit, 1"	
182779	2712-20	Bare Tool, 1"	
221606	2715-20	Bare Tool, 1-1/8"	
171580	2715-22	Kit, 1-1/8"	
178540	2715-22DE	DE(Dust Extractor) Kit, 1-1/8"	
234425	2715-22HD	High Demand Kit, 1-1/8"	
189902	2713-20	Bare Tool, 1" w/ D-Handle	
188836	2713-22	Kit, 1" w/ D-Handle	

### M18™ Cordless Drills (Continued)

#### M18™ FUEL™ SDS Plus Rotary Hammer

Part #	Mfg #	Description	Price
234424	2713-22HD	High Demand Kit, 1" D-Handle	

#### M18 FUEL™ 1-3/4" SDS Max Rotary Hammer w/ ONE KEY™

- POWERSTATE™ brushless motor
- REDLINK PLUS™ electronic intelligence
- One Key™
- 380 RPM
- 8.1 ft-lbs Impact Energy
- 2,900 BPM
- 10 m/s<sup>2</sup> Vibration
- Kit Includes:
  - (1) M18 FUEL™ 1-3/4" SDS Max Rotary Hammer w/ ONE KEY™ (Tool Only) (2718-20)
  - (1) M18 REDLITHIUM™ HIGH OUTPUT™ HD12.0 Battery Pack (48-11-1812)
  - (1) M18™ & M12™ Rapid Charger (48-59-1808)
  - (1) Carrying Case
  - (1) Grease Tube
  - (1) Side Handle



Part #	Mfg #	Description	Price
258596	2718-21HD	Kit	

#### M18 FUEL™ 1" SDS Plus Rotary Hammer with Dedicated Dust Extractor

- POWERSTATE™ brushless motor
- REDLINK PLUS™
- REDLITHIUM™ battery
- AVS system
- Kit includes:
  - (1) M18 FUEL™ 1" SDS Plus Rotary Hammer(2712-20)
  - (1) HAMMERVAC™ Dedicated Dust Extractor (2712-DE)
  - (2) M18™ REDLITHIUM™ XC5.0 Extended Capacity Battery Pack (48-11-1850)
  - (1) M18™ & M12™ Multi-Voltage Charger (48-59-1812)
  - (1) Depth Rod
  - (1) HEPA Filter
  - (1) Side Handle
  - (1) Carrying Case



Part #	Mfg #	Description	Price
185835	2712-22DE	Kit	

## Power Tools

### M18™ HAMMERVAC™ Dedicated Dust Extractor

- Adjustable Depth Stop and Ruler
- Dust Containment Box
- High Capacity Dust Box
- Replaceable Certified HEPA Filter



Part #	Mfg #	Description	Price
228970	2712-DE	Bare Tool	

### HAMMERVAC™ Dedicated Dust Extractor M18™ & M28™ Dust Box

- Replacement dust box, filter, lid
- HEPA Filter
- OSHA Table 1 Compliant with filter cleaning mechanism



Part #	Mfg #	Description	Price
249515	49-90-2342	Dust Extractor	

### HAMMERVAC™ Dedicated Dust Extractor

- Engineered to connect directly to and be powered by the M18 FUEL 1" SDS Plus Rotary Hammer



Part #	Mfg #	Description	Price
159511	2605-22	Kit	

### HAMMERVAC™ Filter

- Use with HAMMERVAC™ 2306-20 and 2306-22 and 2712-22DE & 2715-22DE
- HEPA Certified Filters



Part #	Mfg #	Description	Price
186622	49-90-2306	3 Pack	

### M18 Fuel™ Cordless Drills

#### M18™ FUEL™ 1/2" Hammer Drill/Driver

- POWERSTATE™ brushless motor
- REDLINK PLUS™ Intelligence prevents damage
- No load RPM: 0-550/0-2,000  
BPM: 32,000
- Includes:
  - 1/2" 18V Hammer Drill/Driver
  - Side handle
  - Belt clip
- 5-Year warranty



Part #	Mfg #	Description	Price
179573	2704-20	Bare Tool	

#### M18™ FUEL™ 3/8" Impact Wrench Kit with Friction Ring

- 200 ft-lbs and 2,400 in-lbs of torque in a compact design
- POWERSTATE™ brushless motor
- REDLINK PLUS™
- REDLITHIUM™ battery pack
- Utilizes a friction ring design for fast, easy socket changes
- Includes:
  - (1) M18 FUEL™ 3/8" Impact wrench with friction ring (2654-20)
  - (2) M18™ REDLITHIUM™ XC 4.0 Extended capacity battery pack (48-11-1840)
  - (1) M18 & M12™ multi-voltage charger (48-59-1812)
  - (1) Belt clip
  - (1) Carrying case



Part #	Mfg #	Description	Price
158102	2654-22	Kit	

## Power Tools

### M18™ FUEL™ 1/2" Impact Wrench Kit with Pin Detent

- 210 ft-lbs and 2,520 in-lbs of torque in a compact design
- POWERSTATE™ Brushless Motor
- REDLITHIUM™ XC 4.0 Battery REDLINK PLUS™
- Utilizes a pin detent design for maximum socket retention
- Includes:
  - (1) M18 FUEL™ 1/2" Impact wrench with pin detent (bare tool) (2655-20)
  - (2) M18™ REDLITHIUM™ XC 4.0 extended capacity battery pack (48-11-1840)
  - (1) M18™ & M12™ multi-voltage charger (48-59-1812)
  - (1) Belt clip
  - (1) Carrying case



Part #	Mfg #	Description	Price
158103	2655-22	Kit	

### M18™ FUEL™ Mud Mixer with 180° Handle Kit

- Includes:
  - LED light
  - Church key
  - Contractor's bag
  - M18 REDLITHIUM™ XC5.0
  - M18™ & M12™ Multi-voltage charger
- Up to 15 buckets per charge
- 16 Adjustable handle settings



Part #	Mfg #	Voltage	Price
239069	2810-20	Bare Tool	
239068	2810-22	Kit	

## M18™ Cordless Saws

### M18™ Sawzall® Reciprocating Saw Kit

- Gear-protecting clutch
- Lever action Quik-Lok™ blade clamp
- Battery fuel gauge displays remaining run-time
- Variable speed trigger
- Kit Includes:
  - (1) Sawzall® Reciprocating saw (2621-20)
  - (2) M18™ REDLITHIUM™ XC Battery (48-11-1828)
  - (1) Multi-Voltage Charger (48-59-1812)
  - (1) Blade
  - (1) Carrying Case



Part #	Mfg #	Description	Price
173952	2621-20	Bare Tool	
173953	2621-21	Kit	

### M18™ Cordless Saws (Continued)

#### M18™ Sawzall® Reciprocating Saw Kit

Part #	Mfg #	Description	Price
173954	2621-22	Kit	

#### M18™ HACKZALL® Cordless One-Handed Reciprocating Saw

- Speed: 0 to 3,000 spm
- Stroke length: 3/4"
- Blade clamp: QUIK-LOK™ universal
- Kit includes:
  - M18™ HACKZALL® Reciprocating saw (2625-20)
  - M18™ REDLITHIUM™ XC High capacity battery
  - 10-Hour charger
  - SAWZALL® Blade
  - Contractor bag



Part #	Mfg #	Description	Price
144657	2625-20	Bare Tool	
138662	2625-21	Kit	

#### M18™ HACKZALL® Recip Saw Kit

- One-handed design provides superior control & versatility
- Compact size allows for cutting in tight spaces, and light weight makes overhead work easier
- Built-in LED light
- Includes:
  - (1) M18™ HACKZALL® Recip Saw (2625-20)
  - (1) M18™ Compact REDLITHIUM Battery (48-11-1815)
  - (1) M18™ & M12™ Multi-Voltage Charger (48-59-1812)
  - (1) Contractor Bag



Part #	Mfg #	Description	Price
150993	2625-21CT	Kit	



## Power Tools

### M18™ Cordless Band Saw

- 3-1/4" Cut capacity
- Tool-free adjustable material shoe
- LED Work light
- Blade ejection system
- Drop resistant pulley guard
- Cast aluminum gear case
- Kit includes:
  - M18™ Band saw
  - (2) M18™ REDLITHIUM™ XC High capacity batteries
  - 1-Hour charger
  - Blade
  - Case
- 5-Year warranty



Part #	Mfg #	Description	Price
139287	2629-20	Bare Tool	
143146	2629-22	Kit	

### M18™ Cordless 6-1/2" Circular Saw

- Speed: 3,500 rpm
- Capacity: 2-1/8" @90° and 1-9/16" @45°
- Arbor: 5/8"
- Blade: 6-1/2" 24T carbide tipped
- Kit includes:
  - M18™ Circular saw (2630-20)
  - (2) M18™ REDLITHIUM™ XC High capacity batteries
  - 1-Hour charger
  - Contractor bag



Part #	Mfg #	Description	Price
143400	2630-20	Bare Tool	
138753	2630-22	Kit	

### M18™ Brushless 7-1/4" Circular Saw

- Milwaukee® brushless motor
- Integrated rafter hook
- Integrated dust port on guard
- REDLINK™ Intelligence
- Magnesium upper and lower guards
- Electric brake
- Includes:
  - (1) M18™ Brushless 7-1/4" Circular Saw (2631-20)
  - (1) Contractor bag
  - (1) Blade
  - (1) Blade wrench



Part #	Mfg #	Description	Price
255211	2631-20	Bare Tool	

### M18™ Cordless Jig Saw

- Speed: 0 to 2,700 SPM
- Stroke length: 1"
- Bevel capacity: 45°
- Kit includes:
  - M18™ Jig saw (2645-20)
  - (2) M18™ REDLITHIUM™ XC High capacity batteries
  - 1-Hour charger
  - Jig saw blade
  - Non-marring shoe
  - Carrying case



Part #	Mfg #	Description	Price
142858	2645-20	Bare Tool	
138656	2645-22	Kit	

### M18™ Cordless 5-3/8" Metal Saw

- 4-Pole frameless motor
- Speed: 3,600 rpm
- Cut capacity: 1/8" to 2"
- Blade: 5-3/8" 30T carbide-tipped
- Includes:
  - M18™ 5-3/8" Metal saw
  - (2) M18™ REDLITHIUM™ XC High capacity batteries
  - 1-Hour charger
  - 30T Metal Tech™ carbide-tipped blade
  - Blade wrench
  - Contractor bag



Part #	Mfg #	Description	Price
141828	2682-22	Kit	



## Power Tools

### M18™ FUEL™ Cordless Saws

#### M18™ FUEL™ 6-1/2" Circular Saw

- POWERSTATE™ Brushless motor
- REDLINK PLUS™ Intelligence
- REDLITHIUM™ XC 4.0 Battery
- Kit Includes:

- (1) M18 FUEL™ 6-1/2" Circular saw (bare tool) (2730-20)
- (1) M18™ REDLITHIUM™ XC Extended capacity battery pack
- (1) M18™ & M12™ Multi-voltage charger (48-59-1812)
- (1) Blade
- (1) Blade wrench
- (1) Contractor bag



Part #	Mfg #	Description	Price
162303	2730-20	Bare Tool	
166409	2730-21	Kit	
161702	2730-22	Kit	

#### M18™ FUEL™ 7-1/4" Circular Saw

- POWERSTATE™ Brushless motor
- REDLINK PLUS™ Intelligence
- REDLITHIUM™ XC 4.0 Battery
- Kit Includes:

- (1) M18 FUEL™ 7-1/4" Circular Saw (Bare Tool) (2731-20)
- (2) M18™ REDLITHIUM™ XC5.0 Extended Capacity Battery Pack (48-11-1850)
- (1) M18™ & M12™ Multi-Voltage Charger (48-59-1812)
- (1) Blade
- (1) Blade Wrench
- (1) Contractor Bag



Part #	Mfg #	Description	Price
174393	2731-20	Bare Tool	
172223	2731-21	Kit	
172201	2731-22	Kit	

#### M18™ FUEL™ 7-1/4" Circular Saw

- POWERSTATE™ Brushless Motor
- REDLINK PLUS™ Intelligence
- REDLITHIUM™ HIGH OUTPUT™ HD12.0 Battery
- Magnesium shoe and guards for maximum durability
- Integrated rafter hook
- LED light
- Integrated dust port on guard and included vac adaptor
- Electric brake to stop blade after tripper is released



Part #	Mfg #	Description	Price
257790	2732-20	Bare Tool	
248727	2732-21HD	Kit	

#### M18™ FUEL™ Metal Cutting Circular Saw

- POWERSTATE™ Brushless motor
- REDLITHIUM™ battery
- REDLINK PLUS™ intelligence
- 5-3/8" - 5-7/8"



Part #	Mfg #	Description	Price
233188	2782-20	Bare Tool	
234480	2782-22	Kit	

#### M18 FUEL™ D-Handle Jig Saw

- POWERSTATE™ brushless motor
- REDLITHIUM battery technology
- REDLINK PLUS™ intelligence
- Variable speed ranges between 0 and 3500 strokes per minute
- Includes dust cover and dust extraction tube
- Includes non-marring shoe cover for protection of finished surfaces
- Tool less shoe bevel with positive stops allows for quick and accurate shoe adjustment with detents at 0°, 15°, 30° and 45°



Part #	Mfg #	Description	Price
252950	2737-20	Bare Tool	



## Power Tools

### M18™ FUEL™ Hackzall Reciprocating Saw

- One-handed design
- 7/8" Stroke length
- Pivoting shoe
- POWERSTATE™
- REDLINK PLUS™
- REDLITHIUM™
- Includes SAWZALL® blade
- Kit includes:
  - Contractor's bag
  - SAWZALL® blade
  - M18 XC5.0 Battery pack
  - M18 FUEL Hackzall (2719-20)
  - M18/M12 Multi-voltage charger



Part #	Mfg #	Description	Price
239589	2719-20	Bare Tool	
239591	2719-21	Kit	

### M18™ FUEL™ Sawzall® Reciprocating Saw Kit

- Delivers faster than corded cutting speed and the durability of a corded saw
- POWERSTATE™ Brushless motor
- REDLINK PLUS™ Intelligence
- REDLITHIUM™ XC 4.0 Battery
- 2720-22, 2720-21 Kit Includes:
  - (1) M18 FUEL™ SAWZALL® reciprocating saw (2720-20)
  - (1) M18™ REDLITHIUM™ extended capacity battery pack
  - (1) M18™ & M12™ Multi-voltage charger
  - (1) Blade
  - (1) Carrying case



Part #	Mfg #	Description	Price
161655	2720-20	Bare Tool	
161658	2720-21	Kit	
161581	2720-22	Kit	
235946	2720-22HD	Kit, High Demand	

### M18™ FUEL™ SUPER SAWZALL® Reciprocating Saw

- POWERSTATE™ brushless motor
- REDLINK PLUS™ Intelligence
- REDLITHIUM™ HIGH OUTPUT™ HD12.0 Battery
- 1-1/4" Stroke length removes more material
- Variable speed trigger and 5-speed dial
- Integrated rafter hook
- LED light
- Adjustable shoe
- QUIK-LOK® blade clamp
- Compatible with all M18™ batteries
- Kit includes:
  - (1) M18 FUEL™ SUPER SAWZALL® Reciprocating Saw (2722-20)
  - (1) M18 REDLITHIUM™ HIGH OUTPUT™ HD12.0 Battery pack (48-11-1812)
  - (1) M18™ & M12™ Rapid charger (48-59-1808)
  - (1) Blade
  - (1) Contractor bag



Part #	Mfg #	Description	Price
257792	2722-20	Bare Tool	
248733	2722-21HD	Kit	

### M18™ FUEL™ Deep Cut Band Saw

- POWERSTATE™ brushless motor
- REDLITHIUM™
- REDLINK PLUS™
- Kit Includes:
  - (1) Deep Cut Band Saw (Bare Tool) (2729-20)
  - (1) M18™ REDLITHIUM™ XC5.0 Extended Capacity Battery Pack (48-11-1850)
  - (1) M18™ & M12™ Multi-Voltage Charger (48-59-1812)
  - (1) Blade
  - (1) Carrying Case



Part #	Mfg #	Description	Price
167156	2729-20	Bare Tool	
167158	2729-21	Kit	
167159	2729-22	Kit	

## Power Tools

### M18™ FUEL™ High Demand Deep Cut Band Saw

- POWERSTATE™ brushless motor
- REDLITHIUM™
- REDLINK PLUS™
- Kit Includes:
  - (1) M18 FUEL™ Deep Cut Band Saw (Bare Tool) (2729-20)
  - (1) M18™ & M12™ Rapid Charger (48-59-1808)
  - (2) M18™ REDLITHIUM™ HIGH DEMAND™ 9.0 Battery Pack (48-11-1890)
  - (1) Blade
  - (1) Carrying Case



Part #	Mfg #	Description	Price
230566	2729-22HD	Kit	

### M18™ FUEL™ 7-1/4" Dual Bevel Sliding Compound Miter Saw

- Only 28 lbs with battery
- Dual bevel with stops at 45° and 48°
- Over 600 cuts per charge
- 3-1/2" Vertical capacity
- 2x8 Horizontal capacity
- 3-5/8" Nested crown capacity
- Cam locking miter detent system
- Shadow cut line indicator for quickly lining up cuts
- Integrated top and side carry handles for easy transportation



Part #	Mfg #	Description	Price
240500	2733-20	Bare Tool	
246885	2733-21	Kit	

### M18™ FUEL™ Sliding Compound Miter Saw

- REDLINK PLUS™
- POWERSTATE™ brushless motor
- REDLITHIUM™ battery pack
- Up to 400 cuts per charge
- Shadow cut line indicator
- Top & side carrying handles
- Tall sliding/removable fences
- Cam locking miter system with adjustable miter detent plate and 11 detent locations
- Dual bevel with 9 detents & easy access bevel level
- Kit includes:
  - (1) M18 FUEL™ Dual Bevel Sliding Compound Miter Saw (2734-20)
  - (1) M18™ REDLITHIUM™ HIGH DEMAND™ 9.0 Battery Pack (48-11-1890)
  - (1) M18™ & M12™ Rapid Charger (48-59-1808)
  - (1) Blade Wrench
  - (1) Carbide Tipped Blade
  - (1) Clamp
  - (1) Dust Bag



Part #	Mfg #	Description	Price
239066	2734-20	Bare Tool	
225667	2734-21HD	Kit	

### M18 FUEL™ 18" Chain saw Kit

- KIT INCLUDES:
  - (1) M18 FUEL™ 16" Chain saw(1) 16" Oregon Bar and
  - (1) M18 REDLITHIUM™ HIGH OUTPUT™ HD12.0 Battery Pack (48-11-1812)
  - (1) M18™ & M12™ Rapid Charger (48-59-1808)
  - (1) Scrench



Part #	Mfg #	Description	Price
248734	2727-21HD	Kit	

### Accessories

Part #	Mfg #	Description	Price
251337 0	49-16-2715	16" Replacement Chain	

## Power Tools

### M18™ FUEL™ 8-1/4" Table Saw w/ One-Key™

- POWERSTATE™ Brushless motor
- REDLINK PLUS™ Intelligence
- REDLITHIUM™ HIH OUTPUT™ HD12.0 battery pack
- 24.5" Rip capacity to rip 4x8 sheets of plywood or OSB
- On board storage for guard, riving knife, push stick, fence and miter gauge
- Rack and pinion fence system
- All metal frame
- Single wrench blade change



Part #	Mfg #	Description	Price
257791	2736-20	Bare Tool	
248728	2736-21HD	Kit	

### M18™ Knockout Tools

#### M18™ FORCELOGIC™ 6T Knockout Tool

- Includes:
  - 7/16" Draw stud
  - 3/4" Draw stud
  - 1-1/8" Draw stud
  - EXACT™ 2-1/2" die
  - EXACT™ 2-1/2" punch
  - EXACT™ 3" die
  - EXACT™ 3" punch
  - EXACT™ 3-1/2" die
  - EXACT™ 3-1/2" punch
  - EXACT™ 4" die
  - EXACT™ 4" punch
  - M18™ REDLITHIUM™ battery
  - M18™ & M12™ Multi-voltage charger
  - EXACT™ rapid reset 3/4" draw stud set
  - EXACT™ 1/2"-2" conduit punches and dies
  - Quick-connect alignment system
  - Carrying case



Part #	Mfg #	Description	Price
239293	2677-23	Kit	

### FORCELOGIC™ M18™ 10 Ton Knockout Tool Kit

- Includes:
  - (2) M18™ REDLITHIUM™ XC Extended Capacity Battery (48-11-1828)
  - (1) M18™ & M12™ Multi-voltage charger (48-59-1812)
  - (1) Exact™ 1/2" Stainless steel die (49-16-2660S)
  - (1) Exact™ 1/2" Stainless steel punch (49-16-2661S)
  - (1) Exact™ 3/4" Die (49-16-2662)
  - (1) Exact™ 3/4" Punch (49-16-2663)
  - (1) Exact™ 1" Die (49-16-2664)
  - (1) Exact™ 1" Punch (49-16-2665)
  - (1) Exact™ 1-1/4" Die (49-16-2666)
  - (1) Exact™ 1-1/4" Punch (49-16-2667)
  - (1) Exact™ 1-1/2" Die (49-16-2668)
  - (1) Exact™ 1-1/2" Punch (49-16-2669)
  - (1) Exact™ 2" Die (49-16-2670)
  - (1) Exact™ 2" Punch (49-16-2671)
  - (1) 7/16" Draw Stud (49-16-2680)
  - (1) 3/4" Draw Stud (49-16-2681)
  - (1) Ball Stud
  - (1) Coupler
  - (1) Quick connect collar
  - (1) Carrying case



Part #	Mfg #	Description	Price
167335	2676-22	Kit	

## Power Tools

### FORCELOGIC™ M18™ 10 Ton Knockout Tool

• Includes:

- (1) 1-1/8" Draw Stud
- (2) M18™ REDLITHIUM™ XC extended capacity battery (48-11-1828)
- (1) M18™ & M12™ Multi-voltage charger (48-59-1812)
- (1) EXACT™ 1/2" Stainless steel die (49-16-2660S)
- (1) EXACT™ 1/2" Stainless steel punch (49-16-2661S)
- (1) EXACT™ 3/4" Die (49-16-2662)
- (1) EXACT™ 3/4" Punch (49-16-2663)
- (1) EXACT™ 1" Die (49-16-2664)
- (1) EXACT™ 1" Punch (49-16-2665)
- (1) EXACT™ 1-1/4" Die (49-16-2666)
- (1) EXACT™ 1-1/4" Punch (49-16-2667)
- (1) EXACT™ 1-1/2" Die (49-16-2668)
- (1) EXACT™ 2" Die (49-16-2670)
- (1) EXACT™ 2" Punch (49-16-2672)
- (1) EXACT™ 2-1/2" Die (49-16-2672)
- (1) EXACT™ 2-1/2" Punch (49-16-2673)
- (1) EXACT™ 3" Die (49-16-2674)
- (1) EXACT™ 3" Punch (49-16-2675)
- (1) EXACT™ 3-1/2" Die (49-16-2676)
- (1) EXACT™ 3-1/2" Punch (49-16-2677)
- (1) EXACT™ 4" Die (49-16-2678)
- (1) EXACT™ 4" Punch (49-16-2679)
- (1) 7/16" Draw stud (49-16-2680)
- (1) 3/4" Draw stud (49-16-2681)
- (1) Ball stud
- (1) Coupler
- (1) Quick connect collar
- (2) Carrying case



Part #	Mfg #	Description	Price
167336	2676-23	Kit	

### M18™ Miscellaneous Tools

#### M18™ Compact Heat Gun

- LED light
- Ladder hook
- Guarded nozzle
- REDLINK PLUS™ intelligence
- High performance heating coil
- M18™ REDLITHIUM battery included with -21 Kit



Part #	Mfg #	Description	Price
238367	2688-21	Kit	
240763	2688-20	Tool Only	

### M18™ 3-1/4" Planer Tool

• Kit Includes:

- (1) M18™ 3-1/4" Planer (Tool Only) (2623-20)
- (1) M18™ REDLITHIUM™ XC Extended Capacity Battery (48-11-1828)
- (1) M18™ & M12™ Multi-Voltage Charger (48-59-1812)
- (2) Double Edge Carbide Blade
- (1) Contractor's Bag
- (1) Bevel/Edge Guide



Part #	Mfg #	Description	Price
225421	2623-20	Bare Tool	
225234	2623-21	Kit	

### M18™ Cordless 10oz Caulk and Adhesive Gun

- All metal gears
- Variable-speed trigger
- CFT™ Constant Flow Technology
- Anti-drip mechanism
- Rotating quick-change collar
- 6-Setting max speed dial



Part #	Mfg #	Description	Price
173334	2641-20	Bare Tool	

#### Kit Includes

- (1) M18™ Cordless 10oz. Caulk and Adhesive Gun (Tool Only) (2641-20)
- (1) 10oz Carriage Conversion Kit (48-08-1076)
- (1) M18™ Compact REDLITHIUM™ Battery (48-11-1815)
- (1) M18™ & M12™ Multi-Voltage Charger (48-59-1812)
- Where To Buy

Part #	Mfg #	Description	Price
173333	2641-21CT	Kit	



## Power Tools

### M18™ Cordless 20oz Aluminum Barrel Caulk and Adhesive Gun

- All metal gears
- Variable-speed trigger
- CFT™ Constant Flow Technology
- Anti-drip mechanism
- Rotating quick-change collar
- 6-Setting max speed dial
- Kit Includes:
  - (1) M18™ Cordless Caulk and Adhesive Gun
  - (1) 20oz Aluminum Barrel Sausage Conversion Kit (48-08-1093)
  - (1) M18™ Compact REDLITHIUM™ Battery (48-11-1815)
  - (1) M18™ & M12™ Multi-Voltage Charger (48-59-1812)



Part #	Mfg #	Description	Price
141557	2642-21CT	Kit	

### Quart Carriage Conversion Kit

- For use with M18™ cordless caulk and adhesive guns
- Includes the quart length plunger rod and piston assembly



Part #	Mfg #	Description	Price
189048	48-08-1095	Accessory	

### M18™ FUEL™ Drywall Screw Gun Kit

- Kit includes:
  - (1) M18 FUEL™ Drywall Screw Gun (2866-20)
  - (2) M18™ REDLITHIUM™ XC5.0 Extended Capacity Battery (48-11-1850)
  - (1) M18™ & M12™ Multi-Voltage Charger (48-59-1812)
  - (1) Belt Clip
  - (1) PR2 Bit
  - (1) Contractor Bag



Part #	Mfg #	Description	Price
227453	2866-20	Bare Tool	
231942	2866-22	Kit	

### M18™ FUEL™ 7" Variable Speed Polisher



Part #	Mfg #	Description	Price
224296	2738-20	Bare Tool	

### M18™ Random Orbit Sander

- 12,000 OPM max
- More material removed per charge
- Variable speed control
- 5" Sanding pad
- 7,000-12,000 OPM Variable speed
- 3/32" Orbit diameter
- Dust canister with filter
- Universal hose adapter included



Part #	Mfg #	Description	Price
248146	2648-20	Bare tool	

#### Kit Includes

- (1) M18™ Random Orbit Sander Kit (2648-21)
- (1) Dust Canister
- (1) Universal Hose Adapter
- (1) Extension Adapter
- (2) 80 Grit Sandpaper
- (1) M18™ REDLITHIUM™ XC Ext Capacity Battery
- (1) Multi-Voltage Charger
- (1) Contractor Bag

Part #	Mfg #	Description	Price
248147	2648-21	Kit	

### M18™ FUEL™ 18ga Brad Nailer

- POWERSTATE™ Brushless motor
- REDLINK PLUS™ intelligence
- Zero ramp-up time
- No gas cartridges



Part #	Mfg #	Description	Price
223482	2740-20	Bare Tool	

### M18™ FUEL™ 16ga Straight Finish Nailer

- POWERSTATE™ Brushless Motor
- REDLINK PLUS™
- Sinks 2-1/2" finish nails in solid oak
- No gas cartridges
- Zero ramp-up time



Part #	Mfg #	Description	Price
228977	2741-20	Bare Tool	

## Power Tools

### M18™ FUEL™ 16ga Angled Finish Nailer

- POWERSTATE™ Brushless motor
- REDLINK PLUS™ Electronic Intelligence
- Sink 2-1/2" finish nails in solid oak
- Zero ramp-up time
- No gas cartridges



Part #	Mfg #	Description	Price
190524	2742-20	Bare Tool	

#### Kit Includes

- (1) M18 FUEL™ 16ga Angled Finish Nailer (2742-20)
- (1) M18™ & M12™ Multi-Voltage Charger (48-59-1812)
- (1) M18™ REDLITHIUM™ CP2.0 Battery Pack (48-11-1820)
- (1) Contractor Bag
- (1) Belt Clip

Part #	Mfg #	Description	Price
190525	2742-21CT	Kit	

### M18™ FUEL™ 15ga Finish Nailer

- POWERSTATE™ Brushless motor
- REDLINK PLUS™ Intelligence
- Sink 2-1/2" finish nails in solid oak
- Zero ramp-up time
- No gas cartridges



Part #	Mfg #	Description	Price
189724	2743-20	Bare Tool	

### M18™ Transfer Pump

- Self-priming pump
- Flexible impeller moves water up to 480 gph
- Generates up to 18' of lift and produces up to 75' of head height
- REDLINK™ intelligence
- Kit Includes:
  - (1) M18™ Transfer Pump (2771-20)
  - (1) M18™ REDLITHIUM™ XC Extended Capacity Battery (48-11-1828)
  - (1) M18™ & M12™ Multi-Voltage Charger (48-59-1812)



Part #	Mfg #	Description	Price
226698	2771-20	Bare Tool	
226699	2771-21	Kit	

### M18™ Cordless Multi Tool

- Kit Includes:
  - (1) M18™ Cordless Multi-Tool (Bare Tool) (2626-20)
  - (2) M18™ REDLITHIUM™ XC Extended Capacity Battery (48-11-1828)
  - (1) M18™ & M12™ Multi-Voltage Charger (48-59-1812)
  - (1) Adapter
  - (5) Assorted Sanding Sheets
  - (1) Contractor Bag
  - (1) Sanding Pad
  - (1) Wood Cutting Blade



Part #	Mfg #	Description	Price
166675	2626-20	Bare Tool	
166678	2626-22	Kit	

### M18™ FORCE LOGIC™ CABLE CUTTER

- Powerful 6T hydraulic pump
- Patented anti-spreading jaw design
- POWERSTATE brushless motor
- Jaws automatically open when cut is complete
- Hydraulic system is optimized for consistent performance from 0°F - 122°F
- Includes:
  - (1) M18™ REDLITHIUM™ CP2.0 Battery (48-11-1820)
  - (1) M18™ & M12™ Multi-Voltage Charger (48-59-1812)
  - (1) Allen Key
  - (1) M18™ 750 MCM Cable Cutting Jaw (49-16-2772)
  - (1) Carrying Case



Part #	Mfg #	Description	Price
247553	2672-21	Kit	

#### Kit with 477 ACSR Jaws

- Includes:
  - (1) M18™ 477 ACSR Jaw (49-16-2773)
  - (1) M18™ REDLITHIUM™ CP2.0 Battery (48-11-1820)
  - (1) M18™ & M12™ Multi-Voltage Charger (48-59-1812)
  - (1) Inverter
  - (1) Carabineer
  - (1) Allen Key
  - (1) Utility Bucket Bag

Part #	Mfg #	Description	Price
247462	2672-21S	Kit	



## Power Tools

### M18 FORCE LOGIC™ 6T Crimper

- Weather protected electronics
- Brushless motor
- Tool records and stores every crimp made
- Built In – ONE KEY™ enabled
- In-line design and 350-degree head rotation
- Hydraulic system optimized for consistent performance from 0°F - 122°F



Part #	Mfg #	Description	Price
247552	2678-20	Bare Tool	

#### Kit with D3 Grooves and Fixed O Die

- Includes:
  - (1) M18 FORCE LOGIC™ 6T Crimper (Tool Only)
  - (1) M18™ & M12™ Multi-Voltage Charger (48-59-1812)
  - (2) M18™ REDLITHIUM™ CP2.0 Battery (48-11-1820)
  - (1) Carabineer
  - (1) M18™ 6T Fixed O Crimping Jaw (49-16-00D3)
  - (1) Utility Bucket Bag

Part #	Mfg #	Description	Price
182049	2678-220	Kit	

### M18™ Force Logic™ 12 Ton Crimper

- (1) Carbineer
- (1) Overhead utility bag
- (1) M18 Lithium-Ion AC/DC charger
- (1) M18 REDLITHIUM™ XC5.0 extended capacity battery pack
- (1) M18 REDLITHIUM™ 2.0 compact battery pack
- 350° Head rotation
- Pre-Crimp battery check
- Ergonomic grip design
- ONE-KEY™ technology
- POWERSTATE® brushless motor
- Predictive force monitoring (PFM™)
- REDLINK PLUS™ electronic intelligence



Part #	Mfg #	Description	Price
237770	2778-22	Kit	

### M18™ Force Logic™ 750 MCM Crimper

- (1) Carrying case
- (1) M18 & M12 multi-voltage charger
- (1) M18 REDLITHIUM™ XC5.0 extended capacity battery pack
- (1) M18 REDLITHIUM™ 2.0 compact battery pack
- 350° Head rotation
- Pre-Crimp battery check
- Ergonomic grip design
- ONE-KEY™ technology
- POWERSTATE® brushless motor
- Predictive force monitoring (PFM™)
- REDLINK PLUS™ electronic intelligence



Part #	Mfg #	Description	Price
237771	2779-22	Kit	

### M18™ FUEL™ 4-1/2" / 5" Grinder, Slide Switch Lock-On

- Kit includes:
  - (1) M18 FUEL™ 4-1/2" / 5" Grinder, Slide Switch Lock-On (Bare Tool) (2781-20)
  - (1) M18™ REDLITHIUM™ XC5.0 Extended Capacity Battery Pack (48-11-1850)
  - (1) M18™ & M12™ Multi-Voltage Charger (48-59-1812)
  - (1) Carrying Case
  - (1) Flange Nuts
  - (1) Wheel Guard
  - (1) Spanner Wrench



Part #	Mfg #	Description	Price
166871	2781-20	Bare Tool	
166872	2781-21	Kit	
246699	2781-22	Kit	
251910	2781-22HD	Kit, High Demand	



## Power Tools

### M18™ FUEL™ 4-1/2"/5" Grinder, Paddle Switch No-Lock Kit

- POWERSTATE™ Brushless motor
- REDLINK PLUS™ Intelligence
- REDLITHIUM™ XC 4.0 Battery
- Power TO GRIND
- DURABILITY
- 100% tool free productivity
- Paddle-switch design: provides increased comfort and ease-of-use when operating in various positions
- Kit Includes:
  - (1) M18 FUEL™ 4-1/2"/5" Grinder, paddle switch no-lock (bare tool) (2780-20)
  - (2) M18™ REDLITHIUM™ XCExtended capacity battery pack
  - (1) M18™ & M12™ Multi-voltage charger
  - (1) Carrying case
  - (1) Flange nut
  - (1) Spanner wrench
  - (1) Wheel guard



Part #	Mfg #	Description	Price
162116	2780-20	Bare Tool	
171444	2780-21	Kit	
164099	2780-22	Kit	
236384	2780-22HD	Kit, High Demand	

### M18™ FUEL™ 4-1/2" / 5" Braking Grinder

- 100% tool free: Make all accessory changes and guard adjustments without a wrench for increased productivity
- POWERSTATE™ Brushless Motor
- REDLINK PLUS™ Intelligence



Part #	Mfg #	Description	Price
180423	2783-20	Bare Tool	

#### Kit Includes

- (1) M18 FUEL™ 4-1/2" / 5" Braking Grinder (2783-20)
- (2) M18™ REDLITHIUM™ XC5.0 Extended Capacity Battery Pack (48-11-1850)
- (1) M18™ & M12™ Multi-Voltage Charger (48-59-1812)
- (1) T27 Guard, (1) Flange Nut, (1) FIXTEC Nut

Part #	Mfg #	Description	Price
179534	2783-22	Kit	

### M18™ FUEL™ 7" / 9" Large Angle Grinder

- 100% Tool Free: Make all accessory changes and guard adjustments without a wrench for increased productivity
- Dual action trigger: eliminating accidental trigger actuation
- POWERSTATE™ Brushless Motor
- REDLINK PLUS™ Intelligence
- Kit Includes:
  - (1) M18 FUEL™ 7" / 9" Large Angle Grinder
  - (1) M18 REDLITHIUM™ HIGH OUTPUT™ HD12.0 Battery Pack (48-11-1812)
  - (1) M18™ & M12™ Rapid Charger (48-59-1808)
  - (1) 9 inch T27 Guard
  - (1) Anti-Vibration Side Handle
  - (1) Back Flange
  - (1) Dust Vent Clip
  - (1) FIXTEC Nut
  - (1) Spanner Wrench



Part #	Mfg #	Description	Price
257793	2785-20	Bare Tool	
248730	2785-21HD	Kit, High Demand	
248732	2785-22HD	Kit, High Demand	

### M18™ FUEL™ 1/4" Die Grinder

- Kit Includes:
  - (1) M18 FUEL™ 1/4" Die Grinder (2784-20)
  - (2) M18™ REDLITHIUM™ XC5.0 Extended Capacity Battery Pack (48-11-1850)
  - (1) M18™ & M12™ Multi-Voltage Charger (48-59-1812)
  - (1) 1/4" Collet
  - (2) Wrench



Part #	Mfg #	Description	Price
235256	2784-20	Bare Tool	
231944	2784-22	Kit	

### M18™ Cordless 4-1/2" Cut-Off / Grinder



Part #	Mfg #	Description	Price
141679	2680-20	Bare Tool	

## Power Tools

### M18™ Cut Out Tool



Part #	Mfg #	Description	Price
232311	2627-20	Bare Tool	

### M18 FUEL™ Drain Snake with Cable-Drive Kit

- LED light
- Fully enclosed drum
- REDLINK PLUS™
- POWERSTATE™ brushless motor
- CABLE-DRIVE™ locking feed system
- Capacity: 1/4" x 50', 5/16" x 35' inner core cable
- Includes:
  - Storage bucket
  - M18 REDLITHIUM™ battery
  - M18 & M12™ multi-voltage charger



Part #	Mfg #	Description	Price
254977	2772A-20	Bare Tool	
238924	2772A-21	Kit	
240822	2772B-21XC	Kit	

### M18™ Job Site Fan

- Circulates air over 40 feet
- 120° adjustable head
- 9 stopping positions,
- AC adaptor included
- Four keyhole hangers and two hanging holes
- Compatible with all M18™ REDLITHIUM™ batteries
  - 17 Hours runtime on XC5.0 battery



Part #	Mfg #	Description	Price
176814	0886-20	M18™ Job Site Fan	

### M18™ Compact Blower

- Extension nozzle
- Lock-on switch
- Universal inflator/deflator
- 3-Speed electronic switch and variable speed trigger
- Shock-absorbing polymer and reinforced handle
- Soft plastic nozzle to resist crushing or cracking



Part #	Mfg #	Description	Price
163737	0884-20	(Bare Tool)	

### M18 FUEL™ Blower Kit

- Cruise control
- 100 MPH maximum air speed
- POWERSTATE™ brushless motor
- Kit Includes:
  - M18 FUEL™ Blower (Tool Only) (2728-20)
  - (1) M18™ REDLITHIUM™ HIGH DEMAND™ 9.0 Battery Pack (48-11-1890)
  - (1) M18™ & M12™ Rapid Charger (48-59-1808)



Part #	Mfg #	Description	Price
229242	2728-20	Bare Tool	
229241	2728-21HD	Kit	

### M18 FUEL™ Blower Kit

- Power to clear from 15'
- Full throttle in under 1 second
- up to 4lbs lighter
- POWERSTATE™ brushless motor
- REDLINK PLUS™ intelligence
- REDLITHIUM™ HIGH DEMAND™ 9.0 battery (Kit Only)
- Max air volume: 450 CFM
- Max air speed: 120 MPH



Part #	Mfg #	Description	Price
244533	2724-20	Bare Tool	

- Kit Includes**
- (1) M18 FUEL™ Blower
  - (1) M18™ REDLITHIUM™ HIGH DEMAND™ 9.0 Battery
  - (1) Rapid Charger

Part #	Mfg #	Description	Price
247196	2724-21HD	Kit	



## Power Tools

### M18 FUEL™ String Trimmer

- POWERSTATE™ Brushless Motor
- REDLINK PLUS™ Electronic intelligence
- Cutting Swath: 14" - 16"
- Kit includes:
  - M18 FUEL™ String Trimmer (Tool Only) (2725-20)
  - (1) M18™ REDLITHIUM™ 9.0 Battery (48-11-1890)
  - (1) M18™ & M12™ Rapid Charger (48-59-1808)



### M18 FUEL™ Hedge Trimmer

- POWERSTATE™ brushless motor
- REDLINK PLUS™
- Slider crank mechanism
- 24" Blade with tip guard
- Kit Includes:
  - (1) M18 FUEL™ Hedge Trimmer (Tool Only) (2726-20)
  - (1) M18™ REDLITHIUM™ HIGH DEMAND™ 9.0 Battery Pack (48-11-1890)
  - (1) M18™ & M12™ Rapid Charger (48-59-1808)



Part #	Mfg #	Description	Price
229238	2725-20	Bare Tool	
229237	2725-21HD	Kit	

Part #	Mfg #	Description	Price
229240	2726-20	Bare Tool	
229239	2726-21HD	Kit	

### Accessories

Part #	Mfg #	Description	Price
229245	49-16-2710	Trimmer Head	
229244	49-16-2713	.95" x 250' Trimmer Line	
244532	49-16-2714	Easy Load Trimmer Head	
229246	49-16-2711	Loaded Trimmer Head Spool	

### M18 FUEL™ String Trimmer w/ QUIK-LOK™

- POWERSTATE™ Brushless motor
- Cutting swath: 14" - 16"
- REDLINK PLUS™ Intelligence
- RPM: 0 - 4900 / 0 - 6201
- Kit Includes:
  - (1) M18 FUEL™ Power Head w/ QUIK-LOK™
  - (1) M18 FUEL™ QUIK-LOK™ String Trimmer Attachment (49-16-2717)
  - (1) M18™ REDLITHIUM™ HIGH DEMAND™ 9.0 Battery Pack (48-11-1890)
  - (1) M18™ & M12™ Rapid charger (48-59-1808)



Part #	Mfg #	Description	Price
257484	2825-20ST	Bare Tool	
257483	2825-21ST	Kit	

### M18™ FUEL™ 3-in-1 Backpack Vacuum

- M18 FUEL 3-in-1 Backpack vacuum
- 6' Flexible hose
- HEPA filter
- Telescoping extension wand
- Crevice tool
- Floor tool
- Dust extractor adapter
- Kit Includes:
  - (1) M18 FUEL 3-in-1 Backpack Vacuum (0885-20)
  - (1) M18™ REDLITHIUM™ HIGH DEMAND™ 9.0 Starter Kit (48-59-1890)



Part #	Mfg #	Description	Price
251837	0885-20	Bare Tool	
254979	0885-21HD	Kit	

### M18™ Tool Box Style Wet/Dry Vacuum

- On-board accessory and hose storage
- HEPA Rated high efficiency filter
- Includes:
  - Wet/dry vacuum
  - Filter assembly
  - Crevice tool
  - Wide utility nozzle
  - Wireless vinyl hose
- Battery and charger not included



Part #	Mfg #	Description	Price
136036	0880-20	2 gal, 18V	



## Power Tools

### 18" Hose Adapter



Part #	Mfg #	Description	Price
139837	14-37-0160	1 Pack	

### M18™ Compact Vacuum

- High performance motor
- Adapts from handheld to stationary
- 40 CFM
- Removable HEPA filter
- Clear view and easy to empty canister
- Canister volume: 36oz
- Inlet diameter: 1 1/4"
- Includes:
  - (1) M18™ Compact vacuum (0882-20)
  - (1) Crevice tool
  - (2) Extension
  - (1) HEPA filter



Part #	Mfg #	Description	Price
228972	0882-20	Bare Tool	

### HEPA Dry Filter Kit

- For (0882-20) M18™ Compact Vacuum
- 2/Pk



Part #	Mfg #	Description	Price
228971	49-90-1951	2 Pack	

### M18™ Cordless 2-Speed Grease Gun Kit

- 0,000 PSI max operating pressure
- max flow of up to 10oz / minute
- Pre-set grease counter dial
- 48" flexible hose
- Air bleeder valve for quick priming
- M18™ REDLITHIUM™ System
- Lock-on/ Lock-off trigger
- Includes:
  - (1) M18™ Cordless 2-speed grease gun (2646-20)
  - (1) 48" Flex hose w/spring guard
  - (2) M18™ Compact REDLITHIUM™ battery (48-11-1815)
  - (1) M18™ & M12™ Multi-voltage charger (48-59-1812)
  - (1) High pressure grease coupler
  - (1) Hard carrying case
  - (1) Shoulder strap



Part #	Mfg #	Description	Price
160459	2646-20	Bare Tool	
160923	2646-22CT	Kit	
181713	2646-21CT	Kit	

### M18™ Cordless 18g Double Cut Shear

- 360° Tool-free rotating head
- Ergonomic body design
- Variable speed trigger
- Kit Includes:
  - (1) M18™ Cordless 18 Gauge Double Cut Shear (Bare Tool) (2635-20)
  - (2) M18™ REDLITHIUM™ XC Extended Capacity Battery (48-11-1828)
  - (1) M18™ & M12™ Multi-Voltage Charger (48-59-1812)
  - (1) Contractor Bag



Part #	Mfg #	Description	Price
180620	2635-20	Bare Tool	
171803	2635-22	Kit	

### M18™ 18g Single Cut Shear

- 360° Tool-Free Rotating Head
- Ergonomic Body Design
- Variable Speed Trigger
- Belt Clip



Part #	Mfg #	Description	Price
228271	2637-20	Bare Tool	
176736	2637-22	Kit	

## Power Tools

### M18™ Cordless 14g Double Cut Shear

- 360° Tool-free rotating head
- Ergonomic body design
- Variable speed tripper
- Kit Includes:
  - M18™ 14G Double Cut Shear (2636-20)
  - M18™&M12™ Multi-Voltage Charger (48-59-1812)
  - M18™ REDLITHIUM™ XC Extended Capacity Battery
  - Contractor Bag



Part #	Mfg #	Description	Price
243336	2636-22	Kit	

### M18 FUEL™ SWITCH PACK™ Sectional Drum System Kit

- Fully enclosed drum
- Spin speed: 250 RPM
- Accepts other brand cables
- Includes:
  - Integrated drum brake
  - Built-in backpack straps
  - SWITCH PACK™ powered base
  - SWITCH PACK™ drum w/ anchor cable
  - 3/8" x 50' Inner core coupling cable
  - 5-Piece medium drain line kit
  - M18™ REDLITHIUM™ XC5.0 battery
  - M18™ & M12™ multi-voltage charger
  - REDLINK PLUS
  - POWERSTATE™ brushless motor
  - Electronic foot pedal with non-slip grip



Part #	Mfg #	Description	Price
238925	2775B-211	3/8" Kit	
258415	2775C-222	1/2" Kit	

### M18™ SWITCH PACK™ Drum with Anchor Cable

- Tool-free drum latch
- Full enclosed drum
- Accepts other brand cables
- 1/2" x 50' Inner core cables
- 5/8" x 50' Open wind cable
- Drum capacity: 5/16" x 75' & 3/8" x 50'
- On-board storage for cable head attachments
- Part of the SWITCHPACK™ sectional drum system



Part #	Mfg #	Description	Price
238935	47-53-2775	Drum with Anchor Cable	

### M18™ Tool Combo Kits

#### M18™ 2-Tool Combo Kit (Compact Brushless Hammer Drill and Brushless Impact)



##### Kit Includes

- (1) M18™ 1/2" Compact Brushless Hammer Drill/Driver (2702-20)
- (1) M18™ 1/4" Hex Brushless Impact Driver (2750-20)
- (1) M18™ Compact REDLITHIUM™ Battery (48-11-1815)
- (1) M18™ REDLITHIUM™ XC Ext Cap Battery (48-11-1828)
- (1) Belt Clip, (1) Contractor Bag

Part #	Mfg #	Description	Price
173946	2799-22CX	Kit	

#### M18™ FUEL 2-Tool Combo Kit (Hammer Drill/Driver and Hex Impact Driver)

- (1) M18 FUEL™ 1/2" Hammer Drill/Driver (2704-20)
- (1) M18 FUEL™ 1/4" Hex Impact Driver (2753-20)
- (2) M18™ REDLITHIUM™ XC5.0 Extended Capacity Battery Pack (48-11-1850)
- (1) M18™ & M12™ Multi-Voltage Charger (48-59-1812)
- (2) Belt Clip
- (2) Bit Holder
- (1) Side Handle
- (1) Carrying Case



Part #	Mfg #	Description	Price
179577	2897-22	2-Tool Combo Kit	



## Power Tools

### M18™ FUEL 2-Tool Combo Kit with ONE-KEY™ (Hammer Drill/Driver and Hex Impact Driver)

- M18 FUEL™ 1/2" hammer drill/driver (2706-20)
- M18 FUEL™ 1/4" hex impact driver (2757-20)
- M18™ REDLITHIUM™ (48-11-1850)
- M18™ & M12™ multi-voltage
- (2) Belt Clip
- (2) Bit Holder
- (1) Side Handle
- (1) Carrying Case



Part #	Mfg #	Description	Price
187613	2796-22	2-Tool Combo Kit	

### M18™ FUEL™ 2-Tool Combo Kit (Hammer Drill/Driver and Hex Hydraulic Driver)

- *Kit Includes:*
- (1) M18 FUEL™ 1/2" Hammer Drill/Driver (2704-20)
- (1) M18 FUEL™ SURGE™ 1/4" Hex Hydraulic Driver (2760-20)
- (2) M18™ REDLITHIUM™ XC5.0 Battery Pack (48-11-1850)
- (1) M18™ & M12™ Multi-Voltage Charger (48-59-1812)
- (2) Belt Clip
- (2) Bit Holder
- (1) Carrying Case



Part #	Mfg #	Description	Price
231124	2899-22	Kit	

### M18 FUEL™ 2 Tool Combo Kit (Hammer Drill/Driver and SAWZALL Reciprocating)

- *Includes:*
- (1) M18 FUEL™ 1/2" Hammer drill/driver (bare tool) (2604-20)
- (1) M18 FUEL™ SAWZALL® reciprocating saw (bare tool) (2720-20)
- (2) M18™ REDLITHIUM™ XC 4.0 Extended capacity battery pack (48-11-1840)
- (1) M18™ & M12™ Multi-voltage charger (48-59-1812)
- (1) Contractor bag
- (1) 6" 10 TPI thin kerf SAWZALL® blade



Part #	Mfg #	Description	Price
166501	2794-22	2-Tool Combo Kit	

### M18™ Cordless 2-Tool Combo Kit with DPM™ (Hammer/Drill Driver and Hex Impact Driver)

- *Digital power management protection prevents damage to the tool and battery in abusive situations*
- *Includes:*
- 1/2" Hammer-Drill driver (2602-20)
- 1/4" Hex impact driver (2650-20)
- (2) REDLITHIUM™ batteries
- 1-Hour charger
- Contractor bag
- 5-Year warranty



Part #	Mfg #	Description	Price
139154	2697-22	2-Tool Combo Kit	

### M18 FUEL™ 2-Tool Combo Kit (Hammer Drill/Driver and SAWZALL Saw)

- (1) M18 FUEL™ 1/2" Hammer Drill/Driver (2704-20)
- (1) M18 FUEL™ SAWZALL® Saw (2720-20)
- (2) M18™ REDLITHIUM™ XC5.0 Extended Capacity Battery Pack (48-11-1850)
- (1) M18™ & M12™ Multi-Voltage Charger (48-59-1812)
- (1) Belt Clip
- (1) Bit Holder
- (1) Contractor Bag
- (1) SAWZALL® Blade
- (1) Side Handle



Part #	Mfg #	Description	Price
179583	2894-22	2-Tool Combo Kit	

## Power Tools

### M18™ Cordless LITHIUM-ION 2-Tool Combo Kit (Compact Drill/Driver and Hex Impact Driver)

**Includes:**

- (1) M18™ Compact 1/2" drill driver (bare tool) (2606-20)
- (1) M18™ 1/4" Hex impact driver (bare tool) (2656-20)
- (2) M18™ Compact REDLITHIUM™ battery (48-11-1815)
- (1) M18™ & M12™ Multi-voltage charger (48-59-1812)
- (1) Contractor bag



Part #	Mfg #	Description	Price
153676	2691-22	2-Tool Combo Kit	

### M18™ Cordless LITHIUM-ION 2-Tool Combo Kit (Compact Hammer Drill/Driver and SAWZALL)

**Includes:**

- (1) M18™ Compact 1/2" Hammer drill/driver (bare tool) (2607-20)
- (1) M18™ SAWZALL® Recip saw (bare tool) (2620-20)
- (1) M18™ REDLITHIUM™ XC Extended capacity battery (48-11-1828)
- (1) M18™ & M12™ Multi-Voltage charger (48-59-1812)
- (1) Contractor bag



Part #	Mfg #	Description	Price
155644	2694-22	2-Tool Combo Kit	

### M18 FUEL™ 2-Tool Combo Kit

- (1) M18 FUEL™ 1/2" Hammer Drill/Driver (2804-20)
- (1) M18 FUEL™ 1/4" Hex Impact Driver (2853-20)
- (2) M18™ REDLITHIUM™ XC5.0 Extended Capacity Battery Pack (48-11-1850)
- (1) M18™ & M12™ Multi-Voltage Charger (48-59-1812)
- (1) Carrying Case
- (1) Side Handle
- (2) Belt Clip
- (2) Bit Holder



Part #	Mfg #	Description	Price
248763	2997-22	2-Tool Combo Kit	

### M18 FUEL™ 3 Tool Combo Kit

- (1) M18 FUEL™ 1/2" Hammer Drill/Driver (tool only) (2804-20)
- (1) M18 FUEL™ 1/4" Hex Impact Driver (tool only) (2853-20)
- M18 FUEL™ SAWZALL® Reciprocating Saw (tool only) (2720-20)
- (2) M18™ REDLITHIUM™ XC5.0 Extended capacity battery pack (48-11-1850)
- (1) M18™ & M12™ Multi-voltage charger (48-59-1812)
- (1) Carrying case
- (1) Side handle
- (2) Belt clip
- (2) Bit holder



Part #	Mfg #	Description	Price
248765	2997-23	3-Tool Combo Kit	

### M18™ Cordless 4-Tool Combo Kit

**Includes:**

- 1/2" Hammer drill driver (2602-20)
- Sawzall® reciprocating saw (2620-20)
- 6-1/2" Circular saw (2630-20)
- Work light (49-24-0171)
- (2) REDLITHIUM™ XC High capacity batteries
- 1-Hour charger
- (1) Sawzall® blade
- Contractor bag



Part #	Mfg #	Description	Price
137564	2694-24	4-Tool Combo Kit	

### M18™ Cordless 4-Tool Combo Kit (2)

**Includes:**

- M18™ 1/2" Hammer drill driver (2602-20)
- M18™ HACKZALL® Reciprocating saw (2625-20)
- M18™ 1/4" Hex Impact driver (2650-20)
- M18™ Work light (49-24-0171)
- (2) M18™ REDLITHIUM™ XC High capacity batteries (48-11-1828)
- 1-Hour charger (48-59-1801)
- General purpose Sawzall® blade
- Contractor bag



Part #	Mfg #	Description	Price
138971	2695-24	4-Tool Combo Kit	

## Power Tools

### M18™ Cordless LITHIUM-ION 2-Tool Combo Kit

- Kit Includes:
  - (1) M18™ 1/2" Hammer Drill Driver (2602-20)
  - (1) M18™ HACKZALL® One-Handed Recip Saw (2625-20)



Part #	Mfg #	Description	Price
138928	2695-22	2-Tool Combo Kit	

### M18™ Cordless 4-Tool Combo Kit (3)

- Includes:
  - 1/2" Hammer drill driver (2602-20)
  - 1/4" Hex impact driver (2650-20)
  - Sawzall® M18™ reciprocating saw (2620-20)
  - Work light (49-24-0171)
  - (2) REDLITHIUM™ XC High capacity batteries
  - 1-Hour charger
  - General purpose Sawzall® blade
  - Contractor bag



Part #	Mfg #	Description	Price
138527	2696-24	4-Tool Combo Kit	

### M18 FUEL™ LITHIUM-ION 4-Tool Combo Kit

- Includes:
  - (1) M18 FUEL™ 1/2" Hammer Drill/Driver (bare tool) (2604-20)
  - (1) M18 FUEL™ 1/4" Hex impact driver (bare tool) (2653-20)
  - (1) M18 FUEL™ SAWZALL® Reciprocating saw (bare tool) (2720-20)
  - (1) M18™ LED Work light (2735-20)
  - (1) M18™ REDLITHIUM™ XC 4.0 Extended capacity battery pack (48-11-1840)
  - (1) M18™ & M12™ Multi-voltage charger (48-59-1812)
  - (1) Belt clip
  - (1) Contractor bag
  - (1) Reciprocating blade



Part #	Mfg #	Description	Price
164933	2796-24	4-Tool Combo Kit	

### M18™ FUEL™ 4-Tool Combo Kit

- Includes:
  - (1) M18 FUEL™ 1/2" Hammer Drill/Driver (Tool Only) (2704-20)
  - (1) M18 FUEL™ SAWZALL® Reciprocating Saw (Bare Tool) (2720-20)
  - (1) M18™ LED Work Light (2735-20)
  - (1) M18 FUEL™ 1/4" Hex Impact Driver (Bare Tool) (2753-20)
  - (2) M18™ REDLITHIUM™ XC5.0 Extended Capacity Battery Pack (48-11-1850)
  - (1) M18™ & M12™ Multi-Voltage Charger (48-59-1812)
  - (2) Belt Clip
  - (2) Bit Holder
  - (1) Contractor Bag
  - (1) SAWZALL® Blade
  - (1) Side Handle



Part #	Mfg #	Description	Price
179584	2896-24	4-Tool Combo Kit	

### M18 FUEL™ 5 Tool Combo Kit

- (1) M18 FUEL™ SAWZALL® Reciprocating Saw (2720-20)
- (1) M18 FUEL™ 1/2" Hammer Drill/Driver (tool only) (2804-20)
- (1) M18 FUEL™ 1/4" Hex Impact Driver (tool only) (2853-20)
- (1) M18 FUEL™ 6-1/2" Circular Saw (2730-20)
- (1) M18™ Work Light (tool only) (2735-20)
- (2) M18™ REDLITHIUM™ XC5.0 Extended Capacity Battery Pack (48-11-1850)
- (1) M18™ & M12™ Multi-Voltage Charger (48-59-1812)
- (1) Carrying case
- (1) Side handle
- (2) Belt clip
- (2) Bit holder



Part #	Mfg #	Description	Price
248766	2997-25	5-Tool Combo Kit	



## Power Tools

### M18 FUEL™ LITHIUM-ION 6-Tool Combo Kit

- Includes:
- (1) M18 FUEL™ 1/2" Hammer Drill/Driver (bare tool) (2604-20)
- (1) M18 FUEL™ 1/4" Hex impact driver (bare tool) (2653-20)
- (1) M18 FUEL™ SAWZALL® Reciprocating saw (bare tool) (2720-20)
- (1) M18 FUEL™ 6-1/2" Circular saw (bare tool) (2730-20)
- (1) M18™ LED work light (2735-20)
- (1) M18 FUEL™ 4-1/2"/5" Grinder, paddle switch no-lock (bare tool) (2780-20)
- (2) M18™ REDLITHIUM™ XC 4.0 Extended capacity battery pack (48-11-1840)
- (1) M18™ & M12™ Multi-voltage charger (48-59-1812)
- (1) Belt clip
- (1) Circular saw blade
- (2) Contractor bag
- (1) Reciprocating blade
- (1) Spanner wrench



Part #	Mfg #	Description	Price
164934	2796-26	6-Tool Combo Kit	

### M18 FUEL™ 6-Tool Combo Kit

- Kit Includes:
- (1) M18 FUEL™ 1/2" Hammer Drill/Driver (2704-20)
- (1) M18 FUEL™ SAWZALL® Reciprocating Saw (2720-20)
- (1) M18 FUEL™ 6-1/2" Circular Saw (2730-20)
- (1) M18™ LED Work Light (2735-20)
- (1) M18 FUEL™ 1/4" Hex Impact Driver (2753-20)
- (1) M18 FUEL™ 4-1/2" / 5" Grinder, Paddle Switch No-Lock (2780-20)
- (2) M18™ REDLITHIUM™ XC5.0 Extended Capacity Battery Pack (48-11-1850)
- (1) M18™ & M12™ Multi-Voltage Charger (48-59-1812)
- (2) Belt Clip
- (2) Bit Holder
- (1) Circular Saw Blade
- (2) Contractor Bag
- (1) SAWZALL® Blade
- (1) Side Handle
- (1) Spanner Wrench



Part #	Mfg #	Description	Price
179585	2896-26	6-Tool Combo Kit	

### M18™ Cordless 6-Tool Combo Kit

- (1) Compact 1/2" Hammer Drill/Driver (2607-20)
- (1) SAWZALL® Reciprocating Saw (2621-20)
- (1) 6 1/2" Circular Saw (2630-20)
- (1) 1/4" Hex Impact Driver (2656-20)
- (1) Cordless 4-1/2" Cut-off / Grinder (2680-20)
- (1) LED Work Light (2735-20)
- (2) REDLITHIUM™ XC Extended Capacity Battery (48-11-1828)
- (1) Multi-Voltage Charger (48-59-1812)
- (1) Contractor Bag



Part #	Mfg #	Description	Price
148165	2696-26	6-Tool Combo Kit	

### M18 FUEL™ 7-Tool Combo Kit

- Includes:
- (1) M18 FUEL™ 1/2" Hammer Drill/Driver (2804-20)
- (1) M18 FUEL™ 1/4" Hex Impact Driver (2853-20)
- (1) M18 FUEL™ SAWZALL® Reciprocating (2720-20)
- (1) M18 FUEL™ 6-1/2" Circular Saw (2730-20)
- (1) M18 FUEL™ 1/2" Mid-Torque Impact Wrench with Friction Ring (2861-20)
- (1) M18 FUEL™ 4-1/2" / 5" Grinder, Paddle Switch No-Lock (2780-20)
- (1) M18™ Work Light (2735-20)
- (2) M18™ REDLITHIUM XC5.0 Batteries (48-11-1850)
- (1) M18™ & M12™ Multi-Voltage Charger (48-59-1812)
- (1) 6" 18T Thin Kerf Ice Hardened SAWZALL® Blade
- (1) Circular Saw Blade, (1) Grinding Disc, (3) Belt Clips
- (2) Bit Holder, (2) Contractor Bag, (1) Side Handle

Part #	Mfg #	Description	Price
248769	2997-27	7-Tool Combo Kit	

## Power Tools

### M18™ Cordless LITHIUM-ION 9-Tool Combo Kit

• Includes:

- (1) M18™ Cordless 1/2" hammer drill/driver (2602-20)
- (1) M18™ Cordless right angle drill (2615-20)
- (1) M18™ SAWZALL® Recip saw (2620-20)
- (1) M18™ Cordless LITHIUM-ION 6 -1/2" circular saw (2630-20)
- (1) M18™ Cordless LITHIUM-ION jig saw (2645-20)
- (1) M18™ 1/4" Hex compact impact driver (2650-20)
- (1) M18™ 1/2" High-torque impact wrench with friction ring (2663-20)
- (1) M18™ Cordless LITHIUM-ION 4-1/2" cut-off/grinder (2680-20)
- (2) M18™ REDLITHIUM™ XC Extended capacity battery (48-11-1828)
- (1) M18™ & M12™ Multi-voltage charger (48-59-1812)
- (1) M18™ Work light (49-24-0171)



Part #	Mfg #	Description	Price
156090	2696-29	9-Tool Combo Kit	



## Power Tool Accessories

### Cordless Batteries and Accessories

#### 12V Lithium-Ion Battery

- Over 65% lighter than "compact" NiCd batteries
- For use with Milwaukee® 12V cordless tools
- 2-Year warranty



Part #	Mfg #	Description	Price
137574	48-11-2401	Lithium-Ion	

#### V18™ Lithium-Ion Battery

- 18V power with a 14.4V NiCd battery weight
- Superior cold weather performance
- For use with Milwaukee V18 cordless power tools



Part #	Mfg #	Description	Price
142703	48-11-1830	Lithium-Ion	

#### M12™ REDLITHIUM™ Compact Battery

- 3.0 Amp hour
- REDLINK™ Intelligence
- Best-in-Class Construction
- Delivers fade-free power in extreme job site conditions
- Powers 70+ Milwaukee M12™ cordless solutions



Part#	Mfg#	Amp Hour	Pack	Price
231116	48-11-2460	6.0	Single	
231115	48-11-2430	3.0	Single	
165350	48-11-2420	1.5	Single	
154721	48-11-2411	1.5	2	

#### M12 REDLITHIUM™ XC Battery

- 3.0 Amp hour
- High current discharge
- Sturdy base- Allows M12™ tools to easily stand
- LITHIUM-ION battery delivers long life and run time with fade-free power
- Battery fuel gauge displays charge status on tools
- M12™ Compatibility



Part #	Mfg #	Description	Price
146046	48-11-2402	Single Pack	
171802	48-11-2412	2 Pack	

#### M12™ REDLITHIUM™ XC 4.0 Extended Capacity Batter Pack

- REDLINK™ Intelligence
- All-weather performance
- Powers most M12™ cordless power tools



Part #	Mfg #	Description	Price
166387	48-11-2440	Single Pack	

#### M18™ REDLITHIUM™ HIGH OUTPUT™ HD12.0 Battery Pack

- REDLINK™ Intelligence
- Fuel gauge onboard
- Best-in-class construction
- Powers more than 150 M18™ cordless solutions



Part #	Mfg #	Description	Price
248737	48-11-1812	Single Pack	

#### M18™ REDLITHIUM™ 2.0 Compact Battery Pack

- REDLINK™ Intelligence
- Best-in-class construction
- Fuel gauge onboard
- All-weather performance



Part #	Mfg #	Description	Price
154722	48-11-1820	Compact Battery Pack	

#### M18™ REDLITHIUM™ XC Extended Capacity Battery

- REDLINK™ Intelligence
- Fuel gauge onboard
- All-weather performance
- Powers more than 40 Milwaukee M18™ cordless power tools



Part #	Mfg #	Description	Price
136039	48-11-1828	Single Pack	



## Power Tool Accessories

### M18™ REDLITHIUM™ XC 4.0 Extended Capacity Battery Pack

- REDLINK™ Intelligence
- Best-in-class construction
- Fuel gauge onboard
- All-weather performance
- Versatility: Powers more than 40 Milwaukee M18™ cordless power tools



Part #	Mfg #	Description	Price
158199	48-11-1840	Extended Capacity Battery Pack	

### M18™ REDLITHIUM™ XC 5.0 Extended Capacity Battery Pack

- REDLINK™ Intelligence: Provides optimized performance and overload protection using total system communication between tool, battery and charger
- Best-in-class construction
- Fuel gauge onboard
- All-weather performance
- Versatility- Powers more than 60 Milwaukee® M18™ cordless power tools



Part #	Mfg #	Description	Price
173430	48-11-1850	Extended Capacity Battery	
237660	48-11-1851	Pack of 10	
174426	48-11-1852	Pack of 2	

### M18™ REDLITHIUM™ XC6.0 Battery Pack

- REDLINK™ Intelligence
- Fuel gauge onboard
- All-Weather Performance
- Powers more than 100 M18™ cordless power tools



Part #	Mfg #	Description	Price
225396	48-11-1860	Extended Capacity Battery	

### M18 REDLITHIUM™ HIGH OUTPUT™ XC6.0 Battery Pack



Part #	Mfg #	Description	Price
248741	48-11-1865	High Output	
248742	48-11-1862	Pack of 2	

### M18™ REDLITHIUM™ HIGH DEMAND™ 9.0 Battery Pack

- REDLINK™ Intelligence
- Best-in-Class Construction
- Fuel gauge onboard
- Delivers fade free power in extreme job site conditions
- Powers more than 100 Milwaukee® M18™ cordless power tools



Part #	Mfg #	Description	Price
224567	48-11-1890	Single Pack	

### M18 REDLITHIUM™ High Capacity Battery Two Pack

- 3.0 Amp hour
- LITHIUM-ION battery delivers long life and run time with fade-free
- Battery fuel gauge
- Overload protection
- Temperature management system
- Individual cell monitoring
- Discharge protection
- Best in class construction
- Integrated weld frame
- Cell separator
- Impact and vibration protective rubber



Part #	Mfg #	Description	Price
154296	48-11-1822	Two Pack	

### 18V Ni-Cd Battery

- Works with all 18V NiCd and V18 tools excluding:
  - 1108
  - 3108
  - 5364
  - 6516



Part #	Mfg #	Description	Price
139148	48-11-2230	Easy Release Latch	

## Power Tool Accessories

### 28V Lithium-Ion Battery

- Overload protection
- Temperature management system
- Individual cell voltage monitoring
- Discharge protection
- Battery fuel gauge
- 3-Year warranty



Part #	Mfg #	Description	Price
142696	48-11-2830	Lithium-Ion Battery	

### M12™ Power Source

- 2.1 amp powered USB port charges all portable electronic devices, including tablets
- On-board fuel gauge
- Compatible with all M12™ battery packs
- Compatible with all M12™ heated gear



Part #	Mfg #	Description	Price
161648	49-24-2310	Power Source	

### M18™ Power Source

- Compatible with M18™ compact and XC™ batteries
- Powered USB port charges portable electronic devices
- Compatible with M12™ heated jackets with the expandable battery pocket



Part #	Mfg #	Description	Price
151840	49-24-2371	Power Source	

### M18™ REDLITHIUM™ HIGH DEMAND™ 9.0 Starter Kit

- REDLINK™ Intelligence
- Best-in-Class Construction
- Fuel gauge onboard
- All-Weather Performance



Part #	Mfg #	Description	Price
234175	48-59-1890	18V Lithium-Ion	

### M18™ REDLITHIUM™ XC5.0 System Starter Kit

- REDLINK™ Intelligence
- Best-in-Class Construction
- Fuel gauge onboard
- All-Weather Performance
- Includes:
  - (1) M18™ REDLITHIUM™ XC5.0 Battery (48-11-1850)
  - (1) M18™ & M12™ Multi-Voltage Charger (48-59-1812)



Part #	Mfg #	Description	Price
179457	48-59-1850	18V	

### M12™ AC/DC Wall Vehicle Charger

- 2-In-1 Design
- Charge time: 40 minutes
- Lithium-Ion battery (not included)
- 5-Year warranty



Part #	Mfg #	Description	Price
138274	2510-20	M12™ AC/DC Wall & Vehicle Charger	

### M12™ Lithium-Ion Battery Charger

- 30-Minute charge time
- 5-Year warranty



Part #	Mfg #	Description	Price
137575	48-59-2401	12V Lithium-Ion Charger	

### M12™ Four Bay Sequential Charger

- Accepts up to 4 M12™ Battery Packs
- Sequentially charges batteries
- Compact design with wall mount
- REDLINK™ Intelligence: charger communication with the battery pack to ensure optimum performance and extend life



Part #	Mfg #	Description	Price
173929	48-59-1204	M12™ Four Bay Charger	

## Power Tool Accessories

### M12™ Compact Charger and Power Source

- Provides convenient, compact charging of all M12™ Batteries
- Compatible with in-vehicle USB ports for convenient on-the-go charging
- Includes:
  - (1) 3ft Micro-USB Cable and 2.1A Wall Charger (48-59-1202)
  - (1) M12™ Compact Charger and Power Source (48-59-1201)



Part #	Mfg #	Description	Price
240896	48-59-1201	M12™ Compact Charger and Power Source	

### M18™ Six Pack Sequential Charger

- Charges up to six batteries sequentially
- Convenient carrying handle
- Pass through plug
- Compact size



Part #	Mfg #	Description	Price
154534	48-59-1806	M18™ Six Pack Charger	

### M18™ and M12™ Rapid Battery Charger

- Charges batteries up to 40% faster
- Charges all M12™ and M18™ batteries
- Sequential charging: automatically charges the second inserted pack once the first pack is fully charged
- REDLINK™ Intelligence



Part #	Mfg #	Description	Price
148014	48-59-1808	M18™ and M12™ Charger	

### M18™ and M12™ Multi-Voltage Battery Charger

- 12V and 18V
- 5-Year warranty



Part #	Mfg #	Description	Price
148692	48-59-1812	M18™ and M12™ Charger	

### M18™ & M12™ Rapid Charge Station

- REDLINK™
- Pass through plug
- Charges three batteries simultaneously
- Accepts (3) M18™ and (3) M12™ battery packs



Part #	Mfg #	Description	Price
173750	48-59-1807	18V & 12V	

### M18™ Lithium-Ion AC/DC Wall & Vehicle Charger

- AC Wall charger and DC vehicle charger
- Charges all M18™ batteries
- Charge times:
  - 48-11-1815: 30-Minute
  - 48-11-1828: 1-Hour
  - 48-11-1820: 45-Minute
  - 48-11-1840: 90-Minute



Part #	Mfg #	Description	Price
138273	2710-20	18V	

### M18™ and M12™ Vehicle Charger

- Plugs into vehicle 12V or 24V DC Outlet
- Charges all M18 & M12 batteries
- Automatically shuts down charger to prevent excessive discharge of vehicle battery



Part #	Mfg #	Description	Price
236978	48-59-1810	Vehicle for M18 & M12	

### REDLITHIUM™ USB Battery & Charger Kit

- Charges the Milwaukee® REDLITHIUM™ USB Batteries via Micro USB Cord
- 2X More Capacity than (3) AAA Alkaline Batteries
- LED Fuel Gauge Allows Fast Checking of REDLITHIUM™ USB Battery Charge
- 2ft Heavy Duty Micro-USB Braided Cord w/ Metal Ends



Part #	Mfg #	Description	Price
238974	48-59-2003	Kit	
238972	48-59-2002	Charger and Cord Only	



## Power Tool Accessories

### M28™ 3-Bay Universal Charger

- Single-unit simplicity: Milwaukee M28™ lithium-ion, V18 Lithium-ion and NiCd batteries
- Durable construction: Withstands tough job site conditions
- 9-ft. Pass-through plug
- High-visibility LED light: Displays charge status from across the room



Part #	Mfg #	Description	Price
164783	48-59-0280	M28™ 3-Bay Universal Charger	

### Miscellaneous Batteries

#### REDLITHIUM™ USB Battery

- Over 2,000 charges
- Charge inside USB rechargeable products or with 48-59-2002 REDLITHIUM™ charger



Part #	Mfg #	Description	Price
238970	48-11-2130	REDLITHIUM™ USB Battery	

#### REDLITHIUM™ USB Charger

- LED fuel gauge
- 2FT Micro-USB braided cord
- Stores battery when not in use



Part #	Mfg #	Description	Price
238972	48-59-2002	REDLITHIUM™ USB Charger	

### Milwaukee® Parts & Accessories

#### SDS+ Dust Trap™ Drilling Shroud

- Industry's first OSHA® compliance solution without a vacuum, ideal for overhead drilling applications
- Universal fit allows the DUST TRAP™ to work with all SDS Plus rotary hammers and SDS Plus drill bits up to an 8" length, including stop bits and other anchor installations tools



Part #	Mfg #	Description	Price
244316	48-03-3035	Clear Sleeve, Compact Collapsible Design	

#### 8' 3-Wire QUIK-LOK® Cord

- 8 ft., three-wire grounded QUIK-LOK® feature allows for fast replacement of a damaged cord
- Premium grade Hi-Flex wire 5-15P NEMA type plug



Part #	Mfg #	Description	Price
156222	48-76-4008	8' QUIK-LOK® Cord	

#### Chuck Key

- This chuck key tightens the jaws of the 1/2 inch capacity chuck 48-66-1360, 48-66-1370, and 48-66-1381
- Key holder 48-66-4040 should be used to attach this chuck key to the corset



Part #	Mfg #	Description	Price
140524	48-66-3280	Chuck Key	

#### Bit Holder

Part #	Mfg #	Description	Price
150713	43-72-0550	Bit Holder	

#### Screws, Nuts & Bolts

Part #	Mfg #	Description	Price
150710	06-82-5275	6-32" x 5/16" Torx Head Screw	

#### Spline/Round Hex 2Pc Floor Scraper

Part #	Mfg #	Description	Price
236691	48-62-2016	6" x 25"	



## Power Tool Accessories

### Tamper Shank

- Used to mount tamper plate



Part #	Mfg #	Description	Price
243757	48-62-4060	15-1/2"	

### Tent Stake Driver - Head Only

- Drives in large tent stakes  
(Use with 48-62-4060)



Part #	Mfg #	Description	Price
243756	48-62-4061	5-1/2"	

### Universal Surface Grinding Dust Shroud



Part #	Mfg #	Description	Price
242453	49-40-6105	7"	

### SDS Max Dust Extraction Attachment

Part #	Mfg #	Description	Price
242451	5317-DE	8.75" x 4.6" x 2"	

### Rip Fence Kit

- Provides a straight cutting edge for fast, accurate cuts



Part #	Mfg #	Description	Price
247516	49-22-4146	Rip Fence	

## Cut-Off Machine Accessories

### Cut-Off Wheel

- For general purpose to specialized high performance applications
- Consistent performance from wheel to wheel
- Tested for balance, resulting in smooth, vibration free grinding and cutting



Part #	Mfg #	Size	Type	Price
138407	49-94-4500	4-1/2"	1	
186774	49-94-5000	5"	1	
242287	49-94-5020	5"	27	

## Cut-Off Machine Accessories (Continued)

### Cut-Off Wheel

Part #	Mfg #	Size	Type	Price
162159	49-94-4520	4-1/2"	2	
171104	49-94-4505	4-1/2"	27	
140073	49-94-1405	14"	1	
180939	49-94-6305	6"	27	
252529	49-94-3000	3"		
252524	49-94-3005	3"		
252526	49-94-3010	3"		

## Power Tools

### Pipe Inspecting and Locating

#### SeeSnake® micro™ Inspection Camera

- Allows you to easily perform visual inspections in hard to reach areas
- Lightweight, hand-held design can be carried anywhere
- 3' Cable reach expandable to 30' with optional extensions
- Includes batteries, mirror, hook and magnet



Part #	Mfg #	Display	Diameter	Lighting	Power Source	Price
141173	36738	3.5" Color LCD	17mm	(4) Adj LEDs	(4) AA Batteries	

#### SeeSnake® Sewer Camera Locator

- Flexible transmitters
- 768 x 494 Video resolution
- 6 rugged, high-intensity LED lights built in camera
- Hardened stainless steel snake camera head with spring assembly
- For use with 2-1/2" diameter plumbing line with a max run of 200'



Part #	Mfg #	Size	Color	Price
206936	13998	325'	Red/Gray	



**Refrigeration Tools**

**Refrigerant Piping and Components**

**Rotary Vane Deep Vacuum Pump**

- Internal check valve stops oil blowout in case of accidental power loss
- Gas ballast valve helps prevent oil contamination caused by high moisture
- Manifold valve isolates pump from system when testing for leaks
- Center oil fill port is accessible from front & sides
- Durable light weight die cast aluminum housing
- Delrin vanes for quieter, longer-lasting performance
- 2-Stage for lower pumping pressure
- Oil drain valve at bottom of oil reservoir
- 25 Microns ultimate vacuum
- Electrical Specs: 120V/60Hz (2-Stage\_



Part #	Mfg #	Free Air Displace	Motor	Nom Pump Speed	Price
150637	90066-2V-110	6 CFM	1/3 hp	3440 rpm	

**ACCU-Charge II Electronic Refrigerant Scale**

- Functions:
  - Charge programming
  - Pause/charge
  - Tank capacity programming (empty/full)
  - Repeat
- Capacity: 240 lbs
- Auto off: 3 hours
- Operating temperature: 32° to 120°F
- Battery life approximately 40 hours (9 VDC)



Part #	Mfg #	Description	Price
140934	98210-A	9" x 9" Platform	

**Pro-Set® Cyclone Refrigerant Recovery Machine**

- Fastest overall ARI certified recovery rates in its class in all temperature environments
- Automatic low pressure shut-off feature turns unit off when recovery is completed
- Rugged high density double walled plastic housing with easy view top mounted controls
- R-410A Ready with 550 psi high pressure shut-off switch
- Ergonomic well balanced design for easy transport including shoulder strap, weighs 36 lbs
- Built-in suction filter located under suction port



Part #	Mfg #	Description	Price
112428	87-CR700	1 hp Oil-Less Cyclone	

**Refrigeration Tools**

**Electronic Digital Vacuum Gauge**

- Large 5 digit LCD display
- Measurement units are selectable for microns, in/hg, mBar, Torr. Advanced field
- Cleanable sensor can withstand 400 psi positive pressure
- Operates 30 hours on standard 9V alkaline battery



Part #	Mfg #	Description	Price
113610	87-VG200	Digital Gauge, Carry Hook, Tee, 9V Battery & Case	

**Brass Access Tee - Sweat**

- One valve core included for each tee
- All male flare fittings are internally threaded to accept installation of valve core
- Includes brass cap for use with core wrench



Part #	Mfg #	Fitting 1	Fitting 2	Branch Fitting	Body	Price
092124	83-CC8414-2Pk	1/4" Sweat ODF	1/4" Sweat ODF	1/4" SAE Flare	Copper	
080959	83-CC8438-2Pk	3/8" Sweat ODF	3/8" Sweat ODF	1/4" SAE Flare	Copper	
080956	83-CC8412-2Pk	1/2" Sweat ODF	1/2" Sweat ODF	1/4" SAE Flare	Copper	

**Brass Access Tee - Threaded**

- One valve core included for each tee
- All male flare fittings are internally threaded to accept installation of valve core



Part #	Mfg #	Fitting 1	Fitting 2	Branch Fitting	Body	Price
103852	83-CD9601-2PK	1/4" SAE Flare (F)	1/4" SAE Flare (M)	1/4" SAE Flare (M)	Copper	
167257	83-CD96040-1PK	1/4" SAE Flare (M)	1/4" SAE Flare (M)	1/4" SAE Flare (F)	Copper	

**Valves**

**Pro-Set® Ball Valve**

- Add existing hose to eliminate refrigerant loss to comply with EPA regulations
- 1/4-Turn operation, color-coded handles



Part #	Mfg #	Description	Price
119736	87-BV3-3PK	1/4" Female, 1/4" Male, SAE, 3/PK	

**Microseal™ Anti-Blowback Valve**

- Automated sealing eliminates refrigerant loss and blowback
- Non-restrictive porting for maximum refrigerant flow
- SAE Male x SAE Female



Part #	Mfg #	Description	Price
098447	87-AB3-3PK	1/4" Female, 1/4" Male, SAE, 3/PK	

**Refrigeration Tools**

**Valve Core**



Part #	Mfg #	Description	Price
140745	83-CD4460-6PK	Valve Core, 6/Pk	

**Refrigerant Wrenches**

**6-in-1 Metric Torque Wrench**

- Ideal for installing mini-split systems
- Includes (6) interchangeable heads: 12, 22, 24, 26, 27 & 29mm jaw sizes



Part #	Mfg #	Description	Price
150265	TLTWSM	Metric 6-in-1 Metric Torque Wrench	

**BLACKMAX Digital Torque Wrench**



Part #	Mfg #	Description	Price
232482	BTLDTW	Digital Torque Wrench	

**Chemicals**

**Acid Test Kit**

- Use to determine the acid level in mineral and alkybenzene lubricants typically used with HCFC refrigerants such as R-22 and R-401A (not for use with POE oil)
- One test per kit
- Easy to use, no complicated charts, results in seconds
- Simply add oil, shake, and observe color change (turns yellow if acidic)



Part #	Mfg #	Description	Price
031600	85-25140-01	Ref Oil Acid Test Kit	

**Refrigeration Tools**

**QwikCheck Acid Test Kit**

- Color Change Indicates Pass/Fail
- Tests for Inorganic Acids to the ARI-700 limit of 1ppm
- Works with All Refrigerants & Oils
- Meets EPA Venting Regulations
- Unique Patented Disposable Design
- U.S. Patents #6,514,765 & #6,825,040



Part #	Mfg #	Description	Price
158735	QT2000	Detects inorganic acid in 2-seconds down to 1 part per million	

**Refrigeration Tools**

**Refrigeration Oil Test Kits**

**Phase III® Refrigeration Oil Test Kit**

- For use on POE's, minerals oils, and alkylbenzene
- Tests acid level in refrigeration oil



Part #	Mfg #	Description	Price
140753	4320-W8	Phase III Oil Test Kit	



## Refrigeration Tools

### Refrigerant Parts

#### Gasket

Part #	Mfg #	Description	Price
144859	87-HXG	Hose Gasket, 10/Pack, Fits 1/4"SAE, 1/2" Acme or 1/2" 20 UNF	

#### Hose - Refrigerant

Part #	Mfg #	Description	Price
140755	40360	5' Blue, Red, Yellow Refrigerant Hose Set	
140756	41601	5' Blue Refrigerant Hose	
140757	41602	5' Yellow Refrigerant Hose	
126840	41603	5' Red Refrigerant Hose	
096037	45360	5' Blue, Red, & Yellow Refrigerant Hose Set with Anti-Blowback Fittings	
148224	87-HP5BA	5' Blue Refrigerant Hose with Anti-Blowback Fittings	
148223	87-HP5RA	5' Red Refrigerant Hose with Anti-Blowback Fittings	
148222	87-HP5YA	5' Yellow Refrigerant Hose with Anti-Blowback Fittings	
148221	87-HS3A	3' Refrigerant Hose Set with Anti-Blowback Fittings	

#### Manifold

Part #	Mfg #	Description	Price
132142	57161	Aluminum 2-Way Manifold Gauge Set with 5' Hoses	
105054	87-MBHP5	Manifold with Hose(R-410A-R22)	

#### Vacuum Pump Oil

Part #	Mfg #	Description	Price
148101	85-2600	1 qt	
092114	85-2601	1 gal	

### Tools, Gauges & Solder

#### Valve Core Tool

Part #	Mfg #	Description	Price
104588	91490	Protech Universal Valve Core Tool	

### Tools, Gauges & Solder (Continued)

#### Valve Core Tool

Part #	Mfg #	Description	Price
140984	91496	Valve Core Remover	
140743	83-CD3813-1PK	Valve Core Container/Wrench	
104515	83-CD3800-1PK	Valve Core Wrench	



## Refrigeration Tools

### Manifolds

#### 4-Valve Aluminum Manifold

- Forged aluminum body
- Replaceable ss valve seats
- SAE styl o-ring
- Large sight glass
- 3/8" bore throughout
- Comfort grip
- Glows in the dark
- R22-404A-410A



Part #	Mfg #	Description	Price
167725	1839130	60" Hoses, Low Loss Ball-Valve Adapters	

#### 4-Valve Aluminum Manifold Set

- Forged aluminum body
- Replaceable ss valve seats
- SAE styl o-ring
- Large sight glass
- 3/8" bore throughout
- Comfort grip
- Includes:
  - Valve
  - Dual Readout Thermometer
  - 60" Refrigeration hoses w/ ball valve adapters
- R22-404A-410A



Part #	Mfg #	Description	Price
168342	1839131	60" Hoses, Ball-Valve Adapters	

#### 2-Valve Aluminum Manifold

- Forged aluminum body
- Replaceable ss valve seats
- SAE style o-ring
- Large sight glass
- Comfort grip
- Glows in the dark
- Built-in pressure reminder



Part #	Mfg #	Description	Price
166823	1839134	-30" Hg to 300 - 500 psi	

### Flaring Tools

#### Orbital Flare

- Off-center mounted cone spins on an axis to effectively produce quality flares
- Clutch mechanism stops the flaring when the job is done
- Spring-loaded block grips tube securely
- A tube-stop arrow slides to set correct height and positioning, while ball detents allow for easy flaring cone alignment
- Tube Sizes (O.D.) - 3/16", 1/4", 5/16", 3/8", 1/2", 5/8", 3/4"



Part #	Mfg #	Description	Price
167767	1838952	45° Flare Type	

### Swaging Tools

#### Compact Swage Tool

- The power to swage 1-5/8" tubing and the control to swage 5/16" without splitting the tube
- Compact design
- One-handed operation



**Kit Includes:** 3/8", 1/2", 5/8", 3/4", 7/8", expander heads, body, deburrer, kit box

Part #	Mfg #	Description	Price
165773	1839015	Tube sizes (O.D.) 3/8", 1/2", 5/8", 3/4", 7/8"	

### Pumps

#### Vacuum Pump

- Hands-free carry
- Drains oil quickly
- Quick, easy access
- Easy to check oil
- Extra confidence
- Prolong oil life



Part #	Mfg #	Description	Price
231489	1948121	VP5 5 CFM 1/2HP	

## Refrigeration Tools

### Electronic Tools

#### Dual Readout Thermometer

- Manifold-compatible compact thermometer
- Use it on any gauge set, or remove it and use it independently
- Two easy-to-use, K-style tube clamp thermocouples



Part #	Mfg #	Description	Price
167727	1839106	0° C to +50°C	

### Service Tools

#### Deburrers

- Steel blades



Part #	Mfg #	Description	Price
168257	1891258	1/4" to 1-5/8"	

#### Valve Core Removal Tool

- Max working pressure: 800 psi
- Burst pressure: 4000 psi
- Operating Temp: -20°F to +180°F



Part #	Mfg #	Description	Price
237080	194796	1/4"	
244572	1947968	5/16"	

### Hoses

#### Refrigeration Hoses

- Extra abrasion-resistant layer
- Rated for 800 PSI working pressure
- 60" Length



Part #	Mfg #	Description	Price
168252	1839153	Set of 3 (Red, Blue, Yellow)	

**Rulers & Tape Measures**

**Rulers**

**Fiberglass Folding Ruler**

- Precision made of flexible heavy-duty fiberglass
- With embedded easy-to-read boldface figures and graduations with red 16" stud marks and positive locking joints
- 6" Inside flat reading



Part #	Mfg #	Model	Width	Length	Price
008692	73370	1619F	5/8"	6'	

## Saws & Blades

### Abrasive Saw

- Heavy-duty cast iron base with non-slip rubber feet
- D-Handle grip ergonomic handle
- Die cast aluminum motor housing with externally accessible brushes
- Tool-less fence adjustment
- Arbor lock and arbor wrench included
- Miter cut to 45°



### Replacement Saw Blade

Part #	Mfg #	Description	Price
067703	46956	14" Abrasive Disks for Steel, 10/Pk	

## Saws & Blades

### Hand Saws

#### High Tension Hacksaw

- Reinforced metal frame
- High-leverage tension knob
- Internal blade storage
- 45° Angle blade position
- Overmolded handle



Part #	Mfg #	Description	Price
186596	48-22-0050	12"	

#### Compact Hack Saw

- Tool-free blade change
- Adjustable blade length
- Rubber over mold grip



Part #	Mfg #	Description	Price
137579	48-22-0012	Includes (1) 10" Blade	

#### Rasping Jab Saw

- Rasping holes along the side of the blade to rapidly expand holes or smooth rough edges of sheet rock
- Rubber over mold grip
- 6" Plaster/dry wall blade



Part #	Mfg #	Description	Price
137581	48-22-0304	6" Rasping Jab Saw	

#### Folding Jab Saw

- Folds for easy storage
- Uses standard Sawzall® blades
- Includes:
  - (1) Folding jab saw
  - (3) Reciprocating blades (metal, wood, multi-purpose)



Part #	Mfg #	Description	Price
137583	48-22-0305	6" Folding Jab Saw	

#### 18" PVC/ABS Saw

- Tool free blade change
- Metal core body
- Clamshell design
- Rubber over mold grip



Part #	Mfg #	Description	Price
137580	48-22-0223	18" Blade	
226368	48-22-0218	18" Blade	

### Sawzall® Blades

#### Mega SAWZALL® Blade Kit



Part #	Mfg #	Pack Qty	Price
222915	49-22-1132	32	

#### SAWZALL® Blades

- NAIL GUARD™ Ordinary teeth
  - FANG TIP™
  - Matrix II bi-metal teeth for greater durability
- (5 Pk)



Part #	Mfg #	Blade Size	TPI	Pkg Qty	Price
164267	48-00-5091	6"	8/12 TPI	5 Pk	
233564	48-00-5041	6"	4/6 TPI	5 Pk	
164213	48-00-5035	6"	5 TPI	5 Pk	
164207	48-00-5092	6"	10 TPI	5 Pk	
164210	48-00-5182	6"	14 TPI	5 Pk	
164211	48-00-5184	6"	18 TPI	5 Pk	
233566	48-00-5185	4"	24 TPI	5 Pk	
164212	48-00-5186	6"	24 TPI	5 Pk	
164279	48-00-5093	8"	8/12 TPI	5 Pk	
164202	48-00-5036	9"	5 TPI	5 Pk	
164203	48-00-5016	9"	6 TPI	5 Pk	
164273	48-00-5187	9"	14 TPI	5 Pk	
164274	48-00-5188	9"	18 TPI	5 Pk	
164288	48-00-5189	12"	18 TPI	5 Pk	
233561	48-00-5193	8"	10/14 TPI	5 Pk	
164200	48-00-5037	12"	5 TPI	5 Pk	
169673	48-00-5094	12"	8/12 TPI	5 Pk	
167949	48-00-5194	12"	10/14 TPI	5 Pk	

(25 Pk)

Part #	Mfg #	Blade Size	TPI	Pkg Qty	Price
168482	48-01-2035	6"	5 TPI	25 Pk	
242767	48-01-2093	8"	8/12 TPI	25 Pk	
168483	48-01-2036	9"	5 TPI	25 Pk	



## Saws & Blades

(50 Pk)

Part #	Mfg #	Blade Size	TPI	Pkg Qty	Price
152610	48-01-6035	6"	5 TPI	50 Pk	

### Thin Kerf SAWZALL® Blades

- Optimized tooth design providing 2X more life than our previous generation SAWZALL® blades
- Tough Neck™ ribs strengthen the blade tang and minimize breakage
- Grid Iron™ honeycomb pattern increases blade rigidity to resist blade buckling



(5 Pk)

Part #	Mfg #	Blade Size	TPI	Pkg Qty	Price
167946	48-00-5181	4"	14 TPI	5 Pk	
233565	48-00-5183	4"	18 TPI	5 Pk	

(25 Pk)

Part #	Mfg #	Blade Size	TPI	Pkg Qty	Price
168363	48-01-2184	6"	18 TPI	25 Pk	
168364	48-01-2188	9"	18 TPI	25 Pk	
235498	48-00-8182	6"	14 TPI	25 Pk	
233563	48-00-8184	6"	18 TPI	25 Pk	

(50 Pk)

Part #	Mfg #	Blade Size	TPI	Pkg Qty	Price
240138	48-01-6186	6"	24 TPI	50 Pk	
242750	48-00-4188	9"	18 TPI	50 Pk	

(100 Pk)

Part #	Mfg #	Blade Size	TPI	Pkg Qty	Price
242766	48-01-7092	6"	10 TPI	100 Pk	
175719	48-01-7035	6"	5 TPI	100 Pk	
167948	48-01-7184	6"	18 TPI	100 Pk	
175717	48-01-7188	9"	18 TPI	100 Pk	

### Thin Kerf Ice Hardened™ SAWZALL® Blades

- Optimized tooth design providing 2X more life than our previous generation SAWZALL® blades
- Tough Neck™ ribs strengthen the blade tang and minimize breakage
- Grid Iron™ honeycomb pattern increases blade rigidity to resist blade buckling



(5 Pk)

Part #	Mfg #	Blade Size	TPI	Pkg Qty	Price
169667	48-00-4182	6"	14 TPI	5 Pk	
167951	48-00-4189	12"	18 TPI	5 Pk	

(50 Pk)

Part #	Mfg #	Blade Size	TPI	Pkg Qty	Price
152609	48-01-8184	6"	18 TPI	50 Pk	

### The Torch™ SAWZALL® Blades

- Optimized tooth design providing 2X more life than our previous generation
- SAWZALL® blades Tough Neck™ ribs strengthen the blade tang and minimize breakage
- Grid Iron™ honeycomb pattern increases blade rigidity to resist blade buckling



(5 Pk)

Part #	Mfg #	Blade Size	TPI	Pkg Qty	Price
152136	48-00-5712	6"	10 TPI	5 Pk	
152137	48-00-5782	6"	14 TPI	5 Pk	
152139	48-00-5784	6"	18 TPI	5 Pk	
164297	48-00-5786	6"	24 TPI	5 Pk	
152129	48-00-5713	9"	10 TPI	5 Pk	
152130	48-00-5787	9"	14 TPI	5 Pk	
152131	48-00-5788	9"	18 TPI	5 Pk	
164298	48-00-5790	9"	24 TPI	5 Pk	
152132	48-00-5714	12"	10 TPI	5 Pk	
152133	48-00-5794	12"	14 TPI	5 Pk	
152134	48-00-5789	12"	18 TPI	5 Pk	
169669	48-00-5791	12"	24 TPI	5 Pk	



## Saws & Blades

(25 Pk)

Part #	Mfg #	Blade Size	TPI	Pkg Qty	Price
161705	48-01-2713	9"	10 TPI	25 Pk	
177451	48-00-8782	6"	14 TPI	25 Pk	
234324	48-00-8784	6"	18 TPI	25 Pk	
168987	48-00-8787	9"	14 TPI	25 Pk	
234323	48-00-8788	9"	18 TPI	25 Pk	
226631	48-01-2788	9"	18 TPI	25 Pk	

(100 Pk)

Part #	Mfg #	Blade Size	TPI	Pkg Qty	Price
244875	48-01-7782	6" Pk	14 TPI	100	

### The Torch™ with Carbide Teeth SAWZALL® Blades



- 50X Life in thick metal
- 7 TPI for fast efficient cutting in thick and extreme metals
- Carbide teeth for longer life and greater versatility
- Cuts cast iron, stainless steel, & high strength alloys
- 25% more carbide per tooth for longest life
- 1" Tall for demolition
- Fast in cast iron

Part #	Mfg #	Blade Size	TPI	Pkg Qty	Price
238621	48-00-5201	6"	7 TPI	1	
238623	48-00-5202	9"	7 TPI	1	
246971	48-00-5301	6"	7 TPI	3	
246972	48-00-5302	9"	7 TPI	3	
238622	48-00-5501	6"	7 TPI	5	
238624	48-00-5502	9"	7 TPI	5	

### The Torch™ Ice Hardened™ SAWZALL® Blades

- Optimized tooth design providing 2X more life than our previous generation SAWZALL® blades
- Tough Neck™ ribs
- Grid Iron™ honeycomb pattern



(5 Pk)

Part #	Mfg #	Blade Size	TPI	Pkg Qty	Price
229537	48-00-4712	6"	10 TPI	5 Pk	

### Sawzall® Blades (Continued)

#### The Torch™ Ice Hardened™ SAWZALL® Blades

(5 Pk)

Part #	Mfg #	Blade Size	TPI	Pkg Qty	Price
229538	48-00-4782	6"	14 TPI	5 Pk	
169668	48-00-4784	6"	18 TPI	5 Pk	
229539	48-00-4713	9"	10 TPI	5 Pk	
187923	48-00-4787	9"	14 TPI	5 Pk	
229540	48-00-4788	9"	18 TPI	5 Pk	

#### The Ax™ SAWZALL® Blades

- NAIL GUARD™ Ordinary teeth
- FANG TIP™
- The 1" tall blade body reduces blade twisting for straighter cuts
- Matrix II bi-metal teeth for greater durability



(5 Pk)

Part #	Mfg #	Blade Size	TPI	Pkg Qty	Price
152529	48-00-5021	6"	5 TPI	5 Pk	
152530	48-00-5026	9"	5 TPI	5 Pk	
152531	48-00-5027	12"	5 TPI	5 Pk	
233567	48-00-5052	9"	5 TPI	5 Pk	

(25 Pk)

Part #	Mfg #	Blade Size	TPI	Pkg Qty	Price
167955	48-00-8021	6"	5 TPI	25 Pk	
226632	48-01-2021	6"	5 TPI	25 Pk	

(100 Pk)

Part #	Mfg #	Blade Size	TPI	Pkg Qty	Price
167947	48-01-7021	6" Pk	5 TPI	100	



## Saws & Blades

### The Ax™ with Carbide Teeth SAWZALL® Blades

- Best tooth design
- NAIL GUARD™
- FANG TIP™
- Optimized for cordless: 25% more cuts per charge



Part #	Mfg #	Blade Size	TPI	Pkg Qty	Price
225843	48-00-5221	6"	5	1	
225845	48-00-5226	9"	5	1	
225847	48-00-5227	12"	5	1	

### The Wrecker™ SAWZALL® Blades

- A precise manufacturing process creates a sharper cutting edge on each tooth for a faster cutting blade
- A complete, unset raker tooth on the blade tip allows for easier, faster plunging by minimizing walking and bouncing
- A thicker, more rigid blade body resists fracturing and bending for maximum durability
- The 1" tall blade body reduces blade twisting for straighter, more accurate cuts



(5 Pk)

Part #	Mfg #	Blade Size	TPI	Pkg Qty	Price
152135	48-00-5701	6"	8 TPI	5 Pk	
152128	48-00-5706	9"	8 TPI	5 Pk	
242751	48-00-8706	9"	7/11 TPI	25 Pk	
152127	48-00-5711	12"	8 TPI	5 Pk	
242752	48-00-8711	12"	7/11 TPI	25 Pk	

(100 Pk)

Part #	Mfg #	Blade Size	TPI	Pkg Qty	Price
172982	48-01-7701	6" Pk	7/11	100	

### Fleam Ground SAWZALL® Blades

- Deep gullet design cuts up to 25% faster than standard wood blades
- Fleam ground process creates super sharp teeth for clean cuts
- Matrix II bi-metal teeth for greater durability



(5 Pk)

Part #	Mfg #	Blade Size	TPI	Pkg Qty	Price
169671	48-00-5015	6"	6 TPI	5 Pk	

### Carbide Grit SAWZALL® Blade

- Tungsten carbide for long life
- Coarse grit for fast cutting



Part #	Mfg #	Blade Size	Pkg Qty	Price
169674	48-00-1420	6"	3 Pk	
159451	48-00-1430	9"	3 Pk	

### Diamond Grit THE TORCH™ SAWZALL® Blade

- Diamond Grit delivers up to 30x longer life than standard carbide grit blades
- The precisely controlled size and placement of the diamond grit allow these blades to cut up to 2x faster than standard carbide grit blades
- The 1" tall blade body reduces blade twisting for straighter, more accurate cuts



Part#	Mfg#	Size	Price
152141	48-00-1440	6"	
151654	48-00-1450	9"	

### Wood Cutting Sawzall® Blade

- For cutting stock 3/8" and above
- Recommended for very fast cutting, nail-embedded wood, general roughing-in



Part #	Mfg #	TPI	Blade Size	Pkg Qty	Price
141058	48-00-8036	5 TPI	9" x 1/2"	25 Pk	
175720	48-01-7036	5 TPI	9" x 1/2" Pk	100	

## Saws & Blades

### Sawzall® Flush Cut Blade

- Floor guard shields teeth from floor contact during bottom plate cut-outs
- Double truss design guides blade for straight window cut-outs
- Nail Guard™ unique design protects against tooth fracture when cutting nails between studs and joists
- Fang Tip™ delivers fast plunge cutting for window cut-outs



Part #	Mfg #	TPI	Blade Size	Pkg Qty	Price
140976	48-00-1600	5	12" x 2-1/8"	1 Pk	

### Sawzall® Rough-In Blade

- Low blade profile cuts 2-1/8" diameter holes for 1-1/2" PVC pipe
- Can cut holes through double top plates
- NAIL GUARD™ Unique design protects against tooth fracture when cutting through holes in nail embedded wood
- FANG TIP™ fast plunge cutting through bottom plates and subfloors



Part #	Mfg #	TPI	Blade Size	Pkg Qty	Price
140978	48-00-1610	5	7-3/8" x 1/2"	5 Pk	

### SUPER SAWZALL® Blade

- Double relief angle reduces tooth stress for long life
- Precision forming process creates sharper teeth for fast cutting
- Matrix II bi-metal teeth for greater durability



Part #	Mfg #	TPI	Blade Size	Pkg Qty	Price
170458	48-00-5161	3-5/8"	10 TPI	5 Pk	

### Ductwork SAWZALL® Blade

- Pierce point tip geometry for quick plunging in ductwork with on tool
- Low blade profile for tight radius cuts
- Optimized tooth form designed specifically for cutting ductwork



Part #	Mfg #	Description	Price
169675	48-00-1630	5 Pk	

### Drywall Access SAWZALL® Blade

- Ideal for servicing plumbing and electrical
- Optimized length to minimize damage to pipe and wire
- Cut all directions
- Fast plunge



Part #	Mfg #	Description	Price
156089	48-00-1640	Drywall Access Blade	

### Pruning Sawzall® Blade

Part #	Mfg #	TPI	Blade Size	Pkg Qty	Price
142581	48-00-1303	5	12" x 3/4"	5 Pk	
186164	48-00-1301	5	9"	5 Pk	

### High-Carbon Steel Jig Saw Blade

- Heavy duty: Advanced construction for long life in tough professional applications
- Fast cuts; Tooth shape and sharpness permit clean scroll cutting in wood
- Versatile: Fits any jig saw that accepts a T-shank blade



Part #	Mfg #	TPI	Blade Size	Pkg Qty	Price
162387	48-42-5640	12 TPI	3"	5 Pk	
245521	48-42-5200	6 TPI	4"	5 Pk	
245520	48-22-5220	8 TPI	4"	5 Pk	
245522	48-42-5240	10 TPI	4"	5 Pk	

### B-Metal Jig Saw Blade

- Longer life
- Fast cuts
- Versatile: features a universal tang



Part #	Mfg #	TPI	Blade Size	Pkg Qty	Price
242753	48-42-2120	18 TPI	2-3/4"	5 Pk	
242754	48-42-2190	14 TPI	3-5/8"	5 Pk	
242739	48-42-2310	10 TPI	4-1/8"	5 Pk	



## Saws & Blades

### Sawzall® Blade Sets

#### 12-Piece Assortment General Purpose Sawzall® Blade Kit

• Includes:

- (4) 6" 18 TPI The Torch blades
- (2) 6" 8 TPI The Wrecker blades
- (2) 6" 5 TPI The Ax blades
- (2) 9" 5 TPI The Ax blades
- (2) 9" 14 TPI The Torch blades
- (1) Storage container



Part #	Mfg #	Description	Price
143952	49-22-1129	12-Pc Blade Kit	

#### SAWZALL® General Purpose 10pc Blade Set

• Includes:

- (3) 6" 14 TPI Metal THE TORCH™ SAWZALL® Blades
- (3) 6" 24 TPI Metal SAWZALL® Blades
- (2) 6" 5 TPI SAWZALL® Blade
- (1) 9" 18 TPI Metal THE TORCH™ SAWZALL® Blades
- (1) 9" 5 TPI Wood THE AX™ SAWZALL® Blades



Part #	Mfg #	Description	Price
246700	49-22-1110	10-Pc Blade Set	

#### 9-Piece Sawzall® Blade Set

• Includes:

- (2) 6" Wood cutting blades
- (1) 9" Wood cutting blade
- (3) 6" 14TPI Blades
- (3) 6" 24TPI Blades



Part #	Mfg #	Description	Price
152473	49-22-1145	9-Pc Blade Set	

#### 5-Piece Assortment General Purpose Sawzall® Blade Kit

• Includes:

- The Ax™ wood cutting
- The Torch™ metal cutting blades
- Demolition blades
- 1" tall profile for TOUGH, STRAIGHT CUTS



Part #	Mfg #	Description	Price
237166	49-22-1105	5-Pc Demolition SAWZALL®	

### Hackzall™ Blades

#### M12 Hackzall™ Blade



Part #	Mfg #	TPI	Length	For	Pkg Qty	Price
144141	49-00-5310	10	3-1/2"	Wood	5/Pk	
144142	49-00-5324	24	3-1/2"	Metal	5/Pk	
144143	49-00-5461	6	4"	Plaster	5/Pk	
244543	49-00-5410		4"	Multi	5/Pk	
244544	49-00-5614		6"	PVC/Plastic	5/Pk	
255395	49-00-5418		4"	EMT/Tube	5/Pk	
176363	49-00-5460		4"	Wood	5/Pk	

#### M12 Hackzall™ Blade 10-Pc Set

• Includes:

- (2) Wood blades
- (3) EMT Blades
- (2) Duct Blades
- (3) PVC Blades
- Storage pouch



Part #	Mfg #	Description	Price
143951	49-22-0220	M12™ Hackzall™ 10-Pc Set	

#### Hackzall™ Blades

- Longer life: Bi-metal construction lasts longer than high-speed steel and carbon blades
- Cuts common materials 1/4" - 1/2" thick
- Convenient: Fits most 12" hack saw frames



Part #	Mfg #	TPI	Length	Pkg Qty	Price
006937	48-43-0610	18	12"	10	
186598	48-43-0620	24	12"	10	
006938	48-43-0630	32	12"	10	



## Saws & Blades

### Sawzall® & Hackzall® Accessories

#### Scraper Blade

- Fits all Sawzall® and Hackzall® reciprocating saws
- Induction hardened blade edge
- Corrosion resistant coating
- Chambered corners prevent digging into work material
- Resharpenable blade



49-00-546 49-00-545

Part #	Mfg #	Description	Price
148390	49-00-5463	1-1/2" Scraper Blade	
148391	49-00-5456	3" Scraper Blade	
159007	49-00-5455	5" Scraper Blade	

#### Grout Removal Tool

- Fits all SAWZALL® and HACKZALL™ recip saws
- Curved cutting edge for maximum accuracy
- Coarse carbide grit for fast grout removal
- Corrosion resistant coating for longer life



Part #	Mfg #	Description	Price
159006	49-00-5450	Grout Removal Tool	

#### 3Pc Material Removal Blade

- Fits all Sawzall® and Hackzall™ Recip Saws
- Induction hardened blade edge for maximum durability
- Corrosion resistant coating
- Chamfered corners prevent digging into work material
- Resharpenable blade



Part #	Mfg #	Description	Price
145865	49-22-5403	Scraper, Grout Removal, Coarse Carbide Grit	

### Accessories

#### 18 Gauge Shear Head Assembly



Part #	Mfg #	Description	Price
244205	48-08-0500	18 Gauge	

#### 18 Gauge Shear Blade

- Use with Milwaukee model 6850



Part #	Mfg #	Description	Price
143860	48-44-0150	18 Gauge Center Shear Blade	
143861	48-44-0160	18 Gauge Left Shear Blade	
143862	48-44-0160	18 Gauge Right Shear Blade	

#### PVC Shear Blade

- Compatible only with the M12™ PVC Shear Tool
- Reinforced cutting edge
- Designed to cut PVC, CPVC, PEX, non-metallic conduit and rubber hose
- Bowtie connection



Part #	Mfg #	Description	Price
177853	48-44-0405	4" x 2.5" x 0.149"	

#### Bit Extension for Hex Shank Hole Saw Arbors

- Hex-wrench



Part#	Mfg#	Shank	Length	Price
170805	48-28-4008	3/8"	12"	
229946	48-28-4011	7/16"	18"	

### Band Saw Blades

#### Bi-Metal Band Saw Blade

- Matrix II high speed steel teeth
- For the fastest cutting, longest life blade life available

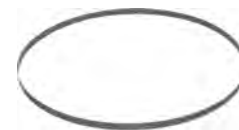

Part #	Mfg #	Description	Price
169677	48-39-0500	10 TPI Standard Deep Cut	
138593	48-39-0511	14 TPI Standard Deep Cut	
169676	48-39-0520	18 TPI Standard Deep Cut	
174043	48-39-0521	18 TPI Standard Deep Cut	
160569	48-39-0531	24 TPI Standard Deep Cut	



## Saws & Blades

### Compact Portable Band Saw Blade

- Matrix II high speed steel teeth
- Alloy backing steel
- Precision formed teeth



Part #	Mfg #	Description	Price
235684	48-39-0509	10 TPI Band Saw Blade, 3 Pk	
163508	48-39-0518	14 TPI Band Saw Blade	
149985	48-39-0519	14 TPI Band Saw Blade	
152649	48-39-0529	18 TPI Band Saw Blade	
163509	48-39-0538	24 TPI Band Saw Blade	
160570	48-39-0539	24 TPI Band Saw Blade	
150495	48-39-0572	18 TPI Band Saw Blade	

### Standard Deep Cut Band Saw Blade

Part #	Mfg #	Description	Price
006935	48-39-0510	14 TPI Portable	
006936	48-39-0530	24 TPI Portable	
233570	48-39-0550	10/14 TPI Portable	
235683	48-39-0501	10 TPI, 3/Pk	

### Extreme Metal Band Saw Blades

- Aggressive tooth design for 2X faster cuts in thick metals
- Fastest cutting blade in thin, hard metals
- Variable TPI, cuts more materials



Part #	Mfg #	Size Material		Price
		Thickness Qty	TPI	
257845	48-39-0711	27" 12/14" 3	Thin Metal	
257844	48-39-0619	35 3/8" 12/14" 3	Thin Metal	
259217	48-39-0616	35 3/8" 12/14" 25	Thin Metal	
257842	48-39-0611	44 7/8" 12/14" 3	Thin Metal	

### Circular Saw Blade

#### Circular Saw Blade 6-1/2"

- 5/8 in. arbor
- Thin kerf for faster cutting
- Framing and ripping blade
- Anti-kickback shoulder
- Precision ground carbide
- Expansion slots for truer cuts under heavy use



Part#	Mfg#	Size	Teeth	Pk Qty
151836	48-40-4015	6-1/2"	48	1
221315	48-40-4112	6-1/2"	40	1

#### 7-1/4" Circular Saw Blade

- 5/8 in. arbor with diamond knockout
- Thin kerf for faster cutting
- Framing and ripping blade
- Anti-kickback shoulder
- Precision ground carbide
- Expansion slots for truer cuts under heavy use



Part#	Mfg#	Size	Teeth	Pk Qty
155049	48-40-4116	7-1/4"	16	1
154493	48-40-4126	7-1/4"	40	1
220097	48-40-4123	7-1/4"	24	25
224590	48-40-4120	7-1/4"	24	1

### Ferrous Metal Circular Saw Blade

- Dry - No lubricant required
- Cool - No extreme heat buildup
- Clean - No burrs



Part #	Mfg #	Description	Price
148958	48-40-4070	5-3/8" 30 Teeth	
167389	48-40-4515	8" 42 Teeth	

### Sanding Disc

- Ceramic resin
- Duct pick up not available



Part #	Mfg #	Grit	Size	Qty/Pk	Price
237738	48-80-0838	80	9"	5/Pk	



## Saws & Blades

### Finish Wood Blades

- A High-ATB tooth pattern provides a superior finish with minimal tearout in the cut material
- Milwaukee's anti-friction coating keeps the blade cool while cutting and resists corrosion & gummying
- Laser cutting technology from 100% sheet steel increase cutting accuracy
- High alternate tooth bevel pattern
- Cobalt infused tungsten carbide
- Thin kerf blade
- Blade tensioning ring
- 100 Tooth; 1" arbor hole
- Great for use with: Softwoods, Hardwoods, Malamine, MDF, Veneered Plywoods, Paneling and Moldings



Part #	Mfg #	Description	Price
247798	48-40-0622	6-1/2" Fine Finish	
247799	48-40-0726	7-1/4" Fine Finish	
247800	48-40-1028	10" Fine Finish	

### Framing Wood Blade

- Laser cut vibration slots minimize wobble and warping
- Thin kerf blade
- 18 Tooth; 10mm arbor hole
- Laser cutting technology from 100% sheet steel increase cutting accuracy
- Cobalt infused tungsten carbide
- Optimized for both cordless & corded tools



Part #	Mfg #	Description	Price
247804	48-41-0710	7-1/4" 24T	
247802	48-41-0720	7-1/4" 24T	
247801	48-41-0620	6-1/2" 24T	

### General Purpose Circular Saw Blade



Part #	Mfg #	Description	Price
247803	48-40-1024	10", 40T	

### Segment Tool Blades

#### Titanium Segment Multi-Tool Blade



Part #	Mfg #	Description	Price
178189	48-90-0035	3-1/8"	

#### Segment Multi-Tool Blade

- Ideal for Cutting Wood, Drywall & Plaster, Fiberglass and Non-Ferrous Metals



Part #	Mfg #	Description	Price
178191	48-90-0045	3-1/8"	

#### Carbide Grit Segment Multi-Tool Blade

- Carbide Grit for Grout Removal and Cutting into Brick, Cement, Drywall & Plaster, and other Abrasive Materials



Part #	Mfg #	Description	Price
178194	48-90-0100	2-1/2"	
178195	48-90-0110	1-1/4"	

### Miscellaneous Blades

#### 25mm Precision Snap Blades

- Optimized grind angles
- Micro carbide dispersed metal
- Includes Snap-Off knife blade storage case



Part #	Mfg #	Length	Pack Qty	Price
239735	48-22-9125	7"	10 Pack	



## Saws & Blades

### Multi-Tool Accessory Blades

- Assortment of Multi-Tool Blades for a variety of applications
- Ideal for Cutting Wood with Nails, non-ferrous metals, and PVC



Part #	Mfg #	Description	Price
178197	48-90-1050	3-Piece	
178196	48-90-1000	3-Piece	
227885	48-90-1009	9-Piece	
178186	48-90-0020	1-3/4" Titanium	
178187	48-90-0025	1-1/8" Titanium	
178188	48-90-0030	1-1/4" Hard Point	
178190	48-90-0040	1-1/4" Bi-Metal	
178192	48-90-0050	2-1/2" Bi-Metal	
178193	48-90-0055	1-1/4" Japanese Tooth	
178184	48-90-0010	1-1/4" Extended Multi-Tool	
178185	48-90-0015	3/4" Multi-Tool	

### Universal Multi-Tool Blade Adapter

- Allows for all Milwaukee Multi-Tool Blades to be used with Porter Cable, Black & Decker, and DeWalt brand multi-tools



Part #	Mfg #	Description	Price
178183	48-90-0000	Universal Multi-Tool	

### Scraper Blade

- Rigid design for heavy duty scraping applications
- Adaptor (48-90-0000) available for Porter Cable®, Black & Decker®, and DeWalt® Multi-Tools



Part #	Mfg #	Description	Price
178198	48-90-0060	2.75" x 2.5"	

### Multi-Tool Sanding Pad

- Universal Shank\* connects to most professional grade multi-tools.
- Designed connection for use with Dust Extractor Kit (49-90-2400)
- Velcro backing for secure connection to sanding paper



Part #	Mfg #	Description	Price
178199	48-90-2000	3-1/2" x 3-1/2"	

### 80 Grit Sand Paper for Multi-Tool

- Velcro backing for secure connection to sanding pad.
- For use with M18™ Sanding Pad (48-90-2000)
- Designed holes for additional use of Dust Extractor Kit (49-90-2400)



Part #	Mfg #	Description	Price
178201	48-90-2080	8-Pk	

## Saws & Blades

### Hand Saws

#### Mini Hacksaw—Pistol Grip & Standard

- Separate screw sets the 6" blade tension
- Good for fine work in small areas.
- Six inch steel blade cuts copper and brass tube, bolts, steel, wood and plaster
- Pistol Grip is easier to hold and grasp



301-062

Part #	Mfg #	Type	Blade	Price
031884	301-062	Deluxe Pistol Grip	6"	
183402	301-065	Standard D-Type	6"	

#### SawHorse™ Multi-Purpose Saw

- High-quality, hardened-steel blade remains sharp through thousands of cuts
- Teeth are on the nose for notching in tight areas and starting cuts in the middle of floor or wall
- Perfect for plastic pipe, wood and many other materials
- 20" model has 10 teeth/inch for faster cutting
- 12" model has 13 teeth/inch for fine cutting.
- Both include plastic teeth protector



300-20

Part #	Mfg #	Blade Size	Price
049442	300-12	20"	
183400	300-20	12"	

### Replacement Blades

#### For: SawHorse™ Multi-Purpose Saws

Part #	Mfg #	For Model:	Price
051535	300-12B	300-12	

#### For: Mini Hacksaw—Pistol Grip & Standard

- 32 Teeth/Inch
- Pin ends

Part #	Mfg #	Material	Blade	Price
031885	301-061	Carbon Steel	6"	

---



---

## Saws & Blades

---



---

### Saws

#### PVC Cable Saw

- *Cuts plumbing or electrical PVC faster than hacksaw*
- *Ideal for tight spots and in-ground repairs*

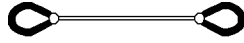

Part #	Mfg #	Description	Price
002737	70390	26" Cable Saw - Std	

## Screwdrivers & Bits

### Screwdrivers

#### #1 Phillips - 3" Screwdriver

- Wrench ready HEX shanks
- Forged tool shanks
- Wire bending hole- bend up to 12 gauge wire
- Wire stripper (Patent Pending)- strip up to 12G wire
- Visible ID markings



Part #	Mfg #	Description	Price
169658	48-22-2011	#1 Phillips - 3"	
245658	48-22-2811	#1 Phillips - 3"	

#### #2 Phillips- 4" Screwdriver

- Wrench ready HEX shanks
- Forged tool shanks
- Wire bending hole - bend up to 12 gauge wire
- Wire stripper (Patent Pending) - strip up to 12G wire
- Visible ID markings



Part #	Mfg #	Description	Price
169659	48-22-2012	#2 Phillips - 4"	
245659	48-22-2812	#2 Phillips - 3"	

#### #3 Phillips - 6" Screwdriver

- Wrench ready HEX shanks
- Forged tool shanks
- Wire bending hole - bend up to 12 gauge wire
- Wire stripper (Patent Pending) - strip up to 12G wire
- Visible ID markings



Part #	Mfg #	Description	Price
169660	48-22-2013	#3 Phillips - 6"	
245660	48-22-2813	#3 Phillips - 6"	

#### 1000V Insulated Screwdriver

- UL® Classified
- 1000V Insulated Protection
- Lanyard Holes



Part #	Mfg #	Description	Price
253689	48-22-2213	#3 Phillips - 6"	
255933	48-22-2221	1/4" Slotted - 6"	

### Demolition Screwdriver

- Wrench ready HEX shanks
- High impact steel cap
- Forged tool shanks
- Visible ID markings



Part #	Mfg #	Description	Price
169661	48-22-2021	1/4" Slotted - 4" Demolition	
162649	48-22-2022	5/16" Slotted- 6" Demolition	
162625	48-22-2023	3/8" Slotted - 8" Demolition	
245662	48-22-2821	1/4" Slotted - 4" Demolition	
245663	48-22-2823	5/16" Slotted- 6" Demolition	
245664	48-22-2825	3/8" Slotted - 8" Demolition	

#### 3/16" Cabinet - Screwdriver

- Forged tool shanks
- Visible ID Markings



Part #	Mfg #	Description	Price
169662	48-22-2032	3/16", 6"	
169663	48-22-2033	3/16" - 8"	
250949	48-22-2831	3/16" - 3"	
245665	48-22-2832	3/16" - 6"	
245666	48-22-2833	3/16" - 8"	

#### #1 Square Screwdriver

- Forged tool shanks
- Visible ID Markings



Part #	Mfg #	Description	Price
245667	48-22-2851	#1 Square - 3"	

#### 9-in-1 Square Drive Ratcheting Multi-bit Driver

- Hex shanks for additional leverage
- Chrome plated bits
- Magnetic bit retention
- Precision machined bit tips



Part #	Mfg #	Description	Price
256556	48-22-2322	9-in-1 Screwdriver Set	

## Screwdrivers & Bits

### 9-in-1 ECX Drive Ratcheting Multi-bit Driver

- Hex shanks for additional leverage
- Chrome plated bits
- Magnetic bit retention
- Precision machined bit tips



Part #	Mfg #	Description	Price
256555	48-22-2331	9-in-1 Screwdriver Set	

### 11-in-1 ECX™ Screwdriver

- Includes:
  - (1) Phillips #1
  - (1) Phillips #2
  - (1) Slotted 3/16"
  - (1) Slotted 1/4"
  - (1) Square #1
  - (1) Square #2
  - (1) ECX (TM) #1
  - (1) ECX (TM) #2
  - (1) 1/4" Nut Driver
  - (1) 3/8" Nut Driver
  - (1) Loop Maker



Part #	Mfg #	Description	Price
239242	48-22-2760	Multi-Use Screwdriver	

### 11-in-1 Screwdriver SQ

- Includes:
  - (1) Phillips #1
  - (1) Phillips #2
  - (1) Slotted 1/4"
  - (1) Slotted 3/16"
  - (1) Square #1
  - (1) Square #2
  - (1) Torx® #10
  - (1) Torx® #15
  - (1) 1/4" Nut Driver
  - (1) 3/8" Nut Driver



Part #	Mfg #	Description	Price
239243	48-22-2761	Multi-Use Screwdriver	

### 13-in-1 Cushion Grip Screwdriver with Schrader Bit

- 8 unique driver bits - P1, P2, SL 3/16, SL 1/4, SQ2, Std. Schrader, Lrg. Schrader
- 4 Unique nut drivers - 1/4", 5/16", 3/8", 1/2"
- 13 Unique functions
- Tri-material cushion grip handle
- Loop maker



Part #	Mfg #	Description	Price
248988	48-22-2881	13-in-1 Screwdriver Set	

### Demo Driver

- All metal core
- Multiple strike surfaces
- Aggressive duct piercing tip



Part #	Mfg #	Description	Price
243684	48-22-2860	Demo Driver	

### 2-PC Demo Screwdriver Set

- Includes:
  - (1) Phillips #6 x 6"
  - (1) Slotted 5/16" x 6"



Part #	Mfg #	Description	Price
239236	48-22-2702	Demo Driver Set	



## Screwdrivers & Bits

### 3-PC 1000V Insulated Screwdriver Set

- Flame retardant & impact resistant handle and shank
- UL® Classified
- Meets OSHA Insulated Tool Standard
- VDE & GS Certified
- Visible ID Markings
- Dual Layer Insulation
- Includes:
  - (1) #2 Phillips - 4" 1000V Insulated Screwdriver (48-22-2212)
  - (1) 1/4" Slotted - 6" 1000V Insulated Screwdriver (48-22-2221)
  - (1) #1 ECX™ - 4" 1000V Insulated Screwdriver (48-22-2241)



Part #	Mfg #	Description	Price
231074	48-22-2202	3Pc Insulated	

### 4-PC Precision Screwdriver Set

- All metal cores: up to 4x stronger
- Precision machined driving tips
- Longer shanks
- 360° rotating back caps
- Includes:
  - (1) Phillip #1 -4"
  - (1) Slotted 1/16" - 2 1/2"
  - (1) Slotted 3/32" - 2 1/2"
  - (1) Slotted 1/8" 3 1/2" Slotted



Part #	Mfg #	Description	Price
171805	48-22-2604	4 PC Precision Screwdriver Set	

### 6-PC Precision Screwdriver Set

- All metal cores: up to 4x stronger
- Precision machined driving tips
- Longer shanks
- 360° rotating back caps



Part #	Mfg #	Description	Price
172872	48-22-2606	6 PC Precision Screwdriver Set	

### 6-PC TORX® Precision Screwdriver Set

- All metal cores: Up to 4X Stronger
- Precision machined driving tips
- Longer shanks for improved visibility and extended reach
- 360-degree rotating back caps
- Color coded markings
- Chrome plated shanks
- Durable case with robust zipper



Part #	Mfg #	Description	Price
174831	48-22-2610	6 PC TORX® Precision	

### 6-PC Screwdriver Set

- Heat treated steel cap
- Wrench ready HEX shanks
- Forged tool shanks
- Wire bending hole
- Wire Stripper
- Visible ID Markings



Part #	Mfg #	Description	Price
175841	48-22-2006	6 Piece Screwdriver Set	

### 8-PC Screwdriver Kit with ECX

- Includes:
  - (1) ECX (TM) #1
  - (1) ECX (TM) #2
  - (1) Phillips #1 x 3"
  - (1) Phillips #2 x 4"
  - (1) Phillips #2 x 6"
  - (1) Slotted 1/4" x 4"
  - (1) Slotted 3/16" x 6"
  - (1) Slotted 5/16" x 6"



Part #	Mfg #	Description	Price
239239	48-22-2708	8 PC Kit w/ ECX	

## Screwdrivers & Bits

### 8-PC Screwdriver Kit with Square Recess



Part #	Mfg #	Description	Price
239240	48-22-2718	8 PC kit w/ Square Recess	

### 10-PC Screwdriver Kit

- Includes:
- (1) Phillips #1 x 3"
- (1) Phillips #2 x 1 1/2"
- (1) Phillips #2 x 4"
- (1) Phillips #2 x 6"
- (1) Slotted 1/4" x 1 1/2"
- (1) Slotted 1/4" x 4"
- (1) Slotted 3/16" x 6"
- (1) Slotted 5/16" x 6"
- (1) Square #1
- (1) Square #2



Part #	Mfg #	Description	Price
254736	48-22-2710	10 PC Screwdriver Set	

### 4Pc Pry Bar Set

- I-Beam design: up to 40% stronger
- All-metal core
- Hammer-ready strike cap
- Comfortable tri-lobe handles
- Chrome finish
- Easy-access storage tray
- Lifetime guarantee



Part #	Mfg #	Description	Price
243159	48-22-9214	8", 12", 18", 24"	

### Nut Drivers

#### Hollow Shaft Nut Driver

- Universal driver head fits 4X more fasteners
- Removes rusted and stripped bolts
- 3" Hollow shaft depth
- Wrench ready HEX shanks
- Chrome plated
- Forged steel shanks
- Deep well sockets
- Multiple ID markings



Part#	Mfg#	Size	Price
163305	48-22-2421	1/4"	
163306	48-22-2422	5/16"	

#### HollowCore™ Magnetic Nut Driver

- HollowCore™ unlimited depth
- Magnetic drivers
- Universal driver head fits 4X more fasteners
- Removes rusted and stripped bolts
- Color coded ID markings
- Wrench ready HEX shanks
- Chrome plated
- Forged steel shanks
- Deep well sockets



Part#	Mfg#	Size	Price
162644	48-22-2521	1/4"	
162645	48-22-2522	5/16"	
162646	48-22-2524	3/8"	
162817	48-22-2525	7/16"	
162818	48-22-2526	1/2"	
162819	48-22-2527	9/16"	
162816	48-22-2523	11/32"	

#### 2-PC SAE Hollow Shaft Nut Driver Set

- Universal driver head fits 4X more fasteners
- Removes rusted and stripped bolts
- 3" Hollow shaft depth
- Wrench ready HEX shanks
- Chrome Plated
- Multiple ID markings



Part #	Mfg #	Description	Price
163307	48-22-2402	2-Pc HollowCore Driver	

## Screwdrivers & Bits

### 4 PC Hollow Shaft SAE Nut Driver Set

- Universal driver head fits 4X more fasteners
- Removes rusted and stripped bolts
- 3" Hollow Shaft Depth
- Wrench Ready HEX shanks
- Chrome Plated
- Deep well sockets
- Multiple ID Markings
- Includes:
  - (1) 1/4" Hollow Shaft Nut Driver (48-22-2421)
  - (1) 5/16" Hollow Shaft Nut Driver (48-22-2422)
  - (1) 7/16" Hollow Shaft Nut Driver (48-22-2425)
  - (1) 9/16" Hollow Shaft Nut Driver (48-22-2427)



Part #	Mfg #	Description	Price
224649	48-22-2404	4-Pc HollowCore Driver	

### 2-PC SAE HollowCore™ Magnetic Nut Driver Set

- HollowCore™
- Magnetic drivers
- Universal driver head fits 4X more fasteners
- Removes rusted and stripped bolts
- Color coded ID markings
- Wrench ready HEX shanks
- Chrome plated
- Forged steel shanks
- Deep well sockets



Part #	Mfg #	Description	Price
162394	48-22-2502	2-Pc Nut Driver Set	

### 7-PC Hollow Shaft SAE Nut Driver Set

- Includes:
  - (1) 1/4" Hollow Shaft Nut Driver (48-22-2421)
  - (1) 5/16" Hollow Shaft Nut Driver (48-22-2422)
  - (1) 11/32" Hollow Shaft Nut Driver (48-22-2423)
  - (1) 3/8" Hollow Shaft Nut Driver (48-22-2424)
  - (1) 7/16" Hollow Shaft Nut Driver (48-22-2425)
  - (1) 1/2" Hollow Shaft Nut Driver (48-22-2426)
  - (1) 9/16" Hollow Shaft Nut Driver (48-22-2427)



Part #	Mfg #	Description	Price
221061	48-22-2407	7Pc Set	

### 7-PC Hollow Shaft Metric Nut Driver Set

- Includes:
  - 5 mm (48-22-2431)
  - 5.5mm (48-22-2432)
  - 6mm (48-22-2433)
  - 7mm (48-22-2434)
  - 8mm (48-22-2435)
  - 10mm (48-22-2436)
  - 13mm (48-22-2437)
  - 9/16" Driver
- 3" Hollow shaft depth
- Forged steel HEX shanks



Part #	Mfg #	Description	Price
241916	48-22-2417	7 Pc Nut Driver Set	

### 7-PC Magnetic HollowCore™ SAE Nut Driver Set

- Universal driver head fits 4X more fasteners
- Removes rusted and stripped bolts
- Color coded ID markings
- Wrench ready HEX shanks
- Chrome plated
- Forged steel shanks
- Deep well sockets
- Includes 9/16" driver



Part #	Mfg #	Description	Price
161964	48-22-2507	7-Pc Nut Driver Set	
242650	48-22-2517	7-Pc Nut Driver Set	

### 8-in-1 Compact Ratcheting Multi-bit Driver

- All metal ratchet
- Wrench ready: Hex shanks for additional leverage
- Chrome plated bits
- Includes:
  - (1) 8-in-1 Compact Ratcheting Multi-bit Driver (48-22-2330)
  - (1) 1/4" Nut Driver
  - (1) Phillips #1
  - (1) Phillips #2
  - (1) Slotted 1/4" x 4"
  - (1) Slotted 3/16" x 6"
  - (1) Square Bit 1" SQ1
  - (1) Square Bit 1" SQ2
  - (1) TORX® Bit 1" T15



Part #	Mfg #	Description	Price
256554	48-22-2330	8-Pc Driver Set	



## Screwdrivers & Bits

### Shockwave® Impact Duty™ Bits

- Steel heat treated to control hardness
- Forged tip for maximum grip
- Geometric design provides the shock absorption zone

#### Shockwave® Reduced Diameter Dry wall Phillips Insert Bit



Part #	Mfg #	Dia	Lgth	Pkg Qty	Phillips	Price
141257	48-32-4444	1/4"	1"	2	#2	

#### Shockwave™ Impact Locking Bit Holder

- Dual magnets
- Optimized shockzone
- Auto-locking design:
  - Fits all inserts and 1/4" HEX bits
- Quick release collar
  - One handed bit changes



Part #	Mfg #	Dia	Lgth	Pkg Qty	Phillips	Price
244547	48-32-4531	1/4"	2.875"	1	-	
241968	48-32-4533	1/4"	12"	1	-	

#### Shockwave® Impact Duty™ Phillips Power Bit



Part #	Mfg #	Dia	Lgth	Pkg Qty	Phillips	Price
141259	48-32-4602	1/4"	2"	5	#2	
164161	48-32-4461	1/4"	2"	1	#1	

#### Shockwave® Impact Duty™ Square Recess Insert Bit



48-32-442



48-32-4471

Part #	Mfg #	Dia	Lgth	Pkg Qty	Phillips	Price
141262	48-32-4421	1/4"	1"	2	#1	
141266	48-32-4471	1/4"	2"	1	#1	
141263	48-32-4422	1/4"	1"	2	#2	
141265	48-32-4605	1/4"	1"	5	#2	
141268	48-32-4606	1/4"	2"	5	#2	
141264	48-32-4423	1/4"	1"	2	#3	
141269	48-32-4473	1/4"	2"	1	#3	
141270	48-32-4572	1/4"	3-1/2"	1	#2	

### Shockwave® Torx® Power Bit



Part #	Mfg #	Dia	Lgth	Pkg Qty	Torx	Price
164162	48-32-4482	1/4"	2"	T10		
141271	48-32-4483	1/4"	2"	1	T15	
164163	48-32-4486	1/4"	2"	T27		
141274	48-32-4487	1/4"	2"	1	T30	

### Shockwave® Impact Torx® Power Bit

- OPTIMIZED SHOCKZONE™
- PRECISE FIT CUSTOM MACHINED TIP™
- CUSTOM ALLOY76™ STEEL



Part #	Mfg #	Lgth	Pkg Qty	Torx	Price
164166	48-32-4436	1"	2	T25	
141273	48-32-4485	2"	1	T25	
219698	48-32-4561	3-1/2"	1	T25	
141272	48-32-4484	2"	1	T20	

### SHOCKWAVE™ Impact Phillips Power Bit

- OPTIMIZED SHOCKZONE™
- PRECISE FIT CUSTOM MACHINED TIP™
- CUSTOM ALLOY76™ STEEL



Part#	Mfg#	Drive Size	Length	Pk Qty	Price
164171	48-32-4604	2	1"	25	
182487	48-32-4762	2	2"	25	
141258	48-32-4462	2	2"	1	
164174	48-32-4564	2	3-1/2"	5	
141261	48-32-4562	2	3-1/2"	1	
164175	48-32-4802	2	6"	1	
164164	48-32-4563	3	3-1/2"	1	
141251	48-32-4411	1	1"	2	
141255	48-32-4601	2	1"	5	
141256	48-32-4413	3	1"	2	
141254	48-32-4412	2	1"	2	
141260	48-32-4463	3	2"	1	
164173	48-32-5004	2	2"	15	



## Screwdrivers & Bits

### SHOCKWAVE™ Impact Square Power Bit

- OPTIMIZED SHOCKZONE™
- PRECISE FIT CUSTOM MACHINED TIP™
- CUSTOM ALLOY76™ STEEL



Part#	Mfg#	Drive Size	Length	Pk Qty	Price
164165	48-32-4573	3	3-1/2"	1	
141267	48-32-4472	2	2"	1	
164176	48-32-4805	2	6"	1	

### Shockwave® Bit Sets

#### SHOCKWAVE™ Impact Duty Drill & Drive Set

- Custom machine tip
- Custom alloy 76 steel
- 60 Piece kit include:
  - (1) Compact bit holder
  - (1) 6" Bit holder
  - Socket Adapter: 3/8"
  - Magnetic nut drivers: 1/4" & 5/16"
  - Hex drill bits: 1/16", 3/32", 1/8", 5/32", 3/16", 1/4"
  - Double ended power bits: PH2/SQ2, PH2/T25, PH2/SL#10, T20/T25
  - Insert driver bits: PH1, (6) PH2, PR2, (2) PH3, SQ1, (3) SQ2, SQ3, T10, T15, (2) T20, (3) T25, T30, SL#6, SL#10, Hex 3/16", Hex 1/4"
  - 2" Power Bits: PH1, (4) PH2, (2) PH3, SQ1, (3) SQ2, SQ3, (2) T20, (2) T25, T30, SL#10



Part #	Mfg #	Description	Price
241621	48-32-4029	60-Pc Set Impact Duty	

### 74-PC Shockwave® Impact Duty Driver Bit Set

- Includes:
  - (1) SHOCKWAVE™ Compact Magnetic Bit Holder
  - (1) 1/4" Magnetic Nut Driver
  - (1) 5/16" Magnetic Nut Driver
  - (1) 3/8" Socket Adapter
  - Phillips Bit
    - (2) 1" P1, (11) 1" P2, (1) 1" PR2, (3) 1" P3
  - Square Bit
    - (2) 1" SQ1, (4) S1" SQ2, (2) 2" SQ3
  - Slotted Bit
    - (1) 1" #8, (2) 1" #10
  - INSERT BIT HEX
    - (1) 1/4", (1) 1/8", (1) 3/16", (1) 9/64", (1) 5/32"
  - HexPower Groove Bit
    - (1) 3mm 312, (1) 4mm 312, (1) 5mm 312, (1) 6mm 312
  - TORX® Bit
    - (1) 1" T10, (2) 1" T15, (4) 1" T20, (7) 1" T25, (2) 1" T27, (2) 1" T30
  - Power Groove Bit
    - (2) P2 2", (1) P3 2", (2) SQ2 2", (1) SQ3 2", (1) T20 2"
    - (1) T25 2" (1) P2 3 1/2", (1) SQ2 3 1/2", (1) T25 3 1/2"
  - Double Ended Bit
    - (1) T20/T25, (1) P2/SL #10, (1) P2/SQ2, (1) P2/T25



Part #	Mfg #	Description	Price
251490	48-32-4062	74-Piece Impact Duty	

### 22-PC Shockwave® Puck Bit Dispenser

- Includes:
  - Magnetic bit holder
  - Phillips: (1) #1, (3) #2, (2) #
  - Square recess: (1) #1, (3) #2, (1) #3
  - Torx: (1) T10, (1) T15, (1) T20, (1) T25, (1) T27, (1) T30
  - Slotted: (1) 1/8", (1) 3/16", (1) 1/4", (1) 9/32"



Part #	Mfg #	Description	Price
143668	48-32-4011	22-Piece Puck Bit Dispenser	

### 7-PC TORX® Insert Bit Kit

- Kit includes:
  - (1) TORX® Bit 1" T10
  - (1) TORX® Bit 1" T15
  - (1) TORX® Bit 1" T20
  - (1) TORX® Bit 1" T25
  - (1) TORX® Bit 1" T27
  - (1) TORX® Bit 1" T30
  - (1) TORX® Bit 1" T40

Part #	Mfg #	Description	Price
164159	48-32-4615	7-Piece	

## Screwdrivers & Bits

### Right Angle Drive Unit

- For use with Milwaukee 1/2" d-handle drills
- Provides 2 additional drilling speeds
- Includes coupling No. 42-90-0175 for 0234-6 and 0244-1
- For 50% more torque or 50% more speed



Part #	Mfg #	Description	Price
162598	48-06-2871	Right Angle Drive Unit	

### 11-PC Shockwave® Impact Duty™ 30° Knuckle™ Pivoting Bit Holder Bit Set

- Locks at 0° or 30° angle
- Maximum torque: 2,000 in-lbs
- Includes:
  - Phillips bits: 1" P Shockwave® 30° Knuckle™ pivoting bit holder 1, P2 & P3
  - Square bits: 1" SQ1 & SQ2
  - Slotted bits: 1" SL1/8", SL 3/16", SL1/4", SL9/32"
  - Torx® bits: 1" T25



Part #	Mfg #	Description	Price
146101	48-32-2301	11-Pc Bit Set & Knuckle Bit Holder	

### 7-PC SHOCKWAVE™ Hex Security Insert Bit Set



Part #	Mfg #	Description	Price
237357	48-32-4619	7-Pc Bit Set	

### Shockwave® Nut Drivers

#### Shockwave® Magnetic Nut Driver

- Steel heat treated to control hardness
- Color-coded rings for size identification
- Chamfered edge



Part #	Mfg #	Size	Pkg Qty	Price
141231	49-66-4502	1/4" x 1-7/8"	1	
141243	49-66-4522	1/4" x 1-7/8"	3	
141247	49-66-4532	1/4" x 2-9/16"	1	

### Shockwave® Nut Drivers (Continued)

#### Shockwave® Magnetic Nut Driver

Part #	Mfg #	Size	Pkg Qty	Price
228380	49-66-4732	1/4" x 2-9/16"	10	
140360	49-66-4503	5/16" x 1-7/8"	1	
141236	49-66-4506	7/16" x 1-7/8"	1	
141244	49-66-4523	5/16" x 1-7/8"	3	
228381	49-66-4733	5/16" x 2-9/16"	10	
141248	49-66-4533	5/16" x 2-9/16"	1	
141245	49-66-4525	3/8" x 1-7/8"	3	
141249	49-66-4535	3/8" x 2-9/19"	1	
141246	49-66-4526	7/16" x 1-7/8"	3	
141250	49-66-4536	7/16" x 2-9/16"	1	
164177	49-66-4537	1/2" x 2-9/16"	1	
141234	49-66-4505	3/8" x 1-7/8"	1	

#### Set



Part #	Mfg #	Size	Pkg Qty	Price
141241	49-66-4562	1-7/8"	4	
141237	49-66-4561	1-7/8"	3	

#### SHOCKWAVE™ 1/4" Hex Adapter SQ 3/8"

- Proprietary steel and heat treat process for maximum strength and durability
- Heavy duty construction for fastening capabilities in all impacts



Part #	Mfg #	Description	Price
153737	48-03-4405	1/4" Hex Adapter SQ 3/8"	

#### SHOCKWAVE™ 1/2" Square to 1/4" Hex Adapter

- Proprietary steel and heat treat process for maximum strength and durability
- Heavy duty construction for fastening capabilities in all impacts



Part #	Mfg #	Description	Price
164154	48-03-4410	SHOCKWAVE™ 1/2" Square to 1/4" Hex Adapter	



## Screwdrivers & Bits

### SHOCKWAVE™ Square Socket Adapter

- Proprietary steel and heat treat process
- Heavy duty construction



Part #	Mfg #	Description	Price
164155	48-32-5030	1/4" Hex to 1/4" Square Socket	
154029	48-32-5031	1/4" Hex to 3/8" Square Socket	
164157	48-32-5032	1/4" Hex to 1/2" Square Socket	

### SHOCKWAVE™ Impact Hex Shank Socket Adapter Set

- Includes:
  - (1) 1/2" Socket Adapter
  - (1) 1/4" Socket Adapter
  - (1) 3/8" Socket Adapter



Part #	Mfg #	Description	Price
255824	48-32-5033	3-Pc Adapter Set	

### Bit Sets

#### 38-PC Universal Quik-Lok™ Drill & Drive Set

- Made of premium grade S2 tool steel
- Titanium hex shank bits
- Magnetic nut drivers



Part #	Mfg #	Description	Price
138409	48-32-1500	38Pc Quick-Lok™ Drill & Drive Set	

#### 4-PC Universal Replacement Bit Set

- Includes:
  - ECX Bit #1 & #2
  - Phillips #1 & #2
  - Slotted 3/16" & 1/4"
  - Square #1 & #2



Part #	Mfg #	Description	Price
142609	48-22-2110	4-Pc Replacement Bit Set	

### Installation Kit for Concrete Screws

- (1) 1/4" Hex Drive Bit
- (1) 3/16" x 7" with 1/4" Hex Rotary Hammer Drill Bit
- (1) 5/16" Hex Drive Bit
- (1) 5/32" x 7" with 1/4" Hex Rotary Hammer Drill Bit
- (1) Drive Sleeve
- (1) #2 Phillips Driver Bit
- (1) #3 Phillips Driver Bit



Part #	Mfg #	Description	Price
169685	48-20-7497	6-Pc Set	

## Screwdrivers & Bits

### Screwdrivers

#### Regular Grip Screwdriver - Electrical Style



Part #	Mfg #	Blade Dia	Blade Length	Price
006380	C22M	1/8"	2"	

### Nut Drivers

#### CONNEXT™ Pre-Assembled Magnetic Hex Driver - Long Lengths



- CONNEXT™ Quick change handles
- Magnetic hex chuck driver shaft components
- Use with Zip-In® and "A" hex head screws

Part #	Mfg #	Hex Dia	Shaft Length	Grips	Price
006416	HHD1	1/4"	6-7/8"	Red	
006417	HHD2	5/16"	6-7/8"	Yellow	

#### CONNEXT™ Pre-Assembled Magnetic Hex Driver



#### Standard Lengths

- CONNEXT™ Quick change handles
- Magnetic hex chuck driver shaft components
- Use with Zip-In® and "A" hex head screws

Part #	Mfg #	Hex Dia	Shaft Length	Grips	Price
132792	HHD1S	1/4"	3"	Red	

#### CONNEXT™ Pre-Assembled Magnetic Hex Driver - Stubby



- CONNEXT™ Quick change handle
- Magnetic hex chuck driver shaft components
- Use with Zip-In® and "A" hex head screws

Part #	Mfg #	Hex Dia	Shaft Length	Grips	Price
132795	HHD2T	5/16"	2-1/4"	Yellow	

### Dual-Sided Hex Chuck Driver

- Reversible
- Red: 1/4"
- Yellow: 5/16"



Part #	Mfg #	Hex Dia	Shaft Length	Price
231525	MSHC	1/4"/5/16"	2"	

### Power Bits

#### Phillips Power Bit

- 1/4" Shank diameter



Part #	Mfg #	Point Size	O/A Length	Price
006444	MBLP3	2	1-15/16"	

#### Magnetic Hex Driver Bit

- 1/4" Shank diameter



Part #	Mfg #	Hex Opening	Nose Diameter	Price
006447	MSH1/4	1/4"	7/16"	
006449	MSH5/16	5/16"	1/2"	
006448	MSH3/8	3/8"	9/16"	

#### Long Style Hex Driver Bit

- 1/4" Shank diameter



Part #	Mfg #	Hex Opening	Nose Dia	Qty	Price
006446	MSHL1/4	1/4"	7/16"	1	
025655	MSHL5/16	5/16"	1/2"	1	

#### Extra Long Style Hex Driver Bit

- 1/4" Shank diameter



Part #	Mfg #	Hex Opening	O/A Length	Price
025042	MSHML1/4	1/4"	4"	
023240	MSHXL1/4	1/4"	6"	
096867	MSHXL5/16	5/16"	6"	

## Screwdrivers & Bits

### Power Bit Extension

- Ball bearing on holder provides a positive lock on 1/4" hex
- Tempered steel
- Black finish
- 9/16" Nose diameter



Part #	Mfg #	Hex Opening	O/A Length	Price
006378	BHE6	1/4"	6"	
006377	BHE10	1/4"	10"	

### Power Driver Hex Adapters

#### Quick Change Hex Adapter



Part #	Mfg #	Hex Dia	Shank Dia	O/A Length	Price
006407	HAD1	1/4"	3/4"	1-3/4"	

### Miscellaneous Tools

#### Tensioning Tool with Manual Cut Off and Grips



Part #	Mfg #	Description	Price
061800	TY4G	Notched Gripper	



## Screwdrivers & Bits

### Screwdrivers

#### 4-In-One Pocket Mini Screwdriver

- Includes:
  - 3/32" & 1/16" Slotted bit
  - #0 & #000 Phillips bit



Part #	Mfg #	Color	Price
136199	24008	Black/Yellow	

#### 6-In-One Screwdriver

- Includes:
  - 1/4" & 3/16" Slotted bit
  - #1 & #2 Phillips bit
  - 1/4" & 5/16" Hex nut driver



Part #	Mfg #	Color	Price
028106	24006	Red	

## Screwdrivers & Bits

### Screwdrivers & Bits

#### 9 in 1 Multi-Tool

- Slip-resistant grip
- Thick-walled shaft
- Included:
  - Bits
  - Valve core remover
  - Square #2
  - 1/2" Hex
  - 5/16" Hex
  - 3/8" Hex
  - Phillips #1 & #2
  - 3/16" and 1/4" slotted



Part #	Mfg #	Description	Price
165766	1839053	9-in-1 Multi-Tool	

#### 3" Shaft Magnetic Nut Drivers

- Secure hold
- Color-coded for quick identification
- Slip-resistant grip
- Hollowed shaft allows for use on long bolts
- Chrome-vanadium steel construction



Part #	Mfg #	Description	Price
171359	1839059	Red, 1/4" x 3"	
171360	1839060	Yellow, 5/16" x 3"	

#### 6" Shaft Magnetic Nut Drivers

- Secure hold
- Color-coded for quick identification
- Slip-resistant grip
- Hollowed shaft allows for use on long bolts
- Chrome-vanadium steel construction



Part #	Mfg #	Description	Price
171362	1839068	Red, 1/4" x 6"	
171363	1839069	Yellow, 5/16" x 6"	
171364	1839074	Set of 2, 1/4" & 5/16"	

### Precision Screwdriver Set

- Comfortable grips
- Maximum precision
  - Rotating head allows for precise adjustments
- Quick identification with easy-to-read tips
- Pouch included for storage
- Includes:
  - #0x3" Phillips, 1/16"x2", 3/32"x3", 1/8"x4", 1/8"x6" Slotted



Part #	Mfg #	Description	Price
174627	1891089	5-Pc Set	



## Hand Sewer Machines

### Flexicore® Closet Augers

#### Regular Head Closet Auger

- With Flexicore double layer wire rope center



3FL

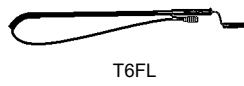

T6FL

Part #	Mfg #	Description	Price
093674	3FL	3' Flexicore (6/Ctn)	
005064	T6FL	6' Teletube Flexicore	

#### Down Head Closet Auger

- Flexicore double layer wire rope center

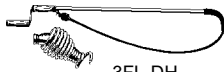

3FL-DH



T6FL-DH

Part #	Mfg #	Description	Price
005068	3FL-DH	3' Flexicore	
005063	T6FL-DH	6' Teletube Flexicore	

### Urinal Augers



Part #	Mfg #	Description	Price
038683	TU4	Telescoping Teletube® - 48" Spring (6/Ctn)	



## Hand Sewer Machines

### Petersen Drain Flushers

- Multi-flex™ multiple ply construction, high flow rate flushing
- Flexible for insertion around bends, internal stiffener for easy insertion
- 3/4" Water hose coupling

Petersen



R193400



R193600



R193700

Part #	Mfg #	Description	Price
008378	R193400	102-001 1-1/2" Drain Jet	
008380	R193600	102-003 3" Drain Jet	
008904	R193700	102-004 4" Drain Jet	

### Suction Guns

Part #	Mfg #	Description	Price
080436	R441825	Last Drop Suction Gun	



## Hand Sewer Machines

### Plungers

#### Rubber Plunger

- Includes funnel-shaped cap that is retractable for use in flat sinks



Part #	Mfg #	Type	Handle	Price
183404	312-2	Funnel	20"	



---

---

## Hand Sewer Machines

---

---

### Clog Buster™ Drain Flushers



Part #	Mfg #	Size	Price
002966	CI1123DRAFLU	1-1/2" - 3"	



## Hand Sewer Machines

### Drain Cleaning & Tools

#### Mighty Mini Sink Plunger

- 4" Black rubber cup
- 8" Plastic handle
- Barcode label



Part #	Mfg #	Description	Price
053480	090288	Mighty Mini Sink Plunger	

#### All Angle Power Plunger

- Flexible black rubber cup with 21" yellow handle
- Fully assembled with header card



Part #	Mfg #	Description	Price
041779	090300	Power Plunger	



---

---

## Hand Sewer Machines

---

---

### Plungers



Part #	Mfg #	Description	Price
008174	93-8	Korky® Plunger	



---

---

## Hand Sewer Machines

---

---

### Snake-Oil™

- *Highly recommended for use with all types of cables*



Part #	Mfg #	Description	Price
010265	SOQ-12	1 qt, 12/Pk	





## Power Sewer Machines

### Ken-Way Junior Drain Cleaner

- Cleans 1" to 4" drain and process lines
- All steel construction
- Can handle cable sizes 1/4" to 1/2"
- Three drum size options
- Chuckless design speeds cable feeding
- Air powered foot switch
- Heavy-duty 1/4 hp motor
- Dimensions: 14"H x 17-1/2"W x 11"D
- Weight without cable: 24 lbs



Part #	Mfg #	Description	Price
110571	J045	Ken-Way Jr. Drain Cleaner w/Regular Drum & 3/8" x 50' Blade End Cable & Blades	



## Power Sewer Machines

### Super-Vee™ Drain Cleaners

#### Super-Vee™ Drain Cleaner Kit

- Includes:
  - Basic unit (side action chuck, variable speed motor with reversing switch)
  - Case
  - HECS Cutter set
  - (1) Additional cartridge

Part #	Mfg #	Description	Price
019540	SV-C-WC	1/4" x 50' (50HE1) & 3/8" x 35' (35HE2) Cables	

### Mini-Router™ Drain Cleaners

#### Mini-Router™ Drain Cleaner Kit

- Includes:
  - Basic unit (MR-200 drum, 1/3 hp motor with reverse switch, 10' power cord, ground fault interrupter, waterproof air foot switch, leather gloves and cable)
  - MRCS Cutter set (AH arrow head, BG boring gimlet, 1-1/2" U & 1-1/2" U-cutter, 2" SCB side cutter blade)

Part #	Mfg #	Description	Price
005054	MR-B	75' x 3/8" (75EM2) Cable & MRCS Cutter Set	

#### Mini-Router™ Drainer Cleaner Accessories



Part #	Mfg #	Description	Price
028942	MR-W	Mini-Router™ Dolly	

### Flexicore Cables

- With male and female connectors 

Part #	Mfg #	Size	Price
005072	50EM2	3/8" x 50'	
027735	100EM5	3/4" x 100'	

### Replacement Cables



Basin Plug Head

Part #	Mfg #	Description	Price
020328	25HE1	1/4" x 25' w/EI Basin Plug Head	
005073	50HE1	1/4" x 50' w/EI Basin Plug Head	

### Cutters

#### Cutters for 3/8" Cable

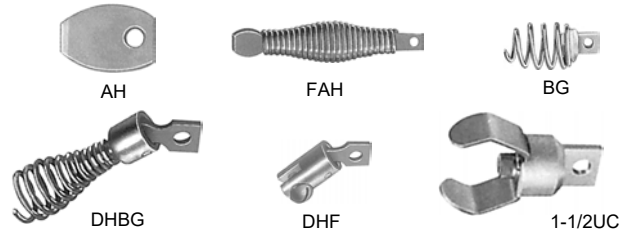

Part #	Mfg #	Description	Price
005048	AH	Arrow Head	
018911	FAH	Flex Arrow Head	
005049	BG	Boring Gimlet	
005051	DHBG	Down Head Boring Gimlet	
005052	DHF	Down Head Fitting	
005065	1-1/2UC	1-1/2" U-Cutter	

#### Cutters for 5/8" & 3/4" Cable

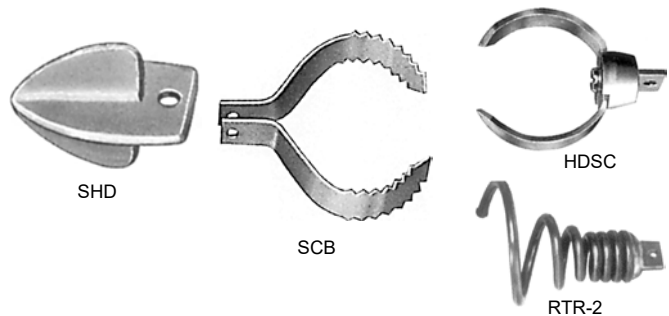

Part #	Mfg #	Description	Price
019877	SHD	Spear Head Starting Drill	
005069	3SCB	3" Side Cutter Blade - 2-Pc	
005071	4SCB	4" Side Cutter Blade - 2-Pc	
017789	3HDSC	3" Heavy-Duty Side Cutter	
019876	RTR-2	Corkscrew Retrieving Tool	



## Power Sewer Machines

### Connectors

#### Basic Connector

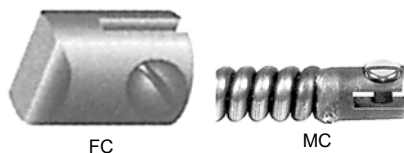

Part #	Mfg #	Description	Price
019868	5/8FC	5/8" Female, Butt Weld	
019870	3/4FC	3/4" Female, Butt Weld	
005070	3/8E-FC	3/8" Female, For 3/8" EM Cable	
019865	3/8MC	3/8" Male	
019867	1/2MC	1/2" Male	
019869	5/8MC	5/8" Male, Butt Weld	
019975	3/4MC	3/4" Male, Butt Weld	

#### Quick Fix Connector



Part #	Mfg #	Description	Price
019860	1/2QF	1/2" Quick Fix	
019862	5/8QF	5/8" Quick Fix	
017788	3/4QF	3/4" Quick Fix	

#### Connector Screw

Part #	Mfg #	Description	Price
019864	5/8CS	5/8", 5-Pack, For Butt Weld	
005050	3/4CS	3/4", 5-Pack, For Butt Weld	

### D-25 Handy™ Drain Cleaner Heads

#### D-25 Handy™ Drain Cleaner Head - Down Head (DH)

- Flexicore™ cable units
- Can be attached to a drill



Part #	Mfg #	Description	Price
095198	D-25-2	1/4" x 25'	

### Flexicore® Wire Rope Center Drain Augers

#### Regular Head less Handle

- Includes rotary handle
- Hand wire only



Part #	Mfg #	Description	Price
043667	L-25FL1	1/4" x 25'	

#### Down Head less Handle

- Includes rotary handle
- Hand wire only



Part #	Mfg #	Description	Price
097172	L-25FL1-DH	1/4" x 25'	

### Flat Sewer Rods

- Oil tempered - rust ban coated
- Quick-Grip handle
- Roller head



#### Flat Sewer Rod for 4" - 6" Pipe

Part #	Mfg #	Size	Lgth	Price
032705	100D	3/4" x 1/8"	100'	

## Refrigeration Tools

### Service Tools

Part #	Mfg #	Description	Price
181298	18978	Schrader Rethreading Tool	
181299	18979	Broken Schrader Remover	

#### 4-In-1 Seal Kit

- Kit includes:
  - Core
  - Cap
  - Gasket
  - 4 "O"-Rings



Part #	Mfg #	Size	Price
181296	18974	1/4"	

#### 4-In-1 Vacuum/Charge Ball Valve Tool

- 800 psi working pressure



Part #	Mfg #	Size	Side Port	Price
181295	18971	1/4"	No	
181298	18978	1/4"	Yes	
181300	18985	5/16"	No	

#### Gas Retention Valve

- 1/4" Female fl. x 1/4" Male fl.
- 500 psi working pressure
- Back seat valve feature to retain gas in hose when disconnecting
- Closes Schrader before disconnecting



Part #	Mfg #	Size	Price
181302	18993	1/4"	

### Hoses

#### FlexFlow™ Low Loss Adapter Hoses

- 8" Bend radius
- 4,000 psi minimum burst
- 800 psi maximum working pressure
- Operating temperature -20° to 180°F
- 3-Pak includes a yellow, blue, & red hose



#### Compact Ball Valve Assemblies

Part #	Mfg #	Size	Length	Color	Price
181631	29201	1/4"	9"	Blue	
181633	29601	1/4"	9"	Red	
181646	29980	1/4"	9"	3 Pak	

### FlexFlow™ Assemblies

Part #	Mfg #	Size	Length	Color	Price
181564	25002	1/4"	9"	Yellow	
181565	25202	1/4"	9"	Blue	
181566	25602	1/4"	9"	Red	
181620	25980	1/4"	9"	3 Pak	

#### Large VolumePlus II™ Hose (3/8" FI. Str. x 3/8" FI. Str.)

- 3,000 psi burst
- 600 psi working pressure
- For vacuum and charging



Part #	Mfg #	Size	Length	Price
181289	14560	3/8"	60"	

#### Plus II™ Heavy Duty Charging/Vacuum Hose

- 8" Bend radius
- 3,000 psi minimum burst
- 600 psi maximum working pressure
- Operating temperature -22° to 176°F



Part #	Mfg #	Size	Length	End Type	Price
181291	15648	3/8"	48"	3/8"StrX3/8"Str	
237904	15660	3/8"	60"	3/8"StrX3/8"Str	
236454	16236	3/8"	36"	3/8"StrX1/4" 45°	
181540	19660	3/8"	60"	3/8"StrX3/8" 45°	
246789	16248	3/8"	48"	3/8"StrX1/4" 45°	

#### Plus II™ Heavy Duty Charging/Vacuum Hose

- 10" Bend radius
- 3,000 psi minimum burst
- 600 psi maximum working pressure
- Operating temperature -22° to 176°F



Part #	Mfg #	Size	Length	End Type	Price
247829	16448	1/4"	48"	1/4"Angle x 1/2"	
181292	15848	1/2"	48"	1/2" x 1/2"	
181543	20660	3/8"	60"	3/8" x 3/8"	

#### Plus II™ "B" Charging Hose

- 6" Bending radius
- 3,000 psi minimum burst
- 600 psi maximum working pressure
- Operating temperature -20° to 180°F



Part #	Mfg #	Color	Length	End Type	Price
181293	18160	Yellow	60"	3/8Str x 3/8 45°	
181542	20460	Yellow	60"	1/4Str x 1/4 45°	
181630	28060	Red	60"	(3/8) Str FlxStr Fl	

## Refrigeration Tools

### Plus II™ Hose with Compact Ball Valve End

- Full flow valve
- 6" Bending radius
- 4,000 psi minimum burst
- 800 psi maximum working pressure
- Operating temperature -20° to 180°F
- Uses standard gasket and valve opener
- 3-Pak includes a yellow, blue, and red hose



Part #	Mfg #	Size	Length	Color	Price
181647	29985	1/4"	60"	3 Pak	

### Plus II™ Charge Hose w/ Double Barrier Protection

- 6" Bending radius
- 4,000 psi minimum burst
- 800 psi maximum working pressure
- Operating temperature -20° to 180°F
- 3-Pak includes a yellow, blue, and red hose



Part #	Mfg #	Size	Length	Color	Price
181545	21024	1/4"	24"	Yellow	
181376	21060	1/4"	60"	Yellow	
181377	21260	1/4"	60"	Blue	
181546	21312	1/4"	12'	Blue	
181547	21636	1/4"	36"	Red	
181378	21660	1/4"	60"	Red	
181548	21712	1/4"	12'	Red	
181550	21985	1/4"	60"	3 Pak	

### Plus II™ Hose with FlexFlow™ Valve

- 6" Bending radius
- 4,000 psi minimum burst
- 800 psi maximum working pressure
- Operating temperature -20° to 180°F
- Valve handle position shows when valve is opened or closed
- 3-Pak includes a yellow, blue, and red hose



Part #	Mfg #	Size	Length	Color	Price
181606	25060	1/4"	60"	Yellow	
181609	25260	1/4"	60"	Blue	
181610	25660	1/4"	60"	Red	
181623	25983	1/4"	36"	3 Pak	
181625	25984	1/4"	48"	3 Pak	
181627	25986	1/4"	72"	3 Pak	

### Plus II™ Hose with SealRight™ Fitting

- 45° End
- 6" Bending radius
- 4,000 psi minimum burst
- 800 psi maximum working pressure
- Operating temperature -20° to 180°F
- Low loss anti-blow back SealRight™ fitting
- Gaskets resist deterioration from existing CFC, HCFC and HFC refrigerants and oils
- Available with SealRight™ fittings on both ends
- 3-Pak includes a yellow, blue, and red hose



Part #	Mfg #	Size	Length	Color	Price
181556	22060	1/4"	60"	Yellow	
181558	22236	1/4"	36"	Blue	
181559	22260	1/4"	60"	Blue	
181560	22660	1/4"	60"	Red	
181561	22983	1/4"	36"	3 Pak	
181340	22985	1/4"	60"	3 Pak	
181562	22986	1/4"	72"	3 Pak	

### Plus II™ Hose for Flare & Service Ports

- For 5/16" flare (1/2 – 20 thread) service ports for R-410A
- 6" Bending radius
- 4,000 psi minimum burst
- 800 psi maximum working pressure
- Operating temperature -20° to 180°F
- Compatible with both POE and PVE oils
- 3-Pak includes a yellow, blue, and red hose
- Yellow hose has 1/4" (7/16-20) compact ball valve



Part #	Mfg #	Size	Length	Color	Price
181644	29485	1/4"	60"	3 Pak	

## Quick Connects

Part #	Mfg #	Description	Price
181307	19010	CH20 & CH14 for 1/4" Hose	
181310	19011	CH11 Gasket for 3/8" Hose	
181313	19020	CH20 for 1/4-1/2" Acme Hose	
181314	19026	3/8" Quad Ring Pack (10Pk)	
181315	19037	1/4" SealRight O-Ring (10PK)	
181316	19040	SealRight Repair Kit with Valve, Gasket, Plug, Spring, and 2 O-Rings	

## SealRight™ Quick Couplers

Part #	Mfg #	Description	Price
181317	19100	Quick Cplg Set 19109&19209	
249860	19203	90° 3/8"FM QC x 3/8" M Flr	



## Refrigeration Tools

### Quick Connects (Continued)

#### SealRight™ Quick Couplers

Part #	Mfg #	Description	Price
181515	19208	45° 1/4" SealRight x 1/4" M Flr	
181516	19209	90° 1/4" SealRight x 1/4" M Flr	

#### Cylinder Valve Adapter

- Finger tight adapters fit 125 and 145 lb cylinders
- Seal remains seated



Part #	Mfg #	Description	Price
181320	19105	3/4" NPS x 1/4" Male Flare	

#### Compact Ball Valve

- 4,000 psi minimum burst
- 800 psi maximum working pressure
- 5/16" for R-410A applications where 5/16" system ports are used



Part #	Mfg #	Description	Price
182367	93825	5/16" for Fml Flr x 1/4" M Flr	
182369	93843	1/4" 45° Compact Ball Valve	

#### Vacuum Pump Adapter

- Convert a 3/8" or 1/2" vacuum pump intake into 1/4" and 1/2" Acme R-134a compatible fittings



Part #	Mfg #	Adapter	Flare	Ftgs	Price
181648	36019	3/8"	1/4"	1/2"	

#### Auto A/C Fittings Couplers



Part #	Mfg #	Description	Price
181319	19102	R-134a 1/4" Fml QCx3/8" M FI	
181321	19109	R-12 (1/4") SealRight x M Flr	
181512	19191	R-12 1/4" fe QC x 90° 1/4" M Flr with Schrader	

### Quick Coupler with Schrader Core in Male End



Part #	Mfg #	Description	Price
181380	19173	5/16" QC Fml x 1/4" Male Flr	

### Manifold Gauge Sets

#### Manifold Parts & Accessories

Part #	Mfg #	Description	Price
181726	40279	Manifold Hanging Hook	
236521	41082	Titan 4-Valve Rebuild Kit	
181364	42001	Series 41 Manifold Only R22/404A/410A	
181809	42004	Series 41 Manifold R22/404A/410A with 60" PLUS II Standard Fittings	

#### Brute II™ Test and Charging Manifold

- 1/4" Hi-/lo-sides with 3/8" vacuum port
- Manifold and hose holder fittings: 1/4"-3/8"-1/4"-1/4"
- Front access for easy field recalibration
- Double "O" ring piston
- Contoured color-coded easy-grip handles



Part #	Mfg #	Description	Price
181835	46003	Test and Charging Manifold	



## Refrigeration Tools

### P51 Series Titan™ Digital Manifold

- Auto shut-off
- USB charging port
- Robust housing
- On board data logging
- 4-way TITAN valve block
- Includes:
  - Vacuum sensor
  - 2 temperature clamps
  - Backpack carrying case
  - Set of four manifold hoses (3 1/4" RYB and 1 3/8" yellow vacuum hose)
- Backlit display with auto-dimming
- Pressure hold mode displays rate of change for both vacuum and positive pressure measurements
- 126 refrigerant profiles stored in the instrument including new blends not currently on the Refprop database
- Maximum working pressure 700 psi
- System superheat and subcooling calculations
- Bluetooth capability for use with ManTooth app
- Re-chargeable battery with battery life indicator
- Displays vapor and liquid saturation temperatures



Part #	Mfg #	Description	Price
246160	P51-870	Titan Digital Manifold	

### Vacuum Gauges

Part #	Mfg #	Description	Price
182267	69071	Gauge Coupler, 1/4" Fml FI	
182268	69073	Replacement Sensor for Models 69070 and 69075	
182286	69095	Tee Fitting for 69080	

### Digital LCD Economy Vacuum Gauge

- Low battery indicator
- Simple On/Off controls
- Calibration standards traceable to NIST
- Sensor handles 450 psi positive pressure
- Automatic battery saver shuts gauge off after 20 minutes with no reading changes
- Includes 9V alkaline battery and hanging hook
- Thermal conductivity sensor automatically compensates for temperature with no calibration



Part #	Mfg #	Description	Price
182282	69080	Battery, Hook, & Pouch Included	

### Hand-Held Digital Vacuum Gauge

- 12" coiled sensor cord
- Low battery indicator
- Accuracy: +/- 20% of reading
- Automatic shut-off after 20 minutes
- Plug-in sensor (part #69087) handles 450 psi positive pressure
- Calibration standards traceable to NIST
- 32° to 122°F operating temperature range
- Magnetized on back for secure, upright positioning on any magnetized surface
- Displays 7 different units of vacuum (microns, milliTorr, Torr, millimeters of mercury, millibar, kiloPascal and Pascal)
- Thermal conductivity sensor automatically compensates for temperature



Part #	Mfg #	Description	Price
181363	69086	Hand-Held with Carry Pouch	

### Omni™ Digital Vacuum Gauge

- 450 psi proof pressure
- (2) AAA batteries included
- 45° degree bend for fitting
- Audio and visual signal when target vacuum level is reached
- Automatic power down and time out
- Low battery indicator and automatic power-down when inactive
- 32°F to 104°F Working temperature
- Electronic paper display for clear visibility
- Power savings – multiple time-out selections
- Adapter fittings available



Part #	Mfg #	Description	Price
231050	69020	With 1/4" Coupler	

### Superevac™ LCD Vacuum Gauge

- 3 Second response time
- Automatic calibration
- D cell battery power
- Accuracy: ± 20% of reading
- 5-1/2' Coiled sensor cable —1/4" male flare connection
- Calibration standards traceable to NIST
- Case protects electronic circuitry and sensor
- 32° to 120°F Operating temperature range
- Automatic shut-off 20 minutes after power up
- Normal handling/jarring will not affect the LCD reading



Part #	Mfg #	Description	Price
182269	69075	Full Range Complete in Case	

## Refrigeration Tools

### Vacuum Pumps & Oil

Part #	Mfg #	Description	Price
181303	18997	Grappler Rod/Nut Assy for Vacuum/Charge Valve	
182337	93047	Bullet Drive Coupling with Spider	
182338	93050	Coupling Spider for 93047	

#### Bullet™ Vacuum Pump

- 28 oz.(7cfm) or 30 oz.(5cfm) oil capacity
- 16.25" L x 6" W x 11.5" H
- 1/4" x 3/8" x 3/8" Intake
- Heavy duty rotors and bearings
- Heavy duty steel handle
- Power cord: 6' motor mounted switch
- Tethered port caps stay with the pump
- Metal with rubber overlay base for stability
- Large oil sight glass for easy monitoring of oil level
- Large brass oil drain for easy access to oil changes
- Intake filter screen keeps damaging particles from entering the pump
- Internal intake check valve prevents oil backup into the system during a power failure
- Wide-mouth oil reservoir port which doubles as pump exhaust-threaded to attach garden hose



Part #	Mfg #	CFM	Volts	HZ	Phase	Price
224708	93605	5	115	60	1	
182366	93600	7	115	60	2	

#### Bullet™ Vacuum Pump Cover Assembly

Part #	Mfg #	Description	Price
246632	93650	Pump Cover Assembly	

### Superevac™ CFM Pump

- 34 oz. oil capacity
- 16.25" L x 6" W x 11.5" H
- 1/4" and 3/8" Male flare intake
- Built-in vacuum indicator gauge
- Heavy duty rotors and bearings
- Heavy duty steel handle with lift hook
- Tethered port caps stay with the pump
- Metal with rubber overlay base for stability
- Gas ballast valve keeps oil cleaner and longer
- Large oil sight glass for easy monitoring of oil level
- Large brass oil drain for easy access to oil changes
- Intake filter screen keeps damaging particles from entering the pump
- Internal intake check valve prevents oil backup into the system during a power failure
- Wide-mouth oil reservoir port which doubles as pump exhaust-threaded to attach garden hose



Part #	Mfg #	CFM	Volts	HZ	Phase	Price
181344	96560	6	115	60	1	

#### Vacuum Pump Oil

- Recommend using the current mineral-based pump oil when working with both R-12 and R-134a A/C systems



Part #	Mfg #	Size	Qty Per Case	Price
181362	93092	Quart	12	
193501	93096	Gallon	6	

### Miscellaneous Tools

Part #	Mfg #	Description	Price
181538	19302	CH14 Openers, 10 Pak	

#### Deluxe Ratchet Hand Bender Kit

- Reverse bending mandrel
- Index marks to locate bends
- Trouble free ratchet mechanism
- Quick change bending mandrels and shoes
- Hard copper must be annealed before bending
- Complete tube bender kit includes all items required to bend 1/4", 5/16", 3/8", 1/2", 5/8", 3/4" and 7/8" tubing



Part #	Mfg #	Description	Price
214566	60325	Ratchet Hand Bender Kit	

## Refrigeration Tools

### Digital Electronic Charging Scale

- Mechanical overload protection and "OL" alert on LCD
- Minus (-) reading shows weight removed from the platform
- Single point load cell strain gauge
- Removable control module on retractable 5' coiled cord
- Calibration standards traceable to NIST
- Convert standard 68802 and 68800 scales to programmable with upgrade kits 68804 and 68805



Part #	Mfg #	Description	Price
182255	68802	Electronic Scale 110 lbs.	

### Mini-Split Tool Kit

- Includes R-410A service tools and:
  - Heat pump manifold —Designed to handle all mini-split refrigerants & pressures
  - 60" PLUS II Hoses —4,000 psi minimum burst —800 psi Max working pressure —RYB 1/4" with 1/4" flare fittings
  - Eccentric cone flare tool —For 3/16" to 3/4" O.D. tubing
  - Hex key set —5/32", 3/16", 5mm and 6mm
  - Vacuum/charge valve with side port —5/16" x 1/4" x 1/4" (18986)
  - Adjustable metric torque wrench —16, 17, 21, 22, 24, 26, 27, & 29 mm flare nuts
  - 45° R-410A coupler 5/16" fml quick coupler x 1/4" m flr
  - Tube cutter and deburring tool
  - 16" Tool bag —Nylon, strap included, 25 pockets



Part #	Mfg #	Description	Price
182248	60991	R-22/407C/410A Heat Pump Manifold	

### Repair Parts Kit

- Five 1/8" gaskets
- Five 1/8" valve openers
- One hundred 3/16"—1/4" gaskets
- Ten 1/4" Adjust-a-Valve openers
- Ten 1/4" flat valve openers
- Ten 3/8" gaskets
- Ten 1/2"—5/8" gaskets
- Ten cylinder valve flat gaskets
- Ten SealRight™ "O" rings
- Four SealRight™ plug and seal assemblies
- Four 1/4" SealRight™ nut and clip



Part #	Mfg #	Description	Price
181305	19003	Complete Kit	

### Recovery Machine Components and Parts

Part #	Mfg #	Description	Price
188504	67002	ManTooth PT Dual with Rubber Boot (tethered)	
226828	67020	ManTooth V (Vacuum-only) w/ Side Grip	
226830	67023	ManTooth PTV Dual w/ Side Grip	
182379	95231	Piston Cup	
182380	95325	High Pressure Switch	
238680	95338	Low Pressure Switch	
238681	95451	High Pressure Gauge	
213654	95730	YJ-LTE Refrigerant Recovery System	
181361	95760	RecoverXLT 115V/60 Hz	



## Sheet Metal Tools

### Snips for Metal and Vinyl

#### Max2000™ Aviation Snips

- An adjustable crossover disk assures an optimal length of cut that remains smooth and accurate
- Machined serrations on outside face of cutting edge
- Thicker, stronger steel handle resists abuse and will not collapse under normal use
- Length: 10-3/4"



Part #	Mfg #	Description	Price
032962	M2001	Cuts Left, Red Ergonomic Grip	
032963	M2002	Cuts Right, Green Ergonomic Grip	
032964	M2003	Combination, Yellow Ergonomic Grip	

#### Max2000™ Bulldog Aviation Snips

- Designed for notching and trimming
- Ideal for cutting multiple layers or "S" cleats



Part #	Mfg #	Description	Price
032965	M2005	Red Ergonomic Grip	

### Max2000™ Offset Aviation Snips

- Cuts straight line and 5" diameter circles



Part #	Mfg #	Description	Price
036461	M2006	Cuts Offset Left, Red Ergonomic Grip	
036462	M2007	Cuts Offset Right, Green Ergonomic Grip	

### Andy™ Classic Snips

- Suitable for mild curve cuts, straight shearing, or cutting multiple layers of sheet metal
- Lightweight aluminum handle
- 3" Cutting length



Part #	Mfg #	Description	Price
006451	M12A	12" Length	

### Andy™ Pattern Snips

- Ground blade edge
- Suitable for mild curve cuts, straight shearing, or cutting multiple layers of sheet metal
- Lightweight aluminum handle
- Larger handle loops
- Extended blade tips
- 3-1/4" Cutting length



Part #	Mfg #	Description	Price
057978	M14N	14" Length	

## Sheet Metal Tools

### Awls

#### Scratch Awl

- High carbon alloy tool steel blade polished to resist rust
- May be re sharpened many times
- Easy-to-spot orange handles are shock and shatter resistant

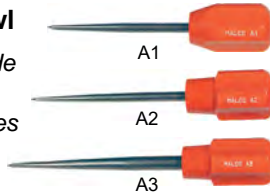

Part #	Mfg #	Blade Dia	Nom Length	Price
006370	A1	7/32"	5-3/4"	
006371	A2	1/4"	6-1/4"	
006373	A3	3/8"	7-1/2"	

### Scribers

#### Pocket Size Sheet Metal Scriber

- Five teeth produce 10 scribing depths
- Compact scribe stores in pocket, pouch or tool box
- Use hang hole or magnet to keep handy on the job

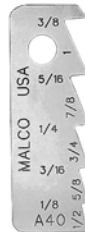

Part #	Mfg #	Min/Max Adjustments	Price
038068	A40	1/8" - 1" Depths	

#### Adjustable Sheet Metal Scriber

- Measure, mark and scribe in one easy operation
- Depth up to 12-1/2"
- Compact design
- Durable construction
- Constructed of rust resistant nickel plated steel
- Knob assembly with hardened steel bolt insert will not strip out
- Uses Zip-In® sheet metal screw making point replacement easy



Part #	Mfg #	Min/Max Adjustments	Price
006376	A60	1/4" - 12-1/2" Depths	

### Dividers

- Length: 11"
- Scratch awl points are easily re sharpened or replaced
- Nickel-plated steel body



Part #	Mfg #	Description	Price
006515	#18	32" Max Circle Diameter	

### Dividers (Continued)

Part #	Mfg #	Description	Price
006522	#24	42" Max Circle Diameter	
021655	RP2	Divider Points for #18 and #27	

### Folding Tools

- Folding seams are formed from two steel halves, permanently joined together



Part #	Mfg #	Width	Folding Depths	Price
006512	12F	12"	3/8" and 1"	
006516	18F	18"	3/8" and 1"	

### Duct Tools and Accessories

#### Duct Stretcher

- Wheels can be changed to other side of tool for applications where side of duct is close to wall or obstruction



Part #	Mfg #	Description	Price
006386	DS1	16"	
006388	DS2	16" Offset Handle	
025654	DS3	12" Locking	

### TurboShear™ Drills

#### TurboShear™

- Attaches to the chuck of a 1200 rpm, 12V cordless or an A/C electric drill
- Makes fast cuts in sheet metal
- Capable of making precise 6" x 6" square hole cuts
- 20 Gauge capacity in spiral duct
- 18 Gauge capacity in galvanized steel
- Material must be pre-set or held by an assistant
- Shear cuts to the left
- Use TSDC drill clamp for 1-hand operation



Part #	Mfg #	Description	Price
007222	TS1	TurboShear™ Sheet Metal Cutter	

## Sheet Metal Tools

### Hole Cutters

#### "Gold Standard" Hole Cutter

- Cuts holes up to 12" diameter in 20 gauge sheet metal
- Use with any standard 1/4" electric drill
- Cast aluminum body
- All wearing parts made of special heat-treated steel



Part #	Mfg #	Hole Diameter	Price
006408	HC1	2" - 12"	

### REDLINE™ Hand Tools

#### 5-Blade Pipe Crimper

- One-hand operation latch
- Soft-touch, non-slip handle insert
- Ergonomically contoured handles



Part #	Mfg #	Throat Depth	Price
131064	C5R	1-5/8"	

#### Hand Notcher

- One-hand operation latch
- Soft-touch, non-slip handle insert
- Ergonomically contoured handles
- Opening maximizes handle leverage



Part #	Mfg #	Throat Depth	Price
132797	N1R	13/16"	
132798	N2R	1"	

### Hand Seamer with Forged Steel Jaw

- One-hand operation latch
- Soft-touch, non-slip handle insert
- Ergonomically contoured handles
- Opening maximizes handle leverage



Part #	Mfg #	Jaw Depth	Jaw Width	Price
132799	S2R	1-1/4"	3-1/4"	
132801	S6R	1-1/4"	6"	

### Offset Hand Seamer with Forged Steel Jaw

- One-hand operation latch
- Soft-touch, non-slip handle insert
- Ergonomically contoured handles
- Opening maximizes handle leverage



Part #	Mfg #	Jaw Depth	Jaw Width	Price
132800	S3R	1-1/4"	3-1/4"	

### Snap Lock Punch for Siding

- One-hand operation
- Ergonomic handles
- Opening maximizes handle leverage



Part #	Mfg #	Length	Throat Depth	Price
006483	SL1R	8"	3/8"	



## Sheet Metal Tools

### Crimpers

#### Single Crimper with Red Grip

- Fast, easy to use and lightweight
- Handy lock makes tool pocket sized
- Length: 8"



Part #	Mfg #	Throat Depth	Price
020268	SC1	1-1/4"	

### Riveting Tools

#### 2-in-1 Hand Riveter

- Adjustment features a single long stroke and a short ratchet action



Part #	Mfg #	Capacity	Price
006518	2-IN-1	1/8"-3/16" Rivet w/Steel Mandrel, 3/32- 5/32" Rivet w/SS Mandrel 8"Long	

### Fiberglass Flex Duct Tools

#### Tensioning Tool

- Hardened steel stampings with weather resistant nickel chrome finish
- Vinyl grips with hand stops
- Tensioning adjustment knob and auto cut-off mechanism



Part #	Mfg #	Description	Price
006499	TY6	High Leverage Tie Tool, Auto Cut-Off	

#### Tie Tool

- Action tie tools feature long wearing, serviceable parts
- Comfortable handles reduce the pinch point area
- Works on all ties including thin designs



Part #	Mfg #	Description	Price
006498	TY4	Manual Cut-Off	

#### Flex Duct Cutter and Shear

- Double edged knife blade
- Thumb operated latch
- Easily resharpenable
- Handles feature non-slip vinyl grips



Part #	Mfg #	Description	Price
006389	FDC1	Flex Duct Cutter	

## Sheet Metal Tools

### Snips

#### Long Straight Cutting Snips

- 3" Long forged alloy steel blades
- One handed locking
- Flush bolt design
- Rust protection
- Serrated Jaws
- Ergonomic handles
- Ruler markings on blade



Part #	Mfg #	Description	Price
219080	48-22-4037	3" Alloy Steel Blades	

#### Aviation Snips

- One handed locking
- Thumb lock
- Flush bolt design
- Forged alloy steel blades
- Rust protection
- Serrated jaws
- Ergonomic handles
- Up to 22-gauge stainless & 18-gauge cold rolled steel



48-22-401



48-22-4020



48-22-4030

Part #	Mfg #	Cut	Price
150224	48-22-4020	Left Angle	
150220	48-22-4030	Straight	

#### Aviation Snips

- One handed metal lock
- Ergonomic grips
- Flush pivot design
- Forged serrated blades bolt lock
- Up to 22-gauge stainless & 18-gauge cold rolled steel



48-22-4510

Part #	Mfg #	Cut	Price
238535	48-22-4510	Left	
150222	48-22-4010	Left	
238536	48-22-4520	Right	
238537	48-22-4530	Straight	
238543	48-22-4537	Long Cut Straight	

### Offset Snips

- One handed metal lock
- Ergonomic grips
- Lanyard hole
- Flush pivot design
- Forged serrated blades bolt lock
- Up to 22-gauge stainless & 18-gauge cold rolled steel

Part #	Mfg #	Cut	Price
238538	48-22-4512	Left	
238540	48-22-4522	Right	
163182	48-22-4022	Right	
238542	48-22-4532	Straight Offset	
238544	48-22-4538	Long Cut Straight	
163183	48-22-4032	Straight Offset	
219079	48-22-4038	Long Offset Left	

**Snip set Includes  
Left cut (48-22-4512)  
Right Cut (48-22-4522)**

Part #	Mfg #	Description	Price
238548	48-22-4523	2-Pc Snip Set	

### Bulldog Snips



Part #	Mfg #	Cut	Price
163647	48-22-4000	Straight Cut	

### Bulldog Aviation Snips

- One handed metal lock
- Ergonomic grips
- Lanyard hole
- Flush pivot design
- Forged serrated blades bolt lock
- Up to 22-gauge stainless & 18-gauge cold rolled steel



Part #	Mfg #	Description	Price
238545	48-22-4500	Bulldog Aviation Snips	

## Sheet Metal Tools

### Angle Snips

- One handed locking
- Flush bolt design
- Serrated jaws
- Forged alloy steel blades
- Ergonomic handles
- Rust protection - hard chrome plated blades
- Up to 22-gauge stainless & 18-gauge cold rolled steel



Part #	Mfg #	Cut	Price
163488	48-22-4011	Right Angle	
162739	48-22-4021	Right Angle	

### Angle Snips

- One handed metal lock
- Ergonomic grips
- Lanyard hole
- Flush pivot design
- Forged serrated blades bolt lock
- Up to 22-gauge stainless & 18-gauge cold rolled steel



Part #	Mfg #	Cut	Price
238546	48-22-4511	Left Angle	
238547	48-22-4521	Right Angle	

### 3-PC Aviation Snips Set

- One-handed locking
- Flush bolt design
- Forged alloy steel blades
- Rust protection
- Serrated jaws
- Ergonomic handles
- Up to 22-gauge stainless & 18-gauge cold rolled steel
- Set includes:
  - Straight cutting snips (48-22-4030)
  - Right cutting snips (48-22-4020)
  - Left cutting snips (48-22-4010)



Part #	Mfg #	Description	Price
238549	48-22-4533	3-Pc Aviation Snips Set	

### Miscellaneous Tools

#### Classic Thinner

- 40% Larger Handles
- Cuts up to 20ga Cold Rolled Steel/22ga Stainless Steel
- Bolt lock technology - Blades will not loosen
- All-metal contoured handles for durability and comfort
- Forged strength design
- Rust Resistant



Part #	Mfg #	Description	Price
175014	48-22-4002	12"	

#### Offset Compound Tinner

- 40% Larger Handles
- Cuts up to 20ga Cold Rolled Steel/22ga Stainless Steel
- Bolt lock technology - Blades will not loosen
- All-metal contoured handles for durability and comfort
- Forged strength design
- Rust Resistant



Part #	Mfg #	Description	Price
175015	48-22-4005	Compound Offset	

#### Lightweight Tinner

- 40% Larger Handles
- Cuts up to 24ga Cold Rolled Steel/26ga Stainless Steel
- Best-in-class 3 1/2" Replaceable Blades
- All-metal contoured handles for durability and comfort
- Rust Resistant



Part #	Mfg #	Description	Price
175016	48-22-4006	13"	

#### Replacement Blades

- Lightweight replacement blades for (48-22-4006) tinner snips



Part #	Mfg #	Description	Price
175017	48-22-4007	For 48-22-4006	

## Sheet Metal Tools

### Bulldog Tinner

- 40% Larger Handles
- Cuts up to 16ga Cold Rolled Steel/18ga Stainless Steel
- Bolt lock technology - Blades will not loosen
- All-metal contoured handles for durability and comfort
- Forged strength design
- Rust Resistant



### Job Site Straight Scissors

- Iron carbide edge blades
- Smooth blades for burr-free cuts
- All metal core
- Bolt lock technology
- Rust protection
- Large handle loops
- Ruler markings on blade
- Index finger groove



Part #	Mfg #	Description	Price
175111	48-22-4001	16"	

Part #	Mfg #	Description	Price
168966	48-22-4041	Straight Scissors	

### Duckbill Tinner

- 40% Larger Handles
- Cuts up to 22ga Cold Rolled Steel/24ga Stainless Steel
- Bolt lock technology - Blades will not loosen
- All-metal contoured handles for durability and comfort
- Forged strength design
- Rust Resistant



### Job Site Offset Scissors

- Iron carbide edge blades
- Micro-Serrated blades
- All metal core
- Bolt lock technology
- Rust protection
- Large handle loops
- Ruler markings on blade
- Index finger groove



Part #	Mfg #	Description	Price
175114	48-22-4004	10"	

Part #	Mfg #	Description	Price
168964	48-22-4040	Offset Scissors	

### Seamers

- Forged head design
- Chrome plated - rust resistance
- Symmetrical handles



Part #	Mfg #	Description	Price
175012	48-22-6000	3" Speed Seamer	

### 5-Blade Crimper

- Reinforced crimper ribs
- Heavy duty spring
- Chrome plated - rust resistance
- Symmetrical handles



Part #	Mfg #	Description	Price
175013	48-22-6001	Up to 22ga rolled steel	

**Sheet Metal Tools**

**General Purpose Tools**

**Offset Snips**

- 1-1/2" Cut length



Part #	Mfg #	Model	Description	Length	Price
017927	16202	796	Cuts Right	10-1/2"	
017926	16207	797	Cuts Left	10-1/2"	

## Sheet Metal Tools

### Sheet Metal Tools

#### Aviation Snips

- Comfortable grip
- High-carbon steel blades with reinforce chrome silicon spring
- Color-coded handle inserts and splines



Part #	Mfg #	Description	Price
177210	1891133	Aviation Snips Left Cut	
177211	1891134	Aviation Snip Right Cut	

#### Hand Seamers

- Comfortable grip
- High-carbon steel blades with reinforced chrome silicon spring
- Quick notification with 1/4" depth marks on blades



Part #	Mfg #	Description	Price
174605	1891183	3" Offset Hand Seamer	
174604	1891185	3" Hand Seamer	

#### Folding Tools

- Built for both 3/8" (10mm) and 1" (25mm) folds
- Equipped with sight holes for proper depth alignment



Part #	Mfg #	Description	Price
174607	1891146	12" Folding Tool	
174608	1890985	18" Folding Tool	
174610	1890986	24" Folding Tool	

#### Hole Cutters

- Lightweight aluminum frame, with a milled bit
- Inch and metric scales
- Fits into any corded or cordless drill with a 1/4" or larger chuck



Part #	Mfg #	Description	Price
175060	1891191	2" to 12" Hole Cutter	



**Shovels****Shovels****Round Point Shovel with Long Handle**

- 14 Gauge steel head and ferrule
- Shovel blades and shanks are 1-piece rustproof, taper-formed, then heat treated
- Handle length: 47"



Part #	Mfg #	Model	Blade Size	Price
008693	52300	170	8-5/8" x 11-1/2"	

## Shovels

### Heavy-Duty Commercial Shovels

#### Round Point Shovel with Long Fiberglass Handle

- 12 Gauge steel head and ferrule
- Closed back
- Wood reinforced fiberglass handle
- Handle length: 48-1/2"
- Overall length: 59-1/4"
- 100% American made



Part #	Mfg #	Description	Price
136120	92515	12ga Round Point Shovel	

### Spades

#### Drain Spade D-Grip with Fiberglass Handle

- 12 Gauge steel head and ferrule
- Closed back
- Wood reinforced fiberglass handle
- Handle length: 32"
- Overall length: 40"
- 100% American made



Part #	Mfg #	Description	Price
136121	92535	12ga Drain Spade, Closed	

### Floral & Speciality Shovels

#### Mud Shovel with Long Fiberglass Handle

- 14 Gauge steel head and ferrule
- Closed back
- Wood reinforced fiberglass handle
- Handle length: 48-1/2"
- Overall length: 59"
- 100% American made



Part #	Mfg #	Description	Price
136122	92705	14ga Mud Shovel, Closed	

#### Trunk Shovel with D-Grip Steel Handle

- 14 Gauge steel head and ferrule
- Closed back
- Steel handle
- Handle length: 24-1/2"
- Overall length: 32-3/4"
- 100% American made



Part #	Mfg #	Description	Price
147666	92712	14ga Trunk Shovel, Steel	

---

---

**Trouble Lights/Extension Cords**

---

---

**Light Bulbs****Rough Service Light Bulb**

- *Multi-support filament*
- *Lasts twice as long as a standard bulb*
- *Frosted to reduce glare*



Part #	Mfg #	Description	Price
002314	8502	100 Watt Frosted	

## Wrenches

### Wrenches

#### Cheater Pipe Wrench

- 3 Length design
  - 10" Mode
  - 18" Mode
  - 24" Mode
- Overbite jaw
- Dual coil springs
- Ergonomic handle form
- Ergonomic hook jaw design
- Tether-ready handle loop



Part #	Mfg #	Description	Price
187995	48-22-7314	Cheater Pipe Wrench	

#### Steel Pipe Wrench

- Overbite Jaw
- Dual coil springs
- Ergonomic handle form
- Ergonomic hook jaw design
- Through hardened jaws
- Tether-ready handle loop



Part #	Mfg#	Size	Lenght	Price
187996	48-22-7110	10"		
187998	48-22-7114	14"		
187997	48-22-7112	12"		
187999	48-22-7118	18"		
255419	48-22-7106	6"		
255420	48-22-7108	8"		
255421	48-22-7124	24"		
255422	48-22-7136	36"		
255423	48-22-7148	48"		
255424	48-22-7160	60"		

### Aluminum Pipe Wrench

- Overbite Jaw
- Dual coil springs
- Ergonomic handle form
- Ergonomic hook jaw design
- Through hardened jaws
- Tether-ready handle loop



Part #	Mfg#	Size	Length	Price
188000	48-22-7210	10"	13-1/2"	
188001	48-22-7212	12"	15"	
188002	48-22-7214	14"	17"	
188003	48-22-7218	18"	20-1/2"	
188004	48-22-7224	24"	27"	
255425	48-22-7236	36"	41"	
255426	48-22-7248	48"	54"	

### Aluminum Offset Pipe Wrenches

- Ergonomic Handle Design
- Jaw Capacity 2"
- Jaw opening parallel to the handle and a narrower hook jaw head



Part #	Mfg #	Description	Price
255429	48-22-7184	14"	
255430	48-22-7185	18"	
255431	48-22-7182	24"	

### Aluminum Pipe Wrench with POWERLENGTH™ Handle

- New-to-world POWERLENGTH™ design featuring high-leverage handle
- OVERBITE JAW™ allows for largest gripping surface
- Dual coil springs for maximum durability and tool life
- Ergonomic handle design that helps prevent fatigue and slip
- Jaw capacity 1-1/2"



Part #	Mfg#	Size	Length	Price
255418	48-22-7213	10"	18-1/2"	

## Wrenches

### Smooth Jaw Pipe Wrench

- Smooth Jaw Protects Surfaces
- Ergonomic Handle
- Jaw Capacity 2-5/8"
- Parallel Grip



Part #	Mfg #	Description	Price
255428	48-22-7186	12"	

### Steel Offset Hex Pipe Wrench

- Smooth jaw
- Ergonomic handle
- Jaw capacity 2-5/8"
- Up to 3 points of contact for a secure grip



Part #	Mfg #	Description	Price
255427	48-22-7171	10-1/2"	

### Adjustable Wrench

- Proprietary adjustment screw
- Ergonomic handle form
- Tether-ready handle loop
- Parallel jaws won't slip or damage finish surfaces
- Adjustment screw gears for smooth adjustment
- Chrome plated for rust protection and durability
- Laser etched ruler for easy-to-read, accurate size adjustment



Part #	Mfg#	Size	Price
187479	48-22-7400	(2Pc) 6"&10"	
187485	48-22-7406	6"	
187484	48-22-7408	8"	
187482	48-22-7410	10"	
187481	48-22-7412	12"	
187480	48-22-7415	15"	

### Wide Jaw Adjustable Wrench

- Wide-jaw design for increased jaw capacity in confined environments
- Proprietary Adjustment Screw
- Ergonomic handle form
- Parallel jaws won't slip or damage finish surfaces
- Adjustment screw gears designed for smooth adjustments
- Chrome plated for rust protection and durability
- Laser etched ruler for easy-to-read, accurate size adjustment



Part #	Mfg #	Size	Price
187483	48-22-7508	8"	

### Basin Wrench

- Forged, spring-loaded jaw
- Ergonomic handle design for maximum comfort and one-handed use
- Ratchet-ready handle design for maximum speed and torque
- Easy to adjust telescoping handle 10"-17"
- Screwdriver ready through hole handle design for maximum leverage and break-away torque
- Pivoting jaws up to 90° for access to tight spaces



Part #	Mfg #	Description	Price
186460	48-22-7001	1.25" Capacity	
186462	48-22-7002	2.5" Capacity	

### 7-PC Combination Wrench Set - SAE

- MAX BITE™ open-end grip
- I-beam handle design
- Ink-filled size labels
- Organized storage solution
- Includes: 3/8", 7/16", 1/2", 9/16", 11/16", 3/4", 5/8"



Part #	Mfg #	Description	Price
241912	48-22-9407	7 Pieces	



## Wrenches

### 7-PC Combination Wrench Set - Metric

- MAX BITE™ Open-End Grip
- Ink-filled size labels
- Includes:
  - (1) 8mm Combination Wrench
  - (1) 10mm Combination Wrench
  - (1) 12mm Combination Wrench
  - (1) 13mm Combination Wrench
  - (1) 14mm Combination Wrench
  - (1) 15mm Combination Wrench
  - (1) 17mm Combination Wrench



Part #	Mfg #	Description	Price
250268	48-22-9507	7 Pieces	

### 7-PC Ratcheting Combination Wrench Set - Metric

- Includes:
  - (1) 8mm Ratcheting Combination Wrench
  - (1) 10mm Ratcheting Combination Wrench
  - (1) 12mm Ratcheting Combination Wrench
  - (1) 13mm Ratcheting Combination Wrench
  - (1) 14mm Ratcheting Combination Wrench
  - (1) 15mm Ratcheting Combination Wrench
  - (1) 17mm Ratcheting Combination Wrench



Part #	Mfg #	Description	Price
247124	48-22-9506	7 Pieces	

### 15-PC Combination Wrench Set - SAE



Part #	Mfg #	Description	Price
240520	48-22-9415	15 Pieces	

### 15-PC Combination Wrench Set - Metric



Part #	Mfg #	Description	Price
240521	48-22-9515	15 Pieces	

### 7-PC Ratcheting Combination Wrench Set - SAE

- 2.5° of Arc Swing
- Includes:
  - (1) 3/8" Ratcheting Combination Wrench
  - (1) 1/2" Ratcheting Combination Wrench
  - (1) 9/16" Ratcheting Combination Wrench
  - (1) 5/8" Ratcheting Combination Wrench
  - (1) 11/16" Ratcheting Combination Wrench
  - (1) 3/4" Ratcheting Combination Wrench



Part #	Mfg #	Description	Price
247123	48-22-9406	7 Pieces	

### 15-PC Ratcheting Combination Wrench Set - SAE

- Includes:
  - (1) 1/4" Ratcheting Combination Wrench
  - (1) 9/32" Ratcheting Combination Wrench
  - (1) 5/16" Ratcheting Combination Wrench
  - (1) 11/32" Ratcheting Combination Wrench
  - (1) 3/8" Ratcheting Combination Wrench
  - (1) 7/16" Ratcheting Combination Wrench
  - (1) 1/2" Ratcheting Combination Wrench
  - (1) 9/16" Ratcheting Combination Wrench
  - (1) 5/8" Ratcheting Combination Wrench
  - (1) 11/16" Ratcheting Combination Wrench
  - (1) 3/4" Ratcheting Combination Wrench
  - (1) 13/16" Ratcheting Combination Wrench
  - (1) 7/8" Ratcheting Combination Wrench
  - (1) 15/16" Ratcheting Combination Wrench
  - (1) 1" Ratcheting Combination Wrench



Part #	Mfg #	Description	Price
247120	48-22-9416	15 Pieces	



## Wrenches

### 15-PC Ratcheting Combination Wrench Set - Metric

- Includes:
- (1) 8mm Ratcheting Combination Wrench
- (1) 9mm Ratcheting Combination Wrench
- (1) 10mm Ratcheting Combination Wrench
- (1) 11mm Ratcheting Combination Wrench
- (1) 12mm Ratcheting Combination Wrench
- (1) 13mm Ratcheting Combination Wrench
- (1) 14mm Ratcheting Combination Wrench
- (1) 15mm Ratcheting Combination Wrench
- (1) 16mm Ratcheting Combination Wrench
- (1) 17mm Ratcheting Combination Wrench
- (1) 18mm Ratcheting Combination Wrench
- (1) 19mm Ratcheting Combination Wrench
- (1) 20mm Ratcheting Combination Wrench
- (1) 21mm Ratcheting Combination Wrench
- (1) 22mm Ratcheting Combination Wrench



Part #	Mfg #	Description	Price
247121	48-22-9516	15 Pieces	

### Miscellaneous Tools

#### Drive Ratchet

- 90 tooth design with 4 degrees of arc swing for tight work spaces
- Slim profile head with flush direction lever
- Removable inner tray specifically designed for steel storage case
- Portable Carrying Case



Part #	Mfg #	Description	Price
250086	48-22-9014	1/4"	
250087	48-22-9038	3/8"	

### 26-PC 1/4" Drive Ratchet & Socket Set - SAE

- FOUR FLAT™ Sides
- 90 tooth design
- Stamped socket sizes portable carrying case



Part #	Mfg #	Description	Price
250080	48-22-9404	26 Pieces	

### 28-Pc 1/4" Drive Ratchet & Socket Set - Metric

- FOUR FLAT™ Sides
- Stamped socket sizes portable carrying case
- 90 tooth design
- Removable inner tray specifically designed for steel storage case



Part #	Mfg #	Description	Price
250081	48-22-9504	28 Pieces	

### 50-PC 1/4" Drive Ratchet & Socket Set

- SAE & Metric



Part #	Mfg #	Description	Price
250082	48-22-9004	50 Pieces	

### 28-PC 3/8" Drive Ratchet & Socket Set - SAE

- FOUR FLAT™ Sides
- 90 Tooth design
- Stamped socket sizes portable carrying case



Part #	Mfg #	Description	Price
250083	48-22-9408	28 Pieces	

### 32-PC 3/8" Drive Ratchet & Socket Set - Metric

- FOUR FLAT™ Sides
- 90 Tooth design with 4 degrees of arc swing
- Stamped socket sizes portable carrying case



Part #	Mfg #	Description	Price
250084	48-22-9508	32 Pieces	

### 56-PC 3/8" Drive Ratchet & Socket Set

- SAE & Metric
- FOUR FLAT™ Sides
- 90 Tooth design with 4 degrees of arc swing
- Stamped socket sizes portable carrying case



Part #	Mfg #	Description	Price
250085	48-22-9008	56 Pieces	

## Wrenches

### Wrenches

#### Heavy-Duty Straight Pipe Wrench

- Sturdy, cast iron housing and I-beam hand with full floating forged hook jaw, nonstick adjustment nut and replaceable hook and heel jaws



Part #	Mfg #	Model	Nom Size	Pipe Capacity	Price
008714	31010	10	10"	1-1/2"	
008686	31020	14	14"	2"	
008695	31025	18	18"	2-1/2"	
029928	31030	24	24"	3"	

#### Aluminum Handle Straight Pipe Wrench

- Nearly 40% lighter than comparable cast iron models of the same size
- Jaws and all other parts identical to RIDGID heavy-duty wrenches



Part #	Mfg #	Model	Nom Size	Pipe Capacity	Price
008768	31090	810	10"	1-1/2"	
054899	47057	812	12"	2"	
008770	31095	814	14"	2"	
008772	31100	818	18"	2-1/2"	
008774	31105	824	24"	3"	
026610	31115	848	48"	6"	

#### Aluminum Handle Offset Pipe Wrench

- Nearly 50% lighter than comparable cast iron models of the same size
- Features a jaw opening parallel to the handle and narrower hook jaw head which provides easy entry into tight spots



Part #	Mfg #	Model	Nom Size	Pipe Capacity	Price
022973	31125	18	18"	2-1/2"	

#### Strap Wrench

- Best for any polished pipe
- Strong, woven nylon strap gives tight grip
- Polyurethane-coated strap prevents scratching
- Replacement straps available



Part #	Mfg #	Model	Handle Length	Strap Length	Strap Width	Pipe Capacity	OD Tube Capacity	Price
008700	31340	2	11-3/4"	17"	1-1/8"	2"	3-1/2"	

#### Hex Wrench

- Gives multi-sided, secure grip on all hex nuts, square nuts, unions, and valve packing nuts



Part #	Mfg #	Model	Description	Nom Size	Pipe Capacity	Price
008571	31305	E110	Offset Hex	9-1/2"	1-1/8" - 2-5/8"	

## Wrenches

### Spud Wrench

- Narrow jaws to fit into tight places
- Smooth, toothless jaws ideal for square or rectangular stock



Part #	Mfg #	Size	Pipe Capacity	Price
008717	31400	12"	3/8" - 2-5/8"	

### Adjustable Wrench

- High strength forged, precision broached superior strength
- Wider and deeper jaws increased bite and grip surface
- Nickel plated superior corrosion resistance
- Acid etched scales English and metric readings



Part #	Mfg #	Model	Nom Size	Pipe Capacity	Price
050314	86902	756	6"	3/4"	
050315	86907	758	8"	7/8"	
050323	86912	760	10"	1-1/8"	
050320	86917	762	12"	1-5/16"	

### Basin Wrench

- Spring-loaded jaws of forged alloy steel
- Tension plug holds head in any position up to 90° angle



Part #	Mfg #	Model	Description	Nom Size	Pipe Capacity	Price
008658	31175	1017	Telescoping Basin	10" - 17"	3/8" - 1-1/4"	
022327	31180	1019	Telescoping Basin	10" - 17"	1-1/4" - 2-1/2"	

### Faucet and Sink Installer (Plastic Nut Basin Wrench)

- Designed to reach and turn plastic mounting nuts on faucets, sprayers and ballcocks
- Used to fasten and remove plastic basin nuts, supply line nuts, and 7/8" and 1" hex nuts
- Notched ends are designed to self-center on 2, 3, 4 and 6 tab nuts and to fit on metal hex nuts
- Strainer basket attachment holds drain unit in place while tightening strainer nut
- High strength plastic with aluminum inserts



Part #	Mfg #	Model	Length	Price
034146	57003	2006	10-1/4"	

### OneStop™ Wrench

- (2) Tools in one
- Provides exact size surface wrenches needed for angle stop and compression coupling installation



Part #	Mfg #	Model	Description	Price
065524	27023	2002	OneStop™ Wrench	

---

---

**Wrenches**

---

---

**Wrench Parts**

Part #	Mfg #	Description	For Model	Price
008614	31675	Heel Jaw & Pin Assembly	18, 818, E-18, S4A	

## Wrenches

### Wrenches

#### Chrome Adjustable Wrench

- Longer jaws grip better, avoiding slippage or nut round off
- Measurement scales are handy for sizing nuts, pipe and tube diameters
- Greater jaw capacity supports larger nuts and bolts
- Thinner jaws for greater access in tight spaces
- Precise jaw design grips tight the first time
- Four thread knurl and non-protruding jaws provide greater capacity
- Minimal head width improves performance in confined spaces
- Chrome vanadium steel construction



Part #	Mfg #	Length	Capacity	Price
058194	R114800	4-1/2"	1/2"	
058195	R114900	6-1/4"	15/16"	
058196	R115000	8"	1-3/16"	
058197	R115100	10"	1-3/8"	
058198	R115200	12"	1-1/2"	

#### Code Blue® Adjustable Wrench

- Longer jaws grip better, avoiding slippage or nut round off
- Measurement scales are handy for sizing nuts, pipe and tube diameters
- Greater jaw capacity supports larger nuts and bolts
- Thinner jaws for greater access in tight spaces
- Precise jaw design grips tight the first time
- Four thread knurl and non-protruding jaws provide greater capacity
- Minimal head width improves performance in confined spaces
- Code Blue® grips are designed for durability and comfort



Part #	Mfg #	Length	Capacity	Price
117996	R115560	8"	1-1/2"	

#### Drain Wrench

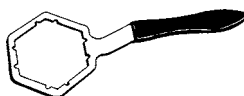

Part #	Mfg #	Description	Price
032867	R124710	Drain Wrench	

## Wrenches

### Wrenches

#### Digital Adjustable Torque Wrench

- Adjustable spanner head
- Digital torque value readout
- +/- 2% accuracy
- CW and CCW operation
- Water contact indicator
- Peak hold and track mode selectable
- Auto sleep (after about 5 minutes idle)
- 50 data memory for recall and joint torque auditing
- 4 user units of measure (ft. lb., in. lb., N-m, kg-cm)
- Buzzer & LED indicator for the 9 pre-set target torques



Part #	Mfg #	Description	Price
236431	60648	3/8" Square Drive	

#### Fan Blade Puller

- Hardened 4140 chrome moly steel
- Pull off fan blades
- Four fingers attach to the fan blade
- Fits 1-3/4" hub maximum
- Remove pulleys or sheaves
- Remove squirrel cage type blower wheels



Part #	Mfg #	Description	Price
182165	60590	Complete Fan Blade Puller	

#### Heavy Duty Ratchet Wrench

- Reversible
- 1/2" and 9/16" Hex openings at one end
- Square 3/16" and 1/4" at the other end



Part #	Mfg #	Description	Price
182169	60612	7" Long	

#### Offset Service Wrench

- Knuckle saver design
- 1/4" and 3/16" Hex openings at one end
- Square 3/8" and 5/16" at the other end



Part #	Mfg #	Description	Price
182172	60616	Offset Service Wrench	

#### Standard Straight Ratchet Wrench

- Reversible
- 1/4" and 3/16" Hex openings at one end
- Square 3/8" and 5/16" at the other end



Part #	Mfg #	Description	Price
182171	60613	Standard Straight Wrench	

### Precision Torque Wrench Kit

- Packaged blow-molded storage carry case
- Exact tightening to 10-8 N-M or 7.4-59 ft. lb
- Newton-meters and foot-pound scales are marked
- Interchangeable open end adapters  
 60650 (6 Heads): Sizes: 17, 22, 24, 26, 27 & 29 mm  
 60652 (8 Heads): Sizes: 16, 17, 21, 24, 26, 27 & 29 mm



Part #	Mfg #	Description	Price
182242	60650	Torque Wrench Kit w/6 Heads	
182243	60652	Torque Wrench Kit w/8 Heads	

### Parts & Accessories

Part #	Mfg #	Description	Price
182167	60609	Hex Key Adapter	



## Wrenches

### Ratchet Wrenches

#### Ratchet Wrench



- For installing or servicing heating, air conditioning or refrigeration units

Part #	Mfg #	Square	Hex	Price
006478	RRW3	3/16", 1/4", 5/16", 3/8"	-	

#### Hex Key Wrench Insert



Part #	Mfg #	Square	Hex	Price
006479	RRW3/16	1/4"	3/16"	

### Hex Keys

#### Folding Hex Key Set

- Professional quality
- Produced from tough alloy steel



Part #	Mfg #	Description	Price
006503	W29	(9) Keys, Deluxe Pocket	

---

---

## Wrenches

---

---

### Razorback™ Wrench

- Remove shower and sink drains from top or bottom with just one hand
- T-Handle rotates 180°



Part #	Mfg #	Description	Price
093510	73055	Razorback™ Wrench	

**Wrenches**

**Tools**

**Smart Dumbell®**

- *Installs or removes drains without cross-bars (Kohler, American Standard)*
- *Heavy duty die-cast aluminum*
- *Prevents scratching of decorative finishes*
- *Use crescent wrench or large Phillips screwdriver to turn the tool*



Part #	Mfg #	Length	Price
008104	4554	6"	

**Basin Wrenches**

**Eureka Cleanout Plug Wrench**

- *Fits slotted or square countersunk cleanout plugs*
- *Strong, malleable iron*



Part #	Mfg #	Description	Price
083108	4567	Cleanout Plug Wrench	

## Wrenches

### Golden Tool™ Tools

#### Golden Grip® Internal Pipe Wrench

- *Installs or extracts pipe nipples from the inside*



Part #	Mfg #	Description	Price
080112	97250	Single 1/2"	

#### Golden Extractor™ Tub Drain Tool

- *Standard 3/8" drive ratchet to extract or install tub drains*



Part #	Mfg #	Description	Price
083657	97258	Universal Size	

## Wrenches

### Faucet Nut Splitter

- Splits old or new zinc or brass nuts in seconds
- Fits over all 1/2" faucet shanks
- Aluminum with a chisel tip of hardened tool steel



Part #	Mfg #	Description	Price
120323	NS-1	Faucet Nut Splitter	

### Plumber's T-Handle Torque Tools

- Unique locking collar
- Slips internally when proper torque achieved



Part #	Mfg #	Socket	Type	in-lbs	Price
022114	2-SH	5/16"	Std No-Hub	60	



Sensible Products



Sensible Products

## Wrenches

### Fan Blade & Blower Wheel Pullers

- Removes fan blades/blower wheels that are frozen to a motor shaft
- Can be used to apply pushing or pulling force
- Includes (4) pulling hooks and (3) set screws
- Accommodates 5/8" belt drive and 1/2" or less direct drive motor shafts



Part #	Mfg #	Description	Price
136604	UP-1	"The Ultimate Puller"	



## Fiberglass Tub Showers

### Tub & Showers

#### 2603SG Everyday 1-Piece Tub & Shower

- Smooth wall finish
- Ergonomic backrest
- Installed acrylic grab bar
- Molded toiletry shelves
- Slip resistant textured bottom



Part #	Mfg #	Finished Dimensions	Drain	Color	Price
029540	2603SG-L-WH	60" x 32" x 72"	LH	White	
029542	2603SG-R-WH	60" x 32" x 72"	RH	White	
029562	2603SGM-L-WH	60" x 32" x 74"	LH	White	
030431	2603SGM-L-BI	60" x 32" x 74"	LH	Biscuit	
029564	2603SGM-R-WH	60" x 32" x 74"	RH	White	
033105	2603SGM-R-BI	60" x 32" x 74"	RH	Biscuit	
029987	2603SGT-L-WH	60" x 32" x 78-1/4"	LH	White	
029989	2603SGT-R-WH	60" x 32" x 78-1/4"	RH	White	

#### 2603TRIO Remodeline Sectional 3-Piece Tub & Shower

- Smooth wall finish
- Molded toiletry shelves
- Installed acrylic grab bar
- Gelcoat surface



Part #	Mfg #	Finished Dimensions	Drain	Color	Price
029536	2603TRIO-L-WH	60" x 30" x 72"	LH	White	

#### 26032P Remodeline Sectional 2-Piece Tub & Shower

- Smooth wall finish
- Installed acrylic grab bar
- Molded toiletry shelves
- Slip resistant, textured bottom



Part #	Mfg #	Finished Dimensions	Drain	Color	Price
029572	26032P-R-WH	60" x 30" x 72"	RH	White	

## Fiberglass Tub Showers

### One-Piece Tub & Shower Units

- Sanitary grade polyester gelcoat surface
- 2" Diameter drain, right-hand or left-hand
- 2-1/2" Diameter overflow
- Textured floor pattern
- Balsa wood core floor structure

#### TS-R-65 ABF Legacy 1-Pc Fiberglass Tub & Shower Module - Above Floor Rough

- Rough-in dimensions: 73-3/4" x 60" x 31"
- Elevated back wall shelf
- Lower level soap tray w/ acrylic rod
- ABF = Above floor rough-in provides 3" drain clearance



Part #	Mfg #	Description	Drain	Finish	Price
092399	TSR-65ABFL	72-1/2" x 60" x 29-3/4"	LH	White	
092398	TSR-65ABFR	72-1/2" x 60" x 29-3/4"	RH	White	
092400	TSR-65ABFR-BI	72-1/2" x 60" x 29-3/4"	RH	Biscuit	

#### TS-6032 Vursa 1-Pc Fiberglass Tub & Shower Module

- Rough-in dimensions: 73-3/4" x 60" x 33-1/4" with 16" apron
- Multi-level back wall shelving
- Accessory shelf with wash cloth rod
- Textured floor pattern
- FH = Fair housing wall reinforcement
- ABF = Above floor drain



Part #	Mfg #	Description	Drain	Finish	Price
145785	TS-6032L-WHT	72-1/2" x 60" x 32" with 16" Apron	LH	White	
145788	TS-6032R-WHT	72-1/2" x 60" x 32" with 16" Apron	RH	White	
140710	TS-6032L-ABF-WHT	72-1/2" x 60" x 32" with 16" Apron, ABF	LH	White	
138775	TS-6032R-ABF-WHT	72-1/2" x 60" x 32" with 16" Apron, ABF	RH	White	
145787	TS-6032L-BSC	72-1/2" x 60" x 32" with 16" Apron	LH	Biscuit	
145789	TS-6032R-BSC	72-1/2" x 60" x 32" with 16" Apron	RH	Biscuit	

## Fiberglass Tub Showers

### TS-6032 ABF Vursa 1-Pc Fiberglass Tub & Shower Module

- *Rough-in dimensions: 73-3/4" x 60" x 33-1/4" with 16" apron*
- *Multi-level back wall shelving*
- *Accessory shelf with wash cloth rod*
- *Textured floor pattern*
- *ABF = Above floor rough-in provides 3" drain clearance*



Part #	Mfg #	Description	Drain	Finish	Price
126944	TS-6032-ABFL	72-1/2" x 60" x 32" with 17-1/4" Apron	LH	White	
126908	TS-6032-ABFR	72-1/2" x 60" x 32" with 17-1/4" Apron	RH	White	
135338	TS-6032-ABFLBI	72-1/2" x 60" x 32" with 17-1/4" Apron	LH	Biscuit	
135225	TS-6032-ABFRBI	72-1/2" x 60" x 32" with 17-1/4" Apron	RH	Biscuit	

### TS-6034 Vursa 1-Pc Fiberglass Tub & Shower Module

- *Rough-in dimensions: 79-1/4" x 60" x 35-1/4" with 16" apron*
- *Multi-level back wall shelving*
- *Accessory shelf with wash cloth rod*
- *Textured floor pattern*



Part #	Mfg #	Description	Drain	Finish	Price
146309	TS-6034L-WHT	78" x 60" x 34" with 16" Apron	LH	White	
149096	TS-6034R-WHT	78" x 60" x 34" with 16" Apron	RH	White	
149097	TS-6034L-BSC	78" x 60" x 34" with 16" Apron	LH	Biscuit	
149098	TS-6034R-BSC	78" x 60" x 34" with 16" Apron	RH	Biscuit	
164858	TS-6034L-BN	78" x 60" x 34" with 16" Apron	LH	Bone	
164860	TS-6034R-BN	78" x 60" x 34" with 16" Apron	RH	Bone	

### TS-6034 ABF Styllis 1-Pc Fiberglass Tub & Shower Module

- *Rough-in dimensions: 79-1/4" x 60" x 35-1/4" with 16" apron*
- *Multi-level back wall shelving*
- *Accessory shelf with wash cloth rod*
- *Textured floor pattern*
- *ABF = Above floor rough-in provides 3" drain clearance*



Part #	Mfg #	Description	Drain	Finish	Price
155091	TS-6034-ABFL	78" x 60" x 34" with 20" Apron	LH	White	

## Fiberglass Tub Showers

### One-Piece Tub & Shower Units (Continued)

#### TS-6034 ABF Stylis 1-Pc Fiberglass Tub & Shower Module

Part #	Mfg #	Description	Drain	Finish	Price
155093	TS-6034-ABFR	78" x 60" x 34" with 20" Apron	RH	White	
155092	TS-6034-ABFL-BSC	78" x 60" x 34" with 20" Apron	LH	Biscuit	

#### TS-6036 Stylis 1-Pc Fiberglass Tub & Shower Module

- Rough-in dimensions: 79-1/4" x 60" x 37-1/4" with 18-1/4" apron
- Multi-level back wall shelving
- Accessory shelf with wash cloth rod
- Textured floor pattern



Part #	Mfg #	Description	Drain	Finish	Price
149092	TS-6036L-WHT	78" x 60" x 36" with 18-1/4" Apron	LH	White	
149093	TS-6036R-WHT	78" x 60" x 36" with 18-1/4" Apron	RH	White	
149094	TS-6036L-BSC	78" x 60" x 36" with 18-1/4" Apron	LH	Biscuit	
149095	TS-6036R-BSC	78" x 60" x 36" with 18-1/4" Apron	RH	Biscuit	

#### TS-6036 ABF Stylis 1-Pc Fiberglass Tub & Shower Module

- Rough-in dimensions: 79-1/4" x 60" x 37-1/4" with 18-1/4" apron
- Multi-level back wall shelving
- Accessory shelf with wash cloth rod
- Textured floor pattern
- ABF = Above floor rough-in provides 3" drain clearance



Part #	Mfg #	Description	Drain	Finish	Price
147914	TS-6036-ABF-L	78" x 60" x 36" with 20" Apron	LH	White	
147913	TS-6036-ABF-R	78" x 60" x 36" with 20" Apron	RH	White	
149009	TS-6036L-ABF-BSC	78" x 60" x 36" with 20" Apron	LH	Biscuit	
149010	TS-6036R-ABF-BSC	78" x 60" x 36" with 20" Apron	RH	Biscuit	

## Fiberglass Tub Showers

### TS-7236 Styllis 1-Pc Fiberglass Tub & Shower Module

- One - piece fiberglass composite construction
- Sanitary grade polyester gelcoat surface
- 2" Dia. drain / RH or LH (see reverse side for location)
- 2-1/2" Dia. overflow (see reverse side for location)
- Generous, multi-level back wall shelving
- Extra deep bathing sump
- Textured floor pattern
- 1/2-inch Balsa wood core floor structure
- ABF = Above floor rough-in provides 3" drain clearance



Part #	Mfg #	Description	Drain	Finish	Price
237102	TS7236L-ABF WHT	78" x 72" x 36" with 18-1/4" Apron, ABF	LH	White	
242044	TS7236R-ABF WHT	78" x 72" x 36" with 18-1/4" Apron, ABF	RH	White	

## Multi-Piece Tub & Shower Units

### TS3P-6030 Vursa 3-Pc Fiberglass Tub & Shower Module

- Rough-in dimensions: 77-1/2" x 60" x 31-1/4" with 16" apron
- Multi-level back wall shelving
- Accessory shelf
- Textured floor pattern



Part #	Mfg #	Description	Drain	Finish	Price
149066	TS3P-6030L	76-1/4" x 60" x 30" with 16" Apron	LH	White	
149849	TS3P-6030R	76-1/4" x 60" x 30" with 16" Apron	RH	White	

### TS3P-6032 Vursa 3-Pc Fiberglass Tub & Shower Module

- Rough-in dimensions: 77-1/2" x 60" x 33-1/4" with 16" apron
- Multi-level back wall shelving
- Accessory shelf with wash cloth rod
- Textured floor pattern



Part #	Mfg #	Description	Drain	Finish	Price
149157	TS3P-6032L-WHT	76-1/4" x 60" x 32" with 16" Apron	LH	White	
149158	TS3P-6032R-WHT	76-1/4" x 60" x 32" with 16" Apron	RH	White	

## Fiberglass Tub Showers

### TS3P-6032 ABF Vursa 3-Pc Fiberglass Tub & Shower Module

- *Rough-in dimensions: 78-3/4" x 60" x 33-1/4" with 17-1/4" apron*
- *Multi-level back wall shelving*
- *Accessory shelf with wash cloth rod*
- *Textured floor pattern*
- *ABF = Above floor rough-in provides 3" drain clearance*



Part #	Mfg #	Description	Drain	Finish	Price
136663	TS3P-6032L ABF-WHT	77-1/2" x 60" x 32" with 17-1/4" Apron	LH	White	
136664	TS3P-6032R ABF-WHT	77-1/2" x 60" x 32" with 17-1/4" Apron	RH	White	
136665	TS3P-6032R ABF-BSC	77-1/2" x 60" x 32" with 17-1/4" Apron	RH	Biscuit	
136586	TS3P-6032L ABF-BSC	77-1/2" x 60" x 32" with 17-1/4" Apron	LH	Biscuit	



## Tub Shower Doors

### Framed Tub & Shower Sliding Doors

#### Deluxe Framed Sliding Tub Door

- Bypass stop keeps the inside panel on the same side as the shower head
- Distinctive towel bars on the interior and exterior of the door
- Sta-Kleen track prevents dirt buildup
- Roller assembly is slotted so that out-of-square wall conditions can be adjusted up to 3/8"

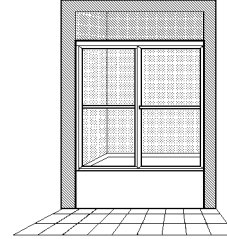

Part #	Mfg #	Fits Openings Between	Height	Glass	Frame	Price
043266	6150-52	50" - 52"	58-1/2"	Obscure	Silver	
043113	6150-56	54" - 56"	58-1/2"	Obscure	Silver	
100067	6150-56S-BN	54" - 56"	56"	Obscure	Brushed Nickel	
043272	6150-60	56" - 60"	58-1/2"	Obscure	Silver	
043496	6150-60S	56" - 60"	56"	Obscure	Silver	

#### Deluxe Framed Sliding Shower Door

- Bypass stop keeps the inside panel on the same side as the shower head
- Distinctive towel bars on the interior and exterior of the door
- Sta-Kleen track's gentle slope and rounded front keep water in the shower and off the floor
- Roller assembly is slotted so that out-of-square wall conditions can be adjusted up to 3/8"

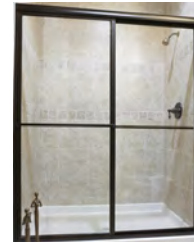

Part #	Mfg #	Fits Openings Between	Height	Glass	Frame	Price
043318	7150-42	40" - 42"	71-1/2"	Obscure	Silver	
045052	7150-44T	42" - 44"	68"	Obscure	Silver	
100302	7150-46	44" - 46"	71-1/2"	Obscure	Silver	
085380	7150-46T	44" - 46"	68"	Obscure	Silver	
044229	7150-52	49" - 52"	71-1/2"	Obscure	Silver	
067032	7150-54T	52" - 54"	68"	Obscure	Silver	
043405	7150-60	56" - 60"	71-1/2"	Obscure	Silver	
045435	7150-60T	56" - 60"	68"	Obscure	Silver	

## Tub Shower Doors

### Frameless Tub & Shower Sliding Doors

#### 3400-3500 Classic Frameless Sliding Tub Door

- Sta-Kleen tract prevents dirt buildup
- (2) Bumpers on each wall jamb to ensure there is no glass-to-metal contact
- Frameless roller assembly keeps door in place
- Towel bar with acrylic brackets and matching aluminum sleeves



Part #	Mfg #	Fits Openings Between	Height	Glass	Frame	Price
043110	3400-56	52" - 56"	57"	Obscure	Silver	
043263	3400-56S	52" - 56"	56"	Obscure	Silver	
105231	3400-56SOR	52" - 56"	56"	Obscure	Oil Rubbed Bronze	
043176	3400-60	56" - 60"	57"	Obscure	Silver	
158235	3400-60S	56"-60"	56"	Obscure	Silver	
043301	3500-44	40" - 44"	70"	Obscure	Silver	
088853	3500-44BN	40" - 44"	70"	Obscure	Brushed Nickel	
043305	3500-48	44" - 48"	70"	Obscure	Silver	
102364	3500-48BN	44" - 48"	70"	Obscure	Brushed Nickel	
046075	3500-56	52" - 56"	70"	Obscure	Silver	
045609	3500-60	56" - 60"	70"	Obscure	Silver	
112578	3500-60BN	56" - 60"	70"	Obscure	Brushed Nickel	

## Vikrell - Sterling Tub Showers

### Vikrell® Tub & Shower Module

- Solid Vikrell® material for strength and durability
- High-gloss finish



#### 7115 Accord® 32" Tub & Shower Module

- 4-Piece wall set
- No caulking required in the seams
- Molded in shelving on back wall
- Complete unit rough-in dimensions including flanges: 75-1/2" x 60-1/4" x 33-1/4"
- Complete AFD unit rough-in dimensions including flanges: 77-1/2" x 60-1/4" x 33-1/4"
- Model (71151124-0) includes
  - 71154123 60" x 32 ADA wall set with grab bars
  - 71151124 60" x 32" Bath with seat



Part #	Mfg #	Description	Drain	Finished Dimensions	Color	Price
122721	71150110-0	Tub & Shower Complete	LH	74-1/4" x 60" x 32"	White	
125865	71150120-0	Tub & Shower Complete	RH	74-1/4" x 60" x 32"	White	
239532	71150125-0	Tub & Shower Complete, 1-1/2" Grab Bars	RH	74-1/4" x 60" x 32"	White	

#### Tub Only Bath Only Installation not recommended

Part #	Mfg #	Description	Drain	Finished Dimensions	Color	Price
122718	71151110-0	Tub Only, 18" Apron	RH	18" x 60" x 32"	White	
125867	71151120-0	Tub Only, 18" Apron	LH	18" x 60" x 32"	White	
125868	71151120-96	Tub Only, 18" Apron	LH	18" x 60" x 32"	Biscuit	
239530	71151124-0	Tub Only, 18" Apron, Includes Seat	RH	18" x 60" x 32"	White	

#### 7116 Accord® 36" Tub & Shower Module

- Geometric back wall design
- 4-Piece wall set
- No caulking required in the seams
- Abundant, recessed storage
- Complete unit rough-in dimensions: 77-1/2" x 60-1/4" x 37-1/4"



Complete Wall Set

Part #	Mfg #	Description	Drain	Finished Dimensions	Color	Price
137779	71160120-0	Tub & Shower Complete	RH	76-1/4" x 60" x 36"	White	
126609	71160110-0	Tub & Shower Complete	LH	76-1/4" x 60" x 36"	White	

#### Tub Only Bath Only Installation not recommended

Part #	Mfg #	Description	Drain	Finished Dimensions	Color	Price
126606	71161110-0	Tub Only, 20" Apron	LH	23" x 60" x 36"	White	
137778	71161120-0	Tub Only, 20" Apron	RH	23" x 60" x 36"	White	

## Vikrell - Sterling Tub Showers

### 7117 Ensemble 30" Tub & Shower Module

- Made of solid Vikrell material for strength, durability, and lasting beauty
- Designed with a 16" apron
- Durable high-gloss finish provides a smooth, shiny surface that is easy to clean
- Gently sloping bath with integral apron
- 2" wainscot allows tile-down installation above bath deck
- Conforms to ANSI Z124.1.2 and CSA B45.1 National Consensus Standards
- Can be installed with Wall Set 71374100
- ADA adaptable when installed per the requirements of the Accessibility Guidelines, Section 608 Shower Stalls, of the Act

**Tub Only**

**Bath Only Installation not recommended**

Part #	Mfg #	Description	Drain	Finished Dimensions	Color	Price
166750	71171110-0	Tub Only, 16" Apron	LH	60" x 30" x 18"	White	
167793	71171120-0	Tub Only, 16" Apron	RH	60" x 30" x 18"	White	

### 7114 Accord® 30" Tile Tub & Shower Module

- 4-Piece wall set (71140120)
- Realistic tile look
- No caulking required in the seams
- d
- Molded in shelving on back wall
- Complete unit rough-in dimensions: 73-1/4" x 60-1/4" x 31-1/4"
- AFD = Above Floor Drain



Left-Hand



Right-Hand

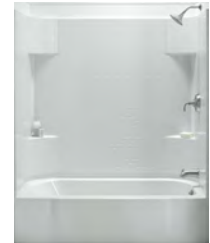

Complete Wall

Part #	Mfg #	Description	Drain	Finished Dimensions	Color	Price
102170	71140120-0	Tub & Shower Complete	RH	72" x 60" x 30"	White	

**Tub Only**

**Bath Only Installation not recommended**

Part #	Mfg #	Description	Drain	Finished Dimensions	Color	Price
102166	71141110-0	Tub Only, 15" Apron	LH	15" x 60" x 30"	White	
102176	71141110-96	Tub Only, 15" Apron	LH	15" x 60" x 30"	Biscuit	
102674	71141112-0	Tub Only, 15" Apron, AFD	LH	17-1/4" x 60" x 30"	White	
113385	71141122-0	Tub Only, 15" Apron, AFD	RH	20-1/4" x 60" x 30"	White	
226243	71141122-96	Tub Only, 15" Apron, AFD	RH	20-1/4" x 60" x 30"	Biscuit	
102168	71141120-0	Tub Only, 17" Apron	RH	17" x 60" x 30"	White	
102179	71141120-96	Tub Only, 17" Apron	RH	17" x 60" x 30"	Biscuit	

## Vikrell - Sterling Tub Showers

### 7124 Accord® 30" Smooth Tub & Shower Module

- 4-Piece wall set
- No caulking required in the seams
- Four integrated and recessed corner shelves
- Complete unit rough-in dimensions: 73-1/4" x 60-1/4" x 31-1/4"
- Complete AFD unit rough-in dimensions: 75-1/2" x 60-1/4" x 31-1/4"
- AFD - Above floor drain



Part #	Mfg #	Description	Drain	Finished Dimensions	Color	Price
107536	71240110-0	Tub & Shower Complete	LH	72" x 60" x 30"	White	
107537	71240110-96	Tub & Shower Complete	LH	72" x 60" x 30"	Biscuit	
138737	71240112-0	Tub & Shower Complete, AFD	LH	74-1/4" x 60" x 30"	White	
107538	71240120-0	Tub & Shower Complete	RH	72" x 60" x 30"	White	
138736	71240122-0	Tub & Shower Complete, AFD	RH	74-1/4" x 60" x 30"	White	
226246	71240122-96	Tub & Shower Complete, AFD	RH	74-1/4" x 60" x 30"	Biscuit	

### 7112 Ensemble™ 32" Tile Tub & Shower Module

- 2" Wainscot on tub allows tile installation above bath deck
- Order back wall and end walls separately
- Tongue and groove interlocking joints
- Shelving on back wall
- Complete unit rough-in dimensions including flanges: 75-1/4" x 60-1/4" x 33-1/4"
- Complete AFD unit rough-in dimensions including flanges: 77-1/4" x 60-1/4" x 33-1/4"
- AFD = Above floor drain



71120110-0

Part #	Mfg #	Description	Drain	Finished Dimensions	Color	Price
079338	71120110-0	Tub & Shower Complete	LH	74" x 60" x 32"	White	
077132	71120120-0	Tub & Shower Complete	RH	74" x 60" x 32"	White	
098105	71120122-0	Tub & Shower Complete, AFD	RH	76" x 60" x 32"	White	

### Tub Only Bath Only Installation not recommended

Part #	Mfg #	Description	Drain	Finished Dimensions	Color	Price
077770	71121110-0	Tub Only, 18" Apron	LH	20" x 60" x 32"	White	
077592	71121110-96	Tub Only, 18" Apron	LH	20" x 60" x 32"	Biscuit	
082991	71121112-0	Tub Only, 20" Apron, AFD	LH	20" x 60" x 32-1/8"	White	
077133	71121120-0	Tub Only, 18" Apron	RH	20" x 60" x 32"	White	
077963	71121120-96	Tub Only, 18" Apron	RH	20" x 60" x 32"	Biscuit	
093803	71121122-0	Tub Only, 20" Apron, AFD	RH	20" x 60" x 32-1/8"	White	

**Vikrell - Sterling Tub Showers**

**7110 Ensemble™ 36" Tile Oval Tub & Shower Module**

- 3" Wainscot allows tile installation above bath deck
- Optional 3-piece wall set
- Realistic tile look
- Tongue and groove interlocking joints
- Shelving on back wall
- Complete unit rough-in dimensions including flanges: 73-1/4" x 60-1/4" x 37-1/2"
- Complete AFD unit rough-in dimensions including flanges: 75-1/2" x 60-1/4" x 37-1/2"
- AFD = Above Floor Drain

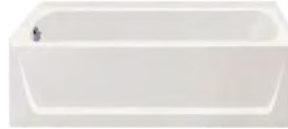

71120110-0

**Tub Only**

**Bath Only Installation not recommended**

Part #	Mfg #	Description	Drain	Finished Dimensions	Color	Price
061465	71101110-0	Tub Only, 19" Apron	LH	19" x 60" x 36"	White	
054343	71101120-0	Tub Only, 19" Apron	RH	19" x 60" x 36"	White	

**7111 Ensemble™ 42" Tile Oval Tub & Shower Module**

- 3" Wainscot allows tile installation above bath deck
- Optional 3-piece wall set
- Realistic tile look
- Tongue and groove interlocking joints
- Shelving on back wall
- Complete unit rough-in dimensions including flanges: 73-1/4" x 60-1/4" x 43-1/2"
- Complete AFD unit rough-in dimensions including flanges: 75-1/2" x 60-1/4" x 43-1/2"
- AFD = Above Floor Drain

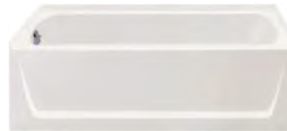

**Tub Only**

**Bath Only Installation not recommended**

Part #	Mfg #	Description	Drain	Finished Dimensions	Color	Price
136157	71111122-0	Tub Only, 18-1/4" Apron, AFD	RH	19" x 60" x 42"	White	

**7122 Ensemble™ 32" Curve Tub & Shower Module**

- 2" Wainscot on tub allows tile installation above bath deck
- Optional 3-piece wall set
- Curve wall with smooth contemporary look
- Tongue and groove interlocking joints
- Shelving on back wall
- Complete unit rough-in dimensions including flanges: 75-1/4" x 60-1/4" x 33-1/4"
- Complete AFD unit rough-in dimensions including flanges: 77-1/4" x 60-1/4" x 33-1/4"
- AFD - Above floor drain



Part #	Mfg #	Description	Drain	Finished Dimensions	Color	Price
111759	71220110-0	Tub & Shower Complete	LH	74" x 60" x 32"	White	
082515	71220110-96	Tub & Shower Complete	LH	74" x 60" x 32"	Biscuit	
111760	71220120-0	Tub & Shower Complete, AFD	RH	76" x 60" x 32"	White	
090694	71220112-0	Tub & Shower Complete, AFD	LH	76" x 60" x 32"	White	
093806	71220122-0	Tub & Shower Complete, AFD	RH	76" x 60" x 32"	White	



## Vikrell - Sterling Tub Showers

### 7132 and 7137 Ensemble™ Medley™ Tub & Shower Module

- Modular design allows it to be moved around corners and through doorways with ease
- Durable high gloss finish
- Innovative Dry-Block™ seal and channeled water containment system form watertight seams
- Clean, contemporary design with ample shelving
- 2" (51 mm) wainscot/tile ledge
- AFD models = Above floor drain



Part #	Mfg #	Description	Drain	Finished Dimensions	Color	Price
167671	71320110-0	Tub & Shower Complete	LH	75" x 60" x 32"	White	
177104	71320112-0	Tub & Shower Complete, AFD	LH	77" x 60" x 32"	White	
165954	71320120-0	Tub & Shower Complete	RH	75" x 60" x 32"	White	
169367	71320122-0	Tub & Shower Complete, AFD	RH	77" x 60" x 32"	White	
225479	71320116-0	Tub & Shower Complete w/ Backer Boards	LH	75" x 60" x 32"	White	
223606	71320126-0	Tub & Shower Complete w/ Backer Boards	RH	75" x 60" x 32"	White	
166752	71370110-0	Tub & Shower Complete	LH	73" x 60" x 30"	White	
171002	71370110-96	Tub & Shower Complete	LH	73" x 60" x 30"	Biscuit	
226844	71370116-0	Tub & Shower Complete w/ Backer Boards	LH	73" x 60" x 30"	White	
244237	71370116-96	Tub & Shower Complete w/ Backer Boards	LH	73" x 60" x 30"	Biscuit	
167794	71370120-0	Tub & Shower Complete	RH	73" x 60" x 30"	White	
168317	71370120-96	Tub & Shower Complete	RH	73" x 60" x 30"	Biscuit	
244256	71370126-96	Tub & Shower Complete w/ Backer Boards	RH	73" x 60" x 30"	Biscuit	

### 7104 Performa™ 29" Tub & Shower Module

- Lightly pebbled bottom surface for sure footing
- Optional 3-piece wall set
- Caulk required in both vertical and horizontal wall seams to finish installation
- Convenient shelving and acrylic towel bar located on the back wall provide generous storage for toiletries, soap, and accessories
- Sloping backrest provides better lumbar support
- Tub liner included to protect the tub during installation
- Complete unit rough-in dimensions including flanges: 76-3/4" x 60-1/4" x 30"
- Complete AFD unit rough-in dimensions including flanges: 79" x 60-1/4" x 30-1/4"
- AFD = Above Floor Drain



Part #	Mfg #	Description	Drain	Finished Dimensions	Color	Price
007900	71040110-0	Tub & Shower Complete	LH	75-3/4" x 60" x 29"	White	
007870	71040120-0	Tub & Shower Complete	RH	75-3/4" x 60" x 29"	White	
188893	71040126-0	Tub & Shower Complete w/ Backer Boards	RH	75-1/2" x 60" x 29"	White	

**Tub Only**  
**Bath Only Installation not recommended**

Part #	Mfg #	Description	Drain	Finished Dimensions	Color	Price
007869	71041110-0	Tub Only, 15" Apron	LH	15" x 60" x 29"	White	
007872	71041120-0	Tub Only, 15" Apron	RH	15" x 60" x 29"	White	

**Vikrell - Sterling Tub Showers**

**Vikrell® Tub & Shower Module (Continued)**

**7104 Performa™ 29" Tub & Shower Module**

**Tub Only**

**Bath Only Installation not recommended**

Part #	Mfg #	Description	Drain	Finished Dimensions	Color	Price
111259	71041112-96	Tub Only, 17-1/4" Apron, AFD	LH	18" x 60" x 29"	Biscuit	
148252	71041122-96	Tub Only, 17-1/4" Apron, AFD	RH	18" x 60" x 29"	Biscuit	

**Wall Sets**

Part #	Mfg #	Description	Drain	Finished Dimensions	Color	Price
244236	71374106-96	Tub & Shower Wall Set w/ Backer Boards	-	60" x 30"	Biscuit	

**Accord® 7115 Series Tub and Shower Wall Set for Right Hand Bath**

- Four-piece "snap together" installation
- Durable high gloss finish
- Caulk-less seam installation
- Compression molded
- Includes 1-1/2" OD stainless steel grab bars



Part #	Mfg #	Description	Drain	Finished Dimensions	Color	Price
239531	71154123-0	Wall Set Only	RH	74" x 60" x 32"	White	

**Accord® 7124 Series Wall Set**

- Solid Vikrell material
- Pivot snap together modular design
- Smooth, high-gloss walls
- No caulk required
- Four corner shelves
- Must be installed with Accord wall set (71244100, 71244103-V, 71244103-N, 71144100, 71144103-V, or 71144103-N)



Part #	Mfg #	Description	Drain	Finished Dimensions	Color	Price
107845	71244100-0	Wall Set Only	-	60" x 31-1/4"	White	

## Airbaths

### Alcove Bubble Massage™ Baths

#### Archer® Alcove BubbleMassage™ Bath

- Acrylic
- (120) BubbleMassage™ airjets
- Integral apron (-A) with removable access panel
- Integral tile flange and lumbar support
- Blower motor with 300 W heater, and electronic user control
- Slotted overflow for maximum bathing depth
- (-W) Bask™ heated surface
- (-H) Built-in heater
- (-L) left-hand drain
- (-R) right-hand drain



Requires K-7172 or K-7171 slotted overflow

Part #	Mfg #	Description	Jets	Color	Price
106114	K-1122-GLA-0	60" x 32" x 19", LH Drain	120	White	
186650	K-1122-GLA-47	60" x 32" x 19", LH Drain	120	Almond	
111754	K-1122-GLA-96	60" x 32" x 19", LH Drain	120	Biscuit	
143995	K-1122-GLA-G9	60" x 32" x 19", LH Drain	120	Sandbar	
223668	K-1122-GLAW-7	60" x 32" x 20-1/4", LH Drain w/Bask™ & Apron	120	Black	
183453	K-1122-GLAW-96	60" x 32" x 20-1/4", LH Drain w/Bask™ & Apron	120	Biscuit	
113847	K-1122-GRA-0	60" x 32" x 19", RH Drain	120	White	
126777	K-1122-GRA-96	60" x 32" x 19", RH Drain	120	Biscuit	
148247	K-1122-GRA-G9	60" x 32" x 19", RH Drain	120	Sandbar	
183454	K-1122-GRAW-0	60"x32"x20-1/4", RH Drain w/Bask™ & Comfort Depth®	120	White	
125922	K-1124-GLA-0	72" x 36" x 20-1/4", LH Drain	120	White	
166827	K-1124-GLAW-0	72" x 36" x 20-1/4", LH Drain w/Bask™ & Apron	120	White	
131240	K-1124-GRA-0	72" x 36" x 20-1/4", RH Drain	120	White	
179993	K-1947-GLA-0	60" x 30" x 19", LH Drain, ExoCrylic	120	White	
226731	K-1947-GLA-96	60" x 30" x 19", LH Drain, ExoCrylic	120	Biscuit	
166785	K-1947-GRA-0	60" x 30" x 19", RH Drain, ExoCrylic	120	White	
181727	K-1947-GRAW-0	60" x 30" x 19", RH Drain w/Bask™ Heated Surface	120	White	
253561	K-1949-GRA-0	60" x 30" x 19", RH Drain, ExoCrylic	120	White	
228108	K-1949-GRA-96	60" x 30" x 19", RH Drain, ExoCrylic	120	Biscuit	
170220	K-1949-GLA-0	66" x 32" x 19", LH Drain, ExoCrylic	120	White	
238584	K-1949-GLA-96	66" x 32" x 19", LH Drain, ExoCrylic	120	Biscuit	

## Airbaths

### Bancroft® Alcove BubbleMassage™ Bath

- Acrylic
- (120) BubbleMassage™ airjets
- Integral apron (-A) with removable access panel
- Integral tile flange and lumbar support
- Variable-speed blower lets you adjust massage intensity to 18 levels
- Electronic keypad
- Textured bottom surface
- (-W) Bask™ heated surface
- (-L) left-hand drain
- (-R) right-hand drain



Part #	Mfg #	Description	Jets	Color	Price
106612	K-1151-GLA-0	60" x 32" x 21-1/4", LH Drain	120	White	
111755	K-1151-GLA-96	60" x 32" x 21-1/4", LH Drain	120	Biscuit	
161691	K-1151-GLAW-0	60" x 32" x 21-1/4", LH Drain w/ Bask™	120	White	
260521	K-1151-GLAW-96	60" x 32" x 21-1/4", LH Drain w/ Bask™	120	Biscuit	
094941	K-1151-GRA-0	60" x 32" x 21-1/4", RH Drain	120	White	
111179	K-1151-GRA-47	60" x 32" x 21-1/4", RH Drain	120	Almond	
099632	K-1151-GRA-96	60" x 32" x 21-1/4", RH Drain	120	Biscuit	
112328	K-1151-GRA-G9	60" x 32" x 21-1/4", RH Drain	120	Sandbar	

### Devonshire® Alcove BubbleMassage™ Bath

- Acrylic
- (120) BubbleMassage™ airjets
- Integral tile flange and lumbar support
- Variable-speed blower lets you adjust massage intensity to 18 levels
- Molded lumbar support and armrests offer extra comfort while bathing
- Textured bottom surface
- Drain sold separately
- (-A) Integral apron
- (-W) Bask™ heated surface
- (-L) left-hand drain
- (-R) right-hand drain



Part #	Mfg #	Description	Jets	Color	Price
089315	K-1357-GLA-0	60" x 32" x 20", LH Drain	120	White	
125617	K-1357-GLA-47	60" x 32" x 20", LH Drain	120	Almond	
100399	K-1357-GLA-96	60" x 32" x 20", LH Drain	120	Biscuit	
148946	K-1357-GLA-G9	60" x 32" x 20", LH Drain	120	Sandbar	
171855	K-1357-GLAW-0	60" x 32" x 20", LH Drain w/ Bask™ Heated Surface	120	White	
084185	K-1357-GRA-0	60" x 32" x 20", RH Drain	120	White	
248987	K-1357-GRA-47	60" x 32" x 20", RH Drain	120	Almond	
084808	K-1357-GRA-96	60" x 32" x 20", RH Drain	120	Biscuit	

## Airbaths

### Mariposa® Alcove BubbleMassage™ Bath

- Acrylic
- (120) BubbleMassage™ airjets
- Variable-speed blower lets you adjust massage intensity to 18 levels
- Electronic keypad
- Textured bottom surface
- Integral apron with removable access panel
- Integral tile flange
- Drain sold separately
- Immediate and manual purge cycles remove residual water from air channels after use
- (-W) Bask™ heated surface
- (-L) left-hand drain
- (-R) right-hand drain
- (-F) Flange only, does not include apron



Part #	Mfg #	Description	Jets	Color	Price
168426	K-1224-GLA-0	66" x 36" x 20", LH Drain	120	White	
257277	K-1224-GLAW-0	66" x 36" x 20", LH Drain, w/ Bask™ Heated Surface	120	White	
231582	K-1224-GLAW-47	66" x 36" x 20", LH Drain, w/ Bask™ Heated Surface	120	Almond	
159122	K-1224-GRA-0	66" x 36" x 20", RH Drain	120	White	
173768	K-1224-GRA-47	66" x 36" x 20", RH Drain	120	Almond	
223873	K-1224-GRA-96	66" x 36" x 20", RH Drain	120	Biscuit	
168262	K-1239-GLA-0	60" x 36" x 20", LH Drain	120	White	
223446	K-1239-GLA-96	60" x 36" x 20", LH Drain	120	Biscuit	
163094	K-1239-GLA-G9	60" x 36" x 20", LH Drain	120	Sandbar	
228054	K-1239-GRA-0	60" x 36" x 20", RH Drain	120	White	
244204	K-1239-GRA-96	60" x 36" x 20", RH Drain	120	Biscuit	
239177	K-1239-GRF-0	60" x 36" x 20", RH Drain w/Flange Less Apron	120	White	
234476	K-1239-GLF-0	60" x 36" x 20", RH Drain w/Flange Less Apron	120	White	
087341	K-1257-GLA-0	72" x 36" x 20", LH Drain	120	White	
111739	K-1257-GLA-96	72" x 36" x 20", LH Drain	120	Biscuit	
116126	K-1257-GLF-0	72" x 36" x 20", LH Drain Less Apron	120	White	
090733	K-1257-GRA-0	72" x 36" x 20", RH Drain	120	White	
110522	K-1257-GRA-96	72" x 36" x 20", RH Drain	120	Biscuit	
118033	K-1257-GRA-G9	72" x 36" x 20", RH Drain	120	Sandbar	
238022	K-1257-GRAW-0	72" x 36" x 20", RH Drain w/ Bask™ Heated Surface	120	White	

## Airbaths

### Winward® Alcove BubbleMassage™ Bath

- Acrylic
- (120) BubbleMassage™ airjets
- Blower motor is supplied with a grounding-type plug-in cord
- Integral apron with removable access panel
- Integral tile flange
- Molded lumbar supports and armrests
- Overflow drain sold separately
- (-F) internal flange less apron
- (-W) Bask™ heated surface
- (-L) left-hand drain
- (-R) right-hand drain



Part #	Mfg #	Description	Jets	Color	Price
142810	K-1112-GLA-96	60" x 42" x 22-1/4", LH Drain	120	Biscuit	
166240	K-1112-GRA-0	60" x 42" x 22-1/4", RH Drain	120	White	
158133	K-1114-GLA-0	72" x 42" x 22-1/4", LH Drain	120	White	
158257	K-1114-GLA-96	72" x 42" x 22-1/4", LH Drain	120	Biscuit	
182991	K-1114-GLF-0	72" x 42" x 22-1/4", LH Drain Less Apron	120	White	
228117	K-1114-GLF-96	72" x 42" x 22-1/4", LH Drain Less Apron	120	Biscuit	
182854	K-1114-GRF-0	72" x 42" x 22-1/4", RH Drain Less Apron	120	White	

### Drop-In BubbleMassage™ Baths

#### Archer™ BubbleMassage™ Bath

- (120) Factory installed color-matched ProFlex® BubbleMassage™ airjets
- Blower motor with 300W heater (-G only) and electronic user control
- Low threshold height
- Slotted overflow for maximum bathing depth
- Armrests and integral lumbar support
- Drop-in installation, 120V electrical service with grounding-type plug-in cord
- Textured bottom surface
- Drain sold separately
- (-W) Bask™ heated surface
- Reversible drain



Part #	Mfg #	Description	Jets	Color	Price
111525	K-1122-G-0	60" x 32" x 19"	120	White	
125534	K-1122-G-47	60" x 32" x 19"	120	Almond	
113956	K-1122-G-96	60" x 32" x 19"	120	Biscuit	
172494	K-1122-GW-96	60" x 32" x 19", Bask™ Heated Surface, ADA	120	Biscuit	
248587	K-1122-GW-47	60" x 32" x 20-1/4", Reversible Drain w/ Bask™	120	Almond	
188404	K-1949-G-0	60" x 32" x 19" Reversible Drain	120	White	
110495	K-1124-G-0	72" x 36" x 19"	120	White	
129415	K-1124-G-47	72" x 36" x 19"	120	Almond	
113182	K-1124-G-96	72" x 36" x 19"	120	Biscuit	
177051	K-1124-GW-0	72" x 36" x 19", Bask™ Heated Surface	120	White	



## Airbaths

### Drop-In BubbleMassage™ Baths (Continued)

#### Archer™ BubbleMassage™ Bath

Part #	Mfg #	Description	Jets	Color	Price
122450	K-1124-H-0	72" x 36" x 20-1/4", Reversible Drain, Heater	120	White	

#### Bancroft® BubbleMassage™ Bath

- Acrylic
- (122) Factory installed airjets
- Lighted keypad
- Three heat settings
- Molded lumbar support and armrests offer extra comfort while bathing
- Variable-speed blower lets you adjust massage intensity to 18 levels
- Zones of Control feature allows you to target massage to back, midsection, or feet
- Immediate and manual purge cycles remove residual water from air channels after use
- Textured bottom surface
- Reversible end drain
- (-GW) Bask™ heated surface



Part #	Mfg #	Description	Jets	Color	Price
260508	1158-GW-0	66" x 42" x 22", Bask™ Heated Surface	122	White	

#### Devonshire® BubbleMassage™ Bath

- Acrylic
- (120) Factory installed airjets
- Molded lumbar support and armrests offer extra comfort while bathing
- Variable-speed blower lets you adjust massage intensity to 18 levels
- Textured bottom surface
- Reversible end drain



Part #	Mfg #	Description	Jets	Color	Price
085755	K-1357-G-0	60" x 32" x 20"	120	White	
183006	K-1357-G-47	60" x 32" x 20"	120	Almond	
083748	K-1357-G-96	60" x 32" x 20"	120	Biscuit	
093628	K-1357-G-G9	60" x 32" x 20"	120	Sandbar	
247417	K-1357-GW-0	60" x 32" x 20", Bask™ Heated Surface	120	White	

#### Mariposa® Drop-In BubbleMassage™ Bath with Reversible Drain

- Acrylic
- (120) BubbleMassage™ airjets
- Variable-speed blower lets you adjust massage intensity to 18 levels
- Electronic keypad
- Textured bottom surface
- Immediate and manual purge cycles remove residual water from air channels after use
- (-W) Bask™ heated surface



Part #	Mfg #	Description	Jets	Color	Price
162955	K-1224-G-0	66" x 36" x 20"	120	White	

## Airbaths

### Drop-In BubbleMassage™ Baths (Continued)

#### Mariposa® Drop-In BubbleMassage™ Bath with Reversible Drain

Part #	Mfg #	Description	Jets	Color	Price
174480	K-1224-G-47	66" x 36" x 20"	120	Almond	
159362	K-1224-G-96	66" x 36" x 20"	120	Biscuit	
175701	K-1224-G-NY	66" x 36" x 20"	120	Dune	
229409	K-1224-GW-0	66" x 36" x 20", w/ Bask™ Heated Surface	120	White	
232940	K-1224-GW-47	66" x 36" x 20", w/ Bask™ Heated Surface	120	Almond	
156463	K-1239-G-0	60" x 36" x 20"	120	White	
172840	K-1239-GW-0	60" x 36" x 20", w/ Bask™ Heated Surface	120	White	
086774	K-1257-G-0	72" x 36" x 20"	120	White	
100958	K-1257-G-47	72" x 36" x 20"	120	Almond	
084479	K-1257-G-96	72" x 36" x 20"	120	Biscuit	
100749	K-1257-G-G9	72" x 36" x 20"	120	Sandbar	
188980	K-1257-GW-0	72" x 36" x 20", w/ Bask™ Heated Surface	120	White	
188575	K-1257-GRW-0	72" x 36" x 20", RH Drain w/ Bask™ Heated Surface	120	White	

#### Memoirs® Drop-In BubbleMassage™ Bath

- Acrylic
- (122) BubbleMassage™ airjets
- Variable-speed blower adjusts to 18 levels
- Lighted keypad
- Molded lumbar support
- Immediate and manual purge cycles remove residual water from air channels after use
- (-W) Bask™ heated surface



Part #	Mfg #	Description	Jets	Color	Price
080855	K-1418-G-0	72" x 42" x 22"	122	White	
126206	K-1418-G-47	72" x 42" x 22"	122	Almond	
076835	K-1418-G-96	72" x 42" x 22"	122	Biscuit	
086204	K-1418-G-G9	72" x 42" x 22"	122	Sandbar	
181201	K-1418-GW-96	72" x 42" x 22", w/ Bask™ Heated Surface	122	Biscuit	

#### Portrait® BubbleMassage™ Drop-In Air Bath with Center Drain

- Acrylic
- Built-in 300 W heater
- Lighted keypad control
- Molded lumbar support and armrests
- (122) BubbleMassage® airjets, 18 levels of massage intensity
- Zones of Control feature allows you to target massage to back, midsection, or feet
- Automatic purge cycles remove residual water from air channels after use



Part #	Mfg #	Description	Jets	Color	Price
084968	K-1457-G-96	67" x 42" x 22"	122	Biscuit	

## Airbaths

### Purist® Drop-In BubbleMassage™ 6' Air Bath

- Acrylic
- Drop-in or under-mount
- (122) BubbleMassage™ airjets, 18 levels of massage intensity
- Built-in 300 W heater
- Lighted keypad control
- Overflow channel for deep soak
- Zones of Control feature allows you to target massage to back, midsection, or feet
- K-7273 End drain required
- K-589 Under-mount installation kit required



Part #	Mfg #	Description	Jets	Color	Price
094266	K-1110-G-0	72" x 46" x 25-11/16"	White		

### Reve® Dual-Mount BubbleMassage™ Bath with Center Drain

- Cast iron
- (44) BubbleMassage™ airjets, 18 levels of massage intensity
- Zones of control feature allows you to target massage to back, midsection, or feet
- Automatic purge cycles remove residual water from air channels after use
- Built-in 300W heater
- Lighted keypad control



Requires: K-7271 or K-7272 Slotted Overflow Drain

Part #	Mfg #	Description	Jets	Color	Price
183154	K-820-G0-0	67" x 32" x 19", Center Drain	44	White	

### Serif® Drop-In BubbleMassage™ Air Bath with End Drain

- Acrylic
- 120 BubbleMassage™ airjets, 18 levels of massage intensity
- Integral lumbar support
- Textured bottom surface
- Built-in 300 W heater
- Lighted electronic keypad control
- Automatic purge cycles remove residual water from air channels after use
- Zones of Control feature allows you to target massage to back, midsection, or feet



Part #	Mfg #	Description	Jets	Color	Price
085802	K-1337-G-0	60" x 42" x 21", End Drain	120	White	
085895	K-1337-G-96	60" x 42" x 21", End Drain	120	Biscuit	

## Airbaths

### Sunward® BubbleMassage™ Bath

- (120) BubbleMassage™ airjets
- Blower motor with 300 W heater and electronic user control
- Molded lumbar support and armrests
- Textured bottom surface
- End drain
- (-W) Bask™ heated surface
- (-S1) ExoCrylic™ material



Part #	Mfg #	Description	Jets	Color	Price
113992	K-1162-G-0	60" x 42" x 20" Acrylic	120	White	
115499	K-1162-G-47	60" x 42" x 20" Acrylic	120	Almond	
119068	K-1162-G-96	60" x 42" x 20" Acrylic	120	Biscuit	
183457	K-1162-S1G-0	60" x 42" x 20" ExoCrylic™	120	White	
168153	K-1162-S1G-96	60" x 42" x 20" Exocrylic™	120	Biscuit	
169184	K-1162-S1GW-0	60" x 42" x 20" Exocrylic™ w/ Bask™ Heated Surface	120	White	
117142	K-1164-G-0	72" x 42" x 20" Acrylic	120	White	
114883	K-1164-G-96	72" x 42" x 20" Acrylic	120	Biscuit	
174496	K-1164-S1GW-0	72" x 42" x 20" Exocrylic™ w/Bask™ Heated Surface	120	White	
168294	K-1164-S1G-0	72" x 42" x 20" Exocrylic™	120	White	
168602	K-1164-S1G-96	72" x 42" x 20" Exocrylic™	120	Biscuit	

### Sunward® BubbleMassage™ Bath

- (118-122) BubbleMassage™ airjets
- 18 Levels of massage intensity
- Electronic keypad control
- Integral lumbar support and armrests
- Textured bottom surface
- End drain
- Variable-speed pump for adjusting hydromassage intensity
- Automatic and manual purge cycles remove residual water from air channels
- (-W) Bask™ heated surface
- (-S1) ExoCrylic™ material



Part #	Mfg #	Description	Jets	Color	Price
245914	K-6347-G-0	66" x 42" x 20" Acrylic	118-122	White	

## Airbaths

### Tea-for-Two® Dual-Mount BubbleMassage™ Bathtub

- Cast iron with Safeguard® finish
- Blower motor with 300 W heater and electronic back-lit user control
- 18 Levels of airflow adjustability with zones of control
- Automatic purge cycles remove residual water from air channels after use
- (44) BubbleMassage™ airjets
- Drain sold separately



Part #	Mfg #	Description	Jets	Color	Price
183155	K-852-G0-0	60" x 32" x 18-1/4", End Drain	44	White	
183156	K-856-G0-0	66" x 36" x 24", End Drain	44	White	

### Tercet® BubbleMassage™ Corner Bath

- 120 BubbleMassage™ airjets
- Blower motor is supplied with a grounding-type plug-in cord
- Molded lumbar supports and has armrests
- Blower motor with 300 W heater and electronic user control
- Drop-in rim style or tile flange, right-hand blower
- Drain sold separately
- (-F) 3T tile flange
- (-A) Apron
- (-L) Left hand drain



Part #	Mfg #	Description	Jets	Color	Price
117557	K-1160-G-0	60" x 60" 21"	120	White	
151937	K-1160-G-96	60" x 60" 21"	120	Biscuit	
107707	K-1160-GF-0	60" x 60" 21" 3T Tile Flange	120	White	
145916	K-1160-GF-96	60" x 60" 21" 3T Tile Flange	120	Biscuit	
120391	K-1160-GLA-0	60" x 60" 21" 3T Tile Flange & Apron	120	White	

### Windward® BubbleMassage™ Bath

- (120) BubbleMassage™ airjets
- Blower motor is supplied with a grounding-type plug-in cord
- Molded lumbar supports and has armrests
- Blower motor with 300 W heater and electronic user control



Part #	Mfg #	Description	Jets	Color	Price
111427	K-1114-G-0	72" x 42" x 21"	120	White	
152434	K-1114-G-96	72" x 42" x 21"	120	Biscuit	

## Airbaths

### Underscore® BubbleMassage™ Air Bath

- Acrylic
- (122) BubbleMassage™ airjets
- Zones of Control™ feature
- Lighted keypad
- Drop-in or under-mount installation
- Slotted overflow allows for deep soaking
- Blower motor with 300 W heater and electronic back-lit user control
- Immediate and manual purge cycles remove residual water from air channels after use
- (-W) Bask™ heated surface
- (-C) Chromatherapy
- (-V) VibrAcoustic®



Requires Overflow Drain: K-7271 or K-7272

Part #	Mfg #	Description	Jets	Color	Price
232137	K-1167-G-0	60" x 30" x 19"	122	White	
155001	K-1849-G-0	60" x 36" x 21"	122	White	
258551	K-1849-GCR-0	60" x 36" x 21" w/ Chromatherapy	122	White	
174958	K-1849-G-96	60" x 36" x 21"	122	White	
179346	K-1822-G-0	66" x 32" x 22"	122	White	
134575	K-1173-GCR-0	66" x 36" x 22", w/ Chromatherapy	122	White	
231223	K-1173-GVBCW-0	66"x36"x22", w/ Chromatherapy, Bask™, VibrAcoustic	122	White	
168301	K-1173-GVBCW-47	66"x36"x22", w/ Chromatherapy, Bask™, VibrAcoustic	122	Almond	
167837	K-1173-GVBCW-96	66" x 36" x 22", w/ Chromatherapy, Bask™, VibrAcoustic	122	Biscuit	
185582	K-1173-GW-0	66" x 36" x 22", w/ Bask™ Heated Surface	122	White	
164468	K-1835-GCR-0	72" x 36" x 23", w/ Chromatherapy	122	White	
183478	K-1835-GCR-G9	72" x 36" x 23 w/ Chromatherapy	122	Sandbar	
245768	K-1835-GCW-0	72" x 36" x 23" w/ Chromatherapy, Bask™	122	White	
163869	K-1835-GW-0	72" x 36" x 23" w/ Bask™	122	White	
130918	K-1174-G-0	72" x 42" x 23"	122	White	
121689	K-1174-G-47	72" x 42" x 23"	122	Almond	
133053	K-1174-G-96	72" x 42" x 23"	122	Biscuit	
156731	K-1174-GCR-0	72" x 42" x 23", w/ Chromatherapy	122	White	
163868	K-1174-GW-0	72" x 42" x 23", with Bask™ Heated Surface	122	Biscuit	
240363	K-1174-GVB-0	72" x 42" x 23", with VibrAcoustic	122	White	
174441	K-1174-GVBCW-0	72" x 42" x 23", w/ Chromatherapy, Bask, VibrAcoustic	122	White	
170341	K-1174-VBW-0	72" x 42" x 23". w/ Bask™, VibrAcoustic	122	White	



## Airbaths

### Underscore® BubbleMassage™ Oval Air Bath

- Acrylic
- (118-122) BubbleMassage™ airjets
- Zones of Control™ feature
- Drop-in or under-mount installation
- Slotted overflow allows for deep soaking
- Variable-speed blower lets you adjust massage intensity to 18 levels
- Automatic purge cycles remove residual water from air channels after use
- (-W) Bask™ heated surface



Requires Overflow Drain: K-7271 or K-7272

Part #	Mfg #	Description	Jets	Color	Price
257092	K-5714-GW-0	60" x 36" x 21" with Bask Heated Surface	122	White	
241399	K-5716-G-0	66" x 36" x 22"	118-122	White	
246873	K-5716-GW-0	66" x 36" x 22" with Bask Heated Surface	118-122	White	
246137	K-5718-G-0	72" x 42" x 23"	118-122	White	

### Freestanding Bubble Massage Baths

#### Archer® Freestanding BubbleMassage™ Bath

- ExoCrylic™
- (118-122) BubbleMassage™ airjets
- End drain
- (-W) Bask® heated surface
- (-2M) Music



Part #	Mfg #	Description	Jets	Color	Price
240650	K-2593-G-0	62" x 32" x 22"	118-122	White	
247644	K-2593-GW-0	62" x 32" x 22" with Bask® Heated Surface	118-122	White	
243892	K-2595-GW-0	68" x 32" x 22" with Bask® Heated Surface	118-122	White	

#### Escale® Freestanding BubbleMassage™ Bath

- Acrylic
- (120) BubbleMassage™ airjets
- Center drain (sold separately)



Part #	Mfg #	Description	Jets	Color	Price
166481	K-14037-G-0	72" x 36" x 24-1/8"	120	White	

## Airbaths

### Stargaze® BubbleMassage™ Freestanding Air Bath with Fluted Shroud

- Acrylic
- Center drain
- 17" soaking depth
- (118-122) airjets, 12 levels of massage intensity
- Bask™ heated surface
- Three heat settings
- Wide ledge along one side
- Textured bottom surface
- Sloped lumbar support on both ends
- Purge cycles remove residual water from air channels after use
- (-W) Bask™ heated surface



Part #	Mfg #	Description	Jets	Color	Price
258956	K-1959-GW-0	72" x 36" x 25"	118-122	White	

### Sunstruck® Freestanding BubbleMassage™ Air Bath with Fluted Shroud

- Acrylic
- 118 to 122 BubbleMassage™ airjets, 18 levels of massage intensity
- Center drain
- Three heat settings
- 16-inch depth
- Integral lumbar support
- Textured bottom surface
- Wide ledge on one side is ideal for deck-mount faucet and/or handshower
- PureFlo™ drains are not recommended for a deck-mount faucet installation
- (-GW) Bask™ heated surface



Part #	Mfg #	Description	Jets	Color	Price
232838	K-1967-G-0	66" x 36" x 25"	118-122	White	
229849	K-1967-GW-96	66" x 36" x 25"	118-122	Almond	

### Sunstruck™ BubbleMassage™ Freestanding Air Bath

- Acrylic
- Straight shroud
- 16" soaking depth
- (118-122) Proflex® hydro-massage airjets, 18 levels of massage intensity
- Three heat settings
- Integral lumbar support
- Wide ledge along one side
- Textured bottom surface
- Center drain
- (-W) Bask™ heated surface



Part #	Mfg #	Description	Jets	Color	Price
231711	K-1966-GW-0	66" x 36" x 25", + Bask Heated Surface	White		
232436	K-1966-G-0	66" x 36" x 25"	White		

## Airbaths

### Underscore® Freestanding Bubble Massage™ Bath

- *ExoCrylic™*
- *(122) BubbleMassage™ airjets*
- *Variable-speed blower adjusts massage intensity to 18 levels*
- *Lighted keypad*
- *Dual lumbar supports*
- *Wide ledge on one side is ideal for deck-mount faucet*
- *Slotted overflow*
- *Automatic purge cycles*
- *Center drain*
- *(-GW) Bask™ heated surface*



Requires K-7271 or K-7272 Clearflo slotted overflow bath drain (sold separately)

Part #	Mfg #	Description	Jets	Color	Price
231333	K-5702-G-0	60" x 36" x 24-3/8" Center Drain	122	White	
222253	K-5702-GW-96	60" x 36" x 24-3/8" Center Drain, Bask Heated Surface	122	Biscuit	

### BubbleMassage™ Accessories

#### ProFlex® BubbleMassage™ Remote Installation Kit

- *For installation of blower motors away from the bath*
- *For use with ProFlex® BubbleMassage™ baths*



Part #	Mfg #	Description	Jets	Color	Price
088874	K-1446-NA	Blower Motor Remote Installation Kit	-	-	

## Airbaths

### Freestanding Tubs

#### Restore™ Freestanding ACR Walk-In Tub

- Cast acrylic construction
- 16 Air jets
- 3 Speed blower
- On/off 4-button electronic keypad
- Chromatherapy color light system
- Removable front and end panels
- Cable operated left or right drain
- 1" Steel frame with adjustable feet
- Optional heated seat and backrest
- 17" High, ADA compliant seat to remain upright while completely submerged



Part #	Mfg #	Description	Jets	Color	Price
238799	8490	51-1/2" x 30" x 40", Right Hand Drain	16	White	

**Airbaths**

**Freestanding Air Bathtubs**

**Miles 2-Piece Drop-In Freestanding Airbath**

- Acrylic
- Center drain
- Above-the-floor
- Compatible with F2 drain
- Four adjustable leveling legs
- Two deck widths for different styles of faucet
- XXXXX-055 = Aerofeel air system



Part #	Mfg #	Description	Blower	Capacity	Finish	Price
163785	MAAXMILESWHT	66" x 36" x 23", Center Drain w/ Aerofeel	B	61 Gal	White/White	

## Soaking Tubs

### Alcove Bathtubs - Cast Iron

#### Bellwether® Alcove Bathtub

- Cast iron
- Safeguard® slip-resistant surface on bath floor
- Integral apron and (3) sided tile flange
- Drain sold separately
- Wide ledges for extra storage space
- Available in (3) sizes 60"x30", 60"x32", & 66"x32"



Part #	Mfg #	Description	Color	Price
152203	K-837-0	60" x 30" x 14", Left Hand Drain	White	
160755	K-837-96	60" x 30" x 14", Left Hand Drain	Biscuit	
183656	K-837-NY	60" x 30" x 14", Left Hand drain	Dune	
155888	K-837-G9	60" x 30" x 14", Left Hand Drain	Sandbar	
149346	K-838-0	60" x 30" x 14", Right Hand Drain	White	
163712	K-838-96	60" x 30" x 14", Right Hand Drain	Biscuit	
163394	K-847-0	66" x 32" x 17", Left Hand Drain	White	
183657	K-847-47	66" x 32" x 17", Left Hand Drain	Almond	
165973	K-848-0	66" x 32" x 17", Right Hand Drain	White	
124196	K-875-0	60" x 32" x 15-1/2", Left Hand Drain	White	
140856	K-875-47	60" x 32" x 15-1/2", Left Hand Drain	Almond	
132780	K-875-96	60" x 32" x 15-1/2", Left Hand Drain	Biscuit	
168233	K-875-G9	60" x 32" x 15-1/2", Left Hand Drain	Sandbar	
137198	K-876-0	60" x 32" x 15-1/2", Right Hand Drain	White	
183157	K-876-47	60" x 32" x 15-1/2", Right Hand Drain	Almond	
136420	K-876-96	60" x 32" x 15-1/2", Right Hand Drain	Biscuit	
157587	K-876-G9	60" x 32" x 15-1/2", Right Hand Drain	Sandbar	

#### Dynametric® Alcove Bathtub with Left-Hand Drain

- Integral apron for quick installation
- Integral lumbar support
- Integral flange
- Safeguard® slip-resistant finish
- Bath with raised bottom allows use of horizontal drain from outlet to wall



Part #	Mfg #	Description	Color	Price
062224	K-519-0	60" x 32" x 16-1/4", Left Hand Drain	White	



## Soaking Tubs

### Mendota® Alcove Bathtub

- Cast iron
- Safeguard® slip-resistant surface on bath floor
- Integral apron and (3) sided tile flange
- Drain sold separately



Part #	Mfg #	Description	Color	Price
060616	K-505-0	60" x 32" x 16-1/4", Left Hand Drain	White	
182460	K-505-47	60" x 32" x 16-1/4", Left Hand Drain	Almond	
074805	K-505-96	60" x 32" x 16-1/4", Left Hand Drain	Biscuit	
056882	K-506-0	60" x 32" x 16-1/4", Right Hand Drain	White	
115394	K-506-47	60" x 32" x 16-1/4", Right Hand Drain	Almond	
089619	K-506-96	60" x 32" x 16-1/4", Right Hand Drain	Biscuit	

### Memoirs® Alcove Bathtub

- Cast iron
- Safeguard® slip-resistant surface on bath floor
- Integral apron and (3) sided tile flange
- Drain sold separately



Part #	Mfg #	Description	Color	Price
076962	K-721-0	60" x 34" x 17-7/16", Left Hand Drain	White	
073515	K-721-47	60" x 34" x 17-7/16", Left Hand Drain	Almond	
059156	K-721-96	60" x 34" x 17-7/16", Left Hand Drain	Biscuit	
058776	K-722-0	60" x 34" x 17-7/16", Right Hand Drain	White	
095196	K-722-47	60" x 34" x 17-7/16", Right Hand Drain	Almond	
058235	K-722-96	60" x 34" x 17-7/16", Right Hand Drain	Biscuit	

### Seaforth™ Alcove Bathtub

- Cast iron
- Safeguard® slip-resistant surface on bath floor
- Integral apron and (3) sided tile flange
- Drain sold separately



Part #	Mfg #	Description	Color	Price
096807	K-745-0	54" x 30-1/4" x 14", Left Hand Drain	White	
091520	K-745-47	54" x 30-1/4" x 14", Left Hand Drain	Almond	
088817	K-745-96	54" x 30-1/4" x 14", Left Hand Drain	Biscuit	
076446	K-746-0	54" x 30-1/4" x 14", Right Hand Drain	White	
084041	K-746-96	54" x 30-1/4" x 14", Right Hand Drain	Biscuit	

## Soaking Tubs

### Villager™ Alcove Bathtub with 4" Ledge

- Cast iron
- Safeguard® slip-resistant surface on bath floor
- Integral apron and (3) sided tile flange
- Drain sold separately
- Left (K-713) or right (K-714) hand drains
- **4" Ledge provides extra room for bath supplies**



Part #	Mfg #	Description	Color	Price
061593	K-713-0	60" x 34-1/4" x 14", Left Hand Drain	White	
118496	K-713-47	60" x 34-1/4" x 14", Left Hand Drain	Almond	
060896	K-713-96	60" x 34-1/4" x 14", Left Hand Drain	Biscuit	
059569	K-714-0	60" x 34-1/4" x 14", Right Hand Drain	White	
067087	K-714-47	60" x 34-1/4" x 14", Right Hand Drain	Almond	
053941	K-714-96	60" x 34-1/4" x 14", Right Hand Drain	Biscuit	

### Villager™ Alcove Bathtub

- Cast iron
- Safeguard® slip-resistant surface on bath floor
- Integral apron and (3) sided tile flange
- Drain sold separately
- Left (K-715) or right (K-716) hand drains



Part #	Mfg #	Description	Color	Price
053196	K-715-0	60" x 30-1/4" x 14", Left Hand Drain	White	
053198	K-715-47	60" x 30-1/4" x 14", Left Hand Drain	Almond	
053199	K-715-96	60" x 30-1/4" x 14", Left Hand Drain	Biscuit	
053197	K-716-0	60" x 30-1/4" x 14", Right Hand Drain	White	
053200	K-716-47	60" x 30-1/4" x 14", Right Hand Drain	Almond	
053206	K-716-96	60" x 30-1/4" x 14", Right Hand Drain	Biscuit	

## Drop-In Bathtubs - Cast Iron

### Reve® Drop-In Bathtub

- Cast iron
- Safeguard® slip-resistant surface on bath floor
- Sloped lumbar support on both ends
- Center toe tap drain (sold separately)



Part #	Mfg #	Description	Color	Price
181965	K-817-0	67" x 32" x 19-1/16", Center Drain	White	
164884	K-892-0	67" x 36" x 19-1/16", Center Drain	White	

## Soaking Tubs

### Soissons® Drop-In Bathtub

- Cast iron
- Safeguard® slip-resistant surface on floor
- Reversible drain



Part #	Mfg #	Description	Color	Price
180434	K-941-0	59"x27-1/2"x16-3/4", Reversible End Drain	White	

### Claw Feet for Soissons® Cast Iron Baths

- Set of four feet
- Designed for above-the-floor bath installation
- Can be adjusted from 3-13/16" to 6-3/16"
- For use with Soissons® cast-iron baths
- Installation hardware included



Part #	Mfg #	Description	Color	Price
183492	K-18416-NA	Claw Feet, for Soissons Bath		

### Tea-for-Two® Drop-in Bathtub

- Cast iron with Safeguard® finish
- Reversible end drain
- Integral lumbar support
- Drop-in, three-wall alcove or undermount installation



Part #	Mfg #	Description	Color	Price
063951	K-850-0	60" x 32" x 18-1/4", Reversible End Drain	White	

### Alcove Bathtubs - Acrylic

#### 6036 Alcove Bathtub

- Exocrylic
- Molded lumbar support and armrests
- (-L) Three-sided tile flange



Part #	Mfg #	Description	Color	Price
091279	K-1142-L-0	60" x 36" x 18-1/8", (3) Sided Tile Flange LH Drain	White	

### Winward® Three-Wall Alcove Bathtub

- Acrylic
- Integral apron and (3) sided tile flange
- Drain sold separately
- Molded lumbar support



Part #	Mfg #	Description	Color	Price
182989	K-1113-LA-0	60" x 42" x 22-1/4", Left Hand Drain	White	

## Soaking Tubs

### Alcove Bathtubs - Acrylic (Continued)

#### Winward® Three-Wall Alcove Bathtub

Part #	Mfg #	Description	Color	Price
182990	K-1113-RA-0	60" x 42" x 22-1/4", Right Hand Drain	White	
154195	K-1113-RA-47	60" x 42" x 22-1/4", Right Hand Drain	Almond	
121847	K-1115-LA-0	72" x 42" x 22-1/4", Left Hand Drain	White	
108657	K-1115-RA-0	72" x 42" x 22-1/4", Right Hand Drain	White	
156934	K-1115-RA-96	72" x 42" x 22-1/4", Right Hand Drain	Biscuit	

#### Archer® Alcove Bathtub

- Acrylic
- (-A) Integral apron and (3) sided tile flange
- Slotted overflow
- Textured bottom surface
- Requires drain K-7271 or K-7272 (sold separately)
- (-LA) left hand drain or (-RA) right hand drain
- (-W) Bask® heated surface



Part #	Mfg #	Description	Color	Price
110348	K-1123-LA-0	60" x 32" x 19", Left Hand Drain	White	
133130	K-1123-LA-47	60" x 32" x 19", Left Hand Drain	Almond	
189638	K-1123-LA-58	60" x 32" x 19", Left Hand Drain	Thunder Grey	
146691	K-1123-LA-7	60" x 32" x 19", Left Hand Drain	Black	
161847	K-1123-LA-95	60" x 32" x 19", Left Hand Drain	Ice Grey	
111316	K-1123-LA-96	60" x 32" x 19", Left Hand Drain	Biscuit	
123481	K-1123-LA-G9	60" x 32" x 19", Left Hand Drain	Sandbar	
162695	K-1123-LA-K4	60" x 32" x 19", Left Hand Drain	Cashmere	
174336	K-1123-LA-NY	60" x 32" x 19", Left Hand Drain	Dune	
106070	K-1123-RA-0	60" x 32" x 19", Right Hand Drain	White	
148794	K-1123-RA-47	60" x 32" x 19", Right Hand Drain	Almond	
244414	K-1123-RA-58	60" x 32" x 19", Right Hand Drain	Thunder Grey	
179677	K-1123-RA-95	60" x 32" x 19", Right Hand Drain	Ice Grey	
118998	K-1123-RA-96	60" x 32" x 19", Right Hand Drain	Biscuit	
223216	K-1123-RA-G9	60" x 32" x 19", Right Hand Drain	Sandbar	
157630	K-1123-RA-K4	60" x 32" x 19", Right Hand Drain	Cashmere	
125004	K-1125-LA-0	72" x 36" x 19", Left Hand Drain	White	
154656	K-1125-LA-7	72" x 36" x 19", Left Hand Drain	Black	
122225	K-1125-LA-96	72" x 36" x 19", Left Hand Drain	Biscuit	
253279	K-1125-LA-NY	72" x 36" x 19", Left Hand Drain	Dune	
116361	K-1125-RA-0	72" x 36" x 19", Right Hand Drain	White	
131703	K-1125-RA-47	72" x 36" x 19", Right Hand Drain	Almond	
135418	K-1125-RA-96	72" x 36" x 19", Right Hand Drain	Biscuit	
253723	K-1125-RA-NA	72" x 36" x 19", Right Hand Drain	Dune	
186494	K-1946-L-0	60" x 30" x 21", Left Hand Drain, ExoCrylic	White	
229760	K-1946-L-NY	60" x 30" x 21", Left Hand Drain, ExoCrylic	Dune	

## Soaking Tubs

### Alcove Bathtubs - Acrylic (Continued)

#### Archer® Alcove Bathtub

Part #	Mfg #	Description	Color	Price
158766	K-1946-LA-0	60" x 30" x 19", Left Hand Drain, ExoCrylic	White	
175572	K-1946-LA-96	60" x 30" x 19", Left Hand Drain, ExoCrylic	Biscuit	
240496	K-1946-LA-K4	60" x 30" x 19", Left Hand Drain, ExoCrylic	Cashmere	
225554	K-1946-LA-NY	60" x 30" x 19", Left Hand Drain, ExoCrylic	Dune	
159069	K-1946-RA-0	60" x 30" x 19", Right Hand Drain, ExoCrylic	White	
175918	K-1946-RA-96	60" x 30" x 19", Right Hand Drain, ExoCrylic	Biscuit	
227204	K-1946-RA-K4	60" x 30" x 19", Right Hand Drain, ExoCrylic	Cashmere	
171150	K-1948-LA-0	66" x 32" x 19", Left Hand Drain, ExoCrylic	White	
173956	K-1948-RA-0	66" x 32" x 19", Right Hand Drain, ExoCrylic	White	
257589	K-1948-RAW-0	66" x 32" x 19", Right Hand Drain, ExoCrylic, Bask® Heated Surface	White	
168178	K-1948-RA-96	66" x 32" x 19", Right Hand Drain, ExoCrylic	Biscuit	

#### Archer® Alcove Bath Less Apron

- ExoCrylic
- Textured bottom surface
- Molded lumbar support
- Slotted overflow drain (sold separately)
- 3 Sided tiling flange



Part #	Mfg #	Description	Color	Price
175936	K-1946-L-58	60" x 30" x 20-1/4", Left Hand Drain, 3T	Thunder Grey	
170259	K-1946-L-96	60" x 30" x 20-1/4", Left Hand Drain, 3T	Biscuit	
175117	K-1946-R-0	60" x 30" x 20-1/4", Right Hand Drain, 3T	White	

#### Mariposa® Alcove Bathtub

- Acrylic
- (-A) Integral apron and (3) sided tile flange
- Drain sold separately
- (-LA) left hand drain or (-RA) right hand drain
- (-W) Bask™ heated surface



Part #	Mfg #	Description	Color	Price
103292	K-1229-LA-0	66" x 36" x 20", Left Hand Drain	White	
183387	K-1229-LA-47	66" x 36" x 20", Left Hand Drain	Almond	
153247	K-1229-LA-96	66" x 36" x 20", Left Hand Drain	Biscuit	
149320	K-1229-L-0	66" x 36" x 20", Left Hand Drain, Tile Flange Less Apron		
231675	K-1229-LAW-0	66" x 36" x 20", Left Hand Drain, Bask™	White	
117897	K-1229-RA-0	66" x 36" x 20", Right Hand Drain	White	
109559	K-1229-RA-47	66" x 36" x 20", Right Hand Drain	Almond	
154616	K-1229-RA-G9	66" x 36" x 20", Right Hand Drain	Sandbar	
255092	K-1229-RAW-0	66" x 36" x 20", Right Hand Drain, Bask™	White	
081171	K-1242-L-0	60" x 36" x 21-1/4", Left Hand Drain Less Apron	White	

## Soaking Tubs

### Alcove Bathtubs - Acrylic (Continued)

#### Mariposa® Alcove Bathtub

Part #	Mfg #	Description	Color	Price
097406	K-1242-L-47	60" x 36" x 21-1/4", Left Hand Drain Less Apron	Almond	
103097	K-1242-L-96	60" x 36" x 21-1/4", Left Hand Drain Less Apron	Biscuit	
080708	K-1242-LA-0	60" x 36" x 21-1/4", Left Hand Drain	White	
086056	K-1242-LA-96	60" x 36" x 21-1/4", Left Hand Drain	Biscuit	
148445	K-1242-LA-G9	60" x 36" x 21-1/4", Left Hand Drain	Sandbar	
110052	K-1242-R-0	60" x 36" x 21-1/4", Right Hand Drain Less Apron	White	
066519	K-1242-RA-0	60" x 36" x 21-1/4", Right Hand Drain	White	
117302	K-1242-RA-47	60" x 36" x 21-1/4", Right Hand Drain	Almond	
105782	K-1242-RA-96	60" x 36" x 21-1/4", Right Hand Drain	Biscuit	
144099	K-1242-RA-G9	60" x 36" x 21-1/4", Right Hand Drain	Sandbar	
255469	K-1242-RA-NY	60" x 36" x 21-1/4", Right Hand Drain	Dune	
246499	K-1242-RAW-0	60" x 36" x 20", Right Hand Drain, Bask™	White	
124469	K-1259-L-0	72" x 36" x 20", Left Hand Drain Less Apron	White	
148998	K-1259-L-96	72" x 36" x 20", Left Hand Drain Less Apron	Biscuit	
057729	K-1259-LA-0	72" x 36" x 20", Left Hand Drain	White	
113159	K-1259-LA-96	72" x 36" x 20", Left Hand Drain	Biscuit	
097409	K-1259-R-0	72" x 36" x 20", Right Hand Drain Less Apron	White	
102360	K-1259-R-96	72" x 36" x 20", Right Hand Drain Less Apron	Biscuit	
099537	K-1259-R-G9	72" x 36" x 20", Right Hand Drain Less Apron	Sandbar	
077814	K-1259-RA-0	72" x 36" x 20", Right Hand Drain	White	
167828	K-1259-RA-96	72" x 36" x 20", Right Hand Drain	Biscuit	
118034	K-1259-RA-G9	72" x 36" x 20", Right Hand Drain	Sandbar	
228767	K-1259-RA-NY	72" x 36" x 20", Right Hand Drain	Dune	
167516	K-1259-RAW-0	72" x 36" x 20", Right Hand Drain, Bask™ Heated Surface	White	

#### Bancroft™ Alcove Bathtub

- Acrylic
- Molded lumbar support
- Integral apron and (3) sided tile flange
- Drain sold separately



Part #	Mfg #	Description	Color	Price
090952	K-1150-LA-0	60" x 32" x 20", Left Hand Drain	White	
108950	K-1150-LA-47	60" x 32" x 20", Left Hand Drain	Almond	
103074	K-1150-LA-96	60" x 32" x 20", Left Hand Drain	Biscuit	
101064	K-1150-LA-G9	60" x 32" x 20", Left Hand Drain	Sandbar	
183455	K-1150-LAW-0	60" x 32" x 22", Left Hand Drain with Bask™ Heated Surface	White	
089591	K-1150-RA-0	60" x 32" x 20", Right Hand Drain	White	
114589	K-1150-RA-47	60" x 32" x 20", Right Hand Drain	Almond	
101727	K-1150-RA-96	60" x 32" x 20", Right Hand Drain	Biscuit	
160117	K-1150-RA-G9	60" x 32" x 20", Right Hand Drain	Sandbar	



## Soaking Tubs

### Devonshire® Alcove Bathtub

- Acrylic
- Integral arm rests and lumbar support
- Textured bottom surface
- Integral apron and (3) sided tile flange
- (-LA) left hand drain or (-RA) right hand drain
- (-W) Bask® heated surface



Part #	Mfg #	Description	Color	Price
070405	K-1184-LA-0	60" x 32" x 20", Left Hand Drain	White	
077568	K-1184-LA-47	60" x 32" x 20", Left Hand Drain	Almond	
064514	K-1184-LA-96	60" x 32" x 20", Left Hand Drain	Biscuit	
122422	K-1184-LA-G9	60" x 32" x 20", Left Hand Drain	Sandbar	
172783	K-1184-LA-NY	60" x 32" x 20", Left Hand Drain	Dune	
076275	K-1184-RA-0	60" x 32" x 20", Right Hand Drain	White	
096283	K-1184-RA-47	60" x 32" x 20", Right Hand Drain	Almond	
086476	K-1184-RA-96	60" x 32" x 20", Right Hand Drain	Biscuit	
126836	K-1184-RA-G9	60" x 32" x 20", Right Hand Drain	Sandbar	

### Expanse® Alcove Bathtub

- Acrylic
- Textured bottom surface
- Integral apron and (3) sided tile flange
- Curved basin and integral apron create spacious bathing experience
- (-W) Bask® heated surface



Part #	Mfg #	Description	Color	Price
149364	K-1100-LA-0	60" x 38" x 18-1/4", Left Hand Drain	White	
176343	K-1100-LA-96	60" x 38" x 18-1/4", Left Hand Drain	Biscuit	
140701	K-1100-RA-0	60" x 38" x 18-1/4", Right Hand Drain	White	
154429	K-1100-RA-96	60" x 38" x 18-1/4", Right Hand Drain	Biscuit	
245291	K-1100-RAW-96	60" x 38" x 18-1/4", Right Hand Drain w/ Bask® Heated Surface	Biscuit	
155269	K-1118-LA-0	60" x 36" x 18-1/4", Left Hand Drain	White	
162020	K-1118-RA-0	60" x 36" x 18-1/4", Right Hand Drain	White	
165949	K-1118-RA-47	60" x 36" x 18-1/4", Right Hand Drain	Almond	

### Hourglass® Alcove Bathtub

- Acrylic
- Textured bottom surface
- (-LA) Integral apron and (3) sided tile flange
- (-L) Tile flange, less apron
- Drain sold separately



Part #	Mfg #	Description	Color	Price
096990	K-1219-LA-0	60" x 32" x 20", Left Hand Drain	White	

## Soaking Tubs

### Alcove Bathtubs - Acrylic (Continued)

#### Hourglass® Alcove Bathtub

Part #	Mfg #	Description	Color	Price
142969	K-1219-LA-96	60" x 32" x 20", Left Hand Drain	Biscuit	
084413	K-1219-L-0	60" x 32" x 20", Left Hand Drain, Less Apron	White	
075974	K-1219-RA-0	60" x 32" x 20", Right Hand Drain	White	
248986	K-1219-RA-47	60" x 32" x 20", Right Hand Drain	Almond	
181846	K-1219-RA-96	60" x 32" x 20", Right Hand Drain	Biscuit	

#### Tercet® Corner Tub

- Acrylic
- Molded lumbar support and arm rests offer extra comfort
- Integral apron and (3) sided tile flange
- Drain sold separately
- (-F) Less apron



Part #	Mfg #	Description	Color	Price
094741	K-1161-0	60" x 60" x 21", Center Drain	White	
110342	K-1161-96	60" x 60" x 21", Center Drain	Biscuit	
090039	K-1161-LA-0	60" x 60" x 21", Center Drain	White	
135897	K-1161-LA-96	60" x 60" x 21", Center Drain	Biscuit	
133895	K-1161-F-0	60" x 60" x 21", Center Drain Less Apron	White	

#### Underscore® Alcove Bathtub

- Acrylic
- Molded lumbar support
- (3) Sided tile flange
- (-W) Bask™ heated surface
- (-L) left hand drain or (-R) right hand drain



Requires slotted overflow drain **K-7271** or **K-7272**

Part #	Mfg #	Description	Color	Price
153431	K-1121-L-0	60" x 30" x 19", Left Hand Drain	White	
155889	K-1121-R-0	60" x 30" x 19", Right Hand Drain	White	
188599	K-1121-R-96	60" x 30" x 19", Right Hand Drain	Biscuit	
152910	K-1121-RW-0	60" x 30" x 19", Right Hand Drain with Bask™ Heated Surface	White	

## Soaking Tubs

### Underscore® Alcove Bathtub

- Acrylic
- Integral lumbar support
- Integral flange
- Integral apron
- Slotted overflow
- Textured bottom surface
- (-L) left hand drain or (-R) right hand drain



Requires slotted overflow drain K-7271 or K-7272

Part #	Mfg #	Description	Color	Price
237017	K-1956-RA-0	60" x 30" x 19", Right Hand Drain	White	
234858	K-1956-LA-0	60" x 30" x 19", Left Hand Drain	White	
243724	K-1957-LA-96	60" x 32" x 21", Left Hand Drain	Biscuit	
235687	K-1957-LA-0	60" x 32" x 21", Left Hand Drain	White	
231772	K-1957-RA-0	60" x 32" x 21", Right Hand Drain	White	
257990	K-1957-RA-96	60" x 32" x 21", Right Hand Drain	Biscuit	
237838	K-20201-LA-0	60" x 30" x 19", Left Hand Drain	White	
239925	K-20201-RA-0	60" x 30" x 19", Right Hand Drain	White	
242142	K-20202-LA-0	60" x 32" x 19", Left Hand Drain	White	
243908	K-20202-RA-0	60" x 32" x 19", Right Hand Drain	White	

### Drop-In Bathtubs - Acrylic

#### 5454 Drop-In Bathtub

- ExoCrylic
- Center drain
- Integral faucet deck
- Molded lumbar support and armrests
- (-F) Integral flange



Part #	Mfg #	Description	Color	Price
078248	K-1155-0	54" x 54" x 20", Center Drain	White	
142010	K-1155-F-0	54" x 54" x 20", Center Drain	White	

#### 6036 Drop-In Bathtub

- Exocrylic
- Molded lumbar support and armrests
- Reversible end drain



Part #	Mfg #	Description	Color	Price
080120	K-1142-0	60" x 36" x 18-1/8", End Drain	White	

## Soaking Tubs

### 6040 Drop-In Bathtub

- *Exocrylic*
- *Molded lumbar support and armrests*
- *End drain*



Part #	Mfg #	Description	Color	Price
078056	K-1147-0	60" x 40" x 17-5/8", End Drain	White	

### 7236 Drop-In Bathtub

- *Exocrylic*
- *Molded lumbar support and armrests*
- *Reversible end drain*



Part #	Mfg #	Description	Color	Price
088870	K-1159-0	72" x 36" x 20-1/8", End Drain	White	
097239	K-1159-47	72" x 36" x 20-1/8", End Drain	Almond	
063711	K-1159-96	72" x 36" x 20-1/8", End Drain	Biscuit	

### 7242 Drop-In Bathtub

- *Exocrylic*
- *Molded lumbar support and armrests*



Part #	Mfg #	Description	Color	Price
053842	K-1132-0	72" x 42" x 20-1/8", Center Drain	White	
079262	K-1149-96	72" x 43" x 19-3/4", Center Drain	Biscuit	

### Archer™ Drop-In Bathtub

- *Exocrylic*
- *Integral arm rests and lumbar support*
- *Slotted overflow for deeper bathing depth*
- *Drain sold separately*
- *(-W) Bask™ heated surface*



K-1123

Requires K-7271 or K-7272 Clearflo slotted bath drain (sold separately)

Part #	Mfg #	Description	Color	Price
179829	K-1946-0	60" x 30" x 19", End Drain, ExoCrylic	White	
228132	K-1946-W1-0	60" x 30" x 19", End Drain, ExoCrylic w/ Bask™ Heated Surface	White	
170676	K-1948-0	66" x 32" x 19", End Drain, ExoCrylic	White	

## Soaking Tubs

### Archer™ Drop-In Bathtub

- Acrylic
- Comfort Depth™ design
- Integral arm rests and lumbar support
- Slotted overflow for deeper bathing depth
- Drain sold separately
- (-W) Bask™ heated surface



K-1123

Requires K-7271 or K-7272 Clearflo slotted bath drain (sold separately)

Part #	Mfg #	Description	Color	Price
110360	K-1123-0	60" x 32" x 19", End Drain	White	
178521	K-1123-95	60" x 32" x 19", End Drain	Ice Grey	
112625	K-1123-96	60" x 32" x 19", End Drain	Biscuit	
182992	K-1123-G9	60" x 32" x 19", End Drain	Sandbar	
160775	K-1123-RAW-0	60" x 32" x 19", End Drain w/ Bask™ Heated Surface	White	
115189	K-1125-0	72" x 36" x 19", End Drain	White	
132165	K-1125-47	72" x 36" x 19", End Drain	Almond	
162483	K-1125-58	72" x 36" x 19", End Drain	Thunder Grey	
113185	K-1125-96	72" x 36" x 19", End Drain	Biscuit	
152278	K-1125-NY	72" x 36" x 19", End Drain	Dune	

### Bancroft® Drop-in 5' Bathtub with End Drain

- Acrylic
- Integral lumbar support



Part #	Mfg #	Description	Color	Price
089590	K-1156-0	65-7/8" x 41-1/4" x 22", End Drain	White	

### Devonshire® Drop-In Bathtub

- Acrylic
- Integral lumbar support and armrests
- Textured bottom surface
- Reversible end drain
- (-W) Bask® Heated Surface



Part #	Mfg #	Description	Color	Price
067768	K-1184-0	60" x 32" x 20", End Drain	White	
081217	K-1184-47	60" x 32" x 20", End Drain	Almond	
091507	K-1184-96	60" x 32" x 20", End Drain	Biscuit	
253795	K-1184-W1-0	60" x 32" x 20", End Drain w/ Bask®	White	

## Soaking Tubs

### Escale® Drop-In Bathtub

- Acrylic
- Sloped lumbar support
- Center drain



Part #	Mfg #	Description	Color	Price
182993	K-11343-47	72" x 36" x 24-1/8", Center Drain	Almond	

### Hourglass® Drop-In Bathtub

- Acrylic
- Textured bottom surface
- End drain



Part #	Mfg #	Description	Color	Price
062621	K-1219-0	60" x 32" x 20", End Drain	White	
182404	K-1219-96	60" x 32" x 20", End Drain	Biscuit	

### Mariposa® Drop-In Bathtub

- Acrylic
- Textured bottom surface
- End drain
- (-W) Bask™ heated surface



Part #	Mfg #	Description	Color	Price
072415	K-1242-0	60" x 36" x 20", End Drain	White	
160106	K-1242-47	60" x 36" x 20", End Drain	Almond	
062568	K-1242-96	60" x 36" x 20", End Drain	Biscuit	
101387	K-1242-G9	60" x 36" x 20", End Drain	Sandbar	
083990	K-1229-0	66" x 36" x 20", End Drain	White	
104235	K-1229-47	66" x 36" x 20", End Drain	Almond	
097371	K-1229-96	66" x 36" x 20", End Drain	Biscuit	
177256	K-1229-W1-0	66" x 36" x 20", Bask™ Heated Surface, End Drain	White	
087401	K-1259-0	72" x 36" x 20", End Drain Less Apron	White	
246876	K-1259-W1-0	72" x 36" x 20", End Drain Less Apron, Bask™	White	

### Memoirs® Drop-In Bathtub

- Acrylic
- Textured bottom surface
- Integral lumbar support
- Center drain
- (-W) Bask™ heated surface



Part #	Mfg #	Description	Color	Price
253494	K-1169-NY	66" x 42" x 22", Center Drain	Dune	
064287	K-1417-0	72" x 42" x 22", Center Drain	White	



## Soaking Tubs

### Portrait® Drop-In Bathtub

- Acrylic
- Molded lumbar support and armrests



**K-1454-0**  
Center Drain



**K-1013-0**  
End Drain

Part #	Mfg #	Description	Color	Price
079699	K-1013-0	60" x 32" x 20", End Drain	White	
063930	K-1454-0	67" x 42" x 22", Center Drain	White	

### Serif® Drop-In Bathtub

- Acrylic
- End drain
- Integral lumbar support
- Textured bottom surface



Part #	Mfg #	Description	Color	Price
075872	K-1183-0	60" x 43" x 21", End Drain	White	

### Sunward® Drop-In Bathtub with End Drain

- Acrylic
- Molded lumbar support and armrests
- Textured bottom surface
- Under-mountable
- (-S1) ExoCrylic™ material
- (-W) Bask® heated surface



Part #	Mfg #	Description	Color	Price
095214	K-1163-0	60" x 42" x 20", End Drain	White	
104449	K-1163-96	60" x 42" x 20", End Drain	Biscuit	
095162	K-1163-G9	60" x 42" x 20", End Drain	Sandbar	
163156	K-1163-S1-0	60" x 42" x 20", End Drain ,ExoCrylic™	White	
230092	K-1163-S1W-0	60" x 42" x 20", End Drain ,ExoCrylic™, Bask®	White	
107959	K-1165-0	72" x 42" x 21", End Drain	White	
111335	K-1165-47	72" x 42" x 21", End Drain	Almond	
105938	K-1165-96	72" x 42" x 21", End Drain	Biscuit	
168098	K-1165-S1-0	72" x 42" x 21", End Drain ,ExoCrylic™	White	
170075	K-1165-S1-96	72" x 42" x 21", End Drain ,ExoCrylic™	Biscuit	
253498	K-6346-W1-0	66" x 42" x 20", End Drain, Bask® Heated Surface	White	
246518	K-6346-W1-96	66" x 42" x 20", End Drain, Bask® Heated Surface	Biscuit	

## Soaking Tubs

### Underscore® Drop-In Bathtub

- Acrylic
- Under-mountable
- Molded lumbar support
- Slotted overflow allows for deep soaking
- End drain or center drain for (1834 & 1137) models
- (-W) Bask™ heated surface



Requires K-7271 or K-7272 Clearflo slotted bath drain (sold separately)

Part #	Mfg #	Description	Color	Price
148325	K-1121-0	60" x 30" x 19", End Drain	White	
154992	K-1121-47	60" x 30" x 19", End Drain	Almond	
152864	K-1130-0	60" x 32" x 21", End Drain	White	
156589	K-1130-47	60" x 32" x 21", End Drain	Almond	
140376	K-1130-96	60" x 32" x 21", End Drain	Biscuit	
128681	K-1136-0	66" x 36" x 22", End Drain	White	
148169	K-1136-47	66" x 36" x 22", End Drain	Almond	
123927	K-1136-96	66" x 36" x 22", End Drain	Biscuit	
133131	K-1136-G9	66" x 36" x 22", End Drain	Sandbar	
133691	K-1137-0	72" x 42" x 23", Center Drain	White	
121938	K-1137-96	72" x 42" x 23", Center Drain	Biscuit	
148326	K-1821-0	66" x 32" x 22", End Drain	White	
244375	K-1821-96	66" x 32" x 22", End Drain	Biscuit	
189704	K-1821-47	66" x 32" x 22", End Drain	Almond	
183473	K-1821-W1-0	66" x 32" x 22", End Drain w. Bask™	White	
169414	K-1834-0	72" x 36" x 23", Center Drain	White	
183476	K-1834-96	72" x 36" x 23", Center Drain	Biscuit	
152670	K-1848-0	60" x 36" x 21", End Drain	White	
183493	K-1848-96	60" x 36" x 21", End Drain	Biscuit	
185911	K-1848-W1-96	60" x 36" x 21" End Drain with Bask™	Biscuit	

### Underscore® Oval Drop-In Bathtub

- Acrylic
- Under-mountable
- Molded lumbar support
- Slotted overflow allows for deep soaking
- Center drain
- (-W) Bask™ heated surface



Requires K-7271 or K-7272 Clearflo slotted bath drain (sold separately)

Part #	Mfg #	Description	Color	Price
248125	K-5713-0	60" x 36" x 21", Center Drain	White	
247445	K-5715-0	66" x 36" x 22", Center Drain	White	

## Soaking Tubs

### Drop-In Bathtubs - Acrylic (Continued)

#### Underscore® Oval Drop-In Bathtub

Part #	Mfg #	Description	Color	Price
251066	K-5715-W1-0	66" x 36" x 22", Center Drain with Bask™	White	
256322	K-5717-0	72" x 42" x 23", Center Drain	White	

#### Windward® Drop-In Bathtub

- Acrylic
- Molded lumbar support and armrests
- End drain



Part #	Mfg #	Description	Color	Price
177419	K-1113-0	60" x 42" x 21", End Drain	White	
133800	K-1115-0	72" x 42" x 21", End Drain	White	
169648	K-1115-96	72" x 42" x 21", End Drain	Biscuit	

### Freestanding Bathtubs

#### Abrazo® Freestanding Bathtub

- Lithocast™
- Integral slotted overflow allows for deep soaking
- Integral lumbar support



Part #	Mfg #	Description	Color	Price
146750	K-1800-HW1	66" x 31-1/2" x 28-1/2"	Honed White	

#### Archer® Freestanding Bathtub

- ExoCrylic™
- Slotted overflow allows for deep soaking
- End drain
- (-W1) Bask™ heated surface



Part #	Mfg #	Description	Color	Price
223700	K-2594-96	68" x 32" x 22", End Drain	Biscuit	
183498	K-2594-0	68" x 32" x 22", End Drain	White	
246913	K-2594-W1-0	68" x 32" x 22", End Drain with Bask®	White	
236936	K-2592-96	62" x 32" x 22", End Drain	Biscuit	

## Soaking Tubs

### Archer® Freestanding Bathtub

- *ExoCrylic™*
- *Two-piece design*
- *Molded lumbar support offers extra comfort*
- *Textured bottom surface*
- *End drain*
- *Slotted overflow allows for deep soaking (K-7271 or K7272 overflow drain required)*



Part #	Mfg #	Description	Color	Price
177430	K-2592-0	62" x 32" x 22", End Drain	White	

### Antique® Ball and Claw Legs for K-100 Birthday Bash®

- *Solid brass construction*
- *Installation hardware included*
- *coordinates with Antique® faucets and accessories=*



Part #	Mfg #	Description	Color	Price
087576	K-102-BV	For K-100 Birthday Bath, *Brushed Bronze		
090629	K-102-CP	For K-100 Birthday Bath, Polished Chrome		

### Birthday Bath® Freestanding Bathtub with End Drain

- *Cast iron*
- *Brass claw feet in a choice of finishes (sold separately)*



Requires K-102 ball and claw legs

Part #	Mfg #	Description	Color	Price
087574	K-100-0	72" x 37-1/2" x 27", End Drain	White	

### Ceric® Freestanding Bathtub with Center Toe-Tap Drain

- *Lithocast® Gloss cast resin*
- *Freestanding design creates a striking focal point in your bathing area*
- *17-inch soaking depth*
- *Sloped lumbar support offers extra comfort while bathing*
- *Integral slotted overflow allows for deep soaking*
- *Center toe-tap drain with KOHLER Lithocast® Gloss cover*



Part #	Mfg #	Description	Color	Price
249125	K-8336-0	65" x 31-1/8 x 22-7/8", Center Drain	White	

## Soaking Tubs

### Chess™ Freestanding Bathtub with Center To-Tap Drain

- Lithocast® gloss
- Sloped lumbar support on both ends
- 17" Bathing depth
- Integral slotted overflow
- Textured bottom surface



Part #	Mfg #	Description	Color	Price
237140	K-8337-0	65" x 30" x 22-5/8", Center Drain	White	

### Escale® Freestanding Bathtub with End Drain

- Acrylic
- Two-piece design
- Drain sold separately



Part #	Mfg #	Description	Color	Price
143003	K-14037-0	72" x 36" x 24-1/8", Center Drain	White	
151956	K-14037-96	72" x 36" x 24-1/8", Center Drain	Biscuit	

### Escale® Freestanding Bathtub with Hole Drilling for Symbol® Roman Bath Filler

- Acrylic
- 6-foot length
- Sloped lumbar support
- Center drain
- Two-piece design
- Drain sold separately



Part #	Mfg #	Description	Color	Price
107029	K-11344-0	72" x 36" x 24-1/8", Center Drain	White	

### Iron Works® Historic Freestanding Bathtub with Feet and Reversible End Drain

- Cast iron
- Molded lumbar support
- Safeguard® slip-resistant surface on floor
- (-A) Almond exterior
- (-W) White exterior
- (-P5) Iron Black exterior
- Requires K-1103 ball-and-claw feet



Part #	Mfg #	Description	Color	Price
166380	K-710-A-47	66" x 36" x 24 1/2" with Feet, End Drain	Almond	
057709	K-710-W-0	66" x 36" x 24 1/2" with Feet, End Drain	White	
236503	K-710-P5-0	66" x 36" x 24 1/2" with Feet, End Drain	White	

## Soaking Tubs

### Iron Works® Historic Ball-and-Claw Feet

- Cast iron
- Required for use with the K-710 Iron Works Historic 5.5-foot bath



Part #	Mfg #	Color	Price
126850	K-1103-0	White	
057710	K-1103-P5	Iron Black	

### Memoirs® Freestanding Bathtub with Toe-Tap Drain

- Lithocast® gloss cast resin
- Sloped lumbar support offers extra comfort while bathing
- 17-Inch soaking depth
- Integral slotted overflow allows for deep soaking



Part #	Mfg #	Description	Color	Price
232986	K-8333-0	66" x 36" x 23-3/4", Center Drain	White	

### Reve® Freestanding Bathtub with Center Toe-Tap Drain

- Cast Iron
- Sloped lumbar support on both ends
- Safeguard® slip-resistant surface on floor
- Slotted overflow allows for deep soaking



Requires slotted overflow drain K-7271 or K-7272

Part #	Mfg #	Description	Color	Price
144897	K-894-F62-0	67" x 36" x 22", Center Drain	White with Brilliant Blanc Base	
157500	K-894-F63-0	67" x 36" x 22", Center Drain	White with Brilliant Ash Base	
230509	K-819-F62-0	67" x 32" x 22", Center Drain	White with Brilliant Blanc Base	

### Stargaze™ Freestanding Bathtub with Center Drain

- Acrylic
- Sloped lumbar support on both ends
- 17" Bathing depth or 18" bathing depth for model (K-24011)
- Textured bottom surface



Part #	Mfg #	Description	Color	Price
165542	K-6366-0	72" x 36" x 25-3/4", Straight Shroud	White	
159758	K-6367-0	72" x 36" x 25-3/4", Fluted Shroud	White	
169000	K-6367-96	72" x 36" x 25-3/4", Fluted Shroud	Biscuit	
252046	K-24010-0	60" x 34" x 25-1/4", Straight Shroud	White	
247987	K-24011-0	60" x 34" x 25-1/4" Fluted Shroud	White	



## Soaking Tubs

### Sunstruck™ Freestanding Bathtub

- Acrylic
- Oval shaped basin with sloped lumbar support on both ends
- Wide deck along one side
- Textured bottom surface
- Center drain



Part #	Mfg #	Description	Color	Price
242507	K-24001-0	60" x 34" x 24-1/2", Straight Shroud	White	
240423	K-24002-0	60" x 34" x 24-1/2", Fluted Shroud	White	
162063	K-6368-0	66" x 36" x 25-3/4", Straight Shroud	White	
161011	K-6369-0	66" x 36" x 25-3/4", Fluted Shroud	White	
163692	K-6369-96	66" x 36" x 25-3/4", Fluted Shroud	Biscuit	

### Underscore® Freestanding Bathtub

- Kohler® ExoCrylic®
- Dual lumbar support accommodates two-person bathing
- Wide ledge on one side is ideal for deck-mount faucet
- Slotted overflow allows for deep soaking
- Center drain



Requires K-7271 or K-7272 slotted overflow bath drain (sold separately)

Part #	Mfg #	Description	Color	Price
177787	K-5701-0	60" x 35-3/4" x 24-3/8", Center Drain	White	
224297	K-5701-96	60" x 35-3/4" x 24-3/8", Center Drain	Biscuit	

### Veil® Freestanding Bathtub with Center Toe-Tap Drain

- Lithocast®
- Slotted overflow
- Integral lumbar support
- Center toe-tap drain with Lithocast® gloss cover
- Above-the-floor drain (AFD) installation option



Part #	Mfg #	Description	Color	Price
244210	K-8331-0	66" x 36" x 24", Center Drain	White	

### Vintage® Freestanding Bathtub with Center Drain

- Heritage design
- Integral lumbar support
- Cast iron with Safeguard® finish
- Drop-in or freestanding (with required base)
- Requires K-709 ceramic base or K-705 wooden base (sold separately)
- Installation with K-709 ceramic base requires caulking in vertical base seams



Part #	Mfg #	Description	Color	Price
067083	K-700-0	72" x 42" x 21-3/16", Center Drain	White	

## Soaking Tubs

### Vintage® Adjustable Feet for use on Vintage®, Maestro®, and Tea-for-Two® 5' Baths

- Set of four feet
- Above-floor bath installation
- Installation hardware included
- Vintage® bath: K-700
- Maestro® baths: K-839, K840
- Maestro® whirlpool bath: K-845-H
- Tea-for-Two® bath: K-850



Part #	Mfg #	Description	Color	Price
061144	K-1172-NA	Set of 4 Feet	NA	

### Vintage® Bath Base for Freestanding Vintage® Bath Only

- L 51-3/8", H 4-1/2", W 31-15/16"
- Durable ceramic construction
- For use with the K-700 Vintage® freestanding bath



Part #	Mfg #	Description	Color	Price
067084	K-709-0	51-3/8" x 31-15/16"	White	

## VibrAcoustic® Bathtubs

### Archer® VibrAcoustic® Drop-In Bathtub

- Acrylic
- Slotted overflow drain
- User-friendly high-resolution color touch screen
- (6) Transducers and control amplifier create a 3-D surround sound experience
- Reversible drain
- Textured bottom surface
- Molded lumbar support and armrests for comfort



Part #	Mfg #	Description	Color	Price
167679	K-1124-VB-0	72" x 36" x 19", End Drain	White	

## Soaking Tubs

### Underscore® VibrAcoustic® Drop-In Bathtub

- Acrylic
- Slotted overflow drain
- User-friendly high-resolution color touch screen
- (6) Concealed speakers
- (4) Original instrumental compositions
- Functions as a hydrotherapy bath when full of water and a stereo system when empty
- Center drain
- Includes 25 feet of wiring and amplifier



Part #	Mfg #	Description	Color	Price
183479	K-1835-VB-0	72" x 36" x 23", VibrAcoustic®, Center Drain	White	

### Underscore® VibrAcoustic® Dual-Mount Bathtub

- Acrylic
- Slotted overflow drain
- Intuitive high-clarity color touch-screen chrome user interface
- (6) Transducers and control amplifier create 3-D surround sound experience
- Under-mount/drop-in style installation
- Chromatherapy model (-VBC) is equipped with 4 lights
- (-W) Bask™ heated surface



**Requires Overflow Drain: K-7271 or K-7272**

Part #	Mfg #	Description	Color	Price
183288	K-1173-VB-0	66" x 36" x 22", VibrAcoustic®, End Drain	White	
155216	K-1173-VBC-0	66" x 36" x 22", w/ Chromatherapy, End Drain	White	
173163	K-1173-VBW-0	66" x 36" x 22", w/ Bask™ Heated Surface, End Drain	White	
183459	K-1174-VB-0	72" x 42" x 23" VibrAcoustic®, Center Drain	White	
183458	K-1174-VB-NY	72" x 42" x 23" VibrAcoustic®, Center Drain	Dune	
156127	K-1174-VBC-0	72" x 42" x 23". w/ Chromatherapy & Center Drain	White	
160418	K-1822-VB-0	66" x 32" x 22", VibrAcoustic®, End Drain	White	
173171	K-1849-VB-0	60" x 36" x 21", VibrAcoustic®, End Drain	White	

## Tub Accessories

### Sunward® Under-Mount Installation Kit

- For use with K-6346 Sunward baths and K-6347 Sunward whirlpools



Part #	Mfg #	Size of Bath & Whirlpool	Price
253486	K-738-NA	Under-Mount Installation Kit	

## Soaking Tubs

### Tea-for-Two® Under-Mount Installation Kit



- *Template and instructions included*
- *(K-582) For use with K-863 Tea-for-Two® bath*
- *(K-586) For use with the K-850 Tea-for-Two® bath*

Part #	Mfg #	Size of Bath & Whirlpool	Price
083639	K-582-NA	6'	
069037	K-586-NA	5'	

### Underscore® Under-Mount Installation Kit



- *For use with K-1121 and K-1167 Underscore® baths, whirlpools, BubbleMassage™ air baths, and VibrAcoustic® baths*

Part #	Mfg #	Description	Price
149426	K-531-NA	Under-Mount Installation Kit	

### Tiling-In Bead



- *Vinyl construction*
- *For use with drop-in baths*
- *Includes vinyl bead and corresponding pressure-sensitive sealing tape*

Part #	Mfg #	Length	Price
057193	K-1177-NA	144"	

## Fiberglass Tubs

### Drop-In Soaking Bathtubs

- Pre-leveled block base system
- 2-1/2" Diameter overflow
- Balsa wood core floor structure
- Textured floor pattern

#### Futura 4260 Oval Acrylic Soaking Bathtub

- Self-rimming
- 2" Drain



Part #	Mfg #	Description	Drain	Finish	Price
092501	OV-B-310/OND-WHT	20-3/4" x 60" x 42"	Universal	White	

#### Geneva 3660 Acrylic Soaking Bathtub

- Self-rimming
- Vacuum formed acrylic
- 2" Drain
- Twin, contoured arm rests



Part #	Mfg #	Description	Drain	Finish	Price
092482	TR-B-240/OND-WHT	21" x 60" x 36"	Universal	White	
092484	TR-B-240/OND-BSC	21" x 60" x 36"	Universal	Biscuit	

#### Geneva 3260 Acrylic Soaking Bathtub

- Self-rimming
- Vacuum formed acrylic
- 2" Drain
- Twin, contoured arm rests



Part #	Mfg #	Description	Drain	Finish	Price
092470	TR-B-200/OND-WHT	21" x 60" x 32"	Universal	White	

#### Prestige 3466 Acrylic Soaking Bathtub

- Self-rimming
- Vacuum formed acrylic
- 2" Drain
- Twin, contoured arm rests



Part #	Mfg #	Description	Drain	Finish	Price
221621	TR-B-220/OND-WHT	21" x 66" x 34-1/4"	Universal	White	

## Fiberglass Tubs

### Geneva 3672 Acrylic Soaking Bathtub

- Self-rimming
- Vacuum formed acrylic
- 2" Drain
- Twin, contoured arm rests



Part #	Mfg #	Description	Drain	Finish	Price
092495	TR-B-270/OND-WHT	21" x 72" x 36-1/4"	Universal	White	
092497	TR-B-270/OND-BSC	21" x 72" x 36-1/4"	Universal	Biscuit	

### Tartane CT-B-470/OND Corner Soaking Tub

- Self-Rimming
- 2" Dia. front center drain (see reverse side for location)
- 2-1/2" Dia. overflow (see reverse side for location)
- Twin, contoured armrests (on each end)
- Pre-Leveled block base system
- Textured floor pattern



Part #	Mfg #	Description	Drain	Finish	Price
092521	CT-B-470/OND	22-1/2" x 60" x 60"	Universal	White	

### Alcove Soaking Bathtubs

- Pre-leveled block base system
- 2-1/2" Diameter overflow
- Balsa wood core floor structure
- Textured floor pattern

#### BA-R-41/BA-R-51 Fiberglass Bathtub - Integral Apron

- BA-R-41 Rough-in dimensions: 18-1/2" x 60" x 30-1/2"
- BA-R-51 Rough-in dimensions: 18-1/2" x 60" x 33-1/4"
- Gel coat surface
- 2" Drain
- (-ABF) models provide 3-1/2" drain clearance



Part #	Mfg #	Description	Drain	Finish	Price
140665	BA-R-41L-WHT	17-1/4" x 60" x 29-1/4"	LH	White	
145093	BA-R-41R-WHT	17-1/4" x 60" x 29-1/4"	RH	White	
149064	BA-R-51L-WHT	17-1/4" x 60" x 32"	LH	White	
156066	BA-R-51L-BI	17-1/4" x 60" x 32"	LH	Biscuit	
108397	BA-R-51R-WHT	17-1/4" x 60" x 32"	RH	White	
150578	BA-R-51R-BI	17-1/4" x 60" x 32"	RH	Biscuit	
244017	BA-R-51L-ABF-WHT	17-1/4" x 60" x 32"	LH	White	
148498	BA-R-51R-ABF-WHT	17-1/4" x 60" x 32"	RH	White	



## Fiberglass Tubs

### Geneva Alcove Soaking Tub

- Vacuum formed fiberglass
- Contoured armrests
- Integral tile flange
- (ABF) Above-the-Floor rough-in installation



Part #	Mfg #	Description	Drain	Finish	Price
113701	TR-S240-ONDR	21" x 60" x 36"	RH	White	
108480	TR-S240-ONDL	21" x 60" x 36"	LH	White	
111614	TR-S200-ONDL	21" x 60" x 32"	LH	White	

### Legacy Series Alcove Soaking Bathtub

- Sanitary grade polyester gelcoat surface
- 2" Dia. RH or LH drain (see reverse side for location)
- 2-1/2" Dia. overflow (see reverse side for location)
- Integral tile flange & apron
- Balsa wood core floor structure
- Textured floor pattern



Part #	Mfg #	Description	Drain	Finish	Price
188574	BA-5429R	54" x 29" x 17-1/4"	RH	White	
188800	BA-5429L	54" x 29" x 17-1/4"	LH	White	

### Styllis Series Alcove Soaking Bathtub

- Sanitary grade polyester gelcoat surface
- 2" Dia. RH or LH drain (see reverse side for location)
- 2-1/2" Dia. overflow (see reverse side for location)
- Integral tile flange & apron
- Contoured neck rest
- Extra deep bathing sump
- Balsa wood core floor structure
- Textured floor pattern
- ABF = Above floor drain models (3-1/2" drain clearance)



Part #	Mfg #	Description	Drain	Finish	Price
223190	SB-6036R	60" x 36" x 23-3/4"	RH	White	
172492	SB-6042L	60" x 42" x 23-3/4"	LH	White	
222934	BA-6036L-ABF	60" x 36" x 23-3/4", ABF	LH	White	
164381	BA-7236R	72" x 36" x 23-3/4"	RH	White	

## Fiberglass Tubs

### Bathtubs

#### 260030 Builders' Choice Everyday Bathtub

- Integral armrests
- Integral tiling flange (3T) and skirt
- Slip resistant textured bottom



Part #	Mfg #	Finished Dimensions	Drain	Finish	Price
029530	260030-L-WH	60" x 30" x 15"	LH	White	
029532	260030-R-WH	60" x 30" x 15"	RH	White	

#### Montrose II Builders' Choice Soaker Tub

- Acrylic grab bars
- Sculpted armrests
- Slip resistant bottom
- Lucite cast acrylic surface



Part #	Mfg #	Finished Dimensions	Drain	Finish	Price
049782	4272620	72" x 36" x 21-3/4"	Universal	White	

## Soaking Tubs

### Acrylic Soaking Tubs

#### 3660 Pro-Fit® Bathtub

- Acrylic
- Integral armrests
- Six ultra-swirl jets
- Dual air knobs for total jet control
- Optional removable apron provides easy access to the motor and plumbing



Part #	Mfg #	Dimensions	Water Capacity	Color	Price
229854	6518-WH	59-3/4" x 35-3/4" x 21-1/4"	45 Gal	White	

#### 3672 Pro-Fit® Drop-In Bathtub

- Acrylic
- Integral armrest
- Six ultra-swirl jets
- Optional removable apron
- Dual air knobs for total jet control



Part #	Mfg #	Dimensions	Water Capacity	Color	Price
229857	6521-WH	71-1/2" x 35-1/2" x 20"	52 Gal	White	

#### 4260 Pro-Fit® Drop-In or Alcove Bathtub

- Acrylic
- Integral skirt
- Integral armrests
- Six ultra-swirl jets
- Optional removable apron
- Dual air knobs for total jet control



Part #	Mfg #	Dimensions	Water Capacity	Color	Price
229856	6524-WH	60" x 42" x 20-1/4"	55 Gal	White	

## Soaking Tubs

### 4272 Pro-Fit® Bathtub

- Acrylic
- Integral armrests
- Six ultra-swirl jets
- Optional removable apron
- Dual air knobs for total jet control



Part #	Mfg #	Dimensions	Water Capacity	Color	Price
229858	6527-WH	71-1/2" x 42" x 19-3/4"	80 Gal	White	

### 3666 Barrett™ Bathtub

- Acrylic
- Two pillows, two-person tub
- Sculpted armrests and lumbar backrest
- Drop-in, alcove, or undermount installation



Part #	Mfg #	Dimensions	Water Capacity	Color	Price
238697	5508-WH	66" x 36" x 24"	60 Gal	White	

## Soaking Tubs

### Freestanding Bathtubs

#### Jazz F 2-Piece Freestanding Soaking Tub

- Center drain
- Above-the-floor
- Concealed seam
- Four adjustable leveling legs
- F2 drain compatible



Part #	Mfg #	Description	Capacity	Color	Price
154502	105359-000-001	66" x 36" x 24", Center Drain	Max 76G/Min 58G	White	

#### Ariosa 6636 Freestanding Tub with Concealed Seam

- Acrylic
- Center drain
- Above-the-floor
- Innovative leveling legs
- Compatible with F2 drain
- Recessed deck for faucet installation



Part #	Mfg #	Description	Capacity	Finish	Price
186933	106267-000-001	66" x 36" x 28", Center Drain	58 Gal	White	

#### Miles 2-Piece Freestanding Tub

- Acrylic
- Center drain
- Above-the-floor
- Compatible with F2 drain
- Four adjustable leveling legs
- Two deck widths for different styles of faucet



Part #	Mfg #	Description	Capacity	Finish	Price
149725	105756-000-001	66" x 36" x 23", Center Drain	61 Gal	White	

## Tub Walls

### Durawall® Bathtub Walls

#### Durawall® Deluxe Thermoplastic Bathtub Wall

- *Hi-impact panels adhesive-mounted to drywall and like surfaces*
- *Fits bathtub alcoves up to 30" deep and 60" wide*
- *(4) Molded-in, self-draining shelves*
- *Can be trimmed for out-of-plumb alcoves or window kits*
- *Smooth, glossy, colorfast finish*

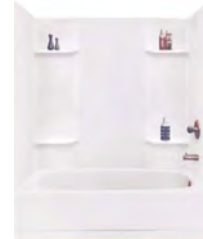

Part #	Mfg #	Pieces	Color	Price
007537	53WHT	5	White	

### DuraTrim® Window Trim Kits

#### DuraTrim® Thermoplastic Window Trim Kit

- *Consists of (3) 36" x 8" panels*
- *Prevents water damage to window sill and side moldings*
- *Scuff resistant*
- *Adjustable*

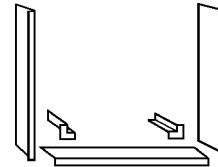

Part #	Mfg #	Pieces	Color	Price
028430	52.600W	3	White	



## Bath Wastes

### Plastic Tubular Bath Waste & Overflow Assemblies

#### Push eN Lift Stopper Assembly

- 2-Hole overflow plate
- With pipe and tee
- 1-1/2" PVC



Part #	Mfg #	Description	Price
145541	1506	Pol Chrome	

#### Turn Top Stopper Assembly

- 2-Hole overflow plate
- With pipe and tee
- 1-1/2" PVC



Part #	Mfg #	Description	Price
145540	1495CP	Pol Chrome	

### Schedule 40 Bath Waste & Overflow Full Kits

#### Push eN Lift Stopper Full Kit

- 1-Hole overflow plate
- With pipe and tee
- 1-1/2" PVC



Part #	Mfg #	Description	Price
145546	911	Pol Chrome	

#### Sch 40 Classic Full Kit w/ Test and 16" FLEX Pipe

- Classic" high-flow capacity slotted overflow plate provides greater drainage through the tub overflow
- Thin gasket included for thick-walled tubs
- With 16" FLEX pipe
- Strainer and stopper are brass unless noted



Part #	Mfg #	Description	Price
185654	2243	PVC w/ Touch Toe Stopper	

### Heavy-Duty "Classic" Waste & Overflow with Test Kit



#### Standard Length with Turn Top Stopper

- 1-1/2" PVC

Part #	Mfg #	Description	Price
146502	4051	Chrome	

#### Standard Length with Push eN Lift Stopper

- 1-1/2" PVC

Part #	Mfg #	Description	Price
146499	4021-SN	Satin Nickel	

### Classic Schedule 40 Bath Waste & Overflow Half Kits

#### PVC with Push eN Lift Stopper Half Kit

- Less pipe and tee

Part #	Mfg #	Description	Price
145547	2218	Pol Chrome	
145549	2222SN	Satin Nickel	
147936	2222W	White	
145550	2222VB	Venetian Bronze	

#### PVC with Turn Top Stopper Half Kit

Part #	Mfg #	Description	Price
145553	2251CP	Chrome	

#### PVC with Push eN Lift Stopper Assembly Half Kit



Part #	Mfg #	Description	Price
159114	976	2-Hole, Pol Chrome	

## Bath Wastes

### PVC with Turn Top Stopper



Part #	Mfg #	Description	Price
161870	1335-CP	2-Hole, Pol Chrome	

### Schedule 40 1-Hole Bath Waste & Overflow Half Kits

- Less pipe and tee

#### Push eN Lift Stopper Assembly Half Kit

- 1- or 2-Hole overflow plate
- Less pipe and tee
- 1-1/2" PVC



Part #	Mfg #	Description	Price
145542	956	1-Hole, Pol Chrome	
145543	960ORB	1-Hole, Oil Rubbed Bronze	
145554	960SN	1-Hole, Satin Nickel	
147422	960VB	1-Hole, Venetian Bronze	

#### 1-Hole Bath Waste & Overflow

- Strainer 1-1/2" x 11-1/2" pipe size
- PVC

Part #	Mfg #	Description	Price
152354	1310-CP	Turn Top Stopper , Pol Chrome 62059	
152358	1263S	Touch Toe Stopper, Pol Chrome 62048	

### Trim Kits

#### Brass Push eN Lift Bathtub Finish Kit

- Includes:
  - 1-3/8"-16 Fine thread strainer
  - Bushing to 1-1/2"-11-1/2
  - Push eN Lift stopper
  - 1-Hole overflow plate with converter bar
  - Screw



Part #	Mfg #	Description	Price
145555	1658	Pol Chrome, Bulk Pack	
145537	1662SN	Satin Nickel, Bulk Pack	
145538	1662VB	Venetian Bronze, Bulk Pack	

#### Classic High-Flow Slotted Trim Kit

- Stopper, strainer, and classic high-flow capacity overflow plate
- "Classic" high-flow capacity slotted overflow plate provides greater drainage through the tub overflow
- Strainer and stopper are brass unless noted



Part #	Mfg #	Description	Price
185655	63250	Touch Toe - Oil Rubbed Bronze	

### Cleanouts & Covers

#### Quick-Fit Cleanout Fitting and Plug

- PVC fits inside 4" S40 DWV

Part #	Mfg #	Pipe Size	Plug Size	Price
239274	400CP	4"	3-1/2" IPS	

**Bath Wastes**

**Brass Bath Wastes**

**Trip Lever Brass Bath Waste for 14" & 16" Tubs**

- Contains waste&overflow assemblies and all pipe lengths required for assembly
- -3 Unfinished



Part #	Mfg #	Size	Gauge	Price
003303	226-3	1-1/2"	20ga	

**Trip Lever Brass Bath Waste for Tubs up to 24" High**

- Contains waste&overflow assemblies and all pipe lengths required for assembly
- -3 Unfinished



Part #	Mfg #	Size	Gauge	Price
109877	230-3	1-1/2"	17ga	

**Uni-Lift 20 Gauge Brass Bath Waste for 14" & 16" Tubs**

- 1-1/2" Waste shoe
- -3 Unfinished



Part #	Mfg #	Size	Gauge	Price
003305	227-3	1-1/2" Hi-Tee	20ga	
003302	227S-3	1-1/2" Side Drain	17ga	

**Brass Uni-Lift Direct Drain**

- 1-1/2"
- -3 Unfinished
- Full kit



Part #	Mfg #	Size	Gauge	Price
003306	227D-3	1-1/2"	17ga	

**Chain & Stopper Brass Bath Waste**

- -1 Polished chrome
- Includes:
  - 20ga Brass tubing rough-in
  - Cast brass slip tee joint
  - 2-Hole cast brass top ell
  - 2-Hole faceplate
  - Black rubber washer
  - 15" Heavy-duty chain with 1-3/4" rubber stopper
  - Blue top ell washer
  - 1-1/4" Drain seat
  - 1-3/8" Reducing tailpiece for 16" leg tubs
  - (2) Nuts
  - (2) Rubber slip joint washers
  - Bottom ell washer
  - 1-1/4" Cast brass waste shoe



Part #	Mfg #	Description	Price
003298	202-1	Chrome-Plated Tubing & Trim	

**Bath Waste Trim Kits**

**Uni-Lift Drain Trim Kit**

- 1-1/2" Spud



Part #	Mfg #	Description	Price
077053	K25TB	Less Spud, Chrome	
077259	K75TRB	Rubbed Bronze	
084848	K75TSN	UltraShine™ PVD Satin Nickel	

**Rough-In Kit Touch Toe Stopper**

- Trim kit for Sch40
- Chrome finish



Part #	Mfg #	Size	Gauge	Price
153090	K24TB	Touch-Toe Stopper		

**Bath Wastes**

**Plastic Bath Wastes**

**Plastic Trip Lever Bath Waste with 1-1/4" Waste Shoe**

- Includes:
  - Tubing rough-in and slip joint tee
  - 2-Hole top ell
  - Trip lever faceplate with linkage
  - Retaining clip
  - Blue top ell washer
  - Strainer
  - Stainless steel strainer cover and cover screw
  - (2) Wing nuts
  - (2) Poly washers
  - Bottom ell washer
  - 1-1/4" Waste shoe
- Boxed



Part #	Mfg #	Description	Price
003259	P9226	PVC Tee, White Poly Tubes, Plastic Strainer, CP Trim	

**Uni-Lift Plastic Bath Wastes**

**Uni-Lift Full Kit Plastic Bath Wastes with 1-1/2" Waste Shoe**

- Includes:
  - Wing nuts
  - Tubing rough-in and slip joint tee
  - 2-Hole top ell
  - Uni-lift faceplate
  - Retaining clip
  - Blue top ell washer
  - 1-1/2" Uni-lift drain unit with o-ring seal
  - (2) Wing nuts
  - (2) Poly washers
  - Bottom ell washer
  - 1-1/2" Waste shoe



Part #	Mfg #	Description	Price
003261	P8227	White PVC, Chrome Trim	

**Uni-Lift Plastic Tubular Full Kits with Direct Drain**

- Includes:
  - 1-1/2" Drain shoe
  - 1-1/2" Drain spud
  - Brass Uni-lift stopper



Part #	Mfg #	Description	Price
048742	P8227D	Chrome Finish w/Black Stopper	

**Full Kit Plastic Bath Wastes with White Cable Stopper**

- Chrome finish trim



Part #	Mfg #	Size	Gauge	Price
157790	P8220	Chrome Finish, Plastic Tubular		

**Uni-Lift Sch 40 Half Kit Bath Wastes 1-Hole Faceplate**

- 1-1/2" Uni-lift drain trim
- Half-Kit Includes all parts required for rough-in, testing, & finish installation
- Less pipes & tee



Part #	Mfg #	Description	Price
076177	P7225B	PVC, Chrome	

**Touch-Toe Plastic Bath Wastes**

**Touch-Toe Plastic Bath Waste, 2-Hole Faceplate**

- Includes:
  - Wing Nuts
  - 1-1/2" Waste Shoe
- Boxed



Part #	Mfg #	Description	Price
030625	P9228	Chrome, PVC, White PP	

## Bath Wastes

### Tap-Tap Sch 40 1/2 Kit

• Includes:

- Sch 40 PVC ell,
- Sch 40 top ell and faceplate
- Blue top ell washer
- 1-1/2" Tap-Tap drain unit with o-ring seal
- Bottom ell washer
- 1-1/2" Waste shoe
- Less tubes & tee



Part #	Mfg #	Description	Price
003255	P7224B	PVC, 1-Hole Faceplate, CP Trim	

### Plastic Push-N-Lock Bath Wastes

#### Push-N-Lock Sch 40 Bath Wastes Rough-In Kit

• For Touch-Toe & Uni-Lift Drains

• Includes:

- Waste & overflow elbows
- Spud
- Test caps
- Gaskets
- Cross-bar & screws



Part #	Mfg #	Description	Price
081508	P7223RK	PVC, Test System	

### Decorator/Conversion Kits

#### Trip-Lever Conversion Kit



Part #	Mfg #	Finish	Price
120253	K26RB	Rubbed Bronze	
091296	K26BN	Brushed Nickel	
087198	K26SN	UltraShine® Satin Nickel	

#### Uni-Lift 1-1/4" 2-Hole Conversion Kit

• Includes:

- 1-1/4" Uni-Lift drain unit with o-ring seal
- Bottom ell washer
- Faceplate and screws
- 1-1/4" x 1-1/2" Threaded adapter



Part #	Mfg #	Finish	Price
003241	K27	Chrome Finish Trim	
078040	K27BN	Brushed Nickel Trim	
003242	K27PB	UltraShine® Pol Brass Trim	

### Decorator/Conversion Kits (Continued)

#### Uni-Lift 1-1/4" 2-Hole Conversion Kit

Part #	Mfg #	Finish	Price
084456	K27RB	Rubbed Bronze Trim	
085025	K27SN	Satin Nickel	

#### Uni-Lift 2-Hole Conversion Kit



Part #	Mfg #	Size	Gauge	Price
251974	K28RB	Rubbed Bronze Trim		

**Bath Wastes**

**Bath Waste & Overflow**

- Teflon® coated stainless steel cable
- No internal linkage or moving parts in the pipe to adjust
- Installation tools included

**TurnControl™ Cable-Operated Rough-In Drain**

- 1-1/2" Tubular polypropylene
- For Euro or traditional TurnControl™ trim kits
- ASME A112.18.2/CSA B125.2 Compliant
- Trim sold separately



Part #	Mfg #	Finish	Tub Depth	Price
114930	151.504.00.1	Chrome	17" - 24"	

**TurnControl™ Trim Kit - Molded Plastic**



Part #	Mfg #	Finish	
114907	151.550.21.1	Chrome	
114906	151.550.CL.1	Bright Brass	
114926	151.550.DY.1	White	
114927	151.550.FF.1	Biscuit	

**TurnControl™ Trim Kit - Metal Trim**



Part #	Mfg #	Finish	
116135	151.551.21.1	Chrome	
114922	151.551.ID.1	Brushed Nickel	
114911	151.551.HM.1	Oil Rubbed Bronze	





## Bath Wastes

### Drains

#### Classics™ Brass Lift & Turn Drain

- 1/2" Brass tubing in 17 Gauge
- Fits most tubs 24" high
- Adj self-retaining rubber head gasket
- Cast brass shoe plug



Part #	Mfg #	Description	Price
112597	41-852	20ga Brass-Plated Zinc Nuts, Chrome	

#### Pop-Up Brass Drain

- Pre-adjustable linkage
- Fits most tubs 14" to 16"
- Roman fits most tubs 24"



Part #	Mfg #	Description	Price
004699	41-806	Fit-All Drain in Shoe, 20ga, Brass-Plated Zinc Nuts, Chrome	
021533	41-807	Fit-All Side Outlet, 20ga, Brass-Plated Zinc Nuts, Chrome	

#### Trip Lever Brass Drain

- Pre-adjustable linkage
- Fits most tubs 14" to 16"
- Roman fits most tubs 24"



Part #	Mfg #	Description	Price
068557	N1-812	Roman, 18" O.F., 9" Shoe, 17ga, Brass Nuts, *Brushed Nickel	
004700	41-813	Roman, 18" O.F., 9" Shoe, 17ga, Brass Nuts, Chrome	

### Drains (Continued)

#### Trip Lever Brass Drain

Part #	Mfg #	Description	Price
004701	41-818	All-Tub Drain in Tee, 20ga, Brass-Plated Zinc Nuts, Chrome	
052596	N1-813	Roman, 18" O.F., 9" Shoe, 17ga, Brass Nuts, *Brushed Nickel	

#### Auto Trip Brass Drain

- Fits most tubs 14" to 16"
- Roman fits most tubs 24"



Part #	Mfg #	Description	Price
004702	41-848	All-Tub Drain in Tee, 20ga, Brass-Plated Zinc Nuts, Chrome	

#### Lift & Turn Brass Drain

- Fits most tubs 14" to 16"
- Roman fits most tubs 24"

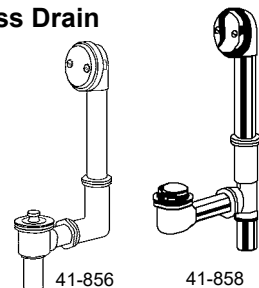

Part #	Mfg #	Description	Price
004705	41-856	Fit-All Drain in Shoe, 20gab, Brass-Plated Nuts, Chrome	
004706	41-858	All-Tub Drain in Tee, 20ga, Brass-Plated Zinc Nuts, Chrome	

\*Physical Vapor Deposition (PVD) Limited Lifetime Finish

[www.plumbsupply.com](http://www.plumbsupply.com) • Serving our Customers Since 1946 • [www.waterconcepts.net](http://www.waterconcepts.net)



## Bath Wastes

### Lift & Turn Brass Bath Drains with Tubing & Tee

- Fits most tubs 14" to 16" high
- 1-1/2" Sch 40 plastic tubing in PVC
- Adjustable self-retaining rubber head gasket
- Cast brass shoe plug



Part #	Mfg #	Description	Price
042189	41-562	PVC Lift & Turn, Chrome	

### PVC & ABS Drains

#### Classics™ PVC Pop-Up Cable Drain

- 1-1/2" Plastic tubing
- Fits most tubs 24" high



Part #	Mfg #	Description	Price
245212	41-100	PVC, Chrome	

#### Classics™ Lift & Turn PVC Tub Drain

- Retaining ring
- Fits most tubs 14" to 16"
- 1-1/2" Plastic tubing in PVC
- Adj self-retaining rubber head gasket
- Cast brass shoe plug



Part #	Mfg #	Description	Price
028420	41-551-76	PVC, Chrome	

### Classics™ Roman Tub Lift & Turn PVC Tub Drain

- Fits most tubs 24" high
- 1-1/2" Plastic tubing in PVC
- Adj self-retaining rubber head gasket
- Cast brass shoe plug



Part #	Mfg #	Description	Price
177449	41-553	PVC, Chrome	

#### Trip Lever PVC/ABS Drain

- Pre-adjustable linkage
- Fits most tubs 14" to 16"



Part #	Mfg #	Description	Price
004697	41-510	All-Tub Drain-In-Tee, PVC, Chrome	

#### Roman Trip Lever PVC/ABS Drain

- Fits most tubs 24"



Part #	Mfg #	Description	Price
026439	41-513	All-Tub Drain-In-Tee, PVC Chrome	

\*Physical Vapor Deposition (PVD) Limited Lifetime Finish

[www.waterconcepts.net](http://www.waterconcepts.net) • Serving our Customers Since 1946 • [www.plumbsupply.com](http://www.plumbsupply.com)



## Bath Wastes

### Auto Trip PVC/ABS Drain

- Fits most tubs 14" to 16"



Part #	Mfg #	Description	Price
134396	41-540	Fit-All Drain-In-Tee, PVC Chrome	

### Lift & Turn PVC Tub Drain

- Fits most tubs 14" to 16"
- 1-1/2" Plastic tubing in PVC
- Adjustable self-retaining rubber head gasket
- Cast brass shoe plug



Part #	Mfg #	Description	Price
023421	41-550	PVC, Chrome	

### Schedule 40 Drains

- Includes tubing and tee

#### Auto Trip Sch 40 Drain



Part #	Mfg #	Description	Price
078520	41-532	PVC, Chrome	

#### Lift & Turn Sch 40 Drain Trim Kit

- Less tubing and tee



Part #	Mfg #	Description	Price
004698	41-552	PVC, Self-Retaining Gasket, Chrome	

### Drain Exposed Parts Trim Kits

#### Classics™ Brass Lift & Turn Trim Kit



Part #	Mfg #	Description	Price
055965	N6-883	Oil Brushed Nickel	

#### Trip Lever Trim Kit

- Includes:
  - Lever/faceplate
  - (2) 2-1/4" Faceplate screws
  - Strainer with screw



Part #	Mfg #	Finish	Price
004457	A6-861	Biscuit	
052896	N6-863	*Brushed Nickel	

#### Lift & Turn Trim Kit

- Includes:
  - Faceplate
  - (2) 2-1/4" Faceplate screws
  - Lift & turn stopper
  - Shoe plug



Part #	Mfg #	Finish	Price
021370	W6-881	White	

\*Physical Vapor Deposition (PVD) Limited Lifetime Finish

[www.plumbsupply.com](http://www.plumbsupply.com) • Serving our Customers Since 1946 • [www.waterconcepts.net](http://www.waterconcepts.net)

## Bath Wastes

### Bath Drains

#### Single-Hole Lift & Turn Drain Strainer

- Complete with single-hole faceplate and faceplate screw
- Brass body

Part #	Mfg #	Finish	Price
115878	540-BU	Bronze Umber	
170478	540-CB	Caramel Bronze	
125717	540-MBK	Matte Black	
115876	540-ORB	Oil Rubbed Bronze	
115877	540-PEW	Pewter	
173164	540-PN	Polished Nickel	
115874	540-SN	Satin Nickel	
176299	540-VB	Vintage Bronze	

#### Two-Hole Lift & Turn Drain Strainer

- Complete with two-hole faceplate and (2) faceplate screws
- Brass body



Part #	Mfg #	Finish	Price
125766	542-AB	Antique Brass	
125759	542-BU	Bronze Umber	
125761	542-MBK	Matte Black	
125762	542-ORB	Oil Rubbed Bronze	
125758	542-PB	Polished Brass	
125760	542-PCH	Polished Chrome	
125764	542-PEW	Pewter	
153340	542-PN	Polished Nickel	
128713	542-SC	Satin Chrome	
125765	542-SN	Satin Nickel	
175380	542-VB	Vintage Bronze	
149054	542-WH	White	

#### Trip Lever Drain Kit

- Contains trip lever, faceplate and grid strainer
- Fits Gerber®, Jaclo®, and most other manufacturers



Part #	Mfg #	Finish	Price
154190	519-AB	Antique Brass	
134019	519-ACU	Antique Copper	
125772	519-BU	Bronze Umber	
125777	519-MBK	Matte Black	

### Bath Drains (Continued)

#### Trip Lever Drain Kit

Part #	Mfg #	Finish	Price
125773	519-ORB	Oil Rubbed Bronze	
154030	519-PB	Polished Brass	
125779	519-PCH	Polished Chrome	
125774	519-PEW	Pewter	
135066	519-PN	Polished Nickel	
128550	519-SC	Satin Chrome	
155804	519-SG	Satin Gold	
125778	519-SN	Satin Nickel	

#### Cable Drain Trim

- All brass construction
- Universal design to fit most manufacturers' cable drains



Part #	Mfg #	Finish	Price
117688	508-BU	Bronze Umber	
117689	508-MBK	Matte Black	
117690	508-ORB	Oil Rubbed Bronze	
117686	508-SN	Satin Nickel	

#### Toe Control Tub Drain Strainer

- Brass body
- Forged brass cap (2" diameter)
- 3" Long coarse threads for thick tubs
- 1-1/2" Course threads
- Fits JACLO, Gerber and most other manufacturers



Part #	Mfg #	Finish	Price
246077	529-75-PCH	Polished Chrome	

#### Top Toe Control Tub Drain

- 3" Round brass top
- Spring loaded internal mechanism
- Bushing allows for use with 1-3/8" fine thread & 1-1/2" course thread drains
- Complete with brass round no hole faceplate



Part #	Mfg #	Finish	Price
238664	537-MBK	Matte Black	



## Bath Wastes

### Bath Waste & Overflow

#### Tubular Bath Waste & Overflow Subassembly

- 1-1/2" PVC tubular
- Stainless steel cable
- Geberit subassemblies
- SUBASSEMBLIES ONLY



Part #	Mfg #	Tub Depth	Cable Length	Price
244459	383-LT	17"-24"	27"	

## Bath Wastes

### Tub & Shower Wastes

#### Clearflo Adjustable Pop-Up Drain

- 17 ga brass construction
- Brass tailpiece
- 1-1/2" NPT connection
- Contoured overflow hood
- Above- or through-the-floor
- For use with Tea-for-Two® 5' and 6' baths, BubbleMassage™ air baths, and whirlpools



Part #	Mfg #	Description	Price
084411	K-7169-AF-BN	*Brushed Nickel	
242579	K-7169-AF-BV	*Brushed Bronze	
069036	K-7169-AF-CP	Polished Chrome	
147062	K-7169-AF-2BZ	Oil Rubbed Bronze	

#### Clearflo Adjustable Pop-Up Drain with Overflow

- 17 ga brass construction
- Brass tailpiece
- 1-1/2" NPT connection
- Contoured overflow hood
- Above- or through-the-floor
- For use with Tea-for-Two® 66" and 36" baths, BubbleMassage™ air baths, and whirlpools



Part #	Mfg #	Description	Price
256602	K-7147-AF-SN	*Polished Nickel	

#### Clearflo Adjustable Pop-Up Bath Drain

- Above-the-floor drain
- 1-1/2", 17" to 24" deep baths



Part #	Mfg #	Description	Price
068367	K-7161-AF-AF	*French Gold	
105386	K-7161-AF-BKB	Brushed Black	
054831	K-7161-AF-BN	*Brushed Nickel	
075013	K-7161-AF-BV	*Brushed Bronze	
053732	K-7161-AF-CP	Polished Chrome	
059178	K-7161-AF-G	Brushed Chrome	
055642	K-7161-AF-PB	*Polished Brass	
074489	K-7161-AF-SN	*Polished Nickel	
176269	K-7161-AF-2BZ	Oil Rubbed Bronze	

### Clearflo Adjustable Pop-Up Drain

- 1-1/2", 14" to 16" deep baths
- (-TF) Through-the-floor
- (-AF) Above-the-floor



Part #	Mfg #	Description	Price
079884	K-7160-AF-BV	*Brushed Bronze	
101228	K-7160-TF-AF	*French Gold	
158249	K-7160-TF-BKB	Brushed Black	
058979	K-7160-TF-BN	*Brushed Nickel	
069491	K-7160-TF-BV	*Brushed Bronze	
056883	K-7160-TF-CP	Polished Chrome	
056165	K-7160-TF-G	Brushed Chrome	
097297	K-7160-TF-PB	*Polished Brass	
173111	K-7160-TF-SN	*Polished Nickel	

### Clearflo Decorative Adjustable Pop-Up Drain

- Above- or through-the-floor
- 1-1/2"
- For use with Iron Works Tellieur® and Historic™ baths



Part #	Mfg #	Description	Price
254032	K-7178-BKB	Brushed Black	
190095	K-7178-BN	*Brushed Nickel	
181583	K-7178-CP	Polished Chrome	

### Clearflo Adjustable Pop-Up Bath Drain with High Volume and Tailpiece

- Above- or through-the-floor
- 2" NPT connection
- 23" to 25" Deep baths



Part #	Mfg #	Description	Price
074946	K-7167-BN	*Brushed Nickel	
069019	K-7167-CP	Polished Chrome	
154101	K-7167-2BZ	Oil Rubbed Bronze	

\* Vibrant Limited Lifetime Warranty

[www.waterconcepts.net](http://www.waterconcepts.net) • Serving our Customers Since 1946 • [www.plumbsupply.com](http://www.plumbsupply.com)



## Bath Wastes

### Clearflo Brass Toe Tap Bath Drain

- Above- or through-the-floor
- Solid brass construction
- K-7259  
-14" to 20" Deep baths
- K-7265  
-20" to 26" Deep baths



Part #	Mfg #	Description	Price
182832	K-7259-AF	*French Gold	
226953	K-7259-BGD	*Moderne Brushed Gold	
134191	K-7259-BN	*Brushed Nickel	
144750	K-7259-BV	*Brushed Bronze	
151871	K-7259-CP	Polished Chrome	
175801	K-7259-SN	*Polished Nickel	
147068	K-7259-2BZ	Oil Rubbed Bronze	
173950	K-7265-AF	*French Gold	
133753	K-7265-BN	*Brushed Nickel	
181870	K-7265-BV	*Brushed Bronze	
138263	K-7265-CP	Polished Chrome	
138244	K-7265-G	Brushed Bronze	
234915	K-7265-SN	*Polished Nickel	
147069	K-7265-2BZ	Oil Rubbed Bronze	

### Clearflo Closing Overflow

- Cable-activated drain
- Closing overflow allows for extra-deep water level
- Includes copper corrugated neck
- For use with 14- to 22-inch deep baths



Part #	Mfg #	Description	Price
159733	K-7116-2BZ	Oil Rubbed Bronze	

### Clearflo Cable Bath Drain - Through-the-Floor Installation

- With PVC tubing and 27" cable
- Metal construction control handle and stopper
- For use with 14" to 21" deep baths or whirlpools



Part #	Mfg #	Finish	Price
116540	K-7213-BN	*Brushed Nickel	
117965	K-7213-BV	*Brushed Bronze	
166438	K-7213-CP	Polished Chrome	
183138	K-7213-SN	*Polished Nickel	
147065	K-7213-2BZ	Oil Rubbed Bronze	

### Clearflo Cable Bath Drain - Through-the-Floor Installation

- Less PVC tubing
- Includes 27" cable
- Metal construction control handle and stopper
- For use with 14" to 21" deep baths or whirlpools



Part #	Mfg #	Finish	Price
104733	K-7214-BN	*Brushed Nickel	
101633	K-7214-BV	*Brushed Bronze	
109948	K-7214-CP	Polished Chrome	
115379	K-7214-G	Brushed Chrome	
173263	K-7214-SN	*Polished Nickel	
240640	K-7214-VNT	Vintage Nickel	
147066	K-7214-2BZ	Oil Rubbed Bronze	

### Clearflo Horizontal Overflow Bath Drain Through-the-Floor Installation

- 17-Gauge brass construction
- 1-1/2" OD connection
- Cable operated
- Includes brass tee & pipe & template
- For use with Fountainhead™ and Purist® baths



Part #	Mfg #	Description	Price
188519	K-7273-BN	*Brushed Nickel	

\* Vibrant Limited Lifetime Warranty

[www.plumbsupply.com](http://www.plumbsupply.com) • Serving our Customers Since 1946 • [www.waterconcepts.net](http://www.waterconcepts.net)

## Bath Wastes

### Tub & Shower Wastes (Continued)

#### Clearflo Horizontal Overflow Bath Drain Through-the-Floor Installation

Part #	Mfg #	Description	Price
122735	K-7273-BV	*Brushed Bronze	

#### Clearflo Slotted Overflow Brass Bath Drain - Above-/Through-the-Floor Installation

- Brass construction
- Toe-activated closing
- Swivel-ball joint construction
- Includes a tee, drain ell, and overflow ell



Part #	Mfg #	Finish	Price
130986	K-7271-BN	*Brushed Nickel	
183139	K-7271-BV	*Brushed Bronze	
147542	K-7271-CP	Polished Chrome	
147070	K-7271-2BZ	Oil Rubbed Bronze	

#### Clearflo Slotted Overflow Bath Drain - Above-/Through-the-Floor Installation

- Brass construction
- Toe-activated closing



Part #	Mfg #	Finish	Price
118967	K-7272-AF	*French Gold	
248777	K-7272-BL	Matte Black	
109672	K-7272-BN	*Brushed Nickel	
116856	K-7272-BV	*Brushed Bronze	
110361	K-7272-CP	Polished Chrome	
106101	K-7272-G	Brushed Chrome	
121197	K-7272-PB	*Polished Brass	
168145	K-7272-SN	*Polished Nickel	
246636	K-7272-TT	*Titanium	
223569	K-7272-VNT	Vintage Nickel	
147071	K-7272-2BZ	Oil Rubbed Bronze	

### Clearflo Retrofit Toe Tap Conversion Kit

- Metal construction
- Replaces existing overflow cover and stopper/drain, flange/toggle linkage
- Toe-tap component installs on most drain bodies with 1-1/2"-11-1/2 NPSM thread
- For drains K-7160-AF, K-7160-TF, K-7161-AF, K-7193
- Vibrant PVD finishes available



Part #	Mfg #	Description	Price
170051	K-7142-BN	*Brushed Nickel	
238399	K-7142-CP	Polished Chrome	

### Escale® Bath Drain

- 1-1/2" connection
- Brass tailpiece
- Above- or through-the-floor
- 17-gauge brass construction
- Adjustable trip lever pop-up
- For use with Escale baths and BubbleMassage™ air baths
- Bent pipe to accommodate Escale® bath slope
- Cable-activated drain uses no internal linkages



Part #	Mfg #	Description	Price
107624	K-7219-BN	*Brushed Nickel	
107030	K-7219-CP	Polished Chrome	

### Iron Works® Exposed Bath Drain

- Above-the-floor
- For use with Iron Works Tellier and Historic™ freestanding baths



Part #	Mfg #	Description	Price
090353	K-7104-BN	*Brushed Nickel	
086603	K-7104-BV	*Brushed Bronze	
057706	K-7104-CP	Polished Chrome	
168642	K-7104-2BZ	Oil Rubbed Bronze	

\* Vibrant Limited Lifetime Warranty

[www.waterconcepts.net](http://www.waterconcepts.net) • Serving our Customers Since 1946 • [www.plumbsupply.com](http://www.plumbsupply.com)

## Bath Wastes

### PureFlo™ Rough-In Cable Drain

- Above- or though-the-floor
- Flexible overflow neck for easy installation to fit various bath angles
- Includes: tee, drain, ell, and overflow ell
- 37386-NA, 37380-NA  
-Fits baths 14" - 21" deep
- 37382-NA  
-Fits baths 21" - 26" deep



Required: PureFlo™ trim (sold separately)

Part #	Mfg #	Description	Price
156158	K-37380-NA	30" Cable, with Brass Tubing	
170466	K-37382-NA	45" Cable, with Brass Tubing	
149703	K-37383-NA	30" Cable, with Tubing	
150612	K-37385-NA	45" Cable, Without Tubing	
153265	K-37386-NA	30" Cable, Without Tubing	

### PureFlo™ Rotary Turn Bath Drain Trim



Part #	Mfg #	Description	Price
239795	K-T37391-AF	Rotary Turn, *French Gold	
256751	K-T37391-BL	Rotary Turn, Matte Black	
149704	K-T37391-BN	Rotary Turn, *Br Nickel	
179639	K-T37391-BV	Rotary Turn, *Br Bronze	
153268	K-T37391-CP	Rotary Turn, Pol Chrome	
162354	K-T37391-SN	Rotary Turn, *Pol Nickel	
254358	K-T37391-TT	Rotary Turn, *Titanium	
153280	K-T37391-2BZ	Rotary Turn, Oil-Rbd Brz	

### PureFlo™ Contemporary Bath Drain Trim

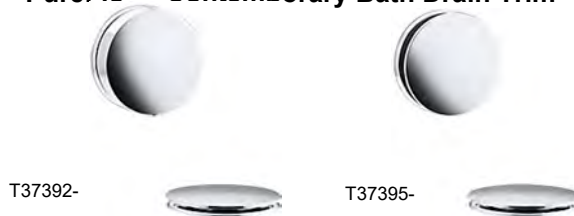

Part #	Mfg #	Description	Price
153269	K-T37392-CP	Rotary Turn, Pol Chrome	
153274	K-T37392-BN	Rotary Turn, *Br Nickel	
170479	K-T37392-SN	Rotary Turn, *Pol Nickel	
150614	K-T37395-CP	Push Button, Pol Chrome	
153275	K-T37395-BN	Push Button, *Br Nickel	

### PureFlo™ Traditional Bath Drain Trim



Part #	Mfg #	Description	Price
153276	K-T37393-BN	Rotary Turn, *Br Nickel	
183394	K-T37393-BV	Rotary Turn, *Br Bronze	
153270	K-T37393-CP	Rotary Turn, Pol Chrome	
244216	K-T37393-SN	Rotary Turn, *Pol Nickel	
153281	K-T37393-2BZ	Rotary Turn, Oil-Rbd Brz	
182833	K-T37396-AF	Push Button, *French Gold	
149848	K-T37396-BN	Push Button, *Br Nickel	
153271	K-T37396-CP	Push Button, Pol Chrome	
153282	K-T37396-2BZ	Push Button, Oil-Rbd Brz	

### PureFlo™ Cable Drain Trim Victorian Rotary



Part #	Mfg #	Description	Price
153277	K-T37394-BN	Rotary Turn, *Br Nickel	
260512	K-T37394-BV	Rotary Turn, *Br Bronze	

\* Vibrant Limited Lifetime Warranty

[www.plumbsupply.com](http://www.plumbsupply.com) • Serving our Customers Since 1946 • [www.waterconcepts.net](http://www.waterconcepts.net)

**Bath Wastes**

**Tub & Shower Wastes (Continued)**

**PureFlo™ Cable Drain Trim Victorian Rotary**

Part #	Mfg #	Description	Price
153272	K-T37394-CP	Rotary Turn, Pol Chrome	
168883	K-T37394-SN	Rotary Turn, *Pol Nickel	
153283	K-T37394-2BZ	Rotary Turn, Oil-Rbd Brz	

**PureFlo™ ABS Adapter Kit**

- Use to join together PVC and ABS fittings
- Includes ABS & PVC fittings with O-ring seal



Part #	Mfg #	Description	Price
157527	K-37388-NA	ABS Adapter Kit	

**Swiftflo™ 1-1/2" Adjustable Pop-Up Bath Drain**

- 17 Gauge brass
- For 14"-16" baths
- Through-the-floor installation



Part #	Mfg #	Description	Price
053730	K-11660-CP	Polished Chrome	

**Swiftflo™ Adjustable Lavatory Drain**

- 20-Gauge brass construction
- Brass tailpiece and pipe
- 1-1/2" connection
- Adjustable trip lever pop-up drain
- For through-the-floor installations
- Removable grid strainer
- For 18-1/2"-20-1/2" deep bath installations



Part #	Mfg #	Description	Price
053731	K-11677-CP	Polished Chrome	

**Vintage® Pop-Up Bath Drain**

- Solid brass construction
- For above-the-floor and free-standing installations
- Includes brass, tee, pipe, and pop-up drain
- For use with Vintage freestanding baths



Part #	Mfg #	Description	Price
065905	K-7159-BN	*Brushed Nickel	
061146	K-7159-CP	Polished Chrome	
182509	K-7159-SN	*Polished Nickel	
183634	K-7159-2BZ	Oil Rubbed Bronze	

**Underscore® Cube Cable Drain Trim Kit**

- Solid-brass construction

For sue with K-8150 cable drain



Part #	Mfg #	Description	Price
155729	K-8134-BN	*Brushed Nickel	
142446	K-8134-CP	Polished Chrome	

\* Vibrant Limited Lifetime Warranty

## Bath Wastes

### Schedule 40 Bath Waste Kits

#### 600 Series Bath Waste

- Coarse thread
- 1-1/2" Solvent weld assembly
- 1-1/4" Deep metal strainer body
- Fits most tubs up to 16" deep
- Theft-resistant stopper



#### Half Bath Waste Kit - Lift and Turn

Part #	Mfg #	Piping	Finish	Price
094109	601-LT-PVC-CP	PVC	Chrome-Plated	

#### Half Bath Waste Kit - Push and Pull

Part #	Mfg #	Piping	Finish	Price
086179	601-PP-PVC-BN	PVC	Brushed Nickel	
084568	601-PP-PVC-BV	PVC	Brushed Bronze	
070343	601-PP-PVC-CP	PVC	Polished Chrome	

#### Half Bath Waste Kit - Foot Actuated

Part #	Mfg #	Piping	Finish	Price
077696	601-FA-PVC-CP	PVC	Polished Chrome	
247004	601-FA-PVC-CP-2H	PVC	Polished Chrome	
247006	601-FA-PVC-BN-2H	PVC	Brushed Nickel	
247007	601-FA-PVC-BZ-2H	PVC	Oil Rubbed Bronze	

#### Innovator® 900 Series Bath Waste

- 1-1/2" Solvent weld assembly
- 1-1/2"-11-1/2" NPSM threads



#### Half Bath Waste Kit - Push and Pull

Part #	Mfg #	Piping	Finish	Price
058964	901-PP-PVC-CP	PVC	Polished Chrome	

#### Half Bath Waste Kit - Lift and Turn

Part #	Mfg #	Piping	Finish	Price
226255	901-LTRI-PVC-CP	PVC	Polished Chrome	

### Stopper/Faceplate Only

Part #	Mfg #	Piping	Finish	Price
226300	900-LTSF-0-CP	-	Polished Chrome	

### Tubular Plastic Bath Waste Kits

#### 500 Series Plastic Bath Waste

- Coarse thread
- For 14" to 16" high tubs
- Slip joint assembly
- Metal strainer body
- 1-1/2" Pipe
- Theft-resistant metal stopper
- Retainer plate



#### Complete Bath Waste Kit - Push Pull®

Part #	Mfg #	Piping	Finish	Price
046494	500-PP-PVC-CP	PVC	Chrome-Plated	

#### Complete Bath Waste Kit - Trip Lever

Part #	Mfg #	Piping	Finish	Price
097994	500-TL-PVC-CP	PVC	Chrome-Plated	

#### Complete Bath Waste Kit - Quick Adjust

- Same as -TL with scale label on the overflow pipe

Part #	Mfg #	Piping	Finish	Price
063696	500-TQ-PVC-CP	PVC	Chrome-Plated	

### Push Pull®

#### Model 615-PP Hub Adapter



Part #	Mfg #	Piping	Finish	Price
079542	615-PP-PVC-CP	PVC	Chrome-Plated	

\*PVD Lifetime Finish

[www.plumbsupply.com](http://www.plumbsupply.com) • Serving our Customers Since 1946 • [www.waterconcepts.net](http://www.waterconcepts.net)





## Bath Wastes

### Trim Kits

#### NuFit® Innovator® Trim Kit

- Converts conventional overflow and drain to Innovator snap-on overflow plate and NuFit strainer body
- Includes:
  - (1) #11121 Star retainer ring
  - (1) #11641 Adapter bar
  - (1) Innovator overflow plate
  - (1) NuFit body
  - (1) Stopper assembly
  - (1) Silicone adhesive
- For Presflo tubs

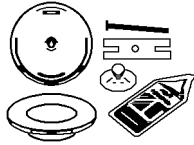

Part #	Mfg #	Closure	Finish	Price
094440	48100CP	PresFlo	Chrome-Plated	

#### Push Pull® 1.6" x 16 Trim Kit with Bushing

- Theft-resistant, brass stopper
- Metal strainer body, 1.25" deep
- Metal overflow plate, 3.375" wide
- Designed for heavy-duty use in hotels, motels, and rental property
- Replaceable, drip-proof Buna-N-Seal
- Adapter bar for changing from two-hole to one-hole overflow plate
- Push to close, pull to open, no stopper rotation required



Part #	Mfg #	Finish	Price
077223	38190CP	Chrome-Plated	
062066	38190BN	Brushed Nickel	
072128	38190BZ	Oil Rubbed Bronze	
062060	38190PB	Polished Brass	

#### Trip Lever & SlipLock® Trim Only

- For either plastic or brass bath wastes
- Includes: (1) Trip Lever faceplate  
(2) Overflow plate crews  
(1) Cotter pin  
(1) Strainer body dome cover & screw



Part #	Mfg #	Piping	Finish	Price
174564	38702BN		Brushed Nickel	
209391	38702PB		Polished Brass	
181127	38702BZ		Oil Rubbed Bronze	

### Flexible Bath Wastes

#### WatcoFlex® Innovator® Complete Bath Waste Lift and Turn Tub Closure

- For lengths 14-1/2" and longer
- Includes 11575 test plug with all Flex bath wastes



Part #	Mfg #	Piping	Finish	Price
098029	FLEX150LTPVC-C	PVC	Chrome-Plated	
	P			

#### Innovator® 900 and 901 Series Schedule 40 Bath Wastes

- 1.5" PVC or ABS Solvent weld assembly
- Built-in testing and snap-on overflow plate
- Threads on strainer body and drain elbow are 1-1/2" to 11-1/2" NPSM (Coarse thread); 11.5 threads per inch

#### 901 Half Bath Waste Push Pull® Tub Closure

- Fits most tubs 14" to 16" high
- IAPMO, SBCCI, CSA
- Conforms to ANSI/ASTM F 409-88

Part #	Mfg #	Piping	Finish	Price
110233	901-PP-PVC-AP	PVC	Aged Pewter	
062058	901-PP-PVC-BN	PVC	Brushed Nickel	
072231	901-PP-PVC-BZ	PVC	Oil Rubbed Bronze	
081131	901-PP-PVC-CB	PVC	Chrome Brushed	

### Quick Trim™ Kits

- Install chrome on the rough-in and easily upgrade to a special finish without removing the strainer body
- Sturdy stainless steel
- No reduction in flow rate
- Uses an o-ring for a tight, snug fit

#### Push Pull® 1-Hole Overflow Quick Trim™ Kit

Part #	Mfg #	Finish	Price
115402	39290-BN	Brushed Nickel	

\*PVD Lifetime Finish

www.waterconcepts.net • Serving our Customers Since 1946 • www.plumbsupply.com





## Bath Wastes

### Innovator Lift and Turn Trim Kit



Part #	Mfg #	Piping	Finish	Price
226258	959290-BN	Brushed Nickel		
226259	959290-BZ	Oil Rubbed Bronze		
226257	959290-CP	Chrome Plated		
246064	959290-WI	Wrought Iron		

\*PVD Lifetime Finish

[www.plumbsupply.com](http://www.plumbsupply.com) • Serving our Customers Since 1946 • [www.waterconcepts.net](http://www.waterconcepts.net)

---

---

**Bath Wastes**

---

---

**Freestanding Tub Drains**

**F2 Drain Plate**

- ABS
- For high-rise construction

Part #	Mfg #	Description	Price
174955	10032747	ABS F2 Drain Plate	

\*Physical Vapor Deposition (PVD) Limited Lifetime Finish

[www.waterconcepts.net](http://www.waterconcepts.net) • Serving our Customers Since 1946 • [www.plumbsupply.com](http://www.plumbsupply.com)



## Disposer Flanges

### Disposer Drains

#### Garbage Disposal Flange Strainer

- Fits ISE (including Evolution Series®), Kenmore®, KitchenAid® and Maytag®
- Positive seal stopper
- Brass construction



Part #	Mfg #	Finish	Price
115914	2827-ORB	Oil Rubbed Bronze	
115913	2827-SN	Satin Nickel	

#### Garbage Disposal Flange with Stopper

- Designed to fit ISE (including Evolution Series®), Kenmore® and Kitchen Aid®
- Easy installation
- Brass construction
- Positive seal stopper



Part #	Mfg #	Finish	Price
115517	2815-MBK	Matte Black	
115909	2815-ORB	Oil Rubbed Bronze	
243803	2815-SG	Satin Gold	
115908	2815SN	Satin Nickel	

#### Extra Deep Disposal Flange with Stopper

- Brass construction
- 3-1/2" Diameter
- Positive seal stopper
- Fits sinks up to 2" thick
- For continuous feed disposals only



Part #	Mfg #	Finish	Price
239361	2819-ORB	Oil Rubbed Bronze	

## Disposer Flanges

### Waste Disposer Parts & Trim

#### Waste Disposer Trim

- With disposer stopper/strainer unit
- For disposers with 3-3/8" ID
- Fits waste disposer models:
  - ISE (including Evolution Series®)
  - Kenmore®
  - Maytag®
  - Ace®
  - KitchenAid®
  - Whirlpool® models



Part #	Mfg #	Finish	Price
117816	MT200EV/BRN	Brushed Nickel	
117817	MT200EV/BRS	Brushed Stainless	
117818	MT200EV/ORB	Oil Rubbed Bronze	
117821	MT200EV/VB	Venetian Bronze™	
240306	MT200EV/MB	Matte Black	

#### Waste Disposer Trim

- With disposer stopper/strainer unit
- For disposers with 3-3/8" ID
- 3 Bolt mounting
- Fits sinks up to 1-3/4" thick
- Fits waste disposer models:
  - ISE (old & new models)
  - Kenmore®
  - Maytag®
  - Ace®
  - KitchenAid®
  - Jenn-Air®
  - Whirlpool®
  - Perfect Grind® (3-bolt mount)



Part #	Mfg #	Finish	Price
239528	MT202/ORB	Oil Rubbed Bronze	

### Universal Flange with Removable Deluxe Strainer

- Fits ISE Evolution Disposer Series®
- Installed into existing flange
- Does not hold disposer



Part #	Mfg #	Finish	Price
086072	BWDUF/BL	Black	
130401	BWDUF/BN	Bone	
077065	BWDUF/BT	Biscuit	
136410	BWDUF/ORB	Oil Rubbed Bronze	
086071	BWDUF/PW	Polar White	

\*PVD Finish

### Waste Disposer Parts & Trim (Continued)

#### Universal Flange with Removable Deluxe Strainer

Part #	Mfg #	Finish	Price
135610	BWDFUG/MLB	Matte Lava Black	

#### Waste Disposer Replacement Stopper

- 3-1/2"W x 1-1/4"H
- For continuous feed waste disposers
- Fits ISE, waste king disposer units, and mountain plumbing 3-bolt



Part #	Mfg #	Finish	Price
241684	BWDS6818/VB	Venetian Bronze	

---



---

**Disposer Flanges**

---



---

**Disposal Flanges****Artesso™ Disposal Flange Stopper**

Part #	Mfg #	Description	Price
222293	69070-BZ	Brushed Bronze*	
245418	69070-GL	Luxe Gold	
222292	69070-PC	Chrome	
222294	69070-PN	Polished Nickel*	
222295	69070-SS	Stainless*	

**Solna® Disposal Flange with Stopper**

Part #	Mfg #	Description	Price
091735	72030	Chrome	
155591	72030-AR	Arctic Stainless	
110264	72030-BZ	Brushed Bronze*	
160783	72030-CZ	Champagne Bronze™	
165747	72030-PN	Polished Nickel*	
078097	72030-SS	Stainless*	

\* Brilliance® Anti-Tarnish Lifetime Finishes

<a href="http://www.plumbsupply.com">www.plumbsupply.com</a> • Serving our Customers Since 1946 • <a href="http://www.waterconcepts.net">www.waterconcepts.net</a>
--------------------------------------------------------------------------------------------------------------------------------------------------------------------

**Disposer Kits**

**C to E Brass Disposer Kits**

- -1 Polished chrome



Part #	Mfg #	Size	Gauge	Price
003276	100201	1-1/2" x 13"	20ga	

**Plastic Disposer Kits**

**End Outlet Kit for In-Sink-Erator**

- B - Bagged



Part #	Mfg #	Size	Description	Price
003250	P9100	1-1/2" x 13"	PVC	

**Telescopic  
For In-Sink-Erator or GE**

- B - Bagged



Part #	Mfg #	Size	Description	Price
061663	P9100T	1-1/2"	PVC	
250410	P9100TB	1-1/2"	PVC	

**Air Gaps**

**Dearborn Air Gap**

- Comes in copper and plastic with chrome plated metal caps



Part #	Mfg #	Description	Price
251941	8000E	For Commercial Applications	



## Disposer Flanges

### Disposer Strainers

#### In-Sink-Erator® Plastic Finish Disposer Waste

- Also for similar brands
- 3-1/2" Celcon® plastic finish



Part #	Mfg #	Description	Price
101357	JBC120E	Black	

#### In-Sink-Erator® Celcon Evolution Disposal Trim

- Remove factory splash guard and snap this trim and splash guard into your existing Evolution disposal flange
- Splash guard is included to replace factory splash guard



Part #	Mfg #	Description	Price
100674	JBC119E	White, Clamshell	
100675	JBC121E	Biscuit, Clamshell	
100676	JBC130E	Oil Rubbed Bronze, Clamshell	

#### In-Sink-Erator® Metal Disposal Flange

- Replaces factory flange on disposal



Part #	Mfg #	Description	Price
111111	JBC129	Brushed Nickel, Clamshell	

**Extension Tubes & Elbows**

**Brass Extension Tubes**

**Slip-Joint Extension Tube**

- -1 Polished chrome



Part #	Mfg #	Size	Gauge	Price
003371	790-1	1-1/4" x 6"	Budget	
003372	790A-1	1-1/4" x 8"	Budget	
003373	790A-17-1	1-1/4" x 8"	17ga	
246278	790A-20-1	1-1/4" x 8"	20 ga	
003374	791A-1	1-1/4" x 12"	Budget	
003375	791A-17-1	1-1/4" x 12"	17ga	
003378	792-1	1-1/2" x 6"	Budget	
003379	792A-1	1-1/2" x 8"	Budget	
003380	793A-1	1-1/2" x 12"	Budget	
003381	793-17-1	1-1/2" x 12"	17 ga	

**Threaded Extension Tubes**

- -1 Polished chrome



Part #	Mfg #	Size	Gauge	Price
003404	820A-1	1-1/4" x 8"	20ga	
003405	822-1	1-1/4" x 12"	20ga	
003408	825A-1	1-1/2" x 8"	20ga	
003409	827-1	1-1/2" x 12"	20ga	
003406	822A-1	1-1/4" x 12"	17ga	
003407	824-1	1-3/8" x 12"	17ga	

**Flanged Strainer Tailpieces**

- Chrome-plated finish
- Tubular flanged design
- 100°F Max working temp

Part #	Mfg #	Size	Gauge	Price
003387	796-1	1-1/2" x 1-1/4" x 8"	20ga	
003388	798-1	1-1/2" x 1-1/4" x 12"	20ga	

**Brass Double Slip Trap Offsets**

- BN - Brass nuts
- -1 Polished chrome



Part #	Mfg #	Size	Gauge	Price
003280	10461	1-1/4"	20ga	
003281	1046A-1	1-1/2"	20ga	

**Brass Slip-Joint Connections**

**Brass Double Slip-Joint Connection**

- -1 Polished chrome



Part #	Mfg #	Size	Gauge	Price
003376	791B-1	1-1/4" x 12"	22ga	
003377	791BD1	1-1/4" x 16"	22ga	
003382	793B-1	1-1/2" x 12"	22ga	
003383	793BD-1	1-1/2" x 16"	22ga	
003384	793C-1	1-1/4" x 2"	20ga	
003385	793D-1	1-1/2" x 2"	20ga	

**Brass 45° Slip-Joint Connector**



Part #	Mfg #	Size	Gauge	Price
062579	8477	1-1/4"	20ga	
062580	8478	1-1/2"	20ga	

**Brass 90° Slip-Joint Connector**

Part #	Mfg #	Size	Gauge	Price
062577	8482	1-1/4"	20ga	
062578	8483	1-1/2"	20ga	

**Extension Tubes & Elbows**

**Brass Tee Slip-Joint Connector**



Part #	Mfg #	Size	Gauge	Price
117403	8480	1-1/4"	20ga	
125125	8481	1-1/2"	20ga	

**Brass Baffle Tee Slip-Joint End Outlet Waste**

- Includes 3" Tailpiece, 2 zinc nuts, 2 rubber washers



Part #	Mfg #	Size	Gauge	Price
035488	2185-1	1-1/2"	20ga	

**Plastic Extension Tubes**

**Solvent Weld Extension Tube**



Part #	Mfg #	Size Description	Price
003268	P9787E	1-1/2" x 16"	PVC

**Slip-Joint Extension Tube**



Part #	Mfg #	Size	Description	Price
107027	P9790	1-1/4" x 6"	PVC	
107028	P9791A	1-1/4" x 12"	PVC	
072056	P9791E	1-1/4" x 6"	PVC Dbl Connect	
228687	P9792	1-1/2" x 6"	PVC	
228710	P9792A	1-1/2" x 8"	PVC	
003269	P9793A	1-1/2" x 12"	PVC	
003270	P9793E	1-1/2" x 16"	PVC Dbl Connect	
228711	P9793EC	1-1/2" x 16"	PVC Dbl Connect	

**Plastic Elbows & Connectors**

**Slip-Joint 90° Elbow**



Part #	Mfg #	Size Description	Price
137160	P9675	1-1/2" PVC	

**Slip-Joint 45° Elbow**

Part #	Mfg #	Size	Gauge	Price
064663	P9665	1-1/2"	PVC	

**Double Slip Connector**



Part #	Mfg #	Size	Description	Price
137162	P9793D	1-1/2" x 2"	PVC	



## Extension Tubes & Elbows

### Tubular

#### Extension Tube

- Threaded at both ends
- Replaces 1-1/4" tube in basin drain to change length up to 12"



Part #	Mfg #	Finish	Price
239592	4237-MBK	Matte Black	
143985	4237-SN	Satin Nickel	

#### Slip-Joint Pattern Extension Tube

- 17 Gauge
- 1-1/4" or 1-1/2" O.D. x 12" slip-joint



Part #	Mfg #	Finish	O.D.	Price
241403	413-PCH	Chrome	1-1/4"	
154233	413-SN	Satin Nickel	1-1/4"	
238308	417-SG	Satin Gold	1-1/2"	

**Grid Drains & PO Plug Drains**

**Wrot Plugs**

**Two-Piece Wrot Plug with Chain & Stopper**

- -1 Polished chrome
- K - Less overflow

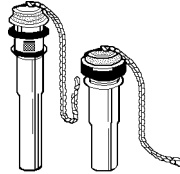

Part #	Mfg #	Size	Gauge	Price
003361	763-1	1-1/4" x 5"	20ga	
003362	763K-1	1-1/4" x 5"	20ga	
003363	764A-1	1-1/4" x 8"	Budget	

**Commercial Plugs**

**Commercial Cast Grid Pop-Up Plug**

- W - Wheelchair
- -1 Polished chrome



760-1



760W-1

Part #	Mfg #	Size	Gauge	Price
003359	7601	1-1/4" x 6"	17ga	
003360	760W-1	1-1/4"	17ga	

## Grid Drains & PO Plug Drains

### Drains

#### 20-Hole Grid Brass Decorative Lavatory Drain

- For vessel, glass, lavatory, and bar sinks
- Without overflow
- Fast flow angle top
- 1-1/4" OD tailpiece
- 1-1/2" Drain opening
- 4" Threaded drain body



#### Without Overflow

Part #	Mfg #	Finish	Price
110158	MT735/BRN	8", Brushed Nickel	
110159	MT735/CPB	8", Polished Chrome	
239526	MT735/ORB	8", Oil Rubbed Bronze	
110157	MT735/VB	8", Venetian Bronze™	

#### With Overflow

Part #	Mfg #	Finish	Price
129510	MT734/BRN	8", Brushed Nickel	
129508	MT734/CPB	8", Polished Chrome	
129511	MT734/PVDBB	8", Brushed Bronze	
129509	MT734/VB	8", Venetian Bronze™	

#### Soft Touch Lavatory Decorative Drain with Overflow

- For vessel, glass, lavatory, and bar sinks
- Soft touch, push-in dome to seal water
- All exposed parts are plated
- 1-1/2" Drain opening



Part #	Mfg #	Description	Price
097376	MT741/CPB	8", Polished Chrome	

#### Soft Touch Lavatory Decorative Drain

- For vessel, glass, lavatory, and bar sinks
- Without overflow
- Soft touch, push-in dome to seal water
- All exposed parts are plated
- 1-1/2" Drain opening



Part #	Mfg #	Description	Price
099928	MT742/BRN	8", Brushed Nickel	
118895	MT742/CPB	8", Polished Chrome	
099958	MT742/ORB	8", Oil Rubbed Bronze	

#### Dome Style Lavatory Decorative Drain

- For vessel, glass, lavatory, and bar sinks
- Without overflow
- Fully plated one-piece brass drain body and tailpiece
- Soft touch, push-in dome to seal water
- All exposed parts are plated
- 1-1/2" Drain opening



Part #	Mfg #	Description	Price
083042	MT745-2/BRN	8", Brushed Nickel	
083044	MT745-2/VB	8", Venetian Bronze™	

### Drain Accessories

#### Slip Joint Tailpiece Extension Tube

- 17 Gauge brass
- Attaches to 1-1/4" tailpiece



Part #	Mfg #	Finish	Price
244051	MT328SJ/ORB	8", Oil Rubbed Bronze	

\*PVD Finish



## Grid Drains & PO Plug Drains

### Lavatory Drains

#### Lavatory Grid Drain Without Overflow

- Brass construction
- 1-1/4" Connection
- Decorative trim caps
- Flower design



Part #	Mfg #	Description	Price
178646	K-7107-AF	*French Gold	
259262	K-7107-BL	Matte Black	
107702	K-7107-BN	*Brushed Nickel	
107927	K-7107-CP	Polished Chrome	
150764	K-7107-SN	*Polished Nickel	
147050	K-7107-2BZ	Oil Rubbed Bronze	

#### Lavatory Grid Drain

- Brass construction
- 1-1/4" Connection
- (A)-Includes overflow drain



Part #	Mfg #	Description	Price
153920	K-7129-AF	*French Gold	
110634	K-7129-BN	*Brushed Nickel	
110633	K-7129-BV	*Brushed Bronze	
111814	K-7129-CP	Polished Chrome	
125490	K-7129-SN	Polished Nickel	
251585	K-7129-TT	*Titanium	
183137	K-7129-VS	*Stainless	
147057	K-7129-2BZ	Oil Rubbed Bronze	
254332	K-7129-A-BL	Matte Black	
123335	K-7129-A-BN	*Brushed Nickel	
139372	K-7129-A-BV	*Brushed Bronze	
110035	K-7129-A-CP	Polished Chrome	
118399	K-7129-A-G	Brushed Chrome	
188864	K-7129-A-PB	*Polished Brass	
182942	k-7129-A-SN	*Polished Nickel	
161695	K-7129-A-VS	*Stainless	
147059	K-7129-A-2BZ	Oil Rubbed Bronze	

#### Lavatory Pop-Up Clicker Drain with 1-1/4" Tailpiece

- Solid brass construction
- 1-1/4" Connection
- (A)-Includes overflow drain



Part #	Mfg #	Description	Price
153918	K-7124-AF	*French Gold	
256619	K-7124-BL	Matte Black	
112209	K-7124-BN	*Brushed Nickel	
114838	K-7124-BV	*Brushed Bronze	
114461	K-7124-CP	Polished Chrome	
165362	K-7124-PB	Polished Brass	
155364	K-7124-SN	Polished Nickel	
146786	K-7124-2BZ	Oil Rubbed Bronze	
111520	K-7124-A-BN	*Brushed Nickel	
121239	K-7124-A-BV	Brushed Bronze	
115149	K-7124-A-CP	Polished Chrome	
114587	K-7124-A-G	Brushed Chrome	
183174	K-7124-A-PB	Polished Brass	
254521	K-7124-A-RGD	*Rose Gold	
183135	K-7124-A-SN	Polished Nickel	
147054	K-7124-A-2BZ	Oil Rubbed Bronze	

#### Lavatory Drain with 1-1/4" Connection

- Brass construction
- Available with non-removable metal stopper
- For use with Spun Glass™ vessels lavatory
- (A)-Includes overflow drain



Part #	Mfg #	Description	Price
153201	K-7127-BN	Less Overflow, *Brushed Nickel	
110409	K-7127-CP	Less Overflow, Pol Chrome	
147055	K-7127-2BZ	Less Overflow, Oil Rubbed Bronze	
146341	K-7127-A-BN	With Overflow, *Brushed Nickel	
242045	K-7127-A-BV	With Overflow, *Brushed Bronze	
125368	K-7127-A-CP	With Overflow, Pol Chrome	
147056	K-7127-A-2BZ	With Overflow, Oil Rubbed Bronze	

\* Vibrant Limited Lifetime Warranty

[www.plumbsupply.com](http://www.plumbsupply.com) • Serving our Customers Since 1946 • [www.waterconcepts.net](http://www.waterconcepts.net)

## Grid Drains & PO Plug Drains

### Premier Exposed Pop-Up Drain

- Solid brass construction
- With overflow
- Brass tailpiece
- 1-1/4" connection



Part #	Mfg #	Description	Price
087964	K-7114-A-CP	Polished Chrome	
125224	K-7114-A-PB	*Polished Brass	

### Premier Pop-Up Drain with Overflow

- Polished brass finish



Part #	Mfg #	Description	Price
255033	K-1035350-AF	*French Gold	

### Standard Non-Exposed Pop-Up Drain with Lift Rod

- For use with overflow sinks.
- Solid-brass construction.
- Pop-up drain with external button.
- 3-inch rough
- Includes 1-1/4-inch tailpiece



Part #	Mfg #	Description	Price
138784	K-7126-CP	Polished Chrome	

### Offset Drain With Open Strainer and Overflow

- Brass construction
- 6" Offset



Part #	Mfg #	Description	Price
169202	K-7131-A-CP	Polished Chrome	

\* Vibrant Limited Lifetime Warranty

[www.waterconcepts.net](http://www.waterconcepts.net) • Serving our Customers Since 1946 • [www.plumbsupply.com](http://www.plumbsupply.com)

## Grid Drains & PO Plug Drains

### Lavatory Pop-Up Drains Push Pop-Up Assembly



Part #	Mfg #	Description	Price
245640	33W576RB	Overflow, Venetian Bronze	
130292	72172	Less Overflow, Chrome	
237673	72172-BL	Less Overflow, Matte Black	
137798	72172-CZ	Less Overflow, Champagne Bronze	
219715	72172-PN	Less Overflow, Polished Nickel	
126838	72172-RB	Less Overflow, Venetian Bronze®	
126637	72172-SS	Less Overflow, Stainless*	
138293	72173	Overflow, Chrome	
154300	72173-CZ	Overflow, Champagne Bronze™	
188079	72173-PN	Overflow, Polished Nickel*	
128864	72173-RB	Overflow, Venetian Bronze®	
131231	72173-SS	Overflow, Stainless*	

### Brizo® Button Push-Up Assembly



Part #	Mfg #	Description	Price
176987	RP72413BL	Less Overflow, Matte Black	
236641	RP72413-G L	Less Overflow, Luxe Gold	
223448	RP72413NK	Less Overflow, Luxe Nickel*	
160853	RP72413PC	Less Overflow, Chrome	
165537	RP72413PN	Less Overflow, Pol Nickel*	
176988	RP72414BL	Overflow, Matte Black	
164707	RP72414BN	Overflow, Brushed Nickel*	
255364	RP72414GL	Overflow, Luxe Gold	
164784	RP72414PC	Overflow, Chrome	
227790	RP72414NK	Overflow, Luxe Nickel*	

### Lavatory Pop-Up Drains (Continued) Brizo® Button Push-Up Assembly

Part #	Mfg #	Description	Price
169115	RP72414RB	Overflow, Ven Bronze*	

### Brizo® Push Button Pop-Up Assembly

- 2-1/8" Diameter
- Fits sinks with 1-5/8" drain hole size
- If used with electronic lavatory, must use plastic tailpiece included



Part #	Mfg #	Description	Price
246211	RP81627GL	Less Overflow, Luxe Gold	
239217	RP81627BL	Less Overflow, Matte Black	
240876	RP81627NK	Less Overflow, Luxe Nickel*	
241650	RP81627PC	Less Overflow, Chrome	
250800	RP81627PN	Less Overflow, Polished Nickel	
252433	RP81627SL	Less Overflow, Luxe Steel	
224880	RP81628BN	Overflow, Brushed Nickel	
250057	RP81628GL	Overflow, Luxe Gold	
240973	RP81628PN	Overflow, Polished Nickel	
230149	RP81628PC	Overflow, Chrome	

### Square Push Pop-Up Assembly



Part #	Mfg #	Description	Price
237177	72175	Overflow Chrome	
258243	72175PN	Overflow, Polished Nickel*	
188199	72175SS	Overflow, Stainless*	
224480	72174	Less Overflow, Chrome	
254241	72174BL	Less Overflow, Matte Black	
232660	72174RB	Less overflow, Venetian Bronze	
185563	72174SS	Less overflow, Stainless*	

\* Brilliance® Anti-Tarnish Lifetime Finishes

[www.plumbsupply.com](http://www.plumbsupply.com) • Serving our Customers Since 1946 • [www.waterconcepts.net](http://www.waterconcepts.net)

## Grid Drains & PO Plug Drains

### Lavatory Grid Strainer



Part #	Mfg #	Description	Price
120486	RP47648	Less Overflow, Chrome	
143949	RP47648CZ	Less Overflow, Champagne Bronze	
175058	RP47648PN	Less Overflow, Pol Nickel*	
098653	RP47648RB	Less Overflow, Ven Bronze®	
106068	RP47648SS	Less Overflow, Stainless*	
248013	RP72411GL	Less Overflow, Luxe Gold	
243910	RP72411NK	Less Overflow, Luxe Nickel*	
185751	RP72412BL	Overflow, Matte Black	
223317	RP72412BN	Overflow, Brushed Nickel*	
247979	RP72412GL	Overflow, Luxe Gold	
225764	RP72412NK	Overflow, Luxe Nickel*	
150941	RP72412RB	Overflow, Ven Bronze®	

### Vessel Bowl Grid Strainer



Part #	Mfg #	Description	Price
003716	RP6346	With Overflow, Chrome	
150942	RP6346SS	With Overflow, Stainless*	
158018	RP6346RB	With Overflow, Ven Brz®	

### Complete Pop-Up Assembly



Part #	Mfg #	Description	Price
178537	RP28653BN	Brushed Nickel*	

### Plastic Pop-Up Drain



Part #	Mfg #	Description	Price
245134	RP41587	Chrome	

### RP26533 Lavatory Drain Assembly

- Less lift rod



Part #	Mfg #	Description	Price
121279	RP26533	Chrome	
247828	RP26533PT	Aged Pewter	
226831	RP26533OB	Oil Rubbed Bronze	
075179	RP26533RB	Venetian Bronze®	
092017	RP26533SS	Stainless*	

### Commercial Drains

#### Open Grid Strainer Wastes



Part #	Mfg #	Description	Price
060000	33T260	1-1/4" Inline open Grid Strainer	
185405	33T2901	1-1/4" Offset Open Grid Strainer w/ 5" Fixed Centers	

\* Brilliance® Anti-Tarnish Lifetime Finishes

[www.waterconcepts.net](http://www.waterconcepts.net) • Serving our Customers Since 1946 • [www.plumbsupply.com](http://www.plumbsupply.com)



## Grid Drains & PO Plug Drains

### Drains

#### Umbrella Drain less Overflow

- *Patented drain channels, increase overall outflow of water while draining*
- *Push button closing mechanism*
- *Solid brass construction*
- *Threads are 3" long*



Part #	Mfg #	Finish	Price
090809	9298-CP	Pol Chrome	
103269	9298-SN	Satin Nickel	

#### Constantly Open Grid Drain

- *Designed to work with lavatories that do not require an overflow*
- *Constantly open*
- *Solid brass construction*
- *Threads are 3" long*



Part #	Mfg #	Finish	Price
096515	9296-CP	Pol Chrome	
102440	9296-SN	Satin Nickel	



## Grid Drains & PO Plug Drains

### Lavatory Drains

#### C.O. Plug Finger Touch Drain less Overflow Holes

- Complete with (2) rubber Mack washers to ensure secure fit
- Use with sinks and vessels not containing overflow hole
- Fits 1-1/2" opening
- Clicker/push-button open and close



Part #	Mfg #	Finish	Price
122029	814-ORB	Oil Rubbed Bronze	
117834	814-PCH	Polished Chrome	
140019	814-SN	Satin Nickel	

#### Finger Touch Round Lavatory Drain

- With overflow
- Fits 1-1/2" opening
- 2-3/4" Finger touch top
- Ideal for vessel sinks/thick installations
- Clicker/push-button open and close



Part #	Mfg #	Finish	Price
238661	840-MBK	Matte Black	
227627	840-CB	Caramel Bronze	

#### C.O. Style Round Top Extra Long Thread Finger Touch Drain (without overflow holes)

- Complete with (2) rubber Mack washers to ensure secure fit
- Use with thick counters
- Fits 1-1/2" opening
- Clicker/push-button open and close



Part #	Mfg #	Finish	Price
115863	832-BU	Bronze Umber	
125703	832-MBK	Matte Black	
115861	832-ORB	Oil Rubbed Bronze	
115858	832-PCH	Polished Chrome	
115862	832-PEW	Pewter	
115859	832-SN	Satin Nickel	
153137	832-VB	Vintage Bronze	

#### C.O. Style Stationary Round Top Extra Long Thread (Without Overflow)

- Complete with (2) rubber Mack washers to ensure secure fit
- Use with thin wall vessels and stainless steel basins not containing overflow hole
- Fits 1-1/2" opening
- Clicker/push-button open and close



Part #	Mfg #	Finish	Price
151411	833-VB	Vintage Bronze	



**J-Bends**

**Brass J-Bends**

**Brass J-Bend less Cleanout**

- -1 Polished chrome



Part #	Mfg #	Size	Gauge	Price
003341	650-1	1-1/4"	20ga	
003342	651-1	1-1/2"	20ga	
025855	653-1	1-1/2"	17ga	

**Center to Center, Slip Joint w/ Baffle Tee**

- 16" or 21" Lengths available
- White or black polypropylene plastic
- Includes:
  - (2) Waste arms
  - (2) Hi-Line nipples
  - (4) Slip nuts
  - (4) Washers

Part #	Mfg #	Size	Color	Price
228608	P9114A	1-1/2" x 16"	White	

**P-Traps**

**Brass P-Traps**

**P-Traps less Cleanout**

- A - 3" Longer
- DF - Deep Flange
- -1 Polished chrome



Part #	Mfg #	Size	Gauge	Price
003345	700-1	1-1/4"	20ga	
228669	2700-1	1-1/4"	Budget	
186600	700DF1	1-1/4"	20 ga	
003349	7021	1-1/2"	20ga	
003347	7011	1-1/4"	17ga	
003348	701A1	1-1/4"	17ga	
003352	7041	1-1/2"	17ga	
003351	704A1	1-1/2"	17ga	
228670	2702-1	1-1/2"	Budget	

**Brass P-Traps with Cleanout**

- -1 Polished chrome



Part #	Mfg #	Size	Gauge	Price
168078	706-1	1-1/4"	20ga	
003354	707-1	1-1/4"	17ga	
003355	710-1	1-1/2"	17ga	

**Brass Repair Trap**

- -1 Polished chrome



Part #	Mfg #	Size	Gauge	Price
003346	700R1	1-1/4"	20ga	

**Brass Low Inlet Tube P-Trap**

- A - 3" Longer
- -1 Polished chrome



Part #	Mfg #	Size	Gauge	Price
029270	711A1	1-1/4"	17ga	
188482	714A1	1-1/2"	17 ga	

**Commercial Products**

**Commercial Semi-Cast P-Trap with Cleanout**

- Deep flange
- Brass nuts
- -1 Polished chrome



Part #	Mfg #	Size	Gauge	Price
003339	5071	1-1/4" x 12"	17ga	
003340	5101	1-1/2" x 12"	17ga	
223966	5510A1	1-1/2" x 15"	17ga	

**Plastic P-Traps**

**PVC P-Traps**

- BG - Bagged



Part #	Mfg #	Description	Price
003262	P9700	1-1/4" Choked Throat Outlet, 1-1/2" Inlet	
003263	P9701BG	1-1/4", Less Flange	

**PVC P-Trap with Threaded Adapter**

- Includes (3) nuts
- DF - Deep flange
- BG - Bagged



Part #	Mfg #	Size	Adapter	Price
003264	P9704	1-1/2"	PVC	
003265	P9704BG	1-1/2"	PVC	
035856	P9704DFB	1-1/2"	PVC	

**PVC P-Trap with Threaded Adapter and Reversible J-Ben<sup>®</sup>**

- Super nuts feature full sized wings and longer threads
- Includes marvel connector
- DF - Deep flange
- BG - Bagged
- W - True Blue Washer



Part #	Mfg #	Size	Gauge	Price
163755	P9703WBG	1-1/2"	PVC	
157580	P9703BG	1-1/2"	PVC	

---



---

**P-Traps**

---



---

**Metal P-Traps**

**Metal P-Trap With Cleanout**

- 17-Gauge brass with chrome plated finish
- For connection to a wall-connected sink drain system
- Compatible with copper pipes
- Slip joint connections



Part #	Mfg #	Size	Gauge	Price
168439	707DF1	1-1/4"	Brass	

## Sink Wastes

### Lavatory Traps

#### P-Trap with Round Box Escutcheon - 1-1/4"

- 17 Gauge
- Contains round box high escutcheon
- All solid brass nuts with washers



Part #	Mfg #	Finish	Price
115864	251-PCH	Pol Chrome	
115867	251-ORB	Oil Rubbed Bronze	
115865	251-SN	Satin Nickel	

### Decorative Round Trap

- Decorative round lavatory trap
- 1 1/4" wall outlet x 1 1/4" inlet
- All brass fully polished & plated
- Complements majority of collections
- Extension wall tubes available



Part #	Mfg #	Finish	Price
227628	255-CB	Caramel Bronze	
125668	255-PCH	Pol Chrome	
172215	255-MBK	Matte Black	
125669	255-SC	Satin Chrome	
125671	255-SN	Satin Nickel	

## P-Traps

### Plastic P-Traps

- Includes reducing washer
- Bagged
- White w/Marvel Adapter



Part #	Mfg #	Size	Price
100186	802PVCBG	1-1/2"	

### Bayonet P-Traps

- Bagged
- White PP w/ Bayonet PVC marvel adapter



Part #	Mfg #	Size	Price
093737	837PVCBG	1/2"	

**S-Traps**

**Brass S-Traps**

- -1 Polished chrome



Part #	Mfg #	Size	Gauge	Price
003356	718-1	1-1/4"	20ga	
003357	720-1	1-1/2"	20ga	

**Plastic S-Traps**

**Plastic S-Trap with PVC S-Bend & Solvent Weld Adapter**

- BG - Bagged



Part #	Mfg #	Size	Description	Price
053462	P9718	1-1/4"	PVC	
003266	P9720	1-1/2"	PVC	
003267	P9722	1-1/2"	PVC	



## Shower Drains

### Shower Drains

#### Complete Square Shower Drain

- 4-1/4" Square drain plate
- 2-5/8" Center-to-center screw holes
- Fits 2" or 3" PVC
- Clamping ring design allows for water tight seal on shower pan membrane



Part #	Mfg #	Finish	Price
246543	86564-AB	Antique Brass	
127688	86564-ORB	Oil Rubbed Bronze	
130086	86564-PCH	Pol Chrome	
130258	86564-SN	Satin Nickel	

#### Complete Round Shower Drain

- 4-1/4" Square drain plate
- 2-5/8" Center-to-center screw holes
- Fits 2" or 3" PVC
- Clamping ring design allows for water tight seal on shower pan membrane



Part #	Mfg #	Finish	Price
242731	86563-PN	Polished Nickel	

#### Square Shower Drain Plate

- 4-1/4" Square
- Fits plumbing product drains
- Complete with screws



Part #	Mfg #	Finish	Price
151449	6264-AB	Antique Brass	
135491	6264-ORB	Oil Rubbed Bronze	
153373	6264-PCH	Pol Chrome	
135490	6264-SN	Satin Nickel	

#### 4-1/4" Diameter Round Shower Drain Plate

- Snap-in

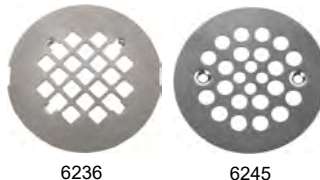

Part #	Mfg #	Finish	Price
115879	6236-PCH	Pol Chrome	
118338	6236-BU	Bronze Umber	
118341	6236-ORB	Oil Rubbed Bronze	
141695	6236-SG	Satin Gold	

### Shower Drains (Continued)

#### 4-1/4" Diameter Round Shower Drain Plate

Part #	Mfg #	Finish	Price
115880	6236-SN	Satin Nickel	
175381	6236-VB	Vintage Bronze	
115890	6245-ORB	Oil Rubbed Bronze	
115892	6245-PEW	Pewter	
146180	6245-SG	Satin Gold	
115888	6245-SN	Satin Nickel	

### Trench Shower Drains

#### Channel Drain Bar Gate

- 1" Wide sleek design grate
- 304 Stainless steel construction
- Slim channel drain body sold separately

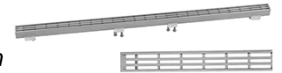

Part #	Mfg #	Finish	Price
242454	6204-24-BSS	24", Brushed Stainless	

#### Channel Drain Tile In Grate

- 304 Stainless steel construction
- Adjustable feet
- Key included to remove grate
- Empty tray-insert your own tiles
- Body sold separately



Part #	Mfg #	Finish	Price
238356	6226-42-BSS	42", Brushed Stainless	

#### ZeroEDGE Channel Drain Body

- 1" Wide sleek design grate
- 2" Bottom outlet
- No sub drain required
- Side outlet not available
- Grates sold separately



Part #	Mfg #	Finish	Price
242455	83224-BSS	24", Brushed Stainless	
243518	83236-BSS	36", Brushed Stainless	
246289	88242-BSS	42", Brushed Stainless	

## Shower Drains

### Shower Wastes

#### Tile-In Shower Drain with Removable Grid Plate

- Brass and PVC construction
- Through-the-floor tile-in installation
- Reversible collar to for a variety of tile thickness
- Inside tailpiece for 2" drains/outside tailpiece 3" dr.



**K-9135-B**



**K-9136-CP**

Part #	Mfg #	Description	Price
127378	K-9135-AF	Round, *French Gold	
222087	K-9135-BGD	Round, *Brushed Gold	
165150	K-9135-BN	Round, *Brushed Nickel	
116821	K-9135-BV	Round, *Brushed Bronze	
232273	K-9135-CP	Round, Polished Chrome	
184872	K-9135-G	Round, Brushed Chrome	
144808	K-9135-SN	Round, *Polished Nickel	
243424	K-9135-VNT	Round, Vintage Nickel	
147075	K-9135-2BZ	Round, Oil Rubbed Bronze	
122885	K-9136-AF	Square, *French Gold	
122884	K-9136-BN	Square, *Brushed Nickel	
246423	K-9136-BL	Square, Matte Black	
119833	K-9136-BV	Square, *Brushed Bronze	
121687	K-9136-CP	Square, Polished Chrome	
167078	K-9136-G	Square, Brushed Chrome	
239515	K-9136-PB	Square, *Polished Brass	
165545	K-9136-SN	Square, *Polished Nickel	
231733	K-9136-TT	Square, *Titanium	
147076	K-9136-2BZ	Square, Oil Rubbed Bronze	

### Shower Wastes (Continued)

#### Round Shower Drain for use with Plastic Pipe

Part #	Mfg #	Description	Price
061212	K-9132-BN	Round, *Brushed Nickel	
077066	K-9132-BV	Round, *Brushed Bronze	
064284	K-9132-CP	Round, Polished Chrome	
086878	K-9132-G	Round, Brushed Chrome	
062968	K-9132-PB	Round, *Polished Brass	
066952	K-9132-SN	Round, *Polished Nickel	
147074	K-9132-2BZ	Round, Oil Rubbed Bronze	

#### Round Shower Drain for use with Plastic Pipe

- 4-3/8" Width
- Gasket included
- Solid brass construction
- Prefoprated strainer
- Includes 2" plastic pipe gasket/bushing
- For acrylic, fiberglass, cast iron, vikrell receptors



Part #	Mfg #	Description	Price
069126	K-9132-AF	Round, *French Gold	
258281	K-9132-BL	Round, Matte Black	

\* Vibrant Limited Lifetime Warranty

[www.waterconcepts.net](http://www.waterconcepts.net) • Serving our Customers Since 1946 • [www.plumbsupply.com](http://www.plumbsupply.com)

## Shower Drains

### Shower Drain Grids

#### MT236 - Shower Grid

- All brass grid
- Snaps into place
- 4-1/4" Diameter, 4-1/4"OD,  
2-7/8" prong to prong



Part #	Mfg #	Finish	Price
086063	MT236/BRN	Brushed Nickel	
245397	MT236/MB	Matte Black	
086066	MT236/ORB	Oil Rubbed Bronze	
086068	MT236/PVDBB	PVD Brushed Bronze™	
086067	MT236/VB	Venetian Bronze™	

#### MT238 - Shower Grid

- All brass 4" diameter grid
- Fits "Plastic Oddities" shower drains
- Includes screws



Part #	Mfg #	Finish	Price
086369	MT238/BRN	Brushed Nickel	
095631	MT238/ORB	Oil Rubbed Bronze	
087911	MT238/VB	Venetian Bronze™	

#### MT245 - Shower Grid

- 4-1/4" Diameter brass
- Fits "Plastic Oddities" shower drains
- Includes screws



Part #	Mfg #	Finish	Price
098854	MT245/BRN	Brushed Nickel	
098855	MT245/ORB	Oil Rubbed Bronze	
098857	MT245/VB	Venetian Bronze™	

### Bath Wastes

#### Economy Lift & Turn Drain Trim

- Trim only
- Two-hole face plate
- Drain for lift and turn with bushing and washer



Part #	Mfg #	Finish	Price
129198	HTRLT/VB	Venetian Bronze™	

\*PVD Finish

**www.plumbsupply.com • Serving our Customers Since 1946 • www.waterconcepts.net**

## Shower Drains

### Residential Shower Drains

#### Linear Shower Drain

- DoubleDuty™ test plug
- 1-1/2"-3" Adjustable height
- Stainless steel head and strainer



#### Linear Shower Drain with Tile-In Strainer

Part #	Mfg #	Sch. 40 Hub	Length	Price
25058 7	823-TX26TP	2" Sch. 40 Hub	26"	
25058 8	823-TX30TP	2" Sch. 40 Hub	30"	

#### Linear Shower Drain with Square-Holes Strainer

Part #	Mfg #	Sch. 40 Hub	Length	Price
24716 3	823-TX26SP	2" Sch. 40 Hub	26"	

#### Round Shower Pan Drain

- 3-Piece
- Cast iron
- Chrome-plated head and strainer

Part #	Mfg #	Sch. 40 Hub	Size	Price
25219 6	821-2IHCP	2" No-Hub	4-1/4" x 2" FPT	

#### Solvent Weld Shower Module Drain (Screw-On 430 Stainless Steel Strainer)

- 1½" hub connection is also 2" spigot
- Do not use putty with plastic shower drains
- Available with brass inserts in top for machine screws or pilot holes for standard screws



Part #	Mfg #	Sch. 40 Hub	Size	Price
09754 8	825-2P	2"	4-1/4" x 2-5/8"	

#### Offset Solvent Weld Shower Module Drain (Screw-On Stainless Steel Strainer)

- Provides a 3/4" offset in any direction
- Use when needed to offset from a joist or other obstacle
- 430 Stainless steel strainer
- Do not use putty with plastic shower drains



Part #	Mfg #	Sch. 40 Hub	Size	Price
09560 4	825-2PFS	2"	4-1/4" x 2"	

#### No-Caulk Shower Module Drain with (Snap-In 430 Stainless Steel Strainer)



- **Brass Body**  
—Body and locknut with elastomer no-caulk gasket
- **PVC Body**  
—Body and locknut with elastomer no-caulk gasket  
—Do not use putty with plastic shower drains

#### Cast Brass Body Drain

Part #	Mfg #	Sch. 40 Hub	Size	Price
03042 5	827-2B	2"	4-1/4" x 2-1/8"	

#### JackRabbit™ Jacking Bolt Shower Drain

- Perfect for replacement applications when workspace is restricted
- Brass body, locknut and pressure plate washer with elastomer no-caulk gasket



Part #	Mfg #	Sch. 40 Hub	Size	Price
08987 5	827-2J	2"	4-1/4" x 2-1/8"	



## Shower Drains

### StreamLine™ Linear Shower Pan Drain with Slotted Strainer (2" Sch. 40 Hub Connection)

- Designed for use in "thin-bed" tile applications with a bonded waterproof membrane (ANSI A118.10)
- Provides a unique, contemporary appearance and functional design for shower areas
- Allows for the use of larger, floor-size tiles
- Perfect for use in residential applications for barrier-free or ADA showers, or along thresholds for overflow control
- All StreamLine™ drains include installation hardware, sealant and an illustrated instruction sheet
- Seamless, internally sloped, PVC body
- Clamping collar: stainless steel
- Strainer: stainless steel, brushed finish

#### Streamline™ Drain — Slotted Strainer

Part #	Mfg #	Length	Conn. Offset	Thickness	Price
18387	823-40PSS	40"	23-3/4"	1-1/2"	
7					
18387	823-60PSS	60"	33-3/4"	1-1/2"	
8					

#### Full Mortar Bed Kit — Slotted Strainer Only

Part #	Mfg #	Length	Price
18387	823-FK40	40"	
9			
18388	823-FK60	60"	
0			

### Shower Drain Accesories

Part #	Mfg #	Description	Price
24327	821-2SRBQ	4-1/2" Square Cast Ring & Strainer	
9	PK1	w/ Screws-Clamshell, Oil Rubbed Brz	

## Shower Drains

### Residential Drains

#### 140 Series No-Calk® Shower Base Drain

- The original Caspers No-Calk® shower drain
- Designed for use with preformed shower bases; fiberglass, acrylic, nylon or metal
- Mechanically attaches over 2" Sch 40 DWV pipe
- The drain is fixed to the drain pipe from above the shower base
- Ideal for slab construction
- 4-1/4" Snap-in strainer
- Fiber and rubber gasket provides a tight seal to the base



Part #	Mfg #	Description	Price
015993	42150	2" NC Brass with SS Strainer	
015992	42099	2" NC PVC with SS Strainer	

#### 101PS Series Solvent Weld Shower Base Drain

- Designed for use with preformed shower bases; fiberglass, acrylic, nylon or metal
- Solvent welds over 2" Sch 40 DWV pipe
- 4-1/4" Snap-in strainer
- Fiber and rubber gasket provides a tight seal to the base



Part #	Mfg #	Description	Price
092438	42097	2" PVC SW with SS Strainer	

#### 102 Series 2-Part PVC Solvent Weld Shower Drain

- Stainless steel strainer
- Sch40 DWV



Part #	Mfg #	Size	Price
192793	42045	2" Sch40 DWV w/ SS Strainer	

#### General Purpose PVC Drain w/ Screw-Tite Strainer

- 5" Stainless steel drain



Part #	Mfg #	Size	Price
192788	43583	3" or 4" PVC w/ SS Strainer	

### Strainer Only

Part #	Mfg #	Size	Price
251106	42358	4" Stainless Steel	

#### 130 Series PVC Drain w/ Strainer

- Low-profile design allows for installation in tight spaces
- Drain body solvent welds over 2" or inside 3" Sch. 40 DWV pipe
- Reversible clamping collar is secured with 4 stainless steel bolts into brass inserts
- 2" IPS threaded strainer barrel is adjustable to allow for easy height adjustment
- Weep holes in the drain assembly allow drainage from the pan liner



Part #	Mfg #	Description	Price
192786	42213	2" or 3" PVC w/ SS Round Strainer	
252093	42237	2" or 3" PVC w/ SS Square Strainer	
253063	42251	2" or 3" PVC w/ BN Square Strainer	
253064	42398	2" or 3" PVC w/ RB Square Strainer	

### Drain Strainers

#### 4-1/4" Square Snap-Tite Strainer

- For 130 series shower drains with square strainers



Part #	Mfg #	Description	Price
250455	46266	4-1/4" Stainless Steel, Carded	
143009	46267	4-1/4" Rubbed Bronze, Carded	
252755	46268	4-1/4" Brushed Nickel, Carded	

#### 4-1/4" Round Snap-Tite Strainer

- For 101BR, 101PNC, 101NPT, 101PS, 102, 103, 130, 131 and 140 NC series shower drains with round strainers
- UltraShine® PVD lifetime finish where noted



Part #	Mfg #	Description	Price
017048	42136	4-1/4" White Plastic	
252096	42019	4-1/4" White Metal	



## Shower Drains

### Drain Strainers (Continued)

#### 4-1/4" Round Snap-Tite Strainer

Part #	Mfg #	Description	Price
016134	42137	4-1/4" PVD Pol Brass	
016135	42138	4-1/4" Stainless Steel	
252094	42014	4-1/4" Satin Nickel	
115322	42017	4-1/4" Rubbed Bronze	
196264	42018	4-1/4" Brushed Nickel	
252097	42004	4-1/4" Polished Brass	

### Cleanouts

#### Snap-In Cleanout Assembly

- 4" PVC Snap-In



Part #	Mfg #	Size	Price
159789	43733	4" PVC Snap-In Cleanout	

### No-Calk® Shower Drain Accessories

#### No-Calk® Drain Rubber Caulking Gasket

- For use with No-Calk® shower drains



Part #	Mfg #	Description	Price
031743	42156	2" Sch 40 Cast Iron Gasket	
198371	42157	For 2" No-Hub Cast Iron Pipe	
050600	42158	For 2" Copper DWV Pipe	
189718	42163	1-1/2" Sch40 DWV Rubber Gasket	

#### No-Calk® Shower Drain Wrench

- Carded



Part #	Mfg #	Size	Price
171106	42239	Shower Drain Wrench	

### Residential Floor Drains

#### Four-Way PVC Area Drain

- Solvent welds over 2" Sch 40. DWV pipe or inside of 3" Sch. 40 DWV pipe
- For use in garage, patio, or utility rooms
- Includes removable plastic screw-in strainer



Part #	Mfg #	Size	Price
242109	43596	2" or 3" White Plastic	

#### PVC Floor Drain with P-Trap & Cleanout

- Optional backwater device



Part #	Mfg #	Size	Price
243028	42724	2" White Plastic	

#### PVC General Purpose Drain

- Includes 6" brass strainer



Part #	Mfg #	Size	Price
245349	72127	3" or 4" White Plastic	
192784	43601	Drain w/ 5" Nickel Alloy Strainer	
192783	43579	Drain w/ 4" Stainless Steel Strainer	

#### Snap-In Drain

- Plastic can be solvent welded or inserted into Sch 40 DWV pipe
- One-Piece design does not allow removal of the cover



Part #	Mfg #	Size	Material	Price
169209	43564	3"	ABS	

#### All Plastic Snap-In Drain

- Plastic Snap-In Drain can be solvent welded or inserted into Sch. 40 DWV pipe
- One piece design does not allow removal of the cover



Part #	Mfg #	Size	Material	Price
114261	43561	2"	PVC	

## Shower Drains

### Shower Drains

#### Round Replacement Strainer

Part #	Mfg #	Size	Finish	Price
252667	63621	4-1/4"	Oil Rubbed Bronze	
252668	63617	4-1/4"	Oil Rubbed Bronze	

### Floor Drains

#### Integral Trap Floor Drain

- One piece ABS or PVC Drain Body
- Conforms to ASTM D2661 (ABS) / ASTM D2665 (PVC)
- Factory Installed 1 1/2" Cleanout Plug
- 3 3/4" Deep Sump Bowl
- 3" Trap Seal



Part #	Mfg #	Size	Material	Price
248895	82331	2"	PVC	

## Sink Strainers

### Strainers

#### Threaded Body Sink Strainer

- Extra thick washer
- Extra wide locknut
- Heavy Duty SS strainer body and basket
- Metal post
- Body is chrome-plated



Part #	Mfg #	Description	Price
228628	10	Threaded Body	
003283	11	Rubber Stopper w/Chrome Plastic Post	
003292	16	Heavy Locknut. Rubber Stopper	
003295	17	Spin-N-Lock w/ Screw in Basket	

#### Locking Cup Sink Strainer

- Body is chrome-plated stainless steel
- Basket contains stainless steel stick post
- Locking cup included
- Neoprene rubber stopper



Part #	Mfg #	Description	Price
232685	6	SS Body, Basket. Metal post, Extra wide Locknut & Washer	
003290	14	2-3/4"L Snap-In Shallow Basket. Fits Deep Cast Iron Sinks	
228618	14T	Same as 14 w/ 4" Chrome Tailpiece	
228615	15T	3-3/4"L w/ 4" Chrome Tailpiece	
003296	18	3-3/4"L Deep Locking Cup	

#### Lucky 7 Sink Basket Strainer

- Stainless Steel 4-prong basket
- Chrome plated brass body
- Metal post
- Rubber stopper
- Heavy locknut
- Extra thick washer
- Machine cut threads



Part #	Mfg #	Description	Price
003246	L7	Pro-Brite Strainer 3-1/2"	

#### Locking Cup Sink Basket Strainer

- With reversible lock nut for make-up with cast iron sinks
- High-quality stainless steel stick post basket and 4-3/8" flange diameter
- Includes metal post, heavy locknut, rubber stopper, extra thick washer, and machine cut threads
- Resists corrosion - maintains new appearance
- Easy installation and cleaning
- Designed for use in residential and commercial sinks



Part #	Mfg #	Size	Gauge	Price
252190	1120	3-1/2" to 4" Opening		

#### Metal Bar Sink Strainer



Part #	Mfg #	Description	Price
003402	815B	Flat Top Bar Strainer for 4" Opening, Brass Body/SS Strainer, 1-7/8"L	
003316	3785A	Standard Bar Sink Strainer, Brass Body/SS Cup, 2-1/8"L	
003364	774	Duplex Bar Strainer, Brass Body/Flat SS Strainer for 2-1/2" Opening	
051560	774A	Tray Plug Bar Strainer, Brass Body/Rubber Stopper for 2-1/2"	
228723	3784	Junior Duo Bar Strainer, Brass Body SS Strainer for 2" Bar Sinks	
228719	4201-5-3	Replacement Basket Strainer for 3784	

#### Easy Mount Strainer

- Body and basket are stainless steel
- Brass nut included
- Triangular mounting flange



Part #	Mfg #	Size	Gauge	Price
228616	3BN	Thumbscrew Strainer w/ Brass Nuts		

---

---

## Sink Strainers

---

---

### Replacement Basket Strainer

- -3 Unfinished



Part #	Mfg #	Description	Price
032365	4201-3-3	Basket for 6, 10 & 16 Strainers	
003317	4201-17-3	Basket for 17 Strainer	
066336	4204-18-3	Basket for 18 Strainer	
016786	4201-L7-3	Basket for L7 Strainer	

**Sink Strainers**

**Sink Strainers**

**Perfect Drain**

Part #	Mfg #	Description	Price
169763	LKDS35	Fits Perfect Drain or InSinkErator®	
169762	LKPD1	Includes Tailpiece	

**InSinkErator® Drain**

Part #	Mfg #	Description	Price
171221	LKDS99	Chrome	

**Disposal Flange**

- Polymer
- 4-1/2" x 4-1/2"
- Includes removable basket strainer & rubber stopper



Part #	Mfg #	Description	Price
240005	LKQD35CH	Charcoal	
240885	LKQD35CN	Chestnut	
238778	LKQD35GR	Greige	
244064	LKQD35GS	Greystone	
249571	LKQD35PA	Parchment	
250834	LKQD35PC	Pecan	
241474	LKQD35PT	Putty	
247457	LKQD35RT	Ricotta	
238940	LKQD35SD	Sand	
237225	LKQD35WH	White	
235611	LKQD35MC	Mocha	

**Sink Strainer**

- Polymer



Part #	Mfg #	Description	Price
241606	LKQS35CH	Charcoal	
240886	LKQS35CN	Chestnut	
237614	LKQS35GS	Greystone	
249569	LKQS35PA	Parchment	
250835	LKQS35PC	Pecan	
241475	LKQS35PT	Putty	
247458	LKQS35RT	Ricotta	
238938	LKQS35SD	Sand	

**Sink Strainers (Continued)**

**Sink Strainer**

Part #	Mfg #	Description	Price
239124	LKQS35MC	Mocha	

**Drain & Strainer**

- For 3-1/2" drain openings
- Conical strainer basket with rubber seal
- 1-1/2" O.D. x 4" tailpiece
- -(LK35) has chrome plated tailpiece
- Stainless steel body with metal stem



LK-35

Part #	Mfg #	Description	Price
006119	LK35	Polished Finish	
051107	LK35B	Polished Finish	
006127	LK99	3-1/2"SS Drain Fitting w/ Conical Strainer, Push&Lock Metal Stem, Rubber Washer, Tailpiece	

**Grid Sink Strainer**

- Fits 3-1/2" opening
- Perforated 3" grid strainer
- 1-1/2" O.D. x 4" tailpiece
- Polished finish



Part #	Mfg #	Description	Price
006111	LK18	Nickel Plated, Tailpiece	
160685	LKVR18	Nickel Plated, Tailpiece	
105236	LKVR18B	Stainless Steel, Tailpiece	

**Sink Basket Strainers**

- Polymer

Part #	Mfg #	Description	Price
130522	LKS35MC	Mocha	

**Drain with Offset Tailpiece**

- Brass tailpiece
- Strainer basket & rubber stopper
- ADA compliant



Part #	Mfg #	Description	Price
064418	LKAD35	Stainless Steel	

**Sink Strainers**

**Stainless Steel Grid Sink Strainer with Lever Arm**

- Chrome plated brass tailpiece
- Perforated grid and lever arm
- 4-1/8" O.D. top stainless steel flange with brass body



Part #	Mfg #	Description	Price
036219	LK24RT	Stainless Steel	

**Lever Operated Sink Strainer**

- Fits 3-1/2" opening
- 4-1/2" O.D. Stainless Steel flange with brass body
- Conical stainless steel strainer basket with flex stem and rubber stopper
- 1-1/2" O.D. x 4" chrome plated brass tailpiece



Part #	Mfg #	Description	Price
115555	LK27	Polished Finish, Tailpiece	

**Adjustable P-Trap**

- For 3-1/2" drain openings
- Cast iron
- 3" Iron pipe outlet with bronze cleanout plug and floor support flange with adjustable nipple
- Chrome plated metal perforated grid strainer



Part #	Mfg #	Description	Price
087324	LK173	Polished Chrome	

**Lavatory Strainers**

**Lavatory Grid Strainer**

- For 1-1/2"—1-3/4" drain fittings
- Perforated drain
- 1-1/4" O.D. x 6" chrome plated brass tailpiece



Part #	Mfg #	Description	Price
095044	LK174LO	Chrome	
006110	LK174	Chrome	



## Sink Strainers

### Sink Drains

#### Adjustable Lutz Sink Strainer

- Post-type
- Adjusts to fit sinks up to 2" thick
- 4-1/2" Diameter complete strainer
- ABS body with stainless steel basket & flange
- Includes 2-1/2" adjustment screw for thick sinks
- Spring loaded ball detent with positive open position



Part #	Mfg #	Finish	Price
243802	2807-SG	Satin Gold	

#### Brass Duo Strainer

- Heavy duty forged brass construction
- 3-1/2" Diameter complete strainer
- Fits most kitchen sink brands
- Brass basket insert strainer included



Part #	Mfg #	Finish	Price
115900	2806-BU	Bronze Umber	
115518	2806-MBK	Matte Black	
115898	2806-ORB	Oil Rubbed Bronze	
115895	2806-PCH	Polished Chrome	
115899	2806-PEW	Pewter	
133425	2806-PN	Polished Nickel	
126927	2806-SC	Satin Chrome	
141691	2806-SDB	Sedona Beige	
115896	2806-SN	Satin Nickel	
150102	2806-VB	Vintage Bronze	
145175	2806-WH	White	

#### Deep Cup Bar Sink Strainer

- 2-7/8" Diameter
- Brass strainer basket lifts out for easy cleaning
- Heavy-duty brass body
- Fits standard 2" drain opening



Part #	Mfg #	Finish	Price
117563	2826-BKN	Black Nickel	
115906	2826-BU	Bronze Umber	
117564	2826-MBK	Matte Black	
115904	2826-ORB	Oil Rubbed Bronze	
115901	2826-PCH	Polished Chrome	
115905	2826-PEW	Pewter	

### Sink Drains (Continued)

#### Deep Cup Bar Sink Strainer

Part #	Mfg #	Finish	Price
117566	2826-PN	Polished Nickel	
117562	2826-SC	Satin Chrome	
115902	2826-SN	Satin Nickel	
157722	2826-VB	Vintage Bronze	

**Sink Strainers**

**Sink Strainers**

**3-in-1 Basket Strainer**

- Fits 3-1/2" drain opening
- Comes with lid to hold water in sink



Part #	Mfg #	Finish	Price
156487	441231	Stainless Steel	

**Decorative Basket Waste Strainer**

- Fits 3-1/2" inside diameter only



Part #	Mfg #	Finish	Price
132817	441091	White	
125840	441090	Anthracite	
125841	441092	Biscuit	
138426	441321	Biscotti	
125679	441094	Cafe Brown	
138425	441322	Truffle	
156803	441481	Cinder	

**Decorative Sink Waste Flange**

- Fits 3-1/2" drain opening
- Fits Insinkerator® disposals



Part #	Mfg #	Finish	Price
147699	441098	Satin Nickel	
132818	441096	White	
125842	441095	Anthracite	
125843	441097	Biscuit	
138428	441323	Biscotti	
125680	441099	Cafe Brown	
138427	441324	Truffle	
156804	441482	Cinder	

**Decorative Basket Strainer**

- Improved material
- Fits 3-1/2" inside diameter only
- Boxed packaging



Part #	Mfg #	Finish	Price
144843	441093	Satin Nickel	

**Capflow**

- Fits 3-1/2" drain
- Brushed finish
- Allows water to flow beneath when installed



Part #	Mfg #	Finish	Price
171572	517666	Brushed Finish	

**3-in-1 Disposal Flange**

- Fits 3-1/2" drain opening
- Comes with lid to hold water in sink



Part #	Mfg #	Finish	Price
150298	441232	Stainless Steel	

## Sink Strainers

### Sink Strainers

#### Bar Sink Strainer for 2" Outlets with 4" Tailpiece

- Solid brass construction
- Duostrainer body with 1-1/2" connection

Part #	Mfg #	Description	Price
075781	K-8820-CP	Polished Chrome	

#### Duostrainer® Sink Strainer

- For sinks with 3-1/2" or 4" outlets
- 1-1/2" x 4" Tailpiece



Part #	Mfg #	Description	Price
054178	K-8801-BN	*Brushed Nickel	
075004	K-8801-BV	*Brushed Bronze	
053681	K-8801-CP	Polished Chrome	
056711	K-8801-G	Brushed Chrome	
053682	K-8801-PB	*Polished Brass	
053897	K-8801-SN	*Polished Nickel	
093259	K-8801-VS	*Stainless	
147015	K-8801-2BZ	Oil Rubbed Bronze	

#### Duostrainer® Manual Sink Strainer Less Tailpiece

- For sinks with 3-1/2" or 4" outlets



Part #	Mfg #	Description	Price
228061	K-8799-CP	Polished Chrome	
064858	K-8799-BN	*Brushed Nickel	
093198	K-8799-BV	*Brushed Bronze	
143413	K-8799-PB	*Polished Brass	
231274	K-8799-SN	*Polished Nickel	
156300	K-8799-VS	*Stainless	
147014	K-8799-2BZ	Oil Rubbed Bronze	

#### Duostrainer® Manual Sink Basket Strainer



Part #	Mfg #	Description	Price
053683	K-8803-0	White	
113547	K-8803-47	Almond	

### Sink Strainers (Continued)

#### Duostrainer® Manual Sink Basket Strainer

Part #	Mfg #	Description	Price
054835	K-8803-7	Black	
054181	K-8803-CP	Polished Chrome	
129123	K-8803-VS	*Stainless	
147017	K-8803-2BZ	Oil Rubbed Bronze	

#### Duostrainer® Manual Body with Tailpiece

- For sinks with 3-1/2" or 4" outlet
- 1-1/2" connection and 4" tailpiece



Part #	Mfg #	Description	Price
053684	K-8804-0	White	
147018	K-8804-2BZ	Oil Rubbed Bronze	
113565	K-8804-47	Almond	
054836	K-8804-7	Black	
054182	K-8804-CP	Polished Chrome	

#### Duostrainer® Sink Basket



Part #	Mfg #	Description	Price
122909	GP41398-BN	*Brushed Nickel	
101598	GP41398-CP	Polished Chrome	

#### Loose Sink Strainer

- 4-7/16" x 1-5/8"
- Cast-brass construction
- For use with the K-12867 Camerton® service sink



Part #	Mfg #	Description	Price
073059	K-13864-CP	Polished Chrome	

\* Vibrant Limited Lifetime Warranty

[www.plumbsupply.com](http://www.plumbsupply.com) • Serving our Customers Since 1946 • [www.waterconcepts.net](http://www.waterconcepts.net)

## Sink Strainers

### Manual Sink Strainer with 4" Tailpiece

- 1-1/2" diameter connection
- Stainless steel and brass construction
- Removable basket with an open/close stopper that seals tightly



Part #	Mfg #	Description	Price
053688	K-8813-CP	Polished Chrome	

### Service Sink Strainer with Removable Grid Stainer

- Brass construction



Part #	Mfg #	Conn.	Finish	Price
185548	K-9142-CP	2" NPT	Chrome	
060840	K-9146-CP	3" NPT	Chrome	
103427	K-9147-CP	2" Caulk	Chrome	

### Disposal Flanges

- Fits standard garbage disposal units (4-1/2" diameter., 1-5/8" depth)
- Includes disposal flange and stopper



Part #	Mfg #	Description	Price
085107	K-11352-BN	*Brushed Nickel	
256847	K-11352-BL	Matte Black	
117831	K-11352-BS	Brushed Stainless	
083621	K-11352-BV	*Brushed Bronze	
091715	K-11352-CP	Polished Chrome	
103207	K-11352-PB	*Polished Brass	
182760	K-11352-SN	*Polished Nickel	
147004	K-11352-2BZ	Oil Rubbed Bronze	

\* Vibrant Limited Lifetime Warranty

[www.waterconcepts.net](http://www.waterconcepts.net) • Serving our Customers Since 1946 • [www.plumbsupply.com](http://www.plumbsupply.com)

## Sink Strainers

### Kitchen Sink Strainers

#### Deluxe Plastic Basket Strainer

- Xenoy plastic molded
- 3-1/2" Strainer with spring loaded center post
- EZ Install from above the sink



Part #	Mfg #	Finish	Price
086070	BWSTU/BL	Black	
077064	BWSTU/BT	Biscuit	
136409	BWSTU/ORB	Oil Rubbed Bronze	
086069	BWSTU/PW	Polar White	
238900	BWSTU/MB	Matte Black	
135611	BWSTUG/MLB	Matte Lava Black	
237562	BWSTUG/LB	Lunar Black	

#### Deluxe Basket Strainer with Metal Finish

- Stainless steel and ABS strainer
- 3-1/2" Strainer with spring loaded center post
- EZ Install from above the sink



Part #	Mfg #	Finish	Price
083059	MT300/BRN	Brushed Nickel	
065288	MT300/ORB	Oil Rubbed Bronze	
083058	MT300/BRS	Brushed Stainless	
083061	MT300/VB	Venetian Bronze™	
090813	MT300/PVDBB	PVD Brushed Bronze™	
240305	MT300/MB	Matte Black	
137710	MPPMT300BSKBR S	Brushed Stainless	

\*PVD Finish

[www.plumbsupply.com](http://www.plumbsupply.com) • Serving our Customers Since 1946 • [www.waterconcepts.net](http://www.waterconcepts.net)

---



---

**Sink Strainers**

---



---

**Sink Strainers****Artesso™ Kitchen Sink Flange & Strainer**

- Polypropylene drain housing
- Brass strainer and basket
- Top-mount flange installation for 3.5" sink openings
- 4-1/2" diameter brass flange
- 1-1/2" x 11-1/2" NPSM threads



Part #	Mfg #	Description	Price
222284	69050-BZ	Brushed Bronze*	
254486	69050-GL	Luxe Gold	
222283	69050-PC	Chrome	
222285	69050-PN	Polished Nickel*	
222286	69050-SS	Stainless*	

**Artesso™ Bar Sink Flange & Strainer**

- Brass strainer and basket
- Drop-in basket with lift handle
- 2-7/8" Diameter brass flange
- 1-1/2" x 11-1/2" NPSM threads



Part #	Mfg #	Description	Price
222287	69051-PC	Chrome	
222288	69051-SS	Stainless*	

**Solna® Kitchen Sink Flange & Strainer**

- Polypropylene drain housing
- Brass strainer and basket
- Top-mount flange installation for 3" sink openings
- 4-1/2" diameter brass flange



Part #	Mfg #	Finish	Price
091734	72010	Chrome	
155139	72010-AR	Arctic Stainless	
160782	72010-CZ	Champagne Bronze™	
165748	72010-PN	Polished Nickel*	
078096	72010-SS	Stainless*	

\* Brilliance® Anti-Tarnish Lifetime Finishes





## Sink Strainers

### Sink Strainers

#### Strainer



Part #	Mfg #	Description	Price
004800	91-292	Strainer, Chrome	

\*Physical Vapor Deposition (PVD) Limited Lifetime Finish

[www.plumbsupply.com](http://www.plumbsupply.com) • Serving our Customers Since 1946 • [www.waterconcepts.net](http://www.waterconcepts.net)

## Sink Strainers

### Strainers

#### Celcon Kitchen Strainer

- Two-piece strainer with Celcon trim and a plastic base
- Resistant to chipping, scratching and peeling



Part #	Mfg #	Description	Price
101239	JBC101	White, Clamshell	
101358	JBC102	Black, Clamshell	
101240	JBC103	Biscuit, Clamshell	

#### Matte Celcon Kitchen Strainer

- Two-piece strainer with Celcon trim and a plastic base
- Resistant to chipping, scratching and peeling
- Fits 3-1/2" openings



Part #	Mfg #	Description	Price
101241	JBC112	Matte Oil Rubbed Bronze, Clamshell	

---

---

**Sink Strainers**

---

---

**Sink Strainers**  
**EZ ON Basket Strainer**



Part #	Mfg #	Description	Price
137003	21901	Satin SS Finish	

## Sink Wastes

### Brass Center Outlet Wastes

#### Hi-Line Center Outlet Waste

- 16" from center to center
- Easy installation
- Cleanout included
- -1 Polished chrome



Part #	Mfg #	Size	Gauge	Price
003287	123A-1	1-1/2" x 16"	20ga	
228713	2123A-1	1-1/2" x 16"	Budget	

### Brass Waste Arms

#### Hi-Line Waste Arm

- Brass construction with a chrome plated finish
- Designed for use with a center outlet kitchen sink drain
- Hi-Line direct connection
- Maximum working pressure of 10 psi
- -1 Polished chrome



Part #	Mfg #	Size	Gauge	For	Price
003289	138C-1	1-1/2" x 15"	20ga	16" EO	
228640	2138C-1	1-1/2" x 15"	Budget	16" EO	

#### Slip-Joint Waste Arm

- -1 Polished chrome



Part #	Mfg #	Size	Gauge	For	Price
003288	137C-1	1-1/2" x 15"	20ga	16" EO	
228717	2137C-1	1-1/2" x 15"	Budget	16" CO	
019577	137D-1	1-1/2" x 20"	20ga	21" EO	

### Brass End Outlet Wastes

#### Slip-Joint End Outlet Waste

- Includes 3 nuts and 3 washers
- -1 Polished chrome



Part #	Mfg #	Size	Gauge	Price
003282	108A-1	1-1/2" x 16"	20ga	

### Slip-Joint End Outlet Waste

- Includes brass nuts, baffle tee and 16" or 21" lengths
- -1 Polished chrome



Part #	Mfg #	Size	Gauge	Price
187184	78A-17BN-1	1-1/2" x 16"	17ga	

### Slip-Joint End Outlet Waste

- Includes 2 tees, 5 zinc nuts, and 5 rubber washers
- -1 Polished chrome



Part #	Mfg #	Size	Gauge	Price
193328	109-20-1	1-1/2" x 24"	20ga	

### Hi-Line End Outlet Waste

- -1 Polished chrome



Part #	Mfg #	Size	Gauge	Price
003299	2121A-1	1-1/2" x 16"	Budget	
003286	121A-1	1-1/2" x 16"	20ga	
025852	131A-1	1-1/2" x 16"	17ga	

### Plastic Bath Wastes & Baffle Tees

#### Slip-Joint Plastic End Outlet Waste

- Meets ASTM F 409
- IAPMO listed
- Made of polypropylene plastic
- Can be used with Hi-Line or slip joint connection



Part #	Mfg #	Size	Slip Joint	Price
003251	P9108A	1-1/2" x 16"	PVC	

#### Slip-Joint Plastic End Outlet Waste with Baffle Tee

- Meets ASTM F 409
- IAPMO listed
- Made of polypropylene plastic
- Can be used with Hi-Line or slip joint connection



Part #	Mfg #	Size	Slip Joint	Price
228727	P9108B	1-1/2" x 21" Polypropylene		

## Sink Wastes

### Plastic Hi-Line/Slip-Joint Combination End Outlet Waste with Telescopic Waste Arm



Part #	Mfg #	Size	Slip Joint	Price
036821	P9108AT	1-1/2" x 11-17"	PVC	
072524	P9121AT	1-1/2" x 11-17"	PVC	
086625	P9121T	1-1/2" x 21"	PVC	

### Plastic Hi-Line Direct Connect End Outlet Waste with Baffle Tee



Part #	Mfg #	Size	Description	Price
046759	P9121	1-1/2" x 16"	PVC	

### Plastic Hi-Line/Slip Joint Combination End Outlet Waste with Baffle Tee



Part #	Mfg #	Size	Description	Price
003252	P9121A	1-1/2" x 16"	PVC	

### Hi-Line Slip-Joint Center Outlet Waste Joint Combination with Baffle Tee

- Includes 2 waste arms, 2 Hi-Line nipples, 4 slip nuts, and 4 washers
- White
- Polypropylene plastic



Part #	Mfg #	Size	Description	Price
003253	P9123A	1-1/2" x 16"		
228729	P9123B	1-1/2" x 21"		

### Hi-Line/Slip Joint Combination w/ Telescopic Waste Arm & Branch

- Meets ASTM F 409
- IAPMO listed
- Can be used with Hi-Line or slip joint connection



Part #	Mfg #	Size	Description	Price
251994	P9121AT-8	1-1/2" x 11"-17"	PVC	
237799	P9121AT-12	1-1/2" x 11"-17"	PVC	

### Baffle Tee



Part #	Mfg #	Size	Description	Price
124332	P9186	1-1/2"	PVC Ctr Outlet SJ	

### Plastic Waste Arms

#### Slip-Joint Waste Arm

- Plastic Tubular Waste Arms with Joint Connection are designed for use in tubular drain applications
- Includes 1 slip joint nut and 1 washer



Part #	Mfg #	Size	Description	Price
003254	P9137C	1-1/2" x 15"	Polypropylene	

#### Hi-Line Waste Arm

- Plastic Tubular Waste Arms with Joint Connection are designed for use in tubular drain applications
- Includes 1 slip joint nut and 1 washer



Part #	Mfg #	Size	Description	Price
146060	P9138C	1-1/2" x 15"	Polypropylene	

**Sink Wastes**

**Plastic Trap Offsets**



Part #	Mfg #	Size	Description	Price
052365	P9046A	1-1/2"	PVC	

**Brass Wall Tubes**

- -1 Polished chrome



Part #	Mfg #	Size	Gauge	Price
133620	402B-17-1	1-1/2" x 15"	17ga	





## Sink Wastes

### Sinkwaste

- Heavy pattern cast brass
- Brass plug
- Available chrome-plated or brass
- Brass or nickel pull ring

#### C-212 1" Sinkwaste

- Includes tailpiece, washers and nuts



Part #	Mfg #	Description	Weight	Price
008254	C-212BR	Brass Finish	20 lbs	

## Tailpieces

### Brass Flanged Strainer Tailpieces

#### Flanged Strainer Tailpiece

- D - Double flange
- -1 Polished chrome



Part #	Mfg #	Size	Gauge	Price
003389	7991	1-1/2" x 4"	Budget	
187186	799173	1-1/2" x 4"	17ga	
003390	8001	1-1/2" x 6"	Budget	
003392	801-1	1-1/2" x 8"	Budget	
003394	803-1	1-1/2" x 12"	Budget	
251990	801-17-3	1-1/2" x 8"	17 ga	
003396	803BD1	1-1/2" x 12"	Budget	
003397	803ED1	1-1/2" x 16"	Budget	
003391	800171	1-1/2" x 6"	17ga	
003398	803171	1-1/2" x 12"	17ga	

### Brass Extension Tube



Part #	Mfg #	Size	Gauge	Price
251992	820C-1	1-1/4" x 8"	17 ga	

### Brass Branch Tailpieces

#### 1/2" Nom Swt Branch Tailpiece

- -1 Polished chrome



Part #	Mfg #	Size	Price
003399	812A1	1-1/2" x 6"	

### Hose & Clamp Branch Tailpiece

- -1 Polished chrome
- Budget gauge



Part #	Mfg #	Size	Price
003401	814A1	1-1/2" x 6"	
166058	814B1	1-1/2" x 8"	
058052	817TB1	1-1/4" x 8"	20ga

### Hose & Clamp Branch Tailpiece w/ Slip Joint Top

- 20 Gauge
- Brass nut (nit down)



Part #	Mfg #	Size	Gauge	Price
180252	817ETBN1	1-1/4" x 8"		

### Trap Primer Tailpieces



Part #	Mfg #	Size	Gauge	Price
135175	8311	1-1/4"	17ga	

### Plastic Branch Tailpieces

#### Slip Joint Top

- Polypropylene construction
- Compatible with soft plastic pipe
- Connects a dishwasher to a plumbing drainage system
- Slip joint nut and washer for connection



PP9817

Part #	Mfg #	Top Size	Branch Size	Price
003274	PP9816	1-1/2" x 8"	1/2"	
167657	PP9817	1-1/2" x 8"	3/4"	

## Tailpieces

### Flanged Top

- Polypropylene construction
- Compatible with soft plastic pipe
- Connects a dishwasher to a plumbing drainage system
- Slip joint nut and washer for connection

Part #	Mfg #	Top Size	Branch Size	Price
088799	PP9818	1-1/2" x 8"	1/2" Hi-Line	

### Plastic Strainer Tailpieces



Part #	Mfg #	Size	Description	Price
228606	P9799	1-1/2" x 4"	PVC	
003271	P9800	1-1/2" x 6"	PVC	
228607	P9801	1-1/2" x 8"	PVC	
003272	P9803	1-1/2" x 12"	PVC	
003273	P9803E	1-1/2" x 16"	PVC Dbl Flg	

## Tailpieces

### Tubular Brass

#### Long Branch™ Dishwasher Tailpiece

- Downward inlet eliminates splash-up
- No connector kits needed
- Long 1/2" nominal copper branch provides work space for easy sweat or hose clamp connection
- Quality 22-gauge copper and brass construction



**Direct Connection - Unfinished - Solid Brass Nut**

Part #	Mfg #	Size	Price
123798	200-084	1-1/2" x 8"	

#### Slip Joint - Unfinished - Solid Brass Nut

Part #	Mfg #	Size	Price
123800	206-084	1-1/2" x 8"	

#### Slip Joint Extension Tube

- 22 Gauge brass
- Die cast chrome nut with poly washer



Part #	Mfg #	Connection	Price
245471	225-128	1-1/4" x 12"	

#### TrapEase™ Trap Primer Tailpiece—Fine Thread

- Gravity feed, no mechanical parts
- Replenishes water in floor drain traps to prevent the escape of sewer gases
- 1/2" nominal branch connection
- Certified by the American Society of Sanitary Engineering to ASSE 1044
- Eco-friendly means of trap priming
- UPC/IAPMO listed



Part #	Mfg #	Size	Finish	Price
152234	213-092	1-1/4" x 6"	Chrome	

### Tubular Specialties

#### End Outlet Waste

- Telescopic 12" to 16" with baffle tee
- Universal slip joint with two direct connect adapters
- Wye "Y" branch connection - 1/2" or 3/4"



Part #	Mfg #	Connection	Color	Price
162117	253-550	Direct	White	

## Washers, Nuts & Stoppers

### Sink Washers

#### Sink Strainer Coupling Washer



Part #	Mfg #	Description	Price
006248	852	1-1/2"	
006249	853	1-1/2" Flanged	

#### Slip Joint Washer



Part #	Mfg #	Description	Price
118268	721A	1-1/2" Molded TPR	
006232	762	1-1/4" Polyethylene	
006233	763	1-1/2" Polyethylene	

#### Gray Cut Slip Joint Washer

• Box of 100



Part #	Mfg #	Description	Price
006227	711	1-1/4" M	
006228	712	1-1/2" M S/C	
006229	713	2" M S/C	
006230	751	1-1/4"H	
005961	753	1-1/2" H	
006231	760	1-1/2" x 1-1/4"	

#### Waste and Overflow Washer

• Box of 25



Part #	Mfg #	Description	Price
006225	675	2-1/8" x 3-3/16", Thickness Tapered from 9/16" to 3/16", Beveled Sponge	
006226	677	1-11/16" x 2-3/4" x 3/32", Flat Rubber	

**Washers, Nuts & Stoppers**

**Plastic Nuts & Washers**

**Slip-Joint Nut**



P9001

Part #	Mfg #	Size	Description	Price
031398	P9001A	1-1/4"	PVC	
003249	P9001	1-1/2"	PVC	

**Slip-Joint Washer**



Part #	Mfg #	Size	Description	Price
003412	9002	1-1/2" x 1-1/2"	Poly	
176601	9002A	1-1/4" x 1-1/4"	Poly	
003413	9003	1-1/2" x 1-1/4"	Poly	

**Sink Strainer Replacement Washer**



Part #	Mfg #	Description	Price
228726	4202-2-3	Washer for 815B	

**Slip Joint True Blue Washer**



Part #	Mfg #	Size	Gauge	Price
159045	7207	1-1/2"		

**Flanged Washer**



Part #	Mfg #	Size	Gauge	Price
077148	7195	1-1/2"	Poly	

**Toilet & Sink Repair Parts**

**Slip-Joint Washer**

Part #	Mfg #	Description	Qty	Price
025958	7202	1-1/4" Rubber SJ	100	

**Toilet & Sink Repair Parts (Continued)**

**Slip-Joint Washer**

Part #	Mfg #	Description	Qty	Price
020208	7203	1-1/2" Rubber SJ	100	

**Slip Nuts - Die Cast**



Part #	Mfg #	Size	Price
003208	8030	1-1/4"	
003209	8031	1-1/2" x 1-1/4"	
003211	8033	1-1/2"	
003212	8034	2"	

**Ground Joint Part Waste Connector**



Part #	Mfg #	Size	Gauge	Price
251951	1005-020	1-1/2"		
251952	1004	1-1/4" MIP x OD		
251958	1012	1-1/4" FIP x OD		
251956	1013	1-1/2" FIP x OD		
251954	1014	1-1/4" OD x 1-1/2" FIP		



**Washers, Nuts & Stoppers**

**Nuts & Washers**

**Die Cast Slip Joint Nut**



Part #	Mfg #	Size	Finish	Price
008041	1330C	1-1/4"	Chrome	
008043	1333C	1-1/2"	Chrome	

**Brass Slip Joint Nut**

Part #	Mfg #	Size	Finish	Price
017186	1336-C	1-1/4"	Chrome	
008045	1338-C	1-1/2"	Chrome	

**Slip Joint Washer**

- Square cut washers



Part #	Mfg #	Size	Price
008084	2209	1-1/4"	
008083	2208	1-1/2" x 1-1/4"	
008082	2204	1-1/2"	

**Poly Washer for Tailpieces**



Beveled

Part #	Mfg #	Size	Description	Price
113502	2219	1-1/4"	Beveled	
096353	2218	1-1/2" x 1-1/4"	Beveled	
096354	2214	1-1/2"	Beveled	

**Tailpiece Washer**

- Cloth inserted rubber



Part #	Mfg #	Size	Price
096352	2211	1-1/2" x 1-1/4"	

**Brass Waste Connector-Tubular x Male Pipe Thread**

- Femal copper sweat under MPT
- Chrome die cast slip nut

Part #	Mfg #	Description	Price
008069	1894	1-1/2" x 1-1/2"	

## Washers, Nuts & Stoppers

### Washers

#### Drip-Free™ Washer

- Beveled design provides a better seal when used with standard slip nut
- Perfect washer for basket strainer installations
- Combo washers:
  - Rubber is thermoplastic
  - Reducing slip joint washer



290-20313

#### Slip Joint Washers

Part #	Mfg #	Size	Material	Color	Price
035392	290-20300	1-1/4"	Soft PVC	White	
035397	290-20310	1-1/2"	Soft PVC	Black	

#### Combo Washers



Part #	Mfg #	Size	Material	Price
160363	290-20313	1-1/2" x 1-1/4"	Rubber	

#### Tailpiece Washer



Part #	Mfg #	Size	Material	Price
035395	290-20380	1-1/2"	Urethane	

#### Tailpiece and Slip Washer Job Pack

- Cloth-inserted C.I. rubber
- Slip washers are square cut



Part #	Mfg #	Size	Type	Material	Price
184091	990-20385	1-1/2"	Tailpiece CI	Rubber	
184092	995-20320	1-1/4"	Slip	Rubber	
184093	995-20330	1-1/2"	Slip	Rubber	
184094	995-20335	1-1/2"x1-1/4"	Slip	Rubber	
184096	995-20340	2"	Slip	Rubber	

#### Beveled Slip Washer

- Polyethylene



996-6

Part #	Mfg #	Size	Price
184097	996-6	1-1/2" x 1-1/2"	
184099	996-8	1-1/2" x 1-1/4"	

### Sammys™ Suspended Anchoring Systems

- Anchors for most common 3/8" all-thread rods
- Installs quickly and easily
- Vertical, horizontal or swivel applications
- Original American-made Sammy® super Screws
- UL & FM listed
- 3/8" Rod length



590-4411

#### Wood Applications

Part #	Mfg #	Type	Length	Price
183514	590-4411	GST20 Vertical	2"	
183518	590-4421	SWG20 Horizontal	2"	

#### Concrete Applications

Part #	Mfg #	Type	Length	Price
183516	590-4412	CST20 Vertical	1-1/4"	

#### Steel Beam Applications

Part #	Mfg #	Type	Length	Price
183517	590-4413	DST20 Vertical	1-1/4"	
195188	590-4423	SWDR516 Horizontal	1-1/4"	

#### Nut Driver for Anchors

- Vertical or horizontal anchors

Part #	Mfg #	Type	Color	Price
183519	590-44ND1	#14 Vertical	Black	
183520	590-44ND2	#14SW Horizontal	Red	



## Urinals

### Urinals

#### Clinton 1.0 Urinal

- Dimensions: 21-3/4"H x 14-1/4"W x 14-3/8"D
- Minimum wall space
- Dual hangers
- 2" SPS Female outlet connection supplied
- Siphon-jet
- Flush valve sold separately
- Limited lifetime warranty



Part #	Mfg #	Description	Color	Price
004652	27-750	3/4" Top Spud	White	

#### Hamilton 1.0 Urinal

- Dimensions: 26-1/2"H x 18"W x 14-1/2"D
- Half stall size
- Integral flush spreader
- Extended shields
- Dual hangers
- 2" SPS Female outlet connection supplied
- Siphon-jet
- Flush valve sold separately
- Limited lifetime warranty



Part #	Mfg #	Description	Color	Price
004653	27-770	3/4" Top Spud	White	

#### Layfayette™ 0.5/1.0 gpf Washout Top Spud Urinal

- This washout wall hung urinal comes with a top spud, integral strainer and a one-piece hanger.
- 3/4" Inlet
- 1 1/2" Outlet
- One-Piece Hanger
- Strainer included
- ADA compliant
- Height - 18 1/2"
- Width - 13 3/8"
- Depth - 14"
- Weight - 30 lbs



Part #	Mfg #	Description	Rough-In	Color	Price
260097	HE-27-740	3/4" Top Spud	White		



## Urinals

### Lafayette™ 1.0 gpf Washout Top Spud Urinal

- This washout wall hung urinal comes with a top spud, integral strainer and a one-piece hanger.
- 3/4" Inlet
- 1 1/2" Outlet
- One-Piece Hanger
- Strainer not included
- Height - 18 1/2"
- Width - 13 3/8"
- Depth - 13 1/4"
- Weight - 30 lbs



Part #	Mfg #	Description	Rough-In	Color	Price
004651	27-740	3/4" Top Spud	White		

### Lafayette™ Contemporary Pint Washout 0.125-1.0 gpf Urinal

- Dimensions: 21-5/8"H x 13-3/8"W x 14-3/16"D
- Elongated rim (14" for finished wall)
- Dual wall hangers and strainer included
- 3/4" Inlet top spud for exposed flushometer
- Outlet connection threaded 2" inside (NPTF)
- High efficiency when used with appropriate flush valve



Part #	Mfg #	Description	Color	Price
244792	HE-27-900	3/4" Top Spud	White	

### Monitor™ Washout 1.0 Urinal

- Dimensions: 26-3/4"H x 18-1/2"W x 12-1/2"D
- Wall hung
- Commercial size
- Integral flush spreader
- Extended shields
- Dual hangers
- 2" SPS Female outlet connection supplied
- Flush valve sold separately
- Limited lifetime warranty



Part #	Mfg #	Description	Color	Price
004654	27-780	3/4" Top Spud	White	



## Urinals

### Monitor™ Pint Washout 0.125-1.0gpf Urinal

- Dimensions: 26-3/16"H x 18-7/8"W x 14-3/16"D
- Wall hung
- Washout flushing system
- Dual wall hangers included
- Elongated rim (14" for finished wall)
- 2" S.P.S female outlet connection
- Outlet connection threaded 2" inside (NPTF)
- 3/4" Inlet top spud for exposed flushometer



Part #	Mfg #	Description	Color	Price
243626	HE27-800	3/4" Top Spud	White	

### North Point™ 0.5gpf Urinal

- Dimensions: 21-7/8"H x 14-1/4"W x 13-5/8"D
- Wall hung, space saving design
- Washout flush action
- 3/4" Inlet top spud for exposed flushometer
- Outlet connection threaded 2" inside
- Dual wall hangers



Part #	Mfg #	Description	Color	Price
156368	HE-27-720	3/4" Top spud, HET	White	

## Urinals

### Vitreous China Urinals

#### Bardon™ High Efficiency Urinal

- Washout urinal
- 14" Extended rim
- 17" High rim from finished floor for ADA compliance
- Flowrate: .125 gpf to 1.0 gpf
- (-SS) Snap-in stainless steel strainer



Part #	Mfg #	Description	Color	Price
171241	K-4991-ER-0	ADA Urinal, 3/4" Rear Spud	White	
171242	K-4991-ET-0	ADA Urinal, 3/4" Top Spud	White	
229071	K-4991-ET-47	ADA Urinal, 3/4" Top Spud	Almond	
223381	K-4991-ET-7	ADA Urinal, 3/4" Top Spud	Black	
183294	K-4991-ET-96	ADA Urinal, 3/4" Top Spud	Biscuit	
253029	K-4991-ETSS-0	ADA Urinal, 3/4" Top Spud	White	

#### Bardon™ Touchless™ Washdown Urinal

- 1/2" Rear spud
- Includes tank cover and tank cover locks
- Includes stainless steel, low-profile strainer for faster drain flow
- ADA-compliant when rim is mounted no higher than 17" from finished floor
- Battery-operated electronic flush valve powered by four AA alkaline batteries (included)
- Flowrate: 0.5 gpf



Part #	Mfg #	Description	Color	Price
230564	2590-0	ADA Urinal, 1/2" Rear Spud	White	

#### Branham™ Washout Floor-Mount Urinal

- Washout urinal
- 3/4" Top spud
- Flowrate: 1.0 gpf



Part #	Mfg #	Description	Rough-In	Color	Price
063730	K-4920-T-0	ADA Urinal, 3/4" Top Spud	White		
108602	K-4920-T-47	ADA Urinal, 3/4" Top Spud	Almond		
065589	K-4920-T-7	ADA Urinal, 3/4" Top Spud	Black		
076975	K-4920-T-96	ADA Urinal, 3/4" Top Spud	Biscuit		

\*Vibrant Limited Lifetime Finish

[www.waterconcepts.net](http://www.waterconcepts.net) • Serving our Customers Since 1946 • [www.plumbsupply.com](http://www.plumbsupply.com)



## Urinals

### Darfield™ Urinal with 3/4" Top Spud

- Washout stall
- Includes
  - Strainer
  - Inlet and outlet 3/4" spuds
  - Bottom outlet for exposed p-trap
  - Hanger
  - 1-1/2" Tailpiece
- Flush valve sold separately
- 17" High mount from finished floor for ADA compliance
- Flow rate: 0.5 gpf to 1.0 gpf



Part #	Mfg #	Description	Color	Price
054421	K-5024-T-0	ADA Urinal, 3/4" Top Spud	White	
155471	K-5024-T-7	ADA Urinal, 3/4" Top Spud	Black	

### Dexter™ Siphon Jet Urinal

- Siphon jet
- 14-1/2" Extended rim
- Includes:
  - Inlet and outlet 3/4" spuds
  - Hangers
  - Anti-backsplash wall
- 17" High mount from finished floor for ADA compliance
- Flow rate: 1.0 gpf



Part #	Mfg #	Description	Color	Price
078997	K-5016-ER-0	ADA Elongated Urinal, 3/4" Rear Spud	White	
167603	K-5016-ER-47	ADA Elongated Urinal, 3/4" Rear Spud	Almond	
053156	K-5016-ET-0	ADA Elongated Urinal, 3/4" Top Spud	White	
060306	K-5016-ET-47	ADA Elongated Urinal, 3/4" Top Spud	Almond	
080552	K-5016-ET-7	ADA Elongated Urinal, 3/4" Top Spud	Black	
060089	K-5016-ET-96	ADA Elongated Urinal, 3/4" Top Spud	Biscuit	
254712	K-5016-ETSS-0	ADA Elongated Urinal, 3/4" Top Spud	White	

### Dexter™ Washout Urinal with Top Spud

- Vitreous china
- 14-3/4" Extended rim
- Includes:
  - 3/4" Inlet spud and 2" outlet spud
  - Hangers
  - Anti-backsplash wall
- 17" High mount from finished floor for ADA compliance
- Flow rate: 1-pint or 0.125 gpf
- WaterSense® compliant when used with WaterSense® flushometer



Part #	Mfg #	Description	Color	Price
238952	K-5452-ET-0	ADA Urinal, 3/4" Top Spud	White	

\*Vibrant Limited Lifetime Finish

[www.plumbsupply.com](http://www.plumbsupply.com) • Serving our Customers Since 1946 • [www.waterconcepts.net](http://www.waterconcepts.net)

## Urinals

### Touchless 0.5 gpf Hybrid Urinal Flushometer

- Brass construction
- Fixture-mount design
- Wave technology
- Slow closing piston technology
- Powered by 30-year hybrid energy cell
- For use with wash-down, washout, and siphon jet installations with 3/4" top spud coupling connection



Part #	Mfg #	Description	Rough-In	Color	Price
232339	K-7526-CP	ADA Touchless Urinal		Polished Chrome	

### Freshman™ Space-Saving Wall-Mount 1.0 gpf Urinal

- Includes:
  - Inlet and outlet 3/4" spuds
  - Hangers
- 17" High mount from finished floor for ADA compliance
- Flow rate: 1.0 gpf



Part #	Mfg #	Description	Color	Price
053155	K-4989-T-0	Urinal, 3/4" Top Spud	White	
227860	K-4989-T-47	Urinal, 3/4" Top Spud	Almond	
098939	K-4989-T-96	Urinal, 3/4" Top Spud	Biscuit	
155688	K-4989-R-0	Urinal, 3/4" Rear Spud	White	
087957	K-4989-R-96	Urinal, 3/4" Rear Spud	Biscuit	

### Stanwell™ Lite Elongated 1.0 Urinal

- Blow-out urinal
- Includes:
  - Inlet and outlet spuds
  - Hangers
  - 1-1/4" Top spud
- 17" High mount from finished floor for ADA compliance
- Flow rate: 1.0 gpf



Part #	Mfg #	Description	Color	Price
251756	K-25048-ER-0	ADA Urinal, 1-1/4" Raer Spud	White	
251757	K-25048-ET-0	ADA Urinal, 1-1/4" Top Spud	White	
115512	K-25048-ET-96	ADA Urinal, 1-1/4" Top Spud	Biscuit	

\*Vibrant Limited Lifetime Finish

[www.waterconcepts.net](http://www.waterconcepts.net) • Serving our Customers Since 1946 • [www.plumbsupply.com](http://www.plumbsupply.com)

## Urinals

### Steward® Hybrid High-Efficiency Urinal

- Washout
- 3/4" Top spud
- Ultra low consumption is WaterSense® certified product: .125 gpf
- 15-5/8" Extended rim allows for ADA installation
- Funnel design eliminates splash back
- Flow rate: .125 gpf



Part #	Mfg #	Description	Rough-In	Color	Price
167721	K-5244-ET-0	ADA Urinal, 3/4" Top Spud	White		
168593	K-5244-ET-96	ADA Urinal, 3/4" Top Spud	Biscuit		
183577	k-5244-ER-0	ADA Urinal, 3/4" Top Spud	White		

### Steward® Waterless Urinal

- 11" wide x 23-3/4" high x 14-3/4" deep
- Vitreous china
- 14-3/4" Extended rim
- Cartridge-free integral trapway
- Touch-free design
- Includes:
  - Removable strainer
  - Universal mounting bracket
  - 2" Rear outlet spud
  - Hangers
  - Sample bottles of waterless urinal sealing liquid and cleaner



Part #	Mfg #	Description	Rough-In	Color	Price
098279	K-4917-0	ADA Urinal, 2" Rear Spud	White		

## Strainers

### Stainless Steel Beehive Grate Urinal Strainer

- For vitreous china urinal stall
- For caulking 2" iron pipe or soldering 2" lead pipe
- Solid brass construction



Part #	Mfg #	Description	Price
065590	K-9183-NA	NA	

\*Vibrant Limited Lifetime Finish

[www.plumbsupply.com](http://www.plumbsupply.com) • Serving our Customers Since 1946 • [www.waterconcepts.net](http://www.waterconcepts.net)

**Urinals**

**China Grate Urinal Strainer**

- For vitreous china urinal stall
- For caulking 2" iron pipe or 2" lead pipe
- Brass construction



		Description	
070972	K-9172-NA	NA	

\*Vibrant Limited Lifetime Finish

[www.waterconcepts.net](http://www.waterconcepts.net) • Serving our Customers Since 1946 • [www.plumbsupply.com](http://www.plumbsupply.com)

**Urinals**

**Wall Hung Urinals**

**WES Waterfree Wall-Hung Urinals**

- Touch-free operation
- Uses no water
- Patented, sealed locking cartridge
- Smooth, non-porous surfaces
- Reduced water and sewer costs
- Water supply piping not required
- Odor-free
- Vandal resistant
- Requires minimal maintenance
- 1-Piece Wall hanger bracket with anchors included



Part #	Mfg #	Model	Description	Price
080390	1001000	WES-1000	19-1/4" x 14-3/8" x 26-1/4"	

**Vitreous China Washdown Urinal**

- Designed to maximize and complement Sloan flushometers
- Thorough washdown flushing action
- Durable, hygienic vitreous china construction
- Vandal resistant stainless steel strainer included
- IAPMO certified to meet or exceed ASME A112.19.2 standards
- Meets ADA guidelines and ANSI A117.1 requirements when installed accordingly



Part #	Mfg #	Model	Description	GPF	Spud	Price
145947	SU-1006-A	SU-1006-A	ADA Urinal	1.0GPF	3/4"	

**SU-1009 Standard Washdown Urinal**

- Vitreous china
- 2" NPT outlet flange
- 3/4" I.P.S. top spud inlet
- Integral flushing rim
- All mounting hardware included



Part #	Mfg #	Description	Flow Rate (GPF)	Color
168199	SU-1009-A	ADA Urinal	0.125-0.5	White

**Urinals**

**Urinal Parts & Accessories**

**WES Waterfree Urinal Cartridge Kit**

- Cartridge is made from recyclable ABS
- Includes:
  - 100% Biodegradable sealant liquid
  - Cartridge installation/removal tool
  - Protective glove
  - Disposal bag



Part #	Mfg #	Model	Description	Price
080533	WES150	WES-150	6,000 to 7,000 Use Urinal Cartridge Kit	

**Scented Urinal Screen**



Part #	Mfg #	Model	Description	GPF	Spud	Price
114106	SJS-9000-9		Fresh Outdoor Scent			



## Urinals

### Urinals

#### Adam™ Urinal

- Washdown urinal
- 0.5 Gpf / 1.9 Lpf
- 13-5/8" x 19-1/2" x 13-1/4"
- Exposed trap
- Includes 3/4" top spud and hanger
- Inlet : 3/4"
- Outlet : 1-1/2"



Part #	Mfg #	Description	Color	Price
216560	401HE-WH	Urinal, 3/4" Top Spud	White	
198610	401HE-BI	Urinal, 3/4" Top Spud	Biscuit	

#### Cascade™ Urinal

- Half-stall, wall-mount, wash-down urinal
- 0.5 Gpf / 1.9 Lpf (also works with 1.0 Gpf flushometers)
- Integral trapway
- Complies with ADA requirements for accessibility
- WaterSense compliant
- Inlet: 3/4"
- Outlet: 2"



Part #	Mfg #	Description	Color	Price
197500	410HE-WH	ADA Urinal, 3/4" Top Spud	White	

#### Suburban™ Urinal

- Siphon jet urinal
- 0.5 Gpf / 1.9 Lpf
- High Efficiency Urinal (HEU)
- Integral trapway
- ADA compliant
- Concealed hanger and bolts
- Includes 3/4" top spud and hangers
- Inlet : 3/4"
- Outlet : 2"



Part #	Mfg #	Description	Color	Price
192334	475HE-WH	ADA Urinal, 3/4" Top Spud	White	

## Backflow Valves

### Backflow Preventers

#### Repair Kit for Series 007

##### 1-1/4" Repair Kit for 007

Part #	Mfg #	Model	Description	Price
132315	0887721	RK007M2RT	Complete Rubber	
051397	0062616	007M2-QT	1-1/2"	

#### Repair Kit for Series 009

Part #	Mfg #	Model	Part	Price
023137	0886020	RK009LUBE	Mechanical Lubricant	

#### 1/4" to 1/2" Repair Kit for Series 009

Part #	Mfg #	Model	Part	Price
023139	0887291	RK009CK1	1st Chk	
023140	0887292	RK009CK2	2nd Chk	
023141	0887294	RK009VT	Total Relief	
023138	0887297	RK009RT	Total Rubber	

#### 3/4" Repair Kit for Series 009

Part #	Mfg #	Model	Part	Price
023142	0887000	RK009M2CK1	1st Chk Kit	
023143	0887001	RK009M2CK2	2nd Chk Kit	
010828	0887002	RK009M2VT	Total Relief	
010826	0886999	RK009M2RT	Total Rubber	
040703	0888520	RK009M3CK1	1st Chk Kit	
040702	0888521	RK009M3CK2	2nd Chk Kit	
040704	0888524	RK009M3VT	Total Relief	
040705	0888526	RK009M3RT	Total Rubber	
058395	1047394	99BA47	Retainer	

#### 3/4" to 1" Repair Kit for Series 009

Part #	Mfg #	Model	Part	Price
023144	0887005	RK009CK1	1st Chk Kit	
023145	0887007	RK009CK2	2nd Chk Kit	
108062	0887009	RK009CK1SS	1st Chk Kit	
108083	0887011	RK009CK2SS	2nd Chk Kit	
010833	0887015	RK009VT	Total Relief	
010830	0887017	RK009RC1	1st Chk Rbr	
010832	0887182	RK009RT	Total Rubber	

#### 1" Repair Kit for Series 009

Part #	Mfg #	Model	Part	Price
064125	0887789	RK009M2CK1	1st Chk Kit	
064126	0887790	RK009M2CK2	2nd Chk Kit	
040707	0887785	RK009M2VT	Total Relief	
040708	0887787	RK009M2RT	Total Rubber	

#### 1-1/4" to 2" Repair Kit for Series 009

Part #	Mfg #	Model	Part	Price
030210	0887006	RK009CK1	1st Chk Kit	
030211	0887008	RK009CK2	2nd Chk Kit	
108085	0887010	RK009CK1SS	1st Chk Kit	
108088	0887012	RK009CK2SS	2nd Chk Kit	
029025	0887016	RK009VT	Total Relief	
023130	0887185	RK009RT	Total Rubber	
023148	0887270	RK009M1CK1	1st Chk Kit	
023149	0887271	RK009M1CK2	2nd Chk Kit	
108086	0887272	RK009M1CK1SS	1st Chk Kit	
108089	0887273	RK009M1CK2SS	2nd Chk Kit	
023131	0887280	RK009M1RT	Total Rubber	
023147	0887301	RK009M2CK2	2nd Chk Kit	
010829	0887307	RK009M2VT	Total Relief	
010827	0887309	RK009M2RT	Total Rubber	
023146	0887300	RK009M2CK1	1st Chk Kit	

#### 2" Repair Kit for Series 009

Part #	Mfg #	Model	Part	Price
042500	WTRK009	RK009M2CK1 M2CK12	1st Chk Kit	
042501	0887541	RK009M2CK2	2nd Chk Kit	
042502	0887545	RK009M2VT	Total Relief	
030216	0887547	RK009M2RT	Total Rubber	

#### 2-1/2" to 3" Repair Kit for Series 009

Part #	Mfg #	Model	Part	Price
156943	0794054	LFRK009CK1	1st Chk Kit	
156944	0794055	LFRK009CK2	2nd Chk Kit	
156945	0794052	LFRK009VT	Total Relief	
156953	0794053	LFRK009RV	Rubber Parts	
156955	0794056	LFRK009RT	Total Rubber	

## Backflow Valves

### 1/4" to 3/4" Repair Kit for Series SS009

Part #	Mfg #	Model	Part	Price
108082	0887516	RKSS009M2/M3CK2	2nd Chk Kit	

### 1/2" Repair Kit for Series SS009

Part #	Mfg #	Model	Part	Price
108060	0887505	RKSS009CK1	1st Chk Kit	
108081	0887506	RKSS009CK2	2nd Chk Kit	

### 3/4" Repair Kit for Series SS009

Part #	Mfg #	Model	Part	Price
108061	0887515	RKSS009M2CK1	1st Chk Kit	

### 1" Repair Kit for Series SS009

Part #	Mfg #	Model	Part	Price
108065	0887525	RKSS009CK1	1st Chk Kit	
108084	0887526	RKSS009CK2	2nd Chk Kit	

### Repair Kit for Series 188A/288A/388A

Part #	Mfg #	Model	Size	Price
029503	0887172	RK188A/288A/388T	3/4" - 1"	
079610	0887171	RK188A/288A	1/2"	

### Repair Kits for Series 909

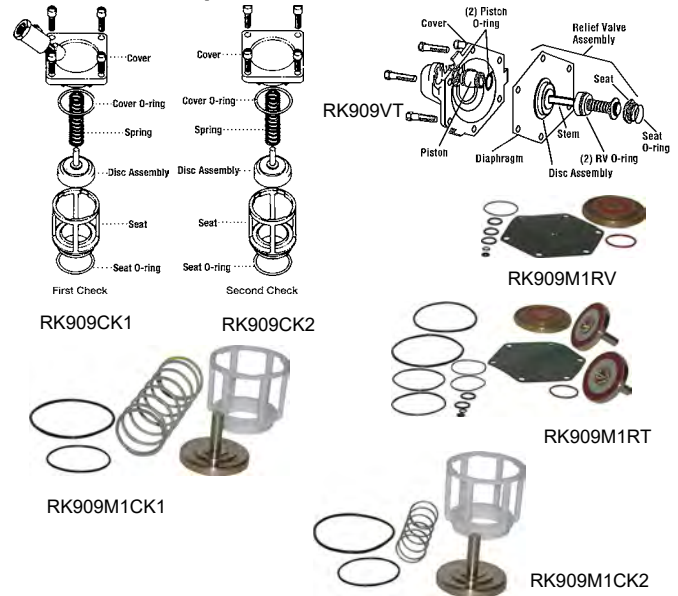

### 3/4" to 1" Repair Kit for Series 909

Part #	Mfg #	Model	Part	Price
023154	0887120	RK909CK1	1st Chk	
023155	0887121	RK909CK2	2nd Chk	
030214	0887122	RK909CK1SS	1st Chk	
030215	0887123	RK909CK2SS	2nd Chk	

### 3/4" to 1" Repair Kit for Series LF909

Part #	Mfg #	Model	Part	Price
156946	0794059	LFRK909VT	Total Relief	
156947	WTLFRK9 09RT341	LFRK909RT Rubber	Complete	

### 1-1/4" to 2" Repair Kit for Series LF909

Part #	Mfg #	Model	Part	Price
164646	0794063	LFRK909M1CK1	1st Chk	
160605	0794064	LFRK909M1CK2	2nd Chk	
159040	0794060	LFRK909M1VT	Total Relief	

### 2-1/2" to 3" Repair Kit for Series LF909

• LF Prefix: lead free

Part #	Mfg #	Model	Part	Price
156957	0794101	LFRK909CK2	2nd Chk Kit	
156963	0794081	LFRK909RV	Rubber Parts	
156965	0794085	LFRK909VT	Total Relief	
163699	0794089	LFRK909RT	Complete Rubber	

## Backflow Valves

### 4" Repair Kit for Series LF909

Part #	Mfg #	Model	Part	Price
156967	0794090	LFRK909RT	Complete Rubber	
156960	0794102	LFRK909CK2	2nd Chk Kit	

### 4" & 6" Repair Kit for Series LF909

Part #	Mfg #	Model	Part	Price
156964	0794082	LFRK909RV	Rubber Parts	
156966	0794086	LFRK909VT	Total Relief	

### 6" Repair Kit for Series LF909

Part #	Mfg #	Model	Part	Price
156968	0794091	LFRK909RT	Complete Rubber	
156959	0794098	LFRK909CK1	1st Chk Kit	
156961	0794103	LFRK909CK2	2nd Chk Kit	

### Hose Assembly for Series 909

Part #	Mfg #	Model	Size	Price
139960	0881487	AK909	6" to 8"	

### Repair Kits for Series LF919

#### 3/4" - 1" Repair Kit for Series LF919

Part #	Mfg #	Model	Size	Price
132377	0888136	RK919RV	Rubber Parts	
132385	0888142	RK919RT	Complete Rubber Parts Kit	

### 757, 757N Series Double Check Valve Assembly

- Extremely compact design
- 70% Lighter than traditional designs
- 304 (Schedule 40) Stainless steel housing & sleeve
- Groove fittings allow integral pipeline adjustment
- Patented tri-link check provides lowest pressure loss
- Replaceable check disc rubber



**OSY-** UL/FM outside stem and yoke, resilient seated gate valves  
**BFG-** UL/FM grooved gear operated butterfly valves with tamper switch

Part #	Mfg #	Model	Size	Price
109090	757-BFG	0111534	2-1/2"	
109092	757-BFG	0111536	4"	
109093	757-BFG	0111537	6"	
109095	757-OSY	0111511	3"	
109096	757-OSY	0111513	6"	

### SilverEagle™ 957 Series RPZ Reduced Pressure Zone Assembly

- Compact design
- 70% Lighter than traditional designs
- 304 (Sch 40) stainless steel housing and sleeve
- Groove fittings allow integral pipeline adjustment
- Patented torsion spring checks provides lowest pressure loss
- Unmatched ease of serviceability
- Available with grooved butterfly valve shutoffs
- May be used for horizontal, vertical, N pattern or Z pattern installations
- Bottom mounted cast stainless steel relief valve
- Replaceable check disc rubber
- Temperature range: 33° - 110°F
- Maximum working pressure: 175 psi
- Suffix Options:
  - - NRS = Non-rising stem resilient seated gate valves
  - OSY = UL/FM outside stem and yoke resilient seated gate valves

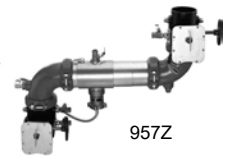

Part #	Mfg #	Model	Size	Option	Price
071743	0111602	957NRS	2-1/2"	NRS	

## Backflow Valves

### Backflow Preventers (Continued)

#### SilverEagle™ 957 Series RPZ Reduced Pressure Zone Assembly

Part #	Mfg #	Model	Size	Option	Price
071505	0111603	957NRS	3"	NRS	
071744	0111604	957NRS	4"	NRS	
088845	0111585	957OSY	3"	OSY	
081866	0111586	957OSY	4"	OSY	

#### Repair Kit for 957 1st Check Kit

Part #	Mfg #	Model	Size	Price
093258	7018129	RK957/957RPDA-CK1	2-1/2" - 4"	

#### 2nd Check Kit

Part #	Mfg #	Model	Size	Price
093256	0899216	RK957/957RPDA-CK2	2-1/2" - 4"	

#### Complete Rubber Parts Kit

Part #	Mfg #	Model	Size	Price
082509	0899245	RK957/957RPDA-RT	6"	

#### Total Relief Valve Kit

Part #	Mfg #	Model	Size	Price
094158	0899232	RK957/957RPDA-VT	2-1/2" - 10"	

#### LF007 Double Check Valve Assembly

- Ease of maintenance — only one cover
- Replaceable seats and seat discs
- Modular construction
- Compact design
- Lead Free\* cast copper silicon alloy body construction — 1/2" – 2" (15 – 50mm)
- Fused epoxy coated cast iron body — 2 1/2" – 3" (65 – 80mm)
- Top mounted Lead Free\* ball valve test cocks
- Low pressure drop
- No special tools required for servicing
- 1/2" – 1" (15 – 25mm) have tee handles



Part #	Mfg #	Model	Size	Price
157033	0063230	LF007-QT	1/2"	
157133	0063232	LF007M1-QT	1"	
157150	0063234	LF007M2-QT	1-1/2"	

### Backflow Preventers (Continued)

#### LF007 Double Check Valve Assembly

Part #	Mfg #	Model	Size	Price
157140	0063235	LF007M1-QT	2"	
160050	0063231	LF007M3-QT	3/4"	
159331	0122593	LF007M3-QTS	3/4"	

#### LF009 Reduced Pressure Zone Assembly

- Single access cover and modular check construction for ease of maintenance
- Top entry - all internals immediately accessible
- Internal relief valve
- Replaceable seats for economical repair
- Lead Free\* cast copper silicon alloy body construction for durability
- 1/4" – 2" (8 – 50mm)
- Fused epoxy coated cast iron body 2 -1/2" and 3" (65 and 80mm)
- Ball valve test cocks — screwdriver slotted 1/4" – 2" (8 – 50mm)
- Large body passages provides low pressure drop
- Compact, space saving design



Part #	Mfg #	Model	Size	Price
157132	0122605	LF009-QT-S	3/8"	
157032	0122695	LF009-QT-S	1/2"	
157162	0122693	LF009M2-QT-S	1"	
157158	0122688	LF009M2-QT-S	1-1/4"	
157159	0122689	LF009M2-QT-S	1-1/2"	
157160	WTLF009 M2QTS2	LF009M2-QT-S	2"	
157163	0122695	LF009M3-QT-S	3/4"	
157136	0122612	LF009-NRS	2-1/2"	
157137	0122613	LF009-NRS	3"	
157141	0122646	LF009-NRS-S-FDA2-1/2"		
157148	0122654	LF009-NRS-S-FDA3"		



## Backflow Valves

### LF909 Reduced Pressure Zone Assembly

- Modular design
- Replaceable seats
- Compact for installation ease
- Horizontal or vertical (up or down) installation



Part #	Mfg #	Model	Size	Price
168773	0122776	LF909-OSY	3"	
157173	0122773	LF909-NRS	2-1/2"	
157199	0391015	LF909-NRS	3"	
157202	0122797	LF909-NRS	4"	
157168	0122758	LF909M1-NRS	8"	
157316	0122771	LF909-QT-S-HW	3/4"	
157317	0122772	LF909-QT-S-HW	1"	
157174	0122774	LF909-QT-S	3/4"	
157175	0122775	LF909-QT-S	1"	
157169	0122765	LF909M1-QT-S	1-1/4"	
157170	0122766	LF909M1-QT-S	1-1/2"	
157171	0122767	LF909M1-QT-S	2"	
157209	0122805	LF909NRSSFDA	3"	
157210	0122798	LF909NRSSFDA	6"	
157207	0122801	LF909NRSSFDA	4"	
157208	0122804	LF909NRSSFDA	2-1/2"	

### LF919 Reduced Pressure Zone Assembly

- Top entry
- All rubber elastomer's of chloramine resistant material
- Check valve poppet assemblies are fully guided by innovative plast seat guide
- Replaceable push-in check valve and relief valve seats eliminates threads from the water way
- EZ twist relief valve cover 1/4 turn locking joint captures the spring load during repair to facilitate disassembly



Part #	Mfg #	Model	Size	Price
157151	0065378	LF919-QT	3/4"	
157152	0065379	LF919-QT	1"	
157153	0065380	LF919-QT	1-1/4"	
157154	0065381	LF919-QT	1-1/2"	
157155	0065382	LF919-QT	2"	

### LF7R Brass Dual Check Valve

- Can be installed vertically or horizontally
- Available with combination of inlet/outlet sizes, types or thread and end connection



Part #	Mfg #	Model	Size	Price
157028	0072203	LF7RU2	1/2"	
157164	0072221	LF7RU2-U2	3/4"	
157165	0072224	LF7RU2-RU2	1"	

### LF7 Dual Check Valves

- Can be installed vertically or horizontally
- Available with combination of inlet/outlet sizes, types or thread and end connection including retrofit compression fittings and hose connections
- Can be installed in many piping configurations and with a wide range of meter horns, copper setters and meter boxes



LF7(Cast Copper Silicon Alloy) Sizes: 1-1/4" (32mm)  
 LF7C(Chrome-Nickel Plated) Sizes: 3/8" (10mm)

Part #	Mfg #	Model	Size	Price
185857	792077	LF7C	3/8"	

### LFH7C Dual Check Valve with Hose Connection



Part #	Mfg #	Model	Size	Price
173743	0792078	LFH7C	3/4"	



## Backflow Valves

### LFN55B-M1 Water Pressure Reducing Valve

- Serviceable in line
- Thermoplastic seat
- Double union-solder union inlet & outlet
- Integral stainless steel strainer
- Sealed spring cage for accessible outdoor or pit installations
- Lead Free\* brass body construction
- Bypass feature controls thermal expansion pressure



Part #	Mfg #	Model	Size	Price
219053	0009587	LFN55BM1-DU-S	3/4"	
194909	0009636	LFN55BM1-DU-S	1"	
218836	0009587	LFN55BM1-DU-PEX	3/4"	

### 9D Series Dual Check Valve with Intermediate Atmospheric Vent Backflow Preventer

- Continuous pressure applications
- Maximum temperature: 250°F
- Maximum pressure: 175 psi
- Minimum pressure: 25 psi



Part #	Mfg #	Model	Size	Option	Price
011323	0061935	9DM3	1/2"	-	
011324	0061888	9DM2	3/4"	-	
074245	0061952	9DSM3	1/2"	-	

### 9BD Series Dual Check Vending Machine Backflow Preventer

- For vending machine water supply lines
- Complies with FDA food additive regulations
- Vented triple check protection
- Temperature range: 33° - 140°F
- Maximum working pressure: 150 psi



Part #	Mfg #	Model	Connection(s)	Price
011322	0061894	9BD	3/8" FCT	

### 7 Series Dual Check Backflow Preventer

- For use at the drinking water supply service entrance or with individual outlets
- For non-health hazard residential water system containment and continuous pressure applications
- Bronze body construction
- Uses two compact replaceable check modules
- Buna-N seals and stainless steel springs
- Can be installed vertically or horizontally
- Suffix Options:
  - C = Chrome nickel-plated finish



Part #	Mfg #	Model	Size	Connection	Price
104202	0061783	7U2-2	1/2"	FNPT	

### SD2 Series Dual Check Valve for Carbonated Beverage Machines

- 316 Stainless steel body
- All rubber compounds comply with FDA food additive regulations
- Prevents the reverse flow of potentially contaminated water into the potable water supply due to back pressure backflow
- For continuous or intermittent pressure conditions



Part #	Mfg #	Model	Size	Connection	Price
084940	0061655	SD2-MF	3/8"	SAE MF Ir	
144769	0061651	SD2-MF	1/4"	SAE MF Ir	

### SD3 Series Dual Check Backflow Preventer With Atmospheric Port

- For use on Post-Mix Carbonated Beverage Equipment and dispensing for tea and coffee
- Prevents reverse flow of potentially contaminated water into potable water supply from pressure backflow
- For continuous or intermittent pressure conditions



Part #	Mfg #	Model	Size	Connection	Price
084941	0061657	SD3MF	3/8"	SAE MF Ir	

## Backflow Valves

### LF8 Hose Connection

- Copper silicon alloy body
- Stainless steel working parts for longevity
- Durable rubber diaphragm and disc for consistent positive seating



Part #	Mfg #	Model	Size	Price
157030	0792085	LF8	3/4"	
156605	0792091	LF8A	3/4"	
156606	0792086	LF8B	3/4"	
156608	0792087	LF8C	3/4"	
156610	0792092	LF8AC	3/4"	
156604	0792093	LFNF8	3/4"	
156609	0792094	LF8FR	3/4"	

### Repair Kit For Series 008

Part #	Mfg #	Model	Size	Option	Price
137538	0887972	RK008T	3/8" - 1/2"	Check	

### Air Gaps

- For use with backflow preventers on horizontal installations
- Can be easily mounted to body



909



957

Part #	Mfg #	Model	Size	Price
011325	0881399	909AGA	1/4" - 3/4"	
011326	0881376	909AGC	3/4" - 1"	
011327	0881378	909AGF	1-1/4" - 2"	
024595	0881385	909AGK	4" - 6"	
071506	0111764	957AG	2-1/2" - 10"	

### 919 Air Gap

- For Reduced pressure zone assemblies



Part #	Mfg #	Model	Size	Price
131593	0881577	919-AG-F	2"	

### Hose Assembly Kits (Sensing Line)

Part #	Mfg #	Model	Size	Price
139959	0881486	AK909	2-1/2" - 4"	

### Backflow Accessories

#### Vent Elbows



Part #	Mfg #	Model	Size	Price
011328	0881382	909ELF		

#### Test Cocks



Part #	Mfg #	Model	Size	Price
157246	0792000	LFTC	1/4"	
157243	0792001	LFNPT-TC	1/8"	



---

---

## Backflow Valves

---

---

### Parts Kit for 825Y Zone Assembly

- Set of rubbers for whole unit



Part #	Mfg #	Size	Description	Price
115070	905-111	3/4" - 1-1/4"	Rubber Parts Kit	
104968	905-112	1-1/2" - 2"	Rubber Parts Kit	

## Backflow Valves

### Wilkins Water Control Products

#### Wilkins 975XL Reduced Pressure Principle Assembly Backflow Preventer

- Maximum working water pressure: 175 psi
- Maximum working water temperature :180°F
- Full port QT ball valves
- ASSE Listed 1013
- UL and cUL Classified
- CSA Certified



**WILKINS**  
A ZURN™ COMPANY

Part #	Mfg #	Size	Price
119692	975XL	3/4"	

#### Wilkins 975XL2SE Reduced Pressure Principle Assembly with 90° Street

- Maximum pressure: 175 psi
- Temperature range: 33°F-180°F
- Two full port resilient seated ball valves for shut-off and four resilient seated ball valve test cocks
- Nickel-plated ball valve handles
- Noryl® replaceable seats and silicone rubber check discs



Part #	Mfg #	Size	Price
178689	975XL2S	1/2"	
178691	975XL2S	1-1/4"	

---

---

**Backwater Valves**

---

---

**Backwater Valves**

**Clean Check™ Extendable Backwater Valve**

Part #	Mfg #	Size	Type	Price
087228	223264WST	4"	PVC	

**Backwater Valves**

**Backwater Valves and Accessories**

**Backwater Valve (DWV Hubs)**



Part #	Mfg #	Size	Type	Price
136981	123285	4"	ABS	
132396	223283W	3"	PVC	
132399	223284W	4"	PVC	

**Backwater Valve Access Sleeve**

Part #	Mfg #	Size	Type	Price
132398	123287-3	3"	ABS	
132401	123285-3	4"	ABS	

**Backwater Valve Sleeve Lid**



Part #	Mfg #	Size	Type	Price
132397	123287-2	3"	ABS	
132402	123285-2	4"	ABS	



## Backwater Valves

### Gate Valves

#### Valterra PVC Slice Gate Valve (Slip)

- *Designed for pool and spa, irrigation, plumbing, waste water and agricultural applications*
- *Stainless steel shaft*
- *Ozone and chemical-resistant Santoprene™ materials*
- *Maximum working pressure: 50 psi (through 2")*
- *Solvent cement traps*
- *Triple o-ring neck seal*
- *3-Piece*



Part #	Mfg #	Size	Price
126449	VSGV200SL	2"	
103183	VSGV300SL	3"	
080021	VSGV400SL	4"	
092827	VSGV600SL	6"	



---

---

## Backwater Valves

---

---

### Check Valves

#### In-Line Spring Check Valve (Soc x Soc)

Part #	Mfg #	Size	Bag	Price
044147	S12-007	3/4"	120	
087121	S12-010	1"	80	
087614	S12-020	2"	40	

**Backwater Valves**

**Check Valves**

PVC Swing Check (Comp)

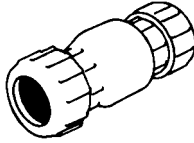

Part #	Mfg #	IPS Size	Body Length	Price
070747	1500-15	1-1/2"	7-1/2"	
004397	1500-20	2"	9-3/4"	

**Sump Pump Valve**

Part #	Mfg #	IPS Size	Body Length	Price
004396	1400-15	1-1/4" - 1-1/2"	5-1/4"	

## Backwater Valves

### DWV Backwater Valves

#### PVC or ABS Solvent Weld Connection

- Threaded access seals hand tight and allows for easy maintenance and inspection
- Model **(869-4AS)** includes 16" sleeve & lid
- Model **(869-4SPS)** includes 16" shallow access sleeve



Part #	Mfg #	Size	Material	Price
099173	869-2P	2"	PVC	
123505	869-3P	3"	PVC	
158124	869-S4PS	4"	PVC	
143131	869-4A	4"	ABS	
143226	869-4AS	4"	ABS	

#### Backwater Device

- Polypropylene thread body and float ball with EDPM sealing gasket
- Not designed for air or water test



Part #	Mfg #	Connection	Price
010031	SC8027	2" FIP	

#### ProCheck™ Residential Backwater Valve

- Available for 3" or 4" sch. 40 DWV lines.
- 3" Hub 5-1/2" x 8-5/8", out height x width
- 4" Hub 6-1/2" x 10-1/8", out height x width
- Valve body: ABS or PVC
- Vertical offset
- The unique flapper creates a tighter seal
- Sealing lid: polypropylene & carrier: ABS
- Flapper: elastomer overmolded polypropylene
- Valves can be adapted for standard, shallow-depth or deep-bury installations
- Modular valve design allows for interchangeable accessories
- Structurally rugged and molded from engineered resins
- **(869-S3PS)** includes 16" shallow access sleeve kit



869-S3P

Part #	Mfg #	Offset	Conn.	Material	Price
160136	869-S3P	1/4"	3"	PVC	
158123	869-S3PS	1/4"	3"	PVC	
159332	869-S4P	3/8"	4"	PVC	

### Parts & Accessories

#### Backwater Valve Replacement Parts

Part #	Mfg #	Description	Price
135088	869-23	Ext Sleeve Kit for 2" Valve Includes Sleeve Locking Collar and Lid	
257248	869-61	Flapper & O-Ring for 6" Valve	
128194	869-33	Ext Sleeve Lid for 3"	
128196	869-34	16" Ext Sleeve for 3"	
135329	869-36	Locking Collar for 869-34 Extension Sleeve	
123951	869-43	Ext Sleeve Lid for 4" Valve	
123506	869-44	16" Ext Sleeve for 4"	
184056	868-60	O-ring for 6" threaded lid	
152427	869-63	Ext Sleeve Lid for 6" Valve	
253941	869-SVLW	Threaded Lid for Backwater Valve - White w/ O-Ring	

#### ProCheck™ Upper and Lower Deep-Bury Adapters

- For use with 3" or 4" backwater valves —purchased separately



Part #	Mfg #	Material	Price
184057	869-S4PDB	PVC	

#### ProCheck™ Shallow Access Sleeve Kit

Part #	Mfg #	Includes:	Price
160138	869-SSK	Collar, Sleeve, & Lid	



---

---

## Backwater Valves

---

---

### Backwater Valves and Accessories

#### Clean Check® Backwater Valve



Part #	Mfg #	Description	Price
117494	97034	4" PVC w/ Adapter and Plug	
195338	97024	4" PVC	
167931	97026	6" PVC	
119223	96981	3"-4" Flapper (Original Style)	

**Ball Valves - Potable**

**Bronze Ball Valves**

**T585-80-LF 2-Piece Full Port Bronze Ball Valve  
(FNPT x FNPT)**

- Fire protection valve
- Lever handle  
(-LL models: CS locking lever)
- Blowout-proof stem
- Chrome-plated ball
- RTFE Seats
- Bar non-shock cold working pressure: 600 psi/41.4



Part #	Mfg #	Size	Price
160383	T585-80-LF	1/4"	
160384	T585-80-LF	3/8"	
160385	T585-80-LF	1/2"	
160386	T585-80-LF	3/4"	
160398	T585-80-LF-LL	3/4"	
160387	T585-80-LF	1"	
160388	T585-80-LF	1-1/4"	
160389	T585-80-LF	1-1/2"	
160390	T585-80-LF	2"	

**S585-80-LF 2-Piece Full Port Bronze Ball Valve  
(C x C)**

- Lever handle
- Blowout-proof stem
- Bar non-shock cold working pressure: 600 psi/41.4
- Maximum temperature rating: 400°F



Part #	Mfg #	Size	Price
160375	S585-80-LF	1/4"	
160376	S585-80-LF	3/8"	
160377	S585-80-LF	1/2"	
160378	S585-80-LF	3/4"	
160379	S585-80-LF	1"	
160380	S585-80-LF	1-1/4"	
160381	S585-80-LF	1-1/2"	
160382	S585-80-LF	2"	

**S-585-80-LF-LL 2-Piece Bronze Ball Valve  
(S x S)**

- Locking lever handle
- Chrome-plated ball
- RTFE Seats
- Blowout-proof stem
- Bar non-shock cold working pressure: 600 psi/41.4
- Bar saturated steam: 150 psi/10.3



Part #	Mfg #	Size	Price
160392	S585-80-LF-LL	1/2"	
160393	S585-80-LF-LL	3/4"	

**T-585-66-LF Lead Free 2-Piece Full Port Bronze  
Ball Valve  
(FNPT x FNPT)**

- Blowout-proof stem
- Chrome-plated ball
- Stainless trim
- RTFE Seats
- Bar non-shock cold working pressure: 600 psi/41.4
- Bar saturated steam: 150 psi/10.3



Part #	Mfg #	Size	Price
160409	T585-66-LF	1/2"	
160410	T585-66-LF	3/4"	
160411	T585-66-LF	1"	
160412	T585-66-LF	1-1/4"	
160413	T585-66-LF	1-1/2"	
160414	T585-66-LF	2"	

**S585-66-LF 2-Piece Full Port Bronze Ball Valve  
(Swt x Swt)**

- Blowout-proof stem
- Vented ball
- Stainless trim
- Bar non-shock cold working pressure: 600 psi/41.1
- Bar saturated steam: 150 psi/10.3



Part #	Mfg #	Size	Price
160401	S585-66-LF	1/2"	
160403	S585-66-LF	3/4"	
160404	S585-66-LF	1"	
160405	S585-66-LF	1-1/4"	
160406	S585-66-LF	1-1/2"	



## Ball Valves - Potable

### Bronze Ball Valves (Continued)

#### S585-66-LF 2-Piece Full Port Bronze Ball Valve

Part #	Mfg #	Size	Price
160407	S585-66-LF	2"	

#### T-595Y-LF 3-Piece Full Port Bronze Ball Valve (FIPT x FIPT)

- Blowout-proof stem
- Silicon performance bronze™ alloy
- Non-shock cold working pressure



Part #	Mfg #	Size	Price
160415	T-595-Y-LF	1/2"	
160416	T-595-Y-LF	3/4"	
160417	T-595-Y-LF	1-1/2"	

### Brass Ball Valves

#### T-FP-600A-LF 2-Piece Full Port Brass Ball Valve (FNPT x FNPT)

- Lever handle
- Blowout-proof stem
- PTFE Seats
- 1/4" - 2" Non-shock cold working pressure: 600 psi
- 2-1/2" - 4" Non-shock cold working pressure: 400 psi
- Lead Free



Part #	Mfg #	Size	Price
157550	14BVNILF	1/4"	
157551	38BVNILF	3/8"	
157552	12BVNILF	1/2"	
157553	34BVNILF	3/4"	
157554	1BVNILF	1"	
157555	114BVNILF	1-1/4"	
157556	112BVNILF	1-1/2"	
157557	2BVNILF	2"	
157558	212BVNILF	2-1/2"	
157559	3BVNILF	3"	
157560	4BVNILF	4"	

#### With Locking Lever

Part #	Mfg #	Size	Price
221379	TFP600A-LF-LL	2"	

#### S-FP-600A-LF 2-Piece Full Port Brass Ball Valve (C x C)

- Lever handle
- Blowout-proof stem
- PTFE Seats
- Non-shock cold working pressure:
  - 1/4" - 2": 600 psi
  - 2-1/2" - 4": 400 psi
- Lead Free



Part #	Mfg #	Size	Price
157561	38SBVNILF	3/8"	
157562	12SBVNILF	1/2"	
157564	34SBVNILF	3/4"	
157565	1SBVNILF	1"	
157566	114SBVNILF	1-1/4"	
157568	112SBVNILF	1-1/2"	
157569	2SBVNILF	2"	
157570	212SBVNILF	2-1/2"	
157571	3SBVNILF	3"	

#### PXCP400-LF PEX Ball Valve

- 100 psi at 180°F
- Dezincification resistant
- Lever handle
- Lead-free\*



Part #	Mfg #	Size	Price
210197	PXCP400-LF	1/2"	
210198	PXCP400-LF	3/4"	
210199	PXCP400-LF	1"	

## Ball Valves - Potable

### Ball Valves

#### 77CLF Series 2-Piece Ball Valve

- Threaded or Solder
- Full port, bronze
- 600 CWP, sizes: 1/4" to 2-1/2"
- LEAD FREE



#### 77CLF-100 Series - Threaded

Part #	Mfg #	Size	Price
175182	77CLF-10101	1/4"	
175183	77CLF-10201	3/8"	
175184	77CLF-10301	1/2"	
175185	77CLF-10401	3/4"	
175186	77CLF-10501	1"	
175187	77CLF-10601	1-1/4"	
175188	77CLF-10701	1-1/2"	
175189	77CLF-10801	2"	
175190	77CLF-10901	2-1/2"	

#### 77CLF-200 Series - Solder

Part #	Mfg #	Size	Price
175191	77CLF-20201	3/8"	
175192	77CLF-20301	1/2"	
175193	77CLF-20401	3/4"	
175194	77CLF-20501	1"	
175195	77CLF-20601	1-1/4"	
175196	77CLF-20701	1-1/2"	
175197	77CLF-20801	2"	
175198	77CLF-20901	2-1/2"	

#### 77VLF Series 2-Piece APOLLOXPRESS® Press End Ball Valve

- Rigid® XL press tool compatible
- Full port, brass
- Max operating pressure: 250 psig
- LEAD FREE



Part #	Mfg #	Size	Price
175143	77VLF-10301	1/2"	
175148	77VLF-10401	3/4"	
175149	77VLF-10501	1"	
175150	77VLF-10601	1-1/4"	
175151	77VLF-10701	1-1/2"	
175152	77VLF-10801	2"	
175154	77VLF-10901	2-1/2"	

### Ball Valves (Continued)

#### 77VLF Series 2-Piece APOLLOXPRESS® Press End Ball Valve

Part #	Mfg #	Size	Price
175155	77VLF-10001	3"	

#### 94XLF Series 2-Piece Crimp PEX Ball Valve

- Lead free
- DZR forged brass



Part #	Mfg #	Size	Price
240845	94XLF-10301	1/2"	
240847	94XLF-10401	3/4"	
240848	94XLF-10501	1"	

## Ball Valves - Potable

### ProPress Series Full Port Ball Valve (EzPress)

#### EzPress (ProPress) Full Port Ball Valve

- 2-piece Body
- Full Port
- Chrome-Plated Ball
- Virgin PTFE Seats
- Double O-ring
- Blow-Out Proof Stem
- MSS-SP-110
- 250 psig Max. End Connection
- AB1953, NSF/ANSI 61 & 372 Certified
- Meet BAA requirement



Part #	Mfg #	Model	Size	Price
157037	12PPBVLF	5520ABLF	1/2"	
157038	34PPBVLF	5520ABLF	3/4"	
157039	1PPBVLF	5520ABLF	1"	
157040	114PPBVLF	5520ABLF	1-1/4"	
157041	112PPBVLF	5520ABLF	1-1/2"	
157036	2PPBVLF	5520ABLF	2"	
157110	212PPBVXLCLF	5520ABXLF	2-1/2"	
157111	3PPBVXLCLF	5520ABXLF	3"	
157112	4PPBVXLCLF	5520ABXLF	4"	

### PEX Ball Valves

#### Lead Free PEX Ball Valve (F1807)

- Regular port
- Virgin PTFE seats
- Double NBR o-ring packing
- Blow-out proof stem
- For use with PEX tubing
- CSA B125.3
- ASTM-F1807
- AB1953, NSF61-G & NSF-372 Certified



Part #	Mfg #	Size	Price
169402	5009AB12	1/2"	
169403	5009AB34	3/4"	
169404	5009AB1	1"	

### Lead Free PEX Ball Valve (F1960)

- Regular port
- Virgin PTFE seats
- Double NBR o-ring packing
- Blow-out proof stem
- For use with PEX tubing
- CSA B125.3
- ASTM-F1960
- AB1953, NSF61-G & NSF-372 Certified



Part #	Mfg #	Model	Size	Price
241571	12APBVRW	5015ABLF	1/2"	
241572	34APBVRW	5015ABLF	3/4"	
241573	1APBVRW	5015ABLF	1"	

### Flange Ball Valves

#### ExPress x Pump Flange Ball Valve

- 3-Piece body
- Full port
- Rotating flange design
- 1/4 Turn ball valve style
- Includes bolt kit
- Includes wing handle



Part #	Mfg #	Model	Size	Price
243915	2420F1	2420F	1"	
243917	2420F114	2420F	1-1/4"	

**Ball Valves - Potable**

**Lead Free CimPress™ Ball Valves**

**1220NL ASC Ball Valve**

- Lead free
- Suitable for 50% glycol/water mixtures
- Sure Connect O-Ring design
- 250 PSI pressure rating and 250° F temperature rating
- Conforms MSS-SP-110



Part #	Mfg #	Size	Price
159792	12PPBVCIML F	1/2"	
159793	34PPBVCIML F	3/4"	
159794	1PPBVCIMLF	1"	
159795	114PPBVCIM LF	1-1/4"	

## Ball Valves - Potable

### Bronze Ball Valves

#### LFB6080G2/LFB8081G2 Ball Valve

- Lead Free\*, forged bronze body and adapter
- Full range of sizes from 1/4" – 2" (8 – 50mm)
- Stainless steel ball & stem option
- Minimal pressure drop due to large ports
- Blowout proof, pressure retaining stem
- Certified to NSF 372
- Adjustable stem packing gland
- White handles for easy Lead Free\* identification
- BAA Compliant
- LFB6080 - NPT connections
- LFB8081 - Solder connections



Part #	Mfg #	Model	Size	Price
182108	WTB6080G 214	LFB-6080G2	1/4"	
182109	WTB6080G 238	LFB-6080G2	3/8"	
178154	WTLFB6080 G22	LFB-6080G2	2"	
158054	WTLFB6080 G212	LFB-6080G2	1/2"	
158045	WTLFB6080 G21	LFB-6080G2	1"	
158046	WTLFB6080 G2114	LFB-6080G2	1-1/4"	
158047	WTLFB6080 G2112	LFB-6080G2	1-1/2"	
158055	WTLFB6081 G212	LFB-6081G2	1/2"	
158049	WTLFB6081 G234	LFB-6081G2	3/4"	
158050	WTLFB6081 G21	LFB-6081G2	1"	
158051	WTLFB6081 G2114	LFB-6081G2	1-1/4"	
158052	WTLFB6081 G2112	LFB-6081G2	1-1/2"	
158053	WTLFB6081 G22	LFB-6081G2	2"	

### LFB6800 3-Piece Full-Port Ball Valve (NPT)

- Lead Free
- 3-piece, lift-out design
- Low operating torque
- Adjustable stem packing gland
- Each valve factory tested
- Stainless steel ball and stem
- Blow-out proof, pressure retaining stem
- Standard actuator mounting pads
- Vinyl insulator on heavy duty, zinc plated carbon steel handles
- Carbon/glass reinforced PTFE Durafill® valve seats



Part #	Mfg #	Model	Size	Price
158042	WTLFB6801 112	LFB-6801	1-1/2"	

### Brass Ball Valves

#### LFB6001 Ball Valve (Swt)

- Brass
- Lead free
- 2-Piece, Standard Port



Part #	Mfg #	Model	Size	Price
164361	WTLFB6001 34	LFB6001	3/4"	
164362	WTLFB6001 1	LFB6001	1"	
156912	WTLFB6001 212	LFB6001	2-1/2"	
156913	WTLFB6001 3	LFB6001	3"	

## Ball Valves - Potable

### LFIT6300/LFIS6301 Series Brass Ball and Waste Full Port Ball Valve

- Brass
- Lead free
- 2-Piece, side drain port
- For draining or venting of downstream line when valve is in the closed (off) position
- Pressure rating: 600 psi WOG (non-shock)
- Virgin PTFE valve seats
- Blow-out proof, pressure retaining stem



**LFIT6300 Ball Valve (NPT)**



Part #	Mfg #	Model	Size	Price
157127	WTLFIT630012	LFIT6300	1/2"	
157128	WTLFIT630034	LFIT6300	3/4"	
178155	WTLFIT63001	LFIT6300	1"	

### IS6301 Ball Valve (Swt)

Part #	Mfg #	Model	Size	Price
157129	WTLFIS630112	LFIS6301	1/2"	
157130	WTLFIS630134	LFIS6301	3/4"	

### FBV-3/FBVS-3 Series Brass Full Port Ball Valve

- Lead free
- 2-Piece construction
- Excellent for throttling and balancing applications
- For non-abrasive liquids or gases
- Temperature range: 40° - 450°F

#### FBVLF-2-Press Series Brass Full Port Ball Valve

- Lead free
- Integral press fitting end XL-C connection
- Designed for use in ProPress® piping systems
- Press connection rated to: 200 psi up to 250°F
- Blowout proof, bottom-loaded stem



Part #	Mfg #	Model	Size	Price
157042	212PPBVLV	FBVLF-2-Press-M1	2-1/2"	

### FBV-3C/FBVS-3C Series 2-Piece Full Port Brass Ball Valve

- Lead free
- Suitable for a full range liquids and gases
- Complies with MSS-SP-110
- Certified to NSF/ANSI Standard 61
- CSA Approved (1.4" to 3" threaded only), UL/FM approved (1.2" to 2" threaded only), UL Listed (1.2" to 2" solder)

#### LFFBV-3C 2-Piece Full Port Ball Valve (FNPT)

- Lead free
- UL Approved and NSF/ANSI 61/8 certified for 1/4" to 2"
- UL/FM Approved
- NSF/ANSI certified
- ASME B16.33, CSA Approved for 1/2" to 2"
- Sizes up to 2" /600 psi WOG/150 psi WSP
- Sizes 2-1/2" and 3" rated 600 psi WOG/125 psi WSP



Part #	Mfg #	Model	Size	Price
157070	14BVLV	LFFBV-3C-M1	1/4"	
157071	38BVLV	LFFBV-3C-M1	3/8"	
157072	12BVLV	LFFBV-3C-M1	1/2"	
157073	34BVLV	LFFBV-3C-M1	3/4"	
157074	1BVLV	LFFBV-3C-M1	1"	
157075	114BVLV	LFFBV-3C-M1	1-1/4"	
157076	112BVLV	LFFBV-3C-M1	1-1/2"	
157077	2BVLV	LFFBV-3C-M1	2"	



## Ball Valves - Potable

### Brass Ball Valves (Continued)

#### FBV-3C/FBVS-3C Series 2-Piece Full Port Brass Ball Valve

##### LFFBV-3C 2-Piece Full Port Ball Valve (FNPT)

Part #	Mfg #	Model	Size	Price
157078	212BVLF	LFFBV-3C-M1	2-1/2"	
157079	3BVLF	LFFBV-3C-M1	3"	

##### LFFBVS-3C 2-Piece Full Port Brass Ball Valve (SWT)

- Lead free
- UL/FM Approved and NSF/ANSI 61/8 certified for 1/2" to 2"
- Sizes 1/2" to 2" rated 150 psi WSP/600 psi WOG
- Sizes 2-1/2" and 3" rated 400 psi WOG/125 psi WSP



Part #	Mfg #	Model	Size	Price
157080	12SBVLF	LFBVS-3C-M1	1/2"	
157081	34SBVLF	LFBVS-3C-M1	3/4"	
157082	1SBVLF	LFBVS-3C-M1	1"	
157083	114SBVLF	LFBVS-3C-M1	1-1/4"	
157084	112SBVLF	LFBVS-3C-M1	1-1/2"	
157085	2SBVLF	LFBVS-3C-M1	2"	
157086	212SBVLF	LFBVS-3C-M1	2-1/2"	
157087	3SBVLF	LFBVS-3C-M1	3"	

##### LFFBV-4 2-Piece Full Port Ball Valve (FNPT)

- Lead free
- Metal-to-metal adapter body seal to eliminate adapter leaks after soldering
- Fluorocarbon elastomer stem O-ring prevents stem leaks
- Adjustable stem packing gland provides longer service life
- Bottom loaded blowout proof stem
- PTFE stem packing seal and seats
- Machined chrome-plated Lead Free brass ball



Part #	Mfg #	Model	Size	Price
157093	14BVSPFLF	LFFBV-4	1/4"	
157094	38BVSPFLF	LFFBV-4	3/8"	
157095	12BVSPFLF	LFFBV-4	1/2"	
157096	34BVSPFLF	LFFBV-4	3/4"	
157097	1BVSPFLF	LFFBV-4	1"	
157098	114BVSPFLF	LFFBV-4	1-1/4"	

### Brass Ball Valves (Continued)

#### LFFBV-4 2-Piece Full Port Ball Valve (FNPT)

Part #	Mfg #	Model	Size	Price
157099	112BVSPFLF	LFFBV-4	1-1/2"	
157100	2BVSPFLF	LFFBV-4	2"	
157101	212BVSPFLF	LFFBV-4	2-1/2"	
157102	3BVSPFLF	LFFBV-4	3"	

##### LFFBVS-4 2-Piece Full Port Ball Valve (Swt)

- Lead free
- Metal-to-metal adapter body seal to eliminate adapter leaks after soldering
- Fluorocarbon elastomer stem O-ring prevents stem leaks
- Adjustable stem packing gland provides longer service life
- Bottom loaded blowout proof stem
- PTFE stem packing seal and seats
- Machined chrome-plated Lead Free brass ball



Part #	Mfg #	Model	Size	Price
157103	12SBVSPFLF	LFFBVS-4	1/2"	
157104	34SBVSPFLF	LFFBVS-4	3/4"	
157105	1SBVSPFLF	LFFBVS-4	1"	
157106	114SBVSPFLF	LFFBVS-4	1-1/4"	
157107	112SBVSPFLF	LFFBVS-4	1-1/2"	
157108	2SBVSPFLF	LFFBVS-4	2"	
157109	3SBVSPFLF	LFFBVS-4	3"	

#### WBVLF-3/WBVSFLF-3 and WBVC Series Brass Standard Port Ball Valve

- Lead free
- For full range of gases and liquids on commercial residential and industrial applications

##### WBVCLF 3-Pc Brass Ball Valve (Comp)

- Lead free
- Pressure rating: 400 psi WOG, 150 psi WSP



Part #	Mfg #	Model	Size	Price
156517	34BVCOMP	WBVCLF	3/4"	

**Ball Valves - Potable**

**ProPEX® Ball Valves**

**ProPEX® LF Brass Ball Valve - Large Bore (PEX x PEX)**

- Not compatible with applications using glycol



Part #	Mfg #	Size	Price
028097	12APBV12PP	1/2" x 1/2"	
028098	34APBV34PP	3/4" x 3/4"	

**ProPEX® LF Brass Ball Valve - Full Port (PEX x PEX)**

- Not compatible with applications using glycol



Part #	Mfg #	Size	Price
101212	WILFC4821010	1" x 1"	

**ProPEX® LF Brass to Copper Ball Valve - Large Bore (PEX x CU Adapter)**



Part #	Mfg #	Size	Price
033028	12APBVPC	1/2" x 1/2"	
056788	34APBVPC	3/4" x 3/4"	

**ProPEX® LF Brass Ball Valve (PEX to MIP)**

- Quarter-turn
- Not Compatible with applications using glycol



Part #	Mfg #	Size	Price
033014	12APBV12PM	1/2" x 1/2"	

**ProPEX® LF Brass Commercial Ball Valves**

- Compatible with applications containing no more than 50% propylene glycol



Part #	Mfg #	Size	Price
172250	WILFC4825050	1/2" x 1/2"	
172251	WILFC4827575	3/4" x 3/4"	
172253	WILFC4821313	1-1/4" x 1-1/4"	
172254	WILFC4821515	1-1/2" x 1-1/2"	
172255	WILFC4822020	2" x 2"	

**Ball Valve**

- Copper Adapter



Part #	Mfg #	Size	Price
144914	WIA5802075	3/4" R20 Thread	
238726	WIA5802575	3/4" R25 Thread	

**Ball and Balancing Valve**

Part #	Mfg #	Size	Price
144915	WIA5902075	3/4" R20 Thread	

**Quick and Easy Valves**

**ProPEX Copper Ball Valve (PEX x CU)**

- Brass shut-off valve for 1/2" and 3/4" AQUAPEX® to 1/2" or 3/4" copper pipe
- Quick and Easy tool and Quick and Easy rings required (sold separately)



Part #	Mfg #	Size	Bore	Price
093399	WIQ5806375	5/8" x 3/4"	0.44"	

## Ball Valves - Potable

### Ball Valves

#### One-Piece Ball Valve

- 316 Stainless steel
- 150#
- Series SC101



Part #	Size	Price
065103	1/2"	

#### Two-Piece Ball Valve

- 316 Stainless steel
- Series SC201



Part #	Size	Price
167534	1/4"	
167535	3/8"	
167536	1/2"	
167537	3/4"	
167538	1"	
167539	1-1/4"	
167540	1-1/2"	
167541	2"	

#### Two-Piece Full Port Ball Valve

- 316 Stainless steel
- 1000#
- Series 50M76



Part #	Size	Price
175676	1/4"	
175677	3/8"	
175678	1/2"	
176137	3/4"	
176138	1"	
176139	1-1/4"	
176140	1-1/2"	
176141	2"	

#### Three-Piece Full Port Ball Valve with Mounting Pad

- 316 Stainless steel
- 1000#
- Series 53036



#### Threaded

Part #	Size	Price
176142	1/2"	
176143	3/4"	
176144	1"	
176145	1-1/4"	
176146	1-1/2"	
176147	2"	

#### Socket Weld

Part #	Size	Price
176148	1/2"	
176149	3/4"	
176150	1"	
176151	1-1/4"	
176152	1-1/2"	
176153	2"	

#### Two-Piece Standard Port Ball Valve

- 316 SS
- 2000 wog
- Series 54576



Part #	Size	Price
187283	3/8"	

## Ball Valves - Potable

### Lead-Free Ball Valves

#### T1001NL Full Port Ball Valve

- Lead-Free
- Bottom-loaded blowout-proof system
- End connections comply with:  
ANSI / ASME B1.20.1 (FNPT)  
ANSI / ASME B16.18 (CTS solder)



Part #	Mfg #	Size	Price
193653	101023NL	1/2" IPS	

#### T-806 Full Port PEX Ball Valve

- Compact forged brass body
- PEX barb end connections are for PEX tubing conforming to ASTM F876 or F877
- 400 psi cold working pressure



Part #	Mfg #	Size	Price
193007	101585NL	1/2"	
193008	101586NL	3/4"	
196521	101587NL	1"	

### Gas Stop Valves

#### T-3100 Sidetap FNPT Gas Ball Valve

- One-piece forged brass body
- Integral 1/8" NPT tapped manometer test port and plug
- 175 psi cold working pressure



Part #	Mfg #	Size	Price
191888	102-515	3/4"	

### Miscellaneous Valves

#### Tankless Kit NL

- Tankless water heater valve kit
- No Lead



Part #	Mfg #	Size	Price
196188	101149NL	3/4" FNPT Union x FNPT	
196187	101154NL	3/4" FNPT Union x Sweat	



## Ball Valves

### Ball Valves

#### Two-Way Clamp End Ball Valve

- Cavity filled seat
- ISO 5211 mount pad
- Blow-out proof stem
- Lockable handle
- 320 grit ID/180 grit OD
- Full port design
- Live-loaded stem packing
- Three-piece design for field service



Part #	Mfg #	Size	Price
177788	1SSSAN316BV	1"	
177878	112SSSAN316BV	1-1/2"	
177789	2SSSAN316BV	2"	
177790	3SSSAN316BV	3"	

**Ball Valves - Non-Potable**

**Bronze Ball Valves**

**T-580-70 Conventional Port 2-Piece Bronze Ball Valve (FNPT x FNPT)**

- Lever handle
- Blowout-proof stem
- PTFE Seats
- Chrome-plated ball
- Bar non-shock cold working pressure: 600 psi/41.4
- Bar saturated steam: 150 psi/10.3



Part #	Mfg #	Size	Price
016216	T-580-70	1-1/4"	
016217	T-580-70	1-1/2"	
016218	T-580-70	2"	
016220	T-580-70	3"	

**T-580-70-UL Conventional Port 2-Piece UL Listed Bronze Ball Valve**

- Lever handle
- Blowout-proof system
- Chrome-plated ball
- Bar non-shock cold LP gas pressure: 250 psi/17.2 per UL842



Part #	Mfg #	Size	Price
136143	T580-70-UL	1-1/4"	

**S-580-70 Conventional 2-Piece Port Bronze Ball Valve (C x C)**

- Lever handle
- Blowout-proof stem
- Chrome-plated ball
- RTFE Seats



Part #	Mfg #	Size	Price
016257	S-580-70	1-1/4"	
016258	S-580-70	1-1/2"	
016259	S-580-70	2"	
016260	S-580-70	2-1/2"	
016261	S-580-70	3"	

**T-585-70-UL 2-Piece Full Port Bronze Ball Valve (FNPT x FNPT)**

- Blowout-proof stem
- Bronze trim
- UL Listed
- Bar non-shock LP Gas per UL842: 250 psi/17.2



Part #	Mfg #	Size	Price
032224	T-585-70-UL	3/4"	
100905	T-585-70-UL	1"	

**T-585-70 2-Piece Full Port Bronze Ball Valve**

- Blowout-proof stem
- Bronze trim
- UL Listed
- Bar non-shock LP Gas per UL842: 250 psi/17.2



Part #	Mfg #	Size	Price
016210	T-585-70	1/4"	
016212	T-585-70	1/2"	
016213	T-585-70	3/4"	
016214	T-585-70	1"	
020608	T-585-70	2"	

**T-585-70-HC 2-Piece Full Port Bronze Ball Valve (T x HC)**

- Non-shock cold working pressure
- Blow out-proof stem
- 3/4" Hose connection with cap and chain
- Bronze trim



Part #	Mfg #	Size	Price
117873	T-585-70-HC	3/4"	

**S-585-70-HC 2-Piece Full Port Bronze Ball Valve**

- Non-shock cold working pressure
- Blow out-proof stem
- **HC Models:** Solder end X 3/4" hose connection with cap and chain



S-585-70-HC

Part #	Mfg #	Size	Price
117530	S-585-70-HC	1/2"	



**Ball Valves - Non-Potable**

**Bronze Ball Valves (Continued)**

**S-585-70-HC 2-Piece Full Port Bronze Ball Valve**

Part #	Mfg #	Size	Price
143191	S-585-70-HC	3/4"	
016255	S-585-70	3/4", Lever Hdl	
016256	S-585-70	1", Lever Hdl	
051256	S-585-70	1-1/4", Lever Hdl	
051258	S-585-70	1-1/2", Lever Hdl	
045647	S-585-70	2", Lever Hdl	

**T-FP-600A 2-Piece Full Port Brass Ball Valve  
(NPT x NPT)**

- 1/4 turn to open and close



Part #	Mfg #	Size	Price
128134	14BVNI	1/4"	
128107	38BVNI	3/8"	
128108	12BVNI	1/2"	
128109	34BVNI	3/4"	
128110	1BVNI	1"	
128111	114BVNI	1-1/4"	
128112	112BVNI	1-1/2"	
128114	2BVNI	2"	
128117	3BVNI	3"	

**S-FP-600A 2-Piece Full Port Brass Ball Valve  
(C x C)**

- 1/4 turn to open and close



Part #	Mfg #	Size	Price
128138	38SBVNI	3/8"	
128118	12SBVNI	1/2"	
128120	34SBVNI	3/4"	
128121	1SBVNI	1"	
128122	114SBVNI	1-1/4"	
128125	112SBVNI	1-1/2"	
128126	2SBVNI	2"	
128127	212SBVNI	2-1/2"	
128129	3SBVNI	3"	

**The Isolator® Uni-Flange Ball Valve  
(SWT x Rotating Flange)**

- Lead free
- Full port forged brass
- Detachable rotating flange
- Adjustable packing gland
- Includes wing style "T" handle, nuts & bolts
- (-HV) models fit both standard & high velocity pumps



Part #	Mfg #	Size	Price
244002	51403W	3/4"	
244003	51404WHV	1"	

**Stainless Steel Ball Valves**

**T-580-S6-R-66-LL 2-Piece Stainless Steel Ball Valve**

- Conventional port
- Blowout-proof stem
- Pressure rating: 2000 psi  
138 bar non-shock cold working pressure
- Max temp: 400°F



Part #	Mfg #	Size	Price
017508	T580-S6R-66-L	1/2"	
	L		

**T-585-S6-R-66-LL 2-Piece Stainless Steel Ball Valve**

- Full port
- Blowout-proof stem
- Pressure rating: 1000 psi  
69 bar non-shock cold working pressure
- Max temp: 400°F



Part #	Mfg #	Size	Price
140221	T585-S6R-66-L	1/2"	
	L		
140220	T585-S6R-66-L	3/4"	
	L		
130022	T585-S6R-66-L	1"	
	L		

## Ball Valves - Non-Potable

### Carbon Steel Ball Valves

**T-580-CS-R-25 Conv Port Threaded Carbon Steel  
Ball Valve  
2-Piece Body, Blowout-Proof Stem  
Chrome Plated Ball**

- 1/4" - 1" 2000# WOG
- CS F x F w/RTFE seat; CS trim
- *Material List*  
 Body - Carbon Steel, A-216 GR WCB, Phosphate coated  
 Body - 1/4" to 1" - Carbon Steel, ASTM A-108  
 Type 12L14, Phosphate coated  
 Ball - Carbon Steel, ASTM A-108  
 Type 12L14, Chrome-plated  
 Stem - Carbon Steel, ASTM A-108  
 Type 12L14, Nickel-plated  
 Handle - Zinc-Plated Steel, Plastisol coated



Part #	Mfg #	Size	Price
121054	T-580-CS-R-25	3/8"	
040659	T-580-CS-R-25	3/4"	
040658	T-580-CS-R-25	1/2"	

### Ball Valve Accessories

#### Lever Handle Extension

Part #	Mfg #	Size	Use with	Price
117510	T025118FG	1/2"	T/S580	
077849	T025121FG	1"	T/S580	
117511	T025124FG	1-1/2"	T/S580	

### PEX Fittings

#### PEX Crimp Sleeve

- *Stainless steel*
- *For potable water use*
- *Complies with ASTM F877*
- *Maximum service temperature: 200°F*



Part #	Mfg #	Size	Price
225123	PX02110	1/2"	
225126	PX02120	3/4"	
225127	PX02130	1"	



## Ball Valves - Non-Potable

### True Union Ball Valves CPVC True Union Ball Valve



#### EPDM

Part #	Mfg #	Size	Conn	Price
127338	12CPVCP8BVTU	1/2"	Thrd x Soc	
138816	34CPVCP8BVTU	3/4"	Thrd x Soc	
140335	1CPVCP8BVTU	1"	Thrd x Soc	
138915	112CPVCP8BVTU	1-1/2"	Thrd x Soc	
121679	2CPVCP8BVTU	2"	Thrd x Soc	

#### FKM

Part #	Mfg #	Size	Conn	Price
180264	12CPVCP8BVTUV	1/2"	Thrd x Soc	
094814	34CPVCP8BVTUV	3/4"	Thrd x Soc	
135668	1CPVCP8BVTUV	1"	Thrd x Soc	
180265	114CPVCP8BVTU V	1-1/4"	Thrd x Soc	
135602	112CPVCP8BVTU V	1-1/2"	Thrd x Soc	



## Ball Valves - Non-Potable

### PVC Ball Valves

#### Compact Ball Valve (Regular Style)

- Pressure rating for 3" - 6" & Flg: 150 psi @ 73°F
- Maximum service temperature: 140°F
- Rated for vacuum service
- Assembled with silicone-free water-soluble lubricants
- Standard 6" valve uses lever style handle



#### Compact Socket Ends Ball Valve - EPDM

Part #	Mfg #	Size	Price
038435	3P8BV	3"	

#### Compact Socket Ends Ball Valve - FKM

Part #	Mfg #	Size	Price
013175	12P8BV	1/2"	
014742	34P8BV	3/4"	
012264	1P8BV	1"	
052610	114P8BV	1-1/4"	
012526	112P8BV	1-1/2"	
013900	2P8BV	2"	

#### PVC True Union Threaded & Socket Ball Valve



FKM

Part #	Mfg #	Size	Conn	Price
064778	12P8TUBV	1/2"	Thrd x Soc	
030772	34PBVTU	3/4"	Thrd x Soc	
064780	1P8TUBV	1"	Thrd x Soc	
064781	112P8TUBV	1-1/2"	Thrd x Soc	
099204	2P8TUBV	2"	Thrd x Soc	

### True Union 2000 Industrial Ball Valve



#### PVC True Union 2000 Thrd & Soc Ball Valve - EPDM

Part #	Mfg #	Size	Price
065742	12P8BVTU	1/2"	
065743	34P8BVTU	3/4"	
065744	1P8BVTU	1"	
065745	114P8BVTU	1-1/4"	
065746	112P8BVTU	1-1/2"	
065747	2P8BVTU	2"	

#### PVC True Union 2000 Thrd & Soc Ball Valve - FKM

Part #	Mfg #	Size	Conn	Price
182039	12P8BVTUVITON	1/2"	Thrd x Soc	
182081	34P8BVTUVITON	3/4"	Thrd x Soc	
182078	1P8BVTUVITON	1"	Thrd x Soc	
191418	114P8BVTUVITO N	1-1/4"	Thrd x Soc	
180287	112P8BVTUVITO N	1-1/2"	Thrd x Soc	
151744	2P8BVTUVITON	2"	Thrd x Soc	

#### PVC True Union 2000 Soc Ball Valve - EPDM

Part #	Mfg #	Size	Price
065749	3P8BVTU	3"	
065750	4P8BVTU	4"	

### True Union Ball Check Valve



Part #	Mfg #	Size	Conn	Price
054067	34P8TUCV	3/4"	Thrd x Soc	
064790	1P8BCV	1"	Thrd x Soc	
064791	114P8BCV	1-1/4"	Thrd x Soc	
064793	2P8BCV	2"	Thrd x Soc	
055280	3P8CV	3"	Soc x Soc	



## Ball Valves - Non-Potable

### Utility Ball Valves

- Maximum pressure: 150 psi @ 73°F
- Maximum service temperature: 140°F
- Assembled with silicone-free water - soluble lubricants
- EPDM O-Ring seal



#### PVC White Utility Threaded Ends Ball Valve - EPDM

Part #	Mfg #	Size	Price
039751	12PBVT	1/2"	
053977	34PBVT	3/4"	
053653	1PBVT	1"	

#### PVC White Utility Socket Ends Ball Valve - EPDM

- Maximum pressure: 150 psi @ 73°F

Part #	Mfg #	Size	Price
013167	12PBV	1/2"	
014738	34PBV	3/4"	
012261	1PBV	1"	
012852	114PBV	1-1/4"	
012492	112PBV	1-1/2"	
013866	2PBV	2"	
017765	3PBV	3"	
045205	4PBV	4"	

### CWV Ball Valve S x S

- Pressure Rating @ 73°F (23°C) Water 150 psi



Part #	Mfg #	Size	Price
251148	12PBVCWV	1/2"	
187036	34PBVCWV	3/4"	
187037	1PBVCWV	1"	

### CWV Ball Valve Threaded

- Pressure Rating @ 73°F (23°C) Water 150 psi



Part #	Mfg #	Size	Price
251147	12PBVTCWV	1/2"	
249725	34PBVTCWV	3/4"	
251146	1PBVTCWV	1"	

## Ball Valves - Non-Potable

### Ball Valves

#### 73A Series 2-Piece Ball Valve

- Threaded
- Standard port
- Forged carbon steel
- 2000 CWP to 1", 1500 CWP to 2"



Part #	Mfg #	Size	Price
175124	73A-101-01A	1/4"	
175125	73A-201-01A	3/8"	
175126	73A-103-01A	1/2"	
175127	73A-104-01A	3/4"	
175128	73A-105-01A	1"	
175129	73A-106-01A	1-1/4"	
175131	73A-701-01A	1-1/2"	
175132	73A-801-01A	2"	

#### 77C Series 2-Piece Ball Valve

- Threaded or solder
- Full port, bronze
- 600 CWP, Threaded sizes:  
1/4" to 2-1/2"
- 600 CWP, Solder sizes:  
3/8" to 2-1/2"



#### 77C-100 Series - Threaded

Part #	Mfg #	Size	Price
175162	77C-101-01	1/4"	
175163	77C-102-01	3/8"	
175164	77C-103-01	1/2"	
175165	77C-104-01	3/4"	
175166	77C-105-01	1"	
175167	77C-106-01	1-1/4"	
175168	77C-107-01	1-1/2"	
175169	77C-108-01	2"	

#### 77C-200 Series - Solder

Part #	Mfg #	Size	Price
175175	77C-202-01	3/8"	
175176	77C-203-01	1/2"	
175177	77C-205-01	1"	
175178	77C-206-01	1-1/4"	

### 94A Series 2-Piece Ball Valve

- Full-Port
- Blow-out Proof Stem Design
- Adjustable Stem Packing Nut
- Silicone Free
- 100% Factory Tested



#### 94A Series - Threaded

Part #	Mfg #	Size	Price
175289	94A-101-01	1/4"	
175290	94A-102-01	3/8"	
175291	94A-103-01	1/2"	
175292	94A-104-01	3/4"	
175293	94A-105-01	1"	
175295	94A-106-01	1-1/4"	
175296	94A-107-01	1-1/2"	
175297	94A-108-01	2"	
175298	94A-109-01	2-1/2"	
175299	94A-100-01	3"	
175300	94A-10A-01	4"	

#### 94A Series - Solder

Part #	Mfg #	Size	Price
175303	94A-203-01	1/2"	
175304	94A-204-01	3/4"	
175305	94A-205-01	1"	
175306	94A-206-01	1-1/4"	
175307	94A-207-01	1-1/2"	
175308	94A-208-01	2"	
175309	94A-209-01	2-1/2"	
175310	94A-200-01	3"	
175311	94A-20A-01	4"	



**Ball Valves - Non-Potable**

**Ball Valves**

**Econo Ball Valve**

- PVC Sch 40
- Rated @ 150PSI @ 72°F static pressure
- ABS Handles
- EPDM O-rings



Part #	Mfg #	Connection Size	Price
191425	PVV34BSS	3/4" IPS Slip Connection	
191426	PVV1BSS	1" IPS Slip Connection	
191427	PVV114BSS	1-1/4" IPS Slip Connection	
191428	PVV112BSS	1-1/2" IPS Slip Connection	
191429	PVV2BSS	2" IPS Slip Connection	

## Butterfly Valves - Non-Potable

### Commercial/Industrial Butterfly Valves

#### Domestic Lug Body Butterfly Valve Fig LD2000 200# Ductile Iron

- For use in commercial and light industrial
- Bi-directional dead-end service
- Pressure rating: 200 psi
- Raised face flange
- EPDM Molded-in seat liner
- Aluminum bronze disc
- Stainless steel stem with copper bushings



Part #	Mfg #	Size	Operator	Price
016146	LD2000-3	2-1/2"	Lever Lock	
016148	LD2000-3	3"	Lever Lock	
016149	LD2000-3	4"	Lever Lock	
019076	LD2000-3	6"	Lever Lock	
071422	LD2000-5	10"	Gear Op	

#### Fig LD3010-3 Domestic DI Lug Body Butterfly Valve Lever Lock Operated Mech

- Pressure rating: 250 psi
- Material list  
Body - ductile iron  
Disc - ductile iron  
Seat - buna-N  
Stem - 416 SS  
Upper & lower - copper alloy  
Collar - brass



Part #	Mfg #	Size	Price
016150	LD3010-3	2-1/2"	
016151	LD3010-3	3"	
016152	LD3010-3	4"	
016153	LD3010-3	5"	
016154	LD3010-3	6"	

### Import Economy Lug Body Butterfly Valve

#### Fig N200-235-LH Import Lug Body Lever Lock Operating Mechanism

- Pressure rating: 200 psi
- Material list  
Body - cast Iron  
Disc - aluminum bronze  
Seat - EPDM



Part #	Mfg #	Size	Price
128245	N200-235-LH	2"	
128246	N200-235-LH	2-1/2"	
128247	N200-235-LH	3"	
128248	N200-235-LH	4"	
128249	N200-235-LH	5"	
128250	N200-235-LH	6"	
128251	N200-235-LH	8"	
128253	N200-235-G	8", Gear Operated O	
128255	N200-235-G	12", Gear Operated O	

### GD-4765 Grooved Butterfly Valve

- Ductile iron
- 300 PSI
- Compatible with IPS pipe



Part #	Mfg #	Size	Price
150153	GD-4765	2-1/2"	
150154	GD-4765	3"	

## Butterfly Valves - Non-Potable

### Butterfly Valves

- For positive shut-off service on commercial, irrigation, HVAC, and industrial applications
- Cast iron body, 416 stainless steel shaft
- Mounting shaft for 10-position lever, gear operator or actuator
- Extended neck for 2" of insulation, pinned disc

#### 03-121-15 Butterfly Valve - Lug, Lever Handle

- Aluminum bronze disc
- EPDM seat
- Standard handle (10-position only)
- DBF Series use domestic and foreign components that have been assembled & tested in USA



Part #	Mfg #	Model	Size	Price
078611	0525567	BF0312115M2	2-1/2"	
078613	0525585	BF0312115M2	3"	
078614	0525603	BF0312115M2	4"	
078616	0525639	BF0312115M2	6"	
078617	0525657	BF0312115M2	8"	

#### 03-121-1G Butterfly Valve - Lug, Gear Operator

- Ductile iron body
- Aluminum bronze disc
- 416 Stainless steel shaft
- EPDM Seat
- Gear operator



Part #	Mfg #	Model	Size	Price
078608	0525669	BF031211GM2	8"	
078609	0525687	BF031211GM2	10"	
078610	0525705	BF031211GM2	12"	

## Butterfly Valves - Non-Potable

### Butterfly Valves

#### Gear Operated Butterfly Valve

- 200 psi
- Cast iron body
- Lug style
- 316 SS disc
- EPDM Seat



Part #	Size	Price
174945	10"	
174946	12"	

#### Lever Operated Butterfly Valve

- 200 psi
- Cast iron body
- Lug style
- Aluminum bronze disc
- EPDM seat



Part #	Size	Price
175019	2"	
169464	2-1/2"	
169465	3"	
169466	4"	
169467	6"	
174944	8"	



---

---

## Butterfly Valves

---

---

### Butterfly Valves

#### Multi-Position Clamp End Butterfly Valve

- EPDM standard seat  
—Silicone and Viton®
- Field serviceable
- 100% Hydraulic pressure tested
- Handle interchangeable to either side
- Operating temperature: 15°F-195°F
- Sanitary polished to a 32Ra on all wetted surfaces
- Repair kits available consisting of seat & bushings



Part #	Mfg #	Size	Price
177659	SSBFV-1.5-30 4	1-1/2"	
177660	SSBFV-2-304	2"	
177662	SSBFV-3-304	3"	

---



---

## Check Valves - Potable

---



---

### Bronze Check Valves

#### T-413-Y 125# Bronze Check Valve (FNPT x FNPT)

- Horizontal swing
- Regrinding type
- Y-Pattern
- Renewable steam seat and disc
- Non-shock cold working pressure: 200 psi



Part #	Mfg #	Size	Price
161659	T413Y-LF	1/2"	
161660	T413Y-LF	3/4"	
161661	T413Y-LF	1"	
161662	T413Y-LF	1-1/4"	
161663	T413Y-LF	1-1/2"	
161664	T413Y-LF	2"	

#### S-413-Y 125# Bronze Check Valve (Swt x Swt)

- Horizontal swing
- Re-grinding type
- Y-Pattern
- Renewable PTFE seat disc
- Non-shock cold working pressure: 200 psi



Part #	Mfg #	Size	Price
161650	S413Y-LF	1/2"	
161652	S413Y-LF	3/4"	
161653	S413Y-LF	1"	
161654	S413Y-LF	1-1/4"	
161656	S413Y-LF	1-1/2"	
161657	S413Y-LF	2"	



## Check Valves - Potable

### Check Valves

#### LF600 Cast Copper Maxi-Flo Check Valve

- PTFE seat
- Silent operation
- Threaded ends
- Conical Lead Free\* check for full fluid flow
- Low pressure drop equivalent to a swing check
- Stainless steel guide, rod and spring (1 1/4" to 2")
- Install in horizontal or vertical position with upward flow  
(consult factory for proper use in vertical installations)



Part #	Mfg #	Model	Size	Price
145898	0555175	LF600	1/2"	
145899	0555176	LF600	3/4"	
157063	0555177	LF600	1"	
157065	0555178	LF600	1-1/4"	
157066	0555179	LF600	1-1/2"	
157067	0555180	LF600	2"	

#### LF601S Cast Copper Maxi-Flo Valves

- Viton® disc
- Cast copper silicon alloy body for durability
- Integral Lead Free\* copper silicon alloy seat
- Install in horizontal or vertical position with upward flow
- Low pressure drop equivalent to a swing check
- Silent operation



Part #	Mfg #	Model	Size	Price
156522	0555181	LF601S	1/2"	
156513	0555182	LF601S	3/4"	
156514	0555183	LF601S	1"	

#### LF709 Double Check Valve Assembly

- Replaceable ss seats
- Max flow at low pressure drop
- No special tools required for servicing
- Captured spring assemblies for safety
- Approved for vertical flow up installation



Part #	Mfg #	Model	Size	Price
157318	0122785	LF709-OSY	2-1/2"	
157319	0122786	LF709-OSY	3"	

### Check Valves (Continued)

#### LF709 Double Check Valve Assembly

Part #	Mfg #	Model	Size	Price
157320	0122789	LF709-OSY	4"	
157321	0122790	LF709-OSY	6"	
157322	0122791	LF709-OSY	8"	
157323	0122794	LF709-OSY	10"	



---

---

## Check Valves - Non-Potable

---

---

### PVC Check Valves

#### PVC White Utility Swing Check Valves - Thrd



Part #	Mfg #	Size	Price
084826	34P4CVTHRD	3/4"	
084827	1P4CVTHRD	1"	



## Check Valves

### Check Valves

#### Spring Loaded Check Valve

- Viton® seats & seals
- Meets 3-A specifications
- Field serviceable
- Operating temperature: 15°F-195°F
- Maximum Operating pressure: 140 PSI



Part #	Mfg #	Size	Price
177880	SS45CV-1.5-31 6	1-1/2"	

#### Spring Loaded Check Valve Repair Kit

- For model SS45CV-size-alloy
- Kit includes:
  - Flow plate
  - Stem
  - SS spring
  - Viton® body gasket

Part #	Mfg #	Size	Price
177794	SS45CV-RK-1	1"	
177795	SS45CV-RK-2	2"	



## Check Valves - Non-Potable

### Viega ProPress® Valves

#### ProPress® Check Valve (P x P)

- Bronze
- Smart Connect® feature
- Inline



Part #	Mfg #	Size	Price
123636	12PPCV	1/2"	
123637	34PPCV	3/4"	
123638	1PPCV	1"	
143972	114PPCV	1-1/4"	
125222	112PPCV	1-1/2"	
123639	2PPCV	2"	

## Check Valves - Non-Potable

### Bronze Check Valves

#### S-413-B 125# Bronze Check Valve (C x C)

- Horizontal swing
- Re-grinding type
- Y-Pattern
- Renewable seat and disc
- 200psi/13.8 Bar non-shock cold working pressure



Part #	Mfg #	Size	Price
062776	S413-B	3/4"	

#### T-413-Y 125# Bronze Check Valve (FNPT x FNPT)

- Y-Pattern
- Horizontal swing
- Re-grindable seat
- Renewable PTFE disc
- Non-shock cold working pressure: 200 psi



Part #	Mfg #	Size	Price
016190	T-413-Y	3/4"	

#### T-433-B 150# Bronze Check Valve (FNPT x FNPT)

- Horizontal swing
- Re-grinding type
- Y-Pattern
- Renewable bronze seat disc
- Non-shock cold working pressure: 300 psi



Part #	Mfg #	Size	Price
062782	T-433-B	3/4"	
062785	T-433-B	1-1/2"	

#### T-433-Y 150# Bronze Check Valve (FNPT x FNPT)

- Horizontal swing
- Re-grinding type
- Y-Pattern
- Renewable PTFE seat disc
- Non-shock cold working pressure: 300 psi



Part #	Mfg #	Size	Price
035223	T-433-Y	3/4"	
158701	T-433-Y	1"	
101111	T-433-Y	2"	
016196	T-433-Y	3"	

#### S-433-Y 150# Bronze Check Valve (Swt x Swt)

- Horizontal swing
- Re-grinding type
- Y-Pattern
- Renewable PTFE seat disc
- Non-shock cold working pressure: 300 psi



Part #	Mfg #	Size	Price
016252	S-433-Y	2-1/2"	

#### T-453-B 200# Bronze Check Valve (NPT x NPT)

- Horizontal swing
- Re-grinding type
- Renewable seat and disc
- Y-Pattern
- Non-shock cold working pressure: 400psi/27.6



Part #	Mfg #	Size	Price
016199	T-453-B	3/4"	
016203	T-453-B	2"	

### Iron Body Check Valves

#### F-918-B 125# Cast Iron Check Valve (Flg x Flg)

- Bolted bonnet
- Horizontal swing
- Renewable seat and disc
- IBBM
- Non-shock cold working pressure: 200 psi/13.8 bar



Part #	Mfg #	Size	Price
016143	F-918-B	2-1/2"	
016144	F-918-B	3"	
016145	F-918-B	4"	
069778	F-918-B	6"	

#### F-910-B-LF 125# Cast Iron Check Valve (Flg x Flg)

- Flanged
- Globe style
- Renewable seat and disc
- Spring actuated
- 200psi/13.8 Bar non-shock cold working pressure



Part #	Mfg #	Size	Price
161668	F-910-B-LF	3"	
161669	F-910-B-LF	4"	

---



---

## Check Valves - Non-Potable

---



---

### W-920-W-LF 125# Cast Iron Wafer Style Check Valve

- *Buna-N seat*
- *Twin bronze discs*
- *Rubber seat*
- *Spring actuated*
- *250psi/17.2 Bar non-shock cold working pressure*



Part #	Mfg #	Size	Price
161671	W-920W-LF	2-1/2"	
161672	W-920W-LF	3"	



## Check Valves - Non-Potable

### Swing Check Valves

#### 521 Brass Swing Check Valve

- 200 WOG
- Lead free



Part #	Mfg #	Size	Price
156233	38ICVLF	3/8" FIP	
156234	12ICVLF	1/2" FIP	
156235	34ICVLF	3/4" FIP	
156236	1ICVLF	1" FIP	
156237	114ICVLF	1-1/4" FIP	
156238	112ICVLF	1-1/2" FIP	
156239	2ICVLF	2" FIP	
156227	12SCVLF	1/2" C x C	
156228	34SCVLF	3/4" C x C	
156229	1SCVLF	1" C x C	
156230	114SCVLF	1-1/4" C x C	
156231	112SCVLF	1-1/2" C x C	
156232	2SCVLF	2" C x C	

## Check Valves - Non-Potable

### Check Valves

#### Stainless Swing Check Valve

- 200# 316SS
- Series SV20276
- Threaded



Part #	Size	Price
176185	1/4"	
176187	3/8"	
176188	1/2"	
176189	3/4"	
176190	1"	
176191	1-1/4"	
176192	1-1/2"	
176193	2"	

#### Forged Carbon Swing Check Valve

- 800#
- Bolted bonnet
- Forged carbon steel A105



#### Socket Weld

Part #	Size	Price
176201	1/2"	
176202	3/4"	
176203	1"	
176204	1-1/4"	
176205	1-1/2"	
176206	2"	

#### Threaded

Part #	Size	Price
176195	1/2"	
176196	3/4"	
176197	1"	
176198	1-1/4"	
176199	1-1/2"	
176200	2"	



## Gas Stop Valves

### Gas Stop Valves - Domestic

**Bronze Flat/Tee Head with Check - 2 psi  
(FIP x FIP)**

- Plug style



Part #	Mfg #	Size	Notes	Price
013133	10596	1/2"	CSA Approved	
014702	10596	3/4"	CSA Approved	
012236	10596	1"		
012827	10596	1-1/4"		
012457	10596	1-1/2"		
013826	10596	2"		

**Iron Body Flat Head Less Check - 100 psi  
(FIP x FIP)**

- Plug style
- Black
- Non-tamperproof



Part #	Mfg #	Size	Price
002136	10685B	1-1/2"	

## Gas Stop Valves

### Stop Valves

#### GBV Series Gas Ball Valve

- CSA/UL Approved
- Brass 2-piece body construction
- Rated 32° - 125°F



#### GBV Ball Valve with Tee Handle (FNPT)

Part #	Mfg #	Model	Size	Price
013130	12GASBV	GBV	1/2"	
014698	34GASBV	GBV	3/4"	
069646	1GASBV	GBV	1"	

## Gate Valves - Non-Potable

### Bronze Gate Valves

#### T-111 125# Multi-Turn Bronze Gate Valve (FNPT x FNPT)

- Screw-in bonnet
- Rising stem
- Solid wedge
- Non-shock cold working pressure: 200 psi



Part #	Mfg #	Size	Price
016155	T-111	1/4"	
016156	T-111	3/8"	
016157	T-111	1/2"	
016158	T-111	3/4"	
016159	T-111	1"	
016160	T-111	1-1/4"	
016161	T-111	1-1/2"	
016162	T-111	2"	
016163	T-111	2-1/2"	
016164	T-111	3"	

#### S-111 125# Bronze Gate Valve (Swt x Swt)

- Screw-in bonnet
- Rising stem
- Solid wedge
- Non-shock cold working pressure: 200 psi



Part #	Mfg #	Size	Price
016230	S-111	1/2"	
016231	S-111	3/4"	
016232	S-111	1"	
016233	S-111	1-1/4"	
016234	S-111	1-1/2"	
016235	S-111	2"	

#### T-113-LF 125# Bronze Gate Valve (FNPT x FNPT)

- Screw-in bonnet
- Non-rising stem
- Solid wedge
- Non-shock cold working pressure: 200 psi



Part #	Mfg #	Size	Price
161683	T-113-LF	1/2"	
161684	T-113-LF	3/4"	
161685	T-113-LF	1"	
161686	T-113-LF	1-1/4"	
161687	T-113-LF	1-1/2"	
161688	T-113-LF	2"	

#### S-113 125# Bronze Gate Valves (Swt x Swt)

- Screw-in bonnet
- Non-rising stem
- Solid wedge
- Non-shock cold working pressure: 200 psi



Part #	Mfg #	Size	Price
016242	S-113	1"	
128277	S-113	1-1/4"	
016244	S-113	2"	

#### T-131 150# Bronze Gate Valves (NPT x NPT)

- Screw-in bonnet
- Rising stem
- Solid wedge
- Bar non-shock working pressure: 300 psi



Part #	Mfg #	Size	Price
106175	T-131	3/4"	
147686	T-131	1"	

## Gate Valves - Non-Potable

### T-134 150# Bronze Gate Valves (FNPT x FNPT)

- Block pattern
- Union bonnet
- Rising stem
- Solid wedge
- Non-shock cold working pressure: 300 psi



Part #	Mfg #	Size	Price
174553	T-134	1/2"	
059019	T-134	3/4"	
059021	T-134	1-1/4"	
059022	T-134	1-1/2"	
059023	T-134	2"	

### S-134 150# Bronze Gate Valves (Swt x Swt)

- Block Pattern
- Union Bonnet
- Rising Stem
- Solid Wedge
- Non-shock cold working pressure: 300 psi



Part #	Mfg #	Size	Price
059025	S-134	1"	
059028	S-134	1-1/2"	
059027	S-134	2"	

### T-174-SS 300# Bronze Gate Valves (FNPT x FNPT)

- Block pattern
- Union bonnet
- Rising stem
- Alloy solid wedge
- Stainless steel seats
- Non-shock cold working pressure: 600 psi



Part #	Mfg #	Size	Price
016173	T-174-SS	1/2"	
016174	T-174-SS	3/4"	
016175	T-174-SS	1"	
016176	T-174-SS	1-1/4"	
021386	T-174-SS	1-1/2"	
016177	T-174-SS	2"	

### T-174-A 300# Bronze Gate Valves (NPT x NPT)

- Block pattern
- Union bonnet
- Rising stem
- Alloy solid wedge
- Non-shock cold working pressure: 600 psi



Part #	Mfg #	Size	Price
021419	T-174-A	3/4"	
027175	T-174-A	1"	
026363	T-174-A	1-1/2"	

### Iron Body Gate Valves

#### F-617-O 125# Cast Iron Flanged Gate Valve (Flg x Flg)

- Bolted bonnet
- Outside screw & yoke
- Solid wedge
- Iron body bronze mounted (IBBM)
- Non-shock cold working pressure: 200 psi



Part #	Mfg #	Size	Price
071050	F-617-O	2"	
016137	F-617-O	2-1/2"	
016138	F-617-O	3"	
016139	F-617-O	4"	
023538	F-617-O	5"	
016140	F-617-O	6"	
022677	F-617-O	8"	

#### F-619 125# Cast Iron Flanged Gate Valve (Flg x Flg)

- Bolted bonnet
- Non-rising stem
- Solid wedge
- Bronze mounted
- Non-shock cold working pressure: 200 psi/13.8 bar



Part #	Mfg #	Size	Price
128235	F-619	2"	
080304	F-619	2-1/2"	
039077	F-619	3"	
080305	F-619	4"	
062873	F-619	6"	



## Gate Valves - Non-Potable

### Commercial Brass Gate Valves

#### Brass Gate Valve

- Non-rising stem (NRS)
- For shut-off service
- Pressure rating: 200 psi WOG
- Maximum temperature: 180°F

#### LFWGV - Round Handle (FNPT)



Part #	Mfg #	Model	Size	Price
164483	0555158	LFWGV	1/2"	
164485	0555159	LFWGV	3/4"	
164486	0555160	LFWGV	1"	
164487	0555167	LFWGV	1/2"	
164488	0555168	LFWGV	3/4"	
164489	0555169	LFWGV	1"	

#### WGVS - Round Handle (Swt)

Part #	Mfg #	Model	Size	Price
010885	0760010	WGVS	1/2"	
010929	0760030	WGVS	3/4"	

### Commercial Iron Gate Valves

#### 405-RW Flanged Gate Valve

- Full port flow, low head loss
- Epoxy coated, internal and external
- Vulcanized encapsulated resilient wedge
- In-line serviceable
- Boss-tapped and plugged
- MSS-SP-70 conformance



Part #	Mfg #	Model	Size	Price
101022	0700103	405RW	2-1/2"	
094797	0700105	405RW	4"	
101023	0700106	405RW	6"	

## Gate Valves

### Gate Valves

#### Forged Stainless Gate Valve

- 800#
- Reduced port
- A182 / 316L SS body
- Bolted bonnet



#### Threaded

Part #	Size	Price
165056	1/2"	
165058	1"	
165059	1-1/2"	
165060	2"	

#### Socket Weld

Part #	Size	Price
165062	1/2"	
165063	3/4"	
165064	1"	
165065	1-1/4"	
165066	1-1/2"	
165067	2"	

#### Forged Carbon Steel Gate Valve

- 800#
- OS&Y
- A105 Forged carbon steel body
- Bolted bonnet



#### Threaded

Part #	Size	Price
176170	1/2"	
176171	3/4"	
176172	1"	
176173	1-1/4"	
176174	1-1/2"	
176175	2"	

#### Socket Weld

Part #	Size	Price
176176	1/2"	
176177	3/4"	

### Gate Valves (Continued)

#### Forged Carbon Steel Gate Valve

#### Socket Weld

Part #	Size	Price
176178	1"	
176179	1-1/4"	
176180	1-1/2"	
176181	2"	

#### Cast Steel Gate Valve

- 150# Flanges
- Full port
- OS&Y
- Bolted bonnet



#### Flanged

Part #	Size	Price
165068	2-1/2"	
165069	3"	
165070	4"	

## Globe Valves

### Bronze Globe Valves

#### T-211-Y 125# Bronze Globe Valves (FNPT x FNPT)

- Screw-in bonnet
- Integral seat
- Renewable seat & disc
- Non-shock cold working pressure: 200 psi



Part #	Mfg #	Size	Price
016179	T-211-Y	1/2"	
016180	T-211-Y	3/4"	
016181	T-211-Y	1"	
016182	T-211-Y	1-1/4"	
016183	T-211-Y	1-1/2"	
016184	T-211-Y	2"	

### Iron Body Globe Valves

#### F-718-B 125# Cast Iron Globe Valve (Flg x Flg)

- Bolted bonnet
- Renewable seat & disc
- Bronze mounted



Part #	Mfg #	Size	Price
128240	F-718-B	2-1/2"	
077393	F-718-B	3"	
060142	F-718-B	6"	

#### S-211-Y 125# Bronze Globe Valves (Swt x Swt)

- Screw-in bonnet
- Integral seat
- Renewable seat & disc
- Non-shock cold working pressure: 200 psi



Part #	Mfg #	Size	Price
021817	S-211-Y	1/2"	
050268	S-211-Y	3/4"	
122199	S-211-Y	1"	
085284	S-211-Y	1-1/4"	
128206	S-211-Y	1-1/2"	
128208	S-211-Y	2"	

#### T-235-Y 150# Bronze Globe Valves (FNPT x FNPT)

- Union bonnet
- Integral seat
- Renewable PTFE seat and disc
- Non-shock cold working pressure: 300 psi



Part #	Mfg #	Size	Price
051868	T-235-Y	1/2"	
051870	T-235-Y	3/4"	
051874	T-235-Y	2"	

**Hose Bibbs**

**Hose Bibbs**

**Poly Hose Bibb**

- *Double O-ring seals*
- *Virgin PTFE seats*
- *Washerless construction*



Part #	Mfg #	Description	Price
149621	RW-302PP	3/4"	

---

---

## Hose Bibbs

---

---

### Vacuum Breakers



Part #	Mfg #	Size	Price
156240	34HBVBLF	3/4" HPT	

---

---

**Hose Bibbs**

---

---

**Sillcocks****SC Series Hose Bibb Hex Shoulder Sillcock with  
Tee Handle**

Part #	Mfg #	Model	Size	Price
157090	0123483	LFSC5	1/2" MIP or Swt	
157091	0123484	LFSC6	3/4" MIP	





## Meter Valves

### Angle Inverted Key Meter Valves

Pack Joint For Copper or Plastic x Meter Swivel  
Nut



Part #	Mfg #	Valve Size	Service Line	Meter Size	Price
004350	KV43-332W	3/4"	3/4"	5/8" x 3/4" & 3/4"	
004386	KV43-341W	3/4"	1"	5/8"	

## Meter Valves

### Commercial Balancing/Flow Valves

#### CSM-61 Series Bronze Flow Measurement Valve

- Used for hot or chilled water units for system balancing/flow measurement
- For fan coil units, unit ventilators, water source heat pumps, finned radiation, reheat coils, unit heaters and more



#### CSM-61-M1-S (Swt)

Part #	Mfg #	Model	Size	Price
180200	0856810	LFCSM61M1S	3/4"	
179998	0856811	LFCSM61M1S	1"	

#### CSM-61-M2-S (Swt)

Part #	Mfg #	Model	Size	Price
043157	0856814	LFCSM61M2S	2"	

#### LFCSM-61-S Flow Measurement Valve

- Lead Free\* brass construction
- Bi-directional flow
- Positive shutoff
- Integral drain port
- Safe "blowout" resistant stem
- Meets NSF 61 Health Effects AnnexG



Part #	Mfg #	Model	Size	Price
043152	0856809	LFCSM-61-S	1/2"-2"	

## Meter Valves

#### LFWAMV Brass Angle Meter Valve

- Cast Lead Free\* cast copper silicon alloy
- Available with or without waste feature
- Angle pattern models



Part #	Mfg #	Model	Size	Price
157027	0123018	LFAMSV	1" x 3/4"	

## Relief Valves

### Water Heater Installation Products

#### 100DT Series Drain Lines for T&P Relief Valve

- Connects to 3/4" T&P relief drain connections
- For use on T&P relief valves up to 100,000 BTUH



Part #	Mfg #	Model	For Use With:	Price
008984	0066125	100DT	Side-Mount RV	

### ASME Hot Water Boiler Relief Valves

#### Boiler Pressure Relief Valve

- ASME Section IV
- For hot water heating and supply boilers
- Pressure protection only
- Standard pressure relief setting: 30 psi



#### LF174A Bronze Body (FNPT Inlet x Outlet - Drain)

Part #	Mfg #	Model	Size	PSI	Price
157290	0121470	LF174A	3/4"	75	
157291	0121475	LF174A	3/4"	100	
157292	0121479	LF174A	3/4"	125	
157293	0121484	LF174A	3/4"	150	
157294	0121504	LF174A	1"	125	

#### Bronze Body (FNPT Inlet x Outlet)

Part #	Mfg #	Model	Size	Price
010891	0274428	174A	3/4"	30
165735	0275022	174A	1"	40
165738	0275118	174A	1"	70
165737	0275178	174A	1"	85
165739	0278329	174A	2"	60

### 740 Series ASME Iron Body Water Pressure Safety Relief Valve

- ASME Section IV
- For hot water heating boiler pressure protection
- Expanded outlet drain connections



#### 740 (FNPT Inlet x Outlet - Drain)

Part #	Mfg #	Model	Size	PSI	Price
165734	0384240	740	2"	40	
011293	0382008	740M1	3/4" x 1"	30	

### 315 Steam Safety Relief Valve



Part #	Mfg #	Model	Size	Price
157305	0342629	315-M2	3/4"	15

### T&P Safety Relief Valves

#### Self-Closing T&P Valve

- For hot water storage tanks and heaters
- Thermo-bonded (non-metallic) protective coating on thermostat
- Fully automatic, includes test levers
- Bronze body with stainless steel spring

#### 10L, 100XL Series ASME (MNPT Inlet x FNPT Outlet)

- ASME Section IV
- For tanks and heaters with extra thick insulation, use Watts L100XL, LL100XL, or LLL100XL
- For new generation water heaters containing extra thick insulation, send for literature ES-SL100XL/LLL100XL
- Prefix options:
  - L - Extended inlet shank for water heaters with up to 2" thick insulation
  - LLL - Extended inlet shank for water heaters with up to 3" thick insulation
- Suffix options:
  - XL-8 With 8" extension thermostat



Part #	Mfg #	Model	Size	PSI	Price
010877	0066100	100XL	3/4"	150	
010879	0066103	100XL-4	3/4"	175	

## Relief Valves

### T&P Safety Relief Valves (Continued)

#### Self-Closing T&P Valve

10L, 100XL Series ASME (MNPT Inlet x FNPT Outlet)

Part #	Mfg #	Model	Size	PSI	Price
010880	0066110	100XL-8	3/4"	150	
080818	0066132	LL100XL	3/4"	150/210	
010757	0066133	L100XL	3/4"	150	
156641	0556000	LF100XL3/4	3/4"	150/200	
157261	0556001	LF100XL8	3/4"	150	
156643	0556002	LFLL100XL	3/4"	150/210	
156644	0556003	LF100XL3	3/4"	150	
052192	0556004	LFLLL100XL	3/4"	150/210	

#### 40 Series ASME Automatic Reseating T&P Valve

- ASME Section IV
- For hot water supply tanks and heaters
- Fully automatic, tamper-resistant bonnet screws
- Series 40 and 140 feature unique thermostat with special thermo-bonded coating
- Series 140 sizes 1" and above are standard furnished with stainless steel thermostat tube
- Bronze body construction
- Suffix options:
  - XL = Test lever and extension thermostat



ASME (MNPT Inlet x FNPT Outlet)

Part #	Mfg #	Model	Size	PSI	Price
010931	0153614	40L	3/4"	150	
010934	0156481	40XL	3/4"	125	
010935	0156731	40XL5	3/4"	150	
022492	0158774	40XL8	3/4"	150	
010932	0163725	40XL4	1"	150	

### Pressure Relief Valves

#### Calibrated Pressure Relief Valve

- For commercial, residential and industrial applications to protect against excessive pressure in systems containing water, oil, or air

#### LF530C Calibrated Pressure Relief Valve

- Lead Free\* brass
- Stainless steel springs
- Calibrated adjustment feature
- Protects against buildup of excessive pressure
- For use in systems containing water, oil, and air



Part #	Mfg #	Model	Size	Price
157306	0556035	LF530-C	1/2"	

#### Poppet Type Water Heater Pressure Relief Valve

- For protection against excessive pressure and pressure emergency conditions
- Fully automatic, includes test levers

#### LF3L ASME (MNPT Inlet x FNPT Outlet)

- Used in conjunction with model 210 gas shut-off valve on gas water heaters to shut off gas to heater at 210°F



Part #	Mfg #	Model	Size	PSI	Price
157249	0556034	LF3L	3/4"	150	

## Relief Valves

### TWS Through the Wall Water Supply Shutoff

- Standardizes location of supply shutoff valve and drain connection
- Access available anytime for winterizing
- Durable bronze valve body and shaft
- One piece valve plunger
- Tamper resistant key operated hydrant
- Exterior chrome finish
- Resilient seated shutoff
- Union connection for ease of installation of backflow preventer
- Manual drain port



Part #	Mfg #	Model	Size	Price
107126	0722046	TWS-10	1"	

### Tankless Water Heater Valves

#### LFTWH Series Tankless Water Heater Valve

- Replace up to 18 fittings and 16 connections used in typical tankless water heater installations
- Hot and cold water valve set
- 3/4" FPT Union connections
- Full-port, quarter-turn ball valve with color-coded tee handle and union
- Quarter-turn purge and drain valve with hose connection and tethered brass cap
- 600 WOG Rated



Part #	Mfg #	Model	Description	Price
157060	0100156	LFTWHFTHCNRV	Relief Valve	
156424	0100165	LFTWH-UTS-HCN	Relief Valve	
157059	0120001	LFTWH-UT-HC-RV	3/4"	

**Relief Valves**

**Tankless Water Heater Installation Kits**

**Tankless Service Valve Kit**



Part #	Mfg #	Description	Price
135157	TWV30RX	3/4" IPS x IPS Service Valve Kit with Pressure Relief Valve	
135158	BRTWV3SRX	3/4"Sw x IPS Service Valve Kit with Pressure Relief Valve	





---

---

## Relief Valves

---

---

### Specialty Valves & Fittings

#### 2600T Pressure Reducing Valve - Single Union



Part #	Mfg #	Size	Price
136118	2600T-3/4	3/4"	

## Relief Valves

### ASME Hot Water Boiler Safety Relief Valves

#### 10 Series Hot Water Boiler ASME Safety Relief Valve- Brass Finish

- For hot water boilers and hydronic heating systems
- Protects against excessive water pressure and steam generated when BTU input controls fail
- Maximum temperature service to 250°F
- Stainless steel springs standard except 10-214
- ASME Section IV



#### 10 Series (MNPT Inlet x FNPT Outlet)

Part #	Mfg #	Size	Wt/ 100 Lbs	Set Press	Price
003009	10-407-05	3/4" M x F	62	30 psig	

#### 13 Series Low Pressure Steam Heating Boiler Safety Valve

- ASME Section IV
- Capacity certified by National Board at 15 psi only in accordance with ASME Boiler and Pressure Vessel Code - Section IV
- All bronze construction
- Flat seat, Teflon® faced disc for positive seal
- Top guided, high capacity



#### 13 Series Side Outlet Model (MNPT Inlet x FNPT Outlet)

Part #	Mfg #	Size	Wt/ 100 Lbs	Set Press	Price
122404	13-211-B15	3/4" M x F	475	15 psig	
003016	13-213B-15	1-1/4" M x 1-1/2" F	1200	15 psig	

### Vacuum Breakers

#### AVB1 (38 Series) Atmospheric Type Vacuum Breaker (FNPT Inlet x Outlet)

- For hot and cold water service up to 212°F @ 125 psig
- Compact and lightweight
- Protects against back-siphonage and low hazard cross connections
- Cast bronze finish options:  
- RB= Rough Brass



Part #	Mfg #	Size	Finish	Price
102861	38-104-01	3/4"	RB	

---

---

## Sillcock Valves

---

---

### Sillcock Valves

ProLine™ Heavy-Duty Brass Sillcock Valve with  
Lockshield

Part #	Mfg #	Size	Price
013025	108-013	1/2"	
014604	108-014	3/4"	

---

---

## Stop Valves

---

---

### Stop Valves

#### Stop & Waste Shut-Off Valve

- 150 psi WOG

Part #	Mfg #	Model	Size	Price
157117	0123612	LFSWT	1/2" FIP	
157119	0123616	LFSWS	1/2" Swt	
157118	0123613	LFSWT	3/4" Comp	

#### Stop Valve

- 150 psi WOG

Part #	Mfg #	Model	Size	Price
013204	0820846	ST	1/2" FIP	
014768	0820851	SS	3/4" Swt	
013199	0820850	SS	1/2" Swt	

## Stop Valves

### Stop Valves

#### Ball-Type Supply Stop

- Angle
- Lead-Free
- 1/4 Turn



Part #	Mfg #	Size	Price
196258	T-595	1/2" PEX x 3/8" O.D.	
193813	T-595	1/2" FIP 3/8" O.D.	
193814	T-595	5/8" O.D. x 3/8" O.D.	
193815	T-595	1/2" SWT x 3/8" O.D.	
244471	T-595NL	1/2" F1960 PEX x 1/4" O.D.	
244470	T-595NL	1/2" F1960 PEX x 3/8" O.D.	

#### Ball-Type Supply Stop

- Straight
- Lead-Free
- 1/4 Turn



Part #	Mfg #	Size	Price
196259	T-596	1/2" PEX x 3/8" O.D.	
193817	T-596	5/8" O.D. x 3/8" O.D.	
193816	T-596	1/2" FIP x 3/8" O.D.	
193818	T-596	1/2" SWT x 3/8" O.D.	
244469	T-596NL	1/2" F1960 PEX x 3/8" O.D.	

#### Multi-Turn Supply Stop

- Dual Outlet
- Lead-Free
- Chrome



Part #	Mfg #	Size	Price
215165	T-587NL	5/8" O.D. x 3/8" O.D. x 1/4"	
215166	T-587NL	5/8" O.D. x 3/8" O.D. x 3/8"	

#### Multi-Turn Supply Stop

- Straight
- Lead-Free
- Chrome



Part #	Mfg #	Size	Price
215158	T-582NL	5/8" O.D. x 3/8" O.D.	
215159	T-582NL	1/2" FIP x 3/8" O.D.	
215164	T-582NL	3/8" FIP x 3/8" O.D.	
215161	T-582NL	3/8" O.D. x 3/8" O.D.	

### Multi-Turn Supply Stop

- Angle
- Lead-Free
- Chrome



Part #	Mfg #	Size	Price
215160	T-581NL	5/8" O.D. x 1/4" O.D.	
195177	T-581NL	5/8" O.D. x 3/8" O.D.	
215163	T-581NL	1/2" FIP x 3/8" O.D.	
215156	T-581NL	3/8" FIP x 3/8" O.D.	

### Gas Stop Valves

#### T-3100 Sidetap FNPT Gas Ball Valve

- One-piece forged brass body
- Integral 1/8" NPT tapped manometer test port and plug
- 175 psi cold working pressure



Part #	Mfg #	Size	Price
191888	T-3100	1"	

## Valves - Miscellaneous

### Tempering/Mixing Valves

#### MMV Series Thermostatic Mixing Valve

- Use in domestic water systems at hot water source or at point of use to provide accurate outlet temperature control or in radiant control
- ASSE 1016, 1017, 1070 Listed CSA B-125 certified
- Maximum working pressure: 150 psi
- Outlet temperature range: 80° - 120°F



Part #	Mfg #	Model	Size	Connection	Price
157283	0559115	LFMMVM1US	1/2"	Union Swt	

#### WAS Series Anti-Sweat Valve for Water Closets - Adjustable

- For residential applications, mixes cold and hot water to avoid condensation build-up on the outside of the water closet and to temper the water inside the toilet tank
- Brass body construction with compression end and/or IPS connections
- Maximum temperature: 180°F



Part #	Mfg #	Model	Size	Price
157284	0559118	LFMMVM1US	3/4"	Union Swt
157285	0559121	LFMMVM1-US	1"	Union Swt
156647	0559116	LFMMVM1-UT	1/2"	Union Thr
157287	0559122	LFMMVM1-UT	1"	Union Thr

#### LF1170 Hot Water Temperature Control Valve

- Lead Free cast copper silicon alloy body construction
- Solid wax hydraulic principle thermostat assures dependable mixing of hot and cold water
- Thermostat controls both hot and cold water
- Models available with solder, thread, Pex, Quick-Connect or cpvc end connections
- Integral filter washers and check valves
- Adjustment cap with locking feature



Part #	Mfg #	Model	Size	Price
156650	0559100	LF1170M2-US	1/2"	
156649	0559104	LF1170M2-UT	3/4"	

#### LF25AUB-Z3 Water Pressure Reducing Valve

- Double union-solder union inlet and outlet (-S-DU)
- Lead Free cast copper silicon alloy body construction
- Includes Z3 sealed spring cage and stainless steel corrosion resistant adjusting & cage screws
- Union inlet connection
- Serviceable in line
- Replaceable seat module
- Integral stainless steel strainer
- Bypass feature controls thermal expansion pressure
- High temperature resistant reinforced diaphragm for hot water



Part #	Mfg #	Model	Size	Price
194319	0009283	LF25AUB-S-DU-Z3	3/4"	

#### Under Sink Guardian™ Professional USG-B Series Thermostatic Mixing Valve (Comp)

- Bronze body
- Built-in check valves
- Includes tamper resistant locking cap
- Maintains mixed water temperature to ± 3°F up to 120°F
- ASSE 1016 Listed



Part #	Mfg #	Model	Size	Price
157282	0204143	LFUSG-B-M2	3/8"	
021272	0215476	WAS	1/2"	



## Valves - Miscellaneous

### Boiler Fill Fittings

#### Residential Boiler Fill Fitting

- Provides ease of service for expansion tanks and water pressure regulator valves in closed loop hot water heating systems
- 3-Way ball valve design
- 1-Piece construction eliminates up to 11 threaded joints
- Drain port with integral ball valve
- Maximum temperature: 250°F
- Maximum pressure: 125 psi
- 0-30 psi Pressure gauge



Part #	Mfg #	Model	Size	Price
131977	0386466	RBFF	1/2"	

### Washing Machine Valves

#### 2-M2 Series Washing Machine Water Shut-Off Valve

- Manually eliminates water pressure on supply hoses and prevents catastrophic water damage
- Controls hot and cold simultaneously
- Maximum pressure: 150 psi
- Maximum temperature: 180°F
- Bronze body, single lever on-off
- Dual copper adapters



#### Dual Elbow Adapter for 1/2" Swt or 1/2" Comp

Part #	Mfg #	Model	Size	Price
010893	0006644	2-M2	1/2"	

#### Dual Straight Adapter for 1/2" MNPT or 1/2" Swt

Part #	Mfg #	Model	Size	Price
010896	0006643	2TM2	1/2"	

### Float Valves

#### Heavy Duty Mechanical Float Valve



Part #	Mfg #	Model	Size	Price
067226	0780003	500	1/2"	
067227	0780007	750	3/4"	

**Valves - Miscellaneous**

**Thermostatic Mixing Valves**

**Navigator® EFX8 Thermostatic Mixing Valve**

- 8 gpm at 30 psi
- Single valve design
- Factory pre-set at 85°F
- Adjustable temperature range: 65° to 95°F
- Universal mounting capability
- Positive shut-off of hot supply when cold supply is lost
- Built-in cold water bypass assures cold flow
- Easily installed and serviced
- Dial thermometer
- Rough bronze or chrome-plated finish
- Meets ANSI standard Z358.1-2009
- Reliable liquid filled thermostat with 10-year warranty



**Navigator® S59-4000A Point-of-Use Thermostatic Mixing Valve with 3/8" Compression Fittings**

- Easy installation and serviceability
- Factory-assembled and tested
- Lead-free brass and glass-filled polysulfone valve body provides superior strength
- Wax-filled thermostat ensures outlet temperature remains constant
- Certified by IAPMO
- ASSE 1070 & cUPC Certified



Part #	Mfg #	Description	Price
125362	S59-4000A	Point-of-Use Thermostatic Valve	

Part #	Mfg #	Description	Price
059075	S19-2000	Emergency Thermostatic Valve	

**Navigator® EFX25 Thermostatic Mixing Valve**

- 36 gpm at 30 psi
- Single valve design
- Factory pre-set at 85°F
- Adjustable temperature range: 65° to 95°F
- Universal mounting capability
- Positive shut-off of hot supply when cold supply is lost
- Built-in cold water bypass assures cold flow
- Easy installation and serviceability
- Dial thermometer
- Rough bronze or chrome-plated finish
- Meets ANSI standard Z358.1-2009
- Reliable liquid filled thermostat with 10-year warranty



Part #	Mfg #	Description	Price
071347	S19-2100	Emergency Thermostatic Valve	

## Valves - Miscellaneous

### Valve Tees

#### Add-A-Line™ Full-Slip Valve Tee (Trunk x Tee)

- Perfect for adding new water lines
- 5/8" or 7/8" OD Compression trunks provide easy and totally torchless installations
- 1-Piece forged brass compression and sweat tee body
- Quality brass ball valve replaces saddle valves



601-20V

Part #	Mfg #	Connection	Price
068535	601-30V	3/4" FSwt x 1/4" O.D. Comp	
067349	601-20CV	5/8" x 1/4" (O.D. Comp)	
068533	601-30CV	7/8" x 1/4" (O.D. Comp)	

#### PowerPEX® F1807 Ice Maker Valve

- For adding 1/4" OD supply lines for ice makers and humidifiers
- Lead-free solder joint



637XG922

Part #	Mfg #	PEX x O.D. Comp	Type	Price
093427	637XG9220	1/2" x 1/4"	Tee	
170894	637XG920	1/2" x 1/4"	Straight	

### Sweat Fittings & Valves

#### 118-Series Frost-Proof Sillcock Vacuum Breaker Repair Kit

- Be sure to measure the stem you are replacing to guarantee correct replacement length

Part #	Mfg #	Includes:	Price
222220	118-08	Cap, Plunger & O-Ring	

#### Add-A-Line™ Full Slip Sweat Valve Tee

- Universal: works with all CTS pipe types
- Adding water lines has never been easier
- Perfect for adding humidifiers, dishwashers, ice makers or any new water line
- Attractive, clamshell packaging in a white cut case carton for peg hooks, counters or shelf displays



601-G20C

Part #	Mfg #	OD Comp TrunkxOD Comp	Price
159741	SC601G20CV	5/8" x 1/4"	
160210	601-G30CV	7/8" x 1/4"	

#### PDQ™ Add-A-Line™ Push Fittings—No Lead

- Plumbing done quickly
- Easy & fast compliant plumbing solutions
- Universal: works with all CTS pipe types
- Removable, replaceable, reusable.
- Adding water lines has never been easier
- Perfect for adding humidifiers, dishwashers, ice makers or any new water line
- Attractive, clamshell packaging in a white cut case carton for peg hooks, counters or shelf displays



601Q20V

Part #	Mfg #	PDQ x OD Comp	Price
186869	601Q20V	1/2" x 1/4"	
184847	601Q30V	3/4" x 1/4"	

**Valves - Miscellaneous**

**Resun® Cast Iron Lubricated Plug Valves**

**R-1430 Rectangular Port, Regular Opening Plug Valve**

- Wrench operated
- Working pressures:
  - 200 psi WOG, Threaded end
  - 125 psi SWP
- Principal parts and materials:
  - Plug - cast iron, ASTM A-126 class B
  - Baseplate - cast iron, ASTM A-126 class B
  - Baseplate spring - Stainless steel 17-7
  - Sealant screw - Commercial steel
  - Double ball check valve - Commercial steel
  - Gasket - glass filled TFE

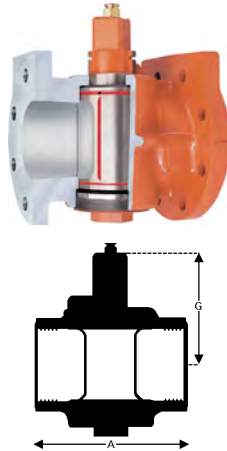

Part #	Mfg #	Dimensions		Weight	Price
		Size	A x G		
009721	R1430	1"	3-7/8" x 2-1/2"	4 lbs	
009723	R1430	1-1/4"	5" x 2-5/8"	5 lbs	
009722	R1430	1-1/2"	5" x 2-3/4"	6 lbs	
009725	R1430	2 "	5-3/4" x 3-3/8"	9 lbs	

**R-1431 Rectangular Port, Regular Opening Plug Valve**

- Wrench operated
- Working pressures:
  - 200 psi WOG-Flanged end
  - 125 psi SWP
- Principal parts and materials:
  - Body - cast iron, ASTM A-126 class B
  - Plug - cast iron, ASTM A-126 class B
  - Baseplate - Cast iron, ASTM A-126 class B
  - Baseplate spring - Stainless steel 17-7
  - Sealant screw - Commercial steel
  - Double ball check valve - Commercial steel
  - Gasket - glass filled TFE
  - Body sealant fitting - Commercial steel (8", 10" & 12" only)

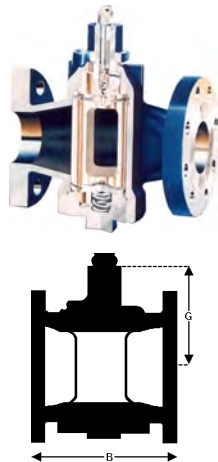

Part #	Mfg #	Dimensions		Weight	Price
		Size	B x G		
020968	R1431	2-1/2"	7-1/2" x 5"	28 lbs	
009728	R1431	3"	8" x 5-1/4"	38 lbs	
027892	R1431	4"	9" x 6-5/8"	66 lbs	

## Wye Strainers

### Bronze Y-Strainers

#### S-221-A Bronze Y-Strainer with Wire Mesh Screen, Solder Ends

- Non-shock cold working pressure: 200 psi/13.8 bar
- Tapped cap with plug
- 20 Mesh stainless steel screen



Part #	Mfg #	Size	Price
132827	NJ2QA06	1/2"	
132825	NJ2QA08	3/4"	
132826	NJ2QA0A	1"	
132828	NJ2QA0B	1-1/4"	
132829	NJ2QA0C	1-1/2"	
132830	NJ2QA0D	2"	

#### T-221-A Bronze Y-Strainer with Wire Mesh Screen, Solder Ends

- Non-shock cold working pressure: 200 psi/13.8 bar
- Tapped cap with plug
- 20 Mesh stainless steel screen



Part #	Mfg #	Size	Price
132831	NL2QA06	1/2"	
132832	NL2QA08	3/4"	
132833	NL2QA0A	1"	
132834	NL2QA0B	1-1/4"	
132835	NL2QA0C	1-1/2"	

### Iron Y-Strainers

#### F-721-A Iron Y-Strainer with Wire Mesh Screen, Flanged Ends

- Non-shock cold working pressure: 200 psi/13.8 bar
- Tapped cap with plug
- 20 Mesh stainless steel screen
- Dezincification resistant



Part #	Mfg #	Size	Price
132846	NHT000E	2-1/2"	
132847	NHT000F	3"	
132848	NHT000H	4"	
132850	NHT000K	6"	
132852	NHT000M	10"	

#### T-751-A Iron Y-Strainer with Wire Mesh Screen, Threaded Ends

- Non-shock cold working pressure: 200 psi/13.8 bar
- Tapped cap with plug
- 20 Mesh stainless steel screen



Part #	Mfg #	Size	Price
132838	NLT1006	1/2"	
132839	NLT1008	3/4"	
132840	NLT100A	1"	
132841	NLT100B	1-1/4"	
132842	NLT100C	1-1/2"	
132843	NLT100D	2"	

## Wye Strainers

### Commercial Y-Strainers

#### Iron Body Y-Type Strainer (End Flanged )

- For liquid or steam service to protect valves, backflow preventers and similar controls from foreign matter



#### 77F-DI - ANSI 125 with Tapped Closure Plug (Flg)

- 125 psi WSP/200 psi WOG

Part #	Mfg #	Model	Size	Price
022414	0825202	77FDI-125	3"	
022415	0825203	77FDI-125	4"	

#### 77F-DI - Epoxy Coated FDA Approved - ANSI 125 with Tapped Closure Plug (Flg)

- 200 psi WOG



Part #	Mfg #	Model	Size	Price
090681	0825210	77FDIFDA125	2-1/2"	
077920	0825211	77FDIFDA125	3"	
074524	0825212	77FDIFDA125	4"	
072090	0825214	77FDIFDA125	6"	

### Cast Iron Y-Type Strainer

- For liquid or steam service
- Install upstream of equipment that need protection from scale, rust, dirt, etc

#### LF777SI WYE-Pattern Strainer, Tapped (FNPT)

- 250 psi WSP/400 psi WOG
- 2-1/2" and 3" have 3/64" perforated screen



Part #	Mfg #	Model	Size	Price
156653	0379111	LF777SI	1/2"	
156654	0379112	LF777SI	3/4"	
156655	0379113	LF777SI	1"	
156656	0379114	LF777SI	1-1/4"	
156657	0379115	LF777SI	1-1/2"	
156658	0379116	LF777SI	2"	

### LFS777SI WYE-Pattern Strainer, Tapped (C)



Part #	Mfg #	Model	Size	Price
156659	0379119	LFS777SI	1/2"	
156660	0379120	LFS777SI	3/4"	
156662	0379121	LFS777SI	1"	
156663	0379122	LFS777SI	1-1/4"	
156664	0379123	LFS777SI	1-1/2"	
156665	0379124	LFS777SI	2"	

### LF777 WYE-Pattern Strainer

- Lead Free\* cast copper silicon alloy body
- Wye-pattern
- Solid retainer cap with gasket



Part #	Mfg #	Model	Size	Price
157309	0123086	LF777M1-20	3/4"	
157308	0124002	LF777SM1-20	3/4"	
157310	0124003	LF777SM1-20	1"	
157312	0124005	LF777SM1-20	1-1/2"	
157307	0124006	LF777SM3-20	2"	





## Wye Strainers

### Valves

#### Titan® YS 12 Wye Strainer

- Threaded body
- Class 250 lb
- Cast iron body



Part #	Mfg #	Size	Price
175082	YS12 12	1/2"	
175083	YS12 34	3/4"	
175084	YS12 1	1"	
175085	YS12 114	1-1/4"	
175086	YS12 112	1-1/2"	
175087	YS12 212	2-1/2"	

#### Titan® YS 58 Wye Strainer

- Threaded body
- Class 125 lb
- Cast iron body



Part #	Mfg #	Size	Price
175089	YS58 2	2"	
175090	YS58 212	2-1/2"	
175091	YS58 3	3"	
175092	YS58 4	4"	

**Wye Strainers**

**Valves**

**(CBV) Circuit Balancing Valve**

- Five full 360° turns from open to closed, providing unparalleled flow control and energy savings
- Line size optimization for ideal performance for 0.7 to 1.3 m/s flow velocity
- Micrometer-style handle enables precise flow-rate adjustment
- Wye pattern, globe-style valve design for reduced turbulence



-LF suffix = Lead Free

Part #	Mfg #	Size	Price
151552	CBV050VSCR	1/2"	
150156	CBV075VSCR	3/4"	
150157	CBV100VSCR	1"	
150948	CBV125VSCR	1-1/4"	
150158	CBV150VSCR	1-1/2"	
150949	CBV200VSCR <sup>LF</sup>	2"	

## Bath Accessories

### Drawer Pulls & Knobs

- Tools and template included for installation

#### Archer® Drawer Knob



Part #	Mfg #	Description	Price
182997	K-11485-CP	Polished Chrome	

#### Archer® Drawer Pull



Part #	Mfg #	Description	Price
158114	K-11486-BN	*Brushed Nickel	
182998	K-11486-CP	Polished Chrome	

#### Artifacts® Drawer Knob



Part #	Mfg #	Description	Price
183645	K-72578-BN	*Brushed Nickel	
183647	K-72578-BV	*Brushed Bronze	
183648	K-72578-CP	Polished Chrome	
174465	K-72578-SN	*Polished Nickel	
183650	K-72578-2BZ	Oil Rubbed Bronze	

#### Artifacts® Drawer Pull



Part #	Mfg #	Description	Price
183651	K-72579-SN	*Polished Nickel	

#### Bancroft™ Drawer Knob



Part #	Mfg #	Finish	Price
126037	K-11425-CP	Polished Chrome	
187833	K-11425-2BZ	Oil Rubbed Bronze	

### Bancroft® Drawer Pull

- 3" x 1-3/8"



Part #	Mfg #	Description	Price
127923	K-11426-CP	Polished Chrome	
117448	K-11426-BN	Brushed Nickel	

### Composed® Drawer Pull



Part #	Mfg #	Description	Price
232039	K-73152-CP	Polished Chrome	

### Composed® Cabinet Knob



Part #	Mfg #	Description	Price
255820	K-73155-TT	*Titanium	

### Damask™ Drawer Knob



Part #	Mfg #	Description	Price
183694	K-99686-HF1	Chrome	
185571	K-99686-HF2	Brushed	

### Damask™ Drawer Pull



Part #	Mfg #	Description	Price
187730	K-99689-HF1	Chrome	
185570	K-99689-HF2	Brushed	

\* Vibrant Limited Lifetime Warranty

[www.plumbsupply.com](http://www.plumbsupply.com) • Serving our Customers Since 1946 • [www.waterconcepts.net](http://www.waterconcepts.net)

**Bath Accessories**

**Devonshire® Drawer Knob**



Part #	Mfg #	Description	Price
168315	K-10575-BN	*Brushed Nickel	
137255	K-10575-BV	*Brushed Bronze	
227983	K-10575-CP	Chrome	
146960	K-10575-2BZ	Oil Rubbed Bronze	

**Devonshire® Drawer Pull**



Part #	Mfg #	Finish	Price
138190	K-10576-BN	*Brushed Nickel	
137256	K-10576-BV	*Brushed Bronze	
227985	K-10576-CP	Chrome	
146961	K-10576-2BZ	Oil Rubbed Bronze	

**Forte® Drawer Knob**



Part #	Mfg #	Description	Price
160267	K-11284-CP	Polished Chrome	
163788	K-11284-BN	*Brushed Nickel	

**Forte® Drawer Pull**



Part #	Mfg #	Description	Price
155646	K-11285-CP	Polished Chrome	
156029	K-11285-BN	*Brushed Nickel	

**Jacquard™ Ring Pull**



Part #	Mfg #	Description	Price
183693	K-99685-HF1	Chrome	

**Drawer Pulls & Knobs (Continued)**

**Jacquard™ Ring Pull**

Part #	Mfg #	Description	Price
181475	K-99685-HF2	Brushed	
233547	K-99685-HF3	Black	

**Jute™ Bar Pull**



Part #	Mfg #	Description	Price
168236	K-99688-HF1	Chrome	
169515	K-99688-HF2	Brushed	

**Kelston® Drawer Knob**



Part #	Mfg #	Description	Price
183463	K-13552-CP	Polished Chrome	
146996	K-13552-2BZ	Oil Rubbed Bronze	

**Kelston® Drawer Pull**



Part #	Mfg #	Description	Price
183464	K-13554-CP	Polished Chrome	
146997	K-13554-2BZ	Oil Rubbed Bronze	

**Loure® Cabinet Knob**



Part #	Mfg #	Description	Price
163167	K-11575-CP	Polished Chrome	
133515	K-11575-BN	*Brushed Nickel	

**Lyntier® Drawer Knob**



Part #	Mfg #	Description	Price
163367	K-11762-BV	*Brushed Bronze	

\* Vibrant Limited Lifetime Warranty

[www.waterconcepts.net](http://www.waterconcepts.net) • Serving our Customers Since 1946 • [www.plumbsupply.com](http://www.plumbsupply.com)

## Bath Accessories

### Margaux® Drawer Knob



Part #	Mfg #	Description	Price
141170	K-16262-CP	Polished Chrome	
112141	K-16262-BN	*Brushed Nickel	
124081	K-16262-BV	*Brushed Bronze	
157444	K-16262-SN	*Polished Nickel	
124109	K-16262-AF	*French Gold	

### Margaux® Drawer Pull



Part #	Mfg #	Description	Price
112140	K-16263-BN	*Brushed Nickel	
124080	K-16263-BV	*Brushed Bronze	
146391	K-16263-CP	Polished Chrome	
183021	K-16263-SN	*Polished Nickel	

### Memoirs® Stately Drawer Pull



Part #	Mfg #	Description	Price
142282	K-523-CP	Polished Chrome	
153892	K-523-BN	*Brushed Nickel	
158649	K-523-BV	*Brushed Bronze	
188935	K-523-2BZ	Oil Rubbed Bronze	

### Memoirs® Stately Drawer Knob



Part #	Mfg #	Description	Price
144455	K-522-CP	Polished Chrome	
153893	K-522-BN	*Brushed Nickel	
188933	K-522-2BZ	Oil Rubbed Bronze	

### Pinstripe® Drawer Pull



Part #	Mfg #	Description	Price
183002	K-13125-CP	Polished Chrome	

### Pinstripe® Drawer Knob



Part #	Mfg #	Description	Price
183003	K-13126-CP	Polished Chrome	

### Poplin™ Drawer Pull

- Premium metal construction



Part #	Mfg #	Description	Price
170473	K-99687-HF1	Polished Chrome	
168877	K-99687-HF3	Black	

### Purist® Drawer Knob



Part #	Mfg #	Description	Price
182962	K-14484-BN	*Brushed Nickel	
185006	K-14484-BV	*Brushed Bronze	
151257	K-14484-SN	*Polished Nickel	

### Purist® 3" Drawer Pull



Part #	Mfg #	Description	Price
137294	K-14485-BN	*Brushed Nickel	
185002	K-14485-BV	*Brushed Bronze	
154617	K-14485-CP	Polished Chrome	
258679	K-14485-RGD	*Rose Gold	
183015	K-14485-SN	*Polished Nickel	

\* Vibrant Limited Lifetime Warranty

[www.plumbsupply.com](http://www.plumbsupply.com) • Serving our Customers Since 1946 • [www.waterconcepts.net](http://www.waterconcepts.net)

## Bath Accessories

### Revival® Drawer Knob



Part #	Mfg #	Description	Price
157872	K-16295-BN	*Brushed Nickel	
144371	K-16295-BV	*Brushed Bronze	

### Revival® Drawer Pull



Part #	Mfg #	Description	Price
157873	K-16296-BN	*Brushed Nickel	
183023	K-16296-BV	*Brushed Bronze	

### Stillness® Drawer Pull



Part #	Mfg #	Description	Price
186200	K-14386-BN	*Brushed Nickel	

### Glass Shelves

#### Devonshire® Single Glass Shelf

- Included tempered-glass shelf
- Tools and installation template included
- 22"L x 5-1/2"W x 2-1/2"H



Part #	Mfg #	Description	Price
099135	K-10563-CP	Polished Chrome	
090871	K-10563-BN	*Brushed Nickel	
153725	K-10563-BV	*Brushed Bronze	
089612	K-10563-PB	* Polished Brass	
146959	K-10563-2BZ	Oil Rubbed Bronze	

#### Forté Glass Shelf

- L22" x W5-3/4" x H3-11/16"
- Includes tempered-glass shelf
- Tools for installation included



Part #	Mfg #	Description	Price
085353	K-11283-CP	Polished Chrome	

### Purist® Glass Shelf

- L22-1/2" x W4-7/8" x H1-7/8"
- Includes tempered-glass shelf
- Installation tools included



Part #	Mfg #	Description	Price
073312	K-14440-CP	Polished Chrome	
254007	K-14440-SN	*Polished Nickel	

### Stillness® Glass Shelf

- Includes tempered-glass shelf
- Tools and installation template included
- 22-1/2" x 4-9/16" x 1-7/8"



Part #	Mfg #	Description	Price
176131	K-14455-CP	Polished Chrome	

### Light Sconces

#### Artifacts® Wall Sconce

- For use with E26 base CFL bulb (sold separately)
- For installation as a downlight only
- Installation hardware included



Part #	Mfg #	Description	Price
238863	K-72584-CP	1-Globe, Chrome	

#### Artifacts® Wall Sconce with Adjustable Cord

- For use with E26 base CFL bulb (sold separately)
- For installation as a downlight only
- Installation hardware included



Part #	Mfg #	Description	Price
256657	K-72581-BN	1-Globe, *Brushed Nickel	

\* Vibrant Limited Lifetime Warranty

[www.waterconcepts.net](http://www.waterconcepts.net) • Serving our Customers Since 1946 • [www.plumbsupply.com](http://www.plumbsupply.com)



## Bath Accessories

### Bancroft® Wall Sconce

- Frosted-glass shades
- Sconces can be positioned up or down
- CUL- and UL-approved up to 100 watts



Part #	Mfg #	Description	Price
131696	K-11421-CP	1-Globe, Chrome	
243912	K-11421-SN	1-Globe, *Pol Nickel	
248884	K-11422-BN	2-Globe, *Brushed Nickel	
124994	K-11422-CP	2-Globe, Chrome	
237462	K-11422-SN	2-Globe, *Pol Nickel	
132914	K-11423-BN	3-Globe, *Brushed Nickel	
124223	K-11423-BV	3-Globe, *Br. Bronze	
132143	K-11423-CP	3-Globe, Chrome	
182996	K-11423-SN	3-Globe, *Pol Nickel	
187787	K-11423-2BZ	3-Globe, Oil Rubbed Bronze	

### Devonshire® Wall Sconce

- Frosted-glass shades
- Sconces can be positioned up or down
- CUL- and UL-approved up to 100 watts



Part #	Mfg #	Description	Price
095251	K-10570-BN	1-Globe, *Brushed Nickel	
094341	K-10570-CP	1-Globe, Pol Chrome	
185600	K-10570-SN	1-Globe, *Pol Nickel	
178418	K-10570-2BZ	1-Globe, Oil Rubbed Bronze	
088463	K-10571-BN	2-Globe, *Brushed Nickel	
182986	K-10571-BV	2-Globe, *Br Bronze	
097831	K-10571-CP	2-Globe, Pol Chrome	
244217	K-10571-SN	2-Globe, *Pol Nickel	
164149	K-10571-2BZ	2-Globe, Oil-Rubd Brz	
113844	K-10572-BN	3-Globe, *Brushed Nickel	
152202	K-10572-BV	3-Globe, *Br Bronze	
102666	K-10572-CP	3-Globe, Pol Chrome	
188513	K-10572-SN	3-Globe, *Pol Nickel	
166028	K-10572-2BZ	3-Globe, Oil-Rubd Brz	

### Forte® Wall Sconce

- Frosted-glass shades
- Sconces can be positioned up or down
- CUL- and UL-approved up to 100 watts



Part #	Mfg #	Description	Price
097113	K-11365-BN	1-Globe, *Brushed Nickel	
091593	K-11365-CP	1-Globe, Pol Chrome	
099731	K-11365-G	1-Globe, Br Chrome	
095185	K-11366-BN	2-Globe, *Brushed Nickel	
093458	K-11366-CP	2-Globe, Pol Chrome	
098396	K-11366-G	2-Globe, Br Chrome	
103173	K-11367-BN	3-Globe, *Brushed Nickel	
104368	K-11367-CP	3-Globe, Pol Chrome	
115073	K-11367-G	3-Globe, Br Chrome	

### Margaux® Wall Sconce

- Frosted-glass shades
- Requires T-10 bulb



Part #	Mfg #	Description	Price
243640	K-16268-BV	1-Globe, *Br. Bronze	
223372	K-16268-SN	1-Globe, Polished Nickel	

### Purist® Wall Sconce



Part #	Mfg #	Description	Price
175746	K-14483-BN	1-Globe, *Brushed Nickel	
167283	K-14483-CP	1-Globe, Polished Chrome	

\* Vibrant Limited Lifetime Warranty

[www.plumbsupply.com](http://www.plumbsupply.com) • Serving our Customers Since 1946 • [www.waterconcepts.net](http://www.waterconcepts.net)

## Bath Accessories

### Light Sconces (Continued)

#### Purist® Wall Sconce

Part #	Mfg #	Description	Price
170467	K-14483-SN	1-Globe, *Pol Nickel	

### Brush Caddy's

#### Reset™ Brush Caddy

- Includes removable silicone drip tray
- Tip resistant design
- Rust-resistant stainless steel
- Dishwasher safe



Part #	Mfg #	Description	Price
172616	K-6378-0	White	

### Rim Guards

#### Stainless Steel Rim Guard

- For use with K-12867 Camerton™ and K-6676 Tyrell™ service sinks



Part #	Mfg #	Description	Price
064178	K-8935-NA	Stainless Steel	

#### Whirlpool Remote Control

- For use with KOHLER® Experience whirlpools with neckjets or BubbleMassage™
- Includes stand



Part #	Mfg #	Description	Price
182815	K-1705-NA	Not Applicable	

### Overflow Caps

#### Escale® Lavatory Overflow Cap

- For use with: Escale®, Reve™, Leaf™, Fit™, and Ronde™



Part #	Mfg #	Description	Price
113952	K-4061-BN	*Brushed Nickel	
143258	K-4061-BV	*Brushed Bronze	

### Overflow Caps (Continued)

#### Escale® Lavatory Overflow Cap

Part #	Mfg #	Description	Price
119576	K-4061-CP	Polished Chrome	
183056	K-4061-SN	*Polished Nickel	
147047	K-4061-2BZ	Oil Rubbed Bronze	

#### Iron Plains® Overflow Cap

- For use with Iron Plain® bathroom sinks



Part #	Mfg #	Description	Price
227982	K-6324-BN	*Brushed Nickel	
230608	K-6324-CP	Polished Chrome	
176738	K-6324-2BZ	Oil Rubbed Bronze	

### Miscellaneous

#### Artifacts® Finishing Ensemble

- Coordinated set includes glass soap dispenser, glass tumbler, and ceramic tray
- Premium metal construction
- Coordinates with other products in the Artifacts® collection



Part #	Mfg #	Description	Price
183686	K-72574-2BZ	Oil Rubbed Bronze	
183638	K-72574-SN	*Polished Nickel	

#### Choreograph® Shower Tray

- 12"L x 1-1/8"H x 4-5/8"W
- Made of natural teak wood
- Easy snap-on installation
- For use with Choreograph® shower bars
- Clips and screws included



Part #	Mfg #	Description	Price
176729	K-97629-NA	12" x 1-1/8" x 4-5/8"	

\* Vibrant Limited Lifetime Warranty

[www.waterconcepts.net](http://www.waterconcepts.net) • Serving our Customers Since 1946 • [www.plumbsupply.com](http://www.plumbsupply.com)

**Bath Accessories**

**Devonshire® Soap Dish**

- 4-3/4"L x 2-7/16"H x 6"W
- Removable glass dish
- Premium metal construction
- Tools & installation template included



Part #	Mfg #	Description	Price
087655	K-10560-CP	Polished Chrome	

**13-Gallon Step Trash Can**

- 13"L x 26-3/8"H x 16-13/16"W
- Hands- free—lid opens with foot pedal
- Fingerprint proof
- Quiet-Close lid
- Removable liner
- Raised liner and rim locks open for effortless bag exchange
- Designed to fit any brand of 13-gallon trash bags



Part #	Mfg #	Description	Price
253258	20940-BST	Black Stainless	
255219	20940-ST	Stainless	

\* Vibrant Limited Lifetime Warranty

## Bath Accessories

### Towel Bars & Rings

• Tools and template included for installation

#### Alteo® Towel Bar



Part #	Mfg#	Size	Finish	Price
143627	K-37050-BN	18"	*Brushed Nickel	
148510	K-37050-CP	18"	Polished Chrome	
152312	K-37050-2BZ	18"	Oil Rubbed Bronze	
142070	K-37051-BN	24"	*Brushed Nickel	
139657	K-37051-CP	24"	Polished Chrome	
149755	K-37051-2BZ	24"	Oil Rubbed Bronze	

#### Archer™ Towel Bar



Part #	Mfg#	Size	Finish	Price
147083	K-11050-BN	18"	*Brushed Nickel	
129549	K-11051-BN	24"	*Brushed Nickel	
142983	K-11051-CP	24"	Polished Chrome	

#### Archer™ Double Towel Bar



Part #	Mfg#	Size	Finish	Price
131642	K-11053-BN	24"	*Brushed Nickel	
159056	K-11053-CP	24"	Polished Chrome	

#### Artifacts® Towel Bar



Part #	Mfg#	Size	Finish	Price
239077	K-72567-BN	18"	*Brushed Nickel	
189564	K-72567-BV	18"	*Brushed Bronze	
173117	K-72567-CP	18"	Polished Chrome	
173106	K-72567-SN	18"	Polished Nickel	
223900	K-72567-VNT	18"	Vintage Nickel	
231269	K-72568-BN	24"	*Brushed Nickel	
189563	K-72568-BV	24"	*Brushed Bronze	
173118	K-72568-CP	24"	Polished Chrome	
173107	K-72568-SN	24"	Polished Nickel	
256659	K-72569-BN	30"	*Brushed Nickel	

### Towel Bars & Rings (Continued)

#### Artifacts® Towel Bar

Part #	Mfg#	Size	Finish	Price
242046	K-72569-BV	30"	*Brushed Bronze	
175226	K-72569-CP	30"	Polished Chrome	

#### Artifacts® Double Towel Bar



Part #	Mfg#	Size	Finish	Price
166098	K-72570-BN	24"	*Brushed Nickel	
183635	K-72570-CP	24"	Polished Chrome	
181720	K-72570-SN	24"	*Polished Nickel	

#### Artifacts® Hotelier



Part #	Mfg#	Size	Finish	Price
166096	K-72575-BN	24"	*Brushed Nickel	
225927	K-72575-BV	24"	*Brushed Bronze	
183639	K-72575-CP	24"	Polished Chrome	
174463	K-72575-SN	24"	*Polished Nickel	
223902	K-72575-VNT	24"	Vintage Nickel	
183640	K-72575-2BZ	24"	Oil Rubbed Bronze	

#### Bancroft® Towel Bar



Part #	Mfg#	Size	Finish	Price
096188	K-11410-BN	18"	*Brushed Nickel	
176831	K-11410-BV	18"	*Brushed Bronze	
087295	K-11410-CP	18"	Polished Chrome	
185467	K-14410-SN	18"	* Polished Nickel	
186091	K-11410-2BZ	18"	Oil Rubbed Bronze	
098107	K-11411-BN	24"	*Brushed Nickel	
114841	K-11411-BV	24"	*Brushed Bronze	
091755	K-11411-CP	24"	Polished Chrome	
239640	K-11411-SN	24"	*Polished Nickel	
169806	K-11411-2BZ	24"	Oil Rubbed Bronze	
227248	K-11412-BV	30"	*Brushed Bronze	
094943	K-11412-CP	30"	Polished Chrome	

\* Vibrant Limited Lifetime Warranty

[www.waterconcepts.net](http://www.waterconcepts.net) • Serving our Customers Since 1946 • [www.plumbsupply.com](http://www.plumbsupply.com)

**Bath Accessories**

**Towel Bars & Rings (Continued)**

**Bancroft® Towel Bar**

Part #	Mfg#	Size	Finish	Price
248546	K-11412-2BZ	30"	Oil Rubbed Bronze	

**Bancroft® Double Towel Bar**



Part #	Mfg#	Size	Finish	Price
096185	K-11413-BN	24"	*Brushed Nickel	
221957	K-11413-BV	24"	*Brushed Bronze	
092263	K-11413-CP	24"	Polished Chrome	
247316	K-11413-SN	24"	*Polished Nickel	
156668	K-11413-2BZ	24"	Oil Rubbed Bronze	

**Components™ Towel Arm**



Part #	Mfg#	Size	Finish	Price
253291	K-78377-BL	3"	Matte Black	

**Composed™ Towel Bar**



Part #	Mfg#	Size	Finish	Price
234133	K-73141-CP	18"	Polished Chrome	
238971	K-73141-TT	18"	*Titanium	
225521	K-73142-CP	24"	Polished Chrome	
246145	K-73142-TT	24"	*Titanium	
234134	K-73143-CP	30"	Polished Chrome	

**Composed™ Double Towel Bar**



Part #	Mfg#	Size	Finish	Price
245927	K-73144-CP	24"	Polished Chrome	
255855	K-73144-TT	24"	*Titanium	

**Composed™ Towel Arm**



Part #	Mfg#	Size	Finish	Price
225522	K-73145-CP	8"	Polished Chrome	

**Towel Bars & Rings (Continued)**

**Composed™ Towel Arm**

Part #	Mfg#	Size	Finish	Price
231734	K-73145-TT	8"	*Titanium	

**Coralais® Towel Bar**



Part #	Mfg#	Size	Finish	Price
113799	K-13430-BN	18"	*Brushed Nickel	
097477	K-13430-CP	18"	Polished Chrome	
117703	K-13430-G	18"	Brushed Chrome	
113800	K-13431-BN	24"	*Brushed Nickel	
097476	K-13431-CP	24"	Polished Chrome	
117702	K-13431-G	24"	Brushed Chrome	

**Devonshire® Towel Bar**



Part #	Mfg#	Size	Finish	Price
075036	K-10550-BN	18"	*Brushed Nickel	
104786	K-10550-BV	18"	*Brushed Bronze	
074750	K-10550-CP	18"	Polished Chrome	
093586	K-10550-PB	18"	*Polished Brass	
190233	K-10550-SN	18"	*Polished Nickel	
146950	K-10550-2BZ	18"	Oil Rubbed Bronze	
078141	K-10551-BN	24"	*Brushed Nickel	
105043	K-10551-BV	24"	*Brushed Bronze	
073746	K-10551-CP	24"	Polished Chrome	
078151	K-10551-PB	24"	*Polished Brass	
244265	K-10551-SN	24"	*Polished Nickel	
146951	K-10551-2BZ	24"	Oil Rubbed Bronze	
085240	K-10552-BN	30"	*Brushed Nickel	
090179	K-10552-CP	30"	Polished Chrome	
146952	K-10552-2BZ	30"	Oil Rubbed Bronze	

**Devonshire® Double Towel Bar**



Part #	Mfg#	Size	Finish	Price
077002	K-10553-BN	24"	*Brushed Nickel	
105044	K-10553-BV	24"	*Brushed Bronze	
087653	K-10553-CP	24"	Polished Chrome	

\* Vibrant Limited Lifetime Warranty

[www.plumbsupply.com](http://www.plumbsupply.com) • Serving our Customers Since 1946 • [www.waterconcepts.net](http://www.waterconcepts.net)

**Bath Accessories**

**Towel Bars & Rings (Continued)**

**Devonshire® Double Towel Bar**

Part #	Mfg#	Size	Finish	Price
079491	K-10553-PB	24"	*Polished Brass	
146953	K-10553-2BZ	24"	Oil Rubbed Bronze	

**Fairfax™ Small Towel Bar Arm**

Part #	Mfg#	Size	Finish	Price
069236	K-12155-BN	7-5/8"	*Brushed Nickel	
072314	K-12155-CP	7-5/8"	Polished Chrome	
160132	K-12155-2BZ	7-5/8"	Oil Rubbed Bronze	

**Fairfax® Towel Bar**



Part #	Mfg#	Size	Finish	Price
069235	K-12150-BN	18"	*Brushed Nickel	
096880	K-12150-CP	18"	Polished Chrome	
154609	K-12150-2BZ	18"	Oil Rubbed Bronze	
072140	K-12151-BN	24"	*Brushed Nickel	
077817	K-12151-CP	24"	Polished Chrome	
160134	K-12151-2BZ	24"	Oil Rubbed Bronze	

**Finial Towel Bar**



Part #	Mfg#	Size	Finish	Price
080562	K-360-AF	24"	*French Gold	
071741	K-360-BN	24"	*Brushed Nickel	
077356	K-360-BV	24"	*Brushed Bronze	
076225	K-360-CP	24"	Polished Chrome	
180594	K-360-2BZ	24"	Oil Rubbed Bronze	

**Forté® Sculpted Towel Bar**



Part #	Mfg#	Size	Finish	Price
080262	K-11370-BN	18"	Brushed Nickel	
090509	K-11370-CP	18"	Polished Chrome	
087273	K-11370-G	18"	Brushed Chrome	
082752	K-11371-BN	24"	*Brushed Nickel	
084207	K-11371-CP	24"	Polished Chrome	

**Towel Bars & Rings (Continued)**

**Forté® Sculpted Towel Bar**

Part #	Mfg#	Size	Finish	Price
087272	K-11371-G	24"	Brushed Chrome	
086148	K-11372-BN	30"	*Brushed Nickel	
087206	K-11372-CP	30"	Polished Chrome	
100767	K-11372-G	30"	Brushed Chrome	

**Forte® Traditional Towel Bar**



Part #	Mfg#	Size	Finish	Price
087029	K-11270-BN	18"	*Brushed Nickel	
092004	K-11270-CP	18"	Polished Chrome	
088018	K-11270-G	18"	Brushed Chrome	
089531	K-11271-BN	24"	*Brushed Nickel	
092003	K-11271-CP	24"	Polished Chrome	
088017	K-11271-G	24"	Brushed Chrome	
087030	K11272BN	30"	*Brushed Nickel	

**Kelston® Towel Bar**



Part #	Mfg#	Size	Finish	Price
136649	K-13500-BN	18"	*Brushed Nickel	
168610	K-13500-CP	18"	Polished Chrome	
146990	K-13500-2BZ	18"	Oil Rubbed Bronze	
134488	K-13501-BN	24"	*Brushed Nickel	
161338	K-13501-CP	24"	Polished Chrome	
146991	K-13501-2BZ	24"	Oil Rubbed Bronze	

**Kelston® Double Towel Bar**



Part #	Mfg#	Size	Finish	Price
134490	K-13503-BN	24"	*Brushed Nickel	
183005	K-13503-CP	24"	Polished Chrome	
146993	K-13503-2BZ	24"	Oil Rubbed Bronze	

\* Vibrant Limited Lifetime Warranty

[www.waterconcepts.net](http://www.waterconcepts.net) • Serving our Customers Since 1946 • [www.plumbsupply.com](http://www.plumbsupply.com)



## Bath Accessories

### Loure® Towel Arm



Part #	Mfg#	Finish	Price
122449	K-11586-CP	Polished Chrome	

### Loure® Towel Bar



Part #	Mfg#	Size	Finish	Price
165334	K-11580-BN	18"	*Brushed Nickel	
122445	K-11580-CP	18"	Polished Chrome	
155634	K-11581-BN	24"	*Brushed Nickel	
122446	K-11581-CP	24"	Polished Chrome	
227500	K-11581-SN	24"	*Polished Nickel	
133512	K-11588-BN	30"	*Brushed Nickel	
122447	K-11588-CP	30"	Polished Chrome	

### Loure® Double Towel Bar



Part #	Mfg#	Size	Finish	Price
122448	K-11582-CP	24"	Polished Chrome	

### Margaux™ Towel Bar



Part #	Mfg#	Size	Finish	Price
109461	K-16250-BN	18"	*Brushed Nickel	
124074	K-16250-BV	18"	*Brushed Bronze	
111196	K-16250-CP	18"	Polished Chrome	
136651	K-16250-SN	18"	Polished Nickel	
183019	K-16251-AF	24"	*French Gold	
112992	K-16251-BN	24"	*Brushed Nickel	
124075	K-16251-BV	24"	*Brushed Bronze	
141179	K-16251-CP	24"	Polished Chrome	
152947	K-16251-SN	24"	Polished Nickel	
137921	K-16252-CP	30"	Polished Chrome	

### Memoirs® Towel Bar



Part #	Mfg#	Size	Finish	Price
061208	K-486-BN	24"	*Brushed Nickel	
075023	K-486-BV	24"	*Brushed Bronze	
074988	K-486-CP	24"	Polished Chrome	
174229	K-486-2BZ	24"	Oil Rubbed Bronze	

### Memoirs® Double Towel Bar



Part #	Mfg#	Size	Finish	Price
251144	K-16253-AF	24"	*French Gold	
135482	K-16253-SN	24"	*Polished Nickel	

### Memoirs® Statelv Towel Bar



Part #	Mfg#	Size	Finish	Price
188931	K-485-2BZ	18"	Oil Rubbed Bronze	

### Pinstripe® Towel Bar



Part #	Mfg #	Description	Price
086164	K-13108-CP	18" Polished Chrome	
106096	K-13109-CP	24" Polished Chrome	
256734	K-13109-BN	24" *Brushed Nickel	
253320	K-13110-SN	30" *Polished Nickel	

### Purist® Towel Bar



Part #	Mfg#	Size	Finish	Price
259379	K-14435-BL	18"	Matte Black	
090892	K-14435-BN	18"	Brushed Nickel	
125811	K-14435-BV	18"	*Brushed Bronze	
069311	K-14435-CP	18"	Polished Chrome	
242536	K-14435-SN	18"	*Polished Nickel	
132494	K-14436-BGD	24"	*Moderne Brushed Gold	
257784	K-14436-BL	24"	Matte Black	
086546	K-14436-BN	24"	*Brushed Nickel	
132500	K-14436-BV	24"	*Brushed Bronze	

\* Vibrant Limited Lifetime Warranty

[www.plumbsupply.com](http://www.plumbsupply.com) • Serving our Customers Since 1946 • [www.waterconcepts.net](http://www.waterconcepts.net)

**Bath Accessories**

**Towel Bars & Rings (Continued)**

**Purist® Towel Bar**

Part #	Mfg#	Size	Finish	Price
069312	K-14436-CP	24"	Polished Chrome	
097144	K-14436-SN	24"	*Polished Nickel	
089326	K-14437-BN	30"	*Brushed Nickel	
085195	K-14437-CP	30"	Polished Chrome	
149459	K-14437-SN	30"	*Polished Nickel	

**Purist® Double Towel Bar**



Part #	Mfg#	Size	Finish	Price
225301	K-14375-BN	24"	*Brushed Nickel	
223721	K-14375-BV	24"	*Brushed Bronze	
172064	K-14375-CP	24"	Polished Chrome	
183679	K-14375-SN	24"	*Polished Nickel	

**Purist® Hotelier**



Part #	Mfg#	Size	Finish	Price
162944	K-14381-BN	24"	*Brushed Nickel	
183011	K-14381-BV	24"	*Brushed Bronze	
182778	K-14381-CP	24"	Polished Chrome	

**Revival® Towel Bar**



Part #	Mfg#	Size	Finish	Price
060834	K-16150-CP	24"	Polished Chrome	

**Stillness® Towel Bar**



Part #	Mfg #	Description	Price
072157	K-14450-CP	18" Polished Chrome	
077073	K-14452-CP	30" Polished Chrome	

**Toobi™ Towel Bar**



Part #	Mfg#	Size	Finish	Price
172249	K-5666-BN	18"	*Brushed Nickel	
155340	K-5666-CP	18"	Polished Chrome	
153085	K-5667-BN	24"	*Brushed Nickel	
162267	K-5667-CP	24"	Polished Chrome	

**Toobi™ Double Towel Bar**



Part #	Mfg#	Size	Finish	Price
223326	K-5668-CP	24"	Polished Chrome	

**IV Georges Brass® Towel Bar**



Part #	Mfg#	Size	Finish	Price
068589	K-6826-BN	24"	*Brushed Nickel	
105372	K-6826-BV	24"	*Brushed Bronze	

\* Vibrant Limited Lifetime Warranty

[www.waterconcepts.net](http://www.waterconcepts.net) • Serving our Customers Since 1946 • [www.plumbsupply.com](http://www.plumbsupply.com)

## Bath Accessories

### Towel Rings Alteo® Towel Ring



Part #	Mfg #	Finish	Price
142072	K37057BN	*Brushed Nickel	
142899	K37057CP	Polished Chrome	
149757	K370572BZ	Oil Rubbed Bronze	

### Archer® Towel Ring



Part #	Mfg #	Finish	Price
120025	K-11057-BN	*Brushed Nickel	
120083	K-11057-CP	Polished Chrome	

### Artifacts® Towel Ring



Part #	Mfg #	Finish	Price
162103	K-72571-BN	*Brushed Nickel	
224548	K-72571-BV	*Brushed Bronze	
175228	K-72571-CP	Polished Chrome	
183636	K-72571-SN	*Polished Nickel	
223889	K-72571-VNT	Vintage Nickel	
183637	K-72571-2BZ	Oil Rubbed Bronze	

### Bancroft™ Towel Ring



Part #	Mfg #	Finish	Price
096189	K-11416-BN	*Brushed Nickel	

### Towel Rings (Continued) Bancroft™ Towel Ring

Part #	Mfg #	Finish	Price
119916	K-11416-BV	*Brushed Bronze	
091754	K11416CP	Polished Chrome	
098453	K-11416-SN	*Polished Nickel	
162433	K-11416-2BZ	Oil Rubbed Bronze	

### Coralais® Towel Ring



Part #	Mfg #	Finish	Price
111508	K-13435-BN	*Brushed Nickel	
098366	K-13435-CP	Polished Chrome	
125016	K-13435-G	Brushed Chrome	

### Devonshire® Towel Ring



Part #	Mfg #	Finish	Price
075034	K-10557-BN	*Brushed Nickel	
086447	K10557-BV	*Brushed Bronze	
073749	K-10557-CP	Polished Chrome	
078148	K-10557-PB	*Polished Brass	
233715	K-10557-SN	*Polished Nickel	
146956	K-10557-2BZ	Oil Rubbed Bronze	

### Fairfax® Towel Ring



Part #	Mfg #	Finish	Price
078771	K-12165-BN	*Brushed Nickel	
095555	K-12165-CP	Polished Chrome	
154611	K-12165-2BZ	Oil Rubbed Bronze	

\* Vibrant Limited Lifetime Warranty

[www.plumbsupply.com](http://www.plumbsupply.com) • Serving our Customers Since 1946 • [www.waterconcepts.net](http://www.waterconcepts.net)

**Bath Accessories**

**Finial® Traditional Towel Ring**



Part #	Mfg #	Finish	Price
080561	K-363-AF	*French Gold	
062461	K-363-BN	*Brushed Nickel	
091093	K-363-BV	*Brushed Bronze	
112920	K-363-CP	Polished Chrome	
074141	K-363-SN	*Polished Nickel	
152087	K-363-2BZ	Oil Rubbed Bronze	

**Forté® Sculpted Towel Ring**



Part #	Mfg #	Finish	Price
082751	K-11377-BN	*Brushed Nickel	
084210	K-11377-CP	Polished Chrome	
098281	K-11377-G	Brushed Chrome	

**Forté® Traditional Towel Ring**



Part #	Mfg #	Finish	Price
089528	K-11277-BN	*Brushed Nickel	
084058	K-11277-CP	Polished Chrome	

**Kelston® Towel Ring**



Part #	Mfg #	Finish	Price
135326	K-13507-BN	*Brushed Nickel	
161342	K-13507-CP	Polished Chrome	
146995	K-13507-2BZ	Oil Rubbed Bronze	

**Loure® Towel Ring**



Part #	Mfg #	Finish	Price
129882	K-11587-BN	12", *Brushed Nickel	
130825	K-11587-CP	12", Polished Chrome	

**Margaux™ Towel Ring**



Part #	Mfg #	Finish	Price
183020	K-16254-AF	*French Gold	
109460	K-16254-BN	*Brushed Nickel	
124077	K-16254-BV	*Brushed Bronze	
119758	K-16254-CP	Polished Chrome	
135084	K-16254-SN	*Polished Nickel	

**Memoirs® Stately Towel Ring**



Part #	Mfg #	Finish	Price
061209	K-487-BN	*Brushed Nickel	
075025	K-487-BV	*Brushed Bronze	

\* Vibrant Limited Lifetime Warranty

[www.waterconcepts.net](http://www.waterconcepts.net) • Serving our Customers Since 1946 • [www.plumbsupply.com](http://www.plumbsupply.com)

**Bath Accessories**

**Towel Rings (Continued)**

**Memoirs® Stately Towel Ring**

Part #	Mfg #	Finish	Price
072577	K-487-CP	Polished Chrome	
170477	K-487-2BZ	Oil Rubbed Bronze	

**Pinstripe® Towel Ring**



Part #	Mfg #	Description	Price
256733	K-13112-BN	*Brushed Nickel	
106095	K-13112-CP	Polished Chrome	
253321	K-13112-SN	*Polished Nickel	

**Purist® Towel Ring**



Part #	Mfg #	Finish	Price
132495	K-14441-BGD	*Moderne Brushed Gold	
258431	K-14441-BL	Matte Black	
080024	K-14441-BN	*Brushed Nickel	
132501	K-14441-BV	*Brushed Bronze	
091548	K-14441-CP	Polished Chrome	
148807	K-14441-SN	*Polished Nickel	

**Revival® Towel Ring**



Part #	Mfg #	Finish	Price
054871	K-16140-BN	*Brushed Nickel	
076861	K-16140-BV	*Brushed Bronze	
058876	K-16140-CP	Polished Chrome	
067095	K-16140-PB	*Polished Brass	

**Stillness® Towel Ring**



Part #	Mfg #	Description	Price
072153	K-14456-CP	Polished Chrome	

**Toobi™ Towel Ring**



Part #	Mfg #	Finish	Price
151265	K-5671-BN	*Brushed Nickel	
167290	K-5671-CP	Polished Chrome	

\* Vibrant Limited Lifetime Warranty

[www.plumbsupply.com](http://www.plumbsupply.com) • Serving our Customers Since 1946 • [www.waterconcepts.net](http://www.waterconcepts.net)

**Bath Accessories**

**Tissue Holders**

**Charlotte Tissue Holder**



Part #	Mfg #	Description	Price
222852	695085-PC	Chrome	
176255	695085-BN	Brushed Nickel*	
148739	695085-PNCO	Cocoa Bronze & Pol Nickel	

**Odin™ Tissue Holder**



Part #	Mfg #	Description	Price
180708	695075-BN	Brushed Nickel*	
226376	695075-BL	Matte Black	
257832	695075-GL	Luxe Gold	

**Levoir™ Tissue Holder**



Part #	Mfg #	Finish	Price
250585	695098-GL	Luxe Gold	
254006	695098-PN	Polished Nickel*	

**Litze™ Tissue Holder**



Part #	Mfg #	Description	Price
229552	695035-NK	Luxe Nickel	
237825	695035-PC	Chrome	
232594	695035-GL	Luxe Gold	

**Siderna Tissue Holder**



Part #	Mfg #	Description	Price
159348	695080-BL	Matte Black	

**Tissue Holders (Continued)**

**Siderna Tissue Holder**

Part #	Mfg #	Description	Price
139359	695080-BN	Brushed Nickel*	
141651	695080-PC	Chrome	

**Rook™ Tissue Holder**



Part #	Mfg #	Description	Price
190001	695061-NK	Luxe Nickel*	
188713	695061-NKBL	Luxe Nickel/Matte Black	
188969	695061-PC	Chrome	
243913	695061-PN	Polished Nickel*	
221137	695061-RB	Venetian Bronze®	

**Sotria™ Tissue Holder**



Part #	Mfg #	Description	Price
182226	695050-BL	Matte Black	
180763	695050-NK	Luxe Nickel*	
181915	695050-PC	Chrome	
187348	695050-PN	Polished Nickel*	

**Traditional Tissue Holder**



Part #	Mfg #	Description	Price
107467	69550-BN	Brushed Nickel*	
117040	69550-BZ	Brushed Bronze*	
079584	69550-PC	Chrome	
175473	69550-PN	Polished Nickel*	
085209	69550-RB	Venetian Bronze®	

**Vettis™ Tissue Holder**



Part #	Mfg #	Description	Price
249069	695088-PC	Chrome	

\* Brilliance® Anti-Tarnish Lifetime Finishes



## Bath Accessories

### Virage® Tissue Holder



Part #	Mfg #	Description	Price
134895	695030-BN	Brushed Nickel*	
146535	695030-PC	Chrome	
136497	695030-RB	Venetian Bronze	

### Towel Rings and Hooks

#### Charlotte™ Towel Ring



Part #	Mfg #	Description	Price
176253	694685-BN	Brushed Nickel*	
171443	694685-PC	Chrome	
212323	694685-PN	Polished Nickel*	
148740	694685-PNCO	Cocoa Bronze & Pol Nickel	

#### Odin™ Towel Ring



Part #	Mfg #	Description	Price
155262	694675-BN	Brushed Nickel*	
226374	694675-BL	Matte Black	
257830	694675-GL	Luxe Gold	

#### Siderna™ Towel Ring



Part #	Mfg #	Finish	Price
162489	694680-BL	Matte Black	
162500	694680-BN	Brushed Nickel*	
141655	694680-PC	Chrome	

### Traditional Towel Ring



Part #	Mfg #	Description	Price
107466	69546-BN	Brushed Nickel*	
131964	69546-BZ	Brushed Bronze*	
081339	69546-PC	Chrome	
174834	69546-PN	Polished Nickel*	
085206	69546-RB	Venetian Bronze®	

### Virage® Towel Ring



Part #	Mfg #	Description	Price
146534	694630-PC	Chrome	
134892	694630-BN	Brushed Nickel*	
140724	694630-RB	Venetian Bronze®	

### Towel Bars

#### Charlotte™ Towel Bar



Part #	Mfg #	Description	Price
222854	691885-PC	18", Chrome	
181826	691885-BN	18", Brushed Nickel*	
166554	691885-PNCO	18", Cocoa Bronze & Pol Nkl	
222855	692485-PC	24", Chrome	
176254	692485-BN	24", Brushed Nickel*	
158270	692485-PNCO	24", Cocoa Bronze & Pol Nkl	

#### Charlotte™ Double Towel Bar



Part #	Mfg #	Description	Price
222853	692585-PC	24", Chrome	
250467	692585-PN	24", Polished Nickel*	

\* Brilliance® Anti-Tarnish Lifetime Finishes

**Bath Accessories**

**Towel Bars (Continued)**

**Charlotte™ Double Towel Bar**

Part #	Mfg #	Description	Price
166553	692585-PNCO	24", Cocoa Bronze & Pol Nkl	

**Levoir™ Mini Towel Bar**



Part #	Mfg #	Description	Price
250586	694798-GL	8", Luxe Gold	
254004	694798-PN	8", Polished Nickel*	

**Levoir™ Towel Bar**



Part #	Mfg #	Description	Price
255700	691898-NK	18", Luxe Nickel	
255712	692498-NK	24", Luxe Nickel	
254003	692498-PN	24", Polished Nickel*	

**Litze™ Towel Bar**



Part #	Mfg #	Description	Price
251334	691835-GL	18" Luxe Gold	
237860	691835-PC	18" Chrome	
257549	691835-PN	18" Polished Nickel*	
248852	692435-GL	24", Luxe Gold	
237859	692435-PC	24", Chrome	
257551	692435-PN	24", Polished Nickel*	
251335	693035-GL	30", Luxe Gold	
229550	693035-NK	30", Luxe Nickel	
252996	693035-PC	30", Chrome	
257552	693035-PN	30", Polished Nickel*	

**Litze™ Towel Bar with Knurling**



Part #	Mfg #	Description	Price
237858	694735-PC	8", Chrome	

**Towel Bars (Continued)**

**Litze™ Towel Bar with Knurling**

Part #	Mfg #	Description	Price
248930	694735-PN	8", Polished Nickel*	

**Odin™ Towel Bar**



Part #	Mfg #	Description	Price
165342	691875-BN	18", Brushed Nickel*	
257835	691875-GL	18", Luxe Gold	
166271	692475-BN	24", Brushed Nickel*	
257836	692475-GL	24", Luxe Gold	

**Rook™ Mini Towel Bar**



Part #	Mfg #	Description	Price
188971	694761-PC	8" Polished Chrome	
243255	694761-PN	8" Polished Nickel*	
242629	694761-RB	8" Venetian Bronze	
235123	694761-NKBL	8" Luxe Nickel/Matte Black	

**Rook™ Towel Bar**



Part #	Mfg #	Description	Price
256200	691861-NK	18", Luxe Nickel*	
223099	691861-NKBL	18", Luxe Nickel/Matte Black	
242178	691861-RB	18", Venetian Bronze	
237293	692461-NK	24", Luxe Nickel	
248926	692461-NKBL	24", Luxe Nickel/Matte Black	
188972	692461-PC	24", Polished Chrome	

**Siderna® Towel Bar**



Part #	Mfg #	Description	Price
163539	691880-BN	18", Brushed Nickel*	
166140	691880-PC	18", Chrome	
162490	692480-BL	24", Matte Black	
139357	692480-BN	24", Brushed Nickel*	
141653	692480-PC	24", Chrome	

\* Brilliance® Anti-Tarnish Lifetime Finishes

## Bath Accessories

### Sotria™ Towel Bar



Part #	Mfg #	Description	Price
182227	691850-BL	18", Matte Black	
179428	691850-PN	18", Polished Nickel*	
245634	691850-PC	18", Chrome	
177254	692450-NK	24", Luxe Nickel*	

### Sotria 8" Mini Towel Bar



Part #	Mfg #	Description	Price
177255	694750-NK	8", Luxe Nickel*	
181914	694750-PC	8", Chrome	

### Traditional Towel Bar



Part #	Mfg #	Description	Price
222317	69518-PC	18", Chrome	
114917	69518-BN	18", Brushed Nickel*	
126231	69518-BZ	18", Brushed Bronze*	
175475	69518-PN	18", Polished Nickel*	
138260	69518-RB	18", Venetian Bronze®	
107468	69524-BN	24", Brushed Nickel*	
117039	69524-BZ	24", Brushed Bronze*	
159532	69524-PC	24", Chrome	
175476	69524-PN	24", Polished Nickel*	
085207	69524-RB	24", Venetian Bronze®	

### Traditional Double Towel Bar

- 2-1/2" Diameter flange
- Coordinates with "Classic" and "Belle" collections



Part #	Mfg #	Description	Price
241469	69525-PN	24" Polished Nickel*	

### Vettis™ Mini Towel Bar



Part #	Mfg #	Description	Price
249070	694788-PC	8", Chrome	

### Vettis™ Towel Bar



Part #	Mfg #	Description	Price
249071	692488-PC	24", Chrome	

### Virage Towel Bar



Part #	Mfg #	Description	Price
189316	691830-PC	18", Chrome	
134893	691830-BN	18", Brushed Nickel*	
177071	691830-BZ	18", Brushed Bronze*	
211206	691830-PN	18", Polished Nickel*	
227603	691830-RB	18", Venetian Bronze®	
134894	692430-BN	24", Brushed Nickel*	
132575	692430-BZ	24", Brushed Bronze*	
146533	692430-PC	24", Chrome	
211207	692430-PN	24", Polished Nickel*	
163800	692430-RB	24", Venetian Bronze®	

### Grab Bars

#### Euro Round Grab Bar



Part #	Mfg #	Description	Price
244632	69275-BN	12" Brushed Nickel*	
244631	69375-BN	24" Brushed Nickel*	
255181	69375-PC	24" Chrome	
244630	69475-BN	18" Brushed Nickel*	

#### Traditional Grab Bar



Part #	Mfg #	Description	Price
245591	69210-BN	12", Brushed Nickel*	
171841	69210-NK	12", Luxe Nickel*	
241470	69410-PN	18", Polished Nickel*	
245593	69310-BN	24", Brushed Nickel*	
171843	69310-NK	24", Luxe Nickel*	
245592	693610-BN	36", Brushed Nickel*	

\* Brilliance® Anti-Tarnish Lifetime Finishes

www.plumbsupply.com • Serving our Customers Since 1946 • www.waterconcepts.net

**Bath Accessories**

**Providence™ Belle Traditional Decorative Grab Bar**

- 1-1/4" Diameter
- Extends 2-3/4" from wall
- Concealed mounting
- 3" Diameter flanges
- 1-1/2" Wall clearance
- Supports up to 500 lbs.



Part #	Mfg #	Description	Price
188711	69310-PN	24" Polished Nickel*	

**Contemporary Decorative ADA Grab Bar**



Part #	Mfg #	Description	Price
236584	69375-NK	24", Luxe Nickel	

**Drawer Pulls and Knobs**

**Litze® Drawer Pull**

- Knurling



Part #	Mfg #	Description	Price
242864	699137-GL	Luxe Gold	
249638	699137-PC	Chrome	

**Litze® Drawer Pull**



Part #	Mfg #	Description	Price
258698	699135-GL	Luxe Gold	

**Litze® Drawer Knob**



Part #	Mfg #	Description	Price
258913	699235-GL	Luxe Gold	

**Sotria Drawer Knob**



Part #	Mfg #	Description	Price
225006	699250-PC	Chrome	

**Rook™ Drawer Knob**



Part #	Mfg #	Description	Price
188718	699261-NKBL	Luxe Nickel/Matte Black	

**Rook™ Drawer Pull**



Part #	Mfg #	Description	Price
188720	699161-NKBL	Luxe Nickel/Matte Black	

**Vesi® Drawer Knob**



Part #	Mfg #	Description	Price
237742	699240-PC	Chrome	

**Light Sconces**

**Charlotte® Wall Sconce**

- 11.41" High



Part #	Mfg #	Description	Price
251529	697085-PNCO	1-Globe, Cocoa Brze/Pol Nkl	

\* Brilliance® Anti-Tarnish Lifetime Finishes

---



---

**Bath Accessories**

---



---

**Virage® Wall Sconce**

- 10-7/8" High
- Glass dome is satin etched
- Uses C7 60 watt maximum bulb
- Mounting hardware and instructions included



Part #	Mfg #	Description	Price
248261	697030-PC	1-Globe, Chrome	
248716	697030-PN	1-Globe, Polished Nickel*	

**Mirrors & Medicine Cabinets****Charlotte® Wall Mirror**

- 20"W x 26"H
- Mounting hardware and mounting instructions included



Part #	Mfg #	Description	Price
251527	698085-PNCO	Cocoa Bronze/Polished Nickel	

**Virage® Wall Mirror**

- 20"W x 30"H



Part #	Mfg #	Description	Price
189235	698030-PC	Chrome	
186515	698030-PN	Polished Nickel*	

\* Brilliance® Anti-Tarnish Lifetime Finishes

<a href="http://www.plumbsupply.com">www.plumbsupply.com</a> • Serving our Customers Since 1946 • <a href="http://www.waterconcepts.net">www.waterconcepts.net</a>
--------------------------------------------------------------------------------------------------------------------------------------------------------------------

## Bath Accessories

### Towel Rings

#### Addison® Towel Ring



Part #	Mfg #	Finish	Price
156850	79746	Chrome	
128420	79246	Chrome	
140639	79246-CZ	Champagne Bronze™	
129949	79246-RB	Venetian Bronze®	
128430	79246-SS	Stainless*	

#### Ara Towel Ring



Part #	Mfg #	Description	Price
112699	77546	Chrome	
234731	77546-BL	Matte Black	
112700	77546-SS	Stainless*	

#### Ashlyn Towel Ring



Part #	Mfg #	Description	Price
174453	76446	Chrome	
172677	76446-RB	Venetian Bronze®	
173619	76446-SS	Stainless*	

#### Cassidy™ Towel Ring



Part #	Mfg #	Description	Price
153133	79746-CZ	Champagne Bronze™	

### Towel Rings (Continued)

#### Cassidy™ Towel Ring

Part #	Mfg #	Description	Price
153344	79746-PN	Polished Nickel*	
151573	79746-RB	Venetian Bronze®	
151702	79746-SS	Stainless*	

#### Dryden™ Towel Ring



Part #	Mfg #	Finish	Price
117217	75146	Chrome	
148646	75146-CZ	Champagne Bronze™	
177157	75146-PN	Polished Nickel*	
117167	75146-SS	Stainless*	
116764	75146-RB	Venetian Bronze®	

#### Grail™ Towel Ring



Part #	Mfg #	Finish	Price
111858	77146	Chrome	
113014	77146-SS	Stainless*	

#### Lahara™ Towel Ring



Part #	Mfg #	Finish	Price
113770	73846	Chrome	
111496	73846-RB	Venetian Bronze®	
111522	73846-SS	Stainless*	

\* Brilliance® Anti-Tarnish Lifetime Finishes



**Bath Accessories**

**Linden™ Towel Ring**



Part #	Mfg #	Finish	Price
143371	79446	Chrome	
144402	79446-CZ	Champagne Bronze™	
144559	79446-RB	Venetian Bronze®	
144200	79446-SS	Stainless*	

**Tesla™ Towel Ring**



Part #	Mfg #	Description	Price
237044	75246	Chrome	
259912	75246-PN	Polished Nickel*	
181649	75246-SS	Stainless*	

**Trinsic™ Towel Ring**



Part #	Mfg #	Description	Price
153130	759460	Chrome	
237337	759460-BL	Matte Black	
186847	759460-CZ	Champagne Bronze™	
163074	759460-RB	Venetian Bronze®	
153360	759460-SS	Stainless*	

**Vero™ Towel Ring**



Part #	Mfg #	Finish	Price
138387	77746	Chrome	
180009	77746-CZ	Champagne Bronze™	
149667	77746-RB	Venetian Bronze®	

**Towel Rings (Continued)**

**Vero™ Towel Ring**

Part #	Mfg #	Finish	Price
138477	77746-SS	Stainless*	

**Victorian® Open Towel Ring**

- 7-1/16" Ring
- Extends 3" from wall



Part #	Mfg #	Finish	Price
055722	75046-RB	Venetian Bronze®	
073347	75046-SS	Stainless*	

**Windemere® Towel Ring**



Part #	Mfg #	Description	Price
159085	70046	Chrome	
166610	70046-OB	Oil Rubbed Bronze	
167371	70046-SS	Stainless*	

**Woodhurst® Towel Ring**



Part #	Mfg #	Description	Price
255963	73246	Chrome	
251188	73246-RB	Venetian Bronze®	
255513	73246-SS	Stainless*	

**Towel Bars**

**Addison® Towel Bar**



Part #	Mfg #	Description	Price
129938	79218	18", Chrome	

\* Brilliance® Anti-Tarnish Lifetime Finishes

## Bath Accessories

### Towel Bars (Continued)

#### Addison® Towel Bar

Part #	Mfg #	Description	Price
126443	79218-RB	18", Venetian Bronze®	
127963	79218-SS	18", Stainless*	
128421	79224	24", Chrome	
137916	79224-CZ	24", Champagne Bronze™	
128429	79224-SS	24", Stainless*	
126444	79224-RB	24", Venetian Bronze®	
162381	79230	30", Chrome	
183315	79230-CZ	30", Champagne Bronze™	
160225	79230-RB	30", Venetian Bronze®	
159798	79230-SS	30", Stainless*	

#### Addison® Double Towel Bar



Part #	Mfg #	Description	Price
171208	79225	24", Chrome	
170713	79225-CZ	24", Champagne Bronze™	
162312	79225-RB	24", Venetian Bronze®	
162348	79225-SS	24", Stainless*	

#### Arzo® Towel Bar



Part #	Mfg #	Description	Price
112693	77518	18", Chrome	
249681	77518-BL	18", Matte Black	
112694	77518-SS	18", Stainless*	
112695	77524	24", Chrome	
112696	77524-SS	24", Stainless*	
175997	77530	30", Chrome	
253326	77530-BL	30", Matte Black	
174592	77530-SS	30", Stainless*	

#### Arzo Double Towel Bar



Part #	Mfg #	Description	Price
161530	77525	24", Chrome	
171631	77525-SS	24", Stainless*	

#### Ashlyn™ Towel Bar



Part #	Mfg #	Description	Price
175996	76418	18", Chrome	
176564	76418-RB	18", Venetian Bronze®	
173618	76418-SS	18", Stainless*	
174520	76424	24", Chrome	
172991	76424-RB	24", Venetian Bronze®	
174018	76424-SS	24", Stainless*	

#### Cassidy™ Towel Bar



Part #	Mfg #	Description	Price
171041	79712	12", Chrome	
174123	79712-RB	12", Venetian Bronze®	
160561	79712-SS	12", Stainless*	
153034	79718	18", Chrome	
151145	79718-CZ	18", Champagne Bronze™	
153035	79718-PN	18", Polished Nickel	
153036	79718-RB	18", Venetian Bronze®	
153037	79718-SS	18", Stainless*	
153038	79724	24", Chrome	
153039	79724-CZ	24", Champagne Bronze™	
153343	79724-PN	24", Polished Nickel*	
151571	79724-RB	24", Venetian Bronze®	
153041	79724-SS	24", Stainless*	
163144	79730	30", Chrome	
168309	79730-CZ	30", Champagne Bronze™	
170754	79730-PN	30", Polished Nickel*	
158699	79730-RB	30", Venetian Bronze®	
158142	79730-SS	30", Stainless*	

#### Cassidy™ Double Towel Bar



Part #	Mfg #	Description	Price
160677	79725	24", Chrome	
217624	79725-CZ	24", Champagne Bronze™	
186110	79725-PN	24", Polished Nickel*	
160809	79725-RB	24", Venetian Bronze®	
167745	79725-SS	24", Stainless*	

\* Brilliance® Anti-Tarnish Lifetime Finishes

## Bath Accessories

### Cassidy™ Glass Shelf with Removable Bar



Part #	Mfg #	Description	Price
186497	79711	24", Chrome	
180597	79711-SS	24", Stainless*	

### Cassidy™ Glass Shelf with Removable Bar



Part #	Mfg #	Description	Price
153683	79710	Chrome	
174697	79710-RB	Venetian Bronze®	

### Cassidy™ 24" Towel Bar/Assist Bar

- 7/8" diameter assist bar
- Extends 4-3/8" from wall
- Supports loads exceeding 250 lbs
- Mounting hardware included
- Retrievable assist bar wall anchor included



Part #	Mfg #	Description	Price
237278	41319	24", Chrome	
250042	41319-CZ	24", Champagne Bronze	
243256	41319-PN	24", Polished Nickel	
167065	41319-SS	24", Stainless*	
162927	41319-RB	24", Venetian Bronze®	

### Compel™ Towel Bar



Part #	Mfg #	Description	Price
113010	77118-SS	18", Stainless*	
113027	77124	24", Chrome	
113011	77124-SS	24", Stainless*	
175932	77130	30", Chrome	
182843	77130-SS	30", Stainless*	

### Contemporary 24" Towel Bar/Assist Bar

- Supports loads exceeding 250 lbs



Part #	Mfg #	Description	Price
179497	41519	Chrome	
172779	41519-SS	Stainless*	

### Delta 24" Double Towel Bar



Part #	Mfg #	Description	Price
171239	77125	24", Chrome	
175569	77125-SS	24", Stainless*	

### Dryden™ Double Towel Bar



Part #	Mfg #	Description	Price
159636	75125	24", Chrome	
181105	75125-CZ	24", Champagne Bronze™	
160333	75125-SS	24", Stainless*	
211836	75125-RB	24", Venetian Bronze®	

### Dryden™ Towel Bar



Part #	Mfg #	Description	Price
117208	75118	18", Chrome	
159516	75118-CZ	18", Champagne Bronze™	
175057	75118-PN	18", Polished Nickel*	
117210	75118-RB	18", Venetian Bronze®	
117211	75118-SS	18", Stainless*	
117212	75124	24", Chrome	
175056	75124-PN	24", Polished Nickel*	
116973	75124-RB	24", Venetian Bronze®	
117166	75124-SS	24", Stainless*	
177726	75130	30", Chrome	
184862	75130-CZ	30", Champagne Bronze™	
182005	75130-PN	30", Polished Nickel*	
168284	75130-RB	30", Venetian Bronze®	
162697	75130-SS	30", Stainless*	

\* Brilliance® Anti-Tarnish Lifetime Finishes

[www.plumbsupply.com](http://www.plumbsupply.com) • Serving our Customers Since 1946 • [www.waterconcepts.net](http://www.waterconcepts.net)

## Bath Accessories

### Lahara™ Towel Bar



Part #	Mfg #	Description	Price
115326	73818	18", Chrome	
111492	73818-RB	18", Venetian Bronze®	
111876	73818-SS	18", Stainless*	
113771	73824	24", Chrome	
149443	73824-CZ	24", Champagne Bronze™	
113095	73824-RB	24" Venetian Bronze®	
111524	73824-SS	24", Stainless*	

### Lahara Double Towel/Assist Bar

- 7/8" diameter assist bar
- Extends 3-5/8" from wall
- Supports weight exceeding 250 lbs
- Retrievable assist bar wall anchor included



Part #	Mfg #	Description	Price
189214	41419	24", Chrome	
163123	41419-CZ	24", Champagne Bronze™	
171617	41419-RB	24", Venetian Bronze®	
164838	41419-SS	24", Stainless*	

### Linden™ Towel Bar

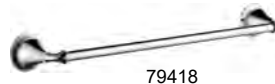

79418

Part #	Mfg #	Description	Price
148475	79418	18", Chrome	
144726	79418-SS	18", Stainless*	
144696	79418-RB	18", Venetian Bronze®	
143370	79424	24", Chrome	
144401	79424-CZ	24", Champagne Bronze™	
145614	79424-RB	24", Venetian Bronze®	
144201	79424-SS	24", Stainless*	

### Pivotal™ Mini Towel Bar



Part #	Mfg #	Description	Price
253043	79908	8", Chrome	
246706	79908-BL	8", Matte Black	
258245	79908-PN	8", Polished Nickel*	
247506	79908-SS	8", Stainless*	

### Pivotal™ Towel Bar



Part #	Mfg #	Description	Price
249349	79918	18", Chrome	
247159	79918-BL	18", Matte Black	
251167	79918-SS	18", Stainless	
249350	79924	24", Chrome	
246710	79924-BL	24", Matte Black	
255582	79930-BL	30", Matte Black	
251166	79930-SS	30", Stainless	

### Stryke™ Towel Bar



Part #	Mfg #	Description	Price
260043	77624-BL	24", Matte Black	
257506	77624-SS	24", Stainless	

### Stryke™ Mini Towel Bar



Part #	Mfg #	Description	Price
260184	77608-BL	8", Matte Black	

### Tesla™ Towel Bar



Part #	Mfg #	Description	Price
235003	75218	18", Chrome	
187677	75218-SS	18", Stainless*	
221720	752240	24", Chrome	
259911	752240-PN	24", Polished Nickel*	
186439	752240-SS	24", Stainless*	
235898	75230	30", Chrome	
229529	75230-SS	30", Stainless*	

### Tesla™ Double Towel Bar



Part #	Mfg #	Description	Price
224767	75225-SS	24", Stainless*	

\* Brilliance® Anti-Tarnish Lifetime Finishes

## Bath Accessories

### Trinsic™ Towel Bar



Part #	Mfg #	Description	Price
159205	75912	12", Chrome	
245293	75912-BL	12", Matte Black	
187487	75912-CZ	12", Champagne Bronze™	
160127	75912-RB	12", Venetian Bronze®	
172524	75912-SS	12", Stainless*	
153323	75918	18", Chrome	
243692	75918-BL	18", Matte Black	
225347	75918-CZ	18", Champagne Bronze™	
172746	75918-RB	18", Venetian Bronze®	
157011	75918-SS	18", Stainless*	
153129	759240	24", Chrome	
237339	759240-BL	24", Matte Black	
225348	759240-CZ	24", Champagne Bronze™	
160129	759240-RB	24", Venetian Bronze®	
153915	759240-SS	24", Stainless*	
176390	75930	30", Chrome	
252874	75930-CZ	30", Champagne Bronze™	
189017	75930-RB	30", Venetian Bronze®	
179771	75930-SS	30", Stainless*	

### Trinsic® Double Towel Bar



Part #	Mfg #	Description	Price
213877	75925	24", Chrome	
244223	75925-BL	24", Matte Black	
186849	75925-CZ	24", Champagne Bronze™	
238766	75925-RB	24", Venetian Bronze	
171856	75925-SS	24", Stainless*	

### Commercial Towel Shelf with Bar

- Concealed mounting
- Mounting hardware included



Part #	Mfg #	Description	Price
170510	43018	18", Chrome	
155322	43024	24", Chrome	

### Vero™ Towel Bar



Part #	Mfg #	Description	Price
138065	77718	18", Chrome	
148548	77718-CZ	18", Champagne Bronze™	
158012	77718-RB	18", Venetian Bronze®	
136654	77718-SS	18", Stainless*	
138067	77724	24", Chrome	
171609	77724-RB	24", Venetian Bronze®	
136655	77724-SS	24", Stainless*	
165157	77730	30", Chrome	
164950	77730-SS	30", Stainless*	

### Vero™ Double Towel Bar



Part #	Mfg #	Description	Price
182239	77725	24" Chrome	
180008	77725-CZ	24", Champagne Bronze™	
167401	77725-RB	24", Venetian Bronze®	
162593	77725-SS	24", Stainless*	

### Victorian® Towel Bar



Part #	Mfg #	Description	Price
055811	75018	18", Chrome	
056972	75018-RB	18", Venetian Bronze®	
073501	75018-SS	18", Stainless*	
146411	75024-CZ	24", Champagne Bronze™	
056971	75024-RB	24", Venetian Bronze®	
075143	75024-SS	24", Stainless*	
184587	75030	30", Chrome	
184586	75030-CZ	30", Champagne Bronze™	
174971	75030-PB	30", Polished Brass*	
181975	75030-RB	30", Venetian Bronze®	
171223	75030-SS	30", Stainless*	
057261	75224-RB	24", Double Bar Venetian Bronze®	

### Windemere® Towel Bar



Part #	Mfg #	Description	Price
179723	70018	18", Chrome	

\* Brilliance® Anti-Tarnish Lifetime Finishes

**www.plumbsupply.com • Serving our Customers Since 1946 • www.waterconcepts.net**

## Bath Accessories

### Towel Bars (Continued)

#### Windemere® Towel Bar

Part #	Mfg #	Description	Price
167370	70018-OB	18", Oil Rubbed Bronze	
162360	70018-SS	18", Stainless*	
179722	70024	24", Chrome	
166607	70024-OB	24", Oil Rubbed Bronze	
162361	70024-SS	24", Stainless*	

#### Woodhurst™ Towel Bar



Part #	Mfg #	Description	Price
255509	73218-SS	18", Stainless*	
255962	73224	24", Chrome	
251184	73224-RB	24", Venetian Bronze	
255505	73224-SS	24", Stainless*	

#### Zura® Towel Bar



Part #	Mfg #	Description	Price
228218	77418	18", Chrome	
228219	774240	24", Chrome	

\* Brilliance® Anti-Tarnish Lifetime Finishes



**Bath Accessories**

**Towel Rings**  
90° Towel Bar/Ring



Part #	Mfg #	Finish	Price
147798	YB8886BN	Brushed Nickel	
132635	YB8886CH	Chrome	

**Align™ Towel Bar**



Part #	Mfg #	Finish	Price
244487	YB0486BL	Matte Black	
249524	YB0486BN	Brushed Nickel	
174591	YB0486CH	Chrome	

**Arris™ Towel Ring**



Part #	Mfg #	Finish	Price
175358	YB0886CH	Chrome	

**Aspen™ Towel Ring**



Part #	Mfg #	Finish	Price
072472	5886CH	Chrome	

**Brantford™ Towel Ring**



Part #	Mfg #	Finish	Price
113975	YB2286CH	Chrome	

**Towel Rings (Continued)**  
Brantford™ Towel Ring

Part #	Mfg #	Finish	Price
103428	YB2286BN	Brushed Nickel	
102306	YB2286ORB	Oil Rubbed Bronze	

**Contemporary Towel Ring**



Part #	Mfg #	Finish	Price
189765	P5860	Chrome	
240227	P5860BN	Brushed Nickel	

**Dartmoor Towel Ring**



Part #	Mfg #	Finish	Price
189421	YB2186CH	Chrome	

**Eva® Towel Ring**



YB2886

YB2808

Part #	Mfg #	Finish	Price
107065	YB2808CH	Chrome	
113432	YB2886CH	Chrome	
097369	YB2886BN	Brushed Nickel	
096192	YB2886ORB	Oil Rubbed Bronze	

**Bath Accessories**

**Glenshire™ Towel Ring**



Part #	Mfg #	Finish	Price
158112	DN2686BN	Brushed Nickel	
165283	DN2686CH	Chrome	

**Kingsley™ Towel Ring**



Part #	Mfg #	Finish	Price
074533	YB5486BN	Brushed Nickel	
072057	YB5486CH	Chrome	
077253	YB5486ORB	Oil Rubbed Bronze	
089446	YB5486WR	Wrought Iron	

**Glyde Towel Ring**



Part #	Mfg #	Finish	Price
239272	YB2386CH	Chrome	

**Lounge™ Towel Ring**



Part #	Mfg #	Finish	Price
099087	DN7786BN	Brushed Nickel	

**Icon™ Towel Ring**



Part #	Mfg #	Finish	Price
096173	YB5886BN	Brushed Nickel	
099703	YB5886CH	Chrome	

**Madison Towel Ring**



Part #	Mfg #	Finish	Price
174049	BP6986OWB	Old World Bronze	

**Iso™ Towel Ring**



Part #	Mfg #	Finish	Price
113841	DN0786CH	Chrome	

**Mason™ Towel Ring**



Part #	Mfg #	Finish	Price
237206	YB8086CH	Chrome	

**Bath Accessories**

**Preston™ Towel Ring**



Part #	Mfg #	Finish	Price
096889	DN8486BN	Brushed Nickel	

**Waterhill™ Towel Ring**



Part #	Mfg #	Finish	Price
123963	YB9886ORB	Oil Rubbed Bronze	

**Retreat® Towel Ring**



Part #	Mfg #	Finish	Price
093026	DN8386BN	Brushed Nickel	

**Wembley® Towel Ring**



Part #	Mfg #	Finish	Price
115110	DN8286BN	Brushed Nickel	

**Sage® Towel Ring**



Part #	Mfg #	Finish	Price
081792	DN6886CH	Chrome	

**Weymouth™ Towel Ring**



Part #	Mfg #	Finish	Price
146271	YB8486BN	Brushed Nickel	
223045	YB8486CH	Chrome	
152849	YB8486NL	Polished Nickel	
181599	YB8486ORB	Oil Rubbed Bronze	

**Voss™ Towel Ring**



Part #	Mfg #	Finish	Price
151704	YB5186BN	Brushed Nickel	
154434	YB5186CH	Chrome	
164523	YB5186ORB	Oil Rubbed Bronze	

**Wynford Towel Ring**



Part #	Mfg #	Finish	Price
217279	YB5286BN	Brushed Nickel	
188045	YB5286CH	Chrome	

**Bath Accessories**

**Towel Rings (Continued)**

**Wynford Towel Ring**

Part #	Mfg #	Finish	Price
223753	YB5286ORB	Oil Rubbed Bronze	

**Yorkshire Towel Ring**



Part #	Mfg #	Finish	Price
104361	BP5386CH	Chrome	
124390	BP5386OWB	Old World Bronze	

**Towel Bars**

**90° Towel Bar**



Part #	Mfg #	Finish	Price
139439	YB8818BN	18", Brushed Nickel	
132637	YB8818CH	18" Chrome	
141014	YB8824BN	24", Brushed Nickel	
132636	YB8824CH	24", Chrome	

**Align Towel Bar**



Part #	Mfg #	Finish	Price
181497	YB0418BN	18", Brushed Nickel	
174589	YB0424CH	24", Chrome	
251193	YG0424BN	24", Brushed Nickel	

**Arris™ Towel Bar**



Part #	Mfg #	Finish	Price
165369	YB0818CH	18", Chrome	

**Towel Bars (Continued)**

**Arris™ Towel Bar**

Part #	Mfg #	Finish	Price
247767	YB0818BN	18", Brushed Nickel	
247768	YB0824BN	24", Brushed Nickel	
175359	YB0824CH	24", Chrome	

**Aspen™ Towel Bar**



Part #	Mfg #	Finish	Price
072471	5818CH	18", Chrome	
113976	5824CH	24", Chrome	

**Banbury™ Double Towel Bar**



Part #	Mfg #	Finish	Price
158111	DN2622BN	24", Brushed Nickel	
099699	DN2622CH	24", Chrome	

**Belfield™ Hand Towel Bar**



Part #	Mfg #	Finish	Price
239305	YB6486CH	Chrome	
239772	YB6486ORB	Oil Rubbed Bronze	

**Belfield™ Towel Bar**



Part #	Mfg #	Finish	Price
252694	YB6418ORB	18", Oil Rubbed Bronze	
252274	YB6424BN	24", Brushed Nickel	

**Bath Accessories**

**Towel Bars (Continued)**

**Belfield™ Towel Bar**

Part #	Mfg #	Finish	Price
239304	YB6424CH	24", Chrome	
239773	YB6424ORB	24", Oil Rubbed Bronze	

**Belfield™ Double Towel Bar**



Part #	Mfg #	Finish	Price
252701	YB6422CH	24", Chrome	
252693	YB6422ORB	24", Oil Rubbed Bronze	

**Brantford™ Towel Bar**



Part #	Mfg #	Finish	Price
118282	YB2218BN	18", Brushed Nickel	
113969	YB2218CH	18", Chrome	
102304	YB2218ORB	18", Oil Rubbed Bronze	
103430	YB2224BN	24", Brushed Nickel	
102305	YB2224ORB	24", Oil Rubbed Bronze	

**Contemporary Towel Bar**



Part #	Mfg #	Finish	Price
189764	P5124	24", Chrome	

**Danbury® Towel Bar**



Part #	Mfg #	Finish	Price
092972	DN6718BN	18", Brushed Nickel	
112420	DN6718ORB	18", Oil Rubbed Bronze	

**Dartmoor Towel Bar**



Part #	Mfg #	Finish	Price
224172	YB2124CH	24", Chrome	

**Eva® Towel Bar**



Part #	Mfg #	Finish	Price
104947	YB2818BN	18", Brushed Nickel	
105254	YB2818CH	18", Chrome	
096167	YB2818ORB	18", Oil Rubbed Bronze	
104948	YB2824BN	24", Brushed Nickel	
107064	YB2824CH	24", Chrome	
098297	YB2824ORB	24", Oil Rubbed Bronze	

**Genta™ Hand Towel Bar**



Part #	Mfg #	Finish	Price
250034	BH3886CH	Chrome	

## Bath Accessories

### Genta™ Towel Bar



Part #	Mfg #	Finish	Price
250031	BH3818CH	18", Chrome	
250032	BH3824CH	24", Chrome	

### Icon™ Double Towel Bar



Part #	Mfg #	Finish	Price
101290	YB5822BN	24", Brushed Nickel	
099704	YB5822CH	24", Chrome	

### Glenshire™ Towel Bar



Part #	Mfg #	Finish	Price
115388	DN2618BN	18", Brushed Nickel	
115389	DN2624BN	24", Brushed Nickel	
165284	DN2624CH	24", Chrome	

### Iso™ Towel Bar



Part #	Mfg #	Finish	Price
113840	DN0718CH	18", Chrome	
113842	DN0724CH	24", Chrome	

### Glyde® Towel Bar

- Pro-fit™ installation



Part #	Mfg #	Finish	Price
239981	YB2318CH	18", Chrome	
242624	YB2324CH	24", Chrome	

### Iso™ Double Towel Bar



Part #	Mfg #	Finish	Price
113843	DN0722CH	24", Chrome	

### Icon™ Towel Bar



Part #	Mfg #	Finish	Price
096175	YB5818BN	18", Brushed Nickel	
099707	YB5818CH	18", Chrome	
109396	YB5824BN	24", Brushed Nickel	
101288	YB5824CH	24", Chrome	

### Kingsley Towel Bar



Part #	Mfg #	Finish	Price
077255	YB5418ORB	18", Oil Rubbed Bronze	
082930	YB5424BN	24", Brushed Nickel	
072064	YB5424CH	24", Chrome	
075566	YB5424WR	24", Wrought Iron	



**Bath Accessories**

**Kingsley® Double Towel Bar**



Part #	Mfg #	Finish	Price
132203	YB5422BN	24", Brushed Nickel	
133194	YB5422CH	24", Chrome	
139824	YB5422ORB	24", Oil Rubbed Bronze	
168068	YB5422WR	24", Wrought Iron	

**Lounge™ Towel Bar**



Part #	Mfg #	Finish	Price
109499	DN7718BN	18", Brushed Nickel	
110043	DN7724BN	24", Brushed Nickel	

**Mason Towel Bar**



Part #	Mfg #	Finish	Price
110825	YB8094CH	24", Chrome	
239254	YB8094OWB	24", Old World Bronze	

**Method™ 9" Towel Bar**



Part #	Mfg #	Finish	Price
153206	YB2486BN	Brushed Nickel	
134233	YB2486CH	Chrome	

**Preston Towel Bar**



Part #	Mfg #	Finish	Price
048796	DN8418CH	18", Chrome	

**Preston Double Towel Bar**



Part #	Mfg #	Finish	Price
050107	DN8422CH	24", Chrome	

**Retreat® Towel Bar**



Part #	Mfg #	Finish	Price
093028	DN8324BN	24", Brushed Nickel	

**Rothbury Towel Bar**



Part #	Mfg #	Finish	Price
229063	YB8286BN	9", Brushed Nickel	
132147	YB8218ORB	18", Oil Rubbed Bronze	
229064	YB8224BN	24", Brushed Nickel	
152542	YB8224CH	24", Chrome	
132403	YB8224ORB	24", Oil Rubbed Bronze	

**Bath Accessories**

**Sage® Towel Bar**



Part #	Mfg #	Finish	Price
081790	DN6824CH	24", Chrome	

**Sage® Double Towel Bar**



Part #	Mfg #	Finish	Price
114452	DN6822BN	24", Brushed Nickel	

**Voss™ Towel Bar**



Part #	Mfg #	Finish	Price
150987	YB5118BN	18", Brushed Nickel	
152103	YB5118CH	18", Chrome	
169224	YB5118ORB	18", Oil Rubbed Bronze	
150988	YB5124BN	24", Brushed Nickel	
152105	YB5124CH	24", Chrome	
158211	YB5124ORB	24", Oil Rubbed Bronze	

**Weymouth™ Towel Bar**



Part #	Mfg #	Finish	Price
173401	YB8418CH	18", Chrome	
189388	YB8418NL	18", Polished Nickel	
173402	YB8424CH	24", Chrome	
152848	YB8424NL	24", Polished Nickel	
181598	YB8424ORB	24", Oil Rubbed Bronze	

**Wynford™ Towel Bar**



Part #	Mfg #	Finish	Price
188041	YB5218CH	18", Chrome	
225352	YB5218BN	18", Brushed Nickel	
180027	YB5224BN	24", Brushed Nickel	
238814	YB5224ORB	24", Oil Rubbed Bronze	

**Wynford™ Double Towel Bar**

Part #	Mfg #	Finish	Price
188043	YB5222CH	24" Chrome	
225333	YB5222BN	24", Brushed Nickel	
241956	YB5222RB	24", Venetian Bronze	

**Yorkshire Towel Bar**



Part #	Mfg #	Finish	Price
134591	5318CH	18", Chrome	
124391	BP5318OWB	18", Old World Bronze	

**Wembley® Double Towel Bar**



Part #	Mfg #	Finish	Price
115109	DN8222BN	24", Brushed Nickel	

## Bath Accessories

### Vanity Shelves

#### Eva® Glass Vanity Shelf



Part #	Mfg #	Finish	Price
126032	YB2894BN	Brushed Nickel	

### Lounge Glass Vanity Shelf



Part #	Mfg #	Finish	Price
118161	DN7790CH	Chrome	
225555	DN7790BN	Brushed Nickel	

#### Icon Vanity Shelf

- Glass construction
- Pro-Fit™ installation system
- Template and mounting hardware included



Part #	Mfg #	Finish	Price
239109	YB5890CH	20", Chrome	
225904	YB5890BN	20", Brushed Nickel	

#### Retreat® Glass Vanity Shelf



Part #	Mfg #	Finish	Price
109498	DN8390BN	Brushed Nickel	

#### Sage® Glass Vanity Shelf



Part #	Mfg #	Finish	Price
106026	DN6890BN	Brushed Nickel	

#### Iso™ Towel Shelf



Part #	Mfg #	Finish	Price
159757	DN0794BN	Brushed Nickel	

### Accessories

#### Mason Mounting Post

- Pro-fit™ installation system



Part #	Mfg #	Finish	Price
239255	YB8000OWB	Old World Bronze	

#### Kingsley™ Glass Vanity Shelf



Part #	Mfg #	Finish	Price
153236	YB5490BN	Brushed Nickel	
139461	YB5490CH	Chrome	
096169	YB5409ORB	Oil Rubbed Bronze	
097027	YB5409WR	Wrought Iron	

#### Kingsley® Towel Shelf



Part #	Mfg #	Finish	Price
132204	YB5494BN	Brushed Nickel	
168624	YB5494CH	Chrome	

**Bath Accessories**

**Toilet Tissue Holders**

• Tools and template included for installation

**Alteo® Pivoting Toilet Tissue Holder**



Part #	Mfg #	Finish	Price
142071	K-37054-BN	*Brushed Nickel	
139658	K-37054-CP	Polished Chrome	
149756	K-37054-2BZ	Oil Rubbed Bronze	

**Alteo® Vertical Toilet Tissue Holder**



Part #	Mfg #	Finish	Price
144467	K-37056-BN	*Brushed Nickel	
148511	K-37056-CP	Polished Chrome	
157866	K-37056-2BZ	Oil Rubbed Bronze	

**Archer® Toilet Tissue Holder**



Part #	Mfg #	Description	Price
120026	K-11054-BN	*Brushed Nickel	
120082	K-11054-CP	Polished Chrome	

**Archer® Vertical Toilet Tissue Holder**



Part #	Mfg #	Description	Price
123908	K-11056-BN	*Brushed Nickel	
135973	K-11056-CP	Polished Chrome	

**Artifacts® Pivoting Tissue Holder**



Part #	Mfg #	Description	Price
174108	K-72573-BN	*Brushed Nickel	
224550	K-72573-BV	*Brushed Bronze	
173115	K-72573-CP	Polished Chrome	
173105	K-72573-SN	Polished Nickel	
223892	K-72573-VNT	Vintage Nickel	
168461	K-72573-2BZ	Oil Rubbed Bronze	

**Artifacts® Vertical Toilet Tissue Holder**



Part #	Mfg #	Description	Price
162104	K-72576-BN	*Brushed Nickel	
183642	K-72576-SN	*Polished Nickel	
183643	K-72576-2BZ	Oil Rubbed Bronze	

**Bancroft® Toilet Tissue Holder**



Part #	Mfg #	Description	Price
096180	K-11415-BN	*Brushed Nickel	
114843	K-11415-BV	*Brushed Bronze	
087297	K-11415-CP	Polished Chrome	
098451	K-11415-SN	*Polished Nickel	
162435	K-11415-2BZ	Oil Rubbed Bronze	

**Composed™ Toilet Tissue Holder**



Part #	Mfg #	Description	Price
225540	K-73147-CP	Polished Chrome	

\* Vibrant Limited Lifetime Warranty

**Bath Accessories**

**Toilet Tissue Holders (Continued)**

**Composed™ Toilet Tissue Holder**

Part #	Mfg #	Description	Price
231736	K-73147-TT	*Titanium	
228448	K-73148-CP	Polished Chrome, Vertical	
238973	K-73148-TT	*Titanium, Vertical	

**Coralais® Toilet Tissue Holder**



Part #	Mfg #	Finish	Price
111507	K-13434-BN	*Brushed Nickel	
097475	K-13434-CP	Polished Chrome	
117701	K-13434-G	Brushed Chrome	

**Devonshire® Toilet Tissue Holder**



Part #	Mfg #	Finish	Price
075035	K-10554-BN	*Brushed Nickel	
086445	K10554BV	*Brushed Bronze	
073748	K-10554-CP	Polished Chrome	
078149	K-10554-PB	Polished Brass	
190234	K-10554-SN	*Polished Nickel	
146954	K-10554-2BZ	Oil Rubbed Bronze	

**Fairfax® Toilet Tissue Holder**



Part #	Mfg #	Description	Price
069237	K-12157-BN	*Brushed Nickel	
072315	K-12157-CP	Polished Chrome	
154610	K-12157-2BZ	Oil Rubbed Bronze	

**Finial® Traditional Toilet Tissue Holder**



Part #	Mfg #	Description	Price
080559	K-361-AF	*French Gold	
062460	K-361-BN	*Brushed Nickel	
077357	K-361-BV	*Brushed Bronze	
060169	K-361-CP	Polished Chrome	
074140	K-361-SN	*Polished Nickel	
152086	K-361-2BZ	Oil Rubbed Bronze	

**Forté® Sculpted Toilet Tissue Holder**



Part #	Mfg #	Finish	Price
080263	K-11374-BN	*Brushed Nickel	
084209	K-11374-CP	Polished Chrome	
087274	K-11374-G	Brushed Chrome	

**Forté® Traditional Toilet Tissue Holder**



Part #	Mfg #	Finish	Price
087031	K-11274-BN	*Brushed Nickel	
084059	K-11274-CP	Polished Chrome	

**Kelston® Toilet Tissue Holder**



Part #	Mfg #	Description	Price
134491	K-13504-BN	*Brushed Nickel	
160293	K-13504-CP	Polished Chrome	
150913	K-13504-2BZ	Oil Rubbed Bronze	

\* Vibrant Limited Lifetime Warranty

[www.plumbsupply.com](http://www.plumbsupply.com) • Serving our Customers Since 1946 • [www.waterconcepts.net](http://www.waterconcepts.net)

## Bath Accessories

### Loure® Covered Toilet Tissue Holder



Part #	Mfg #	Description	Price
133516	K-11584-BN	*Brushed Nickel	
165332	K-11584-CP	Polished Chrome	

### Loure® Vertical Toilet Tissue Holder



Part #	Mfg #	Description	Price
123909	K-11583-BN	*Brushed Nickel	
121347	K-11583-CP	Polished Chrome	
142544	K-11583-SN	*Polished Nickel	

### Margaux™ Toilet Tissue Holder



Part #	Mfg #	Finish	Price
183022	K-16265-AF	*French Gold	
132764	K-16265-BN	*Brushed Nickel	
138823	K-16265-BV	*Brushed Bronze	
141876	K-16265-CP	Polished Chrome	
160874	K-16265-SN	*Polished Nickel	

### Margaux® Vertical Toilet Tissue Holder



Part #	Mfg #	Description	Price
136522	K-16255-AF	*French Gold	
109462	K-16255-BN	*Brushed Nickel	

### Toilet Tissue Holders (Continued)

#### Margaux® Vertical Toilet Tissue Holder

Part #	Mfg #	Description	Price
124078	K-16255-BV	*Brushed Bronze	
111198	K-16255-CP	Polished Chrome	
135086	K-16255-SN	*Polished Nickel	

#### Memoirs® Stately Toilet Tissue Holder



Part #	Mfg #	Description	Price
057962	K-490-BN	*Brushed Nickel	
075021	K-490-BV	*Brushed Bronze	
063413	K-490-CP	Polished Chrome	
170476	K-490-2BZ	Oil Rubbed Bronze	

#### Pinstripe® Toilet Tissue Holder



Part #	Mfg #	Description	Price
086162	K-13114-CP	Polished Chrome	
099492	K-13114-SN	*Polished Nickel	

#### Purist® Pivoting Tissue Holder



Part #	Mfg #	Description	Price
228967	K-14377-BGD	*Moderne Brushed Gold	
253292	K-14377-BL	Matte Black	
159063	K-14377-BN	*Brushed Nickel	
185004	K-14377-BV	*Brushed Bronze	
152949	K-14377-CP	Polished Chrome	
148808	K-14377-SN	*Polished Nickel	

\* Vibrant Limited Lifetime Warranty

[www.waterconcepts.net](http://www.waterconcepts.net) • Serving our Customers Since 1946 • [www.plumbsupply.com](http://www.plumbsupply.com)



**Bath Accessories**

**Purist® Vertical Toilet Tissue Holder**



Part #	Mfg #	Description	Price
132493	K-14444-BGD	*Moderne Brushed Gold	
257783	K-14444-BL	Matte Black	
080025	K-14444-BN	*Brushed Nickel	
132499	K-14444-BV	*Brushed Bronze	
069310	K-14444-CP	Polished Chrome	
091453	K-14444-SN	*Polished Nickel	

**Toobi® Vertical Toilet Tissue Holder**



Part #	Mfg #	Description	Price
162523	K-5673-BN	*Brushed Nickel	
157517	K-5673-CP	Polished Chrome	

**Stillness® Pivoting Tissue Holder**



Part #	Mfg #	Description	Price
183012	K-14393-BN	*Brushed Nickel	
155207	K-14393-CP	Polished Chrome	

**Stillness® Vertical Toilet Tissue Holder**

- Solid-brass construction for durability
- Can be installed vertically or horizontally
- Tools for installation included



Part #	Mfg #	Description	Price
072152	K-14459-CP	Polished Chrome	

**Toobi® Toilet Tissue Holder**



Part #	Mfg #	Description	Price
150831	K-5672-BN	*Brushed Nickel	
155341	K-5672-CP	Polished Chrome	

\* Vibrant Limited Lifetime Warranty

[www.plumbsupply.com](http://www.plumbsupply.com) • Serving our Customers Since 1946 • [www.waterconcepts.net](http://www.waterconcepts.net)

## Bath Accessories

### Tissue Holders

#### Addison® Tissue Holder



Part #	Mfg #	Finish	Price
128419	79250	Chrome	
137914	79250-CZ	Champagne Bronze™	
126442	79250-RB	Venetian Bronze®	
128433	79250-SS	Stainless*	

#### Arzo® Tissue Holder



Part #	Mfg #	Finish	Price
112701	77550	Chrome	
234732	77550BL	Matte Black	
112702	77550-SS	Stainless*	

#### Ashlyn Tissue Holder



Part #	Mfg #	Description	Price
174454	76450	Chrome	
172679	76450-RB	Venetian Bronze®	
173620	76450-SS	Stainless*	

#### Cassidy™ Tissue Holder



Part #	Mfg #	Description	Price
155332	79750	Chrome	
151144	79750-CZ	Champagne Bronze™	
153347	79750-PN	Polished Nickel*	
151572	79750-RB	Venetian Bronze®	
151710	79750-SS	Stainless*	

#### Cassidy™ Tissue Holder/Assist Bar

- 6" Long
- Tissue holder also functions as an assist bar
- 7/8" diameter assist bar
- Pivoting arm
- Extends 5-1/4" from wall
- Supports loads exceeding 250 lbs
- Mounting hardware included



Part #	Mfg #	Description	Price
168134	41350	Chrome	
225974	41350-CZ	Champagne Bronze™	
168130	41350-PN	Polished Nickel*	
170143	41350-RB	Venetian Bronze®	
165281	41350-SS	Stainless*	

#### Contemporary Tissue Holder/Assist Bar



Part #	Mfg #	Description	Price
179498	41550	Chrome	
171287	41550-CZ	Champagne Bronze™	
181197	41550-SS	Stainless*	

#### Compel™ Tissue Holder



Part #	Mfg #	Description	Price
163462	77250	Chrome	
171642	77250-SS	Stainless*	

#### Commercial Twin Tissue Holder

- Includes 2 brass rollers



Part #	Mfg #	Description	Price
245352	45272	Chrome	

\* Brilliance® Anti-Tarnish Lifetime Finishes

## Bath Accessories

### Dryden™ Tissue Holder



Part #	Mfg #	Finish	Price
117219	75150	Chrome	
146203	75150-CZ	Champagne Bronze™	
175055	75150-PN	Polished Nickel*	
116766	75150-RB	Venetian Bronze®	
117165	75150-SS	Stainless*	

### Grail® Tissue Holder



Part #	Mfg #	Finish	Price
111859	77150	Chrome	
113015	77150-SS	Stainless*	

### Lahara™ Tissue Holder



Part #	Mfg #	Finish	Price
114058	73850	Chrome	
157537	73850-CZ	Champagne Bronze™	
111497	73850-RB	Venetian Bronze®	
111523	73850-SS	Stainless*	

### Lahara Tissue Holder/Assist Bar



Part #	Mfg #	Description	Price
170469	41450	Chrome	
163121	41450-CZ	Champagne Bronze™	
171616	41450-RB	Venetian Bronze®	
169509	41450-SS	Stainless*	

### Linden™ Tissue Holder



Part #	Mfg #	Finish	Price
143372	79450	Chrome	
144403	79450-CZ	Champagne Bronze™	
144560	79450-RB	Venetian Bronze®	
143870	79450-SS	Stainless*	

### Pivotal™ Double Tissue Holder



Part #	Mfg #	Description	Price
244646	79955	Chrome	

### Pivotal™ Tissue Holder with Shelf



Part #	Mfg #	Description	Price
253041	79956	Chrome	
246708	79956-BL	Matte Black	
258246	79956-PN	Polished Nickel*	

### Stryke™ Tissue Holder



Part #	Mfg #	Finish	Price
259224	77655-BL	Matte Black	
257505	77655-SS	Stainless*	

### Tesla® Tissue Holder



Part #	Mfg #	Description	Price
230949	752500	Chrome	
222230	752500-PN	Polished Nickel	
186447	752500-SS	Stainless*	

### Trinsic™ Tissue Holder



Part #	Mfg #	Description	Price
151404	75950	Chrome	
237341	75950-BL	Matte Black	
186846	75950-CZ	Champagne Bronze™	
153361	75950-SS	Stainless*	
158327	75950-RB	Venetian Bronze®	

\* Brilliance® Anti-Tarnish Lifetime Finishes

## Bath Accessories

### Victorian® Tissue Holder

- 9-1/4" Long



Part #	Mfg #	Finish	Price
054206	75050	Chrome	
146409	75050-CZ	Champagne Bronze™	
055723	75050-RB	Venetian Bronze®	
073348	75050-SS	Stainless*	

### Zura® Tissue Holder



Part #	Mfg #	Description	Price
230995	774500	Chrome	
255325	774500-BL	Matte Black	

### Zura® Vertical Tissue Holder

- Extends 4-1/4" from wall
- Mounting hardware & template included



Part #	Mfg #	Description	Price
238714	774505	Chrome	

### Vero™ Tissue Holder



Part #	Mfg #	Description	Price
138066	77750	Chrome	
173123	77750-CZ	Champagne Bronze™	
149665	77750-RB	Venetian Bronze®	
136656	77750-SS	Stainless*	

### Windemere Tissue Holder



Part #	Mfg #	Description	Price
159086	70050	Chrome	
164492	70050-OB	Oil Rubbed Bronze	
162359	70050-SS	Stainless*	

### Woodhurst™ Tissue Holder



Part #	Mfg #	Description	Price
255964	73250	Chrome	
251183	73250-RB	Venetian Bronze	
255512	73250-SS	Stainless*	

\* Brilliance® Anti-Tarnish Lifetime Finishes

**Bath Accessories**

**Paper Holders**

**90°™ Pivoting Toilet Paper Holder**



Part #	Mfg #	Finish	Price
139435	YB8808BN	Brushed Nickel	
132634	YB8808CH	Chrome	

**Align™ Toilet Paper Holder**



Part #	Mfg #	Finish	Price
175077	YB0409BN	Brushed Nickel	
174590	YB0409CH	Chrome	

**Align™ Toilet Paper Holder**



Part #	Mfg #	Finish	Price
244486	YB0408BL	Matte Black	
168502	YB0408CH	Chrome	

**Arris™ Pivoting Toilet Paper Holder**



Part #	Mfg #	Finish	Price
247769	YB0808BN	Brushed Nickel	
165370	YB0808CH	Chrome	

**Aspen™ Toilet Paper Holder**



Part #	Mfg #	Finish	Price
072474	5808CH	Chrome	

**Belfield™ Pivoting Toilet Paper Holder**



Part #	Mfg #	Finish	Price
242063	YB6408	Chrome	
244977	YB6408BN	Brushed Nickel	
241210	YB6408ORB	Oil Rubbed Bronze	

**Brantford™ Toilet Paper Holder**



Part #	Mfg #	Finish	Price
103432	YB2208BN	Brushed Nickel	
120275	YB2208CH	Chrome	
102303	YB2208ORB	Oil Rubbed Bronze	

**Contemporary Tissue Holder**



Part #	Mfg #	Finish	Price
189763	P5080	Chrome	

**Danbury® Toilet Tissue Holder**



Part #	Mfg #	Finish	Price
092973	DN6708BN	Brushed Nickel	

**Dartmoor™ Toilet Paper Holder**



Part #	Mfg #	Finish	Price
189420	YB2108CH	Chrome	

**Bath Accessories**

**Donner™ Commercial Paper Holder**



Part #	Mfg #	Finish	Price
157882	DN5075	Chrome	
083507	575	Chrome	

**Glyde Toilet Paper Holder**



Part #	Mfg #	Finish	Price
239271	YB2308CH	Chrome	

**Eva® Toilet Tissue Holder**



Part #	Mfg #	Finish	Price
097220	YB2808BN	Brushed Nickel	
096168	YB2808ORB	Oil Rubbed Bronze	

**Icon™ Pivoting Toilet Paper Holder**



Part #	Mfg #	Finish	Price
096174	YB5808BN	Brushed Nickel	
099702	YB5808CH	Chrome	

**Genta™ Pivoting Toilet Paper Holder**



Part #	Mfg #	Finish	Price
250030	BH3808CH	Chrome	

**Iso™ Toilet Paper Holder**



Part #	Mfg #	Finish	Price
113839	DN0708CH	Chrome	

**Glenshire™ Toilet Paper Holder**



Part #	Mfg #	Finish	Price
115387	DN2608BN	Brushed Nickel	
165282	DN2608CH	Chrome	

**Iso™ Toilet Paper Holder w/ Single Post**



Part #	Mfg #	Finish	Price
141071	DN0709BN	Brushed Nickel	

**Kingsley™ Pivoting Toilet Paper Holder**



Part #	Mfg #	Finish	Price
095723	YB5408BN	Brushed Nickel	
072055	YB5408CH	Chrome	
077254	YB5408ORB	Oil Rubbed Bronze	
075568	YB5408WR	Wrought Iron	



**Bath Accessories**

**Lounge™ Paper Holder**



Part #	Mfg #	Finish	Price
099088	DN7708BN	Brushed Nickel	
118159	DN7708CH	Chrome	

**Rothbury™ Toilet Paper Holder**



Part #	Mfg #	Finish	Price
153847	YB8286CH	Chrome	
120613	YB8286ORB	Oil Rubbed Bronze	

**Sage® Toilet Paper Holder**



Part #	Mfg #	Finish	Price
081791	DN6808CH	Chrome	

**Madison™ Toilet Paper Holder**



Part #	Mfg #	Finish	Price
189816	BP6980CH	European Style, Chrome	
067049	DN6908PW	Pewter	

**Sage™ Freestanding Paper Holder**



Part #	Mfg #	Finish	Price
122121	DN6850BN	Brushed Nickel	

**Preston™ Toilet Paper Holder**



Part #	Mfg #	Finish	Price
048794	DN8408CH	Chrome	
096888	DN8408BN	Brushed Nickel	

**Stockton® Freestanding Paper Holder**



Part #	Mfg #	Finish	Price
105290	DN4150BN	Brushed Nickel	

**Rothbury™ Pivoting Toilet Paper Holder**



Part #	Mfg #	Finish	Price
152540	YB8208BN	Brushed Nickel	
152541	YB8208CH	Chrome	
120612	YB8208ORB	Oil Rubbed Bronze	

## Bath Accessories

### Voss™ Pivoting Toilet Paper Holder



Part #	Mfg #	Finish	Price
150986	YB5108BN	Brushed Nickel	
152106	YB5108CH	Chrome	
154053	YB5108ORB	Oil Rubbed Bronze	

### Yorkshire European Paper Holder



Part #	Mfg #	Finish	Price
134590	BP5380CH	Chrome	

### Weymouth™ Pivoting Toilet Paper Holder



Part #	Mfg #	Finish	Price
143680	YB8408BN	Brushed Nickel	
173403	YB8408CH	Chrome	
152851	YB8408NL	Polished Nickel	
176404	YB8408ORB	Oil Rubbed Bronze	

### Paper Holder Mounting Posts



Part #	Mfg #	Finish	Price
185360	P5100	Chrome	

### Wynford™ Toilet Paper Holder



Part #	Mfg #	Finish	Price
180029	YB5208BN	Brushed Nickel	
188040	YB5208CH	Chrome	
184857	YB5208ORB	Oil Rubbed Bronze	

### Yorkshire Toilet Paper Holder



Part #	Mfg #	Finish	Price
104362	BP5308CH	Chrome	
124392	BP5308OWB	Old World Bronze	

## Bath Accessories

### Robe Hooks

- Tools and template included for installation

#### Alteo® Robe Hook



Part #	Mfg #	Finish	Price
142898	K-37055-CP	Polished Chrome	
144687	K-37055-BN	*Brushed Nickel	
156440	K-37055-2BZ	Oil Rubbed Bronze	

Part #	Mfg #	Description	Price
228447	K-73146-CP	Polished Chrome	
231735	K-73146-TT	*Titanium	

#### Archer® Robe Hook



Part #	Mfg #	Description	Price
129550	K-11055-BN	*Brushed Nickel	

Part #	Mfg #	Description	Price
114304	K-13433-BN	*Brushed Nickel	
097474	K-13433-CP	Polished Chrome	
172002	K-13433-G	Brushed Chrome	

#### Artifacts® Double Robe Hook



#### Devonshire® Robe Hook



Part #	Mfg #	Description	Price
166097	K-72572-BN	*Brushed Nickel	
235854	K-72572-BV	*Brushed Bronze	
175227	K-72572-CP	Polished Chrome	
174464	K-72572-SN	Polished Nickel	
223903	K-72572-VNT	Vintage Nickel	
168460	K-72572-2BZ	Oil Rubbed Bronze	

Part #	Mfg #	Finish	Price
077003	K-10555-BN	*Brushed Nickel	
086446	K10555BV	*Brushed Bronze	
073747	K-10555-CP	Polished Chrome	
078150	K-10555-PB	*Polished Brass	
183448	K-10555-SN	*Polished Nickel	
146955	K-10555-2BZ	Oil Rubbed Bronze	

#### Bancroft® Double Robe Hook



Part #	Mfg #	Description	Price
105975	K-11414-BN	*Brushed Nickel	
114842	K-11414-BV	*Brushed Bronze	
087296	K-11414-CP	Polished Chrome	
098456	K-11414-SN	*Polished Nickel	
187788	K-11414-2BZ	Oil Rubbed Bronze	

Part #	Mfg #	Description	Price
072942	K-12156-CP	Polished Chrome	
078575	K-12156-BN	*Brushed Nickel	
156624	K-12156-2BZ	Oil Rubbed Bronze	

\* Vibrant Limited Lifetime Warranty

[www.plumbsupply.com](http://www.plumbsupply.com) • Serving our Customers Since 1946 • [www.waterconcepts.net](http://www.waterconcepts.net)

**Bath Accessories**

**Fairfax® Double Robe Hook**



Part #	Mfg #	Description	Price
089185	K-12153-CP	Polished Chrome	
074971	K-12153-BN	*Brushed Nickel	
159425	K-12153-2BZ	Oil Rubbed Bronze	

**Finial Robe Hook**



Part #	Mfg #	Description	Price
182451	K-364-CP	Polished Chrome	
180595	K-364-2BZ	Oil Rubbed Bronze	

**Forte® Sculpted Double Robe Hook**



Part #	Mfg #	Description	Price
082750	K-11375-BN	*Brushed Nickel	
090032	K-11375-CP	Polished Chrome	
098282	K-11375-G	Brushed Chrome	

**Forte® Traditional Single Robe Hook**

- *Bullet one*
- *Bullet two all lower case after first word*



Part #	Mfg #	Description	Price
089530	K-11275-BN	*Brushed Nickel	

**Kelston® Robe Hook**



Part #	Mfg #	Description	Price
161343	K-13505-CP	Polished Chrome	
140186	K-13505-BN	*Brushed Nickel	
146994	K-13505-2BZ	Oil Rubbed Bronze	

**Loure® Robe Hook**



Part #	Mfg #	Description	Price
174350	K-11585-CP	Polished Chrome	
155635	K-11585-BN	*Brushed Nickel	

**Margaux® Double Robe Hook**



Part #	Mfg #	Finish	Price
183365	K-16256-AF	*French Gold	
132765	K-16256-BN	*Brushed Nickel	
124079	K-16256-BV	*Brushed Bronze	
111199	K-16256-CP	Polished Chrome	
135087	K-16256-SN	*Polished Nickel	

**Memoirs® Robe Hook**



Part #	Mfg #	Description	Price
061211	K-492-BN	*Brushed Nickel	
075026	K-492-BV	*Brushed Bronze	
063414	K-492-CP	Polished Chrome	
174230	K-492-2BZ	Oil Rubbed Bronze	

\* Vibrant Limited Lifetime Warranty

**Bath Accessories**

**Pinstripe® Robe Hook**



Part #	Mfg #	Description	Price
256731	K-13113-BN	*Brushed Nickel	
114051	K-13113-SN	*Polished Nickel	

**Purist® Robe Hook**



Part #	Mfg #	Description	Price
132496	K-14443-BGD	*Moderne Brushed Gold	
086547	K-14443-BN	*Brushed Nickel	
187198	K-14443-BV	*Brushed Bronze	
069308	K-14443-CP	Polished Chrome	
091452	K-14443-SN	*Polished Nickel	

**Revival® Robe Hook**



Part #	Mfg #	Description	Price
076860	K-16146-BV	*Brushed Bronze	

**Stillness® Robe Hook**



Part #	Mfg #	Description	Price
072155	K-14458-CP	Polished Chrome	

**Toobi™ Double Robe Hook**



Part #	Mfg #	Description	Price
189977	K-5670-BN	*Brushed Nickel	
150366	K-5670-CP	Polished Chrome	

\* Vibrant Limited Lifetime Warranty

[www.plumbsupply.com](http://www.plumbsupply.com) • Serving our Customers Since 1946 • [www.waterconcepts.net](http://www.waterconcepts.net)

**Bath Accessories**

**Robe Hooks**

**Charlotte™ Robe Hook**



Part #	Mfg #	Description	Price
171442	693585-PC	Chrome	
236583	693585-BN	Brushed Nickel	
148745	693585-PNCO	Cocoa Bronze & Pol Nickel	

**Odin™ Robe Hook**



Part #	Mfg #	Description	Price
244602	693575-BL	Matte Black	
165341	693575-BN	Brushed Nickel*	
257828	693575-GL	Luxe Gold	
243246	693575-PC	Chrome	

**Levoir™ Double Robe Hook**



Part #	Mfg #	Description	Price
254005	693598-PN	Polished Nickel*	

**Litze™ Robe Hook**



Part #	Mfg #	Description	Price
241705	693535-GL	Luxe Gold	
229551	693535-NKTK	Luxe Nickel/Teak Wood	
237826	693535-PC	Chrome	
243593	693535-PCTK	Chrome/Teak Wood	

**Litze™ Rotating Double Robe Hook with Knurling**



Part #	Mfg #	Description	Price
248853	693537-GL	Luxe Gold	
242182	693537-NK	Luxe Nickel*	
241634	693537-PC	Chrome	

**Rook™ Double Robe Hook**



Part #	Mfg #	Description	Price
190002	693561-NK	Luxe Nickel*	
188715	693561-NKBL	Luxe Nickel/Matte Black	
188970	693561-PC	Chrome	
242569	693561-RB	Venetian Bronze	

**Siderna™ Robe Hook**



Part #	Mfg #	Description	Price
162488	693580-BL	Matte Black	
139358	693580-BN	Brushed Nickel*	
141656	693580-PC	Chrome	

**Sotria™ Double Robe Hook**



Part #	Mfg #	Description	Price
255326	693550-BL	Matte Black	
177249	693550-NK	Luxe Nickel*	
181913	693550-PC	Chrome	
187349	693550-PN	Polished Nickel*	

\* Brilliance® Anti-Tarnish Lifetime Finishes



---



---

**Bath Accessories**

---



---

**Traditional Robe Hook**

Part #	Mfg #	Description	Price
173168	69535-BN	Brushed Nickel*	
109172	69535-BZ	Brushed Bronze*	
079585	69535-PC	Chrome	
175474	69535-PN	Polished Nickel*	
085208	69535-RB	Venetian Bronze®	

**Vettis™ Double Robe Hook**

Part #	Mfg #	Description	Price
249072	693588-PC	Chrome	

**Vesi® Channel Double Robe Hook**

Part #	Mfg #	Description	Price
170976	693540-BN	Brushed Nickel*	
248588	693540-RB	Venetian Bronze	

**Virage® Robe Hook**

Part #	Mfg #	Description	Price
164494	693530-BN	Brushed Nickel*	
166208	693530-PC	Chrome	
140725	693530-RB	Venetian Bronze®	

\* Brilliance® Anti-Tarnish Lifetime Finishes

<a href="http://www.plumbsupply.com">www.plumbsupply.com</a> • Serving our Customers Since 1946 • <a href="http://www.waterconcepts.net">www.waterconcepts.net</a>
--------------------------------------------------------------------------------------------------------------------------------------------------------------------

## Bath Accessories

### Robe Hooks

#### Addison® Robe Hook



Part #	Mfg #	Finish	Price
128422	79235	Chrome	
141295	79235-CZ	Champagne Bronze™	
129950	79235-RB	Venetian Bronze®	
128431	79235-SS	Stainless*	

#### Ashlyn™ Robe Hook



Part #	Mfg #	Description	Price
173784	76435	Chrome	
172992	76435-RB	Venetian Bronze®	
174019	76435-SS	Stainless*	

#### Arzo Robe Hook



Part #	Mfg #	Description	Price
112697	77535	Chrome	
112698	77535-SS	Stainless*	

#### Cassidy™ Robe Hook



Part #	Mfg #	Description	Price
155318	79735	Chrome	
158509	79735-CZ	Champagne Bronze™	
153345	79735-PN	Polished Nickel*	
152373	79735-RB	Venetian Bronze®	

### Robe Hooks (Continued)

#### Cassidy™ Robe Hook

Part #	Mfg #	Description	Price
154633	79735-SS	Stainless*	

#### Compel Robe Hook



Part #	Mfg #	Description	Price
120917	77135	Chrome	
113013	77135-SS	Stainless*	

#### Dryden™ Robe Hook



Part #	Mfg #	Finish	Price
117214	75135	Chrome	
163749	75135-CZ	Champagne Bronze™	
169982	75135-PN	Polished Nickel*	
116974	75135-RB	Venetian Bronze®	
117216	75135-SS	Stainless*	

#### Lahara™ Robe Hook



Part #	Mfg #	Finish	Price
115327	73835	Chrome	
111494	73835-RB	Venetian Bronze®	
111865	73835-SS	Stainless*	

\* Brilliance® Anti-Tarnish Lifetime Finishes

## Bath Accessories

### Linden™ Robe Hook



Part #	Mfg #	Finish	Price
148347	79435	Chrome	
145612	79435-RB	Venetian Bronze®	
144832	79435-SS	Stainless*	

### Tesla® Double Robe Hook



Part #	Mfg #	Description	Price
223521	75235	Chrome	
186442	75235-SS	Stainless*	

### Trinsic™ Robe Hook



Part #	Mfg #	Description	Price
153132	75935	Chrome	
237338	75935-BL	Matte Black	
187311	75935-CZ	Champagne Bronze™	
152672	75935-SS	Stainless*	
162051	75935-RB	Venetian Bronze®	

### Pivotal™ Robe Hook



Part #	Mfg #	Finish	Price
253037	79936	Chrome	
255583	79936-BL	Matte Black	
258244	79936-PN	Polished Nickel*	
247509	79936-SS	Stainless*	

### Vero™ Robe Hook



Part #	Mfg #	Description	Price
138336	77736	Chrome	
184867	77736-CZ	Champagne Bronze™	
158013	77736-RB	Venetian Bronze®	
140652	77736-SS	Stainless*	

### Rook™ Double Robe Hook



Part #	Mfg #	Description	Price
243264	693561-PN	Polished Nickel*	

### Stryke™ Double Robe Hook



Part #	Mfg #	Description	Price
259223	77638-BL	Matte Black	
257507	77638-SS	Stainless*	

- 3" Flange diameter
- Extends 4-3/4" from wall



Part #	Mfg #	Finish	Price
058902	75035	Chrome	
059504	75035-RB	Venetian Bronze®	

\* Brilliance® Anti-Tarnish Lifetime Finishes

## Bath Accessories

### Windemere® Robe Hook



Part #	Mfg #	Description	Price
159084	70035	Chrome	
166609	70035-OB	Oil Rubbed Bronze	
162362	70035-SS	Stainless*	

### Woodhurst™ Robe Hook



Part #	Mfg #	Description	Price
257270	73235	Chrome	
251185	73235-RB	Venetian Bronze	
255514	73235-SS	Stainless*	

### Zura® Robe Hook

- Extends 3-1/2" from wall
- Mounting hardware & template included



Part #	Mfg #	Description	Price
238475	77435	Chrome	

\* Brilliance® Anti-Tarnish Lifetime Finishes

**Bath Accessories**

**Robe Hooks**  
90° Robe Hook



Part #	Mfg #	Finish	Price
143190	YB8803CH	Chrome	
139438	YB8803BN	Brushed Nickel	

**Align™ Robe Hook**



Part #	Mfg #	Finish	Price
168503	YB0403CH	Chrome	

**Align™ Swivel Robe Hook**



Part #	Mfg #	Finish	Price
244488	YB0402BL	Matte Black	
246430	YB0402BN	Brushed Nickel	
176873	YB0402CH	Chrome	

**Arris™ Double Robe Hook**



Part #	Mfg #	Finish	Price
158614	YB0803BN	Brushed Nickel	
165371	YB0803CH	Chrome	

**Aspen™ Robe Hook**



Part #	Mfg #	Finish	Price
072473	5802CH	Chrome	

**Belfield™ Double Robe Hook**



Part #	Mfg #	Finish	Price
252273	YB6403BN	Brushed Nickel	
239307	YB6403CH	Chrome	
239770	YB6403ORB	Oil Rubbed Bronze	

**Brantford™ Double Robe Hook**



Part #	Mfg #	Finish	Price
127641	YB2203BN	Brushed Nickel	
102302	YB2203ORB	Oil Rubbed Bronze	

**Eva® Robe Hook**



Part #	Mfg #	Finish	Price
097221	YB2803BN	Brushed Nickel	
113431	YB2803CH	Chrome	

**Danbury® Robe Hook**



Part #	Mfg #	Finish	Price
092974	DN6703BN	Brushed Nickel	

**Bath Accessories**

**Genta™ Robe Hook**



Part #	Mfg #	Finish	Price
250029	BH3803CH	Chrome	

**Icon™ Double Robe Hook**



Part #	Mfg #	Finish	Price
109397	YB5803BN	Brushed Nickel	

**Glenshire™ Double Robe Hook**



Part #	Mfg #	Finish	Price
158113	DN2603BN	Brushed Nickel	

**Iso™ Robe Hook**



Part #	Mfg #	Finish	Price
113838	DN0703CH	Chrome	
119409	DN0703BN	Brushed Nickel	

**Glyde Double Robe Hook**



Part #	Mfg #	Finish	Price
242506	YB2303BN	Brushed Nickel	
239270	YB2303CH	Chrome	

**Lounge™ Double Robe Hook**



Part #	Mfg #	Finish	Price
099089	DN7703BN	Brushed Nickel	

**Kingsley Double Robe Hook**



Part #	Mfg #	Finish	Price
072065	YB5403CH	Chrome	
115691	YB5403WR	Wrought Iron	

**Preston™ Robe Hook**



Part #	Mfg #	Finish	Price
059555	DN8403CH	Chrome	

**Retreat® Robe Hook**



Part #	Mfg #	Finish	Price
094646	DN8303BN	Brushed Nickel	



**Bath Accessories**

**Rothbury™ Robe Hook**



Part #	Mfg #	Finish	Price
225080	YB8203CH	Chrome	
229066	YB8203BN	Brushed Nickel	

**Wynford™ Robe Hook**



Part #	Mfg #	Finish	Price
180028	YB5203BN	Brushed Nickel	
188039	YB5203CH	Chrome	
184856	YB5203ORB	Oil Rubbed Bronze	

**Sage® Robe Hook**



Part #	Mfg #	Finish	Price
114451	DN6803BN	Brushed Nickel	

**Voss™ Robe Hook**



Part #	Mfg #	Finish	Price
150989	YB5103BN	Brushed Nickel	
152104	YB5103CH	Chrome	
162350	YB5103ORB	Oil Rubbed Bronze	

**Weymouth™ Double Robe Hook**



Part #	Mfg #	Finish	Price
143679	YB8403BN	Brushed Nickel	
189818	YB8403CH	Chrome	
152852	YB8403NL	Polished Nickel	
181600	YB8403ORB	Oil Rubbed Bronze	

**Bath Accessories**

**Cabinet Hardware**

**90° Drawer Pull**



Part #	Mfg #	Finish	Price
207656	YB8807CH	Chrome	
237277	YB8807BN	Brushed Nickel	

**90° Drawer Knob**



Part #	Mfg #	Finish	Price
147715	YB8805CH	Chrome	

**Kingsley Drawer Pull**



Part #	Mfg #	Finish	Price
162324	YB5407ORB	Oil Rubbed Bronze	

**Rothbury Drawer Knob**



Part #	Mfg #	Finish	Price
228794	YB8205CH	Chrome	

**Waterhill® Drawer Pull**



Part #	Mfg #	Finish	Price
169981	YB9807CH	Chrome	
227074	YB9807ORB	Oil Rubbed Bronze	

**Waterhill Drawer Knob**



Part #	Mfg #	Finish	Price
227075	YB9805ORB	Oil Rubbed Bronze	

**Weymouth™ Drawer Knob**



Part #	Mfg #	Finish	Price
181603	YB8405NL	Polished Nickel	
181601	YB8405ORB	Oil Rubbed Bronze	

**Globe Light Fixtures**

**90° Bath Lighting**



Part #	Mfg#	Globes	Finish	Price
224149	YB8863CH	3	Chrome	
222121	YB8864CH	4	Chrome	

**Belfield™ Bath Lighting**



Part #	Mfg#	Globes	Finish	Price
249634	YB6461BN	1	Brushed Nickel	
244776	YB6462ORB	2	Oil Rubbed Bronze	
240141	YB6463CH	3	Chrome	
239774	YB6463ORB	3	Oil Rubbed Bronze	
250390	YB6464BN	4	Brushed Nickel	
250656	YB6464CH	4	Chrome	

**Bath Accessories**

**Brantford™ Bath Lighting**



Part #	Mfg#	Globes	Finish	Price
250950	YB2261ORB	1	Oil Rubbed Bronze	
224878	YB2262BN	2	Brushed Nickel	
177404	YB2262ORB	2	Oil Rubbed Bronze	
214675	YB2263BN	3	Brushed Nickel	
177365	YB2263ORB	3	Oil Rubbed Bronze	
243407	YB2264BN	4	Brushed Nickel	
177366	YB2264ORB	4	Oil Rubbed Bronze	

**Rothbury™ Bath Lighting**



Part #	Mfg#	Globes	Finish	Price
156251	YB8261BN	1	Brushed Nickel	

**Voss™ Bath Lighting**



Part #	Mfg#	Globes	Finish	Price
176467	YB5162BN	2	Brushed Nickel	
225684	YB5163BN	3	Brushed Nickel	
189713	YB5163CH	3	Chrome	
224372	YB5164CH	4	Chrome	
187072	YB5164ORB	4	Oil Rubbed Bronze	

**Eva™ Bath Lighting**



Part #	Mfg#	Globes	Finish	Price
180777	YB2864CH	4	Chrome	
225703	YB2862BN	2	Brushed Nickel	
226013	YB2863BN	3	Brushed Nickel	
239822	YB2863ORB	3	Oil Rubbed Bronze	

**Waterhill® Bath Lighting**



Part #	Mfg#	Globes	Finish	Price
238633	YB9861BN	1	Brushed Nickel	
247985	YB9862CH	2	Chrome	
139680	YB9862ORB	2	Oil Rubbed Bronze	
161651	YB9863BN	3	Brushed Nickel	
136553	YB9863ORB	3	Oil Rubbed Bronze	
227250	YB9864BN	4	Brushed Nickel	
160743	YB9864ORB	4	Oil Rubbed Bronze	

**Iso™ Bath Lighting**



Part #	Mfg#	Globes	Finish	Price
160523	DN0761BN	1	Brushed Nickel	
162221	DN0761CH	1	Chrome	
177268	DN0762CH	2	Chrome	
177269	DN0763CH	3	Chrome	

**Mirrors**

**Arris™ Magnifying Mirror**



Part #	Mfg #	Finish	Price
173216	YB0892BN	Brushed Nickel	

**Bath Accessories**

**Mirrors (Continued)**

**Arris™ Magnifying Mirror**

Part #	Mfg #	Finish	Price
176261	YB0892CH	Chrome	

**Gilcrest® Mirror**



Part #	Mfg #	Finish	Price
116645	DN0892ORB	Oil Rubbed Bronze	

**Glenshire® Mirror**



Part #	Mfg #	Finish	Price
109190	DN2692BN	Brushed Nickel	
116221	DN2692CH	Chrome	

**Iso™ Mirror**



Part #	Mfg #	Finish	Price
106155	DN0792CH	Chrome	

**Sage® Mirror**



Part #	Mfg #	Finish	Price
104366	DN6892BN	Brushed Nickel	

**Hair Dryer Holders**

**Voss™ Hair Dryer Holder**



Part #	Mfg #	Finish	Price
154325	YB5170BN	Brushed Nickel	

**Shower Seats**

**Home Care Shower Seat**



Part #	Mfg #	Finish	Price
151734	DN7025	Glacier	

**Home Care Transfer Bench**

- Supports up to 300 lbs
- Non-slip seat surface
- Complies with ADA specifications
- 33.25"W x 19.25"D
- 17" to 21" Adjustable height



Part #	Mfg #	Finish	Price
125009	DN7065	Glacier	

## Bath Accessories

### Home Care Shower Chair

- Supports up to 400 lbs
- Non-slip seat surface
- Complies with ADA specifications
- 19"W x 17.7"D
- 18" Leg width
- 15"-21" Adjustable height



Part #	Mfg #	Finish	Price
251753	DN7100	Glacier	

### Home Care Shower Chair



Part #	Mfg #	Finish	Price
173389	DN8060	Glacier	

### Home Care Tub Safety Bar



Part #	Mfg #	Finish	Price
171542	DN7010	Glacier	
110283	DN7005	Glacier	

### Bath/Shower Mat

- Adhesive backing for easy application
- Fits most tubs and showers



Part #	Mfg #	Finish	Price
206482	DN7050	Glacier	

### Bath Safety Teak Folding Shower Seat



Part #	Mfg #	Finish	Price
114623	DN7110	Stainless Hardware	

### Shower Seats (Continued)

#### Bath Safety Teak Folding Shower Seat

Part #	Mfg #	Finish	Price
225112	DN7110OWB	Old World Bronze Hardware	

## Grab Bars

### Grab Bars

#### Contemporary Grab Bar

- Premium metal construction
- ADA Compliant when located and mounted per ADA guidelines



Part #	Mfg #	Description	Price
124629	K-14560-BN	12", *Brushed Nickel	
102409	K-14560-BS	12", Brushed Stainless	
168842	K-14560-S	12", Polished Stainless	
114191	K-14561-BN	18", *Brushed Nickel	
225937	K-14561-S	18", Pol Stainless	
119862	K-14562-BN	24", *Brushed Nickel	
102410	K-14562-BS	24", Brushed Stainless	
131515	K-14562-SN	24", Pol Stainless	
137083	K-14564-BN	36", *Brushed Nickel	
102411	K-14564-BS	36", Brushed Stainless	

#### Traditional Grab Bar

- Premium metal construction
- ADA Compliant when located and mounted per ADA guidelines



Part #	Mfg #	Description	Price
171861	K-10540-S	12", Pol Stainless	
123172	K-10540-BN	12", *Brushed Nickel	
124850	K-10540-BV	12", *Brushed Bronze	
172825	K-10540-SN	12", Pol Nickel	
173985	K-10540-AF	12", *French Gold	
155921	K-10540-2BZ	12", Oil Rubbed Bronze	
137490	K-10541-S	18", Pol Stainless	
112382	K-10541-BN	18", *Brushed Nickel	
117932	K-10541-BV	18", *Brushed Bronze	
189392	K-10541-SN	18", *Polished Nickel	
153140	K-10541-2BZ	18", Oil Rubbed Bronze	
154806	K-10542-AF	24", *French Gold	
256662	K-10542-BS	24", Brushed Stainless	
123173	K-10542-BN	24", *Brushed Nickel	
124851	K-10542-BV	24", *Brushed Bronze	
124878	K-10542-S	24", Polished Stainless	
245830	K-10542-SN	24", *Polished Nickel	
156171	K-10542-2BZ	24", Oil Rubbed Bronze	
125675	K-10544-BN	36", *Brushed Nickel	
176335	K-10544-BV	36", *Brushed Bronze	
226396	K-10544-S	36", Polished Stainless	

### Grab Bars (Continued)

#### Traditional Grab Bar

Part #	Mfg #	Description	Price
189391	K-10544-SN	36", *Polished Nickel	
159745	K-10544-2BZ	36", Oil Rubbed Bronze	
176898	K-10545-BN	42", *Brushed Nickel	
146925	K-10545-BV	42", *Brushed Bronze	
226397	K-10545-S	42", Polished Stainless	
176891	K-10545-2BZ	42", Oil Rubbed Bronze	
240719	K-10546-S	48" Polished Stainless	

#### Traditional Grab Bar



Part #	Mfg #	Description	Price
135482	K-11875-S	36", Pol Stainless	

#### Transitional Grab Bar

- Premium metal construction
- Template included
- ADA Compliant when located and mounted per ADA guidelines



Part #	Mfg #	Description	Price
118169	K-11390-BN	12", *Brushed Nickel	
103055	K-11390-BS	12", Brushed Stainless	
116849	K-11390-BV	12", *Brushed Bronze	
128581	K-11390-S	12", Pol Stainless	
119182	K-11391-BN	18", *Brushed Nickel	
122293	K-11391-BS	18", Brushed Stainless	
116795	K-11391-BV	18", *Brushed Bronze	
102911	K-11391-S	18", Pol Stainless	
117270	K-11392-BN	24", *Brushed Nickel	
103056	K-11392-BS	24", Brushed Stainless	
116850	K-11392-BV	24", *Brushed Bronze	
116955	K-11392-S	24", Pol Stainless	
182994	K-11394-BN	36", *Brushed Nickel	
103058	K-11394-BS	36", Brushed Stainless	
123138	K-11394-BV	36", *Brushed Bronze	
189924	K-11394-S	36", Polished Stainless	
182995	K-11395-BN	42", *Brushed Nickel	

\* Vibrant Limited Lifetime Warranty

[www.waterconcepts.net](http://www.waterconcepts.net) • Serving our Customers Since 1946 • [www.plumbsupply.com](http://www.plumbsupply.com)



## Grab Bars

### Decorative Traditional Grab Bar

- Premium metal construction
- Tools and installation template included



Part #	Mfg #	Description	Price
169144	K-11870-BN	9", *Brushed Nickel	
183000	K-11870-BN	9", *Brushed Bronze	
137760	K-11870-S	9", Polished Stainless	
144718	K-11871-BN	12", *Brushed Nickel	
162716	K-11871-BV	12", Brushed Bronze	
173109	K-11871-S	12", Pol Stainless	
173119	K-11871-SN	12", Pol Nickel	
185461	K-11872-BN	18" * Br Nickel	
162717	K-11872-BV	18", Brushed Bronze	
173108	K-11872-S	18", Polished Stainless	
186682	K-11872-SN	18", *Polished Nickel	
156975	K-11873-BN	24", *Brushed Nickel	
162718	K-11873-BV	24", Brushed Bronze	
173112	K-11873-S	24", Pol Stainless	
186683	K-11873-SN	24" *Pol Nickel	
181159	K-11875-BV	36", *Brushed Bronze	
178625	K-11876-S	42", Polished Stainless	

### Margaux® Grab Bar

- Premium metal construction
- Tools and installation template included
- ADA Compliant when located and mounted per ADA guidelines



Part #	Mfg #	Description	Price
133517	K-11880-BN	9", *Brushed Nickel	
157462	K-11880-BV	9". *Brushed Bronze	
240512	K-11880-S	9" Polished Stainless	
151140	K-11881-BN	12", *Brushed Nickel	
223018	K-11881-S	12", Polished Stainless	
222089	K-11882-SN	18", *Polished Nickel	
183169	K-11883-BV	24", *Brushed Bronze	
222088	K-11883-SN	24", * Polished Nickel	
151142	K-11885-BN	36", *Brushed Nickel	

### Purist® Grab bar

- Premium metal construction
- Tools and installation template included



Part #	Mfg #	Description	Price
136777	K-11891-BN	12", *Brushed Nickel	
143117	K-11891-BS	12", Brushed Stainless	
148126	K-11891-S	12", Pol Stainless	
146886	K-11892-S	18", Pol Stainless	
144509	K-11892-BN	18", *Brushed Nickel	
143789	K-11893-BN	24", *Brushed Nickel	
129939	K-11893-S	24", Pol Stainless	
158402	K-11894-BN	32", *Brushed Nickel	
143790	K-11895-BN	36", *Brushed Nickel	
146761	K-11895-BS	36", Brushed Stainless	
147147	K-11895-BV	36", *Brushed Bronze	
171151	K-11895-S	36", Polished Stainless	
183001	K-11896-BS	42", Brushed Stainless	
258168	K-11897-BS	48", Brushed Stainless	

### Sonata® Accessory Kit

- Includes: Grab bar and shelf kit
- Premium metal construction
- Tempered glass shelf
- Required for 1-piece Sonata® shower stalls, except K-1569



Part #	Mfg #	Description	Price
071873	K-9459-CP	16", Chrome	
081814	K-9459-AF	16", *French Gold	
073663	K-9459-BN	16", *Brushed Nickel	
094052	K-9459-BV	16", *Brushed Bronze	
094053	K-9459-G	16", Brushed Chrome	
074241	K-9459-PB	16", *Polished Brass	
147098	K-9459-2BZ	16", Oil Rubbed Bronze	

### Vigora®Waterscape® Grab Bars

- Set of two grab bars
- Premium metal construction
- For use with k-1418, k-1375, k-1457, k-856 Whirlpools



Part #	Mfg #	Description	Price
079157	K-9653-BN	10-1/2", *Brushed Nickel	
183659	K-9653-2BZ	10-1/2", Oil Rubbed Bronze	

\* Vibrant Limited Lifetime Warranty

[www.plumbsupply.com](http://www.plumbsupply.com) • Serving our Customers Since 1946 • [www.waterconcepts.net](http://www.waterconcepts.net)

**Grab Bars**

**Stainless Steel Grab Bars**  
**Concealed Flange SS Grab Bar**



Part #	Mfg #	Size	Finish	Price
252036	DB8716	1-1/4" x 16"	Satin	
239919	DB8718	1-1/4" x 18"	Satin	
245272	DB8730	1-1/4"	30"	
241807	DB8742	1-1/4" x 42"	Satin	
036268	DB8912	1-1/2" x 12"	Satin	
036269	DB8916	1-1/2" x 16"	Satin	
036272	DB8918	1-1/2" x 18"	Satin	
133504	DB8918P	1-1/2" x 18"	Peened	
036275	DB8924	1-1/2" x 24"	Satin	
255466	DB8924P	1-1/2" x 24"	Peened	
036276	DB8930	1-1/2" x 30"	Satin	
036277	DB8932	1-1/2" x 32"	Satin	
036278	DB8936	1-1/2" x 36"	Satin	
255464	DB8936P	1-1/2" x 36"	Peened	
036279	DB8942	1-1/2" x 42"	Satin	
036280	DB8948	1-1/2" x 48"	Satin	

## Grab Bars

### Tub & Shower Components

#### Straight Thin Grip Grab Bar

- 2-7/8" Thin grip



Part #	Mfg #	Description	Price
153231	80001012-N	12", Nickel	
154517	80001012-V	12", Matte Silver	
143053	80001018-V	18", Matte Silver	
155776	80001024-N	24", Nickel	
138995	80001024-V	24", Matte Silver	
169829	80011032-N	32", Matte Silver	

#### Straight Wide Grip Grab Bar

- 3-1/4"



Part #	Mfg #	Description	Price
171936	80011032-N	32", Nickel	

#### Curved Wide Grip Grab Bar

- 3-1/4" Wide grip



Part #	Mfg #	Description	Price
153230	80012031-N	28", Nickel	
144671	80012031-V	31", Matte Silver	
142413	80012134-N	33-1/2", Nickel	
138042	80012134-V	33-1/2", Matte Silver	

## Grab Bars

### Grab Bars

#### 90° Decorative Grab Bar

- Supports up to 500 lbs
- 1.25" Diameter
- 2.94" From wall



Part #	Mfg #	Finish	Price
165963	YG8812BN	12", Brushed Nickel	
171268	YG8812CH	12", Chrome	
162299	YG8818BN	18", Brushed Nickel	
171372	YG8818CH	18", Chrome	
160224	YG8824BN	24", Brushed Nickel	
171269	YG8824CH	24", Chrome	
171373	YG8836CH	36", Chrome	
182235	YG8836BN	36", Brushed Nickel	
171374	YG8842CH	42", Chrome	

#### Align™ Designer Grab Bar

- Supports up to 500 lbs
- 1.25" Diameter



Part #	Mfg #	Finish	Price
246431	YG0418BN	18", Brushed Nickel	
223772	YG0418CH	18", Chrome	
240624	YG0436BN	36", Brushed Nickel	
219819	YG0436CH	36", Chrome	
240625	YG0442BN	42", Brushed Nickel	

#### Arris™ Designer Grab Bar

- 1.25" Diameter
- 2.75" From wall
- Supports up to 500 lbs
- ADA compliant



Part #	Mfg #	Finish	Price
165367	YG0812CH	12" Chrome	
188943	YG0812BN	12", Brushed Nickel	
165368	YG0818CH	18", Chrome	
188944	YG0824BN	42", Brushed Nickel	

### Belfield Designer Grab Bar

- Supports up to 500 lbs
- 1.25" Bar diameter



Part #	Mfg #	Finish	Price
247421	YG6424ORB	24", Oil Rubbed Bronze	

### Brantford Designer Grab Bar

- Supports up to 500 lbs
- 1.25" Bar diameter



Part #	Mfg #	Finish	Price
179504	YG2212ORB	12", Oil Rubbed Bronze	
177363	YG2218ORB	18", Oil Rubbed Bronze	
228780	YG2224ORB	24", Oil Rubbed Bronze	

### Eva Designer Grab Bar

- Supports up to 500 lbs
- 1.25" Diameter



Part #	Mfg #	Finish	Price
181421	YG2812ORB	12", Oil Rubbed Bronze	
226989	YG2818BN	18", Brushed Nickel	
186303	YG2818CH	18", Chrome	
180901	YG2818ORB	18", Oil Rubbed Bronze	
236999	YG2824BN	24", Brushed Nickel	
186304	YG2824CH	24", Chrome	
186186	YG2824ORB	24", Oil Rubbed Bronze	

### Kingsley® Designer Grab Bar

- 1.25" Diameter
- 2.925" From wall
- ADA Compliant
- Supports up to 500 lbs



Part #	Mfg #	Finish	Price
108390	YG5412CH	12", Chrome	
085509	YG5412BN	12", Brushed Nickel	
102252	YG5412ORB	12", Oil Rubbed Bronze	
094539	YG5418BN	18", Brushed Nickel	
102253	YG5418ORB	18", Oil Rubbed Bronze	
086137	YG5424BN	24", Brushed Nickel	
107134	YG5424CH	24", Chrome	

**Grab Bars**

**Grab Bars (Continued)**

**Kingsley® Designer Grab Bar**

Part #	Mfg #	Finish	Price
102254	YG5424ORB	24", Oil Rubbed Bronze	
117678	YG5430BN	30", Brushed Nickel	
121288	YG5430CH	30", Chrome	
105778	YG5436BN	36", Brushed Nickel	
128051	YG5436CH	36", Chrome	
167309	YG5442BN	42" Brushed Nickel	
128052	YG5442CH	42", Chrome	

**Iso® Decorative Grab Bar**

- 1.25" Diameter
- Supports up to 500 lbs
- ADA compliant
- 2.75" From wall



Part #	Mfg #	Finish	Price
170507	YG0712BN	12", Brushed Nickel	
252219	YG0712CH	12", Chrome	
240384	YG0718CH	18", Chrome	
167207	YG0718BN	18", Brushed Nickel	
170508	YG0724BN	24", Brushed Nickel	
184457	YG0724CH	24", Chrome	
184458	YG0736CH	36", Chrome	
190097	YG0736BN	36", Brushed Nickel	
167208	YG0742BN	42", Brushed Nickel	

**Voss™ Designer Grab Bar**



Part #	Mfg #	Finish	Price
247810	YG5112BN	12", Brushed Nickel	
225686	YG5124BN	24", Brushed Nickel	

**SecureMount™ Designer Elegance Grab Bar**

- 1-1/4" Diameter
- Concealed screw
- ADA Compliant



Part #	Mfg #	Description	Price
114000	R8716D1GBN	16", Brushed Nickel	
117346	LR8716D3BN	16", Brushed Nickel	

**Grab Bars (Continued)**

**SecureMount™ Designer Elegance Grab Bar**

Part #	Mfg #	Description	Price
104832	LR8724D1GCH	24", Chrome	
112704	LR8724D1GBN	24", Brushed Nickel	
127986	LR8724D1GOWB	24", Old World Bronze	

**SecureMount™ Designer Elite Grab Bar**

- 1-1/4" Diameter
- Concealed screw
- ADA Compliant



Part #	Mfg #	Description	Price
093871	LR8716D3GBN	16", Brushed Nickel	
113705	LR8716D3GOWB	16", Old World Bronze	
101166	LR8724D2BN	24", Brushed Nickel	
107061	LR8724D3GCH	24", Chrome	
113706	LR8724D3GOWB	24", Old World Bronze	
106865	LR8724D2CH	24", Chrome	

**SecureMount™ Designer Ultima Grab Bar**

- 1-1/4" Diameter
- Concealed screw
- ADA Compliant



Part #	Mfg #	Description	Price
151733	R8712D3GBN	12", Brushed Nickel	
151461	R8712D3GCH	12", Chrome	
150880	R8712D3GOWB	12", Old World Bronze	
095077	LR8716D3GCH	16", Chrome	
178362	R8718D3GBN	18", Brushed Nickel	
160669	R8718D3GOWB	18", Old World Bronze	
104687	LR8724D3GBN	24", Brushed Nickel	
106566	LR8724D3BN	24", Brushed Nickel	
121836	LR8724D3CH	24", Chrome	
107062	R8736D3GCH	36", Chrome	
131290	R8736D3GBN	36", Brushed Nickel	
174435	R8742D3GBN	42", Brushed Nickel	
107063	R8742D3GCH	42", Chrome	

**Grab Bars**

**Home Care® Concealed Screw Grab Bar**

- 1.25" Diameter
- Supports up to 500 lbs
- ADA Compliant



Part #	Mfg #	Description	Price
165824	8912	12", Stainless	
147414	R8712P	12", Peened	
147415	R8716P	16", Peened	
158549	R8716W	16", Glacier	
158546	8718	18" Stainless	
113597	R8918	18", Stainless	
159011	R8918P	18", Peened	
116799	R8718PS	18", Polished Stainless	
098876	R8718PB	18", Polished Brass	
110247	R8718W	18", Glacier	
107317	R8918W	18", Glacier	
116977	8724	24", Stainless	
142352	R8724P	24", Peened	
109409	R8724PS	24", Polished Stainless	
084087	LR8724PS	24", Polished Stainless - Retail Packaging	
087162	R8724W	24", Glacier	
113349	R8924	24", Stainless	
078165	R8924W	24", Glacier	
201420	R8930	30", Stainless	
114183	R8936	36", Stainless	
134809	R8930W	30", Glacier	
139485	R8730W	30", Glacier	
136776	R8730P	30", Peened	
205876	R8932	32", Stainless	
104545	R8736PS	36", Polished Stainless	
087161	R8736W	36", Glacier	
159012	R8936P	36", Peened	
142353	R8736P	36", Peened	
116728	R8936W	36", Glacier	
190905	8942	42", Stainless	
162301	8742	42" Stainless	
104546	R8742PS	42", Polished Stainless	
078084	8748	48", Stainless	
200253	R8948P	48", Peened	
153952	R8748W	48", Glacier	
227217	R8748P	48", Peened	

**Grab Bars (Continued)**

**Home Care® Concealed Screw Grab Bar**

Part #	Mfg #	Description	Price
190906	DN8948	48", Stainless	

**Home Care® Grab Bar with Accessories**

- Corrosion resistant
- Supports up to 250 lbs
- 1.0" Diameter



Part #	Mfg #	Finish	Price
151460	LR2350DBN	24", Brushed Nickel	

**Corner Grab Bar with Shelf**

- Corrosion resistant
- Supports up to 250 lbs
- 1" Bar diameter



Part #	Mfg #	Finish	Price
163602	LR2354DCH	9", Chrome	
156111	LR2354DBN	9", Brushed Nickel	

**Home Care® Curved Grab Bar with Accessories**

- Supports up to 250 lbs
- 1" Bar diameter



Part #	Mfg #	Finish	Price
183964	LR2356DCH	16", Chrome	
226821	R2356DBN	16", Brushed Nickel	
220767	R2356DOWB	16", Old World Bronze	

**Home Care® Designer Bath Grip**



Part #	Mfg #	Finish	Price
106694	LR2250DCH	9", Chrome	



## Grab Bars

### Home Care® Suction Hand Grip

- Corrosion resistant
- 1.26" Diameter
- Plastic construction



Part #	Mfg #	Finish	Price
163239	LR2308W	12", White	

### Home Care® L-Shaped Grab Bar

- 1.5" Bar diameter
- 16" Bar length
- Supports up to 500 lbs
- Peened finish



Part #	Mfg #	Finish	Price
157449	8992	Chrome	

### Grab Bar with Paper Holder



Part #	Mfg #	Finish	Price
149166	LR2352DCH	8", Chrome	
238672	LR2352DOWB	8", Old World Bronze	

### Flip Up Grab Bar

- 1.25" Bar diameter
- Corrosion resistant
- Supports up to 300 lbs
- ADA Compliant



Part #	Mfg #	Finish	Price
167802	R8960FD	30", Chrome	
176950	R8960FDW	30", Glacier	
138090	R8962FDW	30", Glacier w/ Paper Holder	

### Home Care® SecureMount Anchor

- Supports up to 300 lbs
- ADA compliant
- 2 Anchors with mounting plate



Part #	Mfg #	Finish	Price
100610	SMA1000CH	Chrome Anchor	

## Grab Bars

### Grab Bars

#### Lahara® Corner Shelf/Assist Bar

- 9-1/2"
- 7/8" Diameter assist bar
- Supports loads exceeding 250 lbs when properly installed
- Mounting hardware included



Part #	Mfg #	Description	Price
174533	41416	Chrome	
227417	41416-SS	Stainless*	

#### Décor Assist™ Traditional Shelf with Assist Bar

- 8-3/4" x 8-3/4"
- 300 lbs maximum
- 7/8" Diameter assist bar
- Mounting hardware included



Part #	Mfg #	Description	Price
243782	41316	Chrome	
250043	41316-CZ	Champagne Bronze	

#### Delta 24" Grab Bar

- 24" Long
- 1-1/4" Width



Part #	Mfg #	Description	Price
154282	40024	24", Chrome	
146401	40024-RB	24", Venetian Bronze	
151752	40024-SS	24", Stainless*	

#### Commercial Concealed Mounting Grab Bar

- 1-1/2" Wide
- 3" Diameter flanges
- Mounting hardware included



Part #	Mfg #	Description	Price
205636	40130-SS	30", Stainelss*	
251623	40148-SS	48", Stainless*	

#### Concealed Mounting Grab Bar

1-1/2" Wide



Part #	Mfg #	Description	Price
254707	40118-PS	18", Peened Stainless	
154462	40118-SS	18", Stainless*	

### Grab Bars (Continued)

#### Concealed Mounting Grab Bar

1-1/2" Wide

Part #	Mfg #	Description	Price
156072	40124-SS	24", Stainless*	
240722	40142-SS	42", Stainless*	

1-1/4" Wide

Part #	Mfg #	Description	Price
163858	41218-SN	18", Satin Nickel	

#### Contemporary Grab Bar

- 1-1/4" Diameter
- Extends 2-3/4" from wall
- Concealed mounting
- 3" Diameter
- 1-1/2" Wall clearance
- Supports up to 500 lbs



Part #	Mfg #	Description	Price
181427	41812	12", Chrome	
225342	41812-CZ	12", Champagne Bronze	
255844	41812-RB	12", Venetian Bronze	
167081	41812-SS	12", Stainless*	
158256	41818	18", Chrome	
225346	41818-CZ	18", Champagne Bronze	
167998	41818-RB	18", Venetian Bronze	
167082	41818-SS	18", Stainless*	
164325	41824	24", Chrome	
235666	41824-BL	24", Matte Black	
253053	41824-CZ	24", Champagne Bronze	
168000	41824-RB	24", Venetian Bronze	
170335	41824-SS	24", Stainless*	
173932	41836	36", Chrome	
258471	41836-BL	36", Matte Black	
158753	41836-RB	36", Venetian Bronze	
168818	41836-SS	36", Stainless*	
190274	41842	42", Chrome	
256666	41842-RB	42", Venetian Bronze	
244243	41842-SS	42", Stainless*	

\* Brilliance® Anti-Tarnish Lifetime Finishes

## Grab Bars

### Modern Grab Bar

- 1-1/4" Diameter
- Extends 2-3/4" from wall
- Concealed mounting
- 3" Diameter
- 1-1/2" Wall clearance
- Supports up to 500 lbs



Part #	Mfg #	Description	Price
166139	41912	12", Chrome	
234301	41912-PN	12", Polished Nickel	
182462	41912-RB	12", Venetian Bronze	
167232	41912-SS	12", Stainless*	
169898	41918	18", Chrome	
257185	41918-BL	18", Matte Black	
171387	41918-CZ	18", Champagne Bronze	
186776	41918-PN	18", Polished Nickel*	
160268	41918-RB	18", Venetian Bronze	
163184	41918-SS	18", Stainless*	
169288	41924	24", Chrome	
180880	41924-CZ	24", Champagne Bronze	
176544	41924-RB	24", Venetian Bronze	
158611	41924-SS	24", Stainless*	
171386	41936	36", Chrome	
179989	41936-CZ	36", Champagne Bronze	
166734	41936-RB	36", Venetian Bronze	
164949	41936-SS	36", Stainless*	
229754	41942	42" Chrome	
240681	41942-CZ	42" Champagne Bronze	
253139	41942-RB	42" Venetian Bronze	

### Traditional Grab Bar

- 1-1/4" Diameter
- Extends 2-3/4" from wall
- Concealed mounting
- 3" Diameter
- 1-1/2" Wall clearance
- Supports up to 500 lbs



Part #	Mfg #	Description	Price
174299	41612	12" Chrome	
174842	41612-CZ	12", Champagne Bronze	
171304	41612-PN	12", Polished Nickel*	
168258	41612-RB	12", Venetian Bronze	
164928	41612-SS	12", Stainless*	
169818	41618	18", Chrome	

### Grab Bars (Continued)

#### Traditional Grab Bar

Part #	Mfg #	Description	Price
174843	41618-CZ	18", Champagne Bronze	
222844	41618-PN	18", Polished Nickel	
162432	41618-RB	18", Venetian Bronze	
163976	41618-SS	18", Stainless*	
167709	41624	24", Chrome	
159243	41624-CZ	24" Champagne Bronze	
222845	41624-PN	24", Polished Nickel	
163977	41624-RB	24", Venetian Bronze	
163975	41624-SS	24", Stainless*	
178588	41636	36", Chrome	
172364	41636-CZ	36", Champagne Bronze	
164886	41636-RB	36", Venetian Bronze	
163974	41636-SS	36", Stainless*	
229407	41642	42", Chrome	
259238	41642-RB	42", Venetian Bronze	
226490	41642-SS	42", Stainless*	

#### Transitional Grab Bar

- 1-1/4" Diameter
- Extends 2-3/4" from wall
- Concealed mounting
- 3" Diameter
- 1-1/2" Wall clearance
- Supports up to 500 lbs



Part #	Mfg #	Description	Price
164868	41712	12", Chrome	
160848	41712-CZ	12", Champagne Bronze	
166011	41712-RB	12", Venetian Bronze	
160630	41712-SS	12", Stainless*	
168664	41718	18", Chrome	
163117	41718-CZ	18", Champagne Bronze	
164451	41718-RB	18", Venetian Bronze	
166379	41718-SS	18", Stainless*	
164869	41724	24", Chrome	
167529	41724-CZ	24", Champagne Bronze	
158916	41724-RB	24", Venetian Bronze	
168025	41724-SS	24", Stainless*	
173016	41736	36", Chrome	
166034	41736-CZ	36", Champagne Bronze	
163507	41736-RB	36", Venetian Bronze	
160625	41736-SS	36", Stainless*	

\* Brilliance® Anti-Tarnish Lifetime Finishes

## Grab Bars

### Grab Bars (Continued)

#### Transitional Grab Bar

Part #	Mfg #	Description	Price
224231	41742	42", Chrome	

#### Grab Bar with Adjustable Slide

- 24"



Part #	Mfg #	Description	Price
163865	RP32796	Chrome	

### Shower Rods

#### Curved Shower Rod

- 5' Long
- 6' Bow
- 1" Stainless steel tubing
- Includes mounting brackets



Part #	Mfg #	Description	Price
258857	42205	Chrome	
158651	42205-SS	Stainless*	
157353	42205-ST	Bright Stainless	

#### Straight Shower Rod

- 6" Long
- 1-1/4" Stainless steel tubing
- Includes flanges and concealed screws



Part #	Mfg #	Description	Price
258790	42006	Chrome	

\* Brilliance® Anti-Tarnish Lifetime Finishes

[www.waterconcepts.net](http://www.waterconcepts.net) • Serving our Customers Since 1946 • [www.plumbsupply.com](http://www.plumbsupply.com)



## Grab Bars

### Grab Bars

#### Grab Bar with Traditional Round Flange

- 1-1/4" Diameter
- 18" Center post to center post
- Covers standard 3" flange on stainless steel grab bars



Part #	Mfg #	Finish	Price
239516	2518-PB	18", Polished Brass	

#### Grab Bar with Contemporary Round Flange

- 1-1/4" Diameter
- Covers standard 3" flange on stainless steel grab bars



Part #	Mfg #	Finish	Price
243220	2618-PB	18", Polished Brass	
243222	2624-PB	24", Polished Brass	

## Medicine Cabinets & Mirrors

### Medicine Cabinets

#### Aluminum Single-Door Medicine Cabinet with Framed Mirror Door

- Anodized aluminum construction
- Two adjustable tempered-glass shelves
- Mirrored door with bronze-finish frame
- Mirrors on back of door and interior back of cabinet
- Two-way adjustable hinges with 108° opening capability
- Can be installed with left- or right-hand swing
- Includes mounting hardware for surface or recessed installation
- Includes side mirror kit for surface mount installation



Part #	Mfg #	Description	Price
119763	K-2967-BR1	20"W x 26"H x 5-3/8"D, 1 Door 108° Hinge	

#### Archer® Single Door Medicine Cabinet

- Beveled edges
- Two adjustable glass shelves
- Full-overlay mirrored door with beveled edges
- Mirrors on back of door and interior back of cabinet
- Two-way adjustable hinges with 108° opening
- Can be installed with left- or right-hand swing
- Includes mounting hardware for surface or recessed installation
- Includes side mirror kit for surface mount installation



Part #	Mfg #	Description	Price
109734	K-3073-NA	20"W x 31"H x 5"D, 1 Door 108° Hinge	

#### Bancroft® Single Door Medicine Cabinet

- Full-overlay beveled mirror
- Mirrors on back of door and interior back of cabinet
- Two adjustable glass shelves
- Can be installed with left- or right-hand swing
- Includes mounting hardware for surface or recessed installation
- Includes side mirror kit for surface installation



Part #	Mfg #	Description	Price
117489	K-CB-CLC2031BAN	20"W x 31"H x 5"D, 1 Door	

\* Vibrant Limited Lifetime Warranty

[www.waterconcepts.net](http://www.waterconcepts.net) • Serving our Customers Since 1946 • [www.plumbsupply.com](http://www.plumbsupply.com)



## Medicine Cabinets & Mirrors

### Catalan® Aluminum Cabinet

- 4-3/4"D
- Recessed or surface-mount installation
- Triple mirror design - front of door, back of door, and interior back of cabinet
- (4) Adjustable black-tinted glass shelves
- Reversible left-hand or right-hand door hinge option
- Removable door for easy installation and cleaning



Part #	Mfg #	Description	Price
159381	K-2918-PG-SAA	20-1/8"W x 36"H x 4-3/4"D, 1 Door, 107° Hinge	
153948	K-2936-PG-SAA	24-1/8"W x 36"H x 4-3/4"D, 1 Door	
181828	K-2938-PG-SAA	15"W x 36"H x 4-3/4"D, 1 Door	
156765	K-2939-PG-SAA	20-1/8"W x 36"H x 4-3/4"D, 1 Door	
141972	K-2943-PG-SAA	24-1/8" x 36-1/8" x 4-3/4"D, 1 Door, 170°	

### CL Flat Silver Aluminum Cabinet

- Mirrored door(s)
- 1/2" Beveled frameless door
- (2) Adjustable 1/4" glass shelves inside
- Side kit included for recess- or surface-mount



Part #	Mfg #	Description	Price
109869	K-CB-CLC1526FS	15"W x 26"H x 5"D, 1 Door	
121818	K-CB-CLC2026FS	20"W x 26"H x 5"D, 1 Door	

### CB Aluminum Single Door Medicine Cabinet

- Recessed installation only
- Anodized aluminum construction with a durable rust-free and chip-free finish
- Two adjustable glass shelves
- Full-overlay mirrored door with beveled edges
- Mirrored interior
- Two-way adjustable hinges with 108° opening capability for easy cabinet access
- Can be installed with left- or right-hand swing



Part #	Mfg #	Description	Price
122188	K-CB-CLR1620FS	16"W x 20"H x 5"D, 1 Door 108° Hinge	

\* Vibrant Limited Lifetime Warranty

[www.plumbsupply.com](http://www.plumbsupply.com) • Serving our Customers Since 1946 • [www.waterconcepts.net](http://www.waterconcepts.net)

## Medicine Cabinets & Mirrors

### CB Aluminum Two-Door Medicine Cabinet

- Recessed or surface mount installation
- Includes side mirror kit for surface mount installation
- Can be installed with left- or right-hand swing
- Mirrored interior
- Four adjustable glass shelves with vertical divider
- Two-way adjustable hinges with 108° opening capability for easy cabinet access



Part #	Mfg #	Description	Price
114799	K-CB-CLC2526FS	25"W x 26"H x 5"D, 2 Door 108° Hinge	
111706	K-CB-CLC3026FS	30"W x 26"H x 5"D, 2Door 108° Hinge	
108273	K-CB-CLC3526FS	35"W x 26"H x 5"D, 2Door 108° Hinge	

### Damask™ Solid Wood Medicine Cabinet Surround

- Mounts directly to wall
- Solid wood and veneers
- Coordinates with Damask™ vanities for matched ensemble
- (K-99662-15) if for models K-99000-NA & K-99001-NA
- (K99662-24) is for models K-99006-NA & K-99007-NA



Part #	Mfg #	Description	Price
184122	K-99662-15-1WA	21"W x 36"H x 2"D, Linen White	For Models K-99000-NA & K-99001-NA
187731	K-99662-15-1WD	21"W x 36"H x 2"D, Ramie Walnut	For Models K-99000-NA & K-99001-NA
240136	K-99662-15-1WU	21"W x 36"H x 2"D, Batiste Black	For Models K-99000-NA & K-99001-NA
188987	K-99662-24-1WA	24"W x 32"H x 2"D, Linen White	For Models K-99006-NA & K-99007-NA

### Devonshire® White Enameled Aluminum Single Door Medicine Cabinet

- 20"W x 29-1/2"H x 5-1/4"D
- Anodized aluminum
- Two adjustable tempered-glass shelves
- Right-hand door with mirror and white-enameled frame
- Mirrors on back of door and interior back of cabinet
- Includes side mirror kit for surface installation
- Includes mounting hardware for surface or recessed installation



Part #	Mfg #	Description	Price
108202	K-CB-CLW2030DAW	20"W x 29-1/2"H x 5-1/4"D, 2 Door 108° Hinge	

\* Vibrant Limited Lifetime Warranty

[www.waterconcepts.net](http://www.waterconcepts.net) • Serving our Customers Since 1946 • [www.plumbsupply.com](http://www.plumbsupply.com)

## Medicine Cabinets & Mirrors

### Verdera™ Aluminum Cabinet

- Recessed or surface-mount installation
- Vertically adjustable magnifying mirror on inside of door
- (3) Adjustable glass shelves
- Full-overlay mirrored door
- Mirrored interior
- Slow-close door prevents slamming
- Two-way adjustable hinges with 108° opening capability for easy cabinet access
- Can be installed with left- or right-hand swing
- (-TL) LED task lighting — life expectancy of 36,000 hours
- (-TLC) LED task lighting — life expectancy of 59,000 hours



Requires: K-99012 side mirror kit for surface mount installation

Part #	Mfg #	Description	Price
222823	K-99000-NA	15"W x 30"H x 4-3/4", 1 Door - Less Magnifying Mirror	
160371	K-99001-NA	15"W x 30"H x 4-3/4", 1 Door	
247480	K-99001-SCF-NA	15"W x 30"H x 4-3/4", 1 Door - Flip out mirror on inside of door	
170991	K-99002-NA	20"W x 30"H x 4-3/4", 1 Door - Less Magnifying Mirror	
160140	K-99003-NA	20"W x 30"H x 4-3/4", 1 Door	
257335	K-99003-SCF-NA	20"W x 30"H x 4-3/4", 1 Door - Flip out mirror on inside of door	
240247	K-99003-TL-NA	20"W x 30"H x 4-3/4", 1 Door, LED Task Lighting	
257329	K-99003-TLC-NA	20"W x 30"H x 4-3/4", 1 Door, LED Task Lighting	
173209	K-99006-NA	24"W x 30"H x 4-3/4", 1 Door - Less Magnifying Mirror	
159444	K-99007-NA	24"W x 30"H x 4-3/4", 1 Door	
243542	K-99007-SFC-NA	24"W x 30"H x 4-3/4", 1 Door - Flip out mirror on inside of door	
233659	K-99007-TL-NA	24"W x 30"H x 4-3/4", 1 Door, LED Task Lighting	
183662	K-99008-NA	34"W x 30"H x 4-3/4", 2 Doors	
166495	K-99009-NA	34"W x 30"H x 4-3/4", 2 Doors	
237753	K-99009-TL-NA	34"W x 30"H x 4-3/4", 2 Doors, LED Task Lighting	
257570	K-99009-TLC-NA	34"W x 30"H x 4-3/4", 2 Door, LED Task Lighting	
170057	K-99010-NA	40"W x 30"H x 4-3/4", 3 Doors - Less Magnifying Mirror	
173818	K-99011-NA	40"W x 30"H x 4-3/4", 3 Doors	
258799	K-99011-SCF-NA	40"W x 30"H x 4-3/4", 1 Door - Flip out mirror on inside of door	
237754	K-99011-TL-NA	40"W x 30"H x 4-3/4", 3 Doors, LED Task Lighting	
259044	K-99011-TLC-NA	40"W x 30"H x 4-3/4", 3 Doors, LED Task Lighting	

\* Vibrant Limited Lifetime Warranty

[www.plumbsupply.com](http://www.plumbsupply.com) • Serving our Customers Since 1946 • [www.waterconcepts.net](http://www.waterconcepts.net)

## Medicine Cabinets & Mirrors

### Verdera® Aluminum Cabinet with Open Bottomed Shelf

- Anodized aluminum construction with a durable rust-free and chip-free finish
- Open shelf offers quick access
- Two adjustable glass shelves
- Full-overlay mirrored door
- Mirrored interior
- Slow-close door prevents slamming
- Two-way adjustable hinges with 108-degree opening capability for easy cabinet access
- Includes mounting hardware for surface or recessed installation
- Requires K-99012 side mirror kit (sold separately) for surface mount installation



Part #	Mfg #	Description	Price
171790	K-99005-R-NA	20"W x 30"H x 4-3/4", 1 Door Right-Hand Swing	

### Mirrors

#### Damask™ Framed Mirror

- 21-3/4"W x 36-3/4"H x 1"D



Part #	Mfg #	Description	Price
223008	K-99665-1WC	21-3/4"W x 36-3/4"H x 1"D, Felt Grey	

#### Evandale® Wood-Frame Mirror

- 23-1/2" x 32"
- Solid mahogany
- Includes hardware for vertical wall-mount installation



Part #	Mfg #	Description	Price
183035	K-2746-F25	23-1/2" x 32", Sapele Finish	
183170	K-2746-F44	23-1/2" x 32", Lily Finish	

\* Vibrant Limited Lifetime Warranty

[www.waterconcepts.net](http://www.waterconcepts.net) • Serving our Customers Since 1946 • [www.plumbsupply.com](http://www.plumbsupply.com)

## Medicine Cabinets & Mirrors

### Jacquard™ Wood-Frame Mirror

- 19-1/2" x 34-1/2"
- Solid woods and veneers
- Includes hardware for wall-mount installation
- Coordinates with Jacquard™ vanities for a matched ensemble



Part #	Mfg #	Description	Price
189036	K-99664-1WA	19-1/2" x 34-1/2", Linen White	

### Verdera® Lighted Mirror

- Integrated LED bulbs
- Anodized aluminum construction
- LED task lighting intergrated on the front of the mirror
- 1100 Lux at 22"provides optimal brightness
- Light brightness compatible with separate dimming switch (sold separately)
- Includes mounting hardware for surface installation



Part #	Mfg #	Description	Price
257330	K-99571-TLC-NA	33" x 24", Aluminum	
243658	K-99573-TL-NA	33" x 40", Aluminum	

### Accessories

#### Catalan® Side Mirror Kit

- For Catalan medicine cabinets
- Surface-mount installations only
- Hardware included



Part #	Mfg #	Description	Price
143436	K-2878-NA	Catalan Side Mirror Kit	

\* Vibrant Limited Lifetime Warranty

[www.plumbsupply.com](http://www.plumbsupply.com) • Serving our Customers Since 1946 • [www.waterconcepts.net](http://www.waterconcepts.net)

## Medicine Cabinets & Mirrors

### Verdera™ Side Mirror Kit

- Required for surface mounting of Verdera™ medicine cabinets
- Hardware included



Part #	Mfg #	Description	Price
159445	K-99012-NA	Verdera™ Side Mirror Kit	

### Catalan® Ganging Hardware



Part #	Mfg #	Description	Price
156766	K-2879-NA	Ganging Hardware	

### Jacquard™ Medicine Cabinet Surround

- Designed to fit k-99010-na and k-99011-na Verdera™ Medicine Cabinets (Sold Separately)
- Coordinates with Jacquard™ vanities for a matched ensemble
- Catalyzed conversion varnish provides a durable moisture-resistant finish
- Mounts directly to wall
- Solid wood and veneers



Part #	Mfg #	Description	Price
185462	K-99661-40-1WE	36"H x 46"W x 2"D Terry Walnut	

### Poplin™ Medicine Cabinet Surround

- Designed to fit k-99000-na and k-99001-na Verdera™ medicine cabinets (sold separately)
- Coordinates with Poplin™ and Marabou™
- Catalyzed conversion varnish provides a durable moisture-resistant finish
- Mounts directly to wall
- Solid wood and veneers



Part #	Mfg #	Description	Price
183666	K-99663-15-1WA	36"H x 21"W x 15/16"D Linen White	
250302	K-99663-24-1WT	36"H x 30" x 15/16"D Mohair Gray	

\* Vibrant Limited Lifetime Warranty

[www.waterconcepts.net](http://www.waterconcepts.net) • Serving our Customers Since 1946 • [www.plumbsupply.com](http://www.plumbsupply.com)



---



---

**Medicine Cabinets & Mirrors**

---



---

**Verdera™ Medicine Cabinet Wood Side Kit**

- Includes all hardware
- Solid wood and veneers
- For surface mounting of Verdera™ 30" tall medicine cabinets
- Coordinates with vanities in the KOHLER® Tailored vanity collection



Part #	Mfg #	Description	Price
188604	K-99675-1WA	30"H x 4"W x 2"D Linen White	
251758	K-99675-1WF	30"H x 4"W x 2"D Khaki White Oak	
183692	K-99675-1WL	30"H x 4"W x 2"D Laurentii Silk	
250349	K-99675-1WT	30"H x 4"W x 2"D Mohair Grey	
222371	K-99675-1WU	30"H x 4"W x 2"D Batiste Black	

\* Vibrant Limited Lifetime Warranty

[www.plumbsupply.com](http://www.plumbsupply.com) • Serving our Customers Since 1946 • [www.waterconcepts.net](http://www.waterconcepts.net)

## Vanities

### Vanities

#### Alberly® 36" Vanity with Adjustable Shelf

- 33-1/2"H x 36"W x 21-1/2"D
- Express™
- Double doors with adjustable hinges
- Birch solids and paintable substrate
- Catalyzed polyurethane provides a durable moisture-resistant finish



Part #	Mfg #	Description	Dimensions	Color	Price
150622	K-2488-F40	Vanity Only	33-1/2" x 36" x 21-1/2"	Cinder	

#### Archer® Petite Vanity — 23" x 18-3/4" x 32-13/16"

- Maple solids and veneers
- Catalyzed polyurethane provides a durable moisture-resistant finish
- Pullout basket and bottom drawer



Combines with K-2358 Archer® 24" sink for complete vanity

Part #	Mfg #	Description	Dimensions	Color	Price
103424	K-2449-F2	Vanity Only	23" x 18-3/4" x 32-13/16"	Black Forest	

#### Bancroft® Petite Vanity — 22-1/8" x 19-3/4" x 31-3/4"

- Catalyzed polyurethane provides a durable moisture-resistant finish
- Full-extension bottom drawer



Combines with K-2340 Bancroft® 24" sink for complete vanity

Part #	Mfg #	Description	Dimensions	Color	Price
110521	K-2461-F2	Vanity Only	22-1/8" x 19-3/4" x 31-3/4"	Black Forest	

#### Clermont® Petite Vanity — 24" x 21-1/2" x 33-1/2"

- Ailanthus solids and quarter-sawn ash veneers
- Catalyzed polyurethane provides a durable moisture-resistant finish
- Single door, hinged left, with adjustable hinges
- Adjustable shelf including cabinet hardware
- Express™ vanities are easy to transport and set up in minutes



Part #	Mfg #	Description	Dimensions	Color	Price
181989	K-2415-F39	Vanity Only	24" x 21-1/2" x 33-1/2"	Oxford	

## Vanities

### Clermont® Vanity

- 33-1/2" x 32" x 21-1/2"
- Ailanthus solids and quarter-sawn ash veneers
- Catalyzed polyurethane provides a durable moisture-resistant finish
- Adjustable shelf including cabinet hardware
- Express™ vanities are easy to transport and set up in minutes



Part #	Mfg #	Description	Dimensions	Color	Price
116039	K-2483-F39	Vanity Only	33-1/2" x 32" x 21-1/2"	Oxford	

### Damask™ Vanity

- Catalyzed conversion varnish provides a durable moisture-resistant finish
- Three-way adjustable slow-close door hinges with 110-degree opening capability for easy cabinet access
- Full extension 18" depth drawers with slow-close under-mount slides for smooth opening
- Solid wood and veneers



Part #	Mfg #	Description	Dimensions	Color	Price
183664	K-99515-LG-1WD	Vanity Only, 2 Doors	30" x 21-7/8" x 34-1/2"	Ramie Walnut	
185568	K-99516-LG-1WC	Vanity Only, 2 Doors 1 Drawer	30" x 21-7/8" x 34-1/2"	Felt Grey	
187729	K-99517-LGL-1WD	Vanity Only, 1 Door 3 Drawers on Left	30" x 21-7/8" x 34-1/2"	Ramie Walnut	
240140	K-99517-TKR-1WU	Vanity Only w/ Toe Kick, 1 Door 3 Drawers on Right	30" x 21-7/8" x 34-1/2"	Batiste Black	
236693	K-99563-1WA	Wall-Mount Vanity Only, 2 Doors 4 Drawers	42" x 21-7/8" x 19"	Linen White	
224171	K-99524-LGSD-1WT	Vanity Only, 2 Doors 3 Drawers in Middle	60" x 21-7/8" x 34-1/2"	Mohair Grey	

### Jacquard™ Vanity

- Catalyzed conversion varnish provides a durable moisture-resistant finish
- Three-way adjustable slow-close door hinges with 110-degree opening capability for easy cabinet access
- Full-extension 18" depth drawers with slow-close under-mount slides for smooth opening.
- Solid wood drawers with dovetail construction.
- Optional adjustable shelf / drawer organizer
- Door and drawer pulls are sold separately



Part #	Mfg #	Description	Dimensions	Color	Price
228180	K-99503-LG-1WC	Vanity Only, 2 Doors, 1 Bottom Drawer	30" x 21-7/8" x 34-1/2"	Felt Grey	
181471	K-99506-LG-1WC	Vanity Only, 2 Doors, 1 Bottom Drawer	36" x 21-7/8" x 39"	Felt Grey	
259551	K-99506-LG-1WU	Vanity Only, 2 Doors, 1 Bottom Drawer	36" x 21-7/8" x 39"	Batiste Black	
257349	K-99506-TK-1WU	Vanity Only, 2 Doors, 1 Bottom Drawer w/Toe Kick	36" x 21-7/8" x 34-1/2"	Batiste Black	
173937	K-99507-LG-1WC	Vanity Only, 1 Door, 3 Drawers on Left	36" x 21-7/8" x 39"	Felt Grey	
176499	K-99510-LG-1WC	Vanity Only, 2 Doors, 6 Drawers	60" x 21-7/8" x 34-1/2"	Felt Grey	
240452	K-99508-LG-1WD	Vanity Only, 2 Doors, 0 Drawers	48" x 21-7/8" x 34-1/2"	Ramie Walnut	

## Vanities

### Vanities (Continued)

#### Jacquard™ Vanity

Part #	Mfg #	Description	Dimensions	Color	Price
240454	K-99509-LG-1WD	Vanity Only, 2 Doors, 6 Drawers	48" x 21-7/8" x 34-1/2"	Ramie Walnut	
226204	K-99509-LGSD-1WE	Vanity Only, 2 Doors, 6 Drawers	48" x 21-7/8" x 34-1/2"	Terry Walnut	

#### Jaquard™ Vanity with Toe Kick

- Catalyzed conversion varnish provides a durable moisture-resistant finish
- Frameless construction with full-overlay doors and drawers
- One door and three right offset drawers
- Three-way adjustable slow-close door hinges with 110-degree opening capability for easy cabinet access
- Optional adjustable shelf / drawer organizer (sold separately)
- Coordinates with other products in the Jacquard™ collection
- Toe kick covers blemished or inconsistent flooring
- Full-extension 18" depth drawers with slow-close under-mount slides for smooth opening
- Solid wood drawers with dovetail construction
- Door and drawer pulls are sold separately



Part #	Mfg #	Description	Dimensions	Color	Price
226537	K-99507-TKR-1WA	Vanity, 1 Door, 3 Drawers on Right	36" x 21-7/8" x 34-1/2"	Linen White	

#### Jute™ Wall-Hung Vanity — 21-7/8" x 19-1/2"

- Solid wood drawer with dovetail construction
- Frameless construction with full-overlay doors and drawer.
- Catalyzed conversion varnish provides a durable moisture-resistant finish.
- Full-extension 18" depth drawer with slow-close under-mount slides for smooth opening.
- Three-way adjustable slow-close door hinges with 110-degree opening capability for easy cabinet access.



Part #	Mfg #	Description	Dimensions	Color	Price
177669	K-99540-1WK	Vanity Only, 2 Doors	30" x 21-7/8" x 19-1/2"	Satin Oak	
252479	K-99540-1WJ	Vanity Only, 2 Doors	30" x 21-7/8" x 19-1/2"	Jersey Oak	
186039	K-99542-1WJ	Vanity Only, 2 Doors	36" x 21-7/8" x 19-1/2"	Jersey Oak	
257998	K-99542-1WU	Vanity Only, 2 Doors	36" x 21-7/8" x 19-1/2"	Batiste Black	
231080	K-99543-L-1WM	Vanity Only, 1 Door and 1 Drawer on left	36" x 21-7/8" x 19-1/2"	Walnut Flax	
248708	K-99543-L-1WJ	Vanity Only, 1 Door and 1 Drawer on left	36" x 21-7/8" x 19-1/2"	Jersey Oak	
169514	K-99543-R-1WA	Vanity Only, 1 Door and 1 Drawer on Right	36" x 21-7/8" x 19-1/2"	Linen White	
248707	K-99543-R-1WJ	Vanity Only, 1 Door and 1 Drawer on Right	36" x 21-7/8" x 19-1/2"	Jersey Oak	
168234	K-99544-1WK	Vanity Only, 2 Doors and 2 Drawers	48" x 21-7/8" x 19-1/2"	Satin Oak	
180838	K-99544-1WJ	Vanity Only, 2 Doors and 2 Drawers	48" x 21-7/8" x 19-1/2"	Jersey Oak	
257999	K-99544-1WN	Vanity Only, 2 Doors and 2 Drawers	48" x 21-7/8" x 19-1/2"	Corduroy Teak	
237534	K-99548-SD-1WU	Vanity Only, 2 Doors and 1 Split Drawer	60" x 21-7/8" x 19-1/2"	Batiste Black	
254141	K-99548-SD-1WJ	Vanity Only, 2 Doors and 1 Split Drawer	60" x 21-7/8" x 19-1/2"	Jersey Oak	
246220	K-99548-1WA	Vanity Only, 2 Doors and 1 Drawer	60" x 21-7/8" x 19-1/2"	Linen White	
258000	K-99548-1WN	Vanity Only, 2 Doors and 1 Drawer	60" x 21-7/8" x 19-1/2"	Corduroy Teak	

## Vanities

### Marabou™ Vanity — 21-7/8" x 34-1/2"

- Catalyzed conversion varnish provides a durable moisture-resistant finish.
- Frameless construction with full-overlay doors.
- Three-way adjustable slow-close door hinges with 110-degree opening capability for easy cabinet access.



99553-1WG  
30" Cherry Tweed

Part #	Mfg #	Description	Dimensions	Color	Price
169581	K-99553-1WG	Vanity Only, 2 Doors	30" x 21-7/8" x 34-1/2"	Cherry Tweed	
183691	K-99555-1WG	Vanity Only, 2 Doors	36" x 21-7/8" x 34-1/2"	Cherry Tweed	
170471	K-99555-1WB	Vanity Only, 2 Doors	36" x 21-7/8" x 34-1/2"	Claret Suede	
225001	K-99556-L-1WC	Vanity Only, 2 Doors 2 LH Drawers	36" x 21-7/8" x 34-1/2"	Felt Grey	
183665	K-99557-1WB	Vanity Only, 2 Doors 4 Drawers	48" x 21-7/8" x 34-1/2"	Claret Suede	
242250	K-99558-1WG	Vanity Only, 2 Doors 4 Drawers	60" x 21-7/8" x 34-1/2"	Cherry Tweed	
168876	K-99559-1WG	Vanity Only, 4 Doors and 2 Drawers	60" x 21-7/8" x 34-1/2"	Cherry Tweed	

### Poplin™ Vanity — 21-7/8" x 34-1/2"

- Catalyzed conversion varnish provides a durable moisture-resistant finish
- Frameless construction with full-overlay door and drawers
- Solid wood drawers with dovetail construction
- Full extension 18" depth drawers with slow-close under-mount slides for smooth opening
- (-SD) Split top drawers



Part #	Mfg #	Description	Dimensions	Color	Price
237366	K-99527-TK-1WF	Vanity Only, Toe Kick, 2 Doors, 1 Bottom Drawer	24" x 21-7/8" x 34-1/2"	Khaki White Oak	
226749	K-99529-TK-1WA	Vanity Only, Toe Kick, 2 Doors 1 Drawer	30" x 21-7/8" x 34-1/2"	Linen White	
166450	K-99530-TKR-1WD	Vanity Only, Toe Kick, 1 Door 3 Drawers	30" x 21-7/8" x 34-1/2"	Ramie Walnut	
222223	K-99530-LGR-1WU	Vanity Only, Furniture Legs, 1 Door 3 RH Drawers	30" x 21-7/8" x 34-1/2"	Batiste Black	
230754	K-99532-LG-1WA	Vanity Only, Furniture Legs, 2 Door 1 Drawer	36" x 21-7/8" x 34-1/2"	Linen White	
175683	K-99533-LGL1-WB	Vanity Only, Furniture Legs, 1 Door 3 LH Drawers	36" x 21-7/8" x 34-1/2"	Claret Suede	
240720	K-99533-LGR-1WT	Vanity Only, Furniture Legs, 1 Door 3RH Drawers	36" x 21-7/8" x 34-1/2"	Mohair Grey	
244625	K-99535-TK-1WA	Vanity Only, Toe Kick, 2 Door 6 Drawers	48" x 21-7/8" x 34-1/2"	Linen White	
226540	K-99535-TKSD-1WA	Vanity Only, Toe Kick, 2 Doors 6 Drawers	48" x 21-7/8" x 34-1/2"	Linen White	
237846	K-99537-LG-1WA	Vanity Only, Furniture Legs, 2 Door 3 Drawers	60" x 21-7/8" x 34-1/2"	Linen White	
258932	K-99537-LGSD-1WA	Vanity Only, Furniture Legs, 2 Doors 3 Drawers	60" x 21-7/8" x 34-1/2"	Linen White	
222222	K-99537-LGSD-1WU	Vanity Only, Furniture Legs, 2 Doors 3 Drawers	60" x 21-7/8" x 34-1/2"	Batiste Black	

## Vanities

### Tresham® Vanity

- Ash solids and veneers
- Three-way adjustable slow-close door hinges with 100-degree opening capability for easy cabinet access
- Slow-close under-mount drawer slides for smooth opening
- Includes decorative cabinet hardware
- Coordinates with other products in the Tresham collection
- Solid wood drawer with dovetail construction



Part #	Mfg #	Description	Dimensions	Color	Price
238630	K-5288-1WT	Vanity Only, One door, Two Drawers	36" x 22" x 34-1/2"	Mohair Grey	
190456	K-5289-1WT	Vanity Only, 2 Doors	30" x 21-7/8" x 34-1/2"	Mohair Grey	

### Tresham® Petite Vanity

- Three-way adjustable slow-close door hinges with 100° opening capability for easy cabinet access
- Includes decorative cabinet hardware
- Sink sold separately



Combines with K-2979 Tresham® sink for complete vanity

Part #	Mfg #	Description	Dimensions	Color	Price
240172	K-2604-1WA	Vanity Only	23-3/4" x 18-1/4" x 32-1/2"	Linen White	
144151	K-2604-F69	Vanity Only	23-3/4" x 18-1/4" x 32-1/2"	Woodland	
235443	K-2604-1WT	Vanity Only	23-3/4" x 18-1/4" x 32-1/2"	Mohair Grey	

### Westmore® Vanity

- Ailanthus solids and ash veneers
- Catalyzed polyurethane provides a durable moisture-resistant finish
- Double doors with adjustable hinges
- Adjustable shelf
- Express™ vanities are easy to transport and set up in minutes
- Coordinates with the Westmore mirror



Part #	Mfg #	Description	Dimensions	Color	Price
112571	2489-F41	Vanity Only	37-1/2" x 21-1/2" x 33-3/16"	Westwood	

## Vanity Accessories

### Adjustable Shelf for 30" Tailored Vanities with 2 Doors

- Includes 4 electrical outlets (2 switched, 2 always live)
- Appliances can remain plugged in while vanity door is closed
- Solid wood and veneers



For use with K-99502 Jacquard™, K-99515 Damask™, and K-99528 Poplin™ vanities

Part #	Mfg #	Description	Dimensions	Color	Price
166451	K-99678-SH2-1WR	Vanity Shelf, 4 Electrical Outlets	28-3/8" x 18" x 3-1/8"	Oxford Maple	



## Vanities

### Adjustable Shelf for 60" Tailored Vanities with 2 Doors

- Appliances can remain plugged in while vanity door is closed
- Solid wood and veneers



For use with K-99511 Jacquard™, K-99524 Damask™, and K-99537 Poplin™ vanities

Part #	Mfg #	Description	Dimensions	Color	Price
224170	K-99677-SH6-1WR	Vanity Shelf	22-15/16" x 19" x 3/4"	Oxford Maple	
224169	K-99678-SH6-1WR	Vanity Shelf, 4 Electrical Outlets	22-15/16" x 19" x 3/4"	Oxford Maple	

### Drawer Divider for Tailored Vanities

- Compartmentalizes vanity drawer to maximize storage space and organize items
- Four storage compartments
- Sliding top tray for two-level storage
- Bamboo construction
- Includes 4 compartments plus a sliding top tray for two-level storage



For use with Jacquard™, Damask™, Poplin™, Marabou™, and Jute™ vanities

Part #	Mfg #	Description	Dimensions	Color	Price
166456	K-99684-1WS	Drawer Divider Package	8-3/4" x 16-5/8" x 3"	Bamboo Twill	

### General Storage Package

- Bamboo construction
- Includes one storage tray and one oral care tray
- Rubber feet allow you to set tray on the countertop during use
- Compartmentalizes vanity drawer to maximize storage space and organize items



For use with Jacquard™, Damask™, Poplin™, Marabou™, and Jute™ vanities

Part #	Mfg #	Description	Dimensions	Color	Price
166453	K-99682-1WS	General Storage Package	8-11/16" x 8-1/4"	Bamboo Twill	

### In-Drawer Electrical Outlets

- Three electrical outlets controlled by an on/off switch
- For use with Tailored® vanities with a full-height drawer
- Includes installation guide and hardware



Part #	Mfg #	Description	Dimensions	Color	Price
244330	K-99566-CA3	3 Electrical Outlets, Two include 110V GFCI outlets	5" x 5-7/16"	Black	

## Vanities

### Jute® Vanity Legs

- Set of two
- Includes installation guide and hardware
- Legs offer the polished look of furniture in the bath



Part #	Mfg #	Description	Dimensions	Color	Price
237535	K-99565-NA	Set of Two	-	-	

### Makeup Storage for Tailored Vanities

- Compartmentalizes vanity drawer to maximize storage space and organize items
- Includes removable magnifying mirror
- Compartments for holding makeup brushes and makeup items
- Bamboo construction
- Rubber feet allow you to set tray on the countertop during use



For use with **Jacquard™**, **Damask™**, **Poplin™**, **Marabou™**, and **Jute™** vanities

Part #	Mfg #	Description	Dimensions	Color	Price
166454	K-99683-1WS	Makeup Storage Package	8-11/16" x 8-1/4" x 2-1/4"	Bamboo Twill	

### Memoirs® Stately Console Table Legs

- Set of two
- Solid brass
- Includes towel bar
- 17-5/16"L x 36"H x 23"W
- Combines with K-2269 **Memoirs®** bathroom sink



Part #	Mfg #	Description	Dimensions	Color	Price
250054	K-30003-CP	Set of Two	-	Polished Chrome	

### Rollout Drawer for 30" Tailored Vanities with 1 Door, 3 Drawers

- Full-extension 18-inch depth drawer with slow-close under-mount slides for smooth opening
- Solid wood and veneers

For use with **K-99504 Jacquard™**, **K-99517 Damask™**, and **K-99530 Poplin™** Vanities with 1 Door and 3 Drawers

Requires: **K-99738 Appliance Tray**

Can be paired with the **K-99677 Adjustable Shelf** or **K-99678 Adjustable Shelf with Electrical Outlets**



Part #	Mfg #	Description	Dimensions	Color	Price
166452	K-99679-SH8-1WR	Rollout Drawer	14-7/8" x 18" x 7-11/16"	Oxford Maple	

## Vanities

### Rollout Drawer for 60" Tailored Vanities with Double Basin

- Full-extension 18-inch depth drawer with slow-close under-mount slides for smooth opening
- Solid wood and veneers

For use with K-99511 Jacquard™, K-99524 Damask™, and K-99537 Poplin™ Vanities with 1 Door and 3 Drawers

Requires: K-99738 Appliance Tray

Can be paired with the K-99677 Adjustable Shelf or K-99678 Adjustable Shelf with Electrical Outlets



Part #	Mfg #	Description	Dimensions	Color	Price
237847	K-99679-SH6-1WR	Rollout Drawer	20-11/16" x 18" x 7-11/16"	Oxford Maple	

### Rollout Tray for 60" Tailored Vanities with Double Basin

- Full-extension 18" depth trap with slow-close under-mount slides for smooth opening

For use with K-99511 Jacquard™, K-99524 Damask™, and K-99537 Poplin® vanities



Part #	Mfg #	Description	Dimensions	Color	Price
224168	K-99680-SH6-1WR	Rollout Drawer	20-11/16" x 18" x 3"	Oxford Maple	

### Side-Mount Electrical Outlets

- For use with Jacquard™, Damask™, Poplin™, Marabou™, and Jute™ vanities
- Includes 4 electrical outlets (2 switched, 2 always live)
- Mounts into pre drilled holes in vanity for easy installation



Part #	Mfg #	Description	Dimensions	Color	Price
168235	K-99681-1WR	Side-Mount Electrical Outlet	19" x 2-3/8"	Oxford Maple	

## Vanity Tops

### Oasis Cultured Marble Tops

#### Recessed Single Oval Bowl

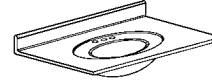

- Integral 4-1/4" high backsplash

Part #	Mfg #	Description	Price
002519	O01-OB2519	25" x 19" White on White Cultured Marble Top	
002520	O01-OB2522	25" x 22" White on White Cultured Marble Top	
002521	O01-OB3122	31" x 22" White on White Cultured Marble Top	
002523	O01-OB3722	37" x 22" White on White Cultured Marble Top	
002524	O01-OB4922	49" x 22" White on White Cultured Marble Top	



## Commercial Electric Water Heaters

### Commercial Electric Water Heaters

#### Light Duty Electric Commercial Water Heater

- With terminal block
- 30 through 119.9 gallon models available
- 3kW through 12kW and in 208,240, 277, and 480 voltages
- Max temp greater than 180°
- Long life tank design
- Long life heating elements
- Wiring options
- Efficient design
- Automatic temperature control
- Durable brass drain valve



#### Simultaneous Wiring

Part#	Mfg#	Gal Capacity	Max Watts	Min Watts	kW	Voltage	H x W	Ship Weight	Price
248097	ELD52-TB	50	12,000	3,000	6	208	58-5/8" x 20-1/4"	155 lbs	
248096	ELD52-TB	50	12,000	3,000	6	240	58-5/8" x 20-1/4"	155 lbs	
248090	ELD40-TB	40	12,000	3,000	3	208	46-1/4" x 22-1/4"	108 lbs	
248091	ELD40-TB	40	12,000	3,000	6	208	46-1/4" x 20-1/4"	140 lbs	
248092	ELD40-TB	40	12,000	3,000	4.5	208	46-1/4" x 22-1/4"	108 lbs	
248094	ELD40-TB	40	12,000	3,000	4.5	480	46-1/4" x 22-1/4"	108 lbs	
248095	ELD40-TB	40	12,000	3,000	4	208	46-1/4" x 22-1/4"	108 lbs	
248098	ELD80-TB	80	12,000	3,000	6	208	59-5/8" x 23-3/4"	220 lbs	
248099	ELD80-TB	80	12,000	3,000	3	208	59-5/8" x 23-3/4"	220 lbs	

#### Non-Simultaneous Wiring

Part#	Mfg#	Gal Capacity	Max Watts	Min Watts	kW	Voltage	H x W	Ship Weight	Price
248090	ELD40-TB	40	12,000	3,000	3	208	48-1/4" x 20-1/4"	140 lbs	
248097	ELD52-TB	50	12,000	3,000	6	208	58-5/8" x 20-1/4"	155 lbs	
248099	ELD80-TB	80	12,000	3,000	3	208	59-5/8" x 23-3/4"	220 lbs	



## Commercial Electric Water Heaters

### Point-of-Use - Commercial

#### 3-Year Limited Warranty on Tank Against Leaks

- 120, 208, 240, 277 & 480 Volts, 1-phase
- Porcelain enamel lined tank
- Patented R-Tech anode rod provides advanced technology, equalizing aggressive water action while prolonging the effective life of the anode rod and in turn the life of the tank
- Rigid polyurethane foam insulation provides superior insulating qualities resulting in reduced operating costs
- Baked enamel steel jacket
- Resistor heating element
- Surface mounted thermostat automatically cycles on and off to maintain the water temperature at a desired preset level
- Manual reset high limit control



**AGA/ASME Rated T&P Valve Included**

Part #	Mfg #	Gal Cap	Min/Max Watts	Tank Height	Width	Approx Ship Weight	Price
066894	EGSP10	10	1,500 / 6,000	22-7/8"	15-3/4"	53 lbs	
167957	EGSP20	20	1,500 / 6,000	25-1/8"	19-3/4"	76 lbs	

### Storage Tank - Commercial

#### 5-Year Limited Warranty Against Tank Leaks

- Meets or exceeds thermal efficiency and standby loss requirements of current ASHRAE standard
- Installed individually, or in parallel manifold
- Steel tank with two coats of high temperature porcelain enamel
- Two magnesium anode rods
- Maximum working pressure: 150 psi
- ST80 and ST120 Can pass through a 30" opening, ST175 passes 33" openings
- 2" Rigid polyurethane foam insulation
- Order T&P valve separately



Part #	Mfg #	Gal Cap	Jacket Height	Diameter	Top Outlet/ Front Side Connections	Approx Ship Weight	Price
067164	ST80	80	58-5/16"	24-7/16"	2" NPT	220 lbs	
066488	ST120	115	59-1/4"	28-1/4"	2" NPT	300 lbs	
077341	ST200A	120	59-1/5"	28-1/5"	2" NPT	315lbs	





## Commercial Gas Water Heaters

### Commercial Gas Water Heaters

#### TRITON™ High-Efficiency Commercial Gas Water Heater

Base Models: SU = Smart Universal

- LeakSense™
- 130K–400K BTU
- Up to 97% Efficiency
- Easy Retrofit Across Brands
- Health Checks
- Built-in Condensate Neutralizer
- EcoNet® Smart Monitoring Technology
- Integrated WiFi
- Power Anodes
- Full Modulation
- 3-Year Warranty



Part #	Mfg #	Type Gas	Gal Cap	Input BTUH	Unit Height	Diameter	Vent	Approx Ship Weight	Price
246485	GHE80SU-130	NG/LP	80	130,000	67-7/8"	26-3/8"	2", 3", 4"	600 lbs	
246486	GHE80SU-200	NG/LP	80	199,900	67-7/8"	26-3/8"	2", 3", 4"	650 lbs	
246554	GHE100SU-160	NG/LP	100	160,000	77"	26-3/8"	2", 3", 4"	725 lbs	
246484	GHE100SU-200	NG/LP	100	199,900	77"	26-3/8"	2", 3", 4"	775 lbs	
246483	GHE100SU-250A	NG/LP	100	250,000	77"	26-3/8"	3", 4", 6"	775 lbs	
246488	GHE100SU-300A	NG/LP	100	300,000	77"	26-3/8"	3", 4", 6"	775 lbs	
246481	GHE100SU-160 LP	LP	100	160,000	77"	26-3/8"	2", 3", 4"	725 lbs	
246487	GHE100SU-200 LP	LP	100	200,000	77"	26-3/8"	2", 3", 4"	775 lbs	
247990	GHE100SU-200A	NG/LP	100	200,000	77"	26-3/8"	2", 3", 4"	775 lbs	
247989	GHE100SU-400A	NG/LP	100	400,000	77"	26-3/8"	3", 4", 6"	775 lbs	



## Commercial Gas Water Heaters

### SPIDERfire Sealed-Combustion Gas Water Heater- Commercial

#### 3-Year Limited Tank Warranty

- Thermal efficiency of up to 95%
- No chimney required, vent using plastic pipe
- Low NOx emissions
- Direct spark ignition system
- Corrosion resistant, high efficiency 3-pass heat exchanger
- Small jacket diameters
- Short floor-to-vent heights
- Self-diagnostic LCD electronic control
- Zero clearance to all combustible surfaces
- Maximum operating temperature: 185°
- Front and back water connections
- Full flow drain valve



**T&P Valve Included**

Part #	Mfg #	Type Gas	Gal Cap	Input BTUH	Unit Height	Diameter	Vent	Approx Ship Weight	Price
151103	GHE80ES-130	NG/LP	80	130,000	69-5/8"	26-1/4"	2",3",4"	725 lbs	
220525	GHE80ES-130A	ASME NG	80	130,000	69-5/8"	26-1/4"	2",3",4"	725 lbs	
210670	GHE80ES-150	NG/LP	80	150,000	69-5/8"	26-1/4"	2", 3", 4"	725 lbs	
151102	GHE80ES-200	NG/LP	80	199,000	69-5/8"	26-1/4"	2", 3", 4"	725 lbs	
130062	GHE100ES-160	NG	100	160,000	78-3/4"	26-1/4"	2",3",4"	785 lbs	
130063	GHE100ES-160A	ASME NG	100	160,000	78-3/4"	26-1/4"	2",3",4"	820 lbs	
130064	GHE100ES-200	NG	100	199,000	78-3/4"	26-1/4"	2",3",4"	785 lbs	
130065	GHE100ES-200A	ASME NG	100	199,000	78-3/4"	26-1/4"	2",3",4"	820 lbs	
130067	GHE100ES-250A	ASME NG	100	250,000	78-3/4"	26-1/4"	3",4"	860 lbs	
130070	GHE100ES-300A	ASME NG	100	300,000	78-3/4"	26-1/4"	3",4"	860 lbs	
186107	GHE100ES-400A	ASME NG	100	400,000	78-3/4"	26-1/4"	3", 4", 6"	800 lbs	



## Commercial Gas Water Heaters

### AdvantagePlus™ Sealed-Combustion Gas Water Heater - Commercial

**3-Year Limited Tank Warranty**

- 316L Stainless steel tank construction (requires no anode rods)
- Thermal efficiency to 95%
- No chimney required, direct vent using plastic pipe
- Low NOx emissions
- 2" Non-CFC polyurethane foam insulation
- Corrosion resistant, high efficiency 90/10 cupronickel heat exchanger
- Self-diagnostic LCD electronic control
- Zero clearance to all combustible surfaces
- Maximum operating temperature: 160°
- Removable front cover



**T&P Valve Included**

Part #	Mfg #	Type Gas	Gal Cap	Input BTUH	Unit Height	Diameter	Vent	Approx Ship Weight	Price
206611	HE55-130	NG	55	130,000	52"	23-1/2"	2"	175 lbs	
062009	HE80-130	NG	80	130,000	72"	23-1/2"	3"	235 lbs	
062016	HE119-199	NG	119	199,000	73"	27"	3"	405 lbs	

### Universal Gas Water Heater - Commercial

**3-Year Limited Tank Warranty**

- Spark-to-pilot ignition system
- 80% Thermal efficiency
- Small jacket diameters
- Short floor-to-vent heights
- System Sentinel™ LED diagnostic system
- Maximum operating temperature: 180°
- Patented multi-flue design
- Low profile automatic flue damper
- Stainless steel burners
- Full port, full flow brass drain valve



**T&P Valve Included**

Part #	Mfg #	Type Gas	Gallon Capacity	Input BTUH	Height To Top Of Flue	Diameter	Flue	Approx Ship Weight	Price
115082	G37-200	NG	35	199,900	49-1/4"	26-1/4"	6"	405 lbs	
062002	G65-360A	ASME NG	65	360,000	70-11/16"	26-1/4"	8"	680 lbs	
061996	G75-125	NG	75	125,000	65-1/2"	26-1/4"	5"	480 lbs	
101953	G75-125 LP	LP	75	125,000	65-1/2"	26-1/4"	5"	480 lbs	
061998	G72-250A	ASME NG	72	250,000	71-1/16"	26-1/4"	6"	630 lbs	
061999	G76-180	NG	76	180,000	68-13/16"	26-1/4"	6"	540 lbs	
062000	G76-200	NG	76	199,900	68-13/16"	26-1/4"	6"	540 lbs	
061994	G91-200	NG	91	199,900	76-5/16"	26-1/4"	6"	600 lbs	
085150	G91-200 LP	LP	91	199,900	76-5/16"	26-1/4"	6"	600 lbs	
191652	G100-200 LP	LP	100	199,900	73-1/16"	30-1/4"	6"	780 lbs	



## Commercial Gas Water Heaters

### Commercial Gas Water Heaters (Continued)

#### Universal Gas Water Heater - Commercial

Part #	Mfg #	Type Gas	Gallon Capacity	Input BTUH	Height To Top Of Flue	Diameter	Flue	Approx Ship Weight	Price
069620	G100-250A	ASME NG	100	250,000	73-1/4"	30-1/4"	8"	835 lbs	
062006	G100-400A	ASME NG	100	399,900	76"	30-1/4"	8"	810 lbs	

#### Medium Duty Gas Water Heater - Commercial

##### 3-Year Limited Tank Warranty

- Small jacket diameters
- Short floor-to-vent heights
- Maximum operating temperature: 180°
- Designed to shut off gas if the pilot flame is extinguished
- Rigid polyurethane foam insulation
- Full port, full flow brass drain valve

AGA/ASME Rated T&P Valve Included

'N' Suffix denotes models meet Low NOx construction standard

"2" Suffix denotes models that are FVIR Compliant



Part #	Mfg #	Type Gas	Gallon Capacity	Input BTUH	Height To Top Of Flue	Diameter	Flue	Approx Ship Weight	Price
062004	G75-75N-3	NG	75	75,100	64"	26-1/4"	4"	320 lbs	
115995	G100-80	NG	100	80,000	69-5/8"	28-1/4"	4"	410 lbs	

#### Super Duty Gas Water Heater - Commercial

##### 3-Year Limited Tank Warranty

- 93% Thermal efficiency
- 4" or 6" PVC vent
- Super duty units can be installed with power vent or power direct vent configurations
- LCD User interface
- Multiple water connections
- Factory installed brass drain valve
- Advance burner design
- Hot surface ignition system
- Altitude certification
- CSA/ASME rated T&P valve: Factory installed relief valve



Part #	Mfg #	Type Gas	Gallon Capacity	Input BTUH	Height To Top Of Flue	Diameter	Flue	Approx Ship Weight	Price
162542	GHE119-500	NG/LG	119	500,000	78-1/2"	32"	4"	1,200	
162543	GHE125-500A	NG/LG	125	500,000	78-1/2"	32"	4"	1,200	

## Indirect Water Heaters

### Indirect Water Heaters

#### Squire® Stainless Steel Indirect Water Heater SIT Model

- 316L Passivated stainless steel tank
- 316L High capacity stainless steel coil
- Optional thermostat kit available
- Fully welded construction
- HCFC free foam insulation
- Limited Lifetime Warranty
- Uses the power and efficiency of the boiler that heats the home to generate domestic hot water for showers, dishwashing, clothes washing, etc.



Part #	Mfg #	Capacity (Gallons)	Heat Source Water Volume Gallons	Standby Loss °F/Hr	Continuous Delivery (GPH)	1st Hour Delivery (Gallons)	Min Coil Loadt (Btu/Hr)	Flow Rate (GPM)	Price
253022	LOSIT030	27	1.1	1.5	160	183	99,000	14.0	
168227	LOSIT040	40	1.6	0.9	181	208	115,000	14.0	
249771	LOSIT050	52	1.7	0.9	209	255	133,000	14.0	
225939	LOSIT065	67	1.9	0.7	263	327	154,000	14.0	
246870	LOSIT119	113	3.2	0.5	349	459	199,999	14.0	

## Indirect Water Heaters

### Water Heaters

#### Aqua Plus Indirect Fired Water Heater

- 316L Stainless steel tank welded with "TIG and Plasma" technology coil tank
- Temperature and pressure relief valve standard equipment
- Thermostat connections already installed for quick and easy wiring
- All connections include boiler supply and return, domestic water and domestic recirculation on side of tank
- Magnesium Anode installed in all tanks
- Inspection port located near bottom of all tanks
- Exceptional "R Value" with 2" dense foam insulation
- Adjustable feet for uneven floors
- Available in gold and pewter colors



Part #	Mfg #	Model	Domestic Water Gallons	Domestic Water Inlet/Outlet	Boiler Water Supply/Return	Dimensions H x Dia	Approx Ship Wt	Price
144390	633-500-000	Aqua Plus 35	29.6	3/4"	1"	36-3/8" x 21-7/8"	94 lbs	
144393	633-500-001	Aqua Plus 45	39.9	3/4"	1"	46-1/4" x 21-7/8"	111 lbs	
144394	633-500-002	Aqua Plus 55	53.1	3/4"	1"	60" x 21-7/8"	122 lbs	
144396	633-500-003	Aqua Plus 85	80.6	1"	1"	59-1/2" x 26"	223 lbs	
144397	633-500-004	Aqua Plus 105	109.4	1"	1"	59-3/4" x 30"	238 lbs	





## Residential Electric Water Heaters

### Electric Water Heaters

#### Professional™ Electric Water Heater

**8-Year Limited Tank and Parts Warranty with a Professional Installation**

**With ProtectionPlus™ the 8-Year Limited Tank Warranty Becomes 12-Years**

- Brass drain valve
- Stainless steel lower heating element
- EverKleen™ self cleaning device
- Premium grade anode rod
- Exclusive Ruudglas® tank lining resists corrosion and prolongs tank life
- Electric junction box located above heating elements for easy installation
- Over-temperature protector cuts off power in excess temperature situations
- Automatic thermostat keeps water at desired temperature
- Meets or exceeds requirements of the National Appliance Energy Conservation Act (NAECA)
- Heaters furnished with standard 240V, single-phase non-simultaneous wiring, and 4500W upper and lower heating elements

**T&P Valve Included**



Tall

Part #	Mfg #	Gal Cap	Tank Height	Jacket Dia	First Hour Rating	Energy Factor	Approx Ship Weight	Price
173873	PRO+E40T2RU95EC1	40	46-3/4"	22-1/4"	56 gph	0.95	104 lbs	
173874	PRO+E50T2RU95EC	50	57"	22-1/4"	67 gph	0.95	123 lbs	

#### Professional Achiever™ Series Electric Water Heaters

**6-Year Limited Tank and Parts Warranty with Professional Installation**

- EverKleen™ patented self-cleaning system
- Isolated tank design
- Highly efficient restored heating elements
- Anode rod
- Electric junction box located above heating elements
- Over-temperature protector
- Automatic thermostat
- Brass drain valve
- Meets or exceeds National Appliance Energy Conservation Act (NAECA) requirements

**T&P Valve Included**



Tall

Part #	Mfg #	Gal Cap	Tank Height	Jacket Diameter	First Hour Rating	Energy Factor	Approx Ship Weight	Price
175819	PROE30T2RU95	30	47-1/2"	19-1/4"	48	0.95	92 lbs	



## Residential Electric Water Heaters

### Electric Water Heaters (Continued)

#### Professional Achiever™ Series Electric Water Heaters

##### Tall

Part #	Mfg #	Gal Cap	Tank Height	Jacket Diameter	First Hour Rating	Energy Factor	Approx Ship Weight	Price
173871	PROE40T2RU95EC1	40	59-1/4"	17-3/4"	57	0.92	96 lbs	
176310	PROE40T2RU95	40	60-3/4"	19-1/4"	57	0.95	109 lbs	
176309	PROE50T2RU95	50	58-5/8"	20-1/4"	67	0.95	121 lbs	
185228	PROE55T2RU94	55	59-3/4"	22-1/4"	71	0.94	128 lbs	

##### Medium

Part #	Mfg #	Gal Cap	Tank Height	Jacket Diameter	First Hour Rating	Energy Factor	Approx Ship Weight	Price
173882	PROE30M2RU95	30	37-1/2"	20-1/4"	44	0.95	92 lbs	
175634	PROE40M2RU95	40	46-1/2"	19-3/4"	53	0.95	95 lbs	
173894	PROE50M2RU95	50	48"	23"	65	0.95	132 lbs	

##### Short

Part #	Mfg #	Gal Cap	Tank Height	Jacket Diameter	First Hour Rating	Energy Factor	Approx Ship Weight	Price
185229	PROE28S2RU95	28	30"	23"	42	.95	95 lbs	
185223	PROE36S2RU95	36	31-1/2"	24-1/4"	45	.95	118 lbs	
173885	PROE30S2RU95B	30	30-1/8"	19-3/4"	42	0.95	95lbs	
173890	PROE38S2RU95B	38	31-1/2"	23"	45	0.92	108 lbs	
173892	PROE47S2RU95	47	32"	26-1/4"	55	0.91	149 lbs	

\* 208V, 4500W



## Residential Electric Water Heaters

### Marathon™ Electric Water Heater 5-Year Parts Warranty, Lifetime Limited Tank Warranty

- PermaGuard Lifetime tank - combines a seamless blow molded polybutylene inner tank reinforced with a filament wound fiberglass outer tank for maximum strength
- Lightweight polyethylene outer jacket resist damage and corrosion
- Patented Envirofoam™ insulation process for superior heat retention
- Upper low watt density element



T&P Valve Included

Tall

Part #	Mfg #	Gal Cap	Tank Height	Jacket Diameter	First Hour Rating	Energy Factor	Approx Ship Weight	Price
062159	MR50245	50	62-3/4"	23-1/2"	61	0.94	100 lbs	

Heavy Duty

Part #	Mfg #	Gal Cap	Tank Height	Jacket Diameter	First Hour Rating	Energy Factor	Approx Ship Weight	Price
175548	MHD85245	85	66-1/4"	28-1/4"	91	0.92	134 lbs	
175547	MHD105245	105	66-3/4"	30-1/4"	104	0.92	152 lbs	

### Marathon™ Electric Point-of-Use Water Heater 5-Year Limited Tank Warranty, 1-Year on Parts

- Seamless, blow-molded, polybutene tank – impervious to rust and corrosion
- Polyurethane insulation helps reduce energy consumption and standby heat loss
- Recessed drain valve is out of the way of brooms and scrubbers
- High temperature polysulfone dip tube
- Tough molded polyethylene outer shell resists dents, scratches, and salt air
- 3/4-Inch inlet and outlet connections
- Thermally fused element to protect against dry-firing; low watt, density for long life
- Full-flow, brass drain valve
- Temperature and pressure relief valve



Part #	Mfg #	Gal Cap	Tank Height	Jacket Diameter	Element Wattage	Voltage	Approx Ship Weight	Price
072829	MR20230	19.9	30-1/2"	23-1/2"	3000	240	61 lbs	



## Residential Electric Water Heaters

### Point-of-Use Ruudglas® Energy Miser® Electric Water Heater

#### 6-Year Limited Tank and Parts Warranty

- Space-saving design for installation in limited spaces
- High efficiency heating elements
- Over-temperature protector
- Automatic thermostat
- Meets or exceeds National Appliance Energy Conservation Act (NAECA) requirements



**T&P Valve Included**

#### 2.5 Gallon Point-of-Use Model

- Standard 120V with (3) prong cord set
- Optional 240V model includes junction box
- Corrosion resistant 1/4-turn drain valve
- Wall bracket for easy wall mount installations
- 1/2" NPT Inlet and outlet
- 3/4" Relief valve connection

Part #	Mfg #	Gal Cap	Tank Height	Jacket Diameter	Approx Ship Weight	Price
161883	PROE21RUPOU	2.5	14"	9-3/4"	22 lbs	

#### 6 Through 30 Gallon Point-of-Use Models

- 3/4" NPT Outlet and inlet
- Anode rod
- Patented R-Foam® Insulation process
- Not available with 3-phase wiring
- Standard 120V, 2,000W single element

Part #	Mfg #	Gal Cap	Tank Height	Jacket Diameter	Energy Factor	Approx Ship Weight	Price
161896	PROE61RUPOU	6	15-1/4"	15-3/4"	-	36 lbs	
161882	PROE101RUPOU	10	23"	15-3/4"	-	46 lbs	
163135	PROE101RUPPOU240 V	10	23"	15-3/4"	-	46 lbs	
161894	PROE151RUPOU	15	24-1/4"	17-3/4"	-	54 lbs	
161897	PROE201RUPOU	20	25-1/4"	19-3/4"	-	69 lbs	
173870	PROE301RU95POU	30	30"	21-3/4"	0.93	91 lbs	
166157	PROE302RU93POU	30	30"	21-3/4"	0.93	91 lbs	

\* Double element - 240V



## Residential Electric Water Heaters

### Hybrid Electric Water Heaters

**10-Year Limited Tank and Parts Warranty**

#### Professional Ultra Series Hybrid Electric Water Heater

- High 3.5 EF reduces operating cost
- Delivers hot water faster than most standard electric water heaters
  - 70 gallons first-hour delivery for 50-gallon model
  - 78 gallons FHD for 65-gallon model
  - 90 gallons FHD for 80-gallon model
- Ambient operating range: 37-145° F is widest in class, offering more days of HP operation annually; designed to meet Northern Climate Spec (Tier 3)
- Easy access side connections, quick access to electrical junction box
- LCD Screen with built-in water sensor alert with audible alarm
- EcoNet™ WiFi-connected† technology and free mobile app
- Operation Modes: Energy Saver, Heat Pump, High Demand, Electric Vacation: 2-28 days (or placed on hold indefinitely)
- 3/4" NPT water inlet and outlet; 3/4" condensate drain connections
- Temperature and pressure relief valve installed
- Low lead compliant



Part #	Mfg #	Gal Cap	Tank Height	Diameter	First Hour Rating	Energy Factor	Approx Ship Weight	Price
228671	PROUH50T2RU350	50	61"	22-1/4"	70	3.50 EF	218 lbs	
228427	PROUH65-T2-RU350	65	64"	24-1/4"	78	3.50 EF	262 lbs	
228672	PROUH80-T2-RU350	80	74"	24-1/4"	90	3.50 EF	281 lbs	

## Residential Electric Water Heaters

### EMT Electric Mini-Tanks

- Glass-lined tank for longer life
- Mounts on wall or floor
- T&P Relief valve included
- 2-Year warranty on parts
- 5-Year warranty on tank



#### EMT2.5 / EMT4 Electric Point-of-Use Mini-Tank

- Plugs into standard 110V outlet, 1.2kW, 10A
- 1/2" NPT Connections

Part #	Mfg #	Recovery Time (60° to 150°)	Dimensions	Use With:	Price
141431	EMT2.5	25 Minutes	17-5/16" x 11-7/16" x 11-7/16"	1 Sink	
141434	EMT4	45 Minutes	18-1/2" x 11-7/16" x 11-7/16"	2 Sinks	

#### EMT6 Hardwired Electric Point-Of-Use Mini-Tank

- 110V/120V, 1.5kW, 16.7A
- Note: 1,500W, 120V requires two 20A breakers
- 3/4" NPT Connections
- 1" Non-CFC foam insulation
- Factory dielectric
- Screw type immersion element
- Fully automatic controls, fast acting surface-mount thermostat
- Protective magnesium anode rod



Part #	Mfg #	Recovery Time (60° to 150°)	Dimensions	Price
141435	EMT6	55 Minutes	16-1/2" x 14"Dia	





## Residential Gas Water Heaters

### PowerVent™ Gas Water Heaters

#### PowerVent™ Induced Draft Residential Gas Water Heater with Guardian System™

##### 6-Year Limited Tank and Parts Warranty

- Guardian System™ - air/fuel shut-off system offers double protection
- Maintenance free - no filter to clean
- Silicon nitride igniter (HSI)
- Flammable vapor detection sensor
- PVC, ABS or CPVC Venting up to 100' with vertical or horizontal termination
- Integrated self-diagnostic system
- Low NOx design for low nitrous oxide emissions
- High altitude compliant
- EverKleen™ patented self-cleaning system on 40 - 60 gal models
- Patented magnesium anode rod design
- Standard 110V electrical connection
- Exceeds National Appliance Energy Conservation Act (NAECA) and ASHRAE requirements
- Energy Star® Phase II on 40 and 50 gal models
- Brass drain valve



**T&P Valve Included**

#### Tall

Part #	Mfg #	Type Gas	Gal Cap	Gas Input BTUH	Height to Top of Assembly	Jacket Diameter	Vent Size	Energy Factor	Approx Ship Weight	Price
161252	PROG4040NRU67PV	NG	40	40,000	67-3/8"	19-3/4"	-	0.67	140 lbs	
161254	PROG4036PRU67PV	LP	40	36,000	67-3/8"	19-3/4"	-	0.67	140 lbs	
161253	PROG5042NRU67PV	NG	50	42,000	66-3/8"	21-3/4"	-	0.67	170 lbs	
161260	PROG5042PRU67PV	LP	50	42,000	66-3/8"	21-3/4"	-	0.67	170 lbs	

#### Short

Part #	Mfg #	Type Gas	Gal Cap	Gas Input BTUH	Height to Top of Assembly	Jacket Diameter	Vent Size	Energy Factor	Approx Ship Weight	Price
161256	PROG40S36NRU67PV	NG	40	36,000	62-1/2"	21-3/4"	-	0.67	155 lbs	
161258	PROG40S32PRU67PV	LP	40	32,000	62-1/2"	21-3/4"	-	0.67	155 lbs	
161261	PROG50S36NRU67PV	NG	50	36,000	62-1/2"	23-3/4"	-	0.67	175 lbs	
161262	PROG50S32PRU67PV	LP	50	32,000	62-1/2"	23-3/4"	-	0.67	175 lbs	

#### Heavy-Duty Tall

Part #	Mfg #	Type Gas	Gal Cap	Gas Input BTUH	Height to Top of Assembly	Jacket Diameter	Vent Size	Energy Factor	Approx Ship Weight	Price
173848	PRO+G7576NRUPV	NG	75	75,000	72"	26-1/4"	-	0.57	330 lbs	
173849	PRO+G7576PRUPV	LP	75	69,000	72"	26-1/4"	-	0.57	330 lbs	



## Residential Gas Water Heaters

### Pacemaker® Gas Water Heaters

#### Pacemaker® Gas Water Heater with Guardian System™

#### 6-Year Limited Tank and Parts Warranty with Professional Installation

- Guardian System™ - air/fuel shut-off system offers double protection and no filter maintenance free
- Low NOx design for low nitrous oxide emissions
- EverKleen™ patented self-cleaning system
- Easy to light - no matches required
- High altitude compliant
- Energy efficient
- Patented magnesium anode rod design
- All models certified for applications up to 6,000 feet above sea level
- Brass drain valve
- Meets or exceeds National Appliance Energy Conservation Act (NAECA) requirements

T&P Valve included



#### Tall

Part #	Mfg #	Type Gas	Gal Cap	Gas Input BTUH	Height to Top of Assembly	Jacket Diameter	Vent Size	Energy Factor	Approx Ship Weight	Price
173853	PROG2930PRU63	LP	29	30,000	59-3/4"	16-1/2"	3" or 4"	0.63	110 lbs	
173852	PROG2932NRU63	NG	29	32,000	59-3/4"	16-1/2"	3" or 4"	0.63	110 lbs	
173855	PROG4038NRU62	NG	40	38,000	61-3/4"	18-1/8"	3" or 4"	0.59	120 lbs	
176566	PROG4036PRU62	LP	40	34,000	61-1/2"	19-3/4"	3" or 4"	0.60	125 lbs	
180245	PROG4036NRU62	NG	40	36,000	61-1/2"	19"	3" or 4"	0.62	127 lbs	
185222	PROG5036PRU60	LP	50	36,000	61-1/4"	20-1/2"	3" or 4"	0.60	150 lbs	
173857	PROG5038NRU60	NG	50	38,000	61-1/2"	20-1/8"	3" or 4"	0.58	130 lbs	
173842	PROG5036PRU62	LP	50	36,000	61-1/2"	21-3/4"	3"	0.58	150 lbs	

#### Short

Part #	Mfg #	Type Gas	Gal Cap	Gas Input BTUH	Height to Top of Assembly	Jacket Diameter	Vent Size	Energy Factor	Approx Ship Weight	Price
173854	PROG30S30NRU63	NG	30	30,000	49-3/4"	19-3/4"	3"	0.61	98 lbs	
174562	PROG40S38NRU62	NG	40	40,000	53-7/8"	20-1/8"	3" or 4"	0.59	130 lbs	
161296	PROG40S36PRU62	LP	40	36,000	53-7/8"	20-1/8"	3" or 4"	0.59	130 lbs	
173844	PROG50S36PRU61	LP	50	40,000	54-1/4"	23-3/4"	3" or 4"	0.61	186 lbs	
173843	PROG50S40NRU61	NG	50	40,000	54-1/4"	22-1/4"	3"	0.59	158 lbs	



## Residential Gas Water Heaters

### Pacemaker® Heavy-Duty Gas Water Heater with Guardian System™

**6-Year Limited Tank and Parts Warranty with Professional Installation**

- Guardian System™ - air/fuel shut-off system offers double protection and no filter maintenance free
- Low NOx design for low nitrous oxide emissions
- EverKleen™ patented self-cleaning system
- Easy to light - no matches required
- Energy efficient
- Patented magnesium anode rod design
- All models certified for applications up to 7,700 feet above sea level
- Brass drain valve
- Meets or exceeds National Appliance Energy Conservation Act (NAECA) requirements

**T&P Valve included**



Tall

Part #	Mfg #	Type Gas	Gal Cap	Gas Input BTUH	Height to Top of Assembly	Jacket Diameter	Vent Size	Energy Factor	Approx Ship Weight	Price
173845	PRO+G7576NRU	NG	75	75,100	64"	26-1/4"	4"	-	320 lbs	
182860	PRO+G7576PRU	LP	75	65,000	64"	26-1/4"	4"	0.53	320 lbs	

### Professional™ Gas Water Heaters

#### Professional™ Achiever Plus™ Gas Water Heater with Guardian System™

**8-Year Limited Tank and Parts Warranty with Professional Installation**

- Guardian System™ - air/fuel shut-off system offers double protection and no filter maintenance free
- Low NOx design for low nitrous oxide emissions
- EverKleen™ patented self-cleaning system
- Easy to light - no matches required
- High altitude compliant
- Energy efficient
- Patented magnesium anode rod design
- Brass drain valve and temperature and pressure relief valve included
- Meets or exceeds National Appliance Energy Conservation Act (NAECA) requirements

**T&P Valve Included**



Tall

Part #	Mfg #	Type Gas	Gal Cap	Gas Input BTUH	Height to Top of Assembly	Jacket Diameter	Vent Size	Energy Factor	Approx Ship Weight	Price
166949	PRO+G4040NRU62	NG	40	40,000	63-1/4"	21"	3"	0.62	135 lbs	
166950	PRO+G4036PRU62	LP	40	34,000	63-1/4"	21"	3"	0.62	135 lbs	

**www.plumbsupply.com • Serving our Customers Since 1946 • www.waterconcepts.net**



## Residential Gas Water Heaters

### Professional™ Gas Water Heaters (Continued)

#### Professional™ Achiever Plus™ Gas Water Heater with Guardian System™

##### Tall

Part #	Mfg #	Type Gas	Gal Cap	Gas Input BTUH	Height to Top of Assembly	Jacket Diameter	Vent Size	Energy Factor	Approx Ship Weight	Price
177076	PRO+G4860NRU60	NG	48	60,000	61-3/4"	21-3/4"	4"	0.60	150 lbs	
166951	PRO+G5036PRU62	LP	50	36,000	62-1/4"	23"	3"	0.62	165 lbs	
166965	PRO+G5040NRU62	NG	50	40,000	62-1/4"	23"	3"	0.62	165 lbs	
176121	PRO+G5550NRU59	NG	55	50,000	59-1/8"	23-3/4"	3" or 4"	0.59	175 lbs	

##### Short

Part #	Mfg #	Type Gas	Gal Cap	Gas Input BTUH	Height to Top of Assembly	Jacket Diameter	Vent Size	Energy Factor	Approx Ship Weight	Price
171816	PRO+G40S40NRU62	NG	40	40,000	53-7/8"	23"	3"	0.62	135 lbs	

#### Professional Achiever™ Atmospheric Water Heater with Gaurdian System

- Professional Classic Plus™ Atmospheric gas water heaters are engineered for more hot water at a low operating cost
- .59 - .62 EF
- More hot water at a low operating cost
- FHR: 54 - 90 gallons
- Recovery: 30.3 to 40.4 GPH at a 90° F rise, depending on model
- Guardian System™ & Sensor
- Exclusive air/fuel shut-off device
- Maintenance free – no filter to clean
- Protective control system that disables the heater in the presence of flammable vapor accumulation
- Eco-friendly burner, low NOx design
- Easy to light – no matches required EverKleen™ patented system fights sediment build-up
- Enhanced flow brass drain valve
- Temperature and pressure relief valve included
- Low lead compliant



##### Tall

Part #	Mfg #	Type Gas	Gal Cap	Gas Input BTUH	Height to Top of Assembly	Jacket Diameter	Vent Size	Energy Factor	Approx Ship Weight	Price
216796	PROG40-32P RU62	LP	50	32,000	61-1/2"	18-1/2"	3" or 4"	.62	125 lbs	



## Residential Gas Water Heaters

### Professional™ Ultra Series: High Efficiency Condensing Power Direct Vent

- .82 EF
- Low NOx design
- Use 2 or 3 inch diameter PVC, ABS, or CPVC vent pipe options
- FVIR compliant protective
- Power direct vents are an ideal choice when either indoor air quality or negative air pressure are concerns
- Two-pipe system: one pipe pulls in outside air for combustion and the other exhausts combustion gases
- 120 VAC, 60Hz, induced draft blower
- New whisper quiet blower



Short

Part #	Mfg #	Type Gas	Gal Cap	Gas Input BTUH	Height to Top of Assembly	Jacket Diameter	Vent Size	Energy Factor	Approx Ship Weight	Price
157608	PHE40S	NG	38	40,000	60-3/8"	22-1/8"	2" or 3"	0.82	220 lbs	
157610	PHE40SP	LP	38	36,000	60-3/8"	22-1/8"	2" or 3"	.82	220 lbs	

Tall

Part #	Mfg #	Type Gas	Gal Cap	Gas Input BTUH	Height to Top of Assembly	Jacket Diameter	Vent Size	Energy Factor	Approx Ship Weight	Price
157611	PHE50	NG	48	40,000	68-3/4"	22-1/8"	2" or 3"	0.82	250 lbs	
157612	PHE50P	LP	48	36,000	68-3/4"	22-1/8"	2" or 3"	.82	250 lbs	

### Professional™ Achiever™ Power Direct Vent Gas Water Heater

- Electronic gas control for improved monitoring and service
- Eco-friendly burner, low NOx design
- Two pipe system: one pipe pulls in outside air for combustion and the other exhausts combustion gases
- 120 VAC powered blower
- New whisper quiet blower
- 6-Year limited tank and parts warranty\*
- Temperature and pressure relief valve included



Tall

Part #	Mfg #	Type Gas	Gal Cap	Gas Input BTUH	Height to Top of Assembly	Jacket Diameter	Vent Size	Energy Factor	Approx Ship Weight	Price
161232	PROG4040NRU67PDV	NG	40	40,000	68-1/2"	19-3/4"	3" or 4"	.67	180 lbs	



## Residential Gas Water Heaters

### Professional™ Powered Damper Water Heater with Guardian System™

#### 8-Year Limited Tank and Parts Warranty with Professional Installation

- Guardian System™ - air/fuel shut-off system offers double protection and no filter maintenance free
- Low NOx design for low nitrous oxide emissions
- Maintenance free - no filter to clean
- Easy to light - no matches required
- High altitude compliant
- Meets or exceeds Energy Star® Phase II certification
- Patented magnesium anode rod design
- Brass drain valve
- Meets or exceeds National Appliance Energy Conservation Act (NAECA) requirements

T&P Valve Included



#### Tall

Part #	Mfg #	Type Gas	Gal Cap	Gas Input BTUH	Height to Top of Assembly	Jacket Diameter	Vent Size	Energy Factor	Approx Ship Weight	Price
161301	PRO+G3836PRU69PD	LP	38	36,000	62-3/4"	19-3/4"	3" or 4"	0.69	140 lbs	
161300	PRO+G3840NRU69PD	NG	38	40,000	62-3/4"	19-3/4"	3" or 4"	0.69	140 lbs	
161302	PRO+G5040NRU67PD	NG	50	40,000	63"	21-3/4"	3" or 4"	0.67	160 lbs	

#### Short

Part #	Mfg #	Type Gas	Gal Cap	Gas Input BTUH	Height to Top of Assembly	Jacket Diameter	Vent Size	Energy Factor	Approx Ship Weight	Price
172525	PRO+G40S40NRU67PD	NG	40	40,000	55-1/2"	21-3/4"	3" or 4"	0.67	140 lbs	
180335	PRO+G50S40NRU67P	NG	50	40,000	55-1/2"	23-3/4"	3" or 4"	0.67	160 lbs	





## Residential Gas Water Heaters

### Warrior Gas Series Water Heaters

#### Warrior Gas Water Heater for Manufactured Housing with Guardian System™ - Tall

##### 5-Year Limited Tank Warranty and 1-Year Limited Parts Warranty

- Guardian System™ - air/fuel shut-off system offers double protection
- Maintenance free - no filter to clean
- Low NOx design for low nitrous oxide emissions
- Side inlet temperature and pressure relief valve opening
- Two-hole top for anode rod and hot water outlet
- Ruudglas® tank lining resists corrosion and prolongs tank life
- Patented R-Foam® insulation process for superior heat retention
- Piezo Igniter - easy light pilot
- Cold water inlet - side connection allows for quick, economical hook-up

**T&P Valve Installed**



Part #	Mfg #	Type Gas	Gal Cap	Gas Input BTUH	Height to Top of Assembly	Jacket Diameter	Vent Size	Energy Factor	Approx Ship Weight	Price
173878	PROG3032NRH63MH	NG	30	32,000	56-3/8"	16-1/8"	3"	0.61	100 lbs	
173877	PROG4034NRH62MH	NG	40	34,000	61-3/4"	18-1/8"	3"	0.59	120 lbs	

#### Warrior DV Direct Vent Gas Water Heater for Manufactured Housing - Tall

##### 5-Year Limited Tank Warranty and 1-Year Limited Parts Warranty

- No external vented door is required
- All combustion air comes from outside the home
- Hot water outlet located at top
- Field convertible controls for natural gas or LP operation
- Ruudglas® tank lining resists corrosion and prolongs tank life
- Piezo Igniter - easy light pilot
- Cold water inlet - side connection allows for quick, economical hook-up
- Meets or exceeds National Appliance Energy Conservation Act (NAECA) requirements

**T&P Valve Installed**



Part #	Mfg #	Type Gas	Gal Cap	Gas Input BTUH	Height to Top of Assembly	Jacket Diameter	Vent Size	Energy Factor	Approx Ship Weight	Price
173875	PROG3030NRH63MH	NG	30	30,000	57"	17-3/4"	3"	0.61	110 lbs	
173876	PROG4030NRH62MH	NG	40	30,000	57-1/2"	19-3/4"	3"	0.59	125 lbs	



## Residential Gas Water Heaters

### XR90 Compact Gas Water Heater 6-Year Limited Tank and Parts Warranty

- Compact, high BTUH and draft induced
- 29 Gallon water heater outperforms standard 50 gallon models
- Energy efficient/low emissions
- Dual certified for both potable water and space heating



Part #	Mfg #	Type Gas	Gal Cap	Gas Input BTUH	Height to Top of Assembly	Jacket Dia	Vent Size	Energy Factor	Approx Ship Weight	Price
161297	PRO+G2960NRU70ID	NG	29	60,000	65-1/2"	17-3/4"	3" or 4"	0.70	136 lbs	



## Tankless Water Heaters

### Tankless Gas Water Heaters

#### 84 Series Prestige™ Direct Vent Condensing Tankless Gas Water Heater

**12-Year Limited Warranty on Heat Exchanger; 5-Year Limited Warranty on Parts; 1-Year on Labor**

- 94% Energy efficient
- 2-Pipe direct vent system designed for PVC pipe
- Compact, continuous hot water
- Digital remote control and 10' of thermostat wire included
- EZ-Link™ cable connects two tankless units to operate as one
- Guardian OFW™ overheat film wrap
- Third-party efficiency listed by AHRI
- Intelligent electronic controls designed to increase energy efficiency and safety
- Self diagnostic program
- Digital display shows temperature setting and maintenance codes
- Built-in electric blower
- Indoor models supplied with a 120V power cord
- Temperature range: 85° to 185°F
- 3/4" Water and gas connections
- Indoor and outdoor models feature freeze protection to -30°F
- Exceeds Energy Star® requirements



#### Indoor

Part #	Mfg #	Type Gas	Gas Input BTUH	Dimensions H x W x D	Vent Diameter	Energy Factor	Approx Ship Weight	Price
139857	RUTGH-84DVN	NG	11,000 - 157,000	27-1/2" x 18-1/2" x 9-3/4"	3" PVC	.94	82 lbs	
139858	RUTGH-84DVP	LP	11,000 - 157,000	27-1/2" x 18-1/2" x 9-3/4"	3" PVC	.94	82 lbs	



## Tankless Water Heaters

### 95 Series Direct Vent Condensing Tankless Gas Water Heater

**12-Year Limited Warranty on Heat Exchanger; 5-Year Limited Warranty on Parts; 1-Year on Labor**

- 2-Pipe direct vent system designed for PVC pipe
- Compact, continuous hot water
- UMC-117 Remote control and 10' of thermostat wire included
- EZ-Link™ cable connects two tankless units to operate as one
- Guardian OFW™ overheat film wrap
- Third-party certified by GAMA
- Qualifies for federal energy tax credit
- Intelligent electronic controls designed to increase energy efficiency and safety
- Self diagnostic program
- Digital display shows temperature setting and maintenance codes
- Built-in electric blower
- Indoor models supplied with a 120V power cord
- Temperature range: 85° to 140°F
- 3/4" Water and gas connections
- Indoor and outdoor models feature freeze protection to -30°F



#### Indoor

Part #	Mfg #	Type Gas	Gas Input BTUH	Dimensions H x W x D	Vent Diameter	Energy Factor	Approx Ship Weight	Price
137358	RUTGH-95DVN	NG	11,000 - 199,900	27-1/2" x 18-1/2" x 9-3/4"	3" PVC	.94	82 lbs	
137703	RUTGH-95DVP	LP	11,000 - 199,900	27-1/2" x 18-1/2" x 9-3/4"	3" PVC	.94	82 lbs	



## Tankless Water Heaters

### Ruud Indoor Direct Vent Tankless Gas Water Heater 10-Year Residential Limited Warranty on Heat Exchanger 3-Year Residential Limited Warranty on Parts

- Includes UMC-117 remote control
- EZ-Link™ cable connects two tankless units
- Guardian SBT™ sensing burner technology
- Guardian OFW™ overhead film wrap
- Optional high-altitude options with altitude chip sold separately
- Certified by GAMA
- Qualifies for up to a \$300 federal energy tax credit
- Can be linked in up to 20 unit manifold installations using optional
- MIC-180 and MICS-180 Manifold control assemblies
- Energy saving design
- Intelligent electronic controls
- Self-diagnostic program
- Digital display shows temperature setting and maintenance codes
- Built-in electric blower
- Uses Category III stainless steel vents, vents vertically or horizontally
- 120V Power cord
- Environmentally friendly Low NOx burner



#### Tankless Water Heaters for Two - Three Bathroom Homes

Part #	Mfg #	Type Gas	Gas Input BTUH	Dimensions H x W x D	Vent Diameter	Energy Factor	Approx Ship Weight	Price
131496	RUTG-84DVN	Indoor NG	11,000 - 180,000	25-5/8" x 13-7/8" x 9-7/8"	3" by 5"	.82	54 lbs	

#### Parts & Accessories

Part #	Mfg #	Gal Cap	Tank Height	Width	Depth	Energy Factor	Approx Ship Weight	Price
240646	RTEX-AB	Water Heater Booster						

## Tankless Water Heaters

### Gas Tankless Water Heaters

#### Premium Condensing Tankless Gas Water Heater (NPE-A)

- 1/2" Gas pipe capable up to 24"
- Field convertible gas system
- Ultra condensing efficiency
- Dual stainless steel heat exchangers
- Low NOx emissions
- SCH 40, 2" venting up to 60'
- Cascading capable

**ComfortFlow** Technology



Part #	Mfg #	Gas	Gas Supply Pressure Min - Max	Heat Capacity Input (BTUH) Min - Max	CAFUE	Dimensions H x W x D	Ship Wt	Price
152650	NPE-180A	NG/LP	3.5"-10.5"wc	15,000-150,000	-	27.4" x 17.3" x 13.2"	75 lbs	
152651	NPE-210A	NG/LP	3.5"-10.5"wc	19,900-180,000	-	27.4" x 17.3" x 13.2"	82 lbs	
152652	NPE-240A	NG/NP	3.5"-10.5"wc	19,900-199,900	-	27.4" x 17.3" x 13.2"	82 lbs	

#### Premium Condensing Tankless Gas Water Heater (NPE-S)

- 1/2" Gas pipe capable up to 24'
- Field convertible gas system
- Ultra condensing efficiency .99EF
- Dual stainless steel heat exchangers
- Low NOx emissions (= 20ppm)
- SCH 40, 2" venting up to 60'
- Cascading capable



Part #	Mfg #	Gas	Gas Supply Pressure Min - Max	Heat Capacity Input (BTUH) Min - Max	CAFUE	Dimensions H x W x D	Ship Wt	Price
181351	NPE-150S	NG/LP	3.5"-10.5"wc	18,000-120,000	-	27.4" x 17.3" x 13.2"	55 lbs	
242912	NPE-180S	NG/LP	3.5"-10.5"wc	19,900-180,000	-	27.4" x 17.3" x 13.2"	67 lbs	
220113	NPE-210S	NG/LP	3.5"-10.5"wc	19,900 -180,000	-	27.4" x 17.3" x 13.2"	75 lbs	
176901	NPE-240S	NG/LP	3.5"-10.5"wc	19,900-199,900	-	27.4" x 17.3" x 13.2"	75 lbs	



## Tankless Water Heaters

### Cleaners & Degreasers

#### Flow-Aide™ Biodegradable Descaler

- Nontoxic concentrate cleaner is certified to NSF/ANSI 60 for use in potable water systems
- NSF registered for use in beverage, pharmaceutical, bottling, poultry, and other food processing plants
- Concentrated formula, up to 5:1 dilution
- 20x more effective, fully diluted than vinegar



Part #	Mfg #	Size	Price
254059	FLOW32	1 qt	
254060	FLOW1	1 Gal	

- Flow-Kit Contents**
- (1) 3.5 Gallon Bucket
  - (1) 725 GPH PUmp
  - (2) 5 Foot Rubber Hoses
  - (1) Quart Flow-Aide™



Part #	Mfg #	Size	Price
254056	FLOWKIT	1 qt with Accessories	

**Water Heater Accessories**

**Direct Connect™ Thermostatic Mixing Valves**

**AMX300 DirectConnect™ Thermostatic Mixing Valve Kit**

- Patented DirectConnect design
- Kit includes:
  - Mixing valve
  - Cold water tee
  - Flexible 8" or 11" metal connectors
  - Thermostrip
- Easy installation on water heaters
- Added safety designed to prevent scalding
- ASSE 1017 approved for point of source/whole house protection
- Teflon® coating extends service life
- Integrated recirculation and hot water ports



Part #	Mfg #	Tank Connection	System Connection	Flow GPM Min - Max	Notes	Price
188973	AMX300TLF/U	3/4" FNPT	3/4" MNPT	0.25 - 19	8" Flex Connector	
131427	AMX300	3/4" FNPT	3/4" MNPT	0.25 - 19	Valve for Repl Only	

**AMX Series DirectConnect™ Thermostatic Mixing Valve**

- Patented DirectConnect design
- Orientation of cold and hot ports typically eliminate need for elbows and tees
- Added safety designed to prevent scalding
- Constant water temperature
- Proportional valve
- Designed to be directly installed on water heater hot outlet port
- Integral check valve on cold port
- Brass/stainless construction
- Teflon® coated wear surfaces



Part #	Mfg #	Pipe Size	Connection	Operating Temperature	Price
094298	AMX101-US-1	3/4"	Union Sweat	90° - 130°F	
094299	AMX102-US-1	1"	Union Sweat	90° - 130°F	

## Water Heater Accessories

### Water Heater Connectors

#### PowerPEX® ASTM F1807 PEX x FIP—Swivel Straight

- Full flow, dielectric fitting – no restriction
- Brass FIP swivel nut includes gasket
- Fitting with 600 WOG full port ball valve available
- ¾" FIP branch for 2 gallon expansion tank



#### Standard

Part #	Mfg #	PEX x FIP Swivel	Length	Material	Ball Valve	Lead Free Solder Joint	Price
119820	633X18	3/4" x 3/4"	18"	Type L Copper Tube	No	Yes	

#### Valved

Part #	Mfg #	PEX x FIP Swivel	Length	Material	Ball Valve	Lead Free Solder Joint	Price
119821	633XG18FP	3/4" x 3/4"	18"	Type L Copper Tube	Yes	Yes	
149089	634XG418FP	3/4" x 1"	18"	Type L Copper Tube	Yes	No	

#### Sweat Water Heater Connector—FIP x FIP Swivel Flex Fitting or FIP x FSwt Flex Fitting

- Flexible copper fitting provides easy connection
- Brass FIP swivel nut includes gasket



Part #	Mfg#	Connection	Length	Price
183729	634-115	3/4" FIP Swivel x 3/4" FIP Swivel	15"	
246967	634-124	3/4" FIP x 3/4" FIP Swivel	24"	
183730	634-318	3/4" FIP Swivel x 3/4" FSWT	18"	

#### PowerPEX® ASTM F1960 Lead-Free—FIP Swivel Flex

- Brass FIP swivel nut includes gasket
- Fitting with 600 WOG full port ball valve available
- Flexible dielectric fitting works well in tight spaces
- Lead-free solder joint
- (-FP) Valved



Part #	Mfg#	Connection	Length	Price
183731	634WG418	3/4" F1960 x 3/4" FIP Swivel	18", Standard	
245565	634WG418FP	3/4" F1960 x 3/4" FIP Swivel	18", Ball Valve	

#### Bands for Expansion Tank Support Kitchen Installations

- Fast, easy, and affordable
- 16 Gauge galvanized bracket, made in the USA
- All stainless steel band, housing and screw



Part #	Mfg#	Band	Diameter	Tank	Price
162391	598-0210	3.25"	10"	2-Gallons	
162392	598-0213	45"	13"	5-Gallons	



## Water Heater Accessories

### No Lead Water Heater Stub-Out Loop

- *Preformed copper loop bypasses water heater before test*



Part #	Mfg #	Description	Material	Price
183732	636-L3888	3/4" Male Sweat	Type L Copper Tube	

**Water Fountains & Coolers**

**EZH2O™ System**

**Hands-Free® EZH2O Enhanced Cooler/Bottle Filling Station**

- Space saving design
- No-touch, sensor activation with automatic 20-second shut-off timer (bottle filler)
- Easy-touch front and side pushbar controls (cooler)
- WaterSentry® Plus™ 3000 gallon filtration system
- Flexi-guard® bubbler
- Silver-Ion anti-microbial protection
- Laminar flow provides minimal splash
- Real drain system eliminates standing water
- Visual interface display on bottle filler
  - Innovative Green Ticker™ counts bottles saved from waste
  - LED visual filter monitor shows when replacement is necessary
- Quick fill rate: 1.1 gpm (refrigerated models);
  - 1.5 gpm (non-refrigerated models)



Part #	Mfg #	Flow Rate	Rated	Full Load	Ship Wt	Description	Price
177746	LZS8WSLP	8.0 gph	115V	6A	87 lbs	Light Gray Granite, Filtered	
183062	LZS8WSSP	8.0 gph	115V		85 lbs	Stainless Steel, Filtered	

**Bi-Level**



Part #	Mfg #	Flow Rate	Rated	Full Load	Ship Wt	Description	Price
235613	LZSTL8WSVRSK	8.0 gph	115V		106 lbs	Stainless Steel, Filtered	

**Water Fountains & Coolers**

**Hands-Free® Cooler/Bottle Filling Station with EZ Cooler**

- Space saving design
- No-touch, sensor activation with automatic 20-second shut-off timer (bottle filler)
- Easy-touch front and side pushbar controls (cooler)
- Optional WaterSentry® Plus™ 3000 gallon filter
- Flexi-guard® bubbler, optional vandal-resistant bubbler available (VR)
- Silver-Ion anti-microbial protection
- Easy-to-install universal design
- Laminar flow provides minimal splash
- Real drain system eliminates standing water
- Visual interface display includes:
  - Innovative Green Ticker™
  - Filter monitor indicating when replacement is necessary for (-LZ) models only
- Quick fill rate: 1.1 gpm
  - 1.5 gpm non-refrigerated models



Part #	Mfg #	Flow Rate	Rated	Full Load	Ship Wt	Description	Price
146628	EZS8WSLK	8.0 gph	115V	5A	68 lbs	Light Gray Granite, Non-Filtered	
203979	EZS8WSSK	8.0 gph	115V	6A	82 lbs	Stainless Steel, Non-Filtered	
153726	EZS8WSVRLK	8.0 gph	115V	5A	68 lbs	Light Gray Granite, Non-Filtered	
170533	LZSDWSLK	Non-Refrigerated	115V	1A	45 lbs	Light Gray Granite, Filtered	
241981	LZSDWSSK	Non-Refrigerated	115V	1A	45 lbs	Stainless Steel, Filtered	
138622	LZS8WSSK	8.0 gph	115V	5A	71 lbs	Stainless Steel, Filtered	
213690	LZS8WSVRLK	8.0 gph	115V	6A	85 lbs	Light Gray Granite, Filtered	

**Hands-Free® EZH2O® Bottle Filling Station with GreenSpec® EZ Cooler**

- High efficiency refrigeration system over average market performance
- No-touch, sensor activation with automatic 20-second shut-off timer (bottle filler)
- Flexi-guard® StreamSaver™ water efficient bubbler
- Optional WaterSentry® Plus™ 3000 gallon filter
- Easy-touch front and side pushbar controls (cooler)
- Silver-ion anti-microbial protection
- Easy-to-install universal design
- Laminar flow provides minimal splash
- Real drain system eliminates standing water
- Visual interface display includes:
  - Innovative Green Ticker™
  - Filter monitor indicating when replacement is necessary
- Quick fill rate: 1.1 gpm
  - 1.5 gpm non-refrigerated models
- Rated for indoor service
- (-EZ) models do not come with a status monitor



Part #	Mfg #	Flow Rate	Rated	Full Load	Ship Wt	Description	Price
249501	EZSG8WSLK	8.0 gph	115V	4.2A	71 lbs	Light Gray Granite, Non-Filtered	
238656	EZSG8WSSK	8.0 gph	115V	4.2A	71 lbs	Stainless Steel, Non-Filtered	
165132	LZSG8WSLK	8.0 gph	115V	4.2A	71 lbs	Light Gray Granite, Filtered	



**Water Fountains & Coolers**

**Enhanced Cooler/Bottle Filling Station with Bi-Level Versatile Cooler**

- Space saving design
- No-touch, sensor activation with automatic 20-second shut-off timer (bottle filler)
- Easy-touch front and side pushbar controls (cooler)
- WaterSentry® Plus 3000 gallon filtration system, certified to NSF/ANSI 42 & 53 —(Lead, class 1 particulate, chlorine, taste & odor)
- Flexi-guard® bubbler
- Silver-Ion anti-microbial protection
- Laminar flow provides minimal splash
- Real drain system eliminates standing water
- Visual interface display on bottle filler —Innovative Green Ticker™ —LED visual filter monitor shows when replacement is necessary —Automatic filter status with each filter change
- Quick fill rate: 1.1 gpm (refrigerated models); —1.5 gpm (non-refrigerated models)



Part #	Mfg #	Flow Rate	Rated	Full Load	Ship Wt	Description	Price
183386	LZSTL8WSLP	8.0 gph	115V	4.2A	98 lbs	Light Gray Granite, Filtered	
177160	LZSTL8WSSP	8.0 gph	115V	4.2A	98 lbs	Stainless Steel, Filtered	

**Swirflo® EZH2O® Bottle Filler Fountain with Integral Cooler**

- Touchless, sensor-activation (bottle filler); easy-to-operate push button activation (fountain)
- Automatic 20-second shut-off timer
- Flexi-Guard® Safety bubblers
- Visual user interface includes: — Innovative Green Ticker™ — Filter monitor indicating when replacement is necessary
- Swirflo™ GRN features the Strea Saver bubbler and high-efficiency water chiller —Chiller operates over 55% more energy than market average performance
- Laminar flow provides minimal splash
- Real drain eliminates standing water
- Rated for indoor service
- Mounting frame included
- Quick fill rate: 1.1 gpm (refrigerated models); —1.5 gpm (non-refrigerated models)



Part #	Mfg #	Flow Rate	Rated	Full Load	Ship Wt	Description	Price
174530	EZWSERPBM28K	8.0 gph	115V	5A	170 lbs	Stainless Steel, Filtered	

**Water Fountains & Coolers**

**EZH2O® Bottle Filling Station with Integral SwirlFlo® Fountain**

- Touchless, sensor-activated bottle filler designed; easy-to-operate push-bar activated bubbler
- FlexiGuard Safety™ bubbler—mechanically activated
- Hands-Free®
- Visual user interface includes:
  - Innovative Green Ticker™
  - Filter monitor indicating when replacement is necessary
- Laminar flow provides clean fill with minimal splash
- Silver ion antimicrobial protection on key plastic components
- Real drain system eliminates standing water
- Rated for indoor use



Part #	Mfg #	Flow Rate	Rated	Full Load	Ship Wt	Description	Price
239846	LZWS-EDFPBM117K	Non-Refrigerated	115V	1	121 lbs	Stainless Steel, Filtered	
218653	LZWS-LRPBM28K	8.0 gph	115V	1A	173 lbs.	Stainless Steel, Filtered	

**In-Wall Recessed EZH2O Bottle Filling Station**

- Stainless steel construction
- Special panel height designed to pair with non-refrigerated (EDFPBM) Swirlflo® models
- Sanitary, touchless, sensor activation with automatic 20-second shut-off timer (bottle filler)
- WaterSentry® Plus 3000-gallon capacity Filtration System
- Silver ion anti-microbial protection
- Visual user interface display includes:
  - Innovative Green ticker™ counts the quantity of 16 ounce bottles saved
  - LED visual filter monitor shows when replacement is necessary
- Includes mounting frame and lower hinged panel for easy access and servicing—Pre order mounting (MFWS100) for model (LZWSDK only)
- Quick fill rate: 1.1 gpm (refrigerated models);
  - 1.5 gpm (non-refrigerated models)



LZWSM8



LZWSD

Part #	Mfg #	Flow Rate	Rated	Full Load	Ship Wt	Description	Price
187409	LZWSDK	Non-Refrigerated	115V	1A	33 lbs	Stainless Steel, Filtered	
132214	LZWSM8K	8.0 gph	115V	5A	80 lbs	Light Gray Granite, Filtered	

**Water Fountains & Coolers**

**In-Wall Recessed EZH2O Filtered Bottle Filling Station with Green Chiller**

- High-efficiency ECH8GRN chilling unit
- Stainless steel construction
- Sanitary, touchless, sensor activation with automatic 20-second shut-off timer (bottle filler)
- WaterSentry® Plus 3000-gallon capacity Filtration System, certified to NSF/ANSI 42 & 53 (Lead, Class 1 Particulate, Chlorine, Taste & Odor)
- Silver ion anti-microbial protection
- Visual user interface display includes:
  - Innovative Green ticker™ counts the quantity of 16 ounce bottles saved
  - LED visual filter monitor shows when replacement is necessary
- Includes mounting frame and lower hinged panel for easy access and servicing
- Quick fill rate: 1.1 gpm (refrigerated models);
  - 1.5 gpm (non-refrigerated models)



Part #	Mfg #	Flow Rate	Rated	Full Load	Ship Wt	Description	Price
178406	LZWSGRN8K	8.0 gph	115V	4.5A	80 lbs	Stainless Steel, Filtered	

**In-Wall Recessed EZH2O® Bottle Filling Station for Pairing with Swirlfo® EDFPB Fountains**

- Ideal for education, health care facilities, fitness clubs, and hospitality
- Stainless steel construction
- Sanitary, touchless, sensor activation with automatic 20-second shut-off timer (bottle filler)
- Hinged door for easy servicing
- Optional WaterSentry® Plus™ 3000 gallon Filtration System
- Silver ion anti-microbial protection
- Visual user interface display includes:
  - Innovative Green ticker™ counts the quantity of 16 ounce bottles saved
  - LED visual filter monitor shows when replacement is necessary
- Includes mounting frame and lower hinged panel for easy access and servicing
- Quick fill rate: 1.1 gpm (refrigerated models);
  - 1.5 gpm (non-refrigerated models)
- Rated for indoor service



Part #	Mfg #	Flow Rate	Rated	Full Load	Ship Wt	Description	Price
158450	EZWSM8PK	8.0 gph	115V	5A	77 lbs	Stainless Steel, Non-Filtered	

**Water Fountains & Coolers**

**In-Wall Recessed EZH2O® Bottle Filling Station with Swirlflo® Green Bi-Level Fountains**

- Ideal for hospitality, health care facilities and office complexes
- Paired with choice of SwirlFlo® Green or SoftSides® refrigerated fountain
- High-efficiency ECH8GRN chilling unit
- Stainless steel construction
- Sanitary, touchless, sensor activation with automatic 20-second shut-off timer (bottle filler)
- WaterSentry® Plus™ 3000-gallon capacity Filtration System
- Laminar flow provides minimal splash while real drain system eliminates standing water
- Silver ion anti-microbial protection
- SwirlFlo® Green features Flexi-Guard StreamSaver™ bubbler and high-efficiency water chiller — Chiller operates over 55% more energy efficient than market average performance
- Visual user interface display includes:
  - Innovative Green ticker™ counts the quantity of bottles saved from waste
  - LED visual filter monitor shows when replacement is necessary
- Includes mounting frame and lower hinged panel for easy access and servicing
- Rated for indoor service
- Quick fill rate: 1.1 gpm (refrigerated models); —1.5 gpm (non-refrigerated models)



Part #	Mfg #	Flow Rate	Rated	Full Load	Ship Wt	Description	Price
176713	LZWSSFGRN28K	8.0 gph	115V	4.5A	164 lbs	Stainless Steel, Filtered	

**EZH2O® Bottle Filling Station with Retrofit Swirlflo® Drinking Fountain**

- Touchless, sensor activation with automatic 20-second shut-off timer (bottle filler)
- Stainless steel construction
- WaterSentry® Plus™ 3000-gallon capacity Filtration System
- Bottle filler meets ADA guidelines for each range
- Fountain meets ADA guidelines for wheelchair access
- Ships with new panel, frame, and integral EZH2O® station
- Designed to retrofit existing refrigerated bi-level pushbutton activated installation models
  - SwirlFlo®
  - SoftSides®
- Reuses existing fountains and chillers, as applicable
- Laminar flow provides minimal splash while real drain system eliminates standing water
- Integrated silver ion anti-microbial protection
- Visual user interface display includes:
  - Innovative Green ticker™ counts the quantity of bottles saved from waste
  - LED visual filter monitor shows when replacement is necessary
- Quick fill rate: 1.1 gpm (refrigerated models); —1.5 gpm (non-refrigerated models)
- Rated for indoor service



Part #	Mfg #	Flow Rate	Rated	Full Load	Ship Wt	Description	Price
171489	EZWSERP8RF	8.0 gph	115V	1A	50 lbs	Stainless Steel, Non-Filtered	

## Water Fountains & Coolers

### Non—Refrigerated Retro-Fit Kit Bottle Filling Station

- Attaches to most 115V/60Hz pushbar activated water coolers
- Space saving ADA-compliant design
- Touchless, sensor activation with automatic 20-second shut-off timer
- Silver-Ion anti-microbial protection
- Laminar flow provides minimal splash
- Real drain system eliminates standing water
- Visual user interface display includes:
  - Innovative green ticker™
  - Filter monitor indicating when replacement is necessary
- Rated for indoor service
- Quick fill rate of 1.1 gpm when connected to refrigerated EZ models;  
1.5 gpm for non-refrigerated connections



Part #	Mfg #	Flow Rate	Rated	Full Load	Ship Wt	Description	Price
159404	EZWSRK	Non-Refrigerated	115V	1A	24 lbs	Stainless Steel, Non-Filtered	
132209	LZWSRK	Non-Refrigerated	115V	1A	19 lbs	Stainless Steel, Filtered	

### Mechanical Surface Mount EZH2O® Non-Refrigerated Bottle Filling

- Ideal for facilities where electric wiring is not easily accessible or locations looking to reduce electrical usage
- Complete mechanical activation and function, no electrical connection required
- Installs onto a wall with robust hanging bracket
- Integrated silver ion Anti-microbial protection
- Optional AquaSentry® 500 gallon filter
- **(LMASMB)** Optional battery powered visual interface display includes:
  - Innovative Green Ticker™
  - Filter monitor indicating when replacement is necessary
- Optional remote chiller can be installed within 15 feet of unit for chilled drinking water
- Laminar flow provides minimal splash while real drain system eliminates standing water
- Pushbutton activation
- Rated for indoor service
- Quick fill rate: 1.0 gpm



Part #	Mfg #	Flow Rate	Rated	Full Load	Ship Wt	Description	Price
176483	EMASM	Non-Refrigerated	N/A	N/A	20 lbs	Stainless Steel, Non-Filtered	
249955	LMASMB	Non-Refrigerated	N/A	N/A	25 lbs	Stainless Steel, Filtered	



**Water Fountains & Coolers**

**Retro-Fit Kit Non-Refrigerated Mechanically Activated Bottle Filling Station**

- Mechanical-activation on water coolers is ideal for disaster-prone regions  
—Operates during power disruptions
- Attaches to most 115V/60Hz EMABF pushbar activated models
- Retro-Fit design includes  
—New basin and real drain system that eliminates standing water
- Touchless, sensor activation (bottle filler) with automatic 20-second shut-off timer
- Easy to operate pushbar activation (cooler)
- Silver-Ion anti-microbial protection
- Laminar flow provides minimal splash
- Visual user interface display includes:  
—Innovative green ticker™  
—Filter monitor indicating when replacement is necessary
- Rated for indoor service
- Quick fill rate of 1.1 gpm when connected to refrigerated EZ models;  
1.5 gpm for non-refrigerated connections



Part #	Mfg #	Flow Rate	Rated	Full Load	Ship Wt	Description	Price
165729	EMABFWSRF	Non-Refrigerated	115V	15W	23 lbs	Stainless Steel, Non-Filtered	
190125	LMABFWSRF	Non-Refrigerated	115V	15W	23 lbs	Stainless Steel, Filtered	

**Hands-Free® EZH2O® Bottle Filling Station with Mechanically Activated Cooler**

- Mechanical-activation on water coolers is ideal for disaster-prone regions  
—Operates during power disruptions
- Touchless, sensor activation (bottle filler) with automatic 20-second shut-off timer
- Easy to operate pushbar activation (cooler)
- WaterSentry® Plus 3000 gallon capacity filter
- Silver-Ion anti-microbial protection
- Flexi-Guard® safety bubbler
- Laminar flow provides minimal splash while
- Real drain system eliminates standing water
- Visual user interface display includes:  
—Innovative green ticker™  
—Filter monitor indicating when replacement is necessary
- Rated for indoor service
- Quick fill rate: 1.1 gpm (refrigerated models);  
—1.5 gpm (non-refrigerated models)



Part #	Mfg #	Flow Rate	Rated	Full Load	Ship Wt	Description	Price
181650	LMABFDWSLK	Non-Refrigerated	N/A	15W	40 lbs	Light Gray Granite, Filtered	
163405	LMABF8WSLK	8.0 gph	115V	370W	75 lbs	Light Gray Granite, Filtered	
163859	LMABF8WSSK	8.0 gph	115V	370W	75 lbs	Stainless Steel, Filtered	



**Water Fountains & Coolers**

**Hands-Free® EZH2O® Bi-Level Bottle Filling Station with Mechanically Activated Cooler**

- Mechanical-activation on water coolers is ideal for disaster-prone regions  
—Operates during power disruptions
- Touchless, sensor activation (bottle filler) with automatic 20-second shut-off timer
- Easy to operate pushbar activation (cooler)
- WaterSentry® Plus 3000 gallon capacity filter
- Silver-Ion anti-microbial protection
- Flexi-Guard® safety bubbler
- Laminar flow provides minimal splash while
- Real drain system eliminates standing water
- Visual user interface display includes:  
—Innovative green ticker™  
—Filter monitor indicating when replacement is necessary
- Rated for indoor service
- Quick fill rate: 1.1 gpm (refrigerated models);  
—1.5 gpm (non-refrigerated models)



Part #	Mfg #	Flow Rate	Rated	Full Load	Ship Wt	Description	Price
240080	LMABFTL8WSSK	8.0 gph	115V	370W	104 lbs	Stainless Steel, Filtered	

**Bi-Level SoftSides® Architectural Fountains with Integral EZH2O® Hands-Free® Bottle Filling Station**

- Touchless, sensor-activation (bottle filler); easy to operate pushbutton activation (fountain)
- Optional WaterSentry® Plus™ 3000 gallon filter
- Automatic 20-second shut-off timer
- Flexi-Guard® safety bubbler
- Laminar flow provides minimal splash
- Real drain system eliminates standing water
- Integrated silver ion anti-microbial protection
- Visual use interface display includes:  
— Innovative Green Ticker™ counts bottles saved from waste  
— Filter monitor indicating when replacement is necessary
- Existing installations would require expanding wall opening
- Mounting frame included
- Rated for indoor service



Part #	Mfg #	Flow Rate	Rated	Full Load	Ship Wt	Description	Price
188246	EZWSDFP217K	Non-Refrigerated	115V	1A	118 lbs	Stainless Steel, Non-Filtered	

**Water Fountains & Coolers**

**Surface Mount EZH2O® Bottle Filling Station**

- Hands-Free®, sensor activation with automatic 20-second shut-off timer
- Ideal for education, health care facilities, fitness clubs, and hospitality
- Designed for application with limited wall depth
- Installs directly onto a wall with robust hanging bracket
- Optional WaterSentry® Plus™ 3000 gallon Filtration System
- Optional remote chiller
- Laminar flow minimizes splashing
- Real drain system eliminates standing water
- Silver ion anti-microbial protection
- Visual user interface display includes:
  - Innovative Green ticker™ counts the quantity of 16 ounce bottles saved
  - LED visual filter monitor shows when replacement is necessary
- Quick fill rate: 1.1 gpm-1.5 gpm
- Rated for indoor service



Part #	Mfg #	Flow Rate	Rated	Full Load	Ship Wt	Description	Price
161874	EZWSSM	Non-Refrigerated	115V	1A	18 lbs	Stainless Steel, Non-Filtered	
168526	LZWSSM	Non-Refrigerated	115V	1A	18 lbs	Stainless Steel, Filtered	

**Vandal-Resistant EZH2O Bottle Filler with Single Filtered Cooler**

- Ideal for heavy-use installations such as educational and indoor recreational facilities
- Embossed graphics
- Vandal-resistant push button activation on bottle filler and cooler
  - Also includes vandal-resistant bubbler
- WaterSentry® VII 1500-gallon capacity filtration system, certified to NSF/ANSI 42 & 53
  - Class 1 particulate, chlorine, taste & odor **(LVRC8WSK model ONLY)**
- Automatic 20-second shut-off on bottle filler water flow
- Laminar flow provides minimal splash while a real drain system eliminates standing water
- Visual user interface display includes:
  - Innovative Green Ticker™
  - LED filter monitor indicating when replacement is necessary **(LVRC8WSK model ONLY)**
- Rated for indoor service
- Quick fill rate: 1.1 gpm (refrigerated models);
  - 1.5 gpm (non-refrigerated models)



Part #	Mfg #	Flow Rate	Rated	Full Load	Ship Wt	Description	Price
158840	LVRC8WSK	8 gph	115V	5A	88 lbs	Stainless Steel, Filtered	
227789	VRCDWSK	Non-Refrigerated	115V	1A	58 lbs	Stainless Steel, Non-Filtered	
176553	VRC8WSK	8 gph	115V	5A	88 lbs	Stainless Steel, Non-Filtered	

**Water Fountains & Coolers**

**Vandal-Resistant EZH2O Bottle Filling Station with Bi-Level Reverse Cooler**

- Ideal for heavy-use installations such as educational and indoor recreational facilities
- Embossed graphics
- Vandal-resistant push button activation on bottle filler and cooler  
—Also includes vandal-resistant bubbler
- Optional WaterSentry® Plus™ VII 3000 gallon filter  
—(Certified to NSF 42 & 53 class 1 particulate, chlorine, taste & odor)
- Automatic 20-second shut-off on bottle filler water flow
- Visual user interface display includes:  
—Innovative Green Ticker™  
—LED filter monitor indicating when replacement is necessary
- Laminar flow provides minimal splash while a real drain system eliminates standing water
- Filter models rated for indoor service, filter less models rated for indoor/outdoor service
- Quick fill rate: 1.1 gpm (refrigerated models);  
—1.5 gpm (non-refrigerated models)



Part #	Mfg #	Flow Rate	Rated	Full Load	Ship Wt	Description	Price
166365	LVRCTL8WSK	8.0 gph	115V	5A	114 lbs	Stainless Steel, Filtered	
153756	VRCTLR8WSK	8.0 gph	115V	5A	88 lbs	Stainless Steel, Non-Filtered	
251476	VRCTLDDWSK	Non-Refrigerated	115V	5A	112 lbs	Stainless Steel, Non-Filtered	

**Versatile Bi-Level EZH2O Cooler/Bottle Filling Station**

- Fully-exposed, wall-mount
- Touchless, sensor-activation with automatic 20-second shut-off timer (Bottle filler)
- Easy-Touch front and side pushbar controls (Cooler)
- Available with Flexi-Guard® bubbler or vandal-resistant bubbler (includes "VR" code in model number)
- Versatile cooler design allows units to be installed either left-hand high and right-hand low or left-low and right high
- Real drain system eliminates standing water
- Laminar flow provides minimal splash
- Visual user interface display includes:  
—Innovative Green Ticker™  
—Filter monitor indicating when replacement is necessary
- Rated for indoor service
- Quick fill rate: 1.1 gpm (refrigerated models);  
—1.5 gpm (non-refrigerated models)



Part #	Mfg #	Flow Rate	Rated	Full Load	Ship Wt	Description	Price
152073	EZSTL8WSLK	8.0 gph	115V	6A	101 lbs	Light Gray Granite, Non-Filtered	
150299	EZSTL8WSSK	8.0 gph	115V	6A	101 lbs	Stainless Steel, Non-Filtered	
178016	EZSTL8WSVRSK	8.0 gph	115V	6A	103 lbs	Stainless Steel, Non-Filtered	
132212	LZSTL8WSLK	8.0 gph	115V	6A	104 lbs	Stainless Steel, Filtered	
160329	LZSTL8WSVRLK	8.0 gph	115V	6A	106 lbs	Light Gray Granite, Filtered	

**Water Fountains & Coolers**

**Versatile GreenSpec® Bi-Level EZH2O® Bottle Filling Cooler Combos**

- Features Flexi-Guard® StreamSaver™ water efficient bubbler
- Touchless, sensor-activation (bottle filler); easy-to-operate push bar activation (cooler)
- Automatic 20-second shut-off timer
- Visual user interface display includes
  - Innovative Green Ticker™
  - Filter monitor indicating when replacement is necessary
- Laminar flow provides minimal splash
- Integrated silver ion anti-microbial protection in key areas
- Real drain system eliminates standing water
- Versatile cooler design
- Energy efficiency performance exceeds average market performance by 35% per CSA 815-99
- Rated for indoor service
- WaterSentry® plus 3000-gallon capacity filtration System **(For L models only)**
- Quick fill rate: 1.1 gpm (refrigerated models);
  - 1.5 gpm (non-refrigerated models)



Part #	Mfg #	Flow Rate	Rated	Full Load	Ship Wt	Description	Price
214444	EZSTLG8WSLK	8.0 gph	115V	7A	101 lbs	Light Gray Granite, Non-Filtered	
168871	EZSTLG8WSSK	8.0 gph	115V	7A	101 lbs	Stainless Steel, Non-Filtered	
168757	LZSTLG8WSLK	8.0 gph	115V	4.2A	92 lbs	Light Gray Granite, Filtered	
172775	LZSTLG8WSSK	8.0 gph	115V	4.2A	92 lbs	Stainless Steel, Filtered	

**EZH2O® Hands-Free® Bottle Filler with Mechanically-Activated Cooler**

- Mechanical-activation on water coolers is ideal for disaster prone regions
  - operates even during power disruptions
- Available as:
  - Retrofit kit
  - Complete water cooler and bottle filling station
- Touchless, sensor-activation (bottle filler); easy to operate pushbar activation (cooler)
- Flexi-Guard® safety bubbler
- Optional WaterSentry® Plus™ 3000 gallon filter
- Automatic 20-second shut-off timer (bottle filler)
- Visual interface display includes:
  - Innovative Green Ticker™
  - Filter monitor indicating when replacement is necessary
- Quick fill rate: 1.1 gpm (refrigerated models);
  - 1.5 gpm (non-refrigerated models)
- Rated for indoor service



Part #	Mfg #	Flow Rate	Rated	Full Load	Ship Wt	Description	Price
222457	EMABFDWSSK	Non-Refrigerated	115V	1.0A	40 lbs	Stainless Steel, Non-Filtered	
189287	EMABF8WSLK	8.0 gph	115V	4.0A	75 lbs	Light Gray Granite, Non-Filtered	

**Water Fountains & Coolers**

**EZH2O® Hands-Free® Bottle Filling Station with GreenSpec Vandal-Resistant Cooler**

- Ideal for educational, health care fitness, and office facilities
- Refrigeration system is over 50% more energy efficient
- Vandal-resistant StreamSaver™ bubbler reduces water usage by nearly 40%
- Sanitary, touchless activation with auto 20-second shut-off (bottle filler)
- WaterSentry® Plus™ 3000 gallon capacity filtration system
- Laminar flow provides minimal splash while a real drain system eliminates standing water
- Visual user interface display includes:
  - Innovative Green Ticker™
  - LED filter monitor indicating when replacement is necessary
- Quick fill rate of 1.1 gpm
- Rated for indoor service



Part #	Mfg #	Flow Rate	Rated	Full Load	Ship Wt	Description	Price
144472	LVRGRN8WSK	8.0 gph	115V	3.8A	89 lbs	Stainless Steel, Filtered	

**EZH2O® Hands-Free® Bi-Level Bottle Filling Station with GreenSpec® Vandal-Resistant Cooler**

- Ideal for educational, health care fitness, and office facilities
- Refrigeration system is over 50% more energy efficient
- Vandal-resistant StreamSaver™ bubbler reduces water usage by nearly 40%
- Sanitary, touchless activation with auto 20-second shut-off (bottle filler)
- WaterSentry® Plus™ 3000 gallon capacity filtration system
- Laminar flow provides minimal splash while a real drain system eliminates standing water
- Visual user interface display includes:
  - Innovative Green Ticker™
  - LED filter monitor indicating when replacement is necessary
- Quick fill rate of 1.1 gpm
- Rated for indoor service



Part #	Mfg #	Flow Rate	Rated	Full Load	Ship Wt	Description	Price
169528	VRCGRNTL8WSK	8.0 gph	115V	3.8A	112 lbs	Stainless Steel, Non-Filtered	

**EZH2O® Outdoor Freeze Resistant Bi-Level Pedestal Bottle Filling Station**

- No electrical required
- Vandal resistant bubbler
- Mechanical front bubbler button
- Floor mount/freestanding
- Non-filtered and non-refrigerated
- Sealed freeze resistant valve system minimizes ground water contamination and prevents drain water from mixing with fresh water
- Laminar flow provides clean fill with minimal splash



Part #	Mfg #	Flow Rate	Rated	Full Load	Ship Wt	Description	Price
245787	LK4420BF1UFRKBR N	Non-Refrigerated	—	—	209 lbs	Brown, Non-Filtered	



**Water Fountains & Coolers**

**Water Coolers**

**Adult or Child Water Cooler**

- Self-contained, wall hung electric refrigerated cooler
- Hooded stream projector with Easy-Touch® controls
- Valve with built-in flow regulator provide constant stream from 20 to 105 psi
- Bubblers orifice fully protected to meet all sanitary codes
- Non-pressurized stainless steel cooling tank
- Front and side pushbars  
—Front pushbars (**LZ8S model only**)



EYS8L

Part #	Mfg #	Flow Rate	Rated	Full Load	Ship Wt	Description	Price
059725	EYS4L	4.0 gph	115V	4A	57 lbs	Light Gray Granite, Non-Filtered	
051564	EYS8L	8.0 gph	115V	4A	56 lbs	Light Gray Granite, Non-Filtered	
065806	EYS8S	8.0 gph	115V	4A	89 lbs	Stainless, Non-Filtered	
173317	LZ8S	8.0 gph	115V	5A	54 lbs	Stainless, Filtered	

**Mechanically-Activated Wall-Mount Water Cooler**

- Operates during power disruptions
- Light-touch front and side pushbuttons with raised buttons
- Optional 1500 gallon capacity WaterSentry® VII filter
- Contoured basin minimizes splashing; with integral drain
- Flexi-Guard® safety bubbler
- Valve with built inflow regulator provides constant stream from 20-105 psi
- Impact resistant vinyl coating
- Vandal-resistant models include **(VR)** in number
- Rated for indoor service



Part #	Mfg #	Flow Rate	Rated	Full Load	Ship Wt	Description	Price
170182	EMABFDL	Non-Refrigerated	N/A	N/A	36 lbs	Light Gray Granite, Non-Filtered	
162497	EMABFVR8S	8.0 gph	115V	5A	58 lbs	Stainless Steel, Non-Filtered	
173252	LMABF8L	8.0 gph	115V	370W	68 lbs	Light Gray Granite, Filtered	

**Mechanically-Activated Bi-Level Wall-Mount Water Cooler**

- Operates during power disruptions
- Light-touch front and side pushbuttons with raised buttons
- Optional 1500 gallon capacity WaterSentry® VII filter
- Contoured basin minimizes splashing; with integral drain
- Flexi-Guard® safety bubbler
- Valve with built inflow regulator provides constant stream from 20-105 psi
- Impact resistant vinyl coating
- Vandal-resistant models include **(VR)** in number
- Rated for indoor service



Part #	Mfg #	Flow Rate	Rated	Full Load	Ship Wt	Description	Price
159021	EMABFTLDDLC	Non-Refrigerated	N/A	N/A	46 lbs	Light Gray Granite	



## Water Fountains & Coolers

### Hands-Free® EZ Sensor Operated Non-Filtered Water Cooler

- 1500 Gallon capacity WaterSentry® VII Filter
- Filter monitor indicating when replacement is necessary
- Auto shut-off device prevents need to turn off water supply to change filter
- Valve with built-in flow regulator, provides constant stream from 20-105 psi
- Barrier-free ADA design meets adult or child ADA standards when properly installed
- Extra deep basin minimizes splashing, with vandal resistant integrated design
- Flexi-Guard® anti-microbial safety bubbler
- Easy-to-install universal design
- Impact resistant vinyl coating
- Rated for indoor service



Part #	Mfg #	Flow Rate	Rated	Full Load	Ship Wt	Description	Price
170532	EZODL	Non-Refrigerated	115V	N/A	25 lbs	Light Gray Granite, Non-Filtered	
172469	EZO8S	8.0 gph	115V	5A	51 lbs	Stainless Steel, Non-Filtered	

### EZ Bi-Level or Single Level Water Cooler

- Wall hung, electric refrigerated cooler
- Extra deep basin minimizes splashing
- Flexi-Guard® safety bubbler and Easy-Touch® controls on front & sides
- Impact resistant vinyl coating
- Valve with built-in flow regulator provides constant stream from 20 to 105 psi
- Versatile cooler design
- Vandal-resistant bubbler (includes "VR" code in model number)
- Non-pressurized stainless steel cooling tank
- Rated for indoor service



LZSVR8L

EZSTLR-8LC

#### Single

Part #	Mfg #	Flow Rate	Rated	Full Load	Ship Wt	Description	Price
248691	LZSVR8L	8.0 gph	115V	4A	72 lbs	Light Gray Granite, Filtered	

#### Versatile Bi-Level

Part #	Mfg #	Flow Rate	Rated	Full Load	Ship Wt	Description	Price
059125	EZSTL8LC	8.0 gph	115V	4A	72 lbs	Light Gray Granite, High Cooler on Left	
070020	EZSTL8SC	8.0 gph	115V	4A	72 lbs	Stainless, High Cooler on Left	
180516	EZSTLVR8LC	8.0 gph	115V	4A	72 lbs	Light Gray Granite, High Cooler on Right	
246470	LZSTLDDLC	Non-Refrigerated Filter	115V	N/A	72 lbs	Light Gray Granite, High Cooler on Lft,	

**Water Fountains & Coolers**

**Versatile GreenSpec® Filtered Bi-Level Water Cooler**

- High-efficiency, electric refrigerated cooler
- Flexi-Guard® StreamSaver™ water conservation bubbler
- Energy efficiency performance exceeds average market performance by 35% per CSA 815-99
- Easy-Touch front and side pushbar
- WaterSentry® VII 1500-gallon capacity Filtration System, certified to NSF/ANSI 42 & 53 (Lead, Class 1 Particulate, Chlorine, Taste & Odor)
- Rated for indoor service



Part #	Mfg #	Flow Rate	Rated	Full Load	Ship Wt	Description	Price
180239	LZSTLG8LC	8.0 gph	115V	3.2A	75 lbs	Light Gray Granite	
188122	LZSTLG8SC	8.0 gph	115V	3.2A	75 lbs	Stainless Steel	

**Legacy Wall-Mount Water Cooler**

- Light-touch controls on front and sides
- One-piece basin with high integral backsplash
- Flexi-guard® safety bubbler
- Impact resistant vinyl coating
- Mounting hangers furnished
- NSF/ANSI 61 & 372 certified
- Rated for indoor service



Part #	Mfg #	Flow Rate	Rated	Full Load	Ship Wt	Description	Price
167248	EHFSADL	Non-Refrigerated	N/A	N/A	39 lbs	Light Gray Granite, Non-Filtered	
006092	EHFSA8L1Z	7.6 gph	115V	4A	70 lbs	Light Gray Granite, Filtered	

**Simulated Semi-Recessed Wall-Mount Water Cooler**

- Complete with mounting hangers
- One-piece satin finish stainless steel top, vinyl sides
- Flexi-Guard® safety bubbler



Part #	Mfg #	Flow Rate	Rated	Full Load	Ship Wt	Description	Price
006098	EWA8L1Z	7.8 gph	115V	3.5A	68 lbs	Light Gray Granite	

**Water Fountains & Coolers**

**Adult or Child Bi-Level Filtered Water Cooler**

- Wall hung electric refrigerated cooler
- Operates during power disruptions
- WaterSentry® VII 1500-gallon capacity filtration system, certified to NSF/ANSI 42 & 53 —Lead, class 1 particulate, chlorine, taste & odor
- Contoured basin minimizes splashing; with integral drain
- Flexi-Guard® safety bubbler
- Models including VR stands for vandal-resistant bubbler style
- Valve with built inflow regulator provides constant stream from 20-105 psi
- Impact resistant vinyl coating
- Rated for indoor service



Part #	Mfg #	Flow Rate	Rated	Full Load	Ship Wt	Description	Price
173251	LMABFTL8LC	8.0 gph	115V	5A	97 lbs	Light Gray Granite	
190250	LMABFTLVR8LC	8.0 gph	115V	5A	97 lbs	Light Gray Granite	

**Legacy Simulated Semi-Recessed Refrigerated Water Cooler**

- One-piece basin with high integral backsplash
- Flexi-Guard® anti-microbial safety bubbler
- Impact resistant vinyl coating
- Front pushbutton activation
- Rated for indoor use



Part #	Mfg #	Flow Rate	Rated	Full Load	Ship Wt	Description	Price
006095	ESWA8L1Z	7.8 gph	115V	325W	57 lbs	Light Gray Granite	

**Legacy Deluxe Electric Refrigerated Water Cooler**

- Traditional, classic styling looks good in any setting
- Optional 1500 gallon capacity WaterSentry® VII filter
- Cascade basin minimizes splashing
- Flexi-Guard® anti-microbial safety bubbler
- Removable front panels for easy access
- Impact resistant vinyl coating
- Rated for indoor service



Part #	Mfg #	Flow Rate	Rated	Full Load	Ship Wt	Description	Price
237165	EWA8LF1Z	7.6 gph	115V	370W	72 lbs	Light Gray	
006096	EWA14L1Z	13.5 gph	115V	665W	76 lbs	Light Grey Granite	
186435	EWA14S1Z	13.5 gph	115V	665W	76 lbs	Stainless Steel	

**Water Fountains & Coolers**

**SwirlFlo® Bi-Level Wheelchair Access Water Cooler**

- Uses HFC-134A refrigerant
- Flexi-Guard safety bubbler
- In-line flow regulator
- Removable louvered front ventilating grill
- ADA Compliant



Part #	Mfg #	Flow Rate	Rated	Full Load	Ship Wt	Description	Price
027068	ERPBM28K	7.5 gph	115V	4.0A	140 lbs	Stainless	

**Space-ette® Flush to Wall Refrigerated Air Cooled Floor Mount Water Cooler**

- Trim, space—saving units
- Impact resistant vinyl coating
- WaterSentry® VII 1500-gallon capacity filtration system  
— Included with **LFDE** models (Models are filtered)  
— **Order separately** for all other models
- Flex—Guard®
- Removable front panel for easy access
- Space-ette® basin has integral vandal-resistant strainer
- Glass filler prepped—models with letter (F)
- Rated for indoor service



Part #	Mfg #	Flow Rate	Rated	Full Load	Ship Wt	Description	Price
134660	FD70010L(F)1Z	9.8 gph	115V	6.8A	65 lbs	Light Gray Granite	
163500	FD70010T1Z	9.8 gph	115V	6.8A	65 lbs	Sandalwood	
132042	FD7003L1Z	3.0 gph	115V	3.5A	54 lbs	Light Gray Granite	
006100	FD7003L(F)1Z	3.0 gph	115V	3.5A	54 lbs	Light Gray Granite	
148216	FD7005L1Z	5.0 gph	115V	3.5A	54 lbs	Light Gray Granite	
133366	LFDE10L(F)1Z	9.8 gph	115V	6.8A	68 lbs	Light Gray Granite	

**Legacy Deluxe Water Cooler**

- Impact resistant vinyl coating
- Optional 1500 gallon capacity WaterSentry® VII filter
- Flexi-Guard® safety bubbler
- Extra deep basin minimizes splashing; with integral vandal-resistant strainer
- Removable front panel for easy access
- Glass filler prepped—models with letter (F)
- Rated for indoor service
- NSF/ANSI 61 and 372 certified



Part #	Mfg #	Flow Rate	Rated	Full Load	Ship Wt	Description	Price
186463	EFA8S1Z	8.0 gph	115V	4A	72 lbs	Stainless Steel, Non-Filtered	

## Water Fountains & Coolers

### Bracket Drinking Fountain

- 300 Series, nickel bearing stainless steel fountain
- 14 Gauge, heavy-duty wall bracket
- Contoured basin to eliminate splashing and standing water
- Basin has rounded corners and removable chrome-plated strainer



Part #	Mfg #	Overall Size	Control	Ship Wt	Price
094889	EDF15R	10"W x 6"D x 3"H	Pushbutton Bubbler	5 lbs	

### Vandal-Resistant Water Cooler

- Ideal for schools and other heavy-use installations
- Vandal-resistant items include
  - Pinned Torx® screws
  - Bubbler
  - Single action, self-closing mechanical pushbutton
- Real drain system eliminates standing water
- ADA design meets adult or child standards when properly installed
- Stream height regulator can be adjusted through hole in pushbutton
  - Provides constant stream from 20 to 105 psi
- Filtered models rated for indoor service, filter less rated for indoor/outdoor service



Part #	Mfg #	Flow Rate	Rated	Full Load	Ship Wt	Description	Price
162371	VRCDS	Non-Refrigerated	N/A	N/A	N/A	Stainless Steel, Non-Filtered	
177830	VRCSC8S	8 gph	115V	5A	59 lbs	Stainless Steel, Non-Filtered	

### Vandal-Resistant Bi-Level Water Cooler

- Ideal for schools and other heavy-use installations
- Vandal-resistant items include
  - Pinned Torx® screws
  - Bubbler
  - Single action, self-closing mechanical pushbutton
- Features louver screens
- Real drain system eliminates standing water
- 115V/60Hz—voltage/hertz
- ADA design meets adult or child standards when properly installed
- Stream height regulator can be adjusted through hole in pushbutton
  - Provides constant stream from 20 to 105 psi
- Filtered models rated for indoor service, filter less rated for indoor/outdoor service



Part #	Mfg #	Flow Rate	Rated	Full Load	Ship Wt	Description	Price
189490	LVRCTLSC8SC	8 gph	115V	5A	94 lbs	Stainless Steel, Filtered	
177251	VRCTLSC8SC	8 gph	115V	5A	94 lbs	Stainless Steel, Non-Filtered	



**Water Fountains & Coolers**

**Vandal-Resistant Bi-Level Water Cooler**

- 14-Gauge stainless steel with integral basin
- Front vandal-resistant push button activation
- Vandal-resistant, StreamSaver™ bubbler —operates on 20-105 psi supply line pressure
- Venting shall include protective screening
- WaterSentry® VII 1500-gallon capacity Filtration System, certified to NSF/ANSI 42 & 53
- Rated for indoor use



Part #	Mfg #	Flow Rate	Rated	Full Load	Ship Wt	Description	Price
237578	LVRCHDTL8SC	8.0 gph	115V		113 lbs	Stainless Steel, Filtered	

**GreenSpec® Vandal-Resistant Bi-Level Water Cooler**

- Over 50% more energy efficient
- Reduces refrigerant use by nearly 8%
- Optional WaterSentry® VII1500 gallon filter
- Vandal-resistant StreaaSaver™ bubbler reduces water usage by almost 40%
- Vandal-resistant, single-action mechanical pushbutton is self-closing —Does not require grasping or twisting —Operates during power disruptions
- Flow regulator provides constant stream from 20 to 105 psi water pressure
- Rated for indoor service
- (-F) LK1110 glass filler



Part #	Mfg #	Flow Rate	Rated	Full Load	Ship Wt	Description	Price
167555	LVRCGRNTL8FC	8 gph	115V	2.8A	98 lbs	Stainless Steel, Filtered	
134332	VRCGRNTL8C	8 gph	115V	2.8A	94 lbs	Stainless Steel, Non-Filtered	
238593	VRCGRNTL8FC	8 gph	115V	2.8A	94 lbs	Stainless Steel, Non-Filtered	

**EZ Wall-Mount Water Cooler**

- ADA design meets adult or child ADA standards when properly installed
- Optional 1500 gallon capacity WaterSentry® VII filter
- Extra deep basin minimizes splashing, with vandal resistant integrated drain
- Valve with built-in flow regulator to provide constant stream from 20-105 psi water pressure
- Glass filler prepped
- Easy-touch controls
- Flexi-Guard® safety bubbler
- Easy-to-install universal design
- Impact resistant vinyl coating
- Rated for indoor service



Part #	Mfg #	Flow Rate	Rated	Full Load	Ship Wt	Description	Price
109946	EZS4LF	4.0 gph	115V	2A	50 lbs	Light Gray Granite, Non-Filtered	
085547	EZS8LF	8.0 gph	115V	4A	51 lbs	Light Gray Granite, Non-Filtered	
152700	LZS8LF	8.0 gph	115V	4A	51 lbs	Light Gray Granite, Filtered	



**Water Fountains & Coolers**

**EZ GreenSpec® Water Cooler**

- High energy efficiency refrigeration system exceeds average market performance by 35%
- Includes Flexi-Guard®StreamSaver® water efficient bubbler
- Easy-to-touch front and side pushbar controls
- Easy-to-install universal design
- Rated for indoor service



Part #	Mfg #	Flow Rate	Rated	Full Load	Ship Wt	Description	Price
167552	EZSG8S	8.0 gph	115V	3.2A	64 lbs	Stainless Steel, Non-Filtered	

**Soft Sides® Composite Gel-Coated Drinking Fountain**

- No electrical required
- Contoured basin minimizes splashing
- Pushbutton, self-closing bubbler with pressure regulator
- Flow regulator provides constant stream from 20 to 105 psi water pressure
- Vandal-resistant bottom cover plate
- Drain and trap assembly included
- Rated for indoor/outdoor service



Part #	Mfg #	Flow Rate	Rated	Full Load	Ship Wt	Description	Price
157484	EDF214WC	Non-Refrigerated	N/A	N/A	N/A	White Granite, Non-Filtered	

**SwirlFlo Oval® Legacy Countertop Non-Refrigerated Drinking Fountain**

- Contoured basin minimizes splashing
- Push button, self-closing bubbler
- Flow regulator provides constant stream from 20 to 105 psi
- Brackets provided for countertop mounting
- Rated for indoor/outdoor service



Part #	Mfg #	Flow Rate	Rated	Full Load	Ship Wt	Description	Price
078307	DRKR14C	Non-Refrigerated	N/A	N/A	7.3 lbs	Stainless Steel, Non-Filtered	

**Water Fountains & Coolers**

**Freeze-Resistant Outdoor Tubular Steel Drinking Fountain**

- Weather-resistant textured finish
- Contour-formed stainless steel design includes:
  - Rounded edges
  - Minimizes splashing
  - Ensures proper drainage
  - Prevents standing water
- Constructed of cold-rolled steel
- 3/8" O.D. tubing—water inlet
- 1-1/4" tube outlet for 1-1/4" slip joint connection—drain outlet
- E-coat immersion process coats inside and outside of fountain for ultimate corrosion protection
- Vandal-resistant pushbuttons with self-closing valve
- Vandal-resistant bubbler—chrome plated, one piece design
- Access panel features vandal-resistant screws
- Optional locking and non-locking hose bib accessories available
- NSF/ANSI 61 certified



Part #	Mfg #	Flow Rate	Rated	Full Load	Ship Wt	Description	Price
182672	LK4405FRK	Non-Refrigerated	N/A	N/A	62 lbs	Evergreen, Non-Filtered	
232193	LK4405GRY	Non-Refrigerated	N/A	N/A	62 lbs	Gray, Non-Filtered	

**Freestanding Outdoor Fountain Pedestal**

- E-coat
- 316 Stainless
- Heavy-duty vandal resistant
- Non-refrigerated
- Non-filtered
- No electrical required
- Mechanically-activated front bubbler



Part #	Mfg #	Flow Rate	Rated	Full Load	Ship Wt	Description	Price
234033	LK4400BLU	Non-Refrigerated	N/A	N/A	134 lbs	Blue, Non-Filtered	

**Barrier-Free Access**

**Fully Recessed Non-Refrigerated Drinking Fountain**

- No electrical required
- Flexi-Guard® safety bubbler
- Front push activation bar
- 18 Gauge, type 304 nickel bearing stainless steel
- Flow regulator provides constant stream from 20 to 105 psi water pressure
- Rated for indoor/outdoor service



Part #	Mfg #	Flow Rate	Rated	Full Load	Ship Wt	Description	Price
029445	EDFB-12-C	Non-Refrigerated	N/A	N/A	27 lbs	Stainless Steel, Non-Filtered	

**Water Fountains & Coolers**

**Legacy Fully Recessed Water Cooler**

- Entire unit does not extend more than 1/2" from wall surface
- Optional 1500 gallon capacity WaterSentry® VII filter
- Stainless steel louvered ventilating grill
- Cooling unit is removable without disturbing electrical or drain connections
- Front push activation
- Flexi-Guard® safety bubbler
- Flow regulator provides constant stream from 20 to 105 psi water pressure
- Complete with refrigeration package, mounting box, and grill
- Rated for indoor service



Part #	Mfg #	Flow Rate	Rated	Full Load	Ship Wt	Description	Price
227438	LJNEM12K	12 gph	115V	4.7A	129 lbs	Stainless Steel, Filtered	

**SoftSides® Heavy-Duty Drinking Fountain**

- No electrical required
- Barrier-free ADA design meets adult standards when properly installed
- Self-closing vandal-resistant pushbuttons do not require grasping or twisting
- Vandal-resistant bubbler
- Contoured basin minimizes splashing
- One-piece vandal-resistant drain
- Bottom cover plate
- Integral P-trap included
- Flow regulator provides constant stream from 20 to 105 psi water pressure
- NSF/ANSI 61 certified
- Rated for indoor/outdoor service



Part #	Mfg #	Flow Rate	Rated	Full Load	Ship Wt	Description	Price
151536	EHWM214C	Non-Refrigerated	N/A	N/A	39 lbs	Stainless Steel, Non-Filtered	

**SwirlFlo® Non-Refrigerated Drinking Fountain**

- Wall-mount-fully exposed with wall plate
- Tubular stainless steel support arm is integrated with basin
- Contoured basin minimizes splashing and has Flexi-Guard® safety bubbler
- Vandal-resistant front pushbutton and bottom cover plate
- Flow regulator provides constant stream from 20 to 105 psi water pressure
- Barrier-Free ADA design meets adult ADA standards when properly installed



Part #	Mfg #	Flow Rate	Rated	Full Load	Ship Wt	Description	Price
094160	EDFPBWM114C	Non-Refrigerated	N/A	N/A	22 lbs	Stainless Steel, Non-Filtered	

**Water Fountains & Coolers**

**Swirlflo® Single Water Cooler**

- Barrier-Free ADA design meets adult ADA standards when properly installed
- Flexi-Guard® safety bubbler, optional vandal-resistant bubbler is available (-VR)
- Removable louvered front ventilating grill encloses refrigeration
- Stainless steel tubular arm integrated with basin
- Contoured basin designed to minimize splashing
- Vandal-resistant front pushbutton
- Flow regulator provides constant stream from 20 to 105 psi water pressure
- Optional WaterSentry® VII 1500 gallon capacity filtration system
- Rated for indoor use only
- Model LRPB8K requires mounting frame (MF100)



Part #	Mfg #	Flow Rate	Rated	Full Load	Ship Wt	Description	Price
228431	LRPB8K	8.0 gph	115V	4A	74 lbs	Stainless Steel, Filtered	
226634	LRPB8K	8 gph	115V	4A	93 lbs	Stainless Steel, Filtered	

**Swirlflo® Bi-Level Water Cooler**

- Barrier-Free ADA design meets adult ADA standards when properly installed
- Vandal-resistant bubbler
- Removable louvered front ventilating grill encloses refrigeration
- Stainless steel tubular arm integrated with basin
- Contoured basin designed to minimize splashing
- Vandal-resistant front pushbutton
- Flow regulator provides constant stream from 20 to 105 psi water pressure
- Optional WaterSentry® VII 1500 gallon capacity filtration system
- Rated for indoor use only
- Model LRPB8K requires mounting frame (MF100)



Part #	Mfg #	Flow Rate	Rated	Full Load	Ship Wt	Description	Price
240143	ERPBMV28K	8.0 gph	115V	4A	140 lbs	Stainless Steel, Filtered	

**Swirlflo® Bi-Level GreenSpec® Filtered Water Fountain**

- Over 55% more energy efficient
- StreamSaver™ bubbler reduces water usage by almost 40%; available as Flexi-Guard® or vandal-resistant style
- Removable louvered front ventilating grill encloses refrigeration
- Reduces refrigerant use by nearly 20%
- Optional WaterSentry® VII 1500-gallon capacity filtration system, certified to NSF/ANSI —Lead, class 1 particulate, chlorine, taste & odor
- Rated for indoor use only



Part #	Mfg #	Flow Rate	Rated	Full Load	Ship Wt	Description	Price
180996	LRPBGRNM28K	8.0gph	260W	2.8A	140 lbs	Stainless Steel	

**Water Fountains & Coolers**

**SwirlFlo® Bi-Level Non-Refrigerated Drinking Fountains**

- Fountain dimensions  
—Length: 38-1/2", Width: 19", Height: 21-15/16"
- Stainless steel support arms are integrated with basin
- Contoured basin minimizes splashing
- ADA design meets adult ADA standards when properly installed
- Flexi-Guard® safety bubblers or vandal-resistant bubbler is available  
—Available if the letter (V) is included in the model number
- Vandal-resistant front pushbutton
- Flow regulator provides constant stream from 20 to 150 psi
- Vandal-resistant bottom cover plates included
- Includes stainless steel back panel and surface mounting plate
- Rated for indoor and outdoor service



Part #	Mfg #	Flow Rate	Rated	Full Load	Ship Wt	Description	Price
104731	EDFPBM117C	Non-Refrigerated	N/A	N/A	72 lbs	Stainless Steel, Non-Filtered	
180858	EDFPBM(V)117C	Non-Refrigerated	N/A	N/A	72 lbs	Stainless Steel, Non-Filtered	

**Swirlflo® Reverse Bi-Level Water Cooler**

- Barrier free ADA design meets adult ADA standards when properly installed
- Optional 1500 gallon capacity WaterSenrty® VII filter
- Contoured basin designed to minimize splashing
- Stream height regulator provides constant stream from 20 to 105 psi
- Flexi-Guard® safety bubbler
- Rated for indoor service



Part #	Mfg #	Flow Rate	Rated	Full Load	Ship Wt	Description	Price
106888	ERPBM28RAK	7.5 gph	115V	370W	140 lbs	Stainless Steel, Non-Filtered	

**Swirlflo® Reverse Bi-Level Drinking Fountain**

- No electrical required
- Barrier free ADA design meets adult ADA standards when properly installed
- Stainless steel tubular arms integrated into basin
- Contoured basin designed to minimize splashing
- Flow regulator provides constant stream from 20 to 105 psi
- Flexi-Guard® safety bubbler is standard, optional vandal-resistant bubbler is available
- Vandal-resistant front pushbutton
- Lower left fountain positioned for wheelchair use
- NSF/ANSI 61 certified
- Rated for indoor service



Part #	Mfg #	Flow Rate	Rated	Full Load	Ship Wt	Description	Price
159954	EDFPBMV117RAC	Non-Refrigerated	N/A	N/A	72 lbs	Stainless Steel, Non-Filtered	



**Water Fountains & Coolers**

**Swirlflo® Hands-Free® Sensor Operated Bi-Level Water Cooler**

- In-the-wall energy officiated refrigerated system with stainless steel grill
- Stainless steel tubular support arms integrated into basin
- All stainless steel is polished to a lustrous satin finish with high shine outer edge
- Barrier free ADA design meets adult ADA standards when properly installed
- Optional 1500 gallon capacity WaterSenrty® VII filter
- Contoured basin designed to minimize splashing
- Stream height regulator provides constant stream from 20 to 105 psi
- Flexi-Guard® safety bubbler
- Rated for indoor service



Part #	Mfg #	Flow Rate	Rated	Full Load	Ship Wt	Description	Price
124692	ENOBM28K	7.5 gph	115V	370W	140 lbs	Stainless Steel, Non-Filterer	

**Soft Sides® Bi-Level Non-Refrigerated Drinking Fountain**

- Wall mount-fully exposed with wall plate
- Barrier-free ADA design meets adult standards when properly installed
- Stream height regulator provides constant stream from 20 to 105 psi
- Vandal-resistant front pushbutton
- Flexi-Guard® safety bubbler
- Contoured basin provides a splash-resistant surface
- Bottom cover plate prevents vandalism
- Integral P-trap included
- Freeze-resistant models include **(FPK)** in model number
- NSF/ANSI 61 certified
- Rated for indoor/outdoor service



Part #	Mfg #	Flow Rate	Rated	Full Load	Ship Wt	Description	Price
040432	EDFP217C	Non-Refrigerated	N/A	N/A	42 lbs	Stainless Steel, Non-Filtered	
163065	EDFP217FPK	Non-Refrigerated	N/A	N/A	69 lbs	Stainless Steel, Non-Filtered	

**Soft Sides® Non-Refrigerated Drinking Fountain**

- Wall mount-fully exposed with wall plate
- Barrier-free ADA design meets adult standards when properly installed
- Stream height regulator provides constant stream from 20 to 105 psi
- Vandal-resistant front pushbutton
- Flexi-Guard® safety bubbler
- Contoured basin provides a splash-resistant surface
- Bottom cover plate prevents vandalism
- Integral P-trap included



Part #	Mfg #	Flow Rate	Rated	Full Load	Ship Wt	Description	Price
066795	EDFP214C	Non-Refrigerated	N/A	N/A	16 lbs	Stainless Steel, Non-Filtered	



**Water Fountains & Coolers**

**Soft Sides® Hands-Free® Drinking Fountain**

- Barrier-free ADA design meets adult standards when properly installed
- Optional 1500 gallon capacity Watersentry® VII filter (LNTE8K)
- Stream height regulator provides constant stream from 20 to 105 psi
- Energy efficient refrigeration system
- Flexi-Guard® safety bubbler is standard, optional vandal-resistant bubbler is available
- Contoured basin provides a splash-resistant surface
- Removable louvered front ventilating grill encloses refrigeration and plumbing
- Bottom cover plate prevents vandalism
- Rated for indoor service



**Single**

Part #	Mfg #	Flow Rate	Rated	Full Load	Ship Wt	Description	Price
187013	EROM8K	8.0 gph	115V	4.5A	100 lbs	Stainless Steel, Non-Filtered	

**Bi-Level**

Part #	Mfg #	Flow Rate	Rated	Full Load	Ship Wt	Description	Price
249923	LNTE8K	8.0 gph	115V	-	98 lbs	Stainless Steel, Filtered	



**Halsey Taylor® Vandal-Resistant ADA Wall-Mount Cooler**

- Barrier-free
- Stainless steel
- One-piece bubbler
- Tamper-resistant pushbutton activation



Part #	Mfg #	Flow Rate	Rated	Full Load	Ship Wt	Description	Price
232350	HTHVR8-WF	8.0 gph	115V	4.0A	62 lbs	Stainless Steel, Filtered	

**Water Fountains & Coolers**

**Halsey Taylor® HydroBoost® Bottle Filling Station & Bi-Level ADA Cooler**

- Green Counter™
- Exclusive Double Bubbler™
- Rated for indoor use
- Activated by electronic bottle filler sensor with mechanical front and side bubbler pushbar



Part #	Mfg #	Flow Rate	Rated	Full Load	Ship Wt	Description	Price
242321	HTHB-HACG8BLPV-WF	8.0 gph	115V	5.5A	110 lbs	Platinum Vinyl, Filtered	

**Halsey Taylor® HydroBoost® In-Wall Bottle Filling Station**

- Touchless, sensor activation
- Green Counter™
- Laminar flow & real drain system
- Automatic 20-second shut off sensor
- Visual filter monitor with LED filter status indicator
- Fill rate: 1.1 gpm
- Rated for indoor use



Part #	Mfg #	Flow Rate	Rated	Full Load	Ship Wt	Description	Price
242322	HTHBGRN8LM-WF	8.0 gph	115V	6A	66 lbs	Stainless Steel, Filtered	

**Halsey Taylor Remote Chiller**

- Non-Filtered 1GPH
- Galvanized steel
- Non bubbler
- 115V/60Hz
- 17"L x 7"W x 14"H



Part #	Mfg #	Flow Rate	Rated	Full Load	Ship Wt	Description	Price
243500	SJ1	1.0 gph	115V		33 lbs	Non-Filtered	

---

---

**Water Fountains & Coolers**

---

---

**Commercial Specialties**  
**Self Closing Drinking Fountain**

- 1/2" FPT
- Flow regulator screw
- Cross handle
- Precision ball bearing action



Part #	Mfg #	Description	Price
008080	2190	Chrome Plated Brass	

**Water Fountains & Coolers**

**Water Chiller Parts**

Part #	Mfg #	Description	Price
125574	27638C	Chiller Shelf	

**Bubblers**



51544C



56073C



LK142



LK1141A

Part #	Mfg #	Description	Price
160547	98481C	StreamSaver™, Chrome	
030555	LK1141A	Flexi-Guard®, Chrome Plated	
006109	LK142	Pushbutton, Chrome	
165885	98533C	Bubbler	

**Cane Aprons**

Part #	Mfg #	Flow Rate	Rated	Full Load	Ship Wt	Description	Price
128063	97258C					Black ABS Plastic	
128010	98324C					Stainless Steel	
076007	LKAPREZL					Gray ABS Plastic	

**Air-Cooled Indoor Remote Water Chillers**

- Converts any drinking fountain into a water cooler
- Galvanized steel cabinet
- Hermetically sealed compressor
- Rated for indoor service

Part #	Mfg #	Flow Rate	Rated	Full Load	Ship Wt	Description	Price
081714	ECH8	8 gph	115V	2-Stations	370W	43 lbs Non-Filtered	
166212	ER101Y	10 gph	115V	2-Stations	490W	74 lbs Non-Filtered	
159955	ER21Y	2 gph	115V	1-Station	185W	44 lbs Non-Filtered	
165758	ERS11Y	1 gph	115V	1-Station	140W	33 lbs Non-Filtered	

**Mounting Frames**

Part #	Mfg #	Flow Rate	Rated	Full Load	Ship Wt	Description	Price
055235	MF200					Bi-Level, For ENOB, ERFP, ERO, ERPB, LNTE, LRPB Models	

## Water Fountains & Coolers

### One-Level Mounting Frame

- 18-3/4"L x 12"W x 40"H
- 16 Gauge galvanized steel
- For use with:
  - In-wall EZH2O models
  - SwirlFlo® one-level water coolers

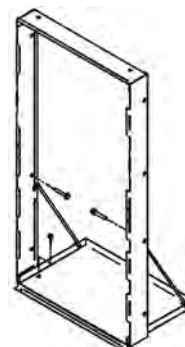

Part #	Mfg #	Level	Size	Price
242323	MFWS100	One Level	18-3/4" x 12" x 40"	

### Mounting Systems

#### In-Wall Mounting Carrier Plate

- For models EDFP210, EDFP214, EDFPB114, EDFPBW114, EHW214 and single HDFF & HRF
- Heavy gauge steel in-wall support legs
  - Supports up to 500 lbs
- Adjustable height setting allows for adult or child installation
- Plate can be installed two ways:
  - Directly to studs
  - Connect with (ML100) mounting legs
- Parts are painted with protective coating
- Universal design enables mounting to EDFP214, EDFPB114, EHW214, and single HDFF & HRF models all on one mounting plate



Part #	Mfg #	Flow Rate	Rated	Full Load	Ship Wt	Description	Price
186102	MPW101	Black					

### Repair Parts

Part #	Mfg #	Flow Rate	Rated	Full Load	Ship Wt	Description	Price
181422	000000238					Control Switch for ECH8 Model	
175384	0000001192					Gasket, 4-Pack	
225110	1000001600					Push Bar Assembly	
178181	1000001673					Regulator Kit	
222929	1000001772					Elbow Fittings	
186852	1000001791					Nipple/Gasket	
189177	1000001913					Regulator	
174397	1000001926					Hex Nut	
168676	101567443730					Hook Rods for Shelf	
161319	15009C					Bubbler Nipple	
190309	20430C					Hanger Bracket	
162775	27209C					ESWA Gray/Beige Wrapper	
225722	28260C					Cooler Bracket, For Bi-Level Models	
222522	28536C					Left Hand Rear Panel, Stainless Steel	

## Water Fountains & Coolers

### Repair Parts (Continued)

Part #	Mfg #	Flow Rate	Rated	Full Load	Ship Wt	Description	Price
222521	28539C					Right Hand Rear Panel, Stainless Steel	
160103	30120C					Overload	
160104	30143C					Relay	
170735	36216C					Wiring Harness	
166556	36248C					Solenoid Assembly	
168765	36272C					Capacitor	
159101	36292C					Power Block	
246285	36296C					Bottle Filler Control Board	
226039	40500C					Valve Replacement Kit	
048471	40572C					Tailpipe	
181369	45330C					Waste Arm	
176361	45662C					Push Button	
181894	45728C					Drain Ferrule	
174396	45736C					Regulator Half Nut	
174394	45738C					Push Button Sleeve	
173736	51560C					Front Push Bar	
176362	56087C					Push Button Extension	
174399	56092C					Poly Tubing	
154777	56118C					Drain Fitting	
166998	70920C					Rod Pivot	
173200	72000483					Brass Washer, For LK24RT Model	
173199	72000484					"C" Spring Washer For LK24 Model	
173201	72000486					Rubber O-Ring, For LK24RT Model	
173203	72000488					CP Brass Packing Nut	
058214	72000492					O-Ring	
179499	72000580					Overflow Tube, NP	
173198	72001879					O-Ring for LK24RT Model	
174305	72002160					Strainer, For LK35 Model	
174398	75672C					Cap Screw	
168538	92776C					Regulator Assembly	
168539	96846C					Drain Assembly	
243686	96883C					Drain Assembly	
188578	97969C					Drain Replacement	
165883	97970C					Drain Tube	
096667	98169C					Replacement Cap	
222185	98498C					Gooseneck Glass Filler	
225194	98546C					Aerator	
134443	98551C					Kitchen LZ Filter Mounting	
174395	98682C					Push Button Assembly	
169108	98719C					Evap Assembly	
168198	98731C					Regulator Kit	
178303	98773C					Cold Control	



---



---

**Water Fountains & Coolers**

---



---

**Repair Parts (Continued)**

Part #	Mfg #	Flow Rate	Rated	Full Load	Ship Wt	Description	Price
246207	98790C					Drain	
158432	98532C					Fountain O-Ring Kit	
170298	98535C					Overload	
165884	98537C					Push Bar Kit	
168732	98539C					Solenoid Assembly	
165744	98543C					Electric Package Kit	
165745	98545C					Solenoid Valve Assembly	
165877	98733C					Kit Freeze Resist Fountain	
165715	98732C					Regulator Kit	
165886	98734C					Push Bar Set	
165879	98755C					Overload/Relay	
165880	98869C					Switch	
172795	A51266					Locknut	
164135	A51853R					Press Balance Cartridge	
163615	A51866R					Cartridge	
158038	A53080					Handle Assembly	
158612	A55961R					Lever Handle Assy, Brushed Nickel	
152310	A74921R					Handle	
185801	LK735					Aerator, Vandal Resistant 1.5 gpm	
172796	P02103					Coupling Nut	
172797	P35163					Wahser	
224492	P45746CR					Spray Head	



## Enviroplug - Bentonite

### ENVIROPLUG® MEDIUM

- Were the first bentonite chips developed and marketed
- Pure Wyoming bentonite
- Designed for use as sealants for hole abandonment, casing seals or any vertical seal to prevent water movement up or down a bore hole
- When absorbing water, ENVIROPLUG® MEDIUM swells to fill voids, exerting pressure against all surfaces to create a flexible low permeability seal
- ENVIROPLUG® is introduced in a "dry" state, shrinkage cannot occur and there is a reserve expansion capacity
- Generally hydration takes one to two hours
- Certified to NSF/ANSI 60



Part #	Mfg #	Description	Price
012164	4230-8250	Medium, 50 lb Bag	

## Jet Pumps

### Booster Pump

- Self-priming
- Ideal for pressure boosting from storage tanks
- Easy to use control panel
- Built-in dry-run protection
- Made from weatherproof, corrosion resistant materials



Part #	Mfg #	HP	Volts	GPM	Price
063318	MQ3-35-115	3/4	115V	Up to 20	
056291	MQ3-45-115	1	115V	Up to 20	

### SCALA2 Booster Pump

- Designed for pressure boosting in single family houses and apartments
- Intelligent pump control
- Water-cooled, permanent magnet motor
- Dry running protection
- Self-priming
- User friendly control panel
- Outdoor-ready
- Easy sizing and selection



Part #	Mfg #	Volts	Max Pressure	Price
190242	SCALA2	240V	145 psi	

## Jet Pumps

### Convertible Jet Pumps

- Cast iron casing and seal plate
- AO Smith higher than standard NEMA service factor dual compartment motor
- Dual voltage 115/230V
- Square D pressure switch preset at 30 to 50 psi
- 1-1/4" Suction, 1" NPT discharge and brass flow control valve
- Pressure gauge included
- Stainless steel motor shaft and dual ball bearings
- Precision engineered thermoplastic impeller, diffuser, nozzle and venturi
- 2-Year fully serviceable warranty



#### Deep Well Pump

- For installations where the vertical distance to pumping water level does not exceed 90'
- Deep well venturi supplied

Part #	Mfg #	Model	HP	Flow	Shut-Off	Price
119521	558281	JPC-050-C	1/2 hp	11 gpm	176'	
119522	558282	JPC-075-C	3/4 hp	18 gpm	164'	
119518	558283	JPC-100C	1 hp	20 gpm	164'	

#### Shallow Well Pump

- Clean-out plug to easily unclog nozzle

Part #	Mfg #	Model	HP	Flow	Shut-Off	Price
119520	558274	JP-050-C	1/2 hp	13 gpm	148'	

---

---

## Jet Pumps

---

---

### Quick-Set® Convertible Jet Pumps

- *Easy-to-stock Quick-Set components convert to deep or shallow well in minutes*
- *Low pressure/high volume or high pressure/low volume settings can be made easily*
- *Includes streamlined case with two discharge openings*



Part #	Mfg #	Description	Price
023935	100RJA	1 hp	

## Submersible Pumps

### 3" SQ/SQE Submersible Well Pumps

- SQ/SQE Pumps are suitable for both continuous and intermittent operation for a variety of applications such as domestic water supply, small waterworks irrigation and tank applications
- Permanent-magnet motor and micro frequency converter
- Simple 2-wire design, single-phase power
- SQE Includes "Smart Motor" which communicates via CU300 status box through power leads



Part #	Mfg #	HP	Volts	Pump Outlet NPT	Price
043807	10SQ07-240	3/4	240V	1-1/4"	
070280	15SQE07-180	3/4	200-240V	1-1/4"	
107447	15SQE15-290	1-1/2	230V	1-1/4"	
085688	22SQE15-220	1-1/2	200-240V	1-1/2"	

### SQ/SQE Constant Pressure Kit

- Includes status box and pressure transducer

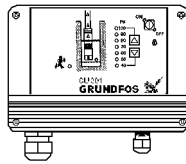

Part #	Mfg #	Description	Price
070281	CU301	"Smart Flo" & Transducer	



## Submersible Pumps

### Submersible Deep Well Pumps

- For new installs and replacement applications where water must be transferred under pressure from wells, cisterns, ponds, lakes and streams
- Stainless steel discharge
- Ceramic bearing sleeve
- Hex rubber bearing has extra-large surface to ensure shaft stability, and multiple flow channels to keep small particles away from bearing surfaces
- Celcon® disk for close tolerances and increased performance
- Stainless steel up-thrust washer
- Built-in Flomatic® check valve
- Removable suction screen



#### 2-Wire Submersible Pump

Part #	Mfg #	Model	Description	Price
119416	558588	W12G05S7-21S	1/2 hp 115V 12 gpm	
119417	558589	W12G05S7-22S	1/2 hp 230V 12 gpm	
119418	558590	W12G07S9-22S	3/4 hp 230V 12 gpm	

#### 3-Wire Submersible Pump

Part #	Mfg #	Model	Description	Price
119421	558593	W12G05S7-32S	1/2 hp 230V 12 gpm	
119422	558594	W12G07S9-32S	3/4 hp 230V 12 gpm	
119423	558595	W12G10S12-32S	1 hp 230V 12 gpm	
120054	558549	W22G15S9-32S	1-1/2 hp 230V 22 gpm	

## Submersible Pumps

### Control Boxes

#### Quick Disconnect Control Box

- *Designed for use with 3-wire single-phase submersible motors through 1 hp*

Part #	Mfg #	HP	Hz	Volts	Price
119523	280 104 4915	1/2	60Hz	115V	
085267	280 105 4915	1/2	60Hz	230V	
085268	280 107 4915	3/4	60Hz	230V	
085269	280 108 4915	1	60Hz	230V	

#### Capacitor Run Control Box

- *Designed for use with 3-wire single-phase submersible motors through 1 hp*

Part #	Mfg #	HP	Hz	Volts	Price
119515	282 405 50	1/2	60Hz	230V	
124472	282 407 50	3/4	60Hz	230V	
119517	282 408 50	1	60Hz	230V	

#### Standard Control Box

- *Designed for use with 3-wire single-phase submersible motors from 1 to 15 hp*
- *Recommended for water systems that use standard/ heavy-duty pressure switches, level switches, or other pilot devices*

Part #	Mfg #	HP	Hz	Volts	Price
119426	282 300 8110	1-1/2	60Hz	230V	



## Water Service Accessories

### PCT Contractor Gauges

- Stainless steel case
- Highly accurate
- Zero adjustment screw
- CRN Registered
- 5-Year warranty



#### 4-1/2" Stainless Steel Gauge with Bottom Connection

- 1/4" NPT Connection

Part #	Mfg #	Range	Price
129051	PCT321	0-30 psi/kPa	
129052	PCT322	0-60 psi/kPa	
129053	PCT323	0-100 psi/kPa	
129054	PCT324	0-160 psi/kPa	
129055	PCT325	0-200 psi/kPa	
129057	PCT326	0-300 psi/kPa	
181244	PCT329-R1	30"/0/30 psi/kPa	

### PEM Series Economy Gauges

- Friction bezel ring
- Black steel case
- Brass internals
- Highly accurate
- CRN Registered
- 5-Year warranty



#### 2" Steel Gauge with Back (CB) Connection

Part #	Mfg #	Range	Conn.	Price
187692	PEM1404	0-60 psi/kPa	1/8"	
242099	PEM1409	0-160 psi/kPa	1/4"	

#### 1-1/2" Steel Gauge with Bottom Connection

- 1/8" Connection

Part #	Mfg #	Range	Price
243045	PEM1320	0-100 psi/kPa	

#### 2-1/2" Steel Gauge with Back (CB) Connection

- 1/4" CB Connection

Part #	Mfg #	Range	Price
242697	PEM1437	0/30 psi-kPa	

### 2-1/2" Steel Gauge with Bottom Connection

- 1/4" NPT Connection

Part #	Mfg #	Range	Price
129059	PEM211	0-15 psi/kPa	
129060	PEM212	0-30 psi/kPa	
129061	PEM213	0-60 psi/kPa	
129063	PEM214	0-100 psi/kPa	
129064	PEM215	0-160 psi/kPa	
129065	PEM216	0-200 psi/kPa	
129066	PEM217	0-300 psi/kPa	

### 4" Steel Gauge with Bottom Connection

- 1/4" NPT Connection

Part #	Mfg #	Range	Price
174195	PEM223	0-100 psi/kPa	

### PPC Process Gauges

- Field liquid-fillable, phenolic solid front blowout back safety case
- Stainless steel full rotary movement for longer life
- Micrometer pointer for ease in calibration
- Under and overload stops
- 316L Stainless steel, brass, Monel® or carbon steel wetted parts
- Restrictor screws standard on dual scale (optional on single scale gauges)
- CRN Registered
- 5-Year warranty



#### Single Scale with Bottom Connection

Part #	Mfg #	Range	Price
181222	PPC5062R1G W	0-30 psi, 1/2" Conn., Glycerin	
181223	PPC5063R1G W	0-60 psi, 1/2" Conn., Glycerin	
181224	PPC5064R1G W	0-100 psi, 1/2" Conn., Glycerin	
181225	PPC5065R1G W	0-160 psi, 1/2" Conn., Glycerin	
181226	PPC5067R1G W	0-300 psi, 1/2" Conn., Glycerin	
187776	PPC5062R1	0-30 psi, 1/2" Connection	
146839	PPC5044R1	0-100 psi, 1/4" Connection	



## Water Service Accessories

### PPC Process Gauges (Continued)

#### Single Scale with Bottom Connection

Part #	Mfg #	Range	Price
181227	PPC5141R1G W	30"/0-30 psi, 1/2" Connection	

#### Dual Scale with Bottom Connection

Part #	Mfg #	Range	Price
189429	PPC5042	0-30 psi/kPa, 1/4" Connection	
185146	PPC5084	0-100 psi/kPa, 1/4" Connection	

### PFP Premium Stainless Steel Liquid Filled Pressure Gauge

- Liquid filled stainless steel case
- Bayonet ring
- Highly accurate
- Back, bottom, or panel mounted
- Under and overload stops
- Ventable plug on 2.5" to 4.5"
- Dry case available
- ASME B40.100 compliant (EN837-1 available)
- CRN registered
- 5 year warranty



#### 4" Steel Gauge with Bottom Connection

- (-GW) Models - Glycerin Water

Part #	Mfg #	Range	Price
181243	PFP1045R1G W	30"/ 0-30 psi	
181238	PFP657R1G W	0-30 psi	
181239	PFP658R1G W	0-60 psi	
181240	PFP659R1G W	0-100 psi	
181241	PFP660R1G W	0-160 psi	
181242	PFP662R1G W	0-300 psi	
189146	PFP660R1	0-160 psi	

### 2.5" Steel Gauge with Bottom Connection

Part #	Mfg #	Range	Price
165895	PFP824DRY	0-100 psi, Dry	
244211	PFP826	0-200 psi, Liquid Filled	

### 2.5" Steel Gauge with Back Connection

Part #	Mfg #	Range	Price
165896	PFP924DRY	0-100 psi, Dry	
172134	PFP924	0-100 psi, Liquid Filled	

### PFQ Stainless Steel Liquid Filled Pressure Gauge

- Pulsation resistant, liquid filled stainless steel case
- Glycerin filled standard
- Brass, lead free brass or stainless steel internals
- Restricted orifice
- Crimp-On bezel
- Single (psi) or dual scale (psi/kPa)/(psi/bar) available
- Optional U-Clamps and front flanges
- Dry case available
- ASME B40.100 compliant
- RoHS compliant (SS internals only)
- CRN registered
- 5 year warranty



### 1.5" Pressure Gauge with Bottom Connection

Part #	Mfg #	Range	Price
190119	PFQ1105	0-160 psi, Brass Internals	
190120	PFQ1106	0-200 psi, Brass Internals	

### 2.5" Pressure Gauge with Bottom Connection

- 1/4" NPT connection

Part #	Mfg #	Range	Price
181232	PFQ802R1G W	0-30 psi, Brass Internals	
181233	PFQ803R1G W	0-60 psi, Brass Internals	
181234	PFQ804R1G W	0-100 psi, Brass Internals	
181235	PFQ805R1G W	0-160 psi, Brass Internals	



## Water Service Accessories

### PFQ Stainless Steel Liquid Filled Pressure Gauge (Continued)

#### 2.5" Pressure Gauge with Bottom Connection

Part #	Mfg #	Range	Price
181236	PFQ807R1G W	0-300 psi, Brass Internals	
184650	PFQ106	30" Hg Vac/kPa, SS Internals	

#### 2.5" Pressure Gauge with Back Connection

- 1/4" NPT connection

Part #	Mfg #	Range	Price
188078	PFQ902	0-30 psi, Brass Internals	

#### 4" Pressure Gauge with Bottom Connection

- 1/4" NPT connection

Part #	Mfg #	Range	Price
181237	PFQ702R1G W	30"/ 0-30 psi, Brass Internals	
157195	PFQ711R1	0-100 psi, Brass Internals	
187017	PFQ760	30" Hg Vac/kPa, SS Internals	

#### 4" Pressure Gauge with Bottom Connection

- 1/2" NPT connection
- Stainless steel internals

Part #	Mfg #	Range	Price
240338	PFQ1551	0-600 psi, SS Internals	

#### 4" Pressure Gauge with Back Connection

Part #	Mfg #	Range	Price
172133	PFQ1274	0-300 psi, SS Internals	

### PSQ 3A All-Purpose Quality Sanitary Gauge

- Food grade glycerin filling standard
- Electro-polish finish
- Industrial grade polycarbonate lens standard
- Clean-In-Place and steam-in-place design
- ASME B40.100 compliant
- CRN Registered
- 5 year warranty
- 0.75", 1.5" and 2" Tri-Clamp® connect bottom and back



#### 2.5" PSQ Sanitary Gauge

Part #	Mfg #	Range	Price
190135	PSQ15802	0-30 psi/bar, 1.5" Btm Connect	

### LF Series Quality Gauges

- AISI 304 Stainless steel case & ring
- Plexiglass lens
- Over-pressure limit is 25% for pressures up to 1,400 psi; 15% for pressures over 1,400 psi
- Working pressure: maximum 75% of full scale value
- OT 59 Brass movement



#### 2-1/2" LF Quality Gauge with Bottom Connection

- 1/4" NPT Connection

Part #	Mfg #	Range	Price
130267	PFQ803	0-60 psi/kPa	
130268	PFQ804	0-100 psi/kPa	
130269	PFQ806	0-200 psi/kPa	

#### 2-1/2" LF Quality Gauge with Back Connection

- 1/4" NPT Connection

Part #	Mfg #	Range	Price
187695	PFQ902LF	0-30 psi/kPa	

## Water Service Accessories

### Economy Test Gauges

- Valve body is chrome/nickel plated
- Steel case
- Adapts to 3/4" MPT
- Brass movement, socket, tube

#### 2-1/2" LF Steel Gauge with Bottom Connection

- 1/4" NPT Connection

Part #	Mfg #	Range	Price
174289	PEM214LF	0-100 psi/kPa	

### 2" Economy Gas Test Gauge



Part #	Mfg #	Range	Price
129072	PETG202	0-30#	
129073	PETG204	0-100#	

### 2-1/2" Economy Maximum Pointer Water Test Gauge

- 3/4" Swivel hose adapter
- CRN Registered
- 5-Year warranty



Part #	Mfg #	Range	Price
129197	PETM217	0-300 psi	

### PLT Low Pressure Test Kits

- Sensitive phosphor bronze diaphragm gauge
- Re-zero with external recalibration screw
- Plastic blow molded black painted steel case
- Sleek design featuring secure latch
- 2.5" White aluminum dial with red and black markings
- 1/4" Brass hose barb connection
- 5-Year warranty



Part #	Mfg #	Range	Price
129076	PLT15	0-15" water/oz/in <sup>2</sup>	

### Accessories

#### SSP Syphon

- 180° Coil
- CRN Registered
- 1-Year warranty



Part #	Mfg #	Description	Price
129967	SSP545	1/4" NPT Sch 40 Brass	
129968	SSP555	1/2" NPT Sch 40 Steel	

#### Test Plug

- Brass
- Facilitates quick pressure and temperature readings at recommended test points within process
- 1-Year warranty



Part #	Mfg #	Description	Price
141896	STP001	1/4" NPT Male Connection	
129058	STP003	2.75 OAL x 1.75" x 0.125" Probe Gauge Adapter	

#### TBR Bi-Metal Threaded Thermowell

- Allows the easy replacement of thermometers without the need to shut down or drain the system
- CRN Registered
- 1-Year warranty



Part #	Mfg #	Description	Price
130608	TBR950	1/2" NPT Brass, 7-1/2" Insertion Length, 9" Stem	
236637	TBR35	1/2" NPT Brass, 2-1/2" Insertion, 4" Stem	

#### TIW-LF Thermowell

Part #	Mfg #	Range	Price
186143	TIW01LF	3/4" LF Brass Thermowell	



## Water Service Accessories

### Thermometers

#### TBM Bi-Metal Thermometer

- A general purpose, versatile 1" to 6" dial, 304 stainless steel thermometer
- Bi-metallic sensing element
- Back, bottom or adjustable angle connection
- Welded stem length from 2.5" and up
- ±1% accuracy
- Anti-parallax dial that reduces operator reading errors (3" -6")
- Recalibrator screw is standard on all dial sizes
- ASME B40.200 compliant
- RoHS compliant
- 5 year warranty



#### 3" Dial, Fixed Center Back

Part #	Mfg #	Range	Price
174469	TBM30025B4	-40 - 160°F, 2.5" Stem	
187009	TBM30025B8	0-250°F, 2.5" Stem	
239273	TBM30040B1	50-500°F, 4" Stem	

#### TIM Industrial 9IT Thermometer

- Includes a separable thermowell
- 9" Case
- Organic filled tube (non-mercury)
- Dual scale (°F and °C)
- Vari-angle connection and 360° case rotation for easy installation
- Graphite filled bulb chamber for maximum heat conduction
- ±1% Accuracy
- 5-Year warranty



#### 3-1/2" Stem with Aluminum Case

Part #	Mfg #	Range	Price
187727	TIM101A	-40°F - 110°F	
129068	TIM102A	0°F - 120°F	
129069	TIM100A	30°F - 240°F	

#### 6" Stem with Aluminum Case

Part #	Mfg #	Range	Price
186206	TIM105-6A	30°F - 300°F	

### Hot Water Thermometer

- Measures air or water temperature
- Dial type or vertical scale type
- 1/2" NPT Process connection
- 5-Year warranty

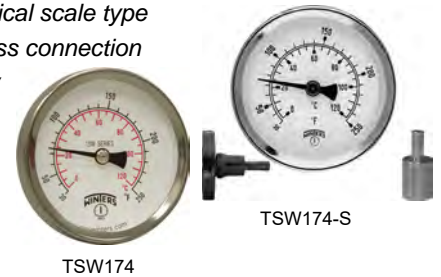

Part #	Mfg #	Description	Price
129071	TSW174	30°F - 250°F, 2" Dial	
129965	TSW174-SW	30°F - 250°F, 2" Dial with Sweat well	

### TASK Industrial 5AS Thermometer

- For use in small pipelines, tanks and other pressurized systems
- 5", Aluminum, painted white and black markings
- Brass, 1/2" NPT standard, separable thermowell
- Accuracy +/- 2% of full scale



Part #	Mfg #	Range	Price
190522	TAS131	20°F - 180°F Straight	
129074	TAS132	30°F - 240°F, Straight	
129075	TAS150	30°F - 240°F, Angle	

### Industrial 9IT Solar Digital Thermometer

- Provides a solar powered digital readout
- Low light compatible
- Durable ABS case
- Vari-angle connection
- 5-Year warranty



Part #	Mfg #	Range	Price
129070	TSD9ITSD	-50°F - 320°F	

## Water Service Accessories

### TCT Clamp-On Thermometer

- *Clamp-on steel spring*
- *For 1/2" to 4" diameter pipe*
- *Features:*
  - *2-1/2" Dial*
  - *Chrome-plated steel case*
  - *Plexiglass lens*
  - *Aluminum pointer*
  - *Bi-metal element*
  - *+/-3% Accuracy*



Part #	Mfg #	Range	Price
129964	TCT167	30°F - 240°F	

### Tridicator

- *Measures both pressure and temperature on the same dial*
- *2" Stem*
- *1-Year warranty*



#### 2-1/2" Dial Size - 1/4" NPT Connection

Part #	Mfg #	Range Conn	Price
129966	TTD404	0 - 75 psi 30°F - 240°F	Back

#### 3" Dial Size - 1/2" NPT Connection

Part #	Mfg #	Range Conn	Price
129067	TTD403	0 - 75 psi 30°F - 240°F Bottom	
129196	TTD402	0 - 75 psi 30°F - 240°F	Back
186033	TTD405	0-200 psi 70°F-320°F Bottom	
136488	TTD398	0 - 250 psi 60°F - 240°F	Back

### Thermowell

Part #	Mfg #	Description	Price
129808	TTW050	1/2" Brass Thermowell	

**Water Service Accessories**

**Century® PVC Submersible Pump Cables**

Flat Double Insulated Cable - 3 Conductor with Ground

• 600V



Part #	Mfg #	Size AWG/Cond	Copper Const.	Ground AWG	Insulation Thickness	Jacket Thickness	Ft/Reel	Price
003231	31712500	12/3	65 x 30	12	45mils	30mils	500'	

## Water System Accessories

### Tank Accessories

- Recommended for all cold water system installations to protect against damage to piping and pressure tanks

#### Field Adjustable Pressure Relief Valve

- Set at 75 psi - field adjustable to 150 psi
- PRVNL Prefix: No lead brass construction



Part #	Mfg #	Inlet x Outlet	Ctn Qty	Ctn Weight	Price
006654	PRV50	1/2" x 1/2"	10	3.5 lbs	
006655	PRV75	3/4" x 1/2"	10	3.8 lbs	

### Air Valve

- Complete with valve core and plastic cap
- Provides method of injecting and holding air in pneumatic water systems
- Air valve with standard core spring



Part #	Mfg #	Size	Price
006701	SV-125	1/8"	
006702	SV-250	1/4"	

### Check Valves

#### Merrill 800 Series Red Brass Check Valve

- Valve body and poppet assembly are cast red brass
- Abrasion resistant o-ring is precision fitted to the poppet for a positive seal into the tapered self cleaning valve seat
- Check valve has Delrin guide bearing for the poppet stem assures smooth, noise-free valve operation
- Can be used in both vertical & horizontal positions

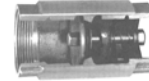

Part #	Mfg #	Pipe Size	Approx Weight	Dia	Length	Ctn Qty	Master Ctn Qty	Price
006567	CV75	3/4"	0.57 lbs	1.43"	2.87"	7	70	
006563	CV100	1"	0.86 lbs	1.75"	3.25"	10	60	
006564	CV125	1-1/4"	1.28 lbs	2.25"	3.87"	5	40	
006565	CV150	1-1/2"	1.65 lbs	2.50"	4.25"	5	30	
006566	CV200	2"	2.89 lbs	3.12"	5.00"	4	20	

### Drive Well Points & Accessories

#### Drive Coupling

- For threaded pipe to drive well points



Part #	Mfg #	Pipe Size	Coupling Length	Material	Approx Weight	Price
006568	DRCOUP125	1-1/4"	2-3/4"	Galv Steel	0.9 lbs	



## Water System Accessories

### Drive Point



Part #	Mfg #	Pipe Size	Coupling Length	Material	Approx Weight	Price
006570	DWP1253660S	1-1/4"	36"	60	7.5 lbs	

### Drop Pipe Couplings

- For threaded pipe to submersible pump
- Chamfered ends for quick easy starting of threads
- Tapered pipe threads for positive watertight connection

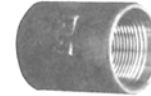

#### Brass

Part #	Mfg #	Pipe Size	Cplg Length	Price
006552	BDC100	1"	2-1/2"	
006553	BDC125	1-1/4"	2-1/2"	

### Heavy Sch 80 PVC

Part #	Mfg #	Pipe Size	Cplg Length	Price
012280	PDC100	1"	2-3/4"	

### Extra Heavy Sch 120 PVC

Part #	Mfg #	Pipe Size	Cplg Length	Price
012866	PDCH125	1-1/4"	2-3/4"	

### Foot Valves

#### Merrill 810 Series Red Brass Foot Valve

- 1-15/16" Dia Stainless steel strainer
- Valve body and poppet assembly are cast red brass
- Abrasion resistant o-ring is precision fitted to the poppet for a positive seal into the tapered self cleaning valve seat
- Check valve has Delrin guide bearing for the poppet stem assures smooth, noise-free valve operation
- Can be used in both vertical & horizontal positions



Part #	Mfg #	Pipe Size	Approx Weight	Length	Ctn Qty	Master Ctn Qty	Price
006579	FV100	1"	0.65 lbs	5.00"	10	60	
006580	FV125	1-1/4"	0.97 lbs	5.50"	5	50	

## Water System Accessories

### 110 Series Plastic Foot Valve

- All spring loaded
- Horizontal or vertical
- Non-corrosive check valve
- Nose cone design reduces turbulence
- Individually pressure tested
- Molded of polymer materials
- Working pressure: 200 psi



Part #	Mfg #	Size	Stand Pipe	Approx Weight	Overall Length	Price
123950	FVB125	1-1/4"	Horizontal or Vertical	0.38 lbs	6.67"	

### Splice Kits

#### Heat Shrink Tubing

- Inside adhesive in shrink tube bonds to splice

#### Extra Heavy Black Tubing Splice Kit

Part #	Mfg #	Tube Qty	Tubing Size	Crimp Qty	Crimp Conn	Wire Sizes	Approx Weight	Price
006556	BSKEH5033	3	1/2" x 3"	3	1014	#10 - 12 - 14	0.04 lbs	
020307	BSKEH50344	4	1/2" x 3"	4	1014	#8 - 10 - 12	0.06 lbs	

### Pitless Units, Kits & Adapters

#### Red Brass Pitless Adapter

- Brass male part of adapter is tapered for easy connection of female and male parts
- Brass female part is tapered for tight connection and easy removal
- Replaceable o-ring seal in solid brass casing
- Molded gasket for positive outside seal on discharge, plus o-ring or gasket glued in place, for seal on inside of casing
- Solid brass collar made for perfect fit and positive seal between molded gasket to discharge and outside of casing to insure sanitary watertight seal to casing
- Extra-wide solid brass nut to accommodate wrench for easier installation



MB50



MB125



MB200

Part #	Mfg #	Drop & Discharge	Discharge Length	Casing Sizes	Will Support	Hole Saw	Approx Weight	Ctn Qty	Price
006600	MB50	1" Brass	1.8" Long Model	5" - 8"	300'	1-3/4"	2.4 lbs	4	
006598	MB125	1-1/4"	1.8" Long Model	5" - 8"	300'	2-1/16"	5.0 lbs	2	
006599	MB200	1" Brass	1.8" Long Model	5" - 8"	400'	1-3/4"	2.8 lbs	4	



## Water System Accessories

### Pressure Switches & Gauges

#### Pressure Gauge

- Suitable for air, steam and other pressure applications that will not deteriorate brass

Part #	Mfg #	Dial Size	Pressure Range	Master Conn	Description	Price
006634	PG100	2"	0-100 psi	1/4" NPT Brass	Plastic Case, Bottom-Mount	

#### Merrill Pressure Switch



Part #	Mfg #	Preset Settings	Price
060597	MPS2040	20/40 psig	
060599	MPS3050	30/50 psig	
060600	MPS4060	40/60 psig	

#### Low Water Cut-Off Pressure Switch

- Auto start, manual start or off lever



Part #	Mfg #	Preset On	Preset Off	Price
079897	MPSM43050	On @ 30 psi	Off @ 50 psi	

#### Class 9013 Square D Pressure Switch

- Diaphragm actuated
- Standard action: contacts open on rising pressure
- Connection: 1/4" NPSF internal

#### Pressure Switch for Pumping Applications



Part #	Mfg #	Cut-Out Range	Approx Adj Diff	Preset Settings	Price
006572	FSG2M420	34-65 psig	15-30 psig	20/40 psig	

## Water System Accessories

### Pressure Switch for Heavy Duty Pumps & Air Compressors



Part #	Mfg #	Cut-Out Range	Approx Adj Diff	Preset Settings	Approx Weight	Ctn Qty	Price
006582	GHG260	65-200 psig	20-40 psig	60/80 psig	2.25 lbs	1	

### Tank Tees, Kits, & Accessories

#### Brass & Red Brass Fabricated Tank Tee

- No nipples included
- Rough brass
- Brass castings and Type L copper tube soldered with no lead solder



Part #	Mfg #	Tank Connection	Lateral	Overall Length	Drain Hole	Approx Weight	Price
006551	BAT125XL	1-1/4" MIP	1-1/4" MIP & 1" FIP	16"	(1) 3/4"	2.4 lbs	

#### Brass & Red Brass All-Cast Tank Tee

- No nipples included
- One-piece cast brass tank tees



BAT100C



BAT1025



BAT1252

Part #	Mfg #	Tank Connection	Lateral	Overall Length	Drain Hole	Approx Weight	Price
006547	BAT100C	1" MIP	1" MIP & 3/4" FIP	11"	(2) 1/2"	2.0 lbs	
023937	BAT100CS	1" MIP	1" MIP & 3/4" FIP	5"	(2) 1/2"	1.2 lbs	
006549	BAT1025	1-1/4" MIP & 1" FIP	1" MIP & 3/4" FIP	5"	(1) 3/4"	1.4 lbs	
040899	BAT1252	1-1/4" MIP & 1" FIP	1-1/4" MIP & 1" FIP	4"	(2) 3/4"	1.7 lbs	

#### Brass Compact Tank Tee



Part #	Mfg #	Tank Connection	Lateral	Overall Length	Drain Hole	Approx Weight	Price
113025	BCT100	1" FIP	1" FIP	2.5"	(1) 1/2"	0.73 lbs	

## Water System Accessories

### Arrestors

#### Deluxe Torque Arrestor

- *Installed directly above submersible pump*
- *Protects pump from starting torque damage*
- *Clamps 1" or 1-1/4" drop pipe and adjusts to fit 4" through 8" well casing*
- *Two-piece construction*
- *FDA Approved compounds in material*



Part #	Mfg #	Description	Length	Qty	Approx Weight	Price
006700	STA48C	All Stainless Steel, Clamps Included	11-3/4"	20	1.5 lbs	

## Water System Tanks

### Water Systems Products

#### Well-X-Trol® Pressurized Diaphragm Well Tank

- 100% Non-metallic water reservoir
- Heavy-duty butyl diaphragm meets FDA requirements for potable water supply
- Rigid water reservoir is 100% corrosion resistant
- Unique diaphragm seal ring
- Stainless steel system construction
- Maximum operating temperature: 200°F
- Maximum working pressure: 150 psig
- Factory pre-charged: 38 psig
- 7-Year warranty



#### WX Well-X-Trol® In-Line Well Tank

Part #	Mfg #	Dia	Height	Volume	Price
012151	WX-101	8"	12-5/8"	2.0 gal	
012152	WX-102	11"	15"	4.4 gal	
012153	WX-103	11"	22-3/4"	7.6 gal	

#### WX Well-X-Trol® Vertical Well Tank

Part #	Mfg #	Dia	Height	Volume	Price
012155	WX-201	15-3/8"	25"	14.0 gal	
012156	WX-202	15-3/8"	31-5/8"	20.0 gal	
012157	WX-203	15-3/8"	46-1/2"	32.0 gal	
012159	WX-250	22"	36"	44.0 gal	
012160	WX-251	22"	46-3/4"	62.0 gal	
012161	WX-302	26"	47-1/4"	86.0 gal	
012162	WX-350	26"	61-7/8"	119.0 gal	

#### WEL-FLO® Precharged Water Stand System Tanks

- 125 PSI Max Working Pressure
- Stainless Steel System Connection
- Fresh Water Turbulator™
- Heavy Duty Diaphragm
- Polypropylene Liner
- Projection-Welded Air Stem
- Welded Steel Base
- Lead-Free Construction



Part #	Mfg #	Dia	Height	Volume	Price
221813	ATWF119	26"	62"	119 gal	

### Water Systems Accessories

#### Tube Hangers - 601 Series



Part #	Mfg #	Diameter	Price
227433	601-1	1/2"	
227434	601-2	3/4"	
144546	601-3	1"	
145047	601-4	1-1/4"	

#### MINI-TROL® Water Hammer Arrestor

- Non-Metallic Internals
- Sealed Air Charge
- Easy Installation



Part #	Mfg #	Dia	Height	Volume	Price
223084	AT513P01	3-3/8"	4"	N/A	

**Reverse Osmosis Systems**

**Reverse Osmosis Systems**

**Reverse Osmosis System**

- 4-Stage
- (1) 5 Micron sediment filter
- (1) 5 Micron carbon block filter
- Produces 50 gallons per day
- (1) 6" GAC inline filter
- 3 Gallon steel water storage tank
- NSF Certified Standard 58



Part #	Mfg#	Model	Description	Price
142207	7100103	PWRO4	4-Stage	

**Kwik-Change™ Reverse Osmosis System**

- 4-Stage
- (1) 5 Micron sediment filter
- (1) Carbon block filter
- (1) Membrane filter
- (1) GAC Inline filter
- Produces up to 60 gallons per day
- Long reach faucet for easy fill
- Kwik-Change™ cartridges
- 1/4-Turn pivot filter head
- Space saving design installs under sink or in limited space
- Adapt-A-Valve™ easily connects to water source for 3/8" compression or 1/2" NPT
- Automatic shutoff
- 3 Gallon water storage tank
- NSF Certified Standard 58



Part #	Mfg#	Model	Description	Price
150184	7100107	PWROKC4	4-Stage	

## Reverse Osmosis Systems

### Eclipse™ Reverse Osmosis Drinking Water System

- Designed to provide the cleanest, healthiest water possible
- Multiple filters clean ordinary household water to reduce unwanted and harmful contaminants
- System performance is verified with a touch monitor on the system's faucet base
- Installation is simple - no electricity needed



Part #	Mfg #	Description	Price
063049	WRO-35	Eclipse™ RO Unit	

### Impression Series® Reverse Osmosis Drinking Water System

- Pre filter contains activated carbon that reduces chlorine and captures large particles, such as silt, rust or scale
- Membrane traps and removes particles too small for the pre filter to catch
- Dissolved solids and other contaminants are flushed out of the system
- Two final carbon filters remove any remaining tastes and odors
- Holding tank stores approximately two gallons of fresh, clean water



Part #	Mfg #	Description	Price
136684	CTFC400	50 gpd RO System	

### Filters

Part #	Mfg #	Description	Price
081202	S7206W-JG	Filter	

### Impression Series® Air Sulfur & Air Iron Filter

- Extremely effective in removing hydrogen sulfide and iron, commonly associated with problem well-water
- Uses a unique air-injection filtering technology to oxidize sulfur or iron into precipitates that can be readily filtered and removed
- Environmentally safe - no toxic chemicals are used

Part #	Mfg #	Mineral cu ft	Gravel Amount	Peak Flow	Total Dimensions	Price
107075	IMB-1054-ME	1.0 Birm	14 lb 1/4 x 1/8	10.0 gpm	52"H x 10"W	

#### Pre filter

Part #	Mfg #	Description	Price
091413	CS7028	Pre filter	
066878	CS7128X	Pre filter	

#### Post filter

Part #	Mfg #	Description	Price
091415	CS7025	Carbon Post Filter	
066879	CS7125X	Post Filter	



## Water Conditioners

### Water Conditioners

#### ClearWave® Water Conditioner

- *Maximum pipe diameter: 1"*
- *Maximum flow rate: 28 gpm*
- *Works without chemicals, salt or plumbing to eliminate scale build-up and prevent scale formation*



Part #	Mfg #	Volts	Watts	Amps	Price
146787	CW-125	18VAC	5	.09A	

## Water Filter Cartridges

### Inline Filter Cartridges

#### In-Line Filter for Reverse Osmosis Systems

- Connection size: 1/4" FNPT
- For residential ice makers, refrigerators, drinking fountains, coffee and tea brewers, motor homes and campers
- Final polishing filter
- Reduces bad taste and odor
- Acid wash coconut shell
- Flow rate: 0.75 gpm



Part #	Mfg#	Model	Lgth	Conn Size	Price
146805	7100453	PWILGAC6	6	1/4" FNPT	
150174	7100454	PWILGAC10	10"	1/4" FNPT	

### Water Filtration System Filters

#### PWMEM Standard Residential RO Membrane

- 25-100 Gallon per day replacement RO membrane



Part #	Mfg#	Order #	Size	Qty	Price
153293	7100122	PWMEM50			

#### PWMEMKC60 Replacement Filter

- 60 Gallon per day replacement RO membrane



Part #	Mfg#	Order #	Size	Qty	Price
153294	7100125	PWMEMKC60			

### Replacement Filter Kit

Part #	Mfg#	Model	Description	Price
142216	7100110	PWFPKSEDCB	Water Guard	
150181	7100111	PWFPKLCV	2-Pk LCV	

### Replacement Filter Kit for Kwik-Change™ Ultra Systems



Part #	Mfg#	Model	Description	Price
150179	7100116	PWFPK2KC4	4-Stage	
150183	7100118	PWFPKKCUF	3-Stage	
155993	7100462	PWKCGAC13	GAC	

### Drinking Water Filtration Systems

#### Under Counter Water Filtration System

- 2-Stage
- (1) 5 Micron sediment filter
- (1) Carbon block filter
- Chrome faucet
- Adapt-A-Valve™
- NSF Certified Standard 58



Part #	Mfg#	Model	Description	Price
146818	7100101	PWDWLCV2	2-Stage LCV	

#### Kwik-Change™ Ultra Filtration Membrane Water Filtration System

- 3-Stage
- (1) 5 Micron sediment filter
- (1) Carbon block filter
- (1) UF Membrane filter
- Long reach faucet for easy fill
- Kwik-Change™ cartridges
- 1/4-Turn pivot filter head
- Space saving design installs under sink or in limited space
- Double Seal o-ring cartridges ensure system integrity
- No storage tank needed
- NSF Certified Standard 58



Part #	Mfg#	Model	Description	Price
150182	7100106	PWDWUFKC3	3-Stage	

## Water Filter Cartridges

### Melt Blown Filter Cartridges

#### 10" Melt Blown Filter Cartridge

- For standard filter housings
- 2-1/2" OD x 9-7/8" Length
- Reduces dirt, sediment, rust and particles
- Food grade for use with beverages, food and potable water



Part #	Mfg#	Model	Size	Micron Rating	Price
146819	7100331	PWMB10M5	10"	5 Mic	
150170	7100335	PWMB10M50	10"	50 Mic	

### String Wound Filter Cartridges

#### 10" String Wound Filter Cartridge

- For standard filter housings
- 2-1/2" OD x 9-7/8" Length
- Reduces dirt, sediment, rust and particles
- Food grade for use with beverages, food and potable water



Part #	Mfg#	Model	Size	Micron Rating	Price
146815	7100357	PWSW10M5	10"	5 Mic	
146816	7100359	PWSW10M50	10"	50 Mic	

#### 20" Melt Blown Filter Cartridge

- For standard filter housings
- 2-1/2" OD x 20" Length
- Reduces dirt, sediment, rust and particles
- Food grade for use with beverages, food and potable water



Part #	Mfg#	Model	Size	Micron Rating	Price
154627	7100337	PWMB20M5	20"	5 Mic	

#### 20" String Wound Filter Cartridge

- Low cost
- Food grade ingredients for potable water
- No leachables to contaminate downstream
- Wide range of lengths and micron ratings
- Cartridges with stainless steel center tubes for higher temperature applications



Part #	Mfg#	Model	Size	Micron Rating	Price
158535	7100375	PWSWB20FFM5 20"		5 Mic	

#### 20" Melt Blown Filter Cartridge for Full-Flow Filter Housings

- For full flow filter housings
- 4-1/2" OD x 20"
- Reduces dirt, sediment, rust and particles
- Food grade for use with beverages, food and potable water



Part #	Mfg#	Model	Size	Micron Rating	Price
148591	7100353	PWMB20FFM5	20"	5 Mic	

#### 10" Big Blue String Wound Filter Cartridge

- For standard filter housings
- 4-1/2" OD x 9-3/4" Length
- Reduces dirt, sediment, rust and particles
- Food grade for use with beverages, food and potable water



Part #	Mfg#	Model	Size	Micron Rating	Price
148020	7100349	PWSW10BBM5	10"	5 Mic	

## Water Filter Cartridges

### Pleated Filter Cartridges

#### 10" Pleated Filter Cartridge

- For standard filter housings
- 2-3/4" OD x 9-3/4" Length
- Reduces dirt, sediment, rust and particles



Part #	Mfg#	Model	Size	Micron Rating	Price
146814	7100387	PWPL10M1AB	10"	1AB Mic	
146811	7100391	PWPL10M20	10"	20 Mic	
148792	7100392	PWPL10M50	10"	50 Mic	

#### 10" Big Blue Pleated Filter Cartridge

- For standard filter housings
- 4-1/2" OD x 9-3/4" Length
- Reduces dirt, sediment, rust and particles



Part #	Mfg#	Model	Size	Micron Rating	Price
153732	7100410	PWPL10FFM5	10"	5 Mic	
150172	7100411	PWPL10BBM20	10"	20 Mic	
148800	7100412	PWPL10BBM50	10"	50 Mic	

#### 20" Big Blue Pleated Filter Cartridge

- For standard filter housings
- 4-1/2" OD x 20" Length
- Reduces dirt, sediment, rust and particles



Part #	Mfg#	Model	Size	Micron Rating	Price
170037	7100417	PWPL20FFM20	20"	20 Mic	

### Carbon Filter Cartridges

#### Big Blue Water Washed Coconut Shell Granular Activated Carbon Cartridge

- Minimum working pressure: 20 psi
- Maximum working pressure: 125 psi



Part #	Mfg#	Model	Description	Price
146812	7100444	PWGAC10BB	4-1/2" x 9-3/4"	

#### Premium Carbon Block Filter Cartridge

- Maximum working pressure: 125 psi
- Mincron rating: 5 Mic
- Low-pressure drop
- 100% coconut shell carbon
- Up to 90% chlorine reduction



Part #	Mfg#	Model	Description	Price
146813	7100446	PWCB10P	2-1/2" x 9-3/4"	

#### Big Blue Premium Carbon Block Filter Cartridge

- Maximum working pressure: 125 psi
- Mincron rating: 5 Mic
- Low-pressure drop
- 100% coconut shell carbon
- Up to 90% chlorine reduction



Part #	Mfg#	Model	Description	Price
150163	7100448	PWCB10BBP	4-1/2" x 9-3/4"	
150173	7100449	PWCB20BBP	4-1/2" x 20"	

#### Carbon Block Filter Cartridge

- 2-1/2" OD x 10" Length



Part #	Mfg#	Model	Description	Price
146820	7100451	PWCB10LCV	Lead, Cysts, VOC	

## Water Filter Cartridges

### Water Washed Coconut Shell GAC Replacement Cartridge

- Granular Activated Carbon (GAC)
- 2-3/4" OD x 9-3/4"



Part #	Mfg#	Model	Description	Price
146803	7100442	PWGAC10	10"	
166943	7100445	PWGAC20FF	20"	

### Filter Housings

#### Individual Boxed Plastic Housing

- Heavy-duty construction, made using high-quality FDA grade polypropylene
- Superior chemical resistance from many aggressive chemicals
- Buttress thread design for superior security
- Thick side walls with heavy-duty ribs to provide greater strength
- Temperature rated to 125°F (52°C)
- Cap, sump and top-seated o-rings compress to provide leak proof sealing



Part #	Mfg#	Model	Description	Price
150178	7100268	PWHIB10BB	10" Big Blue	
150176	7100269	PWHIB20BB	20" Big Blue	

#### Big Blue Filter Cartridge Housing

- For 4-1/2" OD cartridges
- Black cap



Part #	Mfg#	Model	Description	Price
146810	7100287	PWHP10BB1B	1" x 10"	
150161	7100288	PWHP10BB1BPR	1" x 10"	

### Filter Housing Bracket

- Heavy duty steel
- 10" x 20"



Part #	Mfg#	Model	Description	Price
146806	7100463	PWMBSTD1	Standard Single	
153730	7100466	PWMBFF1	Full Flow Single	

### Filter Housing Wrench



Part #	Mfg#	Model	Description	Price
146809	7100298	PWWRSTDHSG	Standard	
153159	7100299	PWWRFFHSG	Full Flow	

**Water Filter Cartridges**

**Housings**

**Slim Line® Housing**

- 3/8" NPT Inlet/outlet
- Pressure relief button
- WMB38 Mounting bracket included
- 4-1/2" Diameter
- Cartridge not included



Part #	Mfg #	Model #	Description	Price
001138	152007	W385-PR	Gray, 7" Long	

**Standard Housing**

- 3/4" NPT Inlet/outlet
- Pressure relief button
- Accepts a wide variety of 2-1/2" to 3" diameter cartridges
- 12-1/4" x 5-1/8" Overall dimensions
- Cartridge not included



Part #	Mfg #	Model #	Description	Price
001109	152018	WC34-PR	Clear	

**Valve-In-Head Housing**

- Closes both the inlet & outlet port simultaneously w/half turn of the handle
- 3/4" NPT inlet/outlet
- Pressure relief button
- Accepts a wide variety of 2-1/2" to 3" diameter cartridges
- 12-1/4" x 5-1/4" Overall dimensions



Part #	Mfg #	Model #	Description	Price
001120	152003	WVC34	Clear	

**Heavy-Duty Housing**

- Large capacity housing designed for whole house & high-flow applications
- Pressure relief button
- Accepts large capacity 4-1/2" diameter cartridges
- Cartridge not included



Part #	Mfg #	Model #	Sump	I/O NPT	Price
001126	152014	W10-PR	Gray	1"	

**Housing Parts & Accessories**

**Standard Housing Bracket**

- For 3/4" housings
- Kit includes bracket & screws
- Constructed of zinc-plated steel



Part #	Mfg #	Model #	Use With:	Price
001117	152040	WMB34	3/4" Inlet/Outlet	

**Heavy-Duty Housing Bracket**

- For 3/4" housings
- Kit includes bracket & screws
- Constructed of zinc-plated steel



Part #	Mfg #	Model #	Use With:	Price
023980	150061	WMB20	For 10" or 20" HD Housing	

**Spanner Wrench**

- Use to loosen sump when changing cartridges



Part #	Mfg #	Model #	Use With:	Price
001123	152037	WW34	3/4" Std & Valve-In-Head	
001122	152039	WWHD	1" & 1-1/2" HD 10" Opaque	

**Sediment Cartridges**

**Spun Polypropylene Sediment Cartridge**

- Manufactured from pure 100% polypropylene
- Spun fibers provide a gradient density from the outer surface to inner core
- High dirt-holding capacity and superior sediment filtration
- Excellent bacteria and chemical resistance
- Dimensions: 2-3/8" Dia x 9-7/8" Length



Part #	Mfg #	Model #	Micron Rating	Max Flow Rate	Price
001141	155014-52	W5P	5	10 gpm	



**Water Filter Cartridges**

**Pleated Cellulose Sediment Cartridge**

- Economically priced
- Pleated design maximizes dirt-holding capacity
- Nominal 5-micron rating for cellulose/polyester cartridges
- Designed for municipal/chlorinated water
- Good for general purpose filtration
- Dimensions: 2-5/8" Dia x 9-3/4" length



Part #	Mfg #	Model #	Micron Rating	Max Flow Rate	Price
001129	155001-52	W20CLA	20	12 gpm	

**Carbon Impregnated Cellulose Cartridge**

- Economically priced
- Dual purpose cartridge provides bad taste/odor/chlorine: taste and odor reduction as well as sediment filtration
- Design maximizes dirt holding capacity
- For municipal/chlorinated water
- Recommended for point of use filtration



Part #	Mfg #	Model #	Max Flow Rate	Length	Price
002022	155022-52	W5CIP478	1 gpm	4-7/8"	
001139	155002-52	W5CIP	5 gpm	9-3/4"	

**Pleated Cellulose Heavy-Duty Cartridge**

- Economically priced
- Pleated design maximizes dirt-holding capacity
- Nominal 5-micron rating for cellulose/polyester cartridges
- Designed for municipal/chlorinated water
- Good for general purpose filtration
- Dimensions: 4-1/2" Dia x 9-3/4" length



Part #	Mfg #	Model #	Micron Rating	Max Flow Rate	Price
001140	155184-51	W5CPHD	5	20 gpm	

**Granular Activated Carbon (GAC) Cartridge**

- Effective taste/odor/chlorine, taste & odor reduction
- Cartridge design ensures that water passes through entire length of the carbon bed maximizing contact time
- Nominal 20-micron post filter reduces carbon fines and suspended carbon



Part #	Mfg #	Model #	Max Flow Rate	Length	Price
001108	155155-51	WCC	1 gpm	9-3/4"	

**Taste & Odor Cartridges**

**Radial Flow Carbon Cartridge**

- Ideal for whole house & other high flow rate applications
- Unique design & nominal 25-micron inner wrap reduces carbon fines
- Effectively reduces bad taste, odor & chlorine
- Granular activated carbon
- 4-1/2" Diameter



Part #	Mfg #	Model #	Max Flow Rate	Length	Price
001119	155141-51	WRC25HD	3 gpm	9-3/4"	

**Refrigerator/Ice Maker Filters**

**Quick-Connect Inline Filter**

- Ideal for refrigerator ice makers & water dispensers, coffee makers & other in-line applications
- Granular activated carbon removes chlorine, taste & odor, bad taste & odor from water
- WICS Includes phosphate crystals to prevent lime/scale build-up
- Quick-connect fittings attach easily to 1/4" copper or plastic cold water lines
- Pressure rated to 125 psi, polyester pre- & post-filters



Part #	Mfg #	Model #	Description	Price
001115	155083-51	WICSA	2" Dia x 10" L	

---



---

**Water Filter Cartridges**

---



---

**Drinking Water Systems**

**DW-600 Quick-Change Under-Sink Drinking  
Water System**

- 1/4" Comp Inlet/outlet
- Works with copper, plastic or flex tubing
- Capacity: 500 gal
- 3" x 3" x 13.5"
- 0.5 Micron reduces lead, cysts, Lindane, Atrazine, chlorine taste & odor, sediment



Part #	Mfg #	Model #	Description	Price
146322	155785-51	600R	Cartridge	

## Water Softeners

### Impression® Series Water Conditioners

#### Impression Series® Metered Water Conditioner

- *Monitors and self-adjusts regeneration cycles based on household trend of water consumption*
- *Flexible adjustable cycle sequence programming - saves salt and water*
- *Features an optional weather cover for outdoor installations*
- *Extended lithium battery backup*
- *Includes Brass Yoke & Bypass*



Part #	Mfg #	Max Capacity (Grains/Lbs NaCl)	Peak Flow Rate (GPM @ P-PSI)	Media (Cu Ft)	Dimensions		Price
					Media Tank	Brine Tank	
073582	IM-844ME	25,600 @ 9.0	11.4 @ 15.0	0.85	52"H x 8"W	33"H x 18"W	
065079	IM-1044ME	32,000 @ 15.0	17.1 @ 15.0	1.0	52"H x 10"W	33"H x 18"W	
068733	IM-1054ME	48,800 @ 21.0	14.3 @ 15.0	1.5	62"H x 10"W	40"H x 18"W	
066032	IM-1354ME	72,800 @ 24.0	18.5 @ 15.0	2.5	62"H x 13"W	40"H x 18"W	
160777	IMPC-1035ME	28,000 @ 15.0	16.0 @ 15.0	2.2	44.5"H x 14"W	-	

#### Impression® Series Softener

- *Solid-state microprocessor control*
- *Meter monitors and self-adjusts regeneration cycles based on household trend of water use*
- *Easily programmed for optimum performance*
- *Extended lithium battery backup*
- *Flexible "adjustable cycle sequence" programming — saves salt and water*
- *Advanced history and diagnostic screens*
- *Less Yoke*



Part #	Mfg #	Max Capacity (Grains/Lbs NaCl)	Peak Flow Rate (GPM @ P-PSI)	Media (Cu Ft)	Dimensions		Price
					Media Tank	Brine Tank	
224603	IM-844	25,600 @ 9.0	11.4 @ 15.0	.85	8"W X 52"H	18"W x 33"H	
224605	IM-1044	32,000 @ 15.0	17.1 @ 15.0	1.0	10"W x 52"H	18"W x 33"H	
224604	IM-1054	48,800 @ 21.0	14.3 @ 15.0	1.5	10"W x 62"H	18"W x 33"H	
224602	IM-1354	72,800 @ 24.0	18.5 @ 15.0	2.5	13"W x 62"H	18"W x 40"H	
125944	IMC-1035	32,000 @ 15.0	17.1 @ 15.0	1.0	42.5"H x 13.5"W	-	

## Water Softeners

### Impression Series® RC Water Conditioner

- Unique "mid-plate" design allows the use of activated carbon and high capacity resin in one tank
- Removes hardness
- Removes chlorine and associated odors
- Softens household water using minimal salt and water
- LY models = Less Yoke

Part #	Mfg #	Max Capacity (Grains/Lbs NaCl)	Peak Flow Rate (GPM @ P-PSI)	Resin Media (Cu Ft)	Carbon Media (Cu Ft)	Dimensions		Price
						Media Tank	Brine Tank	
144557	IMRC-1054	32,000 @ 15.0	15.6 @ 15.0	1.0	0.5	62"H x 10"W	33"H x 18"W	
224606	IMRC-1054LY	32,000 @ 15.0	15.6 @ 15.0	1.0	0.5	62"H x 10"W	33"H x 18"W	

### Sanitizer Plus Series® Water Conditioners

- Exclusive Crystal-Right™ media to remove hardness, iron and manganese, correct pH and control odor
- Patented self-chlorinator technology for bacteria control
- Single unit operation - no chemicals or added equipment
- Visual and audible "Check Salt" indicator
- Extended lithium battery backup
- Flexible "adjustable cycle sequence" programming - saves salt and water
- Features an optional weather cover for outdoor installations
- MP Suffix = preloaded Min-Plus mineral pack



Part #	Mfg #	Max Capacity (Grains/Lbs NaCl)	Peak Flow Rate (GPM @ P-PSI)	Media (Cu Ft)	Dimensions		Price
					Media Tank	Brine Tank	
144566	ASP213540002	60,300 @ 26.5	19 @ 15.0	2.5	62"H x 13"W	40"H x 18"W	
066034	ASP21054ME	34,800 @ 15.9	17 @ 15.0	1.5	62"H x 10"W	33"H x 18"W	
070400	ASP21054MEM P	60,300 @ 26.5	19 @ 15.0	2.5	62"H x 13"W	40"H x 18"W	
066803	ASP21354MEM P	34,800 @ 15.9	17 @ 15.0	1.5	62"H x 10"W	33"H x 18"W	

### Viqua® Home Plus UltraViolet Water Disinfection System

#### Viqua® VH410M UV Water Purification System

- Stainless steel
- Flow rate: 18 gpm
- Power consumption: 60 watts
- 3/4"-1" COMBO NPT connection
- VH410M replaces the Sterilight SSM-37, SSM-39, SCM-200, SCM-320, SP320-HO and SP410-HO systems



Part #	Mfg #	Dimensions	Finish	Power Source	Voltage	Price
224768	VH410M	23-1/2" x 3-1/2"	Stainless Steel	AC	120V	

**Water Softeners**

**Electric Water Softeners**

**Water-King WK-1 Electric Water Softener**

- *Designed to meet the needs of an individual or small family with a home of 1,000 sq ft or less*
- *Transmits a series of low-frequency random sequenced radio waves ranging from 1 to 10kHz, pre-selected and controlled by micro-chip technology*
- *110V Power source is transformed to 12-18V and draws a maximum of 800mA with an antenna transmission of .75W*
- *Includes 110/9V CSA/UL approved transformer*



Part #	Mfg #	Description	Price
148094	WK-1	Water Softener	



---

---

## Water Treatment Chemicals

---

---

### Pellet Salt

Part #	Mfg #	Description	Price
009801	SALT50LBP	50 lb	





---

---

## Water Treatment Chemicals

---

---

### Pellet Salt

Part #	Description	Price
009802	50# Bag Solar Salt	



## Miscellaneous Water Works

### Miscellaneous

#### Utility Vent

- Double outlet design
- Non-potable
- Ideal for use in industrial applications or with traffic control signals
- Iron body, brass screens
- FNPT end connections



Part #	Mfg #	Size	Price
002243	908	1"	

### Insert Stiffeners

#### Stainless Steel Insert Stiffener for Polyethylene Tubing



Part #	Mfg #	Size	Price
041161	6133T	3/4"	
041162	6133T	1"	
112644	6133T	1-1/4"	
112643	6133T	1-1/2"	
107690	6133T	2"	

## Water Meters

### T-10 Meters

- Register
  - Magnetic drive, low torque registration
  - Impact-resistant register
  - High resolution, low flow leak detection
  - Bayonet style register mount
  - Tamperproof seal pin deters theft
- EnviroBrass™ II maincase
  - Lifetime guarantee
  - Resists internal pressure stresses & external damage
  - Handles in-line piping variations & stresses
  - Electrical grounding continuity
- Nutating disc measuring chamber
  - Positive displacement
  - Widest effective flow range for maximum revenue
  - Proprietary polymer materials
  - Floating chamber design is unaffected by meter position or in-line piping stresses



Part #	Mfg #	Description	Price
007737	T-10	5/8" Pro-read Cu ft Meter 2bd	
007736	T-10	3/4" Pro-read Cu ft Meter 2bd	
007734	T-10	1" Pro-read Cu ft Meter 2bd	
007735	T-10	1-1/2" Pro-read Cu ft Meter 2bd	
047865	T-10	2" Pro Read Cu ft Meter 2bd	

### T-10 Parts

Part #	Mfg #	Description	Price
053553	FLG200	2" Bronze Flange Set	



## Water Meters

### Meter Valves

#### Angle Plug Lockwing (Fir x Meter)



Part #	Mfg #	Size	Price
157388	74602	3/4"	
157389	74602	1"	
157390	74602	1" x 3/4"	

#### Angle Plug Lockwing (CTS x Meter)

Part #	Mfg #	Size	Price
158238	74602-22	1"	
160116	74602-22	1" x 3/4"	

#### Angle Stop Valve (Flare x FNPT)

- No lead



Part #	Mfg #	Size	Price
157494	5420-078	3/4" x 3/4"	

#### Straight Meter Coupling with Hole (Swivel x MNPT)



Part #	Mfg #	Size	Price
157385	74620	5/8"	
156330	74620	5/8" x 3/4"	
157386	74620	3/4"	
157387	74620	1"	

### Rubber Meter Gasket



Part #	Mfg #	Size	Price
025319	18-G1	5/8"	
025320	18-G2	5/8" x 3/4" or 3/4"	

### Meter Valves (Continued)

#### Rubber Meter Gasket

Part #	Mfg #	Size	Price
043554	18-G4	1"	



## Water Service Fittings

### Couplings for 3121 Corporation Valves

1/4 Bend - Increasing (FIP x Cpr Flr)

- With swivel nut & gasket included



Part #	Mfg #	Size	Price
156315	74783S	3/4"	

### Couplings for Corporation Valves with MIP Outlets

MIP Outlets - Straight (IPS Comp - PVC x FIP)

- With 4700-44 compression nut



Part #	Mfg #	Size	Price
156394	74754-44	1"	

### Couplings for 3121 Corporation Valves & Corporation Valves with MIP Outlets

Straight Coupling (Cpr Flr x FNPT)

- With 4700 tube nut, no gasket



Part #	Mfg #	Size	Price
157374	AY7475434L F	3/4"	
157379	74754	1" x 3/4"	
157380	74754	1"	
156319	74754	1-1/4"	

MIP Outlets - Straight (CTS Tube Comp x FIP)

- With 4700-22 compression nut



Part #	Mfg #	Size	Price
156371	74754-22	3/4"	
156380	74754-22	1"	
156384	74754-22	1-1/4"	
156387	74754-22	1-1/2"	
156390	74754-22	2"	

### Couplings for Corporation Valves with Copper Flare Outlets

Cpr Flr Outlets - Straight Fixed Nut (Cpr Flr x Flr Nut Thrd)



Part #	Mfg #	Size	Price
156324	74755	1" x 3/4"	
156323	74755	1"x1-1/4"	

Cpr Flr Outlets - Fixed Nut - 1/4 Bend (Flr Nut Thrd x CTS Tube Comp)



Part #	Mfg #	Size	Price
156365	74776-22	3/4"	
156377	74776-22	1"	

Cpr Flr Outlets - Straight Fixed Nut (CTS Tube Comp x Flr Nut Thrd)



Part #	Mfg #	Size	Price
157409	74755-22	1"	

Cpr Flr Outlets - Straight Fixed Nut (FNPT x Fem Cpr Flr Thrd)



Part #	Mfg #	Size	Price
214238	74755F	3/4"	

### Flare & Compression Nut Couplings Straight Coupling (Flr x MNPT)



Part #	Mfg #	Size	Price
157373	74753	3/4"	
157378	74753	1"	



## Water Service Fittings

### Flare & Compression Nut Couplings (Continued)

#### Straight Coupling (Flr x MNPT)

Part #	Mfg #	Size	Price
156318	74753	1-1/4"	
156325	74753	1-1/2"	
156326	74753	2"	

#### Straight Coupling (Tube Comp x MNPT)



Part #	Mfg #	Size	Price
156342	74753T	3/4"	

#### Straight Coupling (Q CTS Comp x MNPT)



Part #	Mfg #	Size	Price
156404	74753Q	3/4"	
156401	74753Q	1"	

#### Straight Coupling Adapter (CTS Comp x MNPT)



Part #	Mfg #	Size	Price
224542	74753-22	1/2"	
157403	74753-22	3/4"	
157407	74753-22	1"	
156383	74753-22	1-1/4"	
156382	74753-22	1" x 3/4"	
156386	74753-22	1-1/2"	
156389	74753-22	2"	

#### Straight Coupling (PVC x MNPT)



Part #	Mfg #	Size	Price
224543	74753-44	3/4"	

### Three-Part Straight Coupling (Copper Flr x X-Strong Lead Comp)



Part #	Mfg #	Size	Price
156399	74758C-67	3/4"	

### Three-Part Straight Coupling (CTS x X-Strong Lead Comp)

- Lead pak fitting



Part #	Mfg #	Size	Price
156397	74758-22-67	3/4"	
156398	74758-22-67	1"	
156396	74758-22-67	3/4" x 5/8"	

### Accessories

#### Compression Gasket and Anti-Friction Ring Assembly

- CTS Polyethylene "-22" Mac-Pak



Part #	Mfg #	Size	Price
192986	4700-22GA3 4	3/4"	

#### 4755 Gasket

Part #	Mfg #	Size	Price
080605	4755-G	1"	





## Water Service Fittings

### Female Flare Couplings for Copper Flare Outlets

1/4 Bend - Swivel Nut  
(Female Flare x Flare)



Part #	Mfg #	Size	Price
157377	74776S	1"	

### 1/4 Bend (CTS x MNPT)



Part #	Mfg #	Size	Price
156363	74779M-22	3/4"	
156376	74779M-22	1"	
193759	74779M-22	1" x 3/4"	

### 1/4 Bend - Swivel Nut (Female Flare x CTS Compression)



Part #	Mfg #	Size	Price
156316	74776S-22	1"	

### 1/4 Bend (PVC x MNPT)



Part #	Mfg #	Size	Price
238816	74779M-44	3/4"	

### No-Lead Elbows 1/4 Bend (FIR x MNPT)



Part #	Mfg #	Size	Price
157376	74779M	3/4"	
156322	74779M	1"	

### 1/4 Bend (CTS x CTS)



Part #	Mfg #	Size	Price
156364	74761-22	3/4"	
156373	74761-22	1"	
199042	74761-22	1-1/4"	
194285	74761-22	1-1/2"	
224545	74761-22	2"	

### 1/4 Bend (CTS x FNPT)



Part #	Mfg #	Size	Price
192987	74779-22	3/4"	



## Water Service Tees

### Tees

#### Flare Tees (Flr x Flr x Flr)

- Lead Free



Part #	Mfg #	Size	Price
156314	74760	3/4"	
156320	74760	1"	

#### Compression Tee (CTS x CTS x CTS)



Part #	Mfg #	Size	Price
156372	74760-22	3/4"	
156381	74760-22	1"	

#### Tee (Q CTS x Q CTS x MNPT)

- Lead Free



Part #	Mfg #	Size	Price
224546	74762Q	3/4"	



## Water Service Unions

### Flare & Compression Nut Unions

#### Straight Coupling

(Q CTS Comp x Fem Cpr Flr Thrd)

- Lead free



Part #	Mfg #	Size	Price
156402	74755Q	3/4"	
156406	74755Q	1"	

#### Two-Part Union (Female Flr x Flr)

- Lead free



Part #	Mfg #	Size	Price
156407	74756	1"	

#### Two-Part Union (CTS Fast Connect Fitting)

- Lead free

Part #	Mfg #	Size	Price
245237	74756CTS	1"	
245238	74756CTS	3/4" x 1"	
245239	74756CTS	3/4"	

#### Three-Part Union (Coupling Flr x Flr)

- Lead free



Part #	Mfg #	Size	Price
157375	74758	3/4"	
157383	74758	3/4" x 1"	
157381	74758	1"	
157382	74758	1-1/4"	
157384	74758	2"	

#### Three-Part Union (Coupling-Q CTS x Q CTS)

- Lead free



Part #	Mfg #	Size	Price
157413	74758Q	3/4"	
156403	74758Q	3/4" x 1"	
157410	74758Q	1"	
157420	74758Q	1-1/4"	

### Flare & Compression Nut Unions

#### (Continued)

#### Three-Part Union (Coupling-Q CTS x Q CTS)

Part #	Mfg #	Size	Price
157419	74758Q	1-1/2"	

#### Three-Part Union (Coupling CTS x CTS)

- Lead free



Part #	Mfg #	Size	Price
157404	74758-22	3/4"	
157408	74758-22	1"	
157405	74758-22	3/4" x 1"	
156385	74758-22	1-1/4"	
156388	74758-22	1-1/2"	
156391	74758-22	2"	

#### Three-Part Union (Coupling CTS x PVC)

- Lead free



Part #	Mfg #	Size	Price
193586	74758-22-44	3/4"	
156340	74758-22-44	1"	
224544	74758-22-44	2"	



## Water Service Stops

### Regular Pattern - Curb Stop Ball Valves

• 300 psig Water

Flathead (Flr x Flr)



Part #	Mfg #	Inlet x Ball Size x Outlet	Price
157396	76100	3/4"	
157397	76100	1"	
156332	76100	1-1/2"	
156334	76100	2"	

Flathead (CTS Tube Comp x CTS Tube Comp)



Part #	Mfg #	Inlet x Ball Size x Outlet	Price
156354	76100-22	1"	
156393	76100-22	1-1/4"	
156356	76100-22	1-1/2"	

Flathead (FIP x FIP)



Part #	Mfg #	Inlet x Ball Size x Outlet	Price
157398	76101	3/4"	
157399	76101	1"	

Flathead (Flr x FIP)



Part #	Mfg #	Inlet x Ball Size x Outlet	Price
156339	76102	3/4"	

### Minneapolis Pattern - Curb Stop Ball Valves

• 300 psig Water

Flathead (Flr x Flr)



Part #	Mfg #	Inlet x Ball Size x Outlet	Price
157402	76104	3/4"	

### Minneapolis Pattern - Curb Stop Ball Valves (Continued)

Flathead (Flr x Flr)

Part #	Mfg #	Inlet x Ball Size x Outlet	Price
156346	76104	1"	
156336	76104	2"	

Flathead (CTS Tube Comp x CTS Tube Comp)



Part #	Mfg #	Inlet x Ball Size x Outlet	Price
156353	76104-22	3/4"	
156355	76104-22	1"	

Flathead (FNPT x FNPT)



Part #	Mfg #	Inlet x Ball Size x Outlet	Price
157400	76105	3/4"	
157401	76105	1"	
157391	76105	2"	

### Regular Pattern - Curb Stop Inverted Plug

Stop with Check  
(FNPT x FNPT)

• Lead free



Part #	Mfg #	Size	Price
156308	73061	1"	

Inverted Stop with Check (Flr x Flr)



Part #	Mfg #	Size	Price
164329	74713	3/4"	
156310	74713	1"	



## Water Service Stops

### Inverted Curb Stop with Check (Q CTS x Q CTS)

- Lead free



Part #	Mfg #	Size	Price
156405	74713Q 34	3/4"	
159660	74713Q 1	1"	

### Regular Pattern-Ball Valves-Thread

#### Ball Valve Stop & Drain (FNPT x FNPT)

- Lead free



Part #	Mfg #	Size	Price
156348	76001	3/4"	
156349	76001	1"	
224547	76001	1-1/2"	
224549	76001	2"	

### Ball Valves

#### 72030EXP Expansion PEX Ball Valve

- Lead Free
- 400 psi



Part #	Mfg #	Size	Price
239263	5427-052	1/2"	
239264	5427-053	3/4"	
239266	5427-054	1"	

### Curb Boxes

#### Arch Style-Erie Pattern - 1" Upper Less Rod



Part #	Mfg #	Size	Description	Price
158194	5601LR	4'		
028959	5601LR	5'		
044727	5601LR	5-1/2'		

### Curb Boxes (Continued)

#### Arch Style-Erie Pattern - 1" Upper Less Rod

Part #	Mfg #	Size	Description	Price
054762	5601LR	6'		

#### Arch Style Curb Box - Erie Pattern - 1" Upper with Rod



Part #	Mfg #	Size	Rod	Price
002214	5601	5'	5660 42"	
002215	5601	6'	5660 54"	
002216	5603	5'	5674 42"	
002217	5603	6'	5674 54"	

#### Minneapolis Style Base Tapped 1-1/2"

- 1-1/4" Upper section (Less rod)



Part #	Mfg #	Size	Price
002221	5614	5'	
002222	5614	6'	

#### Minneapolis Style Base Tapped 2"

- 1-1/4" Upper section (Less rod)



Part #	Mfg #	Size	Price
002223	5615	5'	
002224	5615	6'	

#### Shut-Off Rod - Small Key - 5/8" Rod



Part #	Mfg #	Size	Price
002228	5660	54"	
002229	5660	60"	

#### SS Stationary Rod - Small Key - 1/2" Rod



Part #	Mfg #	Size	Price
095434	5660SS	36"	
108986	5660SS	42"	
024197	5660SS	48"	
158197	5660SS	60"	



## Water Service Stops

### SS Cotter Pin for Shut-Off



Part #	Mfg #	Size	Price
111797	5660SSCP	1-1/2" Long	

### Curb Box Shut-Off Rod - 5/8" Large Key

Part #	Mfg #	Size	Price
029508	5674	42"	

### Bottom Section Screw Style Arch Pattern Service B



Part #	Mfg #	Size	Price
096310	5700B	40"	

### Top Section Screw Style with Lid



Part #	Mfg #	Size	Price
097755	5700T	30"	

### Stationary Rod

Part #	Mfg #	Size	For	Price
002226	4510-235	42"	5660 Curb Boxes	
002227	4510-238	48"	5660 Curb Boxes	

### Curb Box Key

- Slotted key fits top of all shut-off rods
- Spanner wrench end fits 5601L lid
- Pentagon wrench fits 5607L, 5614L, 5623L, 5624L, 5627L lids



Part #	Mfg #	Size	Price
002148	304B-003	3'	
002149	304B-004	4'	
021276	304B-006	6'	

### Pentagon Key

- Fits 5607L, 5614L, 5623L, 5624L and 5627L lids



Part #	Mfg #	Description	Price
020689	304K	Ductile Iron Pentagon Key	
002212	5601L	1"	

### Arch Curb Box w/ Pentagon Lid

- Less Rod
- 1 Upper sm base



Part #	Mfg #	Size	Price
071861	5607L	5'	

### 1" Curb Box Plug Type Lid

- Includes pentagon plug



Part #	Mfg #	Size	Price
071805	5607L	1"	

### 1-1/4" Curb Box Plug Type Lid

- Includes pentagon plug



Part #	Mfg #	Size	Price
049280	5614L	1-1/4"	

### Screw Top Lid

- For 2-1/2" service box



Part #	Mfg #	Description	Price
096311	5700L	Water	





## Water Service Stops

### Screw Style-Service Box Extension



Part #	Mfg #	Size	Price
096312	5700SE	9"	
096313	5700SE	16"	

### Curb Box Repair Coupling

- Fits 1", 1-1/4", 1-1/2", & 2" iron pipe
- Stainless steel bolts
- Cast iron body



Part #	Mfg #	Size	Price
139618	5601TRS	1"	

### Curb Box-Anchor Bolt



Part #	Mfg #	Description	Price
130624	5627AB	Anchor Bolt	

### Corporation Stops

#### Plug Valve (AWWA x Cpr Fir)



Part #	Mfg #	Size	Price
156305	74701	5/8" x 3/4"	
156317	74701	3/4"	
157372	74701	1"	
156306	74701	1-1/4"	
156307	74701	2"	

### Plug Style Corporation Stop (AWWA/CC x Q CTS Comp)



Part #	Mfg #	Size	Price
157418	74701Q	1"	

### Plumbing/Water Valves

#### Angle Stop & Waste Valve (Copper Fir x FIP)



- Lead Free

Part #	Mfg #	Size	Price
157496	5420-081	3/4" x 1/2"	
157495	5420-080	1" x 1"	

### 1/4-Turn PEX Chrome Stop Valve



WPSS-1PB



WPAS-2PB

Part #	Mfg #	Size	Price
158178	5421-236	1/2" CF x 3/8" OD Angle	
158642	5421-232	1/2" CF x 3/8" OD Straight	

### Series 72080C Quarter Turn Supply Stop

- Lead free



#### Straight

Part #	Mfg #	Size	Price
159851	5421-231	3/8" OD x 5/8" OD	
159849	5421-229	3/8" OD x 1/2" FIP	
158716	5421-239	3/8"OD x 3/8"FIP	
159358	5427-041	3/8" OD x 5/8" OD	

#### Angle

Part #	Mfg #	Size	Price
159854	5421-235	5/8" OD x 3/8" OD	
159855	5421-240	3/8" OD x 3/8" FIP	
159852	5421-233	1/2" FIP X 3/8"OD	



## Water Service Stops

### Plumbing/Water Valves (Continued)

#### Series 72080C Quarter Turn Supply Stop

##### Angle

Part #	Mfg #	Size	Price
159853	5421-234	1/2"SWT x 3/8" OD	

##### Icemaker Angle Stop

Part #	Mfg #	Size	Price
155983	5421-283	1/4"OD x 5/8"OD	

#### Series 72080S Quarter Turn Supply Stop

- Lead free



##### Straight

Part #	Mfg #	Size	Price
159850	5421-230	3/8" OD x 1/2"SWT	

#### Quarter Turn Expansion PEX Supply

- Series 7208UP
- Lead Free
- Expansion PEX x COM



##### Straight

Part #	Mfg #	Size	Price
225745	5427-005	1/2" x 3/8"	

##### Angle

Part #	Mfg #	Size	Price
225746	5427-007	1/2" x 3/8"	

#### Angle Quarter Turn Supply Stop (PEX x Comp End Connections)

- No lead
- Ice maker
- Blow-out stem design
- 125 psi cold working pressure



Part #	Mfg #	Size	Price
169407	5421-295	1/2" PEX x 1/4" O.D.	

## Whirlpools

### Alcove Whirlpools

#### 7236 Three-Wall Alcove Hourglass Shaped Whirlpool with Integral Flange

- *ExoCrylic*
- (6) Individually adjustable *ProFlex®* hydro-massage jets
- Molded lumbar supports and armrests
- Pump with air switch and grounding-type plug-in cord
- 3-Sided tile flange, less apron
- 6-foot length
- UL Listed
- Faucet and drain sold separately
- (-H) Integral heater



Part #	Mfg #	Description	Capacity	Color	Price
072446	K-1157-L-0	72" x 36" x 20-1/8", Left Hand Drain 3T	75 Gal	White	
072447	K-1157-L-96	72" x 36" x 20-1/8", Left Hand Drain 3T	75 Gal	Biscuit	
109253	K-1157-LH-0	72" x 36" x 20-1/8", Left Hand Drain 3T with Inline Heater	75 Gal	White	
072449	K-1157-R-0	72" x 36" x 20-1/8", Right Hand Drain 3T	75 Gal	White	
072450	K-1157-R-96	72" x 36" x 20-1/8", Right Hand Drain 3T	75 Gal	Biscuit	
167799	K-1157-RH-0	72" x 36" x 20-1/8", Right Hand Drain 3T with Inline Heater	75 Gal	White	

#### Archer® Three-Wall Alcove Whirlpool Bath

- *Acrylic*
- (8) Color-matched Kohler® hydro-massage jets
- Integral tile flange and lumbar support & armrests
- Pump with air switch and grounding-type plug-in cord
- *Comfort Depth®*
- Slotted overflow
- (-A) Integral apron
- (-H) Integral heater
- (-W) *Bask™* heated surface
- (-19) *ExoCrylic™* material
- Model (K-1124-XHG) includes whirlpool + *BubbleMassage™* air bath —118 *BubbleMassage™* jets



Part #	Mfg #	Description	Capacity	Color	Price
125614	K-1122-HL-0	60" x 32" x 19", Left Hand Drain with Inline Heater	58 Gal	White	
125135	K-1122-HL-96	60" x 32" x 19", Left Hand Drain with Inline Heater	58 Gal	Biscuit	
126197	K-1122-HR-0	60" x 32" x 19", Right Hand Drain with Inline Heater	58 Gal	White	
111331	K-1122-LA-0	60" x 32" x 19", Left Hand Drain	58 Gal	White	
116507	K-1122-LA-96	60" x 32" x 19", Left Hand Drain	58 Gal	Biscuit	
168040	K-1122-LA-NY	60" x 32" x 19", Left Hand Drain	58 Gal	Dune	
110288	K-1122-RA-0	60" x 32" x 19", Right Hand Drain	58 Gal	White	
150553	K-1122-RA-47	60" x 32" x 19", Right Hand Drain	58 Gal	Almond	
136361	K-1122-RA-96	60" x 32" x 19", Right Hand Drain	58 Gal	Biscuit	
153627	K-1122-RA-G9	60" x 32" x 19", Right Hand Drain	58 Gal	Sandbar	
241823	K-1122-RAW-0	60" x 32" x 20-1/4", Right Hand Drain w/ <i>Bask™</i>	58 Gal	White	

## Whirlpools

### Alcove Whirlpools (Continued) Archer® Three-Wall Alcove Whirlpool Bath

Part #	Mfg #	Description	Capacity	Color	Price
231267	K-1122-XHGLA-0	60" x 32" x 20-1/4" + BubbleMassage Bath	58 Gal	White	
120935	K-1124-HL-0	72" x 36" x 19", Left Hand Drain with Inline Heater	72 Gal	White	
125718	K-1124-HR-0	72" x 36" x 19", Right Hand Drain with Inline Heater	72 Gal	White	
159646	K-1124-HR-96	72" x 36" x 19", Right Hand Drain with Inline Heater	72 Gal	Biscuit	
141884	K-1124-LA-0	72" x 36" x 19", Left Hand Drain	72 Gal	White	
249166	K-1124-LAW-0	72" x 36" x 19", Left Hand Drain w/ Bask	72 Gal	White	
223612	K-1124-LAW-96	72" x 36" x 19", Left Hand Drain w/ Bask	72 Gal	Biscuit	
120903	K-1124-RA-0	72" x 36" x 19", Right Hand Drain	72 Gal	White	
130508	K-1124-RA-96	72" x 36" x 19", Right Hand Drain	72 Gal	Biscuit	
239612	K-1124-XHGRA	72" x 36" x 19", Right Hand Drain	72 Gal	White	
246738	K-1947-L-0	60" x 30" x 19", Left Hand Drain	57 Gal	White	
190188	K-1947-LA-96	60" x 30" x 19", Left Hand Drain, ExoCrylic	57 Gal	Biscuit	
250018	K-1947-R-0	60" x 30" x 19", Right Hand Drain	57 Gal	White	
166400	K-1947-RA-0	60" x 30" x 19", Right Hand Drain, ExoCrylic	57 Gal	White	
240913	K-1947-RA-96	60" x 30" x 19", Right Hand Drain, ExoCrylic	57 Gal	Biscuit	
169880	K-1947-RA-G9	60" x 30" x 19", Right Hand Drain, ExoCrylic	57 Gal	Sandbar	
236386	K-1947-HLA-0	60" x 30" x 19", LH Drain with Inline Heater, ExyCrylic	66 Gal	White	
227162	K-1947-HLA-96	60" x 30" x 19", LH Drain with Inline Heater, ExyCrylic	66 Gal	Biscuit	
238682	K-1949-HLA-0	66" x 32" x 19", LH Drain with Inline Heater, ExyCrylic	66 Gal	White	
169279	K-1949-HLA-47	66" x 32" x 19", LH Drain with Inline Heater, ExyCrylic	66 Gal	Almond	
179478	K-1949-LA-0	66" x 32" x 19", Left Hand Drain, ExoCrylic	66 Gal	White	

### Devonshire® Alcove Whirlpool Bath

- Single-speed whirlpool offers performance and value, with 8 fully adjustable jets
- Hydromassage flow and direction can be controlled at each jet
- Molded lumbar support and armrests offer extra comfort while bathing
- Integral apron
- Textured bottom surface



Part #	Mfg #	Description	Capacity	Color	Price
100939	K-1357-HL-96	60" x 32" x 20", LH Drain, Apron, Flange, Heater	60 Gal	White	
070188	K-1357-LA-0	60" x 32" x 20", Left-Hand Drain, Apron	60 Gal	White	
070190	K-1357-LA-96	60" x 32" x 20", Left-Hand Drain, Apron	60 Gal	Biscuit	
064351	K-1357-RA-0	60" x 32" x 20", Right-Hand Drain, Apron	60 Gal	White	

## Whirlpools

### Bancroft® Alcove Single Speed Whirlpool

- Acrylic
- Integral flange
- (8) Fully adjustable ProFlex® hydro-massage jets
- Pump with air switch
- Integral lumbar support.
- Textured bottom surface
- Integral apron with removable access panel
- Drain sold separately
- (-H) Built-in heater



Part #	Mfg #	Description	Capacity	Color	Price
132779	K-1151-HR-0	60" x 32" x 19", Right Hand Drain, Heater	White		
114683	K-1151-RA-0	60" x 32" x 19", Right Hand Drain	White		

### Mariposa® Alcove Whirlpool Bath

- Acrylic
- Integral flange
- (5) Individually adjustable ProFlex® hydro-massage jets
- Pump with air switch and grounding-type plug-in cord
- Optional K-9695 metal finish 5 jet trim kit
- (-A) Integral apron with removable access panel (-HR models includes apron)
- (-H) Built-in heater
- (-W) Bask™ heated surface



Part #	Mfg #	Description	Capacity	Color	Price
125350	K-1239-LA-0	60" x 36" x 20", Left Hand Drain	63 Gal	White	
113666	K-1239-LA-96	60" x 36" x 20", Left Hand Drain	63 Gal	Biscuit	
116895	K-1239-LA-G9	60" x 36" x 20", Left Hand Drain	63 Gal	Sandbar	
137904	K-1239-HR-0	60" x 36" x 20", Right Hand Drain, Heater, Apron	63 Gal	White	
077870	K-1239-R-0	60" x 36" x 20", Right Hand Drain	63 Gal	White	
077601	K-1239-RA-0	60" x 36" x 20", Right Hand Drain	63 Gal	White	
110804	K-1239-RA-96	60" x 36" x 20", Right Hand Drain	63 Gal	Biscuit	
244597	K-1257-HL-47	72" x 36" x 20", Left Hand Drain	72 Gal	Almond	
108791	K-1257-HR-0	72" x 36" x 20", Right Hand Drain, Heater, Apron	72 Gal	White	
072502	K-1257-LA-0	72" x 36" x 20", Left Hand Drain	72 Gal	White	
055216	K-1257-LA-96	72" x 36" x 20", Left Hand Drain	72 Gal	Biscuit	
183461	K-1257-LAW-0	72" x 36" x 20", Left Hand Drain w/ Bask™	72 Gal	White	
071235	K-1257-RA-0	72" x 36" x 20", Right Hand Drain	72 Gal	White	

## Whirlpools

### Mariposa® Alcove Single Speed Whirlpool Bath

- Acrylic
- Integral flange
- Textured bottom surface
- Pump with air switch
- Integral apron with removable access panel
- Integral lumbar support and armrests for comfort
- (5) Fully adjustable ProFlex® hydro-massage jets
- (-H) Built-in 1500W heater
- (-L) Left-hand drain
- (-RA) Right-hand drain
- (-W) Bask™ heated surface



Part #	Mfg #	Description	Capacity	Color	Price
095595	K-1224-HL-0	66" x 36" x 20", Left Hand Drain	67 Gal	White	
095736	K-1224-RA-0	66" x 36" x 20", Right Hand Drain	67 Gal	White	

### Windward® Alcove Whirlpool Bath

- Acrylic
- (6) ProFlex® hydro-massage jets
- Integral tile flange
- Integral lumbar support
- (-A) Integral apron
- (-H) Integral heater



**CB Models: Custom Pump Location**  
**HR/HL or LA/RA Models**

**Integral apron with removable access panel**

Part #	Mfg #	Description	Capacity	Color	Price
178543	K-1112-HL-0	60" x 42" x 21", LH Drain with Apron & Inline Heater	57 Gal	White	
223416	K-1114-L-0	72" x 42" x 21", LH Drain w/ Integral Flange	78.5 Gal	White	
125751	K-1114-LA-0	72" x 42" x 21", LH Drain with Apron	78.5 Gal	White	
128882	K-1114-RA-0	72" x 42" x 21", RH Drain with Apron	78.5 Gal	White	
177049	K-1114-R-0	72" x 42" x 21", RH Drain w/ Integral Flange	78.5 Gal	White	
117881	K-1114-HR-0	72" x 42" x 21", RH Drain with Inline Heater	78.5 Gal	White	
165859	K-1114-HR-47	72" x 42" x 21", RH Drain with Inline Heater	78.5 Gal	Almond	
118947	K-1114-HR-96	72" x 42" x 21", RH Drain with Inline Heater	78.5 Gal	Biscuit	



## Whirlpools

### Drop-In Whirlpools

#### Archer® Drop-In Whirlpool

- (8) Fully adjustable jets
- Comfort Depth® design
- Molded lumber supports and armrests
- Reversible drain
- Textured bottom surface
- (-H) Integral heater



Part #	Mfg #	Description	Capacity	Color	Price
183496	K-1949-0	66" x 32" x 19", Reversible Drain ExoCrylic™	66 Gal	White	
183495	K-1949-H-0	66" x 32" x 19", Reversible Drain with Heater	33 Gal	White	
187930	K-1949-H-58	66" x 32" x 19", Reversible Drain with Heater	33 Gal	Thunder Grey	
253523	K-1122-XHG-0	60" x 32" x 19", End Drain + BubbleMassage Bath	58 Gal	White	

#### ProFlex® 6036 Drop-In Whirlpool

- ExoCrylic™ material
- (6) Individually adjustable ProFlex® hydro-massage jets
- Molded lumbar supports and armrests
- Pump with air switch and grounding-type plug-in cord
- Drop-in or alcove installations
- Reversible drain sold separately



Part #	Mfg #	Description	Capacity	Color	Price
067624	K-1139-0	60" x 36" x 18-1/8", Reversible Drain	57 Gal	White	
070100	K-1139-96	60" x 36" x 18-1/8", Reversible Drain	57 Gal	Biscuit	

#### ProFlex® 6040 Oval Drop-In Whirlpool

- ExoCrylic™ material
- (6) Individually adjustable ProFlex® hydro-massage jets
- Molded lumbar support and armrests
- Reversible end drain
- Drop-In installation only
- Drain sold separately



Part #	Mfg #	Description	Capacity	Color	Price
060850	K-1146-0	60" x 40" x 17-5/8", End Drain	54 Gal	White	
172687	K-1146-47	60" x 40" x 17-5/8", End Drain	54 Gal	Almond	
084752	K-1146-96	60" x 40" x 17-5/8", End Drain	54 Gal	Biscuit	
066549	K-1146-H-0	60" x 40" x 17-5/8", End Drain w/ Inline Heater	54 Gal	White	
066852	K-1146-H-96	60" x 40" x 17-5/8", End Drain w/ Inline Heater	54 Gal	Biscuit	

## Whirlpools

### ProFlex® 7236 Drop-In Whirlpool

- (6) Factory-installed color-matched adjustable ProFlex® jets
- Molded lumbar supports and armrests
- Pump with air switch and grounding-type plug-in cord
- Drop-in or tile flange on (3) sides for alcove drop-in installations
- Drain sold separately



Part #	Mfg #	Description	Capacity	Color	Price
053323	K-1157-0	72" x 36" x 20-1/8", End Drain	72 Gal	White	
063709	K-1157-96	72" x 36" x 20-1/8", End Drain	72 Gal	Biscuit	
077293	K-1157-H-0	72" x 36" x 20-1/8", End Drain w/ Inline Heater	72 Gal	White	

### ProFlex® 7242 Drop-In Whirlpool

- (6) Individually adjustable ProFlex® hydro-massage jets
- Molded lumbar supports and armrests
- Pump with air switch and grounding-type plug-in cord
- Drop-in or 3-wall alcove
- Center drain sold separately
- (-F) Integral flange



Part #	Mfg #	Description	Capacity	Color	Price
053324	K-1131-0	72" x 42" x 20-1/8", Center Drain	78 Gal	White	
088066	K-1131-47	72" x 42" x 20-1/8", Center Drain	78 Gal	Almond	
070089	K-1131-96	72" x 42" x 20-1/8", Center Drain	78 Gal	Biscuit	
071483	K-1131-F-0	72" x 42" x 20-1/8", Center Drain w/ Integral Flange	78 Gal	White	
070847	K-1131-H-0	72" x 42" x 20-1/8", Center Drain w/ Inline Heater	78 Gal	White	

### ProFlex® 7242 Oval Drop-In Whirlpool

- ExoCrylic™ material
- (6) Individually adjustable ProFlex® hydro-massage jets
- Molded lumbar support and armrests
- Reversible drain
- Drain sold separately
- (-H) Integral heater
- (-D) Custom pump location



Part #	Mfg #	Description	Capacity	Color	Price
071249	K-1148-0	72" x 42" x 19-3/4", Reversible Drain	78 Gal	White	
096238	K-1148-47	72" x 42" x 19-3/4", Reversible Drain	78 Gal	Almond	
076071	K-1148-96	72" x 42" x 19-3/4", Reversible Drain	78 Gal	Biscuit	
079810	K-1148-H-0	72" x 42" x 19-3/4", Reversible Drain w/ Inline Heater	78 Gal	White	
086002	K-1148-H-96	72" x 42" x 19-3/4", Reversible Drain w/ Inline Heater	78 Gal	Biscuit	
168532	K-1148-HD-47	72" x 42" x 19-3/4", Custom Pump w/ Inline Heater	78 Gal	Almond	

## Whirlpools

### Archer® Drop-In Whirlpool

- (8) Individually adjustable hydro-massage jets
- Single speed pump
- Comfort Depth®
- Integral lumbar and armrest support
- Textured bottom surface
- Reversible drain
- Slotted overflow allows for deep soaking
- (-H) Built-in heater
- (-L) Left-hand drain



**Required: ClearFlo slotted overflow K-7271 or K-7272**

Part #	Mfg #	Description	Capacity	Color	Price
114529	K-1122-0	60" x 32" x 19", Reversible Drain	58 Gal	White	
121566	K-1122-47	60" x 32" x 19", Reversible Drain	58 Gal	Almond	
123249	K-1122-96	60" x 32" x 19", Reversible Drain	58 Gal	Biscuit	
166075	K-1122-H-0	60" x 32" x 19", Reversible Drain w/ Heater	58 Gal	White	
144342	K-1122-H-95	60" x 32" x 19", Reversible Drain w/ Heater	58 Gal	Ice Grey	
129530	K-1122-H-96	60" x 32" x 19", Reversible Drain w/ Heater	58 Gal	Biscuit	
108489	K-1124-0	72" x 36" x 19", Reversible Drain	72 Gal	White	
105604	K-1124-47	72" x 36" x 19", Reversible Drain	72 Gal	Almond	
126247	K-1124-96	72" x 36" x 19", Reversible Drain	72 Gal	Biscuit	
249472	K-1124-K4	72" x 36" x 19", Reversible Drain	72 Gal	Cashmere	
179977	K-1124-NY	72" x 36" x 19", Reversible Drain	72 Gal	Dune	

### Archer® Drop-In Whirlpool + BubbleMassage™ Air Bath

- Acrylic
- 118 BubbleMassage™ airjets, 8 Whirlpool jets
- Variable-speed blower with 18 levels
- Built-in heater
- Molded lumbar support
- Slotted overflow
- Textured bottom surface
- Reversible drain



**Requires K-7271 or K-7272 Slotted overflow bath drain**

Part #	Mfg #	Description	Capacity	Color	Price
228470	K-1124-XHG-0	72" x 36" x 19", Reversible Drain w/ Heater	72 Gal	White	
173700	K-1124-XHG-96	72" x 36" x 19", Reversible Drain w/ Heater	72 Gal	Biscuit	

## Whirlpools

### Bancroft® Drop-In Whirlpool

- Acrylic
- Variable speed pump with 1.5 kW heater, back-lit user keypad, and remote control
- Less all trim
- (8) Flexjet™ whirlpool jets
- Custom pump locations



Part #	Mfg #	Description	Capacity	Color	Price
127590	K-1158-H2-0	66" x 42" x 22", End Drain w/ Heater Less Trim	95 Gal	White	

### Devonshire® Drop-In Whirlpool with Reversible Drain

- Acrylic
- Textured bottom surface
- (8) Fully adjustable jets
- Single-speed whirlpool offers performance and value
- Pump with air switch and grounding-type plug-in cord
- (-A) Integral apron model (K-1357-HL-0 includes apron and flange)
- (-H) Built-in heater
- (-L) Left-hand drain
- (-R) Right-hand drain



Part #	Mfg #	Description	Capacity	Color	Price
070107	K-1357-0	60" x 32" x 20", End Drain	60 Gal	White	
077206	K-1357-47	60" x 32" x 20", End Drain	60 Gal	Almond	
070111	K-1357-96	60" x 32" x 20", End Drain	60 Gal	Biscuit	
162280	K-1357-NY	60" x 32" x 20", End Drain	60 Gal	Dune	

### Mariposa® Drop-In Whirlpool with ProFlex® Jets and Reversible Drain

- Acrylic
- Three-wall alcove installation
- Molded lumbar supports and armrests
- Textured bottom surface
- (-H) Built-in heater
- (-B) Custom pump location
- (-W1) Bask™ heated surface



Part #	Mfg #	Description	Capacity	Color	Price
053326	K-1239-0	60" x 36" x 20", Drop-In, (5) ProFlex® Jets	63 Gal	White	
110050	K-1239-47	60" x 36" x 20", Drop-In, (5) ProFlex® Jets	63 Gal	Almond	
070101	K-1239-96	60" x 36" x 20", Drop-In, (5) ProFlex® Jets	63 Gal	Biscuit	
146875	K-1239-G9	60" x 36" x 20", Drop-In, (5) ProFlex® Jets	63 Gal	Sandbar	
175903	K-1239-NY	60" x 36" x 20", Drop-In, (5) ProFlex® Jets	63 Gal	Dune	
118984	K-1239-CB-0	60" x 36" x 20", Drop-In, (5) ProFlex® Jets w/ Cust Pump	63 Gal	White	
084339	K-1239-H-0	60" x 36" x 20", Drop-In, (5) ProFlex® Jets w/ Heater	63 Gal	White	
132539	K-1239-H-47	60" x 36" x 20", Drop-In, (5) ProFlex® Jets w/ Heater	63 Gal	Almond	
064896	K-1224-0	66" x 35-7/8" x 20", Drop-In, (5) ProFlex® Jets	67 Gal	White	

## Whirlpools

### Drop-In Whirlpools (Continued)

#### Mariposa® Drop-In Whirlpool with ProFlex® Jets and Reversible Drain

Part #	Mfg #	Description	Capacity	Color	Price
152518	K-1224-47	66" x 35-7/8" x 20", Drop-In, (5) ProFlex® Jets	67 Gal	Almond	
082204	K-1224-96	66" x 35-7/8" x 20", Drop-In, (5) ProFlex® Jets	67 Gal	Biscuit	
076433	K-1224-H-0	66" x 35-7/8" x 20", Drop-In, (5) ProFlex® Jets & Heater	67 Gal	White	
109674	K-1224-H-47	66" x 35-7/8" x 20", Drop-In, (5) ProFlex® Jets & Heater	67 Gal	Almond	
075975	K-1224-H-96	66" x 35-7/8" x 20", Drop-In, (5) ProFlex® Jets & Heater	67 Gal	Biscuit	
063474	K-1257-0	72" x 36" x 20", Drop-In, (6) ProFlex® Jets	72 Gal	White	
171227	K-1257-47	72" x 36" x 20", Drop-In, (6) ProFlex® Jets	72 Gal	Almond	
059110	K-1257-96	72" x 36" x 20", Drop-In, (6) ProFlex® Jets	72 Gal	Biscuit	
064135	K-1257-G9	72" x 36" x 20", Drop-In, (6) ProFlex® Jets	72 Gal	Sandbar	
131246	K-1257-H-0	72" x 36" x 20", Drop-In, (6) ProFlex® Jets & Heater	72 Gal	White	
118950	K-1257-H-47	72" x 36" x 20", Drop-In, (6) ProFlex® Jets & Heater	72 Gal	Almond	
149777	K-1257-H-96	72" x 36" x 20", Drop-In, (6) ProFlex® Jets & Heater	72 Gal	Biscuit	
173824	K-1257-HB-96	72" x 36" x 20"(6) Jets w/ Heater & Custom Pump Loc	72 Gal	Biscuit	
238301	K-1257-W1-0	72" x 36" x 20", (6) Jets, Bask™ Heated Surface	72 Gal	White	

#### Memoirs® Drop-In Whirlpool

- Acrylic
- (8) Hydromassage jets can be individually adjusted for water flow and direction
- Variable speed pump for adjusting massage intensity
- Electronic keypad
- Reversible drain
- LESS jet trim
- Custom pump location for models (K-1170-HN-96) & (K-1170-HH-96)



Part #	Mfg #	Description	Capacity	Color	Price
154561	K-1170-HN-96	66"x42"x22", Built-in Heater, Custom Pump Location	81 Gal	Biscuit	
131985	K-1170-H2-0	66"x42"x22", Built-in Heater	81 Gal	White	
095313	K-1170-H2-96	66"x42"x22", Built-in Heater	81 Gal	Biscuit	
124641	K-1170-HH-96	66"x42"x22", Built-in Heater, Custom Pump Location	81 Gal	Biscuit	
182765	K-1418-H2-47	72"x42"x22", Built-In Heater Less Jet Trim	94 Gal	Almond	

## Whirlpools

### Memoirs® Drop-In Effervescence + Whirlpool with Spa/Massage Package

- Acrylic
- Variable speed pump with 1.5kW heater, back-lit user keypad and remote control
- (6) Flexjets™
- (10) Color-matched sequencing BodyMassage™ backjets
- (2) Pulsating neckjets with pillow
- (8) Effervescent ports
- (4) Chromatherapy lights
- 240 V, 20 A electrical service
- Color-matched jet trim included



Drilled for K-9653 grab bars (required)

Part #	Mfg #	Description	Capacity	Color	Price
072782	K-1418-V-0	72" x 42" x 22", Center Drain	86 Gal	White	
152534	K-1418-V-47	72" x 42" x 22", Center Drain	86 Gal	Almond	
074228	K-1418-V-96	72" x 42" x 22", Center Drain	86 Gal	Biscuit	

### Purist® Drop-In Effervescence Tub

- Acrylic
- Reversible drain
- (6) Individual adjustable ProFlex® hydro-massage jets
- Variable speed pump for adjusting hydromassage intensity
- Chromatherapy lighting
- Includes: built-in heater, electronic keypad, & remote control
- Overflow channel
- (-V) Spa/massage package



Part #	Mfg #	Description	Capacity	Color	Price
117545	K-1110-M-0	72" x 46" x 23-3/16", End Drain	96 Gal	White	
188517	K-1110-V-0	72" x 46" x 24", End Drain Spa + Massage Pckg	96 Gal	White	



## Whirlpools

### RiverBath® Drop-In Whirlpool

- Acrylic
- Integral fill and valves
- Less all trim
- (2) Variable speed pumps with back-lit user control and remote control
- (8) Flexjets™ (4) Riverjets (4) Chromatherapy lights
- Air aspiration "on/off" feature
- (1) Large pillow and (3) small pillows
- 4 kW Heater (on separate electrical service)



**Required: K-9398 Flexjet™ Trim, K-T9540-4 or T9540-7 transfer valve trim handshower, and faucet handles**

Part #	Mfg #	Description	Capacity	Color	Price
069018	K-1397-H2-0	75" x 75" x 25"	215 Gal	White	
154099	K-1397-H2-96	75" x 75" x 25"	215 Gal	Biscuit	

### Sok® Drop-In Effervescence Tub

- 11 effervescence ports deliver gentle, caressing bubbles
- Variable-speed pump
- Chromatherapy lighting allows you to select a preferred color scheme to suit your mood
- Built-in heater
- Remote control
- Overflow channel for deep soak and unique infinity pool effect



Part #	Mfg #	Description	Capacity	Color	Price
119218	K-1188-C1-0	75" x 41" x 25"	142 Gal	White	

### Windward® Drop-In Whirlpool

- Acrylic
- (6) Individual adjustable ProFlex® hydro-massage jets
- Molded lumbar supports and armrests
- Pump with air switch
- (-CB) Custom pump location



Part #	Mfg #	Description	Capacity	Color	Price
135160	K-1112-0	60" x 42" x 21", End Drain	57 Gal	White	
222599	K-1114-CB-0	72" x 42" x 21", Drop-In w/ Custom Pump Location	78.5 Gal	White	
114828	K-1114-H-96	72" x 42" x 21", End Drain w/ Heater	78.5 Gal	Biscuit	

## Whirlpools

### Dual-Mount Whirlpools

#### Greek® Dual-Mount Whirlpool

- Acrylic
- (4) Hydromassage jets
- Variable-speed pump for adjusting massage intensity
- Built-in heater
- Electronic keypad
- Under-mountable
- Reversible drain
- Less jet trim



Part #	Mfg #	Description	Capacity	Color	Price
061905	K-1492-H2-0	48" x 32" x 23-3/8", Reversible Drain	103 lbs	White	
182812	K-1492-H2-96	48" x 32" x 23-3/8", Reversible Drain	103 lbs	Biscuit	

#### Sunward® Dual-Mount Whirlpool

- Acrylic
- Single-speed
- (6) Fully adjustable jets
- Molded lumbar support and armrests
- Reversible end drain
- Drop-in or under-mount
- (-B) Custom pump location
- (-H) Built-in heater
- (S1) ExoCrylic material
- (-W) Bask™ heated surface



Part #	Mfg #	Description	Capacity	Color	Price
093668	K-1162-0	60" x 42" x 21", End Drain	57 Gal	White	
085085	K-1162-96	60" x 42" x 21", End Drain	57 Gal	Biscuit	
126998	K-1162-H-0	60" x 42" x 21", End Drain w/ Inline Heater	57 Gal	White	
087861	K-1162-H-96	60" x 42" x 21", End Drain w/ Inline Heater	57 Gal	Biscuit	
097240	K-1162-HB-96	60" x 42" x 21", End Drain w/ Heater w/ Custom Pump Loc. Biscuit	57 Gal		
187527	K-1162-S1-0	60" x 42" x 20" End Drain	57 Gal	White	
161464	K-1164-S1-0	72" x 42" x 20", End Drain - ExoCrylic	75 Gal	White	
225400	K-1164-S1H-0	72" x 42" x 20", End Drain w/ Heater - ExoCrylic	75 Gal	White	
227052	K-1164-S1HB-0	72" x 42" x 20", End Drain w/ Heater & Cust Pump Loc	75 Gal	White	
252312	K-6347-0	66" x 42" x 20", End Drain	70 Gal	White	
257655	K-6347-96	66" x 42" x 20", End Drain	70 Gal	Biscuit	
246519	K-6347-W1-96	66" x 42" x 20", End Drain w/ Heater	70 Gal	Biscuit	
238662	K-6347-H-0	66" x 42", End Drain w/ Heater	70 Gal	White	

## Whirlpools

### Tea-for-Two® Dual-Mount Whirlpool

- Cast Iron
- Variable-speed pump for adjusting massage intensity
- (6) Hydromassage jets can be individually adjusted for water flow and direction
- Molded armrests
- Safeguard slip-resistant surface on bath floor
- End drain
- Drop-in or under-mount



Part #	Mfg #	Description	Capacity	Color	Price
224284	K-865-H2-0	72" x 36" x 20-7/8", End Drain	89 Gal	White	
136519	K-865-N1-0	72" x 36" x 20-7/8", End Drain, w/ Neck Jets	89 Gal	White	

### Underscore® Rectangle Dual-Mount Whirlpool

- Acyclic
- 8 Flexjet™ whirlpool jets
- Drop-in or undermount installation
- Molded lumbar support
- Less all trim
- Variable-speed pump with 1.5kW heater and back-lit user keypad
- Center drain included with (K-1174)
- (-XH2G) Whirlpool + Bubblemassage airbath
- (-H2) Whirlpool + heater



Requires: K-7271 or K-7272 Slotted Overflow drain  
K-9698 Jet Trim Kit

Part #	Mfg #	Description	Capacity	Color	Price
167393	K-1849-H2-0	60" x 36" x 21", End Drain	81.1 Gal	White	
154957	K-1173-H2-0	66" x 36" x 22", End Drain	102 Gal	White	
151428	K-1173-H2-47	66" x 36" x 22", End Drain	102 Gal	Almond	
162210	K-1173-H2-96	66" x 36" x 22", End Drain	102 Gal	Biscuit	
173085	K-1173-H2-7	66" x 36" x 22", End Drain	102 Gal	Black	
252269	K-1173-XH2G-0	66" x 36" x 22", End Drain + BubbleMassage	102 Gal	White	
173256	K-1822-H2-7	66" x 32" x 22", End Drain	85.8 Gal	Black	
183474	K-1822-H2-0	66" x 32" x 22", End Drain	85.8 Gal	White	
168037	K-1174-H2-0	72" x 42" x 23", Center Drain	139 Gal	White	
158136	K-1174-H2-47	72" x 42" x 23", Center Drain	139 Gal	Almond	
167115	K-1174-H2-G9	72" x 42" x 23", Center Drain	139 Gal	Sandbar	
186662	K-1835-H2-0	72" x 36" x 23", Center Drain, Inline Heater	112.9 Gal	White	
189419	K-1835-H2-58	72" x 36" x 23", Center Drain, Inline Heater	112.9 Gal	Thunder Grey	
161738	K-1835-H2-96	72" x 36" x 23", Center Drain, Inline Heater	112.9 Gal	Biscuit	
167205	K-1835-H2-G9	72" x 36" x 23", Center Drain, Inline Heater	112.9 Gal	Sandbar	
242407	K-1835-H2-NY	72" x 36" x 23", Center Drain, Inline Heater	112.9 Gal	Dune	

## Whirlpools

### Underscore® Dual-Mount Oval Whirlpool

- Acrylic
- 8 Hydromassage jets
- Built-in heater
- Lighted keypad
- Dual lumbar supports two-person bathing
- (-XH2G) Whirlpool + Bubblemassage airbath
- (-H2) Whirlpool + heater



Requires: K-7271 or K-7272 Slotted Overflow drain  
K-9698 Jet Trim Kit

Part #	Mfg #	Description	Capacity	Color	Price
251601	K-5714-H2-0	60" x 36" x 21", Center Drain, Inline Heater	72 Gal	White	
181854	K-5714-H2-G9	60" x 36" x 21", Center Drain, Inline Heater	72 Gal	Sandbar	
257639	K-5716-H2-0	66" x 36" x 22", Center Drain	85.5 Gal	White	
228454	K-5718-XH2G-0	72" x 42" x 22", Center Drain w/ BubbleMassage™	112.2 Gal	White	

### Underscore® Dual-Mount Whirlpool with Built-In Heater

- Acrylic
- Drop-in or under-mount installation
- Two raised corner seats, at 6-3/4" and 11-7/8" from bath floor
- (8) Fully adjustable Flexjet™ whirlpool jets
- Variable speed pump with 1.5kW heater and back-lit user keypad and remote control
- Extra deep 27-1/2" soaking depth
- (-H2) Whirlpool + heater



Requires: K-8150 Cable Drain, K-8134 Drain Trim

Part #	Mfg #	Description	Capacity	Color	Price
155728	K-1969-H2-0	48" x 48" x 34", Dual-Mount w/ Heater	171 Gal	White	

## Corner Whirlpools

### Tercet™ Corner Whirlpool

- Textured bottom
- Integral flange
- Molded lumbar supports and armrests
- Pump with air switch and grounding-type plug-in cord
- (6) Individually adjustable ProFlex® hydro-massage jets
- Center drain sold separately
- Integral apron included with K-1160-HL-0 and K-1160-LA-0
- (-H) Inline Heater



Part #	Mfg #	Description	Capacity	Color	Price
086456	K-1160-0	60" x 60" x 21", Drop-In	96 Gal	White	
105166	K-1160-96	60" x 60" x 21", Drop-In	96 Gal	Biscuit	

## Whirlpools

### Corner Whirlpools (Continued)

#### Tercet™ Corner Whirlpool

Part #	Mfg #	Description	Capacity	Color	Price
105261	K-1160-H-0	60" x 60" x 21", Drop-In w/ Inline Heater	96 Gal	White	
096925	K-1160-F-0	60" x 60" x 21", Tile Flange	96 Gal	White	
088777	K-1160-FH-0	60" x 60" x 21", Tile Flange w/ Inline Heater	96 Gal	White	
084611	K-1160-HL-0	60" x 60" x 21", Tile Flange, Integral Apron & Heater	96 Gal	White	
083219	K-1160-LA-0	60" x 60" x 21", Tile Flange, Integral Apron	96 Gal	White	

#### 5454 Drop-In Single Speed Whirlpool

- (6) fully adjustable Proflex® hydro-massage jets
- Molded lumbar supports and armrests
- Pump with air switch
- Integral faucet deck
- (-CC) Custom pump location
- (-H) Built-in heater
- Faucet and center drain sold separately



Part #	Mfg #	Description	Capacity	Color	Price
073276	K-1154-0	54" x 54" x 20-1/2", Drop-In	76 Gal	White	
078463	K-1154-CC-0	54" x 54" x 20-1/2", Drop-In, Custom Pump	76 Gal	White	
101007	K-1154-H-0	54" x 54" x 20-1/2", Drop-In, Heater	76 Gal	White	

### Whirlpool Trim Kits & Accessories

#### Flexjet® Whirlpool Trim Kit

- Plastic
- 4-1/8" x 29/32"
- includes matching suction cover (metal finish kits only)
- Easy-to-install design with O-ring
- Available in color-matched or faucet finished matched jets



Part #	Mfg #	Description	Capacity	Color	Price
189418	K-9698-58	(8) Jets		Thunder Grey	
240386	K-9698-BKB	(8) Jets		Brushed Black	

#### Flexjet® Whirlpool Trim Kit

- Independently adjustable Flexjets™
- Silicone lubricant
- Jet removal tool
- Suction cover (metal finish kits only)
- Color-matched suction cover shipped with whirlpool



Part #	Mfg #	Description	Color	Price
085917	K-9695-BN	(5) Jets, Includes Suction Cover	*Brushed Nickel	
175904	K-9695-NY	(5) Jets, Includes Suction Cover	Dune	
055275	K-9696-0	(6) Jets, Includes Suction Cover	White	

## Whirlpools

### Whirlpool Trim Kits & Accessories (Continued)

#### Flexjet® Whirlpool Trim Kit

Part #	Mfg #	Description	Color	Price
183165	K-9696-BKB	(6) Jets, Includes Suction Cover	Brushed Black	
054118	K-9698-0	(8) Jets, Includes Suction Cover	White	
061990	K-9698-96	(8) Jets, Includes Suction Cover	Biscuit	
054811	K-9698-BN	(8) Jets, Includes Suction Cover	*Brushed Nickel	
062025	K-9698-CP	(8) Jets, Includes Suction Cover	Polished Chrome	

#### Keypad Trim

- 2.5" Keypad trim
- Surrounds keypad in the finish of your choice
- For use with Experience whirlpools and select BubbleMassage™ air baths



Part #	Mfg #	Description	Capacity	Color	Price
161693	K-9497-CP	2.5" Diameter		Polished Chrome	
091304	K-9497-BV	2.5" Diameter		*Brushed Bronze	
107149	K-9497-G	2.5" Diameter		Brushed Chrome	
095103	K-9497-BN	2.5" Diameter		*Brushed Nickel	

#### Bath/Whirlpool Pillow

- Durable vinyl cover
- Suction cup keeps the pillow in place



Part #	Mfg #	Description	Capacity	Color	Price
058385	K-1491-0	13-5/16" X 5-11/32"		White	
098736	K-1491-7	13-5/16" X 5-11/32"		Black	
066596	K-1491-96	13-5/16" X 5-11/32"		Biscuit	

#### Reve® Bath/BubbleMassage™ Undermount Kit

- For use with the K-892 Reve 36-inch bath and K-899 BubbleMassage air baths



Part #	Mfg #	Description	Capacity	Color	Price
257745	K-136-NA	For use with Réve 32" baths and BubbleMassage air baths			
256611	K-137-NA	For use with Réve 36" baths and BubbleMassage air baths			



## Whirlpools

### Vikrell® Whirlpool Tub & Shower Modules

- Solid Vikrell® material for strength and durability
- High-gloss finish



#### 7632 Ensemble Medley™ Whirlpool Tub & Shower Module

- Caulk-free, making installation a snap and reducing the need for long-term maintenance
- Innovative Dry-Block™ seal and channeled water containment system form watertight seams
- (8) Fully adjustable hydro-massage jets, pre-mounted pump, and front access panel for easy access to system
- Tongued-and-grooved interlocking joints
- Durable high-gloss finish provides a smooth, shiny surface



Part #	Mfg #	Description	Drain	Finished Dimensions	Color	Price
226263	76320120-0	Whirlpool & Shower Complete	RH	75" x 60" x 32"	White	

## Whirlpools

### Whirlpools

#### Geneva 3660 Acrylic Revive Air System Air tub

- Self-rimming
- Vacuum formed acrylic
- 2" Drain
- Twin, contoured arm rests
- Includes:
  - (48) Perimeter air ports
  - Electronic system control
  - 12.0 Amp, 600-watt blower with ceramic heater



Part #	Mfg #	Description	Drain	Finish	Price
132388	TR-B-240/AR2-WHT	21" x 60" x 36"	Universal	White	

#### Geneva 3660 Acrylic Builder System Whirlpool

- Self-rimming
- Vacuum formed acrylic
- 2" Drain
- Twin, contoured arm rests
- Includes:
  - (6) Adjustable jets
  - Twin air controls
  - Pneumatic system control
  - 5.50A Pump/motor



Part #	Mfg #	Description	Drain	Finish	Price
126198	TR-B-240/6P-WHT	21" x 60" x 36"	Universal	White	
145149	TR-B-240/6P-BSC	21" x 60" x 36"	Universal	Biscuit	

#### Geneva 3660 Soaking Tub Whirlpool

- Self-rimming
- Vacuum formed acrylic
- 2" Drain, 2-1/2" overflow
- Twin, contoured arm rests
- Textured floor pattern
- Pre-leveled block base system
- Balsa wood core floor structure



Part #	Mfg #	Description	Drain	Finish	Price
108480	TR-S240-OND-LH	21" x 60" x 36"	Left	White	
113701	TR-S240-OND-RH	21" x 60" x 36"	Right	White	

## Whirlpools

### Geneva 3672 Acrylic Builder System Whirlpool

- Self-rimming
- Vacuum formed acrylic
- 2" Drain
- Twin, contoured arm rests
- Includes:
  - (6) Adjustable jets
  - Twin air controls
  - Pneumatic system control
  - 5.50A Pump/motor



Part #	Mfg #	Description	Drain	Finish	Price
129257	TR-B-270/6P-WHT	21" x 72" x 36-1/4"	Universal	White	
124142	TR-B-270/6P-4BI	21" x 72" x 36-1/4" Pump #4 Location	Universal	Biscuit	
092489	TR-B-270/6P1-BSC	21" x 72" x 36-1/4", (1) Pump	Universal	Biscuit	

### Tartane 6060 Builder System Whirlpool

- Self-Rimming
- Vacuum formed
- 2" Drain
- Twin, contoured armrests
- Includes:
  - (6) Adjustable jets
  - Twin air controls
  - Pneumatic system control
  - 5.50A Pump/motor



Part #	Mfg #	Description	Drain	Finish	Price
092518	CT-B-4706P	22-1/2" x 60" x 60"	Center	White	

### Prestige 3466 Acrylic Builder System Whirlpool

- Vacuum formed acrylic
- 2" Dia. end drain (see reverse side for location)
- 2-1/2" Dia. overflow (see reverse side for location)
- Twin, contoured armrests
- Pre-Leveled block base system
- Balsa wood core floor structure
- Textured floor pattern

Part #	Mfg #	Description	Drain	Finish	Price
120991	TR-B-220-6P	21" x 66" x 34-1/4"	End	White	

## Whirlpools

### Whirlpools

#### Belmont I Builders' Choice Whirlpool

- (8) Hydrotherapy jets
- 3/4 hp Pump
- Advanced safety suction system
- Bath-side on/off button
- Sculpted armrests
- Slip resistant bottom
- Lucite cast acrylic surface



Part #	Mfg #	Finished Dimensions	Drain	Color	Price
039839	3960621	59-1/8" x 40-3/16" x 23-7/8"	Universal	White	

#### Cavalcade Builders' Choice Whirlpool

- (8) Hydrotherapy jets
- 3/4 hp Pump
- Advanced safety suction system
- Bath-side on/off button
- Sculpted armrests
- Slip resistant bottom
- Lucite cast acrylic surface



Part #	Mfg #	Finished Dimensions	Drain	Color	Price
039484	3860621	60" x 30" x 22"	Center Front	White	

#### Montrose I Builders' Choice Whirlpool

- (8) Hydrotherapy jets
- 3/4 hp Pump
- Advanced safety suction system
- Bath-side on/off button
- Acrylic grab bars
- Sculpted armrests
- Slip resistant bottom
- Lucite cast acrylic surface



Part #	Mfg #	Finished Dimensions	Drain	Color	Price
039837	4160621	60" x 36" x 21-1/2"	Universal	White	

#### Montrose II Builders' Choice Whirlpool

- (8) Hydrotherapy jets
- 3/4 hp Pump
- Advanced safety suction system
- Bath-side on/off button
- Sculpted armrests
- Slip resistant bottom
- Lucite cast acrylic surface



Part #	Mfg #	Finished Dimensions	Drain	Color	Price
039483	4272621	72" x 36" x 22"	Universal	White	

## Whirlpools

### Whirlpools (Continued) Montrose II Builders' Choice Whirlpool

Part #	Mfg #	Finished Dimensions	Drain	Color	Price
043995	4272621-BI	72" x 36" x 22"	Universal	Biscuit	

## Whirlpools

### Alcove or Drop-In Whirlpool

#### 3660 Pro-Fit Whirlpool

- Rectangular whirlpool with integral armrests
- Simple, reliable air-switch turns the unit on and off
- Durable single-speed pump
- Six strategically positioned jets deliver a therapeutic massage: Four body jets and two foot jets
- Two air controls adjust the volume of air through the jets – creating mild to vigorous whirlpool action
- Optional removable apron provides easy access to the motor and plumbing
- Color-match trim, chrome and everbrass (PVD), brushed nickel and oil rubbed bronze upgrades available
- Optional cable operated drain in color-match, chrome, everbrass (PVD), brushed nickel or oil rubbed bronze



Part #	Mfg #	Description	Capacity	Color	Price
229859	MAN-6018-WH	6018 36 x 60 Whirlpool White	59-3/4" x 35-3/4" x 21-1/4"	White	

#### 3672 Pro-Fit Whirlpool

- Rectangular whirlpool with integral armrests
- Simple, reliable air-switch turns the unit on and off
- Durable single-speed pump
- Six strategically positioned jets deliver a therapeutic massage: Four body jets and two foot jets
- Two air controls adjust the volume of air through the jets – creating mild to vigorous whirlpool action
- Optional removable apron provides easy access to the motor and plumbing
- Color-match trim, chrome and everbrass (PVD), brushed nickel and oil rubbed bronze upgrades available
- Optional cable operated drain in color-match, chrome, everbrass (PVD), brushed nickel or oil rubbed bronze



Part #	Mfg #	Description	Capacity	Color	Price
229860	MAN-6021-WH	6021 36 x 72 Whirlpool White	71-1/2" x 35-1/2" x 20"	White	

#### 4260 Pro-Fit Whirlpool

- Rectangular shaped whirlpool with oval bathing well
- Simple, reliable air-switch turns the unit on and off
- Durable single-speed pump
- Six strategically positioned jets deliver a therapeutic massage: Four body jets and two foot jets
- Optional removable apron provides easy access to the motor and plumbing
- Two air controls adjust the volume of air through the jets – creating mild to vigorous whirlpool action
- Color-match trim, chrome and everbrass (PVD), brushed nickel and oil rubbed bronze upgrades available
- Optional cable operated drain in color-match, chrome, everbrass (PVD), brushed nickel or oil rubbed bronze



Part #	Mfg #	Description	Capacity	Color	Price
229861	MAN-6024-WH	6024 42 x 60 Whirlpool White	42" x 60" x 20-1/4"	White	



## Whirlpools

### 4272 Pro-Fit Whirlpool

- Rectangular shaped whirlpool with oval bathing well
- Simple, reliable air-switch turns the unit on and off
- Durable single-speed pump
- Six strategically positioned jets deliver a therapeutic massage: Four body jets and two foot jets
- Two air controls adjust the volume of air through the jets – creating mild to vigorous whirlpool action
- Optional removable apron provides easy access to the motor and plumbing
- Color-match trim, chrome and everbrass (PVD), brushed nickel and oil rubbed bronze upgrades available
- Optional cable operated drain in color-match, chrome, everbrass (PVD), brushed nickel or oil rubbed bronze



Part #	Mfg #	Description	Capacity	Color	Price
229862	MAN-6027 -WH	6027 42 x 72 Whirlpool White	42" x 71-1/2" x 19-3/4"	White	

## Work Gloves

### Work Gloves

#### Demolition Gloves

- Built-in terry cloth sweat wipe
- Velcro Closure for a secure fit
- Breathable Lining - Moisture wicking lining provides all day comfort
- Molded Knuckle Protection - TPR pad provides ultimate knuckle protection
- Palms and Finger Tips reinforced with Armortex® for ultimate durability and grip
- Smartswipe™ Knuckle



Part #	Mfg #	Size	Price
229541	48-22-8735	Small	
186454	48-22-8731	Medium	
186456	48-22-8732	Large	
186457	48-22-8733	Extra Large	
186458	48-22-8734	2X Large	

#### Fingerless Work Gloves

- Fingerless design for ultimate dexterity
- Reinforced and padded palm
- Built-in terry cloth sweat wipe
- Hook & loop closure for a secure fit
- Breathable lining provides all day comfort



Part #	Mfg #	Size	Price
224333	48-22-8745	Small	
224334	48-22-8741	Medium	
224335	48-22-8742	Large	
224336	48-22-8743	Extra Large	
224337	48-22-8744	2X Large	

#### Free-Flex Work Gloves

- Built-in terry cloth sweat wipe
- Free-Flex cuff for all day comfort
- Breathable lining provides all day comfort reinforced thumb seam
- High dexterity finger tips provide dexterity when handling small objects
- Smartswipe™ Fingertips, Knuckles and Palms



Part #	Mfg #	Size	Price
224343	48-22-8715	Small	
224346	48-22-8711	Medium	
224347	48-22-8712	Large	
224348	48-22-8713	Extra Large	

### Work Gloves (Continued)

#### Free-Flex Work Gloves

Part #	Mfg #	Size	Price
224349	48-22-8714	2X Large	

#### Performance Work Gloves

- Built-in terry cloth sweat wipe
- Breathable lining provides all day comfort
- Hook & loop closure for a secure fit
- High dexterity finger tips provide dexterity when handling small objects
- Smartswipe™ Fingertips, Knuckles and Palms



Part #	Mfg #	Size	Price
224338	48-22-8725	Small	
224339	48-22-8721	Medium	
224340	48-22-8722	Large	
224341	48-22-8723	Extra Large	
224342	48-22-8724	2X Large	

#### Cut Level 1 Dipped Gloves

- ANSI & EN cut rating 1
- Textured nitrile palm
- SMARTSWIPE™ palm and fingertips
- High dexterity design
- Nylon/lycra blend material
- TDM cut rating C, Abrasion rating 3, Tear rating 2, Puncture rating 1
- Breathable glove design



Part #	Mfg #	Size	Price
244551	48-22-8900	Small	
244552	48-22-8901	Medium	
243227	48-22-8902	Large	
243228	48-22-8903	Extra Large	
244553	48-22-8904	2X Large	

## Work Gloves

### Cut Level 5 Dipped Gloves

- SMARTWIPE™ palm and fingertips
- High dexterity design
- Abrasion rating 4, puncture rating 4
- TDM cut rating E
- Nylon & HPPE liner material
- Double dipped nitrile w/ sandy texture finish



Part #	Mfg #	Size	Price
247748	48-22-8950	Small	
247750	48-22-8951	Medium	
247751	48-22-8952	Large	
247752	48-22-8953	Extra Large	
247753	48-22-8954	2X Large	

### Cut Level 3 Insulated Winter Dipped Gloves

- Sandy latex finish for grip performance
- 3/4 double dipped latex microfinish for water resistance and warmth
- 15GA outer liner for dexterity
- 7GA inner liner for warmth
- Ideal use for demolition, wire-stripping, and pipe threading applications



Part #	Mfg #	Size	Price
254509	48-22-8921	Medium	
254510	48-22-8922	Large	
254511	48-22-8923	Extra Large	



## Gloves, Ear Plugs, Goggles, ETC

### Gloves

#### Disposable Latex Glove

- *Extra large*
- *Reversible*



Part #	Mfg #	Type	Size	Price
060105	390-50177	Heavy-Duty	XL	

**Gloves, Ear Plugs, Goggles, ETC**

**Gloves**

**X10 Knucklehead Glove**

- Synthetic leather palm
- Elastic wrist
- High visibility orange



Part #	Mfg #	Description	Price
148262	21242HOL	Large	
148263	21242HOXL	Extra Large	
148135	21242HOXXL	Extra Extra Large	

**Split Cowhide Double Palm Glove**

- Knuckle strap
- Wing thumb
- Polyethylene safety cuff



Part #	Mfg #	Description	Price
122046	4503CDPXL	Extra Large	

**String Knit Cotton/Polyester Glove**

- Ambidextrous
- PVC Dots on both sides
- Natural color



Part #	Mfg #	Description	Price
122623	3825L	Large	

**A Grade Gold Deerskin Palm Glove**

- Black stretch back
- Velcro closure
- Mechanics style
- Heatlok lined



Part #	Mfg #	Description	Price
129331	2150HM	Medium	
129332	2150HXL	Extra Large	
129346	2150HXXL	Extra Extra Large	

**High Visibility Terry Lined Yellow Knit No Logo Glove**

- Black rubber palm hides dirt
- Rubber palm
- Super fit
- Precurved design promotes easy flexing



Part #	Mfg #	Description	Price
144702	3396HYNL	Large	
144701	3396HYNXL	Extra Large	

**High Visibility Yellow Knit Glove**

- Summer version
- Black rubber palm hides dirt
- Rubber palm
- Super fit
- Precurved design promotes easy flexing



Part #	Mfg #	Description	Price
122621	3397HYL	Large	

**High Visibility Yellow Knit No Logo Glove**

- Rubber palm
- Excellent wear and resistance
- Super fit



Part #	Mfg #	Description	Price
140861	3397HYNM	Medium	
140863	3397HYNL	Large	
140858	3397HYNXL	Extra Large	

**High Visibility Superdex Gloves**

- Nylon shell
- 15 Gauge liner
- 100% Launderable
- Pre-curved finger design
- Ultra cool & breathable coating
- Micro foam nitrile coated palm



Part #	Mfg #	Description	Price
159170	3228HVYL	Large	
159171	3228HVYXL	Extra Large	

## Gloves, Ear Plugs, Goggles, ETC

### High Visibility Orange Knit Glove

- Summer version
- Black rubber palm hides dirt
- Precurved design promotes easy flexing
- Rubber palm
- Super fit



Part #	Mfg #	Description	Price
122620	3397HOL	Large	

### Disposable Nitrile Glove

- Textured fingertips
- Powder-free
- 5 - 6 Mil
- 100/Box



Part #	Mfg #	Description	Price
121772	3276L	Large	
133593	3276XL	Extra Large	

### High Visibility Orange Knit No Logo Glove

- Rubber palm
- Excellent wear and resistance
- Super fit

Part #	Mfg #	Description	Price
140860	3397HONM	Medium	
140862	3397HONL	Large	
140859	3397HONXL	Extra Large	

### SuperDex Gray Nitrile Palm Dipped Glove

- Lightweight black nylon liner
- Knit wrist
- Black/gray



Part #	Mfg #	Description	Price
169298	3270L	Large	
169299	3720XL	Extra Large	

### OXXA X-Pro Flex Gloves

- Micro foam nitrile palm coating nylon shell



Part #	Mfg #	Description	Price
159172	51-290	Medium	
159173	51-290	Large	



**Gloves, Ear Plugs, Goggles, ETC**

**Cowhide Drivers Gloves**

**Elastic Back Rough Rider Gloves**

- Made from top-grain leather
- Deep oil tanned
- Sewn with inset, keystone thumb
- Bound at cuff with leather
- Elastic back for an easy-on easy-off fit



Part #	Mfg #	Size	Qty	Price
051840	2500-L	Large	1 Pair	

**Latex and Vinyl Coated Gloves**

**Yellow Flock Lined Latex Cleaning Gloves**

- 18 Mil natural latex
- Unsupported
- Soft flock lining absorbs moisture for easy off and on



Part #	Mfg #	Size	Qty	Price
051851	6000-L	Large	1 Pair	

**Side Split Leather Gloves**

**Premium Side Split Leather Palm Gloves**

- Blue
- Side-split leather work gloves for longer wear and better protection
- Safety cuff



Part #	Mfg #	Size	Qty	Price
051839	2110-L	Large	1 Pair	

**Hearing Protection**

**MAX Ear Plugs**

- Preshaped foam
- NRR33 Rated



Part #	Mfg #	Description	Qty	Price
051843	9500	Uncorded	100/Pk	

**Howard Leight Quiet Ear Plugs**

- Corded



Part #	Mfg #	Description	Qty	Price
051844	9522	Corded		

**Grain Leather Gloves**

**Rough Rider Grain Leather Palm Gloves**

- Made from top-grain leather
- Deep oil tanned
- Lined with 100 grams 3M Thinsulate insulation
- Heavy yellow canvas
- Knit wrists



Part #	Mfg #	Size	Qty	Price
051841	2160-L	Large	1 Pair	

**Jersey Gloves**

Part #	Mfg #	Size	Qty	Price
051837	3401-L	9 oz Large	1 Pair	

**Double Palm and Chore Cotton Gloves**

**Galeton Gold Cotton Chore Cotton Gloves**

- 18 oz Quilted gold cotton chore
- Two layers of soft cotton
- Insulated against heat and cold
- Knit wrist



Part #	Mfg #	Size	Qty	Price
051838	3112-L	Large	1 Pair	

**Disposable Respirators**

**Nuisance Dust Mask**

- Filters pollen, dust and other non-toxic particles from the air
- Withstands hot and humid conditions
- Double-shell construction resists collapse
- Easily adjustable nosepiece



Part #	Mfg #	Description	Qty	Price
051842	9700	Dust Mask	50/Box	

## Work Gear

### Work Wear

#### GridIron™ Zip-to-Thigh Bib Overall

- Freeflex™
- No Days Off™
- 2" Adjustable waist
- Durable metal buckles
- 100g high-loft insulation
- Tarnish resistant metal zippers
- Pockets include:
  - 2 front hand pockets
  - 2 large back pockets
  - 3 side leg pockets
  - Utility chest pocket
  - Tape measure & hammer loops



Part #	Mfg #	Waist	Inseam	Price
241320	261B-SS	28"-30"	28"	
241319	261B-SR	28"-30"	30"	
241321	261B-ST	28"-30"	32"	
241317	261B-MS	32"-34"	28"	
241316	261B-MR	32"-34"	30"	
241318	261B-MT	32"-34"	32"	
241314	261B-LS	36"-38"	28"	
241313	261B-LR	36"-38"	30"	
241315	261B-LT	36"-38"	32"	
241323	261B-XLS	40"-42"	28"	
241322	261B-XLR	40"-42"	30"	
241324	261B-XLT	40"-42"	32"	
241308	261B-2XS	44"-46"	28"	
241307	261B-2XR	44"-46"	30"	
241309	261B-2XT	44"-46"	32"	
241311	261B-3XS	48"-50"	28"	
241310	261B-3XR	48"-50"	30"	
241312	261B-3XT	48"-50"	32"	

#### Hooded Jacket - Black

- GridIron™ Ripstop polyester
- FreeFlex™ Mobility
- Wind and water resistant
- 100g of High-loft insulation
- Fitted hood
- Rib knit cuffs and waist



Part #	Mfg #	Size	Price
224060	252B-S	Small	
224061	252B-M	Medium	
224062	252B-L	Large	

### Work Wear (Continued)

#### Hooded Jacket - Black

Part #	Mfg #	Size	Price
224063	252B-XL	Extra Large	
224065	252B-2X	2X Large	
224066	252B-3X	3X Large	

#### WorkSkin™ Cold Weather Base Layer - Gray

- Fast wicking sweat zones move moisture away from under arms and upper back
- Durable body fabric
- Drop tail extended back
- Seamless shoulders



Part #	Mfg #	Size	Price
224068	401G-S	Small	
224069	401G-M	Medium	
224070	401G-L	Large	
224071	401G-XL	Extra Large	
224072	401G-2X	2X Large	
224073	401G-3X	3X Large	

#### WorkSkin™ Light Weight Performance Shirt

- CoolCore® fabric
- Seamless shoulders
- Drop tail extended back
- Fast wicking sweat zones extend down the back and under the arms



Part #	Mfg #	Size	Price
238077	410G-S	Small	
238078	410G-M	Medium	
238079	410G-L	Large	
238080	410G-XL	Extra Large	
238081	410G-2X	2X Large	
238082	410G-3X	3X Large	

## Work Gear

### WorkSkin™ Light Weight Performance Shirt High Visibility

- CoolCore® fabric
- Seamless shoulders
- Drop tail extended back
- Fast wicking sweat zones extend down the back and under the arms



Part #	Mfg #	Size	Price
238055	410HV-S	Small	
238056	410HV-M	Medium	
238058	410HV-L	Large	
238059	410HV-XL	Extra Large	
238061	410HV-2X	2X Large	
238063	410HV-3X	3X Large	

### WORKSKIN™ MID-WEIGHT COLD WEATHER HARDHAT LINER

- Breathable fabric moves moisture away from the body
- Durable fabric resists pilling and fights odor
- Fast moisture wicking, accelerated drying
- Low profile, ideal for hardhat use



Part #	Mfg #	Color	Price
252329	422B	Black	

### GRIDIRON™ SNAPBACK TRUCKER HAT

- GRIDIRON™ Ripstop polyester front panel
- Six panel construction
- 3-1/2" Crown
- Curved visor
- One size fits all with adjustable snapback



Part #	Mfg #	Color	Price
251074	505B	Black	

### Fleece Lined Beanie

- One size fits all
- Polyester material wicks sweat
- Abrasion and snag resistant
- 98% Polyester, 2% spandex



Part #	Mfg #	Color	Price
238994	502G	Gray	
238996	502B	Black	
238995	502R	Red	

### Stocking Cap

Part #	Mfg #	Color	Price
224089	501G	Gray	
224090	501R	Red	



## Heated Gear

### Heated Jackets

#### M12™ 3-in-1 Heated Jacket - Black

- Chest and back zones
- Up to 8 hours of run-time
- GridIron™ Ripstop polyester
- Low profile battery
- Washer and dryer safe
- FREEFLEX™ Mobility
- 3 Heat settings: High, Med, Low



#### Kits

Part #	Mfg #	Size	Price
224038	251B-21S	Small	
224039	251B-21M	Medium	
224041	251B-21L	Large	
224042	251B-21XL	Extra Large	
224043	251B-212X	2X Large	
224044	251B-213X	3X Large	

#### Jacket Only (Less Battery Pack)

Part #	Mfg #	Size	Price
224032	251B-20S	Small	
224033	251B-20M	Medium	
224034	251B-20L	Large	
224035	251B-20XL	Extra Large	
224037	251B-203X	3X Large	
224036	251B-202X	2X Large	

### M12™ Heated Jacket - Gray

- Chest and back zones
- Up to 8 hours of run-time
- TOUGHSHELL™ Stretch polyester
- Low profile battery
- Washer and dryer safe
- FREEFLEX™ Mobility
- 3 Heat settings: High, Med, Low



#### Kits

#### Includes:

- (1) M12™ Heated Jacket (Jacket Only) (201-20)
- (1) M12™ REDLITHIUM™ CP2.0 Battery (48-11-2420)
- (1) M12™ Lithium-ion Battery Charger (48-59-2401)
- (1) M12™ Battery Holder with 2.1A USB Charger

Part #	Mfg #	Size	Price
223852	201G-21S	Small	
223853	201G-21M	Medium	
223854	201G-21L	Large	
223855	201G-21XL	Extra Large	
223856	201G-212X	2X Large	
223857	201G-213X	3X Large	

#### Jacket Only (Less Battery Pack)

Part #	Mfg #	Size	Price
223841	201G-20S	Small	
223842	201G-20M	Medium	
223848	201G-20L	Large	
223849	201G-20XL	Extra Large	
223850	201G-202X	2X Large	
223851	201G-203X	3X Large	

## Heated Gear

### M12™ Heated Jacket - Black

- Chest and back zones
- Up to 8 hours of run-time
- TOUGHSHELL™ Stretch polyester
- Low profile battery
- Waster and dryer safe
- FREEFLEX™ Mobility
- 3 Heat settings: High, Med, Low



#### Kits

**Includes:**

- (1) M12™ Heated TOUGHSHELL™ Jacket Kit (202-21)
- (1) M12™ REDLITHIUM™ CP2.0 Battery (48-11-2420)
- (1) M12™ Compact Charger and Power Source (48-59-1201)

Part #	Mfg #	Size	Price
223832	202B-21S	Small	
223833	202B-21M	Medium	
223834	202B-21L	Large	
223835	202B-21XL	Extra Large	
252064	202B-212X	2X Large	
252065	202B-213X	3X Large	

#### Jacket Only (Less Battery Pack)

Part #	Mfg #	Size	Price
223817	202B-20S	Small	
223827	202B-20M	Medium	
223828	202B-20L	Large	
223829	202B-20XL	Extra Large	
223830	202B-202X	2X Large	
223831	202B-203X	3X Large	

### M12™ Heated Jacket - Red

- Chest and back zones
- Up to 8 hours of run-time
- TOUGHSHELL™ Stretch polyester
- Low profile battery
- Waster and dryer safe
- FREEFLEX™ Mobility
- 3 Heat settings: High, Med, Low



#### Kits

**Includes:**

- (1) M12™ Heated TOUGHSHELL™ Jacket Kit (202-21)
- (1) M12™ REDLITHIUM™ CP2.0 Battery (48-11-2420)
- (1) M12™ Compact Charger and Power Source (48-59-1201)

Part #	Mfg #	Size	Price
223865	202R-21S	Small	

### Heated Jackets (Continued)

#### M12™ Heated Jacket - Red

#### Kits

Part #	Mfg #	Size	Price
223866	202R-21M	Medium	
223973	202R-21L	Large	
223974	202R-21XL	Extra Large	
223975	202R-212X	2X Large	
223976	202R-213X	3X Large	

#### Jacket Only (Less Battery Pack)

Part #	Mfg #	Size	Price
223858	202R-20S	Small	
223859	202R-20M	Medium	
223860	202R-20L	Large	
223861	202R-20XL	Extra Large	
223862	202R-202X	2X Large	
223864	202R-203X	3X Large	

### M12™ Heated Jacket - Realtree Xtra® Camo

- Chest and back zones
- Up to 8 hours of run-time
- TOUGHSHELL™ Stretch polyester
- Low profile battery
- Waster and dryer safe
- FREEFLEX™ Mobility
- 3 Heat settings: High, Med, Low



#### Kits

**Includes:**

- (1) (221C-20)
- (1) M12™ REDLITHIUM™ CP2.0 Battery (48-11-2420)
- (1) M12™ Lithium-ion Battery Charger (48-59-2401)
- (1) M12™ Battery Holder with 2.1A USB Charger

Part #	Mfg #	Size	Price
223983	221C-21S	Small	
223984	221C-21M	Medium	
223985	221C-21L	Large	
223986	221C-21XL	Extra Large	
223988	221C-212X	2X Large	
223989	221C-213X	3X Large	



## Heated Gear

### Jacket Only (Less Battery Pack)

Part #	Mfg #	Size	Price
223977	221C-20S	Small	
223978	221C-20M	Medium	
223979	221C-20L	Large	
223980	221C-20XL	Extra Large	
223981	221C-202X	2X Large	
223982	221C-203X	3X Large	

### M12™ Heated QUIETSHELL Jacket

- Heating zones: chest, back, & pockets
- Up to (8) hours of run-time
- QuietShell stretch polyester
- 3 Heat settings per zone
- Washer and dryer safe



#### Kits

- **Includes:**
- (1) M12™ Heated QUIETSHELL Jacket (222-20)
- (1) M12™ REDLITHIUM™ CP2.0 Battery (48-11-2420)
- (1) M12™ Compact Charger and Power Source (48-59-1201)

Part #	Mfg #	Size	Price
252326	222C-21L	Large	
252327	222C-21XL	Extra Large	
252328	222C-212X	2X Large	

### Jacket Only (Less Battery Pack)

Part #	Mfg #	Size	Price
255312	222C-20M	Medium	
253286	222C-20L	Large	

### M12™ Women's Heated Jacket - Black

- Chest and back zones
- Up to 8 hours of run-time
- TOUGHSHELL™ Stretch polyester
- Low profile battery
- Washer and dryer safe
- FREEFLEX™ Mobility
- 3 Heat settings: High, Med, Low



#### Kits

- **Includes:**
- (1) M12™ REDLITHIUM™ CP2.0 Battery (48-11-2420)
- (1) M12™ Lithium-ion Battery Charger (48-59-2401)
- (1) M12™ Battery Holder with 2.1A USB Charger

Part #	Mfg #	Size	Price
223990	231B-21S	Small	
223992	231B-21M	Medium	
223993	231B-21L	Large	
223994	231B-21XL	Extra Large	
223995	231B-212X	2X Large	

### M12™ Women's Heated AXIS™ Jacket

- Quick-heat function
- One-touch LED controller with 3 heat settings
- Up to (8) hours of run-time w/ M12™ REDLITHIUM™ 2.0 compact battery
- Washer and dryer safe
- Reinforced high-wear zones
- 100% Polyester insulation keeps heat in
- (3) Out zip pockets, (1) inner zip pocket, (1) low-profile battery pocket



#### Kits

- **Includes:**
- (1) M12™ Heated Women's AXIS™ Jacket (233-20)
- (1) M12™ REDLITHIUM™ CP2.0 Battery (48-11-2420)
- (1) M12™ Compact Charger and Power Source (48-59-1201)

Part #	Mfg #	Size	Price
252144	233B-21S	Small	
252145	233B-21M	Medium	
252146	233B-21L	Large	
252147	233B-21XL	Extra Large	

### Jacket Only (Less Battery Pack)

Part #	Mfg #	Size	Price
252148	233B-20S	Small	



## Heated Gear

### Heated Jackets (Continued)

#### M12™ Women's Heated AXIS™ Jacket

Jacket Only (Less Battery Pack)

Part #	Mfg #	Size	Price
252149	233B-20M	Medium	
252150	233B-20L	Large	
252151	233B-20XL	Extra Large	

#### M12™ Heated AXIS™ Jacket

- Heating zones: chest, back, & shoulders
- Up to 8 hours of run-time with M12™ REDLITHIUM™ 2.0 compact battery
- 100% Polyester insulation
- Washer and dryer safe
- Quick-heat function reaches selected temperature 3X FASTER
- Adjustable waist with drop tail extended back



#### Kits

Includes:

- (1) M12™ Heated AXIS™ Jacket (203-20)
- (1) M12™ REDLITHIUM™ CP2.0 Battery (48-11-2420)
- (1) M12™ Compact Charger and Power Source (48-59-1201)

Part #	Mfg #	Size	Price
252130	203B-21S	Small	
252132	203B-21M	Medium	
252133	203B-21L	Large	
252134	203B-21XL	Extra Large	
252135	203B-212X	2X Large	
252136	203B-213X	3X Large	

Jacket Only (Less Battery Pack)

Part #	Mfg #	Size	Price
252138	203B-20S	Small	
252139	203B-20M	Medium	
252140	203B-20L	Large	
252142	203B-20XL	Extra Large	
252141	203B-202X	2X Large	
252143	203B-203X	3X Large	

### Heated Hoodies

All kits include

- (1) M12™ Heated Hoodie
- (1) M12™ REDLITHIUM™ Battery (48-11-2401)
- (1) M12™ Lithium-ion Battery Charger (48-59-2401)
- (1) M12™ Battery Holder

#### M12™ Heated Hoodie - Black

- Chest and back zones
- Up to 6 hours of run-time
- Waffle weave lining traps heat
- Washer and dryer safe
- Durable utility pockets
- 3 Heat settings: High, Med, Low



#### Kits

Includes:

- (1) M12™ Heated Hoodie (302-20)
- (1) M12™ REDLITHIUM™ CP1.5 Battery Pack (48-11-2401)
- (1) M12™ Lithium-ion Battery Charger (48-59-2401)
- (1) M12™ Battery Holder

Part #	Mfg #	Size	Price
224014	302B-21S	Small	
252066	302B-21M	Medium	
224016	302B-21L	Large	
224017	302B-21XL	Extra Large	
224018	302B-212X	2X Large	
224019	302B-213X	3X Large	

Hoodie Only (Less Battery Pack)

Part #	Mfg #	Size	Price
224008	302B-20S	Small	
224009	302B-20M	Medium	
224010	302B-20L	Large	
224011	302B-20XL	Extra Large	
224012	302B-202X	2X Large	
227263	302B-203X	3X Large	

## Heated Gear

### M12™ Heated Hoodie - Gray

- Chest and back zones
- Up to 6 hours of run-time
- Waffle weave lining traps heat
- Waster and dryer safe
- Durable utility pockets
- 3 Heat settings: High, Med, Low



#### Kits

Includes:

- (1) M12™ Heated Hoodie (302-20)
- (1) M12™ REDLITHIUM™ CP1.5 Battery Pack (48-11-2401)
- (1) M12™ Lithium-ion Battery Charger (48-59-2401)
- (1) M12™ Battery Holder

Part #	Mfg #	Size	Price
224002	302G-21S	Small	
224003	302G-21M	Medium	
224004	302G-21L	Large	
224005	302G-21XL	Extra Large	
224006	302G-212X	2X Large	
224007	302G-213X	3X Large	

### Hoodie Only (Less Battery Pack)

Part #	Mfg #	Size	Price
223996	302G-20S	Small	
223997	302G-20M	Medium	
223998	302G-20L	Large	
223999	302G-20XL	Extra Large	
224000	302G-202X	2X Large	
224001	302G-203X	3X Large	

### M12™ Heated Hoodie - Red

- Chest and back zones
- Up to 6 hours of run-time
- Waffle weave lining traps heat
- Waster and dryer safe
- Durable utility pockets
- 3 Heat settings: High, Med, Low



#### Kits

Includes:

- (1) M12™ Heated Hoodie (302-20)
- (1) M12™ REDLITHIUM™ CP1.5 Battery Pack (48-11-2401)
- (1) M12™ Lithium-ion Battery Charger (48-59-2401)
- (1) M12™ Battery Holder

Part #	Mfg #	Size	Price
224026	302R-21S	Small	

### Heated Hoodies (Continued)

#### M12™ Heated Hoodie - Red

#### Kits

Part #	Mfg #	Size	Price
224027	302R-21M	Medium	
224028	302R-21L	Large	
224029	302R-21XL	Extra Large	
224030	302R-212X	2X Large	
224031	302R-213X	3X Large	

#### Hoodie Only (Less Battery Pack)

Part #	Mfg #	Size	Price
224022	302R-20L	Small	
224021	302R-20M	Medium	
224020	302R-20S	Large	
224023	302R-20XL	Extra Large	
224024	302R-202X	2X Large	
224025	302R-203X	3X Large	

### M12™ Heated Vest - Black

- Up to 6 hours of run-time
- GridIron™ Ripstop polyester
- Thermal fleece lining
- 3 Heat settings: High, Med, Low



#### Kits

- (1) M12™ Heated Vest - Black (Vest Only) (271B-20)
- (1) M12™ REDLITHIUM™ Battery (48-11-2401)
- (1) M12™ Battery Holder

Part #	Mfg #	Size	Price
224054	271B-21S	Small	
224055	271B-21M	Medium	
224056	271B-21L	Large	
224057	271B-21XL	Extra Large	
224058	271B-212X	2X Large	
224059	271B-213X	3X Large	

#### Vest Only (Less Battery Pack)

Part #	Mfg #	Size	Price
224045	271B-20S	Small	
224046	271B-20M	Medium	
224049	271B-20L	Large	
224050	271B-20XL	Extra Large	

## Heated Gear

### Heated Hoodies (Continued)

#### M12™ Heated Vest - Black Vest Only (Less Battery Pack)

Part #	Mfg #	Size	Price
224051	271B-202X	2X Large	
224053	271B-203X	3X Large	

#### M12™ Heated AXIS™ Vest

- Quick-heat function reaches selected temperature 3X FASTER
- Up to (6) hours of run-time
- 100% Polyester insulation
- One-touch LED controller with (3) heat settings per heat zone: High, Med, Low
- Heating zones: chest & back
- Wind and water resistant
- Adjustable waist with drop tail extended back



#### Kits

#### Includes:

- (1) M12™ Heated AXIS™ Vest (303-20)
- (1) M12™ REDLITHIUM™ Battery (48-11-2401)
- (1) M12™ Battery Holder

Part #	Mfg #	Size	Price
252152	303B-21S	Small	
252153	303B-21M	Medium	
252154	303B-21L	Large	
252155	303B-21XL	Extra Large	
252156	303B-212X	2X Large	
252158	303B-213X	3X Large	

#### Vest Only (Less Battery Pack)

Part #	Mfg #	Size	Price
252159	303B-20S	Small	
252160	303B-20M	Medium	
252161	303B-20L	Large	
252162	303B-20XL	Extra Large	
252163	303B-202X	2X Large	
252164	303B-203X	3X Large	

### M12™ Heated Women's AXIS™ Vest

- Quick-heat function reaches selected temperature 3X FASTER
- Up to 6 hours of run-time
- One-touch LED controller with (3) heat settings per heat zone: High, Med, Low
- Heating zones: chest & back
- Wind & water resistant
- Adjustable waist with drop tail extended back



#### Kits

- (1) M12™ Heated Women's AXIS™ Vest (333-20)
- (1) M12™ REDLITHIUM™ CP1.5 Battery Pack (48-11-2401)
- (1) M12™ Battery Holder

Part #	Mfg #	Size	Price
252168	333B-21S	Small	
252170	333B-21M	Medium	
252171	333B-21L	Large	
252172	333B-21XL	Extra Large	

#### Vest Only (Less Battery Pack)

Part #	Mfg #	Size	Price
252173	333B-20S	Small	
252174	333B-20M	Medium	
252175	333B-20L	Large	
252176	333B-20XL	Extra Large	

### Heated Hand Warmers

#### Kits Include

- (1) M12™ Cordless heated hand warmer only
- (1) M12™ REDLITHIUM™ battery (48-11-2401)
- (1) M12™ Lithium-ion battery charger (48-59-2401)
- (1) M12™ Battery holder

#### M12™ Cordless Black Heated Hand Warmer



Part #	Mfg #	Description	Price
160200	2322-21	Black Hand Warmer Kit	
160199	2322-20	Black Hand Warmer Only	

## Heated Gear

### M12™ Cordless Realtree Xtra® Camo Heated Hand Warmer



Kit

Part #	Mfg #	Description	Price
160198	2321-21	Camo Hand Warmer Kit	
160197	2321-20	Camo Hand Warmer Only	

### M12™ Heated Hand Warmer with LED Work Light Kit

- TOUGHShell™ stretch polyester
- 1 size with adjustable waist strap fits most
- 1 outer zip pockets, 1 outer magnet closure pocket, 1 low-profile battery pocket
- Includes:  
 M12™ REDLITHIUM™ 2.0 compact battery pack  
 M12™ LED work light  
 M12™ battery holder with 2.1A USB charger to power electronic devices



Part #	Mfg #	Size	Price
256498	551B-21	Black Hand Warmer Kit	

## Heated Gloves

### Kits Include

- (1) REDLITHIUM™ USB Battery (48-11-2130)
- (1) REDLITHIUM™ USB Battery & Charger Kit (48-59-2003)
- (1) Heavy Duty Cord and Wall Plug

### USB Rechargeable Heated Gloves

- Quick-heat function reaches selected temperature 3X faster
- Up to (6) hours of run-time with REDLITHIUM™ USB Batter Pack
- GRIDIRON™ Ripstop polyester
- SMARTWIPE™ index fingers permits use of touch screen devices
- Extended cuff protects from the elements
- One-touch LED controller with (3) heat settings
- Leather palms and fingers improve dexterity
- Built-in terry cloth sweat wipe



Part #	Mfg #	Size	Color	Price
252178	561-21M	Medium	Black	
252179	561-21L	Large	Black	
252180	561-21XL	Extra Large	Black	

---



---

## Safety Glasses

---



---

### Safety Glasses

#### Sportster Safety Glasses

- Curved, wrap-around lenses
- Super-light
- 99% UV-A & UV-B Protection



Part #	Mfg #	Description	Qty	Price
080260	9200042	Indoor/Outdoor	1 Pair	

---



---

**Shoe Covers**

---



---

**Shoe Covers****Waterproof Shoe Cover**

- Skid-proof soles
- Waterproof
- Multiuse or disposable
- Dispenser box
- Designed to fit over a size 18 work boot
- Dark blue



Part #	Mfg #	Description	Price
138851	20361	Waterproof Shoe Covers, Box of 50	



---

---

## Shoe Covers

---

---

### Shoe Covers

#### Shoe Liner Booty



Part #	Mfg #	Description	Price
145266	SC-1	Bx/50 Pair Shoe Liner Bootie	
237939	SC-1WP	Bx/40 Pair Shoe Liner Bootie	



## Shoe Covers

### Shoe Covers

#### Disposable Shoe Covers

- Blue-spun polypropylene, non-waterproof
- Fits over shoe sizes 5-15



Part #	Mfg #	Description	Price
076120	390-50176	Shoe Covers - 50 Per Box	

## Shoe Covers

### Yaktrax® Ice Traction Devices

#### Yaktrax® Icewalker

- Ultra lightweight ice traction
- Easy on/off
- Spikeless patented skid lock coil system
- Abrasion resistant 1.2mm steel coil
- Rust-resistant and crush-resistant
- 100% Satisfaction guaranteed



Part #	Mfg #	Size	Color	Fits Shoe Size:	Price
130634	08601	Small	Black	Men's 5 to 8-1/2, Women's 6-1/2 to 10	
128220	08603	Medium	Black	Men's 9 to 11, Women's 10-1/2 to 12-1/2	
128219	08605	Large/Extra-Large	Black	Men's 11-1/2 to 13-1/2, Women's 13 to 15	

**Airease Repair Parts & Accessories**

**Parts & Accessories**

Part #	Mfg #	Description	Price
208935	H4TXV01-HP	1.5-3T HP/AC TXV	
208936	H4TXV02-HP	3-5/T HP/AC TXV	
208937	H4TXV03-HP	4-5/T HP/AC TXV	
209605	AEHBCC05CSA1	1.821056 5KW Heat Kit	
209606	AEHBCC07CSA1	1.821057 7.5KW Heat Kit	
209607	AEHBCC10CSA1	1.821058 10KW Heat Kit	
209608	AEHBCC15CSA1	1.821046 15KW Heat Kit	
209609	AEHBCC20CSA1	1.821048 20KW Heat Kit	
208677	ECB255CBP	12R60 5KW H/K *SER 2	
208678	ECB2575CBP	12S08 7.5KW HK *SER 2	
208679	ECB2510CBP	12S60 10KW H/K *SER 2	
209590	ECB25125CBP	12S77 12.5KW *SER 2	
208680	ECB2515CBP	12S87 15KW H/K *SER2	
208681	ECB2520CBP	12S88 20KW H/K *SER2	
210243	R40403-003	Duct Circuit Board	
209368	11K50	NAT to LP Conversion Kit	

## American Standard Repair Parts

### Faucet Repair/Replacement Parts

#### Diaphragm Kit

Part #	Mfg #	Description	Price
001906	72940-0700	Aquaseal Diaphragm f/Heritage (Pr)	

### Toilet Repair/Replacement Parts

#### Flapper

Part #	Mfg #	Description	Price
026083	47146-0070A	Am Std, Rubber Flapper	

#### Tank-to-Bowl Kit

Part #	Mfg #	Description	Price
001760	47060-07	Am Std, Tank-to-Bowl Kit	

#### Toilet Flush Actuator

Part #	Mfg #	Description	Price
001662	33642-0700	Am Std, Toilet Actuating Valve for #5 w/Disc, Chain, Clip & Grommet	

#### Toilet Installation

Part #	Mfg #	Description	Price
001663	33643-0700	Am Std, Snap-on Seat Disc for 2031.016 Heritage Toilet	

#### Trip Lever

Part #	Mfg #	Description	Price
001778	47242-0020A	Am Std, Chrome f/Cadet II	
001779	47242-0200A	Am Std, White f/Cadet II	



---

---

## Basco Repair Parts

---

---

### Tub & Shower Accessories

#### Self-Adhesive Tape

Part #	Mfg #	Description	Price
048292	SC4248	Self Adhesive Tape	

#### Vinyl

Part #	Mfg #	Description	Price
048294	SCV284	Tapered Drip Vinyl, 37"	





## Bell & Gossett Repair Parts

### Check-Trol™ Isolation Flow Control Flange Sets

- Packaged with an isolation flange of the same size as a pair
- For circulator installations, gives you features of flow control valve, isolation valve and companion flange
- Cap screws and nuts included
- Maximum working pressure: 150 psi
- Maximum operating temperature: 200°F



**Flange for NRF/NBF/SSF Wet Rotors (Except NRF-45 & NBF-45),  
Series PL-30, PL-36, PL-55, Series 100, PR & LR**

Part #	Mfg #	Model	Size	Price
079000	101232	CTF-1	1" NPT x Flange	

**Flange for 4JA87, 4JA88, 4PD08, 4PD11, 4P976, 4P977, 4RC92, 4RD05, 4RD10, 4RD17, 5P428, 5P433, All  
Taco Bronze Pumps Except 4PC79**

Part #	Mfg #	Model	Size	Price
002423	101208LF		3/4" NPT x Flange	

### Pump Motors and Accessories

#### Power Pack Motor

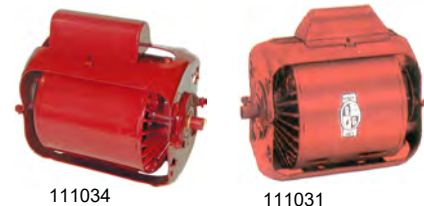

Part #	Mfg #	Phase	Voltage	HP	Price
002433	111034	Single	115V	1/12	
002432	111031	Single	115V	1/6	

#### Motor Coupler



Part #	Mfg #	Description	Price
002446	118473	For PD-35, PD-37, 60 "AA", 1522 (1/2" Shaft Frame)	
002452	118705	Pump Coupler for Series 100, HV, 2", PR	
002454	118723	Coupler	

#### Seal Kit

Part #	Mfg #	Description	Price
002457	186862	Seal Kit #1 1-1/4" ID Bronze Fit	



## Bell & Gossett Repair Parts

### Bearing Assembly



118844

186863

Part #	Mfg #	Description	Price
002455	118844	For 100 Series NFI & BI	
048806	185332	For PD-35, PD-37, 60 "AA"; IB, BF or AB	
002462	189105	For Series PR, 2-1/2", LD-3, HD-3	
002465	189134	Series 100	
044637	189163	Obsolete 1-1/2", Obsolete 2", Obsolete HV	
044778	189165	For HV, 2", 1-1/2" Obsolete IB or BI	

### Flange Gasket Set



118368

Part #	Mfg #	Description	Price
002442	118373	For 1-1/2", HV and All 1-1/2AA or 1-1/2A Models	
002441	118368	For LR, PL-30, PL-36, Series 100, PR, 60 1AA, 60 11/4AA, PL-55 and All 1AA or 1-1/4AA Models	

### Parts & Accessories



Part #	Mfg #	Description	Price
002407	L23401	1.5 oz Oil Tube	

**Bradley Washfountain Repair Parts**

**Classic Washfountain Parts**

**Foot Valve Repair Kit**

• Includes:

- S21-027 Needle assembly
- S64-006 Valve plunger assembly
- 125-001BW Gasket
- 117-016 Valve seat
- 125-001Y Diaphragm
- 124-001V Fibre washer
- 110-095 Body-needle valve
- 135-001P Spring
- 130-033 Key-valve seat

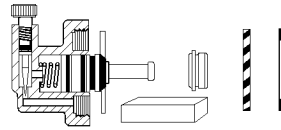

Part #	Mfg #	Description	Price
002730	S65-001A	Foot Valve Repair Kit	

## Chicago Faucet Repair Parts

### Handles & Handle Parts



Part #	Mfg #	Description	Finish	Price
002876	369-PRJKCP	(2) 2-3/8" ADA Levers with Hot/Cold Index Buttons	CP	

### Faucet Stem & Cartridge



1-099XTJKNF/1-100XTJKNF

377-XTRHJKNF/377-XTLHJ

Part #	Mfg #	Description	Finish	Price
016112	1-099XTJKNF	New Style RH Quatum™ Short Stem Unit for Exposed Valve (12/Box Only)	NF	
056563	1-099XKJKNF	RH Ceramic Short Stem Unit for Exposed Valve (12/Box Only)	NF	
016112	1-099XTJK(AB)NF	New Style RH Quatum™ Short Stem Unit for Exposed Valve (12/Box Only)	NF	
016111	1-100XTJKNF	New Style LH Quatum™ Short Stem Unit for Exposed Valve (12/Box Only)	NF	
056562	1-100XKJKNF	LH Ceramic 1/4-Turn Short Stem Unit for Exposed Valve	NF	
099706	377-XKLHJKNF	LH Ceramic 1/4-Turn Long Stem Unit for Concealed Valve (Sold by box 12/Lot)	NF	
099700	377-XKRHJKNF	RH Ceramic 1/4-Turn Long Stem Unit for Concealed Valve (Sold by box 12/Lot)	NF	
002877	377-XTLHJKNF	LH Quatum™ Long Stem Cartridge for Concealed Valve (Sold by box 12/Lot)	NF	
002878	377-XTRHJKNF	RH Quatum™ Long Stem Cartridge for Concealed Valve	NF	
020910	386-XSLOJKNF	Urinal Push-Button Cartridge	NF	

### Pre-Rinse Faucet Components

#### Stainless Steel Hose/Handle Assembly

- Insulated handle
- 3/4"-14 UNS Female outlet, 3/8" MNPT inlet
- T&S & Fisher adapters supplied



Part #	Mfg #	Description	Finish	Price
068698	83-44NF	44" Stainless Steel Hose/Handle Assembly	NF	

### Single Water Inlet Fittings

#### Deck-Mount Fitting

- Solid brass body construction
- 5-1/4" Rigid/swing gooseneck spout
- 1/2" NPSM Coupling nut for 3/8" or 1/2" flexible riser
- Mounting hardware included



Part #	Mfg #	Description	Finish	Price
002897	626-E3CP	1-Hole, E3 Softflo Pressure Compensating Aerator	CP	

## Chicago Faucet Repair Parts

### Spouts

- Fits 1-1/16"-18 UNEF male body outlet



DJ13JKC



L8JKCP

Part #	Mfg #	Description	Finish	Price
002797	DJ13JKCP	Double Jointed Swing Spout, 3-7/8"H, 13" Reach, E3 Softflo® Aerator	CP	
002798	DJ18JKCP	Double Jointed Swing Spout, 3-7/8"H, 17-3/4" Reach, E3 Softflo® Aerator	CP	
002811	L8JKCP	L-Type Swing Spout, 4-3/8"H, 8" Reach, E3 Softflo® Aerator	CP	
020853	L9JKCP	L-Type Swing Spout, 6-1/2"H, 9-1/2" Reach, E3 Softflo® Aerator	CP	
002810	L12JKCP	L-Type Swing Spout, 4-5/8"H, 12" Reach, E3 Softflo® Aerator	CP	
002812	S6JKCP	Swing Spout, 1-3/4"H, 6" Reach, E3 Softflo® Aerator	CP	

### Gooseneck Spouts

- Available in numerous standard dimensions
- Heavy 11/16" OD chrome-plated brass tubing
- Inlet union nut for quick change out
- Allows for field conversion of gooseneck spouts from rigid to swing AND vice-versa

#### Type A Gooseneck Spout

- Designed to accept Group A spout ends
- Fits 1-1/16"-18 UNEF male body outlet



Part #	Mfg #	Description	Finish	Price
002804	GN1AE3JK	Rigid/Swing GN Spout w/13/16"-24 Male Outlet 8-3/8"H, 3-1/2" Reach	CP	
002805	GN2AE3JKCP	Rigid/Swing GN Spout, 9-3/4"H, 5-1/4" Reach, E3 Softflo® Aerator	CP	
002806	GN8AE3JKCP	Rigid/Swing Spout w/E3 Pressure Compensating Softflo® Aerator 2.2 gpm, 11-1/4"H, 8" Reach	CP	

### Outlets & Adapters

- All flow rates up to 80 psi

#### E3 Pressure Compensating Softflo® Aerator

- Maximum flow rate: 2.2 gpm @ 60 psi
- 13/16"-24 Female inlet



Part #	Mfg #	Description	Finish	Price
002802	E3JKCP	Fits Spouts w/Group A Outlets	CP	

#### E12 Pressure Compensating Softflo® Aerator

- Maximum flow rate: 2.2 gpm @ 60 psi
- 13/16"-27 Male inlet



Part #	Mfg #	Description	Finish	Price
002799	E12JKCP	For Widespread & Centerset Lavatory Faucet	CP	

## Chicago Faucet Repair Parts

### Supply & Shank Connections/Inlets Shanks

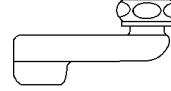

Part #	Mfg #	Description	Finish	Price
020958	HJKCP	2-1/2" Offset Inlet Supply Arm	CP	

### Renewing Kits

#### Quatum™ & Slow Compression Unit Kit - New Style

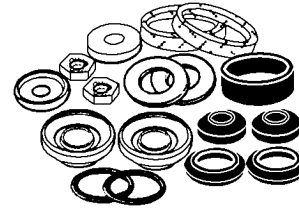

Part #	Mfg #	Description	Price
002833	1277D	Jiffy Kit - Box of 12	

### Replacement Parts



671-XJKNF

Part #	Mfg #	Description	Finish	Price
002818	1-006JKNF	Packing (50/Box Only)	NF	
002819	1-011JKNF	Rubber Washer (50/Box Only)		
002822	1-021JKNF	Rubber Seat Washer for X or XT	NF	
002823	1-022JKNF	Retainer for X or XT (100/Box Only)		
002825	1-027JKNF	Seat for X Style (100/Box Only)		
002826	1-031JKNF	Stem Washer for X Style (100/Box Only)		
002827	1-043JKNF	Cap Gasket for X Style (100/Box Only)		
134195	1-104JKNF	Spout Gland		
100595	1104-007JKNF	O-Ring		
028379	50-035JK(AB)NF	Spout O-Ring		
144383	122-NF	Thermostatic Mixing Valve	NF	
139530	131-NF	Thermostatic Mixing Valve	NF	
026523	217-XTLHJKNF	LH Slo-Comp (12/Box)	NF	
002847	217-XTRHJK	RH Slo-Comp (12/Box)		
002848	244-006JKNF	Rubber Seat Washer for NAIAD Cartridges	NF	
133595	305-SVBJKCP	Rigid Atmospheric Vacuum Breaker Spout w/3/4" Hose Thread	CP	
028864	333-XSLOPSHJKNF	Pushbutton Unit with Slow-Closing Push Button Cartridge, Push Index & Adj Cycle Time Closure		
033135	671-XJKNF	Metering Valve Unit		
135738	734-CP	Vacuum Breaker Kit		
029908	734-005JKNF	Body Gasket		



## Chicago Faucet Repair Parts

### Replacement Parts (Continued)

Part #	Mfg #	Description	Finish	Price
134779	892-254KJKCP	Vacuum Breaker Cover & Screw Kit	CP	
130310	892-302KJKAB	Atmospheric Vacuum Breaker Repair Kit	NA	
173077	892-402KJKAB	Vacuum Breaker	NA	

#### Ceramic Operating Cartridge for Single Lever Faucets

- ECAST™ construction
- Lift on
- Replaceable
- Manual shut off
- Left or right hand
- Short stem for exposed caps



Part #	Mfg #	Description	Finish	Price
227046	2300-XJKABNF	Ceramic Operating Cartridge		

### Parts & Accessories

#### Angle Stop Ball Valve with Loose Key Handle

- Stop with 5/8" Inlet
- 2" Tee Handle, Tapered Square Broach
- 5/8" O.D. (1/2" Nominal) Female Compression Inlet
- 3/8" O.D. Female Compression Outlet
- Chrome Plate Finish
- Weight: 0.506lbs
- ECAST® construction with equal to or less than 0.25% lead content by weighted average



Part #	Mfg #	Description	Finish	Price
186612	STB-31-00-AB	5/8" O.D. x 3/8" F Comp		

#### HyTronic Cover Plate

- Locating pin and mounting hardware included



Part #	Mfg #	Description	Size	Price
103250	240.627.21.1		4"	

## Chicago Faucet Repair Parts

### Check Valve

- 3/8" Compression male thread outlet
- Includes 3/8" Compression nut and ring
- 3/8" Compression female nut thread
- Inlet rubber sealing washer
- Spring loaded check
- ECAST® construction with equal to or less than 0.25% lead content
- Weight: 0.045lbs



Part #	Mfg #	Description	Finish	Price
188846	243.315.AB.1	Package Dimensions: 7.00"L x 6.00"W x 2.00"H		

**Dearborn Brass Repair Parts**

**Waste Repair Parts**

**Repair Part for Bath Waste**

- -1 Polished chrome

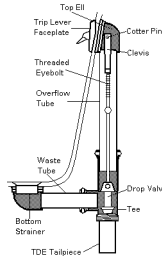

Part #	Mfg #	Description	Price
003327	4503-1	Faceplate, Trip Lever	
026678	4538-3	Pop-Up Waste Drain Seat & Plug includes a fulcrum linkage and nut and plug seat	

**Cast Brass Fittings**

**90° Slip Joint Elbow**

- Cast Brass



Part #	Mfg #	Size	Gauge	Price
175072	1675-2	1-1/2"		

**Showerheads**

Part #	Mfg #	Size	Gauge	Price
176822	122WS			Chrome Plated Brass Water Saving Shower Head

**Sink Repair Accessories**

**Sink Hole Cover**

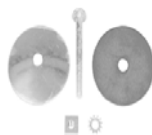

Part #	Mfg #	Size	Gauge	Price
251922	1226	2"		Cover w/ 2-Pc SS Head
251948	1227	1-3/4"		Cover w/ 2-Pc SS Head

## Delta Faucet Repair Parts

### Single-Handle Repair Parts Kit

Part #	Mfg #	Description	Price
243409	RP46748	Metal Lever Handle Kit, Chrome	
168961	RP46748SS	Metal Lever Handle Kit, Stainless*	
157966	RP47270SS	Single Lever Handle Kit	
157967	RP47271	Button and Set Screw	
152794	RP52833	Single Metal Lever Handle Kit	
143022	RP53409	Dryden™ Metal Lever Roman Tub Handle Kit, Chrome	
153001	RP60965	Single Lever Handle Kit w/ Button and Set Screw	
131775	RP63138	Single-Handle Repair Parts Kit	
245340	RP70640RB	Linden™ Volume Control Hdl, Venetian Bronze	
240471	RP72749	Cassidy™ Metal Lever Handle Kit, Chrome	

### Ara® 17 Series Temperature Knob and Cover



Part #	Mfg #	Description	Price
240123	RP75441SS	Stainless*	

### Classic Roman Tub Handle Base & Gasket



Part #	Mfg #	Description	Price
248389	RP62094	Chrome	
155272	RP62094SS	Stainless*	

### Dryden™ Roman Tub Handle Base

- Nut & gasket



Part #	Mfg #	Description	Price
144013	RP53410	Chrome	

### Trinsic® Roman Tub Handle Base

- Gasket included

Part #	Mfg #	Description	Price
243415	RP73161SS	Stainless*	

### Installation Aids

#### Quick-Connect Vegetable Spray Nipple Cap

- Converts "with spray" to "less spray"

Part #	Mfg #	Description	Price
074978	RP40301	Quick Connect Coupling, Vegetable Spray Cap	
181058	RP70613	Set Screw & Wrench	

#### Quick-Connect Hose

- For installing handle and spout farther apart

Part #	Mfg #	Description	Price
144185	RP50390	Hose Assembly & Clip	

#### Hose Assembly



Part #	Mfg #	Description	Price
055924	RP32527	Hose Assembly	

### Lavatory Drains

#### Metal Lavatory Drain Assembly

- Metal pop-up drain
- Metal lift-rod



Part #	Mfg #	Description	Price
003641	RP5651	Chrome	
003643	RP5651PB	Polished Brass*	
093335	RP5651RB	Venetian Bronze®	
103471	RP5651SS	Stainless*	

\* Brilliance® Anti-Tarnish Lifetime Finishes

## Delta Faucet Repair Parts

### Lavatory Drain Stopper



Part #	Mfg #	Description	Price
003637	RP5648	Chrome	
168193	RP5648CZ	Champagne Bronze™	
168478	RP5648NK	Luxe Nickel*	
159075	RP5648RB	Venetian Bronze®	
158887	RP5648SS	Stainless*	

### RP51732 Lift Rod Assembly



Part #	Mfg #	Description	Price
167091	RP51732SS	Stainless*	

### Ara® Lift Rod and Slider

- Metal pop-up

Part #	Mfg #	Description	Price
248925	RP90058	1-Hole, Chrome	

### Peerless Double Bend Lift Rod

- For B2596LF



Part #	Mfg #	Description	Price
245524	RP42092SS	Stainless*	

### Dryden™ Roman Tub Diverter Lift Rod & Finial

- SpotShield®



Part #	Mfg #	Description	Price
249640	RP53411	Chrome	

### Lahara® Lift Rod & Finial



Part #	Mfg #	Description	Price
258430	RP54971RB	Venetian Bronze	

### Lahara® Lift Rod and Finial

- Flextech

Part #	Mfg #	Description	Price
242268	RP64165	Chrome	

### Lift Rod and Finial

- For diverter roman tub



Part #	Mfg #	Description	Price
238742	RP41586	Chrome	

### RP41588 Lift Rod



Part #	Mfg #	Description	Price
164015	RP41588	Chrome	

### RP40267 Lift Rod



Part #	Mfg #	Description	Price
171467	RP40267	Chrome	

\* Brilliance® Anti-Tarnish Lifetime Finishes

## Delta Faucet Repair Parts

### Lavatory Drains (Continued)

#### RP40267 Lift Rod

Part #	Mfg #	Description	Price
249496	RP40267SS	Stainless	

#### RP52597 Lift Rod



Part #	Mfg #	Description	Price
230772	RP52597RB	Venetian Bronze	

#### RP54095 Lift Rod and Finial

Part #	Mfg #	Description	Price
168032	RP26151	Chrome	
187287	RP51291	Chrome	
157901	RP54095RB	Venetian Bronze®	

#### Trinsic® Lift Rod & Finial

- 1H lavatory



Part #	Mfg #	Description	Price
244866	RP74666BL	Matte Black	

#### Trinsic® Roman Tub Diverter Lift Rod & Finial

Part #	Mfg #	Description	Price
257803	RP74235	Chrome	

#### Final - Lavatory Lift Rod Top



Part #	Mfg #	Description	Price
171468	RP41574	Chrome	
173135	RP41574SS	Stainless*	

### Lavatory Drain Flange

- RP5651 & RP26533



Part #	Mfg #	Description	Price
027896	RP23060	Chrome	
168192	RP23060CZ	Champagne Bronze™	
149920	RP23060SS	Stainless*	

### Bath Installation Aids

#### Delta® Extension Kits

- Adds 1" to shanks
- For 3530/3540/3543/3544/3555/3665/3567/3569/3577/3578/3583



Part #	Mfg #	Description	Price
051857	RP10612	For 3530/3540/3543/3544/3555/3665/3567/3569/3577/3578/3583	

#### RP31845 Extension Kit



Part #	Mfg #	Description	Price
046440	RP31845	Extension Kit	

#### TempAssure® 17T Series Extension Kit

- Additional 1-3/4" installation



Part #	Mfg #	Description	Price
183263	RP75136	Extension Kit - 17T Series	

#### Monitor 14 Series MultiChoice Extension Kit



Part #	Mfg #	Description	Price
231280	RP77991	Extension Kit - 14 Series	

\* Brilliance® Anti-Tarnish Lifetime Finishes

[www.waterconcepts.net](http://www.waterconcepts.net) • Serving our Customers Since 1946 • [www.plumbsupply.com](http://www.plumbsupply.com)



## Delta Faucet Repair Parts

### MultiChoice® Integrated Diverter Extension Kit -27 Series



Part #	Mfg #	Description	Price
259604	RP90543	Extension Kit - 27 Series	

### 3-Setting Non-Shared Diverter Cartridge



Part #	Mfg #	Description	Price
163268	RP71718	Diverter Cartridge	

### 3 And 6-Setting Diverter Extension Kit



Part #	Mfg #	Description	Price
157035	RP75137	Extension Kit - Diverter	

### 2-Hdl DIAMOND™ Valve Assembly



Part #	Mfg #	Description	Price
148058	RP60400	Valve Assy	

### Delta® Horizontal Rod



Part #	Mfg #	Description	Price
003436	RP12517	Chrome	

### Euro-Motion™ Valve Assembly



Part #	Mfg #	Description	Price
153040	RP60114	Valve Assy	

### Conversion Ball

- Converts knob to lever handle
- Makes faucet ADA compliant



Part #	Mfg #	Description	Price
003587	RP20111	Conversion Ball	

### Euro-Motion™ Ceramic Valve



Part #	Mfg #	Description	Price
187321	RP75402	Ceramic Valve	

## Cartridges and Valves

### Diverter Cartridge



Part #	Mfg #	Description	Price
135236	RP51919	6-Setting, Diverter Cartridge	
135235	RP51918	3-Setting, Diverter Cartridge	

### Tesla® Lavatory Cartridge

- DIAMOND™ seal valve

Part #	Mfg #	Description	Price
247066	RP78715	Cartridge with Seal Valve	

\* Brilliance® Anti-Tarnish Lifetime Finishes

www.plumbsupply.com • Serving our Customers Since 1946 • www.waterconcepts.net

## Delta Faucet Repair Parts

### Trinsic® DIAMOND™ Euro-Motion Valve

- Short stem



Part #	Mfg #	Description	Price
242251	RP73000	Short Stem	

### Monitor® 13/14 Series Ceramic Valve Cartridge Assembly



Part #	Mfg #	Description	Price
258318	RP74236	Cartridge Assy	

### Multi-Choice® Universal Cartridge Assembly -13/14 Series

- Monitor® single-function pressure-balance cartridge
- Rotational limit stop easily adjusts via lift and turn
- For MultiChoice® universal 13/14 series tub and showers



Part #	Mfg #	Description	Price
095758	RP46074	Cartridge Assy	

### Multi-Choice® Universal Cartridge Assembly -17 Series

- Monitor® dual-function pressure- balance control
- For MultiChoice® 17 series tub and showers
- Allows for separate volume and temperature control



Part #	Mfg #	Description	Price
102530	RP46463	Cartridge Assy	

### Multi-Choice® Universal Cartridge Assembly -17T Series

- TempAssure® dual-function thermostatic cartridge
- For Multi-Choice® 17T series trim
- Allows for separate volume and temperature control



Part #	Mfg #	Description	Price
115704	RP47201	Cartridge Assy	

### Diverter Assembly



Part #	Mfg #	Description	Price
003529	RP17730	Diverter Assembly	
035054	RP19653	Diverter Assembly	

### Transfer Valve



Part #	Mfg #	Description	Price
025321	RP18632	Transfer Valve	

### Stem Cartridge Kit - (2)



Part #	Mfg #	Description	Price
170775	RP41701	Stem Cartridge Kit	

### Two Handle Ceramic Stem Cartridge - (Pair)



Part #	Mfg #	Description	Price
167855	RP47422	Stem Cartridge - Pair	

\* Brilliance® Anti-Tarnish Lifetime Finishes

www.waterconcepts.net • Serving our Customers Since 1946 • www.plumbsupply.com

## Delta Faucet Repair Parts

### Stem Unit Assembly

- Includes:
- Seat
- Spring
- Bonnet Nut
- Washer



Part #	Mfg #	Description	Price
171576	RP54801	Stem Unit Assy	

### Metering Valve



Part #	Mfg #	Description	Price
166640	RP72773	Metering Valve	

### Valve Cartridge



Part #	Mfg #	Description	Price
164727	RP50265	Valve Cartridge	

### Non-Shared Diverter Cartridge



Part #	Mfg #	Description	Price
166480	RP71717	2-Function Non-Shared Diverter Cartridge	

### Cartridge Fluehs



Part #	Mfg #	Description	Price
155280	RP61824	Cartridge Fluehs - Cold	
154243	RP61825	Cartridge Fluehs - Hot	

### RP42410 Cartridge Assembly



Part #	Mfg #	Description	Price
125499	RP42410	Diverter Cartridge	

### Cer-Tek Cartridge

- RH

Part #	Mfg #	Description	Price
130298	063000A	RH Cer-Tek Cartridge	
130299	063001A	LH Cer-Tek Cartridge	

### Thin Wall Installation Aid

- For MultiChoice® universal thin mount installation aid



Part #	Mfg #	Description	Price
094435	RP47202	Thin Mount Aid	

### Shower Renovation Cover Plate

- Covers up 8" center holes



Part #	Mfg #	Finish	Price
040814	RP29827	Chrome	
130864	RP29827RB	Venetian Bronze®	
134118	RP29827SS	Stainless*	

### Ara® Escutcheon and Gasket

- 1- or 3-Hole

Part #	Mfg #	Description	Price
247643	RP90057	Chrome	

### Deep Escutcheon



Part #	Mfg #	Description	Price
222353	RP21633SS	Stainless*	

\* Brilliance® Anti-Tarnish Lifetime Finishes

## Delta Faucet Repair Parts

### 600 / 1600 Series Tub & Shower Escutcheon



Part #	Mfg #	Description	Price
003658	RP5883	Chrome	

### 600 Series Escutcheon - Shallow



Part #	Mfg #	Description	Price
040905	RP6083	Chrome	

### 600 Series Tub and Shower Renovation Kit

- Includes:
  - RP17443RB - Lever handle
  - RP5883RB - Escutcheon
  - RP1050RB - Cap
  - RP5893RB - Sleeve
  - RP196RB - Escutcheon screws
  - RP20111 - Conversion ball
  - RP4993 - Seats and springs
  - RP188 = Cam and packing
- Order RP2865 plug for push button diverter
- Diverter tub spout may be required



Part #	Mfg #	Finish	Price
132394	RP54870	Chrome	
132395	RP54870RB	Venetian Bronze®	
129199	RP54870SS	Stainless*	

### 1900 Conversion Trim Kit



Part #	Mfg #	Description	Price
164080	RP54316	Chrome	
171340	RP54318	Chrome	
167369	RP54318RB	Venetian Bronze*	

### 3-Setting Diverter Escutcheon

Part #	Mfg #	Description	Price
233908	RP51924-RB	Venetian Bronze	

### 6-Setting Diverter Escutcheon

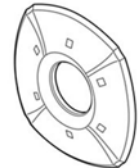

Part #	Mfg #	Description	Price
154615	RP61658SS	Stainless*	

### Deep Escutcheon with Push Button Diverter



Part #	Mfg #	Description	Price
162814	RP21634	Escutcheon, Chrome	

### Escutcheon

- Diagonal escape screw holes



Part #	Mfg #	Description	Price
032826	RP19809	Chrome	
157469	RP19809SS	Stainless*	

### Escutcheon - Shallow



Part #	Mfg #	Description	Price
043944	RP7577	Chrome	

\* Brilliance® Anti-Tarnish Lifetime Finishes

[www.waterconcepts.net](http://www.waterconcepts.net) • Serving our Customers Since 1946 • [www.plumbsupply.com](http://www.plumbsupply.com)

## Delta Faucet Repair Parts

### Escutcheon - Deep

- 1-13/16" Inside diameter



Part #	Mfg #	Description	Price
018419	RP6019	Chrome	

### Escutcheon and Gasket

- 3-Hole



Part #	Mfg #	Description	Price
247521	RP78358	Chrome	

### Tub & Shower Escutcheon

- Square



Part #	Mfg #	Description	Price
154796	RP52583RB	Venetian Bronze®	

### Dryden™ 6-Setting Diverter Escutcheon

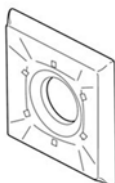

Part #	Mfg #	Description	Price
154795	RP52594RB	Venetian Bronze ®	

### 6-Setting Diverter Escutcheon



Part #	Mfg #	Description	Price
179525	RP42413RB	Venetian Bronze®	

### Escutcheon - 14 Series



Part #	Mfg #	Description	Price
154524	RP48716	Chrome	

### Escutcheon Trim Screws

- Set of 2



Part #	Mfg #	Description	Price
087663	RP196SS	Stainless*	

### Jetted Shower XO® Stem Extender

Part #	Mfg #	Description	Price
135242	RP37902	Stem Extender	
100606	RP37903	Stem Extender	

### Handshower Assembly



Part #	Mfg #	Description	Price
159519	RP52589SS	Stainless*	

### Kitchen Spray Assemblies

#### Victorian® Spray and Hose Assembly

- To be used for DIAMOND™ seal technology models



Part #	Mfg #	Description	Price
244160	RP37489	Chrome	
164086	RP37489SS	Stainless*	

\* Brilliance® Anti-Tarnish Lifetime Finishes



## Delta Faucet Repair Parts

### Classic Spray & Hose Assembly

- To be used for non-DIAMOND™ seal technology models



Part #	Mfg #	Description	Price
074675	RP39360	White	

### Signature® Waterfall® Spray & Hose Assembly

- To be used for non-DIAMOND™ seal technology models
- Includes nest



Part #	Mfg #	Finish	Price
098546	RP39345	Chrome	
091323	RP39345SS	Stainless*	

### Pilar® Linden™ Spray, Hose and Diverter Assembly

- To be used for DIAMOND™ seal technology models
- Touch-Clean® spray holes
- Front trigger control
- Finished spray face



Part #	Mfg #	Description	Price
185590	RP53880	Chrome	
165648	RP53880AR	Arctic Stainless	
156781	RP53880RB	Venetian Bronze®	

### Victorian® Spray, Hose, and Diverter Assembly

- To be used for DIAMOND™ seal technology models



Part #	Mfg #	Description	Price
170824	RP53881RB	Venetian Bronze®	
244811	RP53881SS	Stainless*	

### Collins™ Spray, Hose and Diverter Assembly

- To be used for DIAMOND™ seal technology models
- Touch-Clean® spray holes
- Finished spray face



Part #	Mfg #	Description	Price
130164	RP54235	Chrome	
144787	RP54235SS	Stainless*	

### Cassidy™ Spray and Hose Assembly

- Touch-Clean® spray holes
- Front trigger control
- Finished spray face



Part #	Mfg #	Description	Price
167693	RP72751	Chrome	

### Spray and Hose Assembly



Part #	Mfg #	Description	Price
179527	RP61013RB	Venetian Bronze*	

### Classic and Signature® Spray & Hose Assembly

- To be used for single handle non-DIAMOND™ seal technology models
- Finished sprayer



Part #	Mfg #	Finish	Price
044116	RP31612	Chrome	

### Spray & Hose Assembly



Part #	Mfg #	Finish	Price
058833	RP28900	Chrome	
259103	RP28900CB	Chrome/Brass	

\* Brilliance® Anti-Tarnish Lifetime Finishes



## Delta Faucet Repair Parts

### Kitchen Spray Assemblies (Continued)

#### Spray & Hose Assembly

Part #	Mfg #	Finish	Price
059165	RP28900SS	Stainless*	
168533	RP32250BN	Brushed Nickel*	

#### Kitchen Spray Assembly



Part #	Mfg #	Description	Price
224779	RP43524SS	Stainless*	

#### Classic Spray, Hose and Diverter Assembly

- To be used for DIAMOND™ seal technology models



Part #	Mfg #	Finish	Price
134487	RP60097	Chrome	
180881	RP60097SS	Stainless*	

#### Foundations® Spray, Hose Assembly and Spray Support

- Lead free
- For single handle kitchen models



Part #	Mfg #	Description	Price
145981	RP54807	Chrome	
187325	RP54807SS	Stainless*	

#### Spray Support Assembly



Part #	Mfg #	Description	Price
003664	RP6015	Chrome	

### Quick-Connect Vegetable Spray Hose



Part #	Mfg #	Description	Price
103219	RP37034GR	White	

### 2-Hdl Kitchen or Lavatory 16" Hose



Part #	Mfg #	Description	Price
003676	RP6050	White	

### Pilar® Pull-Down Spray Assembly



Part #	Mfg #	Description	Price
244885	RP53210AR	Arctic Stainless	

### Pull-Out Wand Assembly



Part #	Mfg #	Description	Price
154289	RP53102AR	Arctic Stainless™	
147391	RP53102SS	Stainless*	

### Pull-Down Wand Assembly



Part #	Mfg #	Description	Price
160975	RP72680AR	Pull-Down Wand Assembly	

\* Brilliance® Anti-Tarnish Lifetime Finishes

[www.plumbsupply.com](http://www.plumbsupply.com) • Serving our Customers Since 1946 • [www.waterconcepts.net](http://www.waterconcepts.net)

## Delta Faucet Repair Parts

### Wand Assembly



### Wand Assembly with Hose

- Pull-out faucets



Part #	Mfg #	Description	Price
182191	RP51480	Chrome	
156754	RP51480RB	Venetian Bronze®	
152052	RP51480SS	Stainless*	
237802	RP51480AR	Arctic Stainless	

Part #	Mfg #	Description	Price
063196	RP32542	Chrome	
161322	RP32542AR	Arctic Stainless™	
162140	RP32542BL	Matte Black	
081006	RP32542SS	Stainless*	

### Spray Assembly



Part #	Mfg #	Description	Price
181927	RP46751SS	Stainless*	

### Palo Wand Assembly



Part #	Mfg #	Description	Price
117444	RP44643	Chrome	
168840	RP44643SS	Stainless*	

### Pull-Down Spray Assembly

- Includes aerator



Part #	Mfg #	Description	Price
159024	RP47269SS	Stainless*	

### RP44477 Pull-Out Wand Assembly



Part #	Mfg #	Description	Price
168481	RP44477SS	Stainless*	

### Fuse Pull-Down Wand Assembly

Part #	Mfg #	Description	Price
175890	RP70703SB	Stainless*/Cracked Pepper	

### Sprayer Wand Assembly

- Pull-out faucets



### Soap/Lotion Dispenser Accessories

#### Soap/Lotion Dispenser Nut

Part #	Mfg #	Description	Price
037864	RP21945	Dispenser Nut	

Part #	Mfg #	Description	Price
152076	RP53438SS	Stainless*	

\* Brilliance® Anti-Tarnish Lifetime Finishes

## Delta Faucet Repair Parts

### Soap/Lotion Dispenser Body Assembly



Part #	Mfg #	Description	Price
187739	RP21906SS	Stainless*	

### Soap/Lotion Dispenser Pump Head



Part #	Mfg #	Description	Price
160946	RP21905SS	Stainless*	

### Kitchen Accessories

#### Sliding Weight

- For use with Pull-Down/Out kitchen faucets



Part #	Mfg #	Description	Price
188349	RP49149	N/A	

#### Kitchen Diverter Assembly

- Diverter assembly kit 1-handle Delta® replacement

Part #	Mfg #	Description	Price
133121	RP63135	Kitchen Faucet Diverter Assembly	
136138	RP63135MBS	Diverter Assembly	
132777	RP63136	1-Handle Diverter Assembly	
133157	RP63136MBS	Kitchen Diverter Assembly	

#### Brizo Lavatory Escutcheon

- 3/8" Height
- Can be used with (65005LF)



Part #	Mfg #	Description	Price
243611	RP61619BZ	4", Brushed Bronze*	

### 8" Escutcheon



Part #	Mfg #	Description	Price
149596	RP64070	Chrome	
146679	RP64070AR	Arctic Stainless™	
162388	RP64070CZ	Champagne Bronze™	

### Cassidy™ Escutcheon

- 10-1/4" Length
- 1 or 3-hole installation
- 8" centers on 3-hole installation
- 2-1/2" Maximum deck thickness



Part #	Mfg #	Description	Price
244648	RP71545PN	Polished Nickel*	

### Escutcheon

- 8" Length
- 1-1/2" connection



Part #	Mfg #	Description	Price
249251	061270A	Chrome	

### Escutcheon

- 4" Length
- 1-1/2" connection



Part #	Mfg #	Description	Price
250327	061269A	Chrome	

### Escutcheon and Gasket

- Transitional/contemporary bar



Part #	Mfg #	Description	Price
189018	RP77702	Chrome	
217804	RP77702AR	Arctic Stainless™	

\* Brilliance® Anti-Tarnish Lifetime Finishes

[www.plumbsupply.com](http://www.plumbsupply.com) • Serving our Customers Since 1946 • [www.waterconcepts.net](http://www.waterconcepts.net)

## Delta Faucet Repair Parts

### Escutcheon, Base, and Gasket



Part #	Mfg #	Description	Price
252777	RP70714	Chrome	
236796	RP70714AR	Arctic Stainless	
249466	RP70714BL	Matte Black	

### 10" Escutcheon



Part #	Mfg #	Description	Price
158527	RP47274AR	Arctic Stainless™	
158533	RP47274RB	Venetian Bronze®	

### Escutcheon, Base, and Gasket



Part #	Mfg #	Description	Price
148562	RP64472AR	Arctic Stainless™	
168129	RP64472SS	Stainless*	

### Escutcheon, Gasket (3-Hole)



Part #	Mfg #	Description	Price
225247	RP72991SS	Stainless*	

### Square Escutcheon



Part #	Mfg #	Description	Price
153685	RP63970RB	Venetian Bronze®	
143753	RP63970SS	Stainless*	

### Decorative Escutcheon

- 10" Long



Part #	Mfg #	Description	Price
158526	RP71545	Chrome	
154412	RP71545AR	Arctic Stainless™	
158563	RP71545CZ	Champagne Bronze™	
153577	RP71545RB	Venetian Bronze®	

### Escutcheon - 3 Hole



Part #	Mfg #	Description	Price
170028	RP44645SS	Stainless*	

### Trinsic® Escutcheon, Baseplate & Bolts



Part #	Mfg #	Description	Price
257968	RP75614AR	Arctic Stainless™	

### Shallow Escutcheon

- Pressure balance diverter off indicator

Part #	Mfg #	Description	Price
076614	RP6107	Chrome	

\* Brilliance® Anti-Tarnish Lifetime Finishes

[www.waterconcepts.net](http://www.waterconcepts.net) • Serving our Customers Since 1946 • [www.plumbsupply.com](http://www.plumbsupply.com)

## Delta Faucet Repair Parts

### Handle Base

- Square handle bases
- Sold in pairs
- Includes flange support, gasket and set screw



Part #	Mfg #	Description	Price
157758	RP52659SS	Stainless*	

### Mounting Hardware



Part #	Mfg #	Description	Price
186978	RP52609	Mounting Hardware	

### Pilar® Check Valves



Part #	Mfg #	Description	Price
138069	RP53468	Pilar® Check Valves	

### Shower Parts

#### Single Lever Handle Kit - 17T Series



Part #	Mfg #	Description	Price
153179	RP51309SS	Stainless*	

#### Linden™ 17 Series Handle Assembly

- Temperature knob and cover



Part #	Mfg #	Description	Price
184230	RP70641	Chrome	

### Shower Parts (Continued)

#### Linden™ 17 Series Handle Assembly

Part #	Mfg #	Description	Price
245341	RP70641RB	Venetian Bronze	

#### 13/14 Series Handle Assembly



Part #	Mfg #	Description	Price
132336	RP48717	Chrome	
143667	RP48717SS	Stainless*	

#### Gasket Insert for Showerhead

- Plastic

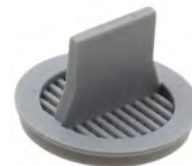

Part #	Mfg #	Description	Price
243850	RP43621	Grey	

#### Handle Assembly



Part #	Mfg #	Description	Price
164895	RP73643	Chrome	
186959	RP72685RB	Venetian Bronze®	

#### Temperature Dial



Part #	Mfg #	Description	Price
163903	RP73642	Chrome	

\* Brilliance® Anti-Tarnish Lifetime Finishes

## Delta Faucet Repair Parts

### Single Lever Handle Kit - 17 Series



Part #	Mfg #	Description	Price
067929	RP32103	Chrome	

### Universal Jet Sleeve Assembly

- Jetted shower™



Part #	Mfg #	Description	Price
243184	RP37891	Jet Sleeve Assy	

### Trim Sleeve - Tub & Shower



Part #	Mfg #	Description	Price
157460	RP50879RB	Venetian Bronze®	
166988	RP50879SS	Stainless*	

### Trim Sleeve - 17 and 18 Series



Part #	Mfg #	Description	Price
249255	RP50880	Chrome	
151398	RP50880RB	Venetian Bronze®	
151435	RP50880SS	Stainless*	

### Trim Sleeve - Tub & Shower



Part #	Mfg #	Description	Price
031006	RP5893	Chrome	

### Trim Sleeve - 13 and 14 Series



Part #	Mfg #	Description	Price
172685	RP22735SS	Stainless*	
096706	RP39407	14 Series Only, Chrome	

### Copper Plug - Shower Only



Part #	Mfg #	Description	Price
021656	RP20032	Copper	

### Hose Clip

- Clip only
- Quick-connect



Part #	Mfg #	Description	Price
144186	RP60911	Hose Clip	

### Valve Sleeve Assembly



Part #	Mfg #	Description	Price
172344	RP51481RB	Venetian Bronze®	

\* Brilliance® Anti-Tarnish Lifetime Finishes



## Delta Faucet Repair Parts

### Bar Slide Knob



Part #	Mfg #	Description	Price
175920	4116BX	For Models 55024 & 55030, Clear	

### Bath Waste Parts

#### Bath Waste Assembly

- Toe-operated
- 13-1/2" Max vertical adjustment
- 7-3/4" max horizontal adjustment
- Brass construction



Part #	Mfg #	Description	Price
177578	RP293	Chrome	
143839	RP693CZ	Champagne Bronze™	

### Tub Drain

- Toe-operated
- Stopper and waste plug
- Stopper screw threads are 5/16"-18



Part #	Mfg #	Description	Price
159165	RP31558CZ	Champagne Bronze™	

### Waste Plug

- Toe operated
- 1-1/2"-11-1/2" NPSM



Part #	Mfg #	Description	Price
166059	RP16687	Chrome	

### Bonnet Cap

- With adjusting ring



Part #	Mfg #	Finish	Price
003631	RP50	Chrome	

### Stopper Assembly

- Toe operated
- 5/16" - 18" thread size



Part #	Mfg #	Description	Price
177577	RP16686PN	Polished Nickel*	

### Mini-Bulk Parts

#### Aerator

- 15/16" - 27 Male thread
- For most kitchen and lavatory faucets
- 2.2 gpm @ 60 psi



Part #	Mfg #	Description	Price
022154	RP330MBS	Chrome, 60 Per Case	

#### Cam and Packing-Knob

- For single knob handle faucets



Part #	Mfg #	Description	Price
003552	RP188	For Single Knob Handle	
017861	RP188MBS	64 Per Case	

#### Cam & Packing - Lever

- For single lever handle faucets



Part #	Mfg #	Description	Price
017522	RP61MBS	64 Per Case	

#### Seat

- For all 1-handle and 2-handle faucets



Part #	Mfg #	Description	Price
022156	RP1806MBS	240 Per Case	

#### Spring

- For all 1-handle and 2-handle faucets



Part #	Mfg #	Description	Price
022158	RP3427MBS	240 Per Case	

\* Brilliance® Anti-Tarnish Lifetime Finishes

[www.plumbsupply.com](http://www.plumbsupply.com) • Serving our Customers Since 1946 • [www.waterconcepts.net](http://www.waterconcepts.net)

## Delta Faucet Repair Parts

### Seats, Springs, Quad Rings

- Qty. 2



Part #	Mfg #	Description	Price
063896	RP28603	Seats, Springs, Quad Rings	

### Seats & Springs Boxed Assortment Kit

- RP4993 (24)



Part #	Mfg #	Description	Price
003740	RP4039	Seats & Springs 24-RP4993	

### Ceramic Seats and Seals

- Qty. 2



Part #	Mfg #	Description	Price
020357	RP10700	Ceramic Seats and Seals	

### Stainless Steel Ball - Knob

- For single knob handle faucets except 1300, 1400 & 1600 tub/shower series and pull-out spray models



Part #	Mfg #	Description	Price
022152	RP212MBS	60 Per Case	

### Stainless Steel Ball - Lever

- For single lever handle faucets except 1300, 1400, 1500, 1600, 1700 & 1800 T/S series and pull-out spray models



Part #	Mfg #	Description	Price
022151	RP70MBS	60 Per Case	

### Stem Unit & Seat

- For 1600 tub/shower series

Part #	Mfg #	Description	Price
003582	RP1991	Stem Unit & Seat	

### Mini-Bulk Parts (Continued)

#### Stem Unit & Seat

Part #	Mfg #	Description	Price
022157	RP1991MBS	Stem Unit & Seat, 12 Per Case	

#### Stem Unit with Stainless Steel Plate

- For 2-handle and basin faucets



Part #	Mfg #	Description	Price
003515	RP1740	Stem Unit Assy	
022155	RP1740MBS	Stem Unit Assy, 60 Per Case	

#### Delta® Plumber's Box of Parts



Part #	Mfg #	Description	Price
134141	RP63139	Plumber's Box of Parts	

#### Ball Assemblies

Part #	Mfg #	Description	Price
003724	RP70	For 1-H Lever	
003592	RP212	For 1-H Knob	

#### O-Rings

Part #	Mfg #	Description	Price
253460	RP10345	Peerless Rings Qty. 2	
114466	RP13938	O-Ring	
071330	RP14414	13/14 Series Qty. 2	
154097	RP18362	O-Ring	
043131	RP23336	O-Ring F/1400	
003605	RP25	1-Hdl Kit Spout	
003589	RP2055	For 2-H Kitchen Spout	
040285	RP22934	For 2-H Waterfall® Kitchen Deck	
061918	RP32520	Spout O-Rings for 470 & 472	
178227	RP50388	O-Ring	
170777	RP73984	Clip and O-Ring	

\* Brilliance® Anti-Tarnish Lifetime Finishes

## Delta Faucet Repair Parts

### Mini-Bulk Parts (Continued)

#### O-Rings

Part #	Mfg #	Description	Price
247379	RP83781	O-Ring & Limit Stop	
249032	RP90771	Cartridge Assy and O-Ring	
142321	RP1745	O-Ring, Tub Spout	

#### O-Rings



Part #	Mfg #	Description	Price
022150	RP25MBS	120 Per Case	
253157	RP44139	Loki O-Ring	

#### Screws

Part #	Mfg #	Description	Price
003437	RP12630	Escutcheon Trim Screws, Extra Long	
155211	RP12630RB	Escutcheon Trim Screws, Extra Long - Ven Bronze®	
003496	RP152	For Single Lever Handle	
003564	RP196	Chrome	
033496	RP25620	Set Screws for Small Handle Bases	
032801	RP26865	Set Screws for Large Handle Bases	
168960	RP40650	Set Screw	
157647	RP54170B	Escutcheon Screws (2)	
158261	RP61819	On Wall Screws 4 Lengths	

### Delta® Repair Parts

Part #	Mfg #	Description	Price
217207	4124CBG	Cap - GL Rail BG	
028507	4959BG	Rubber Gaskets - Bag of 5	
253655	060318A	Flow Control Insert (6)	
144039	060602A	Sngl Blade Hdl w/ Screw	
111465	060683A	Hard Wire Converter	
247208	060791A	Comm Garden Hose Thread Adapter w/ Vacuum Breaker	
207016	060949A	Comm 4" Hooded Lvr Hdl	
248502	061128A	2 H&C Ceramic Cartridges	
238143	061131A	Extension Kit for 060852A Diverter Valve	

### Delta® Repair Parts (Continued)

Part #	Mfg #	Description	Price
162306	063044A	8" Swing Spout Assembly	
023673	060864A	4" Blade Handle Pair	
098175	060302A	Vacuum Breaker Repair	
126956	060638A	1.5 GPM Vandal Resistant Aerator	
252220	060757A	3/8 IP Angle Vac Breaker	
237119	061203A	0.5 gpm VR Laminar Outlet	
243261	061297A	Commercial Driver Board	
225244	061252A	Driver Board, H2Optics and Proximity	
188507	063093A	R3 Spout for 54T2402	
243260	063230A	Commercial Spout Assy	
247528	063257A	Commercial Brass Solenoid	
246656	063258A	Commercial Battery Box	
247639	33W576-BL	Commercial Push Button, Matte Black	
177587	EP73954	AP Power Supply	
183919	EP74854	Solenoid Assembly	
254329	RP100091	Escutcheon, Trinsic Chrome	
256612	RP100091BL	Escutcheon, Trinsic Matte Blk	
258293	RP100091SS	Escutcheon, Trinsic Stainless*	
109632	RP1050	Bonnet Nut, Chrome	
240775	RP1050RB	Bonnet Nut, Venetian Bronze	
188994	RP11768HDF	Commercial Lever Handles, Brass w/ Screws	
003435	RP12516	Strap w/ Screw	
026356	RP12629	Screw Set	
099577	RP16213	Screwdriver Stop Assembly	
003512	RP16423	Reverse Ball	
019240	RP18090	Escutcheon	
025093	RP18276	Chrome Escutcheon	
025092	RP18136	Sleeve, Chrome	
029096	RP21463	Retainer - Spout	
033619	RP21469	1Hdl Lever Kit with Screw	
154634	RP21469SS	1Hdl Lever Kit with Screw	
086213	RP23094SS	Handle Base w/ Gasket	
243320	RP52658	Set Screw & Button Set, Polished Nickel*	
237393	RP53410SS	Roman Tub Handle Base	
003597	RP2389	Clear 1-Handle Lavatory w/Button & Screw	

\* Brilliance® Anti-Tarnish Lifetime Finishes

[www.plumbsupply.com](http://www.plumbsupply.com) • Serving our Customers Since 1946 • [www.waterconcepts.net](http://www.waterconcepts.net)

## Delta Faucet Repair Parts

### Delta® Repair Parts (Continued)

Part #	Mfg #	Description	Price
003599	RP2391	Clear Knob w/Button & Screw	
003601	RP2393	1 Kitchen Lever Handle w/Set Screw	
003603	RP2411	Button, Clear	
003608	RP250	Adjusting Ring	
031329	RP250MBS	Adjusting Ring	
044850	RP28595	Temp Knob and Cover	
054794	RP29569	Spacer	
059633	RP33805	10-1/8" Horizontal Rod	
259376	RP34410SS	Finial, Stainless*	
003623	RP3614	Lever Repair Kit	
155976	RP37022SS	Bonnet, Washer and Clip	
237857	RP38674	Nut and Washer	
253918	RP38958	50/50 Lav Drain Assy, Chr	
259080	RP38958RB	50/50 Lav Drain Assy, Ven Br	
244140	RP40664SS	Roman Tub Hose & Gaskets R4700, Stainless*	
171342	RP42208	Wrench	
243216	RP42407	3-Port 6 Func Diverter Trim Bonnet	
164132	RP47030	Lavatory Wrench	
256214	RP49264	Metal Lvr Diverter Hdl Kit, Chr	
003630	RP4993	Deluxe Seats & Springs (2)	
122686	RP50366	Stem Assembly w/ O-Rings and Nuts	
249098	RP50786SS	Button Indicator, Stainless	
238441	RP50790SS	Single Lvr Handle Kit, Stnlss*	
144187	RP51503	Bonnet Nut	
239500	RP51019	Set Screw & Button, Chrome	
256747	RP51022	Stem Extender	
132784	RP52834	Single Metal Lever Handle Kit	
252844	RP53210SS	Pilar Pull-Down Spray Assy, Stainless*	
131263	RP53997	Diverter Clip	
237661	RP5417	Screw	
003639	RP5649	Diverter Assembly, Chrome	
003649	RP574	Balance Spool Assembly	
003657	RP5861	Coupling Nuts	
003662	RP6011	Hose & Spray, Black/CP	
257384	RP60112SS	Toggle Sprayer	

### Delta® Repair Parts (Continued)

Part #	Mfg #	Description	Price
003678	RP6060	Nut	
003681	RP6068	Plug Button	
037831	RP6079	Bonnet, Chrome	
040904	RP6081	Sleeve, Chrome	
003687	RP6092	Nuts & Washers	
252044	RP60976RB	Addison Wand Assy & Hose, Venetian Bronze	
237655	RP61184	Escutcheon, Chrome	
003695	RP6130	Pivot Seat & Gasket	
153121	RP61820	Stem Assembly	
003705	RP6183	Locknuts	
253156	RP62291	Loki Cartridge	
238406	RP62381SS	6-Setting Escutcheon, Stnlss	
260155	RP63202	Peerless Wand & Hose, Chr	
243523	RP63505	Nut/Tee Kit	
257799	RP63697BN	Handle Cap & O-Ring	
253855	RP64152	Transitional Slidebar Slide Mechanism, Chrome	
224647	RP64240	Mounting Bracket	
227492	RP64288	Gasket for 400DST	
238763	RP64364SS	Metal Lvr Hndl Set, *Stainless	
144951	RP64364	Classic Handle Set, Chrome	
240958	RP64449	Hot&Cold Blade Hdl Set, Chr	
151297	RP64696	Spout Assembly - Locked	
242851	RP70607	Screw, Adapter, & Insert Parts	
259634	RP70918BN	Brizo Button & O-Ring, Br. Nkl	
037345	RP7133	O-Handle Cold	
243590	RP71447PC	Spout Assy with Magnet	
252051	RP72564SS	Cassidy Set Screw & Button, Stainless*	
249519	RP72752AR	Cassidy Spray Nest, Arctic Stainless	
245502	RP73391	Cassidy 2-Hole Kitchen Spout Retainer & Ring	
250641	RP73640	Comm Spout Assy & Tee	
171629	RP74456	Odin Extension Kit	
239499	RP75438SS	Ara 17 Series Escutcheon & Gasket, Stainless*	
244719	RP78360	Lift Rod Hole Button, Chrome	

\* Brilliance® Anti-Tarnish Lifetime Finishes

[www.waterconcepts.net](http://www.waterconcepts.net) • Serving our Customers Since 1946 • [www.plumbsupply.com](http://www.plumbsupply.com)

## Delta Faucet Repair Parts

### Delta® Repair Parts (Continued)

Part #	Mfg #	Description	Price
244994	RP78739PN	Tesla 2H Lav Flange & Gasket, *Pol Nickel	
251251	RP78943	Spout Body Diverter	
239093	RP80523	Hose Weight Assy	
249154	RP80528	Kitchen Faucet Gasket	
258489	RP80977	Magnet Replacement Kit	
003734	RP8230	Ceramic Stem, Seat, O-Ring, Spring	
237520	RP84704SS	Volume Hndl Assy, Stainless*	
239968	RP90056	Ara® Stem & Valve	
259280	RP92714	Bracket, Nut, Wrench	
003434	RP12491	(2) HDF Wrist Blade Handles w/Set Screw	
024497	RP12490	Screws - Red and Blue	
003520	RP17449	Clear Handle w/Button & Screw, for Single Handle Faucet	
023197	RP17451	Clear Handle w/Button & Screw, for Tub & Shower	
024762	RP18627	Extender less Screws	
003572	RP19804	Cartridge Assembly	
022311	RP19807	Limit Stop	
049620	RP22734	Plated Bonnet	
187688	RP23094CZ	Handle Base & Gasket	
030260	RP23498	Clear Knob Handle w/Screws	
185875	RP23611RB	Base with Gasket	
024314	RP24096	Brass Stem Assy	
003604	RP2412	Two Handle Blade (2)	
050183	RP25513	Stem Unit w/Brass Stem	
137175	RP2865	Plug Push Button Diverter	
071395	RP28906	Red/Blue Indicator	
179884	RP30532	Battery Holder	
045840	RP32104	1700 Cartridge	
067930	RP32105	1700 Handle Screw	
048950	RP32522	Quick-Connect Clip	
120382	RP34359RB	Trim Ring - 14 Series	
151759	RP36203	Ext Nut and Washer for Electronic Fct	
187883	RP38367	End Valve Assembly	
184164	RP41702	2Hdl Kitchen Diverter	
140695	RP40668	R4700 Diverter Valve Assembly	
101730	RP41478	Nut and Adapter	

### Delta® Repair Parts (Continued)

Part #	Mfg #	Description	Price
241265	RP41896	Small Glide Ring	
241266	RP41898	Large Glide Ring	
174179	RP44118BN	Handle Kit, Brushed Nickel	
172682	RP44123	Repair Kit	
184827	RP44493	Hose Assembly	
107694	RP44647	Pull-Out Hose Assembly	
241504	RP40505	Roman Tub Top Washer & Body for R2700/RP40505	
144594	RP46079	Pressure Test Hot/Cold Plug	
186204	RP47029	Lavatory Mounting Bracket	
157015	RP48592	Single Lever Handle Kit	
169900	RP49835	Mounting Nut	
169899	RP50391	Gasket and Baseplate	
241137	RP50786RB	Hot/Cold Button, Venetian Brz	
107655	RP51099	7' Leader Hose for Roman Tub	
160483	RP51290SS	Roman Tub Hand Shower Base Escutcheon	
223508	RP51306RB	17 Series Handle Kit	
187868	RP51306SS	17 Series Handle Kit	
151859	RP51307	1-Hdl Lever Handle Kit	
230767	RP51307CZ	17 Series Handle Kit	
223509	RP51307RB	17 Series Handle Kit	
187869	RP51307SS	17 Series Handle Kit	
161418	RP51345	Aerator - 1.5 GPM	
187690	RP51424	Temperature Knob and Cover	
160738	RP51479RB	Valve Sleeve Assembly	
222638	RP51502AR	Bonnet Cap, Arctic Stainless	
241278	RP51502RB	Bonnet Cap, Venetian Bronze	
173807	RP51514SS	Sleeve Assembly	
157876	RP51628RB	Escutcheon & Gasket	
154211	RP51685	Mounting Bracket and Nut	
179559	RP52147SS	Temp Knob and Cover	
164030	RP53879	Handle Button	
166762	RP53879SS	Handle Button, Stainless*	
131262	RP54269	Spray Cap	
157044	RP54974	Hot/Cold Indicator	
137154	RP60923	Kitchen Repair Part	
135054	RP43233	D-Spacer 14 Series	

\* Brilliance® Anti-Tarnish Lifetime Finishes

[www.plumbsupply.com](http://www.plumbsupply.com) • Serving our Customers Since 1946 • [www.waterconcepts.net](http://www.waterconcepts.net)



## Delta Faucet Repair Parts

### Delta® Repair Parts (Continued)

Part #	Mfg #	Description	Price
122117	RP50587	Single Handle Valve Cartridge	
161889	RP51490	Escutcheon - Single Handle Kitchen Faucet	
154210	RP52610	Trim Ring, Base & Gasket	
164131	RP53217	Mounting Hardware - Valve	
176568	RP53531	Mounting Nuts	
173987	RP54232	Handle Kit, Chrome	
181486	RP54232SS	Handle Kit, Stainless	
166331	RP54687	Single Lever Elbow Handle	
153810	RP60962	Escutcheon and Gasket	
177033	RP60979	Trim Ring, Base and Gasket	
236968	RP61122	Addison Anchor Kit	
158729	RP6148	Escutcheon	
177305	RP61839RB	Escutcheon 1H Ven Brz	
260157	RP61839SS	Escutcheon, 1H Stainless*	
151718	RP6185	Stop Stem Assembly	
177217	RP62150SS	Handle Kit	
251901	RP62601RB	Brizo Slide Bar Assy, Venetian Bronze	
251736	RP62778AR	Linden Trim Ring, Base, & Gasket, Arctic Stainless	
171385	RP62961	Bidet Base, Chrome	
164948	RP62961SS	Bidet Base, Stainless	
154459	RP63131	Spout Assembly	
175400	RP63265	1/2" Slip Joint Adapter	
187192	RP64150SS	Mounting Post	
187191	RP64152SS	Slide Mechanism	
158670	RP64706	Handle Kit - 2-Hdl	
158671	RP64760	Stem Unit Assembly	
173247	RP64851	Diverter Bonnet Nut	
181639	RP70635RB	Roman Tub 2-Hdl Handle Kit	
181640	RP70637RB	Handle Flange, Ven Brz	
185771	RP70638RB	Diverter Lift Rod	
168736	RP70639RB	Shower Handle Assembly, Ven Bronze	
178178	RP72289	Lift Rod Plug	
185650	RP72721SS	Handshower Base	
180482	RP73054	Gaskets	
155687	RP73192	Red/Blue Button	
168272	RP73837	Low Flow Regulator	
177576	RP7424PN	Overflow Plate	

### Delta® Repair Parts (Continued)

Part #	Mfg #	Description	Price
156883	RP7424RB	Overflow Plate	
181717	RP74608	54" PO Hose (Small OD)	
181034	RP74812	O-Rings	
252444	RP74836	Cartridge	
173787	RP75408	Rectangular Aerator, Set Screw	
187322	RP75409	Flow Regulator	
237173	RP75497	Handshower Base - Roman Tub	
170776	RP76691	Centerset Extension Kit	
185305	RP77162	Escutcheon	
186205	RP77263SS	Escutcheon - 3 Hole	
186203	RP77457SS	Button - Lift Rod Hole Cover	
166060	RP7900	Gasket	
252441	RP80619	Dominic Bonnet Nut	
189416	RP81914AR	Mateo® Escutcheon	
225577	RP81914	Mateo® Escutcheon	
186097	RP83888	Valve Bracket	
239225	RP84986SS	Diverter Temp Knob & Cover, *Stainless	
252706	RP90838	Addison Wand Assy	
252613	RP91788PC	Litze Handle Kit, Chrome	
245563	0611159A	4" Deck Plate & Holdown Pkg	

\* Brilliance® Anti-Tarnish Lifetime Finishes

[www.waterconcepts.net](http://www.waterconcepts.net) • Serving our Customers Since 1946 • [www.plumbsupply.com](http://www.plumbsupply.com)



**Elkay Repair Parts**

**Elkay Sink Parts & Accessories**

**Mounting Clip**



Part #	Mfg #	Description	Price
238525	LK-0000000222	Black/Grey Slot Clips, 8 Per Package	
006122	LK-363	Long Sink Clips	
104709	LK-463	Sink Clips for 1-5/8", 2", 2-1/2" Thick Tops	
162112	LKUCLIP8	Mounting Clip for Undermount Sinks	

**Parts**

Part #	Mfg #	Description	Price
006120	LK-350	Socket Screwdriver	
197181	LKMK462		
251855	P29248	Cartridge	
240190	1000001877	Drain Replacement Kit for EZ/EZTL	
238906	1000002436	Kitchen LED Board	
237642	100023340560	Waste Tube Gasket	
237637	101570540560	Drain Gasket	
237640	101637451550	Friction Ring	
237639	110346220550	Drain Nut	
237636	160270508640	Strainer Plate	
237641	161637308640	Drain Plug	
250822	45660C	Bubbler	
249178	45833C	Cover Bottom	
250124	45932C	Tail Piece	
237638	51575C	Packing Ring	
249745	75507C	Quick Connect For Solenoid 1/4 NPT x 1/4 OD	
244931	98753C	Overload Relay Kit	
244475	98999C	Drain Pad Kit for VRC8WS	

**Elkay Repair Parts**



35981-C



50986-C

**Water Cooler Parts**



55996-C



61313-C



61314-C

Part #	Mfg #	Description	Price
252075	20723C	Cooler Bracket	
241890	21222C	Elkay Basin EHF/WC with DIMP	
023576	31513C	Elkay Cold Control	
086622	35981C	Elkay 1/4 Solenoid Valve	
045589	55996C	Cooler Y-Strainer	
006168	61313C	Cartridge for Water Cooler	
024551	61314C	Green Cartridge	
252428	98791C	Push Bar	
252640	EZSTLDL	Right Replacement	

**EZH2O™ Parts  
WaterSentry® Filters**

- CTO Filters
- Features:
  - Quick-disconnect
  - 1/4 Turn installation
  - Hand never touch the actual filter media
  - Outer protective wrap
- NSF/ANSI 42 and 53 certified

Part #	Mfg #	Flow Rate	Rated	Full Load	Ship Wt	Description	Price
162211	EWF3000					Complete Kit, 3000 Gallon Filtration System	
189544	WSF6000R2PK					6000 Gallon, 2-pack	
132220	51300C					3000 Gallon, 1-Pack	
164978	51300C12PK					3000 Gallon, 12-Pack	



---

---

## Empire Comfort Repair Parts

---

---

### Replacement Parts

#### Blower

Part #	Mfg #	Description	Price
127041	FBB-4	Variable-Speed Blower	

---



---

## Fenner Drives Repair Parts

---



---

### Belts

#### PowerTwist Plus® V-Belt

- *No tools required, assembles in minutes*
- *High strength and low elongation under load*
- *High performance polyurethane elastomer reinforced with multiple plies of polyester fabric*



Part #	Mfg #	Type	Length	Pack	Price
143772	0418010SL	3L	5'	Slv	
143792	0418030SL	A/4L	5'	Slv	
143793	0405030	A/4L	25'	Box	
143795	0418050SL	B/5L	6'	Slv	
143796	0405050	B/5L	25'	Box	

## General Filter Repair Parts

### Manual Control Humidistats

- Senses variation in relative humidity levels
- Humidity range: 10% - 85%
- Duct cut-out dimensions: 2-1/4" x 1-3/4"
- Duct plate dimensions: 4" x 5-1/2"
- Mounting screws included



### Wall-Mount Housing

- Allows for both wall and duct mount

Part #	Mfg #	Description	Price
146561	WMH3	Wall-Mount Housing for MHX3, MHX3C, or DHX3	

### GeneralAire Replacement Parts 1042 Series Humidifier Replacement Parts

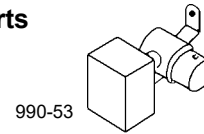

Part #	Mfg #	Description	Price
004874	990-53	Solenoid Valve Assembly - 24V for 1042/1137 (Includes Fittings)	
206827	GA4231	Yellow Orifice	

### Replacement Evaporator Pad

- Aluminum evaporator material enclosed in heavy wire frame and channeling
- Pad has super absorbent coating



Part #	Mfg #	Description	Price
004870	990-13	11-3/4"H x 9-3/4"W Evaporator Pad for Model SL-16, 1042, 1040, 1137	
125681	1099-20	12"H x 14-1/4"W Evaporator Pad for Model 1099, 950	



## Gerber Repair Parts

### Gerber Replacement Parts

#### Cartridge Assembly



92-298

Part #	Mfg #	Description	Price
023522	97-013	Complete Hardwater® Assembly, Less Control Cartridge	
023523	97-014	Complete Safetemp Assembly, Less Control Cartridge	
028493	92-298	Hardwater® Ceramic Cartridge with Limit Stop, Chrome	
088008	95-152	Hardwater® II & Safetemp II Washerless Pressure Balance Cartridge	
088009	95-154	Replacement Cartridge for GS103/GS105	
029460	97-022	Safetemp™ Control Cartridge, Chrome	
004822	97-510	Ceramic Disc Cartridge	
087758	98-674	Compression Cartridge - Cold	
004830	98-688	Compression Cartridge for Deck Faucet - Hot	
004831	98-689	Compression Cartridge for Deck Faucet - Cold	
020941	98-705	Long Ceramic Cartridge	
047463	98-709	T&S Ceramic Disc Cartridge-Cold	

#### Faceplate

Part #	Mfg #	Description	Price
004816	97-130	Faceplate Assembly, Chrome	
026255	97-171-KT	Faceplate Assembly, Chrome	

#### Handle

Part #	Mfg #	Description	Price
031332	86-986	Ceramaflo™ Disc Cartridge, Handle, Cold, Chrome	
031331	86-987	Ceramaflo™ Disc Cartridge, Handle, Hot, Chrome	
082641	97-020	Replacement Shower Handle	
004840	98-879	Wrist Blade Handles, Pair	

### Shower Arm



Part #	Mfg #	Description	Price
004716	49-205	Lock Shower Arm Ell, Thin Wall Install, Less Spray Plate, Rough Brass	

### Stem and Bonnet Assembly



Part #	Mfg #	Description	Price
004827	98-673	Stem & Bonnet Assembly, Hot	
004836	98-726	Diverter Stem & Bonnet Assy	

### Unit Bag

Part #	Mfg #	Description	Price
004849	99-537	Unit Bag 298-290/590/790/794/795/796, White	
063774	99-538	UltraFlush Unit Bag, White	
105006	99-660	Gerber Unit Bag for Avalanche	

### O-Ring



Part #	Mfg #	Description	Price
093297	92-257	O-Ring	
004802	92-660	Spout O-Ring	
004803	92-730	O-Ring	
004837	98-727	Bonnet O-Ring Stem Cage for 40-700 Series	

### Parts

Part #	Mfg #	Description	Price
076038	90-067	Nipple 5/8" - 24 x 2.687"	
004776	90-161	Brass Seat 5/8"-20 NS-2 Thread	
026022	90-390	Fibre Follower	
091688	90-230	Screw	
004792	91-132	Middle Wire	
004799	91-280	Strainer Screw	
246168	91-565	0.5 gpm Aerator	
091418	92-294	Limit Stop for Safetemp	
241782	93-059	1Hdl Escutcheon Sleeve, Chrome	
248228	94-040	Spray Diverter w/ Vacuum Breaker	

\*Physical Vapor Deposition (PVD) Limited Lifetime Finish

[www.waterconcepts.net](http://www.waterconcepts.net) • Serving our Customers Since 1946 • [www.plumbsupply.com](http://www.plumbsupply.com)





## Gerber Repair Parts

### Gerber Replacement Parts (Continued)

#### Parts

Part #	Mfg #	Description	Price
237303	95-163	Safetemp Loop Handle, Chrome	
136096	95-166	Safetemp Escutcheon, Chrome	
004812	96-121	Shoe Plug for Trip Lever	
095128	97-164	Wire/Plunger Assy for Roman Trip Lever Drain	
212516	97-232	Pressure Balance Mixing Valve, Cartridge, & Check Valve	
085928	97-305	Pop-Up Extension Assembly	
237124	97-820	T&S Coupling Nuts (2)	
039568	98-412	Handle, Button, & Screw	
204001	98-736	S/H Bath Body Stem Assy & Bottom Seal Kit	
227955	99-031	Maxwell Dual Flush Valve 1.1/1.6gpf, White	
004843	99-161	Lav Hanger	
027906	99-290	Urinal Wall Hanger (2 QTY)	
004850	99-539	Tank to Bowl Assy Kit (Unit Bag)	
101710	99-579	Channel Pad	
028454	99-605	Lid Locking Assy	
126879	99-685-09	Avalanche LH Trip Lever, Biscuit	
112220	99-685-WH	Avalanche LH Trip Lever, White	
137907	99-788	Flapper	
180235	99-791	Maxwell Flush Valve Kit, 1.1/1.6gpf (DF-28-190/195)	

\*Physical Vapor Deposition (PVD) Limited Lifetime Finish

[www.plumbsupply.com](http://www.plumbsupply.com) • Serving our Customers Since 1946 • [www.waterconcepts.net](http://www.waterconcepts.net)

---

---

**Gibson Repair Parts & Accessories**

---

---

**Parts & Accessories**

**Heater Kits**

Part #	Mfg #	KW	Volts	Price
176342	H8HK005H11	4.8	240	
176339	H8HK010H11	9.6	240	
176338	H8HK015H21	14.4	240	
176337	H8HK020H21	19.2	240	
176336	H8HK024H31	24	240	

**Hi-Velocity (Energy Savings Products) Repair Parts**

**Electrical Components**



EPC Control Board

Part #	Mfg #	Part Name	Description	Price
127481	20120100001	EPC Circuit Board	Circuit Board for all HE/LV-E Fan Coils with EPC Motors	
127483	20120100030	EPC Transformer	Transformer for all HE/LV-E Fan Coils with EPC Motors	

**Refrigerant Components**



Part #	Mfg #	Part Name	Description	Price
097149	10040500010	Fixed Temp Freeze Stat	Fixed Temp Freeze Stat For use with RCM/RM/RPM Units	

**Honeywell Repair Parts**

**Fan Centers**

**R8239 Control Center**



- Provides low voltage control of line voltage fan motors and auxiliary circuits in heating, cooling or heat-cooling circuits
- Includes NEMA D Transformer, relay enclosures
- Convenient connections for thermostat and heating-cooling equipment wiring
- Mounts on standard 4" x 4" junction box in any indoor location without additional enclosures
- Relay is easily replaced without disturbing wiring

Part #	Mfg #	Description	Price
112616	R8239B1076	120/208/240V, DPDT Switching, 50VA Transformer, Includes R8222D	

**R8285 Control Center**



- Transformer powers low voltage control systems and provides overload protection
- Low voltage terminal board provides convenient connections for thermostat and heating/cooling equipment wiring
- Mounts on standard 4" x 4" junction box
- Relay is easily replaced without disturbing wiring

Part #	Mfg #	Description	Price
006780	R8285A1048	120V, SPDT Switching, 40VA Transformer, 24V Secondary, Includes R8222B Plug-In Relay for 1 or 2 Speed Fans	

**Fan Timers**

**Universal Electronic Fan Timer**



- Diagnostic LED
- Replaceable fuse
- DIP switch selectable heat and cool delay on and off times
- Includes EAC and HUM terminal connections & continuous low speed indoor air circulation
- Integrates control of all combustion blower & circulating fan operations in a gas warm-air appliance

Part #	Mfg #	Description	Price
134225	ST9120U1011	Electronic Fan Timer	

**Parts & Accessories**

Part #	Mfg #	Description	Price
138257	50041883-002	TrueEase AC Solenoid Valve	



---

---

**Humidifier Parts & Accessories**

---

---

**Humidifier Parts & Accessories**

**Humidifier Parts**

Part #	Mfg #	Description	Price
037355	32001615-001	Drain Fitting for HE220 and HE260 Humidifiers	
037357	32001639-002	Solenoid Valve Assembly for Honeywell Humidifiers, Includes Water Feed Tube & Nozzle	

**Honeywell Repair Parts**

**Honeywell Accessories**

**Motors**

Part #	Mfg #	Description	Price
006844	802360JA	24V Sealed Replacement Motor for V8043/V8044	
163574	802360LA	120V, 60 Hz Replacement Motor for V4043, V4044	
099342	MZV520-RP	24V 60 Hz Motor for MZV524E/25E/26E/27E w/switch	

**Replacement Head for V Series Zone Valves**

Part #	Mfg #	Description	Price
006841	40003916-026	24VAC, 50/60 Hz Replacement Head with End Switch for V8044E	
031407	40003916-048	24VAC, 50/60 Hz Replacement Head with End Switch for V8043F	

**Checkout Kit for Economizer Logic Modules**

- Includes resistor and jumpers
- Used with W7459, W7210, W7212, and W7215



Part #	Mfg #	Description	Price
223324	4074EJM	Economizer Checkout Kit for W7459, W7210, W7212, and W7215	

**Honeywell Parts**

Part #	Mfg #	Description	Price
074665	32001754-001	Current Sensing Relay for Whole-House Humidification Units	
006842	40003918-006	Adapter Kit for V4043, V8043, 2-Way Hydronic Valves	
127196	50027997-001	Solenoid Valve for TrueSTEAM	
163982	50041883-001	DC Solenoid Valve	
143930	50027998-002	True Steam Water Level Sensor	
152377	Y8427U9045	Universal Service Kit, Carton Consists of: (1) S8610U3009/U. (1) ST9120U1011/U. (1) Q3200U2002/U. (1) S9200U1000/U. (1) Multi tool.	
137379	50033181-001	TrueSTEAM Water Tank - Large	
129898	50028044-001	Humidifier Filter, In-Line Scale/Sediment	
166027	GROW2	Honeywell Kit	
209920	VCZAL1100U	3/4" Valve Body	
171083	THP9045A1023/ U	WireSaver for THX9000 Series Thermostats	



## Hydron Module Repair Parts

### Heat Pump Repair Parts

Part #	Mfg #	Description	Price
131157	11470002001	ECM Board	
099573	01CB28	Time Delay Board	
131158	11470003001	Combo Board	
146360	47P002-01NN	47p002-01nn Hydron Combo Board	
131156	11470001001	Control Board	
102660	01CB30	Control Board	
104349	32EB20	15/20kW Elec Board	
158573	40M100-01NN	ECM Motor Hydron	
177055	85A006-02VN	ECM Blower Motor	
136798	35P002-04NN	35p002-01nn Low Pres Switch	
136799	35P003-01NN	High Pres Switch	
136926	11350001002	Low Pres Switch Thrd	
187486	33K005-01NN	Low Pressure Switch	
136800	50FL001	Drain Pan Switch	
136823	05P001-01NN	Flow Switch	
141084	18R006	Valve	
141085	33P001-01NN	Valve Hydron	
167466	31P004-01CN	Hydron Air Coil	
167465	18V004	Hydron 3-Way Valve	
141083	18R00C	Coil f/Valve	
111761	26C008	3-Pole Contactor	
136803	11430001001	2-Pole Contactor	
131727	11410000001	Wiring Harness ECM	
136801	11450000001	75VA Transformer	
135343	34P060-11B	H062 410A 2-Stage Comp	
176400	50CB10	Compressor Blanket	
176401	50CB40	Compressor Blanket	
172648	51P010-01HN	Blower Wheel	

### Capacitors

Part #	Mfg #	Description	Price
136806	26C101	Capacitor H018 Rev A&B	
136807	26C103	Capacitor All 024 Rev A&B	
136808	26C104	Cap H030&36/w036 Rev A	
136809	26C111	Capacitor	
136810	26C112	Capacitor	

## Kohler Repair Parts

### Kitchen Side Sprays

#### Standard Kitchen Side Spray & Hose



Part #	Mfg #	Description	Price
187506	1011130-VS	Sidespray Assy, *Stainless	
156774	1021724-VF	Sidespray w/Hose, Brass	
122911	GP1021724-7	Sidespray w/Hose, Black Black	

#### Spray & Hose



Part #	Mfg #	Description	Price
171513	1013838-BV	Spray Assy, *Br Brz	
153883	1014048-CP	Hose Secondary, Chrome	
155335	1036940-0	White Spray Head Kit	
153433	1037518-CP	Hose Kit, Polished Chrome	
244327	K-1032256-BN	Brushed Nickel*	
098050	1041319-CP	Pull-Out Spry Head Chrome	
173755	1041319-G	Pull-Out Spry Head Chrome	
152453	1041320-CP	Hose Kit, Polished Chrome	
152453	1041320-CP	Hose Kit, Chrome	
101298	1056336-CP	Hose Kit, Chrome	
153955	1109445-BN	Spray w/ Screen *Br Nickel	
134128	1114379-BC	Hose Kit, Bright Chrome	
164835	1148629-BC	Hose Kit, Bright Chrome	
166252	1155250-CP	Bellera Spray Head Chrome	
182429	1141915	Hose Kit	
183339	1153208	Hose Guide	
156335	1155250-VS	Spray Head, *Stainless	
172261	1155250-2BZ	Spray head, Oil-Rbd Bronze	
165112	1155355-CP	Spray Head, Pol Chrome	
155345	1155355-VS	Spray Head, *Stainless	
162203	1179931	Sprayhead Adapter	
222878	1218822-CP	Spray Assy, Chrome	

### Kitchen Side Sprays (Continued)

#### Spray & Hose

Part #	Mfg #	Description	Price
181715	1218823-CP	Spray Assy, Chrome	
170388	1218824-CP	Spray Assy, Chrome	
173920	1218824-VS	Spray Assy, *Stainless	
167009	1219935-BC	Hose Kit, Bright Chrome	
244611	1296842-CP	Hand spray Assy, Chrome	
258373	1315148-BN	Spray w/ Screen, *Br Nickel	
257811	1346768-BN	Pull-Out Spry Head, *Br Nkl	
157802	GP1092201	Hose Kit	
055348	GP78825-CP	Hose Kit Chrome	

#### Side Spray Assembly

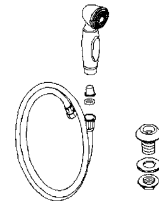

Part #	Mfg #	Description	Price
175894	1005010-CP	Hose Service Kit, Chrome	
153716	1005010-VF	Hose Service Kit, * Brass	
135248	1011130-G	Side Spray Assy Br Chrome	
155090	1085211-CP	Side Spray Assy, Chrome	
166253	1088395-VS	Side Spray Kit, *Stainless	
244405	1304674-BC	Pullout Hose Service Kit, Bright Chrome	

### Shower Installation

#### Pressure Balancing Kit

Part #	Mfg #	Description	Price
134263	K-1144925	PBU for K-306-KS & K-2971-KS	

### Urinal Installation

Part #	Mfg #	Description	Price
056119	21403	Urinal Cleanout Plug	

\* Vibrant Limited Lifetime Warranty

[www.waterconcepts.net](http://www.waterconcepts.net) • Serving our Customers Since 1946 • [www.plumbsupply.com](http://www.plumbsupply.com)

## Kohler Repair Parts

### Urinal Spud Assembly



Part #	Mfg #	Size	Price
145344	18759	1-1/4"	

### Toilet/Urinal Installation & Accessories

Part #	Mfg #	Description	Price
246241	1261108	Urinal Piston, 0.125 GPF	
246242	1261109	Urinal Piston, 0.5 GPF	
246243	1261110	Urinal Piston, 1.0 GPF	
246244	1261111	Toilet Piston, 1.1 GPF	
246247	1261113	Toilet Piston, 1.6 GPF	
246249	1261112	Toilet Piston, 1.28 GPF	

### Urinal Strainer



Part #	Mfg #	Description	Price
183714	53147-S	Urinal Strainer, Pol Stainless	
169956	GP1211759	Urinal Strainer	
173481	GP1217811	Urinal Strainer	
057460	9161-NA	Behive Urinal Strainer	

### Ballcock Retro Fit Valve

- For Rialto/  
San Raphael 3.5 toilets



Part #	Mfg #	Description	Price
055292	K-84499	Plastic	

### Cap Assembly



Part #	Mfg #	Description	Price
072213	1013092-0	Bolt Cap Accy Pack, White	
153559	1013092-G9	Bolt Cap Accy Pack, Sndbr	
186397	1013092-NY	Bolt Cap Accy Pack, Dune	
108130	GP1013092-96	Bolt Cap Accy Pack, Biscuit	
223630	5420-0	Low-Profile, White	
223631	5420-96	Low-Profile, Biscuit	
226816	5420-K4	Low-Profile, Cashmere	

### Faucet Valves

#### Complete Valve Assembly for Retrofitting Faucet

- 1/2" Valve

Part #	Mfg #	Description	Price
137033	1131481	Valve Body w/Hot Stem	
172151	1170273	Valve Replacement	

### Valve Repair Seat

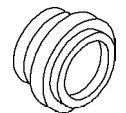

Part #	Mfg #	Description	Price
055320	20774-RP	Renewable Seat	

### Vacuum Breaker

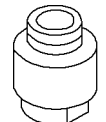

Part #	Mfg #	Description	Price
055422	GP49114	Vacuum Breaker	

### Valve Repair Kit

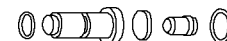

30166



1000187

Part #	Mfg #	Description	Price
182594	30147	Valve Service Kit	
182596	30372	Valve Service Kit	
182627	40409	End Valve Assy	
182681	58076	Valve Assy	
171801	76567	Valve Assy	

\* Vibrant Limited Lifetime Warranty

[www.plumbsupply.com](http://www.plumbsupply.com) • Serving our Customers Since 1946 • [www.waterconcepts.net](http://www.waterconcepts.net)

## Kohler Repair Parts

### Valve Repair (Continued)

#### Valve Repair Kit

Part #	Mfg #	Description	Price
056161	1000187	Valve Repair Kit	
162934	1178733	Valve Assy	
165027	1021121	Valve, Volume Control	
246767	1235756	Valve, 35 MM Short	
132759	GP1017426	Valve, Kitchen	
160355	GP1093674	Valve, Kitchen	
222832	GP1152350	Valve, Centerset Faucet	
222831	GP1192521	Valve, 25 MM White	
055381	GP78579	Valve Repair Kit	
055308	GP30166	Valve Service Kit	
055317	GP30119	Valve, Trend Shower (Hot)	

#### Washers, Nuts & Gaskets



Part #	Mfg #	Description	Price
182530	20496-BC	Lock Nut, Bright Chrome	
182532	20564	Washer	
182533	20565	Washer	
182536	20644	Gasket	
247267	21600	Washer F/STR-PLU	
182569	21766	Nut	
182572	21779	Gasket	
182574	21844	Nut	
153386	23094	Nut	
182584	24003-CP	Nut, Polished Chrome	
153819	32008	Nut	
182601	32060	Washer	
163448	32313	Nut	
182603	32841	Gasket	
182604	33331	Washer	
182606	33504	Washer	
182607	33772	Washer	
182608	34037	Gasket	
182610	34074-CP	Nut, Polished Chrome	
154416	34274	Washer	
182618	36262	Washer	
182626	40295	Washer	
170645	41376	Gasket	
154513	50751	Nut	
112456	50752	Washer	

### Valve Repair (Continued)

#### Washers, Nuts & Gaskets

Part #	Mfg #	Description	Price
182646	50843	Washer	
182647	51250	Gasket	
113702	51531	Gasket	
169200	52705-CP	Nut, Polished Chrome	
055325	53410	Washer	
159433	55164	Nut	
182656	55413	Washer	
182687	59606	Gasket	
181864	65157	Nut	
165926	65885	Gasket	
178854	71108	Nut	
177272	71813	Gasket	
250568	71975	Gasket, Alignment	
255526	76245	Rubber Gasket	
166860	78058	Washer	
166861	78057	Washer	
166859	78087	Gasket	
182733	79252-G	FacePlate Gasket	
182745	1007995	Washer	
182740	1000949	Washer, Plastic	
154945	1009882	Gasket, Molded	
165460	1015190	Washer	
183181	1018336-RP	Nut, Rough Plate	
181866	1020677	Gasket	
183184	1025642	Washer	
166877	1037307	Gasket	
152641	1050048-B	Nut	
183214	1051504-RP	Nut, Rough Plate	
178035	1070291	Gasket Kit	
257289	1101470	Mounting Gasket	
155661	1106733	Washer	
154740	1113583	Locknut & Gasket Kit	
183328	1128531	Washer	
180292	1222738	Gasket	
187471	1181517-RP	Nut, Rough Plate	

\* Vibrant Limited Lifetime Warranty

[www.waterconcepts.net](http://www.waterconcepts.net) • Serving our Customers Since 1946 • [www.plumbsupply.com](http://www.plumbsupply.com)

## Kohler Repair Parts

### Rough-In Valves Parts and Assemblies

#### Rite-Temp® Test Cap for K-8300 Series Valve Bodies

- Includes test cap assembly with seals
- Rated for pressure-testing up to 150 psi maximum (air or water)
- Supplied as standard with K-8300 series valve body rough-ins
- Available as an optional extra for K-8304 series valve body and cartridge kits
- Allows installed valve rough-in to be flushed and pressure-tested without installing cartridge



Part #	Mfg #	Description	Price
226714	K-10351-NA	Test Cap for K-8300 Series Valve Bodies	

#### 10" Rough-In Full Skirt Trap and Attachment System

- 10" (254 mm) rough-in
- Converts standard 12" rough-in products to 10" configuration
- Plastic trapway



For use with the K-3981 Tresham one-piece toilet, K-6428 Memoirs Stately skirted one-piece toilet and K-6424 Memoirs Classic skirted one-piece toilet

Part #	Mfg #	Description	Price
230307	K-5383-NA	10" Rough-In Kit	

### Sink Service Parts Rough-In Kit



GP1030932

Part #	Mfg #	Description	Price
166957	1066498	Rough-In Kit	
170792	1139260-CP	Rough-In Kit, Pol Chrome	
158598	1131486	Rough-In Kit	
168420	1187917	Rough-In Kit	
169472	1194630	Rough-In Kit	
127033	56373-CP	Rough-In Kit, Pol Chrome	
182707	73418-CP	Rough-In Kit, Pol Chrome	
098493	GP1007937-CP	Rough-In Kit Pol Chrome	
090369	GP1025388	Rough-In Kit Pol Chrome	
087416	GP1030932	Rough-In Kit Pol Chrome	

### Parts

Part #	Mfg #	Description	Price
154944	1000193-BV	Escutcheon, *Br Bronze	
166994	1000282-CP	Handle Kit, Pol Chrome	
189946	1001384-47	Service Kit, Almond	
153127	1001384-96	Service Kit, Biscuit	
155078	1001384-89	Service Kit, Desert Bloom	
258998	1001726-CP	Handle Service Kit, Chrome	
185783	1001795-BN	Handle Kit, * Br Nickel	
190273	1001795-47	Handle Kit	
177854	1001978-CP	Escutcheon, Pol Chrome	
153385	1002856	Bracket-Hold Down	
182739	100315	Clicker-Drain Assy	
182018	1003594	Spout Seal	
151709	1005129	O-Ring	
166832	1006008	Lift Rod Kit	
103651	1006026	Retainer	
182741	1006057-CP	Door Hinge, Pol Chrome	
182742	1006134-CP	Door Hinge, Pol Chrome	
177856	1006262	Stem Adapter Assy	
180497	1006269-CP	Escutcheon, Pol Chrome	
182744	1006396	Pin	
245107	1006397-CP	Hinge Cover, Pol Chrome	
167396	1006784-CP	Escutcheon Assy, Chrome	
180037	1007376-CP	Handle Kit, Pol Chrome	
162642	1007718-CP	Handle, Pol Chrome	
156197	1007999	Stem Driver	
257315	1008148-CP	Lift Rod Assy, Chrome	
177857	1008205	Screw	
187098	1009781-CP	Faceplate, Pol Chrome	
189790	1009814-CP	Escutcheon, Pol Chrome	
183175	1009872-AF	Bonnet, *French Gold	
251631	1009888-BN	Base Handle, *Br Nickel	
154055	1009888-CP	Base Handle, Chrome	
251630	1009890-BN	Lever Handle, *Br Nickel	
165459	1010161-BN	Trim Ring, *Br Nickel	
188789	1010315-CP	Escutcheon, Pol Chrome	
181490	1010672	Air Pressure Switch	
182875	1011032-0	Whirlpool Trim Kit, White	
182874	1011031-96	Whirlpool Trim Kit, Biscuit	
165984	1012391-BN	Handle, *Br Nickel	
166803	1012916	Split Coupling	
170229	1012977	Adapter	

\* Vibrant Limited Lifetime Warranty

[www.plumbsupply.com](http://www.plumbsupply.com) • Serving our Customers Since 1946 • [www.waterconcepts.net](http://www.waterconcepts.net)

**Kohler Repair Parts**

**Parts (Continued)**

Part #	Mfg #	Description	Price
167478	1013452-0	Dial Trim Assy, White	
167477	1013453	Detent Spring	
181867	1013469-0	Trim Ring, White	
164795	1013489	Stem	
252425	1013847-BN	Handle Kit, *Br Nickel	
165835	1014065	Tank Plate	
182876	1014072-7	Toilet Seat, Black Black	
165458	1014087-BN	Bonnet, *Br Nickel	
183178	1014554-SN	Spout & Hardware, *Nickel	
160891	1014555-CP	Spout & Hardware, Chrome	
182877	1014556-CP	Spout & Hardware, Chrome	
167744	1014917-G	Lift Rod Assy, Br Chrome	
175018	1015084-BN	Button, *Brushed Nickel	
167746	1015084-G	Button, Brushed Chrome	
136712	1015345	Graphics, Red & Blue	
172143	1015467-2BZ	Handle Assy Oil-Rbd Bronze	
165456	1015782	Screw	
153165	1016455-CP	Escutcheon Assy, Chrome	
183180	1017273	Screw	
259510	1018651-SN	Handle Assy, *Pol Nickel	
181863	1018662	Control Assy	
182879	1020006-G	Shower Arm, Br Chrome	
259288	1020006-2BZ	Shower Arm, Oil Rbd Brz	
182880	1020007-VF	Shower Arm, *Pol Brass	
182881	1020609	Tube	
167479	1023381	Service Tool	
255174	1023391-BN	Stopper, *Br Nickel	
190293	1022562-VF	Trip Lever Kit, Pol Brass	
173541	1024303-0	Button, White	
162318	1024303-2BZ	Button, Oil Rubbed Bronze	
162335	1024303-BN	Button, *Brushed Nickel	
183183	1024303-VF	Button, Polished Brass	
252956	1025208-CP	Handle Kit, Chrome	
183167	1025637-AF	Trim Ring, *French Gold	
154765	1025637-BN	Trim Ring, *Brushed Nickel	
153164	1030689-CP	Escutcheon, Pol Chrome	
183185	1031444	Soap Dish	
176758	1031869-CP	Escutcheon, Pol Chrome	
183186	1031962	Bearing	

**Parts (Continued)**

Part #	Mfg #	Description	Price
183187	1032126-VF	Drain Handle Assy, Brass	
175899	1032250	Seal	
187628	1032253-BC	Body Assy, Bright Chrome	
183188	1032267	Replacement Screw	
186677	1032493-0	Bubble bath Interface, White	
252418	1032501-CP	Escutcheon, Chrome	
177257	1032546	Valve Stops	
223376	1032872-BC	Valve Stem Adapter	
190205	1033209	Tube, 10.50	
171281	1033743-BN	Escutcheon, *Br Nickel	
153729	1034578	Retainer	
184322	1035359-BN	Escutcheon, *Br Nickel	
166029	1035359-CP	Escutcheon, Chrome	
183191	1035359-VS	Escutcheon, *Stainless	
183192	1035564	Drain Link	
168072	1035605	Screw Set	
170434	1035796-CP	Handle, Pol Chrome	
246749	1036041-CP	Body Spray Face, Chrome	
163159	1036044	Clamp	
182830	1036210	Blower Kit	
253206	1036216	Blower Experience Kit	
183193	1036218	Check Valve Assy Kit	
183194	1036221	Cover/CB Assy	
172555	1036453-CP	Handle Assembly, Chrome	
259125	1036775	Service Kit	
171280	1036906	Putty Plate	
187935	1036932-BN	TrimRing, *Brushed Nickel	
183195	1036994-AF	Plunger Assy, *French Gold	
159708	1036994-VF	Plunger Assy, Pol Brass	
175689	1037021-BN	Plunger Assy *Br Nickel	
183197	1037021-G	Plunger Assy Br Chrome	
172528	1037022-BKB	Plunger Assembly, Br Black	
258115	1037022-PGD	Plunger Assy, *Mod Pol Gl	
161237	1037023-BN	Drain Assy, *Br Nickel	
183198	1037023-G	Drain Assy, Br Chrome	
175333	1037334	Plunger Arm Assy	
245304	1037431-BN	Spray Holder Assy, *Br Nkl	
170632	1037431-BV	Spray Holder Assy, *Br Brz	
225585	1037431-G	Spray Holder Assy, Br Chr	

\* Vibrant Limited Lifetime Warranty

[www.waterconcepts.net](http://www.waterconcepts.net) • Serving our Customers Since 1946 • [www.plumbsupply.com](http://www.plumbsupply.com)



## Kohler Repair Parts

### Parts (Continued)

Part #	Mfg #	Description	Price
153316	1039475	Mounting Kit	
184794	1039714-BN	Lever Handle, *Br Nickel	
163161	1039745	Set Screw	
166289	1040484-CP	Spout Kit, Pol Chrome	
183200	1041109-G	Escutcheon, Br Chrome	
174324	1041180-BN	Lift Rod, *Brushed Nickel	
185607	1041321-CP	Handle Kit, Br Chrome	
165318	1041573-G	Spray Face, Br Chrome	
177167	1041840	Drain Rod	
183201	1042007	Check Valve Kit	
177074	1042634	Wall Sleeve Assy	
256583	1043060-A-96	Access Panel 1160, Biscuit	
163145	1044060	O-Ring	
168711	1044616	Retainer	
163427	1045251	Cable Assembly	
248081	1043340-CP	LH Trip Lever Assembly	
163158	1045768	Sprayhead Kit	
165316	1045769	Sprayhead Kit	
177258	1046101	Seal Kit	
183203	1046153	Weight	
258997	1047628-CP	Sleeve Mixer, Chrome	
183204	1048208-B	Screw	
183205	1048208-C	Screw	
183206	1048656-P	Sealing Liquid	
183695	1049146	Floor Mounted Fixing Pack	
163160	1051487	Membrane	
183207	1051503-BN	Bonnet, *Brushed Nickel	
165317	1051682	Membrane	
185403	1052086	Power Supply Kit	
183215	1052857	Reduce Bushing	
183216	1054165-SN	Lift Rod Assy, *Pol Nickel	
183218	1055628	Solenoid Assembly	
135539	1055666	Solenoid	
187554	1055800-BN	Handle Kit, *Br Nickel	
169720	1060438-CP	Escutcheon, Pol Chrome	
120956	1060514	Insert - Square Stem for Coralais Handle	
176650	1060800	Spacer Kit	
169793	1067372-96	Toilet Seat, Biscuit	
183220	1068202-BN	Stopper, *Brushed Nickel	
163642	1068202-BV	Stopper, *Brushed Bronze	
177685	1068525-BN	Assembly Cover, *Br Nickel	

### Parts (Continued)

Part #	Mfg #	Description	Price
163641	1068525-BV	Assembly Cover, *Br Brz	
237117	1068525-2BZ	Assembly Cover, Oil Rd Brz	
187234	1068945	Retainer	
183221	1069315	Spring	
183222	1069723-0	Trip Lever, White	
245108	1070676-01-58	Strike Jamb Seal, Thunder Grey	
183223	1070844	Hardware Bag	
183224	1071000	Storage Locker Parts Kit	
169116	1071652	Hex Bit	
254174	1071965	1/4 Turn Valve Kit	
171261	1074034	Tool Assy	
183225	1074721-BN	Bonnet, *Br Nickel	
183226	1074724-BN	Adapter, *Brushed Nickel	
183227	1075614	O-Ring	
183228	1075615	O-Ring	
178585	1077791-96	Plug Buttons, Biscuit	
245303	1077792-96	Plug Buttons, Biscuit	
171786	1077792-BN	Plug Buttons, *Br Nickel	
183229	1077813	Solenoid Valve Kit	
183230	1077815	Valve Cover Kit	
183231	1077816	Diaphragm Kit	
128818	1078578	Flush Valve Assembly Kit	
155319	10813650-0	Floor Mounting Kit Assy	
183232	1081873-BN	Handle, *Brushed Nickel	
222456	1081873-CP	Handle, Chrome	
257036	1082514-CP	10-24 Brass Screw, Chrm	
114111	1083980	Canister Valve Assy Kit	
156362	1086408-CP	Handle, Pol Chrome	
156410	1086409-58	Ring, Thunder Grey	
222940	1085211-VS	Side Spray Assembly	
155113	1086972	Hinge Mount	
257037	1087472-CP	Strainer Plate, Sqr Chrome	
257039	1087473-CP	Strainer Ring, Sqr Chrome	
163815	1088996	Valve Kit	
181309	1090621-2BZ	Lift Rod Assy, ORB	
183235	1093029	Assembly Body	
161131	1093053-BV	Spout & Diverter *Br Bronze	
160252	1094550-CP	Straight Stop, Pol Chrome	
183236	1094562	Bonnet	

\* Vibrant Limited Lifetime Warranty

[www.plumbsupply.com](http://www.plumbsupply.com) • Serving our Customers Since 1946 • [www.waterconcepts.net](http://www.waterconcepts.net)

## Kohler Repair Parts

### Parts (Continued)

Part #	Mfg #	Description	Price
170190	1094612-CP	Valve, Polished Chrome	
154678	1094633	Seat & Sleeve Assembly	
166611	1094724	Side Body	
251743	1094562-CP	Bonnet, Chrome	
148639	1095910	Diaphragm Assembly	
183240	1098124	O-Ring	
183176	1010343-CP	Handle, Polished Chrome	
182747	1010376	Flapper	
155669	1011059-58	Ring, Thunder Grey	
165461	1011530-BN	Handle, *Brushed Nickel	
246158	1012692	Pressure Switch	
157984	1013457-E-96	Flagship Assy, Biscuit	
159535	1013970	Screw	
152457	1013975	Adapter	
154533	1014049	Steam Adapter	
157985	1015009	Plug Assy	
169377	1016310	Plate	
254563	1016373	Check Valve, 14MM O.D.	
156133	1016953	Pump Assy	
156195	1018651-CP	Handle Polished Chrome	
159106	1018651-BN	Handle *Brushed Nickel	
157818	1018651-BRZ	Handle, Oil Rubbed Bronze	
255937	1018663	NGH Core Upgrade w/ Neck & Back Control Assy	
165985	1019021-BN	Waste Plug, *Br Nickel	
151743	1020678-E-96	Cover/CB Assy, Biscuit	
156951	1020679-A	Cover/CB Assembly	
252615	1020882	Threaded Sleeve	
252955	1021514	Extension Stem	
251115	1021961-BV	Lift Rod Assy, *Br Bronze	
159540	1024303-47	Plug Button, Almond	
160135	1024303-96	Plug Button, Biscuit	
157926	1024303-CP	Plug Button, Pol Chrome	
111678	1024419	Hub	
159622	1025210-BN	Escutcheon Assy, *Br Nkl	
154531	1025639-BC	Drain, Bright Chrome	
159534	1032871-BC	Adapter, Bright Chrome	
151597	1033731	Plug Assembly	
151598	1033732	Mixer Valve	
158221	1034484	Clip	
154831	1035023-CP	Handle Assy, Pol Chrome	

### Parts (Continued)

Part #	Mfg #	Description	Price
152485	1035783	Seal Assy	
152917	1036160	Push Rod Kit	
152344	1036212	Kit, Blower-International	
172556	1036452-CP	Handle Assy, Pol Chrome	
153655	1036994-CP	Plunger Assy, Pol Chrome	
183196	1036994-G	Plunger Assy, Br Chrome	
152915	1037044-CP	Handle Assembly, Chrome	
183199	1038690	Vent Assembly	
159505	1039095-CP	Assy, Polished Chrome	
173128	1041321-BN	Handle Kit, *Brushed Nickel	
155666	1041321-G	Handle Kit, Br Chrome	
248045	1042629-CP	Control Ring Assy, Chrome	
190209	1042831	Flush Valve Kit	
153884	1043004	Screw Set	
152643	1044585	Roller	
223269	1045770	Adapter Kit	
120496	1046987-CP	Handle Kit, Pol Chrome	
223375	1048476	Screw, M4 x 60MM Long	
152637	1051142-A	Screw	
152456	1051609-BN	Lift Rod, *Br Nickel	
152435	1054623-BN	Diverter Assy, *Br Nickel	
162256	1055650-CP	Push Button Assy, Chrome	
153605	1055715	Service Kit	
152639	1059792	Bushing	
135541	1060056	Kit, Piston Cover	
253400	1062356-0	Drain Cover, White	
186964	1062356-33	Drain Cover, Mexican Sand	
157607	1065219	Electronic Unit Assy	
248941	1068202-2BL	Stopper, Black	
155414	1068204	Cartridge Assy	
171397	1068380-0	Access Panel	
253024	1068380-A-0	Access Panel Assy 1124	
246111	1070675-01-58	Strike Jamb Cap, Thunder Grey	
152838	1072961-CP	Button Assy, Pol Chrome	
152644	1077763-A	Bolt	
165893	1077792-BV	Plug Buttons, *Br Bronze	
159625	1077792-47	Plug Buttons, Almond	
152717	1080774	Union Assy	
157870	1081349	Adapter Assy	

\* Vibrant Limited Lifetime Warranty

[www.waterconcepts.net](http://www.waterconcepts.net) • Serving our Customers Since 1946 • [www.plumbsupply.com](http://www.plumbsupply.com)

## Kohler Repair Parts

### Parts (Continued)

Part #	Mfg #	Description	Price
152040	1093052-VF	Kit, Polished Brass	
251740	1094009-BC	RH Vlv Stem, Brght Chrm	
251741	1094010-BC	LH Vlv Stem, Brght Chrm	
183173	1100507-0	Hinge Cover, White	
155987	1100590	Hose	
259287	1101931-2BZ	Flange, Oil Rubbed Bronze	
148638	1102542	Solenoid Assy	
157194	1104111-BV	Nozzle Assy, *Br Bronze	
185157	1104111-CP	Nozzle Assy, Chrome	
164048	1104111-VF	Nozzle Assy, Pol Brass	
164773	1104235	Solenoid Kit	
168064	1104270	Assy	
170369	1104271	Electronic Unit Assy	
168063	1104272	Piston Cover Kit	
154930	1104617	Crank Assy	
172129	1104957	Laminar Insert	
125323	1105656	O-Ring	
189739	1105685-BN	Overflow Cover, *Br Nickel	
247385	1105685-CP	Overflow Cover, Chrome	
183243	1105706	Tool Kit	
188100	1105900	Spout Extension Assy	
165033	1106015	Sensor Assy	
155660	1106729-BN	Handle, *Brushed Nickel	
248480	1109254-CP	Loure Escutcheon, Chrome	
254684	1122899-CP	3/4" Stop Valve, Chrome	
248402	1125009-CP	Cover Assy, Chrome	
253892	1110300	Hose Assembly	
168062	1111139	Solenoid Kit	
244187	1112258	Tank Plate	
253891	1113617	Quick Connect Tee Assy	
251786	1140157-2BZ	Bonnet Handle, Oil Rbd Brz	
251739	1114865	Gasket, .365 ID x .745 OD	
183324	1115286	Ring	
255184	1115287	Threaded Ring	
246840	1115841-CP	Flange, Chrome	
160683	1119112	Slip-Fit Clamp Kit	
183325	1120992-BN	Handle, *Brushed Nickel	
248023	1123790-CP	Handle Assy, Chrome	
253290	1128497-CP	Trip Lever Handle Assy	

### Parts (Continued)

Part #	Mfg #	Description	Price
137034	1131482	Vlv Assy for WS Fcts (Cold)	
140785	1131496	Seal, Canister Dual Flush	
183329	1131838-58	Bumper, Thunder Grey	
152557	1133024	Hardware Pack	
177252	1133070	Service Kit	
155662	1138476-BN	Escutcheon Assy *Br Nickel	
158967	1139558	Collect-Push-In	
183696	1139526-CP	Elbow Assy, Pol Chrome	
168212	1139600	Trapway Service Kit	
155640	1140164-BN	Flange, *Brushed Nickel	
141416	1140858-CP	Slidebar Assy, Chrome	
183331	1140867-BN	Cover, *Brushed Nickel	
183697	1141213-B	Cartridge, Transfer Valve	
222069	1142457-BN	Spout Assembly	
177423	1142538	Filter Block	
259033	1145552	Adapter Kit for K528KNA	
183336	1145563	Kit, SPR Valve Assembly	
254560	1145620	Debris Screen	
172730	1145638-HW1	Toe Tap Assy	
169192	1146417	Pump	
183337	1146802-0	Air Jet Service Assy, White	
152316	1147742-0	Air Switch Kit, White	
157788	1147742-47	Air Switch Kit, Almond	
166779	114847-VS	Spray, *Stainless	
251739	1114865	Gasket	
183338	1150464-0	EB Hinge Kit, White	
249067	1150464-96	EB Hinge Kit, Biscuit	
160674	1151429-CP	Collar, Polished Chrome	
180822	1151441-CP	Shower Arm, Pol Chrome	
163200	1151968-BN	Service Kit, *Brushed Nickel	
163170	1151968-CP	Service Kit, Pol Chrome	
171450	1152299-BN	Spray/Screen Kit, *Br Nickel	
166599	1153944-BN	Handle Kit, *Br Nickel	
164798	1153944-CP	Handle Kit, Pol Chrome	
187838	1153944-G	Handle Kit, Br Chrome	
167699	1154757-58	Screw Cover Service Kit	
188368	1154836	Hose Assy	
249368	1155515	Flush Valve Fixing	
170194	1155520	Pipe System	
177056	1156410-BN	Plug Button, *Br Nickel	

\* Vibrant Limited Lifetime Warranty

**www.plumbsupply.com • Serving our Customers Since 1946 • www.waterconcepts.net**

## Kohler Repair Parts

### Parts (Continued)

Part #	Mfg #	Description	Price
183698	1156410-CP	Plug Button, Pol Chrome	
183702	1160753	Adapter	
183555	1161770	Rotary Assy	
254561	1164600	Flow Regulator, 2.0 GPM	
190321	1166635	3/4" Volume Control Insert	
166308	1166879-BN	Tube, *Brushed Nickel	
223932	1166879-CP	Tube, Pol Chrome	
176945	1173678	Cartridge Assy	
180261	1175870-BN	Lift Rod, *Br Nickel	
254596	1176995	Inlet Filter	
181980	1177160	Sink Clips	
183704	1177161	Installation Clip Kit	
173008	1178736	PCB Board & Cover Assy	
248940	1179957-BL	Strainer, Matte Black	
183706	1179957-BN	Strainer, *Brushed Nickel	
248943	1179957-2BL	Strainer, Black	
069038	1179-NA	Tiling-In Bead, 180" Length	
167166	1180445-VF	Escutcheon, Polished Brass	
259534	1180978-CP	Escutcheon, Chrome	
056792	1181-NA	Tiling-In Bead, 132" Length	
161065	1185540-BN	Assy Slider, *Br Nickel	
256936	1186673	Valve Service Kit	
254562	1186675	Collet Service Kit	
253559	1187796-NX	Handle Kit, Brushed Nickel	
188413	1187796-SH	Handle Kit, Bright Silver	
172092	1187796-SHP	Handle Kit, Bright Pol Silver	
158906	1190050-K-CP	Assy, Polished Chrome	
188463	1191575-CP	Shower Arm, Pol Chrome	
254685	1193202	Potted HEC Battery, 8 oz.	
171043	1194302-CP	Large Escutcheon, Pol Chr	
182831	1194940	Cable	
254876	1198201	Valve Kit	
183710	1200948	Chain Kit	
172093	1201773-BN	Spout Assy, *Br Nickel	
188554	1202708	Mirrored Door Assy	
169231	1202077	Supply Hose SS	
224199	1202709	Mirrored Door Assembly	
186691	1204788-2BZ	Cold Handle Assy, ORB	
186251	1207169	Supply Hose	

### Parts (Continued)

Part #	Mfg #	Description	Price
183711	1207943	Diverter Spout Cap	
165035	1209172-VS	Escutcheon, * Stainless	
222939	1209172-CP	Escutcheon, Oil-Rubbed Brz	
251085	1211811-0	Tank Cover, White	
257070	1213082	Spherical Bushing	
252475	1215251-C	Verdera Glass Shelf Kit with 24" Cabinet	
252474	1215255	Verdera Parts Box	
254765	1215256	Verdera Mag Mirror Kit	
259221	1216617	Canister Valve Assy	
224985	1218071	Supply Adapter	
186669	1218822-VS	Spray Assy, *Stainless	
254980	1218823-2BZ	Spray Assy, Oil Rubd Brz	
176606	1218922-CP	Button, Polished Chrome	
181868	1219654	Heater	
179983	1219693	Pipe Plug	
180294	1222736	Adapter	
188461	1224550-CP	Escutcheon, Pol Chrome	
230778	1225240	Adapter Kit	
257069	1225543-0	Bolt Cap Kit, White	
187872	1229031	Supply Adapter	
171581	1229524	Basin Rack Wheels	
244980	1222873	Quick Connector Kit	
183712	1232221-BN	Handle Assy, *Br Nickel	
177253	1239016	Hardware Pack	
178416	1240529	Overflow Shell	
259544	1247432-SHP-GC05	Panel Assembly	
185308	1256315	OEM Touchless Assy	
251116	1261116-CP	Handle Assy Kit, Chrome	
255066	1262200	Diverter Assy	
189976	1262603-CP	Steam Head Kit, Pol Chr	
258409	1266657	25 MM Valve Kit	
255979	1267750	CAM Assy Kit, Angled Base	
255620	1270681-CP	Spray Assy Detail, Chrome	
256270	1270681-VS	Spray Assy Detail, *Stainlss	
250700	1276184	Cover Assy Detail	
259022	1297594	Vlv Service Kit w/ Hydorrail	

\* Vibrant Limited Lifetime Warranty

[www.waterconcepts.net](http://www.waterconcepts.net) • Serving our Customers Since 1946 • [www.plumbsupply.com](http://www.plumbsupply.com)

## Kohler Repair Parts

### Parts (Continued)

Part #	Mfg #	Description	Price
255495	1303882-BL	Spray Assy, Kitchen Sweep Matte Black	
250654	1345879	Touchless 1.5 Flush Kit RetroFit	
252424	1352289-BN	Bonnet Kit, *Br. Nickel	
158897	13602-NA	Cable Assy	
247220	13603-NA	8' Cable Assy	
124369	18376	3/4" Urinal Spud Assembly	
257272	20003-CP	Escutcheon Plate, July Chr	
182526	20345-BN	Flange & Set Screw Assy, *Br Nickel	
156847	20345-CP	Flange & Set Screw Assy, Chrome	
165097	20345-VF	Flange & Set Screw Assy, Pol Brass	
162187	20363-VF	Flange Assy, Pol Brass	
182529	20413-CP	Valve Stem, Pol Chrome	
182527	20401	Post	
222959	70442	Stem Extension Kit	
182531	20536-CP	Lift Rod, Pol Chrome	
182534	20615-BN	Screw, *Brushed Nickel	
182535	20617-CP	Overflow Hood, Chrome	
182537	20650-CP	Stopper Assy, Chrome	
182538	20652-CP	Screw, Chrome	
182539	20654-RP	Valvet, Rough Plate	
182540	20851-CP	Escutcheon, Pol Chrome	
254341	20852-NA	Aquifer Cartridge Kit	
055337	20961	Seat Washer	
182558	21072-BN	Stopper Assy, * Br Nickel	
182560	21098-CP	Escutcheon, Chrome	
223383	21694	Lift Toggle Assembly	
182570	21775	Screw	
182571	21777	Niedecken Detail	
182573	21843-BC	Screw, Bright Chrome	
182575	21845	Packing	
164410	21152	Screw	
164411	21153	Adjusting Block	
164409	21155	Lift Rod	
158316	21166-BKB	Strainer Body, Br Black	
173074	21166-CP	Strainer Body, Chrome	
182561	21166-VF	Strainer Body, Pol Brass	
182562	21281-CP	Shroud Cover, Chrome	
182882	21318-AF	Stopper Assy, * Fr Gold	

### Parts (Continued)

Part #	Mfg #	Description	Price
158315	21318-BKB	Stopper Assy, Br Black	
182563	21318-VF	Stopper Assy, Pol Brass	
182564	21354	Lift Rod	
182565	21496	O-Ring Assy	
247266	21603-VF	Screw, Oval Countersunk .250-20 x 1.50	
182567	21712-BC	Stem, Bright Chrome	
182568	21745-CP	Cover, Pol Chrome	
172647	22125	Plunger	
172649	22126	Plunger	
172650	22211	Disc Holder	
172651	22212	Disc Holder	
182576	22325	Spline Insert	
182577	22511	Valve	
182578	22692	Diverter Seat	
182579	22859	Screw	
182580	22862-BC	Diverter Stem, Bright Chr	
162949	22910-CP	Sleeve, Polished Chrome	
182581	22916-BN	Overflow Plate, * Br Nickel	
182582	22916-CP	Overflow Plate, Chrome	
182583	22942	Seat	
153611	23023-BC	Valve Stem, Bright Chrome	
153119	23058-BC	Valve Stem, Bright Chrome	
182585	24015	Union Joint	
174497	28518	Pin	
182586	29037-BC	Drain Crank, Bright Chrome	
182587	29039-BC	Drain Crank, Bright Chrome	
182588	29060-BN	Lever Lift, * Br Nickel	
182589	29077-BN	Screw, *Br Nickel	
182590	29643	Lift Toggle	
182591	30040	Valve Stem Ledge	
182592	30042	Valve Stem	
182593	30139	Sleeve & Diverter Kit	
175179	30152	Plunger Assy	
182595	30154	Lift Rod Assy	
151344	30253-RP	Rebuilding Kit, Rough Plate	
154165	30297-CP	Rebuilding Kit, Chrome	
166211	30299	Rebuilding Kit	

\* Vibrant Limited Lifetime Warranty

**www.plumbsupply.com • Serving our Customers Since 1946 • www.waterconcepts.net**



## Kohler Repair Parts

### Parts (Continued)

Part #	Mfg #	Description	Price
177747	30332-RP	Hardware Kit, Rough Plate	
167058	30394-RP	Valve, Rough Plate	
182597	30419	Tank Accessory Pack	
182598	30467	Diverter	
165924	30739	Removal Tool	
160203	30775	WP Control Kit	
258879	31468	Renewable Unit Assy	
163455	31537	Ball & Frame Assy	
182600	31584-BC	Valve Stem Assy, Brgt Chr	
182599	31439-BC	Diverter Assy, Chrome	
153818	32005	Packing	
056023	32462	Renew Unit Assembly, RH	
182602	32657	O-Ring	
182605	33357-BN	Screw, *Brushed Nickel	
189795	33625	Screw	
173081	33681-CP	Strainer, Chrome	
182609	34064-BN	Lever Handle, * Br Nickel	
182611	34117	O-Ring	
153817	34190	Valve Spacer	
154166	34230	Spring	
055365	34263	O-Ring	
055358	34265	Washer, .482 x .815	
168123	34294	Packing	
182612	34532	Post For Soap Dish	
182613	34533-CP	Nut, Pol Chrome	
252853	34649-CP	Self Closing Vlv Unit, Chrm	
160251	34777	Pressure Regulator Assy	
143096	34848	Screw 8-32 x .281"	
170189	34902-G	Condensate Plate, Chrome	
182614	35103	Angle Stop Assy	
182615	35285	Screw	
161208	35296-CP	Bubbler Shank, Chrome	
159530	35311-CP	Lever Handle Assy, Chrome	
170191	35314-CP	Fountain Trap, Pol Chrome	
175962	35594	Union Conn	
251645	36257	Seat & Spring Sleeve	
182616	36258	Push Button	
182617	36261	Valve Stem	
182619	36263	Spring	

### Parts (Continued)

Part #	Mfg #	Description	Price
182620	36415	Spout Bearing	
182621	36417-RP	Swing Spout Post, RP	
182622	39881	Valve Stem Packing	
182623	40004	End Valve Body Assy	
070159	40013	Gasket .250" I.D. x .460" O.D.	
182624	40235	Ball Lever Seat	
136388	40236	Ball-Rod Assembly	
182625	40282	Diverter Bushing	
170179	40343-CP	Handle Assy, Pol Chrome	
182883	40479-BN	Bonnet, *Br Nickel	
182628	40966	Packing	
169521	41240-VF	Insert, Pol Brass	
182629	41489	Stand Pipe	
256147	41981-C-CP	Handle, 4 Arm Cold Chrm	
256148	41981-H-CP	Handle, 4 Arm Hot Chrome	
182630	42036	Hot Plunger	
182631	42038	Cold Plunger	
055996	42043	O-Ring	
182632	42052-CP	Mixer Sleeve, Chrome	
182633	42160	O-Ring	
182634	42258	Sleeve	
182635	42271	Bonnet	
171282	42414	Screw	
182636	42451	O-Ring	
182637	42675	Plug, Handle, Shower	
251197	427280-0	Small Ceramic Insert, White	
179506	43040	Trap	
153582	43070BV	Strainer Plate, *Br Bronze	
172119	48096-CP	Strainer SA, Chrome	
189793	48250-CP	Wall Saddle, Pol Chrome	
189796	48251-CP	Rod, Pol Chrome	
165964	48609-BGD	Bidet Spray, *Moderne Br Gold	
182639	48686	O-Ring	
182640	500180	Bumper Kit	
168997	500306-G3-B11	Paint Kit, Ice	
179745	500452	Rebuild Kit, Diverter	
182641	500455-CP	Stem Extension Kit, Pol Chr	
182642	50338	Detent	

\* Vibrant Limited Lifetime Warranty

[www.waterconcepts.net](http://www.waterconcepts.net) • Serving our Customers Since 1946 • [www.plumbsupply.com](http://www.plumbsupply.com)



**Kohler Repair Parts**

**Parts (Continued)**

Part #	Mfg #	Description	Price
177748	50340-VF	Escutcheon, Pol brass	
182643	50344-CP	Bonnet, Chrome	
182644	50588-BN	Diverter, *Br Nickel	
182648	51261	Clip	
182649	51419	Seat	
189794	51967-CP	Screw, Pol Chrome	
170192	52054	Wall Screw	
182650	52156	Tube	
154844	52478	O-Ring	
164797	52588	Screw	
182651	52703	Overflow Tube	
182888	52865-BN	Screw, * Br Nickel	
182652	52936-CP	Hndl & Btn Assy, Pol Chr	
182653	53448-CP	Screw, Chrome	
159108	534-NA	Install Kit	
173257	550-NA	Install Kit	
182655	55108	O-Ring	
182659	56318-RP	Seat Replacement Kit, RP	
165965	56702	Shank	
225354	57081-CP	Centerpiece®, Handle	
247502	57411-CP	Lift Rod, Chrome	
183342	57411-G	Lift Rod, Br Chrome	
182677	57711	O-Ring	
161416	577-NA	Install Kit	
182679	57745-CP	Blade Handle, Chrome	
056004	57746-CP	Tend Handle, Chrome	
182680	57751	Spray Diverter	
173294	57930-VF	Escutcheon, Pol Brass	
162186	58015-VF	Sleeve, Pol Brass	
168631	58180-CP	Escutcheon, Chrome	
182682	58249	Pipe Cap	
182683	58307-VF	Shower Head, Pol Brass	
182685	58895-CP	Handle Kit, Chrome	
162749	591-NA	Install Kit	
156756	592-NA	Install Kit	
161743	593-NA	Install Kit	
111732	59425	Nut Escutcheon	
256831	59615	Hardware Kit	
182689	59636-G	Sleeve, Br Chrome	
182690	59637-G	Handle Base, Br Chrome	
182691	59637-VF	Handle Base, Pol Brass	
182686	59418	Lower Bushing	

**Parts (Continued)**

Part #	Mfg #	Description	Price
182692	60380	Screw	
182693	64503	Hanger	
182694	65054-S	Screw, Pol Stainless	
182889	65061-BV	Suction Cover, *Br Bronze	
182695	65156-0	Switch Flange, White	
182522	65156-47	Switch Flange, Almond	
182696	65226-96	Suction Cover Plug, Biscuit	
182697	65879	Retaining Ring	
165925	67429	Flange	
165927	67889	Housing Assy	
182699	70504	Plug Button	
182700	70505	Plug Button	
182701	70539	Threaded Sleeve	
250567	70591-CW	SA Ceramic Insert, Chrome w/ White	
180038	70593-CP	Brass Inserts, Pol Chrome	
156915	71015	O-Ring	
182702	71016	O-Ring	
181966	7117-NA	Test Seal Kit	
055352	71906	Stem Adapter	
182703	71911	Mixer Face Plate	
166030	71940	O-Ring	
190311	71973-CP	Handle Lever	
250570	71974-CP	Cover, Chrome	
182704	73065	Stem Adapter	
182705	73066	Stem Adapter	
153331	73094	Adapter	
158723	73175	Flexible Shaft	
158720	73179	Sleeve	
164075	73203-G	Bezel IR Sensor, Chrome	
172152	73330	Spacer	
158722	73404-CP	Tube Assy, Pol Chrome	
158718	73439-CP	Lift Rod, Chrome	
172755	73455-CP	Escutcheon, Chrome	
182198	73703	Side Valve	
182708	73719-BC	Stem Extension, Chrome	
244764	73744-AU	Diverter Spout Kit, Pol Gold	
165687	73744-BN	Spout Kit, *Br Nickel	
182709	73860	Tee Assy	
172068	74385-G	Escutcheon, Br Chrome	

\* Vibrant Limited Lifetime Warranty

[www.plumbsupply.com](http://www.plumbsupply.com) • Serving our Customers Since 1946 • [www.waterconcepts.net](http://www.waterconcepts.net)

## Kohler Repair Parts

### Parts (Continued)

Part #	Mfg #	Description	Price
057294	74392	Diverter Cartridge Assy	
158314	74675-2BZ	Overflow Hood Assy, ORB	
182716	75059	Diaphragm Assy	
182717	7511-58	Shank, Thunder Grey	
053725	7524-CP	Bubbler	
182718	75462	Graphic Cover	
162495	75564	Retaining Ring	
177491	75601-BN	Bonnet, *Br Nickel	
153434	75610-CP	Bonnet, Pol Chrome	
182719	75740	Adjustment Collar Assy	
158239	75771-CP	Cap, Polished Chrome	
225355	42669-CP	Stem/Skirt Handle	
255527	76248-BN	Escutcheon, *Br Nickel	
168741	76602-CP	Escutcheon Assy, Chrome	
182720	76704-0	Bonnet Cap, White	
250024	76704-BN	Bonnet Cap, *Br Nickel	
073775	76704-CP	Bonnet Cap, Pol Chrome	
152934	76713	Screw	
244250	76725-BL	Cap, Matte Black	
250652	76728-0	Mounting Plate	
182722	76755-VF	Handle Skirt, Pol Brass	
182724	77012-VF	Handle Skirt, Pol Brass	
182727	77099	Bearing	
182932	77172-BN	Escutcheon, *Br Nickel	
245980	77172-VF	Escutcheon, *Pol Brass	
164796	77642	O-Ring	
244704	77887-BV	Lever Handle Assy, *Br. Brz	
157465	77887-VF	Lever Handle Assy, Brass	
248992	77948	O-Ring	
251742	77952	O-Ring	
159624	77971-47	Graphic Cover, Almond	
162319	78042-2BZ	Plug Button, ORB	
161850	78042-96	Plug Button, Biscuit	
182933	78050-BN	Escutcheon, *Br Nickel	
181411	78139-BV	Handle Assy, *Br Bronze	
159432	78139-2BZ	Handle Assy, ORB	
182934	78139-CP	Handle Assy, Chrome	
182730	78148-CP	Handle Assy, Chrome	
182731	78155	Screw	
182935	78172-BN	Stopper Assy, *Br Nickel	
160987	78205-47	Plug Button, Almond	

### Parts (Continued)

Part #	Mfg #	Description	Price
156226	78205-96	Plug Button, Biscuit	
163179	78205-BV	Plug Button, *Br Bronze	
156120	78205-2bz	Plug Button, ORB	
183343	78205-G	Plug Button, Br Chrome	
182732	78205-VF	Plug Button, Pol Brass	
158237	78562-58	Grip Ring, Thunder Grey	
131130	78797	Rubber Seal	
068093	78913	Cartridge, Thermostatic Valve	
184161	78923-BN	Collar, *Brushed Nickel	
153015	78925	Hose Guide Assy	
152208	78969-58	Adapter, Thunder Grey	
165028	79150-58	Adapter Kit, Thunder Grey	
182734	800065-CP	Lever Handle, Chrome	
157839	83143	Seal Diaphragm	
183344	834404	Screw	
185858	83451	Cap Assy	
183345	836664	Mounting Hardware	
152205	84100	O-Ring	
249429	84305	Flush Valve Kit	
182737	84786	Hardware Pack Seat	
081376	85500	Mixer Cap Kit	
167088	85516	Set Screw Spout Assy	
182940	85698-CP	Escutcheon, Chrome	
167086	86036	O-Ring/Bearing Kit	
166292	86633	Bath Stem	
166482	86861-CP	Lift Rod, Polished Chrome	
182944	87117	Backing Plate	
164794	87118-CP	Collar, Chrome	
181643	87390	Filter Head	
187099	87448-CP	Sleeve, Pol Chrome	
166995	87536	Screw	
176620	88057-BN	Plug Button, *Br Nickel	
182945	88093-G	Screw, Br Chrome	
175356	88532-96	Trim Ring Kit, Biscuit	
248993	89098	Base Seal	
182948	89279	Hold Down Plate	
158886	91915	Hardware Kit	
186467	93766-0	Cover, White	
166427	93838	PVC Tube	
182950	94497	Flat Pillow Kit	
180291	94853	Service Kit	

\* Vibrant Limited Lifetime Warranty

[www.waterconcepts.net](http://www.waterconcepts.net) • Serving our Customers Since 1946 • [www.plumbsupply.com](http://www.plumbsupply.com)

**Kohler Repair Parts**

**Parts (Continued)**

Part #	Mfg #	Description	Price
182738	95045	Screw	
186466	97740	Switch Assy	
176680	99272-CP	Escutcheon, Chrome	
186260	99272-SN	Escutcheon, *Pol Nickel	
238025	99272-VS	Escutcheon, *Stainless	
258725	99272-2BZ	Escutcheon, Oil Rbd Brnz	
056035	B2100	Rod Parts	
170699	CB-DXCLC10FS	Mirrored Cabinet Door	
188928	CB-DXCLC20BAN	Mirrored Cabinet Door	
183171	CB-DXCLC20FS	Mirrored Cabinet Door	
183347	CB-SHLFCLC20	Inner Shelf	
183348	CB-SHLFCLC30	Inner Shelf	
087887	GP1003736-0	Sprayhead, White	
105414	GP1016515	Valve for Kitchen Faucets	
120573	GP1035350-CP	Premier Drain Chrome	
086238	GP1036940-CP	Spray Head Kit Pol Chrome	
122914	GP1037021-CP	Standard Plunger Assy, Chrome	
122915	GP1037022-CP	Plunger Brass Assy, Chr	
151936	GP1043211-VS	Sprayhead, *Stainless	
135542	GP1056873	Piston Assy	
117018	GP1074231	Spline Adapters	
122905	GP1077791-0	Plug Buttons, White	
122906	GP1077792-0	Plug Buttons, White	
121407	GP1083167	Fill Valve Kit	
152038	GP1092203	Cold Valve Cartridge Assy	
152039	GP1092204	Hot Valve Cartridge Assy	
183237	GP1095915	Handle for Elec Faucets	
183172	GP1105825	Flapper w/ Float Kit	
258178	GP1144142	Hi Flo PBU Cartridge Seals	
055318	GP21087-CP	Trend Handle - Large	
055368	GP30000	Plug Button Kit	
055346	GP30082	Centura Repair Kit	
055128	GP30090	Repair Kit	
055316	GP30100	Plunger Service Kit	
056078	GP30320	Pressure Balance Adapter Kit - Plastic	
055311	GP30413	Valve	
055353	GP30416	Knob Handle Kit	
072769	GP30420	O-Ring Seal Kit	
228375	GP330002	1/4 Turn Valvet, HOT	

**Parts (Continued)**

Part #	Mfg #	Description	Price
228376	GP330004	1/4 Turn Valvet, COLD	
101598	GP41398-CP	Strainer Cup Assy, Chrome	
055340	GP43146	Acrylic Handle	
055305	GP51487	Tank Gasket w/Bolts	
055344	GP52050	Tank Bolt Accessory Pack	
055338	GP71969	Valve Mixer Kit	
056122	GP75878	Diverter Assembly	
055332	GP76671	Coralais Valve, CCW Close	
055339	GP76672	Coralais Valve, CW Close	
055293	GP77005-RP	Ceramic Valve	
055294	GP77006-RP	Ceramic Valve	
055301	GP77548	Ceramic Valve	
121052	GP77759	Mixer Cap Kit	
055351	GP77886	Mixer Cap Kit	
056127	GP78205-0	Plug Button White	
070270	GP78500	Plunger Kit	
230421	GP800881	Repair Cartridge, 8304	
256860	GP800820	Rite-Temp PBU Cartridge	
180982	GP83996	Gasket for Select Flush Vlv	
055367	GP85061	Beehive Strainer	
256861	GP876851	Rite-Temp PBU/CAP Service Kit	
055303	GP88921	Flush Ball Kit	
190060	RGP64512	Hanger (2)	
236510	1052070	Solenoid Manifold Kit	
249428	1068033	Fill Valve Assembly	
145967	1145688	Cartridge, Transfer Valve	
124370	18766	Urinal Outlet Kit	
055355	30006	Valve Repair - Right Hand	
255281	36267	Pedal Shaft	
157034	1103464-SR	Aerator Kit, Bright Nickel	
236984	1105050-CP	Aerator Kit-1.5gpm, Chrome	
120651	84544-0	Service Kit - Feet	
144324	1073881	Deep Rough-In Kit	
087885	86101-CP	Body Spray, Zero Leakage	
055980	34842	Sleeve	
120986	GP1067183	Flapper - Class 5	
055981	30008	Valve Repair - Left Hand	
005942	23004-RP	Valve Seat & Washer Assembly	
067062	30249	Bearing Kit	

\* Vibrant Limited Lifetime Warranty

[www.plumbsupply.com](http://www.plumbsupply.com) • Serving our Customers Since 1946 • [www.waterconcepts.net](http://www.waterconcepts.net)

**Kohler Repair Parts**

**Parts (Continued)**

Part #	Mfg #	Description	Price
136029	1056934	Sensor Clip	
065793	50729	O-Ring	
080954	20242-BC	Valve Stem Assembly, RH	
132172	84999	Toilet Seat Anchor Kit	
094480	1000739	Valve Restrictor Kit	
142908	1157032	Piston Assembly	
145765	73858-RP	Tee Assembly	
129338	1097686	Seal, Flat	
237586	1016154-CP	Deep Rough-In, Rite-Temp	
103305	64839	Lavatory Hanger	
146199	590-NA	Underscore 5' UM Installation Kit	
229514	1123617	Hybrid Power Cell Potted	
137090	1172936-CP	Master Shower/Water Haven SH Service Kit	
071014	30126	Valve Repair Kit	
238418	1068034	Fill Valve Assembly	
113728	1007937-G	Deep Rough-In Kit	
120179	1034693-BN	Trip Lever, Cimarron *Brushed Nickel	
080960	20241	Bonnet SA	
102083	32002	Valve Bonnet	
121450	40372	Adjustable Linkage	
120889	1108711	Spacer Kit	
055366	51291	Plunger	
164079	1014086-05	Seal, Threshold 28.125"	
238804	1102432	Kit, Hardware	
055342	22947	Plunger SA - Clockwise Close - Plastic	
056007	22948	Plunger SA, CCW Close Plastic	
240444	1207327	Emblem, Tank Cover	
249194	1017282-BN	Lever Handle Assembly Bath	

\* Vibrant Limited Lifetime Warranty

[www.waterconcepts.net](http://www.waterconcepts.net) • Serving our Customers Since 1946 • [www.plumbsupply.com](http://www.plumbsupply.com)

## Malco Repair Parts

### Hole Cutter Parts

#### Hole Cutter Replacement Part

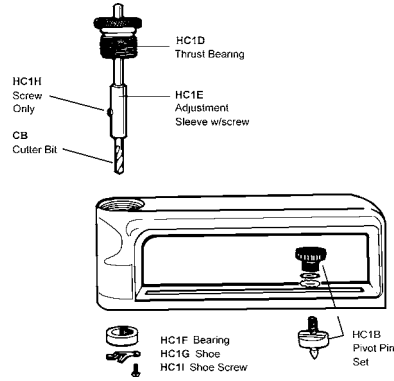

Part #	Mfg #	Description	Price
006379	CB	Malco Bit for HC1 and HC2	
006409	HC1B	Pivot Pinset for HC1	
034909	HC1D	Thrust Bearing w/Adapter	
006410	HC1E	Adjustable Sleeve for HC1	
006411	HC1F	Ball Bearing for HC1	
006412	HC1G	Guide for HC1	
054345	HC1I	Shoe Screw	

## McDonnell & Miller Repair Parts

### Replacement Parts

#### Gasket



Part #	Mfg #	Model #	Used With:	Price
007100	302600	CO-12	42,61,63,64, 65,42S	

#### Strainer Basket Assembly

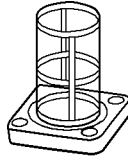

Part #	Mfg #	Model #	Used With:	Price
007104	347100	SA101-38	47, 51, 101	



## Moen Repair Parts

### Handle Adapters



100429

Part #	Mfg #	Description	Price
058893	100429	Handle Adapter Kit	
244987	174329	Handle Adapter Kit	

### Chateau Knob Handle Kit

- 1-Hdl Tub/Shower



Part #	Mfg #	Description	Price
007370	96797	Clear w/ White & Chrome Insert	

### Traditional Handle Kit



Part #	Mfg #	Description	Price
016904	94514	Single-Handle	

### Handle Hub



Part #	Mfg #	Description	Price
244555	114344WR	Wrought Iron	

### Handle Kit



Part #	Mfg #	Description	Price
243526	128866	Chrome	

### Faucet Cartridges

#### 1255 Duralast™ Cartridge



Part #	Mfg #	Description	Price
140023	1255	Duralast™	

#### 1-Hdl Faucet Cartridge

- Brass
- Hot/cold operation
- Includes:
  - Cartridge
  - Retainer Clips
  - Installation tool
  - Installation instructions

1200



1225

Part #	Mfg #	Description	Price
007169	1200B	For 1200 Faucet, Bulk (12/Pk)	
007173	1225B	For All Moen 1-Hdl Faucets Bulk (12/Pk)	

#### Duralast™ 2-Hdl Faucet Cartridge



Part #	Mfg #	Description	Price
189508	1234	2-Hdl, Duralast™	

#### Duralast™ 2-Hdl Roman Tub Faucet Cartridge

- Hot or cold



Part #	Mfg #	Description	Price
249073	1258	2-Hdl, Hot or Cold	

\*Lifeshine® Anti-Tarnish Lifetime Finish

[www.plumbsupply.com](http://www.plumbsupply.com) • Serving our Customers Since 1946 • [www.waterconcepts.net](http://www.waterconcepts.net)

## Moen Repair Parts

### 2-Hdl Faucet Cartridge

- Brass
- Hot/cold operation



Part #	Mfg #	Description	Price
--------	-------	-------------	-------

007172	1224B	For 2-Hdl Moen® Faucets, Bulk (12/Pk)	
--------	-------	---------------------------------------	--

### Posi-Temp 1-Hdl Faucet Cartridge

- Brass
- Hot/cold operation



Part #	Mfg #	Description	Price
--------	-------	-------------	-------

007171	1222B	For 1-Hdl Posi-Temp Faucets, Bulk (12/Pk)	
--------	-------	-------------------------------------------	--

### Commercial Heavy-Duty Posi-Temp Cartridge



Part #	Mfg #	Description	Price
--------	-------	-------------	-------

226819	1222HD	Brass Shell	
--------	--------	-------------	--

### Commercial 2-Hdl Ceramic Disc Cartridge



Part #	Mfg #	Description	Price
--------	-------	-------------	-------

147672	52001	Cold	
--------	-------	------	--

147671	52000	Hot	
--------	-------	-----	--

### Cartridge



Part #	Mfg #	Description	Price
--------	-------	-------------	-------

209555	4000	Replacement	
--------	------	-------------	--

### Replacement Cartridge

- For 4999 Roman Tub Valve



Part #	Mfg #	Description	Price
--------	-------	-------------	-------

007174	1248	For 4999 Roman Tub Valve	
--------	------	--------------------------	--

103661	116719	Replacement Cartridge	
--------	--------	-----------------------	--

### Commercial Cartridge



Part #	Mfg #	Description	Price
--------	-------	-------------	-------

218673	52100	Metering Cartridge	
--------	-------	--------------------	--

### Commercial 2-Hdl Cartridge



Part #	Mfg #	Description	Price
--------	-------	-------------	-------

198775	121550	Hot	
--------	--------	-----	--

198776	121551	Cold	
--------	--------	------	--

\*Lifeshine® Anti-Tarnish Lifetime Finish

[www.waterconcepts.net](http://www.waterconcepts.net) • Serving our Customers Since 1946 • [www.plumbsupply.com](http://www.plumbsupply.com)

## Moen Repair Parts

### Commercial 1-Hdl Cartridge

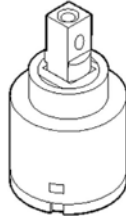

Part #	Mfg #	Description	Price
174468	121620	For Model 8701	

### Cartridge Removal Tool

- For 1200, 1225, or 1222 cartridges



Part #	Mfg #	Description	Price
046820	104421	Cartridge Removal Tool	

### Cartridge Removal Tool



Part #	Mfg #	Description	Price
020117	14272	Cartridge Retainer Removal Tool	

### Service Parts

Part #	Mfg #	Description	Price
090524	A1616BN	Kingsley Extension Kit, Br Nickel	
236533	A780	80" Commercial Metal Hose	
239505	123245	Escutcheon & Gasket Kit, Chrome	
096538	104021	Solenoid Repair Kit	
246689	104570	Commercial Service Kit, Chrome	
253591	137488BL	Showerarm Flange, Matte Black	
230761	147208	Cartridge Repair Kit	
230762	147209	Check Stop	
250132	3806SRN	Diverter Spout, Spot Resist Br Nkl	
036804	93980	Handle Mechanism Kit f/7400/7600 Kitchen Faucet	
226712	116711	Flow Restrictor Kit	
243252	116712	Flow Restrictor Kit	
018319	11985	50/50 Drain Assembly	
019922	12689	Pivot Rod & Clip	
237959	124738CSL	Pull-Out Wand, Stainless	
241464	130142	Spline Adapter & Screw Kit	
243432	130143	Extension Kit	

### Service Parts (Continued)

Part #	Mfg #	Description	Price
243431	130158	Check Stop	
163701	131381	Hose Kit	
020119	96365	Retainer Clips	
007353	883	Retainer Clip	
021710	96914	Posi-Temp Retainer Clip	
244557	114343WR	Handle Cap & Screw, Wrought Iron	
113430	140780	Metal Pop-Up Lav Drain, Chrome	
103739	140780BN	Metal Pop-Up Lav Drain, Brushed Nickel	
103122	140780OR B	Metal Pop-Up Lav Drain, Oil Rubbed Bronze	
226575	131553BN	Pop-Up Lav Drain, Brushed Nickel	
021437	96497	Waste Assembly, Chrome	
023012	12314	Plug & Cap	
007200	1920	Valve Cover Plate, Chrome	
131700	1920BN	Valve Cover Plate, Brushed Nickel	
078637	101663BN	Drain Cover, Brushed Nickel	
101250	101663OR B	Drain Cover, Oil Rubbed Bronze	
238566	101663WR	4-1/4" Drain Cover, Wrought Iron	
236868	101664BN	Drain Cover, Brushed Nickel	
202661	102763BN	4" Drain Cover, Brushed Nickel	
035758	1423	Balancing Spool	
201600	52012	Commercial Vacuum Breaker	
244429	52007	Cartridge Nut	
007391	97557	Monticello Handle Inserts, Chrome	
007382	97462	Monticello Handle Insert, Chrome	
007362	91751	Knob Insert Kit, Chateau	
044029	96782	Chateau Handle Kit	
007369	96791	Chateau Handle Kit	
007360	91192	Diverter Kit for 1Hdl Kit Fct	
007368	96790	Handle Kit, Chrome	
091499	116653	Handle Adapter Kit	
020189	98039	Handle Kit, Acrylic	
118478	136103C	Kitchen Spray and Hose	
144317	106378	Asceri Stem Extension Kit	
007386	97466	Monticello Handle Knob Insert, Porcelain/Chrome	
019330	97556	Monticello Handle Adapter Kit	
020032	95606	Monticello Handle Hub Kit	
032729	95602	Monticello Handle Hub Kit	
007389	97479	Monticello Stem Extension Kit	
007372	97344	Monticello Stem Extension Kit	

\*Lifeshine® Anti-Tarnish Lifetime Finish

[www.plumbsupply.com](http://www.plumbsupply.com) • Serving our Customers Since 1946 • [www.waterconcepts.net](http://www.waterconcepts.net)

## Moen Repair Parts

### Service Parts (Continued)

### Service Parts (Continued)

Part #	Mfg #	Description	Price
124051	145058	Adapter Kit	
026035	14732	Handle Kit, Chrome	
236993	147556	Extension Kit, Vessel	
103271	100818	Extension Kit	
238428	113173	Mounting Kit	
097867	114299	Hose Kit	
252359	100005SL	Hose Guide, Stainless	
045742	12318	Check Stop	
196066	94770	Plug Button & Set Screw	
179477	150259	Hose Kit	
114856	A750	Slide Bars	
238174	52711	Slide/Grab Bar Shower Connector, Gray Plastic	
162734	104524	Manual Override Button - Flush Valve	
031502	101099	Handle Connector, Spacer, Screw & Washer for Loop Hd Kitchens	
043598	101310	Chateau Lever Handle Kit	
165290	104401	Multi-Unit AC Power Adapter	
109518	9601	Choiceflo Replacement Filter 9600/9602/9500/9502	
071412	100021	Chateau Handle Cap, Chrome	
071756	100710	Posi-Temp T&S Acrylic Handle	
017776	14699	Retainer Pivot Nut, 1Hdl Kit Fct	
022554	15528	Escutcheon Screws	
007163	10089	Legend & Chateau 1Hd T&S Knob Handle Stop Tube	
031100	96987	Stop Tube, PosiTemp 1-Hdl TS Trim	
089374	100657	Handle Kit, Chrome	
186665	221672	Weymouth Hot & Cold Handle Caps, Chrome	
225625	221672BN	Weymouth Hot & Cold Handle Caps, Brushed Nickel	
017751	13463	Chateau Tub Fct Stem Extension	
007371	96884	Handle Insert Kit	
215829	155655	Screen Filter	
224150	155658	Hardware Kit	
146281	10116	Plug Button Kit, Chrome	
216901	104444	Commercial Supply Line	
247571	114324	Handle Cap Kit, Chrome	
245748	114324W	Hot & Cold Handle Cap Kit, White	
247885	116731	Bearing Washer Kit	
007168	1198	Push Button Diverter	

Part #	Mfg #	Description	Price
032769	13462	Handle Adapter Kit	
224151	155651	Hardware Kit	
025797	13769	Chateau Escutcheon, Chrome	
017752	13774	Wall Tube, Chrome	
248620	155656	Extension Kit	
121811	163WR	Escutcheon Screws, Wrought Iron	
105725	128284	Twin Elbow	
216105	131109	Handle Kit, Chrome	
240320	137396BN	Handle Kit, Brushed Nickel	
240286	147556BN	90° Vessel Extension Kit	
252294	161143	Extensa Wand Kit, Chrome	
249984	176415	Vaccum Breaker for MO8124/8232	
249405	178755	Remodel Cover Plate for Posi-Temp Valve, Chrome	
249842	179108	Universal Kitchen Spray Kit, Chrome	
185665	AT2099OR B	T/S Accent Kit, Oil Rubbed Bronze	
201230	143530	Diverter Plug	
195900	A714	Vacuum Breaker, Chrome	
121669	96945	Handle Extension Kit	
211430	140710	Cartridge Nut	
221963	130153BN	Handle Escutcheon, Brushed Nickel	
244985	135152	Spacer Kit	
124535	129102BN	Trim Ring, Brushed Nickel	
244548	97577WR	Escutcheon, Wrought Iron	

### Spout O-Ring Kit



Part #	Mfg #	Description	Price
007167	117	Bulk	
215830	155654	O-Ring Kit	
201190	146789	O-Ring Kit	
020120	96778	O-Ring Kit	

\*Lifeshine® Anti-Tarnish Lifetime Finish

---

---

## EL Mustee Repair Parts

---

---

### Shower Stall Parts

Part #	Mfg #	Description	Price
169874	68.600	4" Plastic Shower Valve	
034312	80.451	Cold Index Plug	
007569	82.400	1-1/2" PVC Shower Drain	
007546	65.700	Hose Holder	

---

---

## Lochinvar Repair Parts

---

---

### Repair Parts

Part #	Mfg #	Description	Price
241375	LO10028374 7	NKC Part Kit	
039096	LOARM1001	Seal Kit	
038396	LOFAN2410	Fan Assembly for EB/EW	
043810	LOFAN2712	Fan for all Copper Fin & Copper Fin II	
038280	LOGTP2900	T&P Gauge	
038394	LOHLC2500	HI Limit	
038272	LOHLC2904	Rollout Switch	
039109	LOPLT2016	Burner Pilot NAT.	
039110	LOPLT2303	Pilot Assembly NAT.	
038297	LOPLT2702	Igniter, Hot Surface	
038399	LOPRS2421	Air Pressure Switch	
039125	LORLY3002	Ignition Module	
039127	LORLY3428	Ignition Module	
039135	LOTST2701	Operator Control	
166275	LOTST30010	Limit	
039140	LOWTR2040	Flow Switch	



## Navien Repair Parts

### Parts & Accessories



O-Ring



Packing



Pressure Flow

Part #	Mfg #	Description	Price
149791	2505401A	CPVC Vent Collar	
234582	30000456B	7M Gas 120V/60HZ Circulation Pump	
127478	30000663A	Air Pressure Sensor, NASS9EX00009	
135435	30000669A	Air Pressure Sensor, NASS9EXOS001	
126626	30004802C	Water Flow Sensor, AASS9EXFS003C	
188868	30014451A	Circulation Pump Air Vent	
231214	30014367A	Common Vent Backflow Damper Kit	
172073	30012226A	Igniter NPE	
162623	30010537A	Water Sensor	
136813	BH0914002B	Motorized 2-Way Valve	
126593	BH2507399A	3-Way Valve, A-Type Copper	
136814	BH1201041D	Ignition Transformer with Wire	
126589	BH1205008A	Transformer	
126623	BH1303013A	Inlet Filter	
126630	BH1403081A	Thermostat (Black Wire)	
134822	BH2101273B	Remote Wire	
126587	BH2124012A	Fuse, 125V, 5A	
126599	BH2421008A	O-Ring, Gas Black, 19.8"Dia x 2.4"T	
126653	BH2421997A	Black O-Ring	
126600	BH2423053A	O-Ring, Red, 17.8"Dia x 2.4"T	
126654	BH2423055A	O-Ring, Black, 17.5"Dia x 2.7"T	
126603	BH2423064A	O-Ring, Red Water, 15.8"Dia x 2.7"T	
126597	PH1062017A	Back-Up O-Ring	
126588	BH2501679A	NG Flame Rod	
136815	BH2507507A	Water Pipe Adapter, Black	
127841	GXXX000546	Cascade Cable, Readylink	
245209	GXXX001727	Magnetic Boiler Filter	
136820	NAPU9GLPCT01	NP Series Circulation Pump	
136821	NARC1GSNR007	Remote Control	
126591	NASS9EXGPS01	Gas Pressure Flow Sensor	
126625	NCVM9EX00005	Flow Adjustment Valve	
126595	PAPCT1W0725	058 Pump	
126632	PH1799013A	Pipe Adapter	
241658	30004825A	Motorized 2-Way Valve	
241659	30002491A	Transformer 120V CR/CC	
241661	30003311A	Syphon CR/CC, NR/NP	
245316	30018661A	NPE Parts Kit	

## Navien Repair Parts

### Parts & Accessories (Continued)

Part #	Mfg #	Description	Price
241664	30008834A	Inducer Fan NCB, NPE	
241665	30011534A	Flow Sensor NPE-S	
241667	30011532A	Water Adj Valve NPE-S	
241668	30009756B	Syphon & Hose NPE A/S	
241669	30008366A	Thermistor NPE/NHB	
241670	30015421A	Inducer Fan NPE-150S	
241671	30014183A	Igniter Flame Rod Assembly	
241673	30012241A	Auto Feed Assembly NCB-ALL	
241674	30011586A	Gas Valve NHB All	
241675	30014216A	Syphon & Hose NHB 055/080	
241676	30014024A	Syphon & Hose NHB 110/150	
241677	30014189A	Igniter Flame Rod Assembly	
241678	30012907A	Thermistor NHB	
241680	30013984A	Inducer Fan NHB 055/80	
241681	30013985A	Inducer Fan NHB 150	
223331	30008429A	Gas Valve NPE-A/S, NCB	
227942	30009478A	Exhaust Thermistor NPE	
238359	30008245A	Water Adjustment Valve	
230697	30004819C	3-Way Valve CR/CC, NR/NP	
230698	30002282E	Check Valve CR/CC, NR/NP	
233400	30002475A	Ignition Transformer	
241465	30000466A	Circ Pump CR/CC, NR/NP	
226737	30013685A	Flow Sensor Assembly Dom	
222447	30002493A	Transformer 120V 60 Hz	
233740	30000181A	PCB Control Board CH	
171172	GXXX001322	Residential Neutralizer	
167004	30012950A	Outdoor Sensor & Wire	
188054	20017210A	O-Ring	
167481	30004684A	LP Flame Rod	
171169	PFMZ-02P-01	Smartzone 2-Zone Pump Controller	
186505	GXXX001417	Supply/Return Sensor	
175139	20018013A	O-Ring	
174167	30004680A	NG Flame Rod Kit	
167480	30004834B	Flow Adjustable Valve	
181936	GXXX001324	Neutralization Kit	
165953	30000666A	Gas Pressure Flow Sensor	
165466	30010455A	Ign. Transfer NPE	
184906	30004837B	Mixing Valve	
173551	30010780B	Circulation Pump	
177980	30000182A	Board F/Cr-180	
239003	30008360A	Check Valve NPE	
222617	PBCM-AS-01	Wifi Control	

## Navien Repair Parts

### Parts & Accessories (Continued)

Part #	Mfg #	Description	Price
224573	30009323A	Easy Valve Kit	
183273	30008571A	NPE Flow Sensor	
186308	30014699A	LWCO Water Sensor	
171171	PFMZ-04P-01	Smartzone 4-Zone Pump Controller	
171170	PFMZ-03P-01	Smartzone 3-Zone Pump Controller	
168655	30009757A	Remote for NPE	
165951	30009875A	Thermistoer	
143846	30011330A	NPE Parts Kit	
176969	PFMZ-06P-001	Smartzone 6-Zone Pump Controller	
223557	30011690D	PCB Control Board NPE All	
224914	30013687A	Siphon	
165833	30012685A	NCB Parts Kit	
223559	30013044A	FP Front Panel F/NHB	
154387	GXXX001178	CH Quik-Install Manifold Kit	
223558	30012262B	PCB Control Board F/NCB	
228187	30011450A	CH Parts Kit	
177075	30014307A	NHB Parts Kit	
163395	UA0900002A	3/4 Plumb Easy LF Valve	
227667	30012768A	Circulation Pump	
224572	GXXX001323	Replacement Media	
231992	GXXX001328	Anti-Scale Refill	
188650	30012033B	NCB/NCB-E Flow Sensor	
242432	30004831C	3-Way Valve	

## Reznor Repair Parts

### Limit Controls

Part #	Mfg #	Description	Price
008477	45602	(180°F) White Auto Limit Control	
008480	50417	(125°F) White Auto Limit Control	
008481	50418	(145°F) Blue Auto Limit Control	
008497	82091	(160°F) Red Auto Limit Control	
008498	82414	(306°F) ECO Energy Cut-Out Limit Control	
008500	85449	(200°F) Yellow Auto Limit Control	
008524	96512	(220°F) High Temperature Limit Control	
027171	131449	(228°F) ECO Energy Cut-Out Limit Control	
008458	123974	(135°F) Fan Control	
008459	123976	(135°F) Fan Control	
030936	147676	(150°F) Fan Control w/Bracket for XL/CXL/EEXL/CEEXL 30 - 400	
083879	209184	Fan Control Replacement Kit	

### Gas Conversion Kits



Part #	Mfg #	Description	Price
008536	99244	LP Conversion Kit for F/FE-50	
153551	269835	LP Conversion Kit for Model UDAP/UDAS Size 30, 45	
153552	269836	LP Conversion Kit for Model UDAP/UDAS Size 60, 75	
154397	269837	LP Conversion Kit for Model UDAP/UDAS Size 100, 125	
153554	269838	LP Conversion Kit for Model UDAP/UDAS Size 150, 175	
153553	269839	LP Conversion Kit for Model UDAP/UDAS Size 200, 250	
066004	201732	LP Conversion Kit for Model UDAP/UDAS Size 300, 400	
073497	205515	LP Conversion Kit	
073498	205516	LP Conversion Kit	
127038	257472	Ignition Conversion Kit (Replaces 97782)	
127637	257473	LP Conversion Kit, Old #G77	

### Gas Valves

Part #	Mfg #	Description	Price
008518	96300	1/2" Natural Gas Valve (W/R #36C03-211) Replacement	
008519	96307	1/2" Natural Gas Valve Replacement	
022074	121599	1/2" Single Stage Valve (VR8304M2816)	
027313	147830	1/2" Single Stage Natural Gas Valve (VR8205M1130)	
082010	204301	1/2" Single Stage Natural Gas Valve (VR8205M2955)	
091161	208920	1/2" Single Stage Natural Gas Valve w/Standing Pilot (VR8200M7005)	

**Reznor Repair Parts**

**Motors**

Part #	Mfg #	Description	Price
008476	45331	1/40 hp Motor	
027821	102380	1/8 hp Motor	
008485	61069	1/20 hp Motor	
008508	95547	1/20 hp Motor for Model F 130 & 200	
008509	95548	1/30 hp Motor	
008502	88781	1/6 hp Motor	
066238	196241	Fan Motor for UDAP 45 - 60	
066252	196242	Fan Motor for UDAP 75	
066267	196243	Fan Motor for UDAP 100	
066314	196247	115V Fan Motor for UDAP and UDAS 300 - 400	
008507	95546	Fan Motor	
008515	96287	Fan Motor	
008516	96288	1/15 hp Fan Motor	
102121	147571	Fan Motor	
008514	96018	Venter Motor Assembly	
027692	97727	Venter Motor and Wheel Assembly	
100298	131410	115V Venter Motor with Capacitor	
170634	214067	115V Venter Motor less Capacitor	
033127	148055	115V Venter Blower Motor	
066281	196036	115V Venter Motor for UDAP and UDAS 150 - 175	
109924	214066	115V Venter Motor for VR 175/200 with Capacitor	
144784	217032	120V, 60Hz Venter Motor for UDAP (Replaces 175273)	
139008	260422	115V Venter Motor	

**Pilots & Components**

Part #	Mfg #	Description	Price
008486	61145	Natural Gas Pilot Assy w/ Orifice, High Tension Lead & Flame Probe; less Pilot Tubing & Flame Sensor	
008523	96360	Natural Gas Pilot Assembly with Orifice, Pilot Tubing, & Thermocouple; (for All F Models)	
020439	110853	Natural Gas Spark Pilot Assembly	
066224	175272	DSI Electrode Assembly	

**Pressure Switches**

Part #	Mfg #	Description	Price
066242	196388	High Altitude Pressure Switch for UDAP-CV, UDAS 100	
062419	196653	Pressure Switch	
091540	205442	0.20"wc Low Speed White Label Pressure Switch	
091216	205443	Low Speed Yellow Label Pressure Switch	
066288	201158	1.10"wc Pressure Switch	
020765	121275	Block Vent Switch	

**Reznor Repair Parts**

**Transformers**

Part #	Mfg #	Description	Price
008461	131988	120/24V Transformer	
008462	132204	120/24V, 20VA Transformer	
091211	175265	115V, 30VA Control Transformer	
066225	194808	Transformer, 40VA	

**Vent Caps**



Part #	Mfg #	Description	Price
067827	111849	5" Vent Cap for UDAP 150 - 250	
107774	111848	4" Vent Cap for UDAP 30-125	

**Parts**

Part #	Mfg #	Description	Price
022890	43425	Inducer Blower Wheel (AD326-215-101-2)	
008527	97534	Natural Gas Pilot Assembly	
020436	97535	LP Pilot Assembly with Flame Sensor	
020437	97572	Compression Nut	
020449	97724	Venter Wheel FE130-400	
021456	97725	Venter Wheel FE25-100	
021538	18549	RBM Relay All FE Models	
008534	98697	Flame Rod	
021502	116019	37-1/8" Tubular Section for TR & TR-H Models	
060039	116045	Burner On Light	
091538	120545	Venter Wheel	
026634	132007	Venter Wheel	
061819	135979	Venter Wheel	
027310	147165	Flame Sensor	
027317	148085	18" Ignition Cable	
066231	195036	Venter Wheel Assembly	
090713	195046	Compression Spring for Louvers	
066222	195265	Control Board	
066223	195292	Flame Sensor	
066237	196949	Flame Rollout	
084139	197205	High Altitude Conversion Kit	
067749	201685	3 amp Fuse	
086607	204611	DSI Electrode Assembly for Model VR	
073531	204955	DSI Ignition Control	
123105	257531	UDAP Circuit Board	





**Reznor Repair Parts**

**Parts (Continued)**

Part #	Mfg #	Description	Price
133894	259521	Time Delay Relay Kit	
139262	262971	Time Delay Relay Kit	
036781	CC2	Vertical Vent Terminal/Combustion Air Inlet Assembly through Roof for UEAS Model	
066083	REZBRKT	Low Ceiling Mounting Bracket	



## Ruud Water Heater Repair Parts

### Water Heater Parts & Accessories

Part #	Mfg #	Description	Price
109636	RTG-20040	Ez-Link Cable Connects (2) Tankless Gas Water Heaters to Operate As One Unit	
074314	AP12938	42" Aluminum Anode Rod	
063009	SP11309C	44" Resistor Magnesium Anode Rod	
091619	SP8371B	52" Anode Rod w/Resistor Flex	
164493	SP11526C	Anode Rod - 0.900" x 44-3/8"	
165325	SP20717	GHE Flame Sensor	
063007	SP11248R	Dip Tube	
113598	SP6830	Adapt-O-Flange	
216119	SP20260K	GHE Display & Control Board	
219461	SP20364	Advantage Plus Service Kit - 160,000 BTU/HR	
213463	SP20365	Advantage Plus Service Kit - 199,000 BTU/HR	
190943	AP13044	21"x21"x16" Water Heater Stand	
190942	AP67089	Gasket - Element	
096635	SP20003	Nipples - Heat Trap	

### Blower Assembly

Part #	Mfg #	Description	Price
100247	AP13416	Blower Assembly for 40/50 gal PowerVent Units	
133976	SP13605	Blower Assembly for 40/50 gal PowerVent Units	
137367	AP151091	Blower Assembly for 40/50 gal Tall PowerVent Units	

### Control

Part #	Mfg #	Description	Price
159000	SP20231	Gas Control (Thermostat) - NG	
164454	SP20233	Gas Control(Thermostat) - LP	
113853	SP20161A	Natural Gas Wiper Control & Gas Valve Assembly for PowerVent 2	
113854	SP20162A	LP Gas Wiper Control & Gas Valve Assembly for PowerVent 2	
120504	SP20170A	Natural Gas FV Wiper Control & Gas Valve Assembly	
120505	SP20170B	Natural Gas FV Wiper Control & Gas Valve Assembly	
101157	SP20123B	FV Wiper Electronics	

### OEM Screw-In Elements - 1-1/2" Copper

- Specifically designed for Marathon and Eclipse Water Heaters
- Includes gasket
- Low Watt Density



Part #	Mfg #	Description	Price
116994	SP10698MH	240V/4500W, 12.33" Length	
095422	SP610160	240V/4500W, 13.38" Length	

### OEM Screw-In Elements - 1-1/2" Titanium

- Specifically designed for Marathon and Eclipse Water Heaters
- Includes gasket
- Low Watt Density



Part #	Mfg #	Description	Price
141163	SP213790	240V/4500W, 14" Length	
238106	SP213820	240V/3800W, 14" Length	
132919	SP213670	240V/4500W, 16.5" Length	
111268	SP210198	240V/3800W, 16.46" Length	

### OEM Screw-In Elements - 1" Stainless Steel



Part #	Mfg #	Description	Price
063478	SP10867JL	208V/3000W, 12.38" Length	

### Electric Water Heater Tune-Up Kit

- Includes:
  - (2) Screw-in elements (AP10552MH-4)
  - Electric thermostat (AP11695-4)
  - Electric thermostat (AP11698-5)
  - (2) Element gaskets (AP6708-9)
  - Tune-up kit back card (PD991176)
  - Tune-up kit blister (PD991231)
  - Front card (PD991234)
- For use with PD137981 and SP13266



Part #	Mfg #	Description	Price
140554	SP20060	240V/4500W	



## Ruud Water Heater Repair Parts

### Electric Water Heater Elements Copper - R-Tech

- Screw-in elements - 1 Inch  
-Fits most water heaters with 1" NPSM threads
- R-Tech - Features a patented restored design that increased the life of both the element and water heater tank
- Watt Density Guide - lower watt density means the element stays cooler and will last longer  
-LWD: low watt density (100 watts/in<sup>2</sup> or less)  
-MWD: medium watt density (101-150 watts/in<sup>2</sup>)  
-HWD: high watt density (over 150 watts/in<sup>2</sup>)



Part #	Mfg #	Description	Price
126122	SP10552JH	240V/3000W, 10-5/8" HWD	
063001	SP10552KL	240V/3500W, 13-3/8" LWD	
078390	SP10552ML	240V/4500W, 13-3/4" LWD	
063002	SP10552MH	240V/4500W, 13-5/8" HWD	
063000	SP10552PH	240V/5500W, 13-1/2" HWD	
076289	SP10552QH	240V/6000W, 11-3/4" HWD	
062998	SP10874FH	120V/1500W, 7-11/16" HWD	
062997	SP10874GH	120V/2000W, 7-11/16" HWD	
062996	SP10874HH	120V/2500W, 9-7/16" HWD	

### Electric Water Heater Elements Stainless Steel - R-Tech

- Screw-in elements - 1 Inch  
-Fits most water heaters with 1" NPSM threads
- R-Tech - Features a patented restored design that increased the life of both the element and water heater tank
- Watt Density Guide - lower watt density means the element stays cooler and will last longer  
-LWD: low watt density (100 watts/in<sup>2</sup> or less)  
-MWD: medium watt density (101-150 watts/in<sup>2</sup>)  
-HWD: high watt density (over 150 watts/in<sup>2</sup>)



Part #	Mfg #	Description	Price
063479	SP10867LL	208V/4000W, 10.08", LWD	
063481	SP10867NL	208V/5000W, 19.25", LWD	
063486	SP10869ML	240V/4500W, 15-1/2" LWD	
190941	SP10869KL	240V/3500W, 13-1/2" LWD	
073434	SP10869M	240V/4500W, 13-1/2" MWD	
	M		
063480	SP10867ML	208V/4500W, 17.58" LWD	
063482	SP10867QL	208V/6000W, 19-1/4" LWD	
073434	SP10869M	240V/4500W, 13-1/2" LWD	
	M		
063488	SP10869QL	240V/6000W, 19-1/8" LWD	

### Water Heater Parts & Accessories (Continued)

#### Electric Water Heater Elements Stainless Steel - R-Tech

Part #	Mfg #	Description	Price
063494	SP10870NL	480V/5000W 19.28", LWD	
063493	SP10870ML	480V/4500W 17.63" LWD	
063495	SP10870QL	480V/6000W 19.21" LWD	

#### Heating Element Wrench

- Allows use of screwdriver for additional leverage



Part #	Mfg #	Description	Price
063006	SP35871AB	Fits 1-1/2" Hex	
169225	PT49057	Fits 1-1/2" & 1-7/8" Hex	

#### Igniter

Part #	Mfg #	Description	Price
063860	SP10972	Hot Surface Igniter	
108321	SP12143	Igniter for Advantage Plus Comm Water Heaters	
064395	SP12560B	Spark Igniter & Pilot Assembly (LP) for PowerVent 2	
064396	SP12560C	Spark Igniter & Pilot Assembly (LP) for PowerVent 2	
064393	SP12562	High Performance Blower Assembly for PowerVent 2	
100162	SP13447B	Flammable Vapor Sensor/FV Wiper Replacement Kit	
129324	SP14218A	Igniter for PowerVent Units	
109619	SP14218B	Igniter for PowerVent Units	
146883	SP20307	Piezo Igniter	

#### Pilot Assembly

Part #	Mfg #	Description	Price
104045	SP13418	Pilot Assembly - Natural Gas	
117788	SP13422	Pilot Assembly - Natural Gas	
177859	SP13884A	Pilot Tube Assembly Kit	
190075	SP13884H	Pilot Assembly Kit - NG 12"	
170382	SP20305A	Pilot Assembly - Natural Gas	



## Ruud Water Heater Repair Parts

### Switch

Part #	Mfg #	Description	Price
128923	AP12767	On/Off Switch	
063577	SP11875	Vacuum Switch	
065175	SP12766	Pressure Switch for PowerVent 2	
101155	SP20116	Vacuum Switch for PowerVent	

### Thermostat



Part #	Mfg #	Description	Price
131662	SP20164	Gas Control Thermostat, Natural Gas for Use with 2LAC9	

### Gas Control (Thermostat) - LP



Part #	Mfg #	Description	Price
156423	SP20304B	LP Gas Control	

### Gas Control Assembly

- Rheem/Ruud replacement gas control thermostat
- For PowerVent Models only



Part #	Mfg #	Description	Price
159000	SP20231	6"x6"x4" Replacement Gas Control for PowerVent Models	

### Gas Control (Thermostat) - NG



Part #	Mfg #	Description	Price
180874	AP14270C	Natural Gas Control	

### 2-Pole High Limit - Normally closed Thermostat Contacts (TOD)

- Upper Thermostat in residential electric water heaters
- With Simultaneous design:  
-Both elements are on at the same time



Part #	Mfg #	Description	Price
063011	SP11699	240V Single Element Thermostat	

### 2-Pole High Limit - Normally Open & Normally Closed Thermostat Contacts (TOD)

- Upper thermostat for residential electric water heaters
- Non-Simultaneous element operation
- 59T/66T Series



Part #	Mfg #	Description	Price
063013	SP11698	Upper Thermostat, 90° to 150° Adjustment Range	
135205	SP210245	Upper Thermostat, 80° to 140° Adjustment Range	

### 1-Pole High Limit - Normally Closed Thermostat Contacts (TOD)

- Commonly used for 120V residential water heaters with only one element
- 59T/66T Series



Part #	Mfg #	Description	Price
063004	SP11700	Upper Thermostat, 90° to 150° Adjustment Range	

### Electric Thermostats w/o High Limit Control (TOD)

- Used as the lower Thermostat in residential electric water heaters
- 59T Series



Part #	Mfg #	Description	Price
063012	SP11695	Lower Thermostat, 90° to 150° Adjustment Range	
141066	SP210239	Lower Thermostat, 90° to 150° Adjustment Range	
111142	SP310020	Lower Thermostat, 110° to 170° Adjustment Range	



## Ruud Water Heater Repair Parts

### Robertshaw Thermostat



Part #	Mfg #	Description	Price
063016	SP12258B	LP Gas, 57° - 160° Control Valve with LH Main Burner	

### Thermostat Shank



Part #	Mfg #	Description	Price
147598	AP14696A	Thermostat Shank - 1.926	
139027	AP14696B	Thermostat Shank - 2.870 PV	

### Thermocouple



Part #	Mfg #	Description	Price
063005	SP6379R	24" Thermocouple	

### Valve

Part #	Mfg #	Description	Price
076815	AP12575B-1	3/4" T&P Valve for FVIR Long Shaft	
171596	AP14838G	T&P Valve	
063423	SP11652B	Natural Gas Valve	
109615	SP13845A	Natural Gas Intelli-Vent Valve for PowerVent Units	
109616	SP13845B	Natural Gas Intelli-Vent Valve for PowerVent Units	
109617	SP13846A	LP Gas Intelli-Vent Valve for PowerVent Units	
109618	SP13846B	LP Gas Intelli-Vent Valve for PowerVent Units	
127436	SP20167C	LP Gas Valve and Thermostat	
129691	SP623336	Vacuum Relief Valve Assembly for Marathon Water Heaters	
133902	SP20171A	Gas Control Thermostat Kit	
159270	SP20303A	Nat Gas Control Thermostat Kit	

### Vent Damper

Part #	Mfg #	Description	Price
108929	AP13142	Vent Hood Damper Assembly	
250648	AP131432	Vent Hood Damper Assembly	

### Warranty Upgrade

Part #	Mfg #	Description	Price
078740	SP20079	Protection Plus 4-Year Kit	
234916	SP20866	Protection Plus Warranty Extension Kit	

### Flammable Vapor Ignition Resistant (FVIR) Parts

#### Robertshaw Part



SP20064

Part #	Mfg #	Description	Price
073470	SP20065	Pilot Assembly - Natural Gas	
082616	SP20075	Pilot Assembly - Natural Gas	
097155	SP20055	Piezo & Pilot Assembly Kit	

#### White-Rodgers Part

Part #	Mfg #	Description	Price
109602	SP14270G	Gas Valve - Natural Gas	
109603	SP14270H	Gas Valve - Natural Gas	
109607	SP14269A	Gas Valve - LP Gas	
109609	SP14269E	Gas Valve - LP Gas	
109611	SP20127	Pilot Assembly Kit - Natural Gas	
109612	SP20128	Pilot Assembly Kit - LP Gas	

#### Common Service Part

Part #	Mfg #	Description	Price
073471	SP20064	Thermocouple Kit	
082082	SP12112G	Electric Drain Valve	
073962	SP12112S	Brass Drain Valve	
082825	SP8346	Watts 100XL, 3/4", 150 psi, 100,000 BTU Temperature & Pressure Relief Valve	



## Ruud Water Heater Repair Parts

### Flammable Vapor Ignition Resistant (FVIR) Parts (Continued)

#### Common Service Part

Part #	Mfg #	Description	Price
073469	SP20063	Gasket Kit	

#### Commercial Water Heater Parts

Part #	Mfg #	Description	Price
069329	AP12231B-1	3/4" NPT Brass Drain Valve	
144116	AP9013D	130 to 199K Temperature and Pressure Relief Valve	
144117	AP9012B	250 to 400K Temperature and Pressure Relief Valve	
065179	SP10963D	Natural Gas Valve	
073418	AP12015-1	Thermostat and High Limit	
082771	AP12841	3-Pole Contractor	
144111	AP14074-3	Temperature Sensor	
144120	AP14157-3	GHE Blower Control Harness	
145841	AP14159-5	GHE Gas Valve Harness	
144112	AP14280-1	Exhaust Temperature Flue Sensor	
209545	AP14720	FV Sensor Harness	
144118	AP14758	Display Jumper Harness	
144128	AP14859	Diffuser Nipple	
144124	AP15261	Ground Wire Harness	
143193	RTG20224A	Commercial Upgrade Chip for RTGH-95DVN Natural Gas	
075285	SP12142	ECO/Temperature Probe	
073486	SP12144	Flame Rectification Probe	
073495	SP12189	Combustion Blower	
148468	SP15138	Burner Mounting Flange Gasket	
073485	SP12140	Pressure Switch	
065181	SP10764B	Pilot Assembly for Natural Gas Units	
065180	SP11798B	High Limit Thermostat	
065178	SP12234B	Commercial Light Duty Gas Thermostat	
063119	SP5886	Hand Hole Gasket	
084096	SP8293	Therm-O-Disc Upper Thermostat	
073160	SP8295	Therm-O-Disc Lower Thermostat	
065182	SP10763C	Ignition Control	
093329	SP8828D	Ignition Cable	
131606	RTG20210	Horizontal Vent Termination Kit	



**Schwank Repair Parts**

**Tube Heater Parts**

Part #	Mfg #	Description	Price
129015	JA-0528-XX	4" Horizontal Flue Vent Terminal	
130962	JA-0568-XX	24VAC DSI Control	
134135	JA-0571-KT	DSI Tube Heater Igniter & Gasket	
129442	JA-0775-XX	120/24V, 20VA Transformer	
129441	JL-0703-AA	LP Gas Valve	
147558	JL-0771-XX	1/2" x 24" SS Flexible Gas Connector	
147560	JL-0771-YY	3/4" x 36" SS Flexible Gas Connector	
129016	JL-0772-XX	Dual Scale Line Voltage Thermostat	
129010	JL-0798-SH	1-7/8" 'S' Hook - 25/Pk	
136512	JL-0800-SH	2" Safety Snap Hook - 24/Pk	
129009	JL-0798-JC	50' Box of #8 Jack Chain	
136510	JL-0800-XX	200' Roll of #2 Lion Chain	
130761	JM-0303-KT	24V Transformer/Relay Kit	
129018	JS-0508-SM	90° Aluminum Steel Elbow Kit	
129962	JS-0532-SE	4" Fresh Air Intake Adapter	
129012	JS-0532-VC	4" Outside Air Intake Wall Vent Hood with Birdscreen	
129452	JS-0568-KT	24V Thermostat Control Relay Kit	
129447	JS-0576-AA	Air Proving Switch - .85" WC	
129444	JS-0576-XX	Air Proving Switch - .48" WC	
129445	JS-0576-YY	Air Proving Switch - .30" WC	
129450	JS-0577-SS	Blocked Flue Switch - .58" WC	
129448	JS-0577-ZZ	Blocked Flue Switch - 1.41" WC	
129449	JS-0577-YY	Blocked Flue Switch - .90" WC	
134136	JS-0518-XX	24" High Voltage Ignition Cable	

**Sloan Repair Parts**

**Manual Flushometer Parts**

**Royal Flushometer Parts**

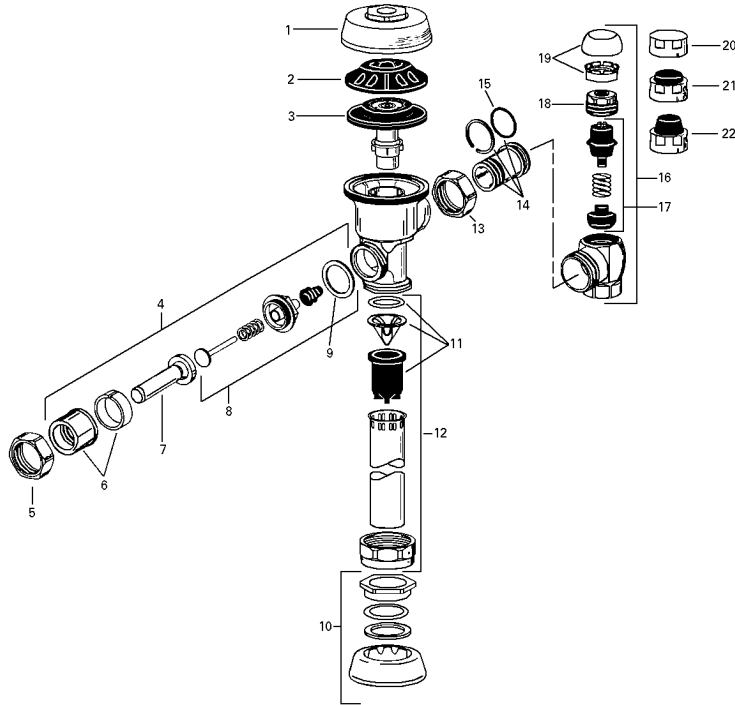

Part #	Mfg #	Model	Ref	Description	Price
083761	3301503	A-1042-A		Repair Kit Royal 1.0 gpf Dual Filter Diaphragm Kit	
036284	3301070	A-1101-A	3-5	Rebuild Kit 1.6 gpf - Closet Exposed	
036283	3301071	A-1102-A	3-6	Rebuild Kit 3.5 gpf - Closet Exposed	
036282	3301074	A-1107-A	3-9	Rebuild Kit 1.0 gpf - Urinal Exposed	
036291	3301075	A-1108-A	3-10	Rebuild Kit 1.5 gpf - Urinal Exposed	
010092	5301188	A-156-A	5	Diaphragm	
010097	5301139	A-31	9	Handle Gasket	
021329	0301082	A-6	5	Handle Coupling, CP	
010107	0301168	A-71	2	Inside Cover	
010108	0301172	A-72	1	Outside Cover, CP	
010112	5302279	B-32-A	4-2	Handle Assembly	
036285	3302306	B-51-A	8	Handle Repair Kit	
010119	0302390	B-73-A	4-1	Handle Assembly	
010137	0306146	F-5-AT	10-3	1-1/2" Spud Coupling, CP	
010138	0306140	F-5-AU	10-2	1-1/4" Spud Coupling, CP	
010136	0306125	F-5-AW	10-1	3/4" Spud Coupling, CP	
020801	3308790	H-1009-A	19-2	3/4" Vandal Resistant Stop Cap For H-700-A	
010148	3308853	H-541-ASD	17-1	1" Screwdriver Stop Repair Kit	
010149	3308856	H-543-ASD	17-2	3/4" Screwdriver Stop Repair Kit	
010150	0308801	H-551-A	14	2-1/16" Tail Assembly, CP	
010152	5308696	H-553	15	O-Ring	

**Sloan Repair Parts**

**Manual Flushometer Parts (Continued)**

**Royal Flushometer Parts**

Part #	Mfg #	Model	Ref	Description	Price
010154	0308848	H-582	20-2	3/4" Cap, CP	
028922	3308386	H-700-A	16-2	1" Adjustable Screwdriver Stop w/Vandal Resistant Cap #19-2	
036290	3393004	V-600-AA	12-1	3/4" x 9" Vacuum Breaker, CP	
036288	3393006	V-600-AA	12-1	1-1/4" x 9" Vacuum Breaker, CP	
036287	3393007	V-600-AA	12-3	1-1/2" x 9" Vacuum Breaker, CP	
036286	3323182	V-651-A	11	Vacuum Breaker Repair Kit	

**Regal Flushometer Parts**

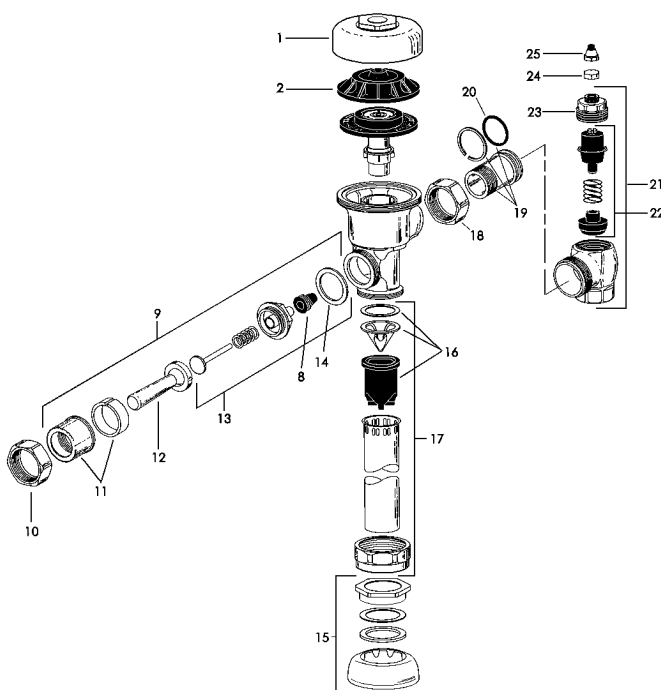

**7. INSIDE PARTS KITS**

<b>A-36-A</b> 3301036 4.5 gpf/17.0 Lpf CLOSET	<b>A-37-A</b> 3301037 1.5 gpf/5.7 Lpf URINAL	<b>A-38-A</b> 3301038 3.5 gpf/13.2 Lpf CLOSET	<b>A-41-A</b> 3301041 1.6 gpf/6.0 Lpf CLOSET	<b>A-42-A</b> 3301044 1.0 gpf/3.8 Lpf URINAL	<b>A-43-A</b> 3301031 0.5 gpf/1.9 Lpf URINAL	<b>A-44-A</b> 3301024 2.4 gpf/9.0 Lpf CLOSET

Part #	Mfg #	Model	Ref	Description	Price
010091	5301111	A-15-A	4	Molded Disc	
010093	5301189	A-156-AA	4,5,8,14	Diaphragm Repair	

---



---

**Sloan Repair Parts**

---



---

**Manual Flushometer Parts (Continued)****Regal Flushometer Parts**

Part #	Mfg #	Model	Ref	Description	Price
010094	5301236	A-163-A	6A	Guide Assembly for 4.5 gpf Closet & 1.5 gpf Urinal	
010095	5301058	A-19-AC	3A	Relief Valve Closet	
010096	5301059	A-19-AU	3B	Relief Valve Urinal	
010098	3301036	A-36-A	7A	4.5 gpf Closet Repair Kit	
010099	3301037	A-37-A	7B	1.5 gpf Urinal Repair Kit	
010100	3301038	A-38-A	7C	3.5 gpf Water Saver Repair Kit	
010101	3301041	A-41-A	7D	1.6 gpf Closet Repair Kit LC	
010102	3301044	A-42-A	7E	1.0 gpf Urinal Kit LC	
010113	5302297	B-39	8	Seal	
010115	5302305	B-50-A	13	Handle Repair Kit	
010141	5308156	H-37	24	Cap CP	
010176	5323005	V-500-AA	17-1	3/4" x 9" Vacuum Breaker CP	
010182	5323006	V-500-AA	17-2	1-1/4" x 9" Vacuum Breaker CP	
010178	5323007	V-500-AA	17-3	1-1/2" x 9" Vacuum Breaker CP	

**Piston Operated Flushometers****GEM 2® Piston Operated Flushometers**

- Fixed volume piston with filtered O-ring by-pass
- ADA Compliant metal oscillating handle
- Vandal-resistant stop cap
- Adjustable tailpiece
- Vacuum breaker flush connection
- High copper, low zinc brass castings for dezincification resistance
- Non-hold-open handle and no external volume adjustment to ensure water conservation
- Handle packing, stop seat and vacuum breaker molded from PERMEX™ rubber compound for chloramine resistance

**GEM 2 Repair Kit**

Part #	Mfg #	Model	Description	Price
112656	5307074	G-50-A	Handle Repair Kit, 6/Pk	

**Sloan Repair Parts**

**Sensor Operated Flushometer Parts  
OptimaPlus® Flushometer Parts**

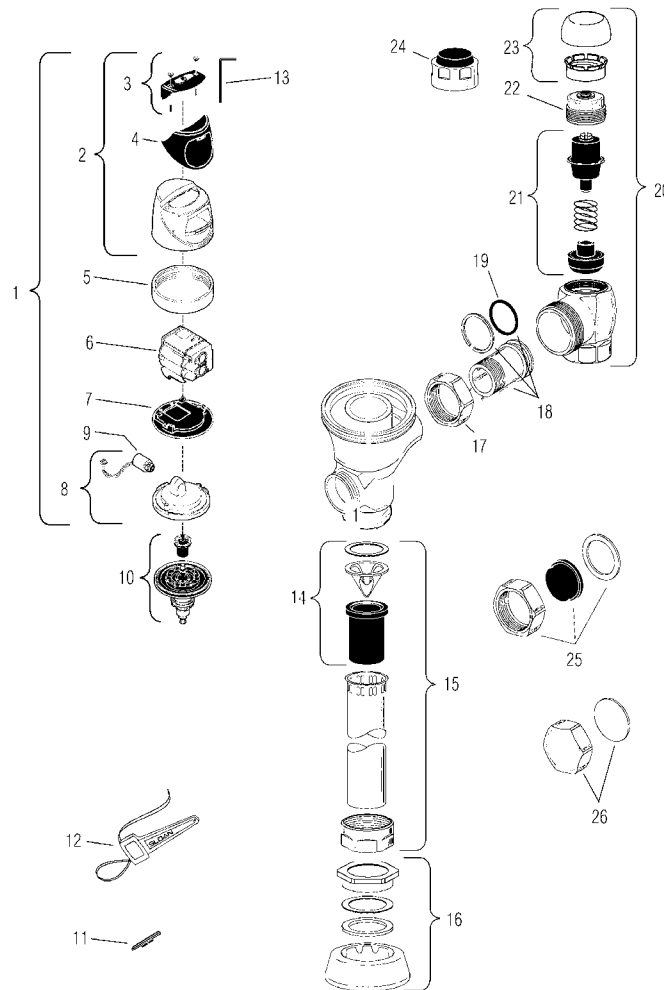

Part #	Mfg #	Model	Ref	Description	Price
057970	3301500	EAF-12		Diaphragm Only Kit	
066898	3325001	EBV-1020-A	10	1.6 Flex Tube Diaphragm Inside Part Kit	
066899	3325000	EBV-1022-A	10	OptimaPlus Repair Kit, 1.0, 1.5 Urinal	
093722	3325450	EBV-129-A-C	6	G2 Electronic Module - Water Closet	
084024	3325451	EBV-129-A-U	6	G2 Electronic Module - Urinal	
100551	0325172	EBV-130-A	3	G2 Override Button Assembly	
080085	3325453	EBV-136-A	9	Isolated Solenoid	
130178	0325160	EBV-138-A	1	G2 Cover/Ring/Sensor Assembly - Water Closet	
085884	3325462	EBV-144-A	9	Isolated Solenoid Operator	
071385	0325176	EBV-146-A-C		G2 Electronic Module Optima 1.6 - Closet	
071242	0325177	EBV-146-A-U		G2 Sensor Module Urinal	
028637	5325813	EBV-18		Quad Ring	

**Sloan Repair Parts**

**Sensor Operated Flushometer Parts (Continued)**

**OptimaPlus® Flushometer Parts**

Part #	Mfg #	Model	Ref	Description	Price
022200	3325013	EBV-60-A		Metal Cover Assembly with Override Button - Water Closet	
057264	0305118	EL-165-2		Solenoid Coil, 24VAC	
049083	0305165	EL-163-A		Sloan Solenoid Assembly	
010216	3308855	H-541-AA	21	1" Screwdriver Angle Stop Repair Kit	

**Flush Valve Transformer**



Part #	Mfg #	Model	Description	Price
010126	0345154	EL-154	120VAC/24VAC, 50/60Hz (50VA), Box-Mount	

**Optima® Flushometer Parts**

**110/111/115/116/140/152/153 ES-S**

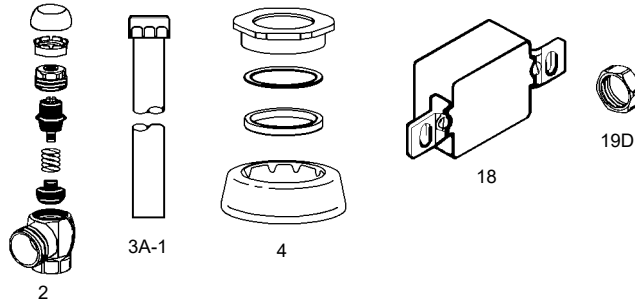

Part #	Mfg #	Model	Ref	Description	Price
010125	3305621	EL-1500-L	18	Sensor Repair Kit - Closet	

**Optima® Systems Solenoid/Sensor Parts and Assemblies List**

Part #	Mfg #	Model	Description	Price
010123	0337086	DO-22	O-Ring	

**Showerheads**

**Act-O-Matic**



Part #	Mfg #	Model	Description	Price
010088	4020100	AC-11	2.5 gpm Std Self-Cleaning Showerhead, CP	



**Sloan Repair Parts**

**Needle Spray Showerhead Repair Kit**

- Kit includes:
  - Gasket
  - Spacer
  - Ball joint coupling
  - Flow control assembly



Part #	Mfg #	Model	Description	GPF	Spud	Price
245242	4328466	SH-1002-A	Needle Spray Showerhead Assembly			

**Replacement Parts and Accessories**

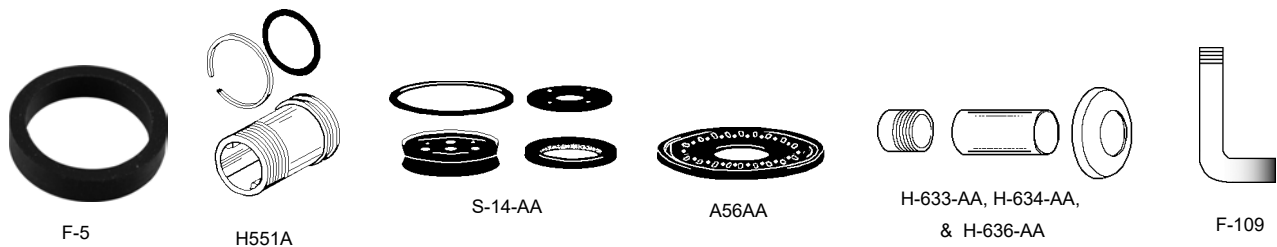

Part #	Mfg #	Model	Description	Price
023238	3301077	A-1008-A	3/4" Spud Coupling Kit	
029505	3301079	A-1010-A	1-1/2" Spud Coupling Kit	
057971	3301501	A-1038-A	Closet Repair Kit	
032380	0301104	A-175-A	Low Pressure Guide Repair Kit (P-600-EGL)	
045723	0301178	A-19-ALCM	Closet Relief Valve, Brass LC	
010103	0301255	A-50	Super Wrench	
010104	5301170	A-56-A	Segment Diaphragm w/A-29 Copper Gasket	
010105	5301176	A-56-AA	Diaphragm Repair	
010122	3303398	C-70-A	Push Button For Concealed Royal & Crown - Contains #7-11	
032633	3305043	EL-128-A	Actuator Cartridge	
019381	3305620	EL-1500	Urinal Sensor Repair Kit	
103862	3365092	ETF-1023-A	Repair Kit .5gpm Male LF CP	
028928	0396322	F-109	1-1/2" x 21" x 5" Tubular Bend, CP	
010134	5306055	F-3	3/4" Red Friction Ring	
010133	5306058	F-3	1-1/2" Red Friction Ring	
010135	5306113	F-5	3/4" Slip Joint Gasket	
020802	3308772	H-1010-A	1" Vandal Resistant Stop Cap	
010143	3308277	H-47-AA	Stop Repair Kit	
010146	3308780	H-533-AS	Sweat Solder Kit For 1" Supply Closet & Urinal	
010147	3308786	H-536-A	3/4" Sweat Adapter Kit	
010151	0308803	H-551-A	3-1/16" Long Adjustable Tailpiece, CP	
034119	0308805	H-551-A	4-1/16" Long Adjustable Tailpiece, CP	
016687	5308850	H-584	Screwdriver Control Stop Seat Only For 1" H-540, H-600 & H-700 Series Stop	
043117	3308782	H-633-AA	Sweat Solder Kit 1" w/Cast Set Screw Flange (YBYC)	
111258	3308785	H-634-AA	Sweat Solder Kit 1", CP	
084384	3308788	H-636-AA	Sweat Solder Kit 3/4" w/Cast Set Screw Flange (YBYC)	

**Sloan Repair Parts**

**Replacement Parts and Accessories (Continued)**

Part #	Mfg #	Model	Description	Price
010186	3323192	V-551-A	Vacuum Repair Kit	
010159	0310083	J-212-A	1-1/2" Solid Ring Pipe Support - 5 C/E Complete, CP	
010170	5319086	S-30	1-1/2" Gasket	
010175	3322079	V-101-A	Vacuum Breaker Repair Kit	
010174	5322001	VBF-5	1-1/2" Gasket	
126485	345125	EL-451	Transformer 6V 25VA	

**Vacuum Breaker**



Part #	Mfg #	Model	Description	Price
010179	0323014	V-500-AA	1-1/2" x 13-1/2", CP	
010180	0323015	V-500-AA	1-1/2" x 21-1/2", CP	
010181	0323016	V-500-AA	1-1/2" x 24-1/2"	
010183	0323020	V-500-AA	1-1/4" x 21-1/2"	
021735	0323057	V-500-AA	1-1/2" x 32-1/2"	
010184	0323210	V-500-AA	3/4" x 15", CP	

**Sloan Repair Parts**

**FLUSHMATE® Replacement Parts**



BU100505-K



C-100500-K

Part #	Mfg #	Description	Price
080376	B-108288	Duckbill Valve (Air Inducer) Allows Air Into Tank but Not Out	
046464	BU100505-K	Upper Supply Kit for Flushmate Pressurized Tank	
010120	C-100500-K	Flush Cartridge for All Flushmate Series	
120907	M-101526-F3 1	Pressure-Assist Flush 1.6 gpf System for 503 Series Tanks Except Kohler K4404	

---

---

**Speakman Repair Parts**

---

---

**Speakman® Parts**

Part #	Mfg #	Description	Price
068748	RPG05-0520	Vacuum Breaker Hub Repair Kit	
164331	RPG05-0532CA	Hot side ceramic cartridge	

## T & S Brass Repair Parts

### Handles



- Chrome-plated zinc handle
- B-WH models come with screw, all others, screw is sold separately

Part #	Mfg #	Description	Price
010415	001636-45	Lever Handle Cold Index	
010416	001637-45	Lever Handle Hot Index	

### Swing Nozzles



Part #	Mfg #	Description	Price
044168	062X	12" Swing Nozzle	

### Repair Kits



B-9K



B-10K

Part #	Mfg #	Description	Price
061402	B-9K	Lever Handle Kit	
010405	B-10K	Repair Kit for B-0107	
046499	B-21K	Eterna Cartridge Replacement	
107843	B-39K	Brass Rotary Waste Valve Parts Kit	
130038	B-0969-RK01	Vacuum Breaker Repair Kit	
010409	001121-45	Spray Face #1	

### T&S Brass Parts

#### Flexible Stainless Steel Hose

- Heat resistant gray handle
- Polyurethane inner tubing
- 3/4-14 UN female outlet
- 3/4-14 UN female inlet
- Hose washers included
- Material: Polished chrome plated brass end fittings, thermoplastic handle and stainless steel hose



Part #	Mfg #	Description	Price
010404	B-0044-H	44" Flexible Stainless Steel	

#### Bonnet Assembly



Part #	Mfg #	Description	Price
030182	002856-40	B502 Bonnet Assembly	

#### Spindle



002711-40



002712-40

Part #	Mfg #	Description	Price
010419	002711-40	Cold Spindle 174A	
010420	002712-40	Hot Spindle 175A	
028123	002713-40	Eterna LH Spindle Assembly	
028124	002714-40	Eterna RH Spindle Assembly	
085560	005960-40	Eterna Spindle Assembly, Hot	
110659	005959-40	Eterna Spindle Assembly, Cold	

#### Supply Nipple

- Brass



Part #	Mfg #	Description	Price
110214	B-0230-K	Angle Supply Nipple	

## T & S Brass Repair Parts

### Waste Valve with Drain Adapter - Twist



Part #	Mfg #	Description	Price
107844	B-3940	3.0" Sink Opening, 1.5" or 2.0" Drain Outlet	
119775	B-3950	3-1/2" x 2" & 1-1/2" Adapter	

### Washer



Part #	Mfg #	Description	Price
010411	001041-45	Spreader Washer	
022191	001092-45	T&S Seat Washer	

### Wall Brackets

#### Wall Bracket

- Fits 3/8" pipe
- 2-1/4" Wall flange
- Polished chrome plated brass
- Chrome-plated mounting screws included



Part #	Mfg #	Size	Price
033142	B-0109-01	6"	

### Parts & Accessories

Part #	Mfg #	Description	Price
010417	018L	Stem	
010427	067L	Stem	
010426	066L	Removable Insert	
010425	064L	Removable Insert	
019815	003164-45	Spring Check Seat Washer with Seat Disc	
208371	011355-45	Overflow Tube	
208370	011356-45	Waste Overflow Head	



## Taco Repair Parts

### Pro-Fit™ Replacement Parts

- For Bell & Gossett and Armstrong pumps

#### Coupler

- Rugged, cast zinc w/steel reinforced eyelets
- Heavy-duty spring
- Fits all 1/2" motor shafts
- Std Woods 3-J for all 5/8" motor shafts (opt 1/2" inserts included)



Part #	Mfg #	B&G Part #	Armstrong Part #	Price
079914	COU-ABC-100	118705,189110,118712,118723	806026-001	
079915	COU-D100	118473,118709	810120-003/006,806137-000,807436-000	

**Thermolec Repair Parts**

**Parts & Accessories**

Part #	Mfg #	Description	Price
130137	10-02-005	Magnetic B/U, 50A Spade Style Contactor	
130139	10-02-006	CCT-140 SPDT Diverting Valve Pump Relay	
241766	16-04-250	TH22 Conversion Kit	
241767	16-04-300	TH22 Controller	
128230	17-02-102	CBLR055 Incoloy Element 5kW, 240V	
121185	17-02-103	CBLR060 Incoloy Element 5.75kW 240V	
130133	17-02-107	CBLR130 Electronic Temperature. Sensor - Supply Water	
110489	17-02-110	CBLR025 Mono Energy Control Board TH-600-M	
130131	17-02-115	CSR113 Solid State Relay SSR-20-DC	
130130	17-02-116	CTR040 Control Transformer 30VA 240/24V	

## Triangle Tube Repair Parts

### Prestige Parts

Part #	Mfg #	Description	For:	Price
115737	PSSSENS01	Outdoor Sensor Kit		
093308	PSSTND01	Floor Stand	PS110, PS175, PS250	
107252	PSSTND02	Wall Kit, Recommended f/Hanging on Anything Other Than a Masonry Wall		
107253	PSSTND03	Floor Stand Kit Use w/PSSTND02 Wall Kit	PE110 & PS399	

### Electronic Components

Part #	Mfg #	Description	For:	Price
091015	PSRKIT04	NTC Sensor	PS110, PS175 & PS250	
091016	PSRKIT13	Blower Kit w/Gasket	PS110 & PS175	
091019	PSRKIT19	Transformer with Surge Protection	SOLO 110	
114363	PSRKIT20	Control Module Display	SOLO 110	
118949	PSRKIT50	Control Module	SOLO 110	
120439	PSRKIT55	Blower Kit w/Gasket	PS110	
117640	PSRKIT58	MCBA Control Module Replacement Kit	PE110	
138226	PSRKIT63	NTC3 Domestic Hot Water Sensor	PE110	

### Burner Components

Part #	Mfg #	Description	For:	Price
091021	PGRKIT01	Gas Valve Kit	PS110	
091017	PSRKIT15	Igniter w/Gasket	SOLO 110	
120440	PSRKIT41	Gas Valve	SOLO 399	

### Internal Components

Part #	Mfg #	Description	For:	Price
091020	PGRKIT20	Lwco Pressure Device	SOLO 110	
118581	PSRKIT40	399 Blower with Gasket	SOLO 399	

**Union Brass Repair Parts**

**Parts**

**Valve Assemblies**

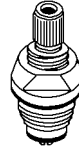

80038



80080

Part #	Mfg #	Description	Price
010503	80038	1837AC Cold Valve Assembly	
051376	80080	1839A-C Cold Valve Assembly	

**Ruud Heating & AC Repair Parts**

**Blower Wheels**

**Blower Wheel**

- CW Rotating



Part #	Mfg #	Rotation	Nom Size	Overall Dia x Overall W	Hub	Disc Shape (Hub Side)	# of Blades	Price
009619	70-18631-01	CW	9" x 7"	9-1/2" x 7-1/8"	1/2"	Convex	43	
024572	70-20218-02	CW	10" x 7"	10-5/8" x 7-3/16"	1/2"	Convex	48	
016858	70-18629-01	CW	10" x 10"	10-5/8" x 10-5/8"	1/2"	Concave	48	
051174	70-23110-30	CCW	10" x 10"	10-5/8" x 10-3/4"	1/2"	Concave	48	
030369	70-23111-05	CW	11" x 7"	11-15/16" x 7-1/8"	1/2"	Concave	54	
074404	70-23111-43	CW	11" x 7"	11-15/16" x 7-1/8"	1/2"	Concave	54	
049454	70-24254-02	CW	11" x 7"	11-15/16" x 7-1/8"	1/2"	Convex	54	
009622	70-20602-01	CW	11" x 10"	11-7/8" x 10-11/16"	1/2"	Concave	54	
050595	70-24119-01	CW	12" x 7"	12-3/4" x 7"	1/2"	Concave	43	
086470	70-24179-01	CW	12" x 11"	12-25/32" x 11-1/8"	1/2"	Convex	43	
019546	70-24041-01	CW	12" x 11"	12-3/4" x 11-1/8"	1/2"	Concave	43	
051179	70-42540-02	Reversible	15" x 15"	15" x 15"	1"	Double Convex	51	

**Blower Motors**

Part #	Mfg #	Rotation	No. of Speeds	RPM	HP	Input Voltage	Hz	Price
160025	51-104671-01	CCW	4	1075	1/2	120	60	
103690	51-25023-01	CCW	4	1075	3/4	120	60	
052996	51-42537-01	Reversible	1	1725	3	208/230	50/60	

**Compressors**

**R-410 Scroll Compressor**

**Copeland R-410A Air Conditioning Scroll Compressor - 208/230**

- Crankcase heater not included



Part #	Mfg #	Vendor #	Capacity MBTUH	Run Capacitor	Start Capacitor	Start Kit	Kick Start	Crankcase Heater	Price
113737	55-102045-14S	ZP16K5E-PFV	15.5	30/370	88-106/330	SK-A1	42-TO5	44-17402-44	
113736	55-102045-01S	ZP21K5E-PFV	21.3	40/370	88-106/330	SK-A1	42-TO5	44-17402-44	
113735	55-102045-02S	ZP21K5E-PFV	21.3	40/370	88-106/330	SK-A1	42-TO5	44-17402-44	

**Ruud Heating & AC Repair Parts**

**Compressors (Continued)**

**R-410 Scroll Compressor**

**Copeland R-410A Air Conditioning Scroll Compressor - 208/230**

Part #	Mfg #	Vendor #	Capacity MBTUH	Run Capacitor	Start Capacitor	Start Kit	Kick Start	Crankcase Heater	Price
113903	55-102045-31S	ZP24K5E-PFV	24.0	40/370	88-106/330	SK-A1	42-TO5	44-17402-44	
113901	55-102045-03S	ZP31K5E-PFV	31.0	45/370	88-106/330	SK-A1	42-TO5	44-17402-44	
131585	55-102045-17S	ZP38K5E-PFV	37.5	45/370	175-216/330	SK-A3	42-KS1	44-17402-45	
113730	55-102045-09S	ZP42K5E-PFV	42.0	70/370	88-106/330	SK-A1	42-KS1	44-17402-45	
113734	55-102045-15S	ZP34K5E-PFV	34.0	45/370	88-106/330	SK-A1	42-TO5	44-17402-45	
113900	55-102045-26S	ZP51K5E-PFV	51.0	70/370	175-216/330	SK-A3	42-KS1	44-17402-45	
175440	55-102045-27S	ZP51K5E-TF5-830	51.0	-	-	-	-	44-17402-45	
113729	55-102045-13S	ZP54K5E-PFV	54.0	80/370	175-216/330	SK-A3	42-KS1	44-17402-45	
250959	ZP49K5E-PFV-800	ZP49K5E-PFV-800	49400	70/370	88-106/330	SK-A1	42-KS1	44-101884-08	

**R-22 Scroll Compressor**

**Copeland R-22 Air Conditioning Scroll Compressor - 208/230-1**



Part #	Mfg #	MBTUH*	Electrical	RLA	Max Dimensions H x W x L	Stub Tube Conn(ID") Dischg, Suc	Mnt Dim W x L	Price
133280	ZR16K5E-PFV-800	20.3	208/230-1-60	9.3	15.86" x 9.50" x 9.50"	1/2", 3/4"	7.5" x 7.5"	
222707	ZR21K5E-PFV-800	27.5	208/230-1-60	32.9	18.75" x 11.23" x 10.38"	22/25", 1-1/8"	7.5" x 7.5"	
133217	ZR25K5E-PFV-800	32.8	208/230-1-60	15	15.86" x 9.50" x 9.50"	1/2", 3/4"	7.5" x 7.5"	
133806	ZR28K5E-PFV-800	36.9	208/230-1-60	15.7	15.86" x 9.50" x 9.50"	1/2", 3/4"	7.5" x 7.5"	
222708	ZR32K5E-PFV-800	42.6	208/230-1-60	17.1	15.86" x 9.50" x 9.50"	1/2", 3/4"	7.5" x 7.5"	
164723	ZR34K5E-PFV-800		208/230-1-60	18.6	15-5/16"H	1/2", 3/4"	7.5" x 7.5"	
180171	ZR42K5E-PFV-800	54.8	208/230-1-60	22.1	16.94" x 9.56" x 9.59"	1/2", 7/8"	7.5" x 7.5"	
141164	ZR54K5E-PFV-800	69.7	208/230-1-60	28.2	16.94" x 9.56" x 9.59"	1/2", 7/8"	7.5" x 7.5"	
139752	ZR48K5E-PFV-800	48.2	208/230/1-60	24.3	16-7/16"H	1/2", 7/8"	7.5" x 7.5"	
176782	ZR61K3E-TF5-950	62	208/230-3-60	19.3	17-3/4"H	1/2", 7/8"	7.5" x 7.5"	
168710	ZR61K3E-PFV-950	62	208/230/1-60	32.1	17-3/8"H	1/2", 7/8"	7.5" x 7.5"	



**Ruud Heating & AC Repair Parts**

**Expansion Valves**  
**Thermal Expansion Valve**



Part #	Mfg #	Description	Price
140730	611006	2T R-22 Expansion Valve	
140731	611007	3T R-22 Expansion Valve	
140732	611008	4T R-22 Expansion Valve	
140733	611009	5TR-22 Expansion Valve	
140734	611011	2T R-410A Expansion Valve	
140735	611012	3T R-410A Expansion Valve	
140736	611013	4T R-410A Expansion Valve	
134296	611064	3T R-410A To R-22 Conversion, Thermal Expansion Valve	
141976	61-103652-05	2T R-410A TX Expansion Valve	
236790	61-106238-37	5T TXV Expansion Valve	
131854	61-21922-46	1.5T R-22 TXV Expansion Valve	
105705	61-21922-47	2T R-22 TXV Expansion Valve	
249495	61-106238-34	2.5T TXV Expansion Valve	
131857	61-21922-50	4T R-22 TXV Expansion Valve	
105707	61-21922-82	2.5T R-22 TXV Expansion Valve	
105708	61-21922-83	3T R-22 TXV Expansion Valve	
105709	61-21922-84	4T R-22 TXV Expansion Valve	
105710	61-21922-85	5T R-22 TXV Expansion Valve	

**Fan Blades**

**Fan Blade with Integral Hub**

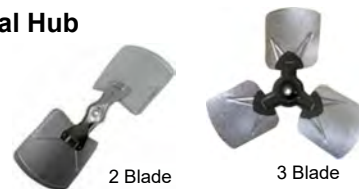

Part #	Mfg #	Diameter	Pitch	Rotation	# of Blades	Price
079832	70-21859-05	18"	28°	CCW	2	
123681	70-102033-05	18"	30°	CCW	3	
071438	70-20607-04	20"	27°	CCW	2	
107473	70-102011-06	20"	29°	CCW	3	
084834	70-21858-06	22"	21°	CCW	2	
009623	70-20608-01	22"	27°	CCW	2	
105796	70-102011-07	22"	35°	CCW	2	
107476	70-102011-09	24"	22°	CCW	2	
024245	70-19897-01	24"	22°	CCW	3	

**Ruud Heating & AC Repair Parts**

**Fan Blades (Continued)**

**Fan Blade with Integral Hub**

Part #	Mfg #	Diameter	Pitch	Rotation	# of Blades	Price
103769	70-100580-03	24"	22°	CCW	3	
123680	70-102011-03	24"	24°	CCW	2	
084787	70-26166-01	24"	24°	CCW	2	
096139	70-100580-04	24"	28°	CCW	3	
086771	70-23137-01	24"	19°	CCW	2	
117441	70-21858-17	24"	22°	CCW	3	
106241	70-21858-12	18"	27°	CCW	2	

**Fan Center**

- Terminals: W, G, Y, R, C
- 120V Primary voltage
- 24V Secondary voltage
- Transformer frequency: 50,60Hz
- Relay not included, SPDT configuration
- Relay coil voltage: 24V



Part #	Mfg #	Description	Price
009344	47-19807-04	Fan Center, 4-1/4" x 4-1/4"	

**Gas Valves**



Part #	Mfg #	Description	Price
009499	60-22174-02	Natural Gas Valve, 150,000 BTU/HR @ 1" WC Pressure Drop	
009501	60-22447-01	Natural Gas Valve, 150,000 BTU/HR @ 1" WC Pressure Drop	
067321	60-24215-03	Modulating Natural Gas Valve	
127859	60-24394-01	Natural Gas Valve, 150,000 BTU/HR @ 1" WC Pressure Drop	

**Gas Control**



Part #	Mfg #	Description	Price
132343	SP20166A	Gas Valve - Natural Gas	
129359	SP20166B	Gas Valve - Natural Gas	
128611	SP20166C	Gas Valve - Natural Gas	

**Ruud Heating & AC Repair Parts**

**White-Rodgers 36G Gas Valve**

- 140,000 BTUH Capacity @ 1"wc pressure drop
- Slow opening
- Hot Surface/ Direct Spark

60-24180-81



Part #	Mfg #	Description	Price
125567	60-24180-81	36G23-202E91 1/2" NG Hot Surface/Direct Spark 1-Stg 140,000	
143224	60-101921-81	36G55-521 1/2" NG Hot Surface/Direct Spark 2-Stg 140,000 BTUH Capacity	

**White-Rodgers 36J Gas Valve**

- Natural gas
- 140,000 BTUH Capacity @ 1"wc pressure drop
- 4-3/4"L x 2-3/8"W x 4-1/4"H



Part #	Mfg #	Description	Price
179394	60-103901-01	36J23-502 1/2" NG Hot Surface/Direct Spark 1-Stg 140,000 BTUH Capacity	

**Honeywell VR8215S1313 Gas Valve**

- Natural gas
- 150,000 BTU/HR Capacity @ 1"wc pressure drop
- 4-7/16"L x 2-3/4"W x 4-1/8"H
- Hot Surface/Direct Spark



Part #	Mfg #	Description	Price
172007	60-105055-01	VR8215S1313 1/2" NG Hot Surface/Direct Spark 1-Stg 150,000 BTU/HR Capacity	

**Honeywell VR8304 Intermittent Pilot Dual Automatic Valve Combo Gas Control**

- For use in 24VAC gas-fired, intermittent pilot with capacities from 30-415 cfh
- Includes all standard features plus:
  - Controls include 100% safety shut-off, manual valve, two automatic operators, pressure regulator & pilot adjustment
  - Standard & slow opening natural gas models include natural to LP gas conversion kits; LP to natural gas conversion kits are also available
  - All adjustments, wiring connections & pilot outlets are accessible from the top of control
  - Adjustable servo regulator
  - Compatible with ECO connector
  - On-Off lighting sequence
  - Use with S86F,H; S860D; S8600F,H; S8610 & S90A,B Control Modules
  - Single stage unless otherwise noted
  - Capacities based on 1" p.d. 30,000 BTUH minimum, 300,000 BTUH maximum

**Honeywell**

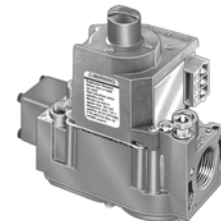

Part #	Mfg #	Description	Price
009498	60-21621-81	VR8304M3101 3/4" NG Pilot 1-Stg 270,000 BTUH Capacity	

**Ruud Heating & AC Repair Parts**

**Gas Valve Spring Kit**

Part #	Mfg #	Description	Price
009490	60-18759-07	Gas Valve Spring Kit	

**Heat Cell**

Part #	Mfg #	Description	Price
008940	AS-61164-83	Heat Cell - Aluminum	

**Inducer Motors**

**Induced Draft Blower with Gasket**



Part #	Mfg #	Description	Price
090631	70-101087-81	120V 1-Stg Sheet Metal Inducer Housing Right Side Discharge	
160013	70-104157-82	Induced Draft Blower Assembly with Gasket	
009627	70-21496-83	120V 1-Stg Polymeric Inducer Housing Left Side Discharge	
009632	70-22436-02	120V Induced Draft Blower w/ Gasket	
009635	70-24033-01	120V 1-Stg Polymeric Inducer Housing Right Side Discharge	
041979	70-24157-03	120V 1-Stg Cast Metal Inducer Housing Right Side Discharge	
027297	70-24206-01	120V 2-Stg Polymeric Inducer Housing Right Side Discharge	

**1-Stage Draft Inducer Blower**

- 115V 1-Speed
- For use with Rheem/Ruud gas furnaces models RGRK-07EMAES and UGRK-07EAMES



Part #	Mfg #	Description	Price
120707	703020	Draft Inducer Blower	
131722	70-24071-94	Draft Inducer Blower	

**2-Stage Draft Inducer Blower**

- 115V 2-Speed
- For use with Rheem/Ruud gas furnaces models RGRK-07EMAES and UGRK-07EAMES



Part #	Mfg #	Description	Price
136280	70-100612-03	Draft Inducer Blower	
139895	70-100612-81	Draft Inducer Blower	
139892	70-102691-81	Draft Inducer Blower	
139896	70-102814-81	Draft Inducer Blower	

**Ruud Heating & AC Repair Parts**

**Inducer Motors (Continued)  
2-Stage Draft Inducer Blower**

Part #	Mfg #	Description	Price
139894	70-103086-01	Draft Inducer Blower	
145465	70-103597-01	Draft Inducer Blower	

**Blower Assembly**



Part #	Mfg #	Description	Price
015970	70-22165-81	Blower Assembly	
009631	70-22436-01	Blower Assembly	
137367	AP15109-1	Blower Assembly	

**Vent Motor with Blades**

- 208/230V, Nominal 3,000 rpm
- Includes centrifugal proving switch
- Mounting bolt pattern 4-1/4" x 4-1/4"
- Includes (3) fan blades (3", 3-1/2" and 4" diameter)



Part #	Mfg #	Description	Price
009414	51-21964-11	Vent Motor with Blades, 208/230V Nominal 3000 rpm	

**Motor Mount**



Part #	Mfg #	Description	Price
022307	562300109	Blower Motor Mount Kit For 48 Frame	
093274	AE-58384-81	Screw Mounting Kit, 5-5/8" 48 Frame Motors, 16" Nom Blower Mounting Bolt Circle Dia, (4) Arms	
041165	AE-61698-82	Screw Mntg Kit, 5-5/8" 48 Frame Motors, 14-13/16" Nom Blower Mntg Bolt Circle Dia, (4) Arms	
008936	AS-55306-02	Condenser Motor Plate Mount Kit	
223191	AS-55306-82	Condenser Motor Plate Kit	

**Ruud Heating & AC Repair Parts**

**Limit Controls**

**Therm-O-Disc Temperature Limit Control Switch**

**36T Small Flanged Airstream - Manual Reset**

- 120/230V maximum rating, 15/10A maximum current rating
- Enclosed disc face
- SPST Switching
- Normally closed
- 300° Open temperature



Part #	Mfg #	Temp Open	Tolerance Open	Color Code	Mounting Tube	Price
009391	47-22861-02	300°F	+/-14°F	Blue	5/32"	
160018	47-22861-04	250°F	+/-12°F	Red	5/32"	

**36T Special Small Flanged Airstream - Manual Reset**

- 120/230V Max rating, 15/10A Max current rating
- Enclosed disc face
- SPST Switching
- Normally closed
- 250° Open temperature



Part #	Mfg #	Temp Open	Tolerance Open	Color Code	Mounting Tube	Price
103688	47-22861-03	250°F	+/-12°F	--	3/16"	

**74T Large Flanged Airstream - Auto Reset**

- 230V Max rating, 25A Max current rating
- Enclosed disc face
- SPST Switching
- 3/8" Maximum mounting insertion depth



Part #	Mfg #	Description	Price
141499	47-25115-02	Open Temp: 135°F - 175°F; Close Temp: Open Temp Minus 40°F, 40° Nom Temp Difference	
141500	47-25115-03	Open Temp: 175°F - 215°F; Close Temp: Open Temp Minus 40°F, 40° Nom Temp Difference	

**Limit Control Switch - Auto Reset - 69T Heat Assisted**

- Normally closed
- Exposed disc face
- SPST Switch type



Part #	Mfg #	Description	Price
009388	47-22860-01	95°F Close Temperature Red	
009389	47-22860-02	100°F Close Temperature Blue	



**Ruud Heating & AC Repair Parts**

**Limit Switch - Auto Reset 60T Series**

- Normally closed
- Flanged airstream
- 1-Pole
- SPST Switch type
- Normally closed



Part #	Mfg #	Description	Price
160015	47-104465-01	95°F Close Temperature Yellow	

**Limit Control Switch - Manual Reset - 36T**

- Flanged Airstream



Part #	Mfg #	Description	Price
009375	47-22453-01	Normally Closed Enclosed Disc Face SPST	
009376	47-22453-02	Normally Closed Enclosed Disc Face SPST	
009390	47-22861-01	Normally Closed Exposed Disc Face SPST	
009393	47-22862-02	Normally Closed Blue Exposed Disc Face SPST	
009395	47-22862-04	Normally Closed Orange Enclosed Disc Face SPST	

**Limit Switch/Defrost Sensor - Auto Reset**

- Tube mount
- Moisture resistant
- SPST switch type
- 120/230



Part #	Mfg #	Description	Price
085224	47-23683-04	Close on Rise Wire Leads - 98" Wire Length	

**Limit Control/Switch**



Part #	Mfg #	Description	Price
009351	47-21663-01	Limit Switch	
009367	47-21900-05	Limit Control	
009368	47-21900-06	Limit Control	
009371	47-22383-13	Limit Switch	
026839	47-22383-33	Limit Control	

**Ruud Heating & AC Repair Parts**

**Limit Control Switch - Auto Reset - 36T**

- Enclosed disc face
- SPST Switch type
- Normally closed
- Board mount 90° strap angle



Part #	Mfg #	Description	Price
009356	47-21711-06	150°F Close Temperature	
009360	47-21711-10	150°F Close Temperature	
034226	47-25349-02	150°F Close Temperature Blue/Blue	
036843	47-25349-03	150°F Close Temperature Yellow/Yellow	
009361	47-21711-11	160°F Close Temperature	
038081	47-25349-01	160°F Close Temperature Red/Red	
038093	47-25349-05	180°F Close Temperature Orange/Orange	
038095	47-25350-07	180°F Close Temperature Green/Green	
034120	47-25350-01	190°F Close Temperature Red/Red	
009354	47-21711-04	200°F Close Temperature	
036657	47-25350-09	200°F Close Temperature Tan/Tan	
040953	47-25350-06	150°F Close Temperature Brown/Brown	
009403	47-24006-08	Limit Switch	
059560	47-25350-02	Limit Control	
050264	47-25350-04	Limit Control	
085327	47-25350-05	Limit Control	
145464	47-25350-12	Limit Control, 195°F Open	

**Motors  
ECM Motor**



Part #	Mfg #	Description	Price
142897	51-102728-05	ECM Outdoor CA330R Motor	
169001	51-104304-28	1/2 hp Variable Speed ECM Motor	
166659	51-104306-01	Variable-Speed 1 hp Direct Drive ECM 48 Frame	
166319	51-104306-03	Variable Speed 1 hp Direct Drive ECM Motor	
166281	51-104306-24	1 hp ECM Motor	
166321	51-104306-25	1 hp ECM Motor	
137902	51-42534-24	1/3 hp Fan Motor	
145469	51-102602-01	1/2 hp Communicating Motor	
168216	51-104304-01	1/2 hp ECM Motor	
235420	51-102870-08	ECM (Outdoor) - Not Programmable	
249815	51-102870-07	ECM (Outdoor) - Not Programmable	
249817	51-105035-05	1/2 hp ECM (Outdoor) - Variable-Speed	

**Ruud Heating & AC Repair Parts**

**Motors (Continued)**

**ECM Motor**

Part #	Mfg #	Description	Price
162407	51-102603-01	3/4 hp ECM 3.0 -Variable Speed 120/230V 60Hz	
168784	51-104306-23	1 hp ECM (Eon) Variable Speed 120/230 50/60Hz	
166489	51-104304-27	1/2 hp ECM (Eon) Variable Speed 120/230 50/60Hz	

**OEM Condenser Motor (208/230V)**

- These motors are OEM replacements for Rheem, Ruud, and WeatherKing models; additionally they may be suitable for after market retrofit in many other applications
- Single speed, single phase



Part #	Mfg #	Description	Price
086497	51-100999-02	1/10 hp 825 rpm 208/230V Condenser Motor	
085274	51-100999-03	1/6 hp 1075 rpm 208/230V Condenser Motor	
086548	51-100999-04	1/5 hp 1075 rpm 208/230V Condenser Motor	
086549	51-100998-05	1/3 hp Condenser Motor	
113859	51-100998-13	1/3 hp 1075 rpm 208/230V Condenser Motor	
249816	51-101774-40	1/5 hp 825 rpm 208/230V Condenser Motor	
123683	51-102500-02	Sgl Speed, 1/6 hp 1075 rpm 208/230V CCW 3/370 Capacitor	
105406	51-102500-04	1/5 hp 825 rpm 208/230V Condenser Motor	
113905	51-102500-05	1/10 hp 825 rpm 208/230V Condenser Motor	
099184	51-42179-01	Sgl Speed, 1/3 hp 1075 rpm 208/230-1-60 CCW 10/370 Run Capacitor	
052997	51-42534-01	Sgl Speed, 1/3 hp 1075 rpm 208/220/230-1-50/60 CCW 10/370 Run Capacitor	

**Condenser Motor**



Part #	Mfg #	Description	Price
239191	51-100998-30	1/3 hp 1075 rpm 208-230V Single Speed Condenser Motor	

**Condenser Fan Motor**

- 60 Hz
- Single stage
- Sleeve bearing
- 825 rpm/ 1 speed
- Input voltage: 208-230
- Counter clockwise rotation

Part #	Mfg #	Description	Price
237994	51-101774-52	1/6 HP	

**Ruud Heating & AC Repair Parts**

**Motors (Continued)**

**Condenser Fan Motor**

Part #	Mfg #	Description	Price
052998	51-42534-02	1/3 HP	

**Ruud Wholesale Condenser Motor (208/230V)**



Part #	Mfg #	Description	Price
009426	51-23055-12	1/5 hp Direct Drive 230V 825 rpm	
009425	51-23055-11	1/5 hp Direct Drive 230V 1075 rpm	
133785	51-21853-11	1/2 hp 1075 rpm/1 speed	

**Ruud Wholesale Condenser Motor (460V)**



Part #	Mfg #	Description	Price
086789	51-23063-11	Sgl Speed, 1/3 hp 1075 rpm 460-1-60 Reversible 7.5/370 Capacitor	

**Condenser Motor**



Part #	Mfg #	Description	Price
132537	51-100998-08	1/8 hp Condenser Motor	
125111	51-102728-11	ECM Condenser	
125103	51-102728-12	ECM Condenser Fan Motor	
125112	51-102728-13	ECM Condenser	
236933	51-102728-24	ECM Condenser Motor	
125432	51-102870-01	ECM Condenser (Outdoor)	
125110	51-102870-03	Condenser Fan Motor	
236636	51-102870-09	Condenser Fan Motor	
140687	5464	1/6 - 1/3 hp 825 rpm 208/230V Emerson RESCUE Condenser Motor	
061734	51-21853-15	Condenser Motor - 1/3 hp 460/1/60	
140686	5462	1/3 to 1/6 hp 1075 rpm 208/230V RESCUE Condenser Motor	

**Ruud Heating & AC Repair Parts**

**TripSaver Condenser Motor**



Part #	Mfg #	Description	Price
009424	51-23053-21	1/3 / 1/5 hp Direct Drive 230V 1,075 rpm	
143484	51-103823-01	1 hp 230V X13 Motor	

**OEM Indoor Blower Motor**



Part #	Mfg #	Capacitor	HP	Volts	Amps	RPM/Speed	Rotation	Price
128889	51-103243-01	15mfd/370V	1/2 hp	120-1-60	8.00A	1,075/4	CCW	
042374	51-23679-01	10mfd/370V	1/2 hp	208/230	2.70A	1,075/3	CW	

**Trip Saver Indoor Blower Motor**



Part #	Mfg #	Description	Price
009422	51-23022-41	4-Speed 1/6-1/2 hp 1,075 rpm 208/230-1-60 REV 5/370, 7.5/370 or 10.370 Capacitor	

**SelecTech Blower Motor**

- Variable # of speeds
- One phase
- Direct drive
- Ball bearings
- Shell-band mounting

Part #	Mfg #	Description	Price
241742	51-104355-11	1/2 hp 120V 1 Phase	
241743	51-104355-12	1/2 hp 120V 1 Phase	
241744	51-104355-13	1/2 hp 120V 1 Phase	
241745	51-104357-04	1 hp 120V 1 Phase	
241746	51-104357-05	1 hp 120V 1 Phase	
241747	51-104357-06	1 hp 120V 1 Phase	
248652	51-104358-09	1/3 hp 208/230V 1 Phase	

**Ruud Heating & AC Repair Parts**

**Motors (Continued)  
 SelecTech Blower Motor**

Part #	Mfg #	Description	Price
248651	51-104359-01	1/2 hp 208/230V 1 Phase	

**Blower Motor**



Part #	Mfg #	Description	Price
100478	51-101879-01	1/3 hp 240V X-13 Blower Motor	
094848	51-101880-01	1/2 hp 208/230V 1-Phase X-13 Blower Motor	
113814	51-102497-01	3/4 hp 230V Variable Speed X-13 Blower Motor with Resilient Rotor	
113813	51-102497-02	3/4 hp 230V Variable Speed X-13 Blower Motor	
009418	51-23012-41	1/6 - 1/2 hp 1,075 rpm 120V 4-Speed Reversible Rotation Tripsaver™ Blower Motor	
028318	51-23017-42	1/4 - 3/4 hp 1,075 rpm 120V Indoor Blower Motor	
016108	51-24070-02	1/2 hp Indoor Blower Motor 120V 1,075 rpm	
024237	51-23555-02	Blower Motor - 3/4 hp 208/230/1/60	
124801	51-21898-01	3/4 hp 208-230/1 V 1075 rpm	
038103	51-23102-08	1/2hp Dir Dr 208-230V 825 rpm	
160026	51-104342-01	3/4 hp 120/1/60 (1075 rpm/4 Speed)	

**Motor**

Part #	Mfg #	Description	Price
009420	51-23015-91	1/5 hp 120/1/60 1075 rpm 3-Speed	
141494	51-23027-31	Blower Motor 3-Speed 230V 3/4 hp	
145470	51-102605-01	1 hp 120/230V ECM Motor	
127336	51-24374-27	1/2 hp ECM Blower Motor	
125741	51-24374-28	1/2 hp ECM Blower Motor	
052874	51-24376-03	Motor w/ICM Module (Modulating Furnace)	
078007	51-24382-81	1/2 hp ECM Module	
134008	51-102008-08	Condenser Fan Motor	

**Motor Mounting Kit**

Part #	Mfg #	Description	Price
125546	70-24104-82	Motor Mounting Kit	



**Ruud Heating & AC Repair Parts**

**Relay's**

**Control Relay**

**Sealed Case (SPDT) Control Relay**



Part #	Mfg #	Contact Bias	Coil Volts	FLA @120V	FLA @230V	LRA @120V	LRA @230V	Price
009290	42-25104-06	NO/NC	24V	14	8	84	48	

**Relay - DPTD**



Part #	Mfg #	Contact Bias	Coil Volts	FLA @120V	FLA @230V	LRA @120V	LRA @230V	Price
009222	42-18287-12	NO/NC (2)	24V	12	6	60	35	

**Open Coil (DPDT) Control Relay**



Part #	Mfg #	Contact Bias	Coil Volts	FLA @120V	FLA @230V	LRA @120V	LRA @230V	Price
027431	42-25106-01	NO/NC (2)	24V	13.8	6.9	82.8	41.4	

**Control Relay - Small Sealed Case (SPDT)**



Part #	Mfg #	Contact Bias	Coil Volts	FLA @277V	LRA @230V	LRA @277V	Price
117427	42-23114-06	NO/NC	24V	20NO, 10NC	60NO, 33NC	60NO, 33NC	

**Ruud Heating & AC Repair Parts**

**Start Relays - Potential Type**



Part #	Mfg #	Hot Pickup (V)	Cold Pickup (V)	Dropout (V)	Max Cont Coil Volt (V)	Start Kit Relay Code	Price
041054	42-25105-01	170-180V	162-175V	40-90V	336V	A	

**Time Delay Relay**



Part #	Mfg #	Time Delay Adj.	Make Time Delay	Voltage Rating	Current Rating Steady State	Current Rating Inrush	Price
042350	42-ICM102	Variable	.03 - 10 Min	18-230 VAC	1.5	15	

**Time Delay Relay**



Part #	Mfg #	Time Delay Adj.	Break Time Delay	Voltage Rating	Current Rating Steady State	Current Rating Inrush	Price
121707	47-23433-93	Fixed	.17 Min	18-30 VAC	1	10	

**Timer Delay**



Part #	Mfg #	Time Delay Adj.	Break Time Delay	Voltage Rating	Current Rating Steady State	Current Rating Inrush	Price
092118	42-ICM	Variable	.17 -16.6 Min	18-230 VAC	1	10	
042351	42-ICM203	Variable	.03 - 10 Min	18-230 VAC	1.5	15	

**Time Delay Relay - On Delay On Break (Anti-Short Cycle)**



42-22655-02

Part #	Mfg #	Time Delay Adj.	Break Time Delay	Voltage Rating	Current Rating Steady State	Current Rating Inrush	Price
044912	42-22655-02	Fixed	5 Min	18-30 VAC	1.5	-	
047231	42-22655-03	Fixed	.5 Min	18-30 VAC	1.5	-	

**Ruud Heating & AC Repair Parts**

**Sequencers**

**Sequencer**

**24V Angle Bracket with (2) Mounting Holes Sequencer**

- DPST-NO



Part #	Mfg #	Poles	Sequencing Off	Sequencing On	Switching	Price
050196	42-23116-08	2	10 - 30	30 - 60	DPST NO	
034057	42-23116-06	2	10 - 40/30 - 160	90 - 160/30 - 60	DPST-NO	
052164	42-23116-09	3	10 - 30	90 - 150/30 - 60	TPST NO	

**Sequencing Relay**

- Flush mount plate w/ mounting hole & tab
- 1/4" Quick connects
- Heater Wattage/ Power Consumption:  
24 VAC/.10A-.18A steady state/.35 - 1.0 amps peak for 0.8 sec



Part #	Mfg #	Poles	Sequencing Off	Sequencing On	Switching	Price
137087	PD425078	2	30 - 60	1 - 30	DPST-NO	
185861	425079	2	1 - 30	30 - 60	DPST-NO	
020492	42-23116-07	3	30-60	10-30	TPST - NO	

**Service Valves**

**Service Valve**

- Front seating valves, isolate sections of a system for servicing and provide a means for refrigerant charging
- All brass corrosion resistant body and solid copper fittings
- Includes 1/4 Flare SAE charge port; communicates with lower fitting when in closed position
- Suitable for R-22 and R-410A, 600 psig maximum working pressure



Part #	Mfg #	Connect	OPP Connect	OAL	Charge Port Location	Price
085196	61-21368-13	3/8" Sweat ODF	3/8" Sweat ODF	4-5/8"	Side	
101321	61-21368-07	3/4" Sweat ODF	3/4" Sweat ODF	5"	Bottom	
096123	61-21368-15	7/8" Sweat ODF	7/8" Sweat ODF	5"	Side	
083261	61-21368-16	7/8" Sweat ODF	3/4" Sweat ODF	5-1/8"	Side	

**Service Valve**



Part #	Mfg #	Description	Price
143354	83-CD8403-6PK	3/16" OD Service Valve	

**Ruud Heating & AC Repair Parts**

**Miscellaneous**

**Remote Sensor for 90 Series®**

- Digital signal output provides superior temperature control, even over long wire runs
- No temperature variance caused by wire resistance
- Choice of styling, indoor models are interchangeable
- Perfect for securing the thermostat in one area or room while sensing temperature in the conditioned space



F145-1378

F145-1328



Part #	Mfg #	Color	Dimensions	Model	Range	Price
102316	F145-1328	Classic White	2-1/8" x 3-1/2" x 3/4"	Indoor	40° to 99°F All Indoor Remote	
101726	F145-1378	Classic White	2-1/8" x 3-1/2" x 3/4"	Outdoor	-40° to 140°F	

**Mixed Air Sensor**

Part #	Mfg #	Description	Price
076571	470010	Mixed Air Sensor	

**Logic Module**

Part #	Mfg #	Description	Price
143968	PD470009	Demand Control Ventilation Economizer Logic Module with Heat Pump Input	

**Start Kit**

- 330 VAC
- 60Hz



Part #	Mfg #	Description	Price
173840	SK-A1	Compatible with RA13, RA14, RA16, RP14, RP15, UA17, & RJMA Units	

**ECM Motor Repair Kit**



Part #	Mfg #	Description	Price
176875	VZREP	ECM Motor Repair Kit	

**Ruud Heating & AC Repair Parts**

**Pressure Switches**

**Pressure Control**

**Low Pressure Control - Auto Reset**



Part #	Mfg #	Description	Price
150872	47-101529-09	50 psig Open Pressure 5/16" Sweat Connection, 90° Elbow End	
249818	47-103670-02	50 psig Open Pressure	
249819	47-103670-04	50 psig Open Pressure	

**High Pressure Control - Auto Reset**



Part #	Mfg #	Description	Price
113929	47-26184-01	610 psig Open Pressure 420 psig Close, 1/4" Swt Connection, Straight Fitting	
163457	47-102290-01	610 psig Open Pressure 420 psig Close	
176655	47-102240-02	15 psig Open Pressure 40 psig close pressure	

**High Pressure Control - Manual Reset**



Part #	Mfg #	Description	Price
177684	47-102431-03	655 psig Open Pressure	
176510	47-23699-03	610 psig Open Pressure	
031417	47-21604-03	Pressure Switch	

**Low Pressure Limit - Auto Reset**



Part #	Mfg #	Description	Price
178391	47-102240-03	50 psig Open Pressure	
141506	47-103670-06	Low Pressure Control	

**Pressure Control Switch**



Part #	Mfg #	Description	Price
161588	42-101225-81	Pressure Switch	
091197	42-101233-81	Pressure Control	
091198	42-101443-89	Pressure Control, 0.45" WC	
091200	42-101443-91	Pressure Control, 0.60" WC	
091311	42-101444-83	Pressure Control, 1.00" WC	
091438	42-101445-83	Pressure Control, 0.40" WC	
083509	42-101447-07	Pressure Control	
098938	42-101447-86	Pressure Control, 1.80" WC	
107479	42-101447-89	Pressure Control, 1.95" WC	
091542	42-101511-84	Pressure Control	
128891	42-101955-02	Pressure Switch for RGRC034T 074T 105T	
137097	42-101955-08	Pressure Switch for RGRC Drain	
109677	42-101956-09	Pressure Switch for RGRC RGTC Vent	
109679	42-101956-10	Pressure Control, 1.20" WC	
128890	42-101956-12	Pressure Switch for RGRC Vent	
107812	42-102056-01	Dual Pressure Control, -0.80" & -1.30" WC	
112161	42-102056-02	Dual Pressure Control, -0.60" & -1.08" WC	
107814	42-102056-03	Dual Pressure Control, -0.86" & -1.20" WC	
125747	42-102056-05	Dual Pressure Control, -0.40" & -0.60" WC	
107813	42-102056-06	Dual Pressure Control, -0.66" & -1.30" WC	
123676	42-102056-13	Dual Pressure Control, -0.30" & -0.50" WC	
136527	42-102056-22	Dual Pressure Control, -0.40" & -0.30" WC	
145463	42-102056-25	Dual Pressure Control	
145462	42-102056-26	Dual Pressure Control	
145461	42-102056-27	Dual Pressure Control	
145460	42-102056-28	Dual Pressure Control	
160008	42-102069-01	Pressure Switch Assembly	
162412	42-102069-06	Pressure Switch Assembly	
162413	42-102070-14	Pressure Switch Assembly	
162414	42-102070-18	Pressure Switch Assembly	
127334	42-103193-01	Dual Pressure Control	

**Ruud Heating & AC Repair Parts**

**Pressure Switches (Continued)**

**Low Pressure Limit - Auto Reset  
Pressure Control Switch**

Part #	Mfg #	Description	Price
186615	42-105601-10	Pressure Switch Assembly	
	5		
089690	42-24194-01	Pressure Switch	
091194	42-24194-82	Pressure Control	
080580	42-24195-03	Pressure Control, for UGRA UGFD 90RS 90RT	
135420	42-24195-81	Pressure Control, 0.50" WC	
080915	42-24196-81	Pressure Control, For UGRA UGFD 90RS	
083251	42-24196-82	Pressure Control	
083259	42-24196-83	Pressure Control	
081061	42-24196-84	Pressure Control	
082670	42-24197-01	Dual Pressure Control, -0.80" & -1.30" WC	
138441	SP20313	Pressure Switch	
162415	42-102070-05	Pressure Switch	

**Ignition Controls & Other Boards**

**Control Boards**

Part #	Mfg #	Description	Price
247921	47-105221-01	Power Inverter - 3.7 kW	
249670	47-105369-02	Control Board - EEV	
249814	47-105395-02	Control Board - EcoNet	
129524	47-100436-02	Control Board for X-13 Motor	
115784	47-102090-82	Control Board for UARL	
163875	47-102090-93	Control Board Kit - Communicating	
186557	47-102077-03	Control Board - ECM	
129219	62-102635-81	Control Board	
110554	62-102636-01	Integrated Furnace Control Board	
133313	62-102860-01	Integrated Control Board	
127527	62-103189-01	Integrated Furnace Control Board	
145473	62-103565-01	Integrated Furnace Control Board	
145475	62-103578-01	Inducer Control Board	
160036	62-104058-02	Integrated Furnace Control Board	
162408	62-104059-01	Integrated Furnace Control Board	

**Ignition Controls & Other Boards  
(Continued)**

**Control Boards**

Part #	Mfg #	Description	Price
241754	62-104061-04	Integrated Furnace Control Board	
222724	62-105217-01	Integrated Furnace Control Board	
241741	62-106321-01	Integrated Furnace Control Board	
150560	62-23599-05	Integrated Furnace Control Board	
081759	62-24140-04	Integrated Furnace Control Board Direct Spark	
093116	62-24174-02	Modulating Control Board	
082900	62-24268-03	Hot Surface Igniter and Integrated Furnace Control	
115091	62-25338-01	Control Board	
071437	62-42506-02	Integrated Furnace Control Board	
033177	62-25341-81	Integrated Furnace Control Board	

**Fan Control Board**



47-22827-83

Part #	Mfg #	Description	Price
009374	47-22445-01	Fan Control Board	
009386	47-22827-83	Fan Control Board	
009378	47-22481-81	Fan Control Board	

**Ignition Module**



Part #	Mfg #	Description	Price
127446	620044	5059-134 Ignition Module White-Rodgers 24V Intermittent Pilot Ignition	



**Ruud Heating & AC Repair Parts**

**Ignition Control**



Part #	Mfg #	Description	Price
086472	62-24181-01	Ignition Control/Direct Spark Ignition	
053123	62-25078-02	Ignition Control	
009561	62-22578-01	Ignition Control Module - HSI	

**Flame Sensor**



Part #	Mfg #	Description	Price
009582	62-23543-01	Flame Sensor Rod, 2-1/2"L Mnt Flg to Sensor Tip 1-9/16"L Sensor Offset 90° Angle Sensor Offset	
051177	62-23543-02	Flame Sensor Rod, 2-1/16"L Mnt Flg to Sensor Tip 1-13/16"L Sensor Offset 90° Angle Sensor	
128886	62-23543-06	Flame Sensor	
036437	62-24044-71	Non-Integrated w/ Mnt Brackets for Ribbon & Inshot Style Burners & 62-23543-01 Igniter	
141681	SP15129	Flame Sensor with Gasket and Mounting Screw	
144183	SP20172	Flammable Vapor Sensor Kit with Cap Plug	

**Ignitors & Flame Sensors**

**Igniters**



Part #	Mfg #	Description	Price
145476	62-103541-01	Hot Surface Igniter	
009550	62-21747-02	Igniter	
009563	62-22669-92	Igniter	
009574	62-22868-93	Igniter	
051183	62-23556-03	Igniter	
137901	62-23556-08	Direct Spark Igniter	
137712	62-23556-10	Igniter	
119752	62-23556-82	Igniter	
051711	62-24141-04	Direct Spark Ignition (DSI)	
160039	62-24141-05	Direct Spark Ignition (DSI)	
042260	62-24164-01	Direct Spark Ignition (DSI)	
166512	SP20794	NG Igniter with Gasket and Mounting Screws	

**Heat Exchangers**

**Heat Exchanger**



Primary



Secondary



Turbulex

Part #	Mfg #	Description	Price
142996	AS-59066-89	Heat Exchanger	
142994	AS-59066-90	Heat Exchanger	
092267	AS-61805-16	Heat Exchanger Assembly	
083250	AS-61805-18	Heat Exchanger	
083242	AS-61805-17	Heat Exchanger Assembly	
110398	AS-61805-20	Heat Exchanger Assembly	
093422	AS-61849-16	Heat Exchanger	

**Transformer**



Part #	Mfg #	Description	Price
160017	46-24124-06	Transformer 120V	

**Discharge Air Sensor**



Part #	Mfg #	Description	Price
154552	470023	Discharge Air Sensor	

**Traps & Connectors**

**Vent Transition**

Part #	Mfg #	Description	Price
080464	68-24047-10	Vent Transition	

**Ruud Heating & AC Repair Parts**

**Condensate Trap Assembly**



Part #	Mfg #	Description	Price
009615	68-24048-01	Condensate Trap Assembly	
080873	68-100651-01	Trap Assembly for UGRK	
021617	68-24021-01	Pipe-Outlet Air	
160002	68-104346-01	Condensate Drain	

**Vent Termination Kit**

• For gas furnace



Part #	Mfg #	Description	Price
135776	SP20245	Concentric Vent Termination Kit for 3" PVC	

**Connection/Transition**

Part #	Mfg #	Description	Price
025662	68-24047-08	Connection/Transition	
125740	68-103061-01	Connection/Transition Assy	

**Trap**



Part #	Mfg #	Description	Price
020322	68-24120-01	Horizontal Trap	

**Trap Assembly Connector**

Part #	Mfg #	Description	Price
022339	68-24047-07	Trap Assembly Connector	
022340	68-24047-09	Trap Assembly Connector	

**Furnace Accessories**

**Gas Valve Conversion Kit**

Part #	Mfg #	Description	Price
031644	60-21193-02	White Rodgers 36E Series LP to Natural Gas Kit	
166053	60-22513-04	Honeywell VR8205 Series Natural Gas to LP	
031639	60-23430-03	Robertshaw 7200 Series LP to Natural Gas Kit	
243423	EP-94D	LP Conversion Kit	
058453	FP-15	Conversion Kit NAT/LPG	
151024	FP-31	HK LP Conversion Kit	
158962	FP-33	JC LP Conversion Kit for 1-Stage	
158963	FP-34	LP Conversion Kit for 2-Stage	
235100	FP-38	LP Conversion Kit for 1-Stage	
185112	FP-37	LP Conversion Kit	
158961	RXGY-ZK	Zero Clearance Downflow Conversion Kit	

**Filter Cores**

**Filter Core**

Part #	Mfg #	Description	Price
149940	83-F48	Filter Core	
149943	83-H48	Filter Core	

**Drier Core**

Part #	Mfg #	Description	Price
149941	83-W48	Drier Core	
149942	83-W100	Drier Core	

**Solid Furnace Bottoms**



Part #	Mfg #	Description	Price
073627	AE-61874-01	AE-61874-01 Solid Bottom 14"	
022627	AE-61874-02	AE-61874-02 Solid Bottom 17"	
022628	AE-61874-03	AE-61874-03 Solid Bottom 21"	

**Ruud Heating & AC Repair Parts**

**Solid Furnace Bottoms (Continued)**

Part #	Mfg #	Description	Price
073628	AE-61874-04	AE-61874-04 Solid Bottom 24"	

**Pilots & Orifices**

**Orifice**



Part #	Mfg #	Description	Price
049438	62-22175-50	Orifice	

**Pilot**



Part #	Mfg #	Description	Price
009572	62-22864-82	Pilot	

**Pilot Burner**



Part #	Mfg #	Description	Price
038148	62-21609-01	Pilot Burner	

**Pilot Orifice**



Part #	Mfg #	Description	Price
009543	62-21489-01	Pilot Orifice	
009545	62-21612-02	Pilot Orifice	
009548	62-21743-05	Pilot Orifice	
009552	62-21883-01	Pilot Orifice	

**Pilot Safety**



Part #	Mfg #	Description	Price
009540	62-21426-02	Pilot Safety	

**Pilot Sensor**



Part #	Mfg #	Description	Price
009549	62-21744-01	Pilot Sensor	
160037	62-23543-08	Flame Sensor	

**Drain Pans**

**Drain Pan**



Part #	Mfg #	Description	Price
229624	68-101805-81	14" 4-Row Drain Pan	
159621	68-101805-82	17" Drain Pan Vertical 6 Row	

**Door Switches**

**Door Switch**



42-21268-04

Part #	Mfg #	Description	Price
050499	42-21268-04	Door Switch	
123748	42-22692-06	Push Button Door Switch	
125543	42-22692-09	Door Switch	
160012	42-22692-10	Door Switch	

**Burners**

Part #	Mfg #	Description	Price
035443	75-22840-02	Burner Tube - Inshot	
028110	75-24001-01	Burner Head Kit	
061420	AS-60993-03	Burner Halves Assembly	
103698	AS-60993-06	Burner	
043357	AS-61984-04	UGRA 1-Pc Burner	
043358	AS-61984-05	UGRA 1-Pc Burner	
043359	AS-61984-06	UGRA 1-Pc Burner	
043360	AS-61984-07	UGRA 1-Pc Burner	
043361	AS-61984-08	UGRA 1-Pc Burner	

**Ruud Heating & AC Repair Parts**

**Burner Support**

Part #	Mfg #	Description	Price
111992	AE-61809-15	Burner Support	
109627	AE-61809-12	Burner Support	

**Anti-Vibration Pads**

**EVA Anti-Vibration Pad**

- 2"x2"x7/8"

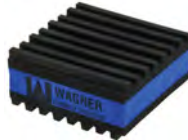

Part #	Mfg #	Description	Price
156821	864011	2"x2" Anti-Vibration Pad	
156822	864013	4"x4" Anti-Vibration Pad	

**Miscellaneous**

**Water Sensor**



Part #	Mfg #	Description	Price
160034	47-104184-01	Water Sensor	

**Jumper Kit**

Part #	Mfg #	Description	Price
101893	RXBJ-A21	Jumper Kit	

**Blower Parts**

Part #	Mfg #	Description	Price
102437	70-42540-04	1" Shaft	

**Choke**



Part #	Mfg #	Description	Price
052335	46-24256-02	Power Factor Choke	

**Tubing**



Part #	Mfg #	Description	Price
020713	79-21491-83	Silicone Tubing	
162989	79-24182-83	Santoprene Tubing, 31-1/2"L, 2 Hose Clamps	
173578	79-21491-93	Silicone Tubing, 120"	

**Sheath Heater Kit**

Part #	Mfg #	Description	Price
037996	AS-58386-92	Sheath Heater Kit 3.5kW	

**Solenoid Assembly**

Part #	Mfg #	Description	Price
044160	61-25055-08	24V Solenoid Assembly	

**Bearing**



Part #	Mfg #	Description	Price
097430	70-41854-02	Ball Bearing With Lock	

**OEM Neoprene Gasket**

- Suitable for temperature range of -70° to 250°F
- Meets UL94HFI and UL94HBF flammability tests



Part #	Mfg #	Description	Price
059148	68-22079-81	1-1/8"W 25'L 5/16" Thick	

**ShuBee Shoe Covers**

- Waterproof
- Box of 40 pairs



Part #	Mfg #	Color	Price
166026	849120	Dark Blue	

**Ruud Heating & AC Repair Parts**

**Novent R410 Locking Cap**

- 50 Pack
- Tamper resisant

Part #	Mfg #	Size	Color	Price
209945	86683	1/4" Thread	Pink	

**Replacement Parts and Accessories**

Part #	Mfg #	Description	Price
111991	AE-61913-02	Overtemperature Switch Bracket	
145536	SP14410	Piezo Igniter with Bracket	
160006	68-104446-01	Parts Bag	
162200	45-22980-05	Button Plug	
107681	1000	FAST-STAT Wire Extender	
161388	AS-58922-01	Turbulator	
168203	6231	Cold Weather Kit - GEN15ADC-E, GEN16AD-E, GEN20AD-E	
180506	630500	SMART Flow Elbow	
230606	RXGY-J02	Sensor Kit - Outdoor	
047567	68-24022-02	Gasket - Outlet Air	



## Ruud Heating & AC Repair Parts

### Ruud Accessories

#### Expansion Valve Kit (TXV)



Part #	Mfg #	Description	Price
236848	PD619062	TXV, R-22 Refrigerant	

#### RXCT - Expansion Valve Conversion Kit

- Use to convert RCBA indoor coils to RCGA/RCGJ/RCHA and RCHJ coils



Part #	Mfg #	Description	Price
132107	RXCT-FBA	R410 Universal TXV Repl Kit	
133834	RXCT-EBA	TXV R22 Universal 2 Ton	
132108	RXCT-FBB	R410 Univ TXV Repl Kit	
132109	RXCT-FBC	Expansion Valve Kit	
132110	RXCT-FBD	TXV Universal Kit	

### Controls

Part #	Mfg #	Description	Price
173851	RXAB-A07	High Pressure Control	
173850	RXAC-A07	Low Pressure Control	
130488	RXRZ-C02	Low Ambient Control	

### RXGF - Media Air Cleaner



RXGF-CB



RXGF-CC



RXGF-CD

Part #	Mfg #	Outside Dimensions	Price
132422	RXGF-CB	Bottom Mount 24-1/4"W x 28-1/4"L x 3-1/2"H	
020727	RXGF-CC	Top Mount Filter Rack - Gas Downflow	
158964	RXGF-CD	Side Return Filter Rack - Gas Upflow	

### External Filter Rack

- Upflow - Electric
- Duct configuration: Through
- Air opening inlet/outlet: 15-3/4" x 19-1/2"
- Housing overall: 17-1/2" x 21" x 3-5/8"
- Hinged door - opening on 17-1/2" side
- Replacement media dimensions: 16" x 20"



Part #	Mfg #	Description	Price
147301	RXHF-17	External Filter Rack - Electric Upflow	
158306	RXHF-21	External Filter Rack - Electric Upflow	

### RXMG - Label Kit

Part #	Mfg #	Description	Price
105390	RXMG-AU	Ruud Label Kit	
127216	RXMG-AY	WeatherKing Label Kit	

### RXBH - Heater Kit



Part #	Mfg #	Description	Price
133645	RXBH-1724A18J	18kW 208-230/1/60	
133870	RXBH-1724A13J	12kW 208-230/1/60	

### Repair & Replacement Parts

Part #	Mfg #	Description	Price
236864	43-25136-21	4/440 Sngle Rnd Capacitor	

### Drain Trap

Part #	Mfg #	Description	Price
125544	791000	Tubing Drain Trap	
125548	791001	Tubing Drain Trap	





## Ruud Heating & AC Repair Parts

### Gas Valve



Part #	Mfg #	Description	Price
009506	60-22525-03	Gas Valve	
009507	60-22525-04	Gas Valve	
236634	60-102787-85	Gas Valve	
009508	60-22525-05	Gas Valve	

### 36J Series Gas Valve

- Natural gas
- 1/2" NPT
- Hot surface/direct spark



Part #	Mfg #	Description	Price
175965	60-103901-02	36J Series White Rodgers	

### Induced Draft Blower with Gasket

- Polymeric
- 460V
- 60Hz



Part #	Mfg #	Side of Discharge	Price
241412	70-42242-01	Left	

### Ignition Control



Part #	Mfg #	Description	Price
034342	62-24084-82	Ignition Control Board	

### Igniter



Part #	Mfg #	Description	Price
137361	AP14698B	NG Igniter Assembly	
137360	AP14700B	LP Igniter Assembly	

### Pressure Switches

Part #	Mfg #	Description	Price
240688	42-105499-07	Pressure Switch	
240687	42-105499-09	Pressure Switch	
239326	42-105583-04	Pressure Switch	
239320	42-105583-08	Pressure Switch	
240689	42-105583-11	Pressure Switch	
240690	42-105583-12	Pressure Switch	

### Vent Damper



Part #	Mfg #	Description	Price
145411	AP15561	Vent Damper	



## Furnace Accessories

### Ruud Furnace Accessories

#### Integrated Furnace Control Board

- IFC



Part #	Mfg #	Description	Price
155291	62-102636-81	Integrated Control Board	
246259	62-105563-02	Integrated Control Board	

#### Low Ambient Control

- Auto reset
- Low pressure limit
- Open pressure: 150 psig
- Close pressure: 275 psig
- Includes 36" capillary tube
- 1/4" Flare (Female SAE) connection size



Part #	Mfg #	Description	Price
090119	47-25343-82	Low Ambient Control	

#### RXGP - Twinning Kit

Part #	Mfg #	Description	Price
138545	RXGP-F03	For Use w/Gas Furnaces for Parallel Operations	

#### ERV/HRV - Vent Termination Kit

Part #	Mfg #	Description	Price
155994	84-ERVHRV	HEPA Vent Termination	

#### RXGY - Vent Termination Kit

- For gas furnace

Part #	Mfg #	Description	Price
087666	RXGY-G01	Horizontal Vent Termination for 3" PVC	
097398	RXGY-G02	Horizontal Vent Termination for 2" PVC	

#### Conversion Kits

Part #	Mfg #	Description	Price
158960	RXGY-CK	Downflow/Horizontal Conversion Kit	

#### RXPF - Fossil Fuel Kit

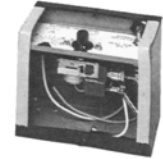

Part #	Mfg #	Description	Price
032692	RXPF-F01	Fossil Fuel Kit - Standard	

#### RXRY - Filter Kit

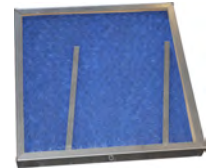

Part #	Mfg #	Description	Price
085898	RXRY-B01	For Vertical or Horizontal Discharge in RQKA & RQMA	

### Furnace Repair & Replacement Parts

Part #	Mfg #	Description	Price
074120	60-21193-01	Gas Valve Spring Kit White-Rodgers F92-0659	
083260	60-22513-03	Gas Valve Spring Kit Honeywell 396221-2	
031641	60-23430-01	Gas Valve Spring Kit Honeywell 394588	

#### Conversion Kit - NG - LP

Part #	Mfg #	Description	Price
025489	FP-02	Nat-LP Conversion Kit	
058453	FP-15	Nat-LP Conversion Kit	
100705	FP-21	Nat-LP Conversion Kit	
121685	FP-26	Nat-LP Conversion Kit	
129578	FP-27	Nat-LP Conversion Kit	

#### Enthalpy Sensor

- Direct replacement for 470008



Part #	Mfg #	Description	Price
124299	470011	Enthalpy Sensor	

## Ruud Heating & AC Repair Parts

### Motors

#### Motor Mount - Flex Bracket

- Torsion flex bracket



Part #	Mfg #	Description	Price
198041	DMB-1	Fits 5-1/2" Diameter Motors	
139342	DMB-3	Fits 5-1/2" Diameter Motors	

#### Multiple Horsepower Blower Motor

- Reversing plugs
- Extended thru bolts
- 36 inch leads
- Designed for 370 volt capacitors.
- Installs with all 48 mounting brackets.



Part #	Mfg #	Description	Price
198034	WG840463	1/6-1/2 HP-FLA 115V Blower Motor	
198035	WG840464	1/6-1/2 HP-FLA 208-230V Blower Motor	
198036	WG840466	1/5-3/4 HP-FLA 115V Blower Motor	
198037	WG840467	1/5-3/4 HP-FLA 208-230V Blower Motor	

#### Multiple Horsepower Condenser Fan Motors

- Reversing plugs
- Extended thru bolts
- 36 inch leads
- Designed for 370 volt capacitors
- Installs with all 48 frame mounting brackets.



Part #	Mfg #	Description	Price
198038	WG840465	1/6-1/3 HP-FLA 208-230V Condenser Fan Motor	
198039	WG840468	1/5-1/2 HP-FLA 208-230V Condenser Fan Motor	
198040	WG840469	1/6-1/2 HP-FLA 208-230V Condenser Fan Motor	

### Direct Drive Furnace Blower Motors

- Installed with standard 48 frame mounting brackets
- Quiet operator and electrically reversible
- Automatic Thermal Overload Protector
- Class B insulation
- 30in. leads and 60 HZ with low power consumption
- Standard 48 frame motor casing size
- Drain holes with plugs on both end plates
- Continuous air over
- 60 C Ambient Design with Extended Studs.



Part #	Mfg #	Description	Price
198021	WG840583	1/4 HP 4.6 FLA 115V Blower Motor	
198022	WG840584	1/4 HP 2.2FLA 208/230V Blower Motor	
198023	WG840585	1/3 HP 6.7 FLA 115V Blower Motor	
198024	WG840586	1/3 HP 2.9 FLA 208/230V Blower Motor	
198025	WG840587	1/2 HP 10.2 FLA 115V Blower Motor	
198026	WG840588	1/2 HP 5.0 FLA 208/230V Blower Motor	
198027	WG840589	3/4 HP 11.3 FLA 115V Blower Motor	
198028	WG840590	3/4 HP 5.4 FLA 208/230V Blower Motor	
206600	WG840595	1HP 12.6 FLA 115V Blower Motor	

## Ruud Heating & AC Repair Parts

### Single Speed Condenser Fan Motors

- *Installs with all standard 48 frame mounting brackets*
- *Quiet operator and electrically reversible*
- *Includes Automatic Thermal Overload Protector*
- *Class B insulation*
- *370V Capacitor*
- *Standard 48 frame motor casing size*
- *2.5in. diameter hub rings included.*



Part #	Mfg #	Description	Price
198029	WG840727	1/6 HP 1.3 FLA 208/230V Condenser Fan Motor	
198030	WG840728	1/4 HP 2.2 FLA 208/230V Condenser Fan Motor	
198031	WG840729	1/3 HP 2.8 FLA 208/230V Condenser Fan Motor	
198032	WG840730	1/2 HP 4.2 FLA 208/230V Condenser Fan Motor	
198033	WG840731	3/4 HP 4.5 FLA 208/230V Condenser Fan Motor	



## Repair Parts

### Faucet Parts

#### Crown-Rinse Spray Head

Part #	Mfg #	Description	Price
257337	1654005	Chrome	
190767	1654000	Black	
190768	1656000	Black w/ Hose Assembly	

#### Basin Rosettes



Part #	Mfg #	Description	Price
254325	1646002	Flat	
254327	1646004	Deep	

### Misc. Parts

#### 4-Way Sillcock Key

- Fits stems 1/4", 9/32", 5/16" and 11/32"



Part #	Mfg #	Description	Price
252717	0421004	Fits stems 1/4", 9/32", 5/16" and 11/32"	

#### Moen Cartridge Removal Tool

- An alternative to the gold key pattern for removal of plastic and brass Moen cartridges



Part #	Mfg #	Description	Price
054583	1849001	T-Handle	

#### Washing Machine Hose

- 3/8" ID
- Double female



Part #	Mfg #	Description	Price
085189	0802004	3/4" FHT x 5'	

#### Black & White Graphite Packing Spools

- Non-asbestos
- Reclosable spool

Part #	Mfg #	Description	Price
045476	1900002	1/4" , 8ft roll	

### Wall-Hung Toilet Carrier Cap

- Each bag contains 4 nuts & 4 washers



Part #	Mfg #	Description	Price
125755	2405002	Standard	

### Test Plugs and Balls

#### Drain-King® Drain Cleaner



Part #	Mfg #	Description	Price
046572	1821002	1-1/2" - 3"	

## Water Right Repair Parts

### Installation Fittings

Part #	Mfg #	Description	Price
126558	CV-3007	1" PVC Male NPT 90° Assembly	
066030	CV-3007-02	1" Brass Sweat Assembly	
066031	CV-3007-03	3/4" Brass Sweat Assembly	
134871	CV-3007-12	3/4" Shark Bite Assembly	
129386	CV-3150	Split Ring	
121817	CV-3005-2	Spacer Stack Assembly	

### Replacement Parts

Part #	Mfg #	Description	Price
075129	CH1072-01	18" dia Salt Grid with 4" Hole	
073577	FP-60049	Plastic Bypass Assembly	
074255	CS-1448-RS	35 gal Replacement Membrane for WRO035	

### Accessories

Part #	Mfg #	Description	Price
101608	HT-5B	Water-Right Hardness Kit	
113671	FP60066	Brine Valve Water-Right	
148693	CU7002	Water Sample Bottle	
150670	RO12N	1.5# Softener Rust Out	
099934	VA-2	Better Air Gap	
192000	M-G20	W-R Gravel Per 1# Bag	





---

---

## Watts Regulator Repair Parts

---

---

### Dielectric Union Kits

#### 3000 Series Dielectric Union Gasket Kit

Part #	Mfg #	Model	Size	Price
030973	0881401	GAB KIT	3/4"	
030972	0881402	GAC KIT	1"	
030971	0881403	GAD KIT	1-1/4"	
030970	0881404	GAE KIT	1-1/2"	
030969	0881405	GAF KIT	2"	

## Weil McLain Repair Parts

### Weil-McLain Boiler Parts & Components

Part #	Mfg.#	Description	For	Price
241885	381-330-027	Ignition Board		
110792	382-200-449	Conversion Kit, NG, from Cycle Pilot System to Gold control HSI		
011885	382-930-216	10C523 Igniter Kit	VHE, HE II	
076751	383-500-345	Repair Plug Kit		
128037	383-500-603	(5) Ultra U-Control Module Fuses, 3A, Fast-Blow AG	F1	
145731	383-500-604	(5) Ultra U-Control Module Fuses, 12A, Slow-Blow AG	F2	
066016	383-500-190	Control Module for All 1 and 2 Ultra Boilers		
237635	383-500-665	Control Module - Ultra Series 1 & 2 Boilers		
129778	383-500-622	Heat Exchanger Replacement Kit	230	
129779	383-500-623	Heat Exchanger Replacement Kit	310	
128030	383-600-069	Low Water Cut-Off		
239617	383-900-064	Evergreen 220 LP Kit		
076395	389-900-203	WMCR-3 3 Zone Circulator Control		
045038	389-900-205	6 Zone Circulator Control		
138955	389-900-206	WMZV-4 4 Zone Valve Control		
136985	389-900-220	BCP-3 Hydronic Multi-Stage Boiler Control Panel		
011893	510-218-099	10C034 Tridicator Gauge, 2-1/2" Short Shank	GV, GO, CG Prior to Jan 2000	
101982	510-300-014	210°C Spill Switch with Reset	CG Sect/Base Series 1-12	
127719	510-312-015	High Limit Temperature Control	HE II, HE, VHE	
011899	510-312-166	10C053 Combination 120/24V Transformer-Relay Receptacle	CG, AHE, EGH, HE II, HE, PFG	
116334	510-312-218	Outdoor Temp Sensor		
038133	510-312-250	10C055 Limit Control & 1/2" Well	CG, CGm, EGH, PFG	
021051	510-312-312	10C567 Blower Motor Assembly	HE II, HE	
011904	510-312-317	10C579 Motor Repl Kit	VHE	
239431	510-312-361	399 MBH Blower Motor Assembly	7050-0118	
011909	510-350-223	10C072 Control Relay, DPST 24V	AHE, CG, EG, EGH, HEII, PFG	
032886	510-811-221	Pilot Assembly NG		
032887	510-811-222	Pilot Assembly Propane		
011913	510-811-362	NG-LP Conversion Kit	CG 25 - 6	
107651	510-811-502	24V Combination Ignition-Sensing Control Module		
022497	510-811-644	Pilot Assembly Kit		
011922	510-811-655	10C528 NG Valve	HE, HEII, VHE	
011923	510-811-656	10C529 Step Open LP Gas Valve	HE, HEII, VHE	
044138	511-044-382	Gas Valve 3/4" x 3/4" NG 10C489		
078890	511-114-479	63m Low Water Cut-off		
078891	511-114-526	w/McLain LWCO 150smd M&M 17180 672619142831		
059929	511-330-081	LP Pilot Burner Assembly		
011934	511-330-095	Ignition Module 10C486	CG, EG, EGH, PFG	
019926	511-330-184	Igniter Only 10C455	HE/VHE	
011943	511-330-186	Pilot Burner Assembly		
011944	511-330-192	Flame Sensor 10C188	HE, VHE	
011945	511-330-197	Pilot Burner	E38-2 24V	

## Weil McLain Repair Parts

### Weil-McLain Boiler Parts & Components (Continued)

Part #	Mfg.#	Description	For	Price
073640	511-330-218	Pin Pilot Burner 10C481	CG	
064739	511-330-221	Pilot Burner Assembly with Ignition Lead and Orifice PSE-NA16		
011947	511-624-510	Switch .95 Pressure Switch 3-5 2, 000'-4, 000' 10C213	HE	
011948	511-624-514	Pressure Switch 51.2 Pressure Switch VHE 2000'-4000' 10C215		
074480	511-724-259	Thermopile for EG-75		
038426	511-724-274	Main Flame Sensor		
011956	512-050-230	Thermal Fuse 10C257	CG, EG, HE, PFG, VHE	
056344	512-200-000	Steel Burner Tube		
056346	512-200-001	Steel Burner Tube with Bracket		
118676	512-200-035	Burner	HE VHE CGI	
011958	512-200-045	Pilot Burner 10B867		
127431	540-131-052	X100 Sentinel Corrosion Inhibitor Kit		
127432	540-131-053	X100 Sentinel Corrosion Inhibitor Kit		
127433	540-131-054	X100 Sentinel Corrosion Inhibitor Kit		
011968	560-742-860	Pilot Tubing		
020911	590-317-610	Blower Gasket		
015274	590-735-140	1/2" x 100" Glass Rope 10B985		
086820	591-200-000	Cover Plate Gasket/Insulation		
239521	591-222-025	Front Base Insulation		
114285	591-706-200	Heat Exchanger Cleaning Tool		
011981	591-706-214	Flue Brush 11B146		
011985	592-800-011	2" Square Cut Seal		
127434	592-900-002	Sentinel X-100 Corrosion Inhibitor Concentrate		
127632	592-900-003	X400 Cleaner		
239853	633-600-012	AcuTemp Thermostat Repair Kit	Series 2	
059875	633-900-102	Thermostat with Cover Plate Kit for Plus Water Heaters		
094665	633-900-130	Gold Plus Thermostat Kit		
011986	635-100-010	Kit Thermostat Plus		

### Vent Damper

Part #	Mfg.#	Description	Price
019945	381-800-474	4" Vent Damper	
019946	381-800-475	10C081 5" Vent Damper for EG30/35	
019944	381-800-476	6" Damper Assembly CGM,EG	
019947	381-800-477	7" Damper Assembly CGM,EG,PFG	
030770	381-800-478	10C478 8" Vent Damper for EG65/75	

### CGa Series Accessories

Part #	Mfg.#	Description	For	Price
146736	381-357-313	Pilot less Ignition for Natural Gas Boilers	CGa-8	
049683	450-021-245	CGa-7 Draft Hood Vertical		

## Weil McLain Repair Parts

### Weil-McLain Boiler Parts & Components (Continued)

#### CGa Series Accessories

Part #	Mfg.#	Description	For	Price
032392	450-021-246	CGa-8 Draft Hood Vertical		
242387	510-811-946	NG-LP Conversion Kit	CGa 25 - CGa 7	
242388	510-811-947	LP Kit	CGa-8	
050610	512-200-077	CGa Main Stainless Steel Burner Tube		
065995	512-200-079	CGa Stainless Steel Burner with Pilot Bracket LP		

#### CGi Series Accessories

Part #	Mfg.#	Description	For	Price
058742	511-330-090	Control Module with 10 Second Pre-purge		
064887	510-312-167	Transformer		
059928	511-330-080	Pilot Assembly Kit NG		

#### CGm Series Accessories

Part #	Mfg.#	Description	For	Price
041152	511-044-256	NG Valve	CGm 7-8	

#### CGs Series Accessories

Part #	Mfg.#	Description	For	Price
017582	311-103-818	Intermediate Section Assembly		

#### CGt Series Accessories

Part #	Mfg.#	Description	For	Price
112055	380-000-000	Combination Pressure-Temperature Gauge Kit, 60° - 360°F	CGt Series	

#### PFG Series Accessories

Part #	Mfg.#	Description	For	Price
011912	510-512-337	Vent Damper Motor Operator		
024710	511-044-287	NG Control Valve, 1" x 1" NPT	PFG	

#### Ultra Series Accessories

Part #	Mfg.#	Description	For	Price
109058	383-500-021	Time Delay/Relay Box		
066027	383-500-025	Gas Valve Kit	Ultra 155	
066028	383-500-030	Gas Valve/Venturi Kit	Ultra 230	
066022	383-500-035	Blower Assembly	Ultra 155	
066024	383-500-040	Blower Assembly	Ultra 230	
066039	383-500-045	Ignition Electrode Kit	Ultra 80 & 105	
066042	383-500-055	Flue Temperature Sensor Replacement Kit		
066040	383-500-085	Burner Replacement Kit	Ultra 155	

## Weil McLain Repair Parts

### Weil-McLain Boiler Parts & Components (Continued)

#### Ultra Series Accessories

Part #	Mfg.#	Description	For	Price
130501	383-500-095	Watts #330 300 psi Pressure Relief Valve, ASME		
120566	383-500-105	3" Vent Termination Bird Screen	Ultra 80, 105, & 155	
105545	383-500-110	4" Vent Termination Bird Screen	Ultra 230 & 310	
066021	383-500-125	Outdoor Temperature Sensor		
066017	383-500-195	115VAC / 24VAC, 50-60Hz, 50 VA Honeywell Transformer		
093857	383-500-210	Pressure/Temperature Gauge Assembly		
143606	383-500-235	5 Amp Fast-Blow Fuses	Circulator Circuit 5/Pk	
143607	383-500-240	4 Amp Slow-Blow Fuses	24-Volt Circuit 5/Pk	
086818	383-500-250	Cover Plate Gasket/Insulation	Ultra 155, 230, & 310	
086819	383-500-255	Cover Plate Gasket	Ultra 155, 230, & 310	
074417	383-500-360	Blower Assembly Kit	Ultra 310	
074418	383-500-390	Gas Valve/Venturi Kit	Ultra 310	
133205	383-500-395	Cover Plate Replacement Kit	Ultra 155 & 230	
116337	383-500-408	Display Board/Bracket Assembly	Ultra 155/230	
121565	383-500-600	Flue Temperature Sensor Replacement Kit		
116333	383-500-601	System Temperature Sensors		
116331	383-500-602	Return/Supply Sensor Kit, (1) Sensor		
120435	383-500-605	Maintenance Kit	Ultra 80 and 105	
120436	383-500-620	Maintenance Kit	Ultra 155, 230, 299, & 399	
129776	383-500-621	Heat Exchanger Kit	Ultra 155	
120152	383-500-628	120V/24V Transformer		
133206	383-500-630	Pressure/Temperature Gauge Assembly		
130577	383-500-649	Ultra Easy-Up Manifold Kit, 1-1/4" Piping	UG 80 & 105	
133204	383-500-650	Blower Assembly Kit	Ultra 399	
133203	383-500-652	Gas Valve Kit	Ultra 399	
127630	383-500-658	Control Module		
127885	383-500-659	Display Board Assembly		
074410	383-501-027	Blower Assembly Kit	Ultra 80 & 105	
074411	383-501-029	Gas Valve/Venturi Kit	Ultra 80	
074413	383-501-030	Gas Valve/Venturi Kit	Ultra 105	
125176	511-100-005	LWCO with Harness & Test Button		
090744	511-405-133	Taco 0014 Boiler Circulator, less Flanges	Ultra 155, 230, & 310	
107709	590-317-310	Gasket Cork		

#### Ultra Commercial Series Accessories

Part #	Mfg.#	Description	For	Price
127629	383-600-065	Watts 174A 80 psi Relief Valve, 3/4" x 3/4", 1,400 mbh Capacity		
143176	383-600-079	Maintenance Kit		

## Weil McLain Repair Parts

### WM97+ Series Accessories

Part #	Mfg.#	Description	For	Price
146863	383-700-113	Igniter, Gasket and Screw	WM97+ 70 & 110	
146859	383-700-139	Ignition Control	WM97+ 70 & 110	
146870	383-700-157	Piping Assembly Blower & Clip	WM97+ 70 & 110	
146871	383-700-159	Piping Assembly Gas Valve	WM97+ 70	
146872	383-700-160	Piping Assembly Gas Valve	WM97+ 110	
146860	511-724-292	Flue Sensor	WM97+ 70 & 110	
146861	511-724-296	Water Temperature Sensor	WM97+ 70 & 110	
146864	511-802-015	50VA Transformer	WM97+ 70 & 110	

### GV Series Accessories

Part #	Mfg.#	Description	For	Price
011874	382-200-325	Burner Replacement Kit	GV4 & GV90+4	
011875	382-200-330	Burner Replacement Kit	GV5 & GV90+5	
011877	382-200-340	Blower Assembly		
011878	382-200-345	Blower Motor Kit 10C380		
011879	382-200-350	Vent 90 10C387		
011881	382-200-375	Switch Kit 10C403	GV90	
011882	382-200-385	Hose Trap Kit		
030451	382-200-410	Boiler Gas Valve 10C399		
065429	382-200-411	Gas Valve Kit GV Series 4		
043582	382-200-448	Ignition Control Module (GV Series 1,2&3) 10C400		
011896	510-312-019	10C411 Limit Control		
050453	510-312-021	Limit Control w/1/2" Well	GV Ser 1, 2, 3 Sect Assy	
011941	511-330-148	Ignition Kit 10C402		
011949	511-624-520	Pressure Switch 10C382	GV	
011955	511-842-370	Transformer 10C401	GV	

### EG/EGH Series Accessories

Part #	Mfg.#	Description	For	Price
239732	321-711-115	Section Assy for EGH 95 Boiler		
239733	381-700-246	42-1/2" Base Panel for EGH 95 Boiler		
239734	381-700-506	Base Assy for EGH 95 Boilers		
035079	381-800-677	EG75 SPDN Boiler Water Trim No Tankless Option		
035078	381-800-675	EGH-30 to 65 Water Trim		
239736	411-800-271	Jacket Assy Carton for EGH-95 Boilers		
239738	450-014-751	Collector Hood for EGH-95 Boilers		
239737	450-206-241	Draft Hood for EGH Series Boiler		
011892	510-218-097	10C526 Tridicator, 2-1/2" Long Shank	EG Series 1-4 Section Base Assy	
074482	511-724-255	36" Thermocouple with Spade Terminal Block	EG 75, EGH 85 & 95	
011966	560-528-985	LP Gas Pilot Orifice		
074479	590-850-561	5" Lead Wire	EG 75	



---

---

## Weil McLain Repair Parts

---

---

### Weil-McLain Boiler Parts & Components (Continued)

#### EG/EGH Series Accessories

Part #	Mfg.#	Description	For	Price
151620	381-800-837	Trim Steam EG30-75		

#### Sentinel Series Accessories

Part #	Mfg #	Description		Price
127435	592-900-005	Sentinel X100 Quik Test Kit		

#### Ultra Oil Accessories

Part #	Mfg #	Description		Price
066035	383-500-300	Water Temperature Sensor Kit		
066012	389-900-180	Wall Mount Kit		

## Westinghouse/Philco Repair Parts

### Blower Wheels

Part #	Mfg #	Description	Price
241795	622683	1/2" HP, CCWLE	
245085	667187R	Draft Inducer Blower Wheel	
119974	667207	10-3/4" x 10", CW	
119975	667251	10" x 6", CW	
245205	667252R	10" x 7", CW	
119976	667258R	11" x 8", CCWLE	
119977	667280	11" x 10", CCW	
119979	667374	11" x 8", CW	

### Burners

Part #	Mfg #	Description	Price
134174	660921	Burner L1	
134173	661128	Inshot Burner G7T	
163685	660812R	Inshot Burner FG6RC	
242549	M0062414 R	Burner Box Kit for Use with Ignitor 10177435	

### Capacitors

Part #	Mfg #	Description	Price
146433	01-0024	10mfd, 370V Round Capacitor	
119928	622135	15mfd, 370V Round Capacitor	
136994	622545	10mfd, 370V Round Capacitor	

### Contactors

Part #	Mfg #	Description	Price
139778	621661	25A, 1-Pole	
139779	621662	35A, 1-Pole	
246424	1014866R	24VAC, 2-Pole, 25 FLA	

### Control Boards

Part #	Mfg #	Description	Price
242566	624689R	Interface Module	
133371	904531	Board All Units	
129223	920915	Control Board G7	
130336	920916	Control Board G7	
128774	920920	Board Direct Torque	

### Control Modules

Part #	Mfg #	Description	Price
139792	624651	Comfort Alert Module New	

### Control Modules (Continued)

Part #	Mfg #	Description	Price
120743	903106	Control Module for G4 G5 G6 Models	

### Defrost Boards

Part #	Mfg #	Description	Price
147380	920338	Defrost Board Adaptive	
127634	917178A	Defrost Board	

### Door Switches

Part #	Mfg #	Description	Price
119950	632125	Door Switch	

### Fan Blades

Part #	Mfg #	Description	Price
139796	667261	Fan Blade	
139797	667318	Fan Blade f/S3QC Series 3 Ton Only	
139784	667319	Fan Blade 2 Blade 24 OD 27p CW 1/2 1200	
139783	667351	Fan Blade 2 Blade 24 OD 25p CW 1/2	
240945	667357R	Fan 3-Blade, 24 OD, 18P, CW 1/2, 1200	
139798	667383	24" CW 3W 20° Fan Blade	

### Flame Sensors

Part #	Mfg #	Description	Price
120728	903600	Flame Sensor (old #632396)	

### Igniters

Part #	Mfg #	Description	Price
120726	903758	Replacement Igniter Kit	
134164	921074	Igniter Replacement Kit G7/GC2	
119987	904839	Igniter Assembly for G7 (New# Is 921074)	
241821	1017743S	Replacement Igniter SI NI G7	

### Limit Controls

Part #	Mfg #	Description	Price
120741	626350	Vent Limit 260°F	

## Westinghouse/Philco Repair Parts

### Limit Controls (Continued)

Part #	Mfg #	Description	Price
120733	626418	Limit 150/20°F	
120735	626419	Limit 195/20°F	
120736	626425	Limit 210/20°F	
120734	626434	3" Limit 180/20°F	
120749	626435	Limit 220/20°F	
120737	626449	3" Limit 250/20°F	
120744	626461	Vent Limit 160°F	
136184	626522	Main Limit Switch	
119934	626541	Switch Blower Limit G7	
119941	626561	Main Air Limit G7	
119945	626563	Main Air Limit G7	
145504	626598	Main Air Limit SD054, 072	
144772	626599	Limit Switch 1/2d,1s, or 16	
145498	626611	Blower Limit KG7SD	

### Lineset Fittings

Part #	Mfg #	Description	Price
131551	664378	Liquid Lineset Fitting	

### Motors

Part #	Mfg #	Description	Price
139793	621952	A/C Fan Motor	
139795	621917	Fan Motor for FS3BA048	
139794	621919	PSC K 1/10 6p 1-Spd CWLE Fan Motor	
139788	622018	PSC 1/4 hp CWLE Fan Motor for 15 SEER	
139782	622066	PSC K 1/4 hp CWLE 6p 1-Spd Fan Motor	
139781	622080	1/4 hp CWLE Fan Motor	
139780	622171	.05 hp CWLE 2 Ton Motor	
130637	622264	Blower Motor 1/2hp 3-Spd	
246090	634632R	Repl, Harness, B3VM, Motor	
245861	634826	Fan Motor Power Wire HRN	
245863	634827	Fan Motor Control Wirehar	
143885	904502	Motor 1/3 3-Spd 115V	
206946	902042	Blower Motor 1/8 HP/115V	
120723	903111	Venter Motor 80% With Gasket	
134163	903962	Venter Motor w/Gasket	
134161	904085	Venter Motor GL1RC	
135437	903404	Inducer Motor	
119983	904796	Inducer Motor G7	

### Motors (Continued)

Part #	Mfg #	Description	Price
119985	904798	Inducer Motor G7	
119991	904857	Blower Motor G7	
119992	904858	Blower Motor G7	
119993	904859	Blower Motor G7	
119994	904860	Blower Motor G7	
241599	1007729	Condenser Fan Motor	

### Orifices

Part #	Mfg #	Description	Price
149071	664067	Orifice #67	
149073	664071	Orifice #71	
245346	151885R	1" Inducer Orifice	

### Pressure Switches

Part #	Mfg #	Description	Price
120746	632302	Pressure Switch Vent for G6D	
139791	632393	Low Pressure Switch 39" (5CO-20CI) 632393	
120780	632444	Pressure Switch NO 1.75 Close 1.55 Open	
139785	632473	High Pressure Switch	
119953	632484	Sensor Flame G7	
119954	632487	Pressure Switch	
119955	632489	Pressure Switch G7	
119956	632491	Pressure Switch Condensate G7	
119958	632493	Pressure Switch Inducer G7	
119960	632499	Pressure Switch G7	
119961	632514	Pressure Switch G7 Variable Speed Downflow	
119962	632515	Pressure Switch G7 Variable Speed Downflow	
119963	632516	Pressure Switch	
119966	632521	Pressure Switch G7	
134165	632546	Pressure Switch Inducer 1.0 for FG7TC	
134168	632547	Pressure Switch G7 Fixed Condensate	
134166	632548	Pressure Switch	
134167	632550	Pressure Switch G7	
134169	632554	Pressure Switch	
130948	632561	Pressure Switch for Fg7	
130950	632563	Pressure Switch for Fg7	

## Westinghouse/Philco Repair Parts

### Pressure Switches (Continued)

Part #	Mfg #	Description	Price
130951	632565	Pressure Switch for Fg7	
130952	632567	Pressure Switch for Fg7	
130953	632594	Pressure Switch 40 Close .20 Open Long Run for iQ Furnace	
122723	632571	Pressure Switch G7	
134010	632585	Pressure Switch	
145499	632622	Pressure Switch for M7	
145500	632624	Pressure Switch for M7	
240803	1016291R	Pressure Switch No. 0.85	
240804	1016292	Pressure Switch No. 0.85	
240802	1016293R	Pressure Switch No. 0.85	

### Plugs

Part #	Mfg #	Description	Price
240979	631756R	12 Pin Male Plug	
239631	634715R	Molded Plug 56" Leads	

### Relays

Part #	Mfg #	Description	Price
139790	621931	Relay Blower	
242942	1017206	AC Relay Kit	
243133	1017207	DC Relay Kit	

### Restrictors

Part #	Mfg #	Description	Price
149069	664048	1.5T Restrictor .048	
149070	664056	2T Restrictor .056	
149072	664061	2.5T Restrictor .061	
149074	664076	4T Restrictor .076	

### Roll-out Switches

Part #	Mfg #	Description	Price
120731	626343	Switch Roll-out 300F	
119938	626558	Roll-out Switch G7	
119939	626559	Roll-out Switch G7	
119940	626560	Roll-out Switch G7	
145497	626609	Roll-out Switch SD038	
145505	626610	Roll-out Switch SD054,072	

### Transformers

Part #	Mfg #	Description	Price
134170	622341	Transformer 40VA/120/24	
134175	622396	Transformer 60 VA for 23 SEER Coil	

### Tubing

Part #	Mfg #	Description	Price
119925	263967	High Temperature Tubing 3/16 36" Long	

### Valves

#### Gas Valve

Part #	Mfg #	Description	Price
119930	624652	Gas Valve 2-Stage for TC TI G7	
130954	624703	Gas Valve for iQ Furnace	
143845	624787	Gas Valve 2-Stage for Fg7	
143844	904081	Gas Valve	
144173	921691	Gas Valve Kit with Harness	

#### Service Valves

Part #	Mfg #	Description	Price
139777	663862	Valve Liquid 3/8"	
139786	663864	Valve Suction 3/4" for FS5BD18-36	
133428	663963	Valve Ball 7/8" for FS4BD48-60, FT4B42-6	

#### TXV Valves

Part #	Mfg #	Description	Price
134244	669681	TXV for C6BAX24	
134245	669682	TXV for C6BAX30	
134246	669683	TXV for C6BAX35 And 36	
134247	669684	TXV for C6BAX42	
134250	669686	TXV for C6BAX60	
134249	669852	TXV R-410A 4.0 Ton	

### Parts & Repair

Part #	Mfg #	Description	Price
243108	2B6462R	Coil Guard 24" Lgtng Bolt	
239223	276921	Cover, Control, Panel, AC&HP	
245674	286802R	FRU, SOW, AH, VS	

---



---

## Westinghouse/Philco Repair Parts

---



---

### Parts & Repair (Continued)

Part #	Mfg #	Description	Price
241050	294941R	12" Duct Collar Kit	
241051	294942R	14" Duct Collar Kit	
240668	297217R	Blower Housing	
244460	624811R	Repl. Coresense Module	
119951	632261	3 Amp Fuse	
119952	632269	5 Amp Fuse	
119981	664435	Drain Assy Upflow/Inline	
145506	664659	PVC Trap KG7SD	
242155	902809	Nordyne Blower	
134162	904573	Inducer for 95% With Gasket	
119986	904799	Blower Kit Inducer G7 Var Sp Downflow	
143415	904986	Replacement Parts Kit	
130955	904800	Induced Draft Blower FG7MQ	
245613	904804	Header Box with Gasket	
240920	919707D	Coil Assy, 030, B5BW, FRU	
131416	920994	Blower Control, Cons CFM, Vs Downflow	
239078	921852	Blwer, B6BM, 1/8, 10X6, 1.5-2T	
243685	922178	Comp-Cope, ZR48K5E-TF5-800	
243666	1010439R	Pressure 2X No. .7/- .2B	
213290	921952	Replacement Coil	

**Repair Parts: White Rodgers**

**Repair Parts**

**Surface (Strap-On) Type Hydronic Control**

- Sensing element has twice the contact area of competitive models.
- Hydraulic action element can be mounted in any position – no leveling required.
- Dustproof steel case.
- Special screw terminals with “ears” securely hold solid and stranded wires.
- Includes pipe strap and mounting screws.



Part #	Mfg #	Description	Price
19115	WR11272	100 to 240°F Range	
9			

**Well Immersion Single Control**

- Types for Use as High Limit, Reverse Action or SPDT Switching
- Action: May be Mounted Either Horizontal or Vertical
- Extra capillary length for extended shank wells.
- Special screw terminals with “ears” securely hold solid and stranded wires.
- Screwdriver-adjustable differential with direct-read indicator.
- Knockouts on top and bottom and plenty of wiring room.
- Hydraulic action element – fast acting.



Part #	Mfg #	Description	Price
19116	WR1131102	Tapered Bulbs, SPDT Action	
0			
19367	WR11D181	Open on Rise Action	
5			

**Hydronic Zone Valves**

- Two Types of Valves, 2-Wire or 3-Wire, for Zoning Hydronic Systems Up to 50 PSI
- Quiet operation.
- Valve stem made of stainless steel.
- Automatic recycling manual operator shows valve position at all times.
- Built-in auxiliary contacts to control burner or circulator relay.
- Motor can be removed from valve assembly without draining system.



**2-Wire, 24V Valves With Screw Terminal Wiring Panel and Auxiliary Switch**

Part #	Mfg #	Description	Price
19116	WR1361103	1" I.D. 2-Wire Valve	
1			

**Refrigeration Temperature Control**

- Provide Positive Control of Refrigeration Applications where Remote Control is Desired
- Hydraulic action element.
- Dustproof steel case with top and bottom knockouts.
- Temperature dial graduated in °F and °C and can be adjusted through cover.
- High electrical ratings allow operation of most equipment without use of relays or motor starters.



Part #	Mfg #	Description	Price
21147	WR1609101	-30 to +90°F Close on Rise	
6			
19114	WR16879	-30 to +90°F SPDT	
8			



**Repair Parts: White Rodgers**

**Electronic Temperature Control**

- Universal
- Refrigeration or Heating Applications
- Alarm Output with Selectable Delay
- No Common Wire Required



Part #	Mfg #	Description	Price
20363 0	WR16E09101	-40°F to 220°F SPDT	

**HotRod Universal Nitride Ignitor Upgrade Kit**

- 120V Nitride Upgrade Kit for Conversion of Silicon Carbide (Flat or Spiral)
- Robust Ignitor Design – for longer life and fewer callback's – 5 year warranty
- Nitride Ignitor with 15.5" leads
- Universal mounting bracket and screw and ceramic wire nuts



Part #	Mfg #	Description	Price
21066 9	WR21D645PK	HotRod 5-Pack 15.5"	

**HotRod™ Series Universal Ignitor Upgrades**

- Nitride ignitors with 14.5" and 15.5" leads-stripped ends
- Universal and standard mounting brackets and 2 ceramic wire nuts
- Replaces most silicon carbide ignitors including many Carborundum carbide applications



Part #	Mfg #	Description	Price
19694 7	21D64-2	15.5" Lead	

**Carbide Ignitors, OEM Direct Replacement**

- Multiple mounting styles
- Works with 15, 17 or 45 second HSI systems
- All models includes ceramic wire nuts for cut and strip connections



Part #	Mfg #	Description	Price
19552 4	767A-371	120 VAC, 60 Hz	

**24A34 Series Electric Heat Sequencers**

- Replaces Honeywell, MARS, TOD, GEMLINE, Klixon (Texas Instruments).
- Any contacts (except M1 & M2) can be used as auxiliary contacts.
- 24V input control.
- Multi-poise mounting.
- Double quick-connect terminals for combination loads.



Part #	Mfg #	Description	Price
19118 0	WR24A341	24A34-1 Sequencer	
19454 7	WR24A3415	24A34-15 Heat Pump Control	
20119 5	WR24A342	24A34-2 Sequencer	
19118 3	WR24A345	24A34-5 Sequencer	
19118 4	WR24A346	24A34-6 Sequencer	

**36C Series Snap Open, Single Function, Standing Pilot Gas Valves**

- Electrical Rating: 0.23 amps
- Ambient Operating Range: -40 to +175°F (-40 to 79°C)
- Maximum Pressure Rating: 1/2 PSI (14.0" W.C.)
- Pilot Gas Connection: 1/4" compression fitting
- Pressure Tap: 1/8" N.P.T.



Part #	Mfg #	Description	Price
19116 2	WR36C03A410	120VAC 3/4" x 3/4" Gas Valve	
19117 5	WR36C03U333	750mV 1/2" x 3/4" Gas Valve	
19116 3	WR36C03333	24V 1/2" x 3/4" Gas Valve	

**Repair Parts: White Rodgers**

**36H Series Gas Valves**



Part #	Mfg #	Description	Price
20285 0	WR36H33412	24VAC 3/4" x 3/4" Gas Valve	
19116 5	WR36H32304	24VAC 50/60Hz	

**36G, 36J Series Gas Valves**

- The 36G, 36J is a Combination Gas Control Valve Designed for Use with Non-Piloted Intermittent Ignition Systems.
- The Control is Designed to Meet Today's Maximum Capacity, Smaller Size and High Efficiency Gas Systems
- Inlet and outlet screens.
- Quiet redundant.
- Built-in pressure tap.
- Quick-connect terminals (1/4")



Part #	Mfg #	Description	Price
20801 1	WR36J22214	1/2" 1 Stage, Fast Opening	
20336 2	WR36J24214	1/2" 1 Stage, Slow Opening	
20495 0	WR36J54214	1/2" Two-Stage, Fast Opening	

**3F05 / 3L05 Series Adjustable Snap Disc Fan & Limit Controls**

- Adjustable Snap Disc Thermostat Allows You to Set the Temperature Set Point to Match Your Specific Needs which Simplifies Inventory
- 1/4" quick connect terminals are standard.
- Reduces inventory while providing coverage for a wide range of temperature applications.
- Replaces the majority of fixed disc thermostats now on heating equipment and various appliances.
- 2 adjustable fan control models replace 7 fixed snap disc models.
- 5 adjustable limit control models replace 10 fixed snap disc models.



Part #	Mfg #	Description	Price
19115 0	WR3F052	140 - 180°F SPST Fan Control	
24299 5	WR3L053	210 - 250°F SPST Limit Control	

**Snap Disc Fan or Limit Controls**

- For Regulation of Fan, Blower or High Limit Safety Control



Part #	Mfg #	Description	Price
19115 2	WR3L01140	100°F Cut-in, 140°F Cut-out	

**5D51 Series Fan & Limit Controls**



Part #	Mfg #	Description	Price
19115 3	WR5D5135	Fan, 5"	
19115 5	WR5D5190	Limit, 8"	
19115 4	WR5D5178	Limit, 11"	

**Repair Parts: White Rodgers**

**Universal Heat Pump Defrost Control**

- Universal upgrade for single stage heat pump systems with a PSC fan Motor.
- Select from: pre-conjured demand timed defrost routines or congure to replicate virtually any set up.
- Universal Replacement: Selectable demand or timed defrost. O or B reversing valve. Congures to any system.
- Easy Installation & Set Up: Universal mounting with rotating display. Pre-congured for major OEM brands. Integrated outdoor thermostat.
- Versitile Matrix Display: Access set up and diagnostic menus from any orientation.
- Compressor Protection: Brown out and short cycle protection plus. Hi/Low pressure inputs.
- Replacement Kit Contents: Defrost control board. Wiring harnesses. New coil and ambient temp thermistors. Mounting accessories and labels
- Timing Specifications: All timing is accurate to +/- 5% of nominal over the full temperature and voltage range at 60Hz. All timings are 20% longer when operated with 50Hz power supply.



Part #	Mfg #	Description	Price
21897	WR47D01U843	Universal Heat Pump Defrost	0

**49P11-843 SURESWITCH™**

- Universal Electronic Upgrade for Mechanical Compressor Contactors.
- 5x Contactor Life, Sealed to Keep Out Ants and Debris
- Microprocessor controlled sealed compressor switching.
- Line voltage brownout protection, short cycle protection, tricolor LED displays.
- Heavy-duty lug connectors, zero chatter latching relay.
- Four-hole mounting matches mechanical contactors.
- Random start delay on power up and brownout recovery.
- Compressor test and cycle count by push-button.



Part #	Mfg #	Description	Price
20918	WR49P11843	Universal SURESWITCH™	9

**Pilot Relite Controls**

- Generates spark pulse until flame is sensed through spark electrode.
- Begins sparking immediately if flame extinguishes.
- Rugged solid state module design.
- Spark plug or spike output configurations available.



Part #	Mfg #	Description	Price
20856	WR505923	Spark plug and 1/4" connectors	2

**50A55-743 Goodman Single Stage Integrated HSI Furnace Control**

- Controls Gas Valve, Ignitor, Blower, Inducer, Humidifier(Both 120V & 24V Input), and Air Cleaner Replaces OEM Goodman and White-Rodgers Models
- Includes flash code diagnostics.
- Twinning connection.
- Fused to protect low voltage system transformer



Part #	Mfg #	Description	Price
21140	WR50A55743	1 Stage HSI Furnace Control	9

**Non-Integrated Ignition Modules**

- Plug in program keys for quick selection of factory timings
- Microprocessor-based ignition control
- Works with single rod or dual rod remote sensor
- Provides ignition, proof of ignition and precise timings
- Led diagnostic indicator
- For use in natural and lp gas applications



Part #	Mfg #	Description	Price
19498	WR50E47843	Single Stage, 120 VAC	2

**Repair Parts: White Rodgers**

**Integrated Furnace Controls**

- Universal replacement
- Diagnostic LED indicators streamline installation and system troubleshooting
- 120V air cleaner output and 120V humidifier output up to 1 Amp max
- Factory standard safety timings and adjustable fan delay options
- Replaceable automotive style fuse



Part #	Mfg #	Description	Price
19595	WR50A55843	24 VAC, 120 Vac 50/60 Hz	1

**Integrated Furnace Controls**

- Universal replacement
- Models include a universal 120V nitride ignitor to allow replacement of 80V and 120V controls
- Simple pushbutton fault recall with Tri-Color LED indicators streamline installation and system troubleshooting
- 120V air cleaner output and 24V or 120V humidifier output up to 1 Amp max
- Factory standard safety timings and adjustable fan delay options



Part #	Mfg #	Description	Price
20055	WR50M56U84	24 Vac, 120 Vac, 50/60 Hz	5 3

**50D50-842 Universal Direct Spark Ignition Control Kit**

- Microprocessor Based Gas Ignition Control for Heating Appliance Using Either Natural or LP Gas. Proof of Flames is Accomplished. The Unit is Designed as a Direct Spark Ignition Source
- Color LED indicator for diagnostics.
- Program keys.
- 1/4" and 3/16" quick connect terminals.
- Damper interface.



Part #	Mfg #	Description	Price
19669	WR50D50842	Universal Spark Ignition Control	5

**50D50-843 Universal Proven Pilot Spark Control Kit**

- Microprocessor Based Gas Ignition and Primary Safety Control.
- Designed for Interrupted Spark and Burner Supervision of All Gases.
- Used in Gas Fired Appliance Applications
- Field service replacement for most Honeywell, Robertshaw, Johnson Controls and UTEC Intermittent Pilot Ignition Controls.
- Provides ignition, proof of ignition and precise timing.
- Works with single rod or dual rod remote sensor.
- Color LED indicator for diagnostics.



Part #	Mfg #	Description	Price
19669	WR50D50843	Universal Pilot Spark Control Kit	6

**50T35-743 Goodman Silicon Carbide Integrated HSI Furnace Control**

- Controls Gas Valve, Ignitor, Two-Speed Blower Motor, Inducer, Humidifier (Both 120v & 24v Input), and Air Cleaner. Replaces OEM Goodman, UTEC and TI Models
- Includes flash code diagnostics.
- Twinning.
- Includes mounting hole template.
- Fused to protect low voltage system transformers.
- Adjustable blower relay.
- 90+ furnace option



Part #	Mfg #	Description	Price
19965	WR50T35743	Integrated HSI Furnace Control	4



**Repair Parts: White Rodgers**

**57T01-843 Blower Time Delay Relay**

- The 57T01-843 Time Delay Relay is for Use in Air Handlers Installed in Compressor-Run Air Conditioning and Heat Pump Systems to Delay the Blower Shut-Off After the Compressor has Shut Off.
- Allows residual cooled air to be blown into the controlled space, increasing the efficiency of the system in cooling.
- Depending on electrical hookup in a heat pump system, delay of blower shut-off could also occur in heating.



Part #	Mfg #	Description	Price
21464	WR57T01843	Blower Time Delay Relay	0

**767A Series Silicon Carbide Hot Surface Ignitors**

- Multiple mounting styles.
- Works with 15, 17 or 45 second HSI systems.



Part #	Mfg #	Description	Price
19552	WR767A369	5.5"	7
19552	WR767A370	5.25"	3

**Fan Control Center**

- Transformer and Relay Combination for Easy Installation on a 4"x 4" Junction Box
- Line voltage connections pre-wired.
- Energy limiting class II transformer design.
- Color coded pre-stripped leads.
- Low voltage connections on terminal board.



Part #	Mfg #	Description	Price
19118	WR90113	SPDT 60 Hz 120V	8

**WR/RBM Type 154 Contactors**

- Any position mounting.
- Interchangeable mounting plate.
- Low wattage coil.
- Double break contacts ensure positive make and break

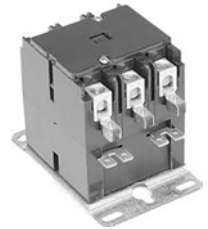

Part #	Mfg #	Description	Price
23966	WR90165	30 Amp 208/240 Voltage AC	9
21128	WR90171	40 Amp 120 Voltage AC	7
20600	WR90172	40 Amp 208/240 Voltage AC	3

**WR/RBM Type 122 Contactors**

- Low VA coil for cooler operation and increased life.
- Quiet operation.
- Universal style mounting bracket fits existing mounting holes.
- Double break contacts ensure positive make and break.
- Screw terminals or pressure connectors and double 1/4" quick connects provided on all models for easy installation.



Part #	Mfg #	Description	Price
19119	WR90245	30 Amp 120 Voltage AC	4

**WR/RBM Type 84 Relays**

- Used for Switching Single or Two Speed Fan Motors, Solenoids, Relays, Resistive Loads and General Purpose Switching
- Compact, totally enclosed design.
- For heating and cooling applications and general switching.
- Quiet, reliable and economical.



Part #	Mfg #	Description	Price
19468	WR90293Q	SPDT 24 Coil Voltage AC	2

**Repair Parts: White Rodgers**

**WR 90 Series 2 Pole Mechanical Contactors**

- Low VA coil for cooler operation and increased life
- Quiet operation
- Universal style mounting bracket fits existing mounting holes
- Double break contacts ensure positive make and break
- Screw terminals or pressure connectors and quad 1/4" quick connects provided on all models for easy installation



Part #	Mfg #	Description	Price
19118	WR90244	24 Coil Voltage, 30 Amp	6
19119	WR90247	24 Coil Voltage, 40Amp	1

**90 Series 3 Pole Mechanical Contactors**

- Any position mounting
- Interchangeable mounting plate
- Low wattage coil
- Double break contacts ensure positive make and break



Part #	Mfg #	Description	Price
19352	WR90170	24 VAC Coil Voltage, 40 Amp	9

**94 Series 1.5 Pole Mechanical Contactors**

- Replaces many contactors used by OEM's
- Universal style mounting bracket fits existing mounting holes
- Screw terminals and 1/4" quick connect terminals for easy installation



Part #	Mfg #	Description	Price
19119	WR94388	24 VAC Coil Voltage 30 Amp	5
19833	WR94394	24 VAC Coil Voltage 40 Amp	1

**WR/RBM Type 91 Relays**

- A Two Pole Double Throw Semi-Enclosed Relay
- 90-340 Fits Fan Control Centers 90-112, 90-113, 90-118E and 90-119
- Easy to install.
- Suited for use in vending machines, appliances, heating and air conditioning applications and general purpose switching.



Part #	Mfg #	Description	Price
22288	WR90340	24 Coil Voltage	0
19119	WR90341	115/120 Coil Voltage	2
19119	WR90342	208/240 Coil Voltage	3

**WR/RBM Type 184 Relays**

- Heavy-Duty General Purpose Relay Operates in Any Position
- Compact, totally enclosed design.
- For heating and cooling applications and general switching.
- Quiet, reliable and economical



Part #	Mfg #	Description	Price
19119	WR90370	SPDT 24 Coil Voltage AC	0

**24 Volt Secondary Class 2 Transformers Energy Limiting**

- For Industrial, Heating and Air Conditioning Controls Applications
- Color coded primary leads.
- Multi-mount styles available.



Part #	Mfg #	Description	Price
19117	WR90T40F1	120V Foot-Mount	3
19117	WR90T40M1	120V Universal Multi-Mount	7
19328	WR90T40M3	120/208/240V Uni Multi-Mount	5
19118	WR90T75C3	120/208/240V Foot-Mount	9



**Repair Parts: White Rodgers**

**90-T Series Energy Limiting 24 VAC Transformer**



Part #	Mfg #	Description	Price
19118	WR90T40F3	120/208/240V Foot-Mount	5

**24A34 Series Electric Heat Sequencer**



Part #	Mfg #	Description	Price
19118	WR24A344	Sequenced Time Delay Relay	2
19118	WR24A343	Sequenced Time Delay Relay	1

**Thermostat Guards - Metal**

- These Durable Metal Guards are Designed for Government, Military, Industrial and Educational Applications to Prevent Adjustment of the Temperature by Unauthorized Personnel
- Model F29-0220 fits ALL Emerson / White-Rodgers Thermostats.
- Each model furnished with one key and can be mounted vertically or horizontally.
- Tamper-resistant design. 18 gauge cover, 22 gauge frame.
- Beige enamel finish over heavy-duty steel enclosure.
- Models available in a ring or solid base.



Part #	Mfg #	Description	Price
20135	WRF290192	Solid Base Metal	7
19324	WRF290222	Ring Base Metal	3

**Thermostat Guards - Plastic**

- These Durable Thermostat Guards are Designed for use in Offices, Churches, Restaurants and Other Public Areas to Prevent Adjustment of the Temperature by Unauthorized Personnel



- F29-0198 will accept ALL Emerson / White-Rodgers thermostat types.
- Each model furnished with one key and can be mounted vertically or horizontally.
- Clear plastic models for applications that need the thermostat visible.
- Opaque plastic models for applications that require the thermostat be kept hidden from view.
- Each model furnished with a ring and/or solid wall mounting plate.

Part #	Mfg #	Description	Price
19117	WRF290198	Clear Plastic	2

**Wallplate for 90 series Blue Touchscreen thermostats**

- 8-1/8"W x 5-3/8"H
- Classic White color
- For use with or without horizontal junction box.



Part #	Mfg #	Description	Price
19752	WRF612600	8-1/8" W x 5-3/8" H	0

**Zone Valves - 1300 Series**

- Valve Assemblies
- Water Seal Replacement Kit (Quad ring, "O" ring, Tru-arc ring and cotter pin)
- Motor Assemblies



Part #	Mfg #	Description	Price
01205	WRF840434	1" Valve Assemblies	7
08778	WRF840435	1-1/4" Valve Assemblies	9
20267	WRF920227	3/4" Water Seal Replacement	1

**Repair Parts: White Rodgers**

**Universal Media Filter Replacements**

- FR- Filter Replacements



Part #	Mfg #	Description	Price
19495	WRFR1400	16" x 26" x 5"	5
19495	WRFR2000	20" x 26" x 5"	6

**PG9 Power Generators, 750 Millivolt**

- For replacement of similar screw-in type generators now in field and E31-12 pilot burners
- PG9 adapter included
- 36" Armored cable leads with split-spade terminals



Part #	Mfg #	Description	Price
19117	WRG01A332	F Spade Terminal	4

**H06E / F Series Universal Replacement Thermocouples**

- Specially Designed for Universal Replacement. Thermocouples are Priced Individually, Order Only in Multiples of 10
- Stainless steel element construction for prolonged thermocouple life.
- Each kit individually enclosed in plastic.
- Universal adapter fittings included with each kit for replacing thermocouple in most types of pilot burners.
- Visible instructions for quick, easy installation.
- Available in a variety of 10-packs in desired thermocouple lengths.
- Standard thermocouple 11/32" double lead thread.
- Replaces Honeywell Q34A, Johnson K19, Robersshaw 1980 and White-Rodgers H06E.



Part #	Mfg #	Description	Price
19116	WRH06E18	18" thermocouple	7
19116	WRH06E30	30" thermocouple	9

**Repair Parts (Continued)**

**H06E / F Series Universal Replacement Thermocouples**

Part #	Mfg #	Description	Price
19117	WRH06E36	36" thermocouple	0
19117	WRH06E48	48" thermocouple	1

**Universal Two-Stage HSI Integrated Variable Speed (ECM) Furnace Control Kit**

- Kit Includes:
- Ignition Control Module
- Wiring Harnesses for Amana/Goodman
- Universal 120V Nitride Ignitor Kit - 21D64-2
- Installation Instructions and OEM Cross-Reference



Part #	Mfg #	Description	Price
20287	WR21V51U843	2 Stage HSI	5

**36H Series Gas Valves**

- Combination Multi-function Controls for a Wide Range of Applications.
- The 36H Combination Gas Control Valve is a Versatile Multifunction
- Control Designed to Meet the Requirements for Use with Intermittent
- Ignition Systems (Direct Ignition, Proven Pilot, HSI). 36H is Our
- Highest Capacity Combination Gas Valve
- Adjustable regulator.
- Quiet operation redundant design.
- Inlet/outlet screens.
- Tamper resistant screws.



Part #	Mfg #	Description	Price
20285	WR36H32423	24 Volt 3/4"	1

**Repair Parts: White Rodgers**

**Humidifier Timer**

- The White-Rodgers A02-0815-017 installation package includes:
- Flushing timer
- Power cord with AC adapter (plugs in to a 120v outlet)
- 15 feet of 3/8" ID tubing
- Mounting hardware
- Installation instructions
- Fittings and tubing clamps for installation on White-Rodgers units, as well as on other manufacturers humidifiers.



Part #	Mfg #	Description	Price
20301	WRA02081501	Humidifier Timer	
9	7		

**Key For F29 Thermostat Guards**

- Key For F29 Thermostat Guards (Bag of 2)



Part #	Mfg #	Description	Price
19899	WRF1450999	2 Keys	
9			

**Compact Zone Valves 13A00 Series - Power Head**

- Includes Seal Ring
- For 2-way Zone Valves
- Includes auxiliary switch
- 24 VAC Power Head for 2 Way 13A00 Zone Valve with Conduit Hub for 13A02-101 & 13A02-102



Part #	Mfg #	Description	Price
24275	F19-0187	24 VAC Power Head	
7			

**Board Mount Limit Controls**

- 1/2" Bimetal Disc with Ranges for Your System Needs
- Proven reliability in a compact, versatile, cost-effective design.
- Provides high-speed contact separation.
- OEM replacement for competitive models.



Part #	Mfg #	Description	Price
24299	WR3L098	180 Opens/160 Closes °F	
9			
24300	WR3L0910	200 Opens/160 Closes °F	
0			

**1/2" Disc Manual Reset Flame Rollout Limit Switches**

- This new line of limit switches complements our existing line of 1/2" automatic (3F11) fan controls & (3L11) limit controls and are offered in a broad range of temperature limit cut-outs to cover most heating applications.



Part #	Mfg #	Description	Price
24300	WR3L12250	250°F Cut-Out Temperature	
5			
24300	WR3L12300	300°F Cut-Out Temperature	
7			
24300	WR3L12350	350°F Cut-Out Temperature	
8			



## Woodford Repair Parts

### Yard Hydrant Repair Parts

Part #	Mfg #	Description	Price
011648	10009	Upper Link for Y34/Y1/Y2	
011649	10011	Reducing Coupling for Y1/Y2/Y34/W34	
011658	10100	Packing Nut for Y1/Y2/Y34/W34	
011659	10101	Packing for Y1/Y2/Y34/W34	
011660	10102	Packing Support Washer for Y1/Y2/Y34/W34	
011662	10104	Brass Rod Stem for Y1/Y2/Y34/W34	
011678	15003	3/4 Head Assembly	

### Nozzle

Part #	Mfg #	Description	Price
011646	10004	3/4" Brass Hose Nozzle for Y34/Y1/W34/X34/R34	
098547	55437	Nozzle for 70/71/B71/81	

### Plunger

Part #	Mfg #	Description	Price
011663	10105	Plunger for Y30/Y34/Y70/Y95/W34	
011664	10106	Plunger for Y1/Y2	

### Thermaline® Repair Parts

#### Thermaline® Parts

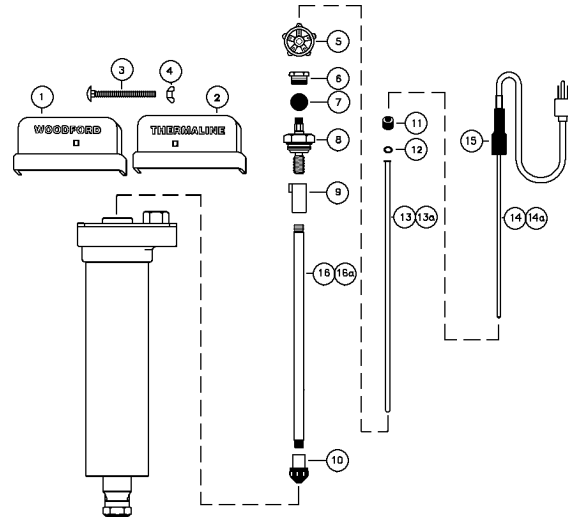

Part #	Mfg #	Description	Price
011747	85015	10 - Combination Valve Ass'y	
011748	85062	14 - 2' Heater Assembly (Includes Item 15)	

### Repair Kits

#### Repair Kit for 14/18 Wall Faucet

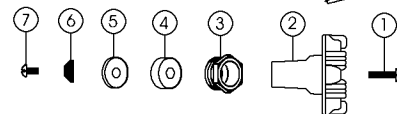
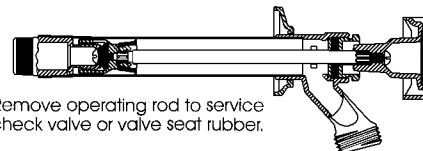

Part #	Mfg #	Description	Price
034143	RK14-MH	Repair Kit for 14/18 Includes 1-7, Metal Hdl	

## Woodford Repair Parts

### Repair Kit for 17 Wall Faucet

- |                       |                             |
|-----------------------|-----------------------------|
| 1. 35301 VB Float Kit | 6. 30421 Packing Washer     |
| 2. 30002 Handle Screw | 7. 30418 Check Valve        |
| 3. 30099 Handle       | 8. 30008 Valve Seat Rubber  |
| 4. 30059 Packing Nut  | 9. 30009 Retainer Screw     |
| 5. 30005 Packing      | 10. 30459 Bevel Check Valve |

Remove operating rod to service check valve or valve seat rubber.

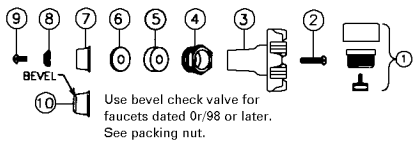

Part #	Mfg #	Description	Price
039455	RK-17	Repair Kit for 17 Includes 1-2, 4-10, 30099 Metal Hdl	

### Repair Kit for 22 Wall Faucet

- 30566 Hot Plug Button
- 30002 Handle Screw (2)
- 30096 Round, Die Cast Alum. Wheel Handle (2)
- 30497 Deep Packing Nut
- 30560 EPDM Packing (2)
- 30006 Packing Washer (2)
- 30565 Cold Plug Button
- 30059 Packing Nut
- 30459 Check Valve (2)
- 30008 Valve Seat Rubber (2)
- 30009 Retainer Screw (2)

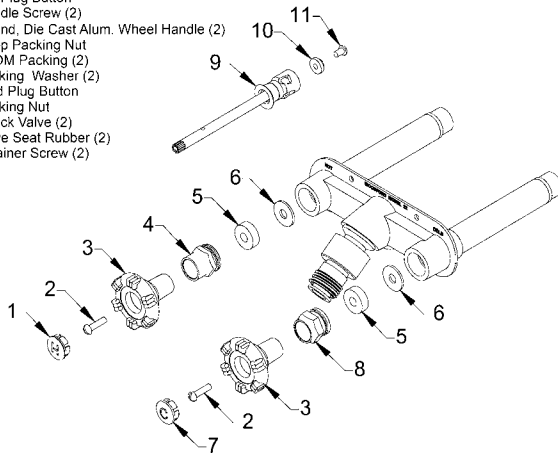

Part #	Mfg #	Description	Price
100876	RK-22MH	Repair Kit for 22 w/Metal Handle	

### Repair Kit for 25/27H Wall Faucet



Part #	Mfg #	Description	Price
032340	RK-25	Wheel Handle Repair 5/16" Square Shank	

### Repair Kit for 65 Wall Hydrant

- |                      |                     |
|----------------------|---------------------|
| 1. 50009 Tee Key     | 5. 50251 "C" Washer |
| 2. 50264 Head Nut    | 6. 51014 Yoke Nut   |
| 3. 50252 Stem Washer | 7. 50250 Plunger    |
| 4. 55062 Stem Screw  |                     |

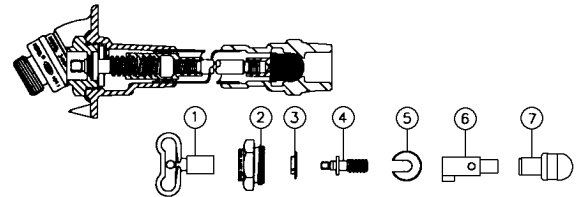

Part #	Mfg #	Description	Price
043118	RK-65	Chrome Repair Kit for 60/65/67 Includes 1-7	

### Repair Kit for 70 Wall Hydrant

- |                         |                            |
|-------------------------|----------------------------|
| 1. 50009 Tee key        | 6. 50027 Support Washer    |
| 2. 30109 Packing Nut    | 7. 51013 Ball Valve Rubber |
| 3. 30247 Packing        | 8. 50028 Round Brass Nut   |
| 4. 55177 Head Nut Assy. |                            |
| 5. 51014 Yoke Nut       |                            |

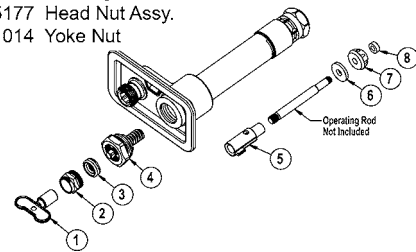

Part #	Mfg #	Description	Price
055079	RK-70	Repair Kit for 70 & Obsolete Models 7/8/80/85/90/95	

### Repair Kit for Y34 Yard Hydrant

- |                      |                         |
|----------------------|-------------------------|
| 1. 10104 Rod Stem    | 4. 10102 Support Washer |
| 2. 10100 Packing Nut | 5. 10105 Plunger        |
| 3. 10101 Packing     |                         |

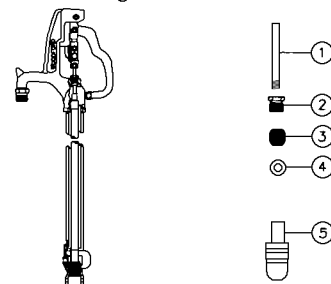

Part #	Mfg #	Description	Price
046472	RK-Y34	Includes 1-5	





## Woodford Repair Parts

### Individual Parts



WF-MS

Part #	Mfg #	Description	Price
025782	30008	Rubber Valve Seat	
025786	30109	Chrome Packing Nut	
011710	30230	Plunger Assembly for 25	
011712	30238	Stem Screw Delrin for 25	
011716	35280	Drain Valve Assembly for 20/25/27	
011723	50250	Plunger for All Auto Drain Hydrants	
019019	50251	"C" Washer All Auto Drain Hydrants	
024447	50252	Stem Washer for All Auto Drain Hydrants	
011726	51014	Yoke Nut for All Freezeless Wall Hydrants	
011725	51013	Ball Valve Rubber	
112487	RH-MS	Roof Hydrant Mounting System	
116915	WF-MS	Mounting Sleeve for Models: 14, 16, 17 & 19	

### Handle



30096

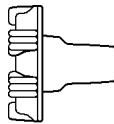

30099

Part #	Mfg #	Description	Price
054339	30096	14/17 Metal Wheel Handle	
011708	30099	14/17/22 Metal Wheel Handle	
095886	30106	24 Unplated Metal Handle	
011711	30233	24 Brown Lexan Wheel Handle	
022301	30239	25 2" Metal Wheel Handle	

### Operating Rod Assembly

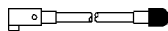

Part #	Mfg #	Description	Price
019023	55412	12" Operating Rod Assembly for Auto Drain 14-5/16" OAL)	

### Packing



Part #	Mfg #	Description	Price
072390	30512	Packing Nut with Stem Gd for 14/17	
080502	30560	EPDM Packing for 14/17/22	

### Rod Assembly

Part #	Mfg #	Description	Price
043133	35722	8" Wall Rod Assembly for 14/ 17/22/V22	
043888	WH35724	12" Wall Rod Assembly for 14/17/22/V22	

### Tee Key



RK-STK

Part #	Mfg #	Description	Price
011719	RK-STK	Tee Key, 1-3/4" Short for 5/16" Square Stem (50009)	
011720	RK-LTK	3-1/4" Long Tee Key for Square Stem (50010)	





---



---

## Yellow Jacket Repair Parts

---



---

### Parts

Part #	Mfg #	Description	Price
181738	41042	Titan Blue Handle w/ Screw	
181739	41044	Titan Red Handle w/ Screw	
181745	41080	Series 41 Rebuild Kit	
181746	41083	Brute II Rebuild Kit	
181797	41103	Brute II 3/8" Piston Assy	
181800	41123	1/4" Liquid Charging Adapter	
181801	41131	O-Rings, 10 Pak	
181802	41133	Complete Valve Piston	
181874	49010	2-1/2" Replacement Crystal for 49011, 49012	
181884	49100	3-1/8" Replacement Crystal	
204202	60349	Tension Spring	

## Zoeller Repair Parts

### Parts & Accessories

#### Simplex Electrical Control Panel

- Alarm horn
- Terminal strip
- Alarm float only
- NEMA 4X enclosure with hinged cover
- Horn silence switch to turn alarm on or off
- Receptacle for use with piggyback pump switch



Part #	Mfg #	Phase	Panel	Price
207659	10-1019	1	Plug-In	

#### Gasket



Part #	Mfg #	Description	Price
052983	267007	Gasket - Case/Cover	

#### Switch Assembly



Part #	Mfg #	Description	Price
028971	004705	M53/98/72 Switch Assembly "50"	
052675	004892	ASM Rack Pk "50/90"AH	

#### Switch-Mate Piggyback Variable Level Float Switch

Part #	Mfg #	Cord Mounting	Price
103476	10-0034	15' Cord	

#### Mechanical Float Switch

Part #	Mfg #	Description	Price
153688	10-1881	Standard, 25' Cord	
115761	10-0744	Standard, 20' Cord	

### Float Rod Guide Assembly



Part #	Mfg #	Description	Price
192528	034086	Float Rod Guide Assembly	

### Arm and Seal Assembly



Part #	Mfg #	Description	Price
052676	004704	Arm & Seal Assembly	

### DC Control Charger with Terminals

Part #	Mfg #	Description	Price
166150	152899	DC Charger	



# Manufacturer Index

## A

---

<b>AB&amp;I Soil Pipe.....</b>	<b>1064</b>
<b>Advanced Cable Ties.....</b>	<b>1268</b>
<b>Advanced Drainage Systems.....</b>	<b>1045, 1245</b>
<b>Airease.....</b>	<b>2654</b>
<b>Airgas.....</b>	<b>1319</b>
<b>American Granby.....</b>	<b>2339</b>
<b>American Plumber.....</b>	<b>2590-2 592</b>
<b>Ametek.....</b>	<b>2590-2 592</b>
<b>Amtrol.....</b>	<b>1291, 2582</b>
<b>Anaco-Husky.....</b>	<b>1057, 1066</b>
<b>Anderson Metals Corporation.....</b>	<b>893-89 8, 900-90 2, 904, 1204, 1460</b>
<b>Anvil International.....</b>	<b>953-95 4</b>
<b>Apollo Valves by Conbraco.....</b>	<b>2346, 2362, 2394</b>
<b>Aquatic.....</b>	<b>1482-1 486, 1498, 1526, 2183, 2238, 2630</b>
<b>Armstrong.....</b>	<b>2406</b>
<b>AY McDonald.....</b>	<b>999, 2377, 2393, 2598, 2600, 2602-2 610</b>
<b>AY McDonald Water Service.....</b>	<b>2601-2 602</b>



## Manufacturer Index

### B

---

<b>B&amp;D Mfg</b> .....	955-95 6, 1238
<b>Basco</b> .....	1507, 2189-2 190, 2656
<b>Basset</b> .....	1280
<b>Bell &amp; Gossett</b> .....	2657-2 658
<b>Bemis</b> .....	1917-1 918, 1928-1 929, 1935-1 936
<b>Bertch</b> .....	2498
<b>Black CI Fittings</b> .....	903
<b>Black MI Threaded Fittings</b> .....	882-88 5, 887-88 8
<b>Black Steel Fittings</b> .....	1115
<b>Blanco</b> .....	128, 323-32 5, 327, 1535-1 536, 1549-1 551, 1614-1 623, 1626-1 632, 1654-1 659, 1697-1 698, 1918, 2298
<b>Blanco, Kitchen Faucets</b> .....	128, 323-32 6
<b>Blue Monster</b> .....	1308-1 309
<b>Bradley Corporation</b> .....	10, 2400, 2659



# Manufacturer Index

## B (Continued)

<b>Bramec</b> .....	975, 1255, 1260, 1265, 1279, 1399, 1423, 1436, 2028, 2167, 2650
<b>Brass Flare Fittings</b> .....	897-89 8
<b>Brass Threaded Fittings</b> .....	893-89 5, 904, 1460
<b>Brasscraft</b> .....	898-89 9
<b>BrassCraft</b> .....	1221, 1424, 1711, 1715, 1718, 1729, 1731, 1737, 1739
<b>Brasscraft</b> .....	1739
<b>BrassCraft</b> .....	1739-1 741, 1746-1 747, 2392
<b>Brasstech Company</b> .....	1624



# Manufacturer Index

## B (Continued)

<b>Brizo</b> .....	118-12 2, 139-14 2, 224-22 8, 271-28 5, 375-38 2, 429-43 9, 444, 486-48 9, 516-51 8, 549-55 5, 571, 658, 663-68 3, 728-73 1, 742, 744, 809-82 1, 843-84 5, 1899-1 900, 2265, 2275, 2302, 2422-2 427, 2458-2 459
<b>Bully Tools</b> .....	2166

## C

---

<b>C &amp; S Mfg Corp</b> .....	1280, 1445
<b>Camis Industries</b> .....	90
<b>Canplas Industries</b> .....	36, 2337-2 338
<b>Cast Copper Pressure Fittings</b> .....	908
<b>Cast Iron No Hub Soil Pipe</b> .....	1209
<b>Cast Iron No-Hub Soil Fittings</b> .....	1053-1 055, 1061-1 063
<b>Century Wire &amp; Cable</b> .....	2575





## Manufacturer Index

### C (Continued)

Charlotte Pipe and Foundry Co.....	1053-1 055, 1061-1 063, 1209
Cherne Industries.....	1449-1 451, 2143
Chicago Faucets.....	190-19 5, 244, 2660-2 664
Church.....	1919-1 920, 1930-1 931, 1937
Cimberio Valve Co.....	2348
Clamp-All.....	941
Compass Manufacturing.....	134, 329-33 0, 414, 538, 714, 772, 831, 1162, 1179, 1687-1 688, 1854, 1890
Conbraco see Apollo.....	2346, 2362, 2394
Conex Banninger.....	1059-1 060
Continental Industries.....	1254
Copper Cast DWV Fittings.....	924-92 7
Copper Cast Pressure Fittings.....	906-90 7, 909-91 0
Copper Wrot Pressure Fittings.....	920, 922-92 3
CPVC Fittings.....	934-93 5
CPVC Pipe.....	985, 1214



# Manufacturer Index

## C (Continued)

CPVC Sch 80 Fittings.....	928-93 3
Creative Specialties.....	1513-1 514, 1901-1 902, 2435-2 443, 2451-2 454, 2463-2 469, 2474-2 477
Cresline Plastic Pipe Co.....	934, 1215, 1217, 1239-1 240, 1242-1 244, 1249

## D

---

Dahl Brothers Canada Ltd.....	1744
Danco.....	1857
Dap, Inc.....	1404
DAP, Inc.....	1405
Dayton Sinks by Elkay.....	1678-1 682, 1684
Dearborn Brass.....	1722-1 723, 1768, 2245-2 247, 2266, 2268-2 269, 2271, 2279-2 281, 2284, 2293-2 294, 2306-2 308, 2310-2 311, 2314, 2472, 2665



# Manufacturer Index

## D (Continued)

Decolav.....	1174, 1188, 2277
Delta.....	95-98, 106-11 7, 139-14 0, 144-16 7, 216-22 4, 282, 286-30 7, 356-37 4, 381, 397-40 3, 436, 440-45 0, 463-46 4, 486, 489-50 9, 519-52 3, 549-55 0, 552, 556-57 2, 621-66 2, 732-75 3, 791-80 8, 814, 838-84 2, 1898-1 899, 2275-2 276, 2426, 2428-2 434, 2448-2 450, 2460-2 462, 2478-2 480, 2666-2 683



# Manufacturer Index

## D (Continued)

DiversiTech.....	974, 1201, 1257, 1266, 1387-1 388, 1994-1 997, 2651, 2779-2 780
Dormont Mfg.....	948, 1220, 1425
Dura Plastics.....	2340

## E

---

EasyHeat.....	1281
Eemax Tankless Water Heaters.....	2512
EGW Utilities.....	1251
EL Mustee.....	1431, 1487, 1501, 1512, 1527, 1699-1 700, 1703, 2242, 2721



**E (Continued)**

<b>Elkay</b> .....	132-13 3, 196-20 2, 331-33 7, 467, 1177, 1537-1 548, 1552-1 568, 1592-1 607, 1660-1 677, 1679-1 680, 1682-1 683, 1706-1 710, 2295-2 296, 2529-2 555, 2558-2 559, 2687-2 688
<b>Elkhart</b> .....	922, 1092-1 094
<b>Elster Perfection Corporation</b> .....	1252-1 253
<b>Empire Comfort Systems</b> .....	2689
<b>Energy Saving Products</b> .....	2695
<b>Erico</b> .....	1284, 1350-1 352, 1354-1 356, 1359-1 361, 1363-1 366, 1368-1 369
<b>Evap Corporation</b> .....	1408

**F**

---

<b>Febco</b> .....	2335
<b>Fenner Drives</b> .....	2690



# Manufacturer Index

## F (Continued)

Fernco Inc.....	941, 1776
Fiat.....	205, 1702, 1704-1 705
Field Controls.....	2585
Flo Control Inc.....	949, 2341, 2363
Fluidmaster.....	1382, 1409, 1717, 1719, 1735-1 736, 1750-1 751, 1762, 1855, 1904-1 908
Ford Meter Box.....	2387
Fralo Plastech.....	61
Franklin Electric.....	2568

## G

---

GA Murdock.....	980, 1241
Galeton Gloves.....	2639, 2649
Galvanized MI Fittings.....	950-95 2
Gas Tanks & Refills.....	1317
Gasoila.....	1305
Geberit Mfg Co.....	2248
General Filters.....	2691
General Wire Spring Co.....	1456, 2023, 2140, 2146, 2148-2 149
Genova Products.....	1022, 1273





# Manufacturer Index

## G (Continued)

Gerber.....	328, 409, 466, 684, 766-76 8, 1136-1 140, 1160-1 161, 1175, 1189-1 190, 1757, 1777-1 778, 1793-1 796, 1811-1 815, 1833-1 846, 1856, 1873, 1880-1 886, 1903, 1932, 2249-2 251, 2303, 2317-2 319, 2692
Glentronics (PHCC).....	53, 78-83
Grundfos Pumps.....	2563, 2566
Gruvlok.....	905, 964-97 1, 1315
Guy Gray Mfg Co.....	1396-1 397

## H

---

Halsey Taylor.....	2555-2 556
Hansgrohe.....	529
Harris Group.....	1321-1 322



# Manufacturer Index

## H (Continued)

Harvey.....	1197, 1200, 1293, 1306, 1346, 1400, 1433, 1437, 1720, 1756, 1763, 1766, 1910, 2144
Hefco Plastics Inc.....	942
Hercules.....	1295, 1310-1 312, 1320, 1401, 1406-1 407, 1421, 1435, 1765
Hilmor.....	866-86 7, 2024, 2044, 2111-2 112, 2139, 2164
HoldRite.....	1378-1 379
Honeywell.....	76, 2526, 2696-2 698
Hydron Module.....	2699

## I

---

Ideal Tridon.....	1058, 1349
Implus Corporation.....	2653
In o Vate Technologies.....	1398
In-Slnk-Erator.....	4
In-Slnk-Erator.....	4
In-Slnk-Erator.....	4-5



**I (Continued)**

In-Sink-Erator.....	136-137
Infiltrator Systems.....	34-35, 62
Innerlynx Seal.....	1282
IPS Corporation.....	1283
IPS Corporation AB&A.....	2243-2244, 2292
IPS Corporation Studor.....	1458-1459
IPS Corporation Test-Tite.....	1446-1447
IPS Corporation Truebro.....	1426
IPS Corporation Water-Tite.....	1448, 1764
IPS Corporation Weld-On.....	1294, 1301-1303, 1434

**J**

---

J-B Products.....	2267, 2283, 2304
Jackel Inc.....	66-69
Jaclo Industries.....	8, 536, 581-582, 1713-1714, 1726, 1730, 1734, 1742, 1749, 1913, 2252-2253, 2263, 2270, 2278, 2282, 2285, 2297, 2481
Johnson Mfg Co.....	1327
Jones Stephens.....	2252



# Manufacturer Index

## K

---

Ken-Way Corporation.....	2147
KitchenAid.....	1



# Manufacturer Index

## K (Continued)

Kohler.....	98, 100-10 4, 138, 159, 168-17 8, 211-21 3, 239-24 2, 247-27 0, 312, 347-35 5, 392-39 6, 415-42 8, 461-46 2, 469-48 5, 530-53 5, 539-54 8, 555, 565, 584-62 0, 715-72 7, 773-79 0, 832-83 7, 1124-1 135, 1143-1 157, 1163-1 173, 1180-1 186, 1191-1 194, 1488-1 497, 1502-1 506, 1515-1 525, 1528-1 533, 1569-1 591, 1608-1 610, 1618, 1633-1 649, 1655, 1691-1 695, 1712, 1727-1 728, 1753-1 755, 1779-1 783, 1785-1 792
-------------	------------------------------------------------------------------------------------------------------------------------------------------------------------------------------------------------------------------------------------------------------------------------------------------------------------------------------------------------------------------------------------------------------------------------------------------------------------------------------------------------------------------------------------------------------------------------------------------------------------------------------------------------



## Manufacturer Index

### L

---

LA-CO Markal.....	1307, 1325, 1334
Lavelle.....	245, 1372, 1738, 1858, 1911, 2145, 2313
Legend Valve.....	859, 899, 2354, 2397
Liberty Pumps.....	49, 54, 70-75
Little Giant.....	50, 55, 77, 84, 2564, 2567
Lochinvar.....	2505, 2722
Lutz File & Tool Co.....	1989, 2138

### M

---

MA-Line.....	1982
MAAX.....	2211, 2241, 2262
Majestic Glove.....	2637-2 638
Malco Tools.....	1261, 1338, 1955, 1967, 1985, 2136-2 137, 2156-2 159, 2177, 2715





# Manufacturer Index

## M (Continued)

<b>Mansfield</b> .....	1142, 1158-1 159, 1178, 1187, 1195, 1799-1 800, 1817-1 818, 1849-1 853, 1887-1 889, 1914, 2210, 2239-2 240, 2327, 2632-2 633
<b>Matco-Norca</b> .....	346, 890-89 1, 1047, 1767, 2375, 2385
<b>Maxstraps</b> .....	1993
<b>Mayco Industries</b> .....	1304, 1464
<b>McDonnell and Miller</b> .....	2716
<b>Merit Brass</b> .....	1076, 1084-1 086, 1248
<b>Merrill Manufacturing</b> .....	863, 975-97 7, 1348, 2576-2 581
<b>Mill-Rose</b> .....	1308-1 309, 1328-1 329, 1337, 1999, 2126, 2178
<b>Milwaukee Tools</b> .....	2647



# Manufacturer Index

## M (Continued)

<b>Milwaukee Tools</b> .....	1007-1 010, 1938-1 954, 1959-1 964, 1966, 1969-1 974, 1977, 1986-1 987, 1991-1 992, 2003-2 014, 2021-2 022, 2026, 2037-2 040, 2045-2 103, 2115-2 124, 2127-2 135, 2160-2 162, 2168-2 171, 2634-2 635, 2640-2 648
<b>Mission Rubber Company</b> .....	938-94 1, 1056, 1065



**M (Continued)**

<b>Moen.....</b>	<b>3, 99, 123-12 7, 143, 179-18 9, 243, 308-32 2, 383-39 0, 404-40 7, 451-45 8, 465, 510-51 5, 524-52 8, 573-57 8, 687-71 1, 754-76 5, 822-82 8, 846-85 0, 1685-1 686, 2717-2 720</b>
<b>Moen, Lavatory Faucets.....</b>	<b>383</b>
<b>Monti &amp; Associates.....</b>	<b>1982</b>
<b>Mountain Plumbing Products.....</b>	<b>7, 130-13 1, 135, 583, 1625, 2264, 2272, 2287, 2301</b>
<b>Mueller Industries.....</b>	<b>901, 1210, 1224, 2395</b>

**N**

---

<b>Navien, Inc.....</b>	<b>2524, 2723</b>
<b>NDS.....</b>	<b>92-93, 942</b>
<b>Neoperl.....</b>	<b>98</b>



## Manufacturer Index

### N (Continued)

Neptune Technology.....	2599
Niagara Conservation.....	1801, 1819, 1879
Nibco.....	908-90 9, 920-92 1, 926-92 7, 934-93 5, 1743, 1748, 2344-2 345, 2356-2 358, 2364, 2368, 2373-2 374, 2379-2 380, 2383, 2403
Nipples, Black Steel.....	885-89 0
Nipples, Brass.....	895-89 6, 904
Nipples, PVC Sch 80.....	1040
Nordyne.....	2790-2 792
Nortek Global.....	2694
Nu-Calgon.....	1198, 1336, 2109
Nupi Americas Inc.....	1226
Nyco Products Co.....	1412
Nylon Insert Fittings.....	974



# Manufacturer Index

## O

---

<b>Oasis</b> .....	1465-1 472, 1499-1 500, 2184-2 188, 2235-2 237, 2628-2 629
<b>Oatey</b> .....	48, 1022, 1271-1 272, 1278, 1290, 1297-1 300, 1323-1 324, 1383, 1389-1 391, 1418, 1432, 1437, 1442-1 443, 1452, 1461, 1463, 1732, 1761, 1765, 1768-1 770, 2290-2 291
<b>OmegaFlex</b> .....	943-94 5, 1218
<b>Orion Fittings</b> .....	998, 1203



# Manufacturer Index

## P

---

Pasco Specialty Mfg Inc.....	214, 579, 852, 1296, 1414, 1430, 1453, 1724, 1758, 1772, 1909, 2001, 2179, 2305, 2315, 2557
Peerless.....	342-34 4, 412-41 3, 712, 771
Perfection Corporation.....	1252-1 253
Philco see NORDYNE.....	2790-2 792
Pipe, Black Steel.....	1206-1 207
Pipe, CPVC.....	1214-1 215
Pipe, Galvanized Steel.....	1222-1 223
Pipe, PVC.....	1215, 1217
Plastic Trends Inc.....	1041-1 044
Plumb4orce.....	129, 338-34 1, 391, 410-41 1, 460, 468, 537, 685-68 6, 769-77 0, 829
Plumberex Specialty Products.....	1427
Polylok Inc.....	58-60
Powers.....	210
Prier Products Inc.....	24, 860, 2309





**P (Continued)**

Prinsco.....	65
Protech.....	1956, 1998, 2751-2 775
PVC DWV Fittings.....	1012-1 022, 1771
PVC Pipe.....	1242
PVC Sch 40 Fittings.....	1024-1 031, 1289
PVC Sch 80 Fittings.....	1033-1 039

**Q**

---

Quality Pipe Products Inc.....	1208
--------------------------------	------

**R**

---

Radiator Specialty Co.....	1912
Rectorseal.....	33
RectorSeal.....	1313, 1326, 1422, 2036, 2180
Rectorseal.....	2343, 2775
Red Devil.....	1385, 1402
Red Head.....	1258-1 259
Red Jacket Water Pumps.....	2565
Red-White Valve Corp.....	2347, 2384
Resun Valves.....	2402
Reznor.....	2726-2 728
Rheem, Water Heaters.....	2509



# Manufacturer Index

## R (Continued)

Rheem-Ruud.....	2730-2 734
Richard Specialty Co Inc.....	215, 1262, 1339, 1347, 1428, 1457, 1965, 2002, 2032, 2043, 2141, 2175
Ridgid Tools.....	1010-1 011, 1331, 1957, 1968, 1990, 2019-2 020, 2027, 2030-2 031, 2033-2 035, 2041, 2104, 2113-2 114, 2163, 2165, 2172-2 174
Riex Company LLC.....	1371
Robertshaw.....	1205
Roth.....	61
Rothenberger.....	1340
Ruud.....	1314, 1318, 1333, 1335, 1975-1 976, 1978, 1981, 1998, 2000, 2105-2 108, 2110, 2517, 2769-2 774, 2776-2 778



# Manufacturer Index

## R (Continued)

Ruud, Water Heaters.....	2499-2 504, 2507-2 511, 2513-2 523
--------------------------	---------------------------------------------------

## S

---

Salt.....	2596-2 597
Sammy - ITW Buildex.....	1370
Sanitary Solutions.....	1087-1 091, 1247, 2355, 2367, 2371
Santeen Products Company.....	1410
Schwank USA.....	2735
Screws, Nuts & Bolts.....	1264, 1357, 1367
Seekonk Manufacturing Co Inc.....	2181
Seelye Plastics.....	1256
Sensible Products.....	2182
Service Metal.....	2405
SFA Saniflo.....	1860-1 861
SharkBite.....	1048-1 052



# Manufacturer Index

## S (Continued)

Sioux Chief.....	18-23, 28-30, 39-47, 91, 246, 580, 830, 879-88 1, 916-92 0, 927, 936, 1022-1 023, 1032, 1067, 1109-1 110, 1202, 1233, 1263, 1267, 1269-1 270, 1274, 1276-1 277, 1285-1 288, 1330, 1358, 1362, 1374-1 377, 1384, 1392-1 395, 1413, 1415-1 417, 1420, 1429, 1438-1 440, 1444, 1454-1 455, 1462, 1716, 1721, 1725, 1733, 1745, 1752, 1759-1 760, 1773-1 775, 2017-2 018, 2029, 2042, 2125, 2142, 2288-2 289, 2312, 2316, 2342, 2401, 2527-2 528
------------------	-------------------------------------------------------------------------------------------------------------------------------------------------------------------------------------------------------------------------------------------------------------------------------------------------------------------------------------------------------------------------------------------------------------------------------------------------------------------------------------------------------------------------------------------------------------------------------------------------------------------------------------------------------------------



**S (Continued)**

<b>SJE Rhombus.....</b>	<b>89</b>
<b>Sloan.....</b>	<b>207-209, 229-238, 1196, 1784, 2325-2326, 2736-2743</b>
<b>Smith Cooper International.....</b>	<b>892, 971-973, 978-979, 1068-1075, 1077-1083, 1246, 2353, 2366, 2376, 2382</b>
<b>Speakman.....</b>	<b>204, 2744</b>
<b>Spears.....</b>	<b>985-986, 1316, 2359-2361</b>
<b>Spears, CPVC CTS Fittings.....</b>	<b>935-936</b>
<b>Spears, CPVC CTS Valves.....</b>	<b>936</b>
<b>Spears, Molded DWV Fittings.....</b>	<b>981-984, 1216</b>
<b>Spears, PVC Ball Valves.....</b>	<b>2360</b>
<b>Spears, PVC Check Valves.....</b>	<b>2370</b>
<b>Steel Weld Fittings.....</b>	<b>1112-1113</b>



# Manufacturer Index

## S (Continued)

<b>Sterling Plumbing Group.....</b>	<b>1141, 1176, 1473-1 481, 1508-1 511, 1534, 1650-1 651, 1653, 1696, 1797-1 798, 1816, 1847-1 848, 1878, 2191-2 196, 2473, 2627</b>
<b>Stuff Sorter by Versapac.....</b>	<b>2016</b>
<b>Swanstone.....</b>	<b>1611-1 613, 1701</b>

## T

---

<b>T&amp;S Brass.....</b>	<b>203, 2745-2 746</b>
<b>Taco.....</b>	<b>2747</b>
<b>Tapco.....</b>	<b>2655</b>
<b>TCC Materials.....</b>	<b>1419</b>
<b>Thermolec.....</b>	<b>2748</b>
<b>Thoro Consumer Products.....</b>	<b>1386</b>
<b>Thrift Marketing Inc.....</b>	<b>1411</b>
<b>Topp Industries Inc.....</b>	<b>63-64</b>
<b>TR Industries.....</b>	<b>1199</b>
<b>Tremco.....</b>	<b>1403</b>
<b>Triangle Tube.....</b>	<b>2749</b>
<b>Tuf-Tite.....</b>	<b>57</b>
<b>TurboTorch.....</b>	<b>1341-1 345</b>





## Manufacturer Index

### U

---

Union Brass Faucet.....	206, 459, 713, 851, 2750
United Pipe & Steel Corp.....	1211-1 213
Universal Enterprises Inc.....	1979-1 980
Uponor.....	864, 869-87 8, 1227-1 228, 1236, 2352

### V

---

Victaulic.....	957-96 4
Viega.....	865, 987-99 1, 1000-1 006, 1095-1 099, 1101-1 103, 1230-1 232, 2372
Viega MegaPress.....	991-99 7

### W

---

Wal-Rich Corporation.....	9, 853, 1250, 1373, 1915, 2781
Wardflex.....	946-94 7, 1219
Waste King.....	6
Watco Manufacturing Company.....	2259-2 261



## Manufacturer Index

### W (Continued)

Water-King USA.....	2595
Water-Right, Inc.....	2584, 2593-2 594, 2782
Water-Right, Inc.....	2782
Watts, Water Technologies.....	345, 408, 1104-1 108, 1229, 2583, 2586-2 589
Watts Drainage.....	11-17, 25-27, 31-32, 37-38, 858, 1275, 1441, 1689-1 690
Watts Radiant.....	1237
Watts Regulator.....	896-89 7, 937, 1111, 1292, 1380, 2328-2 334, 2349-2 351, 2365, 2369, 2378, 2381, 2386, 2388-2 391, 2396, 2398-2 399, 2404, 2783
Watts Water Technologies.....	2586
Weil-McLain.....	2506, 2784-2 789
Whirlpool Corporation.....	2
White Rodgers.....	2794-2 803
Whitlam.....	2525



**W (Continued)**

<b>Winters Instruments.....</b>	<b>2569-2 574</b>
<b>Wirsbo see Uponor.....</b>	<b>864, 869-87 8, 1227-1 228, 1236, 2352</b>
<b>Woodford.....</b>	<b>854-85 7, 861-86 2, 1381, 2804-2 806</b>
<b>Worthington Cylinders.....</b>	<b>868, 1332</b>
<b>Wrot Copper Pressure Fittings.....</b>	<b>909-91 6</b>
<b>Wyo-Ben Inc.....</b>	<b>2562</b>

**Y**

<b>Yellow Jacket.....</b>	<b>1958, 1983-1 984, 2015, 2025, 2150-2 155, 2176, 2807</b>
---------------------------	---------------------------------------------------------------------------------------------

**Z**

<b>Zoeller Pump Co.....</b>	<b>51-52, 56, 85-88, 2808</b>
<b>Zurn.....</b>	<b>94, 1859, 2336</b>
<b>Zurn PEX.....</b>	<b>1116-1 123, 1234-1 235</b>



BR #	Location	Address	Phone	Mgr or Contact
15	Ames	2408 E Lincoln Way - Ames, IA 50010	515-233-5737	Wade Brinkmeyer
228	Branson	110 Warehouse Rd - Branson, MO 65616	417-335-4554	James Gerleman
6	Cedar Rapids	4700 J St. SW - Cedar Rapids, IA 52404	319-366-7891	Greg Wolfe
235	Col Showroom	1729 W Broadway - Columbia, MO 65201	573-445-4481	Ronnie Roberts
210	Columbia	2412 Bus Loop 70E - Columbia , MO 65201	573-875-3131	John Levell
220	Columbia HVAC	1112 Smith St. - Columbia MO 65201	573-874-5661	Mac Stephenson
18	Davenport	4601 Grand Ave - Davenport, IA 52807	563-391-0240	Terry Morrow
1	Des Moines	1622 NE 51st Ave - Des Moines, IA 50313	515-262-9511	Pat Nicholson
13	Dubuque	600 Cedar Cross Rd - Dubuque, IA 52003	563-556-2827	Todd Smith
4	Fort Dodge	1565 Cardinal Ave - Fort Dodge, IA 50501	515-573-8161	Todd Johnson
214	Hannibal	4385 Paris Gravel Rd - Hannibal, MO 63401	573-221-0142	Michele Daniels
8	IC Showroom	214 Southgate Ave - Iowa City, IA 52240	319-351-5010	Jodi Daywitt
17	Iowa City	1925 Boyrum St. - Iowa City, IA 52240	319-351-1004	Blake Schoonover
206	Jefferson City	2027 Christy Drive - Jefferson City, MO 65101	573-634-4515	Kent Robinson
205	Kirkville	405 W Hickory St. - Kirkville, MO 63501	660-665-2626	Jeff Sharp
212	Laurie	203 S Main - Laurie, MO 65038	573-374-8899	Nathan Castle
19	Le Mars	436 2nd Ave NE - Le Mars, IA 51031	712-546-8129	George Regenitter
209	Lenexa	14936 W 101st Terrace - Lenexa, KS 66215	913-782-7455	Doug Crouch
225	Liberty	2108 Kara Ct. Suite D - Liberty, MO 64068	816-335-3020	Bobby Dietz
211	Marshall	735 N Miami - Marshall, MO 65340	660-886-5151	Jeff Hoey
12	Marshalltown	207 Iowa Ave E - Marshalltown, IA 50158	641-753-2847	Jake Boesch
3	Mason City	45 19th St. SW - Mason City, Iowa 50401	641-423-0164	Jeff Frahm
203	Mexico	622 E Liberty - Mexico, MO 65265	573-581-6842	Jeremy Wright
250	Moberly	807 W. Hwy 24 - Moberly, MO 65270	660-263-1280	Eric Clark
11	Muscatine	1418 S Houser - Muscatine, IA 52761	563-264-8655	Deb Moffit
16	North Cedar Rapids	1716 Blairs Ferry Rd - NE Cedar Rapids, IA 52402	319-393-1441	Rick Vraspier
202	Osage Beach	924 Hwy 42 - Osage Beach, MO 65065	573-348-2253	Mike Anderson
2	Ottumwa	420 Gateway Dr - Ottumwa, IA 52501	641-682-8357	Doug Ewing
14	Pella	208 SE 9th St. - Pella, IA 50219	641-620-1406	Ben Sims
5	Red Oak	1949 G Ave - Red Oak, IA 51566	712-623-4841	Gary Porter
201	Rolla	11208 Twitty Dr - Rolla, MO 65401	573-364-5211	Josh Berhorst
7	Spirit Lake	3010 18th Street - Spirit Lake, IA 51360	712-336-0787	Ryan Summers
208	Springfield	2234 E Olive Court - Springfield, MO 65802	417-865-8770	Matt Dabb
204	Warrensburg	133 Railroad - Warrensburg, MO 64093	660-429-3555	Dave Gamblin
207	Washington	205 E 8th St. - Washington , MO 63090	636-239-1969	Kenny Moritz
10	Waterloo	3338 W Airline Hwy - Waterloo , IA 50703	319-236-1511	Stacy Barber
9	Waukee	920 SE Frontier Ave - Waukee IA 50263	515-987-2802	Clint Rees
998	Corporate Missouri	2412 Bus Loop 70E - Columbia, MO 65201	573-875-3131	Jason Metcalf
999	Corporate	1622 NE 51st Ave - Des Moines, IA 50313	515-262-9511	Alan Darnielle

Red Branch Number Designates Showroom Location

\*\*Master copy on "S" Drive under 999 Branch Locations\*\*

# Plumb Supply

COMPANY



[www.plumbsupply.com](http://www.plumbsupply.com)  
[www.facebook.com/PlumbSupplyCompany](http://www.facebook.com/PlumbSupplyCompany)

*Corporate Office*  
*515-262-9511*  
*1622 NE 51st Ave*  
*Des Moines, IA 50313*