



Plumb Supply

COMPANY

2020

HVAC Products

Vol. 1



BR#	Location	Address	Phone	Mgr or Contact
15	Ames	2408 E Lincoln Way - Ames, IA 50010	515-233-5737	Wade Brinkmeyer
228	Branson	110 Warehouse Rd - Branson, MO 65616	417-335-4554	James Gerleman
6	Cedar Rapids	4700 J St. SW - Cedar Rapids, IA 52404	319-366-7891	Greg Wolfe
235	Col Showroom	1729 W Broadway- Columbia, MO 65201	573-445-4481	Ronnie Roberts
210	Columbia	2412 Bus Loop 70E - Columbia, MO 65201	573-875-3131	John Levell
220	Columbia HVAC	1112 Smith St. - Columbia MO 65201	573-874-5661	Mac Stephenson
18	Davenport	4601 Grand Ave - Davenport, IA 52807	563-391-0240	Terry Morrow
1	Des Moines	1622 NE 51st Ave - Des Moines, IA 50313	515-262-9511	Pat Nicholson
13	Dubuque	600 Cedar Cross Rd - Dubuque, IA 52003	563-556-2827	Todd Smith
4	Fort Dodge	637 South 22nd St - Fort Dodge, IA 50501	515-573-8161	Todd Johnson
214	Hannibal	4385 Paris Gravel Rd - Hannibal, MO 63401	573-221-0142	Michele Daniels
8	IC Showroom	214 Southgate Ave - Iowa City, IA 52240	319-351-5010	Jodi Daywitt
17	Iowa City	1925 Boyrum St. - Iowa City, IA 52240	319-351-1004	Blake Schoonover
206	Jefferson City	2027 Christy Drive - Jefferson City, MO 65101	573-634-4515	Kent Robinson
205	Kirksville	405 W Hickory St. - Kirksville, MO 63501	660-665-2626	Jeff Sharp
212	Laurie	203 S Main - Laurie, MO 65038	573-374-8899	Nathan Castle
19	Le Mars	436 2nd Ave NE - Le Mars, IA 51031	712-546-8129	George Regenitter
209	Lenexa	14936 W 101st Terrace - Lenexa, KS 66215	913-782-7455	Doug Crouch
225	Milwaukee ToolBox	14930 W 101st Terrace - Lenexa, KS 66215	816-335-3020	Bobby Dietz
211	Marshall	735 N Miami - Marshall, MO 65340	660-886-5151	Jeff Hoey
12	Marshalltown	4207 Iowa Ave E - Marshalltown, IA 50158	641-753-2847	Danny Moranville
3	Mason City	45 19th St. SW - Mason City, Iowa 50401	641-423-0164	Jeff Frahm
203	Mexico	622 E Liberty - Mexico, MO 65265	573-581-6842	Jeremy Wright
250	Moberly	807 W. Hwy 24 - Moberly, MO 65270	660-263-1280	Eric Clark
11	Muscatine	1418 S Houser - Muscatine, IA 52761	563-264-8655	Deb Moffit
16	North Cedar Rapids	1716 Blairs Ferry Rd - NE Cedar Rapids, IA 52402	319-393-1441	Rick Vraspier
202	Osage Beach	924 Hwy 42 - Osage Beach, MO 65065	573-348-2253	Mike Anderson
2	Ottumwa	420 Gateway Dr - Ottumwa, IA 52501	641-682-8357	Doug Ewing
14	Pella	208 SE 9th St. - Pella, IA 50219	641-620-1406	Andre Young
5	Red Oak	1949 G Ave - Red Oak, IA 51566	712-623-4841	Gary Porter
201	Rolla	11208 Twitty Dr - Rolla, MO 65401	573-364-5211	Josh Berhorst
7	Spirit Lake	3010 18th Street - Spirit Lake, IA 51360	712-336-0787	Ryan Summers
208	Springfield	2234 E Olive Court - Springfield, MO 65802	417-865-8770	Matt Dabb
204	Warrensburg	133 Railroad - Warrensburg, MO 64093	660-429-3555	Dave Gamblin
207	Washington	205 E 8th St. - Washington, MO 63090	636-239-1969	Kenny Moritz
10	Waterloo	3338 W Airline Hwy - Waterloo, IA 50703	319-236-1511	Stacy Barber
9	Waukee	920 SE Frontier Ave - Waukee IA 50263	515-987-2802	Clint Rees
998	Corporate Missouri	2412 Bus Loop 70E - Columbia, MO 65201	573-875-3131	Jason Metcalf
999	Corporate	1622 NE 51st Ave - Des Moines, IA 50313	515-262-9511	Ed Ruth

Red Branch Number Designates Showroom Location

General Conditions

This price service has been designed to assist you in estimating your jobs. It is our sincere desire to maintain the necessary inventory to satisfy your requirements, but we do not stock all of the items in this catalog.

All orders are subject to approval by our credit department, and the possession of this price service is not to be construed as an offer to sell.

All prices are subject to change without notice and due to market conditions over which we have no control, cannot be guaranteed. Orders will be accepted on the basis of the market price prevailing at the time of shipment.

We cannot be held responsible for any errors or omissions in the price service.

Taxes

Sales tax will be added to all invoices unless you have furnished us with a Sales Tax Exemption Certificate for your purchases.

Return Goods

Materials may be returned for credit with prior approval and authorization from our office. Any material claimed defective that is covered by factory warranty must be accompanied by the necessary warranty information. When authorization to return goods is requested, the date of the purchase and our invoice number must be given to either our salesperson or the office.

Special Materials or Non-Stock Orders

Orders for non-stock or special items cannot be cancelled or returned for credit without factory approval. If approval is obtained, credit will be allowed for the net salvage value allowed by the factory.

Warranty

The products we sell are guaranteed only to the extent of the manufacturer's warranty. No allowances will be made for labor, damage or kindred claims, and Plumb Supply Company cannot be held liable for any product liability claims, freight shortages or other claims over which we have no control.



Table of Contents

Air Treatment & Filters

Air Cleaners	1
Air-to-Air Heat Exchangers	8
Humidifiers/Dehumidifiers	14
Throwaway Filters	21

Cooling - Equipment & Rooftop Units

Air Handlers	32
Coils	42
Condensing Units	58
Heat Pumps	74
Electric Heat Kits	89
Mini-Split Components & Accessories	90
Mini-Splits/Multi Zone Systems	96
Mini-Splits/Single Zone Systems	99
Packaged Terminal Air Conditioners	107
Roof Top Units	110
VRF Equipment	119

Cooling - Accessories

Brass Sealing Caps	123
Chemicals	124
Leak Detection	127
Chemicals	128
Condensate Neutralizers	135
Cleaners	136
Condensate Drain Pan Switches	138
Condensate Traps	139
Condenser Pads	141
Defrost Controls	145
Electrical	149
Spade & Other Electrical Connectors	152
Electrical	157
Crankcase Heaters	159
Filter Driers	160
Leak Detection	167
Linesets	175
Mounting Systems	178
Refrigerant Components	180
Secondary Drain Pans	182
Site Glasses	183



Table of Contents

Cooling - Accessories (Continued)

Tap Valves & Piercing Valves	185
------------------------------	-----

Ducts, Fittings & Accessories

Aluminum Faced Board Panning & Grille Frames	186
Canvas Duct Connectors	187
Chimney & Vent	188
Duct Boosters	194
Duct Tape	196
Duct Fasteners	199
Duct Sealants	205
Duct Hangers	206
Flexible Duct	209
Galvanized Sheet Metal	212
Oval Pipe & Fittings	214
Plenum & Return Air Drops	216
PVD/PVC Air Duct	219
Rectangular Collars	222
Rectangular Duct	224
Rectangular Elbows	226
Rectangular Miscellaneous	229
Round Boots	234
Round Collars	236
Round Elbows	238
Round Pipe	239
Round Takeoffs	241
Round Tees & Wyes	243
Round Miscellaneous	245
Wall Stack Duct	248
Wall Stack Fittings	249

Fire Safety

Fire Safety	250
-------------	-----

Geothermal Supplies

Geothermal Accessories	252
------------------------	-----

Grilles & Registers

Ceiling Grilles & Registers	258
Commercial Grilles & Registers	262



Table of Contents

Grilles & Registers (Continued)

Deflectors	270
Floor Grilles & Registers	271
Grille & Register Accessories	276
Sidewall Grilles & Registers	277

Heating - Forced Air

Electric Furnaces	285
Gas Downflow Furnaces	286
Gas Multi-Position Furnaces	308
Gas Upflow/Horizontal Furnaces	310
Gas Unit Heaters	333
Gas Fireplaces	335
Kickspace Heaters	336
Furnace Accessories	337

Heating - Hydronic

Maxifold Manifolds & Accessories	341
Lochinvar Boilers	342
Navien Boilers	346
Thermolec Boilers	350
Triangle Tube (Prestige) Boilers	351
Weil McLain Boilers	353
Uponor (Wirsbo) Heating	360
Watts Heating	369

Heating - Hydronic Accessories

Air Purgers	370
Air Vents	371
Antifreeze & Other Chemicals	377
Aquastats	384
Baseboard Radiation	387
Boiler & Zone Controls	389
Boiler Accessories	395
Circulator Pumps	398
Flow Valves	406
Heat Exchangers	407
Isolation Flanges	409
Low Water Cut-Offs & Feeders	412
Pressure Reducing Valves	415



Table of Contents

Heating - Hydronic Accessories (Continued)

Radiator Traps & Valves	418
Spiralink Couplings	422
Thermal Expansion Tanks	423
Water Gauges & Sight Glasses	425
Zone Valves	428

Heating - Infrared

Schwank Infrared Heating	432
--------------------------	-----

HVAC - General Accessories

Adjustable Pressure Switches	435
Capacitors	436
Chemicals	445
Condensate Pumps	446
Disconnects/Fuses/Electrical Box Covers	452
Electrical Tape	455
Gas Valves	457
Heat Shrink Tubing	463
Igniters	464
Limit Controls	467
Oil Furnace Accessories	468
Pilot Assemblies	472
Pressure Regulators - Gas	473
Relays	475
Smoke Bombs	476
Spades & Other Electrical Connectors	477
Temporary Construction Thermostats	482
Thermocouples	484
Thermostats: Honeywell	486
Thermostats: Pro1	506
Thermostats: Protech	509
Thermostats: Ruud	511
Thermostats: White-Rodgers	513
Thermostat Wire	518
Transformers	521
Universal Ignition Modules	524
Wire Nuts & Leads	527
Wire Ties & Connectors	528
Zone Dampers & Accessories	529



Table of Contents

Insulation

Adhesives & Coatings	535
Duct Liner	536
Duct Wrap	537
Duct Liner	538
Foam Board	540
Fiberglass Pipe Insulation	541
Insulation Tape	542
Mechanical Fasteners	545
R-Foil Insulation	547
Rubber Pipe Insulation	548

Cleaners & Lubricants

Cleaners	550
Lubricants	553

Radon Equipment & Supplies

Radon Fans	556
Radon Pits and Lids	558

Repair Parts

Airease Repair Parts & Accessories	560
American Standard Repair Parts	561
Basco Repair Parts	562
Bell & Gossett Repair Parts	563
Bradley Washfountain Repair Parts	565
Chicago Faucet Repair Parts	566
Dearborn Brass Repair Parts	571
Delta Faucet Repair Parts	572
Elkay Repair Parts	593
Empire Comfort Repair Parts	595
Fenner Drives Repair Parts	596
General Filter Repair Parts	597
Gerber Repair Parts	598
Gibson Repair Parts & Accessories	600
Hi-Velocity (Energy Savings Products) Repair Parts	601
Honeywell Repair Parts	602
Hydron Module Repair Parts	605
Kohler Repair Parts	607
Malco Repair Parts	622

Table of Contents

Repair Parts (Continued)

McDonnell & Miller Repair Parts	623
Moen Repair Parts	624
EL Mustee Repair Parts	629
Lochinvar Repair Parts	630
Navien Repair Parts	631
Reznor Repair Parts	635
Ruud Water Heater Repair Parts	639
Schwank Repair Parts	644
Sloan Repair Parts	645
Speakman Repair Parts	650
T & S Brass Repair Parts	651
Taco Repair Parts	653
Thermolec Repair Parts	654
Triangle Tube Repair Parts	655
Union Brass Repair Parts	656
Ruud Heating & AC Repair Parts	657
Repair Parts: WalRich	687
Water Right Repair Parts	688
Watts Regulator Repair Parts	689
Weil McLain Repair Parts	690
Westinghouse/Philco Repair Parts	696
Repair Parts: White Rodgers	700
Woodford Repair Parts	710
Yellow Jacket Repair Parts	713
Zoeller Repair Parts	714

Tools

Drill Bits	715
Flaring Tools	733
Work Lights	736
Flashlights	742
Hammers	743
Hole Saws	745
HVAC Testing Tools	751
Knives & Replacement Blades	762
Levels	766
Miscellaneous Tools	769
Pipe Cutters - Copper	794
Pipe Cutters - PEX	801
Pipe Cutters - Plastic	802



Table of Contents

Tools (Continued)

Pipe Cutters - Soil Pipe	805
Pipe Cutters - Steel	806
Pipe Threaders	807
Pliers & Wire Strippers	811
Power Tools - M12 and Misc	818
Power Tools - M18	841
Power Tool Accessories	871
Power Tools	877
Refrigeration Tools	878
Saws & Blades	886
Screwdrivers & Bits	899
Hand Sewer Machines	912
Power Sewer Machines	919
Refrigeration Tools	922
Sheet Metal Tools	928
Shovels	937
Trouble Lights/Extension Cords	939
Wrenches	940

Venting

Aluminum Venting	955
Chimney Liners	958
Draft Diverters	959
Dryer Venting	960
Venting	962
Exhaust Fans	963
Power Venters	969
QC Round Venting	970
RV Round Venting	972
Stainless Steel All Fuel Venting	975
WV Oval Venting	977
Roof & Chimney Caps	978
Sealants	980
Stainless Steel Venting	981

Work Wear

Gloves, Ear Plugs, Goggles, ETC	982
Work Gear	988
Heated Gear	990
Safety Glasses	997



Table of Contents

Work Wear (Continued)

Shoe Covers

998

Air Cleaners

Air Cleaners

F100 Media Air Cleaner

- High efficiency media filter captures particles as small as 0.3 microns
- Applicable to all gas, oil and electric forced air furnaces and to compressor cooling up to 5 tons
- Mounts in the return air duct
- Rugged zinc-coated, roll-formed cabinet resists corrosion
- Requires no electrical connections
- Mounts in any position
- Requires no maintenance except periodic media filter replacement
- Quick and easy media filter replacement



Part #	Mfg #	Description	Price
186814	F100F2010	Media Air Cleaner, 20" x 25" x 4", MERV11	
144637	F100F2002	Media Air Cleaner, 16" x 25"	

F300 Electronic Air Cleaner

- Media post-filter provides enhanced filtration on select models
- Solid state power supply is self-regulating and maintains peak efficiency during a wide range of cell dirt loading conditions
- Low-profile door with test button to check system operation
- Helps filter efficiency-robbing "gunk" before it coats critical system parts
- Very low pressure drop
- Exclusive 10-year Clean Coil Guarantee
- Rugged zinc-coated, roll-formed cabinet provides superior strength and corrosion protection



Part #	Mfg #	Description	Price
174188	F300E1019/U	Electronic Air Cleaner, 16"x25" w/ Performance Enhancing Post-Filter	
174189	F300E1027/U	Electronic Air Cleaner, 20"x20" w/ Performance Enhancing Post-Filter	

Merv 11 Air Cleaner

- Replacement filter for DR65A1000



Part #	Mfg #	Description	Price
135480	50049537-005	Media Air Cleaner, Merv 11	

Air Cleaners

Ultraviolet Air Treatment

UV Air Purifier with AirBRIGHT Odor Absorption

- installed in the ductwork of your central air system and is designed to help reduce airborne odors, toxic chemical vapors, germs and mold in your home
- Lamp is Always On
- Replace Lamp Annually
- AirBRIGHT Odor Absorber never needs replacing
- SnapLamp™ features replacement lamp handle with detachable replacement lamp.
- Universal Installation with a single product
 - UV Only
 - UV + Odor Removal
 - Internal Mount
 - External Mount



Part #	Mfg #	Description	Price
163862	UV2400U5000	24V UV Air Purifier with AirBRIGHT Odor Absorption	

120V Ultraviolet Treatment

- Return air application
- Operating temperature range:
Outside duct -- 30°F to 104°F
Inside duct -- 30°F to 140°F
- Reduces contaminants like airborne bacteria



Part #	Mfg #	Description	Price
110564	UV100E2009	120VAC, 36W Each	

Sail Switches

S688 Sail Switch

- Used in forced air systems to activate electronic air cleaners, humidifiers or other auxiliary equipment in response to air flow from system fan
- Polyester film sail mounted on a micro switch snap switch
- SPDT Switching
- Top and bottom conduit knockouts for wiring convenience
- Low air velocity switch operation makes at 250 fpm and breaks at 75 fpm



Part #	Mfg #	Description	Price
006785	S688A1007	5" Wide Sail, 26.2 sq in of Area, 10" Insertion Length	

Air Cleaners

Air Cleaners

Ruud Media Air Cleaner

- Fits a wide variety of equipment
- Platinum metallic paint
- Rugged cabinet construction



Part #	Mfg #	Description	Price
086516	84-25050-01	O/A Dimension: 20-1/4"H x 24-7/8"D x 7-1/8"W MERV8 2000 cfm	
035230	84-25050-03	O/A Dimension: 23-1/2"H x 25-5/8"D x 15-1/2"W, Right Angle	
088498	84-25050-06	O/A Dimension: 16-1/4"H x 24-7/8"D x 7-1/8"W MERV8 1400 cfm	

Electronic Air Cleaner



Part #	Mfg #	Description	Price
129583	84-25052-07	Dimensions: 20-1/4"H x 24-7/8"D x 7-1/8"W, 1400 cfm	

IAQ Chemicals

ClenAir Gel Tub

- Place open tub in HVAC ductwork or in room near source of odor
- Available in regular or cherry



Part #	Mfg #	Description	Price
041980	851500	1/2 lb Clenair Gel Tubs	
042554	851501	1 lb Clenair Gel Tubs	
042555	85-1503	3 lb Clenair Gel Tubs	



Air Cleaners

Air Cleaners

Media Air Filter

Part #	Mfg #	Description	Price
042237	84-16X20-1	16" x 20" x 1", Polarized	
042238	84-16X25-1	16" x 25" x 1", Polarized	
045033	84-20X20-1	20" x 20" x 1", Polarized	
042239	84-20X25-1	20" x 25" x 1", Polarized	
109749	84-28X32-1	28" x 32" x 1"	

Filter Base - ACG Series

- *Uses standard filter sizes*
- *Gasketed door*
- *Fully insulated*
- *Upflow with hinged door*



Part #	Mfg #	Outside Dim (W x L x H)	Price
077769	54-1625-G6	17-3/8" x 28-1/2" x 5-3/4"	

UV Air Cleaners

Ultraviolet Air Disinfection Systems

UltraMAX™ UMX Remote UV Lamp Series with UltraVation® T3™

- T3™ is a patented lamp system that maximizes performance, safety and economy
- Unique interlock that safely turns off UV before lamp removal



Part #	Mfg #	Description	Price
112482	UMX-2412-EZ	(1) 12" Enhanced High Output UV Lamp	

UltraMAX™ UME Single Remote UV Lamp Series with UltraVation T3™

- T3™ is a patented lamp system that maximizes performance, safety and economy
- Unique interlock that safely turns off UV before lamp removal



Part #	Mfg #	Description	Price
125775	UME-1900T	(1) 17" 110V Remote Mount UV Lamp with Odor Control	
125781	UME-1902T	(2) 17" 110V Remote Mount UV Lamp with Odor Control	

UV Replacement Lamps

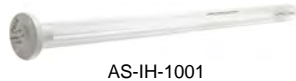

Part #	Mfg #	Description	Fits Model	Price
112052	AS-IH-1001	12" T3 Remote UV-C Lamp		
060697	LPPP-0002	16" "U" Shaped UV Lamp	UME-1036, 2036 UVS-1036, 2036 UVE-1036, 2036	
126917	AS-IH-1003	17" UV, UV-C Lamp Air	All UltraMax, UVS, UVE Germicidal UV Series, and Phototronic Cleaner Models	

Indoor Air Cleaners

Progressive® Media Air Cleaner

- Pleated, layered design
- Produces no ozone
- Filters electrostatically charged
- Custom color match available
- Private label options available
- Includes rails that accepts most major brands of media

Part #	Mfg #	Description	Size	Color	Price
239006	90-064P04	Right Angle MERV 11	20" x 25" x 5"	Gray	

UV Air Cleaners

Air Purifiers

P900GX Portable UV Air Purifier

- Dual zone 19mm UVC/UVV Quartz lamp destroys biological and chemical contaminants
- 9 Electronically controlled speeds
- Touch-pad digital controls with count-down timer
- Purifies up to 900 square feet
- 85 Watts
- Weight: 11 lbs
- Includes integral stand and handle
- Wall mountable
- 3-Year warranty on parts including UV lamp

Part #	Mfg #	Description	Price
141942	P900GX	Dual UVC/UVV Air Purifier	

Sanuvox SR+ In-Duct UV Air Treatment System

- Whole-home system designed to destroy viruses, bacteria, mold, chemicals, odors, allergens & VOCs
- Patented process includes 19mm Quartz UVC/UVV 'J' Lamp
- Multi-color LED Status Display provides important user information
- Most advanced air treatment system available
- 110 / 220V operation
- Microprocessor controlled Thermistor for automatic operation
- UV Chamber rotates for up-flow or down-flow systems
- 3 year warranty including UV Lamp
- ETL



Part #	Mfg #	Description	Price
161214	SR+	In-Duct UV Whole-Home (up to 2,000 sq ft) Air Purification System	

Sanuvox R+ In-Duct UV Air Purification System

- Whole-home system designed to destroy viruses, bacteria, mold, chemicals, odors, allergens and VOCs
- High-intensity UV 'J' lamp (18" arc length), turbulator and reflecting chamber parallel to the airflow
- Microprocessor controlled for automatic operation
- UV Chamber rotates 360° for up or down-flow systems
- Fiber board kit included
- 3-Year warranty including UV lamp



Part #	Mfg #	Description	Price
139088	R PLUS +	In-Duct UV Whole-Home Air Purification System	

UV Air Cleaners

UV Replacement Bulbs

T6 Dual Zone High Intensity Replacement Lamp

- *UVC/UVV Germicidal/oxidizing*

Part #	Mfg #	Description	Price
141941	LMPHGXJ10 5	10.5" UV J Lamp for R4000GX, S300HFX	

Air-to-Air Heat Exchangers

Heat Recovery Ventilators

MAX Series Residential HRV

- 5-Speed electronics
- Lifestyle MAX digital control included
- Compact electrically powered
- Aluminum heat exchange core
- Built-in dehumidistat
- Easy installation
- Increases air exchange rate when humidity rises
- Easy clean filters
- Quiet and reliable five speed motor
- 5-Year warranty on parts, lifetime on heat exchange core



95MAX



155MAX



200MAX

Part #	Mfg #	Dimensions H x W x D	Defrost Type	Electrical	CFM @ 0.1" ESP	Ship Wt	Price
033812	95MAX	24-1/2" x 18-1/2" x 16"	Recirculating	120-1-60	76	56 lbs	
027707	155MAX	19" x 33-5/8" x 14-3/4"	Damper	120-1-60	144	73 lbs	
166054	100-ECM	18-3/4" x 33.62" x 14-3/4"	Recirculating				

RNC Series Residential HRV

- 2-Speed electronics
- Each air stream has one centrifugal blower driven by a common PSC motor
- Compact electrically powered
- Patented aluminum core
- Built-in dehumidistat
- Built-in relay for interfacing to furnace
- Damper defrost system
- Cross-flow heat recovery core transfers heat between two air streams, removable for cleaning
- Washable air filters
- Suffix: DX = with 99-DX01 digital control
- 5-Year warranty on parts, lifetime on heat exchange core



RNC200

Part #	Mfg #	Dimensions H x W x D	Defrost Type	Electrical	CFM @ 0.1" ESP	Ship Wt	Price
188379	RNC-155BC02	19" x 33-5/8" x 14-3/4"	Recirculating	120-1-60	144	67 lbs	
188380	RNC-200BC02	19" x 33-5/8" x 14-3/4"	Recirculating	120-1-60	207	67 lbs	

Air-to-Air Heat Exchangers

Turbulent Flow Precipitators Whole House Air Cleaner

- Removes close to 99.4% of coarser particles such as pollen, fungus spores, dust, animal dander and dirt
- Removes close to 90% of tobacco smoke and wood smoke particles and some bacteria
- Filters down to 1/10 of a micron
- Motor: 2-speed, high efficiency PSC motor
- Filters: (1) replaceable TFP collector and (1) replaceable HEPA filter



Turbulent Flow Precipitators Parts

Part #	Mfg #	Description	Price
118135	65-502R	(1) Replacement HEPA Filter	
080808	65-503R	(1) Replacement TFP Collector	

Indoor Pool and Spa Heat Recover Ventilators

- Controls humidity in wet areas such as pools, spas, whirlpools, saunas, and personal gyms



Part #	Mfg #	Description	Price
077178	700 DD POOL	(2) Air Stream Sections: Each w/PSC, 3-Speed, Sngl Shaft, 120VAC, 4.5A, 1/4 hp, 1450 rpm Motor	

Optional Remote Controls

Digital Electronic Timers

- Can be mounted up to 60' from HRV
- Can override the base module and activate high speed operation
- Easy to install and operate
- Works well in bathrooms, laundries, and other high moisture areas
- Touch pad operation
- Childproof lockout feature
- 20/40/60 Minute status lights
- 60' (18 m) maximum wire length only, may be wired in parallel if no other controls are used



Part #	Mfg #	Connects To	Color	Price
039208	99-107W	Cover Plate for 99-104	White	

Timers

Crank Timer

Part #	Mfg #	Description	Color	Price
030653	99-101	Rotate the Dial for up to 60 Minutes of High Speed Operation	White	

Air-to-Air Heat Exchangers

Lifestyle Controls and Timers

MAX Series Digital Wall Control

- Slim-line design
- Service indicator
- 5-Speed fan setting
- Electronic dehumidistat
- Standby setting (fan speed 0)
- 20/40/60 High speed override button
- Compatible with 99-DET02 wireless timers
- Connects to 3 wire 20 gauge low voltage wire
- Five modes of operation
 - Continuous ventilation
 - 20 min. ventilation / 40 min. recirculation
 - 20 min. ventilation / 40 min. off
 - 10 min. ventilation / 50 min. off
 - Continuous recirculation



Part #	Mfg #	Description	Color	Price
190256	99-DXPL02	(5) Selectable modes, Electronic Dehumidistat	White	

Lifestyle RNC Dehumidistat

- Initiates high speed when the indoor humidity level is above the setpoint
- Optional on RNC



Part #	Mfg #	Description	Color	Price
125855	99-DH01	RNC Series Dehumidistat	White	

Lifestyle RNC Ventilation Control

- 2-Speed operation
- Standby
- Dehumidistat
- Optional on RNC



Part #	Mfg #	Description	Color	Price
125856	99-BC01	RNC Series Ventilation Control	White	

Air-to-Air Heat Exchangers

Lifestyle 20/40/60 Minute Timer

- Initiates high speed operation for 20, 40, or 60 minutes
- Compatible with MAX and RNC Series



Part #	Mfg #	Description	Color	Price
125858	99-DET01	20/40/60 Minute Timer	White	

Wireless 20/40/60 Minute Timer

- Estimated range of 40 feet
- Initiates high speed operation for 20, 40, or 60 minutes
- Compatible with Repeater (99-RX02)
- Can be surface or E-box mounted
- Includes battery



Wireless timer is not backwards compatible

Part #	Mfg #	Description	Color	Price
240371	99-DET02	20/40/60 Minute Timer	Grey	

Dampers

Part #	Mfg #	Description	Price
092347	99-RSK6	6" Spring Loaded Damper	

Weatherhood Kits

- Ideal for HRV/ERV and in-line applications
- High density polyethylene for a durable, long life even in severe climate
- No moving parts, eliminates freezing or sticking potential
- Includes:
 - (2) Hoods
 - 12" Wall sleeve
 - Duct collar
 - Insect/animal screens



Part #	Mfg #	Size	Color	Price
027708	99-186	6" Diameter	White	
028790	99-187	7" Diameter	White	

Air-to-Air Heat Exchangers

Dual Vent Hoods

- Requires only (1) 6" opening for intake/exhaust
- Damage-resistant metal construction for exterior wall connection
- Durable rigid plastic
- Suitable for 5" or 6" connections
- Maximized airflow with lower pressure drop
- Fire-rated, UV-resistant materials
- Ideal for space-constrained HRV or ERV applications
- Includes:
 - Hood assembly
 - Duct splitter
 - Duct insulator (2 pieces)
 - Retainer screw assembly
 - Nylon cable tie
 - Screen



Part #	Mfg #	Description	Color	Price
141190	99-190	Fully Adjustable Thermal Insulation	White	

Accessories

Part #	Mfg #	Description	Price
037748	99-110	HRV/TFP/CAF Interface Relay Kit	
240372	99-RX02	Wireless Repeater	

Optional 3-Speed Control

- 3-Speed high/medium/high
- On/off
- 4-Wire, 20 gauge wire

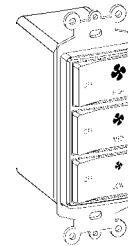

Part #	Mfg #	Description	Price
077599	99-500	3-Speed Control	

Air-to-Air Heat Exchangers

Ventilation

TrueFRESH Energy Recovery Ventilator

- *TrueFRESH eliminates the need for overhead ducting, and balance without adjusting dampers, they change everything when it comes to time consuming installation*
- *Removable duct collars*
- *Damperless balancing*
- *Adjustable hanging straps*
- *Centralized wiring and speed control*
- *Customizable*
- *Compact size*
- *Meets ASHRAE 62.2 standards*
- *5-Year warranty*



Part #	Mfg #	Description	Price
152253	VNT5200E1000U	200 cfm Energy Recovery Ventilator, 120 VAC, 60 Hz	

TrueFRESH Heat Recovery Ventilator

- *TrueFRESH eliminates the need for overhead ducting, and balance without adjusting dampers, they change everything when it comes to time consuming installation*
- *Removable Duct Collars*
- *Damperless Balancing*
- *Adjustable Hanging Straps*
- *Centralized Wiring and Speed Control*
- *Customizable*
- *Compact Size*
- *Meets ASHRAE 62.2 Standards*
- *5-Year Warranty*



Part #	Mfg #	Description	Price
244778	VNT5070H1000U	120 VAC, 60 Hz, 70 cfm at external static pressure 0.4" wc	
243914	VNT5150H1000U	120 VAC, 60 Hz 150 cfm at external static pressure 0.4" wc	

Humidifiers/Dehumidifiers

Humidifiers

TrueEASE™ Flow-Through Humidifier

- Up to 30% water savings, up to 50% water savings with fan-powered model
- PerfectFLO™ water distribution tray
- Common-sense interface
- AgION® humidifier pads with anti-microbial coating
- User-friendly pad access
- Interchangeable bypass
- Integrated wiring and quick-connect plumbing
- Includes humidifier, saddle valve, water supply line, 10' drain hose, H8908 manual humidity control, hardware, mounting template and owner's manual



Advanced



Fan-Powered

Part #	Mfg #	Description	Output	Price
134722	HE100A1000	Bypass Small Basic	12 gpd	
134723	HE150A1005	Bypass Small Advanced	12 gpd	
134724	HE200A1000	Bypass Large Basic	17 gpd	
134725	HE250A1005	Bypass Large Advanced	17 gpd	
134726	HE300A1005	Fan-Powered Advanced	18 gpd	

Humidifier Replacement Pads



HC22A

Part #	Mfg #	Description	Price
030568	HC22A1007	HE220 Pad for HE220, HE225, Aprilaire 110,220,550,558	
034029	HC26A1008	HE260, HE360 Pad for HE260, HE265, HE360, HE365, Aprilaire 350,360,560,568, 600,700,760,768	
144661	HC26E1004	HE200, HE250, HE260, HE265, HE300, HE360, HE365, Aprilaire 350, 360, 560, 568, 600, 700, 760, 769	
146138	HC22E1003	HE225 Pad with AGION™ Coating for HE220, HE225, Aprilaire 110,220,550,558	

Remote Mount Kit

Part #	Mfg #	Description	Price
111236	50024917-001	10' Remote Mount Kit for All TrueSTEAM Humidifiers	
111237	50024917-002	20' Remote Mount Kit for HM512 and HM509R TrueSTEAM Humidifiers	
185466	HM700ADISTKIT /U	5' Stainless Steel Remote Mount Kit for H6062 HumidPRO™ Humidifier	

Reverse Osmosis Water Filter for Honeywell Steam Humidifier

- TrueSTEAM
- 40°F - 100°F

Part #	Mfg #	Description	Price
216297	HM600XROF1U	RO Water Filter for TrueSTEAM Humidifiers	

Humidifiers/Dehumidifiers

Humidity Controllers

H1008 Automatic Humidity Controller

- Provides automatic control for by-pass, flow-through, powered flow-through, steam and drum humidifiers in central heating systems
- Patented Honeywell HumidiCalc+™ software
- Combination temperature and humidity sensor
- Automatically adjusts humidity level based on frost factor set by user
- Duct-mounted
- System status light indicates normal operation, test mode and fault



Part #	Mfg #	Description	Price
037361	H1008A1008	Humidifier, 95% RH@95°F (Non-Condensing), Dew Point Control	

H8908 Humidistat/Dehumidistat

- Provides automatic low voltage control of humidifier and dehumidifiers or ventilators
- SPST, snap-acting, dust-proof switch designed for wall or surface duct mounting
- Positive on and off settings
- 12" Moisture sensitive nylon ribbon wound around three bobbins effectively gives optimum control for reliable operation under changing ambient conditions



H8908ASPST H8908DSPST

Part #	Mfg #	Application	Color	Price
111239	H8908ASPST	Humidification	White	
134079	H8908DSPST	Dehumidification	White	

H6062 HumidPRO™ Digital Humidity Control

- Automatic humidification (window protection) with included outdoor sensor
- Manual humidification control
- Manual dehumidification control
- Dehumidifier compressor protection
- Large, digital backlit display
- Simple, intuitive programming
- RH% and outdoor temperature calibration
- Adjustable high and low range stops (10-90%)
- Automatically detects presence of outdoor sensor to set control to Automatic or Manual Mode



Part #	Mfg #	Description	Price
171473	H6062A1000	Manual Mode: 10% to 90% RH% (Adjustable) Auto Mode: 10% to 60% RH% (35% Default)	

Humidifiers/Dehumidifiers

Power Humidifiers - Drain Type

1042 Legacy Series - By-Pass Flow-Through Power Humidifier

- *Installs on vertical warm air supply or cold air plenum*
- *6" Diameter side bypass duct (collar supplied)*
- *Plenum opening: 10-1/4"W x 9-1/2"H*
- *Replacement filter: 990-13 evaporator pad*
- *Order 1/4" tubing separately*
- *5-Year limited warranty*



Part #	Mfg #	Description	GPD	Unit Size	Electrical	Price
004860	1042LH	Recirculating Type, MHX3 Humidistat	19.2	11-1/2" x 15" x 9"	115V/60Hz	

Humidifiers/Dehumidifiers

Dehumidifiers

Dehumidifier - 50 Point

- Chevalier 11
- Large capacity water tank
- Smart Dehumidifying mode
- 115/60/1 Power supply
- Moisture removal at 30°C, 80% R.H. : 50
- Moisture removal at 27.2°C, 60%R.H. : 530



Part #	Mfg #	Description	Price
225580	CBD-50H1A-D11L	50 Point Dehumidifier	

Humidifier Parts & Accessories

Evaporator Pads



84-25055-01

Part #	Mfg #	Description	Price
089995	84-A97	Autoflo Drum Type Evaporator Pad	
090002	84-4EP	Autoflo Metal Evaporator Pad	
059586	84-25055-01	9"x14"x2" Evaporator Pad	
044159	84-25055-02	9"x11"x2" Evaporator Pad	

Humidifiers/Dehumidifiers

Dehumidifiers

TrueDRY DH65 Whole-House Dehumidifier

- Removes up to 65 pints of water from the indoor air
- Built-in humidity control requires no additional wiring to an external control
- Choice of external control options also available for centrally ducted control
- Feedback on operation and maintenance provided via intuitive on-board LED light interface
- MERV 11 Filtration



Part #	Mfg #	Description	Price
148234	DR65A2000	8" Diameter Plenum Opening w/o Controls Uses R-410A Refrigerant	

TrueDRY DR90 Whole-House Dehumidifier

- Removes up to 90 pints of water from the indoor air
- Built-in fresh air supply
- Uses only 6.7 amps for energy efficiency
- MERV 11 Filtration
- R-410A compliant
- 5-Year warranty
- Energy Star® rated



Part #	Mfg #	Description	Price
131281	DR90A3000	10" Plenum Opening with 6" Ventilation Collar, less Control	

DR90/DR120 Filter

Part #	Mfg #	Description	Price
153194	50070171-002	TruDry Filter used with DR90A2000 and DR120	

TrueDRY DR120 Whole-House Dehumidifier

- Removes 120 pints of water per day from the indoor air
- Built-in fresh air supply
- Energy Star Rated
- E-Coated Coil delivers longer life and increased efficiency
- Certifications include UL474, CSA, C22.2 No 92



Part #	Mfg #	Description	Price
241584	DR120A3000	10" Plenum Opening with 6" Ventilation Collar	

Humidifiers/Dehumidifiers

Humidifiers

Advanced Electrode Humidifier

- On-demand steam humidification solution
- 60Hz frequency
- 120v or 240v voltage
- 11 or 22 gallons per day
- Duct or wall mounting
- Communtion with a variety of thermostat options including Lyric, PrestigeIAQ, and VisionPRO™ HumidiPRO™ included
- Humidifier replacement cylinder designed for Rapid, simplified, DIY replacement —Recommended annually dependent on water quality



Part #	Mfg #	Size	Color	Price
240934	HM750A1000/U	10"W x 7"H x 20"L	Silver	

HM750 Advanced Electrode Humidifier Replacement Cylinder

- On-demand steam humidification solution
- 11 or 22 gallons per day
- Used with HM750 Honeywell electrode steam humidifier
- Communtion with a variety of thermostat options including Lyric, PrestigeIAQ, and VisionPRO™ HumidiPRO™ included
- Humidifier replacement cylinder designed for Rapid, simplified, DIY replacement —Recommended annually dependent on water quality



Part #	Mfg #	Size	Color	Price
240939	HM750ACYL/U	6"W x 13"H x 5.57"L	White	

HM750 Advanced Electrode Humidifier Steam Hose

- On-demand steam humidification solution
- Used with HM750 Honeywell electrode steam humidifier
- Communtion with a variety of thermostat options including Lyric, PrestigeIAQ, and VisionPRO™ HumidiPRO™ included
- Humidifier replacement cylinder designed for Rapid, simplified, DIY replacement —Recommended annually dependent on water quality

Part #	Mfg #	Size	Color	Price
240940	HM750AHOSEKIT/ U	15 ft	Black	

Humidifiers/Dehumidifiers

HM750 Advanced Electrode Humidifier Nozzle Kit

- *Kit includes:*
 - Steam hose
 - Condensate hose
 - Steam distributor
 - Installation hardware
- *On-demand steam humidification solution*
- *Used with HM750 Honeywell electrode steam humidifier*
- *Communtion with a variety of thermostat options including Lyric, PrestigeIAQ, and VisionPRO™ HumidiPRO™ included*
- *Humidifier replacement cylinder designed for Rapid, simplified, DIY replacement*
 - Recommended annually dependent on water quality*

Part #	Mfg #	Size	Color	Price
240941	HM750ANKIT/U	5"W x 15"H x 5"L	-	

HM750 Advanced Electrode Humidifier Replacement PC Board

- *60Hz frequency*
- *120v or 240v voltage*
- *Communtion with a variety of thermostat options including Lyric, PrestigeIAQ, and VisionPRO™ HumidiPRO™ included*
- *Humidifier replacement cylinder designed for Rapid, simplified, DIY replacement*
 - Recommended annually dependent on water quality*

Part #	Mfg #	Size	Color	Price
240942	HM750APCB/U	5"W x 1.65"H x 9.5"L	Green	

HM750 Advanced Electrode Humidifier Valve Kit

- *Use with HM750 Honeywell electrode steam humidifier*
- *Communtion with a variety of thermostat options including Lyric, PrestigeIAQ, and VisionPRO™ HumidiPRO™ included*
- *Humidifier replacement cylinder designed for Rapid, simplified, DIY replacement*
 - Recommended annually dependent on water quality*

Part #	Mfg #	Size	Color	Price
240943	HM750AVKIT/U	4"W x 5"H x 4"L	-	

Throwaway Filters

Z-Line Pleated Series Filters

- Ideal in high velocity systems where maximum square footage of media is necessary
- Features 100% synthetic fibers laminated to galvanized metal backing
- Designed to be utilized as either pre-filters or primary filters in virtually every commercial, industrial, and residential HVAC application
- MERV 7
- 100% Synthetic, charged media



1" ZL Z-Line Series Pleated Filter

Part #	Mfg #	Size	Price
261960	ZLPSP10161	10" x 16" x 1"	
102089	ZLP10201	10" x 20" x 1"	
004301	ZLP12121	12" x 12" x 1"	
261963	ZLPSP12161	12" x 16" x 1"	
102091	ZLP12201	12" x 20" x 1"	
102092	ZLP12241	12" x 24" x 1"	
102094	ZLP14201	14" x 20" x 1"	
042535	ZLP14251	14" x 25" x 1"	
112438	ZLP14301	14" x 30" x 1"	
102095	ZLP15201	15" x 20" x 1"	
035858	ZLP16201	16" x 20" x 1"	
102093	ZLPSP1E	16" x 22" x 1"	
036832	ZLP16251	16" x 25" x 1"	
110862	ZLP18181	18" x 18" x 1"	
070781	ZLP18201	18" x 20" x 1"	
109164	ZLP18241	18" x 24" x 1"	
038324	ZLP20201	20" x 20" x 1"	
102099	ZLP20241	20" x 24" x 1"	
038325	ZLP20251	20" x 25" x 1"	
115791	ZLPSP22D29H1	22.25" x 29.5" x 1"	
102096	ZLP24241	24" x 24" x 1"	
053645	ZLP25251	25" x 25" x 1"	
115787	ZLPSP27M31M1	27-3/4" x 31-3/4" x 1"	
115788	ZLPSP27M35M1	27-3/4" x 35-3/4" x 1"	
131831	ZLPSP1K28341	28" x 34" x 1"	
115793	ZLPSP28D30H1	28.25" x 30.5" x 1"	
121768	ZLP30361	30" x 36" x 1"	
115794	ZLPSP30B32H1	30.125" x 32.5" x 1"	

2" ZL Z-Line Series Pleated Filter

Part #	Mfg #	Size	Price
004314	ZLP16162	16" x 16" x 2"	
031788	ZLP16202	16" x 20" x 2"	
159073	ZLP16242	16" x 24" x 2"	
027336	ZLP16252	16" x 25" x 2"	
261966	ZLP16252	16" x 25" x 2"	
047466	ZLP18182	18" x 18" x 2"	
067619	ZLP18202	18" x 20" x 2"	
042085	ZLP18242	18" x 24" x 2"	
030585	ZLP20202	20" x 20" x 2"	
121378	ZLP20242	20" x 24" x 2"	
034676	ZLP20252	20" x 25" x 2"	
094283	ZLP24242	24" x 24" x 2"	
040794	ZLP25252	25" x 25" x 2"	

4" ZL Z-Line Series Pleated Filter

Part #	Mfg #	Size	Price
083372	ZLP16204	16" x 20" x 4"	
063647	ZLP16254	16" x 25" x 4"	
071312	ZLP20204	20" x 20" x 4"	
023474	ZLP20254	20" x 25" x 4"	
050395	ZLP24244	24" x 24" x 4"	

Z-Line Series Media Replacement Filters

Z-Line Series 500AB and 300AB Air Cleaner

Media

- Replacement options for Trion Air Bear® and Air Cub® filters
- 100% Synthetic, charged media



Part #	Mfg #	Size	Price
080685	ABP16255	16" x 25" x 5", Merv 10	
102417	ABP20255	20" x 25" x 5"	

Throwaway Filters

Filter Pads & Bulk Media

- *UL Class 2*

FSR Fiberglass Service Roll



Part #	Mfg #	Size	Price
004334	FSR30201	30" x 20' x 1"	
004336	FSR36201	36" x 20' x 1"	

Throwaway Filters

Carbon Media Filters

- *MERV 13*
- *Activated carbon core*
- *Rated life cycle: 30 - 90 days*



Replacement Carbon Media Filter Pad

Part #	Mfg #	Size	Qty	Price
109748	C3P2832	28" x 32"	3/Pk	
099419	C3P2836	28" x 36"	3/Pk	



Throwaway Filters

Disposable Media Filters

Filter Media

Part #	Mfg #	Description	Price
045070	54-25051-02	Filter Media 3"	

Media Air Filter

Part #	Mfg #	Description	Price
131298	540013	4-1/2" 2,000 CFM	

Throwaway Filters

Air Filters
Media Air Filters



Part #	Mfg #	Description	Price
062226	54-14X25-R	14" x 25", 3/Pk	
042240	54-16X20-R	16" x 20", 3/Pk	
042241	54-16X25-R	16" x 25", 3/Pk	
048021	54-20X20-R	20" x 20", 3/Pk	
042242	54-20X25-R	20" x 25", 3/Pk	

Throwaway Filters

Commercial & Industrial Disposable Panel Filters

- Economical air filters designed for light-to-medium duty air filtration applications
- Durable construction for all types of industrial and commercial applications
- Progressive density glass or poly filter media
- Heavy-duty frame and corners for added strength and durability
- Environmentally friendly
- Special sizes available
- Easy to install



1" Polyester Media

- Dual-layered high performance media for applications where synthetic filter media is specified

Part #	Mfg #	Size	Price
196132	FF10101	10" x 10" x 1"	
192104	FF10201	10" x 20" x 1"	
192116	FF10251	10" x 25" x 1"	
193946	FF10301	10" x 30" x 1"	
192100	FF12121	12" x 12" x 1"	
192105	FF12201	12" x 20" x 1"	
194254	FF12161	12" x 16" x 1"	
192113	FF12241	12" x 24" x 1"	
192117	FF12251	12" x 25" x 1"	
193638	FF12301	12" x 30" x 1"	
192101	FF14141	14" x 14" x 1"	
192103	FF14181	14" x 18" x 1"	
192106	FF14201	14" x 20" x 1"	
193455	FF14241	14" x 24" x 1"	
192118	FF14251	14" x 25" x 1"	
192126	FF14301	14" x 30" x 1"	
192107	FF15201	15" x 20" x 1"	
192119	FF15251	15" x 25" x 1"	
192102	FF16161	16" x 16" x 1"	
192108	FF16201	16" x 20" x 1"	
194314	FF16241	16" x 24" x 1"	
192121	FF16251	16" x 25" x 1"	
192127	FF16301	16" x 30" x 1"	
194330	FF18181	18" x 18" x 1"	
193758	FF18201	18" x 20" x 1"	
193280	FF18241	18" x 24" x 1"	

Commercial & Industrial (Continued) 1" Polyester Media

Part #	Mfg #	Size	Price
192122	FF18251	18" x 25" x 1"	
193639	FF18301	18" x 30" x 1"	
192110	FF20201	20" x 20" x 1"	
192114	FF20241	20" x 24" x 1"	
192123	FF20251	20" x 25" x 1"	
193195	FF20301	20" x 30" x 1"	
192111	FF22221	22" x 22" x 1"	
192115	FF24241	24" x 24" x 1"	
192128	FF24301	24" x 30" x 1"	
192124	FF25251	25" x 25" x 1"	

2" Polyester Media

- Dual-layered high performance media for applications where synthetic filter media is specified

Part #	Mfg #	Size	Price
192133	FF12242	12" x 24" x 2"	
193471	FF14202	14" x 20" x 2"	
194405	FF14252	14" x 25" x 2"	
192132	FF16162	16" x 16" x 2"	
192135	FF16202	16" x 20" x 2"	
193431	FF16242	16" x 24" x 2"	
192140	FF16252	16" x 25" x 2"	
193430	FF18242	18" x 24" x 2"	
199327	FF18252	18" x 25" x 2"	
192136	FF20202	20" x 20" x 2"	
193618	FF20242	20" x 24" x 2"	
192141	FF20252	20" x 25" x 2"	
194346	FF24242	24" x 24" x 2"	
192142	FF25252	25" x 25" x 2"	

Special Size Polyester Disposable Filters

1" Filters

Part #	Mfg #	Size	Price
201112	FF10161	10" x 16" x 1"	
213283	FF11201	11" x 20" x 1"	
196940	FF12141	12" x 14" x 1"	
204077	FF12211	12" x 21" x 1"	
202132	FF12221	12" x 22" x 1"	
197497	FF13201	13" x 20" x 1"	
202021	FF13211	13" x 21" x 1"	

Throwaway Filters

**Commercial & Industrial (Continued)
Special Size Polyester Disposable Filters**

1" Filters

Part #	Mfg #	Size	Price
196090	FF1321121	13" x 21-1/2" x 1"	
199595	FF131221121	13-1/2" x 21-1/2" x 1"	
194345	FF14161	14" x 16" x 1"	
201093	FF15151	15" x 15" x 1"	
196210	FF15221	15" x 22" x 1"	
203341	FF15241	15" x 24" x 1"	
192120	FF16221	16" x 22" x 1"	
204616	FF1621121	16" x 21-1/2" x 1"	
196089	FF163821121	16-3/8" x 21-1/2" x 1"	
203344	FF161421121	16-1/4" x 2-1/2" x 1"	
198758	FF1712201	17-1/2" x 20" x 1"	
194677	FF18221	18" x 22" x 1"	
193115	FF20221	20" x 20" x 1"	
196088	FF2021121	20" x 21-1/2" x 1"	
202535	FF211223121	21-1/2" x 23-1/2" x 1"	
197777	FF211223341	21-1/2" x 23-3/4" x 1"	

2" Filters

Part #	Mfg #	Size	Price
206602	FF10252	10" x 25" x 2"	
213059	FF14262	14" x 26" x 2"	
195987	FF15202	15" x 20" x 2"	
204378	FF16302	16" x 30" x 2"	
193668	FF18182	18" x 18" x 2"	

Special Size Fiberglass Disposable Filters

1" Filters

Part #	Mfg #	Size	Price
204439	FG163821121	16-3/8" x 21-1/2" x 1"	
205127	FG2021121	20" x 21-1/2" x 1"	
205129	FG18201	18" x 20" x 1"	

**Multi-Pleat XL8™ MERV 8 Extended
Surface Pleated Panel Filters**

- Mechanical Media
- Mechanical MERV 8 media is not reliant on electrostatic charge for efficiency
- Low resistance to airflow
- High Dust Holding Capacity
- Sturdy double-wall frame design
- Moisture resistant beverage board frame
- Standard and High Capacity models
- Available in 1", 2", and 4" depths



1" Filters

Part #	Mfg #	Size	Price
193419	PF10201	10" x 20" x 1"	
197849	PF10241	10" x 24" x 1"	
195274	PF12121	12" x 12" x 1"	
193317	PF12201	12" x 20" x 1"	
194026	PF12241	12" x 24" x 1"	
193315	PF14141	14" x 14" x 1"	
193767	PF14201	14" x 20" x 1"	
196429	PF14221	14" x 22" x 1"	
193417	PF14241	14" x 24" x 1"	
193768	PF14251	14" x 25" x 1"	
193756	PF15201	15" x 20" x 1"	
193769	PF15251	15" x 25" x 1"	
194025	PF16161	16" x 16" x 1"	
193418	PF16201	16" x 20" x 1"	
196905	PF16241	16" x 24" x 1"	
193421	PF16251	16" x 25" x 1"	
193312	PF16301	16" x 30" x 1"	
195983	PF18181	18" x 18" x 1"	
195651	PF18251	18" x 25" x 1"	
193757	PF20201	20" x 20" x 1"	
194597	PF20221	20" x 22" x 1"	
193414	PF20241	20" x 24" x 1"	
193318	PF20251	20" x 25" x 1"	
194660	PF20301	20" x 30" x 1"	
193313	PF24241	24" x 24" x 1"	
193420	PF24301	24" x 30" x 1"	
193844	PF25251	25" x 25" x 1"	

Throwaway Filters

2" Filters

Part #	Mfg #	Size	Price
194812	PF12202	12" x 20" x 2"	
193755	PF12242	12" x 24" x 2"	
193771	PF14202	14" x 20" x 2"	
193772	PF14252	14" x 25" x 2"	
199514	PF15202	15" x 20" x 2"	
193770	PF16202	16" x 20" x 2"	
195885	PF16242	16" x 24" x 2"	
193754	PF16252	16" x 25" x 2"	
194243	PF18182	18" x 18" x 2"	
195623	PF18202	18" x 20" x 2"	
193753	PF18242	18" x 24" x 2"	
193319	PF20202	20" x 20" x 2"	
195272	PF20242	20" x 24" x 2"	
193773	PF20252	20" x 25" x 2"	
197608	PF20302	20" x 30" x 2"	
193874	PF24242	24" x 24" x 2"	
194199	PF25252	25" x 25" x 2"	

Honeywell Replacement Filter for MERV 8

Part #	Mfg #	Size	Price
194289	PF16255HW	16" x 25" x 5"	

4" Filters

Part #	Mfg #	Size	Price
194418	PF16254	16" x 25" x 4"	
198920	PF20204	20" x 20" x 4"	
197791	PF20254	20" x 25" x 4"	
200913	PF16204	16" x 20" x 4"	

Special Size XL MERV 8 Pleated Filters

1" Filters

Part #	Mfg #	Size	Price
196429	PF14221	14" x 22" x 1"	
195235	PF14301	14" x 30" x 1"	
194301	PF16181	16" x 18" x 1"	
196377	PF163821121	16-3/8" x 21-1/2" x 1"	
193316	PF18201	18" x 20" x 1"	
193415	PF18241	18" x 24" x 1"	
193314	PF22221	22" x 22" x 1"	

2" Filters

Part #	Mfg #	Size	Price
194944	PF16162	16" x 16" x 2"	

Throwaway Filters

Residential Media Air Cleaners

Pop-Up Replacement Media Air Filter

- Stores flat and pops into shape for installation
- Store (5) pop-up filters in the space of (1) standard replacement cartridge
- Additional 1" of filtration depth compared to standard replacement cartridges
- No combs, pleat spacers or end caps



Part #	Mfg #	Size	Efficiency	Used With	Price
101237	POPUP2200	20-1/4" x 24-1/4" x 5-7/8"	MERV 11	Space-Gard® 2200	
103142	POPUP2400	26" x 27-1/8" x 5-7/8"	MERV 11	Space-Gard® 2400, Lennox PMAC12	

Residential Air Cleaner Replacement High Efficiency Media Filter



Part #	Mfg #	Size	Efficiency	Used With	Price
052258	FC100A1029	16" x 25"	MERV 10	F100, F200	
052773	FC100A1037	20" x 25"	MERV 10	F100, F200, SpaceGard 2200	
054468	FC100A1011U	20" x 20"	MERV 10	F100, F200	
054467	FC100A1003	16" x 20"	MERV 10	F100, F200	

Throwaway Filters

Media Air Cleaners Replacement Filter Media



Part #	Mfg #	Description	Price
019291	GF12880	MERV 11 Replacement Media for Aprilaire 2200/2250	

Replacement Filter Media



Part #	Mfg #	Description	GPD	Unit Size	Electrical	Price
205149	GF4501	20" x 25" x 5", Replaces TRION media part #255649-102				
211223	GF4511	16" x 25" x 5", MERV 10				
249221	GF4551	20" x 25" x 5", MERV 11				

Throwaway Filters

Throwaway Filters

MEGApleat® M8 Air Filter

- Low operating resistance saves energy
- Highest dust holding capacity (DHC) = Longest life
- Highest breach strength = Strongest construction
- Guaranteed consistent performance – independent, third party testing
- Heavy-duty, galvanized expanded metal support grid – no rust
- Patent-pending filter design
- Moisture-resistant adhesive
- MERV 8



Part #	Mfg #	Size	Price
243600	MP24242	24" x 24" x 2"	
243595	MP20252	20" x 25" x 2"	
243591	MP20202	20" x 20" x 2"	
243589	MP16202	16" x 20" x 2"	
243597	MP16252	16" x 25" x 2"	
243601	MP20242	20" x 24" x 2"	



Air Handlers

Air Handlers

- 4-Way Convertible Upflow, Downflow, Horizontal Left and Horizontal Right Applications
- Factory-Installed Indoor Coil
- Field Installed Auxiliary Heater Kits Available



Warranties
10-Yr Parts Warranty

RH2T Two-Stage Air Handler - Constant Torque Motor (ECM) 230 Volt

Part #	Mfg #	Tons	Max Kw	CFM Lo	CFM Hi	H x L x W	Price
171738	RH2T2421MTANJA	2 Ton	10	525	700	42-1/2" x 21-3/4" x 21"	
171739	RH2T3621MTANJA	3 Ton	18	800	1050	50-1/2" x 21-3/4" x 21"	
171740	RH2T4824MTANJA	4 Ton	25	1050	1400	55-1/2" x 21-3/4" x 24-1/2"	
171741	RH2T6024STANJA	5 Ton	25	1200	1600	55-1/2" x 21-3/4" x 24-1/2"	

RH2T Two-Stage Air Handler - Constant Torque Motor (ECM) EcoNet Enabled

Part #	Mfg #	Tons	Max Kw	CFM Lo	CFM Hi	H x L x W	Price
185067	RH2T2417SEACJA	2 Ton	18	600	1200	42-1/2" x 21-3/4" x 17-1/2"	
178002	RH2T2421MEACJA	2 Ton	25	800	1600	42-1/2" x 21-3/4" x 21"	
185069	RH2T3617SEACJA	3 Ton	18	600	1200	42-1/2" x 21-3/4" x 21"	
178003	RH2T3621MEACJA	3 Ton	25	800	1600	50-1/2" x 21-3/4" x 21"	
178004	RH2T4821MEACJA	4 Ton	25	800	1600	57" x 21-3/4" x 21"	
178005	RH2T6024MEACJA	5 Ton	30	1400	1800	55-1/2" x 21-3/4" x 24-1/2"	

RH1T Single-Stage Air Handler - Constant Torque Motor (ECM) 230 Volt

Part #	Mfg #	Tons	Max Kw	CFM Lo	CFM Hi	H x L x W	Price
171725	RH1T2417STANJA	2 Ton	10	600	800	42-1/2" x 21-3/4" x 17-1/2"	
171727	RH1T3617STANJA	3 Ton	18	1,000	1,200	42-1/2" x 21-3/4" x 17-1/2"	
171731	RH1T3621HTANJA	3 Ton	18	1,000	1,200	57" x 21-3/4" x 21"	
171729	RH1T3621MTANJA	3 Ton	18	1,000	1,200	50-1/2" x 21-3/4" x 21"	
171733	RH1T4821STANJA	4 Ton	25	1,400	1,600	50-1/2" x 21-3/4" x 21"	
171735	RH1T4824STANJA	4 Ton	25	1,400	1,600	50-1/2" x 21-3/4" x 24-1/2"	
176251	RH1T6021STANJA	5 Ton	25	1,600	-	50-1/2" x 21-3/4" x 24-1/2"	
171737	RH1T6024STANJA	5 Ton	25	1,800	-	55-1/2" x 21-3/4" x 24-1/2"	

RH1T Single-Stage Air Handler - Constant Torque Motor (ECM) 115 Volt

Part #	Mfg #	Tons	Max Kw	CFM Lo	CFM Hi	H x L x W	Price
171724	RH1T2417STANAA	2 Ton	10	600	800	42-1/2" x 21-3/4" x 17-1/2"	
171726	RH1T3617STANAA	3 Ton	18	1,000	1,200	42-1/2" x 21-3/4" x 17-1/2"	
171732	RH1T4821STANAA	4 Ton	25	1,000	1,400	50-1/2" x 21-3/4" x 21"	

• Serving our Customers Since 1946 • www.plumbsupply.com



Air Handlers

Air Handlers (Continued)

RH1T Single-Stage Air Handler - Constant Torque Motor (ECM) 115 Volt

Part #	Mfg #	Tons	Max Kw	CFM Lo	CFM Hi	H x L x W	Price
171734	RH1T4824STANAA	4 Ton	25	1,600	-	50-1/2" x 21-3/4" x 24-1/2"	
176250	RH1T6021STANAA	5 Ton	25	1600	1725	57" x 21-3/4" x 21"	
171736	RH1T6024STANAA	5 Ton	25	1,800	-	55-1/2" x 21-3/4" x 24-1/2"	

RH1P Single-Stage Air Handler - (PSC Motor) 230 Volt

Part #	Mfg #	Tons	Max Kw	CFM Lo	CFM Hi	H x L x W	Price
171696	RH1P1817STANJA	1.5 Ton	10	600	800	42-1/2" x 21-3/4" x 17-1/2"	
171698	RH1P2417STANJA	2 Ton	10	600	800	42-1/2" x 21-3/4" x 17-1/2"	
171702	RH1P3617STANJA	3 Ton	18	1,000	1,200	42-1/2" x 21-3/4" x 17-1/2"	
171703	RH1P3621STANJA	3 Ton	18	1,200	-	42-1/2" x 21-3/4" x 21"	
171707	RH1P4821STANJA	4 Ton	25	1,600	-	50-1/2" x 21-3/4" x 21"	
171708	RH1P4824STANJA	4 Ton	25	1,600	1,800	55-1/2" x 21-3/4" x 24-1/2"	
171709	RH1P6024STANJA	5 Ton	25	1,600	1,800	55-1/2" x 21-3/4" x 24-1/2"	

RH1P Single-Stage Air Handler - (PSC Motor) 115 Volt

Part #	Mfg #	Tons	Max Kw	CFM Lo	CFM Hi	H x L x W	Price
171695	RH1P1817STANAA	2 Ton	N/A	600	800	42-1/2" x 21-3/4" x 17-1/2"	
171697	RH1P2417STANAA	2 Ton	N/A	600	800	42-1/2" x 21-3/4" x 17-1/2"	
171699	RH1P3017STANAA	2.5 Ton	N/A	1,000	1,200	42-1/2" x 21-3/4" x 17-1/2"	
171701	RH1P3617STANAA	3 Ton	N/A	1,000	1,200	42-1/2" x 21-3/4" x 17-1/2"	
171705	RH1P4821STANAA	4 Ton	N/A	1,600	-	50-1/2" x 21-3/4" x 21"	

RHMV High Efficiency Modulating Air Handler (CFM Motor)

Part #	Mfg #	Tons	Max Kw	CFM Lo	CFM Hi	H x L x W	Price
188642	RHMV2417SEACJA	2 Ton	N/A	550	750	42-1/2" x 21-11/16" x 17-1/2"	
188647	RHMV6021SEACJA	5 Ton	N/A	830	1565	57" x 21-11/16" x 21"	
188648	RHMV6024MEACJA	5 Ton	N/A	890	1665	55-1/2" x 21-11/16" x 24-1/2"	



Air Handlers

Hydronic Air Handlers

RW1P/RW1T Series Hydronic Air Handler Powered by Tankless Technology

- **Hydronic Air Handler**
 - Low profile 34-inch design is lighter, easier to handle and leaves room for optional accessories
 - Left or right side electric connections
 - Integrated control board features diagnostics, manages all operational functions and provides hookups for humidifier and electronic air cleaner
 - An insulated blower compartment
 - Pre-paint galvanized steel cabinet
 - Molded permanent filter(s)
 - Transformer and control fuse protection
 - Solid bottom is standard
 - A variety of cooling coils and plenums designed to use with the Hydronic Air Handler are available as optional accessories for air conditioning models
 - Stainless steel water pump

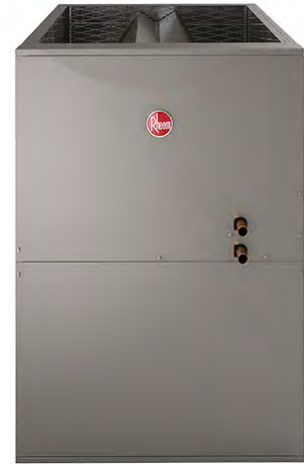

- **Tankless Water Heater**
 - Industry best! Minimum flow rate of .26 GPM, minimum activation flow rate of .40 GPM
 - ENERGY STAR® rated models available
 - Next generation burner technology
 - UMC-117 remote control and 10 ft. of thermostat wire is included
 - EZ-Link™ cable available for high demand applications to connect two tankless units to operate as one
 - High-altitude capability – up to 9,840 ft. elevation above sea level (no chip required)
 - Intelligent electronic controls designed to increase energy efficiency and safety
 - Self Diagnostic System

Part #	Mfg #	Tons	Max Kw	CFM Lo	CFM Hi	Price
181747	RW1T06A3617NAA	3 Ton	60,000	800	1200	
227225	RW1T08A4821NAA	4 Ton	80,000	900	1625	

Air Handlers

Air Handlers

B6BMM0 Air Handler

- Durable, Attractive Cabinet
- Multi-poised
- Multi-speed
- Ease-of-Service
- Plug-in Heater Kits
- Circuit Board
- Air Handler Control Board
- Breaker Accessibility
- No Fasteners on Sides or Back
- Designed to Meet the Requirements 610.2.A.2
- Micro-Channel Evaporator Coil
- Cabinet Insulation



Part #	Mfg #	Blower Size	Motor Type	Dimensions (H x W)	Price
205641	B6BMM024KA	10" x 6"	PSC	43 5/16" x 14 3/16"	
205642	B6BMM024KB	10" x 6"	PSC	43 5/16" x 19 11/16"	
205643	B6BMM030KA	10" x 8"	PSC	43 5/16" x 14 3/16"	
205644	B6BMM030KB	10" x 8"	PSC	43 5/16" x 19 11/16"	
205645	B6BMM036KB	10" x 8"	PSC	43 5/16" x 19 11/16"	
205646	B6BMM042KB	10" x 8"	PSC	49 5/16" x 19 11/16"	
205647	B6BMM048KB	10" x 8"	PSC	49 5/16" x 19 11/16"	
205648	B6BMM048KC	10" x 10"	PSC	55 15/16" x 22 7/16"	
205649	B6BMM060KC	11" x 10"	PSC	55 15/16" x 22 7/16"	

B6BMMX Air Handler

- Durable, Attractive Cabinet
- Multi-poised:
- Multi-speed:
- Ease-of-Service
- Plug-in Heater Kits:
- Circuit Board
- Air Handler Control Board
- Breaker Accessibility
- No Fasteners on Sides or Back
- Cabinet Insulation
- Designed to meet the requirements 610.2.A.2
- Micro-Channel Evaporator Coil



Part #	Mfg #	Blower Size	Motor Type	Dimensions (H x W)	Price
231847	B6BMMX24KA	10" x 6"	PSC	43 5/16" x 14 3/16"	
231848	B6BMMX24KB	10" x 8"	PSC	43 5/16" x 19 11/16"	
231850	B6BMMX30KA	10" x 6"	PSC	43 5/16" x 14 3/16"	
231851	B6BMMX30KB	10" x 8"	PSC	43 5/16" x 19 11/16"	

Air Handlers

B6EMMX Air Handler

- Energy Efficient Fixed Speed ECM Motor
- Quiet Blower Operation
- Reduced air stratification
- Multi-poised
- Built in Filter Rack
- Plug-in Heater Kit
- Circuit Board
- Breaker Accessibility
- Plastic Drain Pan
- Designed to meet the requirements 610.2.A.2
- Thermal Expansion Valve
- Cabinet Insulation
- Anteaater MCTM Micro-Channel Coil Technology



Part #	Mfg #	Blower Size	Motor Type	Dimensions (H x W)	Price
205330	B6EMMX24KA	10" x 6"	Variable	43 1/2" x 14 1/4"	
205331	B6EMMX24KB	11" x 8"	Variable	43 1/2" x 19 3/4"	
205332	B6EMMX30KA	10" x 6"	Variable	43 1/2" x 14 1/4"	
205333	B6EMMX30KB	11" x 8"	Variable	43 1/2" x 19 3/4"	
205334	B6EMMX36KB	11" x 8"	Variable	49 1/2" x 19 3/4"	
205335	B6EMMX42KB	11" x 8"	Variable	49 1/2" x 19 3/4"	
205336	B6EMMX48KC	11" x 10"	Variable	56" x 22 1/2"	
205337	B6EMMX60KC	11" x 10"	Variable	56" x 22 1/2"	

B6VMMX Air Handler

- Energy Efficient Variable Speed ECM Motor
- Quiet Blower Operation
- Constant airflow
- Reduced air stratification
- Multi-poised
- Built in Filter Rack
- Plug-in Heater Kit
- Circuit Board
- Breaker Accessibility
- Plastic Drain Pan
- Designed to meet the requirements 610.2.A.2
- Thermal Expansion Valve
- Cabinet Insulation
- Anteaater MCTM Micro-Channel Coil Technology



Part #	Mfg #	Blower Size	Motor Type	Dimensions (H x W)	Price
213108	B6VMMX24KA	10" x 6"	Variable	43 1/2" x 14 1/4"	
213109	B6VMMX30KA	10" x 6"	Variable	43 1/2" x 14 1/4"	
213110	B6VMMX30KB	11" x 8"	Variable	43 1/2" x 19 3/4"	
225687	B6VMMX36KB	11" x 8"	Variable	43 1/2" x 19 3/4"	

Air Handlers

Air Handlers (Continued)

B6VMMX Air Handler

Part #	Mfg #	Blower Size	Motor Type	Dimensions (H x W)	Price
213111	B6VMMX42KB	11" x 8"	Variable	43 1/2" x 19 3/4"	

B6VMAX Air Handler

- Energy Efficient Variable Speed ECM Motor
- Quiet Blower Operation
- Constant airflow
- Reduced air stratification
- Multi-poised
- Built in Filter Rack
- Plug-in Heater Kit
- Circuit Board
- Breaker Accessibility
- Plastic Drain Pan
- Durable Cabinet
- Designed to meet the requirements 610.2.A.2
- Thermal Expansion Valve
- Cabinet Insulation
- Anteatertm Coil Technology



Part #	Mfg #	Blower Size	Motor Type	Dimensions (H x W)	Price
205654	B6VMAX24KB	10" x 6"	Variable	49 1/2" x 19 3/4"	
205657	B6VMAX36KB	11" x 8"	Variable	49 1/2" x 19 3/4"	
205659	B6VMAX48KC	11" x 10"	Variable	56" x 22 1/2"	
205660	B6VMAX60KC	11" x 10"	Variable	56" x 22 1/2"	

Vertical Wall Mount Air Handler

B6BW Air Handler

- Durable, Attractive Cabinet
- Multi-speed.
- Blower Control Board
- Ease-of-Service
- Heater Kits Installed
- Breaker Accessibility
- Fully insulated Cabinet
- Front and/or Bottom Return air
- Offset Hanging Bracket for Easy



Part #	Mfg #	Blower Size	Motor Type	Dimensions (H x W)	Price
208607	B6BW018K05	10" x 6"	PSC	36 3/8" x 15"	
214445	B6BW018K08	10" x 6"	PSC	36 3/8" x 15"	

Air Handlers

Vertical Wall Mount Air Handler (Continued)

B6BW Air Handler

Part #	Mfg #	Blower Size	Motor Type	Dimensions (H x W)	Price
202181	B6BW024K08	10" x 6"	PSC	36 3/8" x 15"	
202182	B6BW024K10	10" x 6"	PSC	36 3/8" x 15"	
202184	B6BW030K08	10" x 6"	PSC	43 1/2" x 21"	
231844	B6BW036K05	10" x 8"	PSC	43 1/2" x 15"	
231845	B6BW036K08	10" x 8"	PSC	43 1/2" x 15"	
214754	B6BW036K10	10" x 8"	PSC	43 1/2" x 15"	

B6EW Air Handler

- Energy Efficient Fixed Speed ECM Motor
- Thermal Expansion Valve
- Micro-Channel Coil Technology
- Durable, Attractive Cabinet
- Multi-speed
- Ease-of-Service
- Heater Kits Installed
- Breaker Accessibility
- Fully insulated Cabinet
- Front and/or Bottom Return air
- Offset Hanging Bracket for Easy Installation



Part #	Mfg #	Blower Size	Motor Type	Dimensions (H x W)	Price
230799	B6EWX18K05	10" x 6"	ECM	36 3/8" x 15"	
207994	B6EW25K10	10" x 6"	ECM	43 1/2" x 15"	
213115	B6EWX24K08	10" x 6"	ECM	36 3/8" x 15"	
213141	B6EWX30K10	10" x 6"	ECM	43 1/2" x 15"	

Air Handlers

Air Handlers

BCE4S Variable Speed Air Handler

- *MHT™ Technology: Maximum heat transfer and efficiency*
- *Variable speed blower*
- *Comfort Sync®-enabled control board*
- *Optional Heat Strips: Electric heat strips installed inside the cabinet*
- *Insulated Cabinet: Extra-thick insulation and a tight seal along panels and doors*
- *Microban® protection*
- *Two-piece cabinet design*
- *Pair this model with a Pro Series™ variable-capacity or two-stage air conditioner or heat pump and a Comfort Sync thermostat, for optimum performance*



Part #	Mfg #	Tons	Max Kw	Motor	H x L x W	Price
216944	ABCE4M30S00NA4 X	2.5	15	VSB	49-1/4" x 21-1/4" x 20-5/8"	
216943	ABCE4M24S00NA4 X	2	9	VSB	45-1/4" x 16-1/4" x 20-5/8"	
216945	ABCE4M36S00NA4 X	3	20	VSB	51" x 21-1/4" x 22-5/8"	
216946	ABCE4M48S00NA4 X	4	20	VSB	58-1/2" x 21-1/4" x 24-7/8"	
216947	ABCE4M60S00NA4 X	5	20	VSB	58-1/2" x 21-1/4" x 24-7/8"	

BCE3E Constant Torque Air Handler

- *MHT™ Technology: Maximum heat transfer and efficiency*
- *TXV Technology: Factory installed and easily accessible*
- *Optional Heat Strips: Electric heat strips installed inside the cabinet*
- *Choice of High-Performance Motors: Permanent split capacitory, constant-torque and variable-speed units are available*
- *Insulated Cabinet: Extra-thick insulation and a tight seal along panels and doors*
- *Internal Bracing: Rigid bracing makes entire cabinet stronger*
- *Sleeved Distributor Tubes: Protective wrapper prevents copper-to-copper contact*
- *Filter Rack Redesign: Keeps the filter centered over the return opening*
- *Microban®-Protected Drain Pan with industry's lower water retention rate*



Part #	Mfg #	Tons	Max Kw	Motor	H x L x W	Price
230844	ABCE3M24E00NAX 2	2	10	CT	40-1/2" x 18-1/2" x 22"	
230845	ABCE3M30E00NAX 2	2.5	15	CT	43" x 18-1/2" x 22"	
230846	ABCE3M36E00NAX 2	3	15	CT	48" x 21-7/8" x 22"	
230847	ABCE3M42E00NAX 2	3.5	15	CT	48" x 21-7/8" x 26-1/4"	
230848	ABCE3M48E00NAX 2	4	20	CT	52-1/2" x 21-7/8" x 26-1/4"	

Air Handlers

Air Handlers (Continued)

BCE3E Constant Torque Air Handler

Part #	Mfg #	Tons	Max Kw	Motor	H x L x W	Price
213504	ABCE3M60E00NAX 2	5	20	CT	52-1/2" x 21-7/8" x 26-1/4"	

BCE3C Efficient Air Handler

- *MHT™ Technology: Maximum heat transfer and efficiency*
- *TXV Technology: Factory installed and easily accessible*
- *Optional Heat Strips: Electric heat strips installed inside the cabinet*
- *Choice of High-Performance Motors: Permanent split capacitory, constant-torque and variable-speed units are available*
- *Insulated Cabinet: Extra-thick insulation and a tight seal along panels and doors*
- *Internal Bracing: Rigid bracing makes entire cabinet stronger*
- *Sleeved Distributor Tubes: Protective wrapper prevents copper-to-copper contact*
- *Filter Rack Redesign: Keeps the filter centered over the return opening*
- *Microban®-Protected Drain Pan with industry's lower water retention rate*



Part #	Mfg #	Tons	Max Kw	Motor	H x L x W	Price
230836	ABCE3M18C00NAP 2	1.5	7.5	PSC	38" x 15" x 22"	
230837	ABCE3M24C00NAP 2	2	10	PSC	40-1/2" x 18-1/2" x 22"	
230838	ABCE3M30C00NAP 2	2.5	15	PSC	40-1/2" x 18-1/2" x 22"	
230839	ABCE3M36C00NAP 2	3	15	PSC	52-1/2" x 21-7/8" x 22"	
230840	ABCE3M42C00NAP 2	3.5	15	PSC	48" x 21-7/8" x 26-1/4"	
230841	ABCE3M48C00NAP 2	4	20	PSC	52-1/2" x 21-7/8" x 26-1/4"	
230842	ABCE3M60C00NAP 2	5	20	PSC	52-1/2" x 21-7/8" x 26-1/4"	

BCE5E OMNIGUARD™ Enhanced Air Handler

- *Constant Torque Blower Motor*
- *MHT™ Technology*
- *Omniguard™ Total Corrosion Protection Technology*
- *Insulated cabinet*
- *Antimicrobial protection*

Part #	Mfg #	Tons	Max Kw	Motor	H x L x W	Price
257218	ABCE5E24MA4X50	2	10	Constant Torque	45-1/2" x 16-1/2" x 18-1/2"	
257220	ABCE5E30MA4X50	2.5	15	Constant Torque	47" x 16-1/2" x 18-1/2"	
257221	ABCE5E36MA4X50	3	15	Constant Torque	53.63" x 19-1/2" x 21-1/2"	
257222	ABCE5E42MA4X50	3.5	15	Constant Torque	53.63" x 19-1/2" x 21-1/2"	
257223	ABCE5E48MA4X50	4	20	Constant Torque	53.63" x 19-1/2" x 21-1/2"	
257224	ABCE5E60MA4X50	5	20	Constant Torque	59-3/4" x 19-1/2" x 21-1/2"	

Air Handlers

BCE5C OMNIGUARD™ Compact Air Handler

- PSC Blower Motor
- MHT™ Technology
- Omniguard™ Total Corrosion Protection Technology
- Insulated cabinet
- Antimicrobial protection

Part #	Mfg #	Tons	Max Kw	Motor	H x L x W	Price
257211	ABCE5C18MA1P50	1.5	7.5	PSC	43-1/2" x 16-1/2" x 18-1/2"	
257212	ABCE5C24MA1P50	2	10	PSC	45-1/2" x 16-1/2" x 18-1/2"	
257213	ABCE5C30MA1P50	2.5	15	PSC	47" x 16-1/2" x 18-1/2"	
257214	ABCE5C36MA1P50	3	15	PSC	53.63" x 19-1/2" x 21-1/2"	
257215	ABCE5C42MA1P50	3.5	15	PSC	53.63" x 19-1/2" x 21-1/2"	
257216	ABCE5C48MA1P50	4	20	PSC	55" x 19-1/2" x 21-1/2"	
257217	ABCE5C60MA1P50	5	20	PSC	59-3/4" x 19-1/2" x 21-1/2"	

Electronic Furnace Modular Air System

- Upflow, counterflow and horizontal positions
- Cabinet dimensions match standard furnace widths
- Painted galvanized cabinet
- EFC models feature PSC motors
- EFV models feature ECM™ variable speed motors
- Field installed 5-20 kW heat strips
- Factory installed fan relays for non-heat strip installations



EFC Constant PSC Motor

Part #	Mfg #	Tons	Max Kw	CFM	Blower Motor	H x L x W	Price
211991	EFC08BCP1A	1.5 - 2	10	800	1/4 hp	25" x 21" x 17-1/2"	
211624	EFC12BCP1A	2.5 - 3	15	1200	1/3 hp	25" x 21" x 17-1/2"	
212048	EFC16CCP1A	4	20	1600	3/4 hp	26" x 21" x 21"	
212049	EFC20DCP1A	5	20	2000	3/4 hp	26" x 21" x 21"	

EFV Variable Speed ECM Motor

Part #	Mfg #	Tons	Max Kw	CFM	Blower Motor	H x L x W	Price
213904	EFV08BCP1A	1.5 - 2	10	800	1/3 hp	25" x 21" x 17-1/2"	
213900	EFV12BCP1A	2.5 - 3	15	1200	1/2 hp	25" x 21" x 17-1/2"	
213901	EFV16CCP1A	4	20	1600	3/4 hp	26" x 21" x 21"	
213902	EFV20CCP1A	5	20	2000	3/4 hp	26" x 21" x 21"	



Coils

Classic® Series MultiFlex® Indoor Coils

- Available in upflow, downflow, and horizontal configurations
- Patented single-row, single-coil pleated concept results in extremely low pressure drops and ease of cleaning
- Constructed of enhanced aluminum fins bonded to inner grooved copper tubing
- Front refrigerant and drain connections for ease of installation
- Coils have sweat fitting refrigerant connections
- Primary condensate drain connections 3/4" FNPT
- Internal check valves
- Double-wall construction offers sturdiness, dead air space insulation
- 5-Year warranty on all parts



Classic
SERIES

10 SEER Classic® Series Flow check Standard Cooling/Heat Pump Coil - RCBA

- X Suffix - Unit has insulation
- I Suffix - Revised horizontal with insulation

Part #	Mfg #	Type	Tons	Connection	Air Flow	Width	Price
055327	RCBA-2457GP	Uncased	1.5 - 2.0	Front	600 - 800 cfm	12-1/4"	
055328	RCBA-3765GP	Uncased	2.5 - 3.0	Front	1,000 - 1,200 cfm	15-3/4"	
055329	RCBA-4882GP	Uncased	4.0	Front	1,400 - 1,600 cfm	19-1/4"	
055330	RCBA-6089GP	Uncased	5.0	Front	2,000 cfm	22-3/4"	



Coils

Achiever® Series Coils for Gas & Oil Furnaces

- Constructed of aluminum fins bonded to internally grooved copper tubing
- Coils are factory leak tested & have sweat refrigerant connections
- (2) Sets of 3/4" NPT condensate drain connections for easy connection
- Universal duct flanges are included with all coil models
- Compatible with Germicidal Light System (UV resistant)
- Bi-directional airflow eliminates need to switch any internal components from horizontal left to right
- Coils are ARI certified for system application with variety of Ruud Value Series outdoor units
- Condensate drain pan is constructed of high grade, heat resistant corrosion free thermal-set material
- Conditional parts warranty equal to limited parts warranty of outdoor model (registration required)
- 5-Year limited parts warranty



Cased



Uncase

18 SEER R-410A High Efficiency A/C or Heat Pump Multi-Position Coil for Gas & Oil Furnaces - RCFN

Part #	Mfg #	Type	Tons	Air-Flow CFM Range	Nominal Capacity BTUH	Face Area Sq Ft	Coil Size	Line Sets Liq, Suction	Ship Wt	Price
129888	RCFN-HM2417CC	Cased	2.0	600/800	24,000	5.70	17-1/2"	3/8", 3/4"	57 lbs	
129891	RCFN-HM3624CC	Cased	3.0	825/1,175	36,000	9.98	24-1/2"	3/8", 7/8"	118 lbs	
129892	RCFN-HM4824CC	Cased	4.0	1,000/1,600	48,000	9.98	24-1/2"	3/8", 7/8"	118 lbs	
129893	RCFN-HM6024CC	Cased	5.0	1,050/1,700	60,000	9.98	24-1/2"	3/8", 7/8"	118 lbs	

16 SEER R-410A High Efficiency A/C or Heat Pump Multi-Position Coil for Gas & Oil Furnaces - RCFM

Part #	Mfg #	Type	Tons	Air-Flow CFM Range	Nominal Capacity BTUH	Face Area Sq Ft	Coil Size	Line Sets Liq, Suction	Ship Wt	Price
112102	RCFM-HM2421AC	Cased	2.0	600/800	24,000	5.70	21"	3/8", 3/4"	57 lbs	
112107	RCFM-HM6024AC	Cased	5.0	1,300/1,700	60,000	9.98	24-1/2"	3/8", 7/8"	118 lbs	

13-16 SEER R-410A A/C or Heat Pump Multi-Position Coil for Gas & Oil Furnaces - RCFL

Part #	Mfg #	Type	Tons	Air-Flow CFM Range	Nominal Capacity BTUH	Face Area Sq Ft	Coil Size	Line Sets Liq, Suction	Ship Wt	Price
090461	RCFL-HM2414AC	Cased*	1.5-2.0	600/1,000	18,000-24,000	4.56	14"	3/8", 3/4"	50 lbs	
090462	RCFL-HM2417AC	Cased	1.5-2.0	600/1,000	18,000-24,000	4.56	17-1/2"	3/8", 3/4"	51 lbs	
159504	RCFL-HM2514CC	Cased	2.0	600/1000	18,000-24,000	4.56	14"	3/8", 3/4"	50 lbs	
140773	RCFL-HM2617CC	Cased	1.5-2.0	900/1,400	18,000-24,000	5.70	17-1/2"	3/8", 3/4"	57 lbs	
090464	RCFL-HM3617AC	Cased	2.5-3.0	900/1400	30,000-36,000	5.70	17-1/2"	3/8", 3/4"	57 lbs	
090465	RCFL-HM3621AC	Cased	3.0	900/1,400	30,000-36,000	5.70	21"	3/8", 3/4"	60 lbs	
131741	RCFL-HM3821CC	Cased	3.0	1,200/1,800	30,000-36,000	8.55	21"	3/8", 7/8"	83 lbs	
131742	RCFL-HM3824CC	Cased	3.0	1,200/1,800	30,000-36,000	8.55	24-1/2"	3/8", 7/8"	99 lbs	
090466	RCFL-HM4821AC	Cased	3.5-4.0	1,200/1,800	42,000-48,000	8.55	21"	3/8", 7/8"	83 lbs	
090467	RCFL-HM4824AC	Cased	4.0	1,200/1,800	42,000-48,000	8.55	24-1/2"	3/8", 7/8"	99 lbs	
090468	RCFL-HM6024AC	Cased	5.0	1,600/1,900	60,000	9.98	24-1/2"	3/8", 7/8"	118 lbs	

* 14" 2-Ton is part of the "N-Coil" design series, even though the coil shape resembles an "A" coil design



Coils

R-410A Cased/Uncased Coils - Gas & Oil Furnaces - RCF

- Constructed of aluminum fins bonded to internally grooved aluminum tubing
- Coils are tested at the factory with an extensive refrigerant leak check
- Coils have copper sweat refrigerant connections
- Approved for system application with variety of Rheem outdoor units
- Compatible with Germicidal Light System (UV resistant)
- Feature two sets of 3/4" [14.1 mm] N.P.T. Condensate drain connections for ease of connection
- Chatleff metering device connections, at inlet and outlet of TXV or EEV and equalizer connections (TXV only)
- Condensate drain pan is constructed of high grade, heat resistant, corrosion free thermal-set material
- Bi-Directional airflow eliminates the need to switch any internal components from horizontal left to right
- Unique drain pan design maximizes application flexibility and condensate removal
- N-Coil design maximizes performance and minimizes height required at installation



Standard Efficiency

Part #	Mfg #	Type	Tons	Air-Flow CFM Range	Nominal Capacity BTUH	Face Area Sq Ft	Coil Size	Line Sets Liq, Suction	Ship Wt	Price
171742	RCF2414STAMCA	Cased	2.0	600/900	24,000	4.56	14"	3/8", 3/4"	47 lbs	
171743	RCF2417STAMCA	Cased	2.0	600/900	24,000	4.56	17-1/2"	3/8", 3/4"	48 lbs	
171747	RCF3617STAMCA	Cased	3.0	700/1300	36,000	5.70	17-1/2"	3/8", 3/4"	54 lbs	
171748	RCF3621STAMCA	Cased	3.0	700/1300	36,000	5.70	21"	3/8", 3/4"	60 lbs	
171750	RCF4821STAMCA	Cased	4.0	600/1900	48,000	8.55	21"	3/8", 3/4"	78 lbs	
171752	RCF4824STAMCA	Cased	4.0	1100/1800	48,000	8.55	24"	3/8", 3/4"	93 lbs	
171753	RCF6021STAMCA	Cased	5.0	1400/1600	60,000	7.60	21"	3/8", 7/8"	86 lbs	
171754	RCF6024STAMCA	Cased	5.0	1400/1800	60,000	9.98	24.5"	3/8", 3/4"	108 lbs	

Mid. Efficiency

Part #	Mfg #	Type	Tons	Air-Flow CFM Range	Nominal Capacity BTUH	Face Area Sq Ft	Coil Size	Line Sets Liq, Suction	Ship Wt	Price
171745	RCF2417MTAMCA	Cased	2.0	600/900	24,000	4.56	17"	3/8", 3/4"	54 lbs	
171746	RCF2421MTAMCA	Cased	2.0	600/900	24,000	5.70	21"	3/8", 3/4"	60 lbs	
172854	RCF3621MTAMCA	Cased	3.0	600/1900	36,000	8.55	21"	3/8", 3/4"	78 lbs	
171749	RCF3624MTAMCA	Cased	3.0	700/1300	36,000	8.55	24"	3/8", 3/4"	93 lbs	
171751	RCF4821MTAMCA	Cased	4.0	1100/1800	48,000	7.60	21"	3/8", 7/8"	86 lbs	

High Efficiency

Part #	Mfg #	Type	Tons	Air-Flow CFM Range	Nominal Capacity BTUH	Face Area Sq Ft	Coil Size	Line Sets Liq, Suction	Ship Wt	Price
171755	RCF2417HTAMCA	Cased	2.0	600/900	24,000	4.56	17-1/2"	3/8", 3/4"	54 lbs	
171756	RCF2421HTAMCA	Cased	2.0	600/900	24,000	5.70	21"	3/8", 3/4"	60 lbs	
171757	RCF3621HTAMCA	Cased	3.0	700/1300	36,000	7.60	21"	3/8", 7/8"	86 lbs	
171758	RCF3624HTAMCA	Cased	3.0	700/1300	36,000	9.98	24"	3/8", 3/4"	108 lbs	
171759	RCF4824HTAMCA	Cased	4.0	1100/1800	48,000	9.98	24"	3/8", 3/4"	108 lbs	
171760	RCF6024HTAMCA	Cased	5.0	1400/1800	60,000	9.98	24"	3/8", 3/4"	108 lbs	



Coils

EEV Models Standard Efficiency

Part #	Mfg #	Efficiency	Tons	CFM	BTUH	Coil Size	Price
185065	RCF2417SEAMCA	Standard	2 Ton	600/900	24,000	17-1/2"	
185066	RCF3617SEAMCA	Standard	3 Ton	700/1300	36,000	17-1/2"	
229040	RCF3621SEAMCA	Standard	3 Ton	700/1300	36,000	21"	
177565	RCF6021SEAMCA	Standard	5 Ton	1400/1600	60,000	21"	

Mid. Efficiency

Part #	Mfg #	Efficiency	Tons	CFM	BTUH	Coil Size	Price
177563	RCF2421MEAMCA	Mid	2 Ton	600/900	24,000	21"	
177564	RCF3621MEAMCA	Mid	3 Ton	600/1900	36,000	21"	
177566	RCF6024MEAMCA	Mid	5 Ton	1400/1800	60,000	24-1/2"	

Coil Accessories

Part #	Mfg #	Type	Air-Flow		Nominal	Face	Coil	Line Sets	Ship	Price
			Tons	CFM Range	Capacity	Area				
009020	RXBA-AC	Coupler/Adapter To Match Coil to Furnace One Size Smaller								

Coils

CA Series DX-Treme Uncased Upflow/Downflow Coils

- Rifled copper tubing, enhanced aluminum fins
- Immersion-tested at 500 psi, then nitrogen-pressurized and sealed
- Left or right-hand refrigerant and plumbing connections
- Liquid line - 3/8" ODS, suction line - 7/8" ODS
- Externally mounted flowrater body with Schrader valve for hiss-testing
- Heavy duty polypropylene drain pans on most models
- Drain connection: 177L pans have single LH 3/4" MPT
- Upflow without field modification
- Downflow plate kit included
- ARI Certifiable with all brands of A/C and heat pump systems
- ETL Listed for use with R-22 and R-410A when proper metering device is used
- 10-Year limited warranty

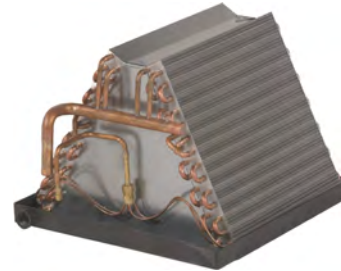

Part #	Mfg #	Tons	Pan Widths	Dimensions Pan Depth	Bare Slab Height	Refrig	Price
104089	CA24A2F-160R	2.0	16"	19-3/8"	12"	R-410A/R-22	
239295	CA24A34-160R	2.5	16"	19-3/8"	21-1/2"	R-410a/R-22	
108690	CA24B3F-130R	2.0	13"	19-3/8"	14"	R-410A/R-22	
108692	CA24B3F-160R	2.0	16"	19-3/8"	14"	R-410A/R-22	
104090	CA30A2F-160R	2.5	16"	19-3/8"	14"	R-410A/R-22	
108693	CA30B3F-160R	2.5	16"	19-3/8"	16"	R-410A/R-22	
104091	CA36A2F-160R	3.0	16"	19-3/8"	16"	R-410A/R-22	
239296	CA36A34-160R	3.0	16"	19-3/8"	16"	R-410A/R-22	
108694	CA36B3F-160R	3.0	16"	19-3/8"	18"	R-410A/R-22	
108695	CA36B3F-195R	3.0	19-1/2"	19-3/8"	18"	R-410A/R-22	
227803	CA48A2F-195R-000	4.0	19-1/2"	19-3/8"	21-1/2"	R-410A/R-22	
227805	CA60A2F-230R-000	5.0	23"	19-3/8"	25-1/2"	R-410A/R-22	

Coils

CC Series DX-Treme Cased Upflow/Downflow Coils

- Rifled copper tubing, enhanced aluminum fins
- Immersion-tested at 500 psi, then nitrogen-pressurized and sealed
- Left or right-hand refrigerant and plumbing connections, L: Left-hand & R: Right-hand
- Liquid line - 3/8" ODS, suction line - 7/8" ODS
- Externally mounted Flowrater body with Schrader valve for hiss-testing
- Heavy-duty polypropylene drain pans on most models
- Embossed galvanized cabinets standard - cabinets feature furnace connectors
- Split access doors in front for easy service
- Fully insulated cabinets with faced insulation
- ARI Certifiable with all brands of A/C and heat pump systems
- ETL Listed for use with R-22 and R-410A when proper metering device is used
- 10-Year limited warranty
- Option codes:
 - (023) - Flanged top duct opening
 - (056) - Painted cabinet and flange top opening

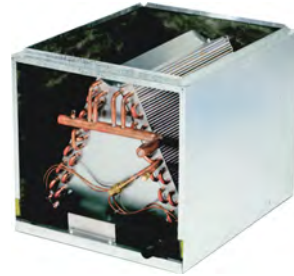

Part #	Mfg #	Tons	Min Width	Dimensions Max Width	Depth	Height	Metering Device	Price
110828	CC24B34-140L	2	14"	23"	21-1/2"	16"	NB TXV R-410	
110829	CC24B34-175L	2	14"	23"	21-1/2"	16"	NB TXV R-410	
110830	CC24D44-175L	2	14"	23"	21-1/2"	20"	NB TXV R-410	
133511	CC30B44-175L1	2.5	14"	23"	21-1/2"	20"	NB TXV R-410	
126429	CC30C44-175L	2.5	14"	23"	21-1/2"	20"	NB TXV R-410	
110831	CC30D44-175L	2.5	14"	23"	21-1/2"	24"	NB TXV R-410	
099999	CC30D4X-210R	2.5	14"	23"	21-1/2"	24"	NB TXV R-22	
110833	CC36B34-175L	3	14" or 17"	23"	21-1/2"	20"	NB TXV R-410	
110834	CC36B34-210L	3	14" or 17"	23"	21-1/2"	20"	NB TXV R-410	
115251	CC36C44-175L	3	14" or 17"	23"	21-1/2"	24"	NB TXV R-410	
110835	CC36D44-175L	3	14" or 17"	23"	21-1/2"	24"	NB TXV R-410	
110836	CC36D44-210L	3	14" or 17"	23"	21-1/2"	24"	NB TXV R-410	
110837	CC48B34-210L	4	17"	26-1/2"	21-1/2"	24"	NB TXV R-410	
110838	CC48D44-210L	4	17"	26-1/2"	21-1/2"	28"	NB TXV R-410	
110839	CC48D44-245L	4	17"	26-1/2"	21-1/2"	28"	NB TXV R-410	
110840	CC60B34-210L	5	20-1/2"	26-1/2"	21-1/2"	28"	NB TXV R-410	
110841	CC60B34-245L	5	20-1/2"	26-1/2"	21-1/2"	28"	NB TXV R-410	
125034	CC60E-44-245L-023	5	24-1/2"	26-1/2"	21-1/2"	28"	NB TXV R-410	
	*							

Coils

CE Series DX-Treme Cased Multi-Position A-Coil

- Rifled copper tubing, enhanced aluminum fins
- Immersion-tested at 500 psi, then nitrogen-pressurized and sealed
- Left- or right-hand refrigerant and plumbing connections
- Liquid line - 3/8" ODS, suction line - 7/8" ODS
- Externally mounted Flowrater body with Schrader valve for hiss-testing
- Heavy duty polypropylene upflow drains pans on most models, powder coated galvanized steel horizontal drain pans standard on all
- Embossed galvanized cabinets standard
- Cabinets feature furnace connectors (patent pending)
- Upflow, horizontal right, or horizontal left without field modification
Downflow applications require plate kit, included
- Split access doors in front for easy service
- Fully insulated cabinets with faced insulation
- ARI Certifiable with all brands of A/C and heat pump systems
- ETL Listed for use with R-22 and R-410A when proper metering device is used
- 10-Year limited warranty

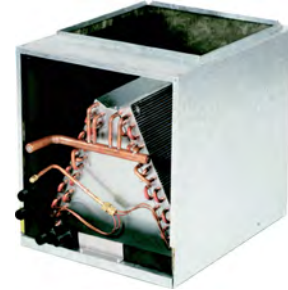

Part #	Mfg #	Tons	Min Width	Dimensions Max Width	Depth	Height	Metering Device	Price
112852	CE24D44-175L	2	14"	23"	21-1/2"	23"	NB TXV R-410	
112860	CE36D44-210L	3	14" or 17"	23"	21-1/2"	27"	NB TXV R-410	
112859	CE36D44175L0	3	14" or 17"	23"	21-1/2"	27"	NB TXV R-410	
112862	CE48D44-210L	4	17"	26-1/2"	21-1/2"	30"	NB TXV R-410	
112865	CE48D44-245L	4	17"	26-1/2"	21-1/2"	30"	NB TXV R-410	
112866	CE60B34-210L	5	20-1/2"	26-1/2"	21-1/2"	30"	NB TXV R-410	
112867	CE60B34-245L	5	20-1/2"	26-1/2"	21-1/2"	30"	NB TXV R-410	

Thermostatic Expansion Valves (TXV)

Part #	Mfg #	Refrigerant	Tons	Bleed Port	For:	Price
095918	4190X2-3	R-22	1.5 to 3.5 Ton	No	Kit for B Coils & F Air Handlers	
106976	4195X2-5	R-22	4, 5 & 6 Ton	No	Kit for B Coils & F Air Handlers	
094022	4200X5-3	R-22	1.5 to 3.5 Ton	No	Kit for B Coils & F Air Handlers	
094023	4202X5-5	R-22	4, 5 & 6 Ton	No	Kit for B Coils & F Air Handlers	

R-22 Coils

Part #	Mfg #	Description	Price
147402	22A2F-130R-003	2.0 Ton R-22 Coil	
147403	22A2F-160R-003	2.0 Ton R-22 Coil	
147404	22A3F-160R-003	3.0 Ton R-22 Coil	
147405	22A3F-195R-003	3.0 Ton R-22 Coil	
147406	22A4F-195R-003	4.0 Ton R-22 Coil	
147407	22A5F-230R-003	5.0 Ton R-22 Coil	



Coils

Pistons

Part #	Mfg #	Description	Price
125462	3960	.089 Orifice R-410A 5.0 Ton Piston	
125459	3987	.068 Orifice R-22 2.5 Ton Piston	
179307	3991	.084 Orifice R-22 5.0 Ton Piston	
179306	3998	.092 Orifice R-22 5.0 Ton Piston	
125457	3999	.055 Orifice R-22 1.5 Ton Piston	
125458	4000	.059 Orifice R-22 2.0 Ton Piston	
125460	4001	.074 Orifice R-22 3.0 Ton Piston	
125456	4006	.049 Orifice R-410A 1.5 Ton Piston	

Coils

C7 Microchannel Cased Indoor Coils



Piston Metering R-410A - "A" Vertical Cased Coil - C7BAM Series

Part #	Mfg #	Order #	Nominal Capacity MBTUH	Refrigerant Sizes Liquid, Suction	Dimensions H x W x D	Price
146441	C7BAM-01824C-A	921515	1.5 - 2.0 Ton	3/8", 3/4"	20-3/4" x 14-1/2" x 20-3/4"	
146443	C7BAM-01824C-B	921519	1.5 - 2.0 Ton	3/8", 3/4"	20-3/4" x 17-1/2" x 20-3/4"	
146444	C7BAM-03036C-A	921517	2.5 - 3.0 Ton	3/8", 3/4"	20-3/4" x 14-1/4" x 20-3/4"	
146445	C7BAM-03036C-B	921521	2.5 - 3.0 Ton	3/8", 3/4"	20-3/4" x 17-1/2" x 20-3/4"	
146446	C7BAM-030C-C	921700	2.5 Ton	3/8", 3/4"	26-3/4" x 21" x 20-3/4"	
146447	C7BAM-03642C-B	921523	3.0 - 3.5 Ton	3/8", 7/8"	26-3/4" x 17-1/2" x 20-3/4"	
146448	C7BAM-03648C-C	921525	3.0 - 4.0 Ton	3/8", 7/8"	26-3/4" x 21" x 20-3/4"	
146449	C7BAM-042C-D	921529	3.5 Ton	3/8", 7/8"	30-1/4" x 24-1/2" x 20-3/4"	
146452	C7BAM-048C-C	921838	4.0 Ton	3/8", 7/8"	30-1/4" x 21" x 20-3/4"	
146453	C7BAM-048C-D	921841	4.0 Ton	3/8", 7/8"	30-1/4" x 24-1/2" x 20-3/4"	
162851	C7BAM-060C-C	922116	5 Ton	3/8", 7/8"	30-1/4" x 21" x 20-3/4"	
162852	C7BAM-060C-D	922119	5 Ton	3/8", 7/8"	30-1/4" x 21" x 20-3/4"	

Coil Accessories

R-410A TXV Kits

Part #	Mfg #	Tons	Refrigerant	Connection	Price
146841	920668A	2.0	R-410A	Mechanical	
146842	920669A	2.5	R-410A	Mechanical	
146843	920670A	3.0	R-410A	Mechanical	
146844	920671A	3.5	R-410A	Mechanical	
146845	920672A	4.0	R-410A	Mechanical	
146846	920673A	5.0	R-410A	Mechanical	

C7 Flex Tube Kit

Part #	Mfg #	Fits Coil Size (S)	Price
150341	921824	1824A, 3036A	
150342	921825	1824B, 3036B	
150343	921826	3642B	
150344	921827	30C	
150345	921828	3648C	
150346	921829	48C, 60C	

Coils

Coil Accessories (Continued)

C7 Flex Tube Kit

Part #	Mfg #	Fits Coil Size (S)	Price
150347	921830	42D	
150348	921831	48D, 60D	

Horizontal Drain Pan Kit

Part #	Mfg #	Fits Coil Size (S)	Price
198694	920265	1824A, 3036A, 1824B, 3036B	
198695	920266	3642B, 30C, 3648C	
198696	920267	48C, 60C, 48D, 60D	

Coils

Intertherm Coils C8 Uncased Coils



		Type	Connections	Nominal Capacity BTUH	Cabinet Width	Line Sets Liq, Suction	
177314	INTC8BAM01830B	Uncased	Downturn	18,000-30,000	14-1/2"	3/8", 3/4"	
177313	INTC8BAM036UB	Uncased	Downturn	36,000	14-1/2"	3/8", 3/4"	
221533	INTC8DAM048UB	Uncased	Downturn	48,000	14-1/2"	3/8", 7/8"	
214895	INTC8DAM01830UB	Uncased	Downturn	18,000-30,000	17-1/2"	3/8", 3/8"	
213953	INTC8DAM036UB	Uncased	Downturn	36,000	17-1/2"	3/8", 3/8"	

Mortex Coils CM Uncased Coils



Part #	Mfg #	Type	Air-Flow CFM Range	Nominal Capacity BTUH	Cabinet Width	Line Sets Liq, Suction	Price
232900	INTCM4B53U	Uncased	1310	53,000	19-5/8"	3/8", 7/8"	
231026	INTCM4B54U	Uncased	1400	54,000	19-5/8"	3/8", 7/8"	

Coils

Coils

EC1P Upflow/Counterflow Coil

- External cabinet mounted distributor body designed for easy changing of orifice sizes and fast TXV connections
- Two dual drain on front of coil for install flexibility of drain lines around furnace vent and utility connections
- Microban® antimicrobial additive in the drain pan to resist mold and mildew growth
- Interlocking door assemblies and snug line seal grommets to minimize air leakage
- Foil-face insulation for easy cleaning
- Tubing located at door split for easy coil service or cleaning
- All drain pans are compatible with UV lights
- All piston coils are compatible with R22 or R410a



Part #	Mfg #	Type	Tons	Nominal Capacity BTUH	Coil Size	Line Sets Liq, Suction	Price
208904	AIREC1P18AG1	Cased	1.5	18,000	14-1/2" x 16-1/2" x 13"	3/8", 3/4"	
208905	AIREC1P19AG1	Cased	1.5	19,000	14-1/2" x 16-1/2" x 13"	3/8", 3/4"	
208908	AIREC1P23AG1	Cased	2	23,000	14-1/2" x 18-1/2" x 13"	3/8", 3/4"	
208909	AIREC1P23BG1	Cased	1.5-2	23,000	17-1/2" x 18-1/2" x 16"	3/8", 3/4"	
208906	AIREC1P24AG1	Cased	2	24,000	14-1/2" x 20-1/2" x 13"	3/8", 3/4"	
208907	AIREC1P24BG1	Cased	2	24,000	17-1/2" x 20-1/2" x 16"	3/8", 3/4"	
208910	AIREC1P29AG1	Cased	2.5	29,000	14-1/2" x 25-1/2" x 13"	3/8", 3/4"	
208911	AIREC1P29BG1	Cased	2.5	29,000	17-1/2" x 25-1/2" x 16"	3/8", 3/4"	
208912	AIREC1P30AG1	Cased	2.5	30,000	14-1/2" x 24-1/2" x 13"	3/8", 3/4"	
208913	AIREC1P30BG1	Cased	2.5	30,000	17-1/2" x 24-1/2" x 16"	3/8", 3/4"	
208914	AIREC1P30CG1	Cased	2.5	30,000	21" x 24-1/2" x 19-1/2"	3/8", 3/4"	
208915	AIREC1P36AG1	Cased	3	36,000	14-1/2" x 24-1/2" x 13"	3/8", 3/4"	
208916	AIREC1P36BG1	Cased	3	36,000	17-1/2" x 24-1/2" x 16"	3/8", 3/4"	
208917	AIREC1P36CG1	Cased	3	36,000	21" x 24-1/2" x 19-1/2"	3/8", 3/4"	
208918	AIREC1P43BG1	Cased	3.5	43,000	17-1/2" x 29-1/2" x 16"	3/8", 7/8"	
208919	AIREC1P43CG1	Cased	3.5	43,000	21" x 29-1/2" x 19-1/2"	3/8", 7/8"	
208920	AIREC1P48BG1	Cased	4	48,000	17-1/2" x 24-1/2" x 16"	3/8", 7/8"	
208921	AIREC1P48CG1	Cased	4	48,000	21" x 24-1/2" x 19-1/2"	3/8", 7/8"	
208922	AIREC1P49CG1	Cased	3.5-5	60,000	21" x 29-1/2" x 19-1/2"	3/8", 7/8"	
208923	AIREC1P50CG1	Cased	4	50,000	21" x 27-1/2" 19-1/2"	3/8", 7/8"	
208926	AIREC1P60DG1	Cased	5	60,000	24-1/2" x 25-1/2" x 23"	3/8", 7/8"	
208925	AIREC1P62CG1	Cased	3.5-5	62,000	21" x 31-1/2" x 19-1/2"	3/8", 7/8"	
208927	AIREC1P62DG1	Cased	3.5-5	62,000	24-1/2" x 29-1/2" x 23"	3/8", 7/8"	

Coils

EM1P Upflow/Horizontal Coil

- Upflow/ Horizontal for application flexibility
- Side drain pan built in for easy horizontal installations
- Foil-face insulation for easy cleaning
- Tubing located at door split for easy coil service or cleaning
- All drain pans are compatible with UV lights
- All piston coils are compatible with R22 or R410a
- Microban® antimicrobial additive in the drain pan to resist mold and mildew growth
- One of the lowest water retention drain pans in the industry to minimize mold and mildew growth
- Interlocking door assemblies and snug line seal grommets to minimize air leakage



Part #	Mfg #	Type	Tons	Nominal Capacity BTUH	Coil Size	Line Sets Liq, Suction	Price
208455	AIREM1P19AG1	Cased	1.5	19,000	14-1/2" x 25-1/2" x 13"	3/8", 3/4"	
208459	AIREM1P23AG1	Cased	1.5-2	23,000	14-1/2" x 25-1/2" x 13"	3/8", 3/4"	
208460	AIREM1P23BG1	Cased	1.5-2	23,000	17-1/2" x 25-1/2" x 16"	3/8", 3/4"	
208461	AIREM1P24AG1	Cased	2	24,000	14-1/2" x 25-1/2" x 13"	3/8", 3/4"	
208462	AIREM1P24BG1	Cased	2	24,000	17-1/2" x 25-1/2" x 16"	3/8", 3/4"	
208463	AIREM1P29AG1	Cased	2	29,000	14-1/2" x 25-1/2" x 13"	3/8", 3/4"	
208464	AIREM1P29BG1	Cased	2.5	29,000	17-1/2" x 25-1/2" x 16"	3/8", 3/4"	
208465	AIREM1P30AG1	Cased	2.5	30,000	14-1/2" x 25-1/2" x 13"	3/8", 3/4"	
208466	AIREM1P30BG1	Cased	2.5	30,000	17-1/2" x 25-1/2" x 16"	3/8", 3/4"	
208467	AIREM1P36AG1	Cased	3	36,000	14-1/2" x 25-1/2" x 13"	3/8", 3/4"	
208468	AIREM1P36BG1	Cased	3	36,000	17-1/2" x 25-1/2" x 16"	3/8", 3/4"	
208469	AIREM1P36CG1	Cased	3	36,000	21" x 25-1/2" x 19-1/2"	3/8", 7/8"	
208470	AIREM1P43BG1	Cased	3.5	43,000	17-1/2" x 27-1/2" x 16"	3/8", 7/8"	
208471	AIREM1P43CG1	Cased	3.5	43,000	21" x 27-1/2" x 19-1/2"	3/8", 7/8"	
208472	AIREM1P48BG1	Cased	4	48,000	17-1/2" x 25-1/2" x 16"	3/8", 7/8"	
208473	AIREM1P48CG1	Cased	4	48,000	21" x 25-1/2" x 19-1/2"	3/8", 7/8"	
208474	AIREM1P50CG1	Cased	5	50,000	21" x 27-1/2" x 19-1/2"	3/8", 7/8"	

Coils

EH1P Dedicated Horizontal Coil

- Microban® antimicrobial additive in the drain pan to resist mold and mildew growth
- One of the lowest water retention drain pans in the industry to minimize mold and mildew growth
- Interlocking door assemblies and snug line seal grommets to minimize air leakage
- Foil-face insulation for easy cleaning
- Tubing located at door split for easy coil service or cleaning
- All drain pans are compatible with UV lights
- All piston coils are compatible with R22 or R410a
- Dedicated horizontal
- Insulated galvanized steel case with durable embossed finish
- Removable top panels for easy service or cleaning
- Refrigerant connections on top of coil for ease of installation in left or right airflow furnaces
- Dual condensate drains on front and back of coil allows flexibility of placement to accommodate left or right airflow furnaces



Part #	Mfg #	Type	Tons	Nominal Capacity BTUH	Coil Size	Line Sets Liq, Suction	Price
208938	AIREH1P23AM1	Cased	2	23,000	14-1/2" x 26-1/2"	3/8", 7/8"	
208939	AIREH1P23BM1	Cased	2	23,000	17-1/2" x 26-1/2"	3/8", 7/8"	
210763	AIREH1P29BM1	Cased	2.5	29,000	17-1/2" x 26-1/2" x 16"	3/8", 7/8"	
208940	AIREH1P36BM1	Cased	3	36,000	17-1/2" x 26-1/2"	3/8", 7/8"	
208941	AIREH1P36CM1	Cased	3	36,000	21" x 26-1/2"	3/8", 7/8"	
208942	AIREH1P49CM1	Cased	4	49,000	21" x 31-1/2"	3/8", 7/8"	
208943	AIREH1P49DM1	Cased	4	49,000	24-1/2" x 31-1/2"	3/8", 7/8"	
208944	AIREH1P62CM1	Cased	5	62,000	21" x 31-1/2"	3/8", 7/8"	
208945	AIREH1P62DM1	Cased	5	62,000	24-1/2" x 31-1/2"	3/8", 7/8"	

EAH1P Dedicated Horizontal Coil

- Microban® antimicrobial additive in the drain pan to resist mold and mildew growth
- Aluminum tubing, hairpins, distributors and header tubes. Copper refrigerant connections for easy brazing to both liquid and suction lines
- Preformed flanges in outlet for quick and easy plenum connections
- One of the lowest water retention drain pans in the industry to minimize mold and mildew growth
- Interlocking door assemblies and snug line seal grommets to minimize air leakage
- Foil-face insulation for easy cleaning
- Tubing located at door split for easy coil service or cleaning
- All drain pans are compatible with UV lights
- All piston coils are compatible with R22 or R410a
- Insulated galvanized steel case with durable embossed finish
- Removable panels provide access to coil.
- Refrigerant lines extend outside of the cabinet for easy connection



Part #	Mfg #	Type	Tons	Nominal Capacity BTUH	Coil Size	Line Sets Liq, Suction	Price
256978	AIREAH1P18AG50	Cased	1.5	18,000	14-1/2" x 26-1/2"	3/4", 3/8"	
256979	AIREAH1P24BG50	Cased	2	24,000	17-1/2" x 26-1/2"	3/4", 3/8"	

Coils

Coils (Continued)

EAH1P Dedicated Horizontal Coil

Part #	Mfg #	Type	Tons	Nominal Capacity BTUH	Coil Size	Line Sets Liq, Suction	Price
256980	AIREAH1P30AG50	Cased	2.5	30,000	14-1/2" x 31-1/2"	3/4", 3/8"	
256981	AIREAH1P30BG50	Cased	2.5	30,000	17-1/2" x 26-1/2"	3/4", 3/8"	
256982	AIREAH1P36BG50	Cased	3	36,000	17-1/2" x 26-1/2"	3/4", 3/8"	
256983	AIREAH1P36CG50	Cased	3	36,000	21" x 26-1/2"	3/4", 3/8"	
256984	AIREAH1P42BG50	Cased	3.5	42,000	17-1/2" x 31-1/2"	7/8", 3/8"	
256985	AIREAH1P42CG50	Cased	3.5	42,000	21" x 26-1/2"	7/8", 3/8"	
256986	AIREAH1P48CG50	Cased	4	48,000	21" x 26-1/2"	7/8", 3/8"	
256987	AIREAH1P60DG50	Cased	5	60,000	24-1/2" x 31-1/2"	7/8", 3/8"	

EAC1P Upflow Coil

- Microban® antimicrobial additive in the drain pan to resist mold and mildew growth
- Aluminum tubing, hairpins, distributors and header tubes
- One of the lowest water retention drain pans in the industry to minimize mold and mildew growth connections for easy brazing to both liquid and suction lines
- Preformed flanges in outlet for quick and easy plenum connections
- Interlocking door assemblies and snug line seal grommets to minimize air leakage
- Foil-face insulation for easy cleaning
- Tubing located at door split for easy coil service or cleaning
- All drain pans are compatible with UV lights
- All piston coils are compatible with R22 or R410a
- External cabinet mounted distributor body designed for easy changing of orifice sizes and fast TXV connections
- Single protruding right side dual drain port for easy installation and service access



Part #	Mfg #	Type	Tons	Nominal Capacity BTUH	Coil Size	Line Sets Liq, Suction	Price
256988	AIREAC1P1824A50	Cased	1.5-2	18,000	14-1/2" x 16-1/2"	3/4", 3/8"	
256989	AIREAC1P1824B50	Cased	1.5-2	18,000	17-1/2" x 16-1/2"	3/4", 3/8"	
256990	AIREAC1P24A50	Cased	2	24,000	14-1/2" x 18-1/2"	3/4", 3/8"	
256991	AIREAC1P24B50	Cased	2	24,000	17-1/2" x 18-1/2"	3/4", 3/8"	
256992	AIREAC1P30A50	Cased	2.5	30,000	14-1/2" x 22-1/2"	3/4", 3/8"	
256993	AIREAC1P30B50	Cased	2.5	30,000	17-1/2" x 22-1/2"	3/4", 3/8"	
256994	AIREAC1P3036A50	Cased	2.5-3	30,000	14-1/2" x 24-1/2"	3/4", 3/8"	
256995	AIREAC1P3036B50	Cased	2.5-3	30,000	17-1/2" x 24-1/2"	3/4", 3/8"	
256996	AIREAC1P3036C50	Cased	2.5-3	30,000	21" x 24-1/2"	3/4", 3/8"	
256997	AIREAC1P36A50	Cased	3	36,000	14-1/2" x 24-1/2"	3/4", 3/8"	
253362	AIREAC1P36B50	Cased	3	36,000	17-1/2" x 24-1/2"	3/4", 3/8"	
256998	AIREAC1P48B50	Cased	4	48,000	17-1/2" x 27-1/2"	7/8", 3/8"	
256999	AIREAC1P48C50	Cased	4	48,000	21" x 27-1/2"	7/8", 3/8"	
257002	AIREAC1P49C50	Cased	4	49,000	21" x 29-1/2"	7/8", 3/8"	
257003	AIREAC1P5060C50	Cased	4-5	50,000	21" x 27-1/2"	7/8", 3/8"	

Coils

Coils (Continued)

EAC1P Upflow Coil

Part #	Mfg #	Type	Tons	Nominal Capacity BTUH	Coil Size	Line Sets Liq, Suction	Price
257004	AIREAC1P60C50	Cased	5	60,000	21" x 27-1/2"	7/8", 3/8"	
247527	AIREAC1P60D50	Cased	5	60,000	24-1/2" x 29-1/2"	7/8", 3/8"	



Condensing Units

Air Conditioners

ACHIEVER
Series

- Scroll compressor
- Composite base pan
- Powder coat paint
- External hauge ports
- Single row coil
- Top can be removed without disconnecting motor
- Quick-Release Louver panel design



Warranties

10-Yr Parts Warranty

RA16 Single Stage Condensing Unit

Part #	Mfg #	Tons	Liq Conn.	Suction Conn.	CFM	RPM	H x L x W	Price
171657	RA1618AJ1NA	1.5	3/8"	3/4"	2404	1095	27" x 29-3/4" x 29-3/4"	
171658	RA1624AJ1NA	2.0	3/8"	3/4"	2851	851	27" x 33-3/4" x 33-3/4"	
171659	RA1630AJ1NA	2.5	3/8"	3/4"	3914	840	27" x 35-3/4" x 35-3/4"	
171660	RA1636AJ1NA	3.0	3/8"	3/4"	4340	819	31" x 35-3/4" x 35-3/4"	
171661	RA1642AJ1NA	3.5	3/8"	7/8"	4450	829	39" x 35-3/4" x 35-3/4"	
171662	RA1648AJ1NA	4.0	3/8"	7/8"	4658	828	45" x 35-3/4" x 35-3/4"	
173277	RA1660AJ1NA	5.0	3/8"	7/8"	1775	795	51" x 35-3/4" x 35-3/4"	

RA14 Single Stage Condensing Unit

Part #	Mfg #	Tons	Liq Conn.	Suction Conn.	CFM	RPM	H x L x W	Price
171646	RA1418AJ1NA	1.5	3/8"	3/4"	2225	1075	25" x 29-3/4" x 29-3/4"	
171647	RA1424AJ1NA	2.0	3/8"	3/4"	2505	1070	25" x 29-3/4" x 29-3/4"	
171648	RA1430AJ1NA	2.5	3/8"	3/4"	2605	1075	27" x 29-3/4" x 29-3/4"	
171649	RA1436AJ1NA	3.0	3/8"	3/4"	3105	805	27" x 33-3/4" x 33-3/4"	
171650	RA1442AJ1NA	3.5	3/8"	7/8"	4265	820	27" x 35-3/4" x 35-3/4"	
171651	RA1448AJ1NA	4.0	3/8"	7/8"	4265	820	31" x 35-3/4" x 35-3/4"	
171652	RA1460AJ1NA	5.0	3/8"	7/8"	4140	850	35" x 35-3/4" x 35-3/4"	

RA13 Single Stage Condensing Unit

Part #	Mfg #	Tons	Liq Conn.	Suction Conn.	CFM	RPM	H x L x W	Price
171633	RA1318AJ1NA	1.5	3/8"	3/4"	2040	1075	27" x 29-3/4" x 29-3/4"	
171634	RA1324AJ1NA	2.0	3/8"	3/4"	2325	1075	25" x 29-3/4" x 29-3/4"	
171635	RA1330AJ1NA	2.5	3/8"	3/4"	2795	1075	25" x 29-3/4" x 29-3/4"	
171636	RA1336AJ1NA	3.0	3/8"	3/4"	2900	1075	27" x 29-3/4" x 29-3/4"	
171637	RA1342AJ1NA	3.5	3/8"	7/8"	2465	1075	31" x 29-3/4" x 29-3/4"	
171638	RA1348AJ1NA	4.0	3/8"	7/8"	4145	850	27" x 33-3/4" x 33-3/4"	
171639	RA1360AJ1NA	5.0	3/8"	7/8"	3870	820	31" x 35-3/4" x 35-3/4"	

• Serving our Customers Since 1946 • www.plumbsupply.com



Condensing Units

RA16 Single Stage Condensing Unit High/Low Pressure

Part #	Mfg #	Tons	Liq Conn.	Suction Conn.	CFM	RPM	H x L x W	Price
171663	RA1636AC1NB	3.0	3/4"	3/8"	4340	819	31" x 35-3/4" x 35-3/4"	
171664	RA1642AC1NB	3.5	3/4"	7/8"	4450	829	39" x 35-3/4" x 35-3/4"	
171665	RA1648AC1NB	4.0	3/4"	7/8"	4658	828	45" x 35-3/4" x 35-3/4"	
171666	RA1660AC1NB	5.0	3/8"	7/8"	4776	795	51" x 35-3/4" x 35-3/4"	

RA14 Single Stage Condensing Unit High/Low Pressure

Part #	Mfg #	Tons	Liq Conn.	Suction Conn.	CFM	RPM	H x L x W	Price
171653	RA1436AC1NB	3.0	3/8"	3/4"	3105	850	27" x 33-3/4" x 33-3/4"	
171654	RA1442AC1NB	3.5	3/8"	7/8"	4265	820	27" x 35-3/4" x 35-3/4"	
171655	RA1448AC1NB	4.0	3/8"	7/8"	4265	820	1" x 35-3/4" x 35-3/4"	
171656	RA1460AC1NB	5.0	3/8"	7/8"	4140	850	35" x 35-3/4" x 35-3/4"	

RA13 Single Stage Condensing Unit High/Low Pressure

Part #	Mfg #	Tons	Liq Conn.	Suction Conn.	CFM	RPM	H x L x W	Price
171641	RA1336AC1NB	3.0	3/8"	3/4"	2900	1075	27" x 29-3/4" x 29-3/4"	
171643	RA1342AC1NB	3.5	3/8"	7/8"	2465	1075	25" x 29-3/4" x 29-3/4"	
171644	RA1348AC1NB	4.0	3/8"	7/8"	4145	850	27" x 33-3/4" x 33-3/4"	
171645	RA1360AC1NB	5.0	3/8"	7/8"	3870	820	31" x 35-3/4" x 35-3/4"	
185055	RA1360AD1NB	5.00	3/8"	7/8"	3870	820	31" x 35-3/4" x 35-3/4"	



Condensing Units

Ultra Series

- Efficiencies up to 17 SEER/13 EER
- EcoNet™ enabled
- Two-Stage
- Scroll compressor
- Optimized fan orifice
- Rust resistant screws
- PlusOne™ Expanded Valve Space
- PlusOne™ Triple Service Access
- New composite base pan
- Two Stage Copeland Scroll™ UltraTech™ Compressor

ULTRA

Series



Warranties

Conditional Unit Replacement - 10 Years (Registration Required)

Parts - 10 Years

UA17 Two Stage Condensing Unit

Part #	Mfg #	Tons	Liq Conn.	Suction Conn.	CFM	RPM	H x L x W	Price
177559	UA1724AJ2CB	2.0	3/8"	3/4"	3326	850	35" x 33-3/4" x 33-3/4"	
177560	UA1736AJ2CB	3.0	3/8"	3/4"	3540	820	39" x 33-3/4" x 33-3/4"	
177561	UA1748AJ2CB	4.0	3/8"	7/8"	4521	646	51" x 35-3/4" x 35-3/4"	
177562	UA1760AJ2CB	5.0	3/8"	7/8"	5133	825	51" x 35-3/4" x 35-3/4"	

Air Conditioners

ULTRA

Series

- Scroll compressor
- Composite base pan
- Powder coat paint
- External gauge ports
- Single Row Coil
- Top can be removed without disconnecting motor
- Quick Release louver panel design



Warranties

10-Yr Parts Warranty

UA20 Variable Speed Condensing Unit

Part #	Mfg #	Tons	Liq Conn.	Suction Conn.	CFM	RPM	H x L x W	Price
188639	UA2024AJVCB	2.0	3/8"	3/4"	3330	772	39" x 33-3/4" x 33-3/4"	
188640	UA2036AJVCB	3.0	3/8"	3/4"	4315	825	39" x 33-3/4" x 33-3/4"	
188641	UA2048AJVCB	4.0	3/8"	7/8"	6240	935	51" x 35-3/4" x 35-3/4"	
188999	UA2060AJVCB	5.0	3/8"	7/8"	6175	900	51" x 35-3/4" x 35-3/4"	

• Serving our Customers Since 1946 • www.plumbsupply.com

Condensing Units

Condensing Units

- Single phase
- Composite base pan
- Permanently lubricated motor
- Durable, attractive cabinet
- Removable top grille assembly
- High pressure switch
- Liquid line filter drier
- One piece Top/Orifice
- Easy compressor and control access
- Complete metal wrapper
- Micro-Channel coils: rows - FPI 1-18
- Operating voltage range: 187v min - 253v max
208/230-60-1
- PSC fan motor
- Liquid line in 3/8" O.D.



JS4BD R-410A 13 Seer Condensor A/C

Part #	Mfg #	Tons	Delay Fuse Max	Suction 0-24'	Suction 25-39'	Suction 40-75'	Pad Size	Unit Height	Price
118705	JS4BD018KB	1.5	20	3/4"	3/4"	3/4"	24 x 24	23-1/2"	
118706	JS4BD024KB	2	25	3/4"	3/4"	3/4"	24 x 24	23-1/2"	
118707	JS4BD030KB	2.5	30	3/4"	3/4"	3/4"	24 x 24	27-1/2"	
118708	JS4BD036KB	3	35	3/4"	7/8"	7/8"	24 x 24	27-1/2"	
118710	JS4BD042KB	3.5	40	7/8"	7/8"	7/8"	32 x 32	27-1/2"	
118711	JS4BD048KB	4	50	7/8"	7/8"	7/8"	32 x 32	27-1/2"	
118712	JS4BD060KB	5	60	7/8"	1-1/8"	1-1/8"	32 x 32	31-1/2"	

JS4BE R-410A 14 Seer Condensor A/C

Part #	Mfg #	Tons	Delay Fuse Max	Suction 0-24'	Suction 25-39'	Suction 40-75'	Pad Size	Unit Height	Price
118698	JS4BE018KA	1.5	20	3/4"	3/4"	3/4"	24 x 24	27"	
118699	JS4BE024KA	2	30	3/4"	3/4"	3/4"	24 x 24	31"	
118700	JS4BE030KA	2.5	30	3/4"	3/4"	3/4"	32 x 32	27"	
118701	JS4BE036KA	3	30	3/4"	7/8"	7/8"	32 x 32	35"	
118702	JS4BE042KA	3.5	40	7/8"	7/8"	7/8"	32 x 32	39"	
118703	JS4BE048KA	4	45	7/8"	7/8"	7/8"	32 x 32	39"	
118704	JS4BE060KA	5	60	7/8"	1-1/8"	1-1/8"	32 x 32	43"	

JS6BD R-410A 13 Seer Builder Series Condensor Unit

Part #	Mfg #	Tons	Delay Fuse Max	Suction 0-24'	Suction 25-39'	Suction 40-75'	Pad Size	Unit Height	Price
202344	JS6BD024K	2	20	3/4"	3/4"	3/4"	24 x 24	27"	
202345	JS6BD030K	2.5	25	3/4"	3/4"	3/4"	24 x 24	27"	
202346	JS6BD036K	3	25	3/4"	7/8"	7/8"	24 x 24	35"	

Condensing Units

High Efficiency Condensing Units

WSA2BD 13 SEER Condensor A/C

- *Quality compressor: Copeland Scroll™*
- *Full service valves*
- *Designed using galvanized steel*
- *Composite base pan*
- *Permanently lubricated motor*
- *Removable top grille assembly*
- *High pressure switch*
- *Liquid line filter drier*
- *One-piece top/orifice*
- *Easy compressor and control access*
- *All-aluminum coils*
- *Powder coated wire guard and mesh hail guard*

Part #	Mfg #	Tons	Delay Fuse Max	Suction 0-24'	Suction 25-39'	Suction 40-75'	Pad Size	Unit Height	Price
260113	WSA2BD4M1SN18K	1.5	20	3/4"	3/4"	3/4"	24 x 24	24-1/2"	
260114	WSA2BD4M1SN24K	2	25	3/4"	3/4"	3/4"	24 x 24	24-1/2"	
260115	WSA2BD4M1SN30K	2.5	30	3/4"	3/4"	3/4"	24 x 24	28-1/2"	
260116	WSA2BD4M1SN36K	3	35	3/4"	7/8"	7/8"	24 x 24	28-1/2"	
260117	WSA2BD4M1SN42K	3.5	40	7/8"	7/8"	7/8"	32 x 32	29-1/4"	
260118	WSA2BD4M1SN48K	4	50	7/8"	7/8"	7/8"	32 x 32	29-1/4"	
260119	WSA2BD4M1SN60K	5	60	7/8"	1-1/8"	1-1/8"	32 x 32	33-1/4"	

Condensing Units

Condensing Units

FS4BD-KB 13 Seer * Condensing Unit

- Designed using galvanized steel
- Permanently Lubricated Motor
- Louvered Condenser Guard
- Removable Top Grille Assembly
- High Pressure Switch
- Liquid Line Filter Drier
- Easy Compressor and Control Access
- Composite Base Pan
- Swept Wing Fan Blade
- Micro-Channel Coils



Part #	Mfg #	Tons	Liq Conn	Suction Conn	Dimensions (H x W)	Price
118771	FRIFS4BD018KA	1.5	3/8"	3/4" (0-24 ft)	25" x 22 3/4"	
118772	FRIFS4BD024KA	2	3/8"	3/4" (0-24 ft)	25" x 22 3/4"	
118773	FRIFS4BD030KA	2.5	3/8"	3/4" (0-24 ft)	29" x 22 3/4"	
118774	FRIFS4BD036KA	3	3/8"	3/4" (0-24 ft)	29" x 22 3/4"	
118775	FRIFS4BD042KB	3.5	3/8"	7/8" (0-24 ft)	29 1/2" x 30 3/4"	
118776	FRIFS4BD048KA	4	3/8"	7/8" (0-24 ft)	29 1/2" x 30 3/4"	
118777	FRIFS4BD060KA	5	3/8"	7/8" (0-24 ft)	33 1/2" x 30 3/4"	

FS4BE 14 Seer * Condensing Unit

- Designed using galvanized steel
- Permanently Lubricated Motor
- Swept-Wing Fan Blade
- Louvered Condenser Guard
- Removable Top Grille Assembly
- High Pressure Switch–
- Liquid Line Filter Drier
- One Piece Top/Orifice
- Easy Compressor and Control Access
- Composite Base Pan
- Micro-Channel Coils



Part #	Mfg #	Tons	Liq Conn	Suction Conn	Dimensions (H x W)	Price
118778	FRIFS4BE018KA	1.5	3/8"	3/4" (0-24 ft)	29" x 22 3/4"	
118779	FRIFS4BE024KA	2	3/8"	3/4" (0-24 ft)	33" x 22 3/4"	
118780	FRIFS4BE030KA	2.5	3/8"	3/4" (0-24 ft)	29" x 30 3/4"	
118781	FRIFS4BE036KA	3	3/8"	3/4" (0-24 ft)	37" X 30 3/4"	
118782	FRIFS4BE042KA	3.5	3/8"	7/8" (0-24 ft)	41" x 30 3/4"	
118783	FRIFS4BE048KA	4	3/8"	7/8" (0-24 ft)	41" x 30 3/4"	
118784	FRIFS4BE060K	5	3/8"	7/8" (0-24 ft)	45" x 30 3/4"	

* When Combined with Proper AHRI Matchup

www.plumbsupply.com • Serving our Customers Since 1946 •

Condensing Units

FS4BF-K (B,C) 16 Seer * Condensing Unit

- CoreSense™ Compressor Protection
- Copeland Scroll UltraTech™ Compressor
- Durable, Attractive Cabinet
- Composite Base Pan
- Swept-Wing Fan Blade
- Louvered Condenser Guard
- Removable Top Grille Assembly
- Low Pressure Switch
- High Pressure Switch
- Liquid Line Filter Drier
- One Piece Top/Orifice
- Easy Compressor and Control Access
- Micro-Channel



Part #	Mfg #	Tons	Liq Conn	Suction Conn	Dimensions (H x W)	Price
118785	FRIFS4BF024KB	2	3/8"	3/4" (0-24 ft)	37" x 22 3/4"	
118786	FRIFS4BF036KB	3	3/8"	7/8" (0-24 ft)	37" x 30 3/4"	
118787	FRIFS4BF048KC	4	3/8"	7/8" (0-24 ft)	41" x 30 3/4"	
118788	FRIFS4BF060KB	5	3/8"	7/8" (0-24 ft)	45" x 30 3/4"	

FS4BG Inventor 20 Seer * Condensing Unit

- iQ Drive®
- Interface Control Board
- System Control
- System Protection
- Cooling operating temperature range
- Five Minute Restart Time Delay
- Compressor and Component Access
- High Efficiency with the low Sound Levels
- Compressor Sound Blanket
- Variable Speed Condenser Motor and Swept-Wing Fan Blade
- Service Port
- High Pressure Switch
- Low Pressure Switch
- Liquid Line Filter Drier
- Louvered Condenser Guard
- Composite Base Pan
- Corrosion Resistance
- One Piece Top/Orifice
- Removable Top Grille Assembly



Part #	Mfg #	Tons	Liq Conn	Suction Conn	Dimensions (H x W)	Price
216523	WSHFS4BG024K	2	3/8"	3/4" (0-24 ft)	37" x 22 1/2"	
216524	FRIFS4BG036K	3	3/8"	7/8" (0-24 ft)	37" x 30 1/2"	
216525	FRIFS4BG048K	4	3/8"	7/8" (0-24 ft)	45" x 30 1/2"	

* When Combined with Proper AHRI Matchup

• Serving our Customers Since 1946 • www.plumbsupply.com



Condensing Units

Condensing Units (Continued)

FS4BG Inventor 20 Seer * Condensing Unit

Part #	Mfg #	Tons	Liq Conn	Suction Conn	Dimensions (H x W)	Price
216526	WSHFS4BG060K	5	3/8"	7/8" (0-24 ft)	45" x 30 1/2"	

* When Combined with Proper AHRI Matchup

www.plumbsupply.com • Serving our Customers Since 1946 •

Condensing Units - New

Condensing Units

ES4BD High Efficiency 13 SEER Single Stage Air Conditioner

- *Designed using galvanized steel*
- *Composite base pan*
- *Permanently lubricated motor*
- *Louvered condenser guard*
- *Removable top grille assembly*
- *High pressure switch*
- *Liquid line filter drier*
- *One piece top/orifice*
- *Easy compressor and control access*
- *Mico-channel coils*



Part #	Mfg #	Tons	Liq Conn	Suction Conn	Dimensions (H x W)	Price
202319	FRIES4BD018KA	1.5	3/8"	3/4"	23-1/2" x 22-3/4"	
202320	FRIES4BD024KB	2	3/8"	3/4"	23-1/2" x 22-3/4"	
202321	FRIES4BD030KB	2.4	3/8"	3/4"	27-1/2" x 22-3/4"	
202322	FRIES4BD036KB	3	3/8"	3/4"(0-24ft) 7/8"(24+ft)	27-1/2" x 22-3/4"	
202323	FRIES4BD042KA	3.5	3/8"	7/8"	27-1/2" x 30-3/4"	

ES4BE High Efficiency 14 SEER Single Stage Air Conditioner

- *Designed using galvanized steel*
- *Composite base pan*
- *Permanently lubricated motor*
- *Louvered condenser guard*
- *Removable top grille assembly*
- *High pressure switch*
- *Liquid line filter drier*
- *One piece top/orifice*
- *Easy compressor and control access*
- *Mico-channel coils*



Part #	Mfg #	Tons	Liq Conn	Suction Conn	Dimensions (H x W)	Price
202331	FRIES4BE048K	4	3/8"	7/8"	39" x 30-3/4"	

* When Combined with Proper AHRI Matchup

• **Serving our Customers Since 1946** • www.plumbsupply.com

Condensing Units - New

FSA1BD High Efficiency 13 Seer Single Stage Air Conditioner

- *Designed Using Galvanized Steel*
- *Permanently Lubricated Motor:*
- *Removable Top Grille Assembly*
- *High Pressure Switch*
- *Liquid Line Filter Drier*
- *One Piece Top/Orifice*
- *Easy Compressor and Control Access*
- *Composite Base Pan*
- *Swept Wing Fan Blade*
- *Micro-Channel Coils*
- *Servicer-Friendly Jacket*



Part #	Mfg #	Tons	Liq Conn	Suction Conn	Dimensions (H x W)	Price
232013	FSA1BD4M1SN18K	1.5	3/8"	3/4"	24.5" x 23.75"	
232015	FSA1BD4M1SN24K	2	3/8"	3/4"	24.5" x 23.75"	
232016	FSA1BD4M1SN30K	2.5	3/8"	3/4"	28.5" x 23.75"	
232017	FSA1BD4M1SN36K	3	3/8"	3/4"	28.5" x 23.75"	
232018	FSA1BD4M1SN42K	3.5	3/8"	7/8"	29.25" x 31.75"	
232019	FSA1BD4M1SN48K	4	3/8"	7/8"	29.25" x 31.75"	
232020	FSA1BD4M1SN60K	5	3/8"	7/8"	33.25" x 31.75"	

FSA1BE High Efficiency 14 SEER Single Stage Air Conditioner

- *Designed Using Galvanized Steel*
- *Permanently Lubricated Motor*
- *Removable Top Grille Assembly*
- *High Pressure Switch*
- *Liquid Line Filter Drier*
- *One Piece Top/Orifice*
- *Easy Compressor and Control Access*
- *Composite Base Pan*
- *Swept Wing Fan Blade*
- *Micro-Channel Coils*
- *Servicer-Friendly Jacket*



Part #	Mfg #	Tons	Liq Conn	Suction Conn	Dimensions (H x W)	Price
232022	FSA1BE4M1SN18K	1.5	3/8"	3/4"	28.5" x 23.75"	
232023	FSA1BE4M1SN24K	2	3/8"	3/4"	32.5" x 23.75"	
232024	FSA1BE4M1SN30K	2.5	3/8"	3/4"	29.25" x 31.75"	
232025	FSA1BE4M1SN36K	3	3/8"	3/4"	37.25" x 31.75"	
232026	FSA1BE4M1SN42K	3.5	3/8"	7/8"	41.25" x 31.75"	
232027	FSA1BE4M1SN48K	4	3/8"	7/8"	41.25" x 31.75"	
232028	FSA1BE4M1SN60K	5	3/8"	7/8"	45.25" x 31.75"	

* When Combined with Proper AHRI Matchup

www.plumbsupply.com • Serving our Customers Since 1946 •

Condensing Units - New

FSA1BF Extra High Efficiency 16 SEER 2 Stage Air Conditioner

- CoreSense™ Compressor Protection
- Copeland Scroll UltraTech™ Compressor
- Designed Using Galvanized Steel
- Composite Base Pan
- Compressor Sound Blanket
- Swept-Wing Fan Blade
- Removable Top Grille Assembly
- Low Pressure Switch
- High Pressure Switch
- One Piece Top/Orifice
- Easy Compressor and Control Access
- Micro-Channel
- Servicer-Friendly Jacket



Part #	Mfg #	Tons	Liq Conn	Suction Conn	Dimensions (H x W)	Price
232029	FSA1BF4M2SN24K	2	3/8"	3/4"	36.5" x 23.75"	
232030	FSA1BF4M2SN36K	3	3/8"	7/8"	37.25" x 31.75"	
232031	FSA1BF4M2SN48K	4	3/8"	7/8"	41.25" x 31.75"	
232032	FSA1BF4M2SN60K	5	3/8"	7/8"	45.25" x 31.75"	

FSA1BG iQ Drive Ultra High Efficiency 20 Seer Variable Stage Air Conditioner

- iQ Drive®: Inverter driven Samsung rotary compressor provides five capacities in modulating operation from a two stage thermostat.
- Cooling operating temperature range: 50 °F to 125 °F.
- Five Minute Restart Time Delay
- Compressor Sound Blanket
- Variable Speed Condenser Motor and Swept-Wing Fan Blade
- High Pressure Switch
- Low Pressure Switch
- Micro-Channel Coils
- Composite Base Pan
- Designed Using Galvanized Steel
- One Piece Top/Orifice
- Removable Top Grille Assembly
- Servicer-Friendly Jacket



Part #	Mfg #	Tons	Liq Conn	Suction Conn	Dimensions (H x W)	Price
232033	FSA1BG4MVRN24K	2	3/8"	3/4"	37" x 22 1/2"	
232034	FSA1BG4MVRN36K	3	3/8"	7/8"	37" x 30 1/2"	
232035	FSA1BG4MVRN48K	4	3/8"	7/8"	45" x 30 1/2"	
232036	FSA1BG4MVRN60K	5	3/8"	7/8"	45" x 30 1/2"	

* When Combined with Proper AHRI Matchup

• Serving our Customers Since 1946 • www.plumbsupply.com

Condensing Units

Condensing Units

4SCU13LE Standard-Efficiency, Single-Stage Air Conditioner

- Up to 14 SEER
- MHT™ Technology
- Compressor sound blanket
- Integrated compressor protection
- Single-Stage scroll compressor
- Sealed contactor with lugs



Part #	Mfg #	Tons	Liq Conn.	Suction Conn.	CFM	RPM	H x L x W	Price
208383	A4SCU13LE118P2	1.5	3/8"	3/4"	650	1010	25.75" x 26.75" x 24.75"	
208384	A4SCU13LE124P2	2	3/8"	3/4"	800	1010	25.75" x 26.75" x 24.75"	
208385	A4SCU13LE130P2	2.5	3/8"	3/4"	1000	1090	29.75" x 26.75" x 24.75"	
208386	A4SCU13LE136P2	3	3/8"	3/4"	1200	1090	29.75" x 26.75" x 24.75"	
208387	A4SCU13LE142P2	3.5	3/8"	7/8"	1400	825	29.75" x 31.25" x 29.38"	
208388	A4SCU13LE148P2	4	3/8"	7/8"	1600	825	33.75" x 31.25" x 29.38"	
208389	A4SCU13LE160P2	5	3/8"	7/8"	1800	830	29.75" x 31.25" x 29.38"	

4SCU14LE Quiet, Single Stage Air Conditioner

- Up to 16 SEER
- MHT™ Technology
- Compressor sound blanket
- Integrated compressor protection
- Single-Stage scroll compressor



Part #	Mfg #	Tons	Liq Conn.	Suction Conn.	CFM	RPM	H x L x W	Price
208393	A4SCU14LE118P1	1.5	3/8"	3/4"	650	1075	29.75" x 26.75" x 24.75"	
208394	A4SCU14LE124P1	2	3/8"	3/4"	850	825	29.75" x 31.25" x 29.38"	
208395	A4SCU14LE130P1	2.5	3/8"	3/4"	1000	825	37.75" x 31.25" x 29.38"	
208396	A4SCU14LE136P1	3	3/8"	7/8"	1200	825	37.75" x 31.25" x 29.38"	
208398	A4SCU14LE142P1	3.5	3/8"	7/8"	1400	825	33.75" x 31.25" x 29.38"	
208400	A4SCU14LE148P1	4	3/8"	7/8"	1600	825	33.75" x 31.25" x 29.38"	
208401	A4SCU14LE160P1	5	3/8"	7/8"	1800	825	37.75" x 37.75" x 35.75"	

4SCU16LE Quiet, Single-Stage Air Conditioner

- Up to 16 SEER
- MHT™ Technology
- Compressor sound blanket
- Integrated compressor protection
- Single-Stage scroll compressor
- Sealed contactor with lugs



Part #	Mfg #	Tons	Liq Conn.	Suction Conn.	CFM	RPM	H x L x W	Price
246809	A4SCU16LE118P1	1.5	3/8"	3/4"	650	1075	29.75" x 26.75" x 24.75"	

Condensing Units

Condensing Units (Continued)

4SCU16LE Quiet, Single-Stage Air Conditioner

Part #	Mfg #	Tons	Liq Conn.	Suction Conn.	CFM	RPM	H x L x W	Price
246812	A4SCU16LE124P1	2	3/8"	3/4"	850	825	29.75" x 31.35" x 29.38"	
246813	A4SCU16LE130P1	2.5	3/8"	3/4"	1000	825	37.75" x 31.25" x 29.38"	
246814	A4SCU16LE136P1	3	3/8"	7/8"	1200	825	37.75" x 31.25" x 29.38"	
246815	A4SCU16LE142P1	3.5	3/8"	7/8"	1400	825	33.75" x 31.25" x 29.38"	
246818	A4SCU16LE148P1	4	3/8"	7/8"	1600	825	33.75" x 31.25" x 29.38"	
246819	A4SCU16LE160P1	5	3/8"	7/8"	1800	825	37.75" x 37.75" x 35.75"	

4SCU16LS High-Efficiency Two-Stage Conditioner

- Up to 16 SEER
- MHT™ Technology
- Compressor sound blanket
- Integrated compressor protection
- Two-Stage scroll compressor
- Sealed contactor with lugs
- Comfort Sync Control Panel
- Comfort Sync Thermostat Compatible
- Comfort Sync Zoning



Part #	Mfg #	Tons	Liq Conn.	Suction Conn.	CFM	RPM	H x L x W	Price
208402	A4SCU16LS124P1	2	3/8"	3/7"		825	43.75" x 31.25" x 29.25"	
208403	A4SCU16LS136P1	3	3/8"	7/8"		825	29.75" x 31.25" x 29.25"	
208404	A4SCU16LS148P1	4	3/8"	7/8"		825	37.75" x 31.25" x 29.25"	
208405	A4SCU16LS160P1	5	3/8"	7/8"		825	43.75" x 37.75" x 35.75"	

4SCU20LX High-Efficiency Variable-Capacity Air Conditioner

- Up to 20 SEER
- MHT™ Technology
- Compressor sound blanket
- Noise reduction
- Integrated compressor protection
- True variable capacity
- Sealed contactor with lugs
- Comfort Sync Control Panel
- Comfort Sync Thermostat Compatible
- Comfort Sync Zoning



Part #	Mfg #	Tons	Liq Conn.	Suction Conn.	CFM	RPM	H x L x W	Price
225324	A4SCU20LX124P	2	3/8"	3/4"		VS	37.5" x 35.75" x 37.75"	
225325	A4SCU20LX136P	3	3/8"	7/8"		VS	37.5" x 35.75" x 37.75"	
225326	A4SCU20LX148P	4	3/8"	7/8"		VS	43.75" x 35.75" x 37.75"	
225327	A4SCU20LX160P	5	3/8"	7/8"		VS	43.75" x 35.75" x 37.75"	

Condensing Units

4SCU16LE Quiet, Single-Stage Air Conditioner

- MHT™ Technology
- Compressor sound blanket
- Integrated compressor protection
- Single-stage scroll compressor
- Selaed contactor with lugs



Part #	Mfg #	Tons	Liq Conn.	Suction Conn.	CFM	RPM	H x L x W	Price
255650	A4SCU16LE118P50	1.5	3/8"	3/4"	650	1075	29.75" x 24.75" x 26.75"	
255651	A4SCU16LE124P50	2	3/8"	3/4"	850	825	29.75" x 29.38" x 31.25"	
255652	A4SCU16LE130P50	2.5	3/8"	3/4"	1000	825	37.75" x 29.38" x 31.25"	
255653	A4SCU16LE136P50	3	3/8"	7/8"	1200	825	37.75" x 29.38" x 31.25"	
255654	A4SCU16LE142P50	3.5	3/8"	7/8"	1400	825	33.75" x 29.38" x 31.25"	
255655	A4SCU16LE148P50	4	3/8"	7/8"	1600	825	33.75" x 29.38" x 31.25"	
255656	A4SCU16LE160P50	4.5	3/8"	7/8"	1800	825	33.75" x 29.38" x 31.25"	

Condensing Units

Condensing Units

4AC13L 13 SEER Split System Air Conditioner

- R410a Refrigerant
- High-quality condenser coil with copper tubing and enhanced louvered fin for maximum heat transfer capacity
- Top discharge directs hot air away from living area and shrubbery
- All units factory run tested
- Available with louvered panel or wire guard coil protection
- Easy access to electrical panels
- Corner mounted service valves for easy hook-up and service
- Liquid line filter drier shipped loose
- Charged for 15 feet of interconnecting tubing
- All units ETL and ETLC approved and AHRI certified
- 10-Year limited warranty on compressor and parts



Part #	Mfg #	Tons	Liq Conn.	Suction Conn.	CFM	RPM	H x L x W	Price
208719	DUC4AC13L18P	1.5	3/8"	3/4"	650	1010	25" x 24.25" x 24.25"	
208720	DUC4AC13L24P	2	3/8"	3/4"	800	1010	25" x 24.25" x 24.25"	
208721	DUC4AC13L30P	2.5	3/8"	3/4"	1000	1090	29" x 24.25" x 24.25"	
208722	DUC4AC13L36P	3	3/8"	7/8"	1200	1090	29" x 24.25" x 24.25"	
208723	DUC4AC13L42P	3.5	3/8"	7/8"	1400	825	29" x 28.25" x 28.25"	
208724	DUC4AC13L48P	4	3/8"	7/8"	1600	825	33" x 28.25" x 28.25"	
208725	DUC4AC13L60P	5	3/8"	7/8"	1800	830	29" x 28.25" x 28.25"	

4AC16L 16 SEER Split System Air Conditioner

- R410A Refrigerant
- High-quality condenser coil with copper tubing and enhanced lanced fin for maximum heat transfer capacity
- Top discharge directs hot air and sound away from living area and shrubbery
- All units factory run tested
- Easy access to electrical panels, pre-wired for easy hook-up
- Liquid line drier shipped loose
- All units ETL and ETLC approved and AHRI Certified
- Charged for 15 feet of interconnecting tubing
- High pressure switch factory installed
- 10-Year limited warranty on compressor and parts



Part #	Mfg #	Tons	Liq Conn.	Suction Conn.	CFM	RPM	H x L x W	Price
246843	DUC4AC16L18P	1.5	3/8"	3/4"	650	1075	29" x 24.25" x 24.25"	
246846	DUC4AC16L24P	2	3/8"	3/4"	850	825	29" x 24.25" x 24.25"	
246847	DUC4AC16L30P	2.5	3/8"	3/4"	1000	825	37" x 28.25" x 28.25"	
246849	DUC4AC16L36P	3	3/8"	7/8"	1200	825	37" x 28.25" x 28.25"	
246850	DUC4AC16L42P	3.5	3/8"	7/8"	1400	825	33" x 28.25" x 28.25"	
246851	DUC4AC16L48P	4	3/8"	7/8"	1600	825	33" x 28.25" x 28.25"	
246852	DUC4AC16L60P	5	3/8"	7/8"	1800	825	37" x 32.25" x 32.25"	

Condensing Units

4AC16L 16 SEER OMNIGAURD Split System Air Conditioner

- R410A Refrigerant
- High-quality condenser coil with copper tubing and enhanced lanced fin for maximum heat transfer capacity
- Top discharge directs hot air and sound away from living area and shrubbery
- All units factory run tested
- Easy access to electrical panels, pre-wired for easy hook-up
- Liquid line drier shipped loose
- All units ETL and ETLC approved and AHRI Certified
- Charged for 15 feet of interconnecting tubing
- High pressure switch factory installed
- 10-Year limited warranty on compressor and parts



Part #	Mfg #	Tons	Liq Conn.	Suction Conn.	CFM	RPM	H x L x W	Price
255631	DUC4AC16L18P50	1.5	3/8"	3/4"	650	1075	29" x 24.25" x 24.25"	
255632	DUC4AC16L24P50	2	3/8"	3/4"	850	825	29" x 24.25" x 24.25"	
255633	DUC4AC16L30P50	2.5	3/8"	3/4"	1000	825	37" x 28.25" x 28.25"	
255634	DUC4AC16L36P50	3	3/8"	7/8"	1200	825	37" x 28.25" x 28.25"	
255635	DUC4AC16L42P50	3.5	3/8"	7/8"	1400	825	33" x 28.25" x 28.25"	
255637	DUC4AC16L48P50	4	3/8"	7/8"	1600	825	33" x 28.25" x 28.25"	
255639	DUC4AC16L60P50	5	3/8"	7/8"	1800	825	37" x 32.25" x 32.25"	

4AC16LT 16 SEER Split System Air Conditioner

- R410A Refrigerant
- High-quality condenser coil with copper tubing and enhanced lanced fin for maximum heat transfer capacity
- Top discharge directs hot air and sound away from living area and shrubbery
- All units factory run tested
- Easy access to electrical panels, pre-wired for easy hook-up
- Liquid line drier shipped loose
- All units ETL and ETLC approved and AHRI Certified
- Charged for 15 feet of interconnecting tubing
- High pressure switch factory installed
- 10-Year limited warranty on compressor and parts



Part #	Mfg #	Tons	Liq Conn.	Suction Conn.	CFM	RPM	H x L x W	Price
228357	DUC4AC16LT24P	2	3/8"	3/4"	800	1075	29-3/4" x 24-3/4" x 26-3/4"	
228359	DUC4AC16LT36P	3	3/8"	3/4"	1200	825	29-3/4" x 29-3/8" x 31-1/4"	
228360	DUC4AC16LT48P	4	3/8"	7/8"	1600	825	37-3/4" x 29-3/8" x 31-1/4"	
228361	DUC4AC16LT60P	5	3/8"	7/8"	1800	825	43-3/4" x 29-3/8" x 31-1/4"	



Heat Pumps

Achiever Series Heat Pumps

ACHIEVER
Series



- Scroll Compressor
- High & Low Pressure Switches
- Composite Base Pan
- Powder Coat Paint
- External Gauge Ports
- Single Row Coil
- Top Can be Removed without Disconnecting Motor
- Quick Release Louver Panel Design

Warranties

10-Yr Parts Warranty

R15 Heat Pump

R-410A

Part #	Mfg #	Tons	BTUH	Liquid Conn	Suction Conn	H x L x W	Price
171675	RP1518AJ1NA	1.5	18,000	3/8"	3/4"	25" x 29-3/4" x 29-3/4"	
171676	RP1524AJ1NA	2.0	24,000	3/8"	3/4"	25" x 29-3/4" x 29-3/4"	
171677	RP1530AJ1NA	2.5	30,000	3/8"	3/4"	31" x 33-3/4" x 33-3/4"	
171678	RP1536AJ1NA	3.0	36,000	3/8"	3/4"	35" x 33-3/4" x 33-3/4"	
171679	RP1542AJ1NA	3.5	42,000	3/8"	7/8"	35" x 33-3/4" x 33-3/4"	
171680	RP1548AJ1NA	4.0	48,000	3/8"	7/8"	39" x 35-3/4" x 35-3/4"	
171681	RP1560AJ1NA	5.0	60,000	3/8"	7/8"	45" x 35-3/4" x 35-3/4"	

RP14 Heat Pump

R-410A

Part #	Mfg #	Tons	BTUH	Liquid Conn	Suction Conn	H x L x W	Price
234447	RP1418FJ1NA	1.5	18,000	3/8"	3/4"	25" x 29-3/4" x 29-3/4"	
234448	RP1424FJ1NA	2.0	24,000	3/8"	3/4"	25" x 29-3/4" x 29-3/4"	
234449	RP1430FJ1NA	2.5	30,000	3/8"	3/4"	25" x 29-3/4" x 29-3/4"	
234450	RP1436FJ1NA	3.0	36,000	3/8"	3/4"	27" x 33-3/4" x 33-3/4"	
234451	RP1442FJ1NA	3.5	42,000	3/8"	7/8"	27" x 33-3/4" x 33-3/4"	
234452	RP1448FJ1NA	4.0	48,000	3/8"	7/8"	35" x 33-3/4" x 33-3/4"	
234453	RP1460FJ1NA	5.0	60,000	3/8"	7/8"	39" x 35-3/4" x 35-3/4"	



Heat Pumps

Ultra Series Heat Pumps

- Scroll compressor
- High & Low pressure switches
- Composite base pan
- Powder coat paint
- External gauge ports
- Single row coil
- Top can be removed without disconnecting motor
- Quick release louver panel design
- R-410A Refrigerant

ULTRA
Series



Warranties

10-Yr Parts Warranty

UP17 Variable Speed Heat Pump 3-Stage R-410A

Part #	Mfg #	Tons	BTUH	Liquid Conn	Suction Conn	H x L x W	Price
185061	UP1724AJVCA	2	24,000	3/8"	3/4"	35" x 33-3/4" x 33-3/4"	
185062	UP1736AJVCA	3	36,000	3/8"	3/4"	35" x 33-3/4" x 33-3/4"	
185063	UP1748AJVCA	4	48,000	3/8"	7/8"	39" x 35-3/4" x 35-3/4"	
185064	UP1760AJVCA	5	60,000	3/8"	7/8"	45" x 35-3/4" x 35-3/4"	

UP20 Variable Speed Heat Pump R-410A

Part #	Mfg #	Tons	BTUH	Liquid Conn	Suction Conn	H x L x W	Price
189000	UP2024AJVCA	2.0	24,000	3/8"	3/4"	35" x 35-3/4" x 35-3/4"	
222340	UP2036AJVCA	3.0	36,000	3/8"	3/4"	39" x 35-3/4" x 35-3/4"	
189001	UP2048AJVCA	4.0	48,000	3/8"	7/8"	51" x 35-3/4" x 35-3/4"	
222820	UP2060AJVCA	5.0	60,000	3/8"	7/8"	51" x 35-3/4" x 35-3/4"	

Heat Pumps

Heat Pumps

JT4BE Series 14 SEER High Efficiency Heat Pump

- Single-stage
- Composite base pan
- Permanently lubricated motor
- Durable, attractive cabinet
- Removable top grill assembly
- High pressure switch
- Liquid line filter drier
- One-piece filter top/orifice
- Five minute restart time delay
- Suction accumulator
- Hot gas muffler
- Easy compressor and control access
- Complete metal wrapper
- Fixed orifice
- Micro-channel coils



Part #	Mfg #	Tons	Delay Fuse Tons	Suction Max	Suction 0-24'	Suction 25-39'	Pad 40-75'	Unit Height	Price
211094	JT4BE018KA	1.5	20	3/4"	3/4"	3/4"	32 x 32	31-1/2"	
211095	JT4BE024KA	2	30	3/4"	3/4"	3/4"	32 x 32	31-1/2"	
211096	JT4BE030KA	2.5	25	3/4"	3/4"	3/4"	32 x 32	39-1/2"	
211097	JT4BE036KA	3	30	7/8"	7/8"	7/8"	32 x 32	43-1/2"	
211098	JT4BE042KA	3.5	40	7/8"	7/8"	7/8"	32 x 32	43-1/2"	
211099	JT4BE048KA	4	45	7/8"	7/8"	7/8"	32 x 32	43-1/2"	
211100	JT4BE060KA	5	60	7/8"	1-1/8"	1-1/8"	32 x 32	43-1/2"	

Heat Pumps

WSH2BE Series 15 SEER High Efficiency Heat Pump

- Quality compressor: Copeland Scroll™
- Patented hot gas bypass defrost
- Full service valves
- Galvanized steel design
- Composite base pan
- Permanently lubricated motor
- Removable top grille assembly
- Suction accumulator and crankcase heater
- Hot gas muffler
- Low pressure switch
- High pressure switch
- One-piece top/orifice
- Easy compressor and control access
- All-aluminum coils
- Powder coated wire guard and mesh hail guard
- Common suction service port
- Five minute restart time dealy

Part #	Mfg #	Tons	Delay Fuse Tons	Suction Max	Suction 0-24'	Suction 25-39'	Pad 40-75'	Unit Height	Price
260127	WSH2BE4M1SP18K	1.5	20	3/4"	3/4"	3/4"	32 x 32	31-1/2"	
260128	WSH2BE4M1SP24K	2	30	3/4"	3/4"	3/4"	32 x 32	31-1/2"	
260129	WSH2BE4M1SP30K	2.5	25	3/4"	3/4"	3/4"	32 x 32	39-1/2"	
260130	WSH2BE4M1SP36K	3	30	7/8"	7/8"	7/8"	32 x 32	43-1/2"	
260131	WSH2BE4M1SP42K	3.5	40	7/8"	7/8"	7/8"	32 x 32	43-1/2"	
260132	WSH2BE4M1SP48K	4	45	7/8"	7/8"	7/8"	32 x 32	43-1/2"	
260133	WSH2BE4M1SP60K	5	60	7/8"	1-1/8"	1-1/8"	32 x 32	43-1/2"	

Heat Pumps

Heat Pumps

FT4BE 14 Seer * Heat Pump

- *Designed using galvanized steel*
- *Permanently Lubricated Motor*
- *Composite Base Pan*
- *Louvered Condenser Guard*
- *Removable Top Grille Assembly*
- *Swept-Wing Fan Blade*
- *High Pressure Switch*
- *Low Pressure Switch*
- *Liquid Line Filter Drier*
- *One Piece Top/Orifice*
- *Five Minute Restart Time Delay*
- *Easy Compressor and Control Access*
- *Fixed Orifice*
- *Micro-Channel Coils*



Part #	Mfg #	Tons	Liq Conn	Suction Conn	Dimensions (H x W)	Price
118823	FRIFT4BE018K	1.5	3/8"	3/4" (0-24 ft)	33 1/2" x 30 3/4"	
118824	FRIFT4BE024K	2	3/8"	3/4" (0-24 ft)	33 1/2" x 30 3/4"	
118825	FRIFT4BE030K	2.5	3/8"	3/4" (0-24 ft)	41 1/2" x 30 3/4"	
118826	FRIFT4BE036K	3	3/8"	7/8" (0-24 ft)	45 1/2" x 30 3/4"	
118827	FRIFT4BE042K	3.5	3/8"	7/8" (0-24 ft)	45 1/2" x 30 3/4"	
118828	FRIFT4BE048K	4	3/8"	7/8" (0-24 ft)	45 1/2" x 30 3/4"	
118829	FRIFT4BE060K	5	3/8"	7/8" (0-24 ft)	45 1/2" x 30 3/4"	

* When Combined with Proper AHRI Matchup

• **Serving our Customers Since 1946** • www.plumbsupply.com

Heat Pumps

FT4BF 16 Seer * Heat Pump

- CoreSense™ Compressor Protection
- Copeland Scroll UltraTech™ Compressor
- Durable, Attractive Cabinet
- Composite Base Pan
- Copper Tube / Aluminum Fin Coils
- Demand Defrost
- Louvered Condenser Guard
- Removable Top Grille Assembly
- Compressor Sound Blanket
- Swept-Wing Fan Blade
- Low Pressure Switch
- High Pressure Switch
- Liquid Line Filter Drier
- One Piece Top/Orifice
- Common Suction Service Port
- Three Minute Restart Time Delay
- Suction Accumulator
- Hot Gas Muffler
- Easy Compressor and Control Access



Part #	Mfg #	Tons	Liq Conn	Suction Conn	Dimensions (H x W)	Price
118812	FRIFT4BF024KA	2	3/8"	3/4" (0-24 ft)	45 1/2" x 31 1/4"	
118813	FRIFT4BF036KA	3	3/8"	7/8" (0-24 ft)	45 1/2" x 31 1/4"	
118814	FRIFT4BF048KA	4	3/8"	7/8" (0-24 ft)	45 1/2" x 31 1/4"	
118815	FRIFT4BF060KA	5	3/8"	7/8" (0-24 ft)	45 1/2" x 31 1/4"	

* When Combined with Proper AHRI Matchup

www.plumbsupply.com • Serving our Customers Since 1946 •

Heat Pumps

FT4BG 19 Seer * Heat Pump

- iQ Drive
- Interface control board
- Utilizes a Nortek Global HVAC
- System Protection
- Cooling operating temperature range:
- Locks out heat pump heating
- Adaptive demand defrost
- Five Minute Restart Time Delay
- Suction Accumulator
- Compressor and Component Access
- High Efficiency with the low Sound Levels
- Compressor Sound Blanket
- Variable Speed Condenser
- Common Suction Service Port
- Discharge muffler
- High Pressure Switch
- Low Pressure Switch
- Liquid Line Filter Drier:
- Copper Tube / Aluminum Fin Coils
- Louvered Condenser Guard
- Composite Base Pan
- Designed using galvanized steel
- One Piece Top/Orifice
- Removable Top Grille Assembly



Part #	Mfg #	Tons	Liq Conn	Suction Conn	Dimensions (H x W)	Price
206889	FRIFT4BG024K	2	3/8"	3/4" (0-24 ft)	37" x 31 1/4"	
206890	FRIFT4BG036K	3	3/8"	7/8" (0-24 ft)	41" x 31 1/4"	
206891	FRIFT4BG048K	4	3/8"	7/8" (0-24 ft)	41" x 31 1/4"	
206892	FRIFT4BG060K	5	3/8"	7/8" (0-24 ft)	45" x 31 1/4"	

* When Combined with Proper AHRI Matchup

• Serving our Customers Since 1946 • www.plumbsupply.com

Heat Pumps - New

Heat Pumps**FSH1BE High Efficiency 14 Seer Single Stage Heat Pump**

- Permanently Lubricated Motor
- Composite Base Pan
- Removable Top Grille Assembly
- Swept-Wing Fan Blade
- High Pressure Switch
- Low Pressure Switch
- Liquid Line Filter Drier
- One Piece Top/Orifice
- Five Minute Restart Time Delay
- Easy Compressor and Control Access
- Fixed Orifice
- Micro-Channel Coils
- Servicer-Friendly Jacket



Part #	Mfg #	Tons	Liq Conn	Suction Conn	Dimensions (H x W)	Price
232043	FSH1BE4M1SP18K	1.5	3/8"	3/4"	33.25" x 31.75"	
232044	FSH1BE4M1SP24K	2	3/8"	3/4"	33.25" x 31.75"	
232045	FSH1BE4M1SP30K	2.5	3/8"	3/4"	41.25" x 31.75"	
232046	FSH1BE4M1SP36K	3	3/8"	7/8"	45.25" x 31.75"	
232047	FSH1BE4M1SP42K	3.5	3/8"	7/8"	45.25" x 31.75"	
232048	FSH1BE4M1SP48K	4	3/8"	7/8"	45.25" x 31.75"	
232049	FSH1BE4M1SP60K	5	3/8"	7/8"	45.25" x 31.75"	

* When Combined with Proper AHRI Matchup

www.plumbsupply.com • Serving our Customers Since 1946 •

Heat Pumps - New

FSH1BF Extra High Efficiency 16 Seer 2 Stage Heat Pump

- CoreSense™ Compressor Protection
- Copeland Scroll UltraTech™ Compressor
- Copeland's proven and simple design equates to years of comfort and reliability for the homeowner with virtually silent operation.
- Designed Using Galvanized Steel
- Composite Base Pan
- Micro-Channel Coils
- Demand Defrost
- Removable Top Grille Assembly
- Compressor Sound Blanket
- Swept-Wing Fan Blade
- Low Pressure Switch
- High Pressure Switch
- Liquid Line Filter Drier
- One Piece Top/Orifice
- Common Suction Service Port
- Five Minute Restart Time Delay
- Suction Accumulator
- Hot Gas Muffler
- Easy Compressor and Control Access
- Servicer-Friendly Jacket



Part #	Mfg #	Tons	Liq Conn	Suction Conn	Dimensions (H x W)	Price
232050	FSH1BF4M2SX24K	2	3/8"	3/4"	37.25" x 31.75"	
232051	FSH1BF4M2SX36K	3	3/8"	7/8"	45.25" x 31.75"	
232052	FSH1BF4M2SX48K	4	3/8"	7/8"	45.25" x 31.75"	
232053	FSH1BF4M2SX60K	5	3/8"	7/8"	45.25" x 31.75"	

* When Combined with Proper AHRI Matchup

• **Serving our Customers Since 1946** • www.plumbsupply.com

Heat Pumps - New

FSH1BG iQ Drive Ultra High Efficiency 19 Seer Variable Stage Heat Pump

- *iQ Drive: Inverter driven Samsung rotary compressor provides five capacities in modulating operation from a two stage thermostat.*
- *Interface control board*
- *System Protection*
- *Cooling operating temperature range: 50 °F to 125 °F.*
- *Locks out heat pump heating: below 0 °F.*
- *Adaptive demand defrost*
- *Five Minute Restart Time Delay*
- *Suction Accumulator*
- *Compressor and Component Access*
- *High Efficiency with the low Sound Levels*
- *Compressor Sound Blanket*
- *Variable Speed Condenser Motor and Swept-Wing Fan Blade*
- *Common Suction Service Port*
- *Dischargemuffler: Reduces compressor noise and vibration.*
- *High Pressure Switch*
- *Low Pressure Switch*
- *Liquid Line Filter Drier:*
- *Copper Tube / Aluminum Fin Coils*
- *Composite Base Pan*
- *One Piece Top/Orifice*
- *Removable Top Grille Assembly*
- *Service-Friendly Jacket*



Part #	Mfg #	Tons	Liq Conn	Suction Conn	Dimensions (H x W)	Price
232054	FSH1BG4CVRX24K	2	3/8"	3/4"	37.25" x 31.75"	
232055	FSH1BG4CVRX36K	3	3/8"	7/8"	41.25" x 31.75"	
232056	FSH1BG4CVRX48K	4	3/8"	7/8"	41.25" x 31.75"	
232057	FSH1BG4CVRX60K	5	3/8"	7/8"	45.25" x 31.75"	

ET4BE High Efficiency 14 SEER Single Stage Heat Pump

- *Designed using galvanized steel*
- *Permanently lubricated motor*
- *Composite base pan*
- *Permanently lubricated motor*
- *Louvered condenser guard*
- *Removable top grille assembly*
- *High pressure switch*
- *Liquid line filter drier*
- *One piece top/orifice*
- *Easy compressor and control access*
- *Mico-channel coils*



Part #	Mfg #	Tons	Liq Conn	Suction Conn	Dimensions (H x W)	Price
202451	FRIET4BE030KA	2.5	3/8"	3/4"	27" x 30-3/4"	

* When Combined with Proper AHRI Matchup

www.plumbsupply.com • Serving our Customers Since 1946 •

Heat Pumps - New

Heat Pumps (Continued)

ET4BE High Efficiency 14 SEER Single Stage Heat Pump

Part #	Mfg #	Tons	Liq Conn	Suction Conn	Dimensions (H x W)	Price
202452	FRIET4BE036KA	3	3/8"	7/8"	35" x 30-3/4"	
202453	FRIET4BE042KA	3.5	3/8"	7/8"	39" x 30-3/4"	

* When Combined with Proper AHRI Matchup

• **Serving our Customers Since 1946** • www.plumbsupply.com

Heat Pumps

Heat Pumps

4SHP16LS High-Efficiency Two-Stage Heat Pump

- Up to 16 SEER / 9 HSPF
- MHT™ Technology
- Quiet Shift™ Technology
- Compressor sound blanket
- Integrated compressor protection
- Two-Stage scroll compressor
- Sealed contactor with lugs
- Dual fuel
- Comfort Sync™ Control Panel
- Comfort Sync™ Thermostat Compatible
- Comfort Sync™ Zoning
- 10-Year limited parts warranty



Part #	Mfg #	Tons	BTUH	Liquid Conn	Suction Conn	H x L x W	Price
208425	A4SHP16LS124P2	2	24,000	3/8"	3/4"	33.75" x 24.75" x 26.75"	
208426	A4SHP16LS136P2	3	36,000	3/8"	7/8"	43.75" x 29.25" x 31.25"	
208427	A4SHP16LS148P2	4	48,000	3/8"	7/8"	37.75" x 35.75" x 37.75"	
208428	A4SHP16LS160P2	5	60,000	3/8"	1-1/8"	43.75" x 35.75" x 37.75"	

4SHP15LE Quiet, Single-Stage Heat Pump

- Up to 15 SEER / 8.50 HSPF
- MHT™ Technology
- Quiet Shift™ Technology
- Compressor sound blanket
- Integrated compressor protection
- Single-Stage scroll compressor
- Sealed contactor with lugs
- Dual fuel
- 10-Year limited parts warranty



Part #	Mfg #	Tons	BTUH	Liquid Conn	Suction Conn	H x L x W	Price
246821	A4SHP15LE118P1	1.5	18,000	3/8"	3/4"	37.75" x 31.25" x 29.25"	
246823	A4SHP15LE124P1	2	24,000	3/8"	3/4"	37.75" x 31.25" x 29.25"	
246824	A4SHP15LE130P1	2.5	30,000	3/8"	3/4"	37.75" x 31.25" x 29.25"	
246827	A4SHP15LE136P1	3	36,000	3/8"	7/8"	33.75" x 31.25" x 29.25"	
246828	A4SHP15LE142P1	3.5	42,000	3/8"	7/8"	37.75" x 37.75" x 35.75"	
246830	A4SHP15LE148P1	4	48,000	3/8"	7/8"	37.75" x 37.75" x 35.75"	
246831	A4SHP15LE160P1	5	60,000	3/8"	1-1/8"	43.75" x 37.75" x 35.75"	

Heat Pumps

4SHP20LX High-Efficiency Variable-Capacity Heat Pump

- Up to 20 SEER / 10 HSPF
- MHT™ Technology
- Quiet Shift™ Technology
- Compressor sound blanket
- Noise reduction
- Integrated compressor protection
- True variable capacity
- Sealed contactor with lugs
- Dual fuel
- Comfort Sync™ Control Panel
- Comfort Sync™ Thermostat Required
- Comfort Sync™ Zoning
- 10-Year limited parts warranty



Part #	Mfg #	Tons	BTUH	Liquid Conn	Suction Conn	H x L x W	Price
225319	A4SHP20LX124P	2	24,000	3/8"	3/4"	37.75" x 37.75" x 35.75"	
225321	A4SHP20LX136P	3	36,000	3/8"	7/8"	37.75" x 37.75" x 35.75"	
225322	A4SHP20LX148P	4	48,000	3/8"	7/8"	43.75" x 37.75" x 35.75"	
225323	A4SHP20LX160P	5	60,000	3/8"	1-1/8"	43.75" x 37.75" x 35.75"	

4SHP15LE Quiet, Single-Stage Heat Pump

- Up to 15 SEER / 8.50 HSPF
- MHT™ Technology
- Quiet Shift™ Technology
- Compressor sound blanket
- Integrated compressor protection
- Single-Stage scroll compressor
- Sealed contactor with lugs
- Dual fuel
- 10-Year limited parts warranty



Part #	Mfg #	Tons	BTUH	Liquid Conn	Suction Conn	H x L x W	Price
255643	A4SHP15LE118P50	1.5	18,000	3/8"	3/4"	37.75" x 31.25" x 29.25"	
255644	A4SHP15LE124P50	2	24,000	3/8"	3/4"	37.75" x 31.25" x 29.25"	
255645	A4SHP15LE130P50	2.5	30,000	3/8"	3/4"	37.75" x 31.25" x 29.25"	
255646	A4SHP15LE136P50	3	36,000	3/8"	7/8"	33.75" x 31.25" x 29.25"	
255647	A4SHP15LE142P50	3.5	42,000	3/8"	7/8"	33.75" x 31.25" x 29.25"	
255648	A4SHP15LE148P50	4	48,000	3/8"	7/8"	33.75" x 31.25" x 29.25"	
255649	A4SHP15LE160P50	5	60,000	3/8"	1-1/8"	43.75" x 37.75" x 35.75"	

Heat Pumps

Heat Pumps

4HP15L 15 SEER Split System Heat Pump

- R410A Refrigerant
- High-quality condenser coil with copper tubing and enhanced louvered fin for maximum heat transfer capacity
- Top discharge directs hot air and sound away from living area and shrubbery
- All units run tested
- Louvered panel coil protection
- Easy access to electrical panels, pre-wired for easy hook-up
- Bi-directional liquid line filter drier factory installed
- Discharge muffler for quiet operation
- Reliable, solid state defrost control
- Defrost control is Quiet Shift™ capable
- Low pressure switch factory installed for loss of charge protection
- Integrated control with LED diagnostics
- Short cycle protection factory installed
- All units ETL and ETLC approved and AHRI Certified
- Charged for 15 feet of interconnecting tubing



Part #	Mfg #	Tons	BTUH	Liquid Conn	Suction Conn	H x L x W	Price
246854	DUC4HP15L18P	1.5	18,000	3/8"	3/4"	37" x 28.25" x 28.28"	
246856	DUC4HP15L24P	2	24,000	3/8"	3/4"	37" x 28.25" x 28.28"	
246857	DUC4HP15L30P	2.5	30,000	3/8"	3/4"	37" x 28.25" x 28.28"	
246858	DUC4HP15L36P	3	36,000	3/8"	3/4"	33" x 28.25" x 28.25"	
246859	DUC4HP15L42P	3.5	42,000	3/8"	7/8"	37" x 32.25" x 32.25"	
246860	DUC4HP15L48P	4	48,000	3/8"	7/8"	37" x 32.25" x 32.25"	
246861	DUC4HP15L60P	5	60,000	3/8"	7/8"	43" x 32.25" x 32.25"	

Heat Pumps

4HP15L 15 SEER OMNIGAURD Split System Heat Pump

- R410A Refrigerant
- High-quality condenser coil with copper tubing and enhanced louvered fin for maximum heat transfer capacity
- Top discharge directs hot air and sound away from living area and shrubbery
- All units run tested
- Louvered panel coil protection
- Easy access to electrical panels, pre-wired for easy hook-up
- Bi-directional liquid line filter drier factory installed
- Discharge muffler for quiet operation
- Reliable, solid state defrost control
- Defrost control is Quiet Shift™ capable
- Low pressure switch factory installed for loss of charge protection
- Integrated control with LED diagnostics
- Short cycle protection factory installed
- All units ETL and ETL approved and AHRI Certified
- Charged for 15 feet of interconnecting tubing



Part #	Mfg #	Tons	BTUH	Liquid Conn	Suction Conn	H x L x W	Price
255623	DUC4HP15L18P50	1.5	18,000	3/8"	3/4"	37" x 28.25" x 28.28"	
255625	DUC4HP15L24P50	2	24,000	3/8"	3/4"	37" x 28.25" x 28.28"	
255626	DUC4HP15L30P50	2.5	30,000	3/8"	3/4"	37" x 28.25" x 28.28"	
255627	DUC4HP15L36P50	3	36,000	3/8"	3/4"	33" x 28.25" x 28.25"	
255628	DUC4HP15L42P50	3.5	42,000	3/8"	7/8"	37" x 32.25" x 32.25"	
255629	DUC4HP15L48P50	4	48,000	3/8"	7/8"	37" x 32.25" x 32.25"	
255630	DUC4HP15L60P50	5	60,000	3/8"	7/8"	43" x 32.25" x 32.25"	

4HP16LT 16 SEER Split System Heat Pump

- Service valves positioned for quick installation and easy service
- Comfort Alert 2 diagnostics factory installed
- Reliable, solid state defrost control
- Defrost control is Quiet Shift™ capable
- Designed for ambients up to 125°F
- All units ETL and ETL approved and AHRI certified
- High pressure switch
- Low pressure switch for loss of charge protection
- High-efficiency 2 stage Copeland Ultra Tech™ scroll compressor
- R410a refrigerant
- Full metal louvered panel coil guard protection



Part #	Mfg #	Tons	BTUH	Liquid Conn	Suction Conn	H x L x W	Price
228364	DUC4HP16LT24P	2	24,000	3/8"	3/4"	33-3/4" x 26-3/4" x 24-3/4"	
228365	DUC4HP16LT36P	3	36,000	3/8"	3/4"	37-3/4" x 31-1/4" x 29-3/8"	
217361	DUC4HP16LT48P	4	48,000	3/8"	7/8"	37-3/4" x 37-3/4" x 35-3/4"	
228366	DUC4HP16LT60P	5	60,000	3/8"	7/8"	43-3/4" x 37-3/4" x 35-3/4"	

Electric Heat Kits

Electric Heat Kits



Electric Heat Kit for Air Handlers

Part #	Mfg #	kW Heat	Electrical	Size	Price
091408	RXBH-24A20J	20kW	208/240-1-60	3.5 - 5.0 Ton	
091409	RXBH-24A25J	25kW	258/240-1-60	3.5 - 5.0 Ton	
133871	RXBH-24A30J	30kW	208/240-1-60	3.5 - 5.0 Ton	
133869	RXBH-1724A05J	5Kw	208/240-1-60	1.5 - 5.0 Ton	
133433	RXBH-1724A07J	7kW	208/240-1-60	1.5 - 5.0 Ton	
133643	RXBH-1724A10J	10kW	208/240-1-60	1.5 - 5.0 Ton	
133644	RXBH-1724A15J	15kW	208/240-1-60	1.5 - 5.0 Ton	

Mini-Split Components & Accessories

Single Zone Indoor Air Handler Units

- *Model Nomenclature Prefix*
- **ASU** Wall Mount
- **ABU** Universal Mount
- **ARU** Slim Duct
- **AUU** Cassette Mount
- **AGU** Floor Mount
- **Y** Models are Wi-Fi capable

Part #	Mfg #	Nom Cool BTUH	Nom Heat BTUH	SEER	HSPF	Dimensions	Price
172855	ASU18RLB	18,000	24,000	19.0	10.6	12-5/8"H x 39-5/16"W x 9"D	
172858	ASU24RLB	24,000	24,000	18.0	10.6	12-5/8"H x 39-5/16"W x 9"D	
223025	ASU30RLE	30,000	32,000	18.7	11.7	13-3/8"H x 45-1/4"W x 11"D	
172861	ASU30RLXB	30,700	30,000	16.5	9.0	12-5/8"H x 39-5/16"W x 9"D	
172864	ASU36RLXB	33,000	34,000	15.5	9.0	12-5/8"H x 39-1/2"W x 9"D	
231323	ASU9RLS3Y	9,000	12,000	33.0	14.00	11-5/8"H x 37"W x 10-5/8"D	
228370	ASU12RLS3Y	12,000	16,000	33.0	13.8	11-5/8"H x 37"W x 10-5/8"D	
230063	ASU15RLS3Y	14,500	18,000	33.0	13.3	11-5/8"H x 37"W x 10-5/8"D	
114270	ASU30RLX	36,000	32,000	17.5	8.5	12-5/8"H x 39-1/2"W x 9"D	
110547	ABU18RULX	17,800	21,500	16.0	8.5	25-7/8"H x 39-1/8"W x 7-7/8"D	
127976	ABU24RULX	22,200	24,000	15.0	8.5	25-7/8"H x 39-1/8"W x 7-7/8"D	
132067	ABU36RSLX	34,100	36,500	14.0	8.5	27-5/8"H x 65-1/2"W x 9-1/2"D	
103316	AUU18RCLX	17,800	21,000	16.0	8.5	9-3/4"H x 32-3/4"W x 32-3/4"D	
103314	AUU24RCLX	22,200	24,200	15.0	8.5	9-3/4"H x 32-3/4"W x 32-3/4"D	
111987	AUU36RCLX	34,100	36,000	14.0	8.5	11-5/8"H x 32-3/4"W x 32-3/4"D	
120771	AUU42RCLX	42,700	45,200	15.0	8.5	11-5/8"H x 32-3/4"W x 32-3/4"D	

Single Zone Outdoor Condenser Units

Part #	Mfg #	Nom Cool BTUH	Nom Heat BTUH	SEER	HSPF	Dimensions	Price
172856	AOU18RLB	18,000	24,000	19.0	10.6	24-7/16"H x 31-1/8"W x 11-7/16"D	
172859	AOU24RLB	24,000	24,000	18.0	10.6	24-7/16"H x 31-1/8"W x 11-7/16"D	
172862	AOU30RLXB	30,700	30,000	16.5	9.0	32-3/4"H x 35-1/2"W x 15-3/4"D	
172865	AOU36RLXB	33,000	34,000	15.5	9.0	32-3/4"H x 35-1/2"W x 15-3/4"D	
223026	AOU30RLXEH	30,000	32,000	18.7	11.7	50-13/16"H x 35-3/8"W x 13"D	
163986	AOU9RLF1	9,000	12,000	23	11.0	21-1/4"H x 26"W x 11-7/16"D	
163991	AOU12RLF1	12,000	16,000	22.0	11.0	21-1/4"H x 31-1/8"W x 11-7/16"D	
136262	AOU18RLXFW	18,000	18,000	Up to 19.2	Up to 10	32-3/4"H x 35-3/8"W x 13"D	
224794	AOU24RLXFW1	24,000	24,000	Up to 18.0	Up to 10	32-3/4"H x 35-3/8"W x 13"D	
189831	AOU24RLXFWH	22,000	25,200	23		32-11/16" x 35-7/16" x 13"	
172181	AOU9RLS3H	9,000	12,000	33	14.00	24-7/16"H x 31-1/8"W x 11-11/32"D	
172186	AOU12RLS3H	12,000	16,000	33	13.8	24-7/16"H x 31-1/8"W x 11-11/32"D	
172192	AOU15RLS3H	14,500	18,000	33	13.3	24-7/16"H x 31-1/8"W x 11-11/32"D	

Mini-Split Components & Accessories

Single Zone Outdoor Condenser Units (Continued)

Part #	Mfg #	Nom Cool BTUH	Nom Heat BTUH	SEER	HSPF	Dimensions	Price
172178	AOU9RLS3	9,000	12,000	27.2	12.5	24-13/32"H x 31-3/32"W x 13-27/32"D	
172184	AOU12RLS3	12,000	16,000	25.0	12.0	24-13/32"H x 31-3/32"W x 13-27/32"D	
172190	AOU15RLS3	14,500	18,000	21.5	12.0	24-13/32"H x 31-3/32"W x 13-27/32"D	
103317	AOU18RLX	17,800	21,000	16.0	8.5	32-3/4"H x 35-1/2"W x 13"D	
103315	AOU24RLX	22,200	24,200	15.0	8.5	32-3/4"H x 35-1/2"W x 13"D	
114272	AOU30RLX	36,000	32,000	17.5	8.5	32-3/4"H x 35-1/2"W x 13"D	
111988	AOU36RLX	34,100	36,500	14.0	8.5	32-3/4"H x 35-1/2"W x 13"D	
120772	AOU42RLX	42,700	45,200	15.0	8.5	50-7/8"H x 35-1/2"W x 13"D	
163994	AOU9RLFF	9,000	12,000	26	12.6	24-7/16"H x 31-1/8"W x 11-7/16"D	
164000	AOU12RLFF	12,000	16,000	22.7	11.6	24-7/16"H x 31-1/8"W x 11-7/16"D	
164005	AOU15RLFF	14,200	18,000	20.3	11.2	24-7/16"H x 31-1/8"W x 11-7/16"D	
163995	AOU9RLFFH	9,000	12,000	26.0	12.6	24-7/16"H x 31-1/8"W x 11-7/16"D	
164001	AOU12RLFFH	12,000	16,000	22.7	11.6	24-7/16"H x 31-1/8"W x 11-7/16"D	
164006	AOU15RLFFH	14,200	18,000	20.3	11.2	24-7/16"H x 31-1/8"W x 11-7/16"D	
154467	AOU9RLFC	9,000	12,000	21.5	12.2	24-13/32"H x 31-3/32"W x 11-11/32"D	
154468	AOU12RLFC	12,000	16,000	20.0	11.5	24-13/32"H x 31-3/32"W x 11-11/32"D	
154469	AOU18RLFC	18,000	21,600	19.7	11.3	24-13/32"H x 31-3/32"W x 13-27/32"D	

Mini Split System Remotes

UTY-DMMUM Central Remote Controller



Part #	Mfg #	Description	Price
133357	UTY-DMMUM	HFI Central Remote	

UTY-RVNUM Wired Remote Controller

- Large backlit LCD display
- Displays room temperature
- Provides full feature access to property managers, building owners, and facility maintenance, as well as providing basic comfort features to tenants, employees, and teachers



Part #	Mfg #	Description	Price
160489	UTY-RVNUM	Wired Remote Controller	

Mini-Split Components & Accessories

UTY-RNNUM Remote Control for Wall Mounts

- Full function wired remote
- Unique lock function



Part #	Mfg #	Description	Price
133358	UTY-RNNUM	HFI Wired Remote Control for Flex Wall Mounts	

UTY-LNHUM Wireless Remote Control

Part #	Mfg #	Description	Price
133360	UTY-LNHUM	HFI Wireless Remote Control	

UTY-RNBYU Wired Remote Control for Wall-Mounted Units

- Remote control thermo sensor
- Child lock capable

Part #	Mfg #	Description	Price
129542	UTY-RNBYU	Wired Remote Control for Wall-Mounted Units	

UTY-RSNUM Simple Wired Remote Control

Part #	Mfg #	Description	Price
133359	UTY-RSNUM	HFI Simple Wired Remote Control	

RC Wired Module

Part #	Mfg #	Description	Price
177221	FJ-RC-WIFI-1NA	RC Wired Module for Cassette, Slim Duct, Ceiling, Universal	

IR Wireless Module

Part #	Mfg #	Description	Price
177218	FJ-IR-WIFI-1NA	IR Wireless Module for Wall Mounts & Floor Mounts	

External Connect Kit

Part #	Mfg #	Description	Price
157680	UTD-ECS5A	For Indoor Unit	
138785	UTY-XWZX	For Outdoor Unit	

Interface Kit

- Required to connect the ASU9RLS2, ASU12RLS2 and ASU15RLS2 to wired remote UTY-RNNUM, Dry contact wire kit UTY-XWZXZ5, and simple remote control UTY-RSNUM

Part #	Mfg #	Description	Price
154241	UTY-TWBXF1	Interface Kit	

Mini-Split Components & Accessories

Fujitsu Halcyon Parts & Accessories

Part #	Mfg #	Description	Price
215120	K9601847014	Motor Fan	
218871	K9708713427	12RLS2 PSCB Control	
210496	K9970101038	TXV Coil B=White	
133362	UTY-LRHUM	HFI Receiver Unit	
239432	UTY-TFNXZ2	WIFI Interface Module	
154501	UTY-XSZX	Remote Sensor	
213095	UTY-XWZXZ5	Dry Contact Wire Kit	
213098	UTZ-KXGC	High Humidity Insulation Kit	
147843	UTD-GXSB-W	Auto Louver Grille Kit (ARU18)	

Branch Box



UTP-PU03A

Part #	Mfg #	Description	Price
133354	UTP-PU03A	Flex Primary Branch Box	
133355	UTP-PU03B	Flex Secondary Branch Box	
158380	UTP-PX-A	Branch Box Outdoor Enclosure	

Fresh Air Intake Kit

- Mixes room air then passes it through a heat exchanger
- Allows for a 4-inch flex duct connection
- Requires a field supplied duct booster fan capable of 60 CFM at 2"W.C. or 90 CFM 4"W.C.



Part #	Mfg #	Description	Price
151930	UTZ-VXAA	Fresh Air Intake Kit	

Condensate Pump

- For ABU36RSLX
- Raises the drain/discharge point of your unit by 11.8"



Part #	Mfg #	Description	Price
141456	UTR-DPB24T	Condensate Pump for ABU36RSLX	

Fitting Kit for 18 and 18 Indoor Combination

Part #	Mfg #	Description	Price
141472	K9FZ1818	Fitting Kit	

Mini-Split Components & Accessories

Parts & Accessories

Part #	Mfg #	Description	Price
124548	K9R410A55	Halcyon Access Fitting (K9R410A)	
213848	K9372266144	Remote Sensor	
242748	K9708511511	Controller PCB AOU30RLX	
232462	K9708513072	Power Supply	
242749	K9708513041	Power Filter PCB RLXS	
241532	K9710621802	Controller PCB	
237164	K9709427347	PCB Board ASU12RLF1	
141252	K9379853002	Cond Fan Motor	

Mini-Split Components & Accessories

Mini-Split Accessories

Desolv™ Cleaning Kit

- *Kit Includes:*
- Desolv Cleaning Solution (1 gal.)
- C-Band Frame Assembly
- Single Use Funnel Bags (2)
- Cleaning Brush (1)
- Drain Pail (5 gal)
- Installation Instructions



Part #	Mfg #	Description	Price
173866	82560	Mini-Split Evaporator Coil Cleaning Kit	

Replacement Bags

Part #	Mfg #	Size	Price
173867	82562	Replacement Bags	

Desolv™ 1 Gallon Cleaner

Part #	Mfg #	Description	Price
173868	82565	1 Gallon	

Mighty Bracket™

Mini-Split Installation Support Tool

- *Allows single person installation*
- *Simple clip on support*
- *Does not damage walls*
- *Use on all brands of mini-splits*



Part #	Mfg #	Description	Price
172977	97705	Clips to Mini-Split Mounting Bracket	

NoKink™ Flexible Refrigerant Line Connector

- *Eliminates kinking of copper refrigerant tubing when wall-mounting mini-split evaporators*
- *Easy flaring*
- *Quick connection*
- *Corrugated 300 Series stainless steel flexible piping*



Part #	Mfg #	Size	Price
172973	66731	1/4" x 3' Flex Hose	
172974	66733	3/8" x 3' Flex Hose	
172976	66737	1/2" x 3' Flex Hose	
172975	66735	5/8" x 3' Flex Hose	

Multi Zone Mini-Split Systems

Multi Zone Mini-Splits - Outdoor Units

Multi-Zone Outdoor Units

- Seven year compressor warranty
- Five year parts warranty
- Energy Star Qualified
- Auto Restart/Reset
- Refrigerant R410A
- Quiet Mode
- Sleep Timer



AOU18, 24RLXFZ

AOU36RLXFZ1

AOU45RLXFZ

Part#	Mfg#	Nom Cool	Nom Heat	SEER	HSPF	Dimensions
136565	AOU18RLXFZ	18,000	18,000	19.2	10	27-9/16"H x 35-7/16"W x 13"D
136566	AOU24RLXFZ	24,000	24,000	18.0	10	27-9/16 "H x 35-7/16"W x 13"D
173774	AOU36RLXFZ1	36,000	36,000	18.0	9.4	32-11/16"H x 35-7/16"W x 13"D
189472	AOU45RLXFZ	48,000	48,000	19.7	10.3	39-5/16"H x 38-3/16"W x 14-9/16"D

Multi-Zone XLTH Outdoor Units

- Individual zoning
- Inverter technology
- Inverter control
- Extra low temperature heating
- Base freeze prevention
- Cassette model fits into standard ceiling tile
- Hidden or showcased indoor unit
- Stable and comfortable



Part#	Mfg#	Nom Cool	Nom Heat	SEER	HSPF	Dimensions
173696	AOU18RLXFZH	18,000	22,000	21.5	10.3	32-11/16"H x 35-7/16"W x 13"D
173697	AOU24RLXFZH	22,000	25,000	20.0	10.3	32-11/16"H x 35-7/16"W x 13"D
189473	AOU36RLXFZH	35,200	36,400	20.0	10.3	39-5/16"H x 38-3/16"W x 14-9/16"D

Multi Zone Mini-Splits - Indoor Units

Compact Wall-Mounted Indoor Heat Pump

- Auto Restart/Reset
- Minimum Heat Mode
- Auto Mode
- Dry Mode
- 24-Hour Timer
- Sleep Timer
- Ion Deodorizing Filter
- Apple Catechin Filter



Part#	Mfg#	Nom Cool	Nom Heat	SEER	HSPF	Dimensions	Price
164013	ASU7RLF1	7,000	8,100	17.0	9.8	10-1/2 "H x 33-1/16"W x 8"D	
163984	ASU9RLF1	9,000	10,200	17.0	9.8	10-1/2 "H x 33-1/16"W x 8"D	
163989	ASU12RLF1	12,000	13,500	17.0	9.8	10-1/2 "H x 33-1/16"W x 8"D	

Multi Zone Mini-Split Systems

Large Wall-Mounted Indoor Heat Pump

- Auto Restart/Reset
- Minimum Heat Mode
- Auto Mode
- Dry Mode
- 24-Hour Timer
- Sleep Timer
- Ion Deodorizing Filter
- Apple Catechin Filter



Part#	Mfg#	Nom Cool	Nom Heat	SEER	HSPF	Dimensions
133344	ASU18RLF	16,200	20,000	17.0	9.8	12-5/8"H x 39-1/4"W x 9"D
133345	ASU24RLF	24,000	27,000	17.0	9.8	12-5/8"H x 39-1/4"W x 9"D

Designer Series Wall-Mounted Indoor Heat Pump

- Auto Restart/Reset
- Minimum Heat Mode
- Auto Mode
- Dry Mode
- 24-Hour Timer
- Sleep Timer
- Ion Deodorizing Filter
- Apple Catechin Filter



Part#	Mfg#	Nom Cool	Nom Heat	SEER	HSPF	Dimensions
229612	ASU15RLF1	14,000	16,300	21.5	-	11-1/8"H x 34-1/4"W x 7-1/4"D

Slim Duct Ducted Indoor Heat Pump

- Fresh Air Intake
- Condensate Pump
- Auto Changeover
- Auto Restart/Reset
- Quiet Mode
- Auto Mode
- Weekly Timer
- Dry Mode



Part#	Mfg#	Nom Cool	Nom Heat	SEER	HSPF	Dimensions
167720	ARU7RLF	7,000	8,100	14.7	9.3	7-25/32"H x 27-9/16"W x 24-13/32"D
133350	ARU9RLF	9,000	12,000	21.5	12.2	7-25/32"H x 27-9/16"W x 24-13/32"D
133351	ARU12RLF	12,000	16,000	20.0	11.5	7-25/32"H x 27-9/16"W x 24-13/32"D
133352	ARU18RLF	18,000	21,600	19.7	11.3	7-25/32"H x 35-7/16"W x 24-13/32"D
133353	ARU24RLF	24,000	27,000	14.7	9.3	7-25/32"H x 43-5/16"W x 24-13/32"D

Multi Zone Mini-Split Systems

Compact Cassette Indoor Heat Pump

- 2-Stage Turbo Fan
- Condensate Pump
- High Ceiling Mode
- Remote Temperature Sensor
- Auto Changeover
- Auto Restart/Reset
- Quiet Mode
- Auto Louver: Up/ Down
- Dry Mode
- Sleep Timer



Required compact cassette grille UTG-CCGF sold separately

Part#	Mfg#	Nom Cool	Nom Heat	SEER	HSPF	Dimensions
167719	AUU7RLF	7,000	8,100	--	--	9-11/16"H x 22-7/16"W x 22-7/16"D
133346	AUU9RLF	9,000	10,200	17.0	9.8	9-11/16"H x 22-7/16"W x 22-7/16"D
133347	AUU12RLF	12,000	13,500	17.0	9.8	9-11/16"H x 22-7/16"W x 22-7/16"D
133348	AUU18RLF	18,000	20,000	17.0	9.8	9-11/16"H x 22-7/16"W x 22-7/16"D

Floor-Mounted Indoor Heat Pump

- Wireless Remote Control
- Apple Catechin Filter
- Ion Deodorizing Filter
- Sleep Timer
- 24-Hour Timer
- Auto Louver: Up/Down
- Auto Mode
- Minimum Heat Mode
- Economy Mode
- Auto Restart/Reset
- Auto Changeover
- Powerful Mode



Part#	Mfg#	Nom Cool	Nom Heat	SEER	HSPF	Dimensions
163993	AGU9RLF	9,000	12,000	26.0	12.6	23-5/8"H x 29-1/8"W x 7-7/8"D
163998	AGU12RLF	12,000	16,000	22.7	11.6	23-5/8"H x 29-1/8"W x 7-7/8"D
164004	AGU15RLF	14,200	18,000	20.3	11.2	23-5/8"H x 29-1/8"W x 7-7/8"D

Single Zone Mini-Split Systems

Single Zone Wall-Mounted Type Mini-Split Systems

RL2 Wall-Mounted Mini-Split System

- 115V
- Up to 16 SEER
- Inverter technology
- Quiet operation
- Wireless remote controller
- Washable panel filter
- Smart system: auto mode
- Humidity control



Indoor Unit: ASU*RL2
Outdoor Unit: AOU*RL2

Part #	Mfg #	Nom Cool	Nom Heat	HSPF	SEER	EER	Components	Price
154248	9RL2	9,000	12,000	9.0	16	10.8	ASU9RL2 In, AOU9RL2 Out	
154249	12RL2	12,000	14,000	9.0	16	10	ASU12RL2 In, AOU12RL2 Out	

RLS3Y Wall-Mounted High-SEER Mini Split System

- 208/230V
- Up to 33 SEER
- Energy saving program (ESP)
- Programmable remote
- Powerful heating
- World class performance
- Quiet operation
- Inverter technology
- Wi-Fi compatible



Indoor Unit: ASU*RLS3Y
Outdoor Unit: AOU*RLS3

Part #	Mfg #	Nom Cool	Nom Heat	HSPF	SEER	EER	Components	Price
231324	9RLS3Y	9,000	12,000	14.2	33.0	18.0	ASU9RLS3Y In, AOU9RLS3 Out	
230103	12RLS3Y	12,000	16,000	14.0	29.3	15.2	ASU12RLS3Y In, AOU12RLS3 Out	
230102	15RLS3Y	14,500	18,000	13.4	25.3	13.9	ASU15RLS3Y In, AOU15RLS3 Out	

Single Zone Mini-Split Systems

RLS3H Wall-Mounted High-Heat Mini Split System

- 208/230V
- Up to 33 SEER
- Powerful heating down to -15°F outdoor temperatures
- Base freeze prevention
- Energy saving program (ESP)
- Programmable remote
- World class performance
- Quiet operation
- Inverter technology
- Wi-Fi compatible



Indoor Unit: ASU*RLS3Y
Outdoor Unit: AOU*RLS3H

Part #	Mfg #	Nom Cool	Nom Heat	HSPF	SEER	EER	Components	Price
231325	9RLS3YH	9,000	12,000	14.0	33.0	18.0	ASU9RLS3Y In, AOU9RLS3H Out	
230101	12RLS3YH	12,000	16,000	13.8	29.3	15.2	ASU12RLS3Y In, AOU12RLS3H Out	
230100	15RLS3YH	14,500	18,000	13.3	25.3	13.9	ASU15RLS3Y In, AOU15RLS3H Out	

RLFW1 Wall-Mounted HFI Mini Split System

- 208/230V
- Up to 23 SEER
- Inverter technology
- ENERGY STAR® qualified
- Clean air
- Quiet operation
- Wireless remote controller
- Washable panel filter
- Smart system: auto mode
- Humidity control



Indoor Unit: ASU*RLF1
Outdoor Unit: AOU*RLFW1

Part #	Mfg #	Nom Cool	Nom Heat	HSPF	SEER	EER	Components	Price
163988	9RLFW1	9,000	12,000	11.0	23.0	13.8	ASU9RLF1 In, AOU9RLFW1 Out	
163992	12RLFW1	12,000	16,000	11.0	22.0	12.5	ASU12RLF1 In, AOU12RLFW1 Out	

Single Zone Mini-Split Systems

RLXFW1 Wall-Mounted High SEER Mini Split System

- 208/230V
- Up to 20 SEER
- Inverter technology
- ENERGY STAR® qualified
- Clean air
- Quiet operation
- Wireless remote controller
- Washable panel filter
- Smart system: auto mode
- Humidity control



Indoor Unit: ASU*RLF
Outdoor Unit: AOU*RLXFW1

Part #	Mfg #	Nom Cool	Nom Heat	HSPF	SEER	EER	Components	Price
230099	18RLXFW1	18,000	21,600	10.4	20.0	13.3	ASU18RLF In, AOU18RLXFW1 Out	
224795	24RLXFW1	22,000	25,200	10.6	19.5	12.5	ASU24RLF In, AOU24RLXFW1 Out	

RLXFWH Wall-Mounted High-Heat Mini Split System

- 208/230V
- Up to 20 SEER
- Inverter technology
- ENERGY STAR® qualified
- Clean air
- Quiet operation
- Wireless remote controller
- Washable panel filter
- Smart system: auto mode
- Humidity control



Indoor Unit: ASU*RLF
Outdoor Unit: AOU*RLXFWH

Part #	Mfg #	Nom Cool	Nom Heat	HSPF	SEER	EER	Components	Price
222876	18RLXFWH	18,000	21,600	10.4	20.0	13.3	ASU18RLF In, AOU18RLXFWH Out	
222879	24RLXFWH	22,000	25,200	10.5	19.5	12.5	ASU24RLF In, AOU24RLXFWH Out	

Single Zone Mini-Split Systems

RLXEH Wall-Mounted High-Heat Mini Split System

- 208/230V
- Up to 18.7 SEER
- Powerful heating down to -15°F outdoor temperatures
- Base freeze prevention
- Energy saving program (ESP)
- Programmable remote
- World class performance
- Quiet operation
- Inverter technology



Indoor Unit: ASU30RLE
Outdoor Unit: AOU30RLXEH

Part #	Mfg #	Nom Cool	Nom Heat	HSPF	SEER	EER	Components	Price
223027	30RLXEH	30,000	32,000	11.7	18.7	12.5	ASU30RLE In, AOU30RLXEH Out	

RLB/RLXB Wall-Mounted Mini Split System

- 208/230V
- Up to 19 SEER
- Inverter technology
- System 18RLB is ENERGY STAR® qualified
- Clean air
- Quiet operation
- Wireless remote controller
- Washable panel filter
- Smart system: auto mode
- Humidity control



Indoor Unit: ASU*RL(X)B
Outdoor Unit: AOU*RL(X)B

Part #	Mfg #	Nom Cool	Nom Heat	HSPF	SEER	EER	Components	Price
172857	18RLB	18,000	18,000	10.6	19.0	12.5	ASU18RLB In, AOU18RLB Out	
172860	24RLB	24,000	24,000	10.6	18.0	10.0	ASU24RLB In, AOU24RLB Out	
172863	30RLXB	30,000	30,000	9.0	16.5	9.5	ASU30RLXB In, AOU30RLXB Out	
172866	36RLXB	33,000	34,000	9.0	15.5	8.5	ASU36RLXB In, AOU36RLXB Out	

Single Zone Mini-Split Systems

Single Zone Floor/Ceiling Mount Type Multi-Split Systems

RULX Universal Floor/Ceiling-Mounted Mini Split System

- 208/230V
- Up to 16 SEER
- Can be mounted low on the wall or transverse mount the ceiling
- Inverter technology
- Wired remote controller UTY-RNBYU (optional)
- 4-Way auto louver for balanced comfort
- Smart system: auto mode
- Humidity control
- Fresh air intake



Indoor Unit: ABU*RULX
Outdoor Unit: AOU*RLX

Part #	Mfg #	Nom Cool	Nom Heat	HSPF	SEER	EER	Components	Price
185923	18RULX	17,800	21,500	8.5	16.0	10.9	ABU18RULX In, AOU18RLX Out	
100489	24RULX	22,200	24,000	8.5	15.0	9.9	ABU24RULX In, AOU24RLX Out	

RSLX Ceiling-Mount Mini Split System

- 208/230V
- Up to 14 SEER
- Inverter technology
- 4-Way auto louver for balanced comfort
- Smart system: auto mode
- Humidity control
- Fresh air intake
- Wired remote controller UTY-RNBYU (optional)



Indoor Unit: ABU36RSLX
Outdoor Unit: AOU36RLX

Part #	Mfg #	Nom Cool	Nom Heat	HSPF	SEER	EER	Components	Price
132106	36RSLX	34,100	36,500	8.5	14.0	8.1	ABU36RSLX In, AOU36RLX	

RLFF Floor-Mounted Mini Split System

- 208/230V
- Up to 26 SEER
- Compact size
- Energy efficient
- 2-Fan and wide airflow
- High performance heating
- Flexible and easy installation



Indoor Unit: AGU*RLF
Outdoor Unit: AOU*RLFF

Part #	Mfg #	Nom Cool	Nom Heat	HSPF	SEER	EER	Components	Price
163996	9RLFF	9,000	12,000	12.6	26.0	16.0	AGU9RLF In, AOU9RLFF Out	

Single Zone Mini-Split Systems

Single Zone Floor/Ceiling Mount Type Multi-Split Systems (Continued)

RLFF Floor-Mounted Mini Split System

Part #	Mfg #	Nom Cool	Nom Heat	HSPF	SEER	EER	Components	Price
164002	12RLFF	12,000	16,000	11.6	22.7	13.1	AGU12RLF In, AOU12RLFF Out	
164007	15RLFF	14,200	18,000	11.2	20.3	12.5	AGU15RLF In, AOU15RLFF Out	

RLFFH Floor-Mounted Mini Split System

- 208/230V
- Up to 26 SEER
- Compact size
- Energy efficient
- 2-Fan and wide airflow
- High performance heating
- Flexible and easy installation



Indoor Unit: AGU*RLF
Outdoor Unit: AOU*RLFFH

Part #	Mfg #	Nom Cool	Nom Heat	HSPF	SEER	EER	Components	Price
163997	9RLFFH	9,000	12,000	12.4	26.0	16.0	AGU9RLF In, AOU9RLFFH Out	
164003	12RLFFH	12,000	16,000	11.3	22.7	13.1	AGU12RLF In, AOU15RLFFH Out	
164008	15RLFFH	14,200	18,000	11.0	20.3	12.5	AGU15RLF In, AOU15RLFFH Out	

Single Zone Slim Duct Multi-Split Systems

RLFCF Slim Duct Mini Split System

- 208/230V
- Up to 21.5 SEER
- Inverter technology
- 4-Way auto louver for balanced comfort
- Smart system: auto mode
- Humidity control
- Fresh air intake
- Wired remote controller UTY-RNBYU (optional)



Indoor Unit: ARU*RLF
Outdoor Unit: AOU*RLFC

Part #	Mfg #	Nom Cool	Nom Heat	HSPF	SEER	EER	Components	Price
154772	9RLFCF	9,000	12,000	12.2	21.5	14.5	ARU9RLF In, AOU9RLFC Out	
154773	12RLFCF	12,000	16,000	11.5	20.0	12.8	ARU12RLF In, AOU12RLFC Out	
154774	18RLFCF	18,000	21,600	11.3	19.7	12.0	ARU18RLF In, AOU18RLFC Out	

Single Zone Mini-Split Systems

Single Zone Cassette Multi-Split Systems

RGLX Halcyon™ Single-Room Cassette Mini-Split System

- Better air distribution using 360-degree louvers
- High energy efficiency
- Individual louver control
- Quiet operation and 4 fan speed control
- Occupancy / human sensor setting (Optional)



Indoor Unit: AUU*RGLX
Outdoor Unit: AOU*RGLX

Part #	Mfg #	Nom Cool	Nom Heat	HSPF	SEER	EER	Components	Price
260076	18RGLX	18,000	21,000	10.9	19.0	13.4	AUU18RGLX In, AOU18RGLX Out	
260077	24RGLX	24,000	27,000	10.8	17.5	12.8	AUU24RGLX In, AOU24RGLX Out	
260078	30RGLX	30,000	32,000	10.4	16.5	11.7	AUU30RGLX In, AOU30RGLX Out	
260079	36RGLX	36,000	36,000	11.3	16.7	10.0	AUU36RGLX In, AOU36RGLX Out	
260080	42RGLX	42,000	47,000	10.5	17.8	11.3	AUU42RGLX In, AOU42RGLX Out	

RLFCC Compact Cassette Mini Split System

- 208/230V
- Up to 24 SEER
- Inverter technology
- High performance heating
- Cassette model fits into standard ceiling tile
- 2-Stage turbo fan
- Quiet operation
- Wired remote controller
- Smart system: auto mode
- Humidity control
- Fresh air intake



Indoor Unit: AUU*RLFCC
Outdoor Unit: AOU*RLFC

Part #	Mfg #	Nom Cool	Nom Heat	HSPF	SEER	EER	Components	Price
158386	9RLFCC	9,000	12,000	13.0	24.0	14.5	AUU9RLF In, AOU9RLFC Out	
158384	12RLFCC	12,000	16,000	12.2	21.9	12.8	AUU12RLF In, AOU12RLFC Out	
158383	18RLFCC	18,000	21,600	11.5	20.1	11.2	AUU18RLF In, AOU18RLFC Out	

Single Zone Mini-Split Systems

RCLX Cassette Mini Split System

- 208/230V
- Up to 16 SEER
- Inverter technology
- Swing louvers
- 4-Way airflow system
- Simple maintenance
- Wired remote controller
- Energy saver
- Smart system: auto mode
- Humidity control
- Fresh air intake



Indoor Unit: AUU*RCLX
Outdoor Unit: AOU*RCLX

Part #	Mfg #	Nom Cool	Nom Heat	HSPF	SEER	EER	Components	Price
103324	18RCLX	17,800	21,000	8.5	16.0	11.1	AUU18RCLX In, AOU18RCLX Out	
103323	24RCLX	22,200	24,200	8.5	15.0	10.6	AUU24RCLX In, AOU24RCLX Out	
111989	36RCLX	34,100	36,000	8.5	14.0	8.1	AUU36RCLX In, AOU36RCLX Out	
106078	42RCLX	42,700	45,200	8.5	15.0	9.2	AUU42RCLX In, AOU42RCLX Out	

Packaged Terminal Air Conditioners

Packaged Terminal Air Conditioners

- Quiet operation
- High energy efficiency
- Digital control display
- Gold Fin™ anti-corrosion
- Auto restart
- Energy saver mode
- Front desk control
- Freeze room protection
- Dip switch setting for temperature limiting
- Temperature display on unit
- Fresh air ventilation, 70 CFM at 0.3 ESP with open damper door
- Dimensions: 16"H x 42"W x 19-7/8"D
- 5-Year parts and labor warranty on sealed refrigerant system
- 1-Year full system warranty on parts and labor, 5-year parts warranty



R-410A Heat/Cool PTAC

Part #	Mfg #	Cooling Capacity BTUH	EER	Electric Heater (kW)	Air Circulation CFM, H/L	Dehumid (Pts/Hr)	Max Overcurrent Protection	Ship Wt	Price
141205	LP093CD3A	9,000/8,800	11.0	3.5/3.1	335/300	2.6	20	86.6 lbs	
141206	LP123CD3A	11,800/11,600	10.5	3.5/3.1	390/355	3.3	20	97.1 lbs	
141207	LP153CD3A	14,300/14,100	9.2	3.5/3.1	390/355	4.4	20	118.1 lbs	
141208	LP153CD5A	14,100/14,300	9.2	4.6/5.0	388/353	4.4	30	118.1 lbs	

R-410A Heat Pump PTAC

Part #	Mfg #	Cooling Capacity BTUH	EER	Heating Capacity BTUH	COP	Electric Heater (kW)	Air Circulation CFM, H/L	Dehumid (Pts/Hr)	Max Overcurrent Protection	Ship Wt	Price
141210	LP093HD3A	9,000/8,800	11.0	8,100/7,900	3.2	3.5/3.1	335/300	2.6	20	101 lbs	
141212	LP123HD3A	11,800/11,600	10.6	10,800/10,600	3.2	3.5/3.1	390/355	3.3	20	101 lbs	
141213	LP153HD3A	14,700/14,500	9.4	12,100/11,900	2.6	3.5/3.1	390/355	4.4	20	109 lbs	

PTAC Accessories

Grille



AYRGALA01



AYAGALA01A

Part #	Mfg #	Description	Price
141217	AYRGALA01	42" Large Stamp Grille	
144096	AYAGALA01 A	42" Aluminum Architectural Grille	

Packaged Terminal Air Conditioners

Sleeve



Part #	Mfg #	Description	Price
141216	AYSVB01A	42" Large Wall Sleeve	

PTAC Accessory Kit



Part #	Mfg #	Description	Price
145162	AYLD1A	Lateral Duct Kit	

Packaged Terminal Air Conditioners

PTAC Units

- Features:
 - Enhanced dehumidification to lengthen cooling cycles
 - Low temperature protection
 - Continuous fan operation or fan cycling governed by thermostat
 - Condensate dispersion
 - Filtered ventilation
 - Clearly labeled digital controls
 - Electronic temperature limiter with (4) pre-programmed temperature ranges
 - Random restart
- Units come with "Smart Controls" to add optional front desk control and remote thermostats
- 5-Year warranty on compressor, 1-year warranty on parts



Heat Pump with Electric Heat - R-410A

Part #	Mfg #	Voltage	BTUH	Heat	Price
133113	EKTH09-1G3KW	208/230V	9,000	3kW	
133108	EKTH12-1G	208/230V	12,000	No Heat	
133116	EKTH12-1G5KW	208/230V	12,000	5kW	
133109	EKTH15-1G	208/230V	15,000	No Heat	
133119	EKTH15-1G5KW	208/230V	15,000	5kW	

PTAC Accessories

Part #	Mfg #	Description	Price
133092	7602-501	42" Stamped Grille	
133090	7602-530A-230	5kW 30A 265V Power Cord for EKTC12-2G, EKTH12-2G, EKTC15-2G & EKTH15-2G	



Roof Top Units

Commercial Series™ Package Gas/Electric Units

R-410A High Efficiency Commercial Series™ Package Gas/Electric 3 to 5 Ton

- Scroll compressors with internal line break overload and high pressure protection
- Single stage compressor
- Convertible airflow
- TXV Refrigerant metering system on each circuit
- High pressure and low pressure/loss of charge protection
- Solid core liquid line filter-drier on each circuit
- Single slab, single pass designed evaporator and condenser coils
- Cooling operation up to 125°F ambient
- Foil faced insulation encapsulated throughout entire unit
- Cabinet features a durable powder-paint finish, steel coated on each side
- One-piece top cover and one-piece base pan with drawn supply and return opening for superior water management
- Externally mounted refrigerant gauge ports
- Forkable base rails
- Single point electrical and gas connections
- 1" Filter standard with slide out design, will accept 2" filter
- 1-Stage gas valve, direct spark ignition, and induced draft
- Tubular heat exchanger
- Solid state furnace control with on-board diagnostics
- Colored and labeled wiring
- Copper tube/aluminum fin indoor coil
- Direct drive or high performance belt drive motor with variable pitch pulleys and quick adjust belt system
- Energy Star® rated
- Drive package:
 - RKNL-XXXXXK: Direct drive
 - RKNL-XXXXXL: Belt drive
- 5-Year limited compressor warranty (commercial)
- 10-Year warranty on factory standard heat exchanger (commercial)
- 1-Year limited parts warranty (commercial)
- 20-Year warranty on stainless steel heat exchanger (commercial)



Part #	Mfg #	Tons	Gross Cooling BTUH	Heating Input BTUH	Electrical	Unit Dimensions H x W x D	Ship Wt	Price
239336	RKPN-A036CK12EAJA	3.0	36,800	120,000	208/230-1-60	35" x 75-17/32" x 46-1/2"	550 lbs	
174992	RKPN-A036JK08E	3.0	36,200	80,000	208/230-1-60	35" x 75-17/32" x 46-1/2"	516 lbs	
174995	RKPN-A036JK08EAJA	3.0	36,800	80,000	208/230-1-60	35" x 75-17/32" x 46-1/2"	550 lbs	
228850	RKPN-A036CK08EAJA	3.0	36,200	80,000	208/230-3-60	35" x 75-17/32" x 46-1/2"	516 lbs	
174996	RKPN-A048JK10EAJA	4.0	50,500	100,000	208/230-1-60	35" x 75-17/32" x 46-1/2"	587 lbs	
228851	RKPN-A048CK10EAJA	4.0	48,000	100,000	208/230-3-60	35" x 75-17/32" x 46-1/2"	545 lbs	
163392	RKPN-A060JK13E-AHF	4.0	59,000	135,000	208/230-3-60	35" x 75-17/32" x 46-1/2"	562 lbs	
247089	RKPN-A060CK10E	5.0	60,000	100,000	208/230-3-60	35" x 75-17/32" x 46-1/2"	559 lbs	
228852	RKPN-A060CK13EAJA	5.0	60,000	135,000	208/230-3-60	35" x 75-17/32" x 46-1/2"	562 lbs	
174997	RKPN-A060JK13EAJA	5.0	61,500	135,000	208/230-1-60	35" x 75-17/32" x 46-1/2"	604 lbs	
228853	RKPN-A060DL13EAJA	5.0	60,000	135,000	460-3-60	35" x 75-17/32" x 46-1/2"	576 lbs	

• Serving our Customers Since 1946 • www.plumbsupply.com



Roof Top Units

Commercial Series™ Package Gas/Electric Units (Continued)

R-410A High Efficiency Commercial Series™ Package Gas/Electric 3 to 5 Ton

Part #	Mfg #	Tons	Gross Cooling BTUH	Heating Input BTUH	Electrical	Unit Dimensions H x W x D	Ship Wt	Price
162127	RKNN-A048CK10EAJA	4.0	50,500	100,000	208/230-3-60	35" x 75-17/32" x 46-1/2"	587 lbs	
162131	RKNN-A060CK10E	5.0	61,500	100,000	208/230-3-60	35" x 75-17/32" x 46-1/2"	597 lbs	



Roof Top Units

13 SEER R-410A High Efficiency Commercial Series™ Package Gas/Electric Rooftop - RKNL-B 6 to 12.5 Ton

- Scroll compressors with internal line break overload and high pressure protection
- Single stage compressor on 6 ton models, dual stage compressor on 7.5 to 12.5 models
- Convertible airflow
- TXV Refrigerant metering system on each circuit except 6 ton model
- High pressure and low pressure/loss of charge protection
- Solid core liquid line filter-drier on each circuit
- Single slab, single pass designed evaporator and condenser coils
- Cooling operation up to 125°F ambient
- Foil faced insulation encapsulated throughout entire unit
- Cabinet features a durable powder-paint finish, steel coated on each side
- Slide out indoor fan assembly
- One-piece top cover and one-piece base pan with drawn supply and return opening for superior water management
- Forkable base rails
- Single point electrical and gas connections
- Internally sloped slide out condensate pan conforms to ASHRAE 62 standard
- 2" Filter standard with slide out design
- 2-Stage gas valve, direct spark ignition, and induced draft
- Tubular heat exchanger
- Solid state furnace control with on-board diagnostics
- Colored and labeled wiring
- Copper tube/aluminum fin indoor coil (12-1/2 ton uses Micro-Channel condenser)
- High performance belt drive motor with variable pitch pulleys and quick adjust belt system
- Electronic ignition
- Energy Star® rated
- Drive package:
 - RKNL-XXXXXL: Belt drive
 - RKNL-XXXXXM: Belt drive high static
- 5-Year limited compressor warranty (commercial)
- 10-Year on factory standard heat exchanger (commercial)
- 1-Year limited parts warranty (commercial)
- 1-Year limited on condenser coil and evaporator coil leaks caused by factory defects (commercial)



Part #	Mfg #	Tons	Gross Cooling BTUH	Heating Input BTUH	Electrical	Unit Dimensions H x W x D	Ship Wt	Price
116742	RKNL-A048JK13E	4.0	50,500	135,000	208/230-1-60	35" x 75-17/32" x 46-1/2"	592 lbs	
167072	RKNL-B090CL15E	7.5	93,000	150,000	208/230-3-60	40-3/16" x 93-11/16" x 58-3/4"	1,054 lbs	
158370	RKNL-B090CM15EAJA	7.5	93,000	150,000	208/230-3-60	40-3/16" x 93-11/16" x 58-3/4"	1,054 lbs	
159031	RKNL-B090DL15EAJA	7.5	93,000	150,000	460-3-60	40-3/16 x 93-11/16" x 58-3/4"	1,062 lbs	
158371	RKNL-B090CM22EAJA	7.5	93,000	225,000	208/230-3-60	40-3/16 " x 93-11/16" x 58-3/4"	1,090 lbs	
147988	RKNL-B090CM22EJBA	7.5	93,000	225,000	208/230-3-60	44" x 93-11/16" x 58-3/4"	1,090 lbs	
158372	RKNL-B120CL22EAJA	8.5	101,000	225,000	208/230-3-60	40-3/16 " x 93-11/16" x 58-3/4"	1,132 lbs	
159033	RKNL-B151DL25EAJA	12.5	146,000	252,000	460-3-60	40-3/16 " x 93-11/16" x 58-3/4"	1,267 lbs	

• Serving our Customers Since 1946 • www.plumbsupply.com



Roof Top Units

Commercial Series™ Package Gas/Electric Units (Continued)

13 SEER R-410A High Efficiency Commercial Series™ Package Gas/Electric Rooftop - RKNL-B 6 to 12.5 Ton

Part #	Mfg #	Tons	Gross Cooling BTUH	Heating Input BTUH	Electrical	Unit Dimensions H x W x D	Ship Wt	Price
150303	RKNL-G090CT22EDPH	7.5	93,000	225,000	208/230-3-60	44" x 93-11/16" x 58-3/4"	1,137 lbs	

11.2 SEER R-410A Standard Efficiency Commercial Series™ Package Gas/Electric Rooftop - RKKL-B 7.5 to 12.5 Ton

- Scroll compressors with internal line break overload and high pressure protection
- 1-Stage compressor on 7.5 and 10 ton models, 2-Stage compressor on 12.5 ton model
- Convertible airflow
- Fixed restriction refrigerant flow control on 7.5 and 10 ton models, TXV on 12.5 ton model
- High pressure and low pressure/loss of charge protection
- Solid core liquid line filter-drier on each circuit
- Single slab, single pass designed evaporator and condenser coils
- Cooling operation up to 125°F ambient
- Foil faced insulation encapsulated throughout entire unit
- Cabinet features a durable powder-paint finish, steel coated on each side
- One-piece top cover indoor section and one-piece base pan
- Forkable base rails
- Single point electrical and gas connections
- 2" Filter standard with slide out design
- 2-Stage gas valve, direct spark ignition, and induced draft
- Tubular heat exchanger
- Solid state furnace control with on-board diagnostics
- Colored and labeled wiring
- Copper tube/aluminum fin indoor coil
- Aluminum Micro-Channel outdoor coil(s)
- High performance belt drive motor with variable pitch pulleys and quick adjust belt system
- Electronic ignition
- Drive package:
 - RKKL-XXXXXL: Belt drive
- 5-Year limited compressor warranty (commercial)
- 10-Year warranty on factory standard heat exchanger (commercial)
- 1-Year limited parts warranty (commercial)
- 1-Year limited warranty on condenser coil and evaporator coil leaks caused by factory defects (commercial)



Part #	Mfg #	Tons	Gross Cooling BTUH	Heating Input BTUH	Electrical	Unit Dimensions H x W x D	Ship Wt	Price
136399	RKKL-B090CL15E	7.5	87,000	150,000	208/230-3-60	44" x 93-11/16" x 58-3/4"	919 lbs	
142306	RKKL-B090CL22E	7.5	87,000	225,000	208/230-3-60	44" x 93-11/16" x 58-3/4"	955 lbs	
140163	RKKL-B120CL22E	10.0	123,000	225,000	208/230-3-60	44" x 93-11/16" x 58-3/4"	1,057 lbs	

www.plumbsupply.com • Serving our Customers Since 1946 •



Roof Top Units

Commercial Series™ Package Gas/Electric Units (Continued)

11.2 SEER R-410A Standard Efficiency Commercial Series™ Package Gas/Electric Rooftop - RKKL-B 7.5 to 12.5 Ton

Part #	Mfg #	Tons	Gross Cooling BTUH	Heating Input BTUH	Electrical	Unit Dimensions H x W x D	Ship Wt	Price
140164	RKKL-B151CL25E	12.5	156,000	252,000	208/230-3-60	44" x 93-11/16" x 58-3/4"	1,303 lbs	
167075	RKKL-B151DL25E	12.5	156,000	252,000	460-3-60	44" x 93-11/16" x 58-3/4"	1,303 lbs	

Commercial Renaissance Line Package Gas Electric Units

- Factory charged with R-410A HFC refrigerant
- Wired and run tested
- Scroll compressors with internal line break overload and high pressure protection
- Model RGEDZR has a single-stage compressor
- Models RGEDZS and RGEDZT have two-stage compressor
- Convertible airflow – vertical down flow or horizontal side flow
- Forkable base rails for easy handling and lifting
- Cooling operation up to 125°F ambient
- Two-stage gas heat input with direct spark ignition system, solid state furnace controls, and optimized induced draft combustion
- MicroChannel evaporator and condenser coil
- PlusOne® ServiceSmart package includes:
Qwik-Change Flex-Fit Rack™
Qwik-Slide Blower Assembly™
Qwik-Clean Drain Pan™
- Over-flow condensate sensor
- PlusOne® Diagnostics with Dual 7-Segment LED Display to meet code compliance
- One-piece top cover and base pan with drawn supply and return opening
- Two-piece control door
- ¼ turn fasteners on filter access door
- Color-coded and labeled wiring
- External lockable gauge ports
- TXV refrigerant metering system
- Solid-core liquid line filter drier
- High pressure and low pressure/loss of charge protection with built-in Smart Logic
- Insulation encapsulated throughout entire unit
- High performance belt drive motor with variable pitch pulleys and quick adjust belt system
- Variable Frequency Drive (VFD) blower is standard on Model RGEDZT and optional on model RGEDZS
- New product footprint with matching connections
- Improved factory lead times



Part #	Mfg #	Tons	Gross Cooling BTUH	Heating Input BTUH	Electrical	Unit Dimensions H x W x D	Ship Wt	Price
245915	RGEDZS090ACB15BAAAA 0	7.5	80,000	150,000	208/230-3-60	50" x 89" x 57-7/8"	878 lbs	
245916	RGEDZS090ACB20BAAAA 0	7.5	80,000	205,000	208/230-3-60	50" x 89" x 57-7/8"	878 lbs	

• Serving our Customers Since 1946 • www.plumbsupply.com



Roof Top Units

Commercial Series™ Package Gas/Electric Units (Continued)

Commercial Renaissance Line Package Gas Electric Units

Part #	Mfg #	Tons	Gross Cooling BTUH	Heating Input BTUH	Electrical	Unit Dimensions H x W x D	Ship Wt	Price
249790	RGEDZS102ACB22BAAAA 0	8.5	99,000	225,000	208/230-3-60	50" x 89" x 57-7/8"	907 lbs	
245917	RGEDZS120ACB22BAAAA 0	10	118,000	225,000	208/230-3-60	50" x 89" x 57-7/8"	935 lbs	
249462	RGEDZS120ADA152AAAA 0	10	118,000	150,000	460-3-60	50" x 89" x 57-7/8"	935 lbs	
245918	RGEDZS150ACA22BAAAA 0	12.5	148,000	225,000	208/230-3-60	60" x 89" x 57-7/8"	1133 lbs	

Parts & Accessories

Part #	Mfg #	Description	Price
245921	RXKG-DDD14	14" Curb	
245922	RXRX-DDCAE	Roof Curb Adapter	

Manual Rooftop Fresh Air Damper

- 25% Manual
- Includes parts:
 - Outside air panel (1)
 - Manual hood (2)
 - Base support (3)
 - Relief blade (4)
 - Latch (5)
 - Gasket
 - Hardware bag

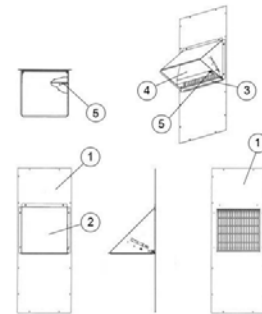

Part #	Mfg #	Description	Price
245920	RXRF-ADA1	Manual Rooftop Fresh Air Damper	



Roof Top Units

MicroMetl Modulating Economizer Assembly

- Fully modulating with single enthalpy
- Includes parts:
 - Sensor-Temperature & humidity (2)
 - Actuator (3)
 - Actuator mount (4)
 - Drive pin, 1/2" x 3/8" x 4-1/4"
 - Hood hardware bag
 - Left hood side
 - Right hood side
 - Hood divider
 - Relief damper assembly
 - Front support bracket
 - Two filters
 - Wiring harness

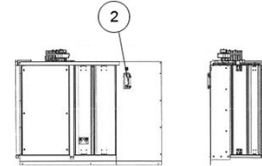
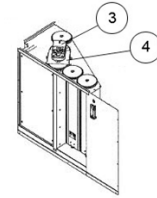

Part #	Mfg #	Description	Price
245919	RXRD-01MDHAM	7.5-12.5T Modulating Economizer	

Outdoor Coil Louver

- Includes parts:
 - Sixteen screws
 - Granite/steel gray tall cabinet
 - Two Louver panels (43.193W x 55.284H)

Part #	Mfg #	Description	Price
245923	RXRX-ADD04B	Outdoor Coil Louver	
242561	RXRX-ADD04A	Outdoor Coil Louver	



Roof Top Units

Roof Top Unit Accessories

RXKG/RXRG/RXRK/RXSG/RRX - Roof Curb

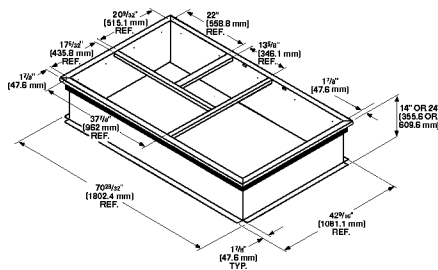

RXKG-CAD14/24

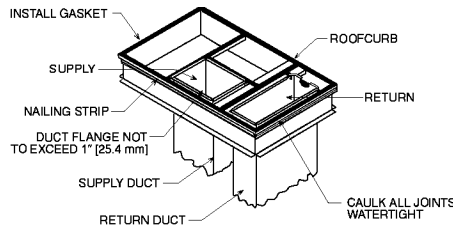

RXKG-CAE14/24

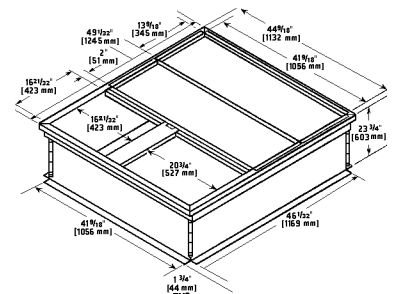

RXSG-AAA2

Part #	Mfg #	Description	Price
036937	RXKG-CAD14	14" 3.0-25.0 Ton	
039546	RXKG-CAE14	14"	
025599	RXSG-AAA14	14" 1.5-4 Ton Pkg Units	

RXRD/RXRE/RXRQ/RXRR - Economizer

Part #	Mfg #	Description	Price
036606	RXRD-CAM10	Fully Modulating Economizer (Downflow Only)	
079102	RXRD-NDCM3	7.5 - 15 Ton Horizontal Economizer	
127255	RXRD-PDCM3	RSI Vertical	
242562	RXRD-01MDDAM3	7.5-12.5T DN	

RXRX - Roof Curb Adapter

Part #	Mfg #	Description	Price
080466	RXRX-BBCDB21	For 3-6 Ton Commercial Units	
035021	RXRX-BBCDB23	For 3-6 Ton Commercial Units	

Economizer

Part #	Mfg #	Description	Price
149611	AXRD-NDCM3	Economizer with Single Enthalpy	
149613	AXRD-PDCM3	Downflow Economizer with Single Enthalpy	
149614	AXRD-RDCM3	Horizontal Economizer with Single Enthalpy	
164772	AXRD-01RECAM	Downflow/Horizontal Economizer with Single Enthalpy	
147992	AXRD-SDCM3	Downflow Economizer with Single Enthalpy and Smoke Detector	
177450	AXRD-01RDDBM3	Downflow 6-12.5T Economizer with Eco Smoke Detector, Gray	
172043	AXRD-01RDDAM3	Downflow Economizer with Single Enthalpy, Gray	
165873	AXRF-JDA1	Fresh Air Damper, Manual	
149628	AXRF-FBA1	Fresh Air Damper, Manual 17"Lx17"Wx21"H	

Louver Panel Kits

Part #	Mfg #	Description	Price
147993	AXRX-AAD01C	For 6-12.5 Ton Package Units, Grey	



Roof Top Units

Roof Top Unit Accessories (Continued)

Louver Panel Kits

Part #	Mfg #	Description	Price
149483	AXRX-AAD01B	For 6-12.5 Ton Package Units, Green	

VRF Equipment

Mini-Split VRF Air Conditioner Systems

- All systems use R-410A refrigerant
- 6-Year compressor warranty
- 2-Year parts warranty



Airstage™ Outdoor Air Unit

- Top class lightweight compact design
- Flexible duct design using a DC motor
- Provides air condition and ventilation air at the same time
- Various controllers—individual & central controllers



Part #	Mfg #	Nom Cool BTUH	Nom Heating BTUH	Electrical	Dimensions	Price
240707	AAUA72TLAV	72,000	47,000	208/230-1-60	16-3/4" x 53-13/16" x 22-1/2"	

21.7 IEER AIRSTAGE® V-II Series Commercial Multi Air Conditioning System

- Allow control of the air conditioning in each room individually
- Round corner type high density multi-path heat exchanger
- Sine wave DC inverter control
- Centralized remote control system



Part #	Mfg #	Nom Cool BTUH	Nom Heating BTUH	Electrical	Dimensions	Price
147753	AQUA72RLBV	72,000	81,000	208/230-3-60	66.54"H x 36.61"W x 30.12"D	
147755	AQUA96RLBV	96,000	108,000	208/230-3-60	66.54"H x 36.61"W x 30.12"D	
167174	AQUA72TLBV	72,000	81,000	208/230-3-60	66.54"H x 36.61"W x 30.12"D	
167176	AQUA96TLBV	96,000	108,000	208/230-3-60	66.54"H x 36.61"W x 30.12"D	
173046	AQUA120TLB V	120,000	135,000	208/230-3-60	66.54"H x 48.82"W x 30.12"D	

Vertical Air Handler

- Selectable capacities from 1 to 5 tons
- Broad static pressure range for a wide range of applications
- Durable power-coated thick steel gauge cabinet
- Acoustical and thermal insulation is upgraded from 1/2" to 1" thick to reduce heat loss
- Equipped with standard MERV 3 filter
- Easily retrofitted into existing installations



Part #	Mfg #	Nom Cool BTUH	Nom Heating BTUH	Electrical	Dimensions	Price
185656	ARUV12TLAV	12,000	13,500	208/230-3-60	51"Hx17-11/16"Wx23-13/16"D	
185658	ARUV18TLAV	18,000	20,000	208/230-3-60	51"Hx17-11/16"Wx23-13/16"D	
185659	ARUV24TLAV	24,000	27,000	208/230-3-60	51"Hx17-11/16"Wx23-13/16"D	

VRF Equipment

Mini-Split VRF Air Conditioner Systems (Continued)

Vertical Air Handler

Part #	Mfg #	Nom Cool BTUH	Nom Heating BTUH	Electrical	Dimensions	Price
185660	ARUV30TLAV	30,000	24,000	208/230-3-60	51"Hx22-3/16"Wx23-13/16"D	

Indoor Slim Duct Air Handler Unit



Part #	Mfg #	Nom Cool BTUH	Type	Price
147768	ARUL7RLAV	7,000	Slim Duct, Heat Pump	
147769	ARUL9RLAV	9,000	Slim Duct, Heat Pump	
147770	ARUL12RLAV	12,000	Slim Duct, Heat Pump	
147772	ARUL18RLAV	18,000	Slim Duct, Heat Pump	
147773	ARUL24RLAV	24,000	Slim Duct, Heat Pump	
173049	ARUL18TLAV	18,000	Slim Duct, Heat Recovery	

Duct Air Handler Unit

- Slim and compact design
- Easy maintenance
- Easy installation
- Two-direction drain piping



Part #	Mfg #	Nom Cool BTUH	Type	Price
147774	ARUM30RLAV	30,000	Duct, Heat Pump	
173071	ARUM24TLAV	24,000	Duct, Heat Recovery	
173050	ARUM30TLAV	30,000	Duct, Heat Recovery	
173051	ARUM36TLAV	36,000	Duct, Heat Recovery	

Indoor Wall-Mounted Air Handler Unit



Part #	Mfg #	Nom Cool BTUH	Type	Price
147785	ASUA7RLAV	7,000	Compact Wall-Mounted, Heat Pump	
147786	ASUA9RLAV	9,000	Compact Wall-Mounted, Heat Pump	
147787	ASUA12RLAV	12,000	Compact Wall-Mounted, Heat Pump	
174051	ASUA9TLAV	9,000	Compact Wall-Mounted, Heat Recovery	
181051	ASUA12TLAV	12,000	Compact Wall-Mounted, Heat Recovery	
181053	ASUA14TLAV	14,000	Compact Wall-Mounted, Heat Recovery	
181054	ASUB18TLAV	18,000	Wall-Mounted, Heat Recovery	
181047	ASUB24TLAV	24,000	Wall-Mounted, Heat Recovery	
147789	ASUB18RLAV	18,000	Wall-Mounted, Heat Pump	
147790	ASUB24RLAV	24,000	Wall-Mounted, Heat Pump	

VRF Equipment

Indoor Ceiling Cassette Air Handler Unit



Part #	Mfg #	Nom Cool BTUH	Type	Price
147756	AUUA7RLAV	7,000	Compact Ceiling Cassette, Heat Pump	
147758	AUUA9RLAV	9,000	Compact Ceiling Cassette, Heat Pump	
147759	AUUA12RLAV	12,000	Compact Ceiling Cassette, Heat Pump	
147760	AUUA14RLAV	14,000	Compact Ceiling Cassette, Heat Pump	
147761	AUUA18RLAV	18,000	Compact Ceiling Cassette, Heat Pump	
147762	AUUA24RLAV	24,000	Compact Ceiling Cassette, Heat Pump	
173047	AUUA7TLAV	7,000	Compact Ceiling Cassette, Heat Recovery	
173048	AUUA12TLAV	12,000	Compact Ceiling Cassette, Heat Recovery	
181048	AUUA24TLAV	24,000	Compact Ceiling Cassette, Heat Recovery	
147766	AUUB30RLAV	30,000	Ceiling Cassette, Heat Pump	

Indoor High Static Pressure Duct Air Handler Unit



Part #	Mfg #	Nom Cool BTUH	Type	Price
173072	ARUH36TLAV	36,000	High Static Pressure Duct, Heat Recovery	
173052	ARUH48TLAV	48,000	High Static Pressure Duct, Heat Recovery	
173054	ARUH60TLAV	60,000	High Static Pressure Duct, Heat Recovery	
181055	ARUH96TLAV	96,000	High Static Pressure Duct, Heat Recovery	

Mini-Split VRF System Remotes

UTY-RNKU Wired Remote Control for VRF Units



Part #	Mfg #	Description	Price
147803	UTY-RNKU	VRF Wired Remote Control	
166394	UTY-RNRU	VRF Individual Touch Panel Controller Wired Remote	
147806	UTY-DCGY	VRF Central Remote Control	
147802	UTY-LNHU	VRF Wireless Remote Control	
181050	UTY-PLGXR1	VRF Centralized Remote Control option for UTY-ALGX Software	
147804	UTY-RSKU	VRF Simple Remote Control	

VRF Equipment

Mini-Split VRF System Parts & Accessories

Part #	Mfg #	Description	Price
147821	UTB-YWC VRF	IR Receiver for Duct	
133356	UTP-SX248A	Separation Tube	
147827	UTR-BP090X	VRF Indoor Separation Tube	
147826	UTR-BP180X	VRF Indoor Separation Tube	
147825	UTR-BP567X	VRF Indoor Separation Tube	
147828	UTR-CP567X	VRF Outdoor Separation Tube	
147757	UTG-CCGV	Compact Cassette Grille for Airstage V-II Units	
147763	UTG-LCGV	Cassette Grille for Airstage V-II Units	
223399	UTP-AX180A	WRF Indoor SEP Tub	
173055	UTP-BX090A	Ind Separation Tube 90 or less MBU Capacity	
173056	UTP-BX180A	Ind Separation Tube 90-180 MBU Capacity	
173057	UTP-BX567A	Ind Separation Tube 180 or more MBU Capacity	
173058	UTP-DX567A	Outdoor Unit Branch Kit	
173059	UTP-RU01AH	Refrigeration Branch Unit - Single Type 20k or Less	
173060	UTP-RU01BH	Refrigeration Branch Unit - Single Type 60k or Less	
181056	UTP-RU01CH	Refrigeration Branch Unit - Single Type 96k or Less	
173061	UTP-RU04BH	Refrigeration Branch Unit - Multi Type 191k or less	
147829	UTR-H0906L	VRF Header (6) Straight Connects	
147830	UTR-H1806L	VRF Header (6) "L" Connects	
147831	UTR-H0908L	VRF Header (8) Straight Connects	
147832	UTR-H1808L	VRF Header (8) "L" Connects	
181049	UTY-ALGX	VRF System Controller Lite Software	
147818	UTY-ABGX	VRF BACnet® Gateway Software	
147823	UTY-ASGX	VRF Service Tool (Software)	
185661	UTY-VSGXZ1	VRF Signal Amplifier	
133361	UTY-XCBXZ1	HFI Interface Kit	
147844	UTZ-PX1NBA	Drain Pump Unit (Duct Type)	
147847	UTZ-KXGC	Insulation Kit for High Humidity	
190428	K00500LW	500' Reel VRF Fujitsu Cable	
190429	K00250LW	250' Reel VRF Fujitsu Cable	



Brass Sealing Caps

Sealing Caps

Brass Sealing Cap - Hex Head Flare Fitting



Part #	Mfg #	Size	Qty	Price
140748	82-A04544	1/4"	50	
140749	82-A04545	3/8"	25	

Brass Sealing Cap - Serrated Head Flare Fitting

Part #	Mfg #	Size	Price
140746	82-A16447	1/4"	

Protective Cap - Brass w/o Core Removal Tool

Part #	Mfg #	Description	Price
126195	83-CD2245-6PK	Protective Cap - Brass w/o Core Removal Tool 6/Pk	

Chemicals

Cleaners

Evap Foam® Coil Cleaner

- High performance detergent with special surfactant's and alkaline cleaners, foaming
- "No rinse required" condenser coil cleaner
- Spray right side up or upside down
- For cooling or evaporator coils



Part #	Mfg #	Description	Price
139433	4171-75	18 oz Aerosol	

Evap Fresh® Coil Cleaner

- Ready-to-use, non-abrasive, one-step cleaner and disinfectant



Part #	Mfg #	Description	Price
199891	4166-75	18 oz Can	

Nu-Brite® Coil Cleaner

- Foaming coil cleaner
- Brightens as it cleans
- Safer than acids
- Biodegradable, USDA approved



4291-18



4291-08

Part #	Mfg #	Description	Price
139431	4291-18	18 oz Aerosol	
139434	4291-08	1 gal	

Foam-Brite® Coil Cleaner

- Non-acidic, alkaline-based cleaner
- Biodegradable ingredients
- High foaming formula



Part #	Mfg #	Description	Price
199978	4178-08	1 gal	

Green Clean® Coil Cleaner

- Powerful environmentally friendly formula for all purpose cleaning
- Product can be used direct from bottle or diluted to match duty of the job
- Safe and non-flammable
- Green Clean is biodegradable
- Approved by the EPA Safer Choice Program
- Use it everywhere



Part #	Mfg #	Description	Price
215601	4186-08	1 gal	

Nu-Solve NR Coil Cleaner

- Ready-to-use, non-rinse condenser coil cleaner
- Non-foaming, detergent based formula for emulsifying grime
- Formulated where water availability for rinsing the coil is problematic or solvent based aerosols are not desired
- For situations when its desirable to have less diluted cleaner on the roof
- Plastic, metal and rubber safe



Part #	Mfg #	Description	Price
189893	4295-08	1 gal	

Pan-Treat

- Condensate tablets control odors can prevent overflows by plugged condensate drain lines
- Non-corrosive, non-toxic, and biodegradable
- Completely soluble in water



Part #	Mfg #	Description	Price
199892	4296-60	1 bottle (200 tablets)	

Nu-Blast® Coil Cleaner

- "No rinse required" condenser coil cleaner
- High pressure blast plus solvent cleaning



Part #	Mfg #	Description	Price
139432	4290-75	18 oz Aerosol	

Chemicals

BlackHawk Foam Coil Cleaner

- HVAC/R applications
- Expanding foam
- Heavy-duty formula
- Safe and problem-free in food processing areas



Part #	Mfg #	Description	Price
189894	4127-75	18 oz Can	

Calci-Solve Cleaner

- Removes scale and rust from:
 - A/C equipment
 - Air compressor jackets
 - Pasteurizers and tanks
 - Dish washing machines
 - Water sealed blowers
 - Refrigerator drains
 - Calendar machines
 - Blue print drains
 - Boilers
 - Air filters
 - Condensers
 - Siphon pipes
 - Water piping
 - Water pumps



Part #	Mfg #	Description	Price
218244	4134-24	1 Quart Bottle	

Complete Care Mini-Split Kit

- Contains one 18 oz can of Evap-Fresh™ No Rinse Evaporator Coil Cleaner & Disinfectant (#4166-75) and one PurCool® Green Mini Strip (#61044)



Part #	Mfg #	Description	Price
186994	4151-08	Mini-Split Cleaner Kit	

Coil Gun

- Quick connect feature
- Fix mix ration settings 3:1, 4:1, 6:1, 9:1, & 10:1
- 2-Quart capacity
- Foam wand to enhance foaming
- Deflector tip to fan out spray
- Connects to optional coil gun probe accessory (4774-1) for 90° direction of spray inside the coil



Part #	Mfg #	Description	Price
199887	4774-0	Coil Gun Sprayer	

A/C Drain Sucker

- Kit Includes:
 - Drain Sucker Pump & Hoses
 - PurCool Green 3 Ton Tablet (#61048)
 - All Fittings for Suction or Pressure Applications



Part #	Mfg #	Description	Price
189898	61308	A/C Drain Sucker	

Rx-Acid Scavenger®

- Neutralizes or "scavenges" acid in refrigeration, air conditioning systems
- Use after burnouts or normal maintenance
- Normal dosage is 2 fl oz/gallon of system oil



Part #	Mfg #	Description	Price
140754	4301-02	2 oz Liquid, Boxed	

Rx11-Flush®

- Ozone-safe solvent for flushing refrigeration and air conditioning systems/line sets
- Rinses away particulate, sludge, carbon residues, acids, oils and water



Part #	Mfg #	Description	Price
201260	4300-08	1 lb. can, hose, gun, valve	
114154	4300-09	1 lb Canister	

Chemicals

Rx11-Flush® (Continued)

Part #	Mfg #	Description	Price
114155	4300-11	2 lb Canister	
210232	4300-30	19.5 fl oz, Unpressurized	
114158	4300-50	Flushing Tool	
199968	4300-51	Rx11 Flush Gun	
139863	4300-89	Injection Valve	

Lubricants

A/C Re-New Lubricant

- Enhances the lubricity and thermal properties of the refrigeration oil when introduced to an a/c or refrigeration system
- Reduces energy consumption
- Improves heat transfer in evaporator and condenser by improving oil return



Part #	Mfg #	Description	Price
170384	4057-55	4 oz liquid	

A/C Re-New Injector Tool

- Designed to inject A/C Re-New into A/C and refrigeration systems
- 4 fl. oz capacity
- Can be used for other injectable products as well
- Rugged aluminum
- Max working pressure: 600 psi



Part #	Mfg #	Description	Price
170385	4057-99	4 fl. oz capacity	

Penetrate HD® Lubricant

- Super penetrating lubricant
- Loosens rusted and frozen metal parts
- Frees stuck fan blades, blower shafts, pulleys, rusted nuts and bolts, etc.
- Saves time and labor
- Lubricates and protects metals
- Dielectric strength to 40,000 volts, Low VOC formula 31,000 volts
- Part numbers 61107 and 61108 meet or exceed California VOC limits
- Can be used with Talon Aerosol Wand (4776-0)



Part #	Mfg #	Description	Price
189895	61105	12 oz Can	

Leak Detection

Leak Sealant

Cal-Blue Leak Detector

- Freeze-protection 5°F up to 225°F



Part #	Mfg #	Description	Price
194279	4182-24	1 Quart Spray Bottle	

Pipe-Dri Pipe Insulation Spray

- Refrigeration Lines
- Air Conditioning Lines
- Cold Water Lines
- Other Cold Surfaces



Part #	Mfg #	Description	Price
210407	4297-75	18 oz Aerosol Can	

A/C EasySeal

- Prevents refrigerant leaks and seals existing leaks in air conditioning and refrigeration systems
- Eliminates expensive leak search and repair
- Travels with refrigerant to find leaks fast



Part #	Mfg #	Description	Price
133636	4050-06	EasySeal - 2.5 oz. pressurized can	
213682	4050-01	EasySeal-SS - 1.23 oz. pressurized can	
199897	4050-02	EasySeal 2+1 Display Pack	

Gas Leak Detector

- Fluorescent spray bottle
- Non-corrosive to metal
- Freeze-protected and safe for use on all refrigerants, natural gas, and oxygen



Part #	Mfg #	Description	Price
167286	4184-24	1 Quart Spray Bottle	

A/C EasySeal Direct Inject 1.5 to 5 Tons

- Easiest sealant to install
- Permanent seal
- Works with all refrigerants
- Professional use only
- Super concentrate



Part #	Mfg #	Description	Price
177997	4050-08	Treats Systems 1.5 to 5 Tons 18,000 BTUs or larger	

A/C EasyDry

- Eliminates moisture in residential and commercial systems
- Treats up to 5 ton systems
- Compatible with all oils and refrigerants
- Compliments the system's drier
- Prevents acid from forming



Part #	Mfg #	Description	Price
204211	4051-06	3 oz Pressurized Can	

Chemicals

Cleaners

Evaporator Coil Cleaner



Pro-Treat® 152 King-Size Premium Condensate Drain Pan Treatment

- Economical, safe, effective king-size tablets last three times longer
- Safe, non-corrosive, odor-free and 100% soluble
- Computer room approved
- Keeps drain pans and condensate lines clean and free flowing
- Dosage: 1 tablet per 3 tons per 3 months



Part #	Mfg #	Description	Price
092115	85-C02	Aerosol Evaporator Coil Cleaner	

Enviro-Coil Cleaner

- Cleans evaporator and condenser coils
- No foaming action, only attacks dirt buildup
- Environmentally safe
- No rinsing required on evaporator coils
- (4) Containers per case
- USDA Accepted



Part #	Mfg #	Description	Price
141525	85-H-EC01	1 gal Enviro-Coil Cleaner	

Cal-Brite Coil Cleaner

- Low pH cleaner for cleaning evaporator coils, air-cooled condensers, and other finned cooling and heating coils
- Based upon glycolic acid and other ingredients, including Mepol®
- Provides moderate foaming and brightening
- Safe for indoor and outdoor use



Part #	Mfg #	Description	Price
176312	4133-08	1 Gal, 3:1 Concentration	



Part #	Mfg #	Description	Price
149945	853002	(12) Tablets per Jar	

Sta-Clean Condensate Pan Strip



Part #	Mfg #	Description	Price
142409	CS100	Up to 2-1/2 Ton	

Leak Freeze

A/C Leak Freeze

- Permanently seals leaks in air conditioning and refrigeration systems
- Does not contain polymers
- Not activated by moisture or oxygen
- Non-clogging to A/C compressor and recovery unit



Part #	Mfg #	Description	Price
149068	00284	1.5 oz Cartridge, Clamshell w/Adapter	

Chemicals

Coil Cleaners

Self-Rinsing Evaporator Coil Cleaner

- No foaming action – only attacks dirt build-up, not metal
- Rinsing not required – normal condensation will carry away dirt and contamination
- May irritate eyes and skin – excessive contact should be avoided
- USDA Accepted



Part #	Mfg #	Size	Color	Price
041217	85-401	1 gal	Green	

Heavy Foaming Acid Condenser Coil Cleaner & Brightener

- Expanding foam action
- Best for brightening – makes condenser coils look new
- Must be thoroughly rinsed with water
- Contains hazardous components hydrofluoric acid and phosphoric acid
- Outdoor use only, protective gloves, and eye/face protection required



Part #	Mfg #	Size	Color	Price
041756	85-501	1 gal	Red	

Heavy Foaming Alkaline Condenser Coil Cleaner & Brightener

- Expanding foam action
- Alkaline formulation is excellent on greasy coils
- Must be thoroughly rinsed with water
- Contains hazardous component potassium hydroxide
- Good ventilation, protective gloves, and eye protection required
- USDA Accepted



Part #	Mfg #	Size	Color	Price
041334	85-1101	1 gal	Orange	

Chemicals

Flush Kits

Pro-Flush HVAC Flushing Solvent

- HVAC/R Flushing solvent for R-410A retrofits, refrigerant conversions and retrofits
- Low toxicity
- Non-flammable
- Residue-free



Part #	Mfg #	Description	Price
213842	PF-08	8 oz. Refill	
134797	PF-16	16 oz Refill	
134796	PF KIT	Power Flush Kit	

Super Change™

- One can treats up to 6 tons
- Eliminates oil change out
- Replaces line set flush
- Boosts oil return
- 20122 Reusable charging hose required —(sold separately)



Part #	Mfg #	Description	Price
189665	981	Super Change R22 Retrofit	

Coil Cleaners

Foam-Plus™ Foaming Coil Cleaner

- Aerosol can
- Non-flammable and water-based with no chlorinated solvents
- Foaming alkaline detergent quickly liquefies dirt, grease, oil or other residue
- Self rinsing on condensate producing coils



Part #	Mfg #	Description	Price
114477	358-20	19 oz Aerosol can	

Saf-N-Kleen™ Aerosol Solvent Coil Cleaner

- High-solvency formula quickly and easily dissolves dirt, grease, oil or other residue while the blasting nozzle separates the materials from the surface.
- Non-flammable, non-conductive formula is safe to use on live equipment.

Part #	Mfg #	Description	Price
193803	357-20	18 oz. Aerosol	

Triple D™ Universal Coil Cleaner

- Triple-D™ is the ultimate universal coil cleaner that can be used on condensers, evaporators, microchannels, roof-top units, and mini-split applications.
- The triple active synergistic highly effective solution is formulated to remove a broad range of soils while degreasing and deodorizing. It is ideal for cleaning most metals including aluminum and copper while extending equipment life and diminishing the potential for refrigerant leaks.
- Using 75% less than comparable products, it reduces the amount of solution needed to clean.
- Triple-D is biodegradable, NSF approved and available in seven different packaging configurations.



Part #	Mfg #	Description	Price
166062	TRIPLE-D	1 quart trigger sprayer	
166063	TRIPLE-D	1 gallon concentrate	
249080	TRIPLE-D-AER	19 oz. Aerosol	

Pro-Green™ No Rinse Coil Cleaner

- Mild Alkaline cleaner
- Can be used on air-cooled condensers, evaporators, electronic and permanent filters, fan blades, grilles, mini-split, and microchannel applications
- Cleans deposits on coils and rids condensate pans of slime
- NSF approved



Part #	Mfg #	Description	Price
193291	8-G	1 Gallon	

Chemicals

Pro-Red+™ Coil Cleaner

- Brightens, removes condensate "gunk," dirt, grime, and oxide deposits while degreasing
- Ideal for small and large condensers
- A 3 to 1 water to solution ratio for condensers



Part #	Mfg #	Description	Price
192096	8-R	1 Gallon	

Pro-Yellow™ Coil Cleaner

- Cleans and brightens
- Vigorous foaming action
- Non acid formula



Part #	Mfg #	Description	Price
193292	8-Y	1 Gallon	

Leak Detectors

Super Seal™ Sealant Total

- Medium systems 1.5-5 tons
- Dries, seals, and includes Flash UV dye for a complete repair solution
- Compatible with all oils and refrigerants
- Ideal for all systems including microchannel, heat pump and geothermal



Part #	Mfg #	Description	Price
236353	972KIT	2 oz	

Pro-Bubble™ Leak Detector

- Easy-to-use, high-bubbling, viscoelastic blue leak detector.
- New improved formula.



Part #	Mfg #	Description	Price
214166	PRO-BUBBLE	32 oz. bottle with Spray Top	

Inspection Lights UV Pocket Light

- UV Pocket Light
- Rotating Magnetic Clip
- 3AAA Batteries Included



Part #	Mfg #	Description	Price
248900	89DC	89DC UV Pocket Light	

Chemicals

Flex Inject Sealant Advanced & Total

- Flex Inject Sealant Advanced & Total are the fastest, most effective proven way to permanently seal and prevent minor air conditioning and refrigeration (AC/R) leaks.
- With no tools or gauges required, the Flex Inject sealant works by traveling through the system with the oil and refrigerant fixing leaks immediately.
- Flex Inject works with all compressors, heat pumps, condensers, and other system components and it will not plug up manifold gauges, metering devices, thermostatic expansion valves (TXVs), pistons or cause cap tube blockages.
- It meets the ASHRAE ARI 700 refrigerant standard and is compatible with any refrigerant including R-410A with no pump downs or recoveries required.
- Flex Inject is suitable for use in aluminum and copper coils and is microchannel friendly.



Part #	Mfg #	Description	Price
248901	995	995 Flex Inject Sealant	

Miscellaneous

Pro-Treat® 200 Economy Condensate Drain Pan Treatment

- Economical with 200 tablets per jar.
- Safe, non-corrosive, odor-free and 100% soluble.
- Approved for computer rooms.
- Convenient, easy-to-use tablet form provides prolonged cleaning action.
- Dosage: 3 tablets per 3 tons per month.



Part #	Mfg #	Description	Price
194908	PROTREAT-200	200 Tablets/Jar	

UV Dyes

- Flash™ UV dye is an advanced class of highly concentrated ultra violet dye that uses DRY R™ instead of POE oil as its carrier.
- This, combined with our patented misting orifice, enables the dye to travel at the speed of the refrigerant while keeping the dye stable.
- One can treat up to 64 oz (1.8L) of oil. Flash UV dye uses the systems refrigerant as the propellant – creating a clean, no-mess injection every time
- Required hose sold separately.



Part #	Mfg #	Description	Price
223617	20122	Clear Charging Hose	

Pro-Flush™ Accessories

- Pro-Flush Accessories include replacement parts and special fittings to maintain your Pro-Flush flushing system.
- Pro-Flush™ Line Set Adapter - Includes fittings for 3/8", 3/4", 7/8" lines



Part #	Mfg #	Description	Price
231955	PF-ADAPTER	Pro-Flush Line Set Adapter	

Pro-Treat® Pan Strips

- Pro-Treat® Pan Strips kill odor causing bacteria and last up to 6 months.
- Use in the primary drain pan of cooling units such as air conditioners and refrigerators.
- Pro-Treat® Pan Strips control foul-smelling odors caused by mildew, fungi, bacteria, algae, and slime.
- For use in hotels, schools, colleges, hospitals, nursing homes, airports, and many other locations.



Part #	Mfg #	Description	Price
249057	PS-01	1-2 Tons Pan Strips	

Chemicals

ParFlush Kits

ParFlush Kit for System Conversion & Clean-Up

- *Developed for refrigerant systems up to eight tons*
- *Ideal for R-410A conversions or system clean-up of air conditioning, heat pump or refrigeration systems with 3/8" OK liquid line sets*
- *Non-toxic and non-flammable*



Part #	Mfg #	Description	Price
139317	PFKIT1	1 lb Kit	

Refrigerant & Recovery Cylinders

Refrigeration Chemicals

Mineral Refrigeration Lubricant

- Viscosity 150 SUS (ISO VG 32) replaces 3GS
- Viscosity 300 SUS *(ISO VG 68) replaces 4GS
- For use with CFC and HCFC refrigerants
- Refined from select naphthenic base oils
- Wax free and oem approved
- Highest quality available and long-term, trouble-free service
- Low temperature properties
- (6) Containers per package



H-2301



H-2401

Part #	Mfg #	Description	Price
104480	85-H-2301	1 gal, 150 Viscosity	
149944	85-H-2401	1 gal, 300 Viscosity	

Ester 32 POE Refrigeration Oil

- Synthetic Ester Compressor Lubricant
- Viscosity 32 cSt @ 40°C
- ISO Viscosity Grade 32
- Long lubricant life
- Properly controlled miscibility
- High system efficiency
- Excellent low temperature fluidity
- Excellent high temperature stability
- Excellent hydrolytic stability
- Outstanding protection against compressor wear



Part #	Mfg #	Description	Price
157479	85-32CST	12 oz, 32 Viscosity	

Condensate Neutralizers

Cooling Tower & Water Treatment Products

pH-TREAT™ pH Neutralizer

- Neutralizes condensate water raising the pH to near neutral
- Includes:
 - (1) C-Clip for mounting
 - (2) 1/2" Barb x 3/8" MPT fittings
 - (2) 3/4" FPT x 3/8" MPT fittings
- Designed for gravity feed
- Product life is expected to have 1-year service life
- Temperature range: 40° to 100°F
- Pressure range: 0 to 125 psi



Part #	Mfg #	Description	Price
148176	4720-06	2.5" x 12" Cartridge Housing with 3/8" FPT Connections	

Cleaners

Condensate Drain Cleaners

Charles Gallo Drain Gun

- Clears condensate drains with a SWOOSH CO2 cartridge
- Lightweight, portable
- Creates 1,200 psi pressure
- Includes a tapered fitting to fit on 3/8" - 3/4" drain openings
- Cartridges are environmentally safe and recyclable



Part #	Mfg #	Description	Price
142154	GG-1	Gallo Gun with SWOOSH CO2 Cartridge	

Swoosh CO2 Cartridge



Part #	Mfg #	Description	Price
142156	GGC-12	Replacement Cartridge for SWOOSH CO2, 12/Pk	

Drain Kat™ Mini Kit for Nitrogen or CO2

- The Drain Kat™ is an over the shoulder refillable, nitrogen or CO2 mini drain cleaning kit.
- Featuring a small cylinder that holds 9 cubic feet of nitrogen or 2-1/2 pounds of CO2.
- The cylinder includes an integral mounted regulator for quick and easy adjustment of discharge pressure.
- Get exactly the amount of pressure you need with a quick adjustment on the regulator.
- Furnished complete with an 87" hose and drain gun kit, the CW-15 whip hose, and the AP-DK Drain Kat™ Accessory Fitting Kit which contains the DF-75 Drain Dawg™ inflatable tip, the CB-03 3/4"-1" cone fitting, the FA-01 male to male CO2 to nitrogen adapter, the FA-03 CO2 trans-fill adapter, and the QN-S3 needle tip.



Part #	Mfg #	Description	Price
249061	MBK-6	Drain Kat mini drain cleaning kit	

Miscellaneous Cleaners

Heavy Duty Reusable Towels

- For wipe ups of grease, oil, water, etc.
- 100% Cotton material is pre-shrunk
- 13" x 16"

Part #	Mfg #	Description	Price
256294	ST-10	13" x 16" 10Pk	

WypAll® X80 ShopPro® Cloth Towels

- Engineered to feel like cloth and work even better
- Absorbs more oil and water faster pound for pound than laundered shop towels
- 160 Towels/box



Part #	Mfg #	Description	Price
256295	5-41041	160 Towels per Box	

Cleaners

Teri® Reinforced Towels

- Multi-ply tissue reinforced with nylon webbing for added strength
- Made from 100% recycled paper
- Towel size: 9-3/4" x 16-3/4"
- White



Part #	Mfg #	Description	Price
107287	5-34790	126 Towels per Box	

All Purpose Cleaning Pads

- For cleaning copper tubes & fittings
- Nylon - will not rust
- Can be used we or dry
- Leaves no residue and is long lasting



Part #	Mfg #	Description	Price
009963	ACP-10	10 Towels per Pack	

Condensate Drain Pan Switches

Condensate Overflow Switches

Condensate Cop™ Clamp-On Float Switch

- Large over clamping area that fits the edge of all types of drain pans
- Separate float/probe assembly swivels to position switch
- Switch opens when rising water presents a flooding condition
- 2-Wire connection
- 24V/1.5A NC Reed switch
- Includes:
 - 5' Leads
 - Wire nuts
 - Clamping screws



Part #	Mfg #	Description	Price
148951	CC-1	Drain Pan Switch	

UA-1 Universal Alarm for Condensate Switches

- Use with the Wet Switch, SOS, Condensate Cop, CP-22 (all types) and all float switches on 24VAC control circuits.



Part #	Mfg #	Description	Price
203939	UA-1	UA-1 Universal Alarm	

Pipe Mounted Switches

- DiversiTech Flood Prevention Switches are simple to install, easy to service and extremely reliable.
- As water level in the auxiliary or main drain pipe rises due to a clogged air conditioning condensate drain, the switch shuts off the system—thus preventing water from overflowing and causing damage to doors, walls and ceilings.
- At the heart of the switch is a durable yet precise magnetic reed switch.
- Constructed of materials that will not rust or stick, the switch operates smoothly every time.



Part #	Mfg #	Description	Price
224406	CS1	Condensate Switch Tee	
250287	CS-2	Condensate Switch Elbow	

Safety Overflow Switch (SOS)

- Designed for use on 3/4in. PVC condensate drain line.
- Snaps easily over existing drain line tubing and can be glued in place using PVC cement.
- The SOS electronically senses water near the inside wall of the PVC drain tubing
- The LED indicator lights to show that there may be system trouble, and the SOS is doing its job.
- Furnished complete with switch, 5' (1.5 meter) 18 AWG, 2 wire lead, and a 3/4in. PVC male fitting adapter for direct coupling to a primary pan drain line connection



Part #	Mfg #	Description	Price
197096	SOS-1	SOS-1 Safety Overflow Switch	

CS1200 AC Shutoff Switch

- The CS1200 is a fast installing, reliable, condensate overflow detection switch.
- Featuring a unique universal pan mount design to assure accurate detection in metal or plastic secondary drain pans.

Part #	Mfg #	Description	Price
214078	CS1200	CS1200 AC Shutoff Switch	

WS-1 Wet Switch® Flood Detector

- A solid state control designed to help prevent flooding, damage to carpets, walls, furniture, ceilings, etc.
- Turns system off when detecting moisture due to condensate or drain leaks.
- A lit LED indicates the Wet Switch is activated and has turned the unit off.
- Connects to 24 VAC.
- More than one unit may be connected to a system.
- 2 amp contact rating.
- Simple 5 wire installation.



Part #	Mfg #	Description	Price
148945	WS-1	Wet Switch Flood Detector	

Condensate Traps

Condensate Traps

100 Series Plain Clear Condensate Trap

- Patented "See-Through" technology
- Watertight lower cap opens for easy access to clean drain pan outlet inside unit
- Remove upper cap to completely clean in seconds
- Cap can be replaced with optional float switch to warn owner if blockage is detected
- 3-Year warranty



Part #	Mfg #	Description	Price
147440	EZT-113B	3/4" Blow Molded Trap w/Brush	
119480	EZT-119	1" Blow Molded Trap w/Brush	



Condensate Traps

Condensate Overflows

Condensate Overflow Safety Switch



84-SS2

Part #	Mfg #	Description	Price
114920	84-SS2	Condensate Overflow Safety Switch - Auxiliary Drain Line Mount	
079708	84-SS3	Condensate Overflow Safety Switch - Pan Mount	

Condenser Pads

Equipment Pads

Plastic Equipment Pads

- Molded with size label and symbol representing content of recycled material
- Rounded edges and concrete gray color
- Limited lifetime warranty

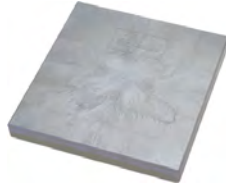

3" E-Lite™ Equipment Pad

Part #	Mfg #	Size	Price
147199	18383PAD	18" x 38" x 3"	
110904	24243PAD	24" x 24" x 3"	
156001	24363PAD	24" x 36" x 3"	
122936	30303PAD	30" x 30" x 3"	
156005	30403PAD	30" x 40" x 3"	
156006	32323PAD	32" x 32" x 3"	
110907	36363PAD	36" x 36" x 3"	
110908	36403PAD	36" x 40" x 3"	
151113	36483PAD	36" x 48" x 3"	
110910	38423PAD	38" x 42" x 3"	
173859	40403PAD	40" x 40" x 3"	

2" UltraLite™ Equipment Pad

- Lightweight Concrete Equipment Pads

Part #	Mfg #	Description	Price
135506	24302PAD	24" x 30" x 2"	
199877	ULTRA4040	40" x 40" x 2"	

3" UltraLite™ Equipment Pad

- Concrete equipment pad

Part #	Mfg #	Size	Price
156007	16363PAD	16" x 36" x 3"	
192089	ULTRA3030	30" x 30" x 3"	
192090	ULTRA3636	36" x 36" x 3"	

EcoPad™ Black Plastic Equipment Pad

- Used where local codes supersede the international code and require a pad thicker than 2"



Part #	Mfg #	Description	Price
215899	30303PADBL K	30" x 30" x 3"	
215900	32323PADBL K	32" x 32" x 3"	

Equipment Pads (Continued)

EcoPad™ Black Plastic Equipment Pad

Part #	Mfg #	Description	Price
215901	36363PADBL K	36" x 36" x 3"	

Heat Pump Pad™

- Raises the pump a full 8" off the ground
- Precision molded from eco-friendly, recycled polypropylene
- Includes (8) high quality anti-vibration pads
- Base angled to direct melting snow or water from the unit



Part #	Mfg #	Size	Price
131414	36368PAD	36" x 36" x 8"	
224224	32328PAD	32" x 32" x 8"	

A/C Condenser Mounting Brackets

- No hardware included
- Pre-punched holes for fastening unit to bracket
- 7/16" Holes for wall mounting hardware
- Load capacity dependent upon hardware/wall load limitations
- 3" Bracket width, 16" height



Part #	Mfg #	Description	Price
132370	ACB-30	30" Steel, Pair	
132372	ACB-36	36" Steel, Pair	
132373	ACB-42	42" Steel, Pair	
132374	ACB-48	48" Steel, Pair	

Anti-Vibration Pads

Iso-Cube Economy Anti-Vibration Pad

- Circular design offers suction cup effect - no need to bolt down pad
- 50 durometer pad will withstand a load of 180 psi



Part #	Mfg #	Size	Price
193873	ISO-2	2" x 2" x 3/4"	
060308	ISO-18	18" x 18" x 3/4"	

Condenser Pads

EVA Anti-Vibration Pad

- The latest generation in vibration dampening technology.
- The most effective vibration dampening pad available on the market.
- The EVA Pad was tested against other pads at four different vibration settings.
- In the most severe vibration extremes, the EVA Pad outperforms cork and rubber by a margin of greater than 3:1!
- This is due to the special composite foam center which is much more structurally sound than cork.
- It is not affected by oils or chemicals that can break down cork and is much more effective at vibration dampening than solid rubber. All this at a very competitive price. Designed to withstand 50 psi.

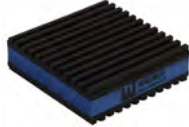

Part #	Mfg #	Size	Price
250456	MP-2E	2in. x 2in. x 7/8in	
206858	MP-3E	3in. x 3in. x 7/8in.	
250457	MP-4E	4in. x 4in. x 7/8in.	

Rubber Anti-Vibration Pad

- Elastomeric oil resistant padding
- Can withstand 50 lbs psi
- Corrugated on both sides

Part #	Mfg #	Size	Price
198252	MP-2	2" x 2" x 3/8"	
058036	MP-4	4" x 4" x 3/8"	
002304	MP-18	18" x 18" x 3/8"	

Rubber / Cork Anti-Vibration Pad

- Highest quality elastomeric oil resistant padding.
- Designed to withstand 50 psi.
- The rubber pads are corrugated on both sides.
- The cork is laminated between two corrugated pads.
- Ideal for air conditioners, compressors, cooling towers, presses, machines, etc.

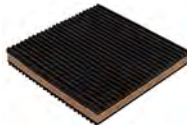

Part #	Mfg #	Description	Price
095859	MP-2C	2" x 2" x 7/8"	
120264	MP-3C	3" x 3" x 7/8"	
027603	MP-4C	4" x 4" x 7/8"	
220263	MP-18C	18" x 18" x 7/8"	

Heat Pump Risers

One-Piece Heat Pump Riser

- Heavy-duty plastic
- Butyl mastic on top & bottom

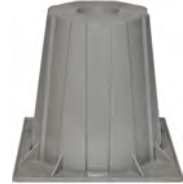

Part #	Mfg #	Size	Price
190278	HPR-3	3"	
190279	HPR-6	6"	
223362	HPR-12	12"	

Adjustable Equipment Riser

- Holds up to 300 lbs.
- Barrel twists up 5"-8"
- Includes top cap



Part #	Mfg #	Size	Price
190280	AER-8	8"	



Condenser Pads

A/C Brackets

Part #	Description	Price
042910	36" Wall Bracket	
042911	42" Wall Bracket	

Condenser Pads

Air Conditioning Hanging Brackets

- 1/8" Thick steel
- Mounts at any height



Part #	Mfg #	Description	Price
066780	19881	42" A/C Bracket	

Equipment Stands & Mounting Blocks**Pump-Up® Equipment Stand**

- Elevate heat pumps and air handling units
- Corrosion-resistant plastic
- Helps prevent corrosion of metal base
- Solid 6" x 6" mounting base
- Top diameter: 4-1/8"

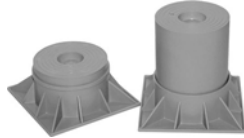

Part #	Mfg #	Description	Price
064183	4004	4" Pump-Up® Extension	
064182	4008	6" High	
056395	4012	10" High	

Defrost Controls

Defrost Controls

Defrost Control Board



Part #	Mfg #	Description	Price
123566	47-102684-83	Defrost Control Board	
182513	47-102685-87	Defrost Control Board Kit	
032874	47-21776-86	24V Defrost Control Time/Temp	

Defrost Controls

Commercial Refrigeration Defrost Controls

8040 Series Defrost Control

- *Time initiated*
- *Time terminated*
- *40 Amp*
- *Adjusted length of defrost 4 to 110 minutes*



Part #	Mfg #	Volts @ 60Hz	Contacts 2-4 / 1-3 / 3-N	Price
149813	8041-00	120V	Closed/Open/Closed	
149808	8041-20	208/240V	Closed/Open/Closed	

Defrost Controls

Commercial Refrigeration Controls

Single Function Pressure Control

- NEMA 1 Enclosure with non-conductive cover
- Front-located captive cover screw
- Super Cap® capillary protection system
- Universal mounting & compact design
- Laser-welded bellows for extended life

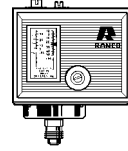

1/4" Male Flare



Part #	Mfg #	Description	Switch	Range	Differential	Price
149810	O10-1483	36" Capillary with Flare Nut	SPST Open Low	10 - 100 psig	10 - 40 psi	
063790	O10-2054	36" Capillary with Flare Nut	SPST Open Low	100 - 400 psig	40 - 150 psi	

Dual Function Pressure Control

- Exclusive "convertible" reset for manual or automatic high pressure reset on some models
- NEMA 1 Enclosure with non-conductive cover
- Front-located captive cover screw
- Super Cap® capillary protection system
- Universal mounting & compact design
- Laser-welded bellows for extended life
- Heavy-duty plated steel frame

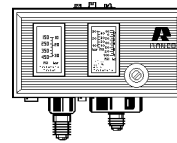

1/4" Male Flare



Part #	Mfg #	Cut-In Range PSIG	Diff. PSI	Cut-Out Range PSIG	Diff. PSI	Low Pressure (Opens Low)	High Pressure (Opens High)	Price
149809	O12-4834	10 - 100	10 - 40	150 - 450	70 Fixed	Automatic	Convertible	

Temperature Controls

ETC Commercial Temperature Control

- Wide temperature range: -30° to 220°F
- Wide differential adjustment: 1° to 30°F
- LCD Read-out for sensor temperature, control settings and relay status
- High amp output relay
- EEPROM Memory retains control settings during power outages
- Keypad lockout to prevent end-user alteration of settings
- Easy 4-step set up
- Heavy-duty relay 1 hp rated



Part #	Mfg #	Number Stages	Enclosure	Input Voltage	0 to 10 Volt Output	Price
066936	ETC-111000	1	NEMA-1	120/208/240VAC	No	
107652	ETC-112000	1	NEMA 1	24VAC	No	
064236	ETC-212000	2	NEMA 1	24VAC	No	

Defrost Controls

General Range Temperature Control

- Maximum adjustment accuracy with 7 revolution range adjustment screws
- NEMA 1 enclosure with non-conductive cover
- Front-located captive cover screw
- Universal mounting & compact design
- Laser-welded bellows for extended life

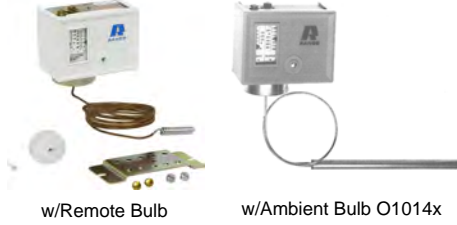

General Range Temperature Control - SPST - Opens High or Low

Part #	Mfg #	Applications	Range	Differential	Description	Price
149812	O10-1072	Low (Freezer)	-15° - 40°F	*+3° - 20°F	Air Coil	
149811	O10-1802	High	25° - 75°F	*+3° - 20°F	Air Coil	

*+Differential at the low end of range is 6 to 25.

Electrical

Contactors

Economy DP-Series Contactor

- *Electro magnetically-operated definite purpose 2-pole contactors provide switching for across-the-line starting of induction motors*
- *Double 1/4" quick connects*
- *Low profile design allows for more wiring room*
- *Multiple mounting holes and slots for convenient, interchangeable mounting with most competitive devices*
- *Not ARI-780 compliant, use where a "ruggedized" device is NOT required*



Part #	Mfg #	Coil Ratings Voltage	Poles	Electrical Contacts Full Load	Electrical Contacts Resistive	Price
169827	DP2030A1004	24V 240/277,480,600VAC	2-Pole	30A @ 240/277VAC	48A @	

* #10 Combination head screws

Electrical

**Protech Contactors
Single Pole Contactor**



Part #	Mfg #	Amps	Coil Volts	FLA @230V	LRA @230V	Resistive @230V	Price
018074	42-25101-01	30A	24V	25	150	35	
030033	42-25101-03	40A	24V	40	240	50	

Two Pole Contactor



Part #	Mfg #	Amps	Coil Volts	FLA @230V	LRA @230V	Resistive @230V	Price
022556	42-25102-01	30A	24V	32	180	40	
069435	42-42139-13	40A	24V	40	240	50	

Three Pole Contactor



Part #	Mfg #	Amps	Coil Volts	FLA @230V	LRA @230V	Resistive @230V	Price
017913	42-25103-01	30A	24V	32	180	40	
053005	42-25103-02	30A	240V	32	180	40	
022561	42-25103-05	50A	24V	50	300	63	

Electrical

Pressure Controls

P70 Series - Single Pole High Pressure Control

- Full adjustability, minimum differential
- Long life contact structure, no bounce on make
- Manual reset models are "trip-free"
- Includes a universal mounting bracket
- For use with:
 - Air conditioning and refrigeration
 - Controls of air, water, and oil pressure

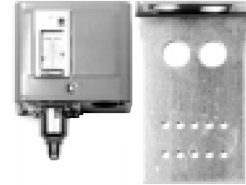

Models for High Pressure Non-Corrosive Refrigerants: R-12, R-22, R134A, R-500, R-502 (R)

Part #	Mfg #	Switch Action	Range PSIG	Diff PSI	Max Over-Pressure PSIG	Limited Knob Adj	Pressure Connection	Price
143982	P70AA-400	SPST Opens Low	100 to 470	35 to 200	690	None	3/6" Cap, 1/4" Flr Nut	

Spade & Other Electrical Connectors

LiquidTite Flex Conduit and Fittings

Liquid Tite Flexible Conduit

- For electrical applications: outside, inside and industrial uses including transformer connections, air conditioning and heating
- Joins with metallic or non-metallic connectors, easy to cut. Impact resistant, chemical resistant, and will not kink.



Part #	Mfg #	Description	Price
192061	34LIQTITE100	3/4" x 100 ft	
194410	12LIQTITE100	1/2" x 100 ft	

DiversiWhip - Connectors

- Liquid-tight flexible conduit system
- Three distinct wire colors
- (1) Straight and (1) 90° metallic connectors
- UL & cUL Listed



Non-Metallic

Part #	Mfg #	Description	Price
011632	WHIP124	1/2" x 4', #10 THHN	
011633	WHIP126	1/2" x 6', #10 THHN	
034348	WHIP346	3/4" x 6', #8 THHN	

Metallic

Part #	Mfg #	Description	Price
235506	WHIP124ME	1/2" x 4', #10 THHN	
235507	WHIP126ME	1/2" x 6', #10 THHN	
235508	WHIP346ME	3/4" x 6', #8 THHN	

Connectors

Liquid Tite Straight Connector

- Type B
- UL & CUL listed
- For use with metallic and Non-metallic liquid conduit



Part #	Mfg #	Size	Metallic	Price
194411	750-NMLT50	1/2"	No	
192063	750-NMLT75	3/4"	No	

Liquid Tite Elbow Connector

- Type B
- UL & CUL listed
- For use with metallic and Non-metallic liquid conduit



Part #	Mfg #	Size	Metallic	Degree	Price
168189	750-NMLT9050	1/2"	No	90°	
192064	750-NMLT9075	3/4"	No	90°	

Romex Connectors

- Metallic
- Zinc die cast
- For use with Romex wire
- UL listed CSA approved



Part #	Mfg #	Description	Price
192071	750-RC841	3/8" for 1/2" knockouts	
211892	750-RC842	3/4" for 3/4" knockouts	

Screw-On Wire Connectors

- Secures connections for positive continuity
- High-dielectric thermoplastic shell resists chemical action
- Deep skirt design



Part #	Mfg #	Description	Price
208281	623-001	Gray 71B 22-16 AWG 100/Pk	
192085	623-002	Blue 72B 22-16 AWG 100/Pk	
193784	623-003	Orange 73B 22-14 AWG 100/Pk	
192084	623-004	Yellow 74B 18-10 AWG 100/Pk	
192086	623-005	Red 76B 18-10 AWG 100/Pk	
255717	623-MIX	Assorted - 600-Pc	

Winged Wire Connectors

- Durable thermoplastic material
- Flame retardant, abrasion resistant, non-porous, and non-corrosive
- For use with copper to copper, aluminum to aluminum, and copper to aluminum (dry locations only)



Part #	Mfg #	Description	Price
159373	8284	Yellow 18 Pack	
159374	8286	Red 14 Pack	
192087	623-000	Gray 50 Pack	

Spade & Other Electrical Connectors

Insulated Butt Connectors

- These insulated terminals crimp to the wires which relieves the need to solder.



Part #	Mfg #	Description	Price
212222	6231	Red, 16 Pack 12-10 Wire	
212223	6217	Yellow, 27 Pack 16-14 Wire	

Insulated Spades

- These insulated terminals crimp to the wires which relieves the need to solder



Part #	Mfg #	Description	Price
215569	6237LX	50 pack wire range 22-18	
215570	6227LX	50 pack wire range 16-14	
215571	60254LX	50 pack wire range 12-10	

Insulated Female Slip-Ons

- These female terminals crimp to the wires which relieves the need to solder.



Part #	Mfg #	Description	Price
212224	6281	22 pack wire range 16-14	
212227	6282	22 pack wire range 22-18	
212228	6235LX	50 pack wire range 22-18	
212229	6235CX	100 pack wire range 22-18	
212230	6235	22 pack wire range 22-18	
212231	6218	22 pack wire range 16-14	
212232	6218LX	50 pack wire range 16-14	
212233	6218CX	100 pack wire range 16-14	
212234	6251	17 pack wire range 12-10	
212235	6251LX	50 pack wire range 12-10	

Standard Wire Connectors

- Connectors are color coded with spring inserts
- Heat resistant (105°C) thermoplastic
- Connectors are for copper to copper connections
- Parts 6294 and 6296 can connect aluminum to aluminum and copper to aluminum (dry locations only)



Part #	Mfg #	Description	Price
159370	6291	29 pack	
159371	6292	25 pack	
159372	6293	20 pack	

Tab Adapters - Single Female Double Male Tabs

- These insulated terminals crimp to the wires which relieves the need to solder



Part #	Mfg #	Description	Price
212243	6211	27 Pack	
212244	6211CX	100 Pack	

Fully Insulated Female Slip-Ons

- Crimp to the wires which relieves the need to solder
- This terminal features insulation grip
- This terminal is usually supplied vinyl and has an insulation grip



Part #	Mfg #	Description	Price
212236	6233	14 pack wire range 16-14	

Tab Adapters - Piggy Back Slip-Ons

- These insulated terminals crimp to the wires which relieves the need to solder



Part #	Mfg #	Description	Price
212242	60210LX	50 pack 16-14W	

Insulated Rings

- These insulated terminals crimp to the wires which relieves the need to solder



Part #	Mfg #	Description	Price
212238	6216LX	50 pack wire range 16-14	
212240	6252	17 pack wire range 12-10	

Spade & Other Electrical Connectors

Contactors

Definite Purpose Contactors

- 50 Amp
- 14 Nom VA
- 120 VAC coil
- Current MA 117
- 45.5 res DC ohms
- 135 Max inrush VA
- Quick connect terminals



Part #	Mfg #	Poles	Amps	VAC	Price
239656	EC503120	3	50	120	
198830	EC40224	2	40	24	
209961	EC30224	2	30	24	

Hard Start Kits

Torque Plus Hard Start Kit

- 120-288 Volts
- For 1/2-10 h.p. compressors



Part #	Mfg #	Description	Price
198713	DST-5	300% Torque Multiplier	
198712	DST-6	500% Torque Multiplier	

Hard Start Kit



Part #	Mfg #	Description	Price
208758	HSK1	3.5-5HP Compressor	
208759	HSK5	1-3HP Compressor	

General Accessories

EMT Thinwall Fittings

- 1/2" Set screw coupling
- Used to join EMT conduit to boxes on enclosures



Part #	Mfg #	Size	Price
239659	625-810	1/2"	

Stranded Copper Wire on Spool

- 100' per spool
- 600V & 90°C
- THHN wire
- 19 Stand copper



Part #	Mfg #	Color	Gauge	Price
239673	W121-100	Black	12	
239674	W141-100	Black	14	

Hanging Wire

- The 18 gauge galvanized can be used to hang HVAC duct work



Part #	Mfg #	Description	Price
192060	710-185G	18 Gauge 830'	

MAC Line Piercing Valve

- Features uniport: 1 connection for piercing and servicing
- Sealed with refrigerant resistant "O" rings



Part #	Mfg #	Description	Price
192412	QTM-1	1/4", 5/16", 3/8"	

Switch/Plug Combo

- These switches are available in single pole- double pole.
- They are UL listed and furnished with screw terminals. The ratings are A:20A- 125VAC, 20-250 VAC, 1 HP at 120-240 V and B 15A- 125/250 VAC, ¾ HP at 240 V

Part #	Mfg #	Description	Price
207369	620-274W	1P 3W grounding, 15A, 120V	

Spade & Other Electrical Connectors

Compressor Repair Kit

- Fits both non-burned and burned terminals
- Connects to the compressor via precision brass cylinders that fit over the terminals and connect with stainless steel set screws.
- Wires are permanently attached.
- Standard factory 600V, 65 strand machine wire.
- Easy to install and guaranteed for the life of the compressor.



Part #	Mfg #	Description	Price
192081	TLC-3-10	3 Wire, 10 Gauge Kit	

Transparent Plastic Boxes with Terminal Assortment

- Boxes are made of soft, pliable, durable K resin with 18 compartments containing the most popular terminals, including hi-temp and compressor terminals



Part #	Mfg #	Description	Price
210238	PA10	180 Terminals (10 Each Kind)	

Adjustable Delay on Make Timer

- Ideal for random starting of multiple units.
- Adjusts from 6 seconds to 8 minutes.
- Spin proof knob.
- Works with 24, 120 or 240 VAC control circuits.
- Supports up to 1.5 Amps.
- Two wire hookup for easy installation.
- Solid state with quick-disconnect terminals.
- Mounts with one self-tapping screw.
- Conformal coated circuitry protects against moisture and shock.



Part #	Mfg #	Description	Price
192404	ADM-1	Adjustable Delay on Make	

Adjustable Delay on Break Timer

- Adjusts from 6 seconds to 8 minutes.
- Spin-proof knob.
- Works with 24, 120 or 240 VAC control circuits.
- Supports up to 1.5 Amps.
- Two wire hookup for easy installation.
- Solid state with quick disconnect terminals.
- Mounts with one self-tapping screw.
- Conformal coated circuitry protects against moisture and shock.



Part #	Mfg #	Description	Price
192405	ADB-1	Adjustable Delay on Break	

Electrical Staples

- We have steel, insulated copper finish, and plastic electrical staples available



Part #	Mfg #	Description	Price
211036	PI332	50 pack 3/8" x 3/4"	

Rayovac Industrial Maximum Alkaline Batteries

- The Shrink Packed Battery has the same battery performance at the Contractor Pack, just at a lower cost.
- This battery is formulated specifically to exceed the everyday demands of the industrial applications and has outstanding dependability for those must work applications.



Part #	Mfg #	Description	Price
206551	7-ALAA-24	AA Battery, pack of 8	
206553	7-ALAAA-18	AAA Battery, pack of 8	
206554	7-ALC-12	C Battery, pack of 6	
206555	7-ALD-12	D Battery, pack of 6	

6180 Series Terminal Blocks

- These terminal blocks are constructed of high barrier thermoplastic are rated 20A-250V
- Terminal block, no. of positions 6, length (in) 2.91, width (in) .88, screw size 6-32, max. wire size 22-14



Part #	Mfg #	Description	Price
249408	6183	Block 6 Position	
249409	6184	Block 8 Position	

Spade & Other Electrical Connectors

General Accessories (Continued)

6180 Series Terminal Blocks

Part #	Mfg #	Description	Price
249410	6185	Block 10 Position	

Electrical Toggle Switches

- Side wire design with automatic grounding and large binding head terminal screws for fast wiring.
- Lubricated cam provides smooth lever action.
- U.L. Listed. C.S.A. Certified.
- Verified to Federal Spec. WS896E
- 15A-1/2 HP toggle switch, 120V, single pole, white



Part #	Mfg #	Description	Price
250040	625-1301W	15A-1/2 HP toggle switch	



Electrical

Electrical Parts & Accessories

RXAD - Low Ambient Control Kit

Part #	Mfg #	Description	Price
124470	RXAD-A08	Installed in Units to be Operated for Cooling at Outdoor Ambient Temperatures Under 70° F	

Low Ambient Control

Part #	Mfg #	Description	Price
108140	47-ICM325HNC	Low Ambient Fan	

Crankcase Heater

Part #	Mfg #	Description	Price
043854	44-17402-17	Crankcase Heater	
033123	44-17402-47	Crankcase Heater	

Hard Start Kit

Part #	Mfg #	Description	Price
141497	42-ICM860	Hard Start Kit	

Kick Start

- For single phase 208V, 230V, 265V A/C refrigeration and heat pump compressors
- 2-Wire pre-assembled starting component utilizes a mechanical potential relay and a start capacitor

Part #	Mfg #	Description	Price
104511	42-KS1	3-1/2 - 5 Ton Condenser Motor Kick Start	
104510	42-TO5	1 - 3 Ton Condenser Kick Start	

Electrical

Solenoid Valves

General Purpose (GP) Type I Two-Way Solenoid Valve

- *Minimum operating pressure differential: 1 psi*
- *Maximum temperature: 225°F*
- *Normally closed only*
- *For general application on non-corrosive fluids such as air, water below 180°F, light oils below 300 SSU and low vacuum*



Part #	Mfg #	Description	Price
005716	70562	1/2" Port, 1/2" FPT	
005717	70712	3/4" Port, 3/4" FPT	

Solenoid Coils for GP Valve

Part #	Mfg #	Description	Price
005722	77300	9W, 24V, 50/60Hz	
005720	77310	9W, 120V, 56/60Hz	
005719	77360	9W, 120/240V, 50/60Hz	

Solenoid Valve Repair Kit

Part #	Mfg #	Description	Price
005723	76731	Valve Repair Kit for GP600 (70712)	

Crankcase Heaters

Crankcase Heaters

Belly Band Type - Scroll Compressor

- Easy to install; adjustable by screw
- Uses high temperature silicone rubber element
- For optimum heat transfer, mount in lowest position on compressor housing



Part #	Mfg #	Volts	Watts	Lead Wire Size (AWG)	Lead Wire Length	Ground Wire Length	Price
137561	44-101884-05	230V	40W	18	48"	48"	
091893	44-17402-44	230V	40W	18	48"	22"	
009323	44-17402-45	230V	40W	18	48"	48"	

Filter Driers

Liquid Line Filter-Driers

Liquid Line Filter-Drier (Uni-Directional)

- Solid core, activated alumina with molecular sieve
- Corrosion resistant epoxy powder paint finish
- Suitable for R-22 and R-410A
- 680 psig Maximum working pressure
- Solid copper fittings



Part #	Mfg #	Connection	OAL	Body Length	Body Diameter	Price
188932	83-25151-40	3/8" Sweat ODF	4-1/2"	3"	2-5/8"	
179891	83-25151-41	3/8" Sweat ODF	5-5/16"	3-7/8"	2-5/8"	
180298	83-25151-42	3/8" Sweat ODF	6-1/8"	4-5/8"	2-5/8"	

Liquid Line Filter-Drier (Bi-Directional)

- Solid core, activated alumina with molecular sieve
- Internal check valve for heat pump applications
- Removes all types of foreign particulate material
- Corrosion resistant epoxy powder paint finish
- For R-22 and R-410A, 680 psig maximum working pressure
- Solid copper fittings



Part #	Mfg #	Connection	OAL	Body Length	Body Diameter	Price
180774	83-25152-10	3/8" Sweat ODF	6-1/8"	4-5/8"	3-1/8"	
096137	83-EK-163S	3/8" Sweat ODF	6-1/4"	4-3/4"	2-5/8"	

ADK Core Style Liquid Line Filter-Drier (Uni-Directional)

- Corrosion resistant epoxy powder paint finish
- High moisture and acid removal capacity
- Solid copper ODF fittings
- Copeland approved for POE oils
- 40 Micron filtration
- UL/cUL File SA3124



Part #	Mfg #	Connection	OAL	Body Length	Body Diameter	Price
149928	83-ADK-052	1/4" Flare SAE	4-13/16"	3"	2-5/8"	
149929	83-ADK-053	3/8" Flare SAE	5-1/8"	3"	2-5/8"	
133408	83-ADK-083	3/8" Flare SAE	5-15/16"	3-3/16"	2-5/8"	
149930	83-ADK-084	1/2" Flare SAE	6-3/16"	3-3/16"	2-5/8"	
094060	83-ADK-162	1/2" Flare SAE	6-7/16"	4-5/8"	2-5/8"	
149932	83-ADK-163	3/8" Flare SAE	6-3/4"	4-5/8"	2-5/8"	
149933	83-ADK-164	1/2" Flare SAE	6-15/16"	4-5/8"	2-5/8"	
149934	83-ADK-165	5/8" Flare SAE	7-7/16"	4-5/8"	2-5/8"	
149935	83-ADK-303	3/8" Flare SAE	9-5/8"	7-1/2"	3-1/16"	
149936	83-ADK-304	1/2" Flare SAE	9-7/8"	7-1/2"	3-1/16"	

Filter Driers

Sporlan Catch-All Liquid Line Filter-Drier (Uni-Directional)

- Solid core, activated alumina with molecular sieve
- Corrosion resistant epoxy powder paint finish
- Suitable for R-22, R-410A
- 650 psig Maximum working pressure

Part #	Mfg #	Connection	OAL	Body Length	Body Diameter	Price
097691	83-25208-01	1/4" Sweat ODF	4-3/16"	3-7/16"	2-7/16"	
080952	83-25208-03	3/8" Sweat ODF	5-1/4"	4-3/8"	2-5/8"	
080950	83-25208-04	3/8" Sweat ODF	5-7/8"	5"	3"	
080951	83-25208-05	1/2" Sweat ODF	6"	5"	3"	

Suction Line Filter-Driers

Suction Line Filter Drier (Standard Shell)

- Solid core; solid copper fittings
- Activated alumina/activated carbon/molecular sieve desiccant
- Suitable for R-22 and R-410A, 500 psig maximum working pressure
- For use after a burnout or when major system work has been performed
- (2) Pressure taps; one each at the inlet and outlet ends
- Corrosion resistant epoxy powder paint finish



83-25153-10

Part #	Mfg #	Connection	OAL	Body Length	Body Diameter	Price
087301	83-25153-10	3/4" Sweat ODF	9-5/8"	7-7/16"	3"	
096158	83-25153-11	7/8" Sweat ODF	9-7/16"	7-7/16"	3"	

Sporlan Catch-All Suction Line Filter-Drier (Standard Shell)

- Solid core, solid copper fittings
- Premium product with activated alumina/activated carbon/molecular sieve desiccant
- Suitable for R-22, R-410A
- 650 psig Maximum working pressure
- For use after burnout or when major system work has been performed
- One pressure tap at the inlet end
- Corrosion resistant epoxy powder paint finish



Part #	Mfg #	Connection	OAL	Body Length	Body Diameter	Price
092126	83-25209-03	7/8" Sweat ODF	6-5/16"	4-9/16"	3"	
087302	83-25209-05	7/8" Sweat ODF	9-3/4"	8"	3"	
092125	83-25209-06	1-1/8" Sweat ODF	9-3/4"	8"	3"	

Filter Driers

CSFD Suction Line Filter-Drier (Compact Shell)

- Solid core; solid copper fittings
- Activated alumina with molecular sieve desiccant
- Suitable for R-22 and R-410A
- Maximum working pressure: 400 psig
- Compact design for short lay-in applications
- Two pressure taps; one each at the inlet and outlet ends
- Corrosion resistant epoxy powder paint finish



Part #	Mfg #	Connection	OAL	Body Length	Body Diameter	Price
149938	83-CSFD-14S4VV	1/2" Sweat ODF	4-1/4"	2-3/4"	4-5/8"	
149939	83-CSFD-14S5VV	5/8" Sweat ODF	4-1/2"	2-3/4"	4-5/8"	
140741	83-CSFD-14S6VV	3/4" Sweat ODF	4-3/8"	2-3/4"	4-5/8"	
140742	83-CSFD-14S7VV	7/8" Sweat ODF	4-9/16"	2-3/4"	4-5/8"	

Filter Driers

Filter-Driers

Liquid Line Filter-Drier

- One valve can be employed for all refrigerants
- Maintains constant evap pressure
- Provides freeze-up protection on A/C
- Compatible with all existing and new refrigerants
- High moisture capacity dessicant



Part #	Mfg #	Size	Connection	Price
008290	SS-083S	3/8"	Sweat	

Suction Line Filter-Drier

- 500 Hours salt spray protection
- High capacity acid retention desiccants
- Solid copper sweat fittings



Part #	Mfg #	Size	Connection	Price
008255	SLD135SV	5/8"	Sweat	
008257	SLD277SV	7/8"	Sweat	



Filter Driers

Condenser Accessories

Filter Drier

Part #	Mfg #	Description	Price
092127	832520902	Filter-Drier 3/4" C166sth	

Filter Driers

Liquid Line Filter-Driers

Liquid Line Filter-Drier

- Solid copper fittings
- Maximum filtration capacity
- High moisture and acid capacity
- Corrosion resistant powder paint
- Spring loaded, XH-9 molecular sieve desiccant
- Exceptional compatibility with new polyester oils
- Compatible with all existing and new refrigerants and blends including:
—134a, 401A/B, 402A/B, 404A, 407A/B/C, 410A, 502, 507A



Part #	Mfg #	Size	Connection	Cubic Inch	Price
239677	DAD164S	1/2"	Sweat	16	
239678	DAD304S	1/2"	Sweat	30	

Filter Driers

Filter Driers

ALF Liquid Line Filters

- The ALF is a liquid line refrigerant filter for recovery, recycle and reclaim usage
- The ALF is also used for protecting solenoid and expansion valve parts from debris
- Filtering media that maximizes removal of finer particles
- Corrosion resistant epoxy powder paint finish



Part #	Mfg #	Description	Price
239676	EMRALF032M	1/4" SAE F	

9Builder Series Filter Drier

- The Builder Series filter drier provides an economical system protection for air conditioning applications
- ODF - Solid copper connections for easy installation
- Solid core construction
- 40 micron filtration
- Maximum working pressure = 680 psig



Part #	Mfg #	Description	Price
218561	EMRBSS166S	Suction 3/4" ODF 16CU	
218562	EMRBSS167S	Suction 7/8" ODF 16CU	
218564	EMRBSS306S	Suction 3/4" ODF 30CU	
218565	EMRBSS307S	Suction 7/8" ODF 30CU	

BSB Builder Series Bi-Directional Filter Drier

- ODF - Solid copper connections for easy installation
- Compacted bead design
- 40 micron filtration



Part #	Mfg #	Description	Price
218568	EMRBSB163S	3/8" ODF BiFlow 16CU	

BSL Builder Series Liquid Line Filter Drier

- ODF - Solid copper connections for easy installation
- Compacted bead design
- 20 micron filtration



Part #	Mfg #	Description	Price
218558	EMRBSL163S	3/8" ODF Liquid 16CU	

Leak Detection

Leak Detectors

Leak-Tech Gold™

- For use on gas lines, gas cylinders, refrigeration condensers, air lines, air pumps or any other system carrying gas
- Can be used on all types of piping
- Non-toxic and non-corrosive
- Temperature range: 28° to 180°F
- Not for use on oxygen systems

Part #	Mfg #	Description	Price
034246	LT08	8 oz with Dauber	
034245	LS16	1 pt Spray Bottle	

Leak Detection

Leak Detectors

Sure-Chek[®] All-Temperature Leak Detector

- Ultra-sensitive, long-lasting bubbles
- Fluorescent for improved visibility
- Safe for oxygen
- Non-corrosive, non-toxic



Part #	Mfg #	Size	Price
033194	32850	1 pt	

VISU-GLOW[®] High Visibility Leak Detector

- Fluorescent color shows brightly even in dimly lit places
- For use on CSST systems
- High viscosity stays on vertical surfaces
- Makes it easy to find leaks
- Non-corrosive, non-toxic
- Safe for oxygen
- Temperature range: 15° to 200°F



Part #	Mfg #	Size	Price
005975	32898	8 oz	



Leak Detection

Leak Detectors

Megabubble® Leak Detector

- Detects gas leaks in pipe lines, tanks, coils, cylinders, valves, etc
- Used to detect leaks of air, natural gas, refrigerants, CO2 and almost all known gases
- Non-toxic and contains only high quality, non-staining ingredients



Part #	Mfg #	Size	Price
132929	45801	8 oz Dauber Bottle	

Leak Detection

All-Purpose Leak Detectors

- *Detects leaks quickly on all types of tubing valves, cylinders, pressure tanks or other systems under air, gas or oxygen pressure*
- *Temperature range: -55 to +160°F*
- *Slow evaporation rate provides longer inspection time*



Part #	Mfg #	Size	Price
018413	LEAKOATEY80 Z	8 oz with Dauber	
031651	OT30212	1 gal	

Leak Detection

Leak Detectors

Big Blu Micro Leak Detector Solution

- *The only bubble detector capable of identifying gas leakage approaching the sensitivity of electronic sniffers*
- *Non-toxic*
- *Biodegradable*
- *Oxygen safe*



Part #	Mfg #	Description	Price
134238	RT100S	1 qt Spray	

Super Blu Micro Leak Detector Solution

- *50% Glycol solution at the same level of Big Blu detector*



Part #	Mfg #	Description	Price
135048	RT150S	1 qt Spray	

Leak Detection

Leak Detection Flashlights

OPTIMAX Jr™ LED Leak Detection Flashlight

- Cordless
- Blue light LED for leak detection
- Perfect for tight spaces
- Power comparable to high intensity 75W lamps
- Inspection range up to 6' or more
- 100,000/Hour LED life
- Powered by (3) "AA" batteries (included)
- Includes fluorescence-enhancing glasses (UVS-40)



Part #	Mfg #	Description	Price
138625	OPX-500CS	OPTIMAX Jr™ Flashlight	

Dual-Max™ Multi-Function LED Flashlight

- Cordless
- Dual-head flashlight features super bright blue light LED for leak detection plus white light LED for general component inspection
- Power comparable to high intensity 75W lamps
- Inspection range up to 6' or more
- Compact design allows easy access into tight spaces
- 100,000/Hour LED life
- Powered by (3) "AAA" batteries (included)
- Includes holster and fluorescence-enhancing glasses (UVS-40)



Part #	Mfg #	Description	Price
138626	OPD-500CS	Dual-Max™ Flashlight	

Leak Detection Kits

GLO-STICK® Kit with OPTIMAX Jr™ Flashlight

- For small to medium size AC&R systems, including high pressure R-410A systems
- Includes:
 - OPTIMAX Jr™ flashlight (OPX-500CS)
 - (1) Bleed valve for attaching GLO-STICK® capsule to service hose (BV-50)
 - (1) Purge capsule (PC-0249)
 - (1) Hose to connect to low side service port (119567)
 - (1) Universal/POE GLO-STICK® dye capsule (GS-1/E)
 - (2) Universal/POE GLO-STICK® dye capsules (GS-2/E)
 - (1) Universal/POE GLO-STICK® dye capsule (GS-3/E)
 - Fluorescence-enhancing glasses (UVS-40)
 - 8 oz Spray bottle of GLO-AWAY™ dye cleaner (CR-800)
 - Plastic carrying case (CC-110)



Part #	Mfg #	Description	Price
138623	OPK-50GS/E	GLO-STICK® Kit w/OPTIMAX Jr™ Flashlight	

Cartridges

EZ-Ject™ Universal Dye Cartridge

- (6) 0.5 oz Dye cartridges for mineral oil, polyolester and alkyl benzene



Part #	Mfg #	Description	Price
138624	EZ-4/ECS	Treats up to 25 lbs of Refrigerant or 2 gals of Lubricant	

Leak Detection

GLO-STICK® Universal Dye Capsules

- For small to medium size systems
- Prefilled, disposable capsules allow dye to be injected into pressurized systems using refrigerant
- Will withstand pressures of more than 1000 psi
- For mineral oil, polyester and alkyl benzene lubricant systems



Part #	Mfg #	Description	Price
138629	GS-101/ECS	Case of (6) 0.03 oz Capsules, Up to 2.9 lbs of Refrigerant or 15 fl oz of Lubricant	
138630	GS-1/ECS	Case of (6) 0.5 oz Capsules, Up to 4.9 lbs of Refrigerant or 1.6 qts of Lubricant	
138632	GS-2/ECS	Case of (6) 0.5 oz Capsules, 5 to 9.9 lbs of Refrigerant or 1.7 to 3.2 qts of Lubricant	
138634	GS-3/ECS	Case of (6) 0.5 oz Capsules, 10 to 25 lbs of Refrigerant or 3.3 qts to 2 gals of Lubricant	

Leak Detection

Leak Detectors

Micro LED UV Leak Detection Kit and Lamp

- *Waterproof*
- *Long life LEDs*
- *Constant ON switch*
- *AA Alkaline battery included*



Part #	Mfg #	Description	Price
182326	69789	Flashlight & Dye Kit for AC/R	

Universal A/C Disposable Injectors

- *1 oz. Injector*
- *One dye minimizes inventory*
- *80 psi maximum system port pressure*
- *Not for direct injection into R-410A systems due to high pressure*
- *No back-up refrigerant to move dye into system*



Part #	Mfg #	Injector Qty	Applications	Price
182321	69700	6 Pak	12 per case	
182324	69721	2 Pak	4 Per Pkg	

SpeediChannel Line Set Cover Systems

SpeediChannel System SpeediChannel™ Line Set Covers

- SpeediChannel™ 6-1/2' long and can be cut-to-size
- UV-Resistant, UL listed
- White finish, paintable



Part #	Mfg #	Size	Description	Price
113862	230-B2M	18"	Type 2 Wall Bracket(Md)	
113863	230-B2L	21"	Type 2 Wall Bracket (Lg)	
113138	230-D3	3"	Channel	
113145	230-D4	4"	Channel	
118518	230-D6	6"	Channel	
113139	230-CP3	3"	Union Coupling	
113146	230-CP4	4"	Union Coupling	
143605	230-CP6	6"	Union Coupling	
117848	230-TC34	3" x 4"	Reducer Coupling	
163115	230-TC46	4" x 6"	Reducer Coupling	
117851	230-DC3	3"	Cap	
117852	230-DC4	4"	End Cap	
156044	230-DC6	6"	End Cap	
113141	230-DE3	3"	End Cap	
113148	230-DE4	4"	End Cap	
237073	230-DE6	6"	End Cap	
117841	230-EB3	3"	90° Inside Elbow	
117843	230-EIN3	3"	90° Outside Elbow	
117844	230-EIN4	4"	90° Outside Elbow	
113140	230-FB3	3"	90° Flat Elbow	
179867	230-FB6	6"	90° Flat Elbow	
117845	230-FB453	3"	45° Flat Elbow	
117846	230-FB454	4"	45° Flat Elbow	
224307	230-FB456	6"	45° Flat Elbow	
117842	230-EB4	4"	90° Inside Elbow	
178071	230-EB6	6"	90° Inside Elbow	
113147	230-FB4	4"	90° Flat Elbow	
117840	230-LFB4	4"	90° Long Radius Flat EI	
248906	230-LFB6	6"	90° Long Radius Flat EI	
117839	230-LFB3	3"	90° Long Radius Flat EI	
113142	230-WC3	3"	Wall Penetration Sleeve	

SpeediChannel System (Continued) SpeediChannel™ Line Set Covers

Part #	Mfg #	Size	Description	Price
113149	230-WC4	4"	Wall Penetration Sleeve	
124976	230-WC6	6"	Wall Penetration Sleeve	
117838	230-WS2	2-1/2"	Wall Penetrating Sleeve	
117850	230-FJ4	4"	Flex Joint	
117849	230-FJ3	3"	Flex Joint	
117847	230-TJ4	4"	T-Joint	
213918	230-TJ6	6"	T-Joint	
116968	230-MB17W	17"	Mounting Block White	
116969	230-MBCW		Mounting Block End Cap	
117853	230-FR3	3"	Wall Escutcheon	
154312	230-DCLIP		SpeediClip 50/PK	
202481	230DSCREW		Screw 100/PK	
117854	230-FR4	4"	Flat Wall Escutcheon	
117855	230-WR3	3"	Wall Escutcheon	
117856	230-WR4	4"	Wall Escutcheon	
156190	230-SF3	3"	Soffit Fitting	
168414	230-SF4	4"	Soffit Fitting	

Mini-Split Drain Line

- Cut marks every 3.28'



Part #	Mfg #	Size	Price
140145	230-DL16	5/8" ID x 160'	



SpeediChannel Line Set System

Wall Brackets

WBB300 Wall Condenser Bracket

- 300lb capacity
- Heavy duty steel w/ powdercoat finish
- Features a sliding cross bar for exceptional equipment width range
- Level for added convenience



Part #	Mfg #	Size	Price
185380	RL87733	22" x 33-1/2" x 18"	

Refrigerant Parts & Accessories

ThermO-Snap Clamps™

Universal Mounting Bracket

- *Pre-mounted brackets provide an easy one-man installation job*
- *Multi-use applications including copper, PVC and ABS pipe*
- *Maintenance free - use indoors or out*
- *Eliminates vibrations and noise call backs*
- *Easy to re-open for an additional or custom adjustment*
- *UV Protected*



Part #	Mfg #	Description	Price
034839	41118	Residential 1-1/2" OD	
094315	41125	Commercial Plastic Line 2" OD	

Mounting Systems

Mounting Brackets and Blocks

Quick-Swivel Flush Mount with H Bracket

- The flush mount hanger is slotted to receive a 3/8 lag bolt 16" or 24" on center. It can be attached parallel or perpendicular to the joist
- Our Quick Swivel is made with 14-gauge steel able to hold 200 lbs
- The swivel allows for 360 degree rotation for setting the perfect direction of air flow
- The square steel tubing cuts down on vibration while 3 hitch-pins add to the safety and sturdiness of the Quick Swivel with "H" bracket
- All necessary hardware for installation provided



Part #	Mfg #	Description	Price
175021	QSQSWI1000	"U" Mount 200lbs, H Bracket with Non-Swinging Rotating Platform	
175024	QSQSWI5000	400lbs, HD Bracket with Non-Swinging Rotating Platform	
175023	QSWI3000	Flush Mount 200lbs, H Bracket with Non-Swinging Rotating Platform	

Mini Split Stand

- 12" High
- The Mini-Split Stands provide a safe, stable platform for mounting a wide variety of HVAC/R equipment
- Keeps unit elevated above lawn mowers, weed trimmers, pets, snow and flooding



Part #	Mfg #	Description	Price
175026	QSMS1201	Holds up to 400lbs, 12" High - Wide	
175025	QSMS1200	Holds up to 400lbs, 12" High - Thin	
175053	QSQSMS120	Holds up to 400 lbs, 12" High - Dual Fan 2	
186115	QSQSMS180	Holds up to 400 lbs, 18" High - Wide 1	

Quick-Sling® Mini Split Super Stand

- Galvanized mounting hardware included
- Include single and double sided U bars to accommodate any multi-unit combination



Part #	Mfg #	Description	Price
238376	QSSS1003	VRV IV-18" W/ 36" Crossrails	
188343	QSQSSS1003	VRV IV-12" W/ 36" Crossrails	
188353	QSQSSS1006	VRV IV-12" W/ 2-pair 36" Crossrails	
188354	QSQSSS1022	VRV IV-12" W/ 1-pair 36" & 1-pair 48" Crossrails	
188355	QSQSSS1008	VRV IV-12" W/ 2-pair 48" Crossrails	

Mounting Systems

Wall Bracket

- *Wall Bracket provides a quick safe, and stable way to mount your unit.*
- *They allow for easy access during installation, service, and maintenance.*
- *Our roof bracket accessory is designed to protect your equipment from snow and freezing rain while maintaining proper air flow around the unit.*



Part #	Mfg #	Description	Price
224115	QSQSWB300 0	Holds up to 300 lbs	
227295	QSQSWB200 0	Holds up to to 350 lbs	

Furnace Mounting Blocks

- *Each furnace mounting block can support 40% more weight than competitive products – over 500 pounds!*
- *Easy peel and stick installation.*



Part #	Mfg #	Description	Price
152470	FB-1	FB1 Furnace Mounting Blocks	



Novent Locking Caps

Refrigerant Parts & Accessories

Refrigerant Caps and Accessories



Part #	Mfg #	Description	Price
139299	NG-R22-2PK	Tamper-Resistant Green Caps R22 2/Pack	
139303	NG-R22-SDT	Screwdriver/Key R22 Green/Silver	
139300	NG-R410-10PK	Tamper-Resistant Pink Caps R410 10 Pack	
139304	NG-R410-SDT	Screwdriver/Key R410 Pink	
139302	NV-MULTI-KEY	Locking Refrigerant Cap Key	

Refrigeration Ball Valves with Press Port

**Refrigerant Ball Valves
ABV Refrigeration Ball Valve**

- Forged brass body, hermetic design with access valve



Part #	Mfg #	Connection Size	OAL	Description	Price
181357	BVS-038	3/8" ODF	5-1/2"	1/2" SAE Port with Schrader Core	
132261	BVS-058	5/8" ODF	5"	Full Press Port Bi-Directional Flow	
181358	BVS-012	1/2" ODF	6-3/8"	1/2" SAE Port with Schrader Core	
181130	BVS-078	7/8" ODF	7-1/2"	3/4" SAE Port with Schrader Core	
181359	BVS-138	1-3/8" ODF	10"	1-1/4" SAE Port with Schrader Core	
157803	BVS-118	1-1/8" ODF	6-11/16"	Bi-Directional Flow	

Secondary Drain Pans

Condensate Drain Pans

A/C Secondary Condensate Drain Pan

- Rolled edges for durability
- Ribbed bottoms for rigidity
- Includes 3/4" PVC fittings



Part #	Mfg #	Bottom Dimensions	Drain Line Outlets	Price
040019	6-3060L	30" x 60" x 2"	Long	
192095	DP3263L	32" x 63" x 2"	Long	
197538	6-2424L	24" x 24" x 2"	Long	
135390	6-3030L	30" x 30" x 2"	Long	

High Rise Pans™

- Black ABS plastic with 5" rise
- Installation kit includes:
 - (1) CC-1 condensate cap
 - (6) MP-2E 2"x2" EVA™ pads
 - (1) 1-3/4" PVC male adapter



Part #	Mfg #	Description	Price
198580	6-HK3060	30" x 60"	
168273	6-HK2748	27" x 48"	
176050	6-HK30501	30" x 50"	

Fittings

A/C Condensate Drain Pan Fittings

- The Drain Pan Fittings are designed to be used with Condensate Drain Pans.



Part #	Mfg #	Size	Price
197627	6-1	3/4"	

Trap

Part #	Mfg #	Size	Type	Price
237421	5-408	3/4"	Slip x Slip	

Site Glasses

Sight Glasses

Ruud™ Sight Glass



Part #	Mfg #	Connection	OAL	Price
140739	83-25156-02	3/8" Sweat ODF	4-5/8"	
140740	83-25156-04	1/2" Sweat ODF	4-7/8"	

See-All Sight Glass - Sporlan

- Painted steel body with copper fittings
- Includes protective cap for glass viewing window
- Suitable for R-22 and R-410A, 650 psig maximum working pressure



Part #	Mfg #	Connection	OAL	Price
022555	83-25211-02	3/8" Sweat ODF	4-5/8"	
022563	83-25211-04	1/2" Sweat ODF	4-7/8"	



Site Glasses

Ruud Sight Glasses

RXAG - Sight Glass Kit

Part #	Mfg #	Description	Price
094285	RXAG-A048	For 125,150,151 Comm Condensing Units & 75,100 Heat Pumps	



Tap Valves & Piercing Valves

Valves

Piercing Valve

Part #	Mfg #	Description	Price
085911	611002	QTM2 Line Piercing Valve	
133637	4051-99	A/C Piercing Valve & Hose	

Valve

Part #	Mfg #	Description	Price
104504	83-CD4338-1PK	Line Tap Valve	

Aluminum Faced Board Panning & Grille Frames

ThermO-Pan®

ThermO-Pan™ with Connectors

- ThermO-Pan® is a high quality, lightweight alternative to sheet metal in constructing return air ducts between joists
- Consists of corrugated insulation faced with aluminum
- Available in light weight sheets in many sizes
- Significantly reduces duct noises and labor
- Requires no shop fabrication
- Molded polypropylene ThermO connectors which easily connect ThermO-Pan® panels
- Kit includes panning, connectors, and (4) headers

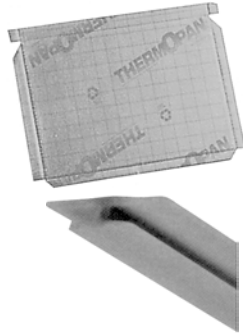

ThermO-Frames™

Standard Return Air Grille Dry Wall Frame

- Precision molded polypropylene
- Safety edged
- Frames can be cut for use as a single frame
- Place grille over frame and screw into precision molded frame holes on finished dry wall
- Allows unfiltered air flow



Part #	Mfg #	Size	Price
026507	14630	30" x 6", or 2 @ 14" x 6"	
168881	14632	30" x 6" (Bag of 10)	

Part #	Mfg #	Size	Price
034604	16049	16" x 47-1/2" Kit	
034602	19049	19-1/2" x 47-1/2"	
034603	24049	24" x 47-1/2"	
034605	32037	32" x 35-1/2"	

ThermO-Headers™

- For tight sealing air block
- ThermO-Headers™ are pre-cut and scored to fit easily between joists
- Specially-sized headers are cut and scored to fit I-joist construction

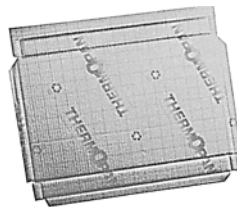

ThermO-Header

Part #	Mfg #	Size	Description	Price
212281	16017R	16" x 17"	I-Joist Header	
212282	16016R	16" x 16"	I-Joist Header	

Fire Rated

Part #	Mfg #	Size	Description	Price
121097	16018	16" x 18"	I-Joist Header	
129601	16020	16" x 20"	I-Joist Header	

Canvas Duct Connectors

Flexible Duct Connectors

Metal-Fab Connector

- 3" Metal, 3" fabric, 3" metal
- 24 Gauge galvanized
- Grip Loc seam
- 100' Roll



Part #	Item #	Item #	Description	Price
036577	INSCMBX 333	MBX333	Black Excelon®	

Chimney & Vent

Type B Round Gas Vent Pipe & Fittings

REA45 45 Degree Adjustable Elbow



Part #	Mfg #	Size	Price
184386	HC1045	10"	
184234	HC360	3"	

REA90 — 90-degree Adjustable Elbow



Part #	Mfg #	Size	Price
184245	HC390	3"	
184269	HC490	4"	
184292	HC590	5"	
184323	HC690	6"	
184368	HC890	8"	

RF Adjustable Roof Flashing (0 - 6/12 pitch)

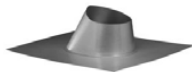

Part #	Mfg #	Size	Price
184253	HC3FLASH	3"	
184276	HC4FLASH	4"	
184299	HC5FLASH	5"	
184331	HC6FLASH	6"	
184356	HC7FLASH	7"	
184376	HC8FLASH	8"	
184392	HC10FLASH	10"	

RP Round Pipe (3-12")

- 3" to 12" pipe and fitting couplers overlap 1-3/8" when joined together; therefore, assembled length is 1-3/8" less than listed length.
- The allowable minimum clearance to combustibles is 1"
- Outside Diameter (OD)
Sizes 3" through 6" is size plus 1/2"
Sizes 7" through 12" is size plus 1"
- A full set of installation instructions are supplied with caps and supports.



Part #	Mfg #	Size	Price
184381	HC103	10" x 3'	
184608	HC105	10" x 5'	
184395	HC123	12" x 3'	
184243	HC312	3" x 12"	
184242	HC318	3" x 18"	
184241	HC32	3" x 2'	
184240	HC33	3" x 3'	
184239	HC34	3" x 4'	
184238	HC35	3" x 5'	
184266	HC412	4" x 12"	
184265	HC418	4" x 18"	
184264	HC42	4" x 2'	
184263	HC43	4" x 3'	
184262	HC44	4" x 4'	
184261	HC45	4" x 5'	
184289	HC512	5" x 12"	
184288	HC518	5" x 18"	
184287	HC52	5" x 2'	
184286	HC53	5" x 3'	
184285	HC54	5" x 4'	
184284	HC55	5" x 5'	
184290	HC56	5" x 6"	
184315	HC612	6" x 12"	
184314	HC618	6" x 18"	
184313	HC62	6" x 2'	
184312	HC63	6" x 3'	
184311	HC64	6" x 4'	
184310	HC65	6" x 5'	
184347	HC718	7" x 18"	
184346	HC72	7" x 2'	
184343	HC75	7" x 5'	
184366	HC812	8" x 12"	
184365	HC818	8" x 18"	

Chimney & Vent

Type B Round Gas Vent Pipe & Fittings (Continued)

RP Round Pipe (3-12")

Part #	Mfg #	Size	Price
184364	HC82	8" x 2'	
184363	HC83	8" x 3'	
184362	HC84	8" x 4'	
184361	HC85	8" x 5'	

RS Storm Collar



Part #	Mfg #	Size	Price
184405	HC12SC	12"	
184255	HC3SC	3"	
184278	HC4SC	4"	
184301	HC5SC	5"	
184333	HC6SC	6"	
184358	HC7SC	7"	
184378	HC8SC	8"	
184394	HC10SC	10"	

RFA Adjustable Roof Flashing (6/12 - 12/12 pitch)

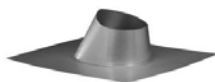

Part #	Mfg #	Size	Price
184259	HC36FLASH	3"	
184282	HC46FLASH	4"	
184309	HC56FLASH	5"	
184337	HC66FLASH	6"	

RHW Rain Cap (3-8")

- Prevents rain and debris from entering the vent.
- External screen prevents entry of birds.



Part #	Mfg #	Size	Price
184505	HC3TOP	3"	
184506	HC4TOP	4"	
184507	HC5TOP	5"	
184509	HC6TOP	6"	

RPA/R18A Adjustable Length Pipe



Part #	Mfg #	Size	Price
184244	HC312A	3" x 12"	
184268	HC412A	4" x 12"	
184291	HC512A	5" x 12"	
184316	HC612A	6" x 12"	
184349	HC718A	7" x 18"	
184367	HC818A	8" x 18"	

RPC Pipe Collar 3-8"

- To cover a rough opening.

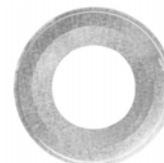

Part #	Mfg #	Size	Price
184257	HC3COL	3"	
184280	HC4COL	4"	
184304	HC5COL	5"	
184335	HC6COL	6"	

RRA Female Adapter

- Adapts Hart & Cooley vent to other brands of B vent (ours to theirs).



Part #	Mfg #	Size	Price
184487	HC3FA	3"	
184488	HC4FA	4"	
184489	HC5FA	5"	
184490	HC6FA	6"	

Chimney & Vent

RT Tee



Part #	Mfg #	Size	Price
184246	HC3T	3"	
184270	HC4T	4"	
184293	HC5T	5"	
184324	HC6T	6"	
184371	HC8T	8"	

RTF Tall Cone Roof Flashing



Part #	Mfg #	Size	Price
184254	HC3TCFF	3"	
184277	HC4TCFF	4"	
184332	HC6TCFF	6"	
184357	HC7TCFF	7"	

RN Increaser



Part #	Mfg #	Size	Price
184272	HC45INC	4" x 5"	
184273	HC46INC	4" x 6"	
184329	HC68INC	6" x 8"	

RWT Wall Thimble

- Provides necessary clearance to combustibles.
- Sleeve is adjustable from 3" to 6"



Part #	Mfg #	Size	Price
184279	HC4WT	4"	
184303	HC5WT	5"	

RAA Male Adapter

- Adapts thicker wall brands of B vent to Hart&Cooley vent (theirs to ours).



Part #	Mfg #	Size	Price
184283	HC5RAA	5"	

RYP Wye



Part #	Mfg #	Size	Price
184495	HC543W	5" x 4" x 3"	
184496	HC544W	5" x 4" x 4"	
184494	HC554W	5" x 5" x 4"	
184500	HC644W	6" x 4" x 4"	

Type B Vent Oval Gas Pipe & Fittings

OC 4" Oval Cap



Part #	Mfg #	Size	Price
184603	HC4OC	4"	

OP Oval Pipe



Part #	Mfg #	Size	Price
184590	HC4OP24	4" x 2'	
184589	HC4OP5	4" x 5'	

OSC Oval Storm Collar

- The storm collar serves as a counter flashing and requires mastic to seal to the vent pipe.



Part #	Mfg #	Size	Price
184605	HC4OSC	4"	

Chimney & Vent

Type B Chimney & Vent Chimney Liner

ALK Aluminum Chimney Liner Kits

- Kits include flexible length, round top, flashing, mortar guard
- Standard kit lengths of 15', 25' and 35'
- Available in 3", 4", 5", 6", 7" and 8" diameters in both kits and 10' extensions
- 10' insulated sleeve has tough polyethylene exterior (sold separately)
- Extension kit includes Flexi-Liner with attached connector and fastener package.
- Pull-downs stretch and lead the Flexi-Liner down the chimney
- Liner Material Aluminum 3003, 2-ply (0.005"each)
- Maximum Flue Gas Temperature 470°F
- Stretch Ratio 5:1 (approximate)
- Clearances 0" between liner and chimney interior 0" between combustible materials and chimney exterior
- Liner listed to UL1777 and ULC-S635
- Compatible with Type B gas vent systems
- Lifetime warranty



Part #	Mfg #	Size	Price
184653	HC3ALK35	3" x 35'	
184654	HC4ALK35	4" x 35'	
184655	HC5ALK35	5" x 35'	
184656	HC6ALK35	6" x 35'	

Type A Chimney & Vent Chimney Lengths

TLC Chimney Lengths

- Slim, advanced design allows for installation between 16" centers and still provides 2" clearance from combustible material
- Secure twist-lock design couples chimney sections together with just a 1/8 turn. Locking bands secure joints
- Includes locking band
- 5"-8" sections overlap by 1 1/8", 10"-14" sections overlap by 1 1/4"
- Chimneys are sized according to the inner diameter and are available in 5" through 14"
- The outside diameter is 2" larger than the inside diameter



Part #	Mfg #	Size	Price
184688	HC6TLC12	6" x 1'	
184689	HC6TLC18	6" x 18"	
184690	HC6TLC24	6" x 2'	
184692	HC6TLC36	6" x 3'	
184694	HC6TLC48	6" x 4'	
184713	HC7TLC48	7" x 4'	
184719	HC8TLC24	8" x 2'	
184720	HC8TLC36	8" x 3'	
184721	HC8TLC48	8" x 4'	

Type A Chimney & Vent Supports

TLCAWS Adjustable Wall Support

- Used to support the chimney on a through-the-wall installation.
- 5" – 8" sizes include top plate, side brackets, hardware, non-twist-lock insulated tee cap, and a long L-bracket to hold tee cap in place.
- 10" – 14" sizes do not include the cap. Use tee cap packaged with tee.
- 2" – 6" clearance away from wall.
- 5" – 8" sizes support between 30 feet and 74 feet of chimney, based on size and orientation. See instructions for specific heights.
- 10" – 14" sizes support up to 40 feet of chimney.
- 12" – 14" sizes are nonadjustable supports.



Part #	Mfg #	Size	Price
184701	HC6TLCAWS	6"	

Chimney & Vent

Type A Chimney & Vent Supports (Continued)

TLCAWS Adjustable Wall Support

Part #	Mfg #	Size	Price
184724	HC8TLCAWS	8"	

TLCCSR Ceiling Supports

- For use in flat ceiling support installations.
- Supports a total of 50 feet of chimney above.
- Chimney pipe cannot pass below support.
- Matte black finish with ceiling ring to cover rough opening.
- Also acts as a firestop.
- Must always use stovepipe adapter.



Part #	Mfg #	Size	Price
184763	HC6TLCCSR	6"	

Type A Vent Flashings & Storm Collars

TLCF6 Adjustable Flashing Assembly 0 - 6/12 pitch

- Used where the chimney passes through a roof with a pitch of Flat to 6/12.
- Comes complete with storm collar.
- All seams are sealed with silicone sealant.
- Galvalume

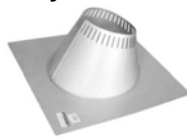

Part #	Mfg #	Size	Price
184704	HC6TLCF6	6"	
184731	HC8TLCF12	8"	

TLCS Storm Collar

- Used in conjunction with roof flashing to keep precipitation out.



Part #	Mfg #	Size	Price
184707	HC6TLCS	6"	
184748	HC8TLCS	8"	

TLCRBF Rubber Boot Flashing Kit

- This kit fits 5", 6", 7" and 8" chimneys.
- Used where the chimney passes through a corrugated roof.
- Rubber boot flashing fits roof pitches up to 12/12.
- Kit includes: Special Storm Collar, Rubber Boot, Spacer Kit and Special Boot-Mounting Screws
- UL-listed.



Part #	Mfg #	Size	Price
184697	HCTLCRBF	5"-8"	

Type A Vent Parts & Accessories

TLCSPA Stovepipe Adapter

- For quick and easy transition from black stovepipe to factory-built chimney.
- Twist-lock for easy connection.
- 5" to 8" is black.



Part #	Mfg #	Size	Price
184709	HC6TLCSPA	6"	
184749	HC8TLCSPA	8"	

TLCWB Wall Band

- Stainless steel construction.
- Provides lateral support for the chimney when installed adjacent to a wall.
- Maintains the mandatory 2-inch clearance to combustibles.
- Used above the tee, then every 8 feet thereafter.

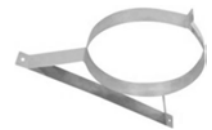

Part #	Mfg #	Size	Price
184710	HC6TLCWB	6"	

Type A Chimney & Vent Rain Caps

TLCC Rain Caps

- Advanced design, premium quality stainless steel.
- Provides protection against the elements.
- 5" - 8" TLCC with twist lock connection
- 10" - 14" Model TLCC with twist lock connection



Part #	Mfg #	Size	Price
184698	HC6TLCC	6"	

Chimney & Vent

Type A Chimney & Vent Rain Caps (Continued)

TLCC Rain Caps

Part #	Mfg #	Size	Price
184714	HC7TLCC	7"	
184722	HC8TLCC	8"	

Type A Chimney & Vent Elbows & Tees

TLCT Insulated Tee With Tee Cap

- The insulated chimney tee may be used for through the-wall installation, using a wall support.
- A chimney length is required to pass safely through a wall.
- Includes the following:
 - Two locking bands
 - 5" to 8" sizes have an uninsulated (single-wall) twist-lock tee cap for non-wall support applications only.
 - 10" to 14" sizes have an insulated press fit tee cap.



Part #	Mfg #	Size	Price
184699	HC6TLCT	6"	

Type A Chimney & Vent Shields

TLCWT Black Wall Thimble

- Used in a wall support installation.
- Radiation shield is included with spacers, which maintain the mandatory 2-inch clearance to combustibles.
- Attractive matte black finishing trim plate is included.
- Adjustable wall thickness from 4 1/2" – 8 3/4" for 5" – 8" sizes and from 6" – 11" for 10" – 14" sizes.



Part #	Mfg #	Size	Price
184767	HC8TLCWTB	8"	

Duct Boosters

Duct Boosters®

010372	DB-2	Original 120V, 1/20 hp, .51A - 6" & 8" Duct
--------	------	--

AireShare™ Transfer Fans

- AireShare™ AS1 & AS2 Room-to-Room transfer fans pull cool air from floor level or warm air from ceiling level and distribute high or low

Part #	Mfg #	Description	Price
114293	AS-1	Room-to-Room	

Duct Fans

- Fans can be used for exhaust or fresh air intake applications
- Fits metal or flex duct
- Capacities from 180 CFM up to 1,200 CFM



Part #	Mfg #	Description	Price
061571	EF-6	For 6" 120V, 30W, .40A	
023837	EF-8	For 8" 120V, 56W, 1.1A	

Duct Boosters

Air Boosters

Air Booster

- *Installs in branch duct of any room*
- *Adds up to 1,150 CFM to needy rooms*
- *Can be wired electrically through the main blower, a wall switch, or a line voltage thermostat in the room*



Part #	Mfg #	Size	Price
116050	84-25253-01	6"	

Duct Tape

Duct Tape

221 Solvent Resistant Duct Tape

- Rubber based adhesive
- Polyethylene coated cloth backing
- Crisp, straight tear and smooth unwind



Part #	Mfg #	Size	Color	Price
010344	221	2" x 60 yds	White	

227 Contractor Grade Duct Tape

- Bonds to all types of surfaces
- Will not twist or curl



Part #	Mfg #	Size	Color	Price
010345	227	2" x 60 yds	Silver	

398 Professional Grade Duct Tape

- 011 mil Thickness
- Excellent balance of tearability and tensile strength; 27 lbs/inch
- Conforms well to irregular surfaces
- Superior holding power for hanging applications
- Tears straight, hangs straight, curl resistant
- Easy unwind
- Low VOC content
- PE-coated cloth backing with rubber adhesive



Part #	Mfg #	Size	Color	Price
077358	398B	2" x 60 yds	Black	
190388	398W	2" x 60 yds	White	

338 FSK Insulation Tape

- Kraft Paper
- Syntetic rubber Adhesive
- Foil/Tri-Directional Fiberglas/Paper
- Aluminum



Part #	Mfg #	Size	Color	Price
176968	338	3" x 50 yds	Aluminum	

Duct Tape

Gaffer's Tape

- Premium vinyl coated
- Low gloss, non-reflective cloth backing



Part #	Mfg #	Size	Color	Price
010351	510	2" x 60 yds	Gray	

Foil Tape

337 Premium Foil Tape

- UL 723 Listed
- 3.7 mil Thickness
- Tensile strength: 14 lb/in
- Exceptional quick stick
- Dead-soft aluminum foil backing for rigid preformed aluminum foil-faced duct systems
- Synthetic rubber adhesive
- Low VOC



Part #	Mfg #	Size	Price
010349	337	2" x 50 yds	
010350	337	3" x 50 yds	

339 Cold Weather Premium UL 181A and B Printed Foil Tape

- 4.8 mil Thickness
- Tensile strength: 23 lb/in
- High performance in both cold and hot weather
- Instant adhesion, superior quick stick
- Premium performance in joining and sealing rigid fiberglass duct board and Class 1 flex duct
- Tear resistant
- Low VOC



Part #	Mfg #	Size	Price
124230	339	3" x 60 yds	

360-17 Waterproofing Repair Tape

- For indoor or outdoor sealing of medium and high pressure HVAC duct systems including metal duct, fiberglass duct, flex duct
- Seals cracks and seams in gutters, roof alleys, eaves, hips and ridges
- Seals around chimneys and vent stacks
- Repair gouges, rips, tears in metal panels
- Foilmastic permanent sealant tape - heavy-duty
- Acceptable for use on galvanized materials
- Provides instant water-tight bond
- Paintable - use in place of caulking
- Excellent resistance to cold, heat, water and sunlight



Part #	Mfg #	Size	Price
038561	360-17	3" x 100'	

227 Contactor Grad Duct Tape

- 11 mil
- Natural rubber adhesive
- Polyethylene coated cloth
- Single coated



Part #	Mfg #	Size	Color	Price
025910	227B	2" x 60 yds	Black	



Duct Accessories

PVC Tape

PVC Tape for Fiberglass

Part #	Mfg #	Size	Price
044361	INSPVCTAP E	2" x 100'	

Duct Fasteners

Rivets

Stainless Rivet



Part #	Mfg #	Rivet Dia	Body Length	Mandrel	Pk Qty	Price
006487	SS/SS42DT	1/8"	.232	Stainless	1,000	
006488	SS/SS44DT	1/8"	.357	Stainless	1,000	

Steel Rivet



Part #	Mfg #	Rivet Dia	Body Length	Mandrel	Pk Qty	Price
006491	SS42DT	1/8"	.232	Plated	1,000	
006490	SS42DX	1/8"	.232	Plated	100	
006492	SS44DX	1/8"	.357	Plated	100	

Screws

Zip-In® Screw

Zip-in®



Part #	Mfg #	Size	Pkg Qty	Price
006427	HW7x1/2Z	7 x 1/2"	15,000	
006428	HW7x1/2ZT	7 x 1/2"	1,000	
006426	HW7x1/2ZX	7 x 1/2"	100	
006434	HW8x1/2ZT	8 x 1/2"	1,000	
006433	HW8x1/2ZX	8 x 1/2"	100	
006436	HW8x3/4ZT	8 x 3/4"	1,000	
006435	HW8x3/4ZX	8 x 3/4"	100	
074763	HW8x3/4Z	8" x 3/4"	10,000	
092077	HW8x1Z	8 x 1"	7,000	
026305	HW8x1ZT	8 x 1"	500	
006429	HW8x1ZX	8 x 1"	100	
006431	HW8x11/2Z T	8 x 1-1/2"	250	
006430	HW8x11/2Z X	8 x 1-1/2"	50	
046929	HW8x2ZT	8 x 2"	250	
006419	HW10x1ZX	10 x 1"	100	

Zip-In® White Screw

Zip-in®

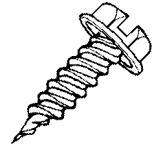

Part #	Mfg #	Size	Pkg Qty	Price
066164	HW8X2ZWT	8 x 2"	250	

Drill-In Screw



Part #	Mfg #	Size	Pkg Qty	Price
084193	HW10X2T	10 x 2"	250	
006424	HW10X2X	10 x 2"	50	

Bit-Tip® #2 Screw - Hex Washer Head

- Taps a matching thread
- Drills it's own hole
- Fastens in steel up to .200 thick

Bit-Tip®



Part #	Mfg #	Screw Size	Driver Size	Pkg Qty	Price
037082	BT131	8-18 x 1/2"	1/4"	100	
037085	BT133T	8-18 x 3/4"	1/4"	500	
037083	BT133	8-18 x 3/4"	1/4"	100	
058127	BT143T	10-16 x 3/4"	5/16"	500	

Duct Fasteners

Connector Systems

Ductmate 35 Rectangular Flange System

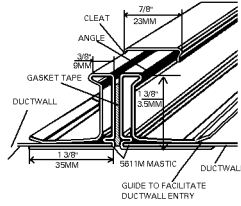

Part #	Mfg #	Description	Price
005621	INSDUCTMATE35	DM35™ Flange System	

Ductmate 35 Corner



Part #	Mfg #	Description	Price
005615	INSDUCTMATECNR	35 Corner with Clips	

Duct Fasteners

Ductmate Cleat

Part #	Mfg #	Description	Price
081245	INSDUCTMATECLEA	6" PVC	

Duct Fasteners

Duct Fasteners

PN Spotter Pin



Part #	Mfg #	Size	Pack	Price
072531	INSPN34	3/4"	1000	

Duct Hangers

DDG3W Eye Bolt and Nut

- 3/8"-16 x 2-1/2"
- 1/2" Thread length
- Zinc plated low carbon steel
- Working load limit: 144 lbs



Part #	Mfg #	Item #	Description	Price
181619	INS30220	DDG3W	100 per box	

Wire Rope

- Galvanized carbon steel

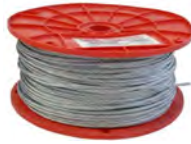

Part #	Mfg #	Size	Price
181611	INS30204	1/8" x 500'	

Duct Fasteners

Mastic Duct Sealants

Versa-Grip™ 181

- For use on metal duct, glass fiber duct board and flexible duct
- Indoor/outdoor use
- Water-based
- All pressure classes
- UL 181A-M/181B-M Listed



Part #	Mfg #	Size	Color	Price
124963	304138	1 gal	White	

Duct-Seal™ 321

- Indoor/outdoor use
- Water-based
- All pressure classes
- UL Classified



Part #	Mfg #	Size	Color	Price
125162	304156	1 gal	Gray	

Iron-Grip™ 601

- For use on metal duct, glass fiber duct board, flex duct, duct fabric and flexible tubing run outs
- Indoor/outdoor use
- Water-based
- All pressure classes
- UL Classified



1 Gallon

Part #	Mfg #	Size	Color	Price
124961	304137	11 oz		

Duct Liner Adhesives

Coil-Tack™

- Formerly Glas-Grip 901
- Low tack, nonflammable, water-based insulation adhesive engineered for spray or extruding coil line applications
- Low-viscosity liquid
- Synthetic latex



Part #	Mfg #	Size	Color	Price
128234	308584	50 gal	Black	

Travel-Tack™

- Portable insulation adhesive spray system
- Polymer-based aerosol spray
- Excellent water resistance



Part #	Mfg #	Description	Color	Price
125163	308599	15 oz Aerosol	VOC Clear	

Damper Accessories

Kwiki Damper Regulator



Part #	Mfg #	Description	Price
125160	307963	Kwiki Damper Regulator	

Duct Fasteners

Insulation Adhesives & Aerosol Products

Aerosol Cylinder Adhesive

- Industrial grade spray adhesives
- Designed to bond duct liner
- Coverage Approx 100 sq ft / lb
- Free of V. O. C. & C. F. X
- Completely Self Contained & Portable
- Does not require outside support systems

Part #	Mfg #	Description	Price
138959	CNADACA40	40 lbs	

Duct Sealants & Accessories

Buttertack Duct Sealant

- Buttertack Sealant Applies Easily
- For best results apply over fiberglass membrane tape; allow to cure 48 to 72 hours before pressure check

Part #	Mfg #	Description	Price
160360	CNBT1DUCTSEAL	1 Gal. Can (4 Per CTN)	

Pins & Clips

Pointer Weld Fastener

- Thru Insulation
- Weld Fastener
- Flat or Cupped Heads
- The Premium Quality Weld Fastener
- 1000 Pack or Bulk CTN
- Sharp Laser Point

Part #	Mfg #	Description	Price
191759	CNLFCWF50B	1/2" 5000 CTN	

Pinchers

Pincher Impact Fastener

- The premium quality impact fastener
- 9 Ga.
- Approx 135" Dia
- Thru insulation impact fastener

Part #	Mfg #	Description	Price
193121	CNLFCMF50	1/2", 1000 Qty/CTN	
193190	CNLFCMF100	1", 1000 Qty/CTN	
193494	CNLFCMF50B	1/2", 5000 Qty/CTN	

Vanes & Rails

Instant Vane Rail (IVR)

- Designed for today's pre-formed single blade vanes
- Roll out, cut and use - no tabs, no special tools
- 3-1/2" wide rail or 2" radius vane
- 4-1/2" wide rail for 4-1/2" radius vane

Part #	Mfg #	Description	Price
191761	CAINRAIV4G	4-1/2" Galv, 100 FT/CTN	

Pre-Formed Single Blade Vane

- Hemmed Edges 22-24 Ga. Galv
- Packaged 10 Foot Sections
- 300 FT/CTN 2" R Vane
- 150 FT/CTN 4 1/2" R Vane

Part #	Mfg #	Description	Price
191764	CNRAV2G	2" x 10' Galv	

Damper Hardware

Kwiki Regulator Sets

Kwiki Regulator Set K70

- K70 Includes:
- 2 K708 Bearing
- 1 K704 Washer
- 1 K705 Handle
- 1 K706 Wing Nut

Part #	Mfg #	Description	Price
191762	CNDHK70	12/Bag, 144 CTN/QTY	

Damper Quadrant Sets

- 3/8" Quadrant Set includes: Q38, B38 and SB38
- 3/8" Quadrant Set is for dampers up to 20" Dia.
- 1/2" Quadrant Set includes RB12, Q12, and B12
- 1/2" Quadrant Set is for dampers up to 30" Dia.

Part #	Mfg #	Description	Price
191763	CNDHQS38	Reg 3/8", 100 Sets/CTN	

Duct Fasteners

Insulation Hangers

Stik-Pins

- *Self Adhesive Hanger*
- *Washers Supplied with Hangers*
- *12 GA. Pins (106" - 2.69 MM)*
- *For Aluminum Nails*
- *Larger Sizes Available Upon Requests*

Part #	Mfg #	Description	Price
193230	CNLFSP1250	1-1/4" 10/CTN	
193489	CNLFSP0750	3/4" 10/CTN	
196535	CNLFSP0750B	3/4" 1000/CTN	

Flexible Duct Connector

Duct Connector Heavy Duty Commercial

- *3" Metal 3" Fabric 3" Metal*
- *24 GA. Galv*
- *"Flex-Loc" Seam*
- *Priced per 100 ft*

Part #	Mfg #	Description	Price
204543	CNCNN100	100' Neoflex 29 oz	

Duct Connector Light Industrial Duty Residential

- *1-3/4" Metal 3" Fabric 1-3/4" Metal*
- *28 GA. Galv*
- *"S-LOC" Seam*
- *Priced Per 100 Ft*

Part #	Mfg #	Description	Price
204546	CNCNRV100	100' Vinylon	

Access Doors

Insulated Access Door for Metal Duct

- *1" Insulated door*
- *2" W.C.*
- *Hinge & cam latches are standard*

Part #	Mfg #	Description	Price
063441	DR CAD 8	8" x 8"	



Duct Sealants

Mastic Duct Sealants

#6 Mastic Fiber Seal

- Low to high velocity air duct sealant
- Non-toxic adhesive-sealant for permanently sealing fabricated joints and seams of sheet metal air ducts, UL-181 listed rigid fiberglass air ducts, UL-181 listed flexible air ducts and thermal insulation
- Water-based and non-flammable
- High solid content
- Fiber reinforced
- Weather resistant
- Elastomeric
- City of Los Angeles Approval #RR820



Part #	Mfg #	Size	Price
121139	106001	1 gal	



Duct Hangers

Basset Brackets - Galvanized Self-Nailing Galvanized Bracket

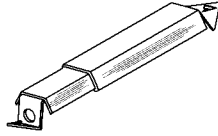

Part #	Mfg #	Description	Ctn Qty	Price
002244	A-150	12" to 19" Regular	50	
192533	A-125	12" to 19" Regular	25	
034448	E-125G	19" to 26" X-Long	25	

"Tab" Galvanized Bracket

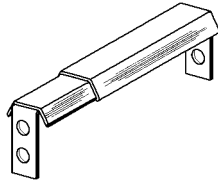

Part #	Mfg #	Description	Ctn Qty	Price
047447	AT-150	12" to 19" Regular	50	

"Tab" Galvanized Bracket with Pre-Loaded Screws

Part #	Mfg #	Description	Ctn Qty	Price
103953	AT-S150	12" to 19" Regular	50	

Pipe Hangers

- Installation of round 5" or 6" heating pipes

Part #	Mfg #	Carton Qty	Price
002245	BH-2	50/Box	

Square Duct Hangers - Galvanized

- 18 Gauge

Part #	Mfg #	Size	Price
035563	BH-8	8"	
038070	BH39	9"	
125557	BH-10	10"	
111709	BH-11	11"	

Basset Straps Duct Strap



- For all square ducts running below the joists
- 18 Gauge galvanized steel

Part #	Mfg #	Qty	Price
002246	DS-3	100/Cartron	

Wire Duct Strap



Part #	Mfg #	Size	Ctn Qty	Price
038142	BAGWS412	12"	100	
192534	BAGWS49	9"	100	

Perforated Pipe Strap

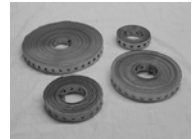

Part #	Mfg #	Size	Ctn Qty	Price
190762	HANG3410GALV	3/4"x10"	100	
190763	HANG34100GALV	3/4"x100"	1	
190764	HANGPS101024C	3/4" x 10"	10	

Hooks

Wire Pipe Hooks

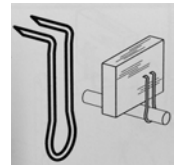

Part #	Mfg #	Size	Ctn Qty	Price
190758	HANG126P	1/2" x 6"	50	
190759	HANG344P	3/4" x 4"	50	
190760	HANG346P	3/4" x 6"	50	
190761	HANG16P	1" x 6"	50	



Duct Hangers

Accessories

Dyna-Tite Cable Lock

- For use with WC4-CL18 wire rope
- Working load limit of up to 250 lbs
- Features easy release pin for simple adjustments w/o use of tools

Part #	Mfg #	Description	Price
239965	INSCL18	Cable Lock for 1/8" Cable	



Duct Hangers

Slider™ Multi-Purpose Flat Bracket

- Two-piece design adjusts to a range of openings
- 20-gauge galvanized steel or copper-plated steel for spot soldering (heat the tube, not the bracket)
- Pre-drilled models have 1/8" pilot holes on 13/64" centers
- Adjustable bracket with flat tabs length—12"-19"

Adjustable Bracket with Flat Tabs

Part #	Mfg #	Material	Pilot Holes	Price
183442	520-419TC	Copper-Plated	Yes	

Flexible Duct

Insulated Flexible Duct - 30 Series

- Air-tight inner core - energy efficient, no fiberglass erosion into air stream
- Encapsulated wire helix, no unraveling when cut to length / quick installation
- Smooth inner core for low friction loss
- Thick blanket of fiberglass insulation
- Tough reinforced polyester jacket is tear and puncture resistant
- Lightweight compact carton reduces warehouse and job site handling cost
- Greenguard Indoor Air Quality Certified



R-4.2 Insulated Metallized Jacket - Class 1 Air Duct - UL181



Part #	Mfg #	Size	Price
060797	425MINFD	4" x 25'	
060798	525MINFD	5" x 25'	
060799	625MINFD	6" x 25'	
060800	725MINFD	7" x 25'	
060801	825MINFD	8" x 25'	
060803	1025MINFD	10" x 25'	
060804	1225MINFD	12" x 25'	
060805	1425MINFD	14" x 25'	
060807	1625MINFD	16" x 25'	
060808	1825MINFD	18" x 25'	
060809	2025MINFD	20" x 25'	
184167	650MINFD	6" x 50'	
184170	850MINFD	8" x 50'	
184173	1050MINFD	10" x 50'	

R6 Insulated Metallized Jacket

Part #	Mfg #	Size	Price
184203	R6625MINFD	6" x 25'	
184204	R6725MINFD	7" x 25'	
184205	R6825MINFD	8" x 25'	
184208	R61025MINFD	10" x 25'	
184209	R61225MINFD	12" x 25'	
184210	R61425MINFD	14" x 25'	
184211	R61625MINFD	16" x 25'	

Insulated Flexible Duct - 31 Series

- Air-tight inner core - energy efficient, no fiberglass erosion into air stream
- Encapsulated wire helix, no unraveling when cut to length / quick installation
- Smooth inner core for low friction loss
- Thick blanket of fiberglass insulation
- Tough reinforced polyester jacket is tear and puncture resistant
- Lightweight compact carton reduces warehouse and job site handling cost
- Greenguard Indoor Air Quality Certified



R8 Insulated Metallized Jacket - Class 1 Air Duct - UL 181



Part #	Mfg #	Size	Price
183939	R8425MINFD	4" x 25'	
183940	R8525MINFD	5" x 25'	
183942	R8625MINFD	6" x 25'	
183943	R8725MINFD	7" x 25'	
183944	R8825MINFD	8" x 25'	
183945	R8925MINFD	9" x 25'	
183946	R81025MINFD	10" x 25'	
183947	R81225MINFD	12" x 25'	
184174	R81425MINFD	14" x 25'	
184175	R81625MINFD	16" x 25'	

Flexible Duct

Insulated Flexible Duct - 70 Series

- Grey polyester vapor barrier air-tight inner core - energy efficient, no fiberglass erosion into air stream
- Encapsulated wire helix, no unraveling when cut to length / quick installation
- Smooth inner core for low friction loss
- Thick blanket of fiberglass insulation
- Tough reinforced polyester jacket is tear and puncture resistant
- Lightweight compact carton reduces warehouse and job site handling cost
- Greenguard Indoor Air Quality Certified



R-4.2 Insulated Grey Jacket - Class 1 Air Duct - UL181



Part #	Mfg #	Size	Price
015419	425INFD	4" x 25'	
015542	525INFD	5" x 25'	
015713	625INFD	6" x 25'	
068880	650INFD	6" x 50'	
015762	725INFD	7" x 25'	
015843	825INFD	8" x 25'	
089317	850INFD	8" x 50'	
015962	925INFD	9" x 25'	
012325	1025INFD	10" x 25'	
013302	1225INFD	12" x 25'	
013585	1425INFD	14" x 25'	
013645	1625INFD	16" x 25'	
013698	1825INFD	18" x 25'	

R-6.0 Insulated Grey Jacket - Class 1 Air Duct - UL181

Part #	Mfg #	Size	Price
091169	R6425INFD	4" x 25'	
091171	R6625INFD	6" x 25'	
091172	R6725INFD	7" x 25'	
091173	R6825INFD	8" x 25'	
091175	R61025INFD	10" x 25'	
091176	R61225INFD	12" x 25'	

R-8.0 Insulated - Grey Jacket - Class 1 Air Duct - UL181

Part #	Mfg #	Size	Price
097743	R8425INFD	4" x 25'	
101787	R8525INFD	5" x 25'	
097744	R8625INFD	6" x 25'	
097745	R8725INFD	7" x 25'	
097746	R8825INFD	8" x 25'	
097738	R81025INFD	10" x 25'	
097739	R81225INFD	12" x 25'	
097740	R81425INFD	14" x 25'	
097741	R81625INFD	16" x 25'	
097742	R81825INFD	18" x 25'	

Aluminum Flex Duct

Uninsulated Flex Duct UL 181 Class 1 Air Duct

- Triple lamination of tough metallized polyester, aluminum foil and polyester
- Wire helix and forms meet requirements of NFPA



Part #	Mfg #	Size	Price
093187	325UNFD	3" x 25'	
015420	425UNFD	4" x 25'	
015543	525UNFD	5" x 25'	
015714	625UNFD	6" x 25'	
015763	725UNFD	7" x 25'	
015844	825UNFD	8" x 25'	
012326	1025UNFD	10" x 25'	

Flexible Duct

Insulated Sleeves

Foil Sleeve



Part #	Mfg #	Size	R-Value	Price
059879	INSULSLEEVE45	4" x 5'	4.2	
102025	INSULSLEEVE55	5" x 5'	4.2	
044535	INSULSLEEVE65	6" x 5'	4.2	
044534	INSULSLEEVE75	7" x 5'	4.2	
044533	INSULSLEEVE85	8" x 5'	4.2	
102924	INSULSLEEVE105	10" x 5'	4.2	
184177	R6INSULSLEEVE45	4" x 5"	6.0	
184179	R6INSULSLEEVE65	6" x 5"	6.0	
184182	R6INSULSLEEVE12	12" x 5"	6.0	
097732	R8INSULSLEEVE45	4" x 5'	8.0	
097733	R8INSULSLEEVE65	6" x 5'	8.0	
097734	R8INSULSLEEVE75	7" x 5'	8.0	
097735	R8INSULSLEEVE85	8" x 5'	8.0	
171990	R8INSULSLEEV105	10" x 5'	8.0	
171991	R8INSULSLEEV125	12" x 5'	8.0	
172478	R8INSULSLEEV145	14" x 5'	8.0	

Galvanized Sheet Metal

Galvanized Sheet Iron



Part #	Gauge	Size	Price
010080	30ga	3' x 8'	
076485	28ga	2' x 8'	
010076	28ga	32" x 8'	
010077	28ga	3' x 8'	
010078	28ga	4' x 8'	
194517	26ga	2' x 8'	
260246	26ga	2-1/2' x 8'	
010074	26ga	3' x 8'	
010075	26ga	4' x 8'	
020573	26ga	4' x 10'	
189107	26ga	5' x 10'	
112800	24ga	5' x 10'	
010072	22ga	3' x 8'	
010073	22ga	4' x 8'	



Galvanized Sheet Metal

Panning Material

No. 48 Panning Material

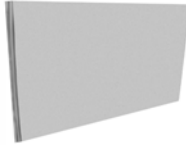

Part #	Mfg #	Size	Price
179149	SW481735	16-1/2"(17) x 30	
179150	SW483235	32" x 35"	

Oval Pipe & Fittings

Oval Pipe

OVP113 113" Jt Oval Pipe

- 30 Gauge galvanized steel



Part #	Mfg #	Size	Price
179279	SWOVP1136	6" x 113"	
179280	SWOVP1137	7" x 113"	

Oval Fittings

106 Oval to Round Reverse (End) Boot

- 30 Gauge galvanized steel



Part #	Mfg #	Size	Price
179290	SW1066	6"	
179291	SW1067	7"	

113 45° Flat Oval Angle (Broadway, Longway)

- 30 Gauge galvanized steel



Part #	Mfg #	Size	Price
179282	SW1136	6"	

115 45° Vertical Oval Angle (Shortway)

- 30 Gauge galvanized steel



Part #	Mfg #	Size	Price
179277	SW1156	6"	
179278	SW1157	7"	

114 90° Flat Oval Elbow (Broadway, Longway)

- 30 Gauge galvanized steel



Part #	Mfg #	Size	Price
179281	SW1146	6"	

116 90° Vertical Oval Angle (Shortway)

- 30 Gauge galvanized steel



Part #	Mfg #	Size	Price
179276	SW1166	6"	

124 Oval to Round 90° Boot

- 30 Gauge galvanized steel



Part #	Mfg #	Size	Price
179287	SW1246	6"	
179289	SW1247	7"	

124R 90° Oval Register Boot

- 30 Gauge galvanized steel



Part #	Mfg #	Size	Price
179296	SW124R2126	2-1/4" x 12" x 6"	



Oval Pipe & Fittings

127 Oval to Round Straight Boot

- 30 Gauge galvanized steel



Part #	Mfg #	Size	Price
179283	SW1276	6"	
179284	SW1277	7"	

127R Straight Oval Register Boot

- 30 Gauge galvanized steel



Part #	Mfg #	Size	Price
179293	SW127R2126	2-1/4" x 12" x 6"	

128 Oval to Oval Reverse (End) Boot

- 30 Gauge galvanized steel



Part #	Mfg #	Size	Price
179285	SW1286	6"	
179286	SW1287	7"	

110 Oval Stackhead



Part #	Mfg #	Size	Price
179292	SW1101066	10" x 6" x 6"	

Plenum & Return Air Drops

Return Air Products

Return Air/Cold Air Package

- Package consists of
 - (1) #20 starting collar
 - (2) 30" duct sections
 - (1) return air plenum w/ 1" filter rack
 - (6) 10" drive straps



Part #	Mfg #	Size	Price
158632	SW810EC	20" x 16"	
158633	SW811EC	25" x 16"	
192672	SW811	25" x 16"	

Return Air Support Box with Filter Rack

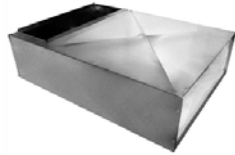

Part #	Mfg #	Size	Return Duct Size	Price
193763	SWSBF36	36" x 26" x 15"	10" x 25"	

Furnace Box

- 20 x 25 Filter
- 26 Gauge galvanized steel
- Fits most furnace sizes
- Easy access to filter for service
- Raises low profile furnace from ground



Part #	Mfg #	W x H x D	Price
193236	SWFB2428	24-3/4" x 28-1/2" x 18-1/2"	



Plenum & Return Air Drops

Plenum

Plenum for Nordyne

Part #	Mfg #	Size	Price
120117	WAPLENUMNOR1448	20.25" x 14.25" x 48"	
122818	WAPLENUMNOR1748	20.25" x 17.5" x 48"	
122820	WAPLENUMNOR2148	20.25" x 21" x 48"	
122821	WAPLENUMNOR2448	20.25" x 24.5" x 48"	



Plenum & Return Air Drops

Plenum & Return Air Drops

Plenum for Ruud

Part #	Mfg #	Size	Price
116829	WAPLENUMRUD1448	14" x 48"	
116830	WAPLENUMRUD1748	17" x 48"	
116831	WAPLENUMRUD2148	21" x 48"	
116832	WAPLENUMRUD2448	24-1/2" x 48"	
179540	WAPLENUMRUD1436	14" x 36"	
179541	WAPLENUMRUD1736	17-1/2" x 36"	
179542	WAPLENUMRUD2136	21" x 36"	
179543	WAPLENUMRUD2436	24" x 36"	

Plenum for Nordyne

Part #	Mfg #	Size	Price
179545	WAPLENUMNOR1736	17-1/2" x 36"	
179546	WAPLENUMNOR2136	21" x 36"	
179547	WAPLENUMNOR2436	24" x 36"	

Return Air Drop with Duct Kit

Part #	Mfg #	Size	Price
158636	WA6387CHAMPION		
158638	WA3910CHAMPION	Side load w/ 5" Drawer	
023408	WA6391	16" x 20"	
023410	WA6392	16" x 25"	
181567	WA3912	5 Ton	

Slant Return Air Drop

Part #	Mfg #	Size	Price
255355	WA4848BOESER	16" x 20"	
255357	WA4849BOESER	16" x 25"	

Duct Kit

Part #	Mfg #	Size	Price
179916	WA2512BOESER	25" x 12" (16x25)	

Return Air Boots

Part #	Mfg #	Size	Price
174331	WA26322612	26" x 32"	
174332	WA26282612	26" x 28"	
181568	WA3913	Side Load	
258901	BOE810B	20" x 16"	

Plenum & Return Air Drops (Continued)

Return Air Boots

Part #	Mfg #	Size	Price
258902	BOE811B	25" x 16"	

Return Air Base

Part #	Mfg #	Size	Price
179536	WA6TALLRABASE14	14" x 28"	
179537	WA6TALLRABASE17	17" x 28"	
179538	WA6TALLRABASE21	21" x 28"	
179539	WA6TALLRABASE24	24" x 28"	

Support Box

Part #	Mfg #	Size	Price
158587	WA6402	5 Ton	
158588	WA6388	4 Ton	

PVD/PVC Air Duct

Heat & Air Duct Pipe



Duct Pipe - Bell on One End

Part #	Mfg #	Size	Price
031122	HA06P	6" x 10'	
031121	HA08P	8" x 10'	
031120	HA10P	10" x 10'	
031119	HA12P	12" x 10'	
031118	HA14P	14" x 10'	
031117	HA16P	16" x 10'	

PVD/PVC Air Duct Fittings

Standard PVC Underground Air Duct Fittings

PVC Air Duct Tee



Part #	Mfg #	Size	Price
058137	T888P	8" x 8" x 8"	

PVC Air Duct Saddle Tee

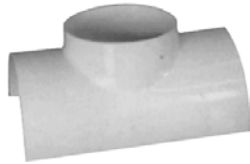

Part #	Mfg #	Size	Price
035155	S086P	8" x 6"	
035156	S106P	10" x 6"	

PVC Air Duct 45° Elbow



Part #	Mfg #	Size	Price
031169	L645P	6"	
031168	L845P	8"	
031167	L105P	10"	
031166	L125P	12"	

PVC Air Duct 90° Elbow



Part #	Mfg #	Size	Price
031163	L690P	6"	
031162	L890P	8"	
031161	L109P	10"	
031160	L129P	12"	

PVC Air Duct Coupling

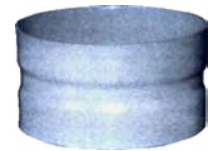

Part #	Mfg #	Size	Price
031194	C600P	6"	
031193	C800P	8"	
031192	C100P	10"	
031191	C120P	12"	
031190	C140P	14"	

PVC Duct Concentric Reducer



Part #	Mfg #	Size	Price
031188	RC86P	8" x 6"	
031187	RC10P	10" x 6"	
031186	RC10P	10" x 8"	
031184	RC12P	12" x 10"	

PVC Air Duct End Cap



Part #	Mfg #	Size	Price
031179	EC60P	6"	

PVD/PVC Air Duct Fittings

Standard PVC Underground Air Duct Fittings (Continued)

PVC Air Duct End Cap

Part #	Mfg #	Size	Price
031178	EC80P	8"	
031177	EC10P	10"	
031176	EC12P	12"	

PVC Blackmax Duct Saddle Boot



Part #	Mfg #	Size	Price
031199	BM4106	4" x 10" on 6" to 16" Pipe	
031198	BM4128	4" x 12" on 8" Pipe	



Black Max PVC Underground Duct Fittings

PVC 90° Register Boot Box



Part #	Mfg #	Size	Price
031205	B4106	4" x 10" x 6"	
031204	B4126	4" x 12" x 6"	

Rectangular Collars

Rectangular Collars

23 Offset Collar

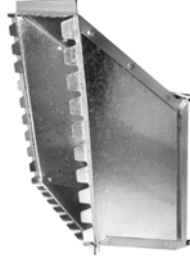

Part #	Mfg #	Size	Price
178788	SW2388	8" x 8"	
178789	SW23108	10" x 8"	
178790	SW23128	12" x 8"	
178791	SW23148	14" x 8"	
178792	SW23168	16" x 8"	
178793	SW23188	18" x 8"	
178794	SW23208	20" x 8"	
178795	SW23228	22" x 8"	
178796	SW23248	24" x 8"	
179231	SW231010	10" x 10"	
179232	SW231210	12" x 10"	
179233	SW231410	14" x 10"	
179234	SW231610	16" x 10"	
179235	SW231810	18" x 10"	
179219	SW232010	20" x 10"	
179230	SW232410	24" x 10"	
179003	SW232412	24" x 12"	

Rectangular Collars (Continued)

20 Straight Starting Collar

Part #	Mfg #	Size	Price
179131	SW201010	10" x 10"	
179132	SW202010	20" x 10"	
178969	SW202510	25" x 10"	

23AT Transition Collar

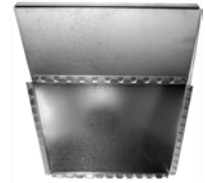

Part #	Mfg #	Size	Price
178878	SW23AT128	12" x 8"	
178879	SW23AT148	14" x 8"	
178880	SW23AT168	16" x 8"	
178881	SW23AT188	18" x 8"	
179218	SW23AT2010	20" x 10"	
178882	SW23AT208	20" x 8"	
178883	SW23AT228	22" x 8"	
179005	SW23AT2410	24" x 10"	
179004	SW23AT2412	24" x 12"	
178884	SW23AT248	24" x 8"	
178885	SW23AT3010	30" x 10"	
178886	SW23AT308	30" x 8"	

20 Straight Starting Collar



Part #	Mfg #	Size	Price
178797	SW2088	8" x 8"	
178798	SW20108	10" x 8"	
178799	SW20128	12" x 8"	
178800	SW20148	14" x 8"	
178801	SW20168	16" x 8"	
178802	SW20188	18" x 8"	
178803	SW20208	20" x 8"	
178804	SW20228	22" x 8"	
178805	SW20248	24" x 8"	



Rectangular Collars

Rectangular Collars

Offset Start Collar

Part #	Mfg #	Size	Price
256815	BOE231010	10" x 10"	
256816	BOE231210	12" x 10"	
256817	BOE231410	14" x 10"	
256818	BOE231610	16" x 10"	
256819	BOE231810	18" x 10"	
256820	BOE232010	20" x 10"	
256821	BOE232410	24" x 10"	

Start Collar

Part #	Mfg #	Size	Price
179907	SW202512	25" x 12"	
174329	WA141SD2S2612	26" x 12"	

Transition Start Collar

Part #	Mfg #	Size	Price
256822	BOE23AT2010	20" x 10"	
256823	BOE23AT2410	24" x 10"	
256824	BOE23AT3010	30" x 10"	



Rectangular Duct

Rectangular Duct

Trunk Duct

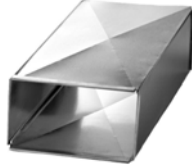

60" Joint Length

Part #	Mfg #	Size	Price
179194	SWTD6088	8" x 8"	
179195	SWTD60108	10" x 8"	
179196	SWTD60128	12" x 8"	
179197	SWTD60148	14" x 8"	
179198	SWTD60168	16" x 8"	
179199	SWTD60188	18" x 8"	
179200	SWTD60208	20" x 8"	
179201	SWTD60228	22" x 8"	
179202	SWTD60248	24" x 8"	
179191	SWTD60268	26" x 8"	
179192	SWTD60288	28" x 8"	
179193	SWTD60308	30" x 8"	
179203	SWTD601010	10" x 10"	
179204	SWTD601210	12" x 10"	
179205	SWTD601410	14" x 10"	
179206	SWTD601610	16" x 10"	
179207	SWTD601810	18" x 10"	
179208	SWTD602010	20" x 10"	
214481	SWTD602012	20" x 12"	
194055	SWTD602210	22" x 10"	
214475	SWTD602212	22" x 12"	
179209	SWTD602410	24" x 10"	
179210	SWTD602510	25" x 10"	
179211	SWTD603010	30" x 10"	

48" Joint Length

Part #	Mfg #	Size	Price
179188	SWTD482010	20" x 10"	
179186	SWTD482410	24" x 10"	
179187	SWTD482412	24" x 12"	

30" Joint Length

Part #	Mfg #	Size	Price
179355	SWTD302510	25" x 10"	



Rectangular Duct

Rectangular Duct

Joint X-Broke

36" Joint

Part #	Mfg #	Size	Price
174327	WA125SD526123 6	26" x 12" x 36" Joint	
179915	SWTD362512	36" x 12"	

60"

Part #	Mfg #	Size	Price
256777	BOETD601010	10" x 10"	
256778	BOETD601210	12" x 10"	
256779	BOETD601410	14" x 10"	
256780	BOETD601610	16" x 10"	
256781	BOETD601810	18" x 10"	
256782	BOETD602010	20" x 10"	
256783	BOETD602410	24" x 10"	
256784	BOETD602510	25" x 10"	
256785	BOETD603010	30" x 10"	



Rectangular Elbows

Rectangular Fittings

13 45° Flat (Broadway) Angle Radius Throat



Part #	Mfg #	Size	Price
178858	SW1388	8" x 8"	
178859	SW13108	10" x 8"	
178860	SW13128	12" x 8"	
178861	SW13148	14" x 8"	
178862	SW13168	16" x 8"	
178863	SW13188	18" x 8"	
178864	SW13208	20" x 8"	
178865	SW13228	22" x 8"	
178866	SW13248	24" x 8"	
178867	SW13308	30" x 8"	
179265	SW131010	10" x 10"	
181829	SW131210	12" x 10"	
179266	SW131410	14" x 10"	
179267	SW131610	16" x 10"	
179268	SW131810	18" x 10"	
179269	SW132010	20" x 10"	
179270	SW132210	22" x 10"	
179271	SW132410	24" x 10"	
179272	SW133010	30" x 10"	

13S 45° Flat (Broadway) Angle Square Throat

Part #	Mfg #	Size	Price
178652	SW13S1210	12" x 10"	
179225	SW13S2510	25" x 10"	

15 45° Vertical (Shortway) Angle Radius Throat

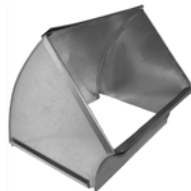

Part #	Mfg #	Size	Price
178846	SW1588	8" x 8"	
178847	SW15108	10" x 8"	

Rectangular Fittings (Continued)

15 45° Vertical (Shortway) Angle Radius Throat

Part #	Mfg #	Size	Price
178848	SW15128	12" x 8"	
178849	SW15148	14" x 8"	
178850	SW15168	16" x 8"	
178851	SW15188	18" x 8"	
178853	SW15208	20" x 8"	
178855	SW15228	22" x 8"	
178856	SW15248	24" x 8"	
178857	SW15308	30" x 8"	
179255	SW151010	10" x 10"	
179257	SW151210	12" x 10"	
179258	SW151410	14" x 10"	
179259	SW151610	16" x 10"	
179260	SW151810	18" x 10"	
179249	SW152010	20" x 10"	
179261	SW152210	22" x 10"	
179263	SW152410	24" x 10"	
179264	SW153010	30" x 10"	

15S 45° Vertical (Shortway) Angle Square Throat

Part #	Mfg #	Size	Price
179224	SW15S2510	25" x 10"	

14 90° Flat (Broadway) Elbow Radius Throat

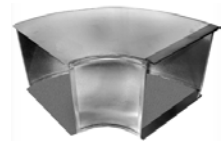

Part #	Mfg #	Size	Price
178868	SW1488	8" x 8"	
178869	SW14108	10" x 8"	
178870	SW14128	12" x 8"	
178871	SW14148	14" x 8"	
178872	SW14168	16" x 8"	
178873	SW14188	18" x 8"	
178874	SW14208	20" x 8"	
178875	SW14228	22" x 8"	
178876	SW14248	24" x 8"	
178877	SW14308	30" x 8"	
179298	SW141010	10" x 10"	
179236	SW141210	12" x 10"	



Rectangular Elbows

Rectangular Fittings (Continued)

14 90° Flat (Broadway) Elbow Radius Throat

Part #	Mfg #	Size	Price
179222	SW142510	25" x 10"	
179275	SW143010	30" x 10"	

14S 90° Flat (Broadway) Elbow Square Throat

Part #	Mfg #	Size	Price
180277	SW14S148	14" x 8"	
179243	SW14S1410	14" x 10"	
179244	SW14S1610	16" x 10"	
179245	SW14S1810	18" x 10"	
179246	SW14S2010	20" x 10"	
179247	SW14S2410	24" x 10"	
179248	SW14S2412	24" x 12"	

16 Vertical (Shortway) Elbow Radius Throat

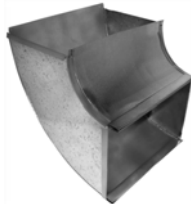

Part #	Mfg #	Size	Price
178835	SW1688	8" x 8"	
178836	SW16108	10" x 8"	
178837	SW16128	12" x 8"	
178838	SW16148	14" x 8"	
178839	SW16168	16" x 8"	
178840	SW16188	18" x 8"	
178841	SW16208	20" x 8"	
178842	SW16228	22" x 8"	
178843	SW16248	24" x 8"	
178845	SW16308	30" x 8"	
181831	SW161010	10" x 10"	
181830	SW161210	12" x 10"	
179274	SW163010	30" x 10"	

16S Vertical (Shortway) Elbow Square Throat

Part #	Mfg #	Size	Price
179237	SW16S1410	14" x 10"	
179238	SW16S1610	16" x 10"	
179239	SW16S1810	18" x 10"	



Rectangular Elbows

Rectangular Fittings

45° Horizontal Radius Duct Elbow

Part #	Mfg #	Size	Price
256794	BOE131010	10" x 10"	
256796	BOE131210	12" x 10"	
256797	BOE131410	14" x 10"	
256798	BOE131610	16" x 10"	
256799	BOE131810	18" x 10"	
256800	BOE132010	20" x 10"	
256801	BOE132410	24" x 10"	

45° Vertical Radius Duct Elbow

Part #	Mfg #	Size	Price
256808	BOE151010	10" x 10"	
256809	BOE151210	12" x 10"	
256810	BOE151410	14" x 10"	
256811	BOE151610	16" x 10"	
256812	BOE151810	18" x 10"	
256813	BOE152010	20" x 10"	
256814	BOE152410	24" x 10"	

90° Horizontal Radius Duct Elbow

Part #	Mfg #	Size	Price
256786	BOE141010	10" x 10"	
256787	BOE141210	12" x 10"	
256788	BOE141410	14" x 10"	
256789	BOE141610	16" x 10"	
256791	BOE141810	18" x 10"	
256792	BOE142010	20" x 10"	
256793	BOE142510	25" x 10"	

90° Vertical Radius Duct Elbow

Part #	Mfg #	Size	Price
256802	BOE161010	10" x 10"	
256803	BOE161210	12" x 10"	
256804	BOE161410	14" x 10"	
256805	BOE161610	16" x 10"	
256806	BOE161810	18" x 10"	
256807	BOE162010	20" x 10"	

Rectangular Miscellaneous

Reducers

35 Duct Reducer



Part #	Mfg #	Size	Price
179608	SW352	0-2"	
179609	SW354	0-4"	
181987	SW356	0-6"	
181988	SW358	0-8"	
178887	SW35210	10"/0-2"	
178888	SW35410	10"/0-4"	
178889	SW35610	10"/0-6"	
178890	SW35810	10"/0-8"	

17 Duct Transition

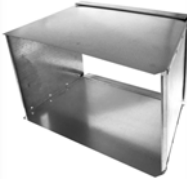

Part #	Mfg #	Size	Price
179220	SW172010208	20" x 10"	
179007	SW172410248	24" x 10"	
179006	SW172412248	24" x 12"	

Caps

21 End Cap

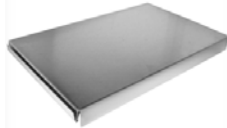

Part #	Mfg #	Size	Price
178891	SW2188	8" x 8"	
178892	SW21108	10" x 8"	
197516	SW211010	10" x 10"	
178893	SW21128	12" x 8"	
178894	SW21148	14" x 8"	
178895	SW21168	16" x 8"	
178896	SW21188	18" x 8"	

Caps (Continued)

21 End Cap

Part #	Mfg #	Size	Price
197511	SW211810	18" x 10"	
178897	SW21208	20" x 8"	
178898	SW21228	22" x 8"	
178899	SW21248	24" x 8"	
178900	SW21308	30" x 8"	
179250	SW211210	12" x 10"	
179251	SW212010	20" x 10"	
194620	SW212210	22" x 10"	
179252	SW212410	24" x 10"	
179148	SW212510	25" x 10"	

Register Frames

31 Return Air Frame



Part #	Mfg #	Size	Price
179102	SW31146	14" x 6"	
179103	SW31246	24" x 6"	
179104	SW31306	30" x 6"	

31PF Plaster Frame

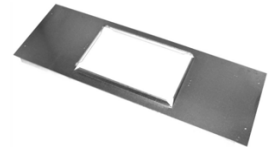

Part #	Mfg #	Size	Price
179105	SW31PF16410	F/16", 4" x 10"	
179106	SW31PF16412	F/16", 4" x 12"	
179107	SW31PF410	F/24", 4" x 10"	
179109	SW31PF412	F/24", 4" x 12"	

Filter Rack



Part #	Mfg #	Size	Price
178978	SWFR1620	16" x 20" x 1"	
178968	SWFR1625	16" x 25" x 1"	



Rectangular Miscellaneous

Register Frames (Continued)

Filter Rack

Part #	Mfg #	Size	Price
243468	SWFR411420	14" x 20"	
243469	SWFR411425	14" x 25"	
243470	SWFR411620	16" x 20"	
243471	SWFR411625	16" x 25"	
243473	SWFR412020	20" x 20"	
243474	SWFR412025	20" x 25"	

Boots

51FCRD Straight Ext Boot w/Flange & Ceiling Radiation Damper

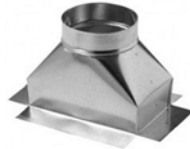

Part #	Mfg #	Size	Price
226531	SW51FCRD	4" x 12" x 6"	

51F Straight Ceiling Box w/ Flange

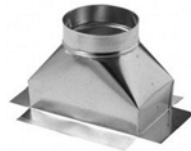

Part #	Mfg #	Size	Price
194003	SW51F244106	4" x 10" x 6"	

51P Straight Ceiling Box with Plate

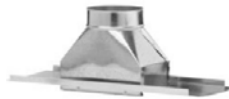

Part #	Mfg #	Size	Price
193689	SW51P4106	4" x 10" x 6"	
243893	SW51P141410	14" x 14" x 10"	

59P Boot w/ Plate

Part #	Mfg #	Size	Price
193690	SW59P4106	4" x 10" x 6"	
179212	SWSW59P4126	4" x 12" x 6"	

Outlets & Boxes

90° Ceiling Box w/ Flange



Part #	Mfg #	Size	Price
194006	SW59F244106	4" x 10" x 6"	
194007	SW59F244126	4" x 12" x 6"	
194008	SW59F244127	4" x 12" x 7"	
195620	SW59F4128	4" x 12" x 8"	

90° Extension Boot w/ Flange & Ceiling Radiation Damper



Part #	Mfg #	Size	Price
196379	SW59FCRD4127	4" x 12" x 7"	

'S' & Drive Cleats

S Clip



Part #	Mfg #	Size	Price
179181	SW3760	60" with 1/2" Leg	
179174	SW6S60	60"	
192605	SW6S120	120"	

Drive Clips

Part #	Mfg #	Size	Price
179175	SW8D8	8"	
179176	SW8D10	10"	
179177	SW8D12	12"	
179178	SW8D60	60"	

Drive Cleats



Part #	Mfg #	Size	Price
179173	SW37120	1/2" x 10'	

• Serving our Customers Since 1946 • www.plumbsupply.com



Rectangular Miscellaneous

'S' & Drive Cleats (Continued)

Drive Cleats

Part #	Mfg #	Size	Price
192604	SW37120	1" x 10'	
192606	SW8D	120"	

Mounting Rails



Part #	Mfg #	Size	Price
193110	SWMR24	24"	



Rectangular Miscellaneous

Rectangular Miscellaneous

Part #	Mfg #	Size	Price
126954	WA1425FSBOX	14" x 25"	
179548	WABOTTOMFILTRA B	14-1/2" x 28-1/2"	
255356	WAINFORHOLDER	Wide Info Holder	

Rectangular Fittings

Speedi-Boot™ Boot Hanger

- Telescoping arms
- Dust and debris cover
- Air tight gasket
- Rigid mud-ring and galvanized frame



Part #	Mfg #	Size	Price
080008	SBH-410	4" x 10"	
080009	SBH-412	4" x 12"	



Round Boots

Round Boots

24R 90° Register Boot



27R Straight Register Boot



Part #	Mfg #	Size	Price
187966	SW24R2104	2-1/4" x 10" x 4"	
179047	SW24R2105	2-1/4" x 10" x 5"	
179048	SW24R2106	2-1/4" x 10" x 6"	
179049	SW24R2125	2-1/4" x 12" x 5"	
179046	SW24R2126	2-1/4" x 12" x 6"	
179050	SW24R2127	2-1/4" x 12" x 7"	
179051	SW24R2146	2-1/4" x 14" x 6"	
179052	SW24R2147	2-1/4" x 14" x 7"	
179216	SW24R486	4" x 8" x 6"	
179053	SW24R4104	4" x 10" x 4"	
179054	SW24R4105	4" x 10" x 5"	
179055	SW24R4106	4" x 10" x 6"	
179056	SW24R4107	4" x 10" x 7"	
179057	SW24R4125	4" x 12" x 5"	
179058	SW24R4126	4" x 12" x 6"	
179059	SW24R4127	4" x 12" x 7"	
179060	SW24R4128	4" x 12" x 8"	
179061	SW24R4146	4" x 14" x 6"	
179062	SW24R4147	4" x 14" x 7"	
179063	SW24R4148	4" x 14" x 8"	
179064	SW24R6106	6" x 10" x 6"	
179065	SW24R6107	6" x 10" x 7"	
192616	SW24R6108	6" x 10" x 8"	
192614	SW24R6126	6" x 12" x 6"	
179066	SW24R6127	6" x 12" x 7"	
179067	SW24R6128	6" x 12" x 8"	
192615	SW24R6146	6" x 14" x 6"	
192617	SW24R6147	6" x 14" x 7"	
179068	SW24R6148	6" x 14" x 8"	

Part #	Mfg #	Size	Price
179024	SW27R2105	2-1/4" x 10" x 5"	
179025	SW27R2106	2-1/4" x 10" x 6"	
179026	SW27R2125	2-1/4" x 12" x 5"	
179027	SW27R2126	2-1/4" x 12" x 6"	
179028	SW27R2146	2-1/4" x 14" x 6"	
179029	SW27R2147	2-1/4" x 14" x 7"	
179030	SW27R4104	4" x 10" x 4"	
179031	SW27R4105	4" x 10" x 5"	
179032	SW27R4106	4" x 10" x 6"	
179033	SW27R4107	4" x 10" x 7"	
179034	SW27R4126	4" x 12" x 6"	
179035	SW27R4127	4" x 12" x 7"	
179036	SW27R4128	4" x 12" x 8"	
179037	SW27R4146	4" x 14" x 6"	
179039	SW27R4147	4" x 14" x 7"	
179040	SW27R4148	4" x 14" x 8"	
179041	SW27R6106	6" x 10" x 6"	
192609	SW27R6107	6" x 10" x 7"	
192610	SW27R6108	6" x 10" x 8"	
179042	SW27R6126	6" x 12" x 6"	
179043	SW27R6127	6" x 12" x 7"	
179044	SW27R6128	6" x 12" x 8"	
192611	SW27R6146	6" x 14" x 6"	
192612	SW27R6147	6" x 14" x 7"	
179045	SW27R6148	6" x 14" x 8"	

28R Center End Register Boot

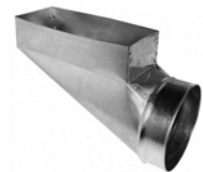

Part #	Mfg #	Size	Price
187967	SW28R2105	2-1/4" x 10" x 4"	
179069	SW28R2105	2-1/4" x 10" x 5"	
179070	SW28R2106	2-1/4" x 10" x 6"	
179071	SW28R2125	2-1/4" x 12" x 5"	
179072	SW28R2126	2-1/4" x 12" x 6"	



Round Boots

Round Boots (Continued)

28R Center End Register Boot

Part #	Mfg #	Size	Price
178655	SW28R2127	2-1/4" x 12" x 7"	
179073	SW28R2146	2-1/4" x 14" x 6"	
179130	SW28R4104	4" x 10" x 4"	
179074	SW28R4105	4" x 10" x 5"	
179075	SW28R4106	4" x 10" x 6"	
192618	SW28R4107	4" x 10" x 7"	
179076	SW28R4126	4" x 12" x 6"	
179077	SW28R4127	4" x 12" x 7"	
179078	SW28R4128	4" x 12" x 8"	
179079	SW28R4146	4" x 14" x 6"	
179080	SW28R4147	4" x 14" x 7"	
179081	SW28R4148	4" x 14" x 8"	
179082	SW28R6106	6" x 10" x 6"	
192627	SW28R6128	6" x 12" x 8"	
192629	SW28R6148	6" x 14" x 8"	

28RR Right End Register Boot



Part #	Mfg #	Size	Price
179092	SW28RR2106	2-1/4" x 10" x 6"	
179093	SW28RR2126	2-1/2" x 12" x 6"	
179094	SW28RR2127	2-1/4" x 12" x 7"	
179095	SW28RR2146	2-1/4" x 14" x 6"	
179096	SW28RR4105	4" x 10" x 5"	
179097	SW28RR4106	4" x 10" x 6"	
179098	SW28RR4126	4" x 12" x 6"	
179099	SW28RR4127	4" x 12" x 7"	

28RL Left End Register Boot



Part #	Mfg #	Size	Price
193525	SW28RL2105	2-1/4" x 10" x 5"	
179083	SW28RL2106	2-1/4" x 10" x 6"	

Round Boots (Continued)

28RL Left End Register Boot

Part #	Mfg #	Size	Price
179084	SW28RL2126	2-1/2" x 12" x 6"	
179085	SW28RL2127	2-1/4" x 12" x 7"	
179087	SW28RL2146	2-1/4" x 14" x 6"	
179088	SW28RL4105	4" x 10" x 5"	
179089	SW28RL4106	4" x 10" x 6"	
179090	SW28RL4126	4" x 12" x 6"	
179091	SW28RL4127	4" x 12" x 7"	

24RWE 90° Basement Head Boot



Part #	Mfg #	Size	Price
181406	SW24RWE4106	4" x 10" x 6"	
179126	SW24RWE6106	6" x 10" x 6"	

Round Collars

Round Collars

Air-Tite Flat Takeoff Collar

- Hot dipped galvanized steel
- 4 pre-drilled screw holes
- Pressure rating: +/- 4" w.g.



Part #	Mfg #	Size	Price
194039	SWATT7	7"	
194040	SWATT10	10"	
194621	SWATT12	12"	
195240	SWATT14	14"	
195241	SWATT16	16"	

AT90 Air-Tite Takeoff Collar

- 90° Bend



Part #	Mfg #	Size	Price
195256	SWAT908	8"	

97LS Long Style Flat Collar



Part #	Mfg #	Size	Price
178996	SW97LS4	4"	
178997	SW97LS5	5"	
178998	SW97LS6	6"	
178999	SW97LS7	7"	
179000	SW97LS8	8"	
179001	SW97LS10	10"	
179002	SW97LS12	12"	
178975	SW97LS14	14"	
179128	SW97LS16	16"	

97LSWD Long Style Flat Collar with Damper



Part #	Mfg #	Size	Price
178994	SW97LSWD4	4"	
178995	SW97LSWD6	6"	
181932	SW97LSWD8	8"	

97 Start Collar

- Crimped



Part #	Mfg #	Size	Price
178809	SW973	3"	
178810	SW974	4"	
178811	SW975	5"	
178812	SW976	6"	
178813	SW977	7"	
178814	SW978	8"	
178815	SW979	9"	
178816	SW9710	10"	
178817	SW9712	12"	
178818	SW9714	14"	
178819	SW9716	16"	
178820	SW9718	18"	
178821	SW9720	20"	
214884	SW9722	22"	
214747	SW9724	24"	

97NC Start Collar

- No Crimp

Part #	Mfg #	Size	Price
178822	SW973NC	3"	
178824	SW974NC	4"	
178825	SW975NC	5"	
178826	SW976NC	6"	
178827	SW977NC	7"	
178829	SW978NC	8"	
178830	SW979NC	9"	
178831	SW9710NC	10"	



Round Collars

Round Collars (Continued)

97NC Start Collar

Part #	Mfg #	Size	Price
178832	SW9712NC	12"	
178833	SW9714NC	14"	
178834	SW9716NC	16"	

97FG Ductboard Spin Collar



Part #	Mfg #	Size	Price
179142	SW97FG6	6"	
179144	SW97FG7	7"	
179145	SW97FG8	8"	
179146	SW97FG10	10"	

1051 Short Collar with Hub

Part #	Mfg #	Size	Price
232691	SW10514	4"	
232692	SW10515	5"	
219782	SW10516	6"	
232641	SW10517	7"	
223039	SW10518	8"	
232693	SW10519	9"	
223040	SW105110	10"	
223041	SW105112	12"	
232695	SW105114	14"	

1150 Crimped Long Collar with Hub

Part #	Mfg #	Size	Price
243862	SW11504	4"	
243863	SW11505	5"	
204130	SW11506	6"	
204131	SW11507	7"	
204132	SW11508	8"	
243864	SW11509	9"	
243866	SW115010	10"	
243867	SW115012	12"	
243868	SW115014	14"	

Round Collars (Continued)

1150 Crimped Long Collar with Hub

Part #	Mfg #	Size	Price
243869	SW115016	16"	

156 Spin Collar for Metal



Part #	Mfg #	Size	Price
179133	SW1566	6"	
179134	SW1568	8"	
179135	SW15612	12"	

156D Spin Collar for Metal w/ Damper



Part #	Mfg #	Size	Price
179136	SW156D6	6"	
179139	SW156D8	8"	
179140	SW156D10	10"	
179141	SW156D12	12"	

84ST Ductboard Collar 1-1/2" Tabs



Part #	Mfg #	Size	Price
188440	SW84ST6	6"	
188441	SW84ST7	7"	
188442	SW84ST8	8"	



Round Elbows

90° Round Elbows



90° 24ga Elbow

Part #	Mfg #	Size	Price
192537	SW90424	4"	
178760	SW90524	5"	
178761	SW90624	6"	
178762	SW90724	7"	
178763	SW90824	8"	
178764	SW90924	9"	
178765	SW901024	10"	
178766	SW901224	12"	
178767	SW901424	14"	
178768	SW901624	16"	
178769	SW901824	18"	

90° 26ga Elbow

Part #	Mfg #	Size	Price
178749	SW90326	3"	
178750	SW90426	4"	
178751	SW90526	5"	
178752	SW90626	6"	
178753	SW90726	7"	
178754	SW90826	8"	
178755	SW901026	10"	
178756	SW901226	12"	
178757	SW901426	14"	
178758	SW901626	16"	

90° 28ga Elbow

Part #	Mfg #	Size	Price
178746	SW90328	3"	
178747	SW90428	4"	
178745	SW901228	12"	
178748	SW901428	14"	

90° 30ga Elbow

Part #	Mfg #	Size	Price
178738	SW90330	3"	
178739	SW90430	4"	

90° Round Elbows (Continued)

90° 30ga Elbow

Part #	Mfg #	Size	Price
178740	SW90530	5"	
178637	SW90630	6"	
178741	SW90730	7"	
178742	SW90830	8"	
178743	SW90930	9"	
178744	SW901030	10"	

45° Round Elbows



45° 30ga Elbow

Part #	Mfg #	Size	Price
178770	SW45530	5"	
178771	SW45630	6"	
178772	SW45730	7"	



Round Pipe

Round Pipe

SL24 24" Joint Round Pipe



24 Gauge

Part #	Mfg #	Size	Price
178698	SWSL24524	5" x 2'	
178699	SWSL24624	6" x 2'	
178700	SWSL24724	7" x 2'	
178701	SWSL24824	8" x 2'	
178702	SWSL24924	9" x 2'	
178703	SWSL241024	10" x 2'	
178704	SWSL241224	12" x 2'	
178705	SWSL241424	14" x 2'	
178706	SWSL241624	16" x 2'	
178707	SWSL241824	18" x 2'	

26 Gauge

Part #	Mfg #	Size	Price
178680	SWSL24326	3" x 2'	
178681	SWSL24426	4" x 2'	
178682	SWSL24526	5" x 2'	
178683	SWSL24626	6" x 2'	
178684	SWSL241426	14" x 2'	
178685	SWSL241626	16" x 2'	
178687	SWSL241826	18" x 2'	

30 Gauge

Part #	Mfg #	Size	Price
178671	SWSL24330	3" x 2'	
178672	SWSL24430	4" x 2'	
178673	SWSL24530	5" x 2'	
178674	SWSL24630	6" x 2'	
178675	SWSL24730	7" x 2'	
178676	SWSL24830	8" x 2'	
178677	SWSL24930	9" x 2'	
178678	SWSL241030	10" x 2'	
178679	SWSL241230	12" x 2'	

SL60 60" Joint Round Pipe



24 Gauge

Part #	Mfg #	Size	Price
246023	SL60424	4" x 5'	

26 Gauge

Part #	Mfg #	Size	Price
178729	SWSL60426	4" x 5'	
178663	SWSL60526	5" x 5'	
178664	SWSL60626	6" x 5'	
178666	SWSL60726	7" x 5'	
178667	SWSL60826	8" x 5'	
178669	SWSL60926	9" x 5'	
178670	SWSL601026	10" x 5'	
178728	SWSL601226	12" x 5'	
178730	SWSL601426	14" x 5'	
178731	SWSL601626	16" x 5'	

30 Gauge

Part #	Mfg #	Size	Price
178633	SWSL60330	3" x 5'	
178634	SWSL60430	4" x 5'	
178635	SWSL60530	5" x 5'	
178636	SWSL60630	6" x 5'	
178658	SWSL60730	7" x 5'	
178659	SWSL60830	8" x 5'	
178661	SWSL60930	9" x 5'	
178662	SWSL601030	10" x 5'	
199472	SWSL601230	12" x 5'	



Round Pipe

SL120 120" Joint Round Pipe



30 Gauge

Part #	Mfg #	Size	Price
178727	SWSL120430	4" x 10'	
178630	SWSL120530	5" x 10'	
178631	SWSL120630	6" x 10'	
178632	SWSL120730	7" x 10'	
192529	SWSL120830	8" x 10'	



Round Takeoffs

Round Takeoffs

63A Adjustable Takeoff



Part #	Mfg #	Size	Price
178773	SW63A5	5"	
178774	SW63A6	6"	
178775	SW63A7	7"	
178776	SW63A8	8"	

62 Top Takeoff



Part #	Mfg #	Size	Price
179013	SW625	5"	
179014	SW626	6"	
179015	SW627	7"	
179016	SW628	8"	

With Slide Lock

Part #	Mfg #	Size	Price
204605	SW62SL6	6"	

63 Side Takeoff



Part #	Mfg #	Size	Price
179010	SW636	6"	
179011	SW637	7"	
179012	SW638	8"	

64 Double Top Takeoff

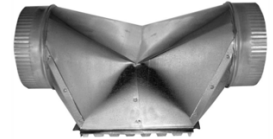

Part #	Mfg #	Size	Price
179018	SW646	6"	

2022 Fiberglass Round to Round Takeoff



Part #	Mfg #	Size	Price
201483	SW20226	6"	
201484	SW20227	7"	

EP15 Full Tab Round to Round Adjustable Takeoff



Part #	Mfg #	Size	Price
178779	SWEP1565	6" x 5"	
178780	SWEP1576	7" x 6"	
178781	SWEP1587	8" x 7"	
178782	SWEP1598	9" x 8"	
213470	SWEP1598CR	9" x 8" (Crimped)	
213468	SWEP1576CR	7" x 6" (Crimped)	
213469	SWEP1587CR	8" x 7" (Crimped)	

HT15 Half Tab Round to Round Adjustable Takeoff



Part #	Mfg #	Size	Price
190191	SWHT1564	6" x 4"	
178638	SWHT1576	7" x 6"	
178787	SWHT1587	8" x 7"	

Round Takeoffs

AT63 Air-Tite Side Takeoff (Square to Round)



Part #	Mfg #	Size	Price
179228	SWAT638	8"	
179226	SWAT6310	10"	

ATTRP Air-Tite Saddle Takeoff



Part #	Mfg #	Size	Price
197802	SWATTRP4	4"	
195321	SWATTRP5	5"	
195252	SWATTRP6	6"	
195253	SWATTRP7	7"	
195254	SWATTRP8	8"	
195747	SWATTRP9	9"	
197499	SWATTRP10	10"	
205840	SWATTRP12	12"	
232661	SWATTRP14	14"	
232662	SWATTRP16	16"	

ATT Air-Tite Takeoff



Part #	Mfg #	Size	Price
195236	SWATT4	4"	
195237	SWATT5	5"	
179253	SWATT6	6"	
179254	SWATT8	8"	
195320	SWATT18	18"	

AT90 90° Air-Tite Takeoff

Part #	Mfg #	Size	Price
195239	SWAT906	6"	

Round Takeoffs (Continued)

AT90 90° Air-Tite Takeoff

Part #	Mfg #	Size	Price
195255	SWAT907	7"	
195256	SWAT908	8"	

ATD Air-Tite Takeoff w/ Damper



Part #	Mfg #	Size	Price
195243	SWATD6	6"	
195244	SWATD7	7"	
195245	SWATD8	8"	
195247	SWATD10	10"	
193597	SWATD12	12"	

ATTRP45 Air-Tite 45° Saddle Takeoff

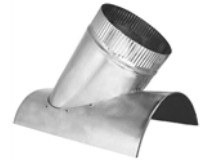

Part #	Mfg #	Size	Price
189069	SWATTRP4510	10"	

S5 Pivot Takeoff



Part #	Mfg #	Size	Price
244398	SWS55	5"	
244399	SWS56	6"	



Round Tees & Wyes

Round Tees

Free Flow Tee



24 Gauge Free Flow Tee

Part #	Mfg #	Size	Price
180537	SW1060246	6"	
180538	SW1060247	7"	
180539	SW1060248	8"	
180541	SW10601024	10"	
180542	SW10602412	12"	
180543	SW10602414	14"	

26 Gauge Free Flow Tee

Part #	Mfg #	Size	Price
180534	SW1060263	3"	
180535	SW1060264	4"	
180536	SW1060265	5"	
180688	SW1060266	6"	
180689	SW1060267	7"	
180690	SW1060268	8"	
180691	SW10602610	10"	
180692	SW10602612	12"	
180693	SW10602614	14"	

54 Regular Tee



26 Gauge Tee

Part #	Mfg #	Size	Price
192650	SW54426	4"	
192651	SW54526	5"	
192637	SW54626	6"	
192646	SW54826	8"	
192648	SW5410	10"	
192649	SW5412	12"	

Round Tees (Continued)

54 Regular Tee

26 Gauge Tee

Part #	Mfg #	Size	Price
194009	SW5414	14"	
192645	SW54726	7"	

24 Gauge Tee

Part #	Mfg #	Size	Price
179114	SW54624	6"	
179116	SW54824	8"	
179111	SW544	4"	

Round Wyes

Stub Wye



Part #	Mfg #	Size	Price
179214	SW203S444	4" x 4" x 4"	
179122	SW203S543	5" x 4" x 3"	
179125	SW203S544	5" x 4" x 4"	
179123	SW203S553	5" x 5" x 3"	
179124	SW203S663	6" x 6" x 3"	
179120	SW203S866	8" x 6" x 6"	

Wye Branch



Part #	Mfg #	Size	Price
179121	SW78866	8" x 6" x 6"	



Round Tees & Wyes

Flue Wye



Part #	Mfg #	Size	Price
192658	SW52433	4" x 3" x 3"	
192657	SW52443	4" x 4" x 3"	
192661	SW52543	5" x 4" x 3"	
193222	SW52544	5" x 4" x 4"	
192659	SW52553	5" x 5" x 3"	
192663	SW52643	6" x 4" x 3"	
192662	SW52653	6" x 5" x 3"	
193253	SW52654	6" x 5" x 4"	
192660	SW52663	6" x 6" x 3"	
193244	SW52666	6" x 6" x 6"	
192654	SW52866	8" x 6" x 6"	
192656	SW521088	10" x 8" x 8"	



Round Miscellaneous

Dampers

44 Damper (Two Quad)

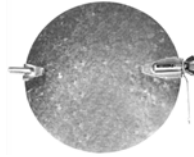

Part #	Mfg #	Size	Price
192697	SW446	6"	
178926	SW448	8"	
178927	SW4410	10"	
178928	SW4412	12"	

44S Damper (Fixed Hardware)

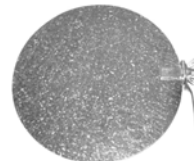

Part #	Mfg #	Size	Price
178921	SW44S4	4"	
178922	SW44S5	5"	
178923	SW44S6	6"	
178924	SW44S7	7"	
178925	SW44S8	8"	

40 Damper Section



Part #	Mfg #	Size	Price
179008	SW404	4"	
179009	SW406	6"	
238609	SW408	8"	

Draw Bands

S75 Snap Drawband



Part #	Mfg #	Size	Price
180255	SWS755	5"	

Draw Bands (Continued)

S75 Snap Drawband

Part #	Mfg #	Size	Price
180256	SWS756	6"	
180257	SWS757	7"	
180258	SWS758	8"	

96 Drawband (Gear Clamp)



Part #	Mfg #	Size	Price
178783	SW965	5"	
178784	SW966	6"	
178785	SW967	7"	

End Caps

55 End Cap

- Cleanout cap
- Crimped



Part #	Mfg #	Size	Price
178912	SW554	4"	
178913	SW555	5"	
178914	SW556	6"	
178915	SW557	7"	
178916	SW558	8"	
178917	SW559	9"	
178918	SW5510	10"	
178919	SW5512	12"	
181322	SW5514	14"	

55NC End Cap

- Cleanout cap
- No Crimp

Part #	Mfg #	Size	Price
178902	SW553NC	3"	
178903	SW554NC	4"	
178904	SW555NC	5"	
178905	SW556NC	6"	

Round Miscellaneous

End Caps (Continued)

55NC End Cap

Part #	Mfg #	Size	Price
178906	SW557NC	7"	
178907	SW558NC	8"	
178908	SW559NC	9"	
178909	SW5510NC	10"	
178910	SW5512NC	12"	
178911	SW5514NC	14"	
178651	SW5516NC	16"	

Fresh Air Intakes

36 Fresh Air Intake

- 1/4" Galvanized mesh cover



Part #	Mfg #	Size	Price
178653	SW364	4"	
178970	SW365	5"	
178971	SW366	6"	
178974	SW368	8"	

Reducers

58 3-Pc No Crimp Reducer



Part #	Mfg #	Size	Price
178943	SW5843	4" x 3"	
178944	SW5853	5" x 3"	
178945	SW5854	5" x 4"	
178946	SW5863	6" x 3"	
178947	SW5864	6" x 4"	
178948	SW5865	6" x 5"	
178949	SW5873	7" x 3"	
178950	SW5874	7" x 4"	
178951	SW5875	7" x 5"	
178952	SW5876	7" x 6"	
178953	SW5884	8" x 4"	

Reducers (Continued)

58 3-Pc No Crimp Reducer

Part #	Mfg #	Size	Price
178954	SW5885	8" x 5"	
178956	SW5886	8" x 6"	
178957	SW5887	8" x 7"	
178958	SW5896	9" x 6"	
178959	SW5897	9" x 7"	
178960	SW5898	9" x 8"	
178961	SW58106	10" x 6"	
178962	SW58107	10" x 7"	
178963	SW58108	10" x 8"	
178964	SW58109	10" x 9"	
178965	SW58128	12" x 8"	
178966	SW581210	12" x 10"	
227738	SW58146	14" x 6"	
178967	SW581412	14" x 12"	
192703	SW581614	16" x 14"	

Saddles

207 90° Vent Saddle



Part #	Mfg #	Size	Price
179019	SW2073	3"	
179020	SW2074	4"	

208 45° Vent Saddle



Part #	Mfg #	Size	Price
179022	SW2083	3"	
179023	SW2084	4"	



Round Fittings

Fresh Air Intakes

Fresh Air Intake

Part #	Mfg #	Size	Price
257951	BOE366	6"	
257952	BOE367	7"	
257953	BOE368	8"	



Wall Stack Duct

Wallstacks

WSJ Wall Stack



24" Joint

Part #	Mfg #	Size	Price
179167	SWWSJ24210	2-1/4" x 10"	
179168	SWWSJ24212	2-1/4" x 12"	
179169	SWWSJ24214	2-1/4" x 14"	
179170	SWWSJ24310	3-1/4" x 10"	
179171	SWWSJ24312	3-1/4" x 12"	
179172	SWWSJ24314	3-1/4" x 14"	

60" Joint

Part #	Mfg #	Size	Price
179164	SWWSJ60212	2-1/4" x 12"	
179165	SWWSJ60310	3-1/4" x 10"	
179166	SWWSJ60312	3-1/4" x 12"	

100" Joint

Part #	Mfg #	Size	Price
179160	SWWSJ100210	2-1/4" x 10"	
179161	SWWSJ100212	2-1/4" x 12"	
179162	SWWSJ100310	3-1/4" x 10"	
179163	SWWSJ100312	3-1/4" x 12"	
234957	SWWSJ100314	3-1/2" x 14"	

Wall Stack Fittings

Elbows

WS14 90° Flat Stack Elbow (Broadway, Longway)



Part #	Mfg #	Size	Price
178940	SWWS14212	2-1/4" x 12"	
178941	SWWS14310	3-1/4" x 10"	
178942	SWWS14312	3-1/4" x 12"	

WS15 45° Vertical Stack Angle (Shortway)



Part #	Mfg #	Size	Price
178935	SWWS15210	2-1/4" x 10"	
178936	SWWS15212	2-1/4" x 12"	
178937	SWWS15310	3-1/4" x 10"	
178938	SWWS15312	3-1/4" x 12"	
178939	SWWS15314	3-1/4" x 14"	

WS16 90° Vertical Stack Elbow (Shortway)



Part #	Mfg #	Size	Price
178929	SWWS16210	2-1/4" x 10"	
178931	SWWS16212	2-1/4" x 12"	
178932	SWWS16310	3-1/4" x 10"	
178933	SWWS16312	3-1/4" x 12"	
178934	SWWS16314	3-1/4" x 14"	

Stack Boots

24 90° Stack Boot



Part #	Mfg #	Size	Price
178984	SW242106	2-1/4" x 10" x 6"	
178985	SW242126	2-1/4" x 12" x 6"	
178986	SW243106	3-1/4" x 10" x 6"	
178987	SW243126	3-1/4" x 12" x 6"	
178988	SW243127	3-1/4" x 12" x 7"	
178989	SW243148	3-1/4" x 14" x 8"	

27 Straight Stack Boot



Part #	Mfg #	Size	Price
179189	SW272106	2-1/4" x 10" x 6"	
178979	SW272126	2-1/4" x 12" x 6"	
178980	SW273106	3-1/4" x 10" x 6"	
178981	SW273107	3-1/4" x 10" x 7"	
178982	SW273126	3-1/4" x 12" x 6"	
178983	SW273127	3-1/4" x 12" x 7"	
227724	SW273147	3-1/4" x 14" x 7"	

28 End Stack Boot



Part #	Mfg #	Size	Price
179190	SW282106	2-1/4" x 10" x 6"	
178990	SW282126	2-1/4" x 12" x 6"	
178991	SW283106	3-1/4" x 10" x 6"	
178992	SW283126	3-1/4" x 12" x 6"	
178993	SW283127	3-1/4" x 12" x 7"	

Fire Safety

AQUASAFE® Looped Fire Safety Systems

**ProPEX® LF Brass Fire Sprinkler Adapter
(PEX x PEX x FNPT)**

- Connects residential fire sprinklers to AQUAPEX tubing
- NSF and UL Approved for combining plumbing and fire sprinkler systems



Part #	Mfg #	Description	Price
132198	WILF7707575	Adapter Tee, 3/4"x3/4"x1/2"	
134020	WILF7701010	Adapter Tee, 1"x1"x1/2"	

Parts & Accessories

Fire Sprinkler Adapter Mounting Bracket

Part #	Mfg #	Description	Price
132271	WIA7750700	3/4" and 1"	

Fire Sprinkler Adapter Push-On Nut

- 25/Pk

Part #	Mfg #	Description	Price
133923	WIF7000005	Adapter Push-On Nut	

Fire Safety

Fire Safety Fittings

Viega PEX Press Tee (P x P x FPT)

- Smart connect feature
- Suitable for ViegaPEX Ultra tubing Model V5009.5, V5009.1, V5009.51
- Polymer



Part #	Mfg #	Size	Price
233376	1112VPTFS	1" x 1" x 1/2"	

Viega PEX Press 90° Elbow (P x FPT)

- Smart connect feature
- Suitable for ViegaPEX Ultra tubing Model V5009.5, V5009.1, V5009.51
- Polymer



Part #	Mfg #	Size	Price
233375	112VPPR90FS	1" x 1/2"	

Fire Safety Accessories

J-Clamp Tubing Fasteners

- For use with ViegaPEX Ultra, Viega FostaPEX, or ViegaPEX Barrier
- Plastic



Part #	Mfg #	Size	Price
233377	12VPJCLAMP	1/2"	
233379	1VPJCLAMP	1"	

Geothermal Accessories

Geothermal Flow Systems

QT Fully Enclosed Non-Pressurized Flow Center

- Removable lid for fast installation easy to fill, check flow rates and add antifreeze
- Air separation chamber continually performs purging function
- Foam insulation eliminates condensation
- Long life check valve
- Hanging handles for ease of handling and installation
- 34"H x 14-3/4"W x 7-1/2"D
- 1" Swivel (FPT) inlet/outlet
- 230/60/1, White cabinet
- Suffix:
 - M = Grundfos 26-116 pump
 - None = without pump
- 5-Year warranty



Part #	Mfg #	Description	Price
104061	1-230QFC	(1) 1/6 hp Pump, 230V	
228498	1-230QFC-L	(1) 1/6 hp Pump, 230V	
130846	1-230QFC-M	(1) 1/6 hp Pump, 230V	
104062	2-230QFC	(2) 1/6 hp Pumps, 230V	
130845	2-230QFC-M	(2) 1/6 hp Pumps, 230V, 26-116 Pump	
228500	2-230QFC-L	(2) 1/16 hp Pumps, 230V	

EA Non-Pressurized Flow Center

- Constructed of stainless steel
- Install (2) heat pumps and connect to the loop field
- Special (2) circuit flow center designed for 6 to 10 ton split coils or total 28 gpm with 2 pumps on each each circuit for one common loop field
- Outlet: 1-1/4" FPT
- Inlet: 1-1/4" MPT
- Field assembly required



Part #	Mfg #	Description	Price
100570	2-1E-A-KFC-SS	(3) 1/6 hp Pumps, 22* gpm. 3.21A/230V	26-99
101424	2-2E-A-KFC-SS.16	(4) 1/6 hp Pumps, 28* gpm. 4.28A/230V	26-99

*Standard: IPT on Inlet Connection. Union can be special ordered. *For Max Flow Use Grundfos 116F-1.8 AMPS per pump. EXTRA for 116F Pumps EA

Flow Center Accessories

WF-400N Series In-Line Flowmeter

- Acrylic rod stock polished to clear-as-glass finish
- Easy to read scales screen printed on meter body
- Adapters reinforced with aluminum stress rings for added strength
- Viton o-ring seals



Part #	Mfg #	Description	Price
270431	F41000LN-16	20 to 20 gpm, 1" FPT	

GT Flowmeter Tool

- Provides direct reading of system flow rate



Part #	Mfg #	Description	Price
055519	1-WFT17-A	17 gal with Case	

Hose Kit - Complete Installation

- Includes:
 - (2) PEVT666S
 - (2) SPE66
 - (2) RGSE10025
 - (2) RBHE1000
 - (12) WS13053
 - (2) N76-02
 - (1) BRC1PE6
 - 12' WH01-200



Part #	Mfg #	Description	Price
131431	FC-CHK-KIT1-12	Complete Installation Hose Kit	5

Hose Kit

- Closed loop



Part #	Mfg #	Size	Price
106902	HK-3/4-1-12	3/4" x 1" x 12'	
097338	HK-1-12	1" x 12'	
099080	HK-1-114-12	1" x 1-1/4" x 12'	



Geothermal Accessories

Hose

Part #	Mfg #	Description	Price
122365	WH01-200	1" x 50' 200 psi Rubber Hose Only	
122366	WH0125-150	1-1/4" x 50' 150 psi Rubber Hose Only	

Parts

Brass Barb Fitting

Part #	Mfg #	Description	Price
098750	RGSE-10725	3/4" MIP x 1" Barb Elbow with PT Port	
098749	RGSE-10025	1" MIP x 1" Barb Elbow with PT Port	
095402	BRC1PE6	1" Brass Barb x 1-1/4" Fusion Coupling	



Geothermal Accessories

Hydron Geothermal Unit Filters

Part #	Mfg #	Size	Price
149446	FILTHY233429341	23.75" x 29.75" x 1"	
149387	FILTHY273429341	27.75" x 29.75" x 1"	
149447	FILTHY277531751	27.75" x 31.75" x 1"	
149386	FILTHY273433341	27.75" x 33.75" x 1"	
149448	FILTHY273435341	27.75" x 35.75" x 1"	

Geothermal Accessories

Hose Kits

Hose Kit: AGHK5C

- 10' 1" Rubber hose
- Hose clamps
- (2) 1/4" P/T fittings
- (2) Double o-ring elbow w/ P/T ports x 1" hose barb
- (2) Double o-ring x 1" hose barb fittings
- (2) Foam elbows

Part #	Mfg #	Description	Price
176442	AGHK5C	1" Hose Kit Double O-Ring	

Hose Kit: AGHK5D

- 10' 1" Rubber hose
- Hose clamps
- (2) 1/4" P/T fittings
- (2) Double o-ring elbow w/ P/T ports x 1" hose barb
- (2) AGBA55 1" MPT x 1" barb fittings
- (2) Foam elbows

Part #	Mfg #	Description	Price
176441	AGHK5D	1" Hose Kit Double O-Ring	

Filters

Washable Filter

Part #	Mfg #	Description	Price
100790	54AF3628	36" x 28" Hydron 2000 Washable F/H042,048,050,060,072,048E,060E,072E	

Electrostatic Filter

Part #	Mfg #	Description	Price
240981	AEF1620A	16" x 20"-1" Electrostatic Filter	
135852	AEF2830A	28" x 30"-1" Electrostatic Filter	
130942	AEF2834A	28" x 34"-1" Electrostatic Filter	

Pressurized Flow Center

- Foam insulated cabinet stops condensation
- High impact polystyrene cabinet will not rust
- Fully assembled and leak tested

Part #	Mfg #	Description	Price
136101	AGFC1D	1-Pump w/Up26-99f	
136102	AGFC2D	2-Pump w/Up26-99f	

Geothermal Accessories

Auxiliary Heaters

- Single-piece design - no separately mounted control box
- Low voltage harness for direct connection to relay board
- Automatic high limit and auxiliary limit switches for over temperature protection
- Factory provided internal unit plenum allows easy installation
- Internal circuit breakers

Internal Auxiliary Heater for Use with Revolution HX Series Units

Part #	Mfg #	Description	Compatible with:	Price
130898	AHTR101B	10kW Internal Plenum Heater	1.5 - 6.0 Ton Vertical Units	
130899	AHTR151B	15kW Internal Plenum Heater	3.0 - 6.0 Ton Vertical Units	
130900	AHTR201B	20kW Internal Plenum Heater	3.5 - 6.0 Ton Vertical Units	

Internal Auxiliary Heater for Use with H Series Units

Part #	Mfg #	Description	Compatible with:	Price
111899	AHTR101A	10kW Internal Plenum Heater	1.5 - 6.0 Ton Vertical Units	
111900	AHTR151A	15kW Internal Plenum Heater	3.0 - 6.0 Ton Vertical Units	
111901	AHTR201A	20kW Internal Plenum Heater	3.5 - 6.0 Ton Vertical Units	

Internal Axillary Heater for Use with Evolution Series

Part #	Mfg #	Description	Compatible with:	Price
177581	AHTR051D	5kW Internal Plenum Heater		
177582	AHTR101D	10kW Internal Plenum Heater	1.5 - 6.0 Ton Vertical Units	
177583	AHTR151D	15kW Internal Plenum Heater	3.0 - 6.0 Ton Vertical Units	
177584	AHTR201D	20kW Internal Plenum Heater	3.5 - 6.0 Ton Vertical Units	

Storage Tanks

Part #	Mfg #	Description	Price
097519	52ST50	RST50 50 gal (was 52ST50)	
106989	52ST80	80 gal	
097518	RST30	30 gal	

Heat Pump Components

Part #	Mfg #	Description	Price
142067	AGHK5A	1" Hose Kit w/DbI O-Ring	
134262	AXDNFL01A	Downflow Kit	
148259	AP3036F	30" x 36" x 2" Poly Foam Pad	
133801	11430007001	7 Amp Breaker	

Pump Module

Part #	Mfg #	Description	Price
103198	50PK011	ABFC1A Hydron 1 Pmp Pump Module	
103199	50PK021	ABFC2A Hydron 2 Pmp Pump Module	

Geothermal Accessories

Parts & Accessories

Filter Rack/Filters

Part#	Mfg#	Description	Price
173441	AFR2830A	Filter Rack for 3T & 4T	
177579	AFR2834A	Filter Rack for 5T & 6T	

Ceiling Grilles & Registers

Residential Ceiling Diffusers

11 Duct Ring for #16 Diffuser

- All-steel construction
- For installation of #16 diffuser when not using a damper
- Golden Sand enamel finish



Part #	Mfg #	Size	Price
005097	HC1110	10"	
005098	HC1112	12"	

12 Butterfly Damper for #16 Diffuser

- All-steel construction
- Controls air volume evenly over entire #16 diffuser
- Removable knob operator for adjustment from closed to fully open
- Golden Sand enamel finish



Part #	Mfg #	Size	Price
005105	HC126	6"	
005106	HC128	8"	
005102	HC1210	10"	
005103	HC1212	12"	

16 Steel Round Diffuser

- All-steel construction
- Step-down diffuser rings deflect air stream 360 degrees
- Bright White finish



Part #	Mfg #	Size	Price
005109	HC166	6"	
005110	HC168	8"	
005107	HC1610	10"	
005108	HC1612	12"	
017523	HC1614	14"	

22 Steel Butterfly Damper for #24 Diffuser

- All-steel construction
- Used with #24 Ceiling Diffuser
- Knob control for quick adjustment (removable)
- Installation flange included
- Golden Sand enamel finish



Part #	Mfg #	Size	Price
005121	HC226	6"	
005122	HC228	8"	
005119	HC2210	10"	

24 Steel, Step Down, Square Diffuser

- All-steel construction
- Step-down face deflects air stream 360 degrees
- Bright White finish



Part #	Mfg #	Size	Price
005125	HC246	6"	
005126	HC248	8"	

Ceiling Grilles & Registers

Ceiling Air Diffusers

Airtec™ Classic Air Diffuser - Standard

- 8" x 8" Diffuser assembly



81911

81914

Part #	Mfg #	Description	Price
043588	81911	Round Grille/Damper/Box	
038122	81914	4-Way Grille/Damper/Box	

Airtec™ Classic Air Diffuser - Small

- 6" x 6" Diffuser assembly



Part #	Mfg #	Description	Price
099312	MV360S	Round Grille/Damper/Box	

Ceiling Support Flanges

Rough-In Flange

- Designed for new construction
- RCF Flashing can be fastened to rough framing
- 3/8" Lip that drops below the ceiling



Part #	Mfg #	Description	Price
038125	81965	16" on Center Framing, 9-1/4" Hole	
124324	81964	24" on Center Framing, 9-1/4" Hole	

Ceiling Grilles & Registers

Ceiling Diffusers

90 Series Step Down Round Diffuser

- Ideal for residential and light commercial applications
- Steel construction
- Attractive concentric ring deflects air stream 360°
- Soft white



Part #	Mfg #	Size	Price
122593	9006	6"	
122594	9008	8"	
122646	9010	10"	
122647	9012	12"	

Ceiling Dampers

91 Series Round Bowtie Damper

- For use with 90 series diffusers
- Field installable bowtie damper with wound ring
- Mill finish

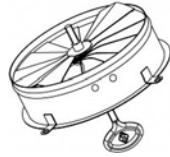

Part #	Mfg #	Size	Price
122595	9106	6"	
122597	9108	8"	
122649	9110	10"	
122650	9112	12"	

92 Series Round Ring

- Use in applications for installing round without damper
- Steel construction

Part #	Mfg #	Size	Price
122659	9206	6"	
122660	9208	8"	
123473	9210	10"	
122661	9212	12"	

Grilles & Registers

Ceiling Air Diffusers

Techgrille Diffuser

- Ceiling-mount
- Fully adjustable 6"



Part #	Mfg #	Description	Price
019280	EAG4CPU	Round, 4" Fully Adjustable	
019281	EAG6CPU	Round, 6" Fully Adjustable	
019282	EAG8CPU	Round, 8" Fully Adjustable	

CFUSA Ceiling/Wall Fit

Part #	Mfg #	Size	Price
019278	EACF6	6"	

Accessories

Part #	Mfg #	Description	Price
049689	EAQMF	6" Quick Mount Fitting	

Commercial Grilles & Registers

Commercial T-Bar Accessories

3800 Round Butterfly Damper for T-bar Diffusers

- Adjustable butterfly damper with removable handle (included)
- For use with 5400 and 6400 Series collars
- Golden Sand finish



Part #	Mfg #	Size	Price
005154	HC3806	6"	
005155	HC3807	7"	
005156	HC3808	8"	
005158	HC3810	10"	
005159	HC3812	12"	
005160	HC3814	14"	

5400PP Push Pins for 5400 Series Ring Collar

- Attaches 5400 collar to molded fiberglass back for the following products:
- 659TI 1 1/4" long
- PFTI 1 1/4" diameter head
- RENP, RENPS/RENPS R6, RE5TI, 96AFBTI, REN4 HVS R6, SRET/SRET R6



Part#	Mfg#	Description	Price
051009	HC5400PP	For 5400 Series	

5400 Galvanized Steel Ring Collar

- Unique snap-in design for easy installation
- 2" high collar permits easy flex connections
- Bead on collar improves the strength and provides retention for flexible duct connections
- 14" collar is mounted to diffuser at factory for steel back panels only.



Part #	Mfg #	Size	Price
005200	HC5406	6"	
005201	HC5407	7"	
005202	HC5408	8"	
005204	HC5410	10"	
005205	HC5412	12"	
005206	HC5414	14"	

SMF Surface Mount Frame for T-bar Diffusers

- Aluminum construction
- Permits installation of standard T-Bar diffusers in a plaster ceiling
- Accepts standard T-Bar diffusers
- Bright White finish

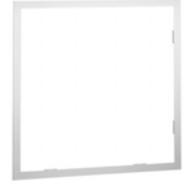

Part #	Mfg #	Size	Price
185026	HCSMF1212	12" x 12"	

Commercial T-Bar Surfaire/Renovator Diffusers

444 Aluminum Renovator Series Diffuser

- Unique deflector apertures
- Formed galvanized steel back panel
- Frame includes four seismic safety connections
- Back plate covered with glass fiber insulation to reduce condensation
- Aluminum foil vapor barrier protects insulation from harmful effects of condensation
- Insulation prescored to accommodate collar size desired
- Accepts snap-in collar (5400 Series) (6" to 12")
- 444 - 14" collar is factory-installed
- Utilizes butterfly damper (3800 Series) inserted in collar
- Bright White finish

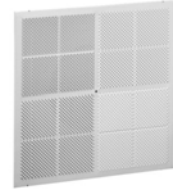

Part #	Mfg #	Size	Price
005194	HC444	23-3/4" x 23-3/4"	

Commercial T-Bar Fixed-pattern Diffusers

DPD Steel Plate Diffuser, 6-14" Fixed Collars

- Aesthetically appealing, single-face plate design
- 360 degree air diffusion pattern
- Detachable face plate
- 2" fixed collar
- Optional R6 insulated back (DPD R6)
- White finish



Part #	Mfg #	Size	Price
184998	HCDPD6	6"	
185000	HCDPD8	8"	
185001	HCDPD10	10"	
185003	HCDPD12	12"	

Commercial Grilles & Registers

FPDSteel/Aluminum 4-way Diffuser, 2 Cone Design, 6-14" Fixed Collars

- Steel construction
- AFPD is Aluminum construction
- Provides high air volume delivery
- 360-degree air diffusion
- Two-cone fixed core
- Fixed collar 6" to 14"
- Unique 2" high collar permits easy flex connections
- Utilizes butterfly damper (3800 Series) inserted in collar; order separately
- Damper adjustable through face
- Formed back panel
- Bright White finish
- FPDR6 features insulated back



Part #	Mfg #	Size	Price
184981	HCFPD6	6"	
184982	HCFPD8	8"	
184983	HCFPD10	10"	
184984	HCFPD12	12"	
184986	HCFPD14	14"	

FPD12 Steel 4-way Diffuser for 1' x 1' T-bar Ceiling, 6-8" Fixed Collar

- Steel construction
- 360-degree air diffusion
- Two-cone fixed core
- Fixed collar
- Removable plug for damper
- Used with SMF for surface-mount applications
- Bright White finish



Part #	Mfg #	Size	Price
184987	HCFPD126	6"	
184988	HCFPD128	8"	

FPD3 Steel 4-way Diffuser, 3 Cone Design, 6-14" Fixed Collars

- Steel construction
- Provides high air volume delivery
- 360-degree air diffusion
- Three cone fixed core
- Fixed collar 6" to 14"
- Unique 2" high collar permits easy flex connections
- Utilizes butterfly damper (3800 Series) inserted in collar
- Damper adjustable through face
- Formed steel back panel
- Bright White finish
- FPD3 R6 features insulated back



Part #	Mfg #	Size	Price
029666	HCFPD308	8"	
029667	HCFPD310	10"	

HVS Steel High Volume Supply Diffuser, 4-way, 3 Cone Design, Molded Insulated Back

- Steel construction
- Provides high air volume delivery
- 360-degree air diffusion
- Formed back panel
- Fixed core
- Fiberglass insulation blanket with foil vapor barrier to minimize condensation on HVS
- Insulation prescored to accommodate collar size desired
- R6 molded fiberglass back on HVS R6; use 5400 with 540PP
- Accepts unique 2' high snap-collar (5400 series) (6" to 12")
- Utilizes butterfly damper (3800 Series) inserted in collar—order separately
- Bright White finish
- HVS14-14" collar factory-installed



Part #	Mfg #	Size	Price
005080	HCHVS2424	24" x 24"	

Commercial Grilles & Registers

Commercial Registers & Grilles

821 Steel Register Vertical Fins, MS damper

- All-steel construction
- Vertical, adjustable face bars
- Horizontal multi-shutter valve
- Bright White finish



Part #	Mfg #	Size	Price
024742	HC82166	6" x 6"	
184729	HC82188	8" x 8"	
005317	HC821104	10" x 4"	
005318	HC821106	10" x 6"	
184730	HC821108	10" x 8"	
062220	HC8211010	10" x 10"	
005319	HC821124	12" x 4"	
005320	HC821126	12" x 6"	
005321	HC821128	12" x 8"	
184732	HC8211210	12" x 10"	
054931	HC8211212	12" x 12"	
005323	HC821144	14" x 4"	
005324	HC821146	14" x 6"	
005325	HC821148	14" x 8"	
184734	HC8211412	14" x 12"	
005322	HC8211414	14" x 14"	
005327	HC821166	16" x 6"	
005328	HC821168	16" x 8"	
005326	HC8211616	16" x 16"	
051585	HC821186	18" x 6"	
115183	HC821188	18" x 8"	
031309	HC8211812	18" x 12"	
184740	HC8211818	18" x 18"	
034182	HC821206	20" x 6"	
005329	HC821208	20" x 8"	
032180	HC8212010	20" x 10"	
184742	HC8212016	20" x 16"	
005331	HC821248	24" x 8"	
184743	HC8212410	24" x 10"	
005330	HC8212412	24" x 12"	
063703	HC8213010	30" x 10"	
184746	HC8213016	30" x 16"	

92VHV Steel Double Deflection Register, OBD damper

- All-steel construction
- Vertical front bars
- Horizontal second bars
- Adjustable face bars may be set to any desired deflection
- Opposed-blade damper
- Larger sizes available in multiple-piece construction
- Bright White finish

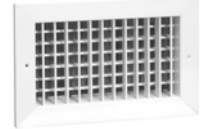

Part #	Mfg #	Size	Price
020316	HC92VHV126W	12" x 6"	

94A — Steel Return Air Grille, 35-degree Fixed Blade

- All-steel construction
- 3/4" spaced fins set at 35 degree, horizontal face bars
- Larger sizes available in multiple-piece construction
- Also available as 94AT T-Bar Return Grille
- Bright White finish



Part #	Mfg #	Size	Price
025524	HC94A1212	12" x 12"	
026458	HC94A2020	20" x 20"	

RHF45 Aluminum Return Air Filter Grille, 45-degree Fixed Blade

- Extruded aluminum construction
- Horizontal bars at 45 degrees
- Hinged on the bottom edge
- Accommodates standard 1" thick disposable filter (not included)
- Filter grilles equipped with plastic slide latch
- Bright White or Satin Anodized finish



Part #	Mfg #	Size	Price
197825	HCRHF452424W	24" x 24"	

Commercial Grilles & Registers

Commercial T-Bar Perforated Supply/Returns

RENPS Steel/Aluminum Perforated Supply

- Perforated steel face with deflector
- Molded fiberglass back panel available in R4.2 or R6
- Accepts 6" to 14" unique tab collar (6400 series) or 6" to 16" unique snap-in collar (5400 and 5400PP series); also accepts standard spin-in collar
- ARENPS constructed with aluminum face
- Bright White finish

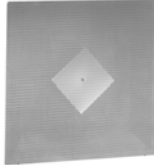

Part #	Mfg #	Size	Price
030255	HCRENPS	24" x 24"	

Commercial T-Bar Return Air Filter Grilles

659T Steel Lanced Return Air Filter Grille, 1/3" Fin Spacing

- Steel construction
- Lanced-face design with 1/3" blade spacing
- Flush, removable face with concealed latches and hinges can be installed in any direction
- Uses standard 1" disposable filters (not furnished)
- Bright White finish
- Available sizes



Part #	Mfg #	Size	Price
005278	HC659T2020	20" x 20"	

Commercial T-Bar Return Air Grilles

RE5T Aluminum Eggcrate Return Air Grille

- All aluminum construction
- Eggcrate style face
- Mount flush with T-Bar ceilings
- Bright White or Mill Aluminum finish

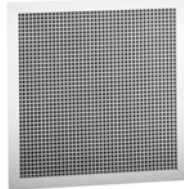

Part #	Mfg #	Size	Price
185005	HCRE5T4824	48" x 24"	

Commercial Ceiling Diffusers

SRE Steel Louvered Ceiling Diffuser, Flat Margin

- Steel construction
- Removable core
- Flat (extended) margin style
- Optional opposed-blade damper available for field installation, SR7
- Bright White enamel finish



Part #	Mfg #	Size	Price
185030	HCSRE1212	12" x 12"	

RE5TI Eggcrate Return Grille with Insulated Back

- All aluminum construction
- Eggcrate style face
- R4.2 molded fiberglass back
- Accepts 6" to 14" unique tab collar (6400 series) or 6" to 16" unique snap-in collar (5400 and 5400PP series); also accepts standard spin-in collar
- Bright White or Mill Aluminum finish

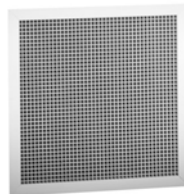

Part #	Mfg #	Size	Price
005091	HCRE5TI	23-3/4" x 23-3/4"	

Molded Fiberglass Plenum-Backed T-Bar Back

- Deep plenum cavity
- "R" Values Of 4.2, 6.0 and 8.0
- UI 181 erosion and impact test
- 6"-16" Diameter pre-scored back allows neck to be determined at time of installation
- Bonded foil vapor barrier minimizes condensation



Part #	Mfg #	Size	Price
240046	HC010147	24" x 24"	

Commercial Grilles & Registers

Commercial Spiral Diffusers

SV Aluminum Single Deflection Spiral Diffuser

- Extruded aluminum construction
- Single row of individually adjustable vertical blades for horizontal air-deflection control
- Available as diffuser only or diffuser with air scoop (SV3)
- Optional face adjustable scoop to direct airflow
- Counter-sunk screw holes
- Bright White and Satin Anodized finishes



Part #	Mfg #	Size	Price
233102	HCSV11048	8"	
233105	HCSV110410	10"	
233106	SV110412	12"	
233107	HCSV110414	14"	
233108	HCSV110418	18"	

Commercial Grilles & Registers

Commercial Grilles

106 FG Series T-Bar Fiberglass Back Filter Grille

- Return air T-Bar lay-in filter grille
- Removable louvered 20 gauge steel face
- 7/8" Fiberglass back plenum cut holes
- Seismic support holes
- Soft white



Part #	Mfg #	Size	Price
123390	106FG	20" x 20"	

111 Series T-Bar Fiberglass Back Grille

- Perforated face
- Seismic support hangers
- One size fits 6" - 16"

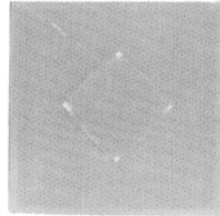

Part #	Mfg #	Size	Price
124378	111	24" x 24"	

USR34 Universal Spiral Grille

- Double deflection adjustable blade grille
- Front blades are parallel to shortest dimension
- Back blades are parallel to longest dimension
- 4-way airflow adjustment
- Galvanized steel construction
- Nylon bushings on adj. blades prevent metal on metal rattle



Part #	Mfg #	Size	Price
184527	USR34-FS-12X3	12" x 3"	
158617	USR34-FS-12X4	12" x 4"	
158618	USR34-FS-12X6	12" x 6"	
158619	USR34-FS-14X6	14" x 6"	
158620	USR34-FS-16X4	16" x 4"	
158622	USR34-FS-18X6	18" x 6"	
158625	USR34-FS-20X6	20" x 6"	
158626	USR34-FS-24X4	24" x 4"	

Commercial Diffusers

600T Series Aluminum Lattice T-Bar Diffuser

- 1/2" x 1/2" x 1/2" Aluminum lattice return air T-Bar lay-in grille
- .055 T6 Extruded aluminum frame
- Square collar
- For 22" x 22" duct
- Soft white

Part #	Mfg #	Size	Price
126891	600T2424	24" x 24"	

601T Series Aluminum Lattice T-Bar Diffuser

- 1/2" x 1/2" x 1/2" Aluminum lattice return air T-Bar lay-in grille
- .055 T6 Extruded aluminum frame
- Fiberglass back (2" x 2" only, collar by others)
- For 22" x 22" duct
- Soft white

Part #	Mfg #	Size	Price
123571	601T2424	24" x 24"	

FTD Series Fixed T-Bar High Volume Diffuser

- Galvaneal steel face designed for high air volume delivery
- 360° Air diffusion
- No labor collar
- Seismic support hangers
- Soft white



Part #	Mfg #	Size	Price
123411	FTD6	24" x 24" x 6"	
123412	FTD8	24" x 24" x 8"	
123408	FTD10	24" x 24" x 10"	
123409	FTD12	24" x 24" x 12"	
123410	FTD14	24" x 24" x 14"	

Commercial Grilles & Registers

FTD-INS Series Fixed T-Bar High Volume Diffuser

- Includes fiberglass backed plenum insulation
- Galvaneal steel face designed for high air volume delivery
- 360° Air diffusion
- No labor collar
- Seismic support hangers
- Soft white



Part #	Mfg #	Size	Price
123422	FTD-INS6	24" x 24" x 6"	
123423	FTD-INS8	24" x 24" x 8"	
123414	FTD-INS10	24" x 24" x 10"	
123419	FTD-INS12	24" x 24" x 12"	
123420	FTD-INS14	24" x 24" x 14"	

HVD Series 3-Cone T-Bar Diffuser

- Cones are 1-piece stamped construction providing a clean, smooth style
- 360° Air diffusion
- Excellent for variable air volume applications
- Hinged-down core for easy access
- No labor collar
- Seismic support hangers
- Soft white



Part #	Mfg #	Size	Price
141067	HVD6	24" x 24" x 6"	
140762	HVD8	24" x 24" x 8"	

Commercial Dampers

BD Series Bowtie Damper

- For use with T-bars
- Field installable butterfly damper
- Mill finish



Part #	Mfg #	Size	Price
123406	BD-6	6"	
123407	BD-8	8"	
123403	BD-10	10"	
123404	BD-12	12"	
123405	BD-14	14"	

Commercial Grilles & Registers

Ventilation Diffusers

Air Return Diffuser

- Egg crate lay-in louver
- White polystyrene 1/2" open cell grid

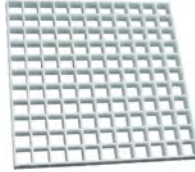

Part #	Mfg #	Size	Price
192724	650-100	2' x 4' x 1/2"	
186187	650-300	2' x 2' x 1/2"	

Deflectors

Dryer Venting

Supurr-Vent® Louvered Vent Hood



Part #	Mfg #	Size	Color	Price
108462	HS6B	6"	Brown	

Specialty Vents/Hoods

Fresh Air Intake Vent

- Includes molded 1/4" plastic screen



Part #	Mfg #	Size	Color	Price
104250	HSM6B	6"	Brown	

Undereve® Vent

For Clothes Dryer or Bathroom Exhaust Venting

- Helps prevent cold air from entering the home
- Helps prevent birds from nesting in the vent and rodents from entering the home
- Designed to vent clothes dryer exhaust, bathroom exhaust and any other venting up to 5" in diameter
- Easy installation: assemble vent, connect duct to opening made in eave, attach Undereve® vent



Part #	Mfg #	Description	Price
045755	EVE/6	White Vent - Case/6	

Floor Grilles & Registers

Residential Floor Registers & Grilles

210 Heavy Duty Steel Floor Register

- All-steel construction
- Provides firm, smooth surface
- Extremely rigid
- Free area averages over 75%
- Toe-operated valve control
- Golden Sand enamel finish



Part #	Mfg #	Size	Price
005117	HC210810GS	8" x 10"	
005118	HC210812GS	8" x 12"	
005111	HC2101012GS	10" x 12"	
026164	HC2101214GS	12" x 14"	

265 Heavy Duty Steel Floor Grille

- All-steel construction
- Provides firm, smooth surface
- Extremely rigid
- Free area averages over 75%
- Golden Sand enamel finish



Part #	Mfg #	Size	Price
005136	HC265410GS	4" x 10"	
005143	HC265612GS	6" x 12"	
005144	HC265614GS	6" x 14"	
042407	HC265616GS	6" x 16"	
005146	HC265624GS	6" x 24"	
005147	HC265630GS	6" x 30"	
032870	HC265810	8" x 10"	
005148	HC265812GS	8" x 12"	
005149	HC265814GS	8" x 14"	
088042	HC265816GS	8" x 16"	
020905	HC265820GS	8" x 20"	
005150	HC265824GS	8" x 24"	
005151	HC265830GS	8" x 30"	
005129	HC2651012GS	10" x 12"	
037475	HC2651014GS	10" x 14"	
184412	HC2651018GS	10" x 18"	
019796	HC2651020GS	10" x 20"	
005130	HC2651024GS	10" x 24"	
005131	HC2651030GS	10" x 30"	
005127	HC265GS1212	12" x 12"	
005132	HC2651214GS	12" x 14"	
050049	HC2651220GS	12" x 20"	
005133	HC2651224GS	12" x 24"	

Residential Floor Registers & Grilles (Continued)

265 Heavy Duty Steel Floor Grille

Part #	Mfg #	Size	Price
005134	HC2651230GS	12" x 30"	
020973	HC2651414GS	14" x 14"	
184413	HC2651420GS	14" x 20"	
184414	HC2651424GS	14" x 24"	
005135	HC2651430GS	14" x 30"	
184415	HC2651616GS	16" x 16"	
005128	HC2651620GS	16" x 20"	
020987	HC2651624GS	16" x 24"	
184416	HC2651818GS	18" x 18"	
027023	HC2651824GS	18" x 24"	
019134	HC2651830GS	18" x 30"	
053515	HC2652020GS	20" x 20"	

420 Steel Toe Kick

- All-steel construction
- Heavy-gauge, stamped face
- Multi-angle fins
- Golden Sand or Bright White enamel finish



Part #	Mfg #	Size	Price
005175	HC42010214	10" x 2-1/4"	
005177	HC42012214	12" x 2-1/4"	
005180	HC42014214	14" x 2-1/4"	
184432	HC420104	10" x 4"	
005176	HC420102GS	10" x 2"	
005178	HC42012214GS	12" x 2-1/4"	
005181	HC42014214GS	14" x 2-1/4"	
184431	HC420104GS	10" x 4"	
184434	HC420124GS	12" x 4"	
116509	HC420144GS	14" x 4"	

Floor Grilles & Registers

421 Steel Floor Register

- All-steel construction
- Multi-angle fin setting
- Rolled fin for strength and safety
- Welded construction
- Foot-operated dial control
- Heavy-gauge, stamped face
- Golden Sand or Bright White enamel finish



462 Steel 2 Ft Baseboard Diffuser

- All-steel construction
- Two-foot length
- Airfoil valves reduce resistance
- Equal air distribution over the length of the diffuser
- Face can be easily removed
- Golden Sand or Bright White enamel finish



Part #	Mfg #	Size	Price
055429	HC42148GS	4" x 8"	
005183	HC42121410GS	2-1/4" x 10"	
005185	HC42121412GS	2-1/4" x 12"	
005187	HC42121414GS	2-1/4" x 14"	
005189	HC421410GS	4" x 10"	
005191	HC421412GS	4" x 12"	
005193	HC421414GS	4" x 14"	
184436	HC421610GS	6" x 10"	
046343	HC421612GS	6" x 12"	
184437	HC421614GS	6" x 14"	
005182	HC42121410	2-1/4" x 10"	
005184	HC42121412	2-1/4" x 12"	
005186	HC42121414	2-1/4" x 14"	
005188	HC421410	4" x 10"	
005190	HC421412	4" x 12"	
005192	HC421414	4" x 14"	
027852	HC421610	6" x 10"	
045827	HC421612	6" x 12"	

Part #	Mfg #	Size	Price
048228	HC462GS	2'	
005195	HC462	2'	

407 Steel Baseboard Return 4.5" Ht

- All-steel construction
- Complementary return air grille for #406 supply
- Golden Sand or Bright White enamel finish



Part #	Mfg #	Size	Price
005165	HC407GS	18"	

657 Steel Baseboard Return

- One-piece steel construction
- 1/3" spaced fins set at 20 degrees
- 7/8" margin turnback
- Exceptional free area
- Install with fins upward or downward for best duct concealment
- Complementary return air grille for #654 supply or #664 supply
- Golden Sand or Bright White enamel finish



Part #	Mfg #	Size	Price
005265	HC657146	14" x 6"	
005267	HC657148	14" x 8"	
005271	HC657306	30" x 6"	
005272	HC657306GS	30" x 6"	

Residential Baseboard Registers & Grilles

406 Steel Baseboard Diffuser 4.5" Ht

- All-steel construction
- Blankets wall or window area
- Golden Sand or Bright White enamel finish
- 406 18" Shown

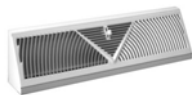

Part #	Mfg #	Size	Price
074588	HC40615	15"	
005162	HC406	18"	
005163	HC406GS	18"	
196111	HC406GS15	15"	

658 Steel Baseboard Return, Base Projection

- All-steel construction
- 1/3" spaced fins set at 20 degrees
- Complementary return air grille for #655 supply
- Bright White enamel finish



Part #	Mfg #	Size	Price
035916	HC658308W	30" x 8"	
005276	HC658306	30" x 6"	

Floor Grilles & Registers

664 Steel Baseboard Register, Multi-Shutter Damper

- All-steel construction
- 1/3"-spaced fins set at 20 degrees
- 7/8" margin turnback
- 1-5/8" depth when fully opened
- Exceptional free area
- Ideal for shallow duct installations
- Multi-shutter valve
- Bright White enamel finish

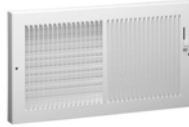

Part #	Mfg #	Size	Price
184516	HC66486	8" x 6"	

Floor Grilles & Registers

Floor Grilles

1165 Series Triangular Baseboard Return Air Grille

- 1/2" Spacing dual angular louvers

Part #	Mfg #	Size	Color	Price
123238	1165W1406	14" x 6"	White	
123239	1165W2406	24" x 6"	White	
123240	1165W3006	30" x 6"	White	

1600 Series Floor Grille

- Steel honeycomb construction
- Flush core and frame provides smooth surface
- Free area equals more than 75% of nominal size
- Driftwood tan



Part #	Mfg #	Size	Price
123675	16000424	4" x 24"	
122662	16000612	6" x 12"	
122663	16000614	6" x 14"	
122664	16000624	6" x 24"	
122665	16000630	6" x 30"	
122666	16000814	8" x 14"	
122667	16000824	8" x 24"	
122668	16001012	10" x 12"	
122670	16001214	12" x 14"	
123873	16001230	12" x 30"	
125839	16001420	14" x 20"	

1075 Series Heavy Duty Return Air Grille

- 1/2" Spacing dual angular louvers
- 20 and 22 Gauge cold roll steel
- Mullions are reinforced with stiffeners for greater strength
- For applications where greater air volume is required
- Install with louvers in up or down position for best duct concealment
- Countersunk mounting holes for flush appearance with color matching Phillips posi-drive screws
- Soft white



Part #	Mfg #	Size	Price
149124	10751204	12" x 4"	

1133 Series Baseboard Return Air Grille

- Stamped face
- 1/3" Spacing dual angular louvers

Part #	Mfg #	Size	Color	Price
124305	1133B1406	14" x 6"	Brown	
123791	1133W1406	14" x 6"	White	
123795	1133W3006	30" x 6"	White	

TD Series Toe Space Grille with Damper

- Formed cold roll steel
- Ideal for return air in the toe space areas between kitchen cabinets, stair risers, built-in vanities, etc
- Countersunk mounting holes for flush appearance with color matching Phillips posi-drive screws
- Multi-shutter damper



Part #	Mfg #	Size	Color	Price
123575	TD21412W	2-1/4" x 12"	White	

Floor Registers

855 Series Baseboard Register

- Stamped face
- Steel construction
- Fan shaped 1/2" spaced louvers
- Steel multi-shutter damper
- 7/8" Margin turnback
- All component parts, rivets, linkage and handle enclosed in valve to assure trouble-free operation
- Soft white



Part #	Mfg #	Size	Price
123569	8551206	12" x 6"	

Floor Diffusers

325 Series Stamped Perimeter Floor Diffuser

- Cold rolled steel construction
- Opposed blade damper standard
- All component parts, rivets, linkage, and handle are enclosed in the valve to assure trouble-free operation
- Locking screw provision concealed beneath the floor for tamper proof settings
- Sold in carton quantity only



Part #	Mfg #	Size	Color	Price
123510	3250410B	4" x 10"	Brown	

Floor Grilles & Registers

Floor Diffusers (Continued)

325 Series Stamped Perimeter Floor Diffuser

Part #	Mfg #	Size	Color	Price
123509	3250410W	4" x 10"	White	
123043	3250412B	4" x 12"	Brown	
123042	3250412W	4" x 12"	White	

350 Series Stamped Deluxe Floor Diffuser

- Heavy-gauge cold-rolled steel
- Louvers designed with rolled rib for maximum strength and rigidity
- Unique fan-shaped air patterns lends to both heating and air conditioning applications
- Opposed blade damper standard on 4" widths
- Parallel blade damper on 6" widths and larger
- All component parts, rivets, linkage, and handle are enclosed in the valve to assure trouble-free operation



Part #	Mfg #	Size	Color	Price
122941	35021410B	2-1/4" x 10"	Brown	
122940	35021410W	2-1/4" x 10"	White	
122942	35021412B	2-1/4" x 12"	Brown	
122943	35021412W	2-1/4" x 12"	White	
122944	35021414B	2-1/4" x 14"	Brown	
122945	35021414W	2-1/4" x 14"	White	
141396	3500414B	4" x 14"	Brown	
122951	3500414W	4" x 14"	White	



Grille & Register Accessories

Accessories

Handle

Part #	Mfg #	Description	Price
130875	55	Bow-Tie Plastic Handle	

Screws and Bits

Part #	Mfg #	Description	Price
124653	C	8" x 2" Phillips Panhead Baseboard Screw	

Insulation

Part #	Mfg #	Description	Price
128739	FBP	Fiberglass Back Plenum	

Paint

Part #	Mfg #	Description	Price
136689	45	Driftwood Tan Spray Paint, 4.5 oz	

Sidewall Grilles & Registers

Residential Sidewall Registers & Grilles

A613MS Aluminum Curved Blade Register 3 Way

- Aluminum face/fin construction
- For sidewall or ceiling application
- Three-way deflection
- Three-way air pattern
- Adjustable curved blades increase deflection control
- Galvanized multi-shutter valve or opposed-blade damper
- Bright White finish



Part #	Mfg #	Size	Price
184953	HCA613MS88	8" x 8"	

A614MS Aluminum Curved Blade Register 4 Way

- Aluminum face/fin construction
- For sidewall or ceiling application
- Four-way deflection
- Four-way air pattern
- Adjustable curved blades increase deflection control
- Galvanized multi-shutter valve or opposed-blade damper
- Bright White finish



Part #	Mfg #	Size	Price
184956	HCA614MS1010	10" x 10"	

A618MS Aluminum Straight Blade, Vertical Fin Register

- Aluminum face/fin construction
- Adjustable straight fins provides individual deflection control
- Stamped-face margins eliminate mitered corners and rough edges
- Galvanized multi-shutter valve or opposed-blade damper
- Bright White finish

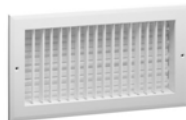

Part #	Mfg #	Size	Price
184957	HCA618MS104	10" x 4"	
184958	HCA618MS106	10" x 6"	
184962	HCA618MS124	12" x 4"	
184963	HCA618MS146	14" x 6"	

650 Steel Return Air Grille, 1/3" Fin Spacing

- Aluminum construction (A650)
- All-steel construction (650)
- 1/3" spaced fins set at 20 degrees
- Exceptional free area
- 5/16" Margin Turnback
- Bright White finish



Part #	Mfg #	Size	Price
073815	HC65064	6" x 4"	
184444	HC65066	6" x 6"	
184445	HC650614	6" x 14"	
005262	HC65088	8" x 8"	
055788	HC650814	8" x 14"	
005212	HC650104	10" x 4"	
005213	HC650106	10" x 6"	
005211	HC6501010	10" x 10"	
184446	HC6501014	10" x 14"	
005217	HC650124	12" x 4"	
005218	HC650126	12" x 6"	
005219	HC650128	12" x 8"	
005215	HC6501212	12" x 12"	
005223	HC650144	14" x 4"	
005224	HC650146	14" x 6"	
005225	HC650148	14" x 8"	
005220	HC6501410	14" x 10"	
005221	HC6501412	14" x 12"	
005222	HC6501414	14" x 14"	
021112	HC6501416	14" x 16"	
026359	HC6501420	14" x 20"	
184448	HC6501424	14" x 24"	
017157	HC6501430	14" x 30"	
005229	HC650166	16" x 6"	
005230	HC650168	16" x 8"	
005226	HC6501612	16" x 12"	
005228	HC6501616	16" x 16"	
064671	HC6501620	16" x 20"	
184449	HC6501624	16" x 24"	
005235	HC650188	18" x 8"	
005232	HC6501816	18" x 16"	
005233	HC6501818	18" x 18"	
030938	HC6501824	18" x 24"	
005242	HC650206	20" x 6"	
005243	HC650208	20" x 8"	
005236	HC6502010	20" x 10"	

Sidewall Grilles & Registers

**Residential Sidewall Registers & Grilles
(Continued)**

650 Steel Return Air Grille, 1/3" Fin Spacing

Part #	Mfg #	Size	Price
005237	HC6502012	20" x 12"	
005238	HC6502014	20" x 14"	
005239	HC6502016	20" x 16"	
005240	HC6502020	20" x 20"	
027499	HC6502024	20" x 24"	
016859	HC6502025	20" x 25"	
184451	HC6502030	20" x 30"	
005251	HC650246	24" x 6"	
005252	HC650248	24" x 8"	
005244	HC6502410	24" x 10"	
005245	HC6502412	24" x 12"	
005246	HC6502414	24" x 14"	
005247	HC6502416	24" x 16"	
051527	HC6502418	24" x 18"	
005248	HC6502420	24" x 20"	
005249	HC6502424	24" x 24"	
184452	HC6502430	24" x 30"	
005259	HC650306	30" x 6"	
005260	HC650308	30" x 8"	
005253	HC6503010	30" x 10"	
005254	HC6503012	30" x 12"	
005255	HC6503014	30" x 14"	
033107	HC6503016	30" x 16"	
005256	HC6503020	30" x 20"	
005257	HC6503024	30" x 24"	
031094	HC6503030	30" x 30"	
057267	HC6503610	36" x 10"	
192979	HC650W104	10" x 4"	

651 Steel 1-way Register, Plate Damper, 1/3" Fin Spacing

- All-steel construction
- 1/3" spaced fins set at 20 degrees
- Volume-control damper
- Bright White finish



Part #	Mfg #	Size	Price
028561	HC651106	10" x 6"	
184461	HC651146	14" x 6"	

659 Steel Return Air Filter Grille, 1/3" Fin Spacing

- All-steel construction
- 1/3" spaced fins set at 20 degrees
- Effectively conceals filter
- Use standard 1" thick disposable filters (not included)
- Removable face for easy installation and cleaning
- Equipped with adjustable filter retainers
- Bright White finish



Part #	Mfg #	Size	Price
184475	HC6592024	20" x 24"	
047973	HC6591616	16" x 16"	
193329	HC6591424	14" x 24"	
025315	HC6591212	12" x 12"	
005280	HC6591414	14" x 14"	
029265	HC6591420	14" x 20"	
005281	HC6591425	14" x 25"	
005282	HC6591620	16" x 20"	
029132	HC6591625	16" x 25"	
184471	HC6591818	18" x 18"	
184473	HC6592010	20" x 10"	
184474	HC6592012	20" x 12"	
005283	HC6592014	20" x 14"	
005284	HC6592016	20" x 16"	
005285	HC6592020	20" x 20"	
005286	HC6592025	20" x 25"	
184476	HC6592030	20" x 30"	
036378	HC6592412	24" x 12"	
074898	HC6592414	24" x 14"	
024434	HC6592418	24" x 18"	
005287	HC6592424	24" x 24"	
030876	HC6592514	25" x 14"	
005288	HC6592516	25" x 16"	
005289	HC6592520	25" x 20"	
005290	HC6592525	25" x 25"	
024640	HC6593012	30" x 12"	
037039	HC6593014	30" x 14"	
005291	HC6593020	30" x 20"	
184484	HC6593024	30" x 24"	
033556	HC6593030	30" x 30"	
197487	HC659W1010	10" x 10"	
197886	HC659W306	30" x 6"	

Sidewall Grilles & Registers

661 Steel 2-way Register, MS damper, 1/3" Fin Spacing

- Stamped aluminum construction (A661)
- All-steel construction (661)
- Used for ceiling or sidewall installations
- For heating or cooling
- Ideal for shallow duct installations
- Two-way deflection
- 1/3" spaced fins set at 20 degrees
- Galvanized multi-shutter valve
- 1-5/8" depth when fully opened
- Interlocking valve louvers for positive shut-off
- Bright White finish



Part #	Mfg #	Size	Price
005308	HC66184	8" x 4"	
005309	HC66186	8" x 6"	
023966	HC66188	8" x 8"	
005295	HC661104	10" x 4"	
005297	HC661106	10" x 6"	
005298	HC661108	10" x 8"	
005299	HC661124	12" x 4"	
005301	HC661126	12" x 6"	
005302	HC661128	12" x 8"	
005303	HC661144	14" x 4"	
005304	HC661146	14" x 6"	
005305	HC661148	14" x 8"	
005306	HC661168	16" x 8"	
034539	HC661206	20" x 6"	
197453	HC661MFL104	10" x 4"	
029170	HC661WFL124	12" x 4"	

672 Steel Return Air Grille, 1/2" Fin Spacing

- All-steel construction
- 1/2" spaced fins set at 40 degrees
- Exceptional free area
- 5/16" Margin Turnback
- Bright White finish



Part #	Mfg #	Size	Price
196547	HC672W188	18" x 8"	
184554	HC6721625	16" x 25"	
196092	HC672W3612	36" x 12"	
061628	HC67288	8" x 8"	
184530	HC672104	10" x 4"	
025481	HC6721010	10" x 10"	

Residential Sidewall Registers & Grilles (Continued)

672 Steel Return Air Grille, 1/2" Fin Spacing

Part #	Mfg #	Size	Price
184533	HC672124	12" x 4"	
184535	HC6721212	12" x 12"	
184540	HC672144	14" x 4"	
109520	HC672146	14" x 6"	
021777	HC672148	14" x 8"	
184542	HC6721412	14" x 12"	
061627	HC6721414	14" x 14"	
184544	HC6721420	14" x 20"	
184545	HC6721424	14" x 24"	
184547	HC672168	16" x 8"	
184548	HC6721610	16" x 10"	
184551	HC6721616	16" x 16"	
184560	HC6721818	18" x 18"	
184562	HC6722010	20" x 10"	
184564	HC6722014	20" x 14"	
184565	HC6722016	20" x 16"	
184566	HC6722020	20" x 20"	
051946	HC672246	24" x 6"	
027205	HC6722414	24" x 14"	
005313	HC6722416	24" x 16"	
184570	HC6722418	24" x 18"	
184571	HC6722420	24" x 20"	
184572	HC6722424	24" x 24"	
109521	HC672306	30" x 6"	
184575	HC672308	30" x 8"	
184576	HC6723010	30" x 10"	
021779	HC6723014	30" x 14"	
184581	HC6723024	30" x 24"	
184573	HC6722430	24" x 30"	
184546	HC6721430	14" x 30"	
060875	HC6721630	16" x 30"	
184583	HC6723614	36" x 14"	

Sidewall Grilles & Registers

673 Steel Return Air Filter Grille, 1/2" Fin Spacing

- All-steel construction
- 1/2" spaced fins set at 40 degrees
- Effectively conceals filter
- Use standard 1" thick disposable filters (not included)
- Removable face for easy installation and cleaning
- Equipped with adjustable filter retainers
- Bright White finish



Part #	Mfg #	Size	Price
184588	HC6731010	10" x 10"	
184596	HC6731212	12" x 12"	
239636	HC6731218	12" x 18"	
184598	HC6731220	12" x 20"	
021780	HC6731224	12" x 24"	
184604	HC6731414	14" x 14"	
184606	HC6731420	14" x 20"	
184607	HC6731424	14" x 24"	
038544	HC6731425	14" x 25"	
184609	HC6731430	14" x 30"	
184610	HC6731616	16" x 16"	
038027	HC6731620	16" x 20"	
038019	HC6731625	16" x 25"	
184613	HC6731818	18" x 18"	
184617	HC6732014	20" x 14"	
184618	HC6732016	20" x 16"	
184619	HC6732020	20" x 20"	
184622	HC6732025	20" x 25"	
184626	HC6732412	24" x 12"	
184627	HC6732414	24" x 14"	
184629	HC6732418	24" x 18"	
184631	HC6732420	24" x 20"	
184632	HC6732424	24" x 24"	
184634	HC6732514	25" x 14"	
184635	HC6732516	25" x 16"	
184636	HC6732520	25" x 20"	
184639	HC6733012	30" x 12"	
184640	HC6733014	30" x 14"	
184643	HC6733020	30" x 20"	
184644	HC6733024	30" x 24"	
184620	HC6732024	20" x 24"	
184625	HC6732410	24" x 10"	

Residential Sidewall Registers & Grilles (Continued)

673 Steel Return Air Filter Grille, 1/2" Fin Spacing

Part #	Mfg #	Size	Price
184628	HC6732416	24" x 16"	
184602	HC673148	14" x 8"	
184611	HC6731624	16" x 24"	

682 Steel 2-way Register, MS damper, 1/2" Fin Spacing

- All-steel construction (682)
- Aluminum construction (A682)
- Used for ceiling or sidewall installations
- Ideal for shallow duct installations
- Two-way deflection
- 1/2" spaced fins set at 40 degrees
- Multi-shutter valve
- 1 5/8" depth when fully opened
- Interlocking valve louvers for positive shut-off
- Bright White finish
- Available with fusible link option, limited sizes (not UL-listed or fire-rated)



Part #	Mfg #	Size	Price
184670	HC68288	8" x 8"	
184671	HC682104	10" x 4"	
184672	HC682106	10" x 6"	
184673	HC682124	12" x 4"	
184674	HC682126	12" x 6"	
184676	HC682144	14" x 4"	
184677	HC682146	14" x 6"	
184678	HC682148	14" x 8"	
184679	HC682168	16" x 8"	

Sidewall Grilles & Registers

Sidewall Grilles

1033 Series Return Air Grille

- 1/3" Spacing dual angular louvers
- 20 and 22 Gauge cold roll steel
- Install with louvers in up or down position for best duct concealment
- Countersunk mounting holes for flush appearance with color matching Phillips posi-drive screws



Part #	Mfg #	Size	Color	Price
123787	1033W1406	14" x 6"	White	
123788	1033W2406	24" x 6"	White	
123789	1033W3006	30" x 6"	White	
123790	1033W3008	30" x 8"	White	

1050 Series Return Air Grille

- 1/2" Spacing dual angular louvers
- 20 and 22 Gauge cold roll steel
- Install with louvers in up or down position for best duct concealment
- Countersunk mounting holes for flush appearance with color matching Phillips posi-drive screws
- Soft white



Part #	Mfg #	Size	Price
127161	105084	8" x 4"	
148603	1050104	10" x 4"	
123194	10501006	10" x 6"	
123195	10501008	10" x 8"	
123196	10501010	10" x 10"	
123197	10501206	12" x 6"	
123198	10501208	12" x 8"	
123199	10501212	12" x 12"	
123200	10501406	14" x 6"	
123201	10501408	14" x 8"	
123202	10501410	14" x 10"	
123203	10501412	14" x 12"	
123204	10501414	14" x 14"	
137588	10501606	16" x 6"	
127463	10501608	16" x 8"	
123205	10501616	16" x 16"	
123206	10502006	20" x 6"	
123207	10502008	20" x 8"	
123208	10502010	20" x 10"	
123209	10502012	20" x 12"	

Sidewall Grilles (Continued)

1050 Series Return Air Grille

Part #	Mfg #	Size	Price
123210	10502014	20" x 14"	
123211	10502016	20" x 16"	
123212	10502020	20" x 20"	
129115	10502024	20" x 24"	
123213	1050244	24" x 4"	
123214	10502406	24" x 6"	
123215	10502408	24" x 8"	
123216	10502410	24" x 10"	
123217	10502412	24" x 12"	
123218	10502414	24" x 14"	
123219	10502416	24" x 16"	
123220	10502420	24" x 20"	
123221	10502424	24" x 24"	
123222	10503006	30" x 6"	
123223	10503008	30" x 8"	
123224	10503010	30" x 10"	
123225	10503012	30" x 12"	
132487	10503014	30" x 14"	

1150 Series Baseboard Return Air Grille

- Stamped face
- 1/2" Spacing dual angular louvers

Part #	Mfg #	Size	Color	Price
123229	1150W1206	12" x 6"	White	
123230	1150B1406	14" x 6"	Brown	
123232	1150W1406	14" x 6"	White	
129392	1150W1408	14" x 8"	White	
164097	1150B1408	14" x 8"	Brown	
123234	1150W2406	24" x 6"	White	
123236	1150B3006	30" x 6"	Brown	
123237	1150W3006	30" x 6"	White	
132412	1150W3008	30" x 8"	White	

Sidewall Grilles & Registers

TS Series Toe Space Grille

- Formed cold roll steel
- Ideal for return air in the toe space areas between kitchen cabinets, stair risers, built-in vanities, etc
- Countersunk mounting holes for flush appearance with color matching Phillips posi-drive screws

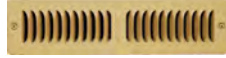

Part #	Mfg #	Size	Color	Price
122736	TS0210B	2" x 10"	Brown	
122591	TS0212B	2" x 12"	Brown	
122737	TS0212W	2" x 12"	White	
122740	TS0214B	2" x 14"	Brown	
122738	TS0214W	2" x 14"	White	
122592	TS0412W	4" x 12"	White	

FG2 Series Stamped Face 2" Filter Grille

- 1/2" Spacing dual angular louvers
- 20 and 22 Gauge cold roll steel
- Hand operated lever for easy filter access
- Holds up to 2" Filter (not included)
- Removable face for easy cleaning and maintenance
- Filter door hinges parallel to longest side
- 4-Way reversible door on square sizes
- 2-Way reversible door on rectangular sizes
- Filter retention tabs
- Concealed mounting holes
- Soft white



Part #	Mfg #	Size	Price
123382	FG21420	14" x 20"	
123383	FG21425	14" x 25"	
123380	FG21620	16" x 20"	
123384	FG21625	16" x 25"	
123385	FG22016	20" x 16"	
123386	FG22020	20" x 20"	
123387	FG22025	20" x 25"	
123388	FG22424	24" x 24"	
123389	FG22516	25" x 16"	
125075	FG22520	25" x 20"	

Sidewall Diffusers

850 Series Stamped 2-Way Diffuser

- Stamped 1/2" fan-shaped louvers for heating and cooling
- For ceiling or sidewall applications
- All component parts, rivets, linkage and handle are enclosed in the valve to assure trouble-free operation
- Countersunk mounting holes for flush appearance with color matching Phillips posi-drive screws
- Steel multi-shutter damper
- Soft white



Part #	Mfg #	Size	Price
123392	8501004	10" x 4"	
123393	8501006	10" x 6"	
123394	8501204	12" x 4"	
123395	8501206	12" x 6"	
123396	8501208	12" x 8"	
123397	8501404	14" x 4"	
123398	8501406	14" x 6"	
123399	8501408	14" x 8"	
123400	8501608	16" x 8"	

875 Series Baseboard Diffuser

- Steel construction
- Generous free area for quiet operation
- Lever operated single-blade damper
- Removable face and damper
- Tension wings to stabilize damper



Part #	Mfg #	Size	Color	Price
122939	875B18	18"	Brown	
122938	875W18	18"	White	

951 Adjustable Steel Blade Diffuser

- Adjustable steel face blades with steel multi-shutter damper
- For ceiling or sidewall applications
- Vertical air deflectors with nylon bushings for easy adjustment and quiet settings
- Countersunk mounting holes for flush appearance with color matching Phillips posi-drive screws
- All component parts, rivets, linkage and handle are enclosed in the valve to assure trouble-free operation

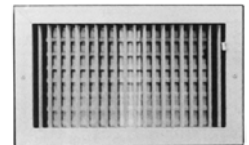

Part #	Mfg #	Size	Price
123028	9511004	10" x 4"	

Sidewall Grilles & Registers

Sidewall Diffusers (Continued)

951 Adjustable Steel Blade Diffuser

Part #	Mfg #	Size	Price
123029	9511006	10" x 6"	
123030	9511204	12" x 4"	
123031	9511206	12" x 6"	
129734	9511404	14" x 4"	
123032	9511406	14" x 6"	
123033	9511408	14" x 8"	
141490	9511606	16" x 6"	
146924	9511608	16" x 8"	



Sidewall Grilles & Registers

Sidewall Air Diffusers

Airtec™ Classic Air Diffuser - Small

- 6" x 6" Diffuser assembly



Part #	Mfg #	Description	Price
098602	MVES	Return/Exhaust Grille/Damper/Box	

Electric Furnaces

Electric Furnaces

E4EB Electric Furnaces

- Choice of air conditioning options
- Easy open door
- Effective air filter
- Nichrome heating elements
- Appliance quality door
- Fully insulated cabinet
- Safety and dependability
- Adaptable
- Versatile
- Heating relays
- Control board



Part #	Mfg #	Tons	KW	Dimensions (H x W)	Price
182797	INTE4EB010H	2.0 - 4.0	10	29" x 20"	
233678	INTE4EB012H	2.0 - 4.0	12	29" x 20"	
182798	INTE4EB015H	2.0 - 4.0	15	29" x 20"	
227914	INTE4EB017H	2.0 - 4.0	17	29" x 20"	
182836	INTE4EB020H	2.0 - 4.0	20	29" x 20"	
221907	INTE4EB23H5T	2.0 - 5.0	23	29" x 20"	

E6EB Electric Furnaces

- Choice of air conditioning options
- Easy open door
- Effective air filter
- Nichrome heating elements
- Appliance quality door
- Fully insulated cabinet
- Safety and dependability
- Adaptable
- Versatile
- Heating relays
- Control board



Part #	Mfg #	Tons	KW	Dimensions (H x W)	Price
259596	INTE6EB010H	2.0 - 4.0	10	29"x 20"	
254629	INTE6EB015H	2.0 - 4.0	15	29"x 20"	
254630	INTE6EB020H	2.0 - 4.0	20	29"x 20"	



Gas Downflow Furnaces

80% AFUE Downflow Gas Furnaces

ACHIEVER
series

- 80% Residential Gas Furnace CSA certified
- Downflow Design
- Single Stage Gas Valves
- PSC Blower Motors
- PlusOne™ Diagnostics 7-Segment LED
- Integrated control board
- Insulated blower compartment
- Heat Exchanger is removable
- PlusOne™ Ignition System - DSI for reliability
- Solid Door for Quiet Operation
- QR codes for quick access to product info from smart phone or tablet



Warranties

10-Yr Part Warranty

20 Year Heat Exchanger

Part #	Mfg #	Tons	Width	Input	Output	AFUE	Price
263693	R801CA075317ZSA	3 Ton	17"	75,000	60,000	80.0%	
263696	R801CA075521ZSA	5 Ton	21"	75,000	60,000	80.0%	
263697	R801CA100521ZSA	5 Ton	21"	100,000	80,000	80.0%	
263699	R801CA125524ZSA	5 Ton	24"	125,000	100,000	80.0%	

Gas Downflow Furnaces

Gas Downflow Furnaces

KG7S (K Series) 80% Gas Downflow Furnace

- Single-stage heat/cool
- 100% fired and tested
- Best packaging in the industry
- Low Boy Height
- Tubular primary heat exchanger
- 30 second blower delay at start-up
- 30 second post purge
- Hot surface ignitor
- Color coded wire harness
- PSC high static blowers
- 90 second cooling cycle blower-off delay (TDR)
- Flexible category I venting system
- Multi-speed direct drive PSC blower
- LP convertible (905028)
- Diagnostic lights for easy troubleshooting without counting flashes
- Integrated control board
- Two piece door design
- Furnace air leakage compliant



Part #	Mfg #	Tons	Motor Type	Input BTUH	Heating Capacity BTUH	Dimensions (H x W)	Price
118722	KG7SK054C23A	2-3	PSC	54,000	43,200	34 1/2" x 14 1/4"	
118723	KG7SK072C24B	2-4	PSC	72,000	57,600	34 1/2" x 17 1/2"	
118724	KG7SK090C24B	2-4	PSC	90,000	72,000	34 1/2" x 17 1/2"	
118725	KG7SK108C35C	3-5	PSC	108,000	86,400	34 1/2" x 21"	
118726	KG7SK126C45D	4-5	PSC	126,000	100,800	34 1/2" x 24 1/2"	

Gas Downflow Furnaces

KG7S (L Series) 92% Gas Downflow Furnace

- *Single-stage heat/cool*
- *100% fired and tested*
- *Best packaging in the industry*
- *30 second blower delay*
- *30 second post purge*
- *Hot surface igniter*
- *Color coded wire harness*
- *Flexible category IV venting system*
- *PSC high static blowers*
- *Low boy height*
- *Tubular primary heat exchanger*
- *90 second fixed cooling cycle blower-off delay (TDR)*
- *Multi-speed direct drive PSC blower*
- *LP convertible (905028)*
- *Diagnostic lights for easy troubleshooting without counting flashes*
- *Incorporates integrated control board*
- *Two piece door design enhances furnace appearance*
- *Seated vestibule*
- *Furnace air leakage compliant*



Part #	Mfg #	Tons	Motor Type	Input BTUH	Heating Capacity BTUH	Dimensions (H x W)	Price
118732	KG7SL054D24B	2-3	PSC	54,000	49,700	34 1/2" x 17 1/2"	
118733	KG7SL072D24B	2-4	PSC	72,000	66,000	34 1/2" x 17 1/2"	
118734	KG7SL090D35C	3-5	PSC	90,000	82,800	34 1/2" x 21"	
118735	KG7SL120D45D	4-5	PSC	120,000	110,400	34 1/2" x 24 1/2"	

Gas Downflow Furnaces

KG7S (M Series) 95% Gas Downflow Furnaces

- Single-stage heat/cool
- 100% fired and tested
- Best packaging in the industry
- 30 second blower delay
- 30 second post purge
- Hot surface igniter
- Color coded wire harness
- Flexible category IV venting system
- PSC high static blower
- Low boy height
- Tubular primary heat exchanger
- 60 second fixed cooling cycle blower-off delay(TDR)
- Multi-speed direct drive PSC blower
- LP convertible (905028)
- Diagnostic lights for easy troubleshooting without counting flashes
- Incorporates integrated control board
- Two piece door design enhances furnace appearance
- Seated vestibule
- Furnace air leakage compliant



Part #	Mfg #	Tons	Motor Type	Input BTUH	Heating Capacity BTUH	Dimensions (H x W)	Price
143088	KG7SM054D24B	2-4	PSC	54,000	51,300	34 1/2" x 17 1/2"	
143087	KG7SM072D35C	3-5	PSC	72,000	68,000	34 1/2" x 21"	
143086	KG7SM090D35C	3-5	PSC	90,000	85,500	34 1/2" x 21"	
143085	KG7SM118D45D	4-5	PSC	118,000	112,100	34 1/2" x 24 1/2"	

Gas Downflow Furnaces

KG7T (L Series) 95% Gas Downflow Furnace

- Two-stage heat/cool
- 100% fired and tested
- Best packaging in the industry
- 30 second blower delay
- 30 second post purge
- Hot surface igniter
- Color coded wire harness
- Flexible category IV venting system
- ECM fixed speed high static blowers
- Low boy height
- Tubular primary heat exchanger
- 60 second fixed cooling cycle blower-off delay(TDR)
- ECM fixed speed direct drive blower
- LP convertible (905028)
- Diagnostic lights for easy troubleshooting without counting flashes
- Incorporates integrated control board
- Two piece door design enhances furnace appearance
- Seated vestibule
- Furnace Air Leakage.



Part #	Mfg #	Tons	Motor Type	Input BTUH	Heating Capacity BTUH	Dimensions (H x W)	Price
118736	KG7TL060D24B	2-4	BLDC	39,000	37,050	34 1/2" x 17 1/2"	
118737	KG7TL080D35C	3-5	BLDC	52,000	49,400	34 1/2" x 21"	
118738	KG7TL100D35C	3-5	BLDC	65,000	61,750	34 1/2" x 21"	
118739	KG7TL120D45D	4-5	BLDC	78,000	74,100	34 1/2" x 24 1/2"	

Gas Downflow Furnaces

Downflow Gas Furnaces

M1 80% Downflow Gas Furnaces

- Sealed Combustion System'
- Easy Open Pawl Latch
- Choice of Air Conditioning Options
- Large, Effective Air Filter
- High Efficiency Drum Heat Exchanger
- Appliance Quality Door
- Fully Insulated Cabinet
- Reliable Burner
- LP Convertible (Kit Included)



Part #	Mfg #	Motor Type	Input BTUH	Heating Capacity BTUH	A/C Ready	Dimensions (H x W)	Price
233692	INTM1MC056ABW	PSC	56,000	46,000	-	76" x 23 3/4"	
233693	INTM1MC070ABW	PSC	70,000	57,000	-	76" x 23 3/4"	
213927	INTM1MC077ABW	PSC	77,000	62,000	-	76" x 23 3/4"	
225783	INTM1MC090ABW	PSC	90,000	72,000	-	76" x 23 3/4"	
178495	INTM1MB056ABW	PSC	56,000	46,000	Up to 3 Tons	76" x 23 3/4"	
177150	INTM1MB070ABW	PSC	70,000	57,000	Up to 3 Tons	76" x 23 3/4"	
177149	INTM1MB077ABW	PSC	77,000	62,000	Up to 3 Tons	76" x 23 3/4"	
177148	INTM1MB090ABW	PSC	90,000	72,000	Up to 3 Tons	76" x 23 3/4"	

Gas Downflow Furnaces

M7RL 95% Downflow Gas Furnaces

- 100% fired and tested
- Clean and quiet operation
- Fixed 30 second blower delay
- Fixed 30-second post purge
- Dependable, hot surface ignitor
- Tubular primary heat exchanger
- Stainless steel secondary heat exchanger
- 60 second fixed cooling cycle blower-off delay (TDR)
- Sealed combustion approved for direct vent furnace category IV venting system
- LP Convertible (Kit Included)
- 3 amp fuse protection against low voltage shorts
- Low voltage terminal board
- Easy open pawl latch
- Appliance quality door
- Fully insulated cabinet
- Color coded wire harness
- Multi-speed direct drive blower
- Diagnostic lights for easy troubleshooting without counting flashes



Part #	Mfg #	Motor Type	Input BTUH	Heating Capacity BTUH	A/C Ready	Dimensions (H x W)	Price
177151	INTM7RL060ABW	PSC	60,000	57,000	Up to 4 Tons	56" x 19 7/8"	
177152	INTM7RL072ABW	PSC	72,000	68,400	Up to 4 Tons	56" x 19 7/8"	

Gas Downflow Furnaces

M7TL 95% Variable Speed 2 Stage Downflow Gas Furnace

- ECM blower
- 2 Stage gas valve
- 100% fired and tested
- Clean and quiet operation
- Fixed 30 second blower delay
- Fixed 30-second post purge
- Dependable, hot surface ignitor
- Tubular primary heat exchanger
- Stainless steel secondary heat exchanger
- 60 second fixed cooling cycle blower-off delay (TDR)
- Sealed combustion approved for direct vent furnace category IV venting system
- LP convertible
- 3 amp fuse protection against low voltage shorts
- Low voltage terminal board
- Easy open pawl latch
- Appliance quality door
- Fully insulated cabinet
- Color coded wire harness
- 40VA transformer included
- Diagnostic lights for easy troubleshooting without counting flashes



Part #	Mfg #	Motor Type	Input BTUH	Heating Capacity BTUH	A/C Ready	Dimensions (H x W)	Price
233701	INTM7TL045ABW	VSB	45,000/29,000	42,750/27,550	-	55" x 19 7/8"	
233704	INTM7TL060ABW	VSB	60,000/39,000	57,000/37,050	-	55" x 19 7/8"	
233691	INTM7TL072ABW	VSB	72,000/47,000	68,400/44,650	-	55" x 19 7/8"	

Gas Downflow Furnaces

Gas Downflow Furnaces**FG7S (K Series) 80% Gas Downflow Furnace**

- 100% fired and tested
- Best packaging in the industry
- Low Boy Height
- Tubular primary heat exchanger
- 30 second blower delay at start-up
- 30 second post purge
- Hot surface igniter
- Color coded wire harness
- High static blowers
- 90 second cooling cycle blower-off delay (TDR)
- Flexible category I venting system
- High efficiency blower kits
- Multi-speed direct drive blower
- LP convertible
- Diagnostic lights for easy troubleshooting without counting flashes
- Integrated control board
- Two piece door design
- Blower Compartment
- Furnace Air Leakage



Part #	Mfg #	Tons	Motor Type	Input BTUH	Heating Capacity BTUH	Dimensions (H x W)	Price
118838	FRIFG7SK054C23A	2-3	PSC	54,000	43,200	34 1/2" x 14 1/4"	
118839	FRIFG7SK072C24B	2-4	PSC	72,000	57,600	34 1/2" x 17 1/2"	
118840	FRIFG7SK090C24B	2-4	PSC	90,000	72,000	34 1/2" x 17 1/2"	
118841	FRIFG7SK108C35C	3-5	PSC	108,000	86,400	34 1/2" x 21"	
118842	FRIFG7SK126C45D	4-5	PSC	126,000	100,800	34 1/2" x 24 1/2"	

Gas Downflow Furnaces

FG7S (L Series) 92% Gas Downflow Furnace

- 100% fired and tested
- Best packaging in the industry
- 30 second blower delay
- 30 second post purge
- Hot surface igniter
- Color coded wire harness
- Flexible category IV venting system
- High Static Blowers
- Low Boy Height
- Tubular primary heat exchanger
- 90 second fixed cooling cycle blower-off delay (TDR)
- High efficiency blower kits
- Multi-speed direct drive blower
- LP convertible
- Diagnostic lights for easy troubleshooting without counting flashes
- Incorporates integrated control board
- Two piece door design
- Blower Compartment
- Sealed Vestibule
- Furnace Air Leakage



Part #	Mfg #	Tons	Motor Type	Input BTUH	Heating Capacity BTUH	Dimensions (H x W)	Price
118792	FRIFG7SL054D24B	2-4	PSC	54,000	49,700	34 1/2" x 17 1/2"	
118793	FRIFG7SL072D24B	2-4	PSC	72,000	66,000	34 1/2" x 17 1/2"	
118794	FRIFG7SL090D35C	3-5	PSC	90,000	82,800	34 1/2" x 21"	
118795	FRIFG7SL120D45D	4-5	PSC	120,000	110,400	34 1/2" x 24 1/2"	

Gas Downflow Furnaces

FG7S (M Series) 95% Gas Downflow Furnace

- 100% fired and tested
- Best packaging in the industry
- 30 second blower delay
- 30 second post purge
- Color coded wire harness
- Flexible category IV venting system
- High Static Blowers
- Low Boy Height
- Tubular primary heat exchanger
- 60 second fixed cooling cycle blower-off delay (TDR)
- High efficiency blower kits
- Multi-speed direct drive blower
- LP convertible
- Diagnostic lights for easy troubleshooting without counting flashes
- Incorporates integrated control board
- Two piece door design
- Blower Compartment
- Sealed Vestibule
- Furnace Air Leakage



Part #	Mfg #	Tons	Motor Type	Input BTUH	Heating Capacity BTUH	Dimensions (H x W)	Price
204434	FRIFG7SM054D24 B	2-4	PSC	54,000	51,300	34 1/2" x 17 1/2"	
204435	FRIFG7SM072D35 C	3-5	PSC	72,000	68,400	34 1/2" x 21"	
204436	FRIFG7SM090D35 C	3-5	PSC	90,000	85,500	34 1/2" x 21"	
204437	FRIFG7SM118D45 D	4-5	PSC	118,000	112,100	34 1/2" x 24 1/2"	

Gas Downflow Furnaces

FG7T (K Series) 80% Variable Speed Gas Downflow Furnace

- iSEER
- 100% fired and tested
- Best packaging in the industry
- Low Boy Height
- Tubular primary heat exchanger
- 30 second blower delay at start-up
- 30 second post purge
- Two Stage Inducer
- Hot surface igniter
- Color coded wire harness
- High static blowers
- 90 second cooling cycle blower-off delay (TDR)
- Flexible category I venting system
- LP convertible
- Diagnostic lights for easy troubleshooting without counting flashes
- Integrated control board
- Two piece door design
- Blower Compartment
- Furnace Air Leakage



Part #	Mfg #	Tons	Motor Type	Input BTUH	Heating Capacity BTUH	Dimensions (H x W)	Price
202382	FRIFG7TK060CVA 1		Variable	39,000	31,200	34 1/2" x 14 1/4"	
202383	FRIFG7TK080CVB 1		Variable	52,000	41,600	34 1/2" x 17 1/2"	
232871	FRIFG7TK100CVC		Variable	65,000	52,000	34 1/2" x 21"	
220794	FRIFG7TK120CVC		Variable	78,000	62,400	34 1/2" x 21"	

Gas Downflow Furnaces

FG7T (L Series) 95% Variable Speed Gas Downflow Furnace

- iSEER
- 100% fired and tested
- Best packaging in the industry
- Low Boy Height
- Tubular primary heat exchanger
- 30 second blower delay at start-up
- 30 second post purge
- Two Stage Inducer
- Hot surface igniter
- Color coded wire harness
- High static blowers
- 90 second cooling cycle blower-off delay (TDR)
- Flexible category I venting system
- LP convertible
- Diagnostic lights for easy troubleshooting without counting flashes
- Integrated control board
- Two piece door design
- Blower Compartment
- Furnace Air Leakage



Part #	Mfg #	Tons	Motor Type	Input BTUH	Heating Capacity BTUH	Dimensions (H x W)	Price
118800	FRIFG7TL060DVB		Variable	39,000	37,050	34 1/2" x 17 1/2"	
118801	FRIFG7TL080DVC		Variable	52,000	49,400	34 1/2" x 21"	
118802	FRIFG7TL100DVC		Variable	65,000	61,750	34 1/2" x 21"	
118804	FRIFG7TL120DVD		Variable	78,000	74,100	34 1/2" x 24 1/2"	

Gas Downflow Furnaces

FG7T (L Series) 95% Gas Downflow Furnace

- *iSEER*
- *100% fired and tested*
- *Best packaging in the industry*
- *Low Boy Height*
- *Tubular primary heat exchanger*
- *30 second blower delay at start-up*
- *30 second post purge*
- *Two Stage Inducer*
- *Hot surface igniter*
- *Color coded wire harness*
- *High static blowers*
- *90 second cooling cycle blower-off delay (TDR)*
- *Flexible category I venting system*
- *LP convertible*
- *Diagnostic lights for easy troubleshooting without counting flashes*
- *Integrated control board*
- *Two piece door design*
- *Blower Compartment*
- *Furnace Air Leakage*



Part #	Mfg #	Tons	Motor Type	Input BTUH	Heating Capacity BTUH	Dimensions (H x W)	Price
118796	FRIFG7TL060D24B	2-4	BLDC	39,000	37,050	34 1/2" x 17 1/2"	
118797	FRIFG7TL080D35C	3-5	BLDC	52,000	49,000	34 1/2" x 21"	
118798	FRIFG7TL100D35C	3-5	BLDC	65,000	61,750	34 1/2" x 21"	
118799	FRIFG7TL120D45D	4-5	BLDC	78,000	74,100	34 1/2" x 24 1/2"	

Gas Downflow Furnaces

Gas Downflow Furnaces

A802V Two-Stage, Variable Speed Furnace Downflow

- 80% AFUE
- EHX™ Technology
- Quiet Combustion™ Technology
- Two-Stage gas valve
- Variable-Speed blower motor
- Comfort Sync™ enabled
- Enhanced humidity control
- Lifetime warranty on heat exchanger
- 10-Year limited parts warranty



Part #	Mfg #	Tons	Width	Input	Output	AFUE	Price
209870	AA80DS2V070A12	3	14.5"	66,000	52,000	80	
209871	AA80DS2V090B16	4	17.5"	88,000	69,000	80	
209872	AA80DS2V110C20	5	21"	110,000	87,000	80	

A962V High-Efficiency, Variable Speed Furnace Downflow

- 96% AFUE
- EHX™ Technology
- Quiet Combustion™ Technology
- Self-Diagnosing control board
- Two-Stage gas valve
- Variable-Speed blower motor
- Comfort Sync™ enabled
- Stainless steel heat exchanger
- Lifetime warranty on heat exchanger
- 10-Year limited parts warranty



Part #	Mfg #	Tons	Width	Input	Output	AFUE	Price
214469	AA96DS2V045B12 S	3	17.5"	29,000/44,000	28,000/43,000	96	
214470	AA96DS2V070B16 S	4	17.5"	43,000/66,000	42,000/64,000	96	
214471	AA96DS2V090C20 S	5	21"	57,000/88,000	56,000/88,000	96	
214472	AA96DS2V110C20 S	5	21"	72,000/110,000	70,000/106,000	96	

Gas Downflow Furnaces

A97MV High-Efficiency Modulating Furnace Testing Downflow

- 97% AFUE
- EHX™ Technology
- Quiet Combustion™ Technology
- Self-Diagnosing control board
- Modulating gas valve Variable-Speed blower motor
- Comfort Sync™ enabled
- Stainless steel heat exchanger
- Lifetime warranty on heat exchanger
- 10-Year limited parts warranty



Part #	Mfg #	Tons	Width	Input	Output	AFUE	Price
209779	AA97DSMV070B12 S	3	17.5"	66,000	64,000	97	
209780	AA97DSMV090C16 S	4	21"	88,000	85,000	97	
209781	AA97DSMV090C20 S	5	21"	88,000	85,000	97	
209782	AA97DSMV110C20 S	5	21"	110,000	107,000	97	

A951S 95% Stainless Single-Stage Furnace

- 95% AFUE
- EHX™ Technology
- Quiet Combustion™ Technology
- Self-Diagnosing control board
- Single-Stage gas valve
- Stainless steel heat exchanger
- Lifetime warranty on heat exchanger
- 10-Year limited parts warranty



Part #	Mfg #	Tons	Width	Input	Output	AFUE	Price
208484	AA95DF1D045B12S	3	17.5"	44,000	42,000	95	

A951A 95% Efficiency Single Stage Furnace Downflow

- 95% AFUE
- EHX™ Technology
- Quiet Combustion™ Technology
- Self-Diagnosing control board
- Single-Stage gas valve
- Lifetime warranty on heat exchanger
- 10-Year limited parts warranty



Part #	Mfg #	Tons	Width	Input	Output	AFUE	Price
208649	AA95DF1D045B12A	3	17"	44,000	42,000	95	
208650	AA95DF1D070B12A	3	17"	44,000	62,500	95	
208651	AA95DF1D090C20A	4	21"	88,000	83,500	95	
208652	AA95DF1D110C20A	5	21"	110,000	104,500	95	

Gas Downflow Furnaces

A951E Single-Stage, Constant Torque Furnace Downflow

- 95% AFUE
- EHX™ Technology
- Quiet Combustion™ Technology
- Self-Diagnosing control board
- Single-Stage gas valve
- Constant Torque blower motor
- Stainless steel heat exchanger
- Lifetime warranty on heat exchanger
- 10-Year limited parts warranty



Part #	Mfg #	Tons	Width	Input	Output	AFUE	Price
208660	AA95DF1E045B12S	3	17.5"	44,000	42,000	95	
208661	AA95DF1E070B16S	4	17.5"	66,000	64,000	95	
208662	AA95DF1E090C16S	4	21"	88,000	85,000	95	
208663	AA95DF1E110C20S	5	21"	110,000	106,000	95	

A931A High-Efficiency Single-Stage Furnace Downflow

- 93% AFUE
- EHX™ Technology
- Quiet Combustion™ Technology
- Self-Diagnosing control board
- Single-Stage gas valve
- Permanent Split Capacitor (PSC) Motor
- Lifetime warranty on heat exchanger
- 10-Year limited parts warranty



Part #	Mfg #	Tons	Width	Input	Output	AFUE	Price
208636	AA93DF1D045B12A	3	17.5"	44,000	42,000	93	
208637	AA93DF1D070B12A	3	17.5"	66,000	62,000	93	
208638	AA93DF1D090C16A	4	21"	88,000	84,000	93	
208639	AA93DF1D110C20A	5	21"	110,000	104,000	93	

A801D 80% Single-Stage Furnace

- 80% AFUE
- EHX™ Technology
- Quiet Combustion™ Technology
- Lifetime warranty on heat exchanger
- 10-Year limited parts warranty



Part #	Mfg #	Tons	Width	Input	Output	AFUE	Price
208506	AA80DF1D045A12	3	14-1/2"	44,000	35,200	80	
208507	AA80DF1D070A12	3	14-1/2"	66,000	52,000	80	
208508	AA80DF1D090B16	4	17"	88,000	69,000	80	
208509	AA80DF1D110C20	5	21"	110,000	87,000	80	

Gas Downflow Furnaces

Gas Downflow Furnaces

80G1 80% Single Stage Gas Furnace

- Crimped no-weld aluminized clam shell heat exchanger construction
- Compact 33" height, standardized widths for easy coil fit
- Multi-speed PSC blower motor
- Single stage gas valve
- Self diagnostics saving last 5 fault codes regardless of power interruption
- Rotatable draft inducer for venting flexibility
- Left or right utility connections
- Removable floor base for bottom return air
- Zero step horizontal conversion
- 10-Year limited parts warranty



Part #	Mfg #	Tons	Width	Input	Output	AFUE	Price
208694	DC80G1DF045AP1 2	3	14.5"	44,000	35,200	80%	
208695	DC80G1DF070AP1 2	3	14.5"	66,000	52,800	80%	
208696	DC80G1DF090BP1 6	4	17.5"	88,000	70,400	80%	
208697	DC80G1DF110CP2 0	5	21"	110,000	88,000	80%	

92G1 92% Single Stage Gas Furnace

- Aluminized steel design primary heat exchanger with crimped no weld construction
- AL 29-4C Stainless steel secondary heat exchanger
- Aluminized steel inshot burners for smooth ignition
- Compact 33" height, standardized widths for easy coil fit
- Multi-speed PSC blower motor
- Easily removable slide-out blower design
- Single Stage gas valve
- Self diagnostics saves last 5 fault codes regardless of power interruption
- Control features electronic air cleaner and humidifier terminals
- Designed certified for direct and non direct applications
- Left or right utility connection
- Designed certified for direct and non-direct vent applications
- Zero step horizontal conversion
- Removable floor base for bottom return air
- 10-Year limited parts warranty



Part #	Mfg #	Tons	Width	Input	Output	AFUE	Price
208707	DC92G1DF045BP1 2	3	17.5"	44,000	42,000	92%	
208708	DC92G1DF070BP1 2	3	17.5"	66,000	62,000	92%	
208709	DC92G1DF090CP1 6	4	21"	88,000	84,000	92%	

Gas Downflow Furnaces

Gas Downflow Furnaces (Continued)

92G1 92% Single Stage Gas Furnace

Part #	Mfg #	Tons	Width	Input	Output	AFUE	Price
208710	DC92G1DF110CP2 0	5	21"	110,000	104,000	92%	

95G1 95% Single Stage Gas Furnace

- *Aluminized steel design primary heat exchanger with crimped no weld construction*
- *AL 29-4C Stainless steel secondary heat exchanger*
- *Aluminized steel inshot burners for smooth fit*
- *Compact 33" height*
- *Standardized widths for easy coil fit*
- *Multi-speed PSC blower motor*
- *Easily removable slide-out blower design*
- *Single Stage Gas Valve*
- *Self diagnostics saves last 5 fault codes regardless of power interruption*
- *Control features electronic air cleaner and humidifier terminals*
- *Designed certified for direct and non direct applications*
- *Left or right utility connection*
- *Designed certified for direct and non-direct vent applications*
- *Zero step horizontal conversion*
- *Removable floor base for bottom return air*
- *10-Year limited parts warranty*



Part #	Mfg #	Tons	Width	Input	Output	AFUE	Price
208838	DC95G1DF045BP1 2	3	17.5"	44,000	42,000	95%	
208839	DC95G1DF070BP1 2	3	17.5"	66,000	64,000	95%	
208840	DC95G1DF090CP2 0	5	21"	88,000	85,000	95%	
208841	DC95G1DF110CP2 0	5	21"	110,000	106,000	95%	

Gas Downflow Furnaces

95G1E 95% Single Stage Constant Torque Motor

- Designed certified for direct (2-pipe) and non direct (1-pipe) applications
- Easily vented with PVC pipe
- Left or right utility connection
- Design certified for direct and non-direct vent applications
- Zero step horizontal conversion
- Removable floor base (upflow / horizontal units) for bottom return air
- Aluminized steel primary heat exchanger with crimped non welded construction
- AL 29-4C Stainless steel secondary heat exchanger
- Aluminized steel inshot burners for smooth ignition
- Compact 33" height, standardized widths for easy coil fit
- Multi-speed high efficiency (constant torque) blower motor
- Easily removable slide out blower design
- Enhanced cooling SEER ratings when applied with properly matched cooling equipment.
- Single stage gas valve
- Durable silicon nitride ignitor
- Self diagnostics saves last 10 fault codes regardless of power interruption
- Control features electronic air cleaner and humidifier terminals
- 10-Year limited parts warranty



Part #	Mfg #	Tons	Width	Input	Output	AFUE	Price
208847	DC95G1DF045BE1 2	3	17.5"	44,000	42,000	95%	
208848	DC95G1DF070BE1 6	4	17.5"	66,000	64,000	95%	
208849	DC95G1DF090CE1 6	4	21"	88,000	85,000	95%	
208850	DC95G1DF110CE2 0	5	21"	110,000	106,000	95%	

Gas Downflow Furnaces

95G2V 95% Two Stage Variable Speed Gas Furnace

- Aluminized steel primary heat exchanger with crimped non welded construction
- AL29-4C Stainless steel secondary heat exchanger
- Aluminized steel in shot burners for smooth ignition
- Isolated burner enclosure for quiet operation
- Standardized widths for easy coil fit
- Efficient ECM variable speed blower motor
- Motor features "soft start" and "soft stop" for quiet operation
- Active and passive dehumidification feature
- Easily removable slide-out blower design
- Two stage gas valve
- Integrated ignition and fan control
- Hot surface ignition system uses silicon nitride ignitor
- Control features 120 volt electronic air cleaner and humidifier terminals
- Control circuit is fuse protected
- Compatible with single or two stage thermostats for heating.
- Two stage thermostat is recommended when installed with two stage cooling unit.
- Left or right gas and electric entry
- Zero step horizontal conversion
- Removable floor base (upflow/horizontal units) for bottom return air
- 2-speed induced draft motor with stainless steel shaft, steel ball bearings, and fan cooled for long life
- Vent materials for Canadian applications must comply with ULC S636
- Certified for direct vent (2-pipe) or non-direct (1-pipe) applications
- Non-welded crimped S-curve primary heat exchanger design for maximum durability
- Heat exchanger compartment is insulated to increase efficiency and reduce sound levels
- Dynamically balanced blower wheel with resilient motor mounts for smooth and quiet operation
- System Sentry™ control retains last five (5) fault codes with push button memory recall, regardless of power interruption
- Direct vent refers to a combustion air supply intake pipe installed in conjunction with flue gas vent pipe.



Part #	Mfg #	Tons	Width	Input	Output	AFUE	Price
218356	DC95G2DF045BV1 2	3	17.5"	29,000, 44,000	28,000, 43,000	95%	
218357	DC95G2DF070BV1 6	4	17.5"	43,000, 66,000	42,000, 64,000	95%	
218358	DC95G2DF090CV2 0	5	21"	57,000, 88,000	56,000, 85,000	95%	
218359	DC95G2DF110CV2 0	5	21"	72,000, 110,000	70,000, 106,000	95%	

Gas Downflow Furnaces

95G2E Two-Stage Constant Torque Gas Furnace

- Two stage gas valve
- Integrated ignition and fan control
- Hot surface ignition system uses silicon nitride ignitor
- Control features 120 volt electronic air cleaner and humidifier terminals
- Control circuit is fuse protected
- Vent materials for Canadian applications must comply with ULC S636
- Certified for direct vent and indirect vent (1 and 2 pipe) applications
- Left or right gas and electric entry
- Zero step horizontal conversion
- Removable floor base (upflow/horizontal units) for bottom return air
- Efficient blower motor
- Easily removable slide-out blower design
- Standardized widths for easy coil fit
- Aluminized steel in shot burners for smooth ignition
- Isolated burner enclosure for quiet operation
- AL29-4C Stainless steel secondary heat exchanger
- Control board retains last ten (10) fault codes with push button memory recall and 7 segment LED display, regardless of power interruption
- Compatible with single or two stage thermostats for heating
Two stage thermostat is recommended when installed with two stage cooling unit
- 2-speed induced draft motor with stainless steel shaft, steel ball bearings, and fan cooled for long life
- Aluminized steel primary heat exchanger with crimped non-welded construction
- Heat exchanger compartment is insulated to increase efficiency and reduce sound levels
- Dynamically balanced blower wheel with resilient motor mounts for smooth and quiet operation
- Non-welded crimped S-curve primary heat exchanger design for maximum durability



Part #	Mfg #	Tons	Width	Input	Output	AFUE	Price
210868	DC95G2DF045BE1 2	3	17.5"	29,000, 44,000	28,000, 43,000	95%	
210869	DC95G2DF070BE1 6	4	17.5"	43,000, 66,000	42,000, 64,000	95%	
210870	DC95G2DF090CE1 6	4	21"	57,000, 88,000	56,000, 85,000	95%	
210871	DC95G2DF110CE2 0	5	21"	72,000, 110,000	70,000, 106,000	95%	



Gas Multi-Position Furnaces

ACHIEVER Series

90+ Gas



- Up to 96% Residential Gas Furnace CSA certified
- 4 Way Multi-Poise Design
- Signal and Two Stage Gas Valves
- PSC and ECM Blower Motors
- PlusOne™ Diagnostics 7-Segment LED
- PlusOne™ Ignition System - DSI for reliability
- PlusOne™ Water management System

Warranties

10-Yr Part Warranty

Limited Lifetime Heat Exchanger

96% 2-Stage Gas Furnaces w/ Constant Torque Motor

Part #	Mfg #	Tons	Width	Input	Output	AFUE	Price
234429	R96TA0402317M	3 Ton	17-1/2"	42,000	40,320	96.0%	
234432	R96TA0602317M	3 Ton	17-1/2"	56,000	53,760	96.0%	
234435	R96TA0702317M	3 Ton	17-1/2"	70,000	67,200	96.0%	
234437	R96TA0852521M	5 Ton	21"	84,000	80,460	95.0%	
234439	R96TA1002521M	5 Ton	21"	98,000	94,080	95.0%	
234440	R96TA1152524M	5 Ton	24-1/2"	112,000	107,520	96.0%	

96% 2-Stage Gas Furnaces w/ PSC Motor

Part #	Mfg #	Tons	Width	Input	Output	AFUE	Price
159994	R96PA0402317MSA	3 Ton	17-1/2"	42,000	41,000	96.0%	
159995	R96PA0602317MSA	3 Ton	17-1/2"	56,000	54,000	96.0%	
159998	R96PA0702317MSA	3 Ton	17-1/2"	70,000	68,000	96.0%	
160001	R96PA0852521MSA	5 Ton	21"	84,000	81,000	95.0%	
160004	R96PA1002521MSA	5 Ton	21"	98,000	94,000	95.0%	
160007	R96PA1152524MSA	5 Ton	24"	112,000	109,000	96.0%	

95% Single Stage Gas Furnaces w/ X-13 Constant Torque Motor

Part #	Mfg #	Tons	Width	Input	Output	AFUE	Price
222224	R95TC0401317MSA	3 Ton	17-1/2"	42,000	40,320	95.0%	
222225	R95TC0601317MSA	3 Ton	17-1/2"	56,000	53,760	95.0%	
222226	R95TC0701317MSA	3 Ton	17-1/2"	70,000	67,200	95.0%	
222227	R95TC0851521MSA	5 Ton	21"	84,000	80,460	95.0%	
222228	R95TC1001521MSA	5 Ton	21"	98,000	94,080	95.0%	
222229	R95TC1151524MSA	5 Ton	24-1/2"	112,000	107,520	95.0%	

• Serving our Customers Since 1946 • www.plumbsupply.com



Gas Multi-Position Furnaces

95% Single Stage Gas Furnaces w/ PSC Motor

Part #	Mfg #	Tons	Width	Input	Output	AFUE	Price
158565	R95PA0401317MSA	3 Ton	17-1/2"	42,000	40,320	95.0%	
158566	R95PA0601317MSA	3 Ton	17-1/2"	56,000	53,760	95.0%	
158567	R95PA0701317MSA	3 Ton	17-1/2"	70,000	67,200	95.0%	
158568	R95PA0851521MSA	5 Ton	21"	84,000	80,460	95.0%	
158569	R95PA1001521MSA	5 Ton	21"	98,000	94,080	95.0%	
158570	R95PA1151524MSA	5 Ton	24-1/2"	112,000	107,520	95.0%	

92% Single Stage Gas Furnaces w/ X-13 Constant Torque Motor

Part #	Mfg #	Tons	Width	Input	Output	AFUE	Price
263700	R92TA0401317MSA	3 Ton	17-1/2"	42,000	39,060	92.0%	
263701	R92TA0601317MSA	3 Ton	17-1/2"	56,000	52,080	92.0%	
263703	R92TA0701317MSA	3 Ton	17-1/2"	70,000	65,100	92.0%	
263704	R92TA0851521MSA	5 Ton	21"	84,000	78,120	92.0%	
263705	R92TA1001521MSA	5 Ton	21"	98,000	91,140	92.0%	
263706	R92TA1151524MSA	5 Ton	24-1/2"	112,000	104,160	92.0%	

Modulating Gas Furnaces

ULTRA
Series

- EcoNet™ Enabled
- ECM Motor
- Modulating Function: when used with an EcoNet Control
- PlusOne™ Ignition System
- PlusOne™ Water Management System
- PlusOne™ Diagnostics 7- Segment LED
- Blower Shelf design – serviceable in all furnace orientations
- Pre marked hoses – insures proper system drainage
- Vent with 2" or 3" PVC
- Integrated control boards feature dip switches for easy system set up
- Self priming condensate trap
- Solid bottom included



Warranties: Parts - 10 Years / Heat Exchanger - Limited Lifetime / Conditional Unit Replacement - Limited Lifetime

96% 2-Stage Variable Speed Gas Furnaces

Part #	Mfg #	Tons	Width	Input	Output	AFUE	Price
170931	U96VA0402317MSA	3 Ton	17-1/2"	42,000	40,320	96.0%	
160836	U96VA0602317MSA	3 Ton	17-1/2"	56,000	53,760	96.0%	
160837	U96VA0702317MSA	3 Ton	17-1/2"	70,000	67,200	96.0%	
160838	U96VA0852521MSA	5 Ton	21"	84,000	80,640	96.0%	
160839	U96VA1002521MSA	5 Ton	21"	98,000	94,080	96.0%	
160840	U96VA1152524MSA	5 Ton	24-1/2"	112,000	107,520	96.0%	

www.plumbsupply.com • Serving our Customers Since 1946 •



Gas Upflow/Horizontal Furnaces

80% Gas Furnaces

- 80% Residential Gas Furnace
- Upflow/Horizontal Design
- PlusOne™ Diagnostics 7-Segment LED
- PlusOne™ Ignition System - DSI for reliability
- Solid Door for Quiet Operation



Warranties

10-Yr Part Warranty

20 Year Heat Exchanger

80% Upflow/Horizontal Single Stage Gas Furnaces w/ x-13 Constant Torque Motor



Part #	Mfg #	Tons	Width	Input	Output	AFUE	Price
263687	R801CA050314MSA	3 Ton	14"	50,000	41,000	80.0%	
263688	R801CA075417MSA	4 Ton	17"	75,000	61,000	80.0%	
263689	R801CA075421MSA	4 Ton	21"	75,000	61,000	80.0%	
263691	R801CA100521MSA	5 Ton	21"	100,000	81,000	80.0%	
263692	R801CA125524MSA	5 Ton	24"	125,000	101,000	80.0%	

80% Upflow/Horizontal Two-Stage Variable Speed Gas Furnace w/ ECM Motor



Part #	Mfg #	Tons	Width	Input	Output	AFUE	Price
256030	U802VA050317MSA	3 Ton	17"	50,000	41,000	80.0%	
255371	U802VA075317MSA	3 Ton	17"	75,000	61,000	80.0%	



Gas Upflow/Horizontal Furnaces

97%+ Gas Furnaces

ULTRA

Series

- EcoNet™ Enabled
- ECM Motor
- Modulating Function: when used with an EcoNet Control
- PlusOne™ Ignition System
- PlusOne™ Water Management System
- PlusOne™ Diagnostics 7- Segment LED
- Blower Shelf design – serviceable in all furnace orientations
- Pre marked hoses – insures proper system drainage
- Vent with 2" or 3" PVC
- Integrated control boards feature dip switches for easy system set up
- Self priming condensate trap
- Solid bottom included



Warranties

Parts - 10 Years

Heat Exchanger - Limited Lifetime

Conditional Unit Replacement - Limited Lifetime

97% Gas Furnaces

Part #	Mfg#	Blower	Width	Input	Output	AFUE	Price
185048	U97VA060M317USA	3 Ton	17-1/2"	56,000	54,320	97.0%	
185049	U97VA070M317USA	3 Ton	17-1/2"	70,000	67,900	97.0%	
185050	U97VA085M521USA	5 Ton	21"	84,000	81,480	97.0%	
185051	U97VA100M521USA	5 Ton	21"	98,000	95,060	97.0%	
185052	U97VA115M524USA	5 Ton	24-1/2"	112,000	408,640	97.0%	

98%+ Gas Furnaces

Part #	Mfg #	Tons	Width	Input	Output	AFUE	Price
243342	U98VB060M317USA	3 Ton	17-1/2"	56,000	55,000	98.7%	
243343	U98VB070M317USA	3 Ton	17-1/2"	70,000	69,000	98.3%	
243344	U98VB085M521USA	5 Ton	21"	84,000	83,000	98.1%	
243345	U98VB100M521USA	5 Ton	21"	98,000	97,000	98.1%	
243346	U98VB115M524USA	5 Ton	24-1/2"	112,000	110,000	98.6%	

Gas Upflow/Horizontal Furnaces

Gas Upflow Furnaces

80% KG7SA Series Gas Upflow/Horizontal Furnace

- Single stage heat/cool
- 100% fired and tested
- Best packaging in the industry
- Low Boy Height
- Tubular primary heat exchanger
- 30 second blower delay at start-up
- 30 second post purge
- Hot surface igniter
- Color coded wire harness
- PSC high static blowers
- 90 second cooling cycle blower-off delay (TDR)
- Flexible category I venting system
- Multi-speed direct drive PSC blower
- LP convertible (905028)
- Diagnostic lights for easy troubleshooting without counting flashes
- Integrated control board
- Two piece door design
- Furnace air leakage compliant



Part #	Mfg #	Tons	Motor Type	Input BTUH	Heating Capacity BTUH	Dimensions (H x W)	Price
118713	KG7SA045C23A	2-3	PSC	45,000	36,000	34 1/2" x 14 1/4"	
118715	KG7SA054C23A	2-3	PSC	54,000	43,200	34 1/2" x 14 1/4"	
118716	KG7SA072C24B	2-4	PSC	72,000	57,600	34 1/2" x 17 1/2"	
118717	KG7SA090C24B	2-4	PSC	90,000	72,000	34 1/2" x 17 1/2"	
118718	KG7SA072C35C	3-5	PSC	72,000	57,600	34 1/2" x 21"	
118719	KG7SA090C35C	3-5	PSC	90,000	72,000	34 1/2" x 21"	
118720	KG7SA108C35C	3-5	PSC	108,000	86,400	34 1/2" x 21"	
118721	KG7SA126C45D	4-5	PSC	126,000	100,800	34 1/2" x 24 1/2"	

Gas Upflow/Horizontal Furnaces

92% KG7SC Series Gas Upflow/Horizontal Furnace

- Single stage heat/cool
- 100% fired and tested
- Best packaging in the industry
- Low Boy Height
- Tubular primary heat exchanger
- 30 second blower delay at start-up
- 30 second post purge
- Hot surface igniter
- Color coded wire harness
- PSC high static blowers
- 90 second cooling cycle blower-off delay (TDR)
- Flexible category I venting system
- Multi-speed direct drive PSC blower
- LP convertible (905028)
- Diagnostic lights for easy troubleshooting without counting flashes
- Integrated control board
- Two piece door design
- Furnace air leakage compliant



Part #	Mfg #	Tons	Motor Type	Input BTUH	Heating Capacity BTUH	Dimensions (H x W)	Price
118758	KG7SC038D23A	2-3	PSC	38,000	35,000	34 1/2" x 14 1/4"	
118759	KG7SC054D24B	2-4	PSC	54,000	49,700	34 1/2" x 17 1/2"	
118760	KG7SC072D24B	2-4	PSC	72,000	66,000	34 1/2" x 17 1/2"	
118761	KG7SC090D35C	3-5	PSC	90,000	82,000	34 1/2" x 21"	
118762	KG7SC072D35C	3-5	PSC	72,000	66,800	34 1/2" x 21"	
118763	KG7SC108D45D	4-5	PSC	108,000	99,000	34 1/2" x 24 1/2"	
118764	KG7SC120D45D	4-5	PSC	120,000	110,400	34 1/2" x 24 1/2"	

Gas Upflow/Horizontal Furnaces

95% KG7TC Series Gas Upflow/Horizontal Furnace

- Two-stage heat/cool
- 100% fired and tested
- Best packaging in the industry
- Low Boy Height
- Tubular primary heat exchanger
- 30 second blower delay at start-up
- 30 second post purge
- Hot surface igniter
- Color coded wire harness
- Fixed speed ECM
- High efficiency blower motor
- 90 second cooling cycle blower-off delay (TDR)
- Flexible category I venting system
- Multi-speed direct drive blower (ECM)
- LP convertible (905028)
- Diagnostic lights for easy troubleshooting without counting flashes
- Integrated control board
- Two piece door design
- Furnace Air Leakage



Part #	Mfg #	Tons	Motor Type	Input BTUH	Heating Capacity BTUH	Dimensions (H x W)	Price
118765	KG7TC060D24B	2-4	BLDC	60,000	57,000	34 1/2" x 17 1/2"	
118766	KG7TC080D35C	3-5	BLDC	80,000	76,000	34 1/2" x 21"	
118767	KG7TC100D35C	3-5	BLDC	100,000	95,000	34 1/2" x 21"	
118768	KG7TC120D45D	4-5	BLDC	120,000	78,000	34 1/2" x 24 1/2"	

Gas Upflow/Horizontal Furnaces

95% KG7SD Series Gas Upflow/Horizontal Furnace

- Single-stage heat/cool
- 100% fired and tested
- Best packaging in the industry
- Low Boy Height
- Tubular primary heat exchanger
- 30 second blower delay at start-up
- 30 second post purge
- Hot surface igniter
- Color coded wire harness
- PSC high static blowers
- 90 second cooling cycle blower-off delay (TDR)
- Flexible category I venting system
- Multi-speed direct drive PSC blower motor
- LP convertible (905028)
- Diagnostic lights for easy troubleshooting without counting flashes
- Integrated control board
- Two piece door design
- Furnace air leakage compliant



Part #	Mfg #	Tons	Motor Type	Input BTUH	Heating Capacity BTUH	Dimensions (H x W)	Price
143089	KG7SD038D24B	2-4	Multi-Speed PSC	38,000	36,100	34 1/2" x 17 1/2"	
143091	KG7SD054D24B	2-4	Multi-Speed PSC	54,000	51,300	34 1/2" x 17 1/2"	
143092	KG7SD072D35C	3-5	Multi-Speed PSC	72,000	68,400	34 1/2" x 21"	
143093	KG7SD090D35C	3-5	Multi-Speed PSC	90,000	85,500	34 1/2" x 21"	
143094	KG7SD108D45D	4-5	Multi-Speed PSC	108,000	102,600	34 1/2" x 24 1/2"	
143095	KG7SD120D45D	4-5	Multi-Speed PSC	120,000	114,000	34 1/2" x 24 1/2"	

Gas Upflow/Horizontal Furnaces

96% KG7TE Series Gas Upflow Furnace

- Two-stage heat/cool
- Energy efficient brushless DC (ECM) motor - fixed speed
- 100% fired and tested
- Best packaging in the industry
- Low Boy Height
- Aluminized steel primary heat exchanger
- 30 second blower delay at start-up
- 30 second post purge
- 90 second fixed cooling cycle blower-off delay
- Hot surface ignitor
- Color coded wire harness
- Flexible category I venting system
- High static blowers
- Variable speed blower kit available
- LP convertible (905028)
- Diagnostic lights for easy troubleshooting without counting flashes
- Integrated control board
- Two piece door design



Part #	Mfg #	Tons	Motor Type	Input BTUH	Heating Capacity BTUH	Dimensions (H x W)	Price
236802	KG7TE060D24B1	2-4	ECM	60,000	57,600	34-1/2" x 17-1/2"	
236804	KG7TE080D35C1	3-5	ECM	80,000	52,000	34-1/2" x 21"	
236806	KG7TE100D35C1	3-5	ECM	100,000	96,000	34-1/2" x 21"	

Gas Upflow/Horizontal Furnaces

Gas Upflow Furnaces

FG7S (A Series) 80% Gas Upflow Furnace

- 100% fired and tested
- Best packaging in the industry
- Low Boy Height
- Tubular primary heat exchanger
- 30 second blower delay at start-up
- 30 second post purge
- Hot surface igniter
- Color coded wire harness
- High static blowers
- 90 second cooling cycle blower-off delay (TDR)
- Flexible category I venting system
- High efficiency blower kits
- Multi-speed direct drive blower
- LP convertible
- Diagnostic lights for easy troubleshooting without counting flashes
- Integrated control board
- Two piece door design
- Blower Compartment
- Furnace Air Leakage



Part #	Mfg #	Tons	Motor Type	Input BTUH	Heating Capacity BTUH	Dimensions (H x W)	Price
118830	FRIFG7SA045C23A	2-3	PSC	45,000	36,000	34 1/2" x 14 1/4"	
118831	FRIFG7SA054C23A	2-3	PSC	54,000	43,200	34 1/2" x 14 1/4"	
118832	FRIFG7SA072C24B	2-4	PSC	72,000	57,600	34 1/2" x 17 1/2"	
118833	FRIFG7SA072C35C	3-5	PSC	72,000	57,600	34 1/2" x 21"	
118834	FRIFG7SA090C24B	2-4	PSC	90,000	72,000	34 1/2" x 17 1/2"	
118835	FRIFG7SA090C35C	3-5	PSC	90,000	72,000	34 1/2" x 21"	
118836	FRIFG7SA108C35C	3-5	PSC	108,000	86,400	34 1/2" x 21"	
118837	FRIFG7SA126C45D	4-5	PSC	126,000	100,800	34 1/2" x 24 1/2"	

Gas Upflow/Horizontal Furnaces

FG7S (C Series) 92% Gas Upflow Furnace

- 100% fired and tested
- Best packaging in the industry
- 30 second blower delay
- 30 second post purge
- Hot surface igniter
- Color coded wire harness
- Flexible category IV venting system
- High Static Blowers
- Low Boy Height
- Tubular primary heat exchanger
- 90 second fixed cooling cycle blower-off delay (TDR)
- High efficiency blower kits
- Multi-speed direct drive blower
- LP convertible
- Diagnostic lights for easy troubleshooting without counting flashes
- Incorporates integrated control board
- Two piece door design
- Blower Compartment
- Sealed Vestibule
- Furnace Air Leakage



Part #	Mfg #	Tons	Motor Type	Input BTUH	Heating Capacity BTUH	Dimensions (H x W)	Price
118843	FRIFG7SC038D23A	2-3	PSC	38,000	35,000	34 1/2" x 14 1/4"	
118844	FRIFG7SC054D24B	2-4	PSC	54,000	49,700	34 1/2" x 17 1/2"	
118845	FRIFG7SC072D24B	2-4	PSC	72,000	66,000	34 1/2" x 17 1/2"	
118847	FRIFG7SC072D35C	3-5	PSC	72,000	66,000	34 1/2" x 21"	
118848	FRIFG7SC090D35C	3-5	PSC	90,000	82,000	34 1/2" x 21"	
118849	FRIFG7SC108D45D	4-5	PSC	108,000	99,000	34 1/2" x 24 1/2"	
118850	FRIFG7SC120D45D	4-5	PSC	120,000	110,400	34 1/2" x 24 1/2"	

Gas Upflow/Horizontal Furnaces

FG7S (D Series) 95% Gas Upflow Furnace

- 100% fired and tested
- Best packaging in the industry
- 30 second blower delay
- 30 second post purge
- Hot surface igniter
- Color coded wire harness
- Flexible category IV venting system
- High Static Blowers
- Low Boy Height
- Tubular primary heat exchanger
- 60 second fixed cooling cycle blower-off delay (TDR)
- High efficiency blower kits
- Multi-speed direct drive blower
- LP convertible
- Diagnostic lights for easy troubleshooting without counting flashes:
- Incorporates integrated control board
- Two piece door design
- Blower Compartment
- Sealed Vestibule
- Furnace Air Leakage



Part #	Mfg #	Tons	Motor Type	Input BTUH	Heating Capacity BTUH	Dimensions (H x W)	Price
142960	FRIFG7SD038D24B	2-4	PSC	38,000	36,100	34 1/2" x 17 1/2"	
142959	FRIFG7SD054D24B	2-4	PSC	54,000	51,300	34 1/2" x 17 1/2"	
142958	FRIFG7SD072D35C	3-5	PSC	72,000	68,400	34 1/2" x 21"	
142957	FRIFG7SD090D35C	3-5	PSC	90,000	85,500	34 1/2" x 21"	
142956	FRIFG7SD108D45D	4-5	PSC	108,000	102,600	34 1/2" x 24 1/2"	
142955	FRIFG7SD120D45D	4-5	PSC	120,000	114,000	34 1/2" x 24 1/2"	

Gas Upflow/Horizontal Furnaces

FG7T (A Series) 80% Gas Upflow Furnace

- *i SEER*
- *100% fired and tested*
- *Best packaging in the industry*
- *Low Boy Height*
- *Tubular primary heat exchanger*
- *30 second blower delay at start-up*
- *30 second post purge*
- *Hot surface igniter*
- *Color coded wire harness*
- *High static blowers*
- *90 second cooling cycle blower-off delay (TDR)*
- *Flexible category I venting system*
- *Variable speed blower kit*
- *LP convertible*
- *Diagnostic lights for easy troubleshooting without counting flashes*
- *Integrated control board*
- *Two piece door design*
- *Blower Compartment*
- *2 Stage Inducer*
- *Furnace Air Leakage*



Part #	Mfg #	Tons	Motor Type	Input BTUH	Heating Capacity BTUH	Dimensions (H x W)	Price
202365	FRIFG7TA060C23A	2-3	BLDC	60,000	48,000	34 1/2" x 14 1/4"	
202366	FRIFG7TA080C24B	2-4	BLDC	80,000	64,000	34 1/2" x 17 1/2"	
202367	FRIFG7TA100C24B	2-4	BLDC	100,000	80,000	34 1/2" x 17 1/2"	
202369	FRIFG7TA120C35C	3-5	BLDC	120,000	96,000	34 1/2" x 21"	
202370	FRIFG7TA140C45D	4-5	BLDC	140,000	112,000	34 1/2" x 24 1/2"	

Gas Upflow/Horizontal Furnaces

FG7T (C Series) 95% Gas Upflow Furnace

- iSEER
- 100% fired and tested
- Best packaging in the industry
- 30 second blower delay
- 30 second post purge
- Hot surface igniter
- Color coded wire harness
- Flexible category IV venting system
- High Static Blowers
- Low Boy Height
- Tubular primary heat exchanger
- 90 second fixed cooling cycle blower-off delay (TDR)
- Variable speed blower kit
- LP convertible
- Diagnostic lights for easy troubleshooting without counting flashes:
- Incorporates integrated control board
- Two piece door design
- Blower Compartment
- Sealed Vestibule
- 2 Stage Inducer
- Furnace Air Leakage



Part #	Mfg #	Tons	Motor Type	Input BTUH	Heating Capacity BTUH	Dimensions (H x W)	Price
118851	FRIFG7TC060D24B	2-4	BLDC	60,000	57,000	34 1/2" x 17 1/2"	
118852	FRIFG7TC080D35C	3-5	BLDC	80,000	76,000	34 1/2" x 21"	
118853	FRIFG7TC100D35C	3-5	BLDC	100,000	95,000	34 1/2" x 21"	
118854	FRIFG7TC120D45D	4-5	BLDC	120,000	114,000	34 1/2" x 24 1/2"	

Gas Upflow/Horizontal Furnaces

FG7T (A Series) 80% Variable Speed Gas Upflow Furnace

- iSEER
- 100% fired and tested
- Best packaging in the industry
- Low Boy Height
- Tubular primary heat exchanger
- 30 second blower delay at start-up
- 30 second post purge
- Two Stage Inducer
- Hot surface igniter
- Color coded wire harness
- High static blowers
- 90 second cooling cycle blower-off delay (TDR)
- Flexible category I venting system
- LP convertible
- Diagnostic lights for easy troubleshooting without counting flashes
- Integrated control board
- Two piece door design
- Blower Compartment
- Furnace Air Leakage



Part #	Mfg #	Tons	Motor Type	Input BTUH	Heating Capacity BTUH	Dimensions (H x W)	Price
202371	FRIFG7TA060CVA 1		Variable	60,000	48,000	34 1/2" x 14 1/4"	
202372	FRIFG7TA080CVB 1		Variable	80,000	64,000	34 1/2" x 17 1/2"	
202373	FRIFG7TA100CVC 1		Variable	100,000	80,000	34 1/2" x 21"	
202374	FRIFG7TA120CVC 1		Variable	120,000	96,000	34 1/2" x 21"	
202375	FRIFG7TA140CVD 1		Variable	140,000	112,000	34 1/2" x 24 1/2"	

Gas Upflow/Horizontal Furnaces

FG7T (C Series) 95% Variable Speed Gas Upflow Furnace

- *i SEER*
- *100% fired and tested*
- *Best packaging in the industry*
- *30 second blower delay*
- *30 second post purge*
- *Two Stage Inducer*
- *Hot surface igniter*
- *Color coded wire harness*
- *Flexible category IV venting system*
- *High Static Blowers*
- *Low Boy Height*
- *Tubular primary heat exchanger*
- *90 second fixed cooling cycle blower-off delay (TDR)*
- *LP convertible*
- *Diagnostic lights for easy troubleshooting without counting flashes*
- *Incorporates integrated control board*
- *Two piece door design*
- *Blower Compartment*
- *Sealed Vestibule*
- *Furnace Air Leakage*



Part #	Mfg #	Tons	Motor Type	Input BTUH	Heating Capacity BTUH	Dimensions (H x W)	Price
118855	FRIFG7TC060DVB		Variable	60,000	57,000	34 1/2" x 17 1/2"	
118856	FRIFG7TC080DVC		Variable	80,000	76,000	34 1/2" x 21"	
118858	FRIFG7TC100DVC		Variable	100,000	95,000	34 1/2" x 21"	
118859	FRIFG7TC120DVD		Variable	120,000	114,000	34 1/2" x 24 1/2"	

Gas Upflow/Horizontal Furnaces

Gas Upflow/Horizontal Furnaces

A951A High-Efficiency Single-Stage Furnace Upflow

- 95% AFUE
- EHX™ Technology
- Quiet Combustion™ Technology
- Self-Diagnosing control board
- Single-Stage gas valve
- Lifetime warranty on heat exchanger
- 10-Year limited parts warranty



Part #	Mfg #	Tons	Width	Input	Output	AFUE	Price
208640	AA95UH1D045B08 A	1.5-2.5	17.5"	44,000	42,000	95	
208641	AA95UH1D045B12 A	2-3	17.5"	44,000	42,000	95	
208642	AA95UH1D070B12 A	2-3	17.5"	66,000	64,000	95	
208644	AA95UH1D090C12 A	2-3	21"	88,000	85,000	95	
208645	AA95UH1D090C16 A	3-4	21"	88,000	85,000	95	
208646	AA95UH1D110C16 A	3-4	21"	110,000	106,000	95	
208647	AA95UH1D110C20 A	4-5	21"	110,000	106,000	95	
208648	AA95UH1D135D20 A	4-5	24.5"	132,000	126,000	95	

A801E Single-Stage, Constant Torque Furnace Upflow

- 80% AFUE
- EHX™ Technology
- Quiet Combustion™ Technology
- Single-Stage gas valve
- Constant torque blower motor
- Lifetime warranty on heat exchanger
- 10-Year limited parts warranty



Part #	Mfg #	Tons	Width	Input	Output	AFUE	Price
208510	AA80UH1E045A12	1-1/2 - 3	14.5"	44,000	35,200	80	
208511	AA80UH1E070B12	1-1/2 - 3	17.5"	66,000	52,800	80	
208512	AA80UH1E090B16	2-1/2 - 4	17.5"	88,000	70,400	80	
208513	AA80UH1E090C20	3 - 5	21"	88,000	70,400	80	
208534	AA80UH1E110C20	4 - 5	21"	110,000	88,000	80	
208535	AA80UH1E135D20	4 - 5	24.5"	132,000	105,600	80	

Gas Upflow/Horizontal Furnaces

A802V Two-Stage, Variable Speed Furnace Upflow

- 80% AFUE
- EHX™ Technology
- Quiet Combustion™ Technology
- Two-Stage gas valve
- Variable-Speed blower motor
- Comfort Sync™ enabled
- Enhanced humidity control
- Lifetime warranty on heat exchanger
- 10-Year limited parts warranty



Part #	Mfg #	Tons	Width	Input	Output	AFUE	Price
209865	AA80US2V070A12	3	14.5"	66,000	52,000	80	
209866	AA80US2V090B12	3	17.5"	88,000	70,000	80	
209867	AA80US2V090C20	5	21"	88,000	70,000	80	
209868	AA80US2V110C20	5	21"	110,000	87,000	80	
209869	AA80US2V135D20	5	24.5"	132,000	105,000	80	

A951E Single-Stage, Constant Torque Furnace Upflow

- 95% AFUE
- EHX™ Technology
- Quiet Combustion™ Technology
- Self-Diagnosing control board
- Single-Stage gas valve
- Constant torque blower motor
- Stainless steel heat exchanger
- Lifetime warranty on heat exchanger
- 10-Year limited parts warranty



Part #	Mfg #	Tons	Width	Input	Output	AFUE	Price
208655	AA95UH1E045B12 S	3	17.5"	44,000	42,000	95	
208656	AA95UH1E070B12 S	3	17.5"	66,000	64,000	95	
208657	AA95UH1E090C16 S	4	21"	88,000	85,000	95	
208658	AA95UH1E110C20 S	5	21"	110,000	106,000	95	
208659	AA95UH1E135D20 S	5	24.5"	132,000	128,000	95	

Gas Upflow/Horizontal Furnaces

A962V 2 Stage, High-Efficiency, Variable Speed Furnace Upflow

- 96% AFUE
- EHX™ Technology
- Quiet Combustion™ Technology
- Self-Diagnosing control board
- Two-Stage gas valve
- Variable-Speed blower motor
- Comfort Sync™ enabled
- Stainless steel heat exchanger
- Lifetime warranty on heat exchanger
- 10-Year limited parts warranty



Part #	Mfg #	Tons	Width	Input	Output	AFUE	Price
214461	AA96US2V045B12 S	3	17.5"	29,000/44,000	28,000/42,000	96	
214462	AA96US2V070B12 S	3	17.5"	43,000/66,000	41,000/62,000	96	
214463	AA96US2V090C12 S	3	21"	57,000/88,000	55,000/84,000	96	
214464	AA96US2V090C16 S	4	21"	57,000/88,000	55,000/85,000	96	
214465	AA96US2V090C20 S	5	21"	57,000/88,000	55,000/85,000	96	
214466	AA96US2V110C16 S	4	21"	72,000/110,000	70,000/105,000	96	
214467	AA96US2V110C20 S	5	21"	72,000/110,000	70,000/106,000	96	
214468	AA96US2V135D20 S	5	24.5"	88,000/132,000	84,000/126,000	96	

A97MV High-Efficiency Modulating Furnace Testing Upflow

- 97% AFUE
- EHX™ Technology
- Quiet Combustion™ Technology
- Self-Diagnosing control board
- Modulating gas valve
- Variable-Speed blower motor
- Comfort Sync enabled
- Stainless steel heat exchanger
- Lifetime warranty on heat exchanger
- 10-Year limited parts warranty



Part #	Mfg #	Tons	Width	Input	Output	AFUE	Price
209773	AA97USMV070B12 S	3	17.5"	66,000	64,000	97	
209774	AA97USMV090C12 S	3	21"	88,000	85,000	97	
209775	AA97USMV090C16 S	4	21"	88,000	85,000	97	

Gas Upflow/Horizontal Furnaces

Gas Upflow/Horizontal Furnaces (Continued)

A97MV High-Efficiency Modulating Furnace Testing Upflow

Part #	Mfg #	Tons	Width	Input	Output	AFUE	Price
209776	AA97USMV090C20 S	5	21"	88,000	85,000	97	
209777	AA97USMV110C20 S	5	21"	110,000	106,000	97	
209778	AA97USMV135D20 S	5	24.5"	132,000	127,000	97	

A931A High-Efficiency Single-Stage Furnace Upflow

- 93% AFUE
- EHX™ Technology
- Quiet Combustion™ Technology
- Self-Diagnosing control board
- Single-Stage gas valve
- Permanent split capacitor (PSC) motor
- Lifetime warranty on heat exchanger
- 10-Year limited parts warranty



Part #	Mfg #	Tons	Width	Input	Output	AFUE	Price
208626	AA93UH1D045B08 A	2	17.5"	44,000	41,000	93	
208627	AA93UH1D045B12 A	3	17.5"	44,000	42,000	93	
208628	AA93UH1D070B08 A	2	17.5"	66,000	62,000	93	
208629	AA93UH1D070B12 A	3	21"	66,000	61,000	93	
208630	AA93UH1D090C12 A	3	21"	88,000	83,000	93	
208631	AA93UH1D090C16 A	4	21"	88,000	83,000	93	
208632	AA93UH1D110C16 A	4	21"	110,000	104,000	93	
208633	AA93UH1D110C20 A	5	21"	110,000	104,000	93	
208635	AA93UH1D135D20 A	5	24.5"	132,000	124,000	93	

Gas Upflow/Horizontal Furnaces

A801A Standard-Efficiency Single-Stage Furnace

- 80% AFUE
- EHX™ Technology
- Quiet Combustion™ Technology
- Single-Stage Gas Valve
- Fixed-Speed blower motor
- Lifetime warranty on heat exchanger
- 10-Year limited parts warranty



Part #	Mfg #	Tons	Width	Input	Output	AFUE	Price
208497	AA80UH1D045A12	3	14.5"	44,000	35,000	80	
208498	AA80UH1D070A08	2	14.5"	66,000	54,000	80	
208499	AA80UH1D070A12	3	14.5"	66,000	54,000	80	
208500	AA80UH1D090B12	3	17.5"	88,000	71,000	80	
208501	AA80UH1D090B16	4	17.5"	88,000	71,000	80	
208502	AA80UH1D110C12	3	21"	110,000	89,000	80	
208503	AA80UH1D110C16	4	21"	110,000	89,000	80	
208504	AA80UH1D110C20	5	21"	110,000	89,000	80	
208505	AA80UH1D135D20	5	24.5"	132,000	107,000	80	

Gas Upflow/Horizontal Furnaces

Gas Upflow/Horizontal Furnaces

80G1 80% Single Stage Gas Furnace

- Crimped no-weld aluminized clam shell heat exchanger construction
- Compact 33" height, standardized widths for easy coil fit
- Multi-speed PSC blower motor
- Easily removable slide out blower design
- Single stage gas valve
- Self diagnostics saving last 5 fault codes regardless of power interruption
- Rotatable draft inducer for venting flexibility
- Left or right utility connections
- Removable floor base for bottom return air
- Zero step horizontal conversion
- 10-Year limited parts warranty



Part #	Mfg #	Tons	AFUE	Input BTUH	Htg Capacity BTUH	Dimensions (H x W)	Price
208685	DC80G1UH045AP12	3	80%	44,000	45,000	33" x 14-1/2"	
208686	DC80G1UH070AP08	2	80%	66,000	70,000	33" x 14-1/2"	
208687	DC80G1UH070AP12	3	80%	66,000	70,000	33" x 14-1/2"	
208688	DC80G1UH090BP12	3	80%	88,000	90,000	33" x 17-1/2"	
208689	DC80G1UH090BP16	4	80%	88,000	90,000	33" x 17-1/2"	
208690	DC80G1UH110CP12	3	80%	110,000	110,000	33" x 21"	
208691	DC80G1UH110CP16	4	80%	110,000	110,000	33" x 21"	
208692	DC80G1UH110CP20	5	80%	110,000	110,000	33" x 21"	
208693	DC80G1UH135DP20	5	80%	132,000	135,000	33" x 24-1/2"	

92G1 92% Single Stage Gas Furnace

- Aluminized steel design primary heat exchanger with crimped no weld construction
- AL 29-4C Stainless steel secondary heat exchanger
- Aluminized steel inshot burners for smooth ignition
- Compact 33" height
- Standardized widths for easy coil fit
- Multi-speed PSC blower motor
- Easily removable slide-out blower design
- Single Stage Gas Valve
- Self diagnostics saves last 5 fault codes regardless of power interruption
- Control features electronic air cleaner and humidifier terminals
- Designed certified for direct and non direct applications
- Left or right utility connection
- Designed certified for direct and non-direct vent applications
- Zero step horizontal conversion
- Removable floor base for bottom return air
- 10-Year limited parts warranty



Part #	Mfg #	Tons	AFUE	Input BTUH	Htg Capacity BTUH	Dimensions (H x W)	Price
208698	DC92G1UH045BP08	2	92%	44,000	45,000	33" x 17-1/2"	

Gas Upflow/Horizontal Furnaces

Gas Upflow/Horizontal Furnaces (Continued)

92G1 92% Single Stage Gas Furnace

Part #	Mfg #	Tons	AFUE	Input BTUH	Htg Capacity BTUH	Dimensions (H x W)	Price
208699	DC92G1UH045BP12	3	92%	44,000	45,000	33" x 17-1/2"	
208700	DC92G1UH070BP08	2	92%	66,000	70,000	33" x 17-1/2"	
208701	DC92G1UH070BP12	3	92%	66,000	70,000	33" x 17-1/2"	
208702	DC92G1UH090CP12	3	92%	88,000	90,000	33" x 21"	
208703	DC92G1UH090CP16	4	92%	88,000	90,000	33" x 21"	
208704	DC92G1UH110CP16	4	92%	110,000	110,000	33" x 21"	
208705	DC92G1UH110CP20	5	92%	110,000	110,000	33" x 21"	
208706	DC92G1UH135DP20	5	92%	132,000	135,000	33" x 24-1/2"	

95G1 95% Single Stage Gas Furnace

- *Aluminized steel design primary heat exchanger with crimped no weld construction*
- *AL 29-4C Stainless steel secondary heat exchanger*
- *Aluminized steel inshot burners for smooth fit*
- *Compact 33" height*
- *Standardized widths for easy coil fit*
- *Multi-speed PSC blower motor*
- *Easily removable slide-out blower design*
- *Single Stage Gas Valve*
- *Self diagnostics saves last 5 fault codes regardless of power interruption*
- *Control features electronic air cleaner and humidifier terminals*
- *Designed certified for direct and non direct applications*
- *Left or right utility connection*
- *Designed certified for direct and non-direct vent applications*
- *Zero step horizontal conversion*
- *Removable floor base for bottom return air*
- *10-Year limited parts warranty*



Part #	Mfg #	Tons	AFUE	Input BTUH	Htg Capacity BTUH	Dimensions (H x W)	Price
208830	DC95G1UH045BP08	2	95%	44,000	45,000	33" x 17-1/2"	
208831	DC95G1UH045BP12	3	95%	44,000	45,000	33" x 17-1/2"	
208832	DC95G1UH070BP12	3	95%	66,000	70,000	33" x 17-1/2"	
208833	DC95G1UH090CP12	3	95%	88,000	90,000	33" x 21"	
208834	DC95G1UH090CP16	4	95%	88,000	90,000	33" x 21"	
208835	DC95G1UH110CP16	4	95%	110,000	110,000	33" x 21"	
208836	DC95G1UH110CP20	5	95%	110,000	110,000	33" x 21"	
208837	DC95G1UH135DP20	5	95%	132,000	135,000	33" x 24-1/2"	

Gas Upflow/Horizontal Furnaces

95G1E 95% Single Stage Gas Furnace Constant Torque Motor

- Designed certified for direct (2-pipe) and non direct (1-pipe) applications
- Easily vented with PVC pipe
- Left or right utility connection
- Design certified for direct and non-direct vent applications
- Zero step horizontal conversion
- Removable floor base (upflow / horizontal units) for bottom return air
- Aluminized steel primary heat exchanger with crimped non welded construction
- AL 29-4C Stainless steel secondary heat exchanger
- Aluminized steel inshot burners for smooth ignition
- Compact 33" height, standardized widths for easy coil fit
- Multi-speed high efficiency (constant torque) blower motor
- Easily removable slide out blower design
- Enhanced cooling SEER ratings when applied with properly matched cooling equipment.
- Single stage gas valve
- Durable silicon nitride ignitor
- Self diagnostics saves last 10 fault codes regardless of power interruption
- Control features electronic air cleaner and humidifier terminals
- 10-Year limited parts warranty



Part #	Mfg #	Tons	AFUE	Input BTUH	Htg Capacity BTUH	Dimensions (H x W)	Price
208842	DC95G1UH045BE12	3	95%	44,000	45,000	33" x 17-1/2"	
208843	DC95G1UH070BE12	3	95%	66,000	70,000	33" x 17-1/2"	
208844	DC95G1UH090CE16	4	95%	88,000	90,000	33" x 21"	
208845	DC95G1UH110CE20	5	95%	110,000	110,000	33" x 21"	
208846	DC95G1UH135DE20	5	95%	132,000	135,000	33" x 24-1/2"	

Gas Upflow/Horizontal Furnaces

95G2V Two Stage Variable Speed Gas Furnace

- *Aluminized steel primary heat exchanger with crimped non welded construction*
- *AL29-4C Stainless steel secondary heat exchanger*
- *Non-welded crimped S-curve primary heat exchanger design for maximum durability*
- *Aluminized steel in shot burners for smooth ignition*
- *Isolated burner enclosure for quiet operation*
- *Compact 33" height*
- *Standardized widths for easy coil fit*
- *Unitized construction for cabinet integrity*
- *Baked on prepainted steel cabinet finish*
- *Efficient ECM variable speed blower motor*
- *Motor features "soft start" and "soft stop" for quiet operation*
- *Active and passive dehumidification feature*
- *Easily removable slide-out blower design*
- *Dynamically balanced blower wheel with resilient motor mounts for smooth and quiet operation*
- *Two stage gas valve*
- *Integrated ignition and fan control*
- *System Sentry™ control retains last five (5) fault codes with push button memory recall, regardless of power interruption*
- *Hot surface ignition system uses silicon nitride ignitor*
- *Control features 120 volt electronic air cleaner and humidifier terminals*
- *Control circuit is fuse protected*
- *Color coded control wiring*
- *Compatible with single or two stage thermostats for heating*
- *Two stage thermostat is recommended when installed with two stage cooling unit*
- *Left or right gas and electric entry*
- *Zero step horizontal conversion*
- *Removable floor base (upflow/horizontal units) for bottom return air*
- *Heat exchanger compartment is insulated to increase efficiency and reduce sound levels*
- *10-Year limited parts warranty*



Part #	Mfg #	Tons	AFUE	Input BTUH	Htg Capacity BTUH	Dimensions (H x W)	Price
210864	DC95G2UH045BV12	3	95%	29,000, 44,000	45,000	33" x 17-1/2"	
210865	DC95G2UH070BV12	3	95%	43,000, 66,000	70,000	33" x 17-1/2"	
210866	DC95G2UH090CV12	3	95%	57,000, 88,000	90,000	33" x 21"	
221672	DC95G2UH090CV20	5	95%	57,000, 88,000	90,000	33" x 21"	
217360	DC95G2UH110CV20	5	95%	72,000, 110,000	110,000	33" x 21"	
210867	DC95G2UH135DV20	5	95%	88,000, 132,000	135,000	33" x 24-1/2"	

Gas Unit Heaters

Unit Heaters

UDAP V3® Power Vented, Low Static, Axial Fan Unit Heater

- All sizes are approved for commercial/industrial installations
- Sizes 30 - 125 are approved for residential application
- Rise range: 50° to 60°F
- Tcore2® Design titanium stabilized aluminized steel heat exchanger and single burner combustion system with 1-piece burner assembly
- 115-1-60 Supply voltage
- Internal overload protection
- Integrated circuit board with diagnostic indicator lights
- Fan relay
- Multi-try direct spark ignition with 100% lockout
- Full fan guard
- 2-Stage natural or propane gas valve on sizes 60 - 400



Part #	Mfg #	Gas Type	Input/ Output MBTUH	Efficiency	CFM	Vent Dia	Blower/ Fan Size	Dimensions H x W x D	Approx Ship Wt	Price
060544	UDAP30	NG	30/25	82%	456	4"	10"	12-1/8" x 25-5/8" x 26"	61 lbs	
060545	UDAP45	NG	45/37	83%	629	4"	10"	12-1/8" x 25-5/8" x 26"	66 lbs	
060546	UDAP60	NG	60/50	83%	769	4"	12"	15-1/8" x 25-5/8" x 27"	74 lbs	
099172	UDAP60AA2	LP	60/50	83%	769	4"	12"	15-1/8" x 25-5/8" x 27"	67 lbs	
060547	UDAP75	NG	75/62	83%	961	4"	12"	15-1/8" x 25-5/8" x 27-5/8"	79 lbs	
099171	UDAP75AA2	LP	75/62	83%	961	4"	12"	15-1/8" x 25-5/8" x 27-5/8"	79 lbs	
060548	UDAP100	NG	105/87	83%	1,345	4"	16"	23-1/8" x 25-5/8" x 28-5/8"	118 lbs	
060549	UDAP125	NG	120/100	83%	1,537	4"	16"	23-1/8" x 25-5/8" x 29-3/8"	123 lbs	
063749	UDAP150	NG	150/125	83%	1,921	5"	18"	20-1/8" x 38-3/16" x 42"	204 lbs	
063750	UDAP175	NG	175/145	83%	2,242	5"	18"	20-1/8" x 38-3/16" x 42"	219 lbs	
063751	UDAP200	NG	200/166	83%	2,562	5"	18"	20-1/8" x 38-3/16" x 42"	219 lbs	
063752	UDAP225	NG	225/187	83%	2,882	5"	18"	26-1/8" x 38-3/16" x 42"	245 lbs	
063753	UDAP250	NG	250/208	83%	3,202	5"	20"	26-1/8" x 38-3/16" x 42"	257 lbs	
063754	UDAP300	NG	300/249	83%	3,843	6"	24"	34-1/8" x 41 x 42"	321 lbs	
093423	UDAP400	NG	400/332	83%	5,123	6"	24"	34-1/8" x 41 x 42"	358 lbs	

Gas Unit Heaters

UEAS Ultra High Efficiency Unit Heater

- Up to 93% Thermal efficient
- 50-60 degree F Rise range
- Arranged for use with natural gas (propane conversion kit included with unit)
- Tcore3 409 stainless steel heat exchanger
- Patented Tcore3 single burner combustion system including a one-piece burner assembly
- Extruded aluminum secondary heat exchanger (patent pending)
- 115/1/60 Supply voltage
- 115 Volt open fan motor with internal overload protection
- Transformer for 24-volt controls
- Integrated circuit board with diagnostic indicator lights
- Multi-try direct ignition with 100% lockout
- Fan relay (included on the circuit board)
- Single-stage natural gas valve (field adjustable for operation to 10,000 ft. [3,000 meters] elevation)
- Vibration/noise isolated fan motor
- Sealed control compartment houses all electrical components
- 48 frame, ball bearing, PSC venter motor
- 4-point Suspension
- Built-in disconnect switch (20A @ 115V Rating)
- External terminal strip for 24-volt wiring
- Sealed junction box for supply wiring
- External gas connection
- Fully gasketed door panel with safety
- Full fan guard ~ engineered for safety
- Improved cabinet design with less visible hardware and a NEW Reznor appearance



Part #	Mfg #	Gas Type	Input/ Output MBTUH	Efficiency	CFM	Vent Dia	Blower/ Fan Size	Dimensions H x W x D	Approx Ship Wt	Price
104638	UEAS130	NG	131/122	93%	2256	4"	18"	20-1/8"x39-3/16"x50-1/2"	255 lbs	
104640	UEAS180	NG	175/159	93%	2458	4"	18"	20-1/8"x39-3/16"x50-1/2"	270 lbs	
104641	UEAS260	NG	260/239	93%	4430	4"	24"	34-1/8"x40-15/16"x53-5/16"	385 lbs	
104642	UEAS310	NG	305/277	93%	4283	4"	24"	34-1/8"x40-15/16"x53-5/16"	420 lbs	

Gas Fireplaces

Direct Vent Gas Fireplaces

Tahoe Deluxe Direct Vent Gas Fireplace

- Millivolt ignition with standing pilot/Piezo



Part #	Mfg #	Input BTUH	Gas Type	Ship Wt	Price
094560	DVD-36-FP30NG	20,000	NG	102 lbs	
094568	DVD-42-FP30NG	25,000	NG	121 lbs	

4" x 6-5/8" Direct Vent Kit

- Includes: cap, wall thimble, collars, gear clamps, vinyl siding shield, and 4' of 4" and 7" flexible vent

Part #	Mfg #	Description	Price
086619	DVVK-4F	DV Horiz Flexible Vent Kit	

Quiet-One Kickspace Heaters

Quiet-One 2000

Kickspace Heater

- 1-Piece chassis with removable grille manufactured from high grade zinc coated steel
- Headered coil made of copper tubes, tested at 300 psi and sealed for quality
- Integral 2-speed, max-off-min fan switches
- 120-60-1 Power supply is required
- Quiet efficient operation; installer friendly
- Easily fits in tight spaces or hard-to-heat areas



Part #	Mfg #	MBTUH	H x W x D	Price
122268	KS-2004	4.3	3-1/2" x 13-7/8" x 10-7/8"	
122273	KS-2008	8.9	3-13/16" x 20" x 10-7/8"	

Furnace Accessories

LP Conversion Kits

Part #	Mfg #	Description	Price
150450	904404A	LP Kit for G7 Furnaces	
143717	905028	LP Conversion Kit	
243032	922311	R8GE Pkg LP Kit	

Furnace Accessories

Concentric Venting

Concentric Vent

- *Allows both the intake for combustion air and the exhaust vent to pass through a standard roof or sidewall*
- *Kit includes:*
 - *Combustion air inlet cap*
 - *Air inlet pipe*
 - *Vent pipe*
 - *Intake/vent concentric "Y"*
 - *Installation instructions on box*



Part #	Mfg #	Description	Price
138703	CVENT-2	For Use w/2" Intake/Vent Systems	
138704	CVENT-3	For Use w/3" Intake/Vent Systems	

Concentric Vent Caps



Part #	Mfg #	Description	Price
176893	CVENTCAP2	2"	
227475	CVENTCAP3	3"	

Furnace Accessories

Accessories

Plenum Connectors

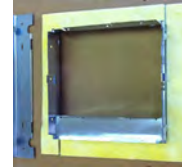

Part #	Mfg #	Description	Price
177147	INT901988A	901988A Plenum Connector 11.25 x 13.5 x 2	
177146	INT901989A	901989A Plenum Connector 11.25 x 13.5 x 4.25	
177145	INT901990A	901990A Plenum Connector 11.25 x 13.5 x 6.25	
177144	INT901991A	901991A Plenum Connector 11.25 x 13.5 x 8.25	

Flue Transition Kit For M7RL 95%



Part #	Mfg #	Description	Price
126521	INT904106	904106 PVC Vent Transition Kit for M7RL Units	

Flat Roof Flue Assembly



Part #	Mfg #	Description	Price
177153	INTFAW15230A	FAW1523-0A Flat Roof Flue Assembly	
233680	INTFAW21350A	FAW2135-0A Flat Roof Flue Assembly	
233682	INTFAW21350S	FAW2135-0S Flat Roof Flue Assembly	
177216	INTFAW27470A	FAW2747-0A Flat Roof Flue Assembly	

Furnace Accessories

Sloped Roof Flue Assembly



Part #	Mfg #	Description	Price
177141	INTSAW21352A	SAW2135-2A Sloped Roof Flue Assembly	
233683	INTSAW21352S	SAW2135-2S Sloped Roof Flue Assembly	
177142	INTSAW27472A	SAW2747-2A Sloped Roof Flue Assembly	
233684	INTSAW27474A	SAW2747-4A Sloped Roof Flue Assembly	
177143	INTSAW35632A	SAW3563-2A Sloped Roof Flue Assembly	
233685	INTSAW35632S	SAW3563-2S Sloped Roof Flue Assembly	
233686	INTSAW35634A	SAW3563-4A Sloped Roof Flue Assembly	
233687	INTSAW51952A	SAW5195-2A Sloped Roof Flue Assembly	
233688	INTSAW51954A	SAW5195-4A Sloped Roof Flue Assembly	
233689	INTSAW51954S	SAW5195-4S Sloped Roof Flue Assembly	

Grille & Frame E-2

Part #	Mfg #	Description	Price
213954	INT902989	902989 Grille & Frame E-2	

Downflow Coil Box E-2

Part #	Mfg #	Description	Price
213955	INT903891	903891 E2 Downflow Coil Box	

Maxifold Manifolds & Accessories

Maxifold Manifolds



1-1/2" Stainless Steel Radiant Heating Manifold

- Includes:
 - Inline valves
 - Adjustable flowmeters - up to 2 gpm per loop
 - 1" Swt Manifold transitions
 - Mounting brackets

Part #	Mfg #	Description	Price
144240	H-4172	For 2 Branches	
144241	H-4173	For 3 Branches	
144242	H-4174	For 4 Branches	
144243	H-4175	For 5 Branches	
144244	H-4176	For 6 Branches	
144245	H-4177	For 7 Branches	
144246	H-4178	For 8 Branches	

Stainless Steel Extension Kit with Manifold Coupler

- Total number of loops not to exceed 14

Part #	Mfg #	Description	Price
144247	H-4172 EXT	For 2 Additional Branches	
144248	H-4173 EXT	For 3 Additional Branches	
144249	H-4174 EXT	For 4 Additional Branches	
144250	H-4175 EXT	For 5 Additional Branches	
144251	H-4176 EXT	For 6 Additional Branches	

Accessories

Part #	Mfg #	Description	Price
144253	H-4700	1" Full-Port Ball Valves (Set)	
144252	H-4004	Caps for Unused Loops	
144259	H-4900	Thermometer	
150018	H-6815	Manifold Gasket	

Electrothermal Actuator (LH)

- For heating manifolds and zone valves

Part #	Mfg #	Description	Price
144239	H-2496	Normally Closed with End Switch, 4-Wire	

Compression Fitting (EK20 Size)

- Use with manifolds, panel radiators, and towel warmers

Part #	Mfg #	Description	Price
144254	H-6849	3/8" PEX	
144255	H-6850	1/2" PEX	
144256	H-6851	5/8" PEX	
144257	H-6852	3/4" PEX	

Lochinvar Boilers

Boilers

Solution Residential Boiler

- Heavy duty, gasketless heat exchanger
- Lo/Hi/Lo temperature control
- Built-in performance loop
- CPVC/PVC vent kit option
- Terminal strip
- Economical, reliable, flexible, safe, and dependable



Part #	Mfg #	Input Max MBH	Input Min MBH	AFUE%	Heating Capacity MBH	Net AHRI Rating MBH	Dimensions H x W x D	Approx Ship Wt lbs	Price
252990	LOCBN075	75		84.0%	62	54	29-1/2" x 15-1/2" x 21-1/2"	155	
252991	LOCBN090	90		84.0%	75	65	29-1/2" x 15-1/2" x 21-1/2"	155	
252993	LOCBN135	135		84.0%	112	97	29-1/2" x 19-1/2" x 21-1/2"	175	
252994	LOCBN180	180		84.0%	149	130	29-1/2" x 23-1/2" x 21-1/2"	195	
252995	LOCBN215	215		84.0%	178	155	29-1/2" x 26-1/2" x 21-1/2"	220	
253126	LOCBN260	260		84.0%	216	188	29-1/2" x 29-1/2" x 21-1/2"	225	

FTXL Fire Tube Boiler

- Smart System™
- Con-X-US® Remote connect capable
- Cascading sequencer
- Firing rate modulation up to 10:1
- Common vent and PVC direct-venting
- Small 6.2 sq ft footprint
- For residential and light commercial applications



Part #	Mfg #	Input Max MBH	Input Min MBH	AHRI Thermal Efficiency	Output MBH	Net AHRI Rating MBH	Dimensions H x W x D	Approx Ship Wt lbs	Price
253005	LOFTX400N	399.9	40.0	98.0%	392	341	53-1/2" x 26-1/4" x 22-1/2"	435	
253006	LOFTX500N	500.0	50.0	97.7%	489	425	53-1/2" x 26-1/4" x 22-1/2"	460	
253007	LOFTX600N	600.0	85.0	97.5%	585	509	53-1/2" x 26-1/4" x 22-1/2"	470	
253008	LOFTX725N	725.0	103.5	97.2%	705	613	53-1/2" x 26-1/4" x 22-1/2"	510	
253009	LOFTX850N	850.0	121.5	97.0%	825	717	53-1/2" x 26-1/4" x 22-1/2"	535	

Lochinvar Boilers

Knight Fire Tube Boiler

- Energy Star® compliant
- CON-X-US® Remote connect capable
- 15/5 Year warranty - Limited 15 Yr Heat Exchanger, Limited 5 Yr parts
- ECM variable speed pump
- Universal vent adapter
- 110 Volt Convenience outlet



15/5 Year warranty
 Limited 15 Year Heat Exchanger
 Limited 5 Year parts

Floor Mount

Part #	Mfg #	Input Max MBH	Input Min MBH	AFUE%	Heating Capacity MBH	Net AHRI Rating MBH	Dimensions H x W x D	Approx Ship Wt lbs	Price
253010	LOKHB055N	55	8.3	95.0%	51	44	43-3/8" x 16" x 19"	160	
253012	LOKHB085N	85	8.5	95.0%	79	69	43-3/8" x 16" x 19"	165	
253013	LOKHB110N	110	11	95.0%	102	89	43-3/8" x 16" x 19"	170	
253015	LOKHB155N	155	15.5	95.0%	144	125	43-3/8" x 16" x 19"	175	
253016	LOKHB199N	199.9	19.9	95.0%	185	161	43-3/8" x 16" x 19"	195	
253017	LOKHB285N	285	28.5	95.0%	264	229	43-3/8" x 16" x 19"	205	

Wall Mount

Part #	Mfg #	Input Max MBH	Input Min MBH	AFUE%	Heating Capacity MBH	Net AHRI Rating MBH	Dimensions H x W x D	Approx Ship Wt lbs	Price
252997	LOWHB055N	55	8.3	95.0%	51	44	40" x 18-3/4" x 16"	139	
252998	LOWHB085N	85	8.5	95.0%	79	69	39-3/4" x 18-3/4" x 16"	142	
253000	LOWHB110N	110	11	95.0%	102	89	41-1/4" x 18-3/4" x 19"	159	
253001	LOWHB155N	155	15.5	95.0%	144	125	41-1/4" x 18-3/4" x 19-1/8"	166	
253002	LOWHB199N	199.9	19.9	95.0%	185	161	41-1/4" x 18-3/4" x 19-1/8"	175	
253003	LOWHB285N	285	28.5	95.0%	185	161	41-3/4" x 18-3/4" x 21-1/8"	184	
253004	LOWHB399N	399	80	94.4*	377#	328	43-1/4" x 25-1/4" x 21-7/8"	213	

* Thermal Efficiency %
 # Gross Output MBH

Lochinvar Boilers

Combination Boilers

Noble High-Efficiency Condensing Gas Combination Boiler

- True instantaneous response
- Easy installation and serviceability
- User-friendly interface
- Quiet operation
- Air handler interlock
- Provides rapid, reliable hot water and efficient space heating
- Designed, engineered and assemble in the USA



Part #	Mfg #	Input Max MBH	Input Min MBH	AFUE%	Heating Capacity MBH	Net AHRI Rating MBH	Dimensions H x W x D	Approx Ship Wt lbs	Price
240483	LONKC110N	110	11	95.0%	102	89	32-1/2" x 17-1/4" x 18"	139	
240484	LONKC150N	150	15	95.0%	139	121	32-1/2" x 18-3/4" x 18"	142	
240485	LONKC199N	199	19.9	95.0%	185	161	32-1/2" x 18-3/4" x 18"	159	

Commercial Boilers

Knight XL Commercial Condensing Heating Boiler

- 94% Thermal efficiency
- Modulating burner with 5:1 turndown
- ASME Stainless steel heat exchanger
- Vertical & horizontal heat exchanger
- PVC, CPVC, or SS Vent - up to 100 ft.
- Smart System Control
- DHW modulation limiting
- Building management system integration
- Condensing stainless steel heat exchanger
- Time clock
- Data logging
- Domestic hot water prioritization
DHW tank piped with priority in the boiler loop
DHW tank piped as a zone in the system with the pumps controlled by the smart system



Part #	Mfg #	Input Max MBH	Input Min MBH	Thermal Efficiency	Gross Output MBH	Net AHRI Rating MBH	Dimensions H x W x D	Approx Ship Wt lbs	Price
165796	LOKBN400	399	80	94.0%	376	327	42-1/2" x 15-1/2" x 27-3/4"	280	
253018	LOKBN501	500	100	94.0%	470	409	42-1/2" x 15-1/2" x 31-1/2"	310	
253019	LOKBN601	600	120	94.0%	564	490	42-1/2" x 15-1/2" x 36-1/4"	340	
253020	LOKBN701	700	140	94.0%	658	572	42-1/2" x 15-1/2" x 40-1/4"	370	
253021	LOKBN801	800	160	94.0%	752	654	42-1/2" x 15-1/2" x 45-1/4"	405	

Lochinvar Boilers

Tanks

Hydronic Buffer Tank

- Capacities from 30-119
- Glass-Lined steel tank
- Hydraulic separator
- High density foam insulation
- Designed to provide thermal storage volume and hydraulic separation of the boiler or heat pump and the building distribution system



Part #	Mfg #	Gallon Capacity	Supply/Return Connections	Height	Diameter	Approx Ship Wt	Price
253335	LORBT030	30	1-1/2" NPT	34-1/2"	20-1/2"	70	
253337	LORBT050	50	1-1/2" NPT	53-7/8"	20-1/2"	120	
253338	LORBT080	80	2" NPT	58-3/8"	24"	153	
253339	LORBT119	119	2" NPT	61-5/8"	29-1/2"	198	

Boilers

Gas Combination Boilers

Condensing Gas Combination Boiler (NCB-E)

- Super condensing efficiency
- Dual stainless steel heat exchangers
- SCH40, 2" PVC venting up to 60'
- ½" Gas pipe up to 24'
- Automatic water filling system
- Integrated controls



Part #	Mfg #	Gas	Gas Supply Pressure Min - Max	Heat Capacity Input (MBTUH) Min - Max	Thermal Efficiency	DOE	Dimensions W x H x D	Approx Ship Wt	Price
181352	NCB-150E	NG/LP	3.5" - 10.5"WC	12,000-120,000	95%		28" x 17" x 12"	66lbs	
181353	NCB-180E	NG/LP	3.5" - 10.5"WC	14,000-150,000	95%		28" x 17" x 12"	74 lbs	
181354	NCB-210E	NG/LP	3.5" - 10.5"WC	18,000-180,000	95%		28" x 17" x 12"	84 lbs	
181356	NCB-240E	NG/LP	3.5" - 10.5"WC	18,000-199,000	95%		28" x 17" x 12"	84 lbs	

Condensing Fire Tube Combi-Boiler (NFC)

- Compact, wall hung design
- Natural or LP gas (field convertible)
- Optional NaviLink WiFi remote control
- Space heating up to 199k BTU/H and DHW up to 199k BTU/H
- Energy efficiency 95.0% — earning the Energy Star Most Efficient 2019 rating
- Patented stainless steel fire tube heat exchanger — resists corrosion for longer life
- NaviClean magnetic filter for boiler and entire system protection included
- Advanced built-in DHW module creates endless hot water up to 3 showers and a dishwasher, all at the same time



Part #	Mfg #	Gas	NG Pressure	LP Pressure	Gas Connection Size	Dimensions H x W x D	Ship Wt	Price
259588	NFC-175	NG/LP	3.5" - 10.5"wc	8.0" - 13.5"wc	3/4" NPT	33.5" x 17.3" x 17.3"	145 lbs	
259589	NFC-200	NG/LP	3.5" - 10.5"wc	8.0" - 13.5"wc	3/4" NPT	33.5" x 17.3" x 17.3"	183 lbs	

Boilers

Gas Heating Boilers

Compact High-Efficiency Condensing Heating Boiler (NHB)

- Compact space saving design
- Super condensing efficiency
- Dual stainless steel heat exchangers
- SCH40, 2" PVC venting up to 60'
- ½" Gas pipe up to 24'
- TDR 7:1 to 11:1
- Integrated controls
- Natural gas supply pressure (from source): 3.5" x 10.5"wc
- Propane gas supply pressure (from source): 8.0"-13.5"wc



Part #	Mfg #	Gas	NG Pressure	LP Pressure	Gas Connection Size	Dimensions H x W x D	Ship Wt	Price
169617	NHB-55	NG/LP	3.5"-10.5"wc	8.0"-13.5"wc	3/4" NPT	24" x 17" x 12"	73 lbs	
169618	NHB-80	NG/LP	3.5"-10.5"wc	8.0"-13.5"wc	3/4" NPT	24" x 17" x 12"	73 lbs	
169619	NHB-110	NG/LP	3.5"-10.5"wc	8.0"-13.5"wc	3/4" NPT	24" x 17" x 13"	80 lbs	
169620	NHB-150	NG/LP	3.5"-10.5"wc	8.0"-13.5"wc	3/4" NPT	24" x 17" x 13"	80 lbs	

Premium High-Efficiency Condensing Heating Boiler (NFB)

- Space saving design — up to 80% smaller than traditional floor standing boilers
- Energy efficiency 95.0% — earning the Energy Star Most Efficient 2019 rating
- Patented stainless steel fire tube heat exchanger — resists corrosion for longer life
- Built-in hardware connects a boiler system pump, 3 zone pumps or 3 zone valves
- Natural or LP gas (field convertible)
- Optional NaviClean magnetic filter for boiler and entire system protection
- Optional NaviLink Wi-Fi remote control



Part #	Mfg #	Gas	NG Pressure	LP Pressure	Gas Connection Size	Dimensions H x W x D	Ship Wt	Price
252975	NFB-175	NG/LP lbs	3.5" - 10.5"wc	8.0"-13.5"wc	3/4" NPT	17.3" x 28.9" x 17.1"	115	
252976	NFB-200	NG/LP lbs	3.5" - 10.5"wc	8.0"-13.5"wc	3/4" NPT	17.3" x 28.9" x 17.1"	115	

Boilers

High-Efficiency Condensing Fire Tube Commercial Boiler

- Robotic and automated manufacturing technology for unmatched quality control
- In-house designed and built components, for system matched compatibility...unlike most competitors who use the same out-sourced parts to build their boilers
- Lower installation costs with our innovative engineered compact wall hung design, intuitive controls, top or bottom piping connections and flexible venting options
- Lower operating costs with the industry's leading thermal efficiency at TE 97.5%... Energy Star approved
- Built-in hardware connects boiler pump & 3 zone pumps: All integrated into circuit board
- Built-In USB port: Download boiler data and settings. Upload software updates and boiler settings
- Advanced 7" touch screen controls: easy intuitive navigation for setup, troubleshooting and operation



Part #	Mfg #	Gas	NG Pressure	LP Pressure	Gas Connection Size	Dimensions H x W x D	Ship Wt	Price
268612	NFB-301C	NG/LP lbs	3.5" - 10.5"wc	8.0" - 13.5"wc	34" NPT	32.8" x 25.1" x 22.3"	278	
268613	NFB-399C	NG/LP lbs	3.5" - 10.5"wc	8.0" - 13.5"wc	34" NPT	32.8" x 25.1" x 22.3"	371	

Parts & Accessories

NHB Series Primary Manifold

- Pre-assembled
- Designed specifically for use with Navien NHB Series
- 1" FNPT dielectric unions for the boiler supply and return
- 1-1/2" sweat connections for heating supply and return piping
- 1" flange connections
- L-copper piping
- Shut-off valves
- (2) 1" stub-outs
- (2) 1/4" service and drain ports
- 1/2" and 3/4" ports for use with heating system accessories



Part #	Mfg #	Description	Price
172465	GFFM-MSOZUS-001	Compatible with NHB-055, NHB-080, NHB-110, and NHB-150	

Boilers

NCB Series Primary Manifold

- Pre-assembled
- Designed specifically for use with Navien NCB Series
- 1" FNPT dielectric unions for the boiler supply and return
- 1-1/4" sweat connections for heating supply and return piping
- L-copper piping
- Shut-off valves
- (2) 1/4" service and drain ports
- (2) 3/4" ports for use with heating system accessories

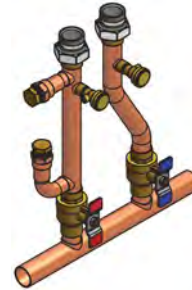

Part #	Mfg #	Description	Price
172715	GFFM-MCOZUS-001	Compatible with NCB-180, NCB-180E, NCB-210, NCB-210E, NCB-240, and NCB-240E	

NFB Series Primary Manifold

- Pre-assembled
- Designed specifically for use with Navien NFB Series



Part #	Mfg #	Description	Price
252977	GFFM-MSOZUS-002	Compatible with NFB-175, NFB-200	

Thermolec Boilers

Electric Stand Alone, Modulating Boilers

Standard Features:

- *Mechanical:*
 - Heavy-duty, fully insulated heat generator
 - Low-watt density Incoloy elements
 - Easy access for installation and maintenance
 - Approved for zero clearance to combustible materials
 - Pressure relief valve
 - Temperature and pressure gauge
- *Electrical:*
 - Convenient plug-in electronic board controls all automatic functions
 - Pre-wired elements electronically controlled for full modulation
 - Quiet magnetic relays for heating elements and pump
 - High-limit thermal protection
 - Adjustable electronic hot water aqua-stat with wide range to suit all applications (80°F to 180°F)
 - Outdoor reset control saves energy and improves comfort
- *FFB Electric Boiler has the above features plus:*
 - Built-in, 2-position, dual fuel control switch allows manual selection of gas/oil or electric
 - Magnetic, diverting valve relay to divert from electric to fossil fuel back-up boiler
- *10-Year warranty on heat generator and Incoloy elements*



Part #	Mfg #	kW	Output BTUH	Total Amps	Breaker Size	Dimensions H x W x D	Weight	Price
121876	B-8U-FFB	8kW	27,296	33.33A	1 x 50A	18" x 18" x 9-1/2"	33 lbs	
121881	B-15U-FFB	15kW	51,180	62.50A	1 x 60A/1 x 30A	18" x 18" x 9-1/2"	37 lbs	
121883	B-20U-FFB	20kW	68,240	83.37A	2 x 60A	18" x 18" x 9-1/2"	42 lbs	
121884	B-23U-FFB	23kW	78,476	95.83A	2 x 60A	18" x 18" x 9-1/2"	42 lbs	
121886	B-30U-FFB	30kW	102,360	125.00A	3 x 60A	28" x 18" x 9-1/2"	59 lbs	
121888	B-40U-FFB	40kW	136,480	166.67A	4 x 60A	28" x 18" x 9-1/2"	62 lbs	

High Performance Electric Boilers

- *Single or multiple-zone applications*
- *Requires no venting*
- *Sturdy aluminum case*
- *Stainless steel tank*
- *Compact and light weight design*
- *Aquastat control: adjustable supply water temperature range up to 190°F*
- *Full modulation for precise BTUH demand output*
- *Thermostat or zone valve end switch connections*
- *Pump switching relay*
- *Load management control connections*
- *Outdoor reset control*
- *Built-in circuit breaker*
- *Pressure relief valve: 30 psi*
- *Temperature and pressure gauge*
- *CSA Listed*



Part #	Mfg #	kW	Output BTUH	Total Amps	Breaker Size	Dimensions H x W x D	Weight	Price
135153	B-6TMB	6kW	20,472	25.00A	1 x 40A	18" x 13" x 8-7/8"	23 lbs	
135156	B-11TMB	11kW	37,532	45.80A	1 x 60A	18" x 13" x 8-7/8"	27 lbs	

All boiler specifications @ 240V / 1-phase

• **Serving our Customers Since 1946** • www.plumbsupply.com

Triangle Tube (Prestige) Boilers

Prestige Condensing Boilers

Prestige Excellence High Efficiency "Tank-in-Tank" Indirect-Fired Condensing Boiler 10-Year Limited Heat Exchanger Warranty

- 96% AFU Efficiency
- Abundant domestic hot water with standard mixing valve
- Highest water content in the industry
- Ideal for small zones without short cycling
- Self cleaning/self descaling
- Quiet operation
- Fully modulating
- Built-in exclusive "Tank-in-Tank"
- Unparalleled resistance to corrosion
- Less sensitive to water flow
- Vertical firetube design
- 439 Grade stainless steel heat exchanger
- Impervious to chloride cracking
- Stable temperature control
- Low pressure drop
- Condensate washes combustion residue away
- Control panel with digital display
- Standard outdoor reset
- Direct vent/sealed combustion



Part #	Mfg #	DOE Heat Capacity	Net IBR	MBH Input Modulation	Dimensions H x W x D	Water Volume	Gas Type	Ship Wt	Price
113080	PE110NG	99	86	30 - 110	37.2" x 24.7" x 20.8"	2.5 gal	NG	190 lbs	
113081	PE110LP	87	76	25 - 97	37.2" x 24.7" x 20.8"	2.5 gal	LP	190 lbs	

Prestige Solo Stainless Steel Wall Mount Condensing Boiler Limited 10-Year warranty

- 95% High efficiency
- Quiet operation
- Fully modulating
- 439 Grade stainless steel heat exchanger
- Digital display
- High temperature limit protection
- Low water protection
- Low NOx
- Low pressure drop
- Self cleaning-condensate washes residue away
- Outdoor temperature sensor
- 30 psi Pressure relief valve



Part #	Mfg #	Doe Heat Capacity MBH	Net IBR	MBH Input Modulation	Dimensions H x W x D	Water Volume	Gas Type	Ship Wt	Price
113827	SOLO-60	54	47	16 - 60	35-1/2" x 20" x 16"	2.5 gal	NG	95 lbs	
091011	SOLO-110	99	86	30 - 110	35-1/2" x 20" x 16"	2.5 gal	NG	106 lbs	

Triangle Tube (Prestige) Boilers

Prestige Condensing Boilers (Continued)

Prestige Solo Stainless Steel Wall Mount Condensing Boiler

Part #	Mfg #	DoE Heat Capacity MBH	Net IBR	MBH Input Modulation	Dimensions H x W x D	Water Volume	Gas Type	Ship Wt	Price
091012	SOLO-110LP	87	76	25 - 97	35-1/2" x 20" x 16"	2.5 gal	LP	106 lbs	
091013	SOLO-175	154	134	50 - 170	35-1/2" x 20" x 16"	4.6 gal	NG	131 lbs	
102609	SOLO-250	223	194	65 - 245	35-1/2" x 20" x 16"	4.1 gal	NG	142 lbs	
107251	SOLO-399	379	330	112 - 399	37-1/2" x 24-3/4" x 20-3/4"	7 gal	NG	200 lbs	

Smart Stainless Steel Indirect Fired Water Heaters

- Exclusive "Tank-in-Tank" Technology
- Abundant domestic hot water at the lowest possible cost
- Limited residential lifetime warranty
- 2" of Polyurethane foam insulation
- Self cleaning/self descaling heat exchanger
- Anti-bacteria growth/maintenance free
- Lowest pressure drop in the industry



Part #	Mfg #	Water Capacity	Boiler Output Btu/Hr	First Hour Recovery	Continuous Flow (Gal)	Peak Flow (Gal/10mi)	Price
154764	SMART100	95	337,000	525	450	150	

Weil McLain Boilers

Residential Gas Boilers

EVG Evergreen Gas Boiler

- Stainless steel fire tube heat exchanger with non-metallic base
- Floor standing boiler with optional wall mount kit
- Sizes 220MBG, 299MBH, 399MBH
- Modulating condensing boiler with 10:1 turndown
- 95% AFUE (220/299); 96.5% combustion (399)
- 4 Pump/auxiliary outputs
- Up to 8 multiple boiler control with lead/lag rotation
- Modbus® to BMS connectivity
- Each input can be assigned to a priority (up to 3)
- Multiple inputs can be assigned on priority (zone base control)
- All lag boiler inputs and output can be used
- 0-10 Volt input (modulation or set point)
- Configurable auxiliary input/output system
- Boiler circulator included



Part #	Mfg #	Boiler Model	CSA Input MBH	AFUE	DOE Heating Capacity MBH	Net AHRI Rating MBH	Vent Size	Approx Ship Wt	Price
179790	383-900-000	EVG220	220	95%	206	179	3" or 4"	215 lbs	
179795	383-900-001	EVG299	299	95%	280	243	4"	260 lbs	
179797	383-900-002	EVG399	399	96.5%	383	333	4"	260 lbs	

WM97+ Wall-Mount Gas Boilers

- Condensing stainless steel fire tube heat exchanger design
- Built in boiler circulator, primary/secondary piping option, low water cutoff and expansion tank
- Pre-wired terminal strip
- Indirect-fired water heater connection
- Capable to vent with PVC, PP and SS up to 100'
- Multi-color LCD display with text
- 3 Zone circulator control with optional domestic hot water priority
- 5 to 1 Turndown ratio capability
- Includes:
 - Propane conversion kit
 - Water treatment kit
 - Vent termination



Part #	Mfg #	Boiler Model	AGA Input BTUH	AFUE	DOE Heating Capacity BTUH	Net I=B=R Rating BTUH	Chimney/Vent Size	Approx Ship Wt	Price
144285	383-700-003	WM97+ 70	70,000	95.2%	65,000	57,000	3"	136 lbs	
144286	383-700-004	WM97+ 110	110,000	95%	101,000	88,000	3"	136 lbs	
151176	383-700-005	WM97+ 155	155,000	95.1	143,000	124,000	3"	162 lbs	

Weil McLain Boilers

ECO Wall-Mount Gas Boiler

- Class-leading 70,000, 110,000, and 155,000 BTUH models
- Exceeds Energy Star requirements at 95% AFUE efficiency rating
- Durable stainless steel fire tube heat exchanger
- Streamlined design configurable for installation
- Display can be mounted on the boiler or wall (up to 2' away)
- Components positioned for fast and easy service
- Multiple vent configurations and material options
- Optional accessories to match virtually any installation



Part #	Mfg #	Boiler Model	AGA Input BTUH	AFUE	DOE Heating Capacity BTUH	Net I=B=R Rating BTUH	Chimney/Vent Size	Approx Ship Wt	Price
170154	383-800-003	ECO70	70,000	95.2%	65,000	57,000	2" or 3"	117 lbs	
183864	383-800-004	ECO110	110,000	95.0%	101,000	88,000	2" or 3"	177 lbs	
166038	383-800-005	ECO155	155,000	95.1%	143,000	124,000	3"	130 lbs	

GV90+ Series High Efficiency Cast Iron Gas Boilers

- Insulated extended jacket
- Hot surface ignition system
- Cast iron primary heat exchanger
- Condensing stainless steel secondary heat exchanger
- Unique 7-pass heat exchanger design
- Vents with PVC
- Multiple vent options (direct vent, direct exhaust, concentric)
- Natural gas, easy conversion to propane (kit included)
- 3" Minimum vent size
- Down-fired, counter flow boiler design
- Built-in dual circulator
- Energy Star® rated
- 2-Year warranty on parts; 20-Year warranty on heat exchanger



Part #	Mfg #	Boiler Model	AGA Input BTUH	AFUE	DOE Heating Capacity BTUH	Net I=B=R Rating BTUH	Chimney/Vent Size	Approx Ship Wt	Price
143723	382-200-601	GV90+4	105,000	91.2%	97,000	84,000	3"	353 lbs	

Weil McLain Boilers

Ultra Series 3 - Condensing High-Efficiency Gas Boilers

- Factory tested
- Cast aluminum block
- 30 psi ASME Relief valve
- Drain valve
- Stainless steel burner with woven steel fiber mesh
- Direct spark ignition
- Variable speed blower assembly
- Gas/air ratio venturi with air silencer
- Negative pressure regulation gas valve
- 50VA Transformer
- Combination T&P gauge
- Outlet and return water temperature sensor
- Flue gas and outdoor temperature sensors
- Energy Star® rated



Ultra 3 Series - Natural Gas

Part #	Mfg #	Boiler Model	CSA Input BTUH	AFUE	DOE Heating Capacity BTUH	Net I=B=R Rating BTUH	Min Pipe Size	Approx Ship Wt	Price
237963	383-500-732	Ultra 80	80,000	95.2%	71,000	62,000	1"	199 lbs	

Ultra 3 Series - Propane Gas

Part #	Mfg #	Boiler Model	CSA Input MBH	AFUE	DOE Heating Capacity MBH	Net I=B=R Rating MBH	Min Pipe Size	Approx Ship Wt	Price
116487	383-500-701	Ultra 80	80,000	95.2%	71,000	62,000	1"	199 lbs	

Ultra Gas S4 Gas Boiler

- Cast aluminum coated heat exchanger
- Up to 94% DOE AFUE efficiency
- Designed to operate in low temperature condensing applications
- Outdoor reset and domestic hot water priority
- Modulates with 5:1 turn-down ratio
- High grade stainless steel burner features quiet operation
- U-Control gives you the power for easy set-up and maintenance:
 - Multiple set-up and zone options
 - System sensing recognizes system and outdoor temperatures
 - Temperature management for up to three different set-points
 - Control multiple boilers from a single control panel
 - Standard screen messages provide service alerts and maintenance reminders



Part #	Mfg #	Boiler Model	CSA Input MBH	AFUE	DOE Heating Capacity MBH	Net I=B=R Rating MBH	Vent Size	Price
237964	383-500-733	Ultra 80	80,000	93.5%	71,000	62,000	2" or 3"	
237965	383-500-734	Ultra 105	105,000	94%	94,000	82,000	2" or 3"	
237966	383-500-735	Ultra 155	155,000	94%	139,000	121,000	3"	
237967	383-500-736	Ultra 230	230,000	94.1%	207,000	180,000	3" or 4"	

Weil McLain Boilers

Residential Gas Boilers (Continued)

Ultra Gas S4 Gas Boiler

Part #	Mfg #	Boiler Model	CSA Input MBH	AFUE	DOE Heating Capacity MBH	Net I=B=R Rating MBH	Vent Size	Price
237968	383-500-737	Ultra 299	299,000	92.5%	270,000	235,000	4"	
237969	383-500-738	Ultra 399	399,000	91.7%	364,000	317,000	4"	

CGa Gold Series Gas Boiler

- Compact design saves valuable living space
- Stainless steel burners for quieter ignition, longer life, and improved combustion
- Gas fired water boiler with cast iron sections
- Easily accessible controls, vertical flueways and top cleaning for easy and quick servicing
- Up to 84% AFUE
- C.S.A. design certified for installation on combustible flooring
- "SPD" for boiler with standing pilot
"PID" for boiler with electronic ignition system
"N" for natural gas
"L" for propane gas



Part #	Mfg #	Boiler Model	AGA Input BTUH	AFUE	DOE Heating Capacity BTUH	Net I=B=R Rating BTUH	Chimney/Vent Size	Approx Ship Wt	Price
146734	381-357-802	CGA-3-PIDN	70,000	84.0%	59,000	51,000	4"	200 lbs	
025732	381-357-804	CGA-4-PIDN	105,000	84.0%	88,000	77,000	5"	240 lbs	
113283	381-357-806	CGA-5-PIDN	140,000	83.5%	117,000	102,000	6"	280 lbs	
059815	381-357-808	CGA-6-PIDN	175,000	83.2%	146,000	127,000	6"	325 lbs	
026674	381-357-810	CGA-7-PIDN	210,000	83.0%	175,000	152,000	7"	370 lbs	

CGi Gold Series Gas Boiler

- Gas fired water boiler with cast iron sections
- Natural draft and direct exhaust capability
- Can be used with natural or propane gas
- All units are factory-tested
- Compact design saves valuable living space
- No vertical draft hood and no mechanical vent damper
- Intermittent electronic ignition with standard components for easy servicing
- Up to 85% AFUE
- C.S.A. design certified for installation on combustible flooring
- "PIN" for natural gas
"PIL" for propane gas



Part #	Mfg #	Boiler Model	AGA Input BTUH	AFUE	DOE Heating Capacity BTUH	Net I=B=R Rating BTUH	Chimney/Vent Size	Approx Ship Wt	Price
151641	381-357-858	CGI-3-PIN	60,000	85.1%	51,000	45,000	4"	200 lbs	
151642	381-357-937	CGI-4-PIN	100,000	84.0%	85,000	74,000	5"	240 lbs	

Weil McLain Boilers

Residential Gas Boilers (Continued)

CGI Gold Series Gas Boiler

Part #	Mfg #	Boiler Model	AGA Input BTUH	AFUE	DOE Heating Capacity BTUH	Net I=B=R Rating BTUH	Chimney/Vent Size	Approx Ship Wt	Price
151643	381-357-864	CGI-5-PIN	120,000	83.3%	100,000	87,000	5"	280 lbs	
151644	381-357-866	CGI-6-PIN	167,000	83.3%	140,000	122,000	5"	325 lbs	
151645	381-357-868	CGI-7-PIN	200,000	83.0%	167,000	145,000	5"	370 lbs	
151646	381-357-870	CGI-8-PIN	233,000	82.7%	194,000	169,000	3"		

EG Gas Boiler

- Comes with automatic vent damper for higher efficiencies and reduced fuel consumption
- Easy access to controls for convenient servicing
- Configured for Natural Gas, intermittent electronic ignition only
- A versatile gas cast iron boiler for water or steam applications
- Cast iron heat exchanger
- Up to 84% AFUE
- "W" for water
"S" for steam
"SPD" for boiler with standing pilot
"PID" for boiler with intermittent electronic ignition system
"N" for Natural gas
"L" for Propane gas



Part #	Mfg #	Boiler Model	AGA Input BTUH	AFUE	DOE Heating Capacity BTUH	Net I=B=R Rating BTUH	Chimney/Vent Size	Approx Ship Wt	Price
151625	EG-45-PIDN	EG-45-PIDN	150,000	82.9%	125,000	94,000	6:"	505 lbs	
151628	EG-55-PIDN	EG-55-PIDN	200,000	82.8%	167,000	125,000	7"	545 lbs	
151629	EG-65-PIDN	EG-65-PIDN	250,000	83.0%	209,000	157,000	7"	630 lbs	
151630	EG-75-PIDN	EG-75-PIDN	299,000	82.4%	240,000	180,000	8"	695 lbs	

Weil McLain Boilers

Commercial Boilers

SlimFit Commercial Condensing Gas Boiler

SlimFit 550-750

- 93.9% Thermal Efficiency
- 94% Combustion Efficiency
- CSD-1 Compliant is Standard
- Low NOx Certified
- PVC, CPVC, PP or SS (AL29-4C) materials approved for Direct Vent and Direct Exhaust
- 20% - 100% Modulation



SlimFit 1000-2000

- Up to 96.1% Combustion Efficiency
- Up to 95.8% Thermal Efficiency
- 1,000,000 TO 2,000,000 BTU/HR
- Low NOx < 20 PPM
- Modulating Burner with 6:1 Turndown Ratio
- CSD-1 Compliant is Standard
- SOLA-Control Flexibility with 7" LCD Touch Screen
- Fully Customizable Outdoor Reset Curve
- Lead/Lag Capability up to 8 Boilers with lead boiler rotation
- Remote modulation through BAS using Modbus or BACnet
- High limit temperature control with manual reset, fixed 200 degree F
- PVC, CPVC, PP or SS (AL29-4C) materials approved for Direct Vent and Direct Exhaust

Part #	Mfg #	Boiler Model	CSA Input MBH	CSA Gross Output MBH	Net I=B=R Rating MBH	Vent Air Size	Vent Air Length	Price
176267	383-600-330	SF550	550	516	449	6"	100'	
176268	383-600-331	SF750	750	702	610	6" or 8"	30', 100'	
160055	383-600-013	SF1500L	1500	1437	1250	8"	100'	
160058	383-600-016	SF1500R	1500	1437	1250	8"	100'	
160059	383-600-017	SF2000R	2000	1906	1657	8"	100'	

Weil McLain Boilers

Ultra Commercial Condensing High-Efficiency Gas Boilers with 20 - 100% Modulation

- Factory test report shipped with boiler
- Cast aluminum block
- CSD-1 Comes standard
- Manual reset low water cut-off
- Adjustable manual reset high limit
- Stainless steel burner with woven steel fiber mesh
- Venting with PVC or CPVC up to 100 feet
- Direct vent or direct exhaust capable
- Venturi mixing system with air silencer
- Variable speed motor
- Negative pressure regulation gas valve
- 50VA Transformer
- Integrated drain in vent adapters
- Outlet and inlet water temperature sensors
- Flue gas and outdoor temperature sensors



Part #	Mfg #	Boiler Model	CSA Input MBH	CSA Gross Output MBH	Net I=B=R Rating MBH	I=B=R Thermal Efficiency	Approx Ship Wt	Price
127626	383-600-010	550	550,000	517,000	445,000	93.9	505 lbs	
127627	383-600-011	750	750,000	702,000	605,000	93.6	550 lbs	

EGH Atmospheric Gas Boilers

- Factory assembled section block
- Insulated extended jacket
- Horizontal to vertical draft hood
- Non-linting pilot burner
- Combination gas valve and regulator
- Aluminized steel burners
- 40VA Transformer
- Built-in Air separator
- Combination pressure-temperature gauge
- Steam boilers include:
 - 15 psi ASME Relief valve
 - High limit pressure control for PI with damper & PI models
 - Low water cut-off (electrode type)
 - Steam pressure gauge
 - Gauge cocks and glass
 - Siphon



EGH Atmospheric Gas Boiler - 24 Volt Intermittent Electronic Ignition Model - Natural Gas - Steam

Part #	Mfg #	Boiler Model	CSA Input BTUH	AFUE	DOE Heating Capacity BTUH	Net I=B=R Rating BTUH	AHRI Chimney/Vent Size	Approx Ship Wt	Price
063973	EGH-85-PIN	EGH-85-PIN	315,000	82.34%	243,000	182,000	9" ID	825 lbs	
063976	EGH-105-PIN	EGH-105-PIN	405,000	82.43%	312,000	234,000	10" ID	1,005 lbs	

Uponor (Wirsbo) Heating

TruFLOW™ Assembled Stainless Manifolds

Stainless Steel Manifold Assembly

- Features isolation valves, balancing valves w/ flow meters, supply and return ball valves with temperature gauges, and come fully assembled
- For commercial and residential radiant heating and cooling applications
- Available in 1" and 1-1/4" sizes

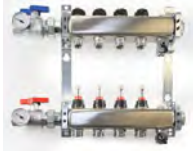

Part #	Mfg #	Size	Loops	Price
171998	WIA2720302	1-1/4"	3	
172123	WIA2720402	1-1/4"	4	
172476	WIA2720502	1-1/4"	5	
188930	WIA2720602	1-1/4"	6	
228374	WIA2720802	1-1/4"	8	
172475	WIA2721002	1-1/4"	10	
172504	WIA2721202	1-1/4"	12	

TruFLOW™ Assembled Brass Manifolds

Part #	Mfg #	Description	Price
074022	WIMF2LOOPLMETE R	2 Loop	
083039	WIMF3LOOPLMETE R	3 Loop	
074023	WIMF4LOOPLMETE R	4 Loop	
083429	WIMF5LOOPLMETE R	5 Loop	

TruFLOW™ Assembled Without Flow/Temp Meter

- Comes fully assembled ready for installation
- The TruFLOW balancing Hex Key is used on the internal balancing valves of the supply manifold to balance the loops
- Manifold is shipped with the appropriate number of actuator adapters (A2630028)
- Maximum recommended flow to the manifold based on manifold body diameter is 21 gpm



Part #	Mfg #	Description	Price
079647	WIMF6LOOPLMETE R	6 Loop	
083428	WIMF7LOOPLMETE R	7 Loop	

TruFLOW™ Assembled Brass Manifolds (Continued)

TruFLOW™ Assembled Without Flow/Temp Meter

Part #	Mfg #	Description	Price
079648	WIMF8LOOPLMETE R	8 Loop	
086861	WIMF10LOOPLMETR	10 Loop	
086863	WIMF12LOOPLMETR	12 Loop	

TruFLOW™ Brass Manifold Specific Accessories

TruFLOW™ Manifold Loop Thermometer

- Comes with R20 (QS-style) female union on one end and an R20 (QS-style) male on the other
- Thermometer well and removable thermometer are included



Use ONLY with Uponor TruFLOW Jr. and Classic Manifolds

Part #	Mfg #	Description	Price
081827	A2610020	TruFLOW Manifold Loop Thermometer	

TruFLOW™ Manifold Supply & Return Ball Valves with Thermometer

- Full-flow 1-1/4" ball valves with R32 male x R32 union nut that fits directly on TruFLOW manifold
- Standard with a thermometer



Use ONLY with Uponor TruFLOW Jr. and Classic Manifolds

Part #	Mfg #	Description	Price
084177	WIA2631250	Ball Valves Supply & Return	

TruFLOW™ Classic Manifold Extension Kit

- For easy in-line extension of up to two additional loops for the TruFLOW classic manifold assembly
- Contains (2) 1-1/4" BSP nipples, (1) supply manifold, (1) return manifold and (2) loop end caps



Part #	Mfg #	Description	Price
093249	WIMF2LOOPEXT	Classic Manifold Ext Kit, 2 Loops	

Uponor (Wirsbo) Heating

Heating Manifolds

EP Heating Manifold

- Includes isolation valve and balancing valve with flow meters
- Made of engineered plastic and fully assembled
- Body ends have R32 unions and loop outlets have R20 male threads
- Mounts on fully assembled bracket (A2670006)



Part #	Mfg #	Loops	Price
120254	WIMANIFOLDEP2L	2	
120255	WIMANIFOLDEP3L	3	
120256	WIMANIFOLDEP4L	4	
120257	WIMANIFOLDEP5L	5	
120258	WIMANIFOLDEP6L	6	
120259	WIMANIFOLDEP7L	7	
120260	WIMANIFOLDEP8L	8	

EP Heating Manifold Accessories



Part #	Mfg #	Description	Price
124454	WIA2671300	Actuator Adapter	

Brass Manifold Accessories

End Cap with Vent

- For 1-1/4" brass manifolds
- Complete with swivel drain valve and manual air vent
- Required gasket included (A2403232)



Part #	Mfg #	Description	Price
011754	WIECWV	End Cap with Vent, R32	

End Cap

- For 1-1/4" brass manifolds
- Required gasket included

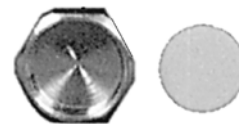

Part #	Mfg #	Description	Price
011753	WIECB	Basic End Cap, R32	
025646	WIEC34	Loop End Cap, R20	

Manifold Accessories for TruFLOW™ and 1-1/4" Brass Manifolds

Copper Manifold Adapter

- Use sweat adapter to transition R32 manifold union nut to 3/4", 1", and 1-1/4" copper pipe, copper fittings and valves



Use with 1-1/4" Brass and TruFLOW Manifolds
Not compatible with TruFLOW Sr.

Part #	Mfg #	Description	Price
011764	WIAR32341	R32 x 3/4" or 1"	
011763	WIAR321114	R32 x 1" or 1-1/4"	

Manifold Threaded Adapter/Bushing

- Manifold Adapter for brass manifold transitions the R32 manifold union nut to PEX or MultiCor tubing with QS-style fittings



Use with 1-1/4" Brass and TruFLOW Manifolds
Not compatible with TruFLOW Sr.

Part #	Mfg #	Description	Price
193883	WIRA2123210	R32 Male x 1" FNPT Bushing	

ProPEX® Manifold Adapter

- Use to transition from the R32 manifold union nut to 3/4" and 1" AQUAPEX® and hePEX™ plus



Use with 1-1/4" Brass and TruFLOW Manifolds
Not compatible with TruFLOW Sr.

Part #	Mfg #	Description	Price
045200	WIAR3234	R32 x 3/4" Straight Adapter	
045201	WIAR321	R32 x 1" Straight Adapter	
099804	WIAR3234EL	R32 x 3/4" Elbow	
223377	WIAR32112	R32 x 1-1/2" Straight Adapter	

Uponor (Wirsbo) Heating

Brass Manifold Pressure Test Kit

- Includes
 - R32 x 3/4" Manifold bushing
 - R32 Solid brass plug
 - 3/4" Brass nipple and pressure gauge assembly (100 psi)
 - Schraeder valve



Use with 1-1/4" Brass and TruFLOW Manifolds
 Not compatible with TruFLOW Sr.

Part #	Mfg #	Description	Price
028958	WIPTK	Pressure Test Kit	

Manifold Gasket

- Spare part
- For 1-1/4" manifold and manifold parts
- NOTE: Gaskets are not interchangeable between parts except as noted - to seal properly the correct gasket must be used



Part #	Mfg #	Description	Price
011755	WIMFECG	End Cap w/Vent Gasket	

TruFLOW Manifold Actuator Adapter

- M28 brass adapter converts the manifold actuator threads to fit the Uponor Thermal Actuator A3023522
- Use only with the TruFLOW Jr. and Classic Manifolds



Part #	Mfg #	Description	Price
110901	WIA2630028	Adapter Replacement Part	

Spacer Ring VA33

- For White Thermal Actuators

Part #	Mfg #	Description	Price
185084	WIA3019900	For White Thermal Actuators	

Manifold Wall Cabinet

- Recessed-style
- 2x4 or 2x6 Stud wall



Part #	Mfg #	Description	Price
087014	WIMFWALLCAB3539	35.5"H x 39"W x 3.5"D	

Replacement and Spare Parts for Manifolds

Part #	Mfg #	Description	Price
163459	WIMFECGSK	Replacement Gasket for R32 Union Connections	
093251	WI2620008	Replacement O-Ring for 1-1/4" BSP Connections	

Fitting Assemblies

QS-Style Fitting Assembly

- Compression fitting assembly with o-ring (sold separately)
- Connects 5/16", 1/2" and 5/8" Uponor hePEX plus and AQUAPEX tubing to all Uponor manifolds and R20 components PEX tubing to Uponor™ manifold outlets R20 components
- Sold as a 3-piece component



This fitting is not compatible with TruFLOW Sr.

Part #	Mfg #	Size	Type	Price
040687	WIFA516	5/16"	R20 Thread	
022644	WIFA12	1/2"	R20 Thread	
022645	WIFA58	5/8"	R20 Thread	

ProPEX® Fitting Assembly (PEX to Brass)

- PEX Tubing to the brass manifolds
- Sold as a 2-piece assembly, it includes a ProPEX® insert and swivel nut
- ProPEX® tool and ProPEX® rings required (sold separately)



This fitting is not compatible with the TruFLOW Sr.

Part #	Mfg #	Size	Type	Price
045203	WIPPPFA12	1/2"	R20 Thread	
045204	WIPPPFA58	5/8"	R20 Thread	
087016	WIPPPFA34	3/4"	R20 Thread	
112192	WIPPPFAR2535	3/4"	R25 Thread	

QS Fitting Assembly O-Ring

Part #	Mfg #	Description	Price
025703	WIOR381258	O-Ring Replacement for R20 Thread	

Uponor (Wirsbo) Heating

ProPEX Baseboard Elbow and Tee (PEX x CU)

- Connects 1/2", 5/8", and 3/4" Uponor PEX tubing products to 3/4" copper baseboard
- ProPEX tool is required



Part #	Mfg #	Description	Price
043564	WIBB905834	5/8" x 3/4"	

Tubing Transition Fittings

QS-Style Coupling Nipple (Thread x Thread)

- Use coupling nipple (brass) and the appropriate fitting assembly to connect 5/16", 3/8", 1/2", 5/8" or 3/4" tubing together



Part #	Mfg #	Description	Price
022651	WICNR20	R20 x R20 Thread	
022655	WICNR25	R25 x R25 Thread	

QS-Style Conversion Nipple (Thread x NPT)

- The QS-style Conversion Nipple (brass) and the appropriate fitting connect 5/16", 3/8", 1/2", 5/8" or 3/4" Uponor tubing to 1/2", 3/4" and 1" NPT



Part #	Mfg #	Description	Price
022653	WICNR2034	R25 x 3/4" NPT	

QS-Style Copper Adapter (Thread x CU)

- Use R20 or R25 adapter and appropriate QS-style fitting assembly to transition PEX tubing to 1/2" and 3/4" copper pipe



Part #	Mfg #	Description	Price
022657	WIAR2012	R20 x 1/2"	
022658	WIAR2034	R20 x 3/4"	

QS-Style Copper Fitting Adapter (Thread x Copper)

- Transition Uponor PEX tubing to 1/2" and 3/4" copper fittings



Part #	Mfg #	Description	Price
022660	WIFAR2012	R20 x 1/2"	
022661	WIFAR2034	R20 x 3/4"	

QS-Style Compression Manifold Fitting Assembly

- Sold as 3-Piece assembly



Part #	Mfg #	Description	Price
033672	WIFA38	3/8" R20 Thread	
169119	WIA4030625	5/8" R25 Thread	
022646	WIFA34	3/4" R25 Thread	

Panels and Plates

Quik Trak™ Panel

- The 1/2" plywood panels are attached to an aluminum heat transfer sheet



Use with Uponor 5/16" hePEX plus only

Part #	Mfg #	Description	Price
040685	WIQTP	7" x 48"	

Quik Trak™ Return Panel

- Designed with a "U" groove to complete tubing turns
- The half-moon grooves are attached to the panels
- Each return panel is shipped with a separate aluminum sheet for installation beneath the panel



Use with Uponor 5/16" hePEX plus only

Part #	Mfg #	Size	Price
040686	WIQTPR	7" x 48"	

Quik Trak™ Joist Trak

- Extruded aluminum heat transfer panels
- Each panel is 4' long x 4" wide
- Comes packaged 20 per box



Part #	Mfg #	Size	Price
066612	WIEXTP12	1/2"	

Uponor (Wirsbo) Heating

Fast Trak™ Edge Strip

- Ideal over pour installation method for remodel and retrofit applications
- Preformed knobbed mats
- 5/16" PEX tubing



Part #	Mfg #	Description	Price
145575	WIFTP05	Fast Trak 0.5. 8.3ft ² /panel	
145576	WIFTEGESTRIP	Strip, 65-ft roll	

ProPEX® Escutcheon's

- Flared sleeve
- Attractive cover for 1/2" AQUAPEX® tubing and ProPEX connections as they exit the wall



Part #	Mfg #	Description	Price
118898	WIF5670500	White	
119669	WIF5650500	Chrome Plated	

Installation Aids

PVC Plastic Bend Support

- Provides rigid 90° bend for 1/2", 5/8", 3/4" and 1" Uponor PEX exiting a concrete slab



Part #	Mfg #	Size	Price
023227	WIPBS12	1/2"	
023195	WIPBS58	5/8"	
023228	WIPBS34	3/4"	
040374	WIPBS1	1"	

Metal Bend Support

- Zinc-plated
- Provides rigid 90° bend for 1/2", 5/8" and 3/4" nominal PEX tubing products



Part #	Mfg #	Size	Price
027955	12APMBS	1/2"	
011777	WIMBS58	5/8"	
022596	34APMBS	3/4"	

PEX Clip - Plastic

- Enhanced Uponor PEX clips provide better holding power and can be attached together laterally for tight installations
- PEX Clips are attached under the wood subfloor for joist-heating applications
- Clips prevent tubing from coming in direct contact with subfloor
- Dry wall screws are commonly used to secure the clips to the wood subfloor



Part #	Mfg #	Size	Price
028881	WIPC1258	1/2" & 5/8"	
137214	WIPC34	3/4"	
137215	WIPC1	1"	
033674	WIPC38	3/8" (100/Bx)	

Fixing Wire

- 6" Galvanized steel tie used to secure PEX tubing products to wire mesh or rebar
- Use with fixing wire twister or auto fixing wire twister (ratchet style)



Part #	Mfg #	Description	Price
011770	WIFW	Fixing Wire, 1000 per Bundle	

Ratchet-Style Fixing Wire Twister

- For use with A7031000 fixing wire



Part #	Mfg #	Description	Price
019018	WIFWAT	Fixing Wire Twister	

Fixing Wire Twister

- For use with A7031000



Part #	Mfg #	Description	Price
011767	WIFWT	Fixing Wire Twister	

Uponor (Wirsbo) Heating

Quik Trak™ Sealant

- 100% Silicone
- Used to adhere tubing in groove and provide good thermal transfer



Part #	Mfg #	Size	Price
040690	WIQTS	10.3 fl oz	

PEX Foam Stapler

- Ideal solution for securing Uponor PEX and (MLC) tubing to foam board insulation in concrete slab radiant heating and cooling applications



Part #	Mfg #	Description	Price
171329	WISTAPLER20	PEX Foam Stapler	

Foam Staple

- For use with E6025075 manual stapler
- Plastic foam staple used to secure 1/2", and 5/8" PEX to rigid insulation
- Use part A7015050 for 1" foam and part A7015075 for 1-1/2" or thicker foam



Part #	Mfg #	Size	Price
040682	WISTAPLEFOAM1.5	1-1/2"	
033641	WISTAPLEFOAM2.5	2-1/2"	

PEX Foam Staple

- For use with Uponor PEX foam stapler (E6025000) to secure 3/8", 1/2", and 3/4" PEX or 1/2" and 5/8" MLC tubing



Part #	Mfg #	Description	Price
171328	WISTAPLEFOAM20	2"	

Metal Tubing Staple

- Use 5/8" staple to secure aluminum plates to furring strips or subfloors
- Use 1-1/4" staples in staple-down installations to secure 1/2" and 5/8" Uponor PEX to wood subfloors

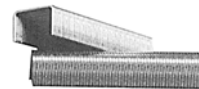

Part #	Mfg #	Size	Pkg Qty	Price
143722	WISTAPLE1142500	1-1/4"	10,000/Box	

PEX Tubing Cutter



Part #	Mfg #	Description	Price
011750	WICUTTER	Metal Tube Cutter Cuts to 1" PEX	
083129	E6081128	Plastic Tube Cutter Cuts to 1" PEX (3/4")	

TruFLOW Manifold Balancing Hex Key

- Use on the supply manifold to adjust the flow rate across the loop for balancing



Part #	Mfg #	Description	Price
081829	A2620002	Replacement Part, Hex Key	

Tube Uncoiler

- Facilitates uncoiling of up to 1" PEX tubing
- Simplifies installation and reduces labor
- Weighted arms hold tubing in place while uncoiling
- Eyelet keeps tubing from tangling
- Base is collapsible
- No additional hardware needed to attach arms
- Easy to assemble
- Upon assembly, guide pin must be moved on the swivel guide arm in order to keep it in place



Part #	Mfg #	Description	Price
035147	WIUNCOILER	Tube Uncoiler	

Uponor (Wirsbo) Heating

Zoning Controls - Radiant Heating

Zone Control Module

- 4-Zone control module for 2-wire operation



Part #	Mfg #	Description	Price
155032	WIZCM3A	3-Zone 2-Wire Operation	
159894	WIZCM4A	4-Zone, 2-Wire Operation	
074018	WIFUSE2AMP	Replacement Fuse (2 amps)	

Uponor Thermal Actuator

- Slow-opening Thermal Actuator (24VAC) mounts directly onto 1-1/4" brass and TruFLOW valved manifolds
- Provides individual loop flow control on a multi-zoned manifold (manifold serving more than one zone)
- The 4-wire Thermal Actuator includes end switch for activation of relay (pump), heat plant or other auxiliary devices
- Do not mount actuators upside down



Part #	Mfg #	Description	Price
171719	WIA3023522	4-Wire Thermal Actuator	

Uponor Set Point Thermostat

- Comfort controllers
- Early start features for recovery from setback
- Override feature for periods of extended absence
- Attractive sleek design



Part #	Mfg #	Description	Price
081433	WIA3040079	Floor Sensor, Replacement Part	

Heat-Only Thermostats

- Touchscreen
- Designed for radiant floor heating



Part #	Mfg #	Description	Price
227368	WISTATHTGONLY	Heat-Only Thermostat w/ Touchscreen	
232157	WISLABSENSOR	Slab Sensor, 10K	

Pump Relay

- Single-zone relay includes secondary low-voltage terminals for boiler operation
- Three-zone relay includes secondary low-voltage terminals for boiler operation and DHW priority options



Part #	Mfg #	Description	Price
041378	WIPUMPRELAY3	24V 3-Zone Multi Pump Relay	
196539	WIA3010100	24V Single-Zone	

Powered Zone Controller



Part #	Mfg #	Description	Price
090979	WI4ZONECONTROL	4-Zone	

Uponor (Wirsbo) Heating

Radiant Heat Tools

Foamboard Stapler

- Operate from standing position
- Ergonomic D-grip handle
- Solid 1-piece magazine
- Leaf spring controlled stop automatically adjusts to set up staple and guide it through the fastening mechanism



Part #	Mfg #	Description	Price
101994	FBSN	37" Height	

Foamboard Staple

- Extra sharp multi-barbed
- 1-1/2" Staples for 1" foamboard
- 2-1/2" Staples for 2" foamboard



Part #	Mfg #	Description	Price
114593	FBSN1	1-1/2" Staples, 200/Pk	
101995	FBSN2	2-1/2" Staples, 200/Pk	

Uponor (Wirsbo) Heating

Thermostatic Mixing Valves

**AM-1 Series 3-Way Thermostatic Mixing Valve
(Union Sweat)**

- *Adjusts, maintains and limits the hot water temperature to a desired setting selected by user*
- *In domestic use, offers scalding protection and bacteria growth control*
- *Dual purpose mixing or diverting*
- *Proportional valve*
- *Nickel-plated brass construction*
- *EPDM o-rings*



Part #	Mfg #	Pipe Size	Operating Temperature	Price
099800	AM-101R-US-1	3/4"	80° - 180°F	
099799	AM-102R-US-1	1"	80° - 180°F	
124499	AM102C-US-1LF	1"	80° - 120°F	

Watts Heating

Stainless Steel Manifolds

- Sold in pairs, mounted to metal bracket
- SS-T20 style fittings are compatible with Stainless Steel manifolds

1" Stainless Steel Flow meter Manifold



D380300SS

Part #	Mfg #	Order #	Size	Price
114163	WTMF2LOOP	81001981	M-2	
114949	WTMF8LOOP	81001985	M-8	
139848	WTMF9LOOP	81003687	M-9	
139847	WTMF12LOOP	81001987	M-12	

Manifold Accessories

Stainless Steel Manifold ISO BV Accessory Kit

- Includes:
 - (1) Vent and purge assembly
 - (1) Manifold end cap
 - (2) FNPT Trunk isolation ball valves
 - Manifold adapters
 - Neoprene and fiber gaskets
- Order Onix, Crimp or compression fittings separately



Part #	Mfg #	Order #	Size	Price
114165	WTDK1000	81003736	1"	

Stainless Steel Manifold Accessory Kit

Part #	Mfg #	Order #	Size	Price
125046	WTDK3000	81005369	1"	

Valve Actuator

- For automatic circuit control
- Optional feature for mounting directly to the balancing manifold
- Incorporates an indicator window that allows you to visually determine whether the valve is fully open or closed
- Provides on/off flow control to individual radiant circuits
- Flow can be balanced prior to installing by turning the adjustment valve under the blue cap
- Actuator is 24VAC with four wires to connect to the thermostat and circulating pump



Part #	Mfg #	Order #	Voltage	Price
127878	WTMVA4	81001541	24V	

PEX Compression Fittings

SST20 PEX Compression Fitting

- PEX Compression x SST20 Swivel BSP
- For connecting:
 - PEX to stainless steel manifolds
 - Custom tubular T20 compression manifolds
 - 3/4" Male BSP x male sweat fittings
- Includes:
 - Insert fitting
 - Compression sleeve
 - BSP threaded nut



Part #	Mfg #	Order #	Size	Price
114166	WTFA12	81005168	1/2" x 3/4"	
117479	WTFA58	81005170	5/8" x 3/4"	

Misc. Accessories

Foam Staple Box

Part #	Mfg #	Order #	Size	Price
159249	WTSTAPLEFO	Foam 2.25 Staple Box		
	AM225			

Air Purgers

Air Elimination

Air Purger

- Cast iron



Part #	Mfg #	Size	Dimensions H x W x L	Price
002010	443-1	1"	4" x 3" x 6"	
002011	444-1	1-1/4"	4" x 3" x 6"	
002012	445-1	1-1/2"	5" x 4" x 8"	
002013	446-1	2"	5" x 4" x 8"	



Air Vents

Air Eliminators

Automatic Air Vent

- Brass body with non-ferrous internals
- Maximum operating temperature: 240°F



Part #	Mfg #	Model	Connection	Max Pressure	Price
002435	113001	7	1/8" FNPT	75 psig	
002468	113020	67	1/8" MNPT	35 psig	

Air Vents

(Air Eliminators)

SuperVent™ Air Eliminator

- Eliminates air from hydronic heating systems without bleeding
- No clog vent, dirt and debris resistant
- 360° Adjustable collar ring
- Bronze body
- Maximum temperature rating: 240°F
- Maximum operating pressure: 125 psi



NPT

Sweat

Part #	Mfg #	Size	Connection	Price
094289	PV075	3/4"	NPT	
094290	PV075S	3/4"	Sweat	
094291	PV100	1"	NPT	
094292	PV100S	1"	Sweat	
094293	PV125	1-1/4"	NPT	
094294	PV125S	1-1/4"	Sweat	
094295	PV150	1-1/2"	NPT	

GoldTop Universal Air Vent

- One-fits-all
- Venting rate 3-4 times that of other products
- Residential or commercial heating and cooling systems

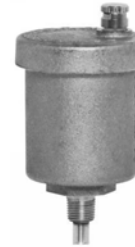

Part #	Mfg #	Size	Connection	Price
200909	FV180	3/4"	Male NPT	
200910	FV180A	1/4"	Male NPT	

Parts & Accessories

Part #	Mfg #	Description	Price
184623	PV-020-RP	PV SuperVent Vent Top Replacement	

Air Vents

Main Steam Vents

Model 75/75H Air Valve (Non-Vacuum)

- For medium and large systems
- Float-type thermostatic vent
- Single non-adjustable port
- 1/2" NPT Female and 3/4" NPT male straight shank
- Maximum pressure: 15 psig



Part #	Mfg #	Model	Max Operating Pressure	Price
005417	401434	75	3 psig	

Radiator Steam Vents

Model 1A Air Valve (Non-Vacuum)

- Float-type vent
- Adjustable port for true proportional venting - 6 port settings from slow (1) to fast (6)
- 1/8" NPT Angle connection
- Maximum operating pressure: 1-1/2 psig
- Maximum pressure: 10 psig



Part #	Mfg #	Model	Straight Shank	Price
005398	401422	1A	1/8" NPT Angle	

Water Vents

Model 79 Water Main Vent Valve

- For use on hot or cold or glycol water mains and process applications with specific gravity > 0.7
- Tapped at top for 1/8" NPT safety drain connection
- Removable top
- Built-in check valve
- Maximum operating pressure: 75 psig
- Maximum hydrostatic pressure: 200 psig
- Maximum temperature: 250°F



Part #	Mfg #	Model	Straight Shank	Price
005418	401488	79	1/2" FPT, 3/4" MPT	

Model 790 Water Vent Valve

- For removing air from convectors, baseboard and wall radiation
- Safety drain connection for discharging moisture
- Fitting and ferrule for 3/16" OD tubing
- Telescopic siphon tube
- Maximum operating pressure: 30 psig
- Maximum pressure: 30 psig



Part #	Mfg #	Model	Straight Shank	Price
005419	401479	790	1/8" NPT	

Model 791 Water Vent Valve

- For convectors and small frame
- Safety drain connection for discharging moisture
- Fitting and ferrule for 3/16" OD tubing
- Telescopic siphon tube
- Maximum operating pressure: 50 psig
- Maximum pressure: 50 psig



Part #	Mfg #	Model	Straight Shank	Price
005420	401482	791	1/4" NPT	

Air Vents

SPIROTOP®

Brass Quick Air Releaser

- 20-Year limited warranty



Part #	Mfg #	Size	Price
017852	VTP 050 FT	1/2" FNPT	

SPIROVENT® JUNIOR

Brass Air Eliminators

- 20-Year limited warranty

Threaded Design



Part #	Mfg #	Size	Price
017848	VJR 075-TM	3/4" FNPT with 1/2" Tank	
017849	VJR 100-TM	1" FNPT with 1/2" Tank	
017850	VJR 125-TM	1-1/4" FNPT with 1/2" Tank	
017851	VJR 150-TM	1-1/2" FNPT with 1/2" Tank	
087403	VJR200-TM	2" FNPT with 1/2" Tank	

Sweat Design

Part #	Mfg #	Size	Price
089288	VJS 075-TM	3/4" Sweat with 1/2" Tank	
089289	VJS 100-TM	1" Sweat with 1/2" Tank	
089290	VJS 125-TM	1-1/4" Sweat with 1/2" Tank	
179832	VJS 150-TM	1-1/2" Sweat with 1/2" Tank	
179833	VJS 200-TM	2" Sweat with 1/2" Tank	

Press Fit Design

Part #	Mfg #	Size	Price
233822	VJP-075TM	3/4" Press	
233823	VJP-100TM	1" Press	
233824	VJP-125TM	1-1/4" Press	
233825	VJP-150TM	1-1/2" Press	
233826	VJP-200TM	2" Press	

SPIROVENT® SENIOR

Steel Air Eliminator

- MT - Male threads



Part #	Mfg #	Size	Price
020540	VSR-200-MT	2" MNPT	
024735	VSR-250-MT	2-1/2" MNPT	
030532	VSR-300-MT	3" MNPT	

SPIROVENT® Quad

Steel Hydraulic Separator

- MT - Male threads
- FA - Flanged ASME

Part #	Mfg #	Size	Price
138420	VDX-200-MT	2" MNPT	

SPIROTRAP® Dirt Separators

Brass Dirt Separator

- Ball valve included
- Patented Spirotube® element



Part #	Mfg #	Pipe Size	Price
082005	TDN-125-FT	1-1/4" IPS	
082006	TDN-150-FT	1-1/2" IPS	

Air Vents

Boiler Feed Air Vents

DuoVent Automatic Air Vent with In-Line Testing Feature

- Maximum temperature: 240°F
- Maximum pressure: 150 psi



Part #	Mfg #	Model	Size	Price
062989	0590719	WADV18	1/8"	

Automatic Air Vent Valve

- Body and cover are brass construction
- Air vent with silicone rubber seal
- Impurities do not usually affect function as maximum float line of water is always lower than the valve seal
- Float is high temperature resistant polyethylene
- Suitable for use with glycol systems
- Can be disassembled for inspection and cleaning



Part #	Mfg #	Model	Size	Price
062267	0590715	FV-4M1	1/8"	

Air Vents

Air Vents
Press Air Separator



Part #	Mfg #	Size	Price
223028	78003	3/4"	
223029	78004	1"	
223030	78005	1-1/4"	



Antifreeze & Other Chemicals

Harvey Heat Antifreeze



016850



016880



016905

Part #	Mfg #	Description	Price
072358	16750	Harvey Heat -100A, 1 gal	
072361	16760	Harvey Heat -100A, 5 gal	
007733	16850	Harvey Heat -100, 1 gal	
019596	16860	Harvey Heat -100, 5 gal	
021756	16870	Harvey Heat -100, 55 gal	
136190	016880	Harvey Heat RV, 1 gal	
108988	16900	Harvey Heat, Arctic Grade, 55 gal	
069501	016905	Harvey Heat, Arctic Grade, 5 gal	
069500	016910	Harvey Heat, Arctic Grade, 1 gal	

Antifreeze & Other Chemicals

Boiler Additives

Pro-Tek™ 922 - Hydronic Hot Water Closed-Loop Treatment

- Concentrated corrosion and scale inhibitor treatment specially formulated for hot water, closed-loop heating systems
- Prevents scale and corrosion on aluminum, copper, iron, brass and stainless steel
- Compatible with standard flexible tubing such as PEX and ONIX used in hydronic installations
- Helps control pH & removes oxygen
- Does not contain nitrite
- Non-hazardous



Part #	Mfg #	Size	Price
137022	922-1	1 gal	

Pro-Tek® QT Aerosol Hydronic System Treatment

- Concentrated organic corrosion inhibitor treatment specially formulated for closed loop heating cooling systems
- Helps reduce corrosion on aluminum, brass, copper, iron, and stainless steel
- Non-toxic, environmentally friendly



Part #	Mfg #	Size	Price
182853	95593	Kit	

RhoGard™ Heat Transfer Fluid

- Aluminum/Stainless Steel safe and multi-metal heat transfer fluid
- Non-toxic, environmentally friendly
- Can be dilute on-site w/ distilled or D.I. water
- Provides freeze protection to < -60°F
Provides burst protection to -100°F
- Meets and exceeds the corrosion protection requirements of ASTM D1384
- Heating, cooling, and solar system fluid



Part #	Mfg #	Size	Price
181175	RG-05	5 gal	
182834	RG-55	55 gal	

RhoGard™ RTU Heat Transfer Fluid

- Premixed ready-to-use (RTU) heat transfer fluid
- Blended with virgin propylene glycol and D.I. Water
- Multi-metal corrosion inhibitors and performance additives
- Protects multiple metals, including aluminum & stainless steel
- Requirements of ASTM D1384
- Meets and exceeds the corrosion protection
- Maximizes system efficiency
- Can be custom blended to any glycol % as needed by customer
- Customized freeze or burst protection
- Environmentally friendly
- Non-Toxic



Part #	Mfg #	Size	Price
226215	RG-RTU-30-05	5 gal	

RhoGard™ Ultra Concentrated Antifreeze

- Aluminum safe and multi-metal antifreeze
- Hydronic and solar system fluid
- Freeze and corrosion protection fluid
- Concentrated Propylene Glycol plus multi-metal corrosion inhibitors
- Protects aluminum, cast iron, copper and steel
- Helps keep heat-exchange surfaces clean
- Helps keep efficiency high
- Non-hazardous
- Burst protection to -100°F
- Environmentally friendly
- Prevents corrosion



Part #	Mfg #	Size	Price
137009	RG-ULTRA-5	5 gal	
184831	RG-ULTRA-55	55 Gal Drum	

Antifreeze & Other Chemicals

Hydro-Solv™ 9100 Hydronic System Cleaner

- Removes bacteria, scale and corrosion
- Cleans aluminum, brass, copper, iron and steel
- Non-hazardous



Part #	Mfg #	Size	Price
137020	HYDRO-SOLV 9100	1 gal	

EnviroGard™ Ultra Heat HD Transfer Fluid

- All ingredients are listed by the USDA and FDA as (GRAS) "Generally Recognized as Safe".
- Approved by Department of Natural Resources and Department of Health for use in Geothermal Systems
- Concentrated for maximum economy
- Protects cast iron, copper and steel
- Provides freeze, corrosion and scale protection
- Helps keep heat-exchange surfaces clean
- Helps keep efficiency high
- Non-hazardous and non-toxic
- Burst protection to -100°F
- Environmentally friendly

Part #	Mfg #	Size	Price
137478	ENVIROGARDULTR AHD55	55 gal	

Antifreeze & Other Chemicals

Gunk® Boiler Products

Rust Raider®

- Protect entire system
- Turns boiler water blue indicating safe conditions
- Water changes color when additional chemical is need



Part #	Mfg #	Size	Price
008855	B5-34	1 gal	
008856	B5-40	5 gal	

Antifreeze & Other Chemicals

Boiler Additives

Safe Liquid Boiler Stop Leak

- Forms a water insoluble seal
- Safe to use in all boilers
- Contains no petroleum or hazardous components
- Will not sludge or clog
- Will not surge
- Compatible with propylene glycol and ethylene glycol anti-freeze



Part #	Mfg #	Description	Price
010085	STOPLEAK	1 qt Can	

Squick Boiler Cleaner/Inhibitor with Anti-Foam Silicone SK-24

- Cleans and protects steam boilers by a patented absorption/precipitation process
- Absorbs grease oil, rust, dissolved and suspended solids
- Prevents formation of insulating scale and crystallizing solids
- Prevents corrosion, protects metal surfaces
- Neutralizes free oxygen
- Prevents foaming, surging or priming
- Maximizes heat transfer
- Safe to use in all boilers - contains no petroleum or hazardous components
- No draining, no blow down required



Part #	Mfg #	Description	Price
010084	SKSQU	5 oz Squick Boiler Cleaner	

#5 Hydronic Formula Cleaner/Inhibitor with Silicon SK-24

- Cleans and protects boilers and hydronic systems
- Prevents formulation of insulating scale on heat transfer surfaces
- Keeps dissolved solids in solution
- Frees and lubricates stuck zone valves
- Dissolves insulating sludge on tankless coils
- Prevents corrosion
- Protects and lubricates pump seals and quiets noisy circulators
- Insures maximum heat transfer
- Safe for all boilers - contains no petroleum or hazardous components
- Compatible with both ethylene glycol and propylene glycol antifreeze



Part #	Mfg #	Description	Price
010087	HF-5	1 qt	



Antifreeze & Other Chemicals

Anti-Freeze

Cryo-Tek™ Original

- Blend of 45% virgin propylene glycol and the triple protection inhibitor package
- Use in systems fabricated with metal, plastics (except CPVC) and rubber pipping, fittings, seals, and other parts



Miscellaneous Chemicals

Hercules® Boiler Liquid

- Prevents steam boiler surging
- Will not clog or coat submerged hot water heating coils, controls, vents or valves
- Resists high pressure and is not affected by boiler cleaners
- Will not cause priming or foaming



Part #	Mfg #	Size	Price
161803	35260	5 gal	

Part #	Mfg #	Size	Price
192884	30-115	1 qt	

Cryo-Tek™ 100 Antifreeze

- Contains virgin (not recycled) propylene glycol with triple protection corrosion inhibitor
- Pre-mixed, ready-to-use formulation
- Pink liquid



Part #	Mfg #	Size	Price
144415	35284	5 gal	

Cryo-Tek™ AG

- Concentrated "Arctic Grade" anti-freeze solution
- Blue liquid.
- 100% pure virgin propylene glycol/triple protection inhibitor package
- Cryo-Tek can also be used in radiant tube heating systems, most solar heating systems and geothermal loops

Part #	Mfg #	Size	Price
176985	35285	5 gal	

Antifreeze & Other Chemicals

Anti-Freeze

Alphi-11 Antifreeze Protector

- Protects against corrosion & lime scale
- Combined antifreeze & protector
- Maintains efficiency so extending system life
- Compatible with all metals and materials commonly used in heating systems
- Non-toxic, environmentally friendly
- Protects heating and chilled water



Part #	Mfg #	Description	Price
225281	Alphi-11	5L	

Protector Test Kit

- Up to 25 tests per kit



Part #	Mfg #	Description	Price
177755	F-57897	Up to 25 Tests per Kit	

HVAC System Protector F1

- Central Heating Protector for mixed metal commercial and HVAC heating and cooling systems
- Renders water non-corrosive to steel, cast iron, copper, brass and aluminum
- Prevents lime scale build-up
- Maintains efficiency so extending system life
- Prevents bacterial contamination
- Compatible with all metals and materials commonly used in heating and cooling systems
- Non-toxic, environmentally friendly
- One 2.6 gallon bottle treats 500 gallons of water and one 55 gallon bottle treats 10000 gallons of water



Part #	Mfg #	Description	Price
178132	F-59700	2.6 Gallons	
177750	F-59900	Express Can	

HVAC System Cleaner F3

- Neutral universal cleaner for pre-commissioning new systems in accordance with BS7593:2006
- Removes sludge, limescale and other debris to restore heating efficiency of existing systems
- When used in conjunction with Protector F1 gas savings of up to 15% can be achieved every time you heat your room
- Compatible with all metals and materials commonly used in heating systems
- Easy to use, system can be left running normally during cleaning
- Suitable for use with all known power flushing machines
- pH Neutral, non-hazardous formula (COSHH rated zero)



Part #	Mfg #	Description	Price
178131	F-59701	500 ML	

Cleaner F5

- Quick, convenient and simple to use – doses in 30 seconds
- Added via a radiator adapter or filling loop supplied
- 100% recyclable can
- Compatible with all metals and materials including aluminum
- Removes sludge and scale and restores heating efficiency
- Removes flux residues and other debris
- pH Neutral, non-hazardous and environmentally formulation



Part #	Mfg #	Description	Price
177752	F-59902	100 ML Express Can	

Express Boiler Commissioning Kit

- Treats up to 26 gallons



Part #	Mfg #	Description	Price
177754	F-62089	Treats up to 26 Gallons	

Aquastats

Aquastats®

L4006A Immersion Type Aquastat Control

- Immersion type controllers for limiting or regulating temperatures of liquids in boilers or tanks
- SPST - Breaks circuit on temperature rise
- Visible control point scale and external adjustment screw permit easy setting
- Horizontal or vertical insertion of the sensing element
- Remote bulb model may be used to sense air temperature in ducts and in outside air sensing applications
- Includes: 3" insulation, Stop Factory-Set @240°F, Well Adapter & Heat-Conductive Compound



Part #	Mfg #	Temperature Operating Range	Temperature Differential, Mid scale	Price
006728	L4006A1678	100°-240°F	5°-30°F Adj	

L4006B Immersion Type Aquastat Control

- Immersion type controllers for limiting or regulating temperatures of liquids in boilers or tanks
- SPST Contacts make on temperature rise
- Includes: 3" Insulation, Stop Factory-Set @240°F, Well Adapter & Heat-Conductive Compound



Part #	Mfg #	Temperature Operating Range	Temperature Differential, Mid scale	Price
022280	L4006B1155	100° - 240°F	5° - 30°F Adj	

L4006E Immersion Type Aquastat Control

- High limit, manual reset
- Contacts break on temp rise
- Immersion type controllers for limiting or regulating temperatures of liquids in boilers or tanks
- Totally enclosed MicroSwitch™ snap-acting switches operate on temperature rise to set point
- Visible control point scale and external adjustment screw permit easy setting
- Horizontal or vertical insertion of the sensing element
- Includes: 3" Insulation, Well Adapter & Heat-Conductive Compound



Part #	Mfg #	Temperature Operating Range	Temperature Differential, Mid scale	Price
006729	L4006E1067	130° - 270°F	250°F	

Aquastats

L6006A Immersion High or Low Limit Aquastat Control, SPDT

- Remote bulb model may be used to sense air temperature in ducts and outside air sensing applications
- Totally enclosed MicroSwitch[®] snap-acting switch
- Visible control point scale and external adjustment screw permit easy setting
- Horizontal or vertical insertion of the sensing element
- Direct or well immersion of the sensing element
- Select models have wells
- Stop Factory-Set @ 240°F, Heat-Conductive Compound



Part #	Mfg #	Temperature Operating Range	Temperature Differential, Mid scale	Price
006740	L6006A1145	100° - 240°F	Stop Factory-Set @ 240°F, Heat-Conductive Compound	

L6006C Strap-On Mount High or Low Circulator Control, SPDT

- Remote bulb model may be used to sense air temperature in ducts and outside air sensing applications
- Totally enclosed MicroSwitch[™] snap-acting switch operates on temperature rise
- Visible control point scale and external adjustment screw permit easy setting
- Horizontal or vertical insertion of the sensing element
- Select models have wells



Part #	Mfg #	Temperature Operating Range	Includes:	Price
006741	L6006C1018	65° - 200°F	Stop Factory-Set @ 200°F	

Aquastat[®] Relays

L8148 Aquastat[®] Relay

- Immersion-type controllers that combine high limit protection with switching relay control of burner and circulator motors
- High limit opens burner circuit only
- Includes transformer and accessory terminals for adding a remote low limit controller
- Requires 24VAC thermostat with heat anticipator set at 0.2 amps
- Includes well adapter and heat-conductive compound
- Mounts horizontally or vertically
- Maximum Bulb: 40° over selected set point up to 265°F
- Maximum Ambient: 150° including zone valves with low voltage loads up to 1.2 amps



Part #	Mfg #	Description	Price
093128	L8148E1265	Line Voltage, 180° - 240°F High Limit, 4-1/2" Capillary, Vertical Mount	
006743	L8148J1009	Millivolt or Low Voltage, 120° - 240°F High Limit, 4-1/2" Capillary, Vertical/Horizontal Mount	

Aquastats

Accessories

Heat Conductive Compound

Part #	Mfg #	Description	Price
076507	107408	4 oz Heat Conductive Compound	
179645	120650U	1/2 oz Heat Conductive Grease	

Well Assemblies



Part #	Mfg #	Description	Price
006831	121371A	3/8" x 3" Bulb Size, Copper 1/2" NPT, 1-1/2" Insulation, 3" Insertion Well with Mounting Clamp	
006832	121371B	3/8" x 3" Bulb Size, Copper 3/4" NPT, 1-1/2" Insulation, 3" Insertion Well with Mounting Clamp	

Thermometers

Thermometer with Thermowell

- Thermowell included to allow thermometer to be removed without draining the system
- Steel case, brass well



Part #	Mfg #	Connection	Dial	Temperature Range	Price
095933	GT162	1/2" NPT	2-1/2" Diameter	32° - 250°F	

Baseboard Radiation

Therma Trim Hydronic Baseboards Therma Trim Baseboard Enclosure



Part #	Mfg #	Description	Price
135109	611-111-005	2' Baseboard Enclosure with 3/4" Element	
135112	611-111-010	3' Baseboard Enclosure with 3/4" Element	
135113	611-111-015	4' Baseboard Enclosure with 3/4" Element	
135114	611-111-020	5' Baseboard Enclosure with 3/4" Element	
135115	611-111-025	6' Baseboard Enclosure with 3/4" Element	
135116	611-111-030	7' Baseboard Enclosure with 3/4" Element	
135117	611-111-035	8' Baseboard Enclosure with 3/4" Element	
135126	611-311-075	2' Baseboard Enclosure	
135127	611-311-080	3' Baseboard Enclosure	
135128	611-311-085	4' Baseboard Enclosure	
135129	611-311-090	5' Baseboard Enclosure	
135130	611-311-095	6' Baseboard Enclosure	
135131	611-311-100	7' Baseboard Enclosure	
135132	611-311-105	8' Baseboard Enclosure	

Therma Trim Baseboard Heating Element

Part #	Mfg #	Description	Price
135118	611-211-040	2' Baseboard 3/4" Heating Element	
135119	611-211-045	3' Baseboard 3/4" Heating Element	
135120	611-211-050	4' Baseboard 3/4" Heating Element	
135122	611-211-055	5' Baseboard 3/4" Heating Element	
135123	611-211-060	6' Baseboard 3/4" Heating Element	
135124	611-211-065	7' Baseboard 3/4" Heating Element	
135125	611-211-070	8' Baseboard 3/4" Heating Element	

Therma Trim Baseboard Accessories

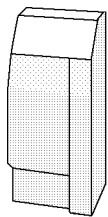

RH End Cap

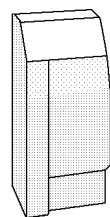

LH End Cap

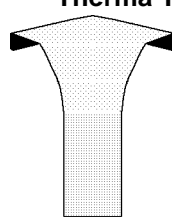

IC/WL

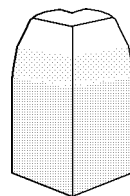

OC/WL

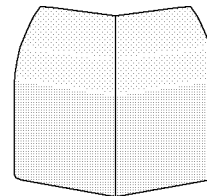

OC35B/W

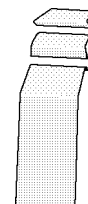

SS20/WL

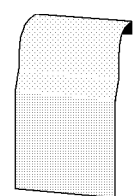

FSS40/W

Part #	Mfg #	Description	Price
135135	611-411-145	4" Baseboard LH End Cap w/Hinge	
135136	611-411-150	4" Baseboard RH End Cap w/Hinge	
135137	611-411-155	2" Baseboard LH End Cap	
135138	611-411-160	2" Baseboard RH End Cap	
135139	611-411-185	2" Baseboard Full Front Splice	
135140	611-411-190	90° Inside Corner	
135141	611-411-195	90° Outside Corner	

Baseboard Radiation

Therma Trim Hydronic Baseboards (Continued)

Therma Trim Baseboard Accessories

Part #	Mfg #	Description	Price
135142	611-411-205	135° Outside Bay Corner	
135143	611-411-210	135° Inside Bay Corner	
135144	611-411-225	Support Bracket with Pivot	
047845	611-490-226	Baseboard Supply Tube Hanger	

Boiler & Zone Controls

Commercial Remote Temperature Controls

T775 Electronic Remote Temperature Controller

- Includes platinum sensor
- Set point range: -40° to 248°F
- Differential temperature: 1° to 150°F
- Heat or cool
- 24/120/240VAC, 50/60Hz



Part #	Mfg #	Control Mode	Temp Inputs	Relay Outputs	Notes	Price
141882	T775P2003	SPDT	3	4	50021579-001 (Three)	
190396	T775L2007/U	SPDT	2	4	Stage Sequencer w/ Reset	

Pressuretrol® Pressure Controllers

PA404A Pressuretrol® Controller

- Provides control for steam pressure
- Sensitive pressure-actuated diaphragm expands or contracts with pressure variations moving lever mechanism operating snap-switch
- SPST Snap-acting switch
- Differential: 1 to 5 psi
- Safety control for steam heating boilers, breaks an electrical circuit to shut down burner if steam pressure rises above safe level
- Makes at set point on pressure fall, breaks at set point plus differential on pressure rise



Part #	Mfg #	Description	Price
006744	PA404A1033	SPST, 0.5 to 9.0 psi	

PA404B Pressuretrol® Controller

- Provides control for steam pressure
- Sensitive pressure-actuated diaphragm expands or contracts with pressure variations moving lever mechanism operating snap-switch
- SPST Snap-acting switch
- Used with suspension-type unit heaters to make the fan circuit when a pressure rise indicates the presence of steam
- Breaks at setpoint on pressure fall, makes at setpoint plus differential on pressure rise



Part #	Mfg #	Description	Price
042522	PA404B1023	Pressuretrol Controller, SPST, 0.5 to 9.0 psi, 1 to 5 psi Differential	

Boiler & Zone Controls

Aquatrol® Boiler Controls

AQ255/AQ257 Aquatrol® Expansion Zoning Panel

- For zoning with pumps or zone valves
- Easily switch from zone valves to pumps with same zoning module - just flip one DIP switch
- Ensures correct voltage is applied to all zone equipment on a panel (120VAC for pumps, 24VAC for valves)
- Works with AQ1000 2-wire communicating thermostats and most digital thermostats and AQ2000 boiler control panels
- Can be combined with additional expansion zoning panels and an AQ2000 control panel for a total of (16) space heating zones



Part #	Mfg #	Description	Price
134583	AQ25542B	Aquatrol Zoning Panel for (4) Zones of Pumps less End Switches	

Parts & Accessories

Programmable Timers, Clock Type

- Switching: 1 spdt
- Universal application with 24-hour or 7-day programming
- Battery backup (quartz drive)
- Screw wiring terminals
- Three-way override
- Captive trippers



Part #	Mfg #	Description	Price
149677	ST6008B1005	Programmable Timers, Clock Type Universal Application 7-Day	

Boiler & Zone Controls

Zone Controls

Zone Circulator Switching Relay

- Universal replaceability and thermostat compatibility
- Indicator lights
- Snap-in PC board to existing enclosure
- Fully enclosed snap-out relay
- UL Approved

1-Zone



Part #	Mfg #	Number of Zones	Maximum Voltage (Input)	Maximum Combined Load	Enclosure Dimensions H x W x D	Price
088487	SR501-4	1	120VAC	5A	5-1/4" x 4-1/4" x 2-3/4"	
095583	SR502	2 with Priority	120VAC	15A	6-3/4" x 10-1/4" x 2-3/4"	
068767	SR503	3 with Priority	120VAC	15A	6-3/4" x 10-1/4" x 2-3/4"	
068768	SR504	4 with Priority	120VAC	20A	6-3/4" x 10-1/4" x 2-3/4"	
095584	SR506	6 with Priority	120VAC	20A	7-1/2" x 11-3/4" x 3"	

Zone Valve Control

- All zone valve controls are relay type DPDT and have single phase motor rating per zone of 1/7 hp (SA) @ 120VAC
- (-EXP) expandable power port



ZVC404



ZVC406

Part #	Mfg #	Number of Zones	Transformer Voltage (Input)	Max Output At 24 VAC	Enclosure Dimensions H x W x D	Price
095585	ZVC403-2	3 with Priority	120VAC	40 VA	6-3/4" x 10-1/4" x 2-3/4"	
095587	ZVC404-2	4 with Priority	120VAC	40 VA	6-3/4" x 10-1/4" x 2-3/4"	
166151	ZVC404-EXP	4 with Priority	120VAC	40VA	6-3/4" x 10-1/4" x 2-3/4"	
095588	ZVC405-3	5 with Priority	120VAC	80 VA	7-1/2" x 11-3/4" x 3"	
095590	ZVC406-3	6 with Priority	120VAC	80 VA	7-1/2" x 11-3/4" x 3"	

Boiler & Zone Controls

Single-Stage Low Voltage Thermostats

Universal Single-Stage Mechanical Replacement Thermostat

- Mercury free
- 24V Replacement for hundreds of White-Rodgers and competitive models installed during the past 50-years
- Same footprint as older models with updated styling
- Enclosed contacts for increased reliability and accuracy
- Heat/cool with heating or cooling 3-wire zone mounting plate included
- Packaging is bilingual (English/Spanish)
- 5-Year warranty



Part #	Mfg #	System	Applications	Style	Color	Terminals	Price
145434	1F56N-444	1 Heat/1 Cool	24V, mV, 3wZn	Horizontal	White	RC,RH,W,Y,G,O,B,A	

Snap Disc Controls

3F05 / 3L05 Series Adjustable Snap Disc Fan & Limit Controls

- ¼" quick connect terminals are standard.
- Reduces inventory while providing coverage for a wide range of temperature applications.
- Replaces the majority of fixed disc thermostats now on heating equipment and various appliances.
- 2 adjustable fan control models replace 7 fixed snap disc models.
- 5 adjustable limit control models replace 10 fixed snap disc models.



Part #	Mfg #	Temperature Range	Differential	Switch Action	Function	Price
153005	WR3F051	90 to 130°F	20°F	SPST	Fan Controls	
153003	WR3L051	135 to 175°F	40°F	SPST	Limit Controls	
222881	WR3L052	175 to 215°F	40°F	SPST	Limit Controls	

Boiler & Zone Controls

Heating Controls

356 Mixing Control

- Microprocessor-based (PID) outdoor reset control
- Designed to operate a permanent capacitor, impedance protected or equivalent pump at varying speeds
- Provides for boiler minimum protection and operation
- 120VAC Rated relay outputs



Part #	Mfg #	Description	Price
047999	356	Variable Speed Reset Controller w/Sensors	

274 Boiler Control

- Microprocessor PID control
- One tN4, four stage boiler & DHW/setpoint control
- Can provide outdoor reset, domestic hot water and setpoint operation with priority
- Not a safety (limit) control
- Indoor use only
- Operates up to four on/off boilers



Part #	Mfg #	Description	Price
127773	274	Boiler Control (1) tN4, 4-Stage Boiler & DHW/Setpoint	

Thermostats Setpoint Controls

- Microprocessor based control
- Extremely accurate +/- 0.5°F
- Wide temperature ranges
- Remote sensing up to 500 feet
- Large load relay capacity
- Low power consumption

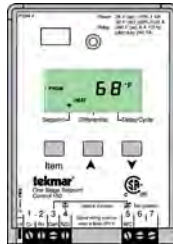

Part #	Mfg #	Description	Price
030576	150	1-Stage Setpoint Control	

Snow Melting Controls

Automatic Snow Melting Control

- Automatic snow/ice detection
- Warm weather cut-off
- Cold weather cut-off
- Accurate slab temperature control
- Slab outdoor reset



090/091

Part #	Mfg #	Description	Price
020296	090	Snow/Ice Sensor	
020298	091	Snow/Ice Sensor Socket	

Boiler/DHW Controls

256 Boiler Control

- Microprocessor-based (PID) control
- Regulates supply water temperature from a single boiler based on outdoor temperature
- Includes:
 - Warm weather shut down (WWSD)
 - Minimum boiler setting
 - Liquid crystal display (LCD)



Part #	Mfg #	Description	Price
047998	256	1-Stage Boiler Control	

667 Snow Detector & Melting Control

- Variable speed injection
- When combined with 090 snow/ice sensor provides automatic snow/ice detection
- Operates a variable speed injection pump to provide several protection and control features
- Microprocess PID control
- Not a safety (limit) control

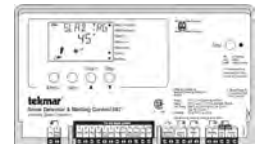

Part #	Mfg #	Description	Price
065840	667	Snow Detector & Melting Control	

Boiler & Zone Controls

Sensors

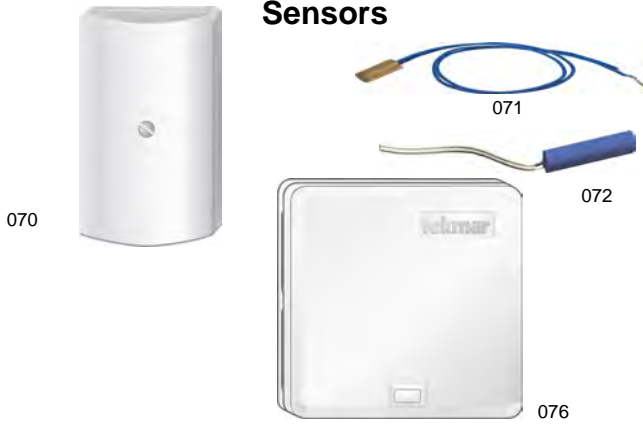

Part #	Mfg #	Description	Price
065350	070	Outdoor Sensor	
037312	071	Universal Sensor w/12" 2-Cond Wire	
044387	072	Slab Sensor w/PVC Sleeve & 20' 2-Cond Wire	
044864	076	Indoor Sensor, Surface Mount	

Boiler Accessories

Hose End Valves

74-CL Multi-Turn Boiler Drain

- Buna-N seat
- 125 psi to 100°F
- Max temp: 180°F
- Screw-in bonnet



Part #	Mfg #	Size	Price
168326	12BDNI	1/2"	
168327	34BDNI	3/4"	

Boiler Drains

Boiler Drains

BD Series Brass Boiler Drain Shut-Off

- 3/4" Hose thread connection on outlet
- Brass body construction
- Cast iron hand wheel
- Maximum pressure: 200 psi
- Maximum temperature: 180°F



Part #	Mfg #	Model	Size	Pattern	Price
013030	0820901	BD1C	1/2" Dual Conn	Angle	
014608	0820902	BD2C	3/4" MNPT	Angle	

BT Series 1/4-Turn Boiler Drain Shut-Off

- 3/4" Hose thread connection on outlet
- Brass body construction
- Tee handle with positive shutoff
- Adjustable Teflon® stem packing
- Maximum pressure: 200 psi



Part #	Mfg #	Model	Size	Price
053099	0820955	BD-QT	1/2" Dual Pattern, MIP or Solder	
053100	0820956	BD-QT	3/4" MNPT	

Boiler Accessories

Boiler Drains

Lead Free Boiler Drain

- Certified to ANSI / NSF Standard 61-G
- End connections comply with
ANSI / ASME B1.20.1 (FNPT)
ANSI / ASME B1.20.7 (Male Garden)



Part #	Mfg #	Size	Price
191910	T-522	1/2" FNPT	
191911	T-522	3/4" FNPT	

Circulator Pumps

UP Circulator Pumps - Closed Systems

- Wet rotor, single-stage, direct drive centrifugal pumps designed for domestic and light commercial applications
- Built-in motor protection
- Quiet, maintenance-free performance
- Flushed bearing design
- 60Hz
- Maximum working pressure: 145 psi
- Minimum fluid temperature: 36°F (unless noted)
- 2-Pole motor, single-phase
- 3-Year warranty

UPS 15-58FC/FRC (3-Speed Motor) SuperBrute Cast Iron Circulator Pump

- Fits most standard hydronic applications
- Cast iron construction
- Includes removable check valve
- Flange - (2) 1/2" diameter bolt holes
- Flow range: 0 to 17 gpm
- Head range: 0 to 19.5'
- Minimum liquid temperature: 36°F
- Maximum liquid temperature: 230°F
- 1/25 hp



Part #	Mfg #	Amps	Volts	Capacitor	Price
076106	UPS1558FC	0.55-0.75A	115V	10µF/180V	
118361	UPS1558FRC	*0.55-.075A	115V	10µF/180V	

* Reversing

UPS 26-99FC (3-Speed Motor) SuperBrute Cast Iron Circulator Pump

- Cast iron construction
- Includes removable check valve
- Flange: (2) 1/2" diameter bolt holes
- Flow range: 0 to 33 gpm
- Head range: 0 to 29'
- Minimum liquid temperature: 36°F
- Maximum liquid temperature: 230°F
- 1/6 hp



Part #	Mfg #	Amps	Volts	Capacitor	Price
098645	UPS2699FC	1.3-1.8A	115V	20µF/180V	
106130	UPS2699FC	1.3-1.8A	230V	20µF/180V	

UPS Series 3-Speed Motor Circulator Pump with IFC

- Stainless steel construction
- Includes removable check valve
- Includes 2 gaskets (O-rings)
- Whisper-quiet operation
- Flanged: 1/2", 3/4", 1", 1-1/4"
- Flow range: 0 to 33 gpm
- Head range: 0 to 29'
- Minimum liquid temperature: 36°F
- Maximum liquid temperature: 230°F
- 1/6 hp



Part #	Mfg #	Amps	Volts	Capacitor	Price
185595	UPS2699SFC	1.3-1.8A	115V	20µF/180V	

UPS 43-44FC (3-Speed Motor) SuperBrute Cast Iron Circulator Pump

- Cast iron construction
- For applications requiring higher head
- Includes removable check valve
- 2-Pole, single-phase
- Flange: (2) 1/2" diameter bolt holes
- Flow range: 0 to 63 gpm
- Head range: 0 to 14'
- Minimum liquid temperature: 32°F
- Maximum liquid temperature: 230°F
- Maximum system pressure: 145 psi
- 1/6 hp



Part #	Mfg #	Amps	Volts	Capacitor	Price
098646	UPS4344FC	1.4-1.8A	115V	20µF/180V	

UPS 26-150F (3-Speed Motor) SuperBrute Cast Iron Circulator Pump

- Cast iron construction
- Flow range: 0 to 53 gpm
- Head range: 0 to 46'
- Flange: (2) 1/2" diameter bolt holes
- 2-Pole, single-phase
- Minimum liquid temperature: 36°F
- Maximum liquid temperature: 230°F
- Maximum system pressure: 145 psi
- 1/6 hp



Part #	Mfg #	Amps	Volts	Capacitor	Price
130966	UPS26150F	2.5-3.5A	115V	40µF/180V	
269271	UPS26150F	2.5-3.5A	230V	40µF/180V	

Circulator Pumps

UPS 43-100F (3-Speed Motor) SuperBrute Cast Iron Circulator Pump

- Flow range: 0 to 65 gpm
- Head range: 0 to 31'
- Flange: (2) 1/2" diameter bolt holes
- 2-Pole, single-phase
- Minimum liquid temperature: 36°F
- Maximum liquid temperature: 230°F
- Maximum system pressure: 145 psi
- 1/6 hp



Part #	Mfg #	Amps	Volts	Capacitor	Price
130968	UPS43100F	3.5A	115V	40µF/180V	
269270	UPS43100FC	3.5A	115V	40µF/180V	

Series UP Comfort Recirculation Pump

Comfort PM Auto Hot Water Recirculation Pump

- 115V, Auto, check valve
- 1-1/4" NPSM union
- 6' line cord included
- Easy installation
- Minimize water waste
- Lower energy consumption
- Learns and adapts to homeowner's water temp needs



Part #	Mfg #	Connection	Price
171389	UP1016APMBU/L C	1-1/4" NPSM Union	

UP Comfort Series Recirculation Kit

- Includes:
 - (1) Pump
 - (1) Valve
 - (2) 1/2" FNPS x 1/2" FNPS x 12" Stainless steel flex hoses



Part #	Mfg #	Description	Price
061116	595916	Recirculation Kit	

UP Circulator Pumps - Open Systems

- Wet rotor, single-stage, direct drive centrifugal pumps designed for domestic & light commercial applications
- For open systems 140°F is maximum recommended fluid temp to avoid precipitation of calcium in water
- Built-in motor protection
- Quiet, maintenance-free performance
- Flushed bearing design
- 60Hz
- 2-Pole, single-phase

UP 15-10B5 Circulator Pump

- Brass, lead-free housing
- 115V, 0.22A, 25W, 1/25 hp
- Capacitor: 2µF/400V



Part #	Mfg #	Connection	Price
039691	UP1510B5	1/2" Sweat	
040255	UP1510B7	3/4" Sweat	

UP 15-42B5 Bronze Circulator Pump

- Bronze construction
- 1/2" Sweat connection
- UP15-42B5 Includes line cord
- LC/TLC Models have 6'3" power cord
- 1/25 hp



Part #	Mfg #	Amps	Volts	Capacitor	Price
023051	UP1542B5	0.74A	115V	10µF/180V	

UPS 15-55SFC (3-Speed Motor) SuperBrute Stainless Circulator Pump

- Stainless construction
- Flange: (2) 1/2" diameter bolt holes
- Includes removable check valve
- Flow rate: 0 to 25 gpm
- Head range: 0 to 18'
- 2-Pole, single-phase
- Minimum liquid temperature: 36°F
- Maximum liquid temperature: 230°F
- Maximum system pressure: 145 psi
- 0.12 hp



Part #	Mfg #	Amps	Volts	Capacitor	Price
110243	UPS1555SFC	.53-.75A	115V	10µF/180V	

Circulator Pumps

UP 26-96BF Bronze Circulator Pump

- Bronze construction
- Flange: (2) 1/2" diameter bolt holes
- Flow range: 0 to 28 gpm
- Head range: 0 to 30'
- 1/12 hp



Part #	Mfg #	Amps	Volts	Capacitor	Price
004961	UP2696BF	1.7A	115V	110µF/180V	

UP 15-29SF Stainless Circulator Pump

- Stainless steel construction
- Flange pipe connection
- Flow range: 0 to 20.5 gpm
- Head range: 0 to 9.7'
- Maximum fluid temperature: 230°F
- 0.12 hp



Part #	Mfg #	Amps	Volts	Capacitor	Price
109850	UP1529SF	0.75A	115V	10µF/180V	

UPS 26-150F Superbrute Circulator Pump

- Cast iron construction
- 3-Speed
- Ceramic shaft and radial bearings
- Carbon axial bearing
- Stainless steel rotor can and bearing plate
- Corrosion-resistant impeller, composite, PES
- Cast iron pump housing



Part #	Mfg #	Amps	Volts	Capacitor	Price
130967	UPS26150F	3.5A	230V	40 µF/180 V	
133525	UPS26-150SF	3.5A	115V	40 µF/180 V	

UP 15-29SU Stainless Circulator Pump

- Stainless steel construction
- 1/4" Union pipe connection
- Flow range: 0 to 20.5 gpm
- Head range: 0 to 9.7'
- Maximum fluid temperature: 230°F
- T Suffix: timer
- LC Suffix: 6', 3-prong line cord
- 0.12 hp

Part #	Mfg #	Amps	Volts	Capacitor	Price
114552	UP1529 SUC/TLC	0.75A	115V	10µF/180V	

UPS 43-100F Superbrute Circulator Pump

- Ceramic shaft and radial bearings
- Carbon axial bearing
- Stainless steel rotor can and bearing plate
- Corrosion-resistant impeller, composite, PES
- Cast iron pump housing.



Part #	Mfg #	Amps	Volts	Capacitor	Price
130969	UPS43100F	1.2-1.7A	230V	10 µF/400 V	

UPS 15-35SFC (3-Speed Motor) Super Brute Stainless Circulator Pump

- Stainless steel construction
- Flange pipe connection
- Capacitor: 10µF/180V
- Flow range: 0 to 21.5 gpm
- Head range: 0 to 12'
- 2-Pole, single-phase
- Minimum liquid temperature: 36°F
- Maximum liquid temperature: 165°F
- Maximum system pressure: 145 psi
- Removable check valve
- 1/3 hp



Part #	Mfg #	Amps	Volts	Price
110113	UPS1535SFC	0.06-0.95A	115V	

UP 26-116BF Bronze Circulator Pump

- Cast iron construction
- Flange: (2) 1/2" diameter bolt holes
- Flow range: 0 to 37 gpm
- Head range: 0 to 37'
- Minimum liquid temperature: 32°F
- Maximum liquid temperature: 150°F
- 1/6 hp



Part #	Mfg #	Amps	Volts	Capacitor	Price
099263	UP26116BF	1.75A	115V	2.5µF/380V	

Circulator Pumps

UP 43-75BF Bronze Circulator Pump

- Bronze construction
- Flange: (2) 1/2" diameter bolt holes
- Flow range: 0 to 41 gpm
- Head range: 0 to 25'
- 1/6 hp



Part #	Mfg #	Amps	Volts	Capacitor	Price
026604	UP4375BF	2.15A	115V	10µF/180V	

Comfort Hot Water Recirculation Solutions - Retrofit

- Stainless steel construction
- No return line required
- Installs in less than one hour
- No electricity needed under sink
- Uses less energy than 25-watt light bulb
- Can save up to 16,000 gallons of water per year
- Flow range: 0 to 6.3 gpm
- Head range: 0 to 5.1'
- Minimum liquid temperature: 36°F
- Maximum liquid temperature: 150°F
- Maximum system pressure: 145 psi



Part #	Mfg #	Description	Price
061115	595926	Comfort Valve	

ALPHA™ Energy-Efficient Circulator Pumps

- AUTOAdapt™ measures system changes automatically and maximizes energy savings
- LED Display shows flow indication and power consumption
- Plugs connections; no wiring required
- Motor: 1X115V
- 115V, 0.65A, 5 to 45W, 1/16 hp
- Flow range: 0 to 21 gpm
- Head range: 0 to 19'
- Maximum working pressure: 150 psi
- Minimum fluid temperature: 36°F
- Maximum fluid temperature: 230°F



ALPHA 15-55F



ALPHA 15-55SF

Closed System

- Cast iron construction

Part #	Mfg #	Connection	Price
233306	1555FC	GF 15/26 Flange & Line Cord, (2) 1/2" Diameter Bolt Holes	
125022	1555FC	GF 15/26 Flange & Line Cord, (2) 1/2" Diameter Bolt Holes	

Circulator Pumps

Alpha2 High Efficiency Circulator

- Can be programmed in one of 3-constant speed, 3-constant pressure, or AUTOADAPT control modes
- Large LED display
- For installation, you have the flexibility to use either our unique ALPHA Plug with line cord or the ALPHA2 with terminal box for conduit connections
- ALPHA2 is complete with an integrated check-valve, foam insulation jacket, and nut captures for flanges
- Comes in both cast iron and stainless steel models
- Robust startup enables the ALPHA2 to continuously attempt to restart – indefinitely – in block conditions
- Motor: 1 x 115V
- Flow, Q: 21 gpm max
- Head, H: 19 FT max
- Max working pressure: 150 PSI
- Liquid Temp: 36°F to 230°F
- Watts: 5-45W
- Amps: 0.65A
- Approvals: ETL, NSF 61, NSF 372



Part #	Mfg #	Amps	Volts	Capacitor	Price
233298	GR1555SFC2			Stainless Flange w/ Terminal Box	

VersaFlo® Circulator Pumps

VersaFlo® UPS32 - Cast Iron - 3-Speed

- Flanges: 2-Bolt with (2) 1/2" diameter hole
- Flow range: 9 to 78 gpm
- Head range: 1 to 46'
- Maximum working pressure: 145 psi
- Maximum fluid temperature: 140°F



Part #	Mfg #	Motor Poles	HP	Volts	Price
048821	UPS3280/2	2-Pole	1/2	115V	

VersaFlo® UPS50 - Cast Iron - 3-Speed

- Flanges: 2", 4-bolt with (4) 9/16" diameter holes (non-ANSI)
- Flow range: 20 to 180 gpm
- Head range: 1 to 62'
- Maximum working pressure: 145 psi
- Maximum fluid temperature: 140°F



Part #	Mfg #	Motor Poles	HP	Volts	Price
031312	UPS5080/4	2-Pole	3/4	115V	

Circulator Pumps

Flange Sets

Flange Set for Stainless Steel Body Union Mount Pumps

UP15-18SU - UP15-42SU - UP25-64SU

Bronze Half Union Set



Part #	Mfg #	Description	Price
058001	529913	1/2" Sweat Half Union	
058000	529911	3/4" Sweat Half Union	

Flanges for Stainless Steel or Bronze Body Flange Mount Pumps

- For use with UM15-18SF, UP15-42SF, UP25-64SF, UP26-96BF, UP26-99BF, & UP43-75BF pumps

Bronze Threaded Valve Set



Part #	Mfg #	Description	Price
004999	519651	3/4" Threaded	
005000	519652	1" Threaded	
034876	539615	1-1/2" Threaded for UP43-75BF	

Flange for Cast Iron Body Flange Mount Pumps

- Includes:
 - (2) Flanges
 - (2) Gaskets
 - (8) Nuts and bolts

Cast Iron Threaded Flange Set



Part #	Mfg #	Description	Price
004995	519601	3/4" Threaded	
004996	519602	1" Threaded	
004997	519603	1-1/4" Threaded	
004998	519604	1-1/2" Threaded	
005005	539605	1-1/2" Threaded for UP43-75F	
084839	96409354	2" Threaded	

Timer Control

- 24-Hour programmable clock/timer
- For use with single speed, series UP circulators



Part #	Mfg #	Description	Price
091576	59-9388	115V Timer Control	

Grundfos® Parts

Part #	Mfg #	Description	Price
051161	GR510231	Full Faced Bolt Hole Style Flange/Gasket	
084284	510179	Gasket F/ UP/UPS/TP Flange Donut	
090178	530244	Gasket for 1-1/2" Flange	
045258	595444	3/4" Clip-On Aquastat Control	
046089	595443	Thermostatic Control, 1/2" Clip-On Mount for 5/8" OD System Piping Size	



Circulator Pumps

Circulating Pumps

Bell & Gossett Wet Rotor Circulating Pump

- Cast Iron
- 115V



Part #	Mfg #	Description	Price
023992	NRF-22	Single Phase, 3 Speed	

Circulator Pumps

Grundfos Pumps

- *1/6 hp Recirculator pump with cast iron pump housing*
- *Built-in motor protection*
- *Stainless steel construction*



Part #	Mfg #	Description	Price
139024	G2-116F	230V	

Flow Valves

Flo-Check Valves

- *Used in forced hot water heating system to prevent gravity circulation during periods when boiler is hot but space heating zone not wanted*
- *Maximum operating pressure: 125 psi*
- *Maximum operating temperature: 277°F*
- *Media: water or water/glycol*



Part #	Mfg #	Size	Body	Type	Conn Inlet	Conn Outlet	Resistance in Feet of Pipe Equivalent	Price
103903	220	1"	Cast Iron	Universal	NPT	NPT	83.7/6.7	
103904	221	1-1/4"	Cast Iron	Universal	NPT	NPT	47.8/17	
103905	222	1-1/2"	Cast Iron	Universal	NPT	NPT	57.9/23.5	

Heat Exchangers

Heat Exchangers

(Brazed Plate Heat Exchanger)

- Single wall copper brazed
- High heat transfer coefficient
- Small size with high heat transfer capacity
- Cost efficient
- Stainless steel 1-1/8" solder
- Easily installed



Part #	Mfg #	Size	Connection	Price
122451	LA14-20	7.5" x 3" x 2.29"	3/4"	
122452	LB31-30X	12" x 5" x 3.19"	1"	

Heat Exchangers

Heat Exchangers

Brazen Plate Heat Exchanger

- *Made of high quality acid-resistant stainless steel with 99.9% pure copper brazing*
- *Compact, lightweight, and designed for a variety of applications including radiant heating, snow melt systems and domestic hot water*
- *Counter flow design resulting high turbulence and maximum heat transfer*

Part #	Mfg #	Input BTUH	Flow Rate	Boiler Pressure Drop PSI	Water @ 90 Temp Rise	Water Pressure Drop PSI	Rated 1st Hour	Price
041811	WMBP1-14E	40,000	1.7 gpm	0.2 psi	0.8 gpm	0.0 psi	86	

Isolation Flanges

The Isolator® Uni-Flange Ball Valves

The Isolator® Uni-Flange Ball Valve (IPS x Flange)

- Full port forged brass ball valve
- Adjustable packing gland
- Bonus wing style T-handle
- Nuts and bolts
- HV Suffix = fits high velocity pumps



Part #	Mfg #	Size	WOG	Price
145019	40402	1/2"	600	
143756	40403	3/4"	600	
143760	40404	1"	600	
146935	40404HV	1"	600	
143761	40405	1-1/4"	600	
146936	40405HV	1-1/4"	600	
143762	40406	1-1/2"	600	
146937	40406HV	1-1/2"	600	
143763	40407HV	2"	600	

The Isolator® Uni-Flange Ball Valve (Swt x Flange)

- Full port forged brass ball valve
- Adjustable packing gland
- Bonus wing style T-handle
- Nuts and bolts
- HV Suffix = fits high velocity pumps



Part #	Mfg #	Size	WOG	Price
145020	50402	1/2"	600	
143768	50403	3/4"	600	
146938	50404HV	1"	600	
146939	50405HV	1-1/4"	600	
143771	50406	1-1/2"	600	
146940	50406HV	1-1/2"	600	
143773	50407HV	2"	600	

The Isolator® Uni-Flange Ball Valve with Rotating Flange (IPS x Rotating Flange)

- Full port forged brass ball valve
- Detachable rotating flange
- Adjustable packing gland
- Bonus wing style T-handle
- Nuts and bolts
- HV Suffix = fits high velocity pumps



Part #	Mfg #	Size	WOG	Price
143764	41403	3/4"	600	
143765	41404	1"	600	
146928	41404HV	1"	600	
143766	41405	1-1/4"	600	
146929	41405HV	1-1/4"	600	
146930	41406HV	1-1/2"	600	
168543	41407WHV	2"	600	

The Isolator® Uni-Flange Ball Valve with Rotating Flange (Swt x Rotating Flange)

- Full port forged brass ball valve
- Detachable rotating flange
- Adjustable packing gland
- Bonus wing style T-handle
- Nuts and bolts
- HV Suffix = fits high velocity pumps



Part #	Mfg #	Size	WOG	Price
143774	51403	3/4"	600	
143775	51404	1"	600	
146931	51404HV	1"	600	
143776	51405	1-1/4"	600	
146932	51405HV	1-1/4"	600	
143777	51406	1-1/2"	600	
146934	51406HV	1-1/2"	600	

Isolation Flanges

The Isolator® Uni-Flange Ball Valve with Drain and Rotating Flange (IPS x Rotating Flange)

- Full port forged brass ball valve
- Detachable rotating flange
- Multi-function hi-flow hose drain
- Adjustable packing gland
- Nuts and bolts
- HV Suffix = fits high velocity pumps



Part #	Mfg #	Size	WOG	Price
143778	41413	3/4"	600	
143779	41414	1"	600	
146941	41414HV	1"	600	
143780	41415	1-1/4"	600	
146942	41415HV	1-1/4"	600	
143781	41416	1-1/2"	600	
146943	41416HV	1-1/2"	600	

The Isolator® Uni-Flange Ball Valve with Drain and Rotating Flange (Swt x Rotating Flange)

- Full port forged brass ball valve
- Detachable rotating flange
- Multi-function hi-flow hose drain
- Adjustable packing gland
- Nuts and bolts
- HV Suffix = fits high velocity pumps



Part #	Mfg #	Size	WOG	Price
143782	51413	3/4"	600	
143783	51414	1"	600	
146944	51414HV	1"	600	
143784	51415	1-1/4"	600	
146945	51415HV	1-1/4"	600	
143785	51416	1-1/2"	600	
146946	51416HV	1-1/2"	600	

The Isolator® Uni-Flange Ball Valve with Detachable Rotating Flange (Press x Rotating Flange)

- Full port forged brass ball valve
- Detachable rotating flange
- Adjustable packing gland
- Nuts and bolts
- HV Suffix = fits high velocity pumps



Part #	Mfg #	Size	WOG	Price
158127	81403HV	3/4"		
158128	81404HV	1"		
158129	81405HV	1-1/4"		
158130	81406HV	1-1/2"		

Mini Ball Valves

4079M Series Mini Ball Valve

- Hex body
- 110 WOG non-shock
- Chrome plated extruded brass



Part #	Mfg #	Size	WOG	Price
239062	40792	3/8" MIP x FIP	110	

Isolation Flanges

Isolation Pump Flanges

IPF Series Isolation Pump Flange

- Isolate circulator pumps to facilitate circulator pump replacement or repairs
- Brass body and flange with bottom loaded blowout proof stem, chrome plated ball and double o-ring stem seal
- Pressure rated at 600 psi WOG



Part #	Mfg #	Model	Size	Price
076650	0068090	IPFM1-T	3/4"	
076651	0068091	IPFM1-T	1"	
076652	0068092	IPFM1-T	1-1/4"	
076657	0068095	IPFM1-S	3/4"	
076658	0068096	IPFM1-S	1"	
082649	0068097	IPFM1-S	1-1/4"	
120420	0068098	IPFM1-S	1-1/2"	

Low Water Cut-Offs & Feeders

Combination Water Feeder/Low Water Cut-Offs

47-2 Combination Mechanical Water Feeder/Low Water Cut-Off

- For steam and hot water boilers with cold water feed
- Continuous maintenance of minimum safe water level, independent of electrical service
- Proportional feed action
- Quick hook-up fittings provided
- Maximum water supply pressure: 150 psi
- Maximum inlet water temperature: 120°F
- Maximum boiler pressure: 25 psi



Part #	Mfg #	Model #	Description	Price
007122	132800	47-2	No 2 Switch	

Low Water Cut-Offs & Feeders

Low Water Cut-Offs

Safgard™ LWCO for Steam Boilers

- No moving parts to wear or stick
- Time delay prevents short cycling
- SV Models include the shorter model EL-1214-SV probe suitable for mounting in standard reducing tees



Part #	Mfg #	Description	Price
097318	500-SV	24V, Manual Reset, Test Button	
097319	550-SV	120V, Manual Reset, Test Button	

Safgard™ Direct Boiler Mounting LWCO with Primary Cut-Offs

- Burner circuit contacts open after 15 second delay in low water condition
- Automatically restarts burner 30 second after water reaches probe
- For residential & commercial boilers to 15 psi
- SV Models include the shorter model EL-1214-SV probe suitable for mounting in standard reducing tees



Part #	Mfg #	Description	Price
097320	400-SV	24VAC, 2VA, SPDT 15 psi	

Feeders

Automatic Water Feeders for Steam Boilers

- Delay before feed: 2 minutes
- Feed setting: LWCO
- Maximum steam pressure: 15 psi
- Maximum water supply pressure: 150 psi
- Maximum amp draw: 5A (24VAC), 2A (120VAC)



Part #	Mfg #	Description	Price
030223	VXT-24	1 gpm, 24V	

Low Water Cut-Offs & Feeders

Boiler Feed Water Backflow Preventers

Combination Backflow Preventer (9D) and Fill Valve (1156F) for Hot Water Boilers - 1/2"

- *Used on boiler feed lines to provide make up water to the boiler and prevent backflow when supply pressure falls below system pressure*
- *High capacity fast fill and purge capability*
- *Maximum pressure: 100 psi*
- *Maximum temperature: 212°F*
- *Suffix Options:*
 - 911 = NPT x NPT Connections



Part #	Mfg #	Model	Description	Price
041894	0386460	911M3	1156F+9D Combo	



Pressure Reducing Valves

Pressure Reducing Valves

- Fast fill feature
- Low inlet pressure check valve
- Convenient cleanable strainer
- Maximum operating temperature: 225°F
- Maximum operating pressure: 125 psig



Combination "Dual Units" Pressure Relief and Reducing Valve

- Relief valve pressure setting: 30 psi
- 1/2" NPT Boiler connection
- Brass/iron body construction

Part #	Mfg #	Model	Components - Relief Plus	Price
002470	110199	8	B-38	

Pressure Reducing Valve

- Brass body construction
- Pressure factory set to 12 psig
- Adjustable range: 10 - 25 psig

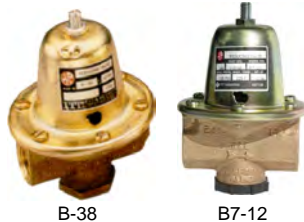

Part #	Mfg #	Model	Connection	Price
002402	110190	B-38	1/2" NPT	
002403	110196	B7-12	3/4" NPT	

Pressure Reducing Valves

Boiler Feed Water Pressure Regulators

High Capacity Feed Water Pressure Regulator

- Iron and bronze body
- Tight seating check valve
- Purge lever for manual purging
- Stainless steel strainer
- Maximum pressure: 100 psi
- Provides make-up water to the system in the event of system leaks
- For use in commercial and residential hydronic heating systems to fill the boiler and piping system with water, and to maintain water pressure in the system at all times



Part #	Mfg #	Model	Inlet Size	Connection	Price
036375	0386425	1156F	1/2"	Threaded	

BD1156F Feed Water Pressure Regulators

- High capacity
- Dial indicator
- Bronze valve body
- Tight seating check valve
- Push button fast fill with auto-stop
- Stainless steel strainer to protect valve disc from fouling



Part #	Mfg #	Model	Inlet Size	Connection	Price
238385	0386456	BD1156F	3/4"	Threaded	

LFN55BM1-U Water Pressure Regulator

- Double union inlet & outlet connections
- Integral stainless steel strainer
- Thermoplastic seat
- Lead Free* brass body construction
- Serviceable in line
- Bypass feature controls thermal expansion pressure***
- Sealed spring cage on all models for accessible outdoor or pit installations



Part #	Mfg #	Model	Size	Price
180454	0009589	LFN55M1-U	3/4"	
180453	0009639	LFN55M1-U	1"	

LFU5B-Z3 Water Pressure Regulator

- Union inlet connection
- Integral stainless steel strainer
- Replaceable seat module
- Lead Free* cast copper silicon alloy construction
- Serviceable in line
- Bypass feature controls thermal expansion pressure***
- High temperature resistant reinforced diaphragm for hot water
- Standard construction includes Z3 sealed spring cage and stainless steel corrosion resistant adjusting & cage screws for accessible outdoor or pit installations



Part #	Mfg #	Model	Size	Price
157252	0009100	LFU5B-Z3	1/2"	
156599	0009118	LFU5B-Z3	3/4"	
157250	0009154	LFU5B-Z3	1"	
157253	0009180	LFU5B-Z3	1-1/4"	
158149	0009204	LFU5B-Z3	2"	
157256	0009108	LFU5B-LP-Z3	1/2"	

LF25AUB-Z3 Water Pressure Regulator

- Union inlet connection
- Integral stainless steel strainer
- Replaceable seat module
- Lead Free* cast copper silicon alloy construction
- Serviceable in line
- Bypass feature controls thermal expansion pressure***
- High temperature resistant reinforced diaphragm for hot water
- Standard construction includes Z3 sealed spring cage and stainless steel corrosion resistant adjusting & cage screws for accessible outdoor or pit installations
- (Spring -LP model only)



Part #	Mfg #	Model	Size	Price
158193	0009217	LF25AUB-Z3	1/2"	
156645	0009257	LF25AUB-Z3	3/4"	
156601	0009128	LF25AUB-LP-Z3	3/4"	
163080	0009309	LF25AUB-Z3	1"	
159642	0009431	LF25AUB-Z3	1-1/2"	
159058	0009465	LF25AUB-Z3	2"	

Pressure Reducing Valves

LF26A Small Pressure Regulator 2-Way

- *Rugged forged Lead Free*
Brass body*
- *Tee handle adjustment*
- *Oversized orifice*



Part #	Mfg #	Model	Size	Price
157268	0009811	LF26A	1/4"	
157269	0009815	LF26A	3/8"	
157270	0009819	LF26A	1/2"	

Radiator Traps & Valves

Radiator Valves

Brass Steam Radiator Globe Valve

- Angled with ground joint union nut and tailpiece
- 60 psi/15 WSP



Part #	Mfg #	Size	Price
148415	11534	1" IPS	
148416	11535	1-1/4" IPS	

Brass Hot Water Radiator Globe Valve

- Angled with ground joint union nut and tailpiece
- 60 psi



Part #	Mfg #	Size	Price
143811	11553	3/4" IPS	
143813	11554	1" IPS	
143814	11555	1-1/4" IPS	
143816	11556	1-1/2" IPS	

Water Heater Accessories

The Isolator E X P E2 Tankless Water Heater Service Valve Kit

- Residential pressure relief valve (150 PSI/200,000 BTU)
- IPS Union x Press
- 250 CWP
- ISO 9001
- Hot & Cold set of full port forged brass ball valves with Hi-flow hose drains, pressure relief valve outlet & Adjustable packing gland



Part #	Mfg #	Size	Price
182466	84443WPR-LF	3/4"	

Radiator Traps & Valves

PRO-PAL® Series Valves

PRO-PAL® Expansion Tank Pro Service Valve™
(FIP x MIP x FIP x Hose)

- Full port forged brass ball valve with hi-flow hose drain



Part #	Mfg #	Size	WOG	Price
143788	41672	1/2"	600	

Radiator Traps & Valves

Radiator Steam Traps

Series 17C Balanced Pressure BearTrap® Thermostatic Steam Trap

- For institutional, commercial, and residential heating system applications where low or moderate water hammer may occur
- Subcooling
- Replaceable Dura-Stat® module
- Stainless steel components
- Resistant to moderate water hammer and chemical attack
- Maximum operating pressure: 25 psig
- 3-Year warranty

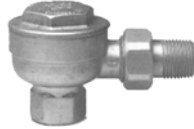

Part #	Mfg #	NPT Size	Description	Price
005399	401536	1/2"	Angle	

Radiator Traps & Valves

Hydronics - Steam Valves

RA Series Steam Radiator Valve (FNPT x MNPT Union)

- Teflon® stem packing



RA-1-AP Angle - Bronze Body

Part #	Mfg #	Model	Size	Price
036349	0067450	RA1AP	1/2"	
036350	0067451	RA1AP	3/4"	
036353	0067453	RA1AP	1-1/4"	
036354	0067454	RA1AP	1-1/2"	

Bronze Union Radiator Elbows

- For use in steam and hot water systems
- Maximum working pressure: 60 psi (non-shock) for hot water, 15 psi (non-shock) for saturated steam



Part #	Mfg #	Model	Size	Price
072758	0067460	UL-1	1/2" FIP x M Union	
031791	0067461	UL-1	3/4" FIP x M Union	



Spiralink Couplings

Spiralink® Couplers

Part #	Mfg #	Description	Price
010269	10010	Spiralink Coupler	

Thermal Expansion Tanks

Thermal Expansion Tanks

Therm-X-Trol® ASME Diaphragm Thermal Expansion Tank

- For use with potable water heaters only
- Non-ASME
- Pre-pressurized, diaphragm type
- Drawn steel domes, welded steel construction
- Rigid polypropylene liner
- Butyl diaphragm, diaphragm hoop ring mechanically grooved for permanent air-tight seal
- Stainless steel system connection
- Maximum operating system: 200°F
- Maximum working pressure: 150 psig
- Factory pre-charge: 40 psig
- 5-Year limited warranty



Therm-X-Trol® ASME Diaphragm In-Line Thermal Expansion Tank

Part #	Mfg #	Dia	Height	Volume	Price
024594	ST-5-C	10"	10-3/8"	2.1 gal	
028941	ST-12-C	12"	13-3/8"	6.4 gal	

Therm-X-Trol® ASME Diaphragm Vertical Stand Thermal Expansion Tank

- Stainless steel system connection
- Maximum operating temperature: 200°F
- Factor pre-charge: 55 psig

Part #	Mfg #	Dia	Height	Volume	Price
029837	ST-20V-C	12"	19"	8.0 gal	
029838	ST-30V-C	16"	19"	14.0 gal	
029839	ST-42V-C	16"	24"	18.0 gal	
029840	ST-60V-C	16-1/4"	34"	25.0 gal	
113382	ST-70V-C	16"	45"	34.0 gal	
030098	ST-80V-C	24"	37"	53.0 gal	

Extrol Thermal Expansion Tank

- For use with closed hydronic heating and cooling systems
- Both space and energy saving
- Butyl/EPDM diaphragm
- Air separation design eliminates absorption of system air



Part #	Mfg #	Dia	Height	Volume	Price
002008	15	8"	12-5/8"	2.0 gal	
002009	30	11"	15-1/2"	4.4 gal	
002016	60	11"	23"	7.6 gal	
021243	90	15-3/8"	21"	14.0 gal	

Standard Expansion Tanks

Extrol® Vertical AX Series Expansion Tank

- Carbon steel shell construction with red oxide primer
- Diaphragm design
- Factory pre-charge: 12 psig
- Operating temperature: 240°F



Part #	Mfg #	Dia	Length	Volume	Price
052098	AX15V	12"	20"	8.0 gal	
048739	AX40V	16"	30"	21.7 gal	

SX Extrol® Vertical Boiler System Expansion Tank

- Factory pre-charge: 12 psig
- Maximum working pressure: 100 psig
- Maximum operating temperature: 240°F



Part #	Mfg #	Dia	Height	Volume	Price
001999	SX-30V	15"	25"	14.0 gal	
002000	SX-40V	15"	32"	20.0 gal	
002001	SX-60V	15"	48"	32.0 gal	
024728	SX-90V	22"	36"	44.0 gal	
101641	SX-160V	26"	47"	86.0 gal	

Thermal Expansion Tanks

Special Application Expansion Tanks

Radiant Extrol® Expansion Tank

- For high-efficiency radiant systems
- Plastic liner is compatible with barrier and non-barrier tubing
- Suitable for use in glycol applications
- Non-ferrous system connection for corrosion resistance
- Factory pre-charged: 12 psig
- Maximum working pressure: 100 psig
- Maximum operating temperature: 200°F

Part #	Mfg #	Dia	Height	Volume	Price
090481	RX-15	8"	13"	2.0 gal	
090482	RX-30	11"	16"	4.4 gal	
090483	RX-60	15"	19"	10.3 gal	

FT Fill-Trol® System Expansion Tank

- Eliminates the need for a separate, automatic fill valve
- Tank pressure controls system fill
- Factory pre-charged: 12 psig
- Fully adjustable up to a maximum working pressure of 100 psig
- Air purger not included



Part #	Mfg #	Dia	Height	Volume	Price
002002	109	8"	13"	2.0 gal	
002004	110	11"	16"	4.4 gal	

Fill-Trol® Expansion Tank Valve

Part #	Mfg #	Air Purger	Price
002003	109-15	Fill-Trol® Valve	

Water Gauges & Sight Glasses

Water Gauges

20 Series Standard Pattern Bronze Water Gauge - Standard Gauge

- Use for all types of liquid level verification
- EPDM Gauge glass gaskets standard
- Equipped with (2) copper guard rods
- Standard 1/4" needle drain valve in lower arm
- CRN Registered
- Rated: 125 psig @ 350°F, 300 psig @ 100°F



Part #	Mfg #	Pipe Size	Glass OD/Length	Wheel Type	Price
003018	20-104-00	1/2"	5/8" x 12"	Aluminum	

20-200 Series Heavy Pattern Bronze Water Gauge- Standard Gauge

- Heavy valve body pattern for higher service ratings
- Rated 200 psig @ 400°F, 400 psig @ 100°F subject to pressure/temperature ratings of gauge glass



Part #	Mfg #	Pipe Size	Glass OD/Length	Wheel Type	Price
003019	20-204-00	1/2"	5/8" x 12"	Aluminum	

Water Gauge Components

Regular Gauge Glass

Part #	Mfg #	Size	Price
004899	9858R08	5/8" x 8"	
004892	9858R12	5/8" x 12"	
004897	9858R30	5/8" x 30"	



Water Gauges & Sight Glasses

Gauge Glasses & Accessories

Gray Cut Gauge Glass Gasket

- Synthetic rubber



Part #	Mfg #	Size	Price
006253	881	9/16" x 13/16" x 5/16"	

Water Gauges & Sight Glasses

TruFLOW™ Classic Specific Accessories

- Use Uponor Silicone Oil (A2620007 - sold separately) on male threads to ease installation

TruFLOW™ Visual Flow Meter

- Can be used on TruFLOW Jr. and TruFLOW Classic manifolds to accurately measure the flow of hydronic radiant loops



Part #	Mfg #	Description	Price
113670	A2640027	0.25 To 2.0 gpm	

Zone Valves

Hydronic Motorized Zone Valves

V8043/V8044 Low Voltage Hydronic Zone Valves

2-Position Normally Closed Straight-Through Valve with End Switch

- For controlling flow of hot and cold water, valve closes when de-energized
- Manual opener included
- With 18" wire leads and auxiliary switch
- Voltage: 24V, 50/60Hz



Part #	Mfg #	Pipe Size	Capacity	Max Close-Off Pressure	End Switch	Electrical Connections	Price
006823	V8043E1012	3/4" Swt	3.5 Cv	20 psi	SPST	18" Leads	
006824	V8043E1061	3/4" Swt	8 Cv	8 psi	SPST	18" Leads	
006825	V8043E1079	1" Swt	8 Cv	8 psi	SPST	18" Leads	
081700	V8043E1145	3/4" NPT	3.5 Cv	20 psi	SPST	18" Leads	

2-Position Normally Closed Straight-Through Motorized Valve

- For controlling flow of hot and cold water
- With end switch, screw terminals and manual opener
- Terminal board with (5) terminals
- Maximum ambient temperature: 125°F
- Electrical connections: screw terminal block
- Voltage: 24V, 50/60Hz



Part #	Mfg #	Pipe Size	Capacity	Max Close-Off Pressure	End Switch	Type	Price
006826	V8043F1036/U	3/4" Swt	3.5 Cv	20 psi	SPST	2-Way Straight Thru	

5000 Series QuickFit® 2-Position Two-Way, Straight-Through Motorized Valve

- On-off and 2-way low voltage valves consist of an actuator and valve assembly
- For controlling flow of hot water and some models steam
- Includes end switch and manual opener
- Terminal board
- Maximum ambient temperature: 125°F
- Static pressure: 300 psi
- Voltage: 24V @ 60Hz



Part #	Mfg #	Pipe Size	Capacity	Max Close-Off Pressure	End Switch	Electrical Connections	Price
094300	V8043E5061	3/4" Swt	8.0 Cv	8 psi	SPST	18" Leads	
094301	V8043E5079	1" Swt	8.0 Cv	8 psi	SPST	18" Leads	
094302	V8043F5036	3/4" Swt	3.5 Cv	20 psi	SPST	Terminal Block	

Zone Valves

V8044A 2-Position Diverting Motorized Valve

- For controlling flow of hot water
- 1/2" Bottom inlet
- Manual opener
- Maximum ambient temperature: 125°F
- Voltage: 24V, 50/60Hz



Part #	Mfg #	Pipe Size	Capacity	Max Close-Off Pressure	End Switch	Electrical Connections	Price
006827	V8044E1011	3/4" Swt	7.0 Cv	10 psi	SPST	18" Leads	

Miscellaneous Parts & Accessories

Part #	Mfg #	Description	Price
168372	Q5020A1003	Globe Valve Linkage with 1/2" Shaft	

2-Way Globe Valve

- Sizes range from 1/2 to 2 inches
- Direct and reverse acting
- High pressure steam models with stainless steel trim
- Spring-loaded, self-adjusting packing
- Stainless steel stem prevents corrosion
- Valve designs provide equal percentage characteristics of flow for close control of water, and linear characteristic of flow for close control of steam or chilled water
- Valves utilize direct mounting, electric or pneumatic linear valve actuators; Q5001 linkage with Modutrol Motor; or Q5020/Q5022A linkages with direct coupled rotary actuators to operate the valve
- Not suitable for combustible gases



Part #	Mfg #	Pipe Size	Capacity	Max Close-Off Pressure	End Switch	Electrical Connections	Price
170336	V5011N2097	2" FPT	46.8 Cv	240 psi	N/A	N/A	

Zone Valves

Zone Valves

Whisper Guard Geothermal Valves

- Pump head: 150 feet of water
- Maximum working pressure: 125 psi
- Temperature range: 40-240°F
- Amperature rating: 0.9
- Volt frequency: 24V 60Hz
- 3-Year head, 5-year body warranty



Part #	Mfg #	Connection Size	Normal Flow Range	Pressure Drop Thru Valve Equivalent Feet of Pipe	Price
101957	5101-G2	3/4" Threaded	2 Way	125	

Zone Sentry® Zone Valve

- Provides on-off, normally open or normally closed control in both open and closed hot or chilled water systems
- Utilizes microcircuit based logic to control a gear driven electronic actuator which drives a ball valve based body design
- Uses up to 93% less energy than other commonly installed zone valves
- Quiet actuator operation
- Suitable for condensing environments
- Universal installation orientation
- Up to 12 valves on (1) 40VA transformer
- Multi-function LED assists with troubleshooting
- Quick release actuator mounting clips
- Positional indicator shows the valve's actual position
- Easy to wire quick connections
- Bi-directional flow (you cannot install the valve backwards)
- The actuator mounts on the valve in either direction
- Shut-off pressure: 125 psi
- Manual override button
- e-smart Energy saving



Part #	Mfg #	Description	Price
136624	Z075C2	2-Way, 3/4" Swt	
135892	Z100C2	2-Way, 1" Swt	

Zone Valve Power Head

555-050RP



Part #	Mfg #	Description	Price
010361	555-050RP	Power Unit Assembly, Snap Action Switch	
010362	555-173RP	Replacement Head	
074288	ZA024Q4A1	NO/NC Replacement Motorized Zone Valve Power Head	

Zone Valves

Zone Valves

Hydronic Zone Control

- Self aligning barrel-type valve stem uses line pressure to seal off binding on opening and closing
- Valve stem made of stainless steel
- Built-in auxiliary contacts to control burner or circulator relay



3-Wire, 24V Valve with Screw Terminal Wiring Panel & Auxiliary Switch

Part #	Mfg #	Tubing Size (ID)	24V AC Thermostat Circuit Rating	Time Cycle Open/Close	Price
012074	1311-102	3/4"	0.2A	45 Sec/45 Sec	
012072	1311-103	1"	0.2A	45 Sec/45 Sec	

2-Wire, 24V Valve with Screw Terminal Wiring Panel & Auxiliary Switch

Part #	Mfg #	Tubing Size (ID)	24V AC Thermostat Circuit Rating	Time Cycle Open/Close	Price
012075	1361-104	1-1/4"	0.2A	45 Sec/60 Sec	
091732	WR1361102	3/4"	0.2A	45 Sec/60 Sec	

Schwank Infrared Heating

Tube Heaters

Builder Schwank Tube Heater

- Line voltage thermostat ready
- Simple relay option for 24V thermostat
- Reflector & end caps improve IR heat output
- Swing-down cabinet service access
- Whisper quiet ceramic burner



Part #	Mfg #	Capacity	Fuel	Length	Price
129084	S100-45-20	45	NG	20'	
129085	S100-60-20	60	NG	20'	
129087	S100-60-30	60	NG	30'	
129088	S100-80-20	80	NG	20'	
129089	S100-80-30	80	NG	30'	
129090	S100-80-40	80	NG	40'	
129092	S100-100-20	100	NG	20'	
129093	S100-110-30	110	NG	30'	
129094	S100-110-40	110	NG	40'	
129095	S100-110-50	110	NG	50'	
129096	S100-130-30	130	NG	30'	
129098	S100-130-40	130	NG	40'	
129099	S100-130-50	130	NG	50'	
129101	S100-155-40	155	NG	40'	
129102	S100-155-50	155	NG	50'	
129103	S100-155-60	155	NG	60'	
129104	S100-175-50	175	NG	50'	
136923	S100-175-50L	175	LP	50'	
129106	S100-175-60	175	NG	60'	
137376	S100-175-60L	175	LP	60'	
129107	S100-175-70	175	NG	70'	
129109	S100-200-50	200	NG	50'	
129111	S100-200-60	200	NG	60'	
129112	S100-200-70	200	NG	70'	
163390	S100-200-70	200	LP	70'	

Set Series WisperJet Two-Stage Tube Heater

- 2-Stage burner operation
- Status indicator lights
- Straight tube or "U" tube configuration
- Swing-down cabinet service access
- Whisper quiet ceramic burner



Part #	Mfg #	Capacity	Fuel	Length	Price
129932	SET 80/60	80/60	NG	20'	
129933	SET 80/60	80/60	NG	30'	
129937	SET 110/75	110/75	NG	30'	
129940	SET 110/75	110/75	NG	40'	
129941	SET 130/90	130/90	NG	30'	
129942	SET 130/90	130/90	NG	40'	
129943	SET 155/110	155/110	NG	40'	
129944	SET 155/110	155/110	NG	50'	
129945	SET 175/125	175/125	NG	50'	
129947	SET 200/140	200/140	NG	50'	
129948	SET 200/140	200/140	NG	60'	

PremierSchwank Tube Heater

- Line voltage or 24V thermostat ready
- Status indicator lights
- Power cord with plug
- 4" Bird screened combustion air collar
- Swing-down cabinet service access
- Whisper quiet ceramic burner
- 'Focus shield' reflector and end caps for Premier IR heat output
- Emissive coated radiant tubes



Part #	Mfg #	Capacity	Fuel	Length	Price
135859	STS-JZ-45-10	45	NG	10'	
143905	STS-JZ-45-20	45	NG	20'	
151663	STS-JZ-60-20	60	NG	20'	
143906	STS-JZ-60-30	60	NG	30'	
143907	STS-JZ-80-20	80	NG	20'	
143710	STS-JZ-80-30	80	NG	30'	
143292	STS-JZ-80-40	80	NG	40'	
143911	STS-JZ-100-20	100	NG	20'	
129457	STS-JZ-110-30	110	NG	30'	
136504	STS-JZ-110-40	110	NG	40'	

Schwank Infrared Heating

Tube Heaters (Continued)

PremierSchwank Tube Heater

Part #	Mfg #	Capacity	Fuel	Length	Price
143912	STS-JZ-110-50	110	NG	50'	
143913	STS-JZ-130-30	130	NG	30'	
143914	STS-JZ-130-40	130	NG	40'	
136509	STS-JZ-130-50	130	NG	50'	
143915	STS-JZ-155-40	155	NG	40'	
143916	STS-JZ-155-50	155	NG	50'	
136967	STS-JZ-155-60	155	NG	60'	
143917	STS-JZ-175-50	175	NG	50'	
151661	STS-JZ-175-50	175	LP	50'	
143918	STS-JZ-175-60	175	NG	60'	
151662	STS-JZ-175-60	175	LP	60'	
143919	STS-JZ-175-70	175	NG	70'	
143920	STS-JZ-200-50	200	NG	50'	
143921	STS-JZ-200-60	200	NG	60'	
143923	STS-JZ-200-70	200	NG	70'	

Tube Heater Accessories

Burner Kit

Part #	Mfg #	Description	Price
129916	JS-080T-BN	NG Burner Kit for SET 80/60	
129918	JS-155T-BN	NG Burner Kit for SET 155/110	
129920	JS-200T-BN	NG Burner Kit for SET 200/140	
137325	JS-110P-BN	NG Burner Kit for STW-JZ-110	
239848	JS-110W-BN	NG Burner Kit for SPW-JZ110	
144704	JS-130P-BN	NG Burner Kit for STW-JZ-130	

Tube Heater Accessories (Continued)

Burner Kit

Part #	Mfg #	Description	Price
128974	JS-E045-BN	NG Burner Kit for S100 45	
128980	JS-E060-BN	NG Burner Kit for S100 60	
128981	JS-E080-BN	NG Burner Kit for S100 80	
128982	JS-E100-BN	NG Burner Kit for S100 100	
128983	JS-E110-BN	NG Burner Kit for S100 110	
128984	JS-E130-BN	NG Burner Kit for S100 130	
128985	JS-E155-BN	NG Burner Kit for S100 155	
128986	JS-E175-BN	NG Burner Kit for S100 175	
136851	JS-E175-BL	LP Burner Kit for S100 175	
162577	JS-E200-BL	LP Burner Kit for S100 200	
128987	JS-E200-BN	NG Burner Kit for S100 200	
136501	JS-S110-AN	NG Burner Kit for STS-JZ-110	
136505	JS-S130-AN	NG Burner Kit for STS-JZ-130	
136965	JS-S155-AN	NG Burner Kit for STS-JZ-155	

Tube Kit

- Stand-alone tube kits require no additional tube kits
- Primary tube kits require at least one additional secondary tube kit
- Secondary tube kits require a primary tube kit
- Kits include:
 - Tubes
 - Reflectors
 - Hanger
 - Tube couplers

Part #	Mfg #	Description	Price
135829	TS-4510-JZ	10' Stand-Alone Kit for STR-JZ-45	
128990	TM-1020-SX	20' Stand-Alone Kit for S100-100	
128989	TM-1420-SX	20' Stand-Alone Kit for SET80/60	
136172	TS-1420-JZ	20' Stand-Alone Kit for STR-JZ-45 & 60	
128991	TM-1430-SX	30' Stand-Alone Kit for SET80/60, 110/75, & 130/90	
128992	TM-1040-SX	40' Stand-Alone Kit for SET110/75, 130/90, & 155/110	
136502	TS-1040-JZ	40' Stand-Alone Kit for STS-JZ-80/110/130/155	
128994	TM-1030-SX	30' Primary Kit for SET175/125 & 200/140	

Schwank Infrared Heating

Tube Heater Accessories (Continued)

Tube Kit

Part #	Mfg #	Description	Price
128993	TM-F030-SX	30' Primary Kit for SET155/110	
136506	TS-F030-JZ	30' Primary Kit for STS-JZ-110/130/155	
137323	TW-F030-JZ	30' Primary Kit for SPW/STW-JZ-110/130/155	
128999	TM-1010-SX	10' Secondary Kit for S100	
128996	TM-0020-SX	20' Secondary Kit for SET	
128997	TM-0030-SX	30' Secondary Kit for SET	
136507	TS-0020-JZ	20' Secondary Kit for STS-JZ	
137324	TW-0020-JZ	20' Secondary Kit for SPW-JZ or STW-JZ	
136966	TS-0030-JZ	30' Secondary Kit for STS-JZ	
128998	TM-0040-SX	40' Secondary Kit for S100	

LP Conversion Kit

Part #	Mfg #	Description	Price
129000	JS-0556-XE	45 MBTUH NG to LP	
129001	JS-0557-XX	60 MBTUH NG to LP	
129002	JS-0559-XX	80/60 MBTUH NG to LP	
129847	JS-0555-TG	110/75 MBTUH NG to LP	
171260	JS-0563-XB	125 MBTUH NG to LP	
129929	JS-0555-TK	130/90 MBTUH NG to LP	
129930	JS-0555-TO	155/110 MBTUH NG to LP	
129129	JS-0565-XX	155 MBTUH NG to LP	

Adjustable Pressure Switches

2374 Series Adjustable Air Pressure Sensing Switches

- *Designed to replace a wide variety of air-sensing switches found in residential & light commercial applications including furnaces, electronic air cleaners & humidifiers*
- *SPDT Switching that can be actuated by positive or negative pressure, or by pressure differential*
- *Highly accurate, practically insensitive to temperature change*
- *Operating temperature range: -40° to 190°F*
- *Electrical connections: 1/4" spade*
- *Air sample line connectors: will accept 1/8", 1/4" or 3/8" tubing*
- *UL & CSA Approved*
- *Includes mounting hardware and adjustment tool*



Part #	Mfg #	Description	Price
044313	2374-495	.25" to 1.0"wc Set Point Range, SPDT Switching	
044314	2374-498	.10" to 4.0"wc Setpoint Range, SPDT Switching	

Capacitors

Capacitors

Motor Start Capacitor

- Plastic housing
- Variable capacitance
- 1.812" Dia x 3.37" height
- (189-227220) & (233-292220) 2.062" Dia x 3.37" height
- (189-227330) 2.062" Dia x 4.37" height



Part #	Mfg #	Description	Price
205576	DV88108	Round Plastic Can, 88-108 μ F, 110/125 VAC	
239652	108-130220	Round Plastic Can, 108-130 μ F, 220/250VAC	
239653	124-156220	Round Plastic Can, 124-156 μ F, 220/250VAC	
239654	189-227220	Round Plastic Can, 189-227 μ F, 220/250VAC	
240453	189-227330	Round Plastic Can, 189-227 μ F, 330VAC	
239655	233-292220	Round Plastic Can, 233-292 μ F, 220/250VAC	

370VAC Single Round Can Capacitor

- This single capacitance round, metal can capacitors are designed for continuous run.



Part #	Mfg #	Description	Price
247686	37800R	370VAC Round 80 μ F	

Capacitors

370VAC Single Oval Run Capacitors

- *Rated Frequency: 50/60 Hz*
- *Applied Standard: UL-810; CSA22.2 No190, IEC60252*
- *Meets 10,000AFC safety requirement per UL-810*
- *Capacitance Tolerance +/-5%*
- *Permissible Temperature: -40°C to +70°C*
- *Individually Packaged*
- *Withstanding Voltage test*
- *Between Terminals: Rated Voltage X 1.75VAC, 10sec*
- *Between Terminals and Case: Rated Voltage X 2+1000VAC, 60sec*
- *Maximum Permissible Voltage: 110% of the rated voltage*
- *Maximum Permissible Current: 130% of the rated current*
- *Oil Filled; Non PCB*
- *1/4" quick connect terminal*



Part #	Mfg #	Description	Price
195226	37-125H	370VAC Oval 12.5µF	

370VAC Dual Oval Run Capacitor

- *Rated Frequency: 50/60 Hz*
- *Capacitance Tolerance -5% - +5%*
- *Permissible Temperature: -40°C - +70°C*
- *Individually Packaged*
- *Withstanding Voltage test*
- *Between Terminals: Rated Voltage X 1.75VAC, 10sec*
- *Between Terminals and Case: Rated Voltage X 2+1000VAC, 60sec*
- *Maximum Permissible Voltage: 110% of the rated voltage*
- *Maximum Permissible Current: 130% of the rated current*
- *Applied Standard: UL-810; CSA22.2 No190, IEC60252*
- *Meets 10,000AFC safety requirement per UL-810*
- *Oil Filled; Non PCB*
- *Quick Connect Terminal - Faston #250 series size*



Part #	Mfg #	Description	Price
195756	3GJ7530	370VAC Oval 30+7.5µF	
214443	3GJ0515	370VAC Oval 15+5µF	

Capacitors

370VAC Dual Round Run Capacitor

- *Rated Frequency: 50/60 Hz*
- *Applied Standard: UL-810; CSA22.2 No190, IEC60252*
- *Meets 10,000 AFC safety requirement per UL-810*
- *Capacitance Tolerance +/-5%*
- *Permissible Temperature: -40°C to +70°C*
- *Individually Packaged*
- *Withstanding Voltage test*
- *Between Terminals: Rated Voltage X 1.75VAC, 10sec*
- *Between Terminals and Case: Rated Voltage X 2+1000VAC, 60sec*
- *Maximum Permissible Voltage: 110% of the rated voltage*
- *Maximum Permissible Current: 130% of the rated current*
- *Oil Filled; Non PCB*
- *1/4" quick connect terminal*



Part #	Mfg #	Description	Price
195759	3GR0525	370VAC Round 25+5μF	
197632	3GR0580	370VAC Round 80+5μF	

440VAC Single Oval Run Capacitors

- *Rated Frequency: 50/60 Hz*
- *Applied Standard: UL-810; CSA22.2 No190, IEC60252*
- *Meets 10,000AFC safety requirement per UL-810*
- *Capacitance Tolerance +/-5%*
- *Permissible Temperature: -40°C to +70°C*
- *Individually Packaged*
- *Withstanding Voltage test*
- *Between Terminals: Rated Voltage X 1.75VAC, 10sec*
- *Between Terminals and Case: Rated Voltage X 2+1000VAC, 60sec*
- *Maximum Permissible Voltage: 110% of the rated voltage*
- *Maximum Permissible Current: 130% of the rated current*
- *Oil Filled; Non PCB*
- *1/4" quick connect terminal*



Part #	Mfg #	Description	Price
202161	45030H	440VAC Oval 3μF	
204347	45040H	440VAC Oval 4μF	
201308	45050H	440VAC Oval 5μF	
211592	45050HU	440VAC Oval 5μF USA	
197360	45075H	440VAC Oval 7.5μF	
211593	45075HU	440VAC Oval 7.5μF USA	
197361	45100H	440VAC Oval 10μF	
211594	45100HU	440VAC Oval 10μF USA	
197362	45125H	440V Oval 12.5μF	
211602	45125HU	440VAC Oval 12.5μF USA	
197363	45150H	440VAC Oval 15μF	
211595	45150HU	440VAC Oval 15μF USA	

Capacitors

Capacitors (Continued) 440VAC Single Oval Run Capacitors

Part #	Mfg #	Description	Price
239668	45175H	440VAC Oval 17.5µF	
211596	45200HU	440VAC Oval 20µF USA	
211597	45250HU	440VAC Oval 25µF USA	
211598	45300HU	440VAC Oval 30µF USA	
211600	45400HU	440VAC Oval 40µF USA	
211601	45450HU	440VAC Oval 45µF USA	
211603	45500HU	440VAC Oval 50µF USA	
211614	45600HU	440VAC Oval 60µF USA	
210278	45700H	440VAC Oval 70µF USA	

440VAC Single Round Run Capacitor

- *Rated Frequency: 50/60 Hz*
- *Applied Standard: UL-810; CSA22.2 No190, IEC60252*
- *Meets 10,000AFC safety requirement per UL-810*
- *Capacitance Tolerance +/-5%*
- *Permissible Temperature: -40°C to +70°C*
- *Individually Packaged*
- *Withstanding Voltage test*
- *Between Terminals: Rated Voltage X 1.75VAC, 10sec*
- *Between Terminals and Case: Rated Voltage X 2+1000VAC, 60sec*
- *Maximum Permissible Voltage: 110% of the rated voltage*
- *Maximum Permissible Current: 130% of the rated current*
- *Oil Filled; Non PCB*
- *1/4" quick connect terminal*



Part #	Mfg #	Description	Price
198900	45150R	440VAC Round 15µF	
198901	45200R	440VAC Round 20µF	
198902	45250R	440VAC Round 25µF	
198903	45300R	440VAC Round 30µF	
198904	45350R	440VAC Round 35µF	
198905	45400R	440VAC Round 40µF	
198906	45450R	440VAC Round 45µF	
198907	45500R	440VAC Round 50µF	
198908	45550R	440VAC Round 55µF	
198909	45600R	440VAC Round 60µF	
198910	45800R	440VAC Round 80µF	

Capacitors

440VAC Dual Oval Run Capacitor

- Rated Frequency: 50/60 Hz
- Applied Standard: UL-810; CSA22.2 No190, IEC60252
- Meets 10,000AFC safety requirement per UL-810
- Capacitance Tolerance +/-5%
- Permissible Temperature: -40°C to +70°C
- Individually Packaged
- Withstanding Voltage test
- Between Terminals: Rated Voltage X 1.75VAC, 10sec
- Between Terminals and Case: Rated Voltage X 2+1000VAC, 60sec
- Maximum Permissible Voltage: 110% of the rated voltage
- Maximum Permissible Current: 130% of the rated current
- Oil Filled; Non PCB
- 1/4" quick connect terminal



Part #	Mfg #	Description	Price
202163	4JJ0530	440VAC Oval 5+30µF	
202164	4JJ0535	440VAC Oval 5+35µF	
202165	4JJ0540	440VAC Oval 5+40µF	
202166	4JJ7535	440VAC Oval 7.5+35µF	

440VAC Dual Round Run Capacitor

- Rated Frequency: 50/60 Hz
- Applied Standard: UL-810; CSA22.2 No190, IEC60252
- Meets 10,000AFC safety requirement per UL-810
- Capacitance Tolerance +/-5%
- Permissible Temperature: -40°C to +70°C
- Individually Packaged
- Withstanding Voltage test
- Between Terminals: Rated Voltage X 1.75VAC, 10sec
- Between Terminals and Case: Rated Voltage X 2+1000VAC, 60sec
- Maximum Permissible Voltage: 110% of the rated voltage
- Maximum Permissible Current: 130% of the rated current
- Oil Filled; Non PCB
- 1/4" quick connect terminal



Part #	Mfg #	Description	Price
197358	4JR0525	440VAC Round 25+5 µF	
211604	4JR0525U	440VAC Round 25+5 µF USA	
196431	4JR0530	440VAC Round 5+30 µF	
211605	4JR0530U	440VAC Round 5+30 µF USA	
196433	4JR0535	440VAC Round 5+35 µF	
211606	4JR0535U	440VAC Round 5+35 µF USA	
196434	4JR0540	440VAC Round 5+40 µF	
211607	4JR0540U	440VAC Round 5+40 µF USA	
196435	4JR0545	440VAC Round 5+45 µF	
211609	4JR0545U	440VAC Round 5+45 µF USA	

Capacitors

Capacitors (Continued) 440VAC Dual Round Run Capacitor

Part #	Mfg #	Description	Price
196436	4JR0550	440VAC Round 5+50 μ F	
211611	4JR0550U	440VAC Round 5+50 μ F USA	
196437	4JR0555	440VAC Round 5+55 μ F	
211612	4JR0555U	440VAC Round 5+55 μ F USA	
196438	4JR0560	440VAC Round 5+60 μ F	
211613	4JR0560U	440VAC Round 5+60 μ F USA	
224820	4JR0570	440VAC Round 5+70 μ F	
249586	4JR0580	440VAC Round 80+5uF	
213845	4JR1080	440VAC Round 10+80 μ F	
197359	4JR7530	440VAC Round 7.5+30 μ F	
196439	4JR7535	440VAC Round 7.5+35 μ F	
196440	4JR7540	440VAC Round 7.5+40 μ F	
211608	4JR7540U	440VAC Round 7.5+40 μ F USA	
196441	4JR7545	440VAC Round 7.5+45 μ F	
211610	4JR7545U	440VAC Round 7.5+45 μ F USA	
201867	4JR7550	440VAC Round 7.5+50 μ F	
204184	4JR7555	440VAC Round 7.5+55 μ F	
204147	4JR7560	440VAC Round 7.5+60 μ F	
224819	4JR7570	440VAC Round 7.5+70 μ F	

Capacitors

Capacitors

Dual Round Capacitor



Part #	Mfg #	Microfarad	Volts	Price
103724	43-25133-01	25/3mfd	370V	
078956	43-25133-02	30/3mfd	370V	
096155	43-25133-21	30/5mfd	370V	
096131	43-25133-03	35/3mfd	370V	
096156	43-25133-35	35/5mfd	370V	
086414	43-25133-04	40/3mfd	370V	
096698	43-25133-22	40/5mfd	370V	
086403	43-25133-05	45/3mfd	370V	
086404	43-25133-06	45/5mfd	370V	
113731	43-26261-48	45/10mfd	370V	
086405	43-25133-07	50/3mfd	370V	
078757	43-25133-25	50/5mfd	370V	
142501	43-25133-28	55/3mfd	370V	
086406	43-25133-08	55/5mfd	370V	
096159	43-25133-29	55/10mfd	370V	
180042	43-25133-27	50/10mfd	370V	
086409	43-25133-09	60/3mfd	370V	
036187	43-25133-10	60/5mfd	370V	
142290	43-25133-19	25/5mfd	370V	
103773	43-25133-31	60/10mfd	370V	
086411	43-25133-32	70/5mfd	370V	
103775	43-26271-47	70/10mfd	370V	
080910	43-25133-33	80/5mfd	370V	
096161	43-25133-34	80/10mfd	370V	
188631	43-25133-44	40/5mfd	370V	
175434	43-25133-36	30/5mfd	440V	
086340	43-25133-11	35/3mfd	440V	
087300	43-25133-12	35/5mfd	440V	
072615	43-25133-14	40/5mfd	440V	
133921	43-25133-16	45/5mfd	440V	
175429	43-25133-24	45/10mfd	440V	
133922	43-25133-26	50/5mfd	440V	
072616	43-25133-17	55/5mfd	440V	
086410	43-25133-30	60/5mfd	440V	
161492	43-25133-37	60/10mfd	440V	
096160	43-26271-45	60/10mfd	440V	
175433	43-101665-06	35/5mfd	440V	

Capacitors (Continued)

Dual Round Capacitor

Part #	Mfg #	Microfarad	Volts	Price
103708	43-25133-13	40/3mfd	440V	

Dual Oval Capacitor

- Certified to the highest level of UL 810
- Tested and approved for 5,000 AFC



Part #	Mfg #	Microfarad	Volts	Price
063489	43-25135-03	35/5mfd	370V	
098888	43-25135-19	40/3mfd	370V	
250947	43-25135-09	25/5mfd	440V	

Single Round Capacitor



Part #	Mfg #	Microfarad	Volts	Price
142502	43-25136-01	3mfd	370V	
142503	43-25136-02	4mfd	370V	
142505	43-25136-03	5mfd	370V	
142506	43-25136-04	6mfd	370V	
082669	43-25136-05	7.5mfd	370V	
094857	43-25136-06	10mfd	370V	
094858	43-25136-07	12.5mfd	370V	
074119	43-25136-08	15mfd	370V	
094861	43-25136-09	20mfd	370V	
142509	43-25136-10	25mfd	370V	
175430	43-25136-25	10 mfd	440V	
125108	43-25136-11	30mfd	370V	
095766	43-25136-12	35mfd	370V	
105798	43-25136-13	40mfd	370V	
142513	43-25136-15	55mfd	370V	
142514	43-25136-16	60mfd	370V	
113922	43-25136-18	80mfd	370V	
142515	43-25136-19	90mfd	370V	
234995	43-25136-24	7.5mfd	440V	
132363	43-25136-32	40mfd	440V	
117432	43-25136-33	45mfd	440V	

Capacitors

Capacitors (Continued)

Single Round Capacitor

Part #	Mfg #	Microfarad	Volts	Price
142512	43-25136-34	50mfd	440V	

Single Oval Capacitor



Part #	Mfg #	Microfarad	Volts	Price
022868	43-25134-01	3mfd	370V	
058909	43-25134-27	4mfd	370V	
022869	43-25134-02	5mfd	370V	
141512	43-25134-28	6mfd	370V	
017773	43-25134-03	7.5mfd	370V	
020049	43-25134-04	10mfd	370V	
020740	43-25134-05	12.5mfd	370V	
030139	43-25134-06	15mfd	370V	
141513	43-25134-07	20mfd	370V	
141515	43-25134-09	30mfd	370V	
141516	43-25134-10	35mfd	370V	
141518	43-25134-17	45mfd	370V	
141519	43-25134-18	50mfd	370V	
141520	43-25134-19	55mfd	370V	
234980	43-25134-22	10mfd	440V	
141521	43-25134-29	60mfd	370V	
141522	43-25134-30	70mfd	370V	
141523	43-25134-31	80mfd	370V	
234988	43-25134-23	15mfd	440V	
234978	43-25134-33	7.5mfd	440V	
234976	43-25134-21	5mfd	440V	

Start Capacitor

- Phenolic case
- 15 Ohm Bleed resistor



Part #	Mfg #	Microfarad	Volts	Price
009293	43-17075-03	135-155mfd	330V	
009294	43-17075-04	88-106mfd	330V	

Capacitors (Continued)

Start Capacitor

Part #	Mfg #	Microfarad	Volts	Price
009295	43-17075-05	189-227mfd	330V	
024251	43-17075-07	270-324mfd	330V	



Capacitors

Capacitors

Dual Round Capacitor

- 440 VAC
- Capacitance (1): 30
- Capacitance (2): 3
- 1/4" Quick connects

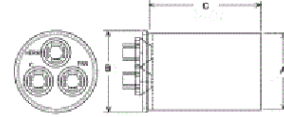

Part #	Mfg #	Description	Price
235604	43-25133-20	Control Volts 440	

Single Round Capacitor

- 440 VAC

Part #	Mfg #	Description	Price
234994	43-25136-22	Single Round (Continuous), 1/4" Quick connects	

Turbo® 200 MINI Capacitor



Part #	Mfg #	Description	Price
106682	439102	2.5 - 12.5mfd	

Turbo® 200 Capacitor



Part #	Mfg #	Description	Price
106680	439100	Control Volts 370-440	

Turbo® 200X Capacitor



Part #	Mfg #	Description	Price
106681	439101	2.5 - 97.5mfd	



Chemicals

Sealants

Furnace Cement

- *Repairs casting cracks and fills voids*
- *For use on coal or wood burning furnaces and stoves*
- *Ready to use, no mixing*
- *Withstands same temperatures as fire brick*



Part #	Mfg #	Description	Price
005542	45050	16 oz Can	

Condensate Pumps

VCMA Automatic Condensate Pumps

- Suitable for high-efficiency, gas furnace condensate
- Fully automatic
- 1/2 Gallon leak proof, rustproof, high impact ABS tank
- (3) Drain holes
- Removable 3/8" barbed check valve
- 3-Prong plug
- Snap-action switch
- Stainless steel shaft
- Polypropylene impeller
- ABS Plastic motor, tank cover and volute
- Includes check valve
- Optional safety switch
- Thermal overload protection



VCMA Series Condensate Pump less Tubing

- S Suffix = safety switch
- 6' Cord

Part #	Mfg #	Model	Description	Price
005997	554405	VCMA-15ULS	115V, 15' Shut-Off	
005998	554425	VCMA-20ULS	115V, 20' Shut-Off	

VCMX NEXTGen™ Automatic Condensate Pumps

- Dimensions: 4.8" x 10.2" x 6.5"
- Oil resistant tank and check valve to eliminate problem of cracked tanks
- 1/4-Turn check valve allows servicing without removal of tubing
- Patent-pending cooling design
- Rubber feet absorb vibration
- Thermal overhead protection
- External overflow safety switch
- External test/run lever
- External tank anti-sweat sleeve
- Multiple brackets: steel mounting bracket for use on either side of tank
- 2-Year warranty



VCMX Series Condensate Pump less Tubing

- 20' Shut-off
- 6' Cord

Part #	Mfg #	Model	Description	Price
120046	554530	VCMX-20ULS	115V, Safety Switch	

Electronic Condensate Pumps

- Maximum flow: 4 gph
- Compact 2-piece design allows flexible installation for mini-split A/C units
- Self-priming pump can be located up to 3' above reservoir
- Suction tubing: 3" x 5/32" ID
Vent tubing: 8" x 5/32" ID
Drain tubing: 3" x 1/2" ID



Part #	Mfg #	Model	Description	Price
053838	553455	EC-400	115V 60Hz	
106971	553458	EC-400	230V 60Hz	

VCC Low Profile Series Condensate Pump

- For removal of condensate from an air conditioner, suitable for high efficiency and gas furnace condensation



Part #	Mfg #	Model	Description	Price
075877	554200	VCC-20ULS	115V	

Condensate Pumps

Condensate Pumps

LCU Series Condensate Pump

- High impact ABS tank
- Wall mounts
- (3) Intake holes
- 3/8" OD Outlet
- Barbed and threaded discharge connection
- Removable check valve
- Stainless steel shaft
- 6' Power cord with ground
- Thermally protected
- Quiet operation
- 3-Year warranty

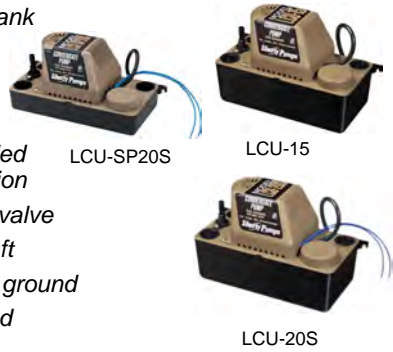

Part #	Mfg #	Description	Price
120642	LCU-15	115V, 1/50 hp	
123251	LCU-20S	115V, 1/30 hp, w/Safety Switch	
124593	LCU-SP20S	115V, 1/30 hp, w/Safety Switch, Shallow Pan Design	

Condensate Pumps

Condensate Pumps

ClearVue™ Pump - No Float, No Problem

- *iQ Technology™ to think and adapt to changing conditions*
- *Variable lift*
- *Self-cleaning*
- *Floatless Sensor™*



Part #	Mfg #	Description	Price
143695	IQP-120	Clearvue™ Pump 120V	
201298	DVIQP120T	ClearVue™ Pump, CVT 120V	

CP-22 Condensate Pump with Hose

- *22ft lift with 20ft of 3/8" CVT*
- *4-3/8" Height*
- *Low profile package*
- *4 inlet holes*
- *Motor mounts*
- *Metal hang tabs*
- *Clear indicator spray*
- *Vibration dampening feet*
- *Float switch and check valve*
- *1/4" quick connect terminals (3 terminals)*



Part #	Mfg #	Description	Price
243155	CP-22-230T	230V with Tubing	
196148	CP-22T	120V with Tubing	
198459	DVCP22LP	Condensate Pump low profile	

High Temp Boiler Condensate Removal Pump

- *46' Lift*
- *Two inlet holes*
- *1/4 turn check valve*
- *Oil resistant tank and impeller*
- *For hot water applications up to 211°*

Part #	Mfg #	Power	Price
238716	BP-46	115V	

Mini Split Condensate Pumps

- *DiversiTech's Mini Split Condensate Pump is a quiet, super compact, and feature rich pump that fits almost anywhere.*
- *Available in 115V and 230V versions.*
- *Pump fits easily in most line sets covers.*

Part #	Mfg #	Description	Price
187890	DVCPM230	230V	

Mini-Split Drain Adapters

- *Mini-Split fan units — either ceiling cassettes or wall cassettes — typically have a unique (metric) drain line fitting.*
- *DiversiTech's adapters convert this metric fitting to standard drain line tubing sizes*



Part #	Mfg #	Description	Price
250737	230-DLF25	25mm Drain Adapter	

Condensate Pumps

Condensate Pumps

Mini-Split Condensate Pump

- *Integral Pump-Tank*
- *Piston pump type*
- *120/230V*
- *3.25ft Power cord length*
- *Safety switch included*
- *104°F Max water temp*



Part #	Mfg #	Power Supply & Consumption	CTN Weight	Price
158107	ASP-MW-UNI	120/230V .11A 16W	1-3/4 lbs	
177095	ASP-MO-UNI	120/230V	.4 lbs	

Condensate Traps

Condensate Traps

- Full-flow condensate traps
- Each trap is carefully sized, minimizing bothersome clogged trap service calls
- Manufactured to demanding standards



Part #	Mfg #	Description	Price
116687	0357	3/4" Sch 40 PVC R-Trap	
116848	16349	1" Sch 40 PVC R-Trap	

Valves

Self-Tapping Water Valve

- Installs on all copper tube lines from 3/8" O.D. to 1-1/8" O.D. without drilling or shutting off w
- 1/4" compression fitting
- Stainless steel piercing needle
- Molded gasket seals



Part #	Mfg #	Size	Model	Price
005888	14SPV	1/4"	0149	

Condensate Traps

Condensate Traps

Residential Condensate Trap

- 3/4" Sch. 40 PVC trap saves fittings and job costs when trapping coil condensate lines



Part #	Mfg #	Type	Size	Price
027598	867-30	P-Trap	8" x 2-1/2"	

Condensate Trap

- One piece 3/4" Sch. 40 PVC trap saves fittings and job costs when trapping condensate lines



Part #	Mfg #	Type	Size	Price
184039	867-35	Running	10-3/4" x 2"	

Disconnects/Fuses/Electrical Box Covers

Electrical Boxes**Handy Boxes - Standard Steel Utility Box**

- Dimensions: 4"H x 2-1/8"W



Part #	Mfg #	Description	Price
002313	7596	2-1/8" Deep, 1/2" KO's	

Steel Electrical Box

- 1/2" & 3/4" Knockouts



Part #	Mfg #	Description	Price
143518	7588	4" Square x 2-1/8" Deep	

Electrical Receptacles**Premium Duplex Receptacle**

- Premium specification grade
- 2-Pole, 3-wire grounding receptacles
- Side-wired



Part #	Mfg #	Description	Price
141783	16573	15A, 125V White	

Electrical Switches**Standard Toggle Switch**

- Combination of side wiring & push-in wiring
- Framed toggle
- 15A 1/2 hp 120V



Part #	Mfg #	Description	Price
140155	16571	Grounded, White	



Disconnects/Fuses/Electrical Box Covers

Fuses



46-22863-82-5P



44-ATC3-5PK

Part #	Mfg #	Description	Price
056101	44-ATC3-5PK	Fuse 3A 5-Pack	
064538	46-22863-82-5PK	Fuse 2A 5-Pack K	
097898	44-ATC5-5PK	Fuse 5A 5-Pack	

Disconnects/Fuses/Electrical Box Covers

Fuses

Box Cover Units

- Maximum 15 Amps
- Maximum 125VAC
- UL Listed and CSA certified
- For use with type T plug fuses



COOPER
Bussmann

Part #	Mfg #	Description	Price
002302	620-608	Switch/Fuse Combo/ESSU	

Blade (Auto) Fuses

- Fast acting low voltage supplementary fuses
- Automotive blade style



Part #	Mfg #	Description	Price
213723	626-AT0003	3AMP, Purple, 5/Pk	
213724	626-AT0005	5AMP, Tan, 5/Pk	

In-Line Fuse Holder

- Controls up to 30 amp
- For use on AC/DC circuits
- Rigid plastic covering for each fuse



Part #	Mfg #	Amps	Price
239670	FH-1	Up to 30	

Dual Element Fuses

- Provides time delay for temporary over-current conditions and motor running protection for heating and air conditioning equipment
- Eliminates unnecessary maintenance from harmless overloads. U.L. Class RK-5, Standard for Safety 198E, Current Limiting Fuses, Interrupting Rating 200,000 Amps. rms. A.C.

Part #	Mfg #	Description	Price
192052	7CRNR-15	Time delay, 15 Amps	
192053	7CRNR-20	Time delay, 20 Amps	
192054	7CRNR-40	Time delay, 40 Amps	
192056	7CRNR-50	Time delay, 50 Amps	
194412	7CRNR-60	Time delay, 60 Amps	
200539	7CRNR-30	Time delay, 30 Amps	

Time Delay Plug Fuses, U.L. listed

- These plugs offer safe protection during momentary overload.
- No adapter necessary. U.L. Listed.



Part #	Mfg #	Description	Price
192066	626-15T	Type T Plug Fuse – 15 Amp	

Disconnects

DiversiTech Pull-Out Disconnect Switch

- Side opening door
- Line, load, and ground terminals aligned
- Reversible door
- Full dead front



Part #	Mfg #	Description	Price
132308	DDS-60U	60A, Non-Fused	

Utility Boxes & Accessories

Standard Steel Utility Box

- 2-1/8" deep
- 1/2" K.O.



Part #	Mfg #	Description	Price
192062	620-202	2-1/8" Deep Handy Box	
192068	620-254	Flat blank cover	
207287	620-252	Flat, 2 duplex receptacle cover	

Steel 1900 Boxes

- Steel Utility Boxes are used for convenience outlets, switch boxes and small junction boxes.



Part #	Mfg #	Description	Price
216595	PI363	4"x4"x2"	

Electrical Tape

Tape

Scotch 3M Super 33+ Electrical Tape

- Premium grade, 7 mil all-weather vinyl insulating
- Temperature range: 0° to 220°F



Part #	Mfg #	Size	Price
132145	ET33	3/4" x 66'	

Economy Electircal Tape

- Up to 175°F and not more than 600V
- UL listed



Part #	Mfg #	Description	Price
196493	6-3460	3/4" x 60'	

Electrical Tape

Amazing! Tile Tape

- *Makes watertight junctions and connections for plastic tubing*
- *Made out of PVC, which provides super stretchability*
- *Properties:*
 - *Tensile strength: 20#/sq inch*
 - *Elongation: 230%*
 - *Dielectric: 8800V*
 - *Thickness: 8 mm*



Part #	Mfg #	Description	Price
127854	BT02ADC	2" x 108' Roll	

Gas Valves

VR Series Combination Gas Controls

- Standard features for combination gas valves include:
 - (2) Automatic valves
 - Solenoid-operated first automatic valve opens on thermostat call for heat; closes when call for heat ends.
 - Diaphragm-operated second automatic valve opens under control of regulator; closes if gas or power supply is interrupted
 - Meets codes requiring dual safety shutoff
 - Mounting: 0° to 90°, any direction from upright position of gas control knob, including vertically

VR8200 Continuous Pilot Dual Automatic Valve Combo Gas Control

- For 24VAC gas-fired, standing pilot appliances with capacities from 20-200 cfh
- Includes all standard features plus:
 - Controls include manual valve, (2) automatic operators, Servco pressure regulator and pilot adjustment
 - Standard and slow opening natural gas models include natural to LP gas conversion kits; LP to natural gas conversion kits are also available
 - All adjustments, wiring connections and pilot outlets are accessible from the top of control
 - LITE-RITE (Off-Pilot-On) lighting sequence
 - Compatible with ECO connector
 - Capacities based on 1" p.d. 20,000 BTUH minimum, 130,000 BTUH maximum



Part #	Mfg #	Inlet/Outlet Size	Capacity cfh	Capacity m3/hr	Pressure Regulator Setting	Type of Gas	Type of Pressure Regulator	Price
006813	VR8200A2132	1/2" x 1/2"	130	3.7	3.5"wc/0.9kPa	NG	Std (1)	

(1) Includes 393691 NG to LP conversion kit, 1/2" x 3/8" reducer bushing, 393690-14 bag assembly - 3/4" straight flange with o-ring, screws and wrench

Universal Standard Opening Direct Ignition Gas Valve

- Control includes manual valve, two automatic operators, pressure regulator, pilot adjustment, pilot plug and ignition adapter
- Replaces many IP, HSI, or DSI gas control
- For use with natural or manufactured gas or LP gas
- Includes converter kit to adapt from natural to LP gas
- Compact size
- All adjustments and wiring connections accessible from top of control
- 4" Swing radius allows easy rotation into position inside the tightest furnace vestibules
- Clearly marked, keyed terminal block allows quick attachment of wires and IP/DSI/HSI jumper
- Internal inlet screen blocks contaminants in gas line from entering valve



Part #	Mfg #	Inlet/Outlet Size	Capacity cfh	Capacity m3/hr	Pressure Regulator Setting	Type of Gas	Type of Pressure Regulator	Price
245091	VR8245M2350	1/2" x 1/2"	200	-	3.5"wc/0.9kPa	NG	Std (1)	
238093	VR8345Q4563	3/4" x 3/4"	415	-	3.5"wc/0.87kPa	NG	Std	

(1) Includes 393691 NG to LP conversion kit, 1/2" x 3/8" reducer bushing, 393690-14 bag assembly - 3/4" straight flange with o-ring, screws and wrench

Gas Valves

VR8300A Continuous Pilot Dual Automatic Valve Combo Gas Control

- For 24VAC gas-fired, standing pilot appliances with capacities from 30-300 cfh
- Includes all standard features plus:
 - Controls include 100% safety shutoff, manual valve, magnetic operators, pressure regulator and pilot adjustment
 - Standard and slow opening natural gas models include natural to LP gas conversion kits; LP to natural gas conversion kits are also available
 - All adjustments, wiring connections and pilot outlets are accessible from the top of control
 - LITE-RITE (Off-Pilot-On) lighting sequence
 - Compatible with ECO connector
 - Ambient temperature ratings: 0° to 175°F
 - Capacities based on 1" p.d. 30,000 BTUH minimum, 190,000 BTUH maximum



Part #	Mfg #	Inlet/Outlet Size	Capacity cfh	Capacity m3/hr	Pressure Regulator Setting	Type of Gas	Type of Pressure Regulator	Price
006815	VR8300A3500	1/2" x 3/4"	190	5.4	3.5"wc/0.87kPa	NG	Std (1)	

(1) Includes (1) 3/4"x 1/2" reducer bushing, 393691 NG to LP conversion kit

VR8345 Universal Electronic Ignition Combination Gas Control

- For use with direct spark ignition, hot surface ignition or intermittent pilot ignition in 24VAC, gas-fired appliances, with capacities from 30 to 415 cfh
- Includes all standard features plus:
 - Manual valve, two automatic operators, pressure regulator, pilot adjustment, pilot plug and ignition adapter
 - Replaces virtually any IP, HSI or DSI gas control
 - For use with natural or manufactured gas or LP gas
 - Includes converter kit to adapt from natural gas to LP gas
 - 4" Swing radius allows easy rotation into position inside the tightest furnace vestibules
 - Clearly marked, keyed terminal block allows quick attachment wires and IP/DSI/HSI jumper
 - Internal inlet screen blocks contaminants in gas line from entering valve
 - Capacities based on 1" p.d. 30,000 BTUH minimum, 300,000 BTUH maximum



Part #	Mfg #	Inlet/Outlet Size	Capacity cfh	Capacity m3/hr	Pressure Regulator Setting	Type of Gas	Type of Pressure Regulator	Price
025055	VR8345M4302	3/4" x 3/4"	300	8.5	3.5"wc/0.87kPa	NG	Std (1)	

(1) Includes two 3/4" x 1/2" NPT reducer bushings and one 1/2" x 1/2" NPT bushing

Gas Valves

Combination Gas Controls

V800 Low Voltage Standing Pilot Gas Control

- Auto 24V control for use with 30mV thermocouple, includes integral A and B gas cock, magnetic operator, pressure regulator, auto pilot, 100% shut-off, pressure tap and filter, one 36" thermocouple and LP kit
- Color coded blue to identify 24V operation



Part #	Mfg #	Inlet/Outlet Size	Capacity cfh	Capacity m3/hr	Pressure Regulator Setting	Type of Gas	Type of Pressure Regulator	Price
006820	V800A1070	1/2" x 3/4"	250	7.1	3.5"wc/0.87kPa	NG	Std (1)(2)(3)	
006821	V800A1088	3/4" x 3/4"	335	9.5	3.5"wc/0.87kPa	NG	Std (1)(2)(3)	

- (1) Includes one 3/4" x 1/2" and one 1/2" x 3/8" reducer bushing/adapter
- (2) Includes Q340 (36") thermocouple with adapters
- (3) NG to LP Conversion Kit

VS820 Millivoltage Combo

- Provides complete control of continuous pilot gas-fired central furnaces and boilers
- Self-powered automatic control for use with 750mV thermocouple
- Includes pilot flow adjustment screw
- All adjustments and connections are accessible from top of control
- Add separate energy cutoff (ECO) where codes call for dual safety shutoff
- Complete safety shutoff on pilot flame failure
- LITE-RITE (Off-Pilot-On) lighting sequence
- Adjustable pressure regulator
- Temperature range: 32° to 175°F
- Mounting 0° to 90° in any direction from the upright position of the gas control knob, including vertically

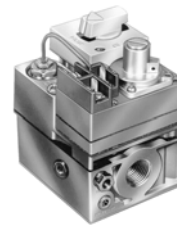

Part #	Mfg #	Inlet/Outlet Size	Capacity cfh	Capacity m3/hr	Pressure Regulator Setting	Type of Gas	Type of Pressure Regulator	Price
006816	VS820A1047	1/2" x 3/4", 1/2" Side Outlets	250	7.1	3.5"wc/0.87kPa	NG	Std (1)	

- (1) Includes one 3/4" x 1/2" and one 1/2" x 3/8" reducer bushing/adapter

Gas Valves

SmartValve® Hot Surface Pilot Ignition Controls

SV9501 SmartValve® System Control

- Provides easy field replacement of a wide range of SV9500, SV9501, SV9502, SV9601 and SV9602 SmartValve® System models
- Gas appliance manufacturers use these models in many types of gas fired heating appliances including central furnaces, residential boilers, rooftop furnaces, commercial cooking appliances and unit heaters
- Provides intermittent pilot gas ignition sequencing, pilot flame sensing, and both pilot and main gas control functions in a single control
- Ignition sequence includes timed trial for ignition
- Compatible with Q3450 or Q3480 intermittent pilot burners used with the original controls on the appliance



Part #	Mfg #	Description	Price
231871	SV9502H2522	Intermittent HSI Pilot , 1/2" x 1/2" In/Out, 3.2"wc Standard Opening, Natural Gas	
098756	SV9501M2528	Intermittent HSI Pilot , 1/2" x 1/2" In/Out, 3.5"wc Standard Opening, Natural Gas	

SV9641 SmartValve® System Control

- Combines gas flow control and electronic intermittent pilot sequencing functions
- Q3450 or Q3480 Pilot hardware supplies the low voltage igniter, flame sensor and pilot burner
- Communicates directly with an electronic fan timer (ST9160 for single-stage applications; ST9162 for 2-stage applications) in typical forced warm air furnace applications
- Provides pre purge, post purge, timed trial for pilot ignition, with 100% shutoff and continuous retry
- Suitable for wide range of fan assisted combustion gas-fired appliances including: furnaces, rooftop furnaces, boilers, unit heaters, infrared heaters, water heaters, and commercial cooking appliances
- Ambient temperature range: -40° to 175°F
- Diagnostic LED



Part #	Mfg #	Description	Price
144233	SV9641M4510	2-Rod Flame Sense, 3/4" NPT x 3/4" NPT Intermittent Hot Surface Pilot Ignition SmartValve®	

Gas Valves

Gas Valves

700 24 Volt Combination Valve

- Electrical rating: 0.18A @ 12VDC
0.2A @ 24VAC



Part #	Mfg #	Inlet Size	Outlet Size	Straight Through	Side Outlet w/Plugs	Pressure Regulator Setting	Capacity	Price
058059	700-400	1/2" FPT	3/4" FPT	Yes	None	Uni-Kit	240,000	

720 Series Dual Valve Gas Control
24V Hot Surface - Intermittent Pilot Ignition



Part #	Mfg #	Inlet Size	Outlet Size	Straight Through	Side Outlet w/Plugs	Pressure Regulator Setting	Capacity	Price
042430	720-400	1/2" FPT	3/4" FPT	Yes	None	Uni-Kit	150,000	

24V Standing Pilot - Step-Opening w/Convertible Pressure Regulator

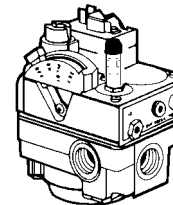

Part #	Mfg #	Inlet Size	Outlet Size	Straight Through	Side Outlet w/Plugs	Pressure Regulator Setting	Capacity	Price
044307	720-474	1/2" FPT	1/2" FPT	Yes	1/2" FPT	Yes	150,000	

Gas Valves

720 Series Gas Valve Uni-Kits®

- *Designed for intermittent pilot ignition applications*
- *24V*
- *Direct spark, electronic ignition*
- *Valve features:*
 - *Manual valve*
 - *Pilot valve*
 - *(2) Dual automatic valves*
 - *Main gas pressure regulator*



Part #	Mfg #	Inlet Size	Outlet Size	Straight Through	Side Outlet w/Plugs	Pressure Regulator Setting	Capacity	Price
044306	720-079	1/2" FPT	3/4" FPT	Yes	1/2" FPT	Uni-Kit	150,000	

Temperature Controls

Ranco® A22 Series Ice Bin Cold Control

- *SPDT switch*
- *Dial included*
- *6°F differential*
- *Ice bin level & harvest control*
- *48" Capillary sensing element*
- *Normal off: 35°F, normal on: 51°F*
- *High-amperage contacts*
- *Laser-welded stainless steel elbows*
- *Constant on or off positions available*
- *Fixed or adjustable temperature settings*
- *1/4" Quick-connect terminals with optional screw terminals*



Part #	Mfg #	Switch	Differential	Connection	Price
239663	A22-1129	SPDT	6°F	1/4"	

Heat Shrink Tubing

**Heat Shrink
Heat Shrink Tubing**



Part #	Mfg #	Description	Price
140501	455062	Assortment: (5) 1/4", (4) 3/16", & (3) 3/8"	
140612	455153	Rainbow Assortment: (5) 1/4", (4) 3/16", & (3) 3/8"	

Igniters

Igniters

Glowfly™ Universal Hot Surface Igniter

- Uses a 120V silicon nitride igniter design with long life and high resistance to damage or burn out in the appliance
- Kit includes specially designed silicon nitride igniter and six different bracket configurations
- Clear instructions and application templates are provided
- Replaces over 110 different models
- 3-Year warranty



Part #	Mfg #	Description	Price
126476	Q3200U1004	Glowfly™ Universal Hot Surface Igniter Kit, Pack of 1	
200822	Q3200U2002	Glowfly™ Universal Hot Surface Igniter Kit, Pack of 6	

Q4100 Silicon Carbide Hot Surface Igniter

- Q4100 igniters work with most configurations of element shapes, brackets, connectors, and lead wire lengths
- Honeywell igniters are made in the USA and backed by a 2-year warranty
- Temperature rating: 392 °F
- 120 Volt
- Natural LP gas



Part #	Mfg #	Description	Price
181450	Q4100C9040/U	120 Volt, Silicon Carbide Hot Surface Igniter with 5-1/4 in. lead lengths	
181451	Q4100C9042/U	120 Volt, Silicon Carbide Hot Surface Igniter with 5-1/2 in. lead lengths	
181452	Q4100C9044/U	120 Volt, Silicon Carbide Hot Surface Igniter with 6 in. lead lengths	
181453	Q4100C9046/U	120 Volt, Silicon Carbide Hot Surface Igniter with 19-1/8 in. lead lengths	
181454	Q4100C9048/U	120 Volt, Silicon Carbide Hot Surface Igniter with 5-1/4 in. lead lengths	
181455	Q4100C9050/U	120 Volt, Silicon Carbide Hot Surface Igniter with 11 in. lead lengths	
181456	Q4100C9052/U	120 Volt, Silicon Carbide Hot Surface Igniter with 5 in. lead lengths	
181457	Q4100C9054/U	120 Volt, Silicon Carbide Hot Surface Igniter with 5-1/4 in. lead lengths	
181459	Q4100C9056/U	120 Volt, Silicon Carbide Hot Surface Igniter with 5-1/4 in. lead lengths	
181460	Q4100C9058/U	120 Volt, Silicon Carbide Hot Surface Igniter with 4-1/2 in. lead lengths	
181461	Q4100C9060/U	120 Volt, Silicon Carbide Hot Surface Igniter with 5-1/4 in. lead lengths	
181462	Q4100C9062/U	120 Volt, Silicon Carbide Hot Surface Igniter with 5-1/4 in. lead lengths	
181463	Q4100C9066/U	120 Volt, Silicon Carbide Hot Surface Igniter with 5-1/4 in. lead lengths	
181464	Q4100C9068/U	120 Volt, Silicon Carbide Hot Surface Igniter with 5-1/4 in. lead lengths	
181465	Q4100C9070/U	120 Volt, Silicon Carbide Hot Surface Igniter with 5-11/16 in. lead lengths	
181466	Q4100C9072/U	120 Volt, Silicon Carbide Hot Surface Igniter with 5-5/16 in. lead lengths	

Igniters

Igniter Flame Rod Assembly

- Use with SV9500, SV9600
- Field replacement for Q3450/Q3480 hot surface pilot burner



Part #	Mfg #	Description	Price
097708	Q3400A1024	30" Lead Length	

Igniters

Igniters

41 Series Silicon Carbide Hot Surface Igniters

- Delivers dependable ignition in heating systems of every description
- Engineered for easy handling, simple installation & trouble free operation

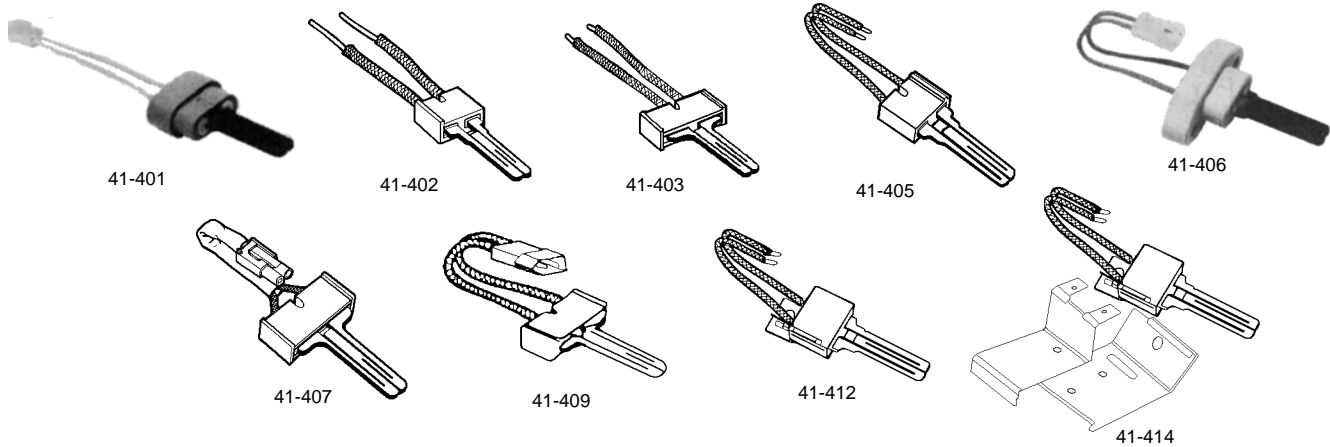

Part #	Mfg #	Factory Model#	Ceramic Block Style	Terminal Conn Type	Lead Wire Length	Price
044297	41-401	271A	A	A	4-1/2"	
044298	41-402	217W	B	None	19"	
044299	41-403	271	C	None	5-1/2"	
044300	41-405	2711D	D	None	5-1/2"	
044301	41-406	271Y	E	None	10-1/2"	
044302	41-407	271	C	B	4-1/2"	
044303	41-409	271	C	D	4-1/2"	
044305	41-412	271NM	F	None	5-1/4"	
045277	41-414	271NM	F	None	5-1/4"	

Series 41-600



Part #	Mfg #	Factory Model	Housing Length	Comments	Price
058084	41-605	601XBM +Harness & Brackets	2.5"	York Replacement Conversion Kit #473-20937-001	

Limit Controls

Fan & Limit Controls

L4064B Combination Fan & Limit Furnace Control

- For control of high limit and fan motor in forced air heating systems
- (3) Wiring terminal options:
 - Female receptacles for 1/4" male flange connectors
 - Push-in receptacles for stripped wire
 - Field add-on screw terminals
- Helical bimetal sensing element, high limit set @ 200°F
- Manual fan switch
- Includes jumper



Part #	Mfg #	Description	Price
006734	L4064B2210	11-1/2" Insertion, Surface-Mount	
006735	L4064B2228	5" Insertion, Surface-Mount	
006736	L4064B2236	8" Insertion, Surface-Mount	

Oil Furnace Controls

Oil Primary Controls

R8184G Protectorelay® Oil Burner Control

- Provides automatic, non-recycling control of an intermittent ignition oil burner system
- Low volt terminals, line volt lead wire connections and screw
- Intermittent ignition, safety switch
- 120V 60-Cycle or 110V 50-cycle
- Mount on 4" x 4" junction box or direct mount on burner housing
- With LED for lockout indication and manual trip lever on safety switch to assure burner shutdown during servicing
- C554 Cadmium Sulfide Flame Detector and 24VAC thermostat required



Part #	Mfg #	Description	Price
006771	R8184G4009	45-Second Safety Switch	

R8184M Protectorelay® Oil Burner Control

- Operates the oil burner and oil valve (if desired) in response to call for heat from a low voltage control circuit
- Burner mount, low volt terminals, line volt lead wire connections
- Intermittent ignition, 45-second safety switch
- 120V 60-Cycle, intermittent ignition
- 40VA Transformer for heat/cool, 0.2A thermostat current
- Use with C554



Part #	Mfg #	Description	Price
006773	R8184M1051	45 Second Safety Switch, 0.2A Anticipator Setting, Use with C554	

R7284B Electric Oil Primary Control

- Microprocessor oil control
- Mount onto junction box on main burner
- UL and cUL component recognized
- Burner motor, oil valve, ignition, cad cell, limit, thermostat, alarm
- Interrupted ignition type
- LED display
- 15 Second lock out



Part #	Mfg #	Description	Price
189629	R7284B1024/U	15 Second Safety Switch, -40° F to +147° F	

RA116/RA117 Protectorelay® Oil Burner Control

- 1-Piece, stack-mounted oil burner primary controls cycle burner on and shut down burner on flame loss or system malfunction
- 2- or 3-Wire, includes manual trip safety switch lever
- Use with line voltage or 24VAC control circuit
- RA116 - Safety switch heater energizes on flame or power failure lockout occurs if flame is not reestablished by end of safety switch timing



Part #	Mfg #	Description	Price
006764	RA116A1055	360VA, Intermittent Ignition Protectorelay	

Oil Furnace Accessories

Flame Sensors

C554 Cadmium Sulfide Flame Detector

- *Photo conductive flame sensing device for sequencing oil burner systems*



Part #	Mfg #	Description	Price
006719	C554A1463	60" Lead, A/B/E/J/P Type & Oil Line Mounting Bracket Included	

Oil Furnace Accessories

Oil Burner Nozzles - Type A Red Vial

- *Hollow cone*
- *Creates stable flame at low flows*



60° Angle Oil Burner Nozzle - Type A

Part #	Mfg #	GPH	Price
007771	0007560A	.75	

70° Angle Oil Burner Nozzle - Type A

Part #	Mfg #	GPH	Price
007778	0008570A	.85	
007759	0010070A	1.00	

80° Angle Oil Burner Nozzle - Type A

Part #	Mfg #	GPH	Price
007779	0008580A	.85	
007761	0010080A	1.00	
007746	0011080A	1.10	
007751	0012580A	1.25	
007756	0015080A	1.50	

Oil Burner Nozzles - Type B Blue Vial

- *Solid cone*
- *For larger burners & where air pattern is heavy in the center or for long fires*



80° Angle Oil Burner Nozzle - Type B

Part #	Mfg #	GPH	Price
007780	0008580B	.85	

Oil Burner Nozzles - Type W Green Vial

- *Neither truly hollow nor solid*
- *Can be used in place of Type A or B Types in reducing specific problems*



80° Angle Oil Burner Nozzle - Type W

Part #	Mfg #	GPH	Price
007770	0006580W	.65	
007781	0008580W	.85	
007747	0011080W	1.10	

Oil Furnace Accessories

Fuel Filters

Replacement Filter Cartridge

- 10 Micron wool felt
- Center core bonded to prevent media migration



Part #	Mfg #	Description	Price
004856	1A-30	Wool Felt - for Filter 1A-25A	

Pilot Assemblies

Pilot Burners

Q314 Pilot Burner

- Non-primary aerated, insert orifice-type, for main burner ignition with Q340 or Q390 thermocouple for Pilotstat safety control operation
- Use with Q313 Thermopile generator for 750mV power pile applications
- Includes natural gas and LP orifice
- Compression fitting size: 1/4"
- Special mounting bracket with screws for converting "B" bracket to "A"



Part #	Mfg #	Description	Price
006748	Q314A4586	B Bracket, BCR-18/BCR-10 Orifice, Single (F) Front Tip	
037901	Q314A6094	B Bracket, BCR-18 Orifice, Single (L) Left Front Tip	
037902	Q314A6102	B Bracket, BCR-18 Orifice, Single (K) Right Front Tip	

Q327A Standing Pilot Burner

- Variety of mounting brackets available
- Variety of tip styles to provide desired flame pattern
- Interchangeable, color-coded orifices can be ordered to convert between natural and LP gas
- Batwing tip style



Part #	Mfg #	Description	Price
006749	Q327A-1626	A26 and K14 Orifices, For Standing Pilot Applications	

Pressure Regulators

Gas Appliance Pressure Regulators

- Gasses: natural, manufactured, mixed, liquefied, petroleum and LP gas-air mixtures
- Corrosion-resistant construction

325-3 Lever Acting Pressure Regulator

- Self-aligning valve with lever action for dead end lockup
- Multi-poise mounting
- Maximum individual load: 100,000 BTUH
- Capacity: 150,000 BTUH
- Vent pipe connection: 1/8" NPT



Part #	Mfg #	Description	Price
124028	325-3L12	1/2" Line Reg with 12A09	
079070	325-3L48-44	1/2" Line Reg with 12A09	

325-5A Lever Acting Pressure Regulator

- Self-aligning valve with lever action for dead end lockup
- Maximum individual load: 250,000 BTUH
- Capacity: 300,000 BTUH
- Vent pipe connection: 3/8" NPT
- Multi-poise mounting



Part #	Mfg #	Description	Price
138743	325-5L48	1/2" Line Reg with 12A39 & OPD 48 Installed	
113435	325-5L48	3/4" Line Reg with 12A39 & OPD 48 Installed	
078926	325-5L600	3/4" Line Reg with 12A39 & OPD 600 Installed	
118426	325-5L34	3/4" Line Reg with 12A39 Installed	
124030	325-5L1	1" Line Reg with 12A39 Installed	
138744	325-5L600	1" Line Reg with 12A39 & OPD 600 Installed	

325-5L Lever Acting Pressure Regulator

- High leverage linkage assembly to deliver positive dead-end lockup
- Maximum individual load: 425,000 BTUH
- Capacity: 600,000 BTUH
- Multi-positional mounting



Part #	Mfg #	Description	Price
214294	325-5L12	1/2" w/ Vent Limiter 425 CFH w/v Limiter	
214291	325-5L34	3/4" w/ Vent Limiter 425 CFH w/v Limiter	
214580	325-5L1	1" w/ Vent Limiter 425 CFH w/v Limiter	

325-7 Lever Acting Pressure Regulator

- Self-aligning valve with lever action for dead end lockup
- Maximum individual load: 1,250,000 BTUH
- Capacity: 1,250,000 BTUH
- Vent pipe connection: 1/2" NPT
- Multi-poise mounting



Part #	Mfg #	Description	Price
086239	325-7AL	1-1/4" Line Press Rated Reg with 12A49 Installed	
075957	325-7AL 1-1/2	1-1/2" Line Press Reg Cert. to 2PSI Ansi Z21.80	

Gas Appliance Pressure Regulators Accessories

Vent Limiting Means

- Automatic vent limiting device
- When using, regulator must be mounted in horizontal upright position
- 12A04 - IAS Certified for 14" wc and European approval, use on RV48, RV52, RV53, RV61



Part #	Mfg #	Description	Price
134390	12A49	For use with 325-7AL	
150323	12A09	For use with 325-3 and 325-3L	

Pressure Regulators

Vent Protector

- *Designed for outdoor applications*
- *Protect breather hole from outside elements*
- *Must be mounted in upright position*
- *13A15 - Use in 325-3, 325-3L*
- *13A15-5 - Use in 325-5A, 325-5AL*



Part #	Mfg #	Description	Price
071088	13A15	For 1/8" NPT Vent	
152096	13A155	For 3/8" NPT Vent	
145637	13A25	For 1/2" NPT Vent	

Maxitrol® Maxicap

- *Rain and bug shield for regulators*
- *Rubber*



Part #	Mfg #	Description	Price
041419	MAXICAP-3R	For 325-3 and 3R Series	
098862	MAXICAP-5R	For 325-3	

Relays

Relays

General Purpose Relay

- Provides general purpose switching for refrigeration and air conditioning equipment, appliances, vending machines, etc
- 50/60Hz

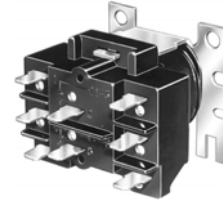

Part #	Mfg #	Description	Price
006769	R4222D1013	DPDT 120V General Purpose, 1 - 6 Power Poles	
006774	R8222B1067	SPDT 24V General Purpose, Double Quick Connect, 1 - 3 Power Poles	
006775	R8222D1014	DPDT 24V General Purpose, Double Quick Connect, 1 - 6 Power Poles	

Hydronic Switching Relays

R8845 Universal Hydronic Switching Relay

- Enclosed switching relay with internal 24V transformer
- (2) SPST, Plus PowerPile® rated low voltage SPST relay (if normally closed contacts are needed, use RA889A)
- Replaces Honeywell models: R182A,B,C,J; R482A,B,C,J; R845; R882A,B,C,J and RA832



Part #	Mfg #	Description	Price
135224	R8845U1003	Intermediate Switching of Line and Low Voltage Devices from a Line or Low Voltage Controller	

Hydronic Switching Relay

- Provides intermediate switching of line voltage device from low voltage controller
- Integral transformer provides low voltage power for control circuit
- Provides DPST switching for hot water zone control systems, or SPST control of two separate loads
- Color-coded lead wire for easier wiring
- 50/60Hz



RA89

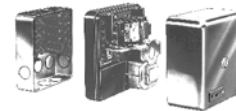

RA832



R845

Part #	Mfg #	Description	Price
006767	RA89A1074	SPST 120V Enclosed 2-Wire for 1-Line Voltage Load	
006766	RA832A1066	DPST 120V Enclosed 2-Wire for 2-Line Voltage Loads	
030533	RA832A1074	DPST 240V Enclosed 2-Wire for 2-Line Voltage Loads	
033261	R845A1030	DPST 120V for Hot Water Zone Control Systems, 2-Wire for 2-Line Voltage Loads	

Smoke Bombs

Smoke Testers

Smoke Bomb

- *Emits dense oil-free non-toxic smoke*
- *Easily locates leaks in furnaces and ductwork*
- *Non-explosive, packaged in sealed capsules*



Part #	Mfg #	Description	Price
135427	14340	2,500 Cu/Ft, 4 Min Burn	

Spades & Other Electrical Connectors

Motor Accessories

Wiring Harness

- Use with Copeland Compressor with Molded Plug Connections



Part #	Mfg #	Description	Price
105788	45-100834-8	Bulk Pack (25/Case)	
	0		

Terminals & Connectors

Ring Flag Terminal

- 50/Pk



Part #	Mfg #	AWG	Connector Type	Size	Price
140452	455011	16-14	Ring Terminal	#10 Stud	

Quick Connect Flag Terminal

- 50/Pk



Part #	Mfg #	AWG	Connector Type	Size	Price
140454	455014	16-14	Quick Connect	1/4" FIP	

Quick Connect Compressor Terminal

- 50/Pk



Part #	Mfg #	AWG	Connector Type	Size	Price
140455	455015	12-8	Compressor Terminal	1/4" FIP	

Quick Connect to Stud Adapter

- 50/Pk
- Uninsulated



Part #	Mfg #	Tab Size	Terminal Size	Price
140458	455018	1/4"	#10 Stud	

Quick Connect Spade Adapter

- Female to double male (Flat Style)
- 50/Pk
- Uninsulated



Part #	Mfg #	Tab Size	Tab Type	Price
140459	455019	1/4"	Female	

Quick Connect Adapter

- .296 Chair Gold Double Male/Single Female Adapter
- 50/Pk



Part #	Mfg #	Description	Price
140456	455016	Chair Style	
140457	455017	Piggyback Style	

Insulated Quick Connect



Part #	Mfg #	AWG	Color	Tab Size	Pk	Price
140482	455043	22-18	Red	1/4"	50	
140483	455045	16-14	Blue	1/4"	100	
140484	455046	16-14	Blue	1/4"	50	
140485	455047	16-14	Blue	1/4"	100	
140486	455048	16-14	Blue	1/4"	50	
140488	455049	12-10	Yellow	1/4"	100	
140489	455050	12-10	Yellow	1/4"	50	
140564	455091	16-14	Blue	3/16"	15	
140565	455092	16-14	Blue	1/4"	15	
140566	455093	12-10	Yellow	1/4"	15	
140611	455152	22-18	Red	1/4"	50	
140562	455089	12-10	N/A	1/4"	25	

Spades & Other Electrical Connectors

With Piggyback



Part #	Mfg #	AWG	Color	Tab Size	Pk	Price
140492	455052	16-14	Blue	1/4"	50	

Uninsulated Butt Connectors



Part #	Mfg #	AWG	Color	Pk	Price
140608	455149	16-14	SS	50	

Fully Insulated Quick Connect



455145

Part #	Mfg #	AWG	Color	Tab Size	Pk	Price
140493	455053	16-14	Blue	1/4"	100	
140603	455144	12-10	Yellow	1/4"	50	
140604	455145	16-14	Blue	1/4"	100	
140628	455170	16-14	Blue	1/4"	20	

Insulated Butt Connectors



455039

Part #	Mfg #	AWG	Color	Pk	Price
140478	455038	22-18	Red	100	
140479	455039	16-14	Blue	100	
140480	455040	16-14	Blue	50	
140481	455042	12-10	Yellow	50	
140518	455076	22-18	Red	15	
140520	455078	16-14	Blue	15	
140563	455090	12-10	Yellow	15	
140630	455172	12-10	Yellow	100	

Twist-On Plastic Wire Connector



455163

Part #	Mfg #	AWG	Color	Pk	Price
140622	455163	22-14	Blue	1000	
140517	PD455075	22-14	Blue	50	
140567	455094	22-14	Blue	15	
140631	455173	22-14	Orange	50	
140627	455169	18-12	Yellow	100	
179414	PD455633	22-14	Blue	50	
179413	PD455632	22-14	Orange	50	

Ring Terminal



455080

Part #	Mfg #	AWG	Size	Pk	Price
140451	455010	8	1/4" Stud	25	
140521	455080	16-14	#10 Stud	50	

Closed Connector



Part #	Mfg #	AWG	Color	Pk	Price
140460	455020	22-14	Clear	50	
140461	455021	12-10	Clear	25	

Insulated Ring Terminal



455024

Part #	Mfg #	AWG	Color	Size	Pk	Price
140463	455024	16-14	Blue	#6	100	
140464	455025	16-14	Blue	#6	50	
140465	455026	16-14	Blue	#10	100	
140466	455027	16-14	Blue	#10	50	
140469	455030	12-10	Yellow	#10	100	
140470	455031	12-10	Yellow	#10	50	
140471	455032	12-10	Yellow	5/16"	50	
140472	455033	8	Red	#10	50	

Spades & Other Electrical Connectors

Terminals & Connectors (Continued)

Insulated Ring Terminal

Part #	Mfg #	AWG	Color	Size	Pk	Price
140605	455146	8	Red	1/4"	50	
140606	455147	8	Red	1/4"	25	
140607	455148	12-10	Yellow	1/4"	100	
140613	455154	16-14	Blue	#8	19	
140614	455155	16-14	Blue	1/4"	100	

Insulated Spade Terminal



Part #	Mfg #	AWG	Color	Size	Pk	Price
140516	455074	16-14	Blue	#8	50	
140474	455034	16-14	Blue	#8	15	
140475	455035	16-14	Blue	#10	100	
140476	455036	12-10	Yellow	#8	25	
140477	PD455037	12-10	Yellow	#10	25	

Compressor Lead Set



Part #	Mfg #	AWG	Ring Size	Butt Size	Price
140498	455059	10	#10	10"	

Strip-Tie



Part #	Mfg #	Length	Width	Max Dia	Pk	Price
140467	455028	12"	3/4"	3"	Black	
140468	455029	12"	3/4"	3"	Yellow	

Motor Hook-Up Wire



Part #	Mfg #	AWG	Length	Color	Price
140522	455081	10	8'	Black	
140600	455141	10	8'	Blue	
179378	PD455082	10	8'	Red	
140601	455142	10	8'	White	
140556	455083	12	12'	Black	
140597	455138	12	12'	Blue	
140557	455084	12	12'	Red	
140598	455139	12	12'	White	
140558	455085	14	15'	Black	
140595	455136	14	15'	Blue	
140599	455140	14	15'	Green	
140559	455086	14	15'	Red	
140596	455137	14	15'	White	
140560	455087	16	16'	Black	
140561	455088	16	16'	Red	
140594	455135	16	16'	White	

Metal Box for Electrical Connectors

- 14"x9-1/4"x2"



Part #	Mfg #	Description	Price
140616	455157	21 Compartment	

Spades & Other Electrical Connectors

Terminal Kits

Serviceman's Terminal Kit

- Consists of 175 assorted insulated and non-insulated items that are often used to service air conditioning, refrigeration and cooling units



Part #	Mfg #	Description	Price
111395	MA02652-2	Heavy-Duty Molded Plastic Case	



Spades & Other Electrical Connectors

Terminals & Connectors

Connector Kit

Part #	Mfg #	Description	Price
140444	86-6966F-1PK	665-Piece Professional HVAC Connector Kit	

Terminal

Part #	Mfg #	Description	Price
092116	QT2910	Qwiklug Terminal Repair Kit	

Temporary Construction Thermostats

Thermostats**Temporary Construction Thermostat**

- *Low cost*
- *Mercury-free and non-adjustable*
- *Rugged construction is not effected by heat, moisture, paint and drywall dust*



Part #	Mfg #	Description	Price
034003	20064	TS-60, 60°F, Heat Only	
034004	20065	TS-65, 65°F, Heat Only	
034005	20066	TS-70, 70°F, Heat Only	

Temporary Construction Thermostats

T812 Low Voltage Control Thermostats

- Snap-acting, bi-metal switch less mercury and requires no leveling
- For low voltage control of single-stage heating, cooling or heating/cooling systems
- Includes dealer logo pocket
- Switch type: snap-acting
- Electrical ratings: 18 to 30VAC
- Setting temperature change: 50° to 90°F
- Dimensions: 3-1/8"H x 3-1/8"W x 7/8"D
- Mounting: square



Part #	Mfg #	Application	Switching Action	Terminal Designations	Color	Price
101204	T812A1002	Heat Only	SPST	W,R	White	

Thermocouples

Power Generators

Q313 Replacement Thermopile Generator

- Provides power for a millivoltage, self-powered control system
- Includes spade terminals
- Use with Q314, Q324, Q327, Q377, Q379 and Q382 pilot burners



Part #	Mfg #	Description	Price
006746	Q313A1139	600-750mV Replacement Thermopile Generator, 35" Lead, Push-in Clip	
006747	Q313A1170	600-750mV Replacement Thermopile Generator, 35" Lead, PG9 Adapter	

Thermocouples

Q340 Universal 30 mV Thermocouple

- Includes push-in clip, split nut and adapter assembly for easy pilot burner installation
- Male nut connector for Pilotstat™ safety control power units



Part #	Mfg #	Description	Connection	Price
006750	Q340A1066	18" Lead	11/32"-32 Male Connector Nut	
006751	Q340A1074	24" Lead	11/32"-32 Male Connector Nut	
006752	Q340A1082	30" Lead	11/32"-32 Male Connector Nut	
006753	Q340A1090	36" Lead	11/32"-32 Male Connector Nut	
006754	Q340A1108	48" Lead	11/32"-32 Male Connector Nut	

Thermocouples

Thermocouples & Pilots

1951 Thermopile

- *Designed for use on self-powered gas control systems*
- *Easy burner installation with attached threaded nut*
- *Stainless steel outer jacket for long life and resistance to heat blistering*
- *Combination of copper and nickel alloys for good electrical conductivity*
- *Mica washer to insulate from shorting conditions*
- *Various lengths available for multiple applications*

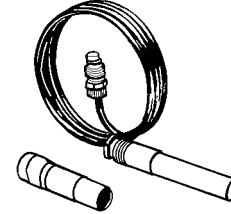

Part #	Mfg #	Length	Includes PG 9Pilot Adapter	Connection Type	Price
044312	1951-536	36"	Yes	Coaxial	

1980 Snap-Fit™ Thermocouple

- *Offers easy installation into the majority of pilot burners*

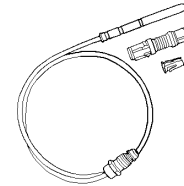

Part #	Mfg #	Length	Price
044326	1980-018	18"	
044329	1980-036	36"	

Thermostats

Non-Programmable Thermostats

T87K, T87N Non-Programmable Thermostats - The Round®

- Mercury free
- Provides electronic control of 24VAC heating and cooling systems
- Separate temperature setting and thermometer
- Classic twist dial
- Manual changeover
- Battery assisted power stealing
- Setting temperature range: 40° to 90°F
- Premier White®



T87K1007



T87N1000



T87N1026

Part #	Mfg #	Application	Terminal Designations	Dimensions	Price
099889	T87K1007	Heat Only	R,W,Y	3-11/16" Dia x 1-3/4"D	
096104	T87N1000	1 Heat/1 Cool Conv & Heat Pump	R,Rc,W,Y,G,O,B	3-11/16" Dia x 1-3/4"D	
099891	T87N1026	1 Heat/1 Cool Conv & Heat Pump*	R,Rc,W,Y,G,O,B	4" Dia x 1-3/4"D	

* EASY-TO-SEE Model with large raised markings & click at each 2° set point change, includes 6" cover ring & switch position labels

T822K, T827K Heat Only Non-Programmable Thermostats

- Mercury free
- 24VAC Control of single stage low voltage heating systems
- Vented cover for improved temperature sensing
- Coiled bi-metal element operates mercury switch
- Mounts vertically directly on the wall or on vertical outlet box
- Precision snap action switch
- Dimensions: 4-3/4"H x 2-7/8"W x 1-3/8"D
- Premier White®



Part #	Mfg #	Application	Switching Action	Setting Temp Range	Terminal Designations	Description	Price
124832	T822K1042	1 Heat	SPST	35° - 85°F	R,W	Heat-Off	

Thermostats

T8775 The Digital Round™ Electronic Non-Programmable Thermostats

- Attractive styling complements any decor
- Large easy-to-read display - the temperature reading is easily seen from a distance
- Backlit display
- No batteries required - the set point temperature is held permanently in memory in the event of a power failure.
- Powered through heating-cooling system controls
- 24VAC Gas or oil
- System and fan switches on the T8775C model
- Manual changeover from heat to cool on T8775C model
- Easy installation and set up
- Easily configurable by the use of DIP switches
- Fahrenheit or Celsius temperature
- Selectable heating cycle rates (1, 3, 6, 9 CPH) for a variety of applications
- Cooling cycle rate is fixed at 3 CPH (standard compressor setting)
- Minimum off-time for the compressor in the cooling mode. Protects and extends the life of the equipment
- Decorative cover plate is available to cover marks on the wall or to mount the T8775 Thermostat to an electrical box
- Premier White®



T8775A



T8775C

Part #	Mfg #	Application	Terminal Designations	Notes:	Price
099892	T8775A1009	1-Stage Heat Only, Gas or Oil; 2-Wire	R,Rc,W,Y,G,O,B		
074622	T8775C1005	1 Heat/1 Cool Heat Pump, No Aux Heat Changeover	R,Rc,W,Y,G,O,B	Manual	

FocusPRO® 5000 Non-Programmable Digital Thermostats

- Electronic control of 24VAC, heating and cooling systems or 750mV heating systems
- Clear back light display available with large (2.98 sq in) or standard (1.95 sq in) screen
- Precise comfort control +/- 1°F of your set temperature
- Temperature control range stops
- Soft-key, simplified controls
- Easy change battery door - flips out without disassembling thermostat
- Automatic/manual selectable changeover
- Dual-powered, battery or hardwired
- Built-in compressor protection: minimum-off timer protects compressor from restarting too early after a shutdown
- Temperature range:
 - Heat: 40° to 90°F
 - Cool: 50° to 99°F
- Dimensions: 3-7/16"H x 4-1/2"W x 1-5/16"D
- Premier White®



Standard



Large Display

Part #	Mfg #	Application	Terminal Designations	Screen	Price
079592	TH5110D1006	1 Heat/1 Cool	R,Rc,C,W(O/B),Y,G	Standard	
079593	TH5110D1022	1 Heat/1Cool	R, Rc, C, W(O/B), Y, G	Standard	
084587	TH5220D1003	2H/2C Conv, 2H/1C Heat Pump	Rc,R,W(O/B),W2(AUX),Y,Y2,(E),G,L,C	Standard	
098663	TH5220D1029	2H/2C Conv, 2H/1C Heat Pump	R,Rc,W(O/B),W2 (AUX),Y,Y2,(E),G,L,C	Large	
105599	TH5320U1001	2H/2C Conv, 3H/2C Heat Pump	R,Rc,W(O/B),W2(AUX/E),Y,Y2,G,L,C	Large	

Thermostats

PRO® 3000 Basic Non-Programmable Digital Thermostats

- Electronic control of 24VAC, heating and cooling systems or 750mV heating systems
- Digital back light display - both current and set temperature are easy to read
- Precise comfort control (+/- 1°F)
- Easy slide switches allow selection of heat or cool mode and fan operation
- Manual changeover
- Dual-powered, battery or hardwired
- Temperature range:
 - Heat: 40° to 90°F
 - Cool: 50° to 99°F
- Dimensions: 3-13/16"H x 5-3/8"W x 1-1/4"D
- Premier White®



Part #	Mfg #	Application	Terminal Designations	Price
186398	TH3210D1004	Up to 2 Heat/ 1 Cool Heat Pump Systems	R, Y, AUX, E, G, O, B, L, C	

PRO® 1000 Builder Series Non-Programmable Digital Thermostats

- Electronic control of 24VAC, heating and cooling systems or 750mV heating systems
- Perfect for multi-family housing developments or apartment complexes
- Clear, back light digital display
- Manual changeover
- Simple-set programming
- Dual-powered, battery or hardwired
- Temperature range:
 - Heat: 40° to 90°F
 - Cool: 50° to 99°F
- Dimensions: 4-11/16"H x 2-7/8"W x 1-1/8"D
- Premier White®



Part #	Mfg #	Application	Mount	Terminal Designations	Price
162924	TH1100DV1000	Heat Only	Vertical	R, C, W	

PRO 1000 Vertical Non-Programmable Thermostat

- Vertical mount
- Switch positions: HEAT-OFF-COOL
- Dual Powered: Battery or Hardware
- Terminal Designations: R, RC, C, W, Y, G, O, B
- Manual changeover



Part #	Mfg #	Description	Price
211713	TH1110DV1009	1H/1C Conventional, Heat Pumps with No Auxiliary Heat	

Thermostats

Low Volt Electric Heating (Ambient and Floor) Non-Programmable Manual Thermostat

- Three choices of temperature control in a single thermostat (Ambient, Floor, or Ambient with Floor temperature limits)
- 5 mA ground fault circuit interrupter (GFCI) on GA models
- 15 mA equipment ground fault protection devices (EGFPD) on GB models
- GFCI and EGFPD test light verifies safety control is functioning properly and alerts if a leak is detected
- Advanced temperature control ensures total comfort by minimizing temperature swings
- ON/STANDBY switch enables thermostat shutdown at the end of heating season for added security
- On-screen heating power indicator gives at-a-glance verification of power being used
- Backlit display
- Battery-free



Part #	Mfg #	Description	Price
129145	TH114-AF-024T/U	Easy-to-read backlit display, slim contemporary design and precise temp control	

T1 Pro Non-Programmable Thermostat

- For 24 Vac systems, single stage heat and cool systems
single stage heat pumps without aux heat
- UWP mounting system
- 20 to 30 Vac
- Up to 1 heat/1 cool heat pumps; up to 1 heat/1 cool conventional systems
- Battery or hardwired



Part #	Mfg #	Description	Price
253669	TH1110D2009/U	1H/1C Heat Pumps; 1H/1C Conventional systems	

Programmable Thermostats

Lyric Wi-Fi Thermostat

- Remote Access
- Lyric App allows you to control with your smart phone or tablet
- Geofence control for savings when you're away and comfort when you're home
- Fine Tune temperature control
- Smart Cues for system information and recommendations
- Programmable with Geofencing
- Hardwired, battery back-up, power transformation



Part #	Mfg #	Description	Price
223085	TH8732WFH5002	3 Heat/2 Cool Heat Pumps; Up to 2 Heat/2 Cool Conventional Systems	

Thermostats

Lyric™ T6 Pro Wi-Fi Thermostat

- Stages: up to 3 heat/2 cool heat pumps and 2 heat/2 cool conventional systems
- Includes thermostat, UWP mounting system, installation (j-box) adapter, small decorative plate, screws and anchors, installation guide, and user guide
- Programmability: 7 day, 5-1-1 day, 5-2 day, 1-week or non-programmable
- Geofence technology
- Optional wired indoor/outdoor sensors
- Electrical ratings & supply voltage: 20 to 30 vac
- Integrates with smart home Apple HomeKit and Amazon Alexa
- Dimensions: 4-1/16" long x 4-1/16" wide x 1-3/32" deep



Part #	Mfg #	Description	Price
228228	TH6320WF2003	3 Heat/2 Cool Heat Pumps; Up to 2 Heat/2 Cool Conventional Systems	

FocusPRO® 6000 5+2 or 5+1+1 Day Programmable Digital Thermostats

- Selectable to 5-1-1 (weekdays, Saturday, Sunday) or 5-2 (weekdays, weekend) programmable thermostat
- Large, clear, back light display - easy to read in various lighting conditions
- Display size options - available in large screen or standard
- Precise comfort control (+/- 1°F) - maintains consistent comfort to the highest level of accuracy
- Simplified programming and operation
- Easy change battery door - flips out without disassembling thermostat
- Built in instructions - simple, pull out instruction manual
- Adaptive Intelligent Recovery™ - ensures programmed temperature is reached by programmed time
- Temperature range stops - prevents user from setting the temperature too high or too low
- Temperature range:
 - Heat: 40° to 90°F
 - Cool: 50° to 99°F
- Dimensions: 3-9/16"H x 5-13/16"W x 1-1/2"D
- Premier White®
- 5-Year warranty



Large Display

Part #	Mfg #	Application	Terminal Designations	Screen	Price
084585	TH6110D1005	1 Heat/1 Cool	Rc,R,W(O/B),C,Y,G	Standard	
086938	TH6110D1021	1 Heat/1 Cool	Rc,R,W(O/B),C,Y,G	Large	
084586	TH6220D1002	2H/2C Conv, 2H/1C Heat Pump	Rc,R,W(O/B),W2(AUX),Y,Y2(E),G,L,C	Standard	
173731	TH6220D1028	2H/2C Conv, 2H/1C Heat Pump	R, RC, C, W(O/B), G, Y, W2(AUX, E, Y2-L	Standard	
135014	TH6320U1000	2H/2C Conv, 3H/2C Heat Pump	Rc,R,W(O/B),W2(AUX/E),Y,Y2,G,L,C	Large	

Thermostats

VisionPRO® 8000 Universal Touchscreen 7-Day Programmable Thermostats

- Electronic control of 24VAC, heating and cooling systems or 750mV heating systems
- Universal system compatibility, heating only or heating and cooling; conventional or heat pump systems
- Large back light on-screen menu
- Ability to select multiple days
- Real-time clock
- Armchair programming - allows you to remove thermostat from wall to set the schedule
- Multiple HOLD, lockout options
- Adaptive Intelligent Recovery™
- Programmable fan
- Auto or manual changeover
- Dual-powered, battery or hardwired
- Change reminders - reminds you to service or replace the air filter, humidifier pad, ultraviolet lamp or thermostat batteries
- Temperature range:
 - Heat: 40° to 90°F
 - Cool: 50° to 99°F
- Horizontal mounting, dimensions: 4-9/16"H x 6"W x 1-1/4"D
- Premier White®
- 5-Year warranty



Part #	Mfg #	Application	Terminal Designations	Notes:	Price
155766	TH8321R1001	3H/2C Heat Pump, 2H/2C Conv	R,RC,W,(O/B),W2(AUX),Y,Y2,L*,E,G,C,S1,S2	Dehumidity Control	
155765	TH8320R1003	3H/2C Heat Pump, 2H/2C Conv	R,RC,C,W-O/B,W2-AUX/E,Y,Y2,G,A-L/A,K,S1		
181757	TH8321WF1001	3H/2C Heat Pump, 2H/2C Conv	R,RC,W,(O/B),W2(AUX),Y,Y2,L*,E,G,C,S1,S2		

* The L terminal is an input or output

Thermostats

VisionPRO® 8000 with RedLINK™ Technology

- Thermostat works standalone or with the THM5421R1021 Equipment Interface Module or with the TrueZONE Wireless Adapter
- Smart Schedule - programs in seconds for any lifestyle
- Patented interview based programming and installer setup
- RedLINK™ wireless communication
- Customizable service reminders allow dealers to remind their customers when its time to call for service, when their warranty is expiring and to provide customized alerts.
- MicroSD port for copying the installer setup, customizable reminders, custom events and holidays to multiple thermostats.
- 1 assignable output on the TH8321 model to control humidification, dehumidification, ventilation or a stage of heating/cooling.
- 3 assignable outputs on the Equipment Interface Module to control humidification, dehumidification, ventilation or a stage of heating/cooling
The TH8110 and TH8320 models require the use of a wireless indoor sensor to control humidification and dehumidification
- 1 assignable input can be used with a wired outdoor, indoor or discharge sensor
- 4 assignable inputs on the Equipment Interface Module can be used with wired outdoor, indoor or discharge sensors, occupancy sensor for remote setback and dry contact devices to trip pre-packaged or custom alerts such as a full drain pan or water leak
- Extend wireless range of the Equipment Interface Module by connecting a THM4000R1000 Wireless Adapter to the ABCD terminals
- Dual powered - battery or hardwired (C wire)
- Precise temperature control (+/- 1° F) for reliable and consistent temperature
- Multiple staging options to provide comfort or energy savings



Part #	Mfg #	Application	Terminal Designations	Notes:	Price
155764	TH8110R1008	1H/1C Conv and Heat Pump	R, RC, C, W-O/B, Y, G, K, S1 S1		

VisionPRO® 8000 with RedLINK™ Technology - Kit

- Includes:
 - RedLINK™ Internet Gateway
 - Portable Comfort Control
 - Wireless Outdoor Sensor
 - Wireless Indoor Sensor
 - Wireless Entry/Exit Remote
 - Wireless Vent
 - Filter Boost Remote



Part #	Mfg #	Description	Price
173007	YTH8321R1002/U	3H/2C Heat Pump, 2H/2C Conv R,RC,C,W-O/B,W2-AUX/E,Y.Y2,G,A-L/A,K,U1,S1	

LineVolt™ TH450/U Electric Manual Thermostat

- Electric heating, baseboard heater, convector or fan-forced heater
- Battery-free, min & max temperature locks
- Minimum Load: 1.25 A (resistive only) 300 W @240 Vac, 150 W @ 120 Vac, Maximum Load: 16.7 A (resistive only), 4000 W @ 240 Vac, 2000 W @ 120 Vac
- Temp range: 40 F to 85



Part #	Mfg #	Description	Price
181190	TH450/U	Line Voltage T-Stat, Non-Programmable	

Thermostats

T6 Pro Series Programmable Thermostat

- 24 Vac systems; Gas, Oil, Electric Warm Air; Hot water Coil; Gas, Oil, Electric Hydronic; or Steam / Gravity Systems
- Includes:
 - Thermostat
 - UWP mounting system
 - Installation (J-box) adaptor
 - Small decorative cover plate
 - Screws and anchors
 - Installation Guide & User Guides
 - 2 AA Batteries



Part #	Mfg #	Description	Price
228229	TH6320U2008/U	Up to 3 Heat/2 Cool Heat Pumps; Up to 2 Heat/2 Cool Conventional Systems	
228231	TH6210U2001/U	Up to 2 Heat/1 Cool Heat Pumps; Up to 1 Heat/1 Cool Conventional Systems	
228230	TH6220U2000/U	Up to 2 Heat/1 Cool Heat Pumps; Up to 2 Heat/2 Cool Conventional Systems	

PRO® 4000 5+2 Day Programmable Digital Thermostats

- Electronic control of 24VAC, heating and cooling systems or 750mV heating systems
- Weekday/weekend programming to fit your lifestyle
- Clear, back light display
- Precise comfort control +/- 1°F of your set temperature
- Easy slide switches allow selection of heat or cool mode, and fan operation
- Dual-powered, battery or hardwired
- Manual changeover
- Built-in instructions - simple, pull out instruction manual
- Adaptive Intelligent Recovery™ - ensures programmed temperature is reached by programmed time
- Temperature range:
 - Heat: 40° to 90°F
 - Cool: 50° to 99°F
- Dimensions: 3-13/16"H x 5-3/8"W x 1-1/4"D
- Premier White®



Part #	Mfg #	Application	Terminal Designations	Price
096358	TH4110D1007	1 Heat/1 Cool Conv & Heat Pump	Rc,R,W,Y,G,O,B,C	
199720	TH4210D1005	2 Heat/1 Cool Heat Pump	R, Y, AUX, E, G, O, B, L, C	

LineVoltPro™ 8000 Programmable Electric Heat Only Thermostats

- Use for electric baseboards, convectors and fan forced heaters (resistive rated loads)
- 7-Day preprogrammed schedule or modify programming to suit your lifestyle
- On-demand back light
- On/off switch and visible heat indicator
- Electrical rating: 15.0A
- 4-Wire/DPST Switching action



Part #	Mfg #	Description	Price
144533	TL8230A1003	7-Day Programmable Electric Heat, Premier White®	

Thermostats

Thermostat Accessories

Cover Plate Assembly For Use With Lyric T6 Pro, T6 Pro, T4 Pro, and T1 Pro Thermostats

- 6-7/64" x 6-7/64"
- Square mounting with two screw holes
- Includes small & large cover plate, one bracket & mounting hardware
- Use to cover marks on wall or mount thermostat to a 2" x 4" electrical box

Part #	Mfg #	Description	Price
232739	THP2400A1068	Cover Plate Assembly	

Universal Thermostat Guard

- Tamper-resistant lock; key cannot be removed unless in locked position
- Vents in guard base allow airflow

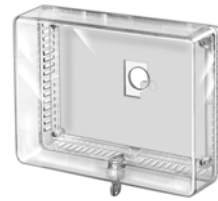

TG511A /TG512A

Part #	Mfg #	Description	Price
006787	TG511A1000	Fits Series TH3000, TH4000, TH5000, TH6000, TH8000 & Similar 6-1/2"H x 7-1/2"W x 2-15/16"D	
006788	TG512A1009	Fits Series TH5000, TH6000, TH8000 & Most Electronic Thermostats 7-1/4"H x 9-3/4"W x 3-3/8"D	

Coverplate Assembly for Prestige® 2-Wire IAQ Thermostat

- Use to cover marks on the wall or to mount the thermostat to a 2 in. X 4 in. electrical box. Includes a small and large cover plate, one bracket and mounting hardware

Part #	Mfg #	Description	Price
209854	THP2400A1027W	Used with: THX9421R5021WW Prestige® 2-Wire IAQ Thermostat	

Coverplate Assembly for VisionPRO® Series Thermostats

- 7-7/8" x 5-1/2"
- Premium White®



Part #	Mfg #	Description	Price
078078	32003796-001	Used with: TH8000 VisionPRO® Series Thermostats	

Thermostats

Wall Plate for 8000 Series Thermostat

- Includes bracket and mounting hardware
- Use to cover marks on wall or mount thermostat to a 2" x 4" electrical box



Part #	Mfg #	Description	Price
170430	THP2400A1019/U	Wall Plate for 8000 Series Thermostat	

Wire Saver C-Wire Adapter

- For use with Wi-Fi thermostats or RedLINK 8000 Series models
- Acts as a splitter for applications that do not include a 24-volt C wire



Part #	Mfg #	Description	Price
246383	THP9045A1098	Replaces the need for a C wire (common wire) to power a thermostat	

Wireless Thermostat Systems & Accessories

Prestige® IAQ Comfort System

- 4 Heat/2 cool heat pump or up to 3 heat/2 cool conventional
- Powered by RedLINK™ reliability
- Wireless outdoor sensor
- Large back-lit color display shows current indoor temperature, humidity, temperature setting, date and time on the home screen (also displays outdoor temperature and humidity on home screen if wireless outdoor sensor is installed)
- Automatic daylight savings update
- Auto or manual changeover
- Change reminders for air filter, humidifier pad, ultraviolet bulb or batteries in connected devices
- 7-Day multiple day programming or non-programmable
- Humidity and dehumidity control
- 18 to 30VAC
- Arctic white



Part #	Mfg #	Description	Price
155759	YTHX9421R5101W	Prestige HD IAQ Thermostat, Equipment Interface Module	
155758	YTHX9421R5085W	Prestige HD IAQ Thermostat, 2-Wire Comfort System Kit White Front/White Sides	
174482	YTHX9421R5085W	Prestige HD IAQ Thermostat, 2-Wire Comfort System Kit White Front/Gray Sides	
155761	THX9421R5021WW	Prestige HD IAQ Kit, w/ 2 Sensor 7-Day Programmable	
223119	YTHX9421R5127W	Prestige HD IAQ Kit, w/ RedLINK, 2-Wire Touchscreen, Interface Module, & Return Sensors	

Thermostats

D6 Pro Wi-Fi Ductless Controller

- Compatible with most major brands and models
- Wi-Fi communication
- Infrared range to ductless unit in line of sight is 30 ft.
- Programmable (through app) for a time based 7 day, 5-2 day, or 1-week programs, or non-programmable, or GeoFence with sleep periods
- D6 control can sit on the tabletop stand (included) or be mounted to a wall using the adhesive strips (included)
- 5-year warranty
- Powered from USB cable (included) or wall plug (included). Plugs into 120 volt AC wall outlet



Part #	Mfg #	Description	Price
246382	DC6000SF1001	D6 Pro Wi-Fi Ductless Controller	

Honeywell IAQ Equipment Interface Module

- 4 Sensor inputs for wired sensors or dry contact devices
- 3 Sets of IAQ contacts to control humidification, dehumidification, and ventilation
- Used with all versions of Prestige IAQ thermostats and RedLINK™ VisionPRO thermostats
- 4 Heat/2 cool heat pump
- 3 Heat/2 cool traditional



Part #	Mfg #	Description	Price
163861	YTHM5421R1010	Prestige 2-Wire IAQ Equipment Interface Module Kit w/ 2 Duct Sensors	
155767	THM5421R1021	3 Universal IAQ Contacts to control Humidification, Dehumidification, or Ventilation	

Wifi Heat and Cool Thermostat

FocusPRO® Thermostat Kit with RedLINK Internet Gateway

- Includes:
 - C7735A1000 Return Air Sensor
 - THM5320R1000 Equipment Interface Module
 - THM6000R1002 RedLINK Internet Gateway
 - (YTH6320R1114/U has TH5320R1002 Thermostat)
 - (YTH6320R1122/U has TH6320R1004 Thermostat)
- 3 Heat/2 cool heat pump or up to 2 heat/2 cool conventional



Part #	Mfg #	Description	Price
174483	YTH6320R1114/U	Includes TH5320R1002 Wireless Non-Programmable FocusPRO® Thermostat	
174484	YTH6320R1122/U	Includes TH6320R1004 Wireless 5+1+1 Programmable FocusPRO® Thermostat	

Thermostats

FocusPRO® Wireless Thermostat Kit

- Powered by RedLINK™ reliability
- Can display outdoor temperature and humidity
- 1-Year battery life, 2-month low battery warning



YTH5320R1000



YTH5320R1017

Part #	Mfg #	Description	Price
119159	YTH5320R1000	Includes TH5320R1002 Wireless Non-Programmable FocusPRO® Thermostat	
119158	YTH5320R1017	Includes TH5320R1002 Wireless Non-Programmable FocusPRO® Thermostat	
119161	YTH5320R1025	Includes TH5320R1002 Wireless Non-Programmable FocusPRO® Thermostat	
119090	YTH6320R1001	Includes TH6320R1004 Wireless FocusPRO® 5+1+1 Programmable Thermostat	
119089	YTH6320R1015	Includes TH6320R1004 Wireless FocusPRO® 5+1+1 Programmable Thermostat	

Wi-Fi 9000 with Voice Control

- Change temperature with Voice Control (English only)
- Get Connected – Connect to homes existing Wi-Fi network
- Remote Control – Convenience, comfort and control from anywhere through web, tablet or smartphone access
- App available for tablet and smartphones
- Automatic software updates through Wi-Fi
- Selectable to 7 Day or Non-Programmable
- Program thermostat locally or over the web or app
- Customize the screen color to match any décor



Part #	Mfg #	Description	Price
167150	TH9320WVF	7-Day Program or Non-Programmable, Up to 2H/2C Conv or 3H/2C Heat Pump	

Wi-Fi 9000 Color Touchscreen Thermostat

- Get Connected – Connect to home's existing Wi-Fi network
- Remote Control – Convenience, comfort and control from anywhere through web, tablet or smartphone access
- Apps available for tablet and smartphones
- Automatic software updates through Wi-Fi
- Selectable to 7 Day or Non-Programmable
- Program thermostat locally or over the web or app
- Customize the screen color to match any décor
- TH9320WF5003 is ENERGY STAR® Certified



Part #	Mfg #	Description	Price
163964	TH9320WF5003	7-Day Program Or Non-Programmable, Up to 2H/2C Conv or 3H/2C Heat Pump	

Thermostats

Wireless FocusPRO® Thermostat

- Compatible with gas, oil, electric, heat pump, forced warm air, hot water, steam or gravity
- Easily add a zone to a TrueZONE™ system without running new wires
- Powered by RedLINK™ reliability
- No interference with other wireless devices in the home
- Works with compatible RedLINK™ enabled devices
- Same great features of the FocusPRO® thermostat now wireless
- Installs in minutes
- Can display outdoor temperature and humidity (if wireless outdoor sensor is installed)
- Battery powered only
- 1-Year battery life, 2-month low battery warning
- Premier White®



TH5320R1002



TH6320R1004

Part #	Mfg #	Description	Price
119160	TH5320R1002	Non-Programmable, Up to 3 Heat/2 Cool Heat Pump or Up to 2 Heat/2 Cool Conventional	
119091	TH6320R1004	5+1+1 or 5+2 Day Programmable, Up to 3 Heat/2 Cool Heat Pump or Up to 2 Heat/2 Cool Conventional	
154516	TH6320WF1005	7-Day Program, Up to 3Heat/2 Cool Heat Pump or Up to 2 Heat/2 Cool Conventional	

Wireless Outdoor Temperature Sensor

- Powered by RedLINK™ reliability
- No interference with other wireless devices in the home
- Reliable performance in all climates
- Installs in minutes
- Up to 5-years battery life, 2-month low battery warning
- Battery warning displayed on RedLINK™ enabled thermostats
- Includes (2) AA Lithium batteries and mounting hardware



Part #	Mfg #	Description	Price
120395	C7089R1013	Wireless Outdoor Sensor, Senses Outdoor Temperature and Humidity, RedLINK™	

Personal Comfort Station™

- Works in both zoned and non-zoned applications
- Powered by RedLINK™ reliability
- Built in pager with an audible noise helps locate the device in the home
- Battery powered
- Touchscreen interface with back light display
- Can display outdoor temperature and humidity



Part #	Mfg #	Description	Price
120396	REM5000R1001	Portable Comfort Station Control, RedLINK™ Enabled	

Thermostats

RedLINK™ Equipment Remote Module Kit

- Wireless RedLink™ communication between condensing unit/compressor or boiler and thermostat
- Eliminates the need to run additional wires to your equipment, for example, during a heat pump upgrade
- Suitable for outdoor use
- Temperature sensor terminals for outdoor temp sensors or indoor freeze protection
- LEDs for easy installation checkout
- May reduce damage to homes since wiring/drilling is eliminated



Part #	Mfg #	Description	Price
220491	YERM5220RVPEIM	Includes: Equipment Remote Module (ERM) (ERM5220R1018), VisionPRO 8000 (TH8321R1001), and Equipment Interface Module (EIM) (THM5421R1021)	

RedLINK™ Equipment Remote Module

- Wireless RedLink™ communication between condensing unit/compressor or boiler and thermostat
- Eliminates the need to run additional wires to your equipment
- Suitable for outdoor use
- Temperature sensor terminals for outdoor temp sensors or indoor freeze protection
- LEDs for easy installation checkout
- May reduce damage to homes since wiring/drilling is eliminated
- Erm is NOT compatible with RedLink Zone Boards



Part #	Mfg #	Description	Price
189864		Suitable for outdoor use. Wireless RedLink™ communication between condensing unit/compressor or boiler and thermostat	

RedLINK™ to Internet Gateway and Ethernet Cable and Power Cord

- 20-30 Vac
- 24 Volt plug in transformer
- 5Vdc, 1000mA power adapter
- 902-928 MHz frequency
- Includes 3' ethernet cable



Part #	Mfg #	Description	Price
240373	THM6000R7001/U	4Heat/2Cool Heat Pumps	

RedLINK™ Internet Gateway

- Provides remote access to any RedLINK® enabled thermostat through the internet, smart phone or tablet
- Includes 3' Ethernet cable and plug-in power adapter
- Operating temperature: 32° to 120°F



Part #	Mfg #	Description	Price
143270	THM6000R1002	Up to 4 Heat/2 Cool Heat Pumps	

Thermostats

RedLINK™ Wireless Indoor Air Sensor

- Used to change the sensing location of the thermostat
- Works with RedLINK™ 2.0 thermostats
- Sense temperature and humidity remotely
- Control temperature and humidity in separate locations
- Humidify and dehumidify in separate locations
- Up to (6) wireless sensors per thermostat
- Dimensions: 2-7/8"H x 1-7/8"W x 15/16"D
- Operating temperature: 0° to 120°F
- Includes:
 - (2) AAA Batteries
 - Mounting hardware



Part #	Mfg #	Description	Price
143274	C7189R1004	RedLINK™ Wireless Indoor Sensor	

TrueIAQ™ Total Home Comfort System

- Manages humidification, dehumidification, ventilation and bathroom fans from a central point in your home
- Setting changes can be made easily with the touch of a button
- Simultaneously displays both indoor and outdoor temperature and humidity
- y levels on-screen
- Automatically adjusts inside settings based on outdoor conditions
- Include individual air quality enhancements to your system with TrueIAQ™, or integrate them all as part of a total air quality system
- Intuitive digital back light display.



Part #	Mfg #	Description	Price
111238	DG115EZIAQ	Steam Type, 120VAC, Duct or Remote Mount with Outdoor Temperature/Humidity Sensor, White	

Sensors

C7089 Remote Outdoor Temperature Sensor

- Senses outdoor temperature for display; can manage dual-fuel and lock-out auxiliary heat in heat pump applications
- Maximum wire run of 200'
- Includes 60" lead wire, mounting clips and screws
- Dimensions: 2-1/4" x 3/8" with 60" lead wire
- Factory calibrated



Part #	Mfg #	Description	Price
078072	C7089U1006	For VisionPRO® & VisionPRO® IAQ Thermostats	

Thermostats

PT1000 Duct TempSensor

- Electronic temperature sensors used with DDC systems
- PT1000 Tempensor, 6" insertion
- Use w/ T775, operating range -40-250FPT1000 TempSensor



Part #	Mfg #	Description	Price
190400	C7031B2005/U	For Duct, Use with Excel 10, 50, 80, 100, 500, T775 Series 2000	

C7041 Immersion Sensor

- 20K ohm NTC temp sensor, 5 in. insertion
- Immersion sensor for hot or chilled water, purchase well 50001774-001 separately



Part #	Mfg #	Description	Price
190399	C7041D2001/U	For Excel 10, 50, 80, 100, 500	

Outdoor Air Temperature Sensor

- Electronic temperature sensors used with DDC systems
- 1715 ohm, for use with W7100 (outdoor reset)
- Outside air temperature



Part #	Mfg #	Description	Price
190401	C7031G2006/U	1715 ohm Outdoor Air Temperature Sensor, for use with W7100	

Discharge Temperature Sensor

- Primary and/or secondary sensors in electronic control systems
- No settings or calibration required.
- Solid state components not affected by dust or dirt.
- Fast reacting.
- Rugged aluminum insertion probe.
- Mounts on duct or plenum surface with integral mounting flange, or in a 2 x 4 in. junction box.



Part #	Mfg #	Description	Price
190397	C7046D1008/U	1097 ohm @ 77 F PTC, Excel 600, Excel 500, Excel 100, Excel 80, and T775 Series 2000	

Thermostats

Slab/Floor Sensor for use with AQ1000 Series Thermostats

- Sensor-- -58 F to +230 F



Part #	Mfg #	Description	Price
134580	AC12C20	Slab/Floor sensor for use with AQ2000 series control panels & AQ1000 series thermostats	

C7189 Remote Indoor Sensor

- Mounts in living space up to 200' away from W8900 remote module



Part #	Mfg #	Description	Price
078076	C7189U1005	For VisionPRO and VisionPRO IAQ Thermostats	

Water Leak Freeze Detectors and Sensor Cables

- 4-Pack
- Place near sinks, washers, water heaters, sump pumps—anywhere leaks could happen
- Battery life lasts up to 3 years without incident
- Notification messages can alert you or your family/ friends, while audible (100 dB alarm) alerts sound when you are at home
- Use to detect temperatures that can freeze pipes, and humidity
- Runs on WiFi - No Extra Hub or hardware purchase required
- Daisy chain extra cable sensors and cover up to 500 feet of space with one leak detector
- Five year warranty for professionally installed devices



Part #	Mfg #	Description	Price
234359	YCHW4000W4004	Sold in Packs of 4. 3-1/16" Square x 1-1/4" high for each detector	

Lyric C1 Wi-Fi Security Camera

- Allows the user to keep an eye on their home or business while they are away
- Intelligent sound detection
- High definition wide angle view
- Adjustable alert zones
- Cloud and SD storage
- Night vision
- Two-way talk



Part #	Mfg #	Description	Price
236992	CHC8080W1000/U	Compatible with Lyric App for iPhone, iPad and Android	

Commercial Thermostats

Programmable Commercial Thermostats

TL8100 Hydronic 7-Day Programmable Electronic Thermostat

- Controls 2- or 3-way zone valves or circulator pumps in both line and low volt
- Special protection modes to prevent system seizures and reduce call backs
- Easy to install
- Millivolt compatible
- Electrical ratings: maximum load: 5A (resistive), 2A (inductive) @ 24VDC, 120VAC and 240VAC



Part #	Mfg #	Description	Price
128315	TL8100A1008	Programmable Electronic Thermostat, White	

T4 Pro Programmable Thermostat

- Stages: up to 1 heat/1 cool heat pumps or 1 heat/1 cool conventional systems
- Includes thermostat, UWP mounting system, installation (j-box) adapter
- Programmability: 7 day, 5-1-1 day, 5-2 day, or non-programmable
- Electrical ratings: 20 to 30 vac
- Dimensions: 4-1/16" long x 4-1/16" wide x 1-3/32" deep



Part #	Mfg #	Description	Price
233821	TH4110U2005/U	Programmable Electronic Thermostat, White	

Lyric T6 Pro Wi-Fi Programmable Thermostat

- Stages: up to 2 heat/1 cool heat pumps or 2 heat/2 cool conventional systems
- Includes thermostat, UWP mounting system, installation (j-box) adapter, small decorative cover plate, screws & anchors, installation guide, user guide, and 2 AA batteries
- Programmability: 7 day, 5-1-1 day, 5-2 day, 1 day, geolocation or non-programmable
- Electrical ratings: 20 to 30 vac
- Dimensions: 4-1/16" long x 4-1/16" wide x 1-3/32" deep



Part #	Mfg #	Description	Price
228227	TH6220WF2006	T-Series Wi-Fi Programmable Thermostat, White	

Commercial Thermostats

Line Voltage Commercial Thermostats

T451 Medium-Duty Line Voltage Commercial Thermostat with Thermometer

- SPST Switching action, makes on temperature fall, breaks on temperature rise
- Heating application
- Control line voltage on valves, motors, contactors, electric heat elements, duct furnaces and fan coil units
- Mounts on standard vertical or horizontal outlet box
- Includes vertical scale plate with thermometer and high accuracy dual diaphragm sensor
- Dimensions: 4-1/2"H x 2-15/16"W x 1-1/2"D (switches and wiring terminals protrude into outlet box 3/4")
- Champagne gold faceplate with beige cover



Part #	Mfg #	Temp Setting	Description	Price
065237	T451A3005	44° - 86°F	Range Stops, Locking Cover Screws & Wall Plate	

T631A-C Farm Controller

- Provides line voltage control of heating, cooling and ventilating systems in farm buildings or storage areas
- Light-duty line volt thermostat, 2°F fixed differential
- Treated to resist corrosion



Part #	Mfg #	Description	Price
006794	T631A1006	Farm-O-Stat, 35° - 100°F, SPDT Snap Switch, Red	

Winter Watchman

- Used as freeze warning device
- Completes circuit to household lamp on temperature fall, indicating inoperative heating equipment



Part #	Mfg #	Description	Price
006784	S483B1002	Winter Watchman Freeze Warning Device, 30° - 60°F, Adjustable	

Thermostat Accessories

Thermostat Cover Plate for FocusPRO® & PRO® Series

- Small cover plate: 4-5/16"H x 5-1/2"W
- Medium cover plate: 5"H x 6-7/8"W
- Large cover plate: 6"H x 8-5/16"W
- Premier White®

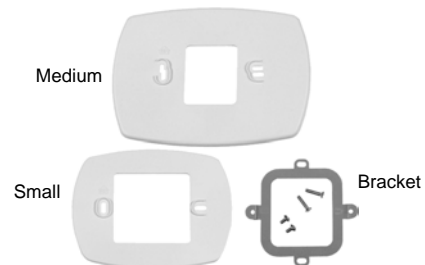

Part #	Mfg #	Description	Price
079594	50001137-001	For TH5110 Thermostat	

Commercial Thermostats

Thermostat Accessories (Continued)

Thermostat Cover Plate for FocusPRO® & PRO® Series

Part #	Mfg #	Description	Price
079595	50002883-001	For FocusPRO® 6000/5000, PRO® 4000/3000	

C2 Indoor Wi-Fi Security Camera

- Intelligent sound detection
- Adjustable alert zones
- Cloud and microSD storage
- Night vision
- Two-way talk
- 5V/2A power adaptor
- High definition wide angle view



Part #	Mfg #	Description	Price
240959	CHC8480W1013/ U	C2 Indoor Wi-Fi Security Camera	

Pro1 Thermostats

Pro1 Thermostats

- Separate heating and cooling swing adjustments
- Battery or 24V power
- 5-Year warranty

T700 Thermostat

- Blue back light with glow-in-the-dark light button
- Easy access battery compartment
- Electric or gas configurable
- Simple private label badge system
- Separate B & O terminals
- Easy wire color-coded terminal blocks
- Room temperature calibration adjustment
- 5-Minute compressor delay protection
- Universal sub-base
- Mounts on wall or junction box



T701/T771/T721



T705/T715



T755/ T755H

Part #	Mfg #	Stages	Programs	Description	Price
138686	T701	1 Heat/1 Cool	Non-Programmable	Single-Stage	
138687	T705	1 Heat/1 Cool	5+1+1	Single-Stage	
138688	T715	2 Heat/2 Cool	5+1+1	Multi-Stage	
219730	T721	2 Heat/1 Cool	Non-Programmable	Single-Stage	
148128	T755S	2 Heat/2 Cool	5+1+1	Multi-Stage	
138690	T755	3 Heat/2 Cool	5+1+1 or Non-Programmable	Heat Pump	
140228	T755H	3 Heat/2 Cool	5+1+1 or Non-Programmable	Universal	
138691	T771	1 Heat/1 Cool	Non-Programmable	Single-Stage	

T800 Thermostat

- Blue back light with glow-in-the-dark light button
- Easy access battery compartment
- Extra large, easy-to-read temperature display
- Electric or gas configurable
- Simple private label badge system
- Separate B & O terminals
- Easy wire color-coded terminal blocks
- Room temperature calibration adjustment
- 5-Minute compressor delay protection
- Universal sub-base
- Mounts on wall or junction box



Part #	Mfg #	Stages	Programs	Description	Price
138693	T805	1 Heat/1 Cool	5+1+1	Single-Stage	
138694	T855	2 Heat/2 Cool	7-Day or 5+1+1	Universal	
240777	T855S	3 Heat/2 Cool	7-Day or 5+1+1 or NP	Universal	
172146	T855I	2 Heat/2 Cool	7-Day or 5+1+1	Multi-Stage	

Pro1 Thermostats

T801 Thermostat

- Extra large, easy-to-read temperature display
- Auto Changeover
- 8 sq. inch display
- Blue Back-light
- Glow in the dark light button
- Separate B & O terminals
- Room temperature calibration adjustment
- 5 minute compressor delay protection (selectable on or off)
- Filter change indicator(selectable on or off)
- Simple private label badge system
- Easy wire color coded terminal blocks
- Universal sub-base
- Mounts on wall or junction box
- Battery or 24v power
- 5 year warranty



Part #	Mfg #	Stages	Programs	Description	Price
169127	T801	1 Heat/1 Cool	Non-Programmable	Single Stage	

T900 Thermostat

- Touchscreen with blue back light and glow-in-the-dark light button
- Auto changeover
- Easy access battery compartment
- Electric or gas configurable
- Filter change indicator
- Simple private label badge system
- Keypad lockout
- Separate B & O terminals
- Easy wire color-coded-terminal blocks
- Room temperature calibration adjustment
- 5-Minute compressor delay protection
- Universal sub-base
- Mounts on wall or junction box



Part #	Mfg #	Stages	Programs	Description	Price
138905	T925	3 Heat/2 Cool	7-Day or 5+1+1	Heat Pump	

Pro1 Thermostats

T955W Wireless Thermostat

- 13" Touchscreen display with blue back light and glow in the dark light button
- Set dual fuel balance points
- Connects up to 4 indoor remotes (R251W)
- Connects to outdoor remotes (R250W)
- Auto changeover
- Programmable fan
- Electric or gas configurable
- Heating and cooling setpoint limit
- Room temperature calibration adjustment
- 5 Minute compressor delay protection
- Mounts on junction box



Part #	Mfg #	Stages	Programs	Description	Price
159881	PD411093	3 Heat/2 cool	7-Day, 5+1+1 or Non-Programmable	Universal with Humidity Control	

Thermostat Accessories

Wireless Wire® Base Module

- Replaces 25V wire
- Input module: 7 terminal inputs and 2 terminal outputs
- Output module: 7 terminal outputs and 2 terminal inputs



Part #	Mfg #	Description	Price
138696	WW160W	Includes Both Input Base Module and Output Base Module	

Remote Temperature Sensor



Part #	Mfg #	Description	Price
138685	PD411070	Remote Indoor Sensor	
138683	PD411071	Remote Outdoor Sensor	
146724	PD411098	Remote Outdoor Sensor	

T119 Wall Plate

- 5-1/2" x 7-1/2"
- White
- Fits all Pro1 IAQ models



Part #	Mfg #	Stages	Programs	Description	Price
142069	PD411073	Wall Plate			

Protech Thermostats

Thermostats

500 Series High Definition Communicating Thermostat

- Universal choice of 7-day, 5/2 day programmable or non-programmable
- Dehumidification and humidification control
- Outdoor temperature display
- Intelligent scheduling ramp-up/program anticipation
- USB connection for uploading of programming and configuration
- Maintenance reminders
- Compressor short cycle protection
- 5-Year limited warranty



RHC-TST550CMM

Part #	Mfg #	Description	System	Type	Price
126929	UHC-TST550CMMS	2 Heat/2 Cool	Dual Fuel	Dehumidification & Humidification	

T701i WiFi Single Stage Thermostat

- 1 Heat 1 cool
- 4" sq. inch display
- Glow in the dark light button
- Universal sub-base
- Electric or gas configurable
- Easy wire color coded terminal blocks
- Programming optional through app
- Separate heating and cooling swing (cycle rate) adjustments
- 5-Minute compressor delay protection (selectable on or off)



Part #	Mfg #	Description	Price
177242	T7011	1 Heat/1 Cool Single Stage WiFi Thermostat	

EcoNET™ Smart Thermostat

- Built-In WiFi
- 4.3" LCD Touch Screen
- Amazon Alexa Compatible – Enables the use of voice commands to control the HVAC system with Amazon Echo or Echo Dot devices¹
- Local Weather – Current conditions plus 6-day forecast
- 5 Operating Modes – Heat, Cool, Auto, Emergency Heat and Fan Only
- 7-Day Programmable Schedule – Offers comfort without thought
- One-Touch Away – Quickly switch to your energy-saving away preferences
- Vacation Scheduling – Allows you to save while you're away and come home to comfort
- Motion Sensor – Automatically wakes the screen as you approach
- Standby Screen – Displays indoor temperature and current weather



Part #	Mfg #	Description	Price
250408	UETST700SYS	Compatible w/ select HVAC and Water Heating Products, and the new R96V Furnaces	

Protech Thermostats

EcoNet WiFi Kit

- *Enables remote operation*
- *WiFi Kit Components:*
 - EcoNet WiFi Module
 - Installation Instructions
 - V Power Adapter
 - Junction Box
 - 24" Port to Port Connection Cable
 - 1" x 2" Double Adhesive Mounting Tape
 - RJ12 Y Splitter (for use with communicating electric water heaters)



Part #	Mfg #	Description	Price
174498	REWRA630SYS	Works with any HVAC system which includes an EcoNet Enabled Furnace or Air Handler	



Ruud Thermostats

Thermostats

200 Series Universal Programmable Thermostat

- Universal choice of 7-day, 5+1+1 or 5+2 programmable or non-programmable
- 4 Time and 4 temperature settings per program (heat & cool)
- 4" Lighted blue display
- Permanent program retention
- Battery/hardwired



Part #	Mfg #	Description	System	Type	Price
131301	UHC-TST213UNMS	2 Heat/2 Cool	Universal (AC/HP/GE)	Multi-Stage	

300 Series Deluxe Programmable Thermostat

- Universal programming, choice of 7-day, 5+2 or non-programmable
- 12 Sq inch touchscreen display
- Larger, easy-to-read character size
- Keypad lockout option
- Dual power - hardwired or battery
- Easy, menu-drive programming
- Audio prompting to ensure program change confirmation
- Intuitive red/blue temperature keys
- 5-Year warranty from date of purchase



Part #	Mfg #	Description	Price
123952	UHC-TST305UNMS	4 Heat / 2 Cool Gas, Oil, Electric, Heat Pump, Dual Fuel	

400 Series Special Deluxe Programmable Thermostat

- Hardwired power source
- Lighted display



Part #	Mfg #	Description	System	Type	Price
124272	UHC-TST412MDMS	1 Heat/2 Cool	Dual Fuel	Multi-Stage	



Ruud Thermostats

500 Series Touchscreen Communicating Thermostat

- *Scrolling system status*
- *Dehumidification control*
- *Armchair programming allows users to remove thermostat from wall to set the schedule*
- *Outdoor temperature display*
- *Intelligent scheduling ramp-up/program anticipation*
- *Maintenance reminders*
- *Compressor short cycle protection*
- *5-Year limited warranty*



Part #	Mfg #	Description	System	Type	Price
131449	UHC-TST501CMM S	4 Heat/2 Cool	Dual Fuel	Dehumidification	

White-Rodgers Thermostats

Thermostats

Blue™ Series 6" Thermostats

- Heat pump dual fuel option (with or without outdoor sensor) eliminates the need for a fossil fuel kit on selected models
- Easy Reader model is easy to read and easy to use



Part #	Mfg #	Stages	Program	Control Range	Terminals	Price
199490	1F95EZ-0671	4Heat/2Cool	Non-Prog	45 to 99°F	RC, RH, C, W/E, W2, Y, Y2, O/B, G, L, 6	

80 Series® Blue 2" Thermostat

- 2" Wide LCD lighted screen
- Fossil fuel or electric heat compatible
- Dual powered, choice of battery or hardwired for all applications
- Easy push-connect color coded terminals
- Cool Savings™
- Dimensions: 3.8"H x 4.8"W x 1.5"D
- Classic white color
- 5-Year warranty



Part #	Mfg #	Stages	Program	Control Range	Terminals	Price
200231	1F80-0261	1Heat/1Cool	5+1+1	45 to 90°F	R, C, Y, W, G, O/B	
127608	1F86-0244	1 Heat/1 Cool	Non-Prog	45 to 90°F	R,C,W,Y,G,O/B	
200234	1F89-0211	2 Heat/1 Cool	Non-Prog	45 to 90°F	R, C, W2, Y, O/B, G, L	

80 Series® Universal Thermostat

- Attractive Sensi thermostat styling for non-wi-fi applications
- Universal (single stage, multi-stage, heat pump), conventional and heat pump models
- Bright, high contrast backlight
- Automatic heat/cool changeover option
- Keypad lockout and adjustable heat/cool temperature limits
- Built in dual fuel logic program eliminates the need for an outdoor sensor



Part #	Mfg #	Stages	Program	Control Range	Terminals	Price
227366	1F85U-42PR	2 Heat/2 Cool	7, 5+1+1, ∅	45 to 99°F	RC, RH, C, W/E, W2, Y, Y2, O/B/6, G, L	
220808	1F85U-42NP	4Heat/2 Cool	Non-Prog	45 to 99°F	RC, RH, C, W/E, W2, Y, Y2, O/B/6, G, L	
221337	1F85U-22PR	2 Heat/2 Cool	7, 5+1+1	45 to 99°F	RC, RH, C, W/E, W2, Y, Y2, O/B/6, G, L	
227365	1F85U-22NP	2 Heat/2 Cool	Non-Prog	45 to 99°F	RC, RH, C, W/E, W2, Y, Y2, O/B/6, G, L	
227364	1F83C-11PR	1Heat/1Cool	7, 5+1+1	45 to 99°F	RC, RH, C, W, Y, O/B, G	
227363	1F83C-11NP	1 Heat/1 Cool	Non-Prog	45 to 99°F	RC, RH, C, W, Y, O/B, G	

White-Rodgers Thermostats

80 Series® Classic Thermostat

- Conventional system 1H/1C



Part #	Mfg #	Stages	Program	Control Range	Terminals	Price
062261	1F86-344	1 Heat/1 Cool	Non-Prog	32 to 105°F	RC, RH, C, W, Y, O, B, G	

70 Series™ Digital Thermostat

- (-E) Economy series



Part #	Mfg #	Stages	Program	Control Range	Terminals	Price
195752	1E78-140	1Heat/1Cool	Non-Prog	45 to 99°F	RC, RH, W, Y, O, B, G	
195654	1E78-144	1 Heat/1 Cool	Non-Prog	45 to 90°F	RC,RH, W, Y,O, B, G	
194271	1F78-144	1Heat/1Cool	Non-Prog	45 to 90°F	RC,RH, W, Y,O, B, G	
195653	1E78151	1Heat/1Cool	5+2	45 to 90°F	RC,RH, W, Y,O, B, G	
194272	1F78151	1Heat/1Cool	5+2	45 to 90°F	RC,RH, W, Y,O, B, G	
194460	1F79111	2Heat/1Cool	Non-Prog	45 to 90°F	RC, C, Wx, E, Y, O/B, G, L	

Line Voltage Thermostat

- For Direct Control of Fan Coils, Fans, Motor Starters, Circulator Motors, Contactors, Valves for Heating and SPDT Applications
- Two dial stops for setting a maximum or minimum temperature. Minimum between 66 to 87°F. Maximum between 60 to 81°F.
- Thermostat mounts on 2" x 4" electrical box.
- Includes set point locking feature at 66°, 69°, 72°, 75°, 78° or 81°F
- Optional heating and cooling subbase S29-21 available



Part #	Mfg #	Description	Price
191149	1A10651	36 to 90°F, SPDT Switch Action, 1.5°F Differential	

White-Rodgers Thermostats

Light Duty Fan Coil Thermostat

- For Direct Control of Line Voltage Valves and/or Blower Motors on
- Fan Coil Units Featuring Manual Changeover from Heat to Cool and a 3-Speed Fan Switch, Subbase Included
- Mounts to a standard vertical outlet box or on a two-gang outlet box. May also be mounted on a 4"x 4" junction box with an adapter (not provided).
- Wiring color coded for ease of installation.
- 3-speed manual fan switch: High – Medium – Low.
- System Switch: Heat – OFF – Cool. "OFF" breaks both valve and fan circuits.



Part #	Mfg #	Description
210672	1A112	36 to 90°F, SPDT Switch Action, 1.5°F Differential

Line Voltage Baseboard Thermostat

- 1A66 types are a double-pole disconnect model with "OFF" position which mechanically breaks both sides of line.
- Electric Heat Thermostats Used for Controlling Baseboards, Cable Heat, Glass Panels, etc.



Part #	Mfg #	Description
191145	1A65641	40 to 85°F, Open on Rise, 1.0°F Switch Action
191146	1A66641	40 to 85°F, Open on Rise, 1.0°F Switch Action

Economy Mechanical Thermostat

- Rugged snap-action contacts.
- Adjustable heat anticipator.
- Bi-Metal thermometer.
- Heat / Cool model includes switching subbase.
- Heat / Cool model compatible with Electric Heat systems.



Part #	Mfg #	Stages	Program	Control Range	Terminals	Price
194088	1C20101	1 Heat	Non-Prog	50-90°F	R, W	
191147	1C26101	1 Heat/1 Cool	Non-Prog	50-90°F	RC, RH, W, Y, O, B, G, A	

White-Rodgers Thermostats

Mechanical Thermostat

- Mercury free snap-action contacts with dust cover.
- Resistant to vibration.
- Mounts to wall or junction box.
- Built in bimetal thermometer.
- Horizontal and Vertical models.
- 24 Volt, 750 mV and 3 - wire zone options.



Part #	Mfg #	Stages	Program	Control Range	Terminals	Price
198249	1E30N910	Heat Only	Non-Prog	50 to 90°F	R, W	
198248	1E56N444	Heat-Cool	Non-Prog	50 to 90°F	RC, RH, W, Y, O, B, G, A	

Line Voltage Digital Thermostat

- Line Voltage Digital Thermostats for Applications Covering 150W
- Up to 4000W. Choice of Programmable or Non-programmable
- Models. For Electric Baseboard, Convectors and Fan-Forced Heater
- Applications. 1E65-144 will Also Cover Radiant Floor and Ceiling
- Large LCD with great contrast for greater viewing.
- 100% silent operation with optional proportional control feature.
- Selectable anticipation for ultimate performance.
- Celsius or Fahrenheit compatible.



Part #	Mfg #	Description	Price
205606	1E65144	45 to 90°F, Open On Rise, 0.5°C Differential	

Blue 12" Touchscreen Thermostat

- Universal models quickly configure for single stage, multi-stage or heat pump and heat pump dual fuel systems - programmable or non-programmable.
- Humidity control offers humidification/dehumidification.
- Commercial offers occupied damper or economizer control.
- Staging control for nearly all conventional and heat pump systems.
- Single stage model compatible with all single stage systems low voltage, 750 mV and 3-wire zone systems.
- Heat Pump dual fuel option eliminates the need for a fossil fuel kit.
- Automatic changeover option.
- Program fan options.
- Keypad lockout and setpoint temperature limit options.
- Indoor remote sensor for averaging option.
- Outdoor remote sensor option. Add to Universal models for outdoor temp reading or, on select models, dual fuel balance point and outdoor thermostat functions.
- Dual power - hardwire and/or battery or Tripower—hardwire and/or battery with system assist.



Part #	Mfg #	Stages	Program	Control Range	Terminals	Price
198569	1F95-1291	Universal 7, 5+1+1, ∅		45 to 99 F	RC, RH, C, W/E, W2, Y, Y2, O/B, G, L, 6, +, S, -	
196546	1F95-1277	Universal 7, 5+1+1, ∅		45 to 99 F	RC, RH, C, W/E, W2, Y, Y2, O/B, G, L, 6, +, S, -	

White-Rodgers Thermostats

Sensi™ Wi-Fi Thermostat

- Installs and operates like a standard thermostat when not connected to Wi-Fi
- App changes color to show if the system is heating or cooling
- Compatible with Apple HomeKit, Amazon Echo and Wink
- Geofencing option and smart alerts
- Built-in dual fuel heat pump option



Part #	Mfg #	Stages	Program	Control Range	Terminals	Price
235884	1F87U-42WF	2Heat/2Cool	7 Day	50 to 99°F	RC, RH, C, W/E, W2, Y, Y2, O/B, G, L	

Sensi™ Touch Wi-Fi Thermostat

- Extensive Compatibility
- Easy to install
- Energy saving features
- Touchscreen color display
- Smart Home Compatible: integrates directly with Apple HomeKit, Amazon Alexa and Wink
- Smart Alerts: detects extreme temperatures and humidity levels to keep you informed
- Automatic Upgrades: as features are enhanced and released, Sensi thermostat software is kept up-to-date automatically
- Control from Anywhere: use the intuitive mobile app to set, change and program your home comfort from across the room or across the country
- Multi-Thermostat Control: using the Sensi online portal or mobile app, available on Apple and Android smart devices
- Indoor Humidity Sensor: for readings on the humidity levels in your home



Part #	Mfg #	Stages	Program	Control Range	Terminals	Price
235885	1F95U-42WF	2Heat/2Cool	7 Day	50 to 99°F	RC, RH, C, W/E, W2, Y, Y2, O/B/6, G, L	

Thermostat Accessories

90 Series Wired Indoor Remote Sensor

- Indoor Remote Sensor
- Compatible With ALL White-Rodgers Thermostats With Wired Indoor Remote Sensor Option



Part #	Mfg #	Description	Price
094177	F1451328	40 to 99°F Wired Indoor Remote Sensor	

Thermostat Wire

Genesis Cable

Mini Split Cable

- For mini-split systems
- Sunlight resistant
- RoHS Compliant PVC jacket
- 600V Direct burial
- Operating temperature: -4° to 194°F
- UL Listed



Part #	Mfg #	Description	Price
120933	MINIWIRE4	14 AWG 4/C Solid, 250' Spool	
177516	MINIWIRE4EZ	14 AWG 4/C Solid, 250' Spool	
209840	MSW14450	14 AWG 4Stranded, 50' Spool	

Jacketed Cables Shielded (Overall Shield) - CL2 Rated

- For wiring of thermostat controls, heating & air conditioning equipment, doorbells, and other low voltage applications
- Sunlight resistant
- Copper conductors, polypropylene insulation & polyvinyl-chloride jacket



Part #	Mfg #	Description	Price
131441	THERMWIRE6SHIEL	18 AWG 6/C Stranded OAS, 250'	

Jacketed Cables Overall Shield - CL2P Rated

- For wiring of burglar alarms, public address systems, intercoms, telephone stations, speakers, instrumentation, control and other low voltage circuits that are power-limited
- Sequential footage markings
- Twisted copper conductors, low smoke PVC insulation, aluminum/mylar shield, low smoke PVC jacket



Part #	Mfg #	Description	Price
224240	THERMWIRE2W	18 AWG 2/C Solid, 500' Spool	
010365	THERMWIRE2	18 AWG 2/C Solid, 500' Spool	
010366	THERMWIRE3	18 AWG 3/C Solid, 500' Spool	
222664	THERMWIRE3W	18 AWG 3/C Solid, 500' Spool	
010368	THERMWIRE5	18 AWG 5/C Solid, 250' Spool	
029999	THERMWIRE6	18 AWG 6/C Solid, 250' Spool	
222666	THERMWIRE8W	18 AWG 8/C Solid, 250' Spool	
030000	THERMWIRE8	18 AWG 8/C Solid, 250' Spool	
117899	THERMWIRE10	18 AWG 10/C Solid, 250' Spool	

Thermostat Wire

Jacketed Stranded Shielded (OAS) CM/CL2 (PVC) Cable

- 1000ft - 22/1pr
- Grey Jacket
- HVAC applications
- AWG: 22



Part #	Mfg #	Description	Price
155918	VRFCABLE	22 AWG CM/CL2, 1000'	

Stranded CL2P Rated Plenum Control Cable

- For wiring of burglar alarms, public address systems, intercoms, telephone stations, speakers, instrumentation, control and other low voltage circuits that are power-limited
- Available in 500 ft or 1,000 ft tangle-free boxes or spools



Part #	Mfg #	Description	Price
201661	THERMW184PLNM	18/4 Stranded Plenum 500' Roll	

Solid CL2P Plenum Thermostat Cable

- Braided ripcord
- Sunlight resistant except CL2P
- For use with all power-limited circuits
- For wiring of thermostat controls, heating and air conditioning equipment, doorbells, as well as other low voltage applications



Part #	Mfg #	Description	Price
094124	THERMWIRE4PL	18/4 Solid Plenum 250' Roll	
094125	THERMWIRE8PL	18/8 Solid Plenum 250' Roll	

Solid Thermostat CL2

- UL Standard 13; NEC Article 725
- Tubed jacket over untwisted insulated conductors
- Temperature Rating: -20 to 60 oC
- Operating Voltage: 300 Volts max.
- Capacitance: 25 pf/ft nom.
- Characteristic Impedance: 100 Ohms nom.
- DC Resistance: 6.5 Ohms/M' at 20oC
- Flame Rating: UL 1685 Vertical Tray



Part #	Mfg #	Description	Price
010367	THERMWIRE4	18 AWG 4/C Solid, 250' Spool	

Tracer Wire

- For water pipes, fiber optics, gas pipes, and dog containment systems
- Polyethylene insulation
- 600V Direct burial
- UL Listed

Part #	Mfg #	Description	Price
104923	TRACERWIREBLUE	12 AWG 1/C Solid, 500' Blue	



Thermostat Wire

Tracer Wire (Continued)

Part #	Mfg #	Description	Price
159042	TRACERWIREYELLO	500' Yellow	

Transformers

Transformers

AT72 NEMA Standard Transformer

- 24V Control circuit step-down transformer designed to power any 24V control system, including thermostats, gas valves and relays
- NEMA Type D, meets NEC Class 2 Not Wet, Class 3 Wet and UL 1585 requirements
- Color-coded lead wire for primary connections
- 9" Lead wire (primary)
- Combination mount can be foot-mounted, plate-mounted on 4 x 4", 4" octagon or 2" x 4" electrical boxes (transformer all above or 3/4 above plate) or clamp-mounted via a junction box knockout

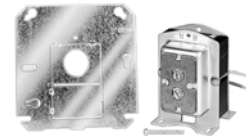

Part #	Mfg #	Output (100 % Factor)	Primary Voltage @ 50/60 Hz	Secondary Voltage (Open Circuit)	Mounting	Electrical Connections Secondary	Price
006714	AT72D1683	40VA	120V	26.5	Combination	(2) Screw Terminals	
006715	AT72D1691	40VA	208/240V	26.5	Combination	(2) Screw Terminals	

AT87 NEMA Standard Transformer

- Used primarily for powering 24V air conditioning circuits
- NEMA Type E, meets NEC Class 2 Not Wet, Class 3 Wet and UL 1585 requirements
- Overload protection provided
- Color-coded lead wire for primary connections
- 13" Lead wire, built-in protection, primary winding burnout

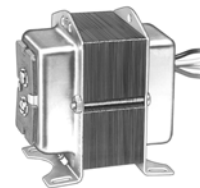

Part #	Mfg #	Output (100 % Factor)	Primary Voltage @ 50/60 Hz	Secondary Voltage (Open Circuit)	Mounting	Electrical Connections Secondary	Price
006717	AT87A1106	50VA	120/208/240V	26.5	Foot or 4" x 4" Plate	(2) Screw Terminals	

AT175A Class 2 General Purpose Transformer

- Color-coded lead wire for primary connections
- 9" Leads (primary)
- Screw terminal secondary
- UL Listed, CSA certified



AT140A



AT175A

Part #	Mfg #	Output (100 % Factor)	Primary Voltage @ 60 Hz	Mounting	Price
006713	AT140A1000	40VA	120V	Universal-Mount (Plate, Foot & K/O)	
098836	AT140A1018	40VA	120/208/240V	Universal-Mount (Plate, Foot & K/O)	
098838	AT175A1008	75VA	120/208/240V	Universal-Mount (Plate, Foot & K/O)	

Transformers

AT150F/AT175F Circuit Breaker Transformer

- 9" Leads on primary and secondary
- Includes circuit breaker button
- UL Listed, CSA certified

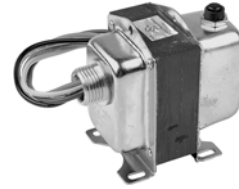

Part #	Mfg #	Output (100 % Factor)	Primary Voltage @ 60 Hz	Mounting	Price
120399	AT150F1022	50VA	120/208/240V	Conduit & Foot-Mount	



Transformers

Parts & Accessories

Transformer

Part #	Mfg #	Description	Price
107986	46-101496-01	120V-24V 40VA Fused Control Transformer (OEM Mount), Leads with 1/4" Insulated Female Quick Connects	
094838	46-101905-01	208/230V Primary 24V Secondary 40VA Transformer	
094839	46-101944-02	120V Transformer	
145468	46-102856-01	Transformer	
037653	46-22863-04	Transformer	
055227	46-23115-02	208/230V-24V 40VA Transformer (OEM Mount), Leads with Stripped Ends	
020764	46-25107-02	Transformer	
030177	46-25107-03	Transformer	
141189	46-25107-04	120/208/240V-24V 40VA Transformer (Channel Mount - 2-Hole), Leads with Stripped Ends	
141509	46-25107-12	120/208/230/460V-24V 75VA Transformer (Channel Mount - 2-Hole), Leads with Stripped Ends	
172658	46-102856-02	120V Primary 24V Secondary 50VA Transformer	

Universal Ignition Modules

Ignition Pilot Modules

Y8610U Universal Retrofit Intermittent Pilot Gas Burner Ignition System

- Complete kit for converting conventional standing pilot systems to intermittent pilot systems
- For use with 24VAC gas-fired atmospheric furnaces, boiler and heating appliances
- Includes:
 - S8610U Intermittent pilot module
 - VR8304M Dual valve combination gas control or VR8204A dual valve combination gas control
 - 392431 Igniter sensor
 - 394800-30 Ignition cable
 - 393691 Natural to LP gas conversion kit
 - Wiring harness
 - 393690-14 3/4" Straight flange kit
 - Reducer adapters for gas control with VR8304M
 - Installation hardware



Part #	Mfg #	Description	Price
021614	Y8610U6006	Y-Pack Containing S8610U3009 & VR8304M w/1/2" x 3/4" Inlet/Outlet, Flange Kit, LP Conversion Kit	

S8610U Universal Intermittent Pilot Module

- Field service replacement for most Honeywell, Robert Shaw, Johnson and UTEC (HSC) intermittent pilot ignition modules
- Provides electronic control of most intermittent pilot ignition systems used on gas-fired furnaces, boilers and other heating appliances
- For use in systems with combination igniter-sensor (single rod or dual rod sense)
- 100% Pilot gas shut-off and lockout on loss of pilot flame
- Includes relay contacts for use with any intermittent pilot gas control string with max 1.0A pilot or 2.0A main valve rating
- Honeywell VR8204, VR8304 or VR8345M combination gas control recommended
- Functional equivalent of S86, S8600, S8610 and S90 modules
- Includes spark cable adapters to allow field replacement of both Honeywell and competitive controls without replacing existing spark cable
- Includes damper connection and automatic vent damper plug



Part #	Mfg #	Description	Price
102849	S8610U3009	NG or LP Gas, 90 Second Trial for Ignition, 6-Minute Wait, Continuous Retry (Replaces S8610U1003)	

Universal Ignition Modules

S8910U Universal Hot Surface Ignition Module

- Provides operating control of a direct ignition system using 120VAC hot surface igniter
- Replaces most hot surface ignition modules manufactured by Honeywell, Robert Shaw and White-Rodgers
- Flame failure response time: 1.5 seconds
- For local (single rod) or remote (dual rod) rectification type flame sensing
- Provides (1) or (3) ignition trials (4-second or 7-second trials) per call for heat; pre purge of 32-seconds or less; up to 96-seconds between purge trial times
- Number of trials for ignition and trial time is determined by the selection tab. If a selection tab is not installed, the module will operate at 4-seconds trial time and (1) ignition trial
- Temperature range: -40° to 175°F



Part #	Mfg #	Description	Price
016077	S8910U1000	60 Hz Frequency	
229139	S89103000	50 Hz; 60 Hz Frequency	

S9200U Hot Surface Ignition Control

- Universal hot surface ignition integrated furnace control
- Controls a standard induction-type circulating fan motor
- Can be used with conventional thermostats as well as the EnviraCOM™ enable VisionPRO IAQ and FocusPRO
- Main burner ignition using a 120V hot surface igniter
- Flame rectification circuit to monitor flame presence
- Monitors system pressure switch, high temperature limit, and Rollout functions



Part #	Mfg #	Description	Price
110086	S9200U1000	Universal Integrated Furnace Control	

Universal Ignition Modules

**Pilot Ignition
Automatic Pilot Relight Kit**



Part #	Mfg #	Description	Price
044310	785-001	24/120V Includes Igniter Assembly & Mounting Bracket	

780-910 Universal Hot Surface Ignition Module Uni-Kit®

- Local or remote flame sensors
- 1 or 3 Ignition attempts
- 17 or 34 Second igniter warm-up time
- 34 seconds or less prepurge
- Natural or LP gas controls
- 120VAC



Part #	Mfg #	Description	Price
044309	780-910	100% Lockout/Complete Gas Shutoff if Main Burner Does Not Light After the Selected Trial f/Ignition Sequence Has Been Completed	

Wire Nuts & Leads

Wire Connectors

Screw-On Wire Connector

- Color-coded connector shells
- Heat resistant up to 221°F
- Resists practically all chemical action
- Unaffected by gasoline, oils, diluted acids and alkaline solutions



Part #	Mfg #	Description	Price
139015	8651	Blue, #22 - #14 AWG, Min 3 #22, Max 2 #16, 300V	
139016	8652	Orange, #22 - #14 AWG, Min 3 #22, Max 3 #16 & 1 #18, 600V	
139017	8653	Yellow, #18 - #12 AWG, Min 1 #14 & 1 #18, Max 2 #14 & 3 #16, 600V	

Wire Ties & Connectors

Wire Ties

Stainless Steel Wire Tie

Part #	Mfg #	Description	Price
140499	455060	7.5", 250 lb Tensile Strength, 50/Pk	
140500	455061	14.5", 250 lb Tensile Strength, 50/Pk	

Nylon Wire Tie

Part #	Mfg #	Description	Price
140502	455063	4" Natural, 100/Pk	
140503	455064	4" UV Black, 100/Pk	
140504	455065	5.5" Natural, 100/Pk	
140506	455066	5.5" UV Black, 100/Pk	
140507	455067	7.5" Natural, 100/Pk	
140508	455068	7.5" UV Black, 100/Pk	
140509	455069	11.5" Natural, 100/Pk	
140510	455070	11.5" UV Black, 100/Pk	
140513	455071	14.5" Natural, 100/Pk	
140514	455072	14.5" UV Black, 100/Pk	
140515	455073	7.5" UV Black, Screw Mount-Heat, 100/Pk	
179377	PD455068	7.5" UV Black, 100/Pk	

Zone Dampers & Accessories

Wifi Heat and Cool Accessories

TrueZONE™ Wireless Zoning Kit

- Includes TrueZONE panel, transformer and discharge air temperature sensor



Part #	Mfg #	Description	Price
111211	HZ311K	For Conventional, Single-Stage Applications up to (3) Zones	
111209	HZ322K	For Conventional & Heat Pump Applications up to (3) Zones (2 Heat/2 Cool)	
111207	HZ432K	For Conventional, Heat Pump or Dual Fuel Applications up to (3) Zones (3 Heat/2 Cool)	
202880	HZ221K	For Single Stage Heat Pumps w/ Auxiliary Heat Applications up to 2 Zones	

Wireless RedLINK™ Adapter

- Allows you to easily add RedLINK™ enabled thermostats to a TrueZONE™ system without running new wires



Part #	Mfg.#	Description	Price
129308	THM4000R1000	Add RedLINK™ Enabled Thermostats to a TrueZONE™ System	

TrueZONE™ Panel

- Universal application
- Robust push terminals
- Common-sense LED's
- Clean, professional installation
- Smaller footprint
- Auto changeover
- Variable-speed fan control
- Discharge air temperature compatible
- Resettable fuse
- Individual zone fan control



Part #	Mfg #	Description	Price
111206	HZ432	3 Heat/2 Cool Conv, Heat Pump or Dual Fuel, 4-Zone Expandable, Standard Checkout Procedure	

Zone Dampers & Accessories

Communicating Programmable Thermostats

VisionPRO® IAQ Communicating Touchscreen Digital 7-Day Programmable Thermostat

- Electronic control of 24VAC heating and cooling systems in addition to humidification, dehumidification and ventilation control with just 3 wires to the thermostat in conventional and heat pump systems
- 7-Day multiple day programming or non-programmable
- For use with W8835A Envirazone Panel and THM5421C1008 equipment interface module
- Eliminate the need for fossil fuel kit
- Clear back light display available in large or standard screen
- Precise Comfort control +/- 1°F of your set temperature
- Temperature range:
 - Heat: 40° to 90°F
 - Cool: 60° to 99°F
- Automatic/manual selectable changeover
- Premier White®
- 5-Year warranty



Part #	Mfg #	Description	Price
103348	TH9421C1004	Up to 3 Heat/2 Cool Conventional, up to 4 Heat/2 Cool in Heat Pump Mode	

Wifi Temperature Sensors

C7735A1000 Discharge Air Temperature Sensor

- Use with THM5320R1000 Equipment Interface Module; TH6320R1004 or TH5320R1002 Wireless FocusPRO® Thermostat
- Mount on return duct for backup control of non-zoned systems RedLINK™ enabled wireless systems
- Works with EIM to maintain safe indoor temperatures if power is lost at the wireless thermostat
- Operating temperature range: 0° to 200°F
- Dimensions: 3-7/8"H x 4-1/8"W x 1-1/4"D
- Gray



Part #	Mfg #	Description	Price
068726	C7735A1000	Discharge Air Temperature Sensor, Includes Mounting Hardware	

Zone Control Dampers

Automatic Round Damper

- Galvanized steel, single-blade damper
- Side or top motor mount
- Used with Honeywell zoning systems
- 24V, 60Hz, 2-Position motor type, (2) wires to motor



Part #	Mfg #	Size	Price
179708	ARD6TZ/U	6"	
179709	ARD8TZ/U	8"	
179704	ARD10TZ/U	10"	
179705	ARD12TZ/U	12"	

• Serving our Customers Since 1946 • www.plumbsupply.com

Zone Dampers & Accessories

Zone Control Dampers (Continued)

Automatic Round Damper

Part #	Mfg #	Size	Price
179707	ARD14TZ/U	14"	

Retrofit Round Damper

- Inserts into rigid round ducts for retrofit zoning in forced air heating and cooling
- Power open, power closed actuator draws 2.5 VA allowing multiple dampers per zone



Part #	Mfg #	Size	Price
104578	RRD6	6"	

TrueZONE® Bypass Pressure Regulating Damper

- Quick installation and setup
- No weight to adjust
- Can be installed in any orientation
- Engineered to provide constant system pressure regardless of changes in zones ceiling or blower speed



Part #	Mfg #	Size	Shape	Price
155823	CPRD8U	8"	Round	
155822	CPRD10U	10"	Round	
155824	CPRD12U	12"	Round	
155885	CPRD14U	14"	Round	

Zone Dampers & Accessories

ZD Series Damper

- Power close, spring open
- 24V Spring-return motor used to control circulating air in HVAC systems
- Used when a normally open damper is required, typically used with the TrueZONE™ systems and other electronic zoning damper systems
- Kevlar gearing reduces wear, more than doubling damper life
- Adjustable range stops
- Mechanical visual position indicator for damper status
- Solid construction using extruded aluminum frame and blades
- Parallel blade design for low leakage performance
- Quieter operation with fewer blades
- Simple, easy-to-wire, 2-wire installation
- Compatible with conventional and networked zoning
- Ordering Instructions: Order ZD + dimension 1 x dimension 2; note: motor is always mounted on dimension 2 side
- Damper can be installed in any orientation (mounting side can be on either the bottom or the side of the duct)



Part #	Mfg #	Size	Shape	Motor Mount	Price
179655	ZD8X8TZU	8" x 8"	Square	Side	
179656	ZD8X10TZU	8" x 10"	Rectangular	Bottom	
179657	ZD8X12TZU	8" x 12"	Rectangular	Bottom	
179658	ZD8X14TZU	8" x 14"	Rectangular	Bottom	
179659	ZD8X16TZU	8" x 16"	Rectangular	Bottom	
179660	ZD8X18TZU	8" x 18"	Rectangular	Bottom	
179661	ZD8X20TZU	8" x 20"	Rectangular	Bottom	
179662	ZD8X22TZU	8" x 22"	Rectangular	Bottom	
179663	ZD8X24TZU	8" x 24"	Rectangular	Bottom	
179703	ZD8X24TZU	8" x 28"	Rectangular	Bottom	
179664	ZD10X8TZU	10" x 8"	Rectangular	Side	
179697	ZD10X10TZU	10" x 10"	Square	Side	
179698	ZD10X12RZU	10" x 12"	Rectangular	Bottom	
179694	ZD10X14TZU	10" x 14"	Rectangular	Bottom	
179695	ZD10X16TZU	10" x 16"	Rectangular	Bottom	
179696	ZD10X18TZU	10" x 18"	Rectangular	Bottom	
179699	ZD10X20TZU	10" x 20"	Rectangular	Bottom	
179700	ZD10X24TZU	10" x 24"	Rectangular	Bottom	
179665	ZD12X8TZU	12" x 8"	Rectangular	Side	
204141	ZD12X10TZU	12" x 10"	Rectangular	Side	
113931	ZD12X12TZU	12" x 12"	Rectangular	Side	
205075	ZD12X14TZU	12" x 14"	Rectangular	Side	
208374	ZD12X16TZU	12" x 16"	Rectangular	Side	
179666	ZD14X8TZU	14" x 8"	Rectangular	Side	
204142	ZD14X10TZU	14" x 10"	Rectangular	Side	
179667	ZD16X8TZU	16" x 8"	Rectangular	Side	
207829	ZD16X10TZU	16" x 10"	Rectangular	Side	
206764	ZD16X12TZU	16" x 12"	Rectangular	Side	
206512	ZD16X16TZU	16" x 16"	Square	Side	

Zone Dampers & Accessories

Zone Control Dampers (Continued)

ZD Series Damper

Part #	Mfg #	Size	Shape	Motor Mount	Price
179668	ZD18X8TZU	18" x 8"	Rectangular	Side	
179669	ZD20X8TZU	20" x 8"	Rectangular	Side	
179701	ZD20X10TZU	20" x 10"	Rectangular	Side	
205792	ZD20X12TZU	20" x 12"	Rectangular	Side	
179670	ZD22X8TZU	22" x 8"	Rectangular	Side	
207321	ZD22X10TZU	22" x 10"	Rectangular	Side	
179671	ZD24X8TZU	24" x 8"	Rectangular	Side	
213765	ZD24X10TZU	24" x 10"	Rectangular	Side	

Damper Actuators

M847D 24VAC Spring Return Damper Actuator

- 2-Position, 24 VAC spring return actuator for ARD, EARD, and ZD dampers
- Low voltage, spring-return damper actuator.
- Equipped with anti-rotation and drive shaft extensions for direct mounting to 7/16 inch diameter coupling style dampers.
- Adjustable range stops.
- Direct replacement for M847D1004



Part #	Mfg #	Description	Price
185746	M847D-ZONE	Replacement Motor for ARD and ZD Dampers	

MSTN Damper Actuator

- Power open/power close damper motor
- Use with MVRV; MVRH; SRTD; IOBD; AOBD-BM; AOBD; ASCD; ARCD



Part #	Mfg #	Description	Price
023257	MSTN	3-Wire 24V Actuator Motor	

Zone Control Accessories

Freeze Protection Control

- Breaks Y circuit to compress below 36°F and remakes it at 46°F
- For use with minizone panels



Part #	Mfg #	Description	Price
023258	FPC	Protects A/C Coil From Freezing Due to Low Air Flow or Excessive Bypass Air	

Zone Dampers & Accessories

Fresh Air Ventilators

Y8150 Fresh Air Ventilation System

- "Set it and forget it" program calculates needs based on square feet and number of rooms, etc.
- Operates a fresh air intake damper and when necessary activates the main HVAC blower to efficiently meet ASHRAE ventilation rates
- Includes W8150A fresh air ventilation control, EARD6 normally closed 6" damper, AT120B 120VAC/24VAC 20VA transformer, mounting hardware, homeowner information label
- 5-Year warranty



Part #	Mfg #	Description	Price
179801	Y8150A1017	50 to 160 CFM Fresh Air Ventilation System	

Duct Insulation & Adhesives

Duct Liner Insulation Adhesives

Insta-Tack™ Insulation Adhesive

- Instant-tacking, solvent-based spray booth application
- UL Classified



Part #	Mfg #	Size	Color	Price
124942	308591	1 gal	Red	



Duct Liner

Duct Liner

Part #	Mfg #	Size	Price
058537	INS1259100	1/2" x 59" x 100'	

Black Duct Liner

Part #	Mfg #	Size	Price
005629	INSF1247100	1/2" x 47" x 100'	
141887	INSF1259100	1/2" x 59" x 100'	
005631	INSF147100	1" x 47" x 100'	
190433	INSF124712100	1/2" x 47-1/2" x 100'	
190432	INSF14712100	1" x 47-1/2" x 100'	

Duct Board

Part #	Mfg #	Size	Price
222851	INSDB4101SHT	4 x 10'	



Duct Wrap

Foil Duct Wrap

Foil Duct Wrap - R4.2

Part #	Mfg #	Size	Price
005622	INSDUCTWRAP112	1-1/2" x 48" x 100'	

Foil Duct Wrap - R6

Part #	Mfg #	Size	Price
190435	INSDUCTWRAP218	2-1/8" x 48" x 75'	

Foil Duct Wrap - R8

Part #	Mfg #	Size	Price
094791	INSDUCTWRAPR83	3" x 48" x 50'	

Duct Liner

Duct Liner

rFOIL Big8™ Reflective Bubble with Spacer

- 97% reflectivity.
- Inhibits condensation, mold and fungi growth
- Helps reduce heat loss through your duct surfaces
- Raises your cooling and heating efficiency
- Performance Tested UL723 Test Standard
- Class 1 / Class A fire rating approved
- Only 1" Thick for minimal space requirements

Part #	Mfg #	Size	Price
237000	2280-48-050	48" x 50'	
237030	2280-48-075	48" x 75'	

Thermo Reflect Reflective Double Bubble

- 97% reflectivity
- Easy to install
- Fiber free and environmentally friendly
- Inhibits condensation, mold and fungi
- NFPA 286 Full Room Burn Test Approved
- Helps reduce heat loss through your duct surfaces
- Raises your cooling and heating efficiency
- Helps ensure better climate control and comfort
- R-6 with air-space, R-4.3 without air-space
- ASTM E84-Class 1/Class A fire rating approved also
- ASTM C411-Passed

Part #	Mfg #	Size	Price
189839	T12290-36-050	36" x 50'	
195275	T12290-48-1255	48" x 125'	
197219	T12290-60-1255	60" x 125'	

Duct Liner

Mastic Duct Sealants

Duct-Seal™ 321

- Indoor/outdoor use
- Water-based
- All pressure classes
- UL Classified



Part #	Mfg #	Size	Color	Price
094151	DS-321	1 gal	Gray	

Foam Board

In-Floor Heating Systems

Thermo-Snap™ Foam Board

- Quick, easy PEX tube installation
- Panels hold PEX in place during concrete pour - no float or displacement
- Retains strong bond with concrete
- Panels are easily trimmed to accommodate custom shapes



Part #	Mfg#	Size	PSI	Price
158110	24416PSI	2" x 4' x 4'	16	
159066	24425PSI	2" x 4' x 4'	25	
177240	2124416PSI	2-1/2" x 4' x 4'	16	
177241	2124425PSI	2-1/2" x 4' x 4'	25	



Fiberglass Pipe Insulation

Fiberglass Pipe Covering

Part #	Mfg #	Size	Price
005607	INSC1212	1/2" x 1/2"	
076280	INSC121	1/2" x 1"	
189766	INSC7812	7/8" x 1/2"	
005613	INSC5812	5/8" x 1/2"	
005611	INSC3412	3/4" x 1/2"	
005604	INSC112	1" x 1/2"	
005606	INSC11412	1-1/4" x 1/2"	
005605	INSC11212	1-1/2" x 1/2"	
005608	INSC212	2" x 1/2"	
005640	INSC31	3" x 1"	

Insulation Tape

Insulation Tape**Cork Insulation Tape**

- Adheres firmly to all metals
- Can be used on hot and cold pipes
- Won't dry or crack
- Stops condensation and drips



Part #	Mfg #	Description	Price
002287	1006	1/8" x 2" x 30' Roll	

Foam Insulation Tape

- Self-adhesive tape
- Easily cut and molded
- Works on both hot and cold pipes, valves and fittings



Part #	Mfg #	Description	Price
002288	1007	1/8" x 2" x 30' Roll	



Insulation Tape

Insulation Accessories

ASJ White Tape for Fiberglass

Part #	Mfg #	Size	Price
087593	TAPEASJ	3" x 50 yds	

FSK Tape for Foil Wrap

Part #	Mfg #	Size	Price
010342	TAPEFSK	3" x 50 yds	

Insulation Tape

Polyken Pipeline Accessory Products

Polyken 826 Joint and Pipe Wrap Tape

- 12 mil Thickness
- Tensile strength: 25 lb/in
- Polyethylene joint and pipe wrap
- Use Polyken primer for surface prep
- Corrosion protection for use interior, exterior and in-ground of small diameter pipe



Part #	Mfg #	Size	Color	Price
010352	826	2" x 100'	Black	

Mechanical Fasteners

Insulation Fasteners

Weld-Ons™



Part #	Mfg #	Size	Qty	Price
132418	308119	1/2" Flat Head	5,000/Box	
132419	308120	3/4" Flat Head	5,000/Box	

Duct Fasteners

Insulation Fasteners

**DynaStick Self-Adhesive Hanger
with Steel Washer**



Part #	Mfg #	Size	Pack	Price
005633	INSF2PIN	2"	100	
157583	INSF34PIN	3/4"	100	

Standard Bangers™



Part #	Mfg #	Size	Pack	Price
005637	INSGRIPNAIL	1/2" - 2 lbs	1,000	

R-Foil Insulation

Reflective Insulation

Reflective Duct Insulation

- Double layer of polyethylene bubbles sandwiched between two highly reflective surfaces
- Three methods of installation that will yield thermal resistances of R-4.3, R-5.5 and R-6.0
- Class 1/Class A in accordance with ASTM E84 fire test standard
- Vapor barrier
- Inhibits condensation, mold and fungi growth
- Non-toxic and non-carcinogenic
- Reflects 94% of radiant heat



Part #	Mfg #	Description	Price
098392	2290-48-100	48" x 100' Insulation	

Rubber Pipe Insulation

Pipe Insulation

Double Stick Rubber Pipe Insulation

- 318' (I80) or 24' (I81) per carton
- Environmentally friendly
- Split with adhesive on both sides
- CFC-free
- Color – Black with blue ink
- Easy installation, flexible
- Sold in 6' joints

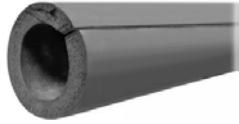

Part#	Mfg#	Size	Wall	Price
229189	34INSLTS38W	3/4" OD	3/8"	

Seamless Rubber Pipe Insulation

- Environmentally friendly
- Tough skin withstands tearing, rough handling and severe environmental conditions
- CFC-Free
- Color: black with blue ink
- Flexible
- Sold in 6' joints



Part #	Mfg #	Copper (IPS/PVC)	Wall	Price
015045	38INSLT	3/8" OD	3/8"	
013153	12INSLT	1/2" OD (1/4")	3/8"	
015580	58INSLT	5/8" OD (3/8")	3/8"	
014724	34INSLT	3/4" OD	3/8"	
015774	78INSLT	7/8" OD (1/2")	3/8"	
013018	118INSLT	1-1/8" OD	3/8"	
013450	138INSLT	1-3/8" OD	3/8"	
013631	158INSLT	1-5/8" OD (1-1/4")	3/8"	
012476	112INSLT	2" OD (1-1/2")	3/8"	
014204	218INSLT	2-1/8" OD	3/8"	
013841	2INSLT	2-1/2" OD (2")	3/8"	
014278	258INSLT	2-5/8" OD	3/8"	
014511	318INSLT	3-1/8" OD	3/8"	
014366	3INSLT	3-1/2" OD (3")	3/8"	
092086	58INSLT12W	5/8" OD (3/8")	1/2"	
092087	34INSLT12W	3/4" OD	1/2"	
092578	78INSLT12W	7/8" OD	1/2"	
092579	118INSLT12W	1-1/8" OD	1/2"	
140961	138INSLT12W	1-3/8" OD	1/2"	
126912	158INSLT12W	1-5/8" OD (1-1/4")	1/2"	
126911	112INSLT12W	1-1/2" IPS	1/2"	
143431	218INSLT12W	2-1/8" OD	1/2"	

Pipe Insulation (Continued)

Seamless Rubber Pipe Insulation

Part #	Mfg #	Copper (IPS/PVC)	Wall	Price
126909	2INSLT12W	2-1/2" OD (2")	1/2"	
126913	212INSLT12W	2-1/2"	12"	
140963	3INSLT12W	3" IPS	1/2"	
074497	358INSLT12W	3-5/8" OD	1/2"	
122310	4INSLT12W	4-1/2" OD (4")	1/2"	
237573	38INSLT34W	3/8" OD	3/4"	
173788	58INSLT34W	5/8" OD	3/4"	
237572	12INSLT34W	1/2" OD (1/4"IPS)	3/4"	
173789	34INSLT34W	3/4" OD	3/4"	
173790	78INSLT34W	7/8" OD	3/4"	
173791	118INSLT34W	1-1/8" OD	3/4"	
173792	138INSLT34W	1-3/8" OD	3/4"	
173793	158INSLT34W	1-5/8" OD	3/4"	
173795	112INSLT34W	1-1/2" OD	3/4"	
173796	218INSLT34W	2-1/8" OD	3/4"	
173797	2INSLT34W	2" OD	3/4"	
173798	258INSLT34W	2-5/8" OD	3/4"	
173911	3INSLT34W	3" OD	3/4"	
227362	58INSLT1W	5/8" OD	1"	
167464	78INSLT1W	7/8" OD	1"	

Double Stick Pipe Insulation

- Complete seal assured on hot or cold water pipes
- (2) Strips of self-adhesive mylar seal easily at any length
- 100% Closed cell polyethylene
- Temperature range: -160° to 200°F
- Sold in 6' joints



Part #	Mfg #	Size	Wall	Price
014723	34IMCO	3/4" Nom ID	3/8"	
015579	58IMCO	5/8" Nom ID	3/8"	
015773	78IMCO	7/8" Nom ID	3/8"	
013017	118IMCO	1-1/8" Nom ID	3/8"	
013449	138IMCO	1-3/8" Nom ID	3/8"	
055569	158IMCO	1-5/8" Nom ID	3/8"	
101687	2IMCO	2" Nom ID	3/8"	
045207	218IMCO	2-1/8" Nom ID	3/8"	
142337	238IMCO	2-3/8" Nom ID	3/8"	
086331	258IMCO	2-5/8" Nom ID	3/8"	
072530	3IMCO	3-1/8" Nom ID	3/8"	

Rubber Pipe Insulation

Pipe Insulation (Continued)

Double Stick Pipe Insulation

Part #	Mfg #	Size	Wall	Price
191221	38IMCO12W	3/8" Nom ID	1/2"	
191220	58IMCO12W	5/8" Nom ID	1/2"	
191223	34IMCO12W	3/4" Nom ID	1/2"	
191224	78IMCO12W	7/8" Nom ID	1/2"	
191234	218IMCO12W	2-1/8" Nom ID	1/2"	
191225	118IMCO12W	1-1/8" Nom ID	1/2"	
191231	138IMCO12W	1-3/8" Nom ID	1/2"	
191226	158IMCO12W	1-5/8" Nom ID	1/2"	
191233	2IMCO12W	2" Nom ID	1/2"	
191241	238IMCO12W	2-3/8" Nom ID	1/2"	
191243	258IMCO12W	2-5/8" Nom ID	1/2"	
191244	318IMCO12W	3-1/8" Nom ID	1/2"	
191240	3IMCO12W	3-1/2" Nom ID	1/2"	
140583	418IMCO12W	4-1/8" Nom ID	1/2"	
032093	4IMCO12W	4-1/2" Nom ID	1/2"	
129849	781IMCO	7/8" Nom ID	1"	

Insulation Contact Adhesives

- *Fast tack*
- *Brush top cans*
- *For use with rubber insulation only*



Part #	Mfg #	Size	Price
005643	INSTG1PT	1 Pt	



Cleaners

Hand Cleaners

Cit-Grit Hand Cleaner

- Natural citrus formula, biodegradable
- Contains aloe, lanolin and jojoba oil
- Flip-top spout plastic bottle



Part #	Mfg #	Description	Price
005539	38125	15 fl oz	

Cleaners

Ice Machine Maintenance

IMS-III Sanitizing Concentrate

- EPA Registered
- Registered in all 50 states
- Controls slime build-up on all hard surface areas
- Bacteria will not grow or multiply
- Controls mold and mildew formation
- Eliminates odor



Part #	Mfg #	Description	Price
202563	4211-34	16 fl oz	

De-Greasing Solvents

Degreasing Solvent EF

- Dries at a controlled rate, leaving no residue
- Dissolves grease and oil in seconds
- Has a dielectric strength greater than 26,000 volts
- Non-corrosive
- Environmentally & Ozone safe



Part #	Mfg #	Description	Price
221598	4083-75	EF- 14oz Can	

Nickel-Safe IMC

- Specially formulated citric/phosphoric food-grade product for removing scale deposits from ice makers having nickel-plated or tin-plated evaporators



Part #	Mfg #	Description	Price
208988	4287-08	1 Gallon	
208987	4287-34	16 fl oz	

Hand Cleaners

Great Wipes

- Industrial strength hand towels
- Waterless wipes made specifically for the A/C, and Plumbing services
- Absorbent, non-scratching abrasive hand towels



Part #	Mfg #	Description	Price
189899	4185-75	75/Pk	

Urinal Cleaners

UrinaKleen Urinal Cleaner

- Acid-based bowl cleaner removes scale deposits and odors
- Ideal for dissolving rust, urinary salts and mineral scale from flush tanks, urinal drains and bowls



Part #	Mfg #	Description	Price
159421	4590-24	1 Quart	
159422	4590-08	1 Gallon	



Cleaners

Cleaners

Gel-Gloss® Cleaner

- *Contains non-harmful abrasive cleaning agents that remove surface oxidation and light scratches while leaving behind a protective carnauba wax coating*
- *Cleans, protects and restores luster while providing a long lasting protective finish*

Part #	Mfg #	Description	Price
120346	GA-12	12 oz, Aerosol	

Gel-Gloss® No-Streak Glass & Silver Polish Cleaner

- *Contains silicone and protects like a wax*
- *Wipe it on, allow it to dry to a haze and polish it off*
- *Cleaner works aggressively on hard water spots and tough residue*
- *Beads water and leaves behind a protective coating*

Part #	Mfg #	Description	Price
141442	NS-8	1/2 pt	



Lubricants

Pipe Joint Lubricant

Plumber's Faucet & Valve Grease

- *Waterproof*
- *Resists high temperature*
- *Frees sticky faucets, prevents rust*
- *Use on hot water or steam up to 350°F*



Part #	Mfg #	Description	Price
029140	05005012	1 oz Tube	

Lubricants

Lubricants

Pull-A-Spout Oiler

- All purpose oiler
- 14" Telescoping spout



Part #	Mfg #	Size	Price
002300	CO-1	4 oz	

Rust Breaker

- Loosens rusted bolts, screws, shafts, piping etc
- Telescoping spout applicator



Part #	Mfg #	Size	Price
002299	CR-1	4 oz	

Lubricants

Lubricants

Dow 111 Silicone Lubricant

- For o-rings and valve stems



Part #	Mfg #	Tub Size	Price
060945	963-01	1/4 Ounce	

Radon Fans

Fans for Radon Applications

RN Series Radon Fans

- 4.5" Duct
- Record low power consumption

Part #	Mfg #	Wattage Range	Max Amps	CFM @ 0.75"	Price
253107	RN1				
253108	RN2				

Radon Fans

Fans for Radon Applications

RadonAway® GP Series Radon Mitigation Fan

- Quiet operation
- Water-hardened motor
- Seams sealed under negative pressure to inhibit radon leakage
- Mounts on duct pipe or with integral flange
- 3" diameter ducts for use with 3" or 4" pipe
- Electrical box for hard wire or plug in
- ETL Listed - for indoor or outdoor use
- 4 interchangeable GP models



Part #	Mfg #	Wattage Range	Max Pressure	CFM @ 1"	Price
162821	SETIGP501	70-140	4.2	95	

RadonAway® XP/XR Series Radon Mitigation Fan

- Low energy consumption
- Quiet operation
- Low-profile design
- Seams sealed to inhibit radon leakage
- Meets all electrical code requirements
- Water-hardened, thermally protected motor
- ETL Listed - for indoor or outdoor use
- Rated for commercial and residential use



Part #	Mfg #	Wattage Range	Max Pressure	CFM @ 1"	Price
162560	SETIXP201	45-66	1.8	70	

RadonAway® RP Series Radon Mitigation Fan

- Energy efficient
- Ultra-quiet operation
- Meets all electrical code requirements
- Water-hardened motorized impeller
- Seams sealed to inhibit radon leakage (RP140 & RP145 double snap sealed)
- ETL Listed - for indoor or outdoor use
- Thermally protected motor
- Rated for commercial and residential use



Part #	Mfg #	Wattage Range	Max Pressure	CFM @ 1"	Price
162823	SETIRP140	15-21	0.8	-	
162822	SETIRP145	41-72	2.1	82	

Parts & Accessories

Part #	Mfg #	Description	Price
162562	SETIRADONTKIT	Radon-T Kit	
162563	SETIMANOMETER	U-Tube Manometer	
162564	SETIRRCSL	Radon Reduction Central	
162565	SETIRRSCL	Radon Reduction System	
162937	SETIDR2	Retro-Fit Floor Drain	
162938	SETI280971	ABS Dome Cover, .093"	
162939	SETI280972	ABS Dome Cover, .187"	
163244	SETILSRADONTEST	Radon Test Kit	
163249	33CPLGRADONWHT	Radon Coupling, 3x3 White	
163250	34CPLGRADONWHT	Radon Coupling, 3x4 White	
163251	36CPLGRADONWHT	Radon Coupling, 3x6 White	
163252	44CPLGRADONWHT	Radon Coupling, 4x4 White	
163253	46CPLGRADONWHT	Radon Coupling, 4x6 White	
163298	SETIRADONKIT33	Radon Install Kit, 3x3	
163300	SETIRADONKIT34	Radon Install Kit, 3x4	
163302	SETIRADONKIT44	Radon Install Kit, 4x4	
163304	SETIRADONKIT46	Radon Install Kit, 4x6	
248465	SETIMANOMETERR	Mamometer, EasyRead	
248466	SETIRADONKIT44R	Radon Install Kit, 4x4	
248467	SETIRADONKIT46R	Radon Install Kit, 4x6	
248468	SETIRADONKIT34R	Radon Install Kit, 3x4	
248469	SETIRADONKIT33R	Radon Install Kit, 3x3	

Radon Pits and Lids

Radon Sewage Basins

- *Constructed of durable, corrosion-resistant polyethylene resin*

Economy Basin - 18" x 22"

- *Designed for new construction or retrofit applications*
- *Rotationally molded*
- *22 Gallon capacity*



Part #	Mfg #	Description	Price
180279	E222001UD	4" Inlet Grommet	

Radon Economy Basin - 18" x 22"

- *Includes: gas-tight Ringer grommets*
- *22 Gallon capacity*



Part #	Mfg #	Description	Price
013695	B22SSR	Gas-Tight Simplex Steel Cover	

Radon Pits and Lids

Radon Sump Pump Basins

Corrugated Pit and Radon Lid

- Includes:
 - (1) 18" x 24" Pit
 - (1) 18" Radon pit lid (SLR1)



Part #	Mfg #	Description	Price
133074	COMBO RADON	Radon Pit & Lid	

Accessories

GOLDLINE® Radon Safety Locking Lid

- For radon abatement systems
- Child-proof, rugged self-locking lid is drilled for gasketed piping and venting
- Includes gaskets



Part #	Mfg #	Description	Price
133071	SLR1	Radon Safety Locking Lid	

Airease Repair Parts & Accessories

Parts & Accessories

Part #	Mfg #	Description	Price
208935	H4TXV01-HP	1.5-3T HP/AC TXV	
208936	H4TXV02-HP	3-5/T HP/AC TXV	
208937	H4TXV03-HP	4-5/T HP/AC TXV	
209605	AEHBCC05CSA1	1.821056 5KW Heat Kit	
209606	AEHBCC07CSA1	1.821057 7.5KW Heat Kit	
209607	AEHBCC10CSA1	1.821058 10KW Heat Kit	
209608	AEHBCC15CSA1	1.821046 15KW Heat Kit	
209609	AEHBCC20CSA1	1.821048 20KW Heat Kit	
208677	ECB255CBP	12R60 5KW H/K *SER 2	
208678	ECB2575CBP	12S08 7.5KW HK *SER 2	
208679	ECB2510CBP	12S60 10KW H/K *SER 2	
209590	ECB25125CBP	12S77 12.5KW *SER 2	
208680	ECB2515CBP	12S87 15KW H/K *SER2	
208681	ECB2520CBP	12S88 20KW H/K *SER2	
210243	R40403-003	Duct Circuit Board	
209368	11K50	NAT to LP Conversion Kit	

American Standard Repair Parts

Faucet Repair/Replacement Parts

Diaphragm Kit

Part #	Mfg #	Description	Price
001906	72940-0700	Aquaseal Diaphragm f/Heritage (Pr)	

Toilet Repair/Replacement Parts

Flapper

Part #	Mfg #	Description	Price
026083	47146-0070A	Am Std, Rubber Flapper	

Tank-to-Bowl Kit

Part #	Mfg #	Description	Price
001760	47060-07	Am Std, Tank-to-Bowl Kit	

Toilet Flush Actuator

Part #	Mfg #	Description	Price
001662	33642-0700	Am Std, Toilet Actuating Valve for #5 w/Disc, Chain, Clip & Grommet	

Toilet Installation

Part #	Mfg #	Description	Price
001663	33643-0700	Am Std, Snap-on Seat Disc for 2031.016 Heritage Toilet	

Trip Lever

Part #	Mfg #	Description	Price
001778	47242-0020A	Am Std, Chrome f/Cadet II	
001779	47242-0200A	Am Std, White f/Cadet II	



Basco Repair Parts

Tub & Shower Accessories

Self-Adhesive Tape

Part #	Mfg #	Description	Price
048292	SC4248	Self Adhesive Tape	

Vinyl

Part #	Mfg #	Description	Price
048294	SCV284	Tapered Drip Vinyl, 37"	



Bell & Gossett Repair Parts

Check-Trol™ Isolation Flow Control Flange Sets

- Packaged with an isolation flange of the same size as a pair
- For circulator installations, gives you features of flow control valve, isolation valve and companion flange
- Cap screws and nuts included
- Maximum working pressure: 150 psi
- Maximum operating temperature: 200°F



**Flange for NRF/NBF/SSF Wet Rotors (Except NRF-45 & NBF-45),
Series PL-30, PL-36, PL-55, Series 100, PR & LR**

Part #	Mfg #	Model	Size	Price
079000	101232	CTF-1	1" NPT x Flange	

**Flange for 4JA87, 4JA88, 4PD08, 4PD11, 4P976, 4P977, 4RC92, 4RD05, 4RD10, 4RD17, 5P428, 5P433, All
Taco Bronze Pumps Except 4PC79**

Part #	Mfg #	Model	Size	Price
002423	101208LF		3/4" NPT x Flange	

Pump Motors and Accessories

Power Pack Motor

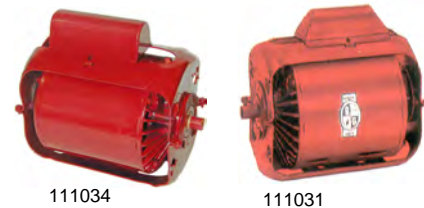

111034

111031

Part #	Mfg #	Phase	Voltage	HP	Price
002433	111034	Single	115V	1/12	
002432	111031	Single	115V	1/6	

Motor Coupler



Part #	Mfg #	Description	Price
002446	118473	For PD-35, PD-37, 60 "AA", 1522 (1/2" Shaft Frame)	
002452	118705	Pump Coupler for Series 100, HV, 2", PR	
002454	118723	Coupler	

Seal Kit

Part #	Mfg #	Description	Price
002457	186862	Seal Kit #1 1-1/4" ID Bronze Fit	



Bell & Gossett Repair Parts

Bearing Assembly



118844

186863

Part #	Mfg #	Description	Price
002455	118844	For 100 Series NFI & BI	
048806	185332	For PD-35, PD-37, 60 "AA"; IB, BF or AB	
002462	189105	For Series PR, 2-1/2", LD-3, HD-3	
002465	189134	Series 100	
044637	189163	Obsolete 1-1/2", Obsolete 2", Obsolete HV	
044778	189165	For HV, 2", 1-1/2" Obsolete IB or BI	

Flange Gasket Set



118368

Part #	Mfg #	Description	Price
002442	118373	For 1-1/2", HV and All 1-1/2AA or 1-1/2A Models	
002441	118368	For LR, PL-30, PL-36, Series 100, PR, 60 1AA, 60 11/4AA, PL-55 and All 1AA or 1-1/4AA Models	

Parts & Accessories



Part #	Mfg #	Description	Price
002407	L23401	1.5 oz Oil Tube	

Bradley Washfountain Repair Parts

Classic Washfountain Parts

Foot Valve Repair Kit

• Includes:

- S21-027 Needle assembly
- S64-006 Valve plunger assembly
- 125-001BW Gasket
- 117-016 Valve seat
- 125-001Y Diaphragm
- 124-001V Fibre washer
- 110-095 Body-needle valve
- 135-001P Spring
- 130-033 Key-valve seat

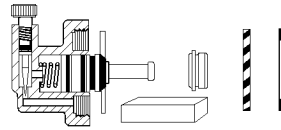

Part #	Mfg #	Description	Price
002730	S65-001A	Foot Valve Repair Kit	

Chicago Faucet Repair Parts

Handles & Handle Parts



Part #	Mfg #	Description	Finish	Price
002876	369-PRJKCP	(2) 2-3/8" ADA Levers with Hot/Cold Index Buttons	CP	

Faucet Stem & Cartridge



1-099XTJKNF/1-100XTJKNF

377-XTRHJKNF/377-XTLHJ

Part #	Mfg #	Description	Finish	Price
016112	1-099XTJKNF	New Style RH Quatum™ Short Stem Unit for Exposed Valve (12/Box Only)	NF	
056563	1-099XKJKNF	RH Ceramic Short Stem Unit for Exposed Valve (12/Box Only)	NF	
016112	1-099XTJK(AB)NF	New Style RH Quatum™ Short Stem Unit for Exposed Valve (12/Box Only)	NF	
016111	1-100XTJKNF	New Style LH Quatum™ Short Stem Unit for Exposed Valve (12/Box Only)	NF	
056562	1-100XKJKNF	LH Ceramic 1/4-Turn Short Stem Unit for Exposed Valve	NF	
099706	377-XKLHJKNF	LH Ceramic 1/4-Turn Long Stem Unit for Concealed Valve (Sold by box 12/Lot)	NF	
099700	377-XKRHJKNF	RH Ceramic 1/4-Turn Long Stem Unit for Concealed Valve (Sold by box 12/Lot)	NF	
002877	377-XTLHJKNF	LH Quatum™ Long Stem Cartridge for Concealed Valve (Sold by box 12/Lot)	NF	
002878	377-XTRHJKNF	RH Quatum™ Long Stem Cartridge for Concealed Valve	NF	
020910	386-XSLOJKNF	Urinal Push-Button Cartridge	NF	

Pre-Rinse Faucet Components

Stainless Steel Hose/Handle Assembly

- Insulated handle
- 3/4"-14 UNS Female outlet, 3/8" MNPT inlet
- T&S & Fisher adapters supplied



Part #	Mfg #	Description	Finish	Price
068698	83-44NF	44" Stainless Steel Hose/Handle Assembly	NF	

Single Water Inlet Fittings

Deck-Mount Fitting

- Solid brass body construction
- 5-1/4" Rigid/swing gooseneck spout
- 1/2" NPSM Coupling nut for 3/8" or 1/2" flexible riser
- Mounting hardware included



Part #	Mfg #	Description	Finish	Price
002897	626-E3CP	1-Hole, E3 Soffflo Pressure Compensating Aerator	CP	

Chicago Faucet Repair Parts

Spouts

- Fits 1-1/16"-18 UNEF male body outlet



Part #	Mfg #	Description	Finish	Price
002797	DJ13JKCP	Double Jointed Swing Spout, 3-7/8"H, 13" Reach, E3 Softflo® Aerator	CP	
002798	DJ18JKCP	Double Jointed Swing Spout, 3-7/8"H, 17-3/4" Reach, E3 Softflo® Aerator	CP	
002811	L8JKCP	L-Type Swing Spout, 4-3/8"H, 8" Reach, E3 Softflo® Aerator	CP	
020853	L9JKCP	L-Type Swing Spout, 6-1/2"H, 9-1/2" Reach, E3 Softflo® Aerator	CP	
002810	L12JKCP	L-Type Swing Spout, 4-5/8"H, 12" Reach, E3 Softflo® Aerator	CP	
002812	S6JKCP	Swing Spout, 1-3/4"H, 6" Reach, E3 Softflo® Aerator	CP	

Gooseneck Spouts

- Available in numerous standard dimensions
- Heavy 11/16" OD chrome-plated brass tubing
- Inlet union nut for quick change out
- Allows for field conversion of gooseneck spouts from rigid to swing AND vice-versa

Type A Gooseneck Spout



- Designed to accept Group A spout ends
- Fits 1-1/16"-18 UNEF male body outlet

Part #	Mfg #	Description	Finish	Price
002804	GN1AE3JK	Rigid/Swing GN Spout w/13/16"-24 Male Outlet 8-3/8"H, 3-1/2" Reach	CP	
002805	GN2AE3JKCP	Rigid/Swing GN Spout, 9-3/4"H, 5-1/4" Reach, E3 Softflo® Aerator	CP	
002806	GN8AE3JKCP	Rigid/Swing Spout w/E3 Pressure Compensating Softflo® Aerator 2.2 gpm, 11-1/4"H, 8" Reach	CP	

Outlets & Adapters

- All flow rates up to 80 psi

E3 Pressure Compensating Softflo® Aerator

- Maximum flow rate: 2.2 gpm @ 60 psi
- 13/16"-24 Female inlet



Part #	Mfg #	Description	Finish	Price
002802	E3JKCP	Fits Spouts w/Group A Outlets	CP	

E12 Pressure Compensating Softflo® Aerator

- Maximum flow rate: 2.2 gpm @ 60 psi
- 13/16"-27 Male inlet



Part #	Mfg #	Description	Finish	Price
002799	E12JKCP	For Widespread & Centerset Lavatory Faucet	CP	

Chicago Faucet Repair Parts

Supply & Shank Connections/Inlets Shanks

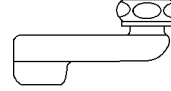

Part #	Mfg #	Description	Finish	Price
020958	HJKCP	2-1/2" Offset Inlet Supply Arm	CP	

Renewing Kits

Quaturn™ & Slow Compression Unit Kit - New Style

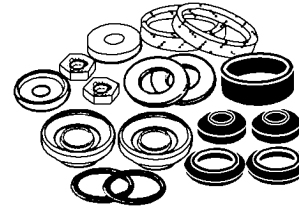

Part #	Mfg #	Description	Price
002833	1277D	Jiffy Kit - Box of 12	

Replacement Parts



671-XJKNF

Part #	Mfg #	Description	Finish	Price
002818	1-006JKNF	Packing (50/Box Only)	NF	
002819	1-011JKNF	Rubber Washer (50/Box Only)		
002822	1-021JKNF	Rubber Seat Washer for X or XT	NF	
002823	1-022JKNF	Retainer for X or XT (100/Box Only)		
002825	1-027JKNF	Seat for X Style (100/Box Only)		
002826	1-031JKNF	Stem Washer for X Style (100/Box Only)		
002827	1-043JKNF	Cap Gasket for X Style (100/Box Only)		
134195	1-104JKNF	Spout Gland		
100595	1104-007JKNF	O-Ring		
028379	50-035JK(AB)NF	Spout O-Ring		
144383	122-NF	Thermostatic Mixing Valve	NF	
139530	131-NF	Thermostatic Mixing Valve	NF	
026523	217-XTLHJKNF	LH Slo-Comp (12/Box)	NF	
002847	217-XTRHJK	RH Slo-Comp (12/Box)		
002848	244-006JKNF	Rubber Seat Washer for NAIAD Cartridges	NF	
133595	305-SVBJKCP	Rigid Atmospheric Vacuum Breaker Spout w/3/4" Hose Thread	CP	
028864	333-XSLOPSHJKNF	Pushbutton Unit with Slow-Closing Push Button Cartridge, Push Index & Adj Cycle Time Closure		
033135	671-XJKNF	Metering Valve Unit		
135738	734-CP	Vacuum Breaker Kit		
029908	734-005JKNF	Body Gasket		

Chicago Faucet Repair Parts

Replacement Parts (Continued)

Part #	Mfg #	Description	Finish	Price
134779	892-254KJKCP	Vacuum Breaker Cover & Screw Kit	CP	
130310	892-302KJKAB	Atmospheric Vacuum Breaker Repair Kit	NA	
173077	892-402KJKAB	Vacuum Breaker	NA	

Ceramic Operating Cartridge for Single Lever Faucets

- ECAST™ construction
- Lift on
- Replaceable
- Manual shut off
- Left or right hand
- Short stem for exposed caps



Part #	Mfg #	Description	Finish	Price
227046	2300-XJKABNF	Ceramic Operating Cartridge		

Parts & Accessories

Angle Stop Ball Valve with Loose Key Handle

- Stop with 5/8" Inlet
- 2" Tee Handle, Tapered Square Broach
- 5/8" O.D. (1/2" Nominal) Female Compression Inlet
- 3/8" O.D. Female Compression Outlet
- Chrome Plate Finish
- Weight: 0.506lbs
- ECAST® construction with equal to or less than 0.25% lead content by weighted average



Part #	Mfg #	Description	Finish	Price
186612	STB-31-00-AB	5/8" O.D. x 3/8" F Comp		

HyTronic Cover Plate

- Locating pin and mounting hardware included



Part #	Mfg #	Size	Price
103250	240.627.21.1	4"	

Chicago Faucet Repair Parts

Check Valve

- 3/8" Compression male thread outlet
- Includes 3/8" Compression nut and ring
- 3/8" Compression female nut thread
- Inlet rubber sealing washer
- Spring loaded check
- ECAST® construction with equal to or less than 0.25% lead content
- Weight: 0.045lbs



Part #	Mfg #	Description	Finish	Price
188846	243.315.AB.1	Package Dimensions: 7.00"L x 6.00"W x 2.00"H		

Dearborn Brass Repair Parts

Waste Repair Parts

Repair Part for Bath Waste

- -1 Polished chrome

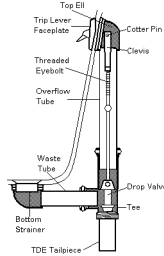

Part #	Mfg #	Description	Price
003327	4503-1	Faceplate, Trip Lever	
026678	4538-3	Pop-Up Waste Drain Seat & Plug includes a fulcrum linkage and nut and plug seat	

Cast Brass Fittings

90° Slip Joint Elbow

- Cast Brass



Part #	Mfg #	Size	Gauge	Price
175072	1675-2	1-1/2"		

Showerheads

Part #	Mfg #	Size	Gauge	Price
176822	122WS	Chrome Plated Brass Water Saving Shower Head		

Sink Repair Accessories

Sink Hole Cover

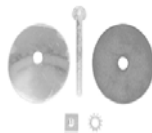

Part #	Mfg #	Size	Gauge	Price
251922	1226	2" Cover w/ 2-Pc SS Head		
251948	1227	1-3/4" Cover w/ 2-Pc SS Head		

Miscellaneous

Part #	Mfg #	Size	Gauge	Price
082258	5130	Vent Key		

Delta Faucet Repair Parts

Single-Handle Repair Parts Kit

Part #	Mfg #	Description	Price
243409	RP46748	Metal Lever Handle Kit, Chrome	
168961	RP46748SS	Metal Lever Handle Kit, Stainless*	
143022	RP53409	Dryden™ Metal Lever Roman Tub Handle Kit, Chrome	
157966	RP47270SS	Single Lever Handle Kit	
157967	RP47271	Button and Set Screw	
152794	RP52833	Single Metal Lever Handle Kit	
153001	RP60965	Single Lever Handle Kit w/ Button and Set Screw	
131775	RP63138	Single-Handle Repair Parts Kit	
245340	RP70640RB	Linden™ Volume Control Hdl, Venetian Bronze	
240471	RP72749	Cassidy™ Metal Lever Handle Kit, Chrome	

Ara® 17 Series Temperature Knob and Cover



Part #	Mfg #	Description	Price
240123	RP75441SS	Stainless*	

Classic Roman Tub Handle Base & Gasket



Part #	Mfg #	Description	Price
248389	RP62094	Chrome	
155272	RP62094SS	Stainless*	

Dryden™ Roman Tub Handle Base

- Nut & gasket



Part #	Mfg #	Description	Price
144013	RP53410	Chrome	
237393	RP53410SS	Roman Tub Handle Base	

Trinsic® Roman Tub Handle Base

- Gasket included

Part #	Mfg #	Description	Price
243415	RP73161SS	Stainless*	

Installation Aids

Quick-Connect Vegetable Spray Nipple Cap

- Converts "with spray" to "less spray"

Part #	Mfg #	Description	Price
074978	RP40301	Quick Connect Coupling, Vegetable Spray Cap	
181058	RP70613	Set Screw & Wrench	

Quick-Connect Hose

- For installing handle and spout farther apart

Part #	Mfg #	Description	Price
144185	RP50390	Hose Assembly & Clip	

Hose Assembly



Part #	Mfg #	Description	Price
055924	RP32527	Hose Assembly	

Lavatory Drains

Metal Lavatory Drain Assembly

- Metal pop-up drain
- Metal lift-rod



Part #	Mfg #	Description	Price
003641	RP5651	Chrome	
003643	RP5651PB	Polished Brass*	
093335	RP5651RB	Venetian Bronze®	
103471	RP5651SS	Stainless*	

* Brilliance® Anti-Tarnish Lifetime Finishes

• Serving our Customers Since 1946 • www.plumbsupply.com

Delta Faucet Repair Parts

Lavatory Drain Stopper



Part #	Mfg #	Description	Price
003637	RP5648	Chrome	
168193	RP5648CZ	Champagne Bronze™	
168478	RP5648NK	Luxe Nickel*	
159075	RP5648RB	Venetian Bronze®	
158887	RP5648SS	Stainless*	

RP51732 Lift Rod Assembly



Part #	Mfg #	Description	Price
167091	RP51732SS	Stainless*	

Ara® Lift Rod and Slider

- Metal pop-up

Part #	Mfg #	Description	Price
248925	RP90058	1-Hole, Chrome	

Peerless Double Bend Lift Rod

- For B2596LF



Part #	Mfg #	Description	Price
245524	RP42092SS	Stainless*	

Dryden™ Roman Tub Diverter Lift Rod & Finial

- SpotShield®



Part #	Mfg #	Description	Price
249640	RP53411	Chrome	

Lahara® Lift Rod & Finial



Part #	Mfg #	Description	Price
258430	RP54971RB	Venetian Bronze	

Lahara® Lift Rod and Finial

- Flextech

Part #	Mfg #	Description	Price
242268	RP64165	Chrome	

Lift Rod and Finial

- For diverter roman tub



Part #	Mfg #	Description	Price
238742	RP41586	Chrome	

RP41588 Lift Rod



Part #	Mfg #	Description	Price
164015	RP41588	Chrome	

RP40267 Lift Rod



Part #	Mfg #	Description	Price
171467	RP40267	Chrome	

* Brilliance® Anti-Tarnish Lifetime Finishes

www.plumbsupply.com • Serving our Customers Since 1946 •

Delta Faucet Repair Parts

Lavatory Drains (Continued)

RP40267 Lift Rod

Part #	Mfg #	Description	Price
249496	RP40267SS	Stainless	

RP52597 Lift Rod



Part #	Mfg #	Description	Price
230772	RP52597RB	Venetian Bronze	

RP54095 Lift Rod and Finial

Part #	Mfg #	Description	Price
168032	RP26151	Chrome	
187287	RP51291	Chrome	
157901	RP54095RB	Venetian Bronze®	

Trinsic® Lift Rod & Finial

- 1H lavatory



Part #	Mfg #	Description	Price
244866	RP74666BL	Matte Black	

Trinsic® Roman Tub Diverter Lift Rod & Finial

Part #	Mfg #	Description	Price
257803	RP74235	Chrome	

Final - Lavatory Lift Rod Top



Part #	Mfg #	Description	Price
171468	RP41574	Chrome	
173135	RP41574SS	Stainless*	

Lavatory Drain Flange

- RP5651 & RP26533



Part #	Mfg #	Description	Price
027896	RP23060	Chrome	
168192	RP23060CZ	Champagne Bronze™	
149920	RP23060SS	Stainless*	

Bath Installation Aids

Delta® Extension Kits

- Adds 1" to shanks
- For 3530/3540/3543/3544/3555/3665/3567/3569/3577/3578/3583



Part #	Mfg #	Description	Price
051857	RP10612	For 3530/3540/3543/3544/3555/3665/3567/3569/3577/3578/3583	

RP31845 Extension Kit



Part #	Mfg #	Description	Price
046440	RP31845	Extension Kit	

TempAssure® 17T Series Extension Kit

- Additional 1-3/4" installation



Part #	Mfg #	Description	Price
183263	RP75136	Extension Kit - 17T Series	

Monitor 14 Series MultiChoice Extension Kit



Part #	Mfg #	Description	Price
231280	RP77991	Extension Kit - 14 Series	

* Brilliance® Anti-Tarnish Lifetime Finishes

• Serving our Customers Since 1946 • www.plumbsupply.com

Delta Faucet Repair Parts

MultiChoice® Integrated Diverter Extension Kit -27 Series



Part #	Mfg #	Description	Price
259604	RP90543	Extension Kit - 27 Series	

3 And 6-Setting Diverter Extension Kit



Part #	Mfg #	Description	Price
157035	RP75137	Extension Kit - Diverter	

Delta® Horizontal Rod



Part #	Mfg #	Description	Price
003436	RP12517	Chrome	

Conversion Ball

- Converts knob to lever handle
- Makes faucet ADA compliant



Part #	Mfg #	Description	Price
003587	RP20111	Conversion Ball	

Cartridges and Valves

Diverter Cartridge



Part #	Mfg #	Description	Price
135236	RP51919	6-Setting, Diverter Cartridge	
135235	RP51918	3-Setting, Diverter Cartridge	

3-Setting Non-Shared Diverter Cartridge



Part #	Mfg #	Description	Price
163268	RP71718	Diverter Cartridge	

2-Hdl DIAMOND™ Valve Assembly



Part #	Mfg #	Description	Price
148058	RP60400	Valve Assy	

Euro-Motion™ Valve Assembly



Part #	Mfg #	Description	Price
153040	RP60114	Valve Assy	

Euro-Motion™ Ceramic Valve



Part #	Mfg #	Description	Price
187321	RP75402	Ceramic Valve	

Tesla® Lavatory Cartridge

- DIAMOND™ seal valve

Part #	Mfg #	Description	Price
247066	RP78715	Cartridge with Seal Valve	

* Brilliance® Anti-Tarnish Lifetime Finishes

www.plumbsupply.com • Serving our Customers Since 1946 •

Delta Faucet Repair Parts

Trinsic® DIAMOND™ Euro-Motion Valve

- Short stem



Part #	Mfg #	Description	Price
242251	RP73000	Short Stem	

Monitor® 13/14 Series Ceramic Valve Cartridge Assembly



Part #	Mfg #	Description	Price
258318	RP74236	Cartridge Assy	

Multi-Choice® Universal Cartridge Assembly -13/14 Series

- Monitor® single-function pressure-balance cartridge
- Rotational limit stop easily adjusts via lift and turn
- For MultiChoice® universal 13/14 series tub and showers



Part #	Mfg #	Description	Price
095758	RP46074	Cartridge Assy	

Multi-Choice® Universal Cartridge Assembly -17 Series

- Monitor® dual-function pressure- balance control
- For MultiChoice® 17 series tub and showers
- Allows for separate volume and temperature control



Part #	Mfg #	Description	Price
102530	RP46463	Cartridge Assy	

Multi-Choice® Universal Cartridge Assembly -17T Series

- TempAssure® dual-function thermostatic cartridge
- For Multi-Choice® 17T series trim
- Allows for separate volume and temperature control



Part #	Mfg #	Description	Price
115704	RP47201	Cartridge Assy	

Diverter Assembly



Part #	Mfg #	Description	Price
003529	RP17730	Diverter Assembly	
035054	RP19653	Diverter Assembly	

Transfer Valve



025321	RP18632	Transfer Valve	
170775	RP41701	Stem Cartridge Kit	

Two Handle Ceramic Stem Cartridge - (Pair)



Part #	Mfg #	Description	Price
167855	RP47422	Stem Cartridge - Pair	

Stem Unit Assembly

- Includes:
 - Seat
 - Spring
 - Bonnet Nut
 - Washer



Part #	Mfg #	Description	Price
171576	RP54801	Stem Unit Assy	

* Brilliance® Anti-Tarnish Lifetime Finishes

• Serving our Customers Since 1946 • www.plumbsupply.com

Delta Faucet Repair Parts

Metering Valve



Part #	Mfg #	Description	Price
166640	RP72773	Metering Valve	

Valve Cartridge



Part #	Mfg #	Description	Price
164727	RP50265	Valve Cartridge	

Non-Shared Diverter Cartridge



Part #	Mfg #	Description	Price
166480	RP71717	2-Function Non-Shared Diverter Cartridge	

Cartridge Fluehs



Part #	Mfg #	Description	Price
155280	RP61824	Cartridge Fluehs - Cold	
154243	RP61825	Cartridge Fluehs - Hot	

RP42410 Cartridge Assembly



Part #	Mfg #	Description	Price
125499	RP42410	Diverter Cartridge	

Cer-Tek Cartridge

- RH

Part #	Mfg #	Description	Price
130298	063000A	RH Cer-Tek Cartridge	
130299	063001A	LH Cer-Tek Cartridge	

Thin Wall Installation Aid

- For MultiChoice® universal thin mount installation aid



Part #	Mfg #	Description	Price
094435	RP47202	Thin Mount Aid	

Shower Renovation Cover Plate

- Covers up 8" center holes



Part #	Mfg #	Finish	Price
040814	RP29827	Chrome	
130864	RP29827RB	Venetian Bronze®	
134118	RP29827SS	Stainless*	

Ara® Escutcheon and Gasket

- 1- or 3-Hole

Part #	Mfg #	Description	Price
247643	RP90057	Chrome	

Deep Escutcheon



Part #	Mfg #	Description	Price
222353	RP21633SS	Stainless*	

600 / 1600 Series Tub & Shower Escutcheon



Part #	Mfg #	Description	Price
003658	RP5883	Chrome	

* Brilliance® Anti-Tarnish Lifetime Finishes

www.plumbsupply.com • Serving our Customers Since 1946 •

Delta Faucet Repair Parts

600 Series Escutcheon - Shallow



Part #	Mfg #	Description	Price
040905	RP6083	Chrome	

Deep Escutcheon with Push Button Diverter



Part #	Mfg #	Description	Price
162814	RP21634	Escutcheon, Chrome	

600 Series Tub and Shower Renovation Kit

- Includes:
 - RP17443RB - Lever handle
 - RP5883RB - Escutcheon
 - RP1050RB - Cap
 - RP5893RB - Sleeve
 - RP196RB - Escutcheon screws
 - RP20111 - Conversion ball
 - RP4993 - Seats and springs
 - RP188 = Cam and packing
- Order RP2865 plug for push button diverter
- Diverter tub spout may be required



Part #	Mfg #	Finish	Price
132394	RP54870	Chrome	
132395	RP54870RB	Venetian Bronze®	
129199	RP54870SS	Stainless*	

1900 Conversion Trim Kit



Part #	Mfg #	Description	Price
164080	RP54316	Chrome	
171340	RP54318	Chrome	
167369	RP54318RB	Venetian Bronze*	

3-Setting Diverter Escutcheon

Part #	Mfg #	Description	Price
233908	RP51924RB	Venetian Bronze	

6-Setting Diverter Escutcheon

Part #	Mfg #	Description	Price
154615	RP61658SS	Stainless*	

Escutcheon

- Diagonal escape screw holes



Part #	Mfg #	Description	Price
032826	RP19809	Chrome	
157469	RP19809SS	Stainless*	

Escutcheon - Shallow



Part #	Mfg #	Description	Price
043944	RP7577	Chrome	

Escutcheon - Deep

- 1-13/16" Inside diameter



Part #	Mfg #	Description	Price
018419	RP6019	Chrome	

Escutcheon and Gasket

- 3-Hole



Part #	Mfg #	Description	Price
247521	RP78358	Chrome	

* Brilliance® Anti-Tarnish Lifetime Finishes

• Serving our Customers Since 1946 • www.plumbsupply.com

Delta Faucet Repair Parts

Tub & Shower Escutcheon

- Square



Part #	Mfg #	Description	Price
154796	RP52583RB	Venetian Bronze®	

Dryden™ 6-Setting Diverter Escutcheon

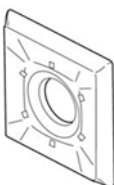

Part #	Mfg #	Description	Price
154795	RP52594RB	Venetian Bronze®	

6-Setting Diverter Escutcheon



Part #	Mfg #	Description	Price
179525	RP42413RB	Venetian Bronze®	

Escutcheon - 14 Series



Part #	Mfg #	Description	Price
154524	RP48716	Chrome	

Escutcheon Trim Screws

- Set of 2



Part #	Mfg #	Description	Price
087663	RP196SS	Stainless*	

Jetted Shower XO® Stem Extender

Part #	Mfg #	Description	Price
135242	RP37902	Stem Extender	
100606	RP37903	Stem Extender	

Handshower Assembly



Part #	Mfg #	Description	Price
159519	RP52589SS	Stainless*	

Kitchen Spray Assemblies

Victorian® Spray and Hose Assembly

- To be used for DIAMOND™ seal technology models



Part #	Mfg #	Description	Price
244160	RP37489	Chrome	
164086	RP37489SS	Stainless*	

Classic Spray & Hose Assembly

- To be used for non-DIAMOND™ seal technology models



Part #	Mfg #	Description	Price
074675	RP39360	White	

Signature® Waterfall® Spray & Hose Assembly

- To be used for non-DIAMOND™ seal technology models
- Includes nest



Part #	Mfg #	Finish	Price
098546	RP39345	Chrome	
091323	RP39345SS	Stainless*	

* Brilliance® Anti-Tarnish Lifetime Finishes

www.plumbsupply.com • Serving our Customers Since 1946 •

Delta Faucet Repair Parts

Pilar® Linden™ Spray, Hose and Diverter Assembly

- To be used for DIAMOND™ seal technology models
- Touch-Clean® spray holes
- Front trigger control
- Finished spray face



Part #	Mfg #	Description	Price
185590	RP53880	Chrome	
165648	RP53880AR	Arctic Stainless	
156781	RP53880RB	Venetian Bronze®	

Victorian® Spray, Hose, and Diverter Assembly

- To be used for DIAMOND™ seal technology models



Part #	Mfg #	Description	Price
170824	RP53881RB	Venetian Bronze®	
244811	RP53881SS	Stainless*	

Collins™ Spray, Hose and Diverter Assembly

- To be used for DIAMOND™ seal technology models
- Touch-Clean® spray holes
- Finished spray face



Part #	Mfg #	Description	Price
130164	RP54235	Chrome	
144787	RP54235SS	Stainless*	

Cassidy™ Spray and Hose Assembly

- Touch-Clean® spray holes
- Front trigger control
- Finished spray face



Part #	Mfg #	Description	Price
167693	RP72751	Chrome	

Spray and Hose Assembly



Part #	Mfg #	Description	Price
179527	RP61013RB	Venetian Bronze*	

Classic and Signature® Spray & Hose Assembly

- To be used for single handle non-DIAMOND™ seal technology models
- Finished sprayer



Part #	Mfg #	Finish	Price
044116	RP31612	Chrome	

Spray & Hose Assembly



Part #	Mfg #	Finish	Price
058833	RP28900	Chrome	
259103	RP28900CB	Chrome/Brass	
059165	RP28900SS	Stainless*	
168533	RP32250BN	Brushed Nickel*	

Kitchen Spray Assembly



Part #	Mfg #	Description	Price
224779	RP43524SS	Stainless*	

* Brilliance® Anti-Tarnish Lifetime Finishes

• Serving our Customers Since 1946 • www.plumbsupply.com

Delta Faucet Repair Parts

Classic Spray, Hose and Diverter Assembly

- To be used for DIAMOND™ seal technology models



Part #	Mfg #	Finish	Price
134487	RP60097	Chrome	
180881	RP60097SS	Stainless*	

Foundations® Spray, Hose Assembly and Spray Support

- Lead free
- For single handle kitchen models



Part #	Mfg #	Description	Price
145981	RP54807	Chrome	
187325	RP54807SS	Stainless*	

Spray Support Assembly



Part #	Mfg #	Description	Price
003664	RP6015	Chrome	

Quick-Connect Vegetable Spray Hose



Part #	Mfg #	Description	Price
103219	RP37034GR	White	

2-Hdl Kitchen or Lavatory 16" Hose



Part #	Mfg #	Description	Price
003676	RP6050	White	

Pilar® Pull-Down Spray Assembly



Part #	Mfg #	Description	Price
244885	RP53210AR	Arctic Stainless	

Pull-Out Wand Assembly



Part #	Mfg #	Description	Price
154289	RP53102AR	Arctic Stainless™	
147391	RP53102SS	Stainless*	

Pull-Down Wand Assembly



Part #	Mfg #	Description	Price
160975	RP72680AR	Pull-Down Wand Assembly	

Wand Assembly



Part #	Mfg #	Description	Price
182191	RP51480	Chrome	
156754	RP51480RB	Venetian Bronze®	
152052	RP51480SS	Stainless*	
237802	RP51480AR	Arctic Stainless	

* Brilliance® Anti-Tarnish Lifetime Finishes

www.plumbsupply.com • Serving our Customers Since 1946 •

Delta Faucet Repair Parts

Spray Assembly



Wand Assembly with Hose

- Pull-out faucets



Part #	Mfg #	Description	Price
181927	RP46751SS	Stainless*	

Part #	Mfg #	Description	Price
063196	RP32542	Chrome	
161322	RP32542AR	Arctic Stainless™	
162140	RP32542BL	Matte Black	
081006	RP32542SS	Stainless*	

Pull-Down Spray Assembly

- Includes aerator



Palo Wand Assembly



Part #	Mfg #	Description	Price
159024	RP47269SS	Stainless*	

Fuse Pull-Down Wand Assembly



Part #	Mfg #	Description	Price
117444	RP44643	Chrome	
168840	RP44643SS	Stainless*	

Part #	Mfg #	Description	Price
175890	RP70703SB	Stainless*/Cracked Pepper	

Sprayer Wand Assembly

- Pull-out faucets



RP44477 Pull-Out Wand Assembly



Part #	Mfg #	Description	Price
152076	RP53438SS	Stainless*	

Part #	Mfg #	Description	Price
168481	RP44477SS	Stainless*	

Soap/Lotion Dispenser Accessories

Soap/Lotion Dispenser Nut

Part #	Mfg #	Description	Price
037864	RP21945	Dispenser Nut	

* Brilliance® Anti-Tarnish Lifetime Finishes

• Serving our Customers Since 1946 • www.plumbsupply.com

Delta Faucet Repair Parts

Soap/Lotion Dispenser Body Assembly



Part #	Mfg #	Description	Price
187739	RP21906SS	Stainless*	

Soap/Lotion Dispenser Pump Head



Part #	Mfg #	Description	Price
160946	RP21905SS	Stainless*	

Kitchen Accessories

Sliding Weight

- For use with Pull-Down/Out kitchen faucets



Part #	Mfg #	Description	Price
188349	RP49149	N/A	

Kitchen Diverter Assembly

- Diverter assembly kit 1-handle Delta® replacement

Part #	Mfg #	Description	Price
133121	RP63135	Kitchen Faucet Diverter Assembly	
136138	RP63135MBS	Diverter Assembly	
132777	RP63136	1-Handle Diverter Assembly	
133157	RP63136MBS	Kitchen Diverter Assembly	

Brizo Lavatory Escutcheon

- 3/8" Height
- Can be used with (65005LF)



Part #	Mfg #	Description	Price
243611	RP61619BZ	4", Brushed Bronze*	

8" Escutcheon



Part #	Mfg #	Description	Price
149596	RP64070	Chrome	
146679	RP64070AR	Arctic Stainless™	
162388	RP64070CZ	Champagne Bronze™	

Cassidy™ Escutcheon

- 10-1/4" Length
- 1 or 3-hole installation
- 8" centers on 3-hole installation
- 2-1/2" Maximum deck thickness



Part #	Mfg #	Description	Price
244648	RP71545PN	Polished Nickel*	

Escutcheon

- 8" Length
- 1-1/2" connection



Part #	Mfg #	Description	Price
249251	061270A	Chrome	

Escutcheon

- 4" Length
- 1-1/2" connection



Part #	Mfg #	Description	Price
250327	061269A	Chrome	

Escutcheon and Gasket

- Transitional/contemporary bar



Part #	Mfg #	Description	Price
189018	RP77702	Chrome	
217804	RP77702AR	Arctic Stainless™	

* Brilliance® Anti-Tarnish Lifetime Finishes

www.plumbsupply.com • Serving our Customers Since 1946 •

Delta Faucet Repair Parts

Escutcheon, Base, and Gasket



Part #	Mfg #	Description	Price
252777	RP70714	Chrome	
236796	RP70714AR	Arctic Stainless	
249466	RP70714BL	Matte Black	

10" Escutcheon



Part #	Mfg #	Description	Price
158527	RP47274AR	Arctic Stainless™	
158533	RP47274RB	Venetian Bronze®	

Escutcheon, Base, and Gasket



Part #	Mfg #	Description	Price
148562	RP64472AR	Arctic Stainless™	
168129	RP64472SS	Stainless*	

Escutcheon, Gasket (3-Hole)



Part #	Mfg #	Description	Price
225247	RP72991SS	Stainless*	

Decorative Escutcheon

- 10" Long



Part #	Mfg #	Description	Price
158526	RP71545	Chrome	
154412	RP71545AR	Arctic Stainless™	
158563	RP71545CZ	Champagne Bronze™	
153577	RP71545RB	Venetian Bronze®	

Square Escutcheon



Part #	Mfg #	Description	Price
153685	RP63970RB	Venetian Bronze®	
143753	RP63970SS	Stainless*	

Trinsic® Escutcheon, Baseplate & Bolts



Part #	Mfg #	Description	Price
257968	RP75614AR	Arctic Stainless™	

Escutcheon - 3 Hole



Part #	Mfg #	Description	Price
170028	RP44645SS	Stainless*	

Escutcheon

- 6-1/16" Width
- 2-3/16" Depth



Part #	Mfg #	Description	Price
254329	RP100091	Escutcheon, Trinsic Chrome	
256612	RP100091BL	Escutcheon, Trinsic Matte Blk	

* Brilliance® Anti-Tarnish Lifetime Finishes

• Serving our Customers Since 1946 • www.plumbsupply.com

Delta Faucet Repair Parts

Kitchen Accessories (Continued)

Escutcheon

Part #	Mfg #	Description	Price
258293	RP100091SS	Escutcheon, Trinsic Stainless*	

Shallow Escutcheon

- Pressure balance diverter off indicator

Part #	Mfg #	Description	Price
076614	RP6107	Chrome	

Handle Base

- Square handle bases
- Sold in pairs
- Includes flange support, gasket and set screw



Part #	Mfg #	Description	Price
157758	RP52659SS	Stainless*	

Mounting Hardware



Part #	Mfg #	Description	Price
186978	RP52609	Mounting Hardware	

Pilar® Check Valves



Part #	Mfg #	Description	Price
138069	RP53468	Pilar® Check Valves	

Shower Parts

Single Lever Handle Kit - 17T Series



Part #	Mfg #	Description	Price
153179	RP51309SS	Stainless*	

Linden™ 17 Series Handle Assembly

- Temperature knob and cover



Part #	Mfg #	Description	Price
184230	RP70641	Chrome	
245341	RP70641RB	Venetian Bronze	

13/14 Series Handle Assembly



Part #	Mfg #	Description	Price
132336	RP48717	Chrome	
143667	RP48717SS	Stainless*	

Gasket Insert for Showerhead

- Plastic



Part #	Mfg #	Description	Price
243850	RP43621	Grey	

Handle Assembly



Part #	Mfg #	Description	Price
164895	RP73643	Chrome	
186959	RP72685RB	Venetian Bronze®	

* Brilliance® Anti-Tarnish Lifetime Finishes

www.plumbsupply.com • Serving our Customers Since 1946 •

Delta Faucet Repair Parts

Temperature Dial



Part #	Mfg #	Description	Price
163903	RP73642	Chrome	

Single Lever Handle Kit - 17 Series



Part #	Mfg #	Description	Price
067929	RP32103	Chrome	

Universal Jet Sleeve Assembly

- *Jetted shower™*



Part #	Mfg #	Description	Price
243184	RP37891	Jet Sleeve Assy	

Trim Sleeve - Tub & Shower



Part #	Mfg #	Description	Price
157460	RP50879RB	Venetian Bronze®	
166988	RP50879SS	Stainless*	

Trim Sleeve - 17 and 18 Series



Part #	Mfg #	Description	Price
249255	RP50880	Chrome	
151398	RP50880RB	Venetian Bronze®	
151435	RP50880SS	Stainless*	

Trim Sleeve - Tub & Shower



Part #	Mfg #	Description	Price
031006	RP5893	Chrome	

Trim Sleeve - 13 and 14 Series



Part #	Mfg #	Description	Price
172685	RP22735SS	Stainless*	
096706	RP39407	14 Series Only, Chrome	

Copper Plug - Shower Only



Part #	Mfg #	Description	Price
021656	RP20032	Copper	

Hose Clip

- *Clip only*
- *Quick-connect*



Part #	Mfg #	Description	Price
144186	RP60911	Hose Clip	

Valve Sleeve Assembly



Part #	Mfg #	Description	Price
172344	RP51481RB	Venetian Bronze®	

* Brilliance® Anti-Tarnish Lifetime Finishes

• **Serving our Customers Since 1946** • www.plumbsupply.com

Delta Faucet Repair Parts

Bar Slide Knob



Part #	Mfg #	Description	Price
175920	4116BX	For Models 55024 & 55030, Clear	

Bath Waste Parts

Bath Waste Assembly

- Toe-operated
- 13-1/2" Max vertical adjustment
- 7-3/4" max horizontal adjustment
- Brass construction



Part #	Mfg #	Description	Price
177578	RP293	Chrome	
143839	RP693CZ	Champagne Bronze™	

Tub Drain

- Toe-operated
- Stopper and waste plug
- Stopper screw threads are 5/16"-18



Part #	Mfg #	Description	Price
159165	RP31558CZ	Champagne Bronze™	

Waste Plug

- Toe operated
- 1-1/2"-11-1/2" NPSM



Part #	Mfg #	Description	Price
166059	RP16687	Chrome	

Bonnet Cap

- With adjusting ring



Part #	Mfg #	Finish	Price
003631	RP50	Chrome	

Stopper Assembly

- Toe operated
- 5/16" - 18" thread size



Part #	Mfg #	Description	Price
177577	RP16686PN	Polished Nickel*	

Mini-Bulk Parts

Aerator

- 15/16" - 27 Male thread
- For most kitchen and lavatory faucets
- 2.2 gpm @ 60 psi



Part #	Mfg #	Description	Price
022154	RP330MBS	Chrome, 60 Per Case	

Cam and Packing-Knob

- For single knob handle faucets



Part #	Mfg #	Description	Price
003552	RP188	For Single Knob Handle	
017861	RP188MBS	64 Per Case	

Cam & Packing - Lever

- For single lever handle faucets



Part #	Mfg #	Description	Price
017522	RP61MBS	64 Per Case	

Seat

- For all 1-handle and 2-handle faucets



Part #	Mfg #	Description	Price
022156	RP1806MBS	240 Per Case	

Spring

- For all 1-handle and 2-handle faucets



Part #	Mfg #	Description	Price
022158	RP3427MBS	240 Per Case	

* Brilliance® Anti-Tarnish Lifetime Finishes

www.plumbsupply.com • Serving our Customers Since 1946 •

Delta Faucet Repair Parts

Seats, Springs, Quad Rings

- Qty. 2



Part #	Mfg #	Description	Price
063896	RP28603	Seats, Springs, Quad Rings	

Seats & Springs Boxed Assortment Kit

- RP4993 (24)



Part #	Mfg #	Description	Price
003740	RP4039	Seats & Springs 24-RP4993	

Ceramic Seats and Seals

- Qty. 2



Part #	Mfg #	Description	Price
020357	RP10700	Ceramic Seats and Seals	

Stainless Steel Ball - Knob

- For single knob handle faucets except 1300, 1400 & 1600 tub/shower series and pull-out spray models



Part #	Mfg #	Description	Price
022152	RP212MBS	60 Per Case	

Stainless Steel Ball - Lever

- For single lever handle faucets except 1300, 1400, 1500, 1600, 1700 & 1800 T/S series and pull-out spray models



Part #	Mfg #	Description	Price
022151	RP70MBS	60 Per Case	

Stem Unit & Seat

- For 1600 tub/shower series

Part #	Mfg #	Description	Price
003582	RP1991	Stem Unit & Seat	

Mini-Bulk Parts (Continued)

Stem Unit & Seat

Part #	Mfg #	Description	Price
022157	RP1991MBS	Stem Unit & Seat, 12 Per Case	

Stem Unit with Stainless Steel Plate

- For 2-handle and basin faucets



Part #	Mfg #	Description	Price
003515	RP1740	Stem Unit Assy	
022155	RP1740MBS	Stem Unit Assy, 60 Per Case	

Delta® Plumber's Box of Parts



Part #	Mfg #	Description	Price
134141	RP63139	Plumber's Box of Parts	

Ball Assemblies

Part #	Mfg #	Description	Price
003724	RP70	For 1-H Lever	
003592	RP212	For 1-H Knob	

O-Rings

Part #	Mfg #	Description	Price
253460	RP10345	Peerless Rings Qty. 2	
114466	RP13938	O-Ring	
071330	RP14414	13/14 Series Qty. 2	
154097	RP18362	O-Ring	
043131	RP23336	O-Ring F/1400	
003605	RP25	1-Hdl Kit Spout	
003589	RP2055	For 2-H Kitchen Spout	
040285	RP22934	For 2-H Waterfall® Kitchen Deck	
061918	RP32520	Spout O-Rings for 470 & 472	
178227	RP50388	O-Ring	
170777	RP73984	Clip and O-Ring	

* Brilliance® Anti-Tarnish Lifetime Finishes

• Serving our Customers Since 1946 • www.plumbsupply.com

Delta Faucet Repair Parts

Mini-Bulk Parts (Continued)

O-Rings

Part #	Mfg #	Description	Price
247379	RP83781	O-Ring & Limit Stop	
249032	RP90771	Cartridge Assy and O-Ring	
142321	RP1745	O-Ring, Tub Spout	

O-Rings



Part #	Mfg #	Description	Price
022150	RP25MBS	120 Per Case	
253157	RP44139	Loki O-Ring	

Screws

Part #	Mfg #	Description	Price
003437	RP12630	Escutcheon Trim Screws, Extra Long	
155211	RP12630RB	Escutcheon Trim Screws, Extra Long - Ven Bronze®	
003496	RP152	For Single Lever Handle	
003564	RP196	Chrome	
033496	RP25620	Set Screws for Small Handle Bases	
032801	RP26865	Set Screws for Large Handle Bases	
168960	RP40650	Set Screw	
157647	RP54170B	Escutcheon Screws (2)	
158261	RP61819	On Wall Screws 4 Lengths	

Delta® Repair Parts

Part #	Mfg #	Description	Price
217207	4124CBG	Cap - GL Rail BG	
028507	4959BG	Rubber Gaskets - Bag of 5	
253655	060318A	Flow Control Insert (6)	
144039	060602A	Sngl Blade Hdl w/ Screw	
111465	060683A	Hard Wire Converter	
247208	060791A	Comm Garden Hose Thread Adapter w/ Vacuum Breaker	
207016	060949A	Comm 4" Hooded Lvr Hdl	
248502	061128A	2 H&C Ceramic Cartridges	
238143	061131A	Extension Kit for 060852A Diverter Valve	

Delta® Repair Parts (Continued)

Part #	Mfg #	Description	Price
162306	063044A	8" Swing Spout Assembly	
023673	060864A	4" Blade Handle Pair	
098175	060302A	Vacuum Breaker Repair	
126956	060638A	1.5 GPM Vandal Resistant Aerator	
252220	060757A	3/8 IP Angle Vac Breaker	
237119	061203A	0.5 gpm VR Laminar Outlet	
243261	061297A	Commercial Driver Board	
225244	061252A	Driver Board, H2Optics and Proximity	
188507	063093A	R3 Spout for 54T2402	
243260	063230A	Commercial Spout Assy	
247528	063257A	Commercial Brass Solenoid	
246656	063258A	Commercial Battery Box	
247639	33W576-BL	Commercial Push Button, Matte Black	
177587	EP73954	AP Power Supply	
183919	EP74854	Solenoid Assembly	
109632	RP1050	Bonnet Nut, Chrome	
240775	RP1050RB	Bonnet Nut, Venetian Bronze	
188994	RP11768HDF	Commercial Lever Handles, Brass w/ Screws	
003435	RP12516	Strap w/ Screw	
026356	RP12629	Screw Set	
099577	RP16213	Screwdriver Stop Assembly	
003512	RP16423	Reverse Ball	
019240	RP18090	Escutcheon	
025093	RP18276	Chrome Escutcheon	
025092	RP18136	Sleeve, Chrome	
029096	RP21463	Retainer - Spout	
033619	RP21469	1Hdl Lever Kit with Screw	
154634	RP21469SS	1Hdl Lever Kit with Screw	
086213	RP23094SS	Handle Base w/ Gasket	
243320	RP52658	Set Screw & Button Set, Polished Nickel*	
003597	RP2389	Clear 1-Handle Lavatory w/Button & Screw	
003599	RP2391	Clear Knob w/Button & Screw	
003601	RP2393	1 Kitchen Lever Handle w/Set Screw	
003603	RP2411	Button, Clear	
003608	RP250	Adjusting Ring	

* Brilliance® Anti-Tarnish Lifetime Finishes

www.plumbsupply.com • Serving our Customers Since 1946 •

Delta Faucet Repair Parts

Delta® Repair Parts (Continued)

Part #	Mfg #	Description	Price
031329	RP250MBS	Adjusting Ring	
044850	RP28595	Temp Knob and Cover	
054794	RP29569	Spacer	
059633	RP33805	10-1/8" Horizontal Rod	
259376	RP34410SS	Finial, Stainless*	
003623	RP3614	Lever Repair Kit	
155976	RP37022SS	Bonnet, Washer and Clip	
237857	RP38674	Nut and Washer	
253918	RP38958	50/50 Lav Drain Assy, Chr	
259080	RP38958RB	50/50 Lav Drain Assy, Ven Br	
244140	RP40664SS	Roman Tub Hose & Gaskets R4700, Stainless*	
171342	RP42208	Wrench	
243216	RP42407	3-Port 6 Func Diverter Trim Bonnet	
164132	RP47030	Lavatory Wrench	
256214	RP49264	Metal Lvr Diverter Hdl Kit, Chr	
003630	RP4993	Deluxe Seats & Springs (2)	
122686	RP50366	Stem Assembly w/ O-Rings and Nuts	
249098	RP50786SS	Button Indicator, Stainless	
238441	RP50790SS	Single Lvr Handle Kit, Stnlss*	
144187	RP51503	Bonnet Nut	
239500	RP51019	Set Screw & Button, Chrome	
256747	RP51022	Stem Extender	
132784	RP52834	Single Metal Lever Handle Kit	
252844	RP53210SS	Pilar Pull-Down Spray Assy, Stainless*	
131263	RP53997	Diverter Clip	
237661	RP5417	Screw	
003639	RP5649	Diverter Assembly, Chrome	
003649	RP574	Balance Spool Assembly	
003657	RP5861	Coupling Nuts	
003662	RP6011	Hose & Spray, Black/CP	
257384	RP60112SS	Toggle Sprayer	
003678	RP6060	Nut	
003681	RP6068	Plug Button	
037831	RP6079	Bonnet, Chrome	
040904	RP6081	Sleeve, Chrome	
003687	RP6092	Nuts & Washers	

Delta® Repair Parts (Continued)

Part #	Mfg #	Description	Price
252044	RP60976RB	Addison Wand Assy & Hose, Venetian Bronze	
237655	RP61184	Escutcheon, Chrome	
003695	RP6130	Pivot Seat & Gasket	
153121	RP61820	Stem Assembly	
003705	RP6183	Locknuts	
253156	RP62291	Loki Cartridge	
238406	RP62381SS	6-Setting Escutcheon, Stnlss	
260155	RP63202	Peerless Wand & Hose, Chr	
243523	RP63505	Nut/Tee Kit	
257799	RP63697BN	Handle Cap & O-Ring	
253855	RP64152	Transitional Slidebar Slide Mechanism, Chrome	
224647	RP64240	Mounting Bracket	
227492	RP64288	Gasket for 400DST	
238763	RP64364SS	Metal Lvr Hndl Set, *Stainless	
144951	RP64364	Classic Handle Set, Chrome	
240958	RP64449	Hot&Cold Blade Hdl Set, Chr	
151297	RP64696	Spout Assembly - Locked	
242851	RP70607	Screw, Adapter, & Insert Parts	
259634	RP70918BN	Brizo Button & O-Ring, Br. Nkl	
037345	RP7133	O-Handle Cold	
243590	RP71447PC	Spout Assy with Magnet	
252051	RP72564SS	Cassidy Set Screw & Button, Stainless*	
249519	RP72752AR	Cassidy Spray Nest, Arctic Stainless	
245502	RP73391	Cassidy 2-Hole Kitchen Spout Retainer & Ring	
250641	RP73640	Comm Spout Assy & Tee	
171629	RP74456	Odin Extension Kit	
239499	RP75438SS	Ara 17 Series Escutcheon & Gasket, Stainless*	
244719	RP78360	Lift Rod Hole Button, Chrome	
244994	RP78739PN	Tesla 2H Lav Flange & Gasket, *Pol Nickel	
251251	RP78943	Spout Body Diverter	
239093	RP80523	Hose Weight Assy	
249154	RP80528	Kitchen Faucet Gasket	
258489	RP80977	Magnet Replacement Kit	

* Brilliance® Anti-Tarnish Lifetime Finishes

• Serving our Customers Since 1946 • www.plumbsupply.com

Delta Faucet Repair Parts

Delta® Repair Parts (Continued)

Part #	Mfg #	Description	Price
003734	RP8230	Ceramic Stem, Seat, O-Ring, Spring	
237520	RP84704SS	Volume Hndl Assy, Stainless*	
239968	RP90056	Ara® Stem & Valve	
259280	RP92714	Bracket, Nut, Wrench	
003434	RP12491	(2) HDF Wrist Blade Handles w/Set Screw	
024497	RP12490	Screws - Red and Blue	
003520	RP17449	Clear Handle w/Button & Screw, for Single Handle Faucet	
023197	RP17451	Clear Handle w/Button & Screw, for Tub & Shower	
024762	RP18627	Extender less Screws	
003572	RP19804	Cartridge Assembly	
022311	RP19807	Limit Stop	
049620	RP22734	Plated Bonnet	
187688	RP23094CZ	Handle Base & Gasket	
030260	RP23498	Clear Knob Handle w/Screws	
185875	RP23611RB	Base with Gasket	
024314	RP24096	Brass Stem Assy	
003604	RP2412	Two Handle Blade (2)	
050183	RP25513	Stem Unit w/Brass Stem	
137175	RP2865	Plug Push Button Diverter	
071395	RP28906	Red/Blue Indicator	
179884	RP30532	Battery Holder	
045840	RP32104	1700 Cartridge	
067930	RP32105	1700 Handle Screw	
048950	RP32522	Quick-Connect Clip	
120382	RP34359RB	Trim Ring - 14 Series	
151759	RP36203	Ext Nut and Washer for Electronic Fct	
187883	RP38367	End Valve Assembly	
184164	RP41702	2Hdl Kitchen Diverter	
140695	RP40668	R4700 Diverter Valve Assembly	
101730	RP41478	Nut and Adapter	
241265	RP41896	Small Glide Ring	
241266	RP41898	Large Glide Ring	
174179	RP44118BN	Handle Kit, Brushed Nickel	
172682	RP44123	Repair Kit	
184827	RP44493	Hose Assembly	
107694	RP44647	Pull-Out Hose Assembly	

Delta® Repair Parts (Continued)

Part #	Mfg #	Description	Price
241504	RP40505	Roman Tub Top Washer & Body for R2700/RP40505	
144594	RP46079	Pressure Test Hot/Cold Plug	
186204	RP47029	Lavatory Mounting Bracket	
157015	RP48592	Single Lever Handle Kit	
169900	RP49835	Mounting Nut	
169899	RP50391	Gasket and Baseplate	
241137	RP50786RB	Hot/Cold Button, Venetian Brz	
107655	RP51099	7' Leader Hose for Roman Tub	
160483	RP51290SS	Roman Tub Hand Shower Base Escutcheon	
223508	RP51306RB	17 Series Handle Kit	
187868	RP51306SS	17 Series Handle Kit	
151859	RP51307	1-Hdl Lever Handle Kit	
230767	RP51307CZ	17 Series Handle Kit	
223509	RP51307RB	17 Series Handle Kit	
187869	RP51307SS	17 Series Handle Kit	
161418	RP51345	Aerator - 1.5 GPM	
187690	RP51424	Temperature Knob and Cover	
160738	RP51479RB	Valve Sleeve Assembly	
222638	RP51502AR	Bonnet Cap, Arctic Stainless	
241278	RP51502RB	Bonnet Cap, Venetian Bronze	
173807	RP51514SS	Sleeve Assembly	
157876	RP51628RB	Escutcheon & Gasket	
154211	RP51685	Mounting Bracket and Nut	
179559	RP52147SS	Temp Knob and Cover	
164030	RP53879	Handle Button	
166762	RP53879SS	Handle Button, Stainless*	
131262	RP54269	Spray Cap	
157044	RP54974	Hot/Cold Indicator	
137154	RP60923	Kitchen Repair Part	
135054	RP43233	D-Spacer 14 Series	
122117	RP50587	Single Handle Valve Cartridge	
161889	RP51490	Escutcheon - Single Handle Kitchen Faucet	
154210	RP52610	Trim Ring, Base & Gasket	
164131	RP53217	Mounting Hardware - Valve	
176568	RP53531	Mounting Nuts	
173987	RP54232	Handle Kit, Chrome	

* Brilliance® Anti-Tarnish Lifetime Finishes

www.plumbsupply.com • Serving our Customers Since 1946 •

Delta Faucet Repair Parts

Delta® Repair Parts (Continued)

Part #	Mfg #	Description	Price
181486	RP54232SS	Handle Kit, Stainless	
166331	RP54687	Single Lever Elbow Handle	
153810	RP60962	Escutcheon and Gasket	
177033	RP60979	Trim Ring, Base and Gasket	
236968	RP61122	Addison Anchor Kit	
158729	RP6148	Escutcheon	
177305	RP61839RB	Escutcheon 1H Ven Brz	
260157	RP61839SS	Escutcheon, 1H Stainless*	
151718	RP6185	Stop Stem Assembly	
177217	RP62150SS	Handle Kit	
251901	RP62601RB	Brizo Slide Bar Assy, Venetian Bronze	
251736	RP62778AR	Linden Trim Ring, Base, & Gasket, Arctic Stainless	
171385	RP62961	Bidet Base, Chrome	
164948	RP62961SS	Bidet Base, Stainless	
154459	RP63131	Spout Assembly	
175400	RP63265	1/2" Slip Joint Adapter	
187192	RP64150SS	Mounting Post	
187191	RP64152SS	Slide Mechanism	
158670	RP64706	Handle Kit - 2-Hdl	
158671	RP64760	Stem Unit Assembly	
173247	RP64851	Diverter Bonnet Nut	
181639	RP70635RB	Roman Tub 2-Hdl Handle Kit	
181640	RP70637RB	Handle Flange, Ven Brz	
185771	RP70638RB	Diverter Lift Rod	
168736	RP70639RB	Shower Handle Assembly, Ven Bronze	
178178	RP72289	Lift Rod Plug	
185650	RP72721SS	Handshower Base	
180482	RP73054	Gaskets	
155687	RP73192	Red/Blue Button	
168272	RP73837	Low Flow Regulator	
177576	RP7424PN	Overflow Plate	
156883	RP7424RB	Overflow Plate	
181717	RP74608	54" PO Hose (Small OD)	
181034	RP74812	O-Rings	
252444	RP74836	Cartridge	
173787	RP75408	Rectangular Aerator, Set Screw	
187322	RP75409	Flow Regulator	

Delta® Repair Parts (Continued)

Part #	Mfg #	Description	Price
237173	RP75497	Handshower Base - Roman Tub	
170776	RP76691	Centerset Extension Kit	
185305	RP77162	Escutcheon	
186205	RP77263SS	Escutcheon - 3 Hole	
186203	RP77457SS	Button - Lift Rod Hole Cover	
166060	RP7900	Gasket	
252441	RP80619	Dominic Bonnet Nut	
189416	RP81914AR	Mateo® Escutcheon	
225577	RP81914	Mateo® Escutcheon	
186097	RP83888	Valve Bracket	
239225	RP84986SS	Diverter Temp Knob & Cover, *Stainless	
252706	RP90838	Addison Wand Assy	
252613	RP91788PC	Litze Handle Kit, Chrome	
245563	0611159A	4" Deck Plate & Holdown Pkg	

* Brilliance® Anti-Tarnish Lifetime Finishes

• **Serving our Customers Since 1946** • www.plumbsupply.com

Elkay Repair Parts

Elkay Sink Parts & Accessories

Mounting Clip



Part #	Mfg #	Description	Price
238525	LK-0000000222	Black/Grey Slot Clips, 8 Per Package	
006122	LK-363	Long Sink Clips	
104709	LK-463	Sink Clips for 1-5/8", 2", 2-1/2" Thick Tops	
162112	LKUCLIP8	Mounting Clip for Undermount Sinks	

Parts

Part #	Mfg #	Description	Price
006120	LK-350	Socket Screwdriver	
197181	LKMK462		
251855	P29248	Cartridge	
240190	1000001877	Drain Replacement Kit for EZ/EZTL	
238906	1000002436	Kitchen LED Board	
237642	100023340560	Waste Tube Gasket	
237637	101570540560	Drain Gasket	
237640	101637451550	Friction Ring	
237639	110346220550	Drain Nut	
237636	160270508640	Strainer Plate	
237641	161637308640	Drain Plug	
250822	45660C	Bubbler	
250124	45932C	Tail Piece	
237638	51575C	Packing Ring	
249745	75507C	Quick Connect For Solenoid 1/4 NPT x 1/4 OD	
244931	98753C	Overload Relay Kit	
244475	98999C	Drain Pad Kit for VRC8WS	

Elkay Repair Parts



Water Cooler Parts



Part #	Mfg #	Description	Price
252075	20723C	Cooler Bracket	
241890	21222C	Elkay Basin EHF/WC with DIMP	
023576	31513C	Elkay Cold Control	
086622	35981C	Elkay 1/4 Solenoid Valve	
045589	55996C	Cooler Y-Strainer	
006168	61313C	Cartridge for Water Cooler	
024551	61314C	Green Cartridge	
252428	98791C	Push Bar	
252640	EZSTLDL	Right Replacement	

**EZH2O™ Parts
WaterSentry® Filters**

- CTO Filters
- Features:
 - Quick-disconnect
 - 1/4 Turn installation
 - Hand never touch the actual filter media
 - Outer protective wrap
- NSF/ANSI 42 and 53 certified

Part #	Mfg #	Flow Rate	Rated	Full Load	Ship Wt	Description	Price
162211	EWf3000					Complete Kit, 3000 Gallon Filtration System	
189544	WSF6000R2PK					6000 Gallon, 2-pack	
132220	51300C					3000 Gallon, 1-Pack	
164978	51300C12PK					3000 Gallon, 12-Pack	



Empire Comfort Repair Parts

Replacement Parts

Blower

Part #	Mfg #	Description	Price
127041	FBB-4	Variable-Speed Blower	

Fenner Drives Repair Parts

Belts

PowerTwist Plus® V-Belt

- *No tools required, assembles in minutes*
- *High strength and low elongation under load*
- *High performance polyurethane elastomer reinforced with multiple plies of polyester fabric*



Part #	Mfg #	Type	Length	Pack	Price
143772	0418010SL	3L	5'	Slv	
143792	0418030SL	A/4L	5'	Slv	
143793	0405030	A/4L	25'	Box	
143795	0418050SL	B/5L	6'	Slv	
143796	0405050	B/5L	25'	Box	

General Filter Repair Parts

Manual Control Humidistats

- Senses variation in relative humidity levels
- Humidity range: 10% - 85%
- Duct cut-out dimensions: 2-1/4" x 1-3/4"
- Duct plate dimensions: 4" x 5-1/2"
- Mounting screws included



Wall-Mount Housing

- Allows for both wall and duct mount

Part #	Mfg #	Description	Price
146561	WMH3	Wall-Mount Housing for MHX3, MHX3C, or DHX3	

GeneralAire Replacement Parts 1042 Series Humidifier Replacement Parts

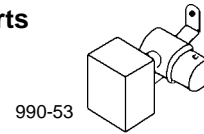

Part #	Mfg #	Description	Price
004874	990-53	Solenoid Valve Assembly - 24V for 1042/1137 (Includes Fittings)	
206827	GA4231	Yellow Orifice	

Replacement Evaporator Pad

- Aluminum evaporator material enclosed in heavy wire frame and channeling
- Pad has super absorbent coating



990-13

1099-20

Part #	Mfg #	Description	Price
004870	990-13	11-3/4"H x 9-3/4"W Evaporator Pad for Model SL-16, 1042, 1040, 1137	
125681	1099-20	12"H x 14-1/4"W Evaporator Pad for Model 1099, 950	



Gerber Repair Parts

Gerber Replacement Parts

Cartridge Assembly



92-298

Part #	Mfg #	Description	Price
023522	97-013	Complete Hardwater® Assembly, Less Control Cartridge	
023523	97-014	Complete Safetemp Assembly, Less Control Cartridge	
028493	92-298	Hardwater® Ceramic Cartridge with Limit Stop, Chrome	
088008	95-152	Hardwater® II & Safetemp II Washerless Pressure Balance Cartridge	
088009	95-154	Replacement Cartridge for GS103/GS105	
029460	97-022	Safetemp™ Control Cartridge, Chrome	
004822	97-510	Ceramic Disc Cartridge	
087758	98-674	Compression Cartridge - Cold	
004830	98-688	Compression Cartridge for Deck Faucet - Hot	
004831	98-689	Compression Cartridge for Deck Faucet - Cold	
020941	98-705	Long Ceramic Cartridge	
047463	98-709	T&S Ceramic Disc Cartridge-Cold	

Faceplate

Part #	Mfg #	Description	Price
004816	97-130	Faceplate Assembly, Chrome	
026255	97-171-KT	Faceplate Assembly, Chrome	

Handle

Part #	Mfg #	Description	Price
031332	86-986	Ceramaflo™ Disc Cartridge, Handle, Cold, Chrome	
031331	86-987	Ceramaflo™ Disc Cartridge, Handle, Hot, Chrome	
082641	97-020	Replacement Shower Handle	
004840	98-879	Wrist Blade Handles, Pair	

Shower Arm



Part #	Mfg #	Description	Price
004716	49-205	Lock Shower Arm Ell, Thin Wall Install, Less Spray Plate, Rough Brass	

Stem and Bonnet Assembly



Part #	Mfg #	Description	Price
004827	98-673	Stem & Bonnet Assembly, Hot	
004836	98-726	Diverter Stem & Bonnet Assy	

Unit Bag

Part #	Mfg #	Description	Price
004849	99-537	Unit Bag 298-290/590/790/794/795/796, White	
063774	99-538	UltraFlush Unit Bag, White	
105006	99-660	Gerber Unit Bag for Avalanche	

O-Ring



Part #	Mfg #	Description	Price
093297	92-257	O-Ring	
004802	92-660	Spout O-Ring	
004803	92-730	O-Ring	
004837	98-727	Bonnet O-Ring Stem Cage for 40-700 Series	

Parts

Part #	Mfg #	Description	Price
076038	90-067	Nipple 5/8" - 24 x 2.687"	
004776	90-161	Brass Seat 5/8"-20 NS-2 Thread	
026022	90-390	Fibre Follower	
091688	90-230	Screw	
004792	91-132	Middle Wire	
004799	91-280	Strainer Screw	
246168	91-565	0.5 gpm Aerator	
091418	92-294	Limit Stop for Safetemp	
241782	93-059	1Hdl Escutcheon Sleeve, Chrome	
248228	94-040	Spray Diverter w/ Vacuum Breaker	

*Physical Vapor Deposition (PVD) Limited Lifetime Finish

• Serving our Customers Since 1946 • www.plumbsupply.com



Gerber Repair Parts

Gerber Replacement Parts (Continued)

Parts

Part #	Mfg #	Description	Price
237303	95-163	Safetemp Loop Handle, Chrome	
136096	95-166	Safetemp Escutcheon, Chrome	
004812	96-121	Shoe Plug for Trip Lever	
095128	97-164	Wire/Plunger Assy for Roman Trip Lever Drain	
212516	97-232	Pressure Balance Mixing Valve, Cartridge, & Check Valve	
085928	97-305	Pop-Up Extension Assembly	
237124	97-820	T&S Coupling Nuts (2)	
039568	98-412	Handle, Button, & Screw	
204001	98-736	S/H Bath Body Stem Assy & Bottom Seal Kit	
227955	99-031	Maxwell Dual Flush Valve 1.1/1.6gpf, White	
004843	99-161	Lav Hanger	
027906	99-290	Urinal Wall Hanger (2 QTY)	
004850	99-539	Tank to Bowl Assy Kit (Unit Bag)	
101710	99-579	Channel Pad	
028454	99-605	Lid Locking Assy	
126879	99-685-09	Avalanche LH Trip Lever, Biscuit	
112220	99-685-WH	Avalanche LH Trip Lever, White	
137907	99-788	Flapper	
180235	99-791	Maxwell Flush Valve Kit, 1.1/1.6gpf (DF-28-190/195)	

*Physical Vapor Deposition (PVD) Limited Lifetime Finish

www.plumbsupply.com • Serving our Customers Since 1946 •

Gibson Repair Parts & Accessories

Parts & Accessories

Heater Kits

Part #	Mfg #	KW	Volts	Price
176342	H8HK005H11	4.8	240	
176339	H8HK010H11	9.6	240	
176338	H8HK015H21	14.4	240	
176337	H8HK020H21	19.2	240	
176336	H8HK024H31	24	240	

Hi-Velocity (Energy Savings Products) Repair Parts

Electrical Components



EPC Control Board

Part #	Mfg #	Part Name	Description	Price
127481	20120100001	EPC Circuit Board	Circuit Board for all HE/LV-E Fan Coils with EPC Motors	
127483	20120100030	EPC Transformer	Transformer for all HE/LV-E Fan Coils with EPC Motors	

Refrigerant Components



Part #	Mfg #	Part Name	Description	Price
097149	10040500010	Fixed Temp Freeze Stat	Fixed Temp Freeze Stat For use with RCM/RM/RPM Units	

Honeywell Repair Parts

Fan Centers

R8239 Control Center

- Provides low voltage control of line voltage fan motors and auxiliary circuits in heating, cooling or heat-cooling circuits
- Includes NEMA D Transformer, relay enclosures
- Convenient connections for thermostat and heating-cooling equipment wiring
- Mounts on standard 4" x 4" junction box in any indoor location without additional enclosures
- Relay is easily replaced without disturbing wiring



Part #	Mfg #	Description	Price
112616	R8239B1076	120/208/240V, DPDT Switching, 50VA Transformer, Includes R8222D	

R8285 Control Center

- Transformer powers low voltage control systems and provides overload protection
- Low voltage terminal board provides convenient connections for thermostat and heating/cooling equipment wiring
- Mounts on standard 4" x 4" junction box
- Relay is easily replaced without disturbing wiring



Part #	Mfg #	Description	Price
006780	R8285A1048	120V, SPDT Switching, 40VA Transformer, 24V Secondary, Includes R8222B Plug-In Relay for 1 or 2 Speed Fans	

Fan Timers

Universal Electronic Fan Timer

- Diagnostic LED
- Replaceable fuse
- DIP switch selectable heat and cool delay on and off times
- Includes EAC and HUM terminal connections & continuous low speed indoor air circulation
- Integrates control of all combustion blower & circulating fan operations in a gas warm-air appliance



Part #	Mfg #	Description	Price
134225	ST9120U1011	Electronic Fan Timer	

Parts & Accessories

Part #	Mfg #	Description	Price
138257	50041883-002	TrueEase AC Solenoid Valve	



Humidifier Parts & Accessories

Humidifier Parts & Accessories

Humidifier Parts

Part #	Mfg #	Description	Price
037355	32001615-001	Drain Fitting for HE220 and HE260 Humidifiers	
037357	32001639-002	Solenoid Valve Assembly for Honeywell Humidifiers, Includes Water Feed Tube & Nozzle	

Honeywell Repair Parts

Honeywell Accessories

Motors

Part #	Mfg #	Description	Price
006844	802360JA	24V Sealed Replacement Motor for V8043/V8044	
163574	802360LA	120V, 60 Hz Replacement Motor for V4043, V4044	
099342	MZV520-RP	24V 60 Hz Motor for MZV524E/25E/26E/27E w/switch	

Replacement Head for V Series Zone Valves

Part #	Mfg #	Description	Price
006841	40003916-026	24VAC, 50/60 Hz Replacement Head with End Switch for V8044E	
031407	40003916-048	24VAC, 50/60 Hz Replacement Head with End Switch for V8043F	

Checkout Kit for Economizer Logic Modules

- Includes resistor and jumpers
- Used with W7459, W7210, W7212, and W7215



Part #	Mfg #	Description	Price
223324	4074EJM	Economizer Checkout Kit for W7459, W7210, W7212, and W7215	

Honeywell Parts

Part #	Mfg #	Description	Price
074665	32001754-001	Current Sensing Relay for Whole-House Humidification Units	
006842	40003918-006	Adapter Kit for V4043, V8043, 2-Way Hydronic Valves	
127196	50027997-001	Solenoid Valve for TrueSTEAM	
163982	50041883-001	DC Solenoid Valve	
143930	50027998-002	True Steam Water Level Sensor	
152377	Y8427U9045	Universal Service Kit, Carton Consists of: (1) S8610U3009/U. (1) ST9120U1011/U. (1) Q3200U2002/U. (1) S9200U1000/U. (1) Multi tool.	
137379	50033181-001	TrueSTEAM Water Tank - Large	
129898	50028044-001	Humidifier Filter, In-Line Scale/Sediment	
166027	GROW2	Honeywell Kit	
209920	VCZAL1100U	3/4" Valve Body	
171083	THP9045A1023/ U	WireSaver for THX9000 Series Thermostats	

Hydron Module Repair Parts

Heat Pump Repair Parts

Part #	Mfg #	Description	Price
131157	11470002001	ECM Board	
099573	01CB28	Time Delay Board	
131158	11470003001	Combo Board	
146360	47P002-01NN	47p002-01nn Hydron Combo Board	
131156	11470001001	Control Board	
102660	01CB30	Control Board	
104349	32EB20	15/20kW Elec Board	
158573	40M100-01NN	ECM Motor Hydron	
177055	85A006-02VN	ECM Blower Motor	
136798	35P002-04NN	35p002-01nn Low Pres Switch	
136799	35P003-01NN	High Pres Switch	
136926	11350001002	Low Pres Switch Thrd	
187486	33K005-01NN	Low Pressure Switch	
136800	50FL001	Drain Pan Switch	
136823	05P001-01NN	Flow Switch	
141084	18R006	Valve	
141085	33P001-01NN	Valve Hydron	
167466	31P004-01CN	Hydron Air Coil	
167465	18V004	Hydron 3-Way Valve	
141083	18R00C	Coil f/Valve	
111761	26C008	3-Pole Contactor	
136803	11430001001	2-Pole Contactor	
131727	11410000001	Wiring Harness ECM	
136801	11450000001	75VA Transformer	
135343	34P060-11B	H062 410A 2-Stage Comp	
176400	50CB10	Compressor Blanket	
176401	50CB40	Compressor Blanket	
172648	51P010-01HN	Blower Wheel	
189666	AGO5INS	Double O-Ring x 1" Hose	

Capacitors

Part #	Mfg #	Description	Price
136806	26C101	Capacitor H018 Rev A&B	
136807	26C103	Capacitor All 024 Rev A&B	
136808	26C104	Cap H030&36/w036 Rev A	
136809	26C111	Capacitor	
136810	26C112	Capacitor	

Hydron Module Repair Parts

Accessories

Part #	Mfg #	Description	Price
249196	AP2836R	28x36x3/4 Rubber Pad	

Kohler Repair Parts

Kitchen Side Sprays

Standard Kitchen Side Spray & Hose



Part #	Mfg #	Description	Price
187506	1011130-VS	Sidespray Assy, *Stainless	
156774	1021724-VF	Sidespray w/Hose, Brass	
122911	GP1021724-7	Sidespray w/Hose, Black Black	

Spray & Hose



Part #	Mfg #	Description	Price
171513	1013838-BV	Spray Assy, *Br Brz	
153883	1014048-CP	Hose Secondary, Chrome	
155335	1036940-0	White Spray Head Kit	
153433	1037518-CP	Hose Kit, Polished Chrome	
244327	K-1032256-BN	Brushed Nickel*	
152453	1041320-CP	Hose Kit, Polished Chrome	
152453	1041320-CP	Hose Kit, Chrome	
101298	1056336-CP	Hose Kit, Chrome	
153955	1109445-BN	Spray w/ Screen *Br Nickel	
134128	1114379-BC	Hose Kit, Bright Chrome	
164835	1148629-BC	Hose Kit, Bright Chrome	
166252	1155250-CP	Bellera Spray Head Chrome	
182429	1141915	Hose Kit	
183339	1153208	Hose Guide	
156335	1155250-VS	Spray Head, *Stainless	
172261	1155250-2BZ	Spray head, Oil-Rbd Bronze	
165112	1155355-CP	Spray Head, Pol Chrome	
155345	1155355-VS	Spray Head, *Stainless	
162203	1179931	Sprayhead Adapter	
222878	1218822-CP	Spray Assy, Chrome	
181715	1218823-CP	Spray Assy, Chrome	
170388	1218824-CP	Spray Assy, Chrome	
173920	1218824-VS	Spray Assy, *Stainless	

Kitchen Side Sprays (Continued)

Spray & Hose

Part #	Mfg #	Description	Price
167009	1219935-BC	Hose Kit, Bright Chrome	
244611	1296842-CP	Hand spray Assy, Chrome	
258373	1315148-BN	Spray w/ Screen, *Br Nickel	
257811	1346768-BN	Pull-Out Spry Head, *Br Nkl	
157802	GP1092201	Hose Kit	
055348	GP78825-CP	Hose Kit Chrome	

Side Spray Assembly

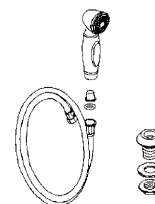

Part #	Mfg #	Description	Price
175894	1005010-CP	Hose Service Kit, Chrome	
153716	1005010-VF	Hose Service Kit, * Brass	
135248	1011130-G	Side Spray Assy Br Chrome	
155090	1085211-CP	Side Spray Assy, Chrome	
166253	1088395-VS	Side Spray Kit, *Stainless	
244405	1304674-BC	Pullout Hose Service Kit, Bright Chrome	

Shower Installation

Pressure Balancing Kit

Part #	Mfg #	Description	Price
134263	K-1144925	PBU for K-306-KS & K-2971-KS	

Urinal Installation

Part #	Mfg #	Description	Price
056119	21403	Urinal Cleanout Plug	

* Vibrant Limited Lifetime Warranty

www.plumbsupply.com • Serving our Customers Since 1946 •

Kohler Repair Parts

Urinal Spud Assembly



Part #	Mfg #	Size	Price
145344	18759	1-1/4"	

Cap Assembly



Part #	Mfg #	Description	Price
072213	1013092-0	Bolt Cap Accy Pack, White	
153559	1013092-G9	Bolt Cap Accy Pack, Sndbr	
186397	1013092-NY	Bolt Cap Accy Pack, Dune	
108130	GP1013092-96	Bolt Cap Accy Pack, Biscuit	
223630	5420-0	Low-Profile, White	
223631	5420-96	Low-Profile, Biscuit	
226816	5420-K4	Low-Profile, Cashmere	

Toilet/Urinal Installation & Accessories

Part #	Mfg #	Description	Price
246241	1261108	Urinal Piston, 0.125 GPF	
246242	1261109	Urinal Piston, 0.5 GPF	
246243	1261110	Urinal Piston, 1.0 GPF	
246244	1261111	Toilet Piston, 1.1 GPF	
246247	1261113	Toilet Piston, 1.6 GPF	
246249	1261112	Toilet Piston, 1.28 GPF	

Faucet Valves

Complete Valve Assembly for Retrofitting Faucet

- 1/2" Valve

Part #	Mfg #	Description	Price
137033	1131481	Valve Body w/Hot Stem	
172151	1170273	Valve Replacement	

Urinal Strainer



Part #	Mfg #	Description	Price
183714	53147-S	Urinal Strainer, Pol Stainless	
169956	GP1211759	Urinal Strainer	
173481	GP1217811	Urinal Strainer	
057460	9161-NA	Behve Urinal Strainer	

Valve Repair Seat

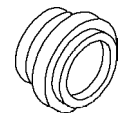

Part #	Mfg #	Description	Price
055320	20774-RP	Renewable Seat	

Vacuum Breaker

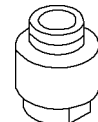

Part #	Mfg #	Description	Price
055422	GP49114	Vacuum Breaker	

Ballcock Retro Fit Valve

- For Rialto/
San Raphael 3.5 toilets



Part #	Mfg #	Description	Price
055292	K-84499	Plastic	

Valve Repair Kit



30166



1000187

Part #	Mfg #	Description	Price
182594	30147	Valve Service Kit	
182596	30372	Valve Service Kit	
182627	40409	End Valve Assy	
182681	58076	Valve Assy	
171801	76567	Valve Assy	

* Vibrant Limited Lifetime Warranty

• Serving our Customers Since 1946 • www.plumbsupply.com

Kohler Repair Parts

Valve Repair (Continued)

Valve Repair Kit

Part #	Mfg #	Description	Price
056161	1000187	Valve Repair Kit	
162934	1178733	Valve Assy	
165027	1021121	Valve, Volume Control	
132759	GP1017426	Valve, Kitchen	
160355	GP1093674	Valve, Kitchen	
222832	GP1152350	Valve, Centerset Faucet	
222831	GP1192521	Valve, 25 MM White	
055381	GP78579	Valve Repair Kit	
055308	GP30166	Valve Service Kit	
055317	GP30119	Valve, Trend Shower (Hot)	

Valve Repair (Continued)

Washers, Nuts & Gaskets

Part #	Mfg #	Description	Price
182647	51250	Gasket	
113702	51531	Gasket	
169200	52705-CP	Nut, Polished Chrome	
055325	53410	Washer	
159433	55164	Nut	
182656	55413	Washer	
182687	59606	Gasket	
181864	65157	Nut	
165926	65885	Gasket	
178854	71108	Nut	
177272	71813	Gasket	
250568	71975	Gasket, Alignment	
255526	76245	Rubber Gasket	
166860	78058	Washer	
166861	78057	Washer	
166859	78087	Gasket	
182733	79252-G	FacePlate Gasket	
182745	1007995	Washer	
182740	1000949	Washer, Plastic	
154945	1009882	Gasket, Molded	
165460	1015190	Washer	
183181	1018336-RP	Nut, Rough Plate	
181866	1020677	Gasket	
183184	1025642	Washer	
166877	1037307	Gasket	
152641	1050048-B	Nut	
183214	1051504-RP	Nut, Rough Plate	
178035	1070291	Gasket Kit	
257289	1101470	Mounting Gasket	
155661	1106733	Washer	
154740	1113583	Locknut & Gasket Kit	
183328	1128531	Washer	
180292	1222738	Gasket	
187471	1181517-RP	Nut, Rough Plate	

Washers, Nuts & Gaskets



Part #	Mfg #	Description	Price
182530	20496-BC	Lock Nut, Bright Chrome	
182532	20564	Washer	
182533	20565	Washer	
182536	20644	Gasket	
247267	21600	Washer F/STR-PLU	
182569	21766	Nut	
182572	21779	Gasket	
182574	21844	Nut	
153386	23094	Nut	
182584	24003-CP	Nut, Polished Chrome	
153819	32008	Nut	
182601	32060	Washer	
163448	32313	Nut	
182603	32841	Gasket	
182604	33331	Washer	
182606	33504	Washer	
182607	33772	Washer	
182608	34037	Gasket	
182610	34074-CP	Nut, Polished Chrome	
154416	34274	Washer	
182618	36262	Washer	
182626	40295	Washer	
170645	41376	Gasket	
154513	50751	Nut	
112456	50752	Washer	
182646	50843	Washer	

* Vibrant Limited Lifetime Warranty

www.plumbsupply.com • Serving our Customers Since 1946 •

Kohler Repair Parts

Rough-In Valves Parts and Assemblies

Rite-Temp® Test Cap for K-8300 Series Valve Bodies

- Includes test cap assembly with seals
- Rated for pressure-testing up to 150 psi maximum (air or water)
- Supplied as standard with K-8300 series valve body rough-ins
- Available as an optional extra for K-8304 series valve body and cartridge kits
- Allows installed valve rough-in to be flushed and pressure-tested without installing cartridge



Part #	Mfg #	Description	Price
226714	K-10351-NA	Test Cap for K-8300 Series Valve Bodies	

10" Rough-In Full Skirt Trap and Attachment System

- 10" (254 mm) rough-in
- Converts standard 12" rough-in products to 10" configuration
- Plastic trapway



For use with the K-3981 Tresham one-piece toilet, K-6428 Memoirs Stately skirted one-piece toilet and K-6424 Memoirs Classic skirted one-piece toilet

Part #	Mfg #	Description	Price
230307	K-5383-NA	10" Rough-In Kit	

Sink Service Parts Rough-In Kit



GP1030932

Part #	Mfg #	Description	Price
166957	1066498	Rough-In Kit	
170792	1139260-CP	Rough-In Kit, Pol Chrome	
158598	1131486	Rough-In Kit	
168420	1187917	Rough-In Kit	
169472	1194630	Rough-In Kit	
127033	56373-CP	Rough-In Kit, Pol Chrome	
182707	73418-CP	Rough-In Kit, Pol Chrome	
098493	GP1007937-CP	Rough-In Kit Pol Chrome	
090369	GP1025388	Rough-In Kit Pol Chrome	
087416	GP1030932	Rough-In Kit Pol Chrome	

Parts

Part #	Mfg #	Description	Price
154944	1000193-BV	Escutcheon, *Br Bronze	
166994	1000282-CP	Handle Kit, Pol Chrome	
189946	1001384-47	Service Kit, Almond	
153127	1001384-96	Service Kit, Biscuit	
155078	1001384-89	Service Kit, Desert Bloom	
258998	1001726-CP	Handle Service Kit, Chrome	
185783	1001795-BN	Handle Kit, * Br Nickel	
190273	1001795-47	Handle Kit	
177854	1001978-CP	Escutcheon, Pol Chrome	
153385	1002856	Bracket-Hold Down	
182739	100315	Clicker-Drain Assy	
182018	1003594	Spout Seal	
151709	1005129	O-Ring	
166832	1006008	Lift Rod Kit	
103651	1006026	Retainer	
182741	1006057-CP	Door Hinge, Pol Chrome	
182742	1006134-CP	Door Hinge, Pol Chrome	
177856	1006262	Stem Adapter Assy	
180497	1006269-CP	Escutcheon, Pol Chrome	
182744	1006396	Pin	
245107	1006397-CP	Hinge Cover, Pol Chrome	
167396	1006784-CP	Escutcheon Assy, Chrome	
180037	1007376-CP	Handle Kit, Pol Chrome	
162642	1007718-CP	Handle, Pol Chrome	
156197	1007999	Stem Driver	
257315	1008148-CP	Lift Rod Assy, Chrome	
177857	1008205	Screw	
187098	1009781-CP	Faceplate, Pol Chrome	
189790	1009814-CP	Escutcheon, Pol Chrome	
183175	1009872-AF	Bonnet, *French Gold	
251631	1009888-BN	Base Handle, *Br Nickel	
154055	1009888-CP	Base Handle, Chrome	
251630	1009890-BN	Lever Handle, *Br Nickel	
165459	1010161-BN	Trim Ring, *Br Nickel	
188789	1010315-CP	Escutcheon, Pol Chrome	
181490	1010672	Air Pressure Switch	
182875	1011032-0	Whirlpool Trim Kit, White	
182874	1011031-96	Whirlpool Trim Kit, Biscuit	
165984	1012391-BN	Handle, *Br Nickel	
166803	1012916	Split Coupling	
170229	1012977	Adapter	

* Vibrant Limited Lifetime Warranty

• Serving our Customers Since 1946 • www.plumbsupply.com

Kohler Repair Parts

Parts (Continued)

Part #	Mfg #	Description	Price
167478	1013452-0	Dial Trim Assy, White	
167477	1013453	Detent Spring	
181867	1013469-0	Trim Ring, White	
164795	1013489	Stem	
252425	1013847-BN	Handle Kit, *Br Nickel	
165835	1014065	Tank Plate	
165458	1014087-BN	Bonnet, *Br Nickel	
182876	1014072-7	Toilet Seat, Black Black	
183178	1014554-SN	Spout & Hardware, *Nickel	
160891	1014555-CP	Spout & Hardware, Chrome	
182877	1014556-CP	Spout & Hardware, Chrome	
167744	1014917-G	Lift Rod Assy, Br Chrome	
175018	1015084-BN	Button, *Brushed Nickel	
167746	1015084-G	Button, Brushed Chrome	
136712	1015345	Graphics, Red & Blue	
172143	1015467-2BZ	Handle Assy Oil-Rbd Bronze	
165456	1015782	Screw	
153165	1016455-CP	Escutcheon Assy, Chrome	
183180	1017273	Screw	
259510	1018651-SN	Handle Assy, *Pol Nickel	
181863	1018662	Control Assy	
182879	1020006-G	Shower Arm, Br Chrome	
259288	1020006-2BZ	Shower Arm, Oil Rbd Brz	
182880	1020007-VF	Shower Arm, *Pol Brass	
182881	1020609	Tube	
167479	1023381	Service Tool	
255174	1023391-BN	Stopper, *Br Nickel	
190293	1022562-VF	Trip Lever Kit, Pol Brass	
173541	1024303-0	Button, White	
162318	1024303-2BZ	Button, Oil Rubbed Bronze	
162335	1024303-BN	Button, *Brushed Nickel	
183183	1024303-VF	Button, Polished Brass	
252956	1025208-CP	Handle Kit, Chrome	
183167	1025637-AF	Trim Ring, *French Gold	
154765	1025637-BN	Trim Ring, *Brushed Nickel	
153164	1030689-CP	Escutcheon, Pol Chrome	
183185	1031444	Soap Dish	
176758	1031869-CP	Escutcheon, Pol Chrome	
183186	1031962	Bearing	

Parts (Continued)

Part #	Mfg #	Description	Price
183187	1032126-VF	Drain Handle Assy, Brass	
175899	1032250	Seal	
187628	1032253-BC	Body Assy, Bright Chrome	
183188	1032267	Replacement Screw	
186677	1032493-0	Bubble bath Interface, White	
252418	1032501-CP	Escutcheon, Chrome	
177257	1032546	Valve Stops	
223376	1032872-BC	Valve Stem Adapter	
190205	1033209	Tube, 10.50	
171281	1033743-BN	Escutcheon, *Br Nickel	
153729	1034578	Retainer	
184322	1035359-BN	Escutcheon, *Br Nickel	
166029	1035359-CP	Escutcheon, Chrome	
183191	1035359-VS	Escutcheon, *Stainless	
183192	1035564	Drain Link	
168072	1035605	Screw Set	
170434	1035796-CP	Handle, Pol Chrome	
246749	1036041-CP	Body Spray Face, Chrome	
163159	1036044	Clamp	
182830	1036210	Blower Kit	
253206	1036216	Blower Experience Kit	
183193	1036218	Check Valve Assy Kit	
183194	1036221	Cover/CB Assy	
172555	1036453-CP	Handle Assembly, Chrome	
259125	1036775	Service Kit	
171280	1036906	Putty Plate	
187935	1036932-BN	TrimRing, *Brushed Nickel	
183195	1036994-AF	Plunger Assy, *French Gold	
159708	1036994-VF	Plunger Assy, Pol Brass	
175689	1037021-BN	Plunger Assy *Br Nickel	
183197	1037021-G	Plunger Assy Br Chrome	
172528	1037022-BKB	Plunger Assembly, Br Black	
258115	1037022-PGD	Plunger Assy, *Mod Pol Gld	
161237	1037023-BN	Drain Assy, *Br Nickel	
183198	1037023-G	Drain Assy, Br Chrome	
175333	1037334	Plunger Arm Assy	
245304	1037431-BN	Spray Holder Assy, *Br Nkl	
170632	1037431-BV	Spray Holder Assy, *Br Brz	
225585	1037431-G	Spray Holder Assy, Br Chr	

* Vibrant Limited Lifetime Warranty

www.plumbsupply.com • Serving our Customers Since 1946 •

Kohler Repair Parts

Parts (Continued)

Part #	Mfg #	Description	Price
153316	1039475	Mounting Kit	
184794	1039714-BN	Lever Handle, *Br Nickel	
163161	1039745	Set Screw	
166289	1040484-CP	Spout Kit, Pol Chrome	
183200	1041109-G	Escutcheon, Br Chrome	
174324	1041180-BN	Lift Rod, *Brushed Nickel	
185607	1041321-CP	Handle Kit, Br Chrome	
165318	1041573-G	Spray Face, Br Chrome	
177167	1041840	Drain Rod	
183201	1042007	Check Valve Kit	
177074	1042634	Wall Sleeve Assy	
256583	1043060-A-96	Access Panel 1160, Biscuit	
163145	1044060	O-Ring	
168711	1044616	Retainer	
163427	1045251	Cable Assembly	
248081	1043340-CP	LH Trip Lever Assembly	
163158	1045768	Sprayhead Kit	
165316	1045769	Sprayhead Kit	
110496	1046104	Thermostatic Vlv Cartridge	
177258	1046101	Seal Kit	
183203	1046153	Weight	
258997	1047628-CP	Sleeve Mixer, Chrome	
183204	1048208-B	Screw	
183205	1048208-C	Screw	
183206	1048656-P	Sealing Liquid	
183695	1049146	Floor Mounted Fixing Pack	
163160	1051487	Membrane	
183207	1051503-BN	Bonnet, *Brushed Nickel	
165317	1051682	Membrane	
185403	1052086	Power Supply Kit	
183215	1052857	Reduce Bushing	
183216	1054165-SN	Lift Rod Assy, *Pol Nickel	
183218	1055628	Solenoid Assembly	
135539	1055666	Solenoid	
187554	1055800-BN	Handle Kit, *Br Nickel	
169720	1060438-CP	Escutcheon, Pol Chrome	
120956	1060514	Insert - Square Stem for Coralais Handle	
176650	1060800	Spacer Kit	
169793	1067372-96	Toilet Seat, Biscuit	
183220	1068202-BN	Stopper, *Brushed Nickel	
163642	1068202-BV	Stopper, *Brushed Bronze	

Parts (Continued)

Part #	Mfg #	Description	Price
177685	1068525-BN	Assembly Cover, *Br Nickel	
163641	1068525-BV	Assembly Cover, *Br Brz	
237117	1068525-2BZ	Assembly Cover, Oil Rd Brz	
187234	1068945	Retainer	
183221	1069315	Spring	
183222	1069723-0	Trip Lever, White	
245108	1070676-01-58	Strike Jamb Seal, Thunder Grey	
183223	1070844	Hardware Bag	
183224	1071000	Storage Locker Parts Kit	
169116	1071652	Hex Bit	
254174	1071965	1/4 Turn Valve Kit	
171261	1074034	Tool Assy	
183225	1074721-BN	Bonnet, *Br Nickel	
183226	1074724-BN	Adapter, *Brushed Nickel	
183227	1075614	O-Ring	
183228	1075615	O-Ring	
178585	1077791-96	Plug Buttons, Biscuit	
245303	1077792-96	Plug Buttons, Biscuit	
171786	1077792-BN	Plug Buttons, *Br Nickel	
183229	1077813	Solenoid Valve Kit	
183230	1077815	Valve Cover Kit	
183231	1077816	Diaphragm Kit	
128818	1078578	Flush Valve Assembly Kit	
155319	10813650-0	Floor Mounting Kit Assy	
183232	1081873-BN	Handle, *Brushed Nickel	
222456	1081873-CP	Handle, Chrome	
257036	1082514-CP	10-24 Brass Screw, Chrm	
114111	1083980	Canister Valve Assy Kit	
156362	1086408-CP	Handle, Pol Chrome	
156410	1086409-58	Ring, Thunder Grey	
222940	1085211-VS	Side Spray Assembly	
155113	1086972	Hinge Mount	
257037	1087472-CP	Strainer Plate, Sqr Chrome	
257039	1087473-CP	Strainer Ring, Sqr Chrome	
163815	1088996	Valve Kit	
181309	1090621-2BZ	Lift Rod Assy, ORB	
183235	1093029	Assembly Body	
161131	1093053-BV	Spout & Diverter *Br Bronze	
160252	1094550-CP	Straight Stop, Pol Chrome	

* Vibrant Limited Lifetime Warranty

• Serving our Customers Since 1946 • www.plumbsupply.com

Kohler Repair Parts

Parts (Continued)

Part #	Mfg #	Description	Price
183236	1094562	Bonnet	
170190	1094612-CP	Valve, Polished Chrome	
154678	1094633	Seat & Sleeve Assembly	
166611	1094724	Side Body	
251743	1094562-CP	Bonnet, Chrome	
148639	1095910	Diaphragm Assembly	
183240	1098124	O-Ring	
183176	1010343-CP	Handle, Polished Chrome	
182747	1010376	Flapper	
155669	1011059-58	Ring, Thunder Grey	
165461	1011530-BN	Handle, *Brushed Nickel	
246158	1012692	Pressure Switch	
157984	1013457-E-96	Flagship Assy, Biscuit	
159535	1013970	Screw	
152457	1013975	Adapter	
154533	1014049	Steam Adapter	
157985	1015009	Plug Assy	
169377	1016310	Plate	
254563	1016373	Check Valve, 14MM O.D.	
156133	1016953	Pump Assy	
156195	1018651-CP	Handle Polished Chrome	
159106	1018651-BN	Handle *Brushed Nickel	
157818	1018651-BRZ	Handle, Oil Rubbed Bronze	
255937	1018663	NGH Core Upgrade w/ Neck & Back Control Assy	
165985	1019021-BN	Waste Plug, *Br Nickel	
151743	1020678-E-96	Cover/CB Assy, Biscuit	
156951	1020679-A	Cover/CB Assembly	
252615	1020882	Threaded Sleeve	
252955	1021514	Extension Stem	
251115	1021961-BV	Lift Rod Assy, *Br Bronze	
159540	1024303-47	Plug Button, Almond	
160135	1024303-96	Plug Button, Biscuit	
157926	1024303-CP	Plug Button, Pol Chrome	
111678	1024419	Hub	
159622	1025210-BN	Escutcheon Assy, *Br Nkl	
154531	1025639-BC	Drain, Bright Chrome	
159534	1032871-BC	Adapter, Bright Chrome	
151597	1033731	Plug Assembly	
151598	1033732	Mixer Valve	
158221	1034484	Clip	

Parts (Continued)

Part #	Mfg #	Description	Price
154831	1035023-CP	Handle Assy, Pol Chrome	
152485	1035783	Seal Assy	
152917	1036160	Push Rod Kit	
152344	1036212	Kit, Blower-International	
172556	1036452-CP	Handle Assy, Pol Chrome	
153655	1036994-CP	Plunger Assy, Pol Chrome	
183196	1036994-G	Plunger Assy, Br Chrome	
152915	1037044-CP	Handle Assembly, Chrome	
183199	1038690	Vent Assembly	
159505	1039095-CP	Assy, Polished Chrome	
173128	1041321-BN	Handle Kit, *Brushed Nickel	
155666	1041321-G	Handle Kit, Br Chrome	
248045	1042629-CP	Control Ring Assy, Chrome	
190209	1042831	Flush Valve Kit	
153884	1043004	Screw Set	
152643	1044585	Roller	
223269	1045770	Adapter Kit	
120496	1046987-CP	Handle Kit, Pol Chrome	
223375	1048476	Screw, M4 x 60MM Long	
152637	1051142-A	Screw	
152456	1051609-BN	Lift Rod, *Br Nickel	
152435	1054623-BN	Diverter Assy, *Br Nickel	
162256	1055650-CP	Push Button Assy, Chrome	
153605	1055715	Service Kit	
152639	1059792	Bushing	
135541	1060056	Kit, Piston Cover	
253400	1062356-0	Drain Cover, White	
186964	1062356-33	Drain Cover, Mexican Sand	
157607	1065219	Electronic Unit Assy	
248941	1068202-2BL	Stopper, Black	
155414	1068204	Cartridge Assy	
171397	1068380-0	Access Panel	
253024	1068380-A-0	Access Panel Assy 1124	
246111	1070675-01-58	Strike Jamb Cap, Thunder Grey	
152838	1072961-CP	Button Assy, Pol Chrome	
152644	1077763-A	Bolt	
165893	1077792-BV	Plug Buttons, *Br Bronze	
159625	1077792-47	Plug Buttons, Almond	
152717	1080774	Union Assy	

* Vibrant Limited Lifetime Warranty

www.plumbsupply.com • Serving our Customers Since 1946 •

Kohler Repair Parts

Parts (Continued)

Part #	Mfg #	Description	Price
157870	1081349	Adapter Assy	
152040	1093052-VF	Kit, Polished Brass	
251740	1094009-BC	RH Vlv Stem, Brght Chrm	
251741	1094010-BC	LH Vlv Stem, Brght Chrm	
183173	1100507-0	Hinge Cover, White	
155987	1100590	Hose	
259287	1101931-2BZ	Flange, Oil Rubbed Bronze	
148638	1102542	Solenoid Assy	
157194	1104111-BV	Nozzle Assy, *Br Bronze	
185157	1104111-CP	Nozzle Assy, Chrome	
164048	1104111-VF	Nozzle Assy, Pol Brass	
164773	1104235	Solenoid Kit	
168064	1104270	Assy	
170369	1104271	Electronic Unit Assy	
168063	1104272	Piston Cover Kit	
154930	1104617	Crank Assy	
172129	1104957	Laminar Insert	
125323	1105656	O-Ring	
189739	1105685-BN	Overflow Cover, *Br Nickel	
247385	1105685-CP	Overflow Cover, Chrome	
183243	1105706	Tool Kit	
188100	1105900	Spout Extension Assy	
165033	1106015	Sensor Assy	
155660	1106729-BN	Handle, *Brushed Nickel	
248480	1109254-CP	Loure Escutcheon, Chrome	
254684	1122899-CP	3/4" Stop Valve, Chrome	
248402	1125009-CP	Cover Assy, Chrome	
253892	1110300	Hose Assembly	
168062	1111139	Solenoid Kit	
244187	1112258	Tank Plate	
253891	1113617	Quick Connect Tee Assy	
251786	1140157-2BZ	Bonnet Handle, Oil Rbd Brz	
251739	1114865	Gasket, .365 ID x .745 OD	
183324	1115286	Ring	
255184	1115287	Threaded Ring	
246840	1115841-CP	Flange, Chrome	
160683	1119112	Slip-Fit Clamp Kit	
183325	1120992-BN	Handle, *Brushed Nickel	
248023	1123790-CP	Handle Assy, Chrome	

Parts (Continued)

Part #	Mfg #	Description	Price
253290	1128497-CP	Trip Lever Handle Assy	
137034	1131482	Vlv Assy for WS Fcts (Cold)	
140785	1131496	Seal, Canister Dual Flush	
183329	1131838-58	Bumper, Thunder Grey	
152557	1133024	Hardware Pack	
177252	1133070	Service Kit	
155662	1138476-BN	Escutcheon Assy *Br Nickel	
158967	1139558	Collect-Push-In	
183696	1139526-CP	Elbow Assy, Pol Chrome	
168212	1139600	Trapway Service Kit	
155640	1140164-BN	Flange, *Brushed Nickel	
141416	1140858-CP	Slidebar Assy, Chrome	
183331	1140867-BN	Cover, *Brushed Nickel	
183697	1141213-B	Cartridge, Transfer Valve	
222069	1142457-BN	Spout Assembly	
177423	1142538	Filter Block	
259033	1145552	Adapter Kit for K528KNA	
183336	1145563	Kit, SPR Valve Assembly	
254560	1145620	Debris Screen	
172730	1145638-HW1	Toe Tap Assy	
169192	1146417	Pump	
183337	1146802-0	Air Jet Service Assy, White	
152316	1147742-0	Air Switch Kit, White	
157788	1147742-47	Air Switch Kit, Almond	
166779	114847-VS	Spray, *Stainless	
251739	1114865	Gasket	
183338	1150464-0	EB Hinge Kit, White	
249067	1150464-96	EB Hinge Kit, Biscuit	
160674	1151429-CP	Collar, Polished Chrome	
180822	1151441-CP	Shower Arm, Pol Chrome	
163200	1151968-BN	Service Kit, *Brushed Nickel	
163170	1151968-CP	Service Kit, Pol Chrome	
171450	1152299-BN	Spray/Screen Kit, *Br Nickel	
166599	1153944-BN	Handle Kit, *Br Nickel	
164798	1153944-CP	Handle Kit, Pol Chrome	
187838	1153944-G	Handle Kit, Br Chrome	
167699	1154757-58	Screw Cover Service Kit	
188368	1154836	Hose Assy	
249368	1155515	Flush Valve Fixing	
170194	1155520	Pipe System	

* Vibrant Limited Lifetime Warranty

• Serving our Customers Since 1946 • www.plumbsupply.com

Kohler Repair Parts

Parts (Continued)

Part #	Mfg #	Description	Price
177056	1156410-BN	Plug Button, *Br Nickel	
183698	1156410-CP	Plug Button, Pol Chrome	
183702	1160753	Adapter	
183555	1161770	Rotary Assy	
254561	1164600	Flow Regulator, 2.0 GPM	
190321	1166635	3/4" Volume Control Insert	
166308	1166879-BN	Tube, *Brushed Nickel	
223932	1166879-CP	Tube, Pol Chrome	
176945	1173678	Cartridge Assy	
180261	1175870-BN	Lift Rod, *Br Nickel	
254596	1176995	Inlet Filter	
181980	1177160	Sink Clips	
183704	1177161	Installation Clip Kit	
173008	1178736	PCB Board & Cover Assy	
248940	1179957-BL	Strainer, Matte Black	
183706	1179957-BN	Strainer, *Brushed Nickel	
248943	1179957-2BL	Strainer, Black	
069038	1179-NA	Tiling-In Bead, 180" Length	
167166	1180445-VF	Escutcheon, Polished Brass	
259534	1180978-CP	Escutcheon, Chrome	
056792	1181-NA	Tiling-In Bead, 132" Length	
161065	1185540-BN	Assy Slider, *Br Nickel	
256936	1186673	Valve Service Kit	
254562	1186675	Collet Service Kit	
253559	1187796-NX	Handle Kit, Brushed Nickel	
188413	1187796-SH	Handle Kit, Bright Silver	
172092	1187796-SHP	Handle Kit, Bright Pol Silver	
158906	1190050-K-CP	Assy, Polished Chrome	
188463	1191575-CP	Shower Arm, Pol Chrome	
254685	1193202	Potted HEC Battery, 8 oz.	
171043	1194302-CP	Large Escutcheon, Pol Chr	
182831	1194940	Cable	
254876	1198201	Valve Kit	
183710	1200948	Chain Kit	
172093	1201773-BN	Spout Assy, *Br Nickel	
188554	1202708	Mirrored Door Assy	
169231	1202077	Supply Hose SS	
224199	1202709	Mirrored Door Assembly	
186691	1204788-2BZ	Cold Handle Assy, ORB	

Parts (Continued)

Part #	Mfg #	Description	Price
186251	1207169	Supply Hose	
183711	1207943	Diverter Spout Cap	
165035	1209172-VS	Escutcheon,* Stainless	
222939	1209172-CP	Escutcheon, Oil-Rubbed Brz	
251085	1211811-0	Tank Cover, White	
257070	1213082	Spherical Bushing	
252475	1215251-C	Verdera Glass Shelf Kit with 24" Cabinet	
252474	1215255	Verdera Parts Box	
254765	1215256	Verdera Mag Mirror Kit	
259221	1216617	Canister Valve Assy	
224985	1218071	Supply Adapter	
186669	1218822-VS	Spray Assy, *Stainless	
254980	1218823-2BZ	Spray Assy, Oil Rubd Brz	
176606	1218922-CP	Button, Polished Chrome	
181868	1219654	Heater	
179983	1219693	Pipe Plug	
180294	1222736	Adapter	
188461	1224550-CP	Escutcheon, Pol Chrome	
230778	1225240	Adapter Kit	
257069	1225543-0	Bolt Cap Kit, White	
187872	1229031	Supply Adapter	
171581	1229524	Basin Rack Wheels	
244980	1222873	Quick Connector Kit	
183712	1232221-BN	Handle Assy, *Br Nickel	
177253	1239016	Hardware Pack	
178416	1240529	Overflow Shell	
259544	1247432-SHP-GC05	Panel Assembly	
185308	1256315	OEM Touchless Assy	
251116	1261116-CP	Handle Assy Kit, Chrome	
255066	1262200	Diverter Assy	
189976	1262603-CP	Steam Head Kit, Pol Chr	
258409	1266657	25 MM Valve Kit	
255979	1267750	CAM Assy Kit, Angled Base	
267474	1357001-VS	Spray Assy Detail, *Stainlss	
267475	1357001-CP	Spray Assembly	
250700	1276184	Cover Assy Detail	
259022	1297594	Vlv Service Kit w/ Hydorail	

* Vibrant Limited Lifetime Warranty

www.plumbsupply.com • Serving our Customers Since 1946 •

Kohler Repair Parts

Parts (Continued)

Part #	Mfg #	Description	Price
255495	1303882-BL	Spray Assy, Kitchen Sweep Matte Black	
250654	1345879	Touchless 1.5 Flush Kit RetroFit	
252424	1352289-BN	Bonnet Kit, *Br. Nickel	
158897	13602-NA	Cable Assy	
247220	13603-NA	8' Cable Assy	
124369	18376	3/4" Urinal Spud Assembly	
257272	20003-CP	Escutcheon Plate, July Chr	
182526	20345-BN	Flange & Set Screw Assy,*Br Nickel	
156847	20345-CP	Flange & Set Screw Assy, Chrome	
165097	20345-VF	Flange & Set Screw Assy, Pol Brass	
162187	20363-VF	Flange Assy, Pol Brass	
182529	20413-CP	Valve Stem, Pol Chrome	
182527	20401	Post	
222959	70442	Stem Extension Kit	
182531	20536-CP	Lift Rod, Pol Chrome	
182534	20615-BN	Screw, *Brushed Nickel	
182535	20617-CP	Overflow Hood, Chrome	
182537	20650-CP	Stopper Assy, Chrome	
182538	20652-CP	Screw, Chrome	
182539	20654-RP	Valvet, Rough Plate	
182540	20851-CP	Escutcheon, Pol Chrome	
254341	20852-NA	Aquifer Cartridge Kit	
055337	20961	Seat Washer	
085742	21076	Stem Assembly	
182558	21072-BN	Stopper Assy, * Br Nickel	
182560	21098-CP	Escutcheon, Chrome	
223383	21694	Lift Toggle Assembly	
182570	21775	Screw	
182571	21777	Niedecken Detail	
182573	21843-BC	Screw, Bright Chrome	
182575	21845	Packing	
164410	21152	Screw	
164411	21153	Adjusting Block	
164409	21155	Lift Rod	
158316	21166-BKB	Strainer Body, Br Black	
173074	21166-CP	Strainer Body, Chrome	
182561	21166-VF	Strainer Body, Pol Brass	
182562	21281-CP	Shroud Cover, Chrome	

Parts (Continued)

Part #	Mfg #	Description	Price
182882	21318-AF	Stopper Assy, * Fr Gold	
158315	21318-BKB	Stopper Assy, Br Black	
182563	21318-VF	Stopper Assy, Pol Brass	
182564	21354	Lift Rod	
182565	21496	O-Ring Assy	
247266	21603-VF	Screw, Oval Countersunk .250-20 x 1.50	
182567	21712-BC	Stem, Bright Chrome	
182568	21745-CP	Cover, Pol Chrome	
172647	22125	Plunger	
172649	22126	Plunger	
172650	22211	Disc Holder	
172651	22212	Disc Holder	
182576	22325	Spline Insert	
182577	22511	Valve	
182578	22692	Diverter Seat	
182579	22859	Screw	
182580	22862-BC	Diverter Stem, Bright Chr	
162949	22910-CP	Sleeve, Polished Chrome	
182581	22916-BN	Overflow Plate, * Br Nickel	
182582	22916-CP	Overflow Plate, Chrome	
182583	22942	Seat	
153611	23023-BC	Valve Stem, Bright Chrome	
153119	23058-BC	Valve Stem, Bright Chrome	
182585	24015	Union Joint	
174497	28518	Pin	
182586	29037-BC	Drain Crank, Bright Chrome	
182587	29039-BC	Drain Crank, Bright Chrome	
182588	29060-BN	Lever Lift, * Br Nickel	
182589	29077-BN	Screw, *Br Nickel	
182590	29643	Lift Toggle	
182591	30040	Valve Stem Ledge	
182592	30042	Valve Stem	
182593	30139	Sleeve & Diverter Kit	
175179	30152	Plunger Assy	
182595	30154	Lift Rod Assy	
151344	30253-RP	Rebuilding Kit, Rough Plate	
154165	30297-CP	Rebuilding Kit, Chrome	

* Vibrant Limited Lifetime Warranty

• **Serving our Customers Since 1946** • www.plumbsupply.com

Kohler Repair Parts

Parts (Continued)

Part #	Mfg #	Description	Price
166211	30299	Rebuilding Kit	
177747	30332-RP	Hardware Kit, Rough Plate	
167058	30394-RP	Valve, Rough Plate	
182597	30419	Tank Accessory Pack	
182598	30467	Diverter	
165924	30739	Removal Tool	
160203	30775	WP Control Kit	
258879	31468	Renewable Unit Assy	
163455	31537	Ball & Frame Assy	
182600	31584-BC	Valve Stem Assy, Brgt Chr	
182599	31439-BC	Diverter Assy, Chrome	
153818	32005	Packing	
056023	32462	Renew Unit Assembly, RH	
182602	32657	O-Ring	
182605	33357-BN	Screw, *Brushed Nickel	
189795	33625	Screw	
173081	33681-CP	Strainer, Chrome	
182609	34064-BN	Lever Handle, * Br Nickel	
182611	34117	O-Ring	
153817	34190	Valve Spacer	
154166	34230	Spring	
055365	34263	O-Ring	
055358	34265	Washer, .482 x .815	
168123	34294	Packing	
182612	34532	Post For Soap Dish	
182613	34533-CP	Nut, Pol Chrome	
252853	34649-CP	Self Closing Vlv Unit, Chrm	
160251	34777	Pressure Regulator Assy	
143096	34848	Screw 8-32 x .281"	
170189	34902-G	Condensate Plate, Chrome	
182614	35103	Angle Stop Assy	
182615	35285	Screw	
161208	35296-CP	Bubbler Shank, Chrome	
159530	35311-CP	Lever Handle Assy, Chrome	
170191	35314-CP	Fountain Trap, Pol Chrome	
175962	35594	Union Conn	
251645	36257	Seat & Spring Sleeve	
182616	36258	Push Button	
182617	36261	Valve Stem	

Parts (Continued)

Part #	Mfg #	Description	Price
182619	36263	Spring	
182620	36415	Spout Bearing	
182621	36417-RP	Swing Spout Post, RP	
182622	39881	Valve Stem Packing	
182623	40004	End Valve Body Assy	
070159	40013	Gasket .250" I.D. x .460" O.D.	
182624	40235	Ball Lever Seat	
182625	40282	Diverter Bushing	
170179	40343-CP	Handle Assy, Pol Chrome	
182883	40479-BN	Bonnet, *Br Nickel	
182628	40966	Packing	
169521	41240-VF	Insert, Pol Brass	
182629	41489	Stand Pipe	
256147	41981-C-CP	Handle, 4 Arm Cold Chrm	
256148	41981-H-CP	Handle, 4 Arm Hot Chrome	
182630	42036	Hot Plunger	
182631	42038	Cold Plunger	
055996	42043	O-Ring	
182632	42052-CP	Mixer Sleeve, Chrome	
182633	42160	O-Ring	
182634	42258	Sleeve	
182635	42271	Bonnet	
171282	42414	Screw	
182636	42451	O-Ring	
182637	42675	Plug, Handle, Shower	
251197	427280-0	Small Ceramic Insert, White	
179506	43040	Trap	
153582	43070BV	Strainer Plate, *Br Bronze	
172119	48096-CP	Strainer SA, Chrome	
189793	48250-CP	Wall Saddle, Pol Chrome	
189796	48251-CP	Rod, Pol Chrome	
165964	48609-BGD	Bidet Spray, *Moderne Br Gold	
182639	48686	O-Ring	
182640	500180	Bumper Kit	
168997	500306-G3-B11	Paint Kit, Ice	
179745	500452	Rebuild Kit, Diverter	
182641	500455-CP	Stem Extension Kit, Pol Chr	
182642	50338	Detent	

* Vibrant Limited Lifetime Warranty

www.plumbsupply.com • Serving our Customers Since 1946 •

Kohler Repair Parts

Parts (Continued)

Part #	Mfg #	Description	Price
177748	50340-VF	Escutcheon, Pol brass	
182643	50344-CP	Bonnet, Chrome	
182644	50588-BN	Diverter, *Br Nickel	
182648	51261	Clip	
182649	51419	Seat	
189794	51967-CP	Screw, Pol Chrome	
170192	52054	Wall Screw	
182650	52156	Tube	
154844	52478	O-Ring	
164797	52588	Screw	
182651	52703	Overflow Tube	
182888	52865-BN	Screw, * Br Nickel	
182652	52936-CP	Hndl & Btn Assy, Pol Chr	
182653	53448-CP	Screw, Chrome	
159108	534-NA	Install Kit	
173257	550-NA	Install Kit	
182655	55108	O-Ring	
182659	56318-RP	Seat Replacement Kit, RP	
165965	56702	Shank	
225354	57081-CP	Centerpiece®, Handle	
247502	57411-CP	Lift Rod, Chrome	
183342	57411-G	Lift Rod, Br Chrome	
182677	57711	O-Ring	
161416	577-NA	Install Kit	
182679	57745-CP	Blade Handle, Chrome	
056004	57746-CP	Tend Handle, Chrome	
182680	57751	Spray Diverter	
173294	57930-VF	Escutcheon, Pol Brass	
162186	58015-VF	Sleeve, Pol Brass	
168631	58180-CP	Escutcheon, Chrome	
182682	58249	Pipe Cap	
182683	58307-VF	Shower Head, Pol Brass	
182685	58895-CP	Handle Kit, Chrome	
162749	591-NA	Install Kit	
156756	592-NA	Install Kit	
161743	593-NA	Install Kit	
111732	59425	Nut Escutcheon	
256831	59615	Hardware Kit	
182689	59636-G	Sleeve, Br Chrome	
182690	59637-G	Handle Base, Br Chrome	
182691	59637-VF	Handle Base, Pol Brass	
182686	59418	Lower Bushing	

Parts (Continued)

Part #	Mfg #	Description	Price
182692	60380	Screw	
182693	64503	Hanger	
182694	65054-S	Screw, Pol Stainless	
182889	65061-BV	Suction Cover, *Br Bronze	
182695	65156-0	Switch Flange, White	
182522	65156-47	Switch Flange, Almond	
182696	65226-96	Suction Cover Plug, Biscuit	
182697	65879	Retaining Ring	
165925	67429	Flange	
165927	67889	Housing Assy	
182699	70504	Plug Button	
182700	70505	Plug Button	
182701	70539	Threaded Sleeve	
250567	70591-CW	SA Ceramic Insert, Chrome w/ White	
180038	70593-CP	Brass Inserts, Pol Chrome	
156915	71015	O-Ring	
182702	71016	O-Ring	
181966	7117-NA	Test Seal Kit	
055352	71906	Stem Adapter	
182703	71911	Mixer Face Plate	
166030	71940	O-Ring	
190311	71973-CP	Handle Lever	
250570	71974-CP	Cover, Chrome	
182704	73065	Stem Adapter	
182705	73066	Stem Adapter	
153331	73094	Adapter	
158723	73175	Flexible Shaft	
158720	73179	Sleeve	
164075	73203-G	Bezel IR Sensor, Chrome	
172152	73330	Spacer	
158722	73404-CP	Tube Assy, Pol Chrome	
158718	73439-CP	Lift Rod, Chrome	
172755	73455-CP	Escutcheon, Chrome	
182198	73703	Side Valve	
182708	73719-BC	Stem Extension, Chrome	
244764	73744-AU	Diverter Spout Kit, Pol Gold	
165687	73744-BN	Spout Kit, *Br Nickel	
182709	73860	Tee Assy	
172068	74385-G	Escutcheon, Br Chrome	

* Vibrant Limited Lifetime Warranty

• Serving our Customers Since 1946 • www.plumbsupply.com

Kohler Repair Parts

Parts (Continued)

Part #	Mfg #	Description	Price
057294	74392	Diverter Cartridge Assy	
158314	74675-2BZ	Overflow Hood Assy, ORB	
182716	75059	Diaphragm Assy	
182717	7511-58	Shank, Thunder Grey	
053725	7524-CP	Bubbler	
182718	75462	Graphic Cover	
162495	75564	Retaining Ring	
177491	75601-BN	Bonnet, *Br Nickel	
153434	75610-CP	Bonnet, Pol Chrome	
182719	75740	Adjustment Collar Assy	
158239	75771-CP	Cap, Polished Chrome	
225355	42669-CP	Stem/Skirt Handle	
255527	76248-BN	Escutcheon, *Br Nickel	
168741	76602-CP	Escutcheon Assy, Chrome	
182720	76704-0	Bonnet Cap, White	
250024	76704-BN	Bonnet Cap, *Br Nickel	
073775	76704-CP	Bonnet Cap, Pol Chrome	
152934	76713	Screw	
244250	76725-BL	Cap, Matte Black	
250652	76728-0	Mounting Plate	
182722	76755-VF	Handle Skirt, Pol Brass	
182724	77012-VF	Handle Skirt, Pol Brass	
182727	77099	Bearing	
182932	77172-BN	Escutcheon, *Br Nickel	
245980	77172-VF	Escutcheon, *Pol Brass	
164796	77642	O-Ring	
244704	77887-BV	Lever Handle Assy, *Br. Brz	
157465	77887-VF	Lever Handle Assy, Brass	
248992	77948	O-Ring	
251742	77952	O-Ring	
159624	77971-47	Graphic Cover, Almond	
162319	78042-2BZ	Plug Button, ORB	
161850	78042-96	Plug Button, Biscuit	
182933	78050-BN	Escutcheon, *Br Nickel	
181411	78139-BV	Handle Assy, *Br Bronze	
159432	78139-2BZ	Handle Assy, ORB	
182934	78139-CP	Handle Assy, Chrome	
182730	78148-CP	Handle Assy, Chrome	
182731	78155	Screw	
182935	78172-BN	Stopper Assy, *Br Nickel	
160987	78205-47	Plug Button, Almond	

Parts (Continued)

Part #	Mfg #	Description	Price
156226	78205-96	Plug Button, Biscuit	
163179	78205-BV	Plug Button, *Br Bronze	
156120	78205-2bz	Plug Button, ORB	
183343	78205-G	Plug Button, Br Chrome	
182732	78205-VF	Plug Button, Pol Brass	
158237	78562-58	Grip Ring, Thunder Grey	
131130	78797	Rubber Seal	
068093	78913	Cartridge, Thermostatic Valve	
184161	78923-BN	Collar, *Brushed Nickel	
153015	78925	Hose Guide Assy	
152208	78969-58	Adapter, Thunder Grey	
165028	79150-58	Adapter Kit, Thunder Grey	
182734	800065-CP	Lever Handle, Chrome	
157839	83143	Seal Diaphragm	
183344	834404	Screw	
185858	83451	Cap Assy	
183345	836664	Mounting Hardware	
152205	84100	O-Ring	
249429	84305	Flush Valve Kit	
182737	84786	Hardware Pack Seat	
081376	85500	Mixer Cap Kit	
167088	85516	Set Screw Spout Assy	
182940	85698-CP	Escutcheon, Chrome	
167086	86036	O-Ring/Bearing Kit	
166292	86633	Bath Stem	
166482	86861-CP	Lift Rod, Polished Chrome	
182944	87117	Backing Plate	
164794	87118-CP	Collar, Chrome	
181643	87390	Filter Head	
187099	87448-CP	Sleeve, Pol Chrome	
166995	87536	Screw	
176620	88057-BN	Plug Button, *Br Nickel	
182945	88093-G	Screw, Br Chrome	
175356	88532-96	Trim Ring Kit, Biscuit	
248993	89098	Base Seal	
182948	89279	Hold Down Plate	
158886	91915	Hardware Kit	
186467	93766-0	Cover, White	
166427	93838	PVC Tube	
182950	94497	Flat Pillow Kit	
180291	94853	Service Kit	

* Vibrant Limited Lifetime Warranty

www.plumbsupply.com • Serving our Customers Since 1946 •

Kohler Repair Parts

Parts (Continued)

Part #	Mfg #	Description	Price
182738	95045	Screw	
186466	97740	Switch Assy	
176680	99272-CP	Escutcheon, Chrome	
186260	99272-SN	Escutcheon, *Pol Nickel	
238025	99272-VS	Escutcheon, *Stainless	
258725	99272-2BZ	Escutcheon, Oil Rbd Brnz	
056035	B2100	Rod Parts	
170699	CB-DXCLC10FS	Mirrored Cabinet Door	
188928	CB-DXCLC20BAN	Mirrored Cabinet Door	
183171	CB-DXCLC20FS	Mirrored Cabinet Door	
183347	CB-SHLFCLC20	Inner Shelf	
183348	CB-SHLFCLC30	Inner Shelf	
087887	GP1003736-0	Sprayhead, White	
105414	GP1016515	Valve for Kitchen Faucets	
120573	GP1035350-CP	Premier Drain Chrome	
086238	GP1036940-CP	Spray Head Kit Pol Chrome	
122914	GP1037021-CP	Standard Plunger Assy, Chrome	
122915	GP1037022-CP	Plunger Brass Assy, Chr	
151936	GP1043211-VS	Sprayhead, *Stainless	
135542	GP1056873	Piston Assy	
117018	GP1074231	Spline Adapters	
122905	GP1077791-0	Plug Buttons, White	
122906	GP1077792-0	Plug Buttons, White	
121407	GP1083167	Fill Valve Kit	
152038	GP1092203	Cold Valve Cartridge Assy	
152039	GP1092204	Hot Valve Cartridge Assy	
183237	GP1095915	Handle for Elec Faucets	
183172	GP1105825	Flapper w/ Float Kit	
258178	GP1144142	Hi Flo PBU Cartridge Seals	
055318	GP21087-CP	Trend Handle - Large	
055368	GP30000	Plug Button Kit	
055346	GP30082	Centura Repair Kit	
055128	GP30090	Repair Kit	
055316	GP30100	Plunger Service Kit	
056078	GP30320	Pressure Balance Adapter Kit - Plastic	
055311	GP30413	Valve	
055353	GP30416	Knob Handle Kit	
072769	GP30420	O-Ring Seal Kit	
228375	GP330002	1/4 Turn Valvet, HOT	

Parts (Continued)

Part #	Mfg #	Description	Price
228376	GP330004	1/4 Turn Valvet, COLD	
101598	GP41398-CP	Strainer Cup Assy, Chrome	
055340	GP43146	Acrylic Handle	
055305	GP51487	Tank Gasket w/Bolts	
055344	GP52050	Tank Bolt Accessory Pack	
055338	GP71969	Valve Mixer Kit	
056122	GP75878	Diverter Assembly	
055332	GP76671	Coralais Valve, CCW Close	
055339	GP76672	Coralais Valve, CW Close	
055293	GP77005-RP	Ceramic Valve	
055294	GP77006-RP	Ceramic Valve	
055301	GP77548	Ceramic Valve	
121052	GP77759	Mixer Cap Kit	
055351	GP77886	Mixer Cap Kit	
056127	GP78205-0	Plug Button White	
070270	GP78500	Plunger Kit	
230421	GP800881	Repair Cartridge, 8304	
256860	GP800820	Rite-Temp PBU Cartridge	
180982	GP83996	Gasket for Select Flush Vlv	
055367	GP85061	Beehive Strainer	
256861	GP876851	Rite-Temp PBU/CAP Service Kit	
055303	GP88921	Flush Ball Kit	
190060	RGP64512	Hanger (2)	
236510	1052070	Solenoid Manifold Kit	
249428	1068033	Fill Valve Assembly	
145967	1145688	Cartridge, Transfer Valve	
124370	18766	Urinal Outlet Kit	
055355	30006	Valve Repair - Right Hand	
255281	36267	Pedal Shaft	
157034	1103464-SR	Aerator Kit, Bright Nickel	
236984	1105050-CP	Aerator Kit-1.5gpm, Chrome	
120651	84544-0	Service Kit - Feet	
144324	1073881	Deep Rough-In Kit	
087885	86101-CP	Body Spray, Zero Leakage	
055980	34842	Sleeve	
120986	GP1067183	Flapper - Class 5	
055981	30008	Valve Repair - Left Hand	
005942	23004-RP	Valve Seat & Washer Assembly	
067062	30249	Bearing Kit	

* Vibrant Limited Lifetime Warranty

• Serving our Customers Since 1946 • www.plumbsupply.com

Kohler Repair Parts

Parts (Continued)

Part #	Mfg #	Description	Price
136029	1056934	Sensor Clip	
065793	50729	O-Ring	
080954	20242-BC	Valve Stem Assembly, RH	
132172	84999	Toilet Seat Anchor Kit	
094480	1000739	Valve Restrictor Kit	
142908	1157032	Piston Assembly	
145765	73858-RP	Tee Assembly	
129338	1097686	Seal, Flat	
237586	1016154-CP	Deep Rough-In, Rite-Temp	
103305	64839	Lavatory Hanger	
146199	590-NA	Underscore 5' UM Installation Kit	
229514	1123617	Hybrid Power Cell Potted	
137090	1172936-CP	Master Shower/Water Haven SH Service Kit	
071014	30126	Valve Repair Kit	
238418	1068034	Fill Valve Assembly	
113728	1007937-G	Deep Rough-In Kit	
120179	1034693-BN	Trip Lever, Cimarron *Brushed Nickel	
080960	20241	Bonnet SA	
102083	32002	Valve Bonnet	
121450	40372	Adjustable Linkage	
120889	1108711	Spacer Kit	
055366	51291	Plunger	
164079	1014086-05	Seal, Threshold 28.125"	
238804	1102432	Kit, Hardware	
055342	22947	Plunger SA - Clockwise Close - Plastic	
056007	22948	Plunger SA, CCW Close Plastic	
240444	1207327	Emblem, Tank Cover	
249194	1017282-BN	Lever Handle Assembly Bath	
126902	K1037390	Lift Rod w/ Plastic Ball	

* Vibrant Limited Lifetime Warranty

www.plumbsupply.com • Serving our Customers Since 1946 •

Malco Repair Parts

Hole Cutter Parts

Hole Cutter Replacement Part

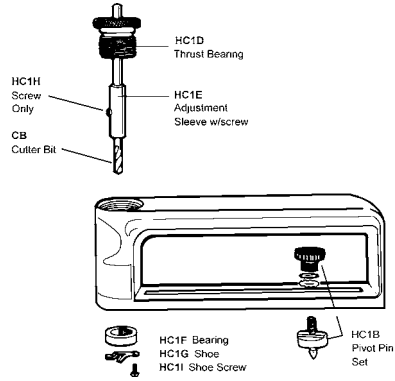

Part #	Mfg #	Description	Price
006379	CB	Malco Bit for HC1 and HC2	
006409	HC1B	Pivot Pinset for HC1	
034909	HC1D	Thrust Bearing w/Adapter	
006410	HC1E	Adjustable Sleeve for HC1	
006411	HC1F	Ball Bearing for HC1	
006412	HC1G	Guide for HC1	
054345	HC1I	Shoe Screw	

McDonnell & Miller Repair Parts

Replacement Parts

Gasket



Part #	Mfg #	Model #	Used With:	Price
007100	302600	CO-12	42,61,63,64, 65,42S	

Strainer Basket Assembly

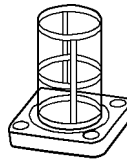

Part #	Mfg #	Model #	Used With:	Price
007104	347100	SA101-38	47, 51, 101	

Moen Repair Parts

Handle Adapters



100429

Part #	Mfg #	Description	Price
058893	100429	Handle Adapter Kit	
244987	174329	Handle Adapter Kit	

Chateau Knob Handle Kit

- 1-Hdl Tub/Shower



Part #	Mfg #	Description	Price
007370	96797	Clear w/ White & Chrome Insert	

Traditional Handle Kit



Part #	Mfg #	Description	Price
016904	94514	Single-Handle	

Handle Kit



Part #	Mfg #	Description	Price
243526	128866	Chrome	

Faucet Cartridges

1255 Duralast™ Cartridge



Part #	Mfg #	Description	Price
140023	1255	Duralast™	

1-Hdl Faucet Cartridge

- Brass
- Hot/cold operation
- Includes:
 - Cartridge
 - Retainer Clips
 - Installation tool
 - Installation instructions

1200



1225

Part #	Mfg #	Description	Price
007169	1200B	For 1200 Faucet, Bulk (12/Pk)	
007173	1225B	For All Moen 1-Hdl Faucets Bulk (12/Pk)	

Duralast™ 2-Hdl Faucet Cartridge



Part #	Mfg #	Description	Price
189508	1234	2-Hdl, Duralast™	

Duralast™ 2-Hdl Roman Tub Faucet Cartridge

- Hot or cold



Part #	Mfg #	Description	Price
249073	1258	2-Hdl, Hot or Cold	

*Lifeshine® Anti-Tarnish Lifetime Finish

• Serving our Customers Since 1946 • www.plumbsupply.com

Moen Repair Parts

2-Hdl Faucet Cartridge

- Brass
- Hot/cold operation



Part #	Mfg #	Description	Price
007172	1224B	For 2-Hdl Moen® Faucets, Bulk (12/Pk)	

Posi-Temp 1-Hdl Faucet Cartridge

- Brass
- Hot/cold operation



Part #	Mfg #	Description	Price
007171	1222B	For 1-Hdl Posi-Temp Faucets, Bulk (12/Pk)	

Commercial Heavy-Duty Posi-Temp Cartridge



Part #	Mfg #	Description	Price
226819	1222HD	Brass Shell	

Commercial 2-Hdl Ceramic Disc Cartridge



Part #	Mfg #	Description	Price
147672	52001	Cold	
147671	52000	Hot	

Cartridge



Part #	Mfg #	Description	Price
209555	4000	Replacement	

Replacement Cartridge

- For 4999 Roman Tub Valve



Part #	Mfg #	Description	Price
007174	1248	For 4999 Roman Tub Valve	
103661	116719	Replacement Cartridge	

Commercial Cartridge



Part #	Mfg #	Description	Price
218673	52100	Metering Cartridge	

Commercial 2-Hdl Cartridge



Part #	Mfg #	Description	Price
198775	121550	Hot	
198776	121551	Cold	

*Lifeshine® Anti-Tarnish Lifetime Finish

www.plumbsupply.com • Serving our Customers Since 1946 •

Moen Repair Parts

Commercial 1-Hdl Cartridge

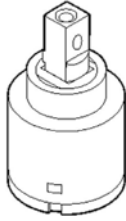

Part #	Mfg #	Description	Price
174468	121620	For Model 8701	

Cartridge Removal Tool

- For 1200, 1225, or 1222 cartridges



Part #	Mfg #	Description	Price
046820	104421	Cartridge Removal Tool	

Cartridge Removal Tool



Part #	Mfg #	Description	Price
020117	14272	Cartridge Retainer Removal Tool	

Service Parts

Part #	Mfg #	Description	Price
090524	A1616BN	Kingsley Extension Kit, Br Nickel	
236533	A780	80" Commercial Metal Hose	
239505	123245	Escutcheon & Gasket Kit, Chrome	
096538	104021	Solenoid Repair Kit	
246689	104570	Commercial Service Kit, Chrome	
253591	137488BL	Showerarm Flange, Matte Black	
230761	147208	Cartridge Repair Kit	
230762	147209	Check Stop	
250132	3806SRN	Diverter Spout, Spot Resist Br Nkl	
036804	93980	Handle Mechanism Kit f/7400/7600 Kitchen Faucet	
176166	115055	Handle Cap & Screw	
259147	115055BN	Handle Cap & Screw	
226712	116711	Flow Restrictor Kit	
243252	116712	Flow Restrictor Kit	
018319	11985	50/50 Drain Assembly	
019922	12689	Pivot Rod & Clip	
237959	124738CSL	Pull-Out Wand, Stainless	

Service Parts (Continued)

Part #	Mfg #	Description	Price
241464	130142	Spline Adapter & Screw Kit	
243432	130143	Extension Kit	
243431	130158	Check Stop	
163701	131381	Hose Kit	
020119	96365	Retainer Clips	
007353	883	Retainer Clip	
021710	96914	Posi-Temp Retainer Clip	
244557	114343WR	Handle Cap & Screw, Wrought Iron	
113430	140780	Metal Pop-Up Lav Drain, Chrome	
103739	140780BN	Metal Pop-Up Lav Drain, Brushed Nickel	
103122	140780OR B	Metal Pop-Up Lav Drain, Oil Rubbed Bronze	
226575	131553BN	Pop-Up Lav Drain, Brushed Nickel	
244132	161150OR B	Wand Kit, Oil Rubbed Bronze	
021437	96497	Waste Assembly, Chrome	
023012	12314	Plug & Cap	
007200	1920	Valve Cover Plate, Chrome	
131700	1920BN	Valve Cover Plate, Brushed Nickel	
078637	101663BN	Drain Cover, Brushed Nickel	
101250	101663OR B	Drain Cover, Oil Rubbed Bronze	
238566	101663WR	4-1/4" Drain Cover, Wrought Iron	
236868	101664BN	Drain Cover, Brushed Nickel	
202661	102763BN	4" Drain Cover, Brushed Nickel	
035758	1423	Balancing Spool	
201600	52012	Commercial Vacuum Breaker	
007391	97557	Monticello Handle Inserts, Chrome	
007382	97462	Monticello Handle Insert, Chrome	
007362	91751	Knob Insert Kit, Chateau	
044029	96782	Chateau Handle Kit	
007369	96791	Chateau Handle Kit	
007360	91192	Diverter Kit for 1Hdl Kit Fct	
007368	96790	Handle Kit, Chrome	
091499	116653	Handle Adapter Kit	
020189	98039	Handle Kit, Acrylic	
118478	136103C	Kitchen Spray and Hose	
144317	106378	Asceri Stem Extension Kit	
007386	97466	Monticello Handle Knob Insert, Porcelain/Chrome	
019330	97556	Monticello Handle Adapter Kit	
020032	95606	Monticello Handle Hub Kit	

*Lifeshine® Anti-Tarnish Lifetime Finish

• Serving our Customers Since 1946 • www.plumbsupply.com

Moen Repair Parts

Service Parts (Continued)

Part #	Mfg #	Description	Price
032729	95602	Monticello Handle Hub Kit	
007389	97479	Monticello Stem Extension Kit	
007372	97344	Monticello Stem Extension Kit	
124051	145058	Adapter Kit	
026035	14732	Handle Kit, Chrome	
236993	147556	Extension Kit, Vessel	
103271	100818	Extension Kit	
238428	113173	Mounting Kit	
097867	114299	Hose Kit	
252359	100005SL	Hose Guide, Stainless	
045742	12318	Check Stop	
196066	94770	Plug Button & Set Screw	
179477	150259	Hose Kit	
114856	A750	Slide Bars	
238174	52711	Slide/Grab Bar Shower Connector, Gray Plastic	
162734	104524	Manual Override Button - Flush Valve	
031502	101099	Handle Connector, Spacer, Screw & Washer for Loop HdL Kitchens	
043598	101310	Chateau Lever Handle Kit	
165290	104401	Multi-Unit AC Power Adapter	
109518	9601	Choiceflo Replacement Filter 9600/9602/9500/9502	
071412	100021	Chateau Handle Cap, Chrome	
071756	100710	Posi-Temp T&S Acrylic Handle	
017776	14699	Retainer Pivot Nut, 1Hdl Kit Fct	
022554	15528	Escutcheon Screws	
007163	10089	Legend & Chateau 1Hd T&S Knob Handle Stop Tube	
031100	96987	Stop Tube, PosiTemp 1-Hdl TS Trim	
089374	100657	Handle Kit, Chrome	
186665	221672	Weymouth Hot & Cold Handle Caps, Chrome	
225625	221672BN	Weymouth Hot & Cold Handle Caps, Brushed Nickel	
017751	13463	Chateau Tub Fct Stem Extension	
007371	96884	Handle Insert Kit	
215829	155655	Screen Filter	
224150	155658	Hardware Kit	
146281	10116	Plug Button Kit, Chrome	
216901	104444	Commercial Supply Line	
247571	114324	Handle Cap Kit, Chrome	

Service Parts (Continued)

Part #	Mfg #	Description	Price
245748	114324W	Hot & Cold Handle Cap Kit, White	
247885	116731	Bearing Washer Kit	
007168	1198	Push Button Diverter	
032769	13462	Handle Adapter Kit	
224151	155651	Hardware Kit	
025797	13769	Chateau Escutcheon, Chrome	
017752	13774	Wall Tube, Chrome	
248620	155656	Extension Kit	
121811	163WR	Escutcheon Screws, Wrought Iron	
105725	128284	Twin Elbow	
216105	131109	Handle Kit, Chrome	
240320	137396BN	Handle Kit, Brushed Nickel	
240286	147556BN	90° Vessel Extension Kit	
252294	161143	Extensa Wand Kit, Chrome	
249984	176415	Vaccum Breaker for MO8124/8232	
249405	178755	Remodel Cover Plate for Posi-Temp Valve, Chrome	
249842	179108	Universal Kitchen Spray Kit, Chrome	
185665	AT2099ORB	T/S Accent Kit, Oil Rubbed Bronze	
201230	143530	Diverter Plug	
195900	A714	Vacuum Breaker, Chrome	
121669	96945	Handle Extension Kit	
211430	140710	Cartridge Nut	
221963	130153BN	Handle Escutcheon, Brushed Nickel	
244985	135152	Spacer Kit	
124535	129102BN	Trim Ring, Brushed Nickel	
244548	97577WR	Escutcheon, Wrought Iron	
255909	900-001	Flo Leak Detect System	
255544	262955	Shank Kit	
263885	182546	Deck Plate	

Spout O-Ring Kit



Part #	Mfg #	Description	Price
007167	117	Bulk	
215830	155654	O-Ring Kit	
201190	146789	O-Ring Kit	

*Lifeshine® Anti-Tarnish Lifetime Finish

www.plumbsupply.com • Serving our Customers Since 1946 •



Moen Repair Parts

Service Parts (Continued)

Spout O-Ring Kit

Part #	Mfg #	Description	Price
020120	96778	O-Ring Kit	

*Lifeshine® Anti-Tarnish Lifetime Finish

• Serving our Customers Since 1946 • www.plumbsupply.com

EL Mustee Repair Parts

Shower Stall Parts

Part #	Mfg #	Description	Price
169874	68.600	4" Plastic Shower Valve	
034312	80.451	Cold Index Plug	
007569	82.400	1-1/2" PVC Shower Drain	
007546	65.700	Hose Holder	

Lochinvar Repair Parts

Repair Parts

Part #	Mfg #	Description	Price
241375	LO10028374 7	NKC Part Kit	
039096	LOARM1001	Seal Kit	
038396	LOFAN2410	Fan Assembly for EB/EW	
043810	LOFAN2712	Fan for all Copper Fin & Copper Fin II	
038280	LOGTP2900	T&P Gauge	
038394	LOHLC2500	HI Limit	
038272	LOHLC2904	Rollout Switch	
039109	LOPLT2016	Burner Pilot NAT.	
039110	LOPLT2303	Pilot Assembly NAT.	
038297	LOPLT2702	Igniter, Hot Surface	
038399	LOPRS2421	Air Pressure Switch	
039125	LORLY3002	Ignition Module	
039127	LORLY3428	Ignition Module	
039135	LOTST2701	Operator Control	
166275	LOTST30010	Limit	
039140	LOWTR2040	Flow Switch	

Navien Repair Parts

Parts & Accessories



O-Ring



Packing



Pressure Flow

Part #	Mfg #	Description	Price
149791	2505401A	CPVC Vent Collar	
234582	30000456B	7M Gas 120V/60HZ Circulation Pump	
127478	30000663A	Air Pressure Sensor, NASS9EX00009	
135435	30000669A	Air Pressure Sensor, NASS9EXOS001	
126626	30004802C	Water Flow Sensor, AASS9EXFS003C	
188868	30014451A	Circulation Pump Air Vent	
231214	30014367A	Common Vent Backflow Damper Kit	
172073	30012226A	Igniter NPE	
162623	30010537A	Water Sensor	
136813	BH0914002B	Motorized 2-Way Valve	
126593	BH2507399A	3-Way Valve, A-Type Copper	
136814	BH1201041D	Ignition Transformer with Wire	
126589	BH1205008A	Transformer	
126623	BH1303013A	Inlet Filter	
126630	BH1403081A	Thermostat (Black Wire)	
134822	BH2101273B	Remote Wire	
126587	BH2124012A	Fuse, 125V, 5A	
126599	BH2421008A	O-Ring, Gas Black, 19.8"Dia x 2.4"T	
126653	BH2421997A	Black O-Ring	
126600	BH2423053A	O-Ring, Red, 17.8"Dia x 2.4"T	
126654	BH2423055A	O-Ring, Black, 17.5"Dia x 2.7"T	
126603	BH2423064A	O-Ring, Red Water, 15.8"Dia x 2.7"T	
126597	PH1062017A	Back-Up O-Ring	
126588	BH2501679A	NG Flame Rod	
136815	BH2507507A	Water Pipe Adapter, Black	
127841	GXXX000546	Cascade Cable, Readylink	
245209	GXXX001727	Magnetic Boiler Filter	
136820	NAPU9GLPCT01	NP Series Circulation Pump	
136821	NARC1GSNR007	Remote Control	
126591	NASS9EXGPS01	Gas Pressure Flow Sensor	
126625	NCVM9EX00005	Flow Adjustment Valve	
126595	PAPCT1W0725	058 Pump	
126632	PH1799013A	Pipe Adapter	
241658	30004825A	Motorized 2-Way Valve	
241659	30002491A	Transformer 120V CR/CC	
241661	30003311A	Syphon CR/CC, NR/NP	
245316	30018661A	NPE Parts Kit	

Navien Repair Parts

Parts & Accessories (Continued)

Part #	Mfg #	Description	Price
241664	30008834A	Inducer Fan NCB, NPE	
241665	30011534A	Flow Sensor NPE-S	
241667	30011532A	Water Adj Valve NPE-S	
241669	30008366A	Thermistor NPE/NHB	
241670	30015421A	Inducer Fan NPE-150S	
241671	30014183A	Igniter Flame Rod Assembly	
241673	30012241A	Auto Feed Assembly NCB-ALL	
241674	30011586A	Gas Valve NHB All	
241675	30014216A	Syphon & Hose NHB 055/080	
241676	30014024A	Syphon & Hose NHB 110/150	
241677	30014189A	Igniter Flame Rod Assembly	
241678	30012907A	Thermistor NHB	
241680	30013984A	Inducer Fan NHB 055/80	
241681	30013985A	Inducer Fan NHB 150	
227942	30009478A	Exhaust Thermistor NPE	
238359	30008245A	Water Adjustment Valve	
230697	30004819C	3-Way Valve CR/CC, NR/NP	
230698	30002282E	Check Valve CR/CC, NR/NP	
233400	30002475A	Ignition Transformer	
241465	30000466A	Circ Pump CR/CC, NR/NP	
226737	30013685A	Flow Sensor Assembly Dom	
222447	30002493A	Transformer 120V 60 Hz	
233740	30000181A	PCB Control Board CH	
171172	GXXX001322	Residential Neutralizer	
167004	30012950A	Outdoor Sensor & Wire	
188054	20017210A	O-Ring	
167481	30004684A	LP Flame Rod	
171169	PFMZ-02P-01	Smartzone 2-Zone Pump Controller	
186505	GXXX001417	Supply/Return Sensor	
175139	20018013A	O-Ring	
174167	30004680A	NG Flame Rod Kit	
167480	30004834B	Flow Adjustable Valve	
181936	GXXX001324	Neutralization Kit	
165953	30000666A	Gas Pressure Flow Sensor	
165466	30010455A	Ign. Transfer NPE	
184906	30004837B	Mixing Valve	
173551	30010780B	Circulation Pump	
177980	30000182A	Board F/Cr-180	
239003	30008360A	Check Valve NPE	
222617	PBCM-AS-01	Wifi Control	
224573	30009323A	Easy Valve Kit	
183273	30008571A	NPE Flow Sensor	

Navien Repair Parts

Parts & Accessories (Continued)

Part #	Mfg #	Description	Price
186308	30014699A	LWCO Water Sensor	
171171	PFMZ-04P-01	Smartzone 4-Zone Pump Controller	
171170	PFMZ-03P-01	Smartzone 3-Zone Pump Controller	
168655	30009757A	Remote for NPE	
165951	30009875A	Thermistor	
143846	30011330A	NPE Parts Kit	
176969	PFMZ-06P-001	Smartzone 6-Zone Pump Controller	
223557	30011690D	PCB Control Board NPE All	
224914	30013687A	Siphon	
165833	30012685A	NCB Parts Kit	
223559	30013044A	FP Front Panel F/NHB	
154387	GXXX001178	CH Quik-Install Manifold Kit	
223558	30012262B	PCB Control Board F/NCB	
228187	30011450A	CH Parts Kit	
177075	30014307A	NHB Parts Kit	
163395	UA0900002A	3/4 Plumb Easy LF Valve	
227667	30012768A	Circulation Pump	
224572	GXXX001323	Replacement Media	
231992	GXXX001328	Anti-Scale Refill	
188650	30012033B	NCB/NCB-E Flow Sensor	
242432	30004831C	3-Way Valve	
188053	20006947A	O-Ring	
187282	20006948A	O-Ring	
188055	20006949A	O-Ring	
242435	20006950A	O-Ring	
243041	20006958A	O-Ring	
181732	30003873B	Vent Bird Screen NPE, 3"	
177260	30009933A	Universal O-Ring Kit	
241241	30010747A	Vent Bird Screen, 2"	
225642	30013686A	Syphon	
241748	30015811A	APS-02-A	
259762	3001690E	Control Board	
255956	30018659A	CR/CC - NR/NP	
255958	30018660A	CH Series Part	
245568	30018663A	NHB Parts Kit	
245571	30018664A	NCB/NCB-E Parts	
242820	30019042A	RL Manifold 4 Back	
263258	30022965A	Navicirc Kit	
253681	GFFM-KDIZUS-003	Ready-Link Rack	
266046	GFFM-KDIZUS-004	Ready link Rack	
252977	GFFM-MSOZUS-002	Manifold	
189741	GXXX001327	Peakflow Anti-Scale	

Navien Repair Parts

Parts & Accessories (Continued)

Part #	Mfg #	Description	Price
251904	GXXX001725	Peakflow Anti-Scale	
258610	GXXX001726	PeakFlow Replacement	
269928	GXXX001891	Sidewall Termination Kit	
269929	GXXX001892	Sidewall Termination Kit	
269930	GXXX001893	Conc Roof Termination	
269931	GXXX001894	80-125mm 45 Degree Elbow	
269932	GXXX001895	80-125mm 90 Degree Elbow	
269933	GXXX001896	Vent Pipe Extension	
269934	GXXX001897	Vent Pipe Extension	

Reznor Repair Parts

Limit Controls

Part #	Mfg #	Description	Price
008477	45602	(180°F) White Auto Limit Control	
008480	50417	(125°F) White Auto Limit Control	
008481	50418	(145°F) Blue Auto Limit Control	
008497	82091	(160°F) Red Auto Limit Control	
008498	82414	(306°F) ECO Energy Cut-Out Limit Control	
008500	85449	(200°F) Yellow Auto Limit Control	
008524	96512	(220°F) High Temperature Limit Control	
027171	131449	(228°F) ECO Energy Cut-Out Limit Control	
008458	123974	(135°F) Fan Control	
008459	123976	(135°F) Fan Control	
030936	147676	(150°F) Fan Control w/Bracket for XL/CXL/EEXL/CEEXL 30 - 400	
083879	209184	Fan Control Replacement Kit	

Gas Conversion Kits



Part #	Mfg #	Description	Price
008536	99244	LP Conversion Kit for F/FE-50	
153551	269835	LP Conversion Kit for Model UDAP/UDAS Size 30, 45	
153552	269836	LP Conversion Kit for Model UDAP/UDAS Size 60, 75	
154397	269837	LP Conversion Kit for Model UDAP/UDAS Size 100, 125	
153554	269838	LP Conversion Kit for Model UDAP/UDAS Size 150, 175	
153553	269839	LP Conversion Kit for Model UDAP/UDAS Size 200, 250	
066004	201732	LP Conversion Kit for Model UDAP/UDAS Size 300, 400	
073497	205515	LP Conversion Kit	
073498	205516	LP Conversion Kit	
127038	257472	Ignition Conversion Kit (Replaces 97782)	
127637	257473	LP Conversion Kit, Old #G77	

Gas Valves

Part #	Mfg #	Description	Price
008518	96300	1/2" Natural Gas Valve (W/R #36C03-211) Replacement	
008519	96307	1/2" Natural Gas Valve Replacement	
022074	121599	1/2" Single Stage Valve (VR8304M2816)	
027313	147830	1/2" Single Stage Natural Gas Valve (VR8205M1130)	
082010	204301	1/2" Single Stage Natural Gas Valve (VR8205M2955)	
091161	208920	1/2" Single Stage Natural Gas Valve w/Standing Pilot (VR8200M7005)	

Reznor Repair Parts

Motors

Part #	Mfg #	Description	Price
008476	45331	1/40 hp Motor	
027821	102380	1/8 hp Motor	
008485	61069	1/20 hp Motor	
008508	95547	1/20 hp Motor for Model F 130 & 200	
008509	95548	1/30 hp Motor	
008502	88781	1/6 hp Motor	
066238	196241	Fan Motor for UDAP 45 - 60	
066252	196242	Fan Motor for UDAP 75	
066267	196243	Fan Motor for UDAP 100	
066314	196247	115V Fan Motor for UDAP and UDAS 300 - 400	
008507	95546	Fan Motor	
008515	96287	Fan Motor	
008516	96288	1/15 hp Fan Motor	
102121	147571	Fan Motor	
008514	96018	Venter Motor Assembly	
027692	97727	Venter Motor and Wheel Assembly	
100298	131410	115V Venter Motor with Capacitor	
170634	214067	115V Venter Motor less Capacitor	
033127	148055	115V Venter Blower Motor	
066281	196036	115V Venter Motor for UDAP and UDAS 150 - 175	
109924	214066	115V Venter Motor for VR 175/200 with Capacitor	
139008	260422	115V Venter Motor	

Pilots & Components

Part #	Mfg #	Description	Price
008486	61145	Natural Gas Pilot Assy w/ Orifice, High Tension Lead & Flame Probe; less Pilot Tubing & Flame Sensor	
008523	96360	Natural Gas Pilot Assembly with Orifice, Pilot Tubing, & Thermocouple; (for All F Models)	
020439	110853	Natural Gas Spark Pilot Assembly	
066224	175272	DSI Electrode Assembly	

Pressure Switches

Part #	Mfg #	Description	Price
066242	196388	High Altitude Pressure Switch for UDAP-CV, UDAS 100	
062419	196653	Pressure Switch	
091540	205442	0.20"wc Low Speed White Label Pressure Switch	
091216	205443	Low Speed Yellow Label Pressure Switch	
066288	201158	1.10"wc Pressure Switch	
020765	121275	Block Vent Switch	

Reznor Repair Parts

Transformers

Part #	Mfg #	Description	Price
008461	131988	120/24V Transformer	
008462	132204	120/24V, 20VA Transformer	
091211	175265	115V, 30VA Control Transformer	
066225	194808	Transformer, 40VA	

Vent Caps

Part #	Mfg #	Description	Price
067827	111849	5" Vent Cap for UDAP 150 - 250	
107774	111848	4" Vent Cap for UDAP 30-125	

Parts

Part #	Mfg #	Description	Price
022890	43425	Inducer Blower Wheel (AD326-215-101-2)	
008527	97534	Natural Gas Pilot Assembly	
020436	97535	LP Pilot Assembly with Flame Sensor	
020437	97572	Compression Nut	
020449	97724	Venter Wheel FE130-400	
021456	97725	Venter Wheel FE25-100	
021538	18549	RBM Relay All FE Models	
008534	98697	Flame Rod	
021502	116019	37-1/8" Tubular Section for TR & TR-H Models	
060039	116045	Burner On Light	
091538	120545	Venter Wheel	
026634	132007	Venter Wheel	
061819	135979	Venter Wheel	
027310	147165	Flame Sensor	
027317	148085	18" Ignition Cable	
066231	195036	Venter Wheel Assembly	
090713	195046	Compression Spring for Louvers	
066222	195265	Control Board	
066223	195292	Flame Sensor	
066237	196949	Flame Rollout	
084139	197205	High Altitude Conversion Kit	
067749	201685	3 amp Fuse	
086607	204611	DSI Electrode Assembly for Model VR	
073531	204955	DSI Ignition Control	
123105	257531	UDAP Circuit Board	

Reznor Repair Parts

Parts (Continued)

Part #	Mfg #	Description	Price
133894	259521	Time Delay Relay Kit	
139262	262971	Time Delay Relay Kit	
036781	CC2	Vertical Vent Terminal/Combustion Air Inlet Assembly through Roof for UEAS Model	
066083	REZBRKT	Low Ceiling Mounting Bracket	



Ruud Water Heater Repair Parts

Water Heater Parts & Accessories

Part #	Mfg #	Description	Price
109636	RTG-20040	Ez-Link Cable Connects (2) Tankless Gas Water Heaters to Operate As One Unit	
074314	AP12938	42" Aluminum Anode Rod	
063009	SP11309C	44" Resistor Magnesium Anode Rod	
091619	SP8371B	52" Anode Rod w/Resistor Flex	
164493	SP11526C	Anode Rod - 0.900" x 44-3/8"	
165325	SP20717	GHE Flame Sensor	
063007	SP11248R	Dip Tube	
113598	SP6830	Adapt-O-Flange	
216119	SP20260K	GHE Display & Control Board	
219461	SP20364	Advantage Plus Service Kit - 160,000 BTU/HR	
213463	SP20365	Advantage Plus Service Kit - 199,000 BTU/HR	
190943	AP13044	21"x21"x16" Water Heater Stand	
190942	AP67089	Gasket - Element	
096635	SP20003	Nipples - Heat Trap	

Blower Assembly

Part #	Mfg #	Description	Price
100247	AP13416	Blower Assembly for 40/50 gal PowerVent Units	
133976	SP13605	Blower Assembly for 40/50 gal PowerVent Units	
137367	AP151091	Blower Assembly for 40/50 gal Tall PowerVent Units	

Control

Part #	Mfg #	Description	Price
159000	SP20231	Gas Control (Thermostat) - NG	
164454	SP20233	Gas Control(Thermostat) - LP	
113853	SP20161A	Natural Gas Wiper Control & Gas Valve Assembly for PowerVent 2	
113854	SP20162A	LP Gas Wiper Control & Gas Valve Assembly for PowerVent 2	
120504	SP20170A	Natural Gas FV Wiper Control & Gas Valve Assembly	
120505	SP20170B	Natural Gas FV Wiper Control & Gas Valve Assembly	
101157	SP20123B	FV Wiper Electronics	

OEM Screw-In Elements - 1-1/2" Copper

- Specifically designed for Marathon and Eclipse Water Heaters
- Includes gasket
- Low Watt Density



Part #	Mfg #	Description	Price
116994	SP10698MH	240V/4500W, 12.33" Length	
095422	SP610160	240V/4500W, 13.38" Length	

OEM Screw-In Elements - 1-1/2" Titanium

- Specifically designed for Marathon and Eclipse Water Heaters
- Includes gasket
- Low Watt Density



Part #	Mfg #	Description	Price
141163	SP213790	240V/4500W, 14" Length	
238106	SP213820	240V/3800W, 14" Length	
132919	SP213670	240V/4500W, 16.5" Length	
111268	SP210198	240V/3800W, 16.46" Length	

OEM Screw-In Elements - 1" Stainless Steel



Part #	Mfg #	Description	Price
063478	SP10867JL	208V/3000W, 12.38" Length	

Electric Water Heater Tune-Up Kit

- Includes:
 - (2) Screw-in elements (AP10552MH-4)
 - Electric thermostat (AP11695-4)
 - Electric thermostat (AP11698-5)
 - (2) Element gaskets (AP6708-9)
 - Tune-up kit back card (PD991176)
 - Tune-up kit blister (PD991231)
 - Front card (PD991234)
- For use with PD137981 and SP13266



Part #	Mfg #	Description	Price
140554	SP20060	240V/4500W	



Ruud Water Heater Repair Parts

Electric Water Heater Elements Copper - R-Tech

- *Screw-in elements - 1 Inch*
-Fits most water heaters with 1" NPSM threads
- *R-Tech - Features a patented restored design that increased the life of both the element and water heater tank*
- *Watt Density Guide - lower watt density means the element stays cooler and will last longer*
-LWD: low watt density (100 watts/in 2 or less)
-MWD: medium watt density (101-150 watts/in2)
-HWD: high watt density (over 150 watts/in2)



Part #	Mfg #	Description	Price
126122	SP10552JH	240V/3000W, 10-5/8" HWD	
063001	SP10552KL	240V/3500W, 13-3/8" LWD	
078390	SP10552ML	240V/4500W, 13-3/4" LWD	
063002	SP10552MH	240V/4500W, 13-5/8" HWD	
063000	SP10552PH	240V/5500W, 13-1/2" HWD	
076289	SP10552QH	240V/6000W, 11-3/4" HWD	
062998	SP10874FH	120V/1500W, 7-11/16" HWD	
062997	SP10874GH	120V/2000W, 7-11/16" HWD	
062996	SP10874HH	120V/2500W, 9-7/16" HWD	

Electric Water Heater Elements Stainless Steel - R-Tech

- *Screw-in elements - 1 Inch*
-Fits most water heaters with 1" NPSM threads
- *R-Tech - Features a patented restored design that increased the life of both the element and water heater tank*
- *Watt Density Guide - lower watt density means the element stays cooler and will last longer*
-LWD: low watt density (100 watts/in2 or less)
-MWD: medium watt density (101-150 watts/in2)
-HWD: high watt density (over 150 watts/in2)



Part #	Mfg #	Description	Price
063479	SP10867LL	208V/4000W, 10.08", LWD	
063481	SP10867NL	208V/5000W, 19.25", LWD	
063486	SP10869ML	240V/4500W, 15-1/2" LWD	
190941	SP10869KL	240V/3500W, 13-1/2" LWD	
073434	SP10869M	240V/4500W, 13-1/2" MWD	
	M		
063480	SP10867ML	208V/4500W, 17.58" LWD	
063482	SP10867QL	208V/6000W, 19-1/4" LWD	
073434	SP10869M	240V/4500W, 13-1/2" LWD	
	M		
063488	SP10869QL	240V/6000W, 19-1/8" LWD	

Water Heater Parts & Accessories (Continued)

Electric Water Heater Elements Stainless Steel - R-Tech

Part #	Mfg #	Description	Price
063494	SP10870NL	480V/5000W 19.28", LWD	
063493	SP10870ML	480V/4500W 17.63" LWD	
063495	SP10870QL	480V/6000W 19.21" LWD	

Heating Element Wrench

- *Allows use of screwdriver for additional leverage*



Part #	Mfg #	Description	Price
063006	SP35871AB	Fits 1-1/2" Hex	
169225	PT49057	Fits 1-1/2" & 1-7/8" Hex	

Igniter

Part #	Mfg #	Description	Price
063860	SP10972	Hot Surface Igniter	
108321	SP12143	Igniter for Advantage Plus Comm Water Heaters	
064395	SP12560B	Spark Igniter & Pilot Assembly (LP) for PowerVent 2	
064396	SP12560C	Spark Igniter & Pilot Assembly (LP) for PowerVent 2	
064393	SP12562	High Performance Blower Assembly for PowerVent 2	
100162	SP13447B	Flammable Vapor Sensor/FV Wiper Replacement Kit	
129324	SP14218A	Igniter for PowerVent Units	
109619	SP14218B	Igniter for PowerVent Units	
146883	SP20307	Piezo Igniter	

Pilot Assembly

Part #	Mfg #	Description	Price
104045	SP13418	Pilot Assembly - Natural Gas	
117788	SP13422	Pilot Assembly - Natural Gas	
177859	SP13884A	Pilot Tube Assembly Kit	
190075	SP13884H	Pilot Assembly Kit - NG 12"	
170382	SP20305A	Pilot Assembly - Natural Gas	



Ruud Water Heater Repair Parts

Switch

Part #	Mfg #	Description	Price
128923	AP12767	On/Off Switch	
063577	SP11875	Vacuum Switch	
065175	SP12766	Pressure Switch for PowerVent 2	
101155	SP20116	Vacuum Switch for PowerVent	

Thermostat



Part #	Mfg #	Description	Price
131662	SP20164	Gas Control Thermostat, Natural Gas for Use with 2LAC9	

Gas Control (Thermostat) - LP



Part #	Mfg #	Description	Price
156423	SP20304B	LP Gas Control	

Gas Control Assembly

- Rheem/Ruud replacement gas control thermostat
- For PowerVent Models only



Part #	Mfg #	Description	Price
159000	SP20231	6"x6"x4" Replacement Gas Control for PowerVent Models	

Gas Control (Thermostat) - NG



Part #	Mfg #	Description	Price
180874	AP14270C	Natural Gas Control	

2-Pole High Limit - Normally closed Thermostat Contacts (TOD)

- Upper Thermostat in residential electric water heaters
- With Simultaneous design:
-Both elements are on at the same time



Part #	Mfg #	Description	Price
063011	SP11699	240V Single Element Thermostat	

2-Pole High Limit - Normally Open & Normally Closed Thermostat Contacts (TOD)

- Upper thermostat for residential electric water heaters
- Non-Simultaneous element operation
- 59T/66T Series



Part #	Mfg #	Description	Price
063013	SP11698	Upper Thermostat, 90° to 150° Adjustment Range	
135205	SP210245	Upper Thermostat, 80° to 140° Adjustment Range	

1-Pole High Limit - Normally Closed Thermostat Contacts (TOD)

- Commonly used for 120V residential water heaters with only one element
- 59T/66T Series



Part #	Mfg #	Description	Price
063004	SP11700	Upper Thermostat, 90° to 150° Adjustment Range	

Electric Thermostats w/o High Limit Control (TOD)

- Used as the lower Thermostat in residential electric water heaters
- 59T Series



Part #	Mfg #	Description	Price
063012	SP11695	Lower Thermostat, 90° to 150° Adjustment Range	
141066	SP210239	Lower Thermostat, 90° to 150° Adjustment Range	
111142	SP310020	Lower Thermostat, 110° to 170° Adjustment Range	



Ruud Water Heater Repair Parts

Robertshaw Thermostat



Part #	Mfg #	Description	Price
063016	SP12258B	LP Gas, 57° - 160° Control Valve with LH Main Burner	

Thermostat Shank



Part #	Mfg #	Description	Price
147598	AP14696A	Thermostat Shank - 1.926	
139027	AP14696B	Thermostat Shank - 2.870 PV	

Thermocouple



Part #	Mfg #	Description	Price
063005	SP6379R	24" Thermocouple	

Valve

Part #	Mfg #	Description	Price
076815	AP12575B-1	3/4" T&P Valve for FVIR Long Shaft	
171596	AP14838G	T&P Valve	
063423	SP11652B	Natural Gas Valve	
109615	SP13845A	Natural Gas Intelli-Vent Valve for PowerVent Units	
109616	SP13845B	Natural Gas Intelli-Vent Valve for PowerVent Units	
109617	SP13846A	LP Gas Intelli-Vent Valve for PowerVent Units	
109618	SP13846B	LP Gas Intelli-Vent Valve for PowerVent Units	
127436	SP20167C	LP Gas Valve and Thermostat	
129691	SP623336	Vacuum Relief Valve Assembly for Marathon Water Heaters	
133902	SP20171A	Gas Control Thermostat Kit	
159270	SP20303A	Nat Gas Control Thermostat Kit	

Vent Damper

Part #	Mfg #	Description	Price
108929	AP13142	Vent Hood Damper Assembly	
250648	AP131432	Vent Hood Damper Assembly	

Warranty Upgrade

Part #	Mfg #	Description	Price
078740	SP20079	Protection Plus 4-Year Kit	
234916	SP20866	Protection Plus Warranty Extension Kit	

Flammable Vapor Ignition Resistant (FVIR) Parts

Robertshaw Part



SP20064

Part #	Mfg #	Description	Price
073470	SP20065	Pilot Assembly - Natural Gas	
082616	SP20075	Pilot Assembly - Natural Gas	
097155	SP20055	Piezo & Pilot Assembly Kit	

White-Rodgers Part

Part #	Mfg #	Description	Price
109602	SP14270G	Gas Valve - Natural Gas	
109603	SP14270H	Gas Valve - Natural Gas	
109607	SP14269A	Gas Valve - LP Gas	
109609	SP14269E	Gas Valve - LP Gas	
109611	SP20127	Pilot Assembly Kit - Natural Gas	
109612	SP20128	Pilot Assembly Kit - LP Gas	

Common Service Part

Part #	Mfg #	Description	Price
073471	SP20064	Thermocouple Kit	
082082	SP12112G	Electric Drain Valve	
073962	SP12112S	Brass Drain Valve	
082825	SP8346	Watts 100XL, 3/4", 150 psi, 100,000 BTU Temperature & Pressure Relief Valve	



Ruud Water Heater Repair Parts

Flammable Vapor Ignition Resistant (FVIR) Parts (Continued)

Common Service Part

Part #	Mfg #	Description	Price
073469	SP20063	Gasket Kit	

Commercial Water Heater Parts

Part #	Mfg #	Description	Price
069329	AP12231B-1	3/4" NPT Brass Drain Valve	
144116	AP9013D	130 to 199K Temperature and Pressure Relief Valve	
144117	AP9012B	250 to 400K Temperature and Pressure Relief Valve	
065179	SP10963D	Natural Gas Valve	
073418	AP12015-1	Thermostat and High Limit	
082771	AP12841	3-Pole Contractor	
144111	AP14074-3	Temperature Sensor	
144120	AP14157-3	GHE Blower Control Harness	
145841	AP14159-5	GHE Gas Valve Harness	
144112	AP14280-1	Exhaust Temperature Flue Sensor	
209545	AP14720	FV Sensor Harness	
144118	AP14758	Display Jumper Harness	
144128	AP14859	Diffuser Nipple	
144124	AP15261	Ground Wire Harness	
143193	RTG20224A	Commercial Upgrade Chip for RTGH-95DVN Natural Gas	
075285	SP12142	ECO/Temperature Probe	
073486	SP12144	Flame Rectification Probe	
073495	SP12189	Combustion Blower	
148468	SP15138	Burner Mounting Flange Gasket	
073485	SP12140	Pressure Switch	
065181	SP10764B	Pilot Assembly for Natural Gas Units	
065180	SP11798B	High Limit Thermostat	
065178	SP12234B	Commercial Light Duty Gas Thermostat	
063119	SP5886	Hand Hole Gasket	
084096	SP8293	Therm-O-Disc Upper Thermostat	
073160	SP8295	Therm-O-Disc Lower Thermostat	
065182	SP10763C	Ignition Control	
093329	SP8828D	Ignition Cable	
131606	RTG20210	Horizontal Vent Termination Kit	

Schwank Repair Parts

Tube Heater Parts

Part #	Mfg #	Description	Price
129015	JA-0528-XX	4" Horizontal Flue Vent Terminal	
130962	JA-0568-XX	24VAC DSI Control	
134135	JA-0571-KT	DSI Tube Heater Igniter & Gasket	
129442	JA-0775-XX	120/24V, 20VA Transformer	
129441	JL-0703-AA	LP Gas Valve	
147558	JL-0771-XX	1/2" x 24" SS Flexible Gas Connector	
147560	JL-0771-YY	3/4" x 36" SS Flexible Gas Connector	
129016	JL-0772-XX	Dual Scale Line Voltage Thermostat	
129010	JL-0798-SH	1-7/8" 'S' Hook - 25/Pk	
136512	JL-0800-SH	2" Safety Snap Hook - 24/Pk	
129009	JL-0798-JC	50' Box of #8 Jack Chain	
136510	JL-0800-XX	200' Roll of #2 Lion Chain	
130761	JM-0303-KT	24V Transformer/Relay Kit	
129018	JS-0508-SM	90° Aluminum Steel Elbow Kit	
129962	JS-0532-SE	4" Fresh Air Intake Adapter	
129012	JS-0532-VC	4" Outside Air Intake Wall Vent Hood with Birdscreen	
129452	JS-0568-KT	24V Thermostat Control Relay Kit	
129447	JS-0576-AA	Air Proving Switch - .85" WC	
129444	JS-0576-XX	Air Proving Switch - .48" WC	
129445	JS-0576-YY	Air Proving Switch - .30" WC	
129450	JS-0577-SS	Blocked Flue Switch - .58" WC	
129448	JS-0577-ZZ	Blocked Flue Switch - 1.41" WC	
129449	JS-0577-YY	Blocked Flue Switch - .90" WC	
134136	JS-0518-XX	24" High Voltage Ignition Cable	

Sloan Repair Parts

Manual Flushometer Parts

Royal Flushometer Parts

Part #	Mfg #	Model	Ref	Description	Price
083761	SLA1042A	3301503		Repair Kit Royal 1.0 gpf Dual Filter Diaphragm Kit	
036284	SLA1101A	3301070	3-5	Rebuild Kit 1.6 gpf - Closet Exposed	
036283	SLA1102ABX	3301071	3-6	Rebuild Kit 3.5 gpf - Closet Exposed	
036282	SLA1107A	3301074	3-9	Rebuild Kit 1.0 gpf - Urinal Exposed	
036291	SLA1108A	3301075	3-10	Rebuild Kit 1.5 gpf - Urinal Exposed	
010092	SLA156A	5301188	5	Diaphragm	
010097	SLA31	5301139	9	Handle Gasket	
021329	SLA6	0301082	5	Handle Coupling, CP	
010107	SLA71	0301168	2	Inside Cover	
010108	SLA72	0301172	1	Outside Cover, CP	
010112	SLB32A	5302279	4-2	Handle Assembly	
036285	SLB51A	3302306	8	Handle Repair Kit	
010119	SLB73A	0302390	4-1	Handle Assembly	
010137	SLF5AT	0306146	10-3	1-1/2" Spud Coupling, CP	
010138	SLF5AU	0306140	10-2	1-1/4" Spud Coupling, CP	
010136	SLF5AW	0306125	10-1	3/4" Spud Coupling, CP	
020801	SLH1009A	3308790	19-2	3/4" Vandal Resistant Stop Cap For H-700-A	
010148	SLH541ASD	3308853	17-1	1" Screwdriver Stop Repair Kit	
010149	SLH543ASD	3308856	17-2	3/4" Screwdriver Stop Repair Kit	
010150	SLH551A2116	0308801	14	2-1/16" Tail Assembly, CP	
010152	SLH553	5308696	15	O-Ring	
010154	SLH582	0308848	20-2	3/4" Cap, CP	
028922	SLH700A1	3308386	16-2	1" Adjustable Screwdriver Stop w/Vandal Resistant Cap #19-2	
036290	SLV600AA349	3393004	12-1	3/4" x 9" Vacuum Breaker, CP	
036288	SLV600AA1149	3393006	12-1	1-1/4" x 9" Vacuum Breaker, CP	
036287	SLV600AA1129	3393007	12-3	1-1/2" x 9" Vacuum Breaker, CP	
036286	SLV651A	3323182	11	Vacuum Breaker Repair Kit	

Regal Flushometer Parts

Part #	Mfg #	Model	Ref	Description	Price
010091	SLA15A	5301111	4	Molded Disc	
010093	SLA156AA	5301189	4,5,8,14	Diaphragm Repair	
010094	SLA163A	5301236	6A	Guide Assembly for 4.5 gpf Closet & 1.5 gpf Urinal	
010095	SLA19AC	5301058	3A	Relief Valve Closet	
010096	SLA19AU	5301059	3B	Relief Valve Urinal	
010098	SLA36A	3301036	7A	4.5 gpf Closet Repair Kit	
010099	SLA37A	3301037	7B	1.5 gpf Urinal Repair Kit	
010100	SLA38A	3301038	7C	3.5 gpf Water Saver Repair Kit	
010101	SLA41A	3301041	7D	1.6 gpf Closet Repair Kit LC	
010102	SLA42A	3301044	7E	1.0 gpf Urinal Kit LC	

Sloan Repair Parts

Manual Flushometer Parts (Continued)

Regal Flushometer Parts

Part #	Mfg #	Model	Ref	Description	Price
010113	SLB39	5302297	8	Seal	
010115	SLB50A	5302305	13	Handle Repair Kit	
010141	SLH1012A	5308156	24	Cap CP	
010176	SLV500AA	5323005	17-1	3/4" x 9" Vacuum Breaker CP	
010182	SLV500AA114	5323006	17-2	1-1/4" x 9" Vacuum Breaker CP	
010178	SLV500AA112	5323007	17-3	1-1/2" x 9" Vacuum Breaker CP	

Piston Operated Flushometers

GEM 2® Piston Operated Flushometers

- Fixed volume piston with filtered O-ring by-pass
- ADA Compliant metal oscillating handle
- Vandal-resistant stop cap
- Adjustable tailpiece
- Vacuum breaker flush connection
- High copper, low zinc brass castings for dezincification resistance
- Non-hold-open handle and no external volume adjustment to ensure water conservation
- Handle packing, stop seat and vacuum breaker molded from PERMEX™ rubber compound for chloramine resistance



GEM 2 Repair Kit

Part #	Mfg #	Model	Description	Price
112656	SLG50A	5307074	Handle Repair Kit, 6/Pk	

Sensor Operated Flushometer Parts

OptimaPlus® Flushometer Parts

Part #	Mfg #	Model	Ref	Description	Price
057970	SLA1037A	3301500		Diaphragm Only Kit	
066898	SLEBV1020A	3325001	10	1.6 Flex Tube Diaphragm Inside Part Kit	
066899	SLEBV1022A	3325000	10	OptimaPlus Repair Kit, 1.0, 1.5 Urinal	
093722	SLEBV129AC	3325450	6	G2 Electronic Module - Water Closet	
084024	SLEBV129AU	3325451	6	G2 Electronic Module - Urinal	
100551	SLEBV130A	0325172	3	G2 Override Button Assembly	
080085	SLEBV136AG2	3325453	9	Isolated Solenoid	
130178	SLEBV138A	0325160	1	G2 Cover/Ring/Sensor Assembly - Water Closet	
085884	SLEBV144A	3325462	9	Isolated Solenoid Operator	
071385	SLEBV146ACG2	0325176		G2 Electronic Module Optima 1.6 - Closet	
071242	SLEBV146AUG2	0325177		G2 Sensor Module Urinal	
028637	SLEBV18	5325813		Quad Ring	
022200	SLEBV60A	3325013		Metal Cover Assembly with Override Button - Water Closet	
057264	SLEL1652	0305118		Solenoid Coil, 24VAC	
049083	SLEL163A	0305165		Sloan Solenoid Assembly	
010216	SLH541AAW	3308855	21	1" Screwdriver Angle Stop Repair Kit	

Sloan Repair Parts

Flush Valve Transformer



Part #	Mfg #	Model	Description	Price
010126	SLEL154	0345154	120VAC/24VAC, 50/60Hz (50VA), Box-Mount	

Optima® Flushometer Parts 110/111/115/116/140/152/153ES-S

Part #	Mfg #	Model	Ref	Description	Price
010125	SLEL1500L	3305621	18	Sensor Repair Kit - Closet	

Optima® Systems Solenoid/Sensor Parts and Assemblies List

Part #	Mfg #	Model	Description	Price
010123	SLDO22	0337086	O-Ring	

Showerheads

Act-O-Matic



Part #	Mfg #	Model	Description	Price
010088	SLAC11	4020100	2.5 gpm Std Self-Cleaning Showerhead, CP	

Needle Spray Showerhead Repair Kit

- *Kit includes:*
 - Gasket
 - Spacer
 - Ball joint coupling
 - Flow control assembly



Part #	Mfg #	Model	Description	GPF	Spud	Price
245242	SLSH1002A	4328466	Needle Spray Showerhead Assembly			

Replacement Parts and Accessories

Part #	Mfg #	Model	Description	Price
023238	SLA1008A	3301077	3/4" Spud Coupling Kit	
029505	SLA1010A	3301079	1-1/2" Spud Coupling Kit	
057971	SLA1038A	3301501	Closet Repair Kit	
032380	SLA175A	0301104	Low Pressure Guide Repair Kit (P-600-EGL)	
045723	SLA19ALCM	0301178	Closet Relief Valve, Brass LC	
010103	SLA50	0301255	Super Wrench	
010104	SLA56A	5301170	Segment Diaphragm w/A-29 Copper Gasket	

Sloan Repair Parts

Replacement Parts and Accessories (Continued)

Part #	Mfg #	Model	Description	Price
010105	SLA56AA	5301176	Diaphragm Repair	
010122	SLC70A	3303398	Push Button For Concealed Royal & Crown - Contains #7-11	
032633	SLEL128A	3305043	Actuator Cartridge	
019381	SLEL1500	3305620	Urinal Sensor Repair Kit	
103862	SLETF1023A	3365092	Repair Kit .5gpm Male LF CP	
028928	SLF109112	0396322	1-1/2" x 21" x 5" Tubular Bend, CP	
010134	SLF3FR34	5306055	3/4" Red Friction Ring	
010133	SLF3	5306058	1-1/2" Red Friction Ring	
010135	SLF5	5306113	3/4" Slip Joint Gasket	
020802	SLH1010A	3308772	1" Vandal Resistant Stop Cap	
010143	SLH47AA	3308277	Stop Repair Kit	
010146	SLH533A	3308780	Sweat Solder Kit For 1" Supply Closet & Urinal	
010147	SLH536A	3308786	3/4" Sweat Adapter Kit	
010151	SLH551A3116	0308803	3-1/16" Long Adjustable Tailpiece, CP	
034119	SLH551A4116	0308805	4-1/16" Long Adjustable Tailpiece, CP	
016687	SLH584	5308850	Screwdriver Control Stop Seat Only For 1" H-540, H-600 & H-700 Series Stop	
043117	SLH633AA	3308782	Sweat Solder Kit 1" w/Cast Set Screw Flange (YBYC)	
111258	SLH634AA	3308785	Sweat Solder Kit 1", CP	
084384	SLH636AA	3308788	Sweat Solder Kit 3/4" w/Cast Set Screw Flange (YBYC)	
010186	SLV551A	3323192	Vacuum Repair Kit	
010159	SLJ212A	0310083	1-1/2" Solid Ring Pipe Support - 5 C/E Complete, CP	
010170	SLS30	5319086	1-1/2" Gasket	
010175	SLV101A	3322079	Vacuum Breaker Repair Kit	
010174	SLVBF5	5322001	1-1/2" Gasket	
126485	SLEL451	345125	Transformer 6V 25VA	

Vacuum Breaker

Part #	Mfg #	Model	Description	Price
010179	SLV500AA11213	0323014	1-1/2" x 13-1/2", CP	
010180	SLV500AA1122112	0323015	1-1/2" x 21-1/2", CP	
010181	SLV500AA1122412	0323016	1-1/2" x 24-1/2"	
010183	SLV500AA1142112	0323020	1-1/4" x 21-1/2"	
021735	SLV500AA1123212	0323057	1-1/2" x 32-1/2"	
010184	SLV500AA3415	0323210	3/4" x 15", CP	

Sloan Repair Parts

FLUSHMATE® Replacement Parts



BU100505-K



C-100500-K

Part #	Mfg #	Description	Price
080376	B-108288	Duckbill Valve (Air Inducer) Allows Air Into Tank but Not Out	
046464	BU100505-K	Upper Supply Kit for Flushmate Pressurized Tank	
010120	C-100500-K	Flush Cartridge for All Flushmate Series	
120907	M-101526-F3 1	Pressure-Assist Flush 1.6 gpf System for 503 Series Tanks Except Kohler K4404	

Speakman Repair Parts

Speakman® Parts

Part #	Mfg #	Description	Price
068748	RPG05-0520	Vacuum Breaker Hub Repair Kit	
164331	RPG05-0532CA	Hot side ceramic cartridge	

T & S Brass Repair Parts

Handles



- Chrome-plated zinc handle
- B-WH models come with screw, all others, screw is sold separately

Part #	Mfg #	Description	Price
010415	001636-45	Lever Handle Cold Index	
010416	001637-45	Lever Handle Hot Index	

Swing Nozzles



Part #	Mfg #	Description	Price
044168	062X	12" Swing Nozzle	

Repair Kits



Part #	Mfg #	Description	Price
061402	B-9K	Lever Handle Kit	
010405	B-10K	Repair Kit for B-0107	
046499	B-21K	Eterna Cartridge Replacement	
107843	B-39K	Brass Rotary Waste Valve Parts Kit	
130038	B-0969-RK01	Vacuum Breaker Repair Kit	
010409	001121-45	Spray Face #1	

T&S Brass Parts

Flexible Stainless Steel Hose

- Heat resistant gray handle
- Polyurethane inner tubing
- 3/4-14 UN female outlet
- 3/4-14 UN female inlet
- Hose washers included
- Material: Polished chrome plated brass end fittings, thermoplastic handle and stainless steel hose



Part #	Mfg #	Description	Price
010404	B-0044-H	44" Flexible Stainless Steel	

Bonnet Assembly



Part #	Mfg #	Description	Price
030182	002856-40	B502 Bonnet Assembly	

Spindle



002711-40



002712-40

Part #	Mfg #	Description	Price
010419	002711-40	Cold Spindle 174A	
010420	002712-40	Hot Spindle 175A	
085560	005960-40	Eterna Spindle Assembly, Hot	
110659	005959-40	Eterna Spindle Assembly, Cold	

Supply Nipple

- Brass



Part #	Mfg #	Description	Price
110214	B-0230-K	Angle Supply Nipple	

T & S Brass Repair Parts

Waste Valve with Drain Adapter - Twist



Part #	Mfg #	Description	Price
107844	B-3940	3.0" Sink Opening, 1.5" or 2.0" Drain Outlet	
119775	B-3950	3-1/2" x 2" & 1-1/2" Adapter	

Washer



Part #	Mfg #	Description	Price
010411	001041-45	Spreader Washer	
022191	001092-45	T&S Seat Washer	

Wall Brackets

Wall Bracket

- Fits 3/8" pipe
- 2-1/4" Wall flange
- Polished chrome plated brass
- Chrome-plated mounting screws included



Part #	Mfg #	Size	Price
033142	B-0109-01	6"	

Parts & Accessories

Part #	Mfg #	Description	Price
010417	018L	Stem	
010427	067L	Stem	
010426	066L	Removable Insert	
010425	064L	Removable Insert	
019815	003164-45	Spring Check Seat Washer with Seat Disc	
208371	011355-45	Overflow Tube	
208370	011356-45	Waste Overflow Head	

Taco Repair Parts

Pro-Fit™ Replacement Parts

- For Bell & Gossett and Armstrong pumps

Coupler

- Rugged, cast zinc w/steel reinforced eyelets
- Heavy-duty spring
- Fits all 1/2" motor shafts
- Std Woods 3-J for all 5/8" motor shafts (opt 1/2" inserts included)



Part #	Mfg #	B&G Part #	Armstrong Part #	Price
079914	COU-ABC-100	118705,189110,118712,118723	806026-001	
079915	COU-D100	118473,118709	810120-003/006,806137-000,807436-000	

Thermolec Repair Parts

Parts & Accessories

Part #	Mfg #	Description	Price
130137	10-02-005	Magnetic B/U, 50A Spade Style Contactor	
130139	10-02-006	CCT-140 SPDT Diverting Valve Pump Relay	
241766	16-04-250	TH22 Conversion Kit	
241767	16-04-300	TH22 Controller	
128230	17-02-102	CBLR055 Incoloy Element 5kW, 240V	
121185	17-02-103	CBLR060 Incoloy Element 5.75kW 240V	
130133	17-02-107	CBLR130 Electronic Temperature. Sensor - Supply Water	
110489	17-02-110	CBLR025 Mono Energy Control Board TH-600-M	
130131	17-02-115	CSR113 Solid State Relay SSR-20-DC	
130130	17-02-116	CTR040 Control Transformer 30VA 240/24V	

Triangle Tube Repair Parts

Prestige Parts

Part #	Mfg #	Description	For:	Price
115737	PSSENS01	Outdoor Sensor Kit		
093308	PSSTND01	Floor Stand	PS110, PS175, PS250	
107252	PSSTND02	Wall Kit, Recommended f/Hanging on Anything Other Than a Masonry Wall		
107253	PSSTND03	Floor Stand Kit Use w/PSSTND02 Wall Kit	PE110 & PS399	

Electronic Components

Part #	Mfg #	Description	For:	Price
091015	PSRKIT04	NTC Sensor	PS110, PS175 & PS250	
091016	PSRKIT13	Blower Kit w/Gasket	PS110 & PS175	
091019	PSRKIT19	Transformer with Surge Protection	SOLO 110	
114363	PSRKIT20	Control Module Display	SOLO 110	
118949	PSRKIT50	Control Module	SOLO 110	
120439	PSRKIT55	Blower Kit w/Gasket	PS110	
117640	PSRKIT58	MCBA Control Module Replacement Kit	PE110	
138226	PSRKIT63	NTC3 Domestic Hot Water Sensor	PE110	

Burner Components

Part #	Mfg #	Description	For:	Price
091021	PGRKIT01	Gas Valve Kit	PS110	
091017	PSRKIT15	Igniter w/Gasket	SOLO 110	
120440	PSRKIT41	Gas Valve	SOLO 399	

Internal Components

Part #	Mfg #	Description	For:	Price
091020	PGRKIT20	Lwco Pressure Device	SOLO 110	
118581	PSRKIT40	399 Blower with Gasket	SOLO 399	

Union Brass Repair Parts

Parts

Valve Assemblies

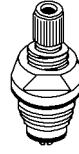

80038



80080

Part #	Mfg #	Description	Price
010503	80038	1837AC Cold Valve Assembly	
051376	80080	1839A-C Cold Valve Assembly	

Ruud Heating & AC Repair Parts

Blower Wheels

Blower Wheel

- CW Rotating



Part #	Mfg #	Rotation	Nom Size	Overall Dia x Overall W	Hub	Disc Shape (Hub Side)	# of Blades	Price
009619	70-18631-01	CW	9" x 7"	9-1/2" x 7-1/8"	1/2"	Convex	43	
024572	70-20218-02	CW	10" x 7"	10-5/8" x 7-3/16"	1/2"	Convex	48	
016858	70-18629-01	CW	10" x 10"	10-5/8" x 10-5/8"	1/2"	Concave	48	
051174	70-23110-30	CCW	10" x 10"	10-5/8" x 10-3/4"	1/2"	Concave	48	
030369	70-23111-05	CW	11" x 7"	11-15/16" x 7-1/8"	1/2"	Concave	54	
074404	70-23111-43	CW	11" x 7"	11-15/16" x 7-1/8"	1/2"	Concave	54	
049454	70-24254-02	CW	11" x 7"	11-15/16" x 7-1/8"	1/2"	Convex	54	
009622	70-20602-01	CW	11" x 10"	11-7/8" x 10-11/16"	1/2"	Concave	54	
050595	70-24119-01	CW	12" x 7"	12-3/4" x 7"	1/2"	Concave	43	
086470	70-24179-01	CW	12" x 11"	12-25/32" x 11-1/8"	1/2"	Convex	43	
019546	70-24041-01	CW	12" x 11"	12-3/4" x 11-1/8"	1/2"	Concave	43	
051179	70-42540-02	Reversible	15" x 15"	15" x 15"	1"	Double Convex	51	

Blower Motors

Part #	Mfg #	Rotation	No. of Speeds	RPM	HP	Input Voltage	Hz	Price
160025	51-104671-01	CCW	4	1075	1/2	120	60	
103690	51-25023-01	CCW	4	1075	3/4	120	60	
052996	51-42537-01	Reversible	1	1725	3	208/230	50/60	

Compressors

R-410 Scroll Compressor

Copeland R-410A Air Conditioning Scroll Compressor - 208/230

- Crankcase heater not included



Part #	Mfg #	Vendor #	Capacity MBTUH	Run Capacitor	Start Capacitor	Start Kit	Kick Start	Crankcase Heater	Price
113737	55-102045-14S	ZP16K5E-PFV	15.5	30/370	88-106/330	SK-A1	42-TO5	44-17402-44	
113736	55-102045-01S	ZP21K5E-PFV	21.3	40/370	88-106/330	SK-A1	42-TO5	44-17402-44	
113735	55-102045-02S	ZP21K5E-PFV	21.3	40/370	88-106/330	SK-A1	42-TO5	44-17402-44	

Ruud Heating & AC Repair Parts

Compressors (Continued)

R-410 Scroll Compressor

Copeland R-410A Air Conditioning Scroll Compressor - 208/230

Part #	Mfg #	Vendor #	Capacity MBTUH	Run Capacitor	Start Capacitor	Start Kit	Kick Start	Crankcase Heater	Price
113903	55-102045-31S	ZP24K5E-PFV	24.0	40/370	88-106/330	SK-A1	42-TO5	44-17402-44	
113901	55-102045-03S	ZP31K5E-PFV	31.0	45/370	88-106/330	SK-A1	42-TO5	44-17402-44	
131585	55-102045-17S	ZP38K5E-PFV	37.5	45/370	175-216/330	SK-A3	42-KS1	44-17402-45	
113730	55-102045-09S	ZP42K5E-PFV	42.0	70/370	88-106/330	SK-A1	42-KS1	44-17402-45	
113734	55-102045-15S	ZP34K5E-PFV	34.0	45/370	88-106/330	SK-A1	42-TO5	44-17402-45	
113900	55-102045-26S	ZP51K5E-PFV	51.0	70/370	175-216/330	SK-A3	42-KS1	44-17402-45	
175440	55-102045-27S	ZP51K5E-TF5-830	51.0	-	-	-	-	44-17402-45	
113729	55-102045-13S	ZP54K5E-PFV	54.0	80/370	175-216/330	SK-A3	42-KS1	44-17402-45	
250959	ZP49K5E-PFV-800	ZP49K5E-PFV-800	49400	70/370	88-106/330	SK-A1	42-KS1	44-101884-08	

R-22 Scroll Compressor

Copeland R-22 Air Conditioning Scroll Compressor - 208/230-1



Part #	Mfg #	MBTUH*	Electrical	RLA	Max Dimensions H x W x L	Stub Tube Conn(ID") Dischg, Suc	Mnt Dim W x L	Price
133280	ZR16K5E-PFV-800	20.3	208/230-1-60	9.3	15.86" x 9.50" x 9.50"	1/2", 3/4"	7.5" x 7.5"	
222707	ZR21K5E-PFV-800	27.5	208/230-1-60	32.9	18.75" x 11.23" x 10.38"	22/25", 1-1/8"	7.5" x 7.5"	
133217	ZR25K5E-PFV-800	32.8	208/230-1-60	15	15.86" x 9.50" x 9.50"	1/2", 3/4"	7.5" x 7.5"	
133806	ZR28K5E-PFV-800	36.9	208/230-1-60	15.7	15.86" x 9.50" x 9.50"	1/2", 3/4"	7.5" x 7.5"	
222708	ZR32K5E-PFV-800	42.6	208/230-1-60	17.1	15.86" x 9.50" x 9.50"	1/2", 3/4"	7.5" x 7.5"	
164723	ZR34K5E-PFV-800		208/230-1-60	18.6	15-5/16"H	1/2", 3/4"	7.5" x 7.5"	
180171	ZR42K5E-PFV-800	54.8	208/230-1-60	22.1	16.94" x 9.56" x 9.59"	1/2", 7/8"	7.5" x 7.5"	
141164	ZR54K5E-PFV-800	69.7	208/230-1-60	28.2	16.94" x 9.56" x 9.59"	1/2", 7/8"	7.5" x 7.5"	
139752	ZR48K5E-PFV-800	48.2	208/230/1-60	24.3	16-7/16"H	1/2", 7/8"	7.5" x 7.5"	
176782	ZR61K3E-TF5-950	62	208/230-3-60	19.3	17-3/4"H	1/2", 7/8"	7.5" x 7.5"	
168710	ZR61K3E-PFV-950	62	208/230/1-60	32.1	17-3/8"H	1/2", 7/8"	7.5" x 7.5"	

Ruud Heating & AC Repair Parts

Expansion Valves
Thermal Expansion Valve



Part #	Mfg #	Description	Price
140730	611006	2T R-22 Expansion Valve	
140731	611007	3T R-22 Expansion Valve	
140732	611008	4T R-22 Expansion Valve	
140733	611009	5TR-22 Expansion Valve	
140734	611011	2T R-410A Expansion Valve	
140735	611012	3T R-410A Expansion Valve	
140736	611013	4T R-410A Expansion Valve	
134296	611064	3T R-410A To R-22 Conversion, Thermal Expansion Valve	
141976	61-103652-05	2T R-410A TX Expansion Valve	
236790	61-106238-37	5T TXV Expansion Valve	
131854	61-21922-46	1.5T R-22 TXV Expansion Valve	
105705	61-21922-47	2T R-22 TXV Expansion Valve	
249495	61-106238-34	2.5T TXV Expansion Valve	
131857	61-21922-50	4T R-22 TXV Expansion Valve	
105707	61-21922-82	2.5T R-22 TXV Expansion Valve	
105708	61-21922-83	3T R-22 TXV Expansion Valve	
105709	61-21922-84	4T R-22 TXV Expansion Valve	
105710	61-21922-85	5T R-22 TXV Expansion Valve	

Fan Blades

Fan Blade with Integral Hub



Part #	Mfg #	Diameter	Pitch	Rotation	# of Blades	Price
079832	70-21859-05	18"	28°	CCW	2	
123681	70-102033-05	18"	30°	CCW	3	
071438	70-20607-04	20"	27°	CCW	2	
107473	70-102011-06	20"	29°	CCW	3	
084834	70-21858-06	22"	21°	CCW	2	
009623	70-20608-01	22"	27°	CCW	2	
105796	70-102011-07	22"	35°	CCW	2	
107476	70-102011-09	24"	22°	CCW	2	
024245	70-19897-01	24"	22°	CCW	3	

Ruud Heating & AC Repair Parts

Fan Blades (Continued)
Fan Blade with Integral Hub

Part #	Mfg #	Diameter	Pitch	Rotation	# of Blades	Price
103769	70-100580-03	24"	22°	CCW	3	
123680	70-102011-03	24"	24°	CCW	2	
084787	70-26166-01	24"	24°	CCW	2	
096139	70-100580-04	24"	28°	CCW	3	
086771	70-23137-01	24"	19°	CCW	2	
117441	70-21858-17	24"	22°	CCW	3	
106241	70-21858-12	18"	27°	CCW	2	

Fan Center

- Terminals: W, G, Y, R, C
- 120V Primary voltage
- 24V Secondary voltage
- Transformer frequency: 50,60Hz
- Relay not included, SPDT configuration
- Relay coil voltage: 24V



Part #	Mfg #	Description	Price
009344	47-19807-04	Fan Center, 4-1/4" x 4-1/4"	

Gas Valves



Part #	Mfg #	Description	Price
009499	60-22174-02	Natural Gas Valve, 150,000 BTU/HR @ 1" WC Pressure Drop	
009501	60-22447-01	Natural Gas Valve, 150,000 BTU/HR @ 1" WC Pressure Drop	
067321	60-24215-03	Modulating Natural Gas Valve	
127859	60-24394-01	Natural Gas Valve, 150,000 BTU/HR @ 1" WC Pressure Drop	

Gas Control



Part #	Mfg #	Description	Price
132343	SP20166A	Gas Valve - Natural Gas	
129359	SP20166B	Gas Valve - Natural Gas	
128611	SP20166C	Gas Valve - Natural Gas	

Ruud Heating & AC Repair Parts

White-Rodgers 36G Gas Valve

- 140,000 BTUH Capacity @ 1"wc pressure drop
- Slow opening
- Hot Surface/ Direct Spark

60-24180-81



Part #	Mfg #	Description	Price
125567	60-24180-81	36G23-202E91 1/2" NG Hot Surface/Direct Spark 1-Stg 140,000	
143224	60-101921-81	36G55-521 1/2" NG Hot Surface/Direct Spark 2-Stg 140,000 BTUH Capacity	

White-Rodgers 36J Gas Valve

- Natural gas
- 140,000 BTUH Capacity @ 1"wc pressure drop
- 4-3/4"L x 2-3/8"W x 4-1/4"H



Part #	Mfg #	Description	Price
179394	60-103901-01	36J23-502 1/2" NG Hot Surface/Direct Spark 1-Stg 140,000 BTUH Capacity	

Honeywell VR8215S1313 Gas Valve

- Natural gas
- 150,000 BTU/HR Capacity @ 1"wc pressure drop
- 4-7/16"L x 2-3/4"W x 4-1/8"H
- Hot Surface/Direct Spark



Part #	Mfg #	Description	Price
172007	60-105055-01	VR8215S1313 1/2" NG Hot Surface/Direct Spark 1-Stg 150,000 BTU/HR Capacity	

Honeywell VR8304 Intermittent Pilot Dual Automatic Valve Combo Gas Control

- For use in 24VAC gas-fired, intermittent pilot with capacities from 30-415 cfh
- Includes all standard features plus:
 - Controls include 100% safety shut-off, manual valve, two automatic operators, pressure regulator & pilot adjustment
 - Standard & slow opening natural gas models include natural to LP gas conversion kits; LP to natural gas conversion kits are also available
 - All adjustments, wiring connections & pilot outlets are accessible from the top of control
 - Adjustable servo regulator
 - Compatible with ECO connector
 - On-Off lighting sequence
 - Use with S86F,H; S860D; S8600F,H; S8610 & S90A,B Control Modules
 - Single stage unless otherwise noted
 - Capacities based on 1" p.d. 30,000 BTUH minimum, 300,000 BTUH maximum

Honeywell



Part #	Mfg #	Description	Price
009498	60-21621-81	VR8304M3101 3/4" NG Pilot 1-Stg 270,000 BTUH Capacity	

Ruud Heating & AC Repair Parts

Gas Valve Spring Kit

Part #	Mfg #	Description	Price
009490	60-18759-07	Gas Valve Spring Kit	

Heat Cell

Part #	Mfg #	Description	Price
008940	AS-61164-83	Heat Cell - Aluminum	

Inducer Motors

Induced Draft Blower with Gasket



Part #	Mfg #	Description	Price
090631	70-101087-81	120V 1-Stg Sheet Metal Inducer Housing Right Side Discharge	
160013	70-104157-82	Induced Draft Blower Assembly with Gasket	
009627	70-21496-83	120V 1-Stg Polymeric Inducer Housing Left Side Discharge	
009632	70-22436-02	120V Induced Draft Blower w/ Gasket	
009635	70-24033-01	120V 1-Stg Polymeric Inducer Housing Right Side Discharge	
041979	70-24157-03	120V 1-Stg Cast Metal Inducer Housing Right Side Discharge	
027297	70-24206-01	120V 2-Stg Polymeric Inducer Housing Right Side Discharge	

1-Stage Draft Inducer Blower

- 115V 1-Speed
- For use with Rheem/Ruud gas furnaces models RGRK-07EMAES and UGRK-07EAMES



Part #	Mfg #	Description	Price
120707	703020	Draft Inducer Blower	
131722	70-24071-94	Draft Inducer Blower	

2-Stage Draft Inducer Blower

- 115V 2-Speed
- For use with Rheem/Ruud gas furnaces models RGRK-07EMAES and UGRK-07EAMES



Part #	Mfg #	Description	Price
136280	70-100612-03	Draft Inducer Blower	
139895	70-100612-81	Draft Inducer Blower	
139892	70-102691-81	Draft Inducer Blower	
139896	70-102814-81	Draft Inducer Blower	

Ruud Heating & AC Repair Parts

**Inducer Motors (Continued)
2-Stage Draft Inducer Blower**

Part #	Mfg #	Description	Price
139894	70-103086-01	Draft Inducer Blower	
145465	70-103597-01	Draft Inducer Blower	

Blower Assembly



Part #	Mfg #	Description	Price
015970	70-22165-81	Blower Assembly	
009631	70-22436-01	Blower Assembly	
137367	AP15109-1	Blower Assembly	

Vent Motor with Blades

- 208/230V, Nominal 3,000 rpm
- Includes centrifugal proving switch
- Mounting bolt pattern 4-1/4" x 4-1/4"
- Includes (3) fan blades (3", 3-1/2" and 4" diameter)



Part #	Mfg #	Description	Price
009414	51-21964-11	Vent Motor with Blades, 208/230V Nominal 3000 rpm	

Motor Mount



Part #	Mfg #	Description	Price
022307	562300109	Blower Motor Mount Kit For 48 Frame	
093274	AE-58384-81	Screw Mounting Kit, 5-5/8" 48 Frame Motors, 16" Nom Blower Mounting Bolt Circle Dia, (4) Arms	
041165	AE-61698-82	Screw Mntg Kit, 5-5/8" 48 Frame Motors, 14-13/16" Nom Blower Mntg Bolt Circle Dia, (4) Arms	
008936	AS-55306-02	Condenser Motor Plate Mount Kit	
223191	AS-55306-82	Condenser Motor Plate Kit	

Ruud Heating & AC Repair Parts

Limit Controls

Therm-O-Disc Temperature Limit Control Switch

36T Small Flanged Airstream - Manual Reset

- 120/230V maximum rating, 15/10A maximum current rating
- Enclosed disc face
- SPST Switching
- Normally closed
- 300° Open temperature



Part #	Mfg #	Temp Open	Tolerance Open	Color Code	Mounting Tube	Price
009391	47-22861-02	300°F	+/-14°F	Blue	5/32"	
160018	47-22861-04	250°F	+/-12°F	Red	5/32"	

36T Special Small Flanged Airstream - Manual Reset

- 120/230V Max rating, 15/10A Max current rating
- Enclosed disc face
- SPST Switching
- Normally closed
- 250° Open temperature



Part #	Mfg #	Temp Open	Tolerance Open	Color Code	Mounting Tube	Price
103688	47-22861-03	250°F	+/-12°F	--	3/16"	

74T Large Flanged Airstream - Auto Reset

- 230V Max rating, 25A Max current rating
- Enclosed disc face
- SPST Switching
- 3/8" Maximum mounting insertion depth



Part #	Mfg #	Description	Price
141499	47-25115-02	Open Temp: 135°F - 175°F; Close Temp: Open Temp Minus 40°F, 40° Nom Temp Difference	
141500	47-25115-03	Open Temp: 175°F - 215°F; Close Temp: Open Temp Minus 40°F, 40° Nom Temp Difference	

Limit Control Switch - Auto Reset - 69T Heat Assisted

- Normally closed
- Exposed disc face
- SPST Switch type



Part #	Mfg #	Description	Price
009388	47-22860-01	95°F Close Temperature Red	
009389	47-22860-02	100°F Close Temperature Blue	

Ruud Heating & AC Repair Parts

Limit Switch - Auto Reset 60T Series

- Normally closed
- Flanged airstream
- 1-Pole
- SPST Switch type
- Normally closed



Part #	Mfg #	Description	Price
160015	47-104465-01	95°F Close Temperature Yellow	

Limit Control Switch - Manual Reset - 36T

- Flanged Airstream



Part #	Mfg #	Description	Price
009375	47-22453-01	Normally Closed Enclosed Disc Face SPST	
009376	47-22453-02	Normally Closed Enclosed Disc Face SPST	
009390	47-22861-01	Normally Closed Exposed Disc Face SPST	
009393	47-22862-02	Normally Closed Blue Exposed Disc Face SPST	
009395	47-22862-04	Normally Closed Orange Enclosed Disc Face SPST	

Limit Switch/Defrost Sensor - Auto Reset

- Tube mount
- Moisture resistant
- SPST switch type
- 120/230



Part #	Mfg #	Description	Price
085224	47-23683-04	Close on Rise Wire Leads - 98" Wire Length	

Limit Control/Switch



Part #	Mfg #	Description	Price
009351	47-21663-01	Limit Switch	
009367	47-21900-05	Limit Control	
009368	47-21900-06	Limit Control	
009371	47-22383-13	Limit Switch	
026839	47-22383-33	Limit Control	

Ruud Heating & AC Repair Parts

Limit Control Switch - Auto Reset - 36T

- Enclosed disc face
- SPST Switch type
- Normally closed
- Board mount 90° strap angle



Part #	Mfg #	Description	Price
009356	47-21711-06	150°F Close Temperature	
009360	47-21711-10	150°F Close Temperature	
034226	47-25349-02	150°F Close Temperature Blue/Blue	
036843	47-25349-03	150°F Close Temperature Yellow/Yellow	
009361	47-21711-11	160°F Close Temperature	
038081	47-25349-01	160°F Close Temperature Red/Red	
038093	47-25349-05	180°F Close Temperature Orange/Orange	
038095	47-25350-07	180°F Close Temperature Green/Green	
034120	47-25350-01	190°F Close Temperature Red/Red	
009354	47-21711-04	200°F Close Temperature	
036657	47-25350-09	200°F Close Temperature Tan/Tan	
040953	47-25350-06	150°F Close Temperature Brown/Brown	
009403	47-24006-08	Limit Switch	
059560	47-25350-02	Limit Control	
050264	47-25350-04	Limit Control	
085327	47-25350-05	Limit Control	
145464	47-25350-12	Limit Control, 195°F Open	

**Motors
ECM Motor**



Part #	Mfg #	Description	Price
142897	51-102728-05	ECM Outdoor CA330R Motor	
169001	51-104304-28	1/2 hp Variable Speed ECM Motor	
166659	51-104306-01	Variable-Speed 1 hp Direct Drive ECM 48 Frame	
166319	51-104306-03	Variable Speed 1 hp Direct Drive ECM Motor	
166281	51-104306-24	1 hp ECM Motor	
166321	51-104306-25	1 hp ECM Motor	
137902	51-42534-24	1/3 hp Fan Motor	
145469	51-102602-01	1/2 hp Communicating Motor	
168216	51-104304-01	1/2 hp ECM Motor	
235420	51-102870-08	ECM (Outdoor) - Not Programmable	
249815	51-102870-07	ECM (Outdoor) - Not Programmable	
249817	51-105035-05	1/2 hp ECM (Outdoor) - Variable-Speed	

Ruud Heating & AC Repair Parts

Motors (Continued)

ECM Motor

Part #	Mfg #	Description	Price
162407	51-102603-01	3/4 hp ECM 3.0 -Variable Speed 120/230V 60Hz	
168784	51-104306-23	1 hp ECM (Eon) Variable Speed 120/230 50/60Hz	
166489	51-104304-27	1/2 hp ECM (Eon) Variable Speed 120/230 50/60Hz	

OEM Condenser Motor (208/230V)

- These motors are OEM replacements for Rheem, Ruud, and WeatherKing models; additionally they may be suitable for after market retrofit in many other applications
- Single speed, single phase



Part #	Mfg #	Description	Price
086497	51-100999-02	1/10 hp 825 rpm 208/230V Condenser Motor	
085274	51-100999-03	1/6 hp 1075 rpm 208/230V Condenser Motor	
086548	51-100999-04	1/5 hp 1075 rpm 208/230V Condenser Motor	
086549	51-100998-05	1/3 hp Condenser Motor	
113859	51-100998-13	1/3 hp 1075 rpm 208/230V Condenser Motor	
249816	51-101774-40	1/5 hp 825 rpm 208/230V Condenser Motor	
123683	51-102500-02	Sgl Speed, 1/6 hp 1075 rpm 208/230V CCW 3/370 Capacitor	
105406	51-102500-04	1/5 hp 825 rpm 208/230V Condenser Motor	
113905	51-102500-05	1/10 hp 825 rpm 208/230V Condenser Motor	
099184	51-42179-01	Sgl Speed, 1/3 hp 1075 rpm 208/230-1-60 CCW 10/370 Run Capacitor	
052997	51-42534-01	Sgl Speed, 1/3 hp 1075 rpm 208/220/230-1-50/60 CCW 10/370 Run Capacitor	

Condenser Motor



Part #	Mfg #	Description	Price
239191	51-100998-30	1/3 hp 1075 rpm 208-230V Single Speed Condenser Motor	

Condenser Fan Motor

- 60 Hz
- Single stage
- Sleeve bearing
- 825 rpm/ 1 speed
- Input voltage: 208-230
- Counter clockwise rotation

Part #	Mfg #	Description	Price
237994	51-101774-52	1/6 HP	

Ruud Heating & AC Repair Parts

Motors (Continued)

Condenser Fan Motor

Part #	Mfg #	Description	Price
052998	51-42534-02	1/3 HP	

Ruud Wholesale Condenser Motor (208/230V)



Part #	Mfg #	Description	Price
009426	51-23055-12	1/5 hp Direct Drive 230V 825 rpm	
009425	51-23055-11	1/5 hp Direct Drive 230V 1075 rpm	
133785	51-21853-11	1/2 hp 1075 rpm/1 speed	

Ruud Wholesale Condenser Motor (460V)



Part #	Mfg #	Description	Price
086789	51-23063-11	Sgl Speed, 1/3 hp 1075 rpm 460-1-60 Reversible 7.5/370 Capacitor	

Condenser Motor



Part #	Mfg #	Description	Price
132537	51-100998-08	1/8 hp Condenser Motor	
125111	51-102728-11	ECM Condenser	
125103	51-102728-12	ECM Condenser Fan Motor	
125112	51-102728-13	ECM Condenser	
236933	51-102728-24	ECM Condenser Motor	
125432	51-102870-01	ECM Condenser (Outdoor)	
125110	51-102870-03	Condenser Fan Motor	
236636	51-102870-09	Condenser Fan Motor	
140687	5464	1/6 - 1/3 hp 825 rpm 208/230V Emerson RESCUE Condenser Motor	
061734	51-21853-15	Condenser Motor - 1/3 hp 460/1/60	
140686	5462	1/3 to 1/6 hp 1075 rpm 208/230V RESCUE Condenser Motor	

Ruud Heating & AC Repair Parts

TripSaver Condenser Motor



Part #	Mfg #	Description	Price
009424	51-23053-21	1/3 / 1/5 hp Direct Drive 230V 1,075 rpm	
143484	51-103823-01	1 hp 230V X13 Motor	

OEM Indoor Blower Motor



Part #	Mfg #	Capacitor	HP	Volts	Amps	RPM/Speed	Rotation	Price
128889	51-103243-01	15mfd/370V	1/2 hp	120-1-60	8.00A	1,075/4	CCW	
042374	51-23679-01	10mfd/370V	1/2 hp	208/230	2.70A	1,075/3	CW	

Trip Saver Indoor Blower Motor



Part #	Mfg #	Description	Price
009422	51-23022-41	4-Speed 1/6-1/2 hp 1,075 rpm 208/230-1-60 REV 5/370, 7.5/370 or 10.370 Capacitor	

SelecTech Blower Motor

- Variable # of speeds
- One phase
- Direct drive
- Ball bearings
- Shell-band mounting

Part #	Mfg #	Description	Price
241742	51-104355-11	1/2 hp 120V 1 Phase	
241743	51-104355-12	1/2 hp 120V 1 Phase	
241744	51-104355-13	1/2 hp 120V 1 Phase	
241745	51-104357-04	1 hp 120V 1 Phase	
241746	51-104357-05	1 hp 120V 1 Phase	
241747	51-104357-06	1 hp 120V 1 Phase	
248652	51-104358-09	1/3 hp 208/230V 1 Phase	

Ruud Heating & AC Repair Parts

Motors (Continued)
SelecTech Blower Motor

Part #	Mfg #	Description	Price
248651	51-104359-01	1/2 hp 208/230V 1 Phase	

Blower Motor



Part #	Mfg #	Description	Price
100478	51-101879-01	1/3 hp 240V X-13 Blower Motor	
094848	51-101880-01	1/2 hp 208/230V 1-Phase X-13 Blower Motor	
113814	51-102497-01	3/4 hp 230V Variable Speed X-13 Blower Motor with Resilient Rotor	
113813	51-102497-02	3/4 hp 230V Variable Speed X-13 Blower Motor	
009418	51-23012-41	1/6 - 1/2 hp 1,075 rpm 120V 4-Speed Reversible Rotation Tripsaver™ Blower Motor	
028318	51-23017-42	1/4 - 3/4 hp 1,075 rpm 120V Indoor Blower Motor	
016108	51-24070-02	1/2 hp Indoor Blower Motor 120V 1,075 rpm	
024237	51-23555-02	Blower Motor - 3/4 hp 208/230/1/60	
124801	51-21898-01	3/4 hp 208-230/1 V 1075 rpm	
038103	51-23102-08	1/2hp Dir Dr 208-230V 825 rpm	
160026	51-104342-01	3/4 hp 120/1/60 (1075 rpm/4 Speed)	

Motor

Part #	Mfg #	Description	Price
009420	51-23015-91	1/5 hp 120/1/60 1075 rpm 3-Speed	
141494	51-23027-31	Blower Motor 3-Speed 230V 3/4 hp	
145470	51-102605-01	1 hp 120/230V ECM Motor	
127336	51-24374-27	1/2 hp ECM Blower Motor	
125741	51-24374-28	1/2 hp ECM Blower Motor	
052874	51-24376-03	Motor w/ICM Module (Modulating Furnace)	
078007	51-24382-81	1/2 hp ECM Module	

Motor Mounting Kit

Part #	Mfg #	Description	Price
125546	70-24104-82	Motor Mounting Kit	

Ruud Heating & AC Repair Parts

Relay's

Control Relay

Sealed Case (SPDT) Control Relay



Part #	Mfg #	Contact Bias	Coil Volts	FLA @120V	FLA @230V	LRA @120V	LRA @230V	Price
009290	42-25104-06	NO/NC	24V	14	8	84	48	

Relay - DPTD



Part #	Mfg #	Contact Bias	Coil Volts	FLA @120V	FLA @230V	LRA @120V	LRA @230V	Price
009222	42-18287-12	NO/NC (2)	24V	12	6	60	35	

Open Coil (DPDT) Control Relay



Part #	Mfg #	Contact Bias	Coil Volts	FLA @120V	FLA @230V	LRA @120V	LRA @230V	Price
027431	42-25106-01	NO/NC (2)	24V	13.8	6.9	82.8	41.4	

Control Relay - Small Sealed Case (SPDT)



Part #	Mfg #	Contact Bias	Coil Volts	FLA @277V	LRA @230V	LRA @277V	Price
117427	42-23114-06	NO/NC	24V	20NO, 10NC	60NO, 33NC	60NO, 33NC	

Ruud Heating & AC Repair Parts

Time Delay Relay



Part #	Mfg #	Time Delay Adj.	Make Time Delay	Voltage Rating	Current Rating Steady State	Current Rating Inrush	Price
042350	42-ICM102	Variable	.03 - 10 Min	18-230 VAC	1.5	15	

Time Delay Relay



Part #	Mfg #	Time Delay Adj.	Break Time Delay	Voltage Rating	Current Rating Steady State	Current Rating Inrush	Price
121707	47-23433-93	Fixed	.17 Min	18-30 VAC	1	10	

Timer Delay



Part #	Mfg #	Time Delay Adj.	Break Time Delay	Voltage Rating	Current Rating Steady State	Current Rating Inrush	Price
092118	42-ICM	Variable	.17 -16.6 Min	18-230 VAC	1	10	
042351	42-ICM203	Variable	.03 - 10 Min	18-230 VAC	1.5	15	

Time Delay Relay - On Delay On Break (Anti-Short Cycle)



42-22655-02

Part #	Mfg #	Time Delay Adj.	Break Time Delay	Voltage Rating	Current Rating Steady State	Current Rating Inrush	Price
044912	42-22655-02	Fixed	5 Min	18-30 VAC	1.5	-	
047231	42-22655-03	Fixed	.5 Min	18-30 VAC	1.5	-	

Ruud Heating & AC Repair Parts

Sequencers

Sequencer

24V Angle Bracket with (2) Mounting Holes Sequencer

- DPST-NO



Part #	Mfg #	Poles	Sequencing Off	Sequencing On	Switching	Price
050196	42-23116-08	2	10 - 30	30 - 60	DPST NO	
034057	42-23116-06	2	10 - 40/30 - 160	90 - 160/30 - 60	DPST-NO	
052164	42-23116-09	3	10 - 30	90 - 150/30 - 60	TPST NO	

Sequencing Relay

- Flush mount plate w/ mounting hole & tab
- 1/4" Quick connects
- Heater Wattage/ Power Consumption:
24 VAC/.10A-.18A steady state/.35 - 1.0 amps peak for 0.8 sec



Part #	Mfg #	Poles	Sequencing Off	Sequencing On	Switching	Price
137087	PD425078	2	30 - 60	1 - 30	DPST-NO	
185861	425079	2	1 - 30	30 - 60	DPST-NO	
020492	42-23116-07	3	30-60	10-30	TPST - NO	

Service Valves

Service Valve

- Front seating valves, isolate sections of a system for servicing and provide a means for refrigerant charging
- All brass corrosion resistant body and solid copper fittings
- Includes 1/4 Flare SAE charge port; communicates with lower fitting when in closed position
- Suitable for R-22 and R-410A, 600 psig maximum working pressure



Part #	Mfg #	Connect	OPP Connect	OAL	Charge Port Location	Price
085196	61-21368-13	3/8" Sweat ODF	3/8" Sweat ODF	4-5/8"	Side	
101321	61-21368-07	3/4" Sweat ODF	3/4" Sweat ODF	5"	Bottom	
096123	61-21368-15	7/8" Sweat ODF	7/8" Sweat ODF	5"	Side	
083261	61-21368-16	7/8" Sweat ODF	3/4" Sweat ODF	5-1/8"	Side	

Service Valve



Part #	Mfg #	Description	Price
143354	83-CD8403-6PK	3/16" OD Service Valve	

Ruud Heating & AC Repair Parts

Miscellaneous

Remote Sensor for 90 Series®

- Digital signal output provides superior temperature control, even over long wire runs
- No temperature variance caused by wire resistance
- Choice of styling, indoor models are interchangeable
- Perfect for securing the thermostat in one area or room while sensing temperature in the conditioned space



Part #	Mfg #	Color	Dimensions	Model	Range	Price
102316	F145-1328	Classic White	2-1/8" x 3-1/2" x 3/4"	Indoor	40° to 99°F All Indoor Remote	
101726	F145-1378	Classic White	2-1/8" x 3-1/2" x 3/4"	Outdoor	-40° to 140°F	

Mixed Air Sensor

Part #	Mfg #	Description	Price
076571	470010	Mixed Air Sensor	

Logic Module

Part #	Mfg #	Description	Price
143968	PD470009	Demand Control Ventilation Economizer Logic Module with Heat Pump Input	

Start Kit

- 330 VAC
- 60Hz



Part #	Mfg #	Description	Price
173840	SK-A1	Compatible with RA13, RA14, RA16, RP14, RP15, UA17, & RJMA Units	

ECM Motor Repair Kit



Part #	Mfg #	Description	Price
176875	VZREP	ECM Motor Repair Kit	

Ruud Heating & AC Repair Parts

Pressure Switches

Pressure Control

Low Pressure Control - Auto Reset



Part #	Mfg #	Description	Price
150872	47-101529-09	50 psig Open Pressure 5/16" Sweat Connection, 90° Elbow End	
249818	47-103670-02	50 psig Open Pressure	
249819	47-103670-04	50 psig Open Pressure	

High Pressure Control - Auto Reset



Part #	Mfg #	Description	Price
113929	47-26184-01	610 psig Open Pressure 420 psig Close, 1/4" Swt Connection, Straight Fitting	
163457	47-102290-01	610 psig Open Pressure 420 psig Close	
176655	47-102240-02	15 psig Open Pressure 40 psig close pressure	

High Pressure Control - Manual Reset



Part #	Mfg #	Description	Price
177684	47-102431-03	655 psig Open Pressure	
176510	47-23699-03	610 psig Open Pressure	
031417	47-21604-03	Pressure Switch	

Low Pressure Limit - Auto Reset



Part #	Mfg #	Description	Price
178391	47-102240-03	50 psig Open Pressure	
141506	47-103670-06	Low Pressure Control	

Pressure Control Switch



Part #	Mfg #	Description	Price
161588	42-101225-81	Pressure Switch	
091197	42-101233-81	Pressure Control	
091198	42-101443-89	Pressure Control, 0.45" WC	
091200	42-101443-91	Pressure Control, 0.60" WC	
091311	42-101444-83	Pressure Control, 1.00" WC	
091438	42-101445-83	Pressure Control, 0.40" WC	
083509	42-101447-07	Pressure Control	
098938	42-101447-86	Pressure Control, 1.80" WC	
107479	42-101447-89	Pressure Control, 1.95" WC	
091542	42-101511-84	Pressure Control	
128891	42-101955-02	Pressure Switch for RGRC034T 074T 105T	
137097	42-101955-08	Pressure Switch for RGRC Drain	
109677	42-101956-09	Pressure Switch for RGRC RGTC Vent	
109679	42-101956-10	Pressure Control, 1.20" WC	
128890	42-101956-12	Pressure Switch for RGRC Vent	
107812	42-102056-01	Dual Pressure Control, -0.80" & -1.30" WC	
112161	42-102056-02	Dual Pressure Control, -0.60" & -1.08" WC	
107814	42-102056-03	Dual Pressure Control, -0.86" & -1.20" WC	
125747	42-102056-05	Dual Pressure Control, -0.40" & -0.60" WC	
107813	42-102056-06	Dual Pressure Control, -0.66" & -1.30" WC	
123676	42-102056-13	Dual Pressure Control, -0.30" & -0.50" WC	
136527	42-102056-22	Dual Pressure Control, -0.40" & -0.30" WC	
145463	42-102056-25	Dual Pressure Control	
145462	42-102056-26	Dual Pressure Control	
145461	42-102056-27	Dual Pressure Control	
145460	42-102056-28	Dual Pressure Control	
160008	42-102069-01	Pressure Switch Assembly	
162412	42-102069-06	Pressure Switch Assembly	
162413	42-102070-14	Pressure Switch Assembly	
162414	42-102070-18	Pressure Switch Assembly	
127334	42-103193-01	Dual Pressure Control	

Ruud Heating & AC Repair Parts

Pressure Switches (Continued)

**Low Pressure Limit - Auto Reset
Pressure Control Switch**

Part #	Mfg #	Description	Price
186615	42-105601-10	Pressure Switch Assembly 5	
089690	42-24194-01	Pressure Switch	
091194	42-24194-82	Pressure Control	
080580	42-24195-03	Pressure Control, for UGRA UGFD 90RS 90RT	
135420	42-24195-81	Pressure Control, 0.50" WC	
080915	42-24196-81	Pressure Control, For UGRA UGFD 90RS	
083251	42-24196-82	Pressure Control	
083259	42-24196-83	Pressure Control	
081061	42-24196-84	Pressure Control	
082670	42-24197-01	Dual Pressure Control, -0.80" & -1.30" WC	
138441	SP20313	Pressure Switch	
162415	42-102070-05	Pressure Switch	

Ignition Controls & Other Boards

Control Boards

Part #	Mfg #	Description	Price
247921	47-105221-01	Power Inverter - 3.7 kW	
249670	47-105369-02	Control Board - EEV	
249814	47-105395-02	Control Board - EcoNet	
129524	47-100436-02	Control Board for X-13 Motor	
115784	47-102090-82	Control Board for UARL	
163875	47-102090-93	Control Board Kit - Communicating	
186557	47-102077-03	Control Board - ECM	
129219	62-102635-81	Control Board	
110554	62-102636-01	Integrated Furnace Control Board	
133313	62-102860-01	Integrated Control Board	
127527	62-103189-01	Integrated Furnace Control Board	
145473	62-103565-01	Integrated Furnace Control Board	
145475	62-103578-01	Inducer Control Board	
160036	62-104058-02	Integrated Furnace Control Board	
162408	62-104059-01	Integrated Furnace Control Board	

**Ignition Controls & Other Boards
(Continued)**

Control Boards

Part #	Mfg #	Description	Price
241754	62-104061-04	Integrated Furnace Control Board	
222724	62-105217-01	Integrated Furnace Control Board	
241741	62-106321-01	Integrated Furnace Control Board	
150560	62-23599-05	Integrated Furnace Control Board	
081759	62-24140-04	Integrated Furnace Control Board Direct Spark	
093116	62-24174-02	Modulating Control Board	
082900	62-24268-03	Hot Surface Igniter and Integrated Furnace Control	
115091	62-25338-01	Control Board	
071437	62-42506-02	Integrated Furnace Control Board	
033177	62-25341-81	Integrated Furnace Control Board	

Fan Control Board



47-22827-83

Part #	Mfg #	Description	Price
009374	47-22445-01	Fan Control Board	
009386	47-22827-83	Fan Control Board	
009378	47-22481-81	Fan Control Board	

Ignition Module



Part #	Mfg #	Description	Price
127446	620044	5059-134 Ignition Module White-Rodgers 24V Intermittent Pilot Ignition	

Ruud Heating & AC Repair Parts

Ignition Control



Part #	Mfg #	Description	Price
086472	62-24181-01	Ignition Control/Direct Spark Ignition	
053123	62-25078-02	Ignition Control	
009561	62-22578-01	Ignition Control Module - HSI	

Flame Sensor



Part #	Mfg #	Description	Price
009582	62-23543-01	Flame Sensor Rod, 2-1/2"L Mnt Flg to Sensor Tip 1-9/16"L Sensor Offset 90° Angle Sensor Offset	
051177	62-23543-02	Flame Sensor Rod, 2-1/16"L Mnt Flg to Sensor Tip 1-13/16"L Sensor Offset 90° Angle Sensor	
128886	62-23543-06	Flame Sensor	
036437	62-24044-71	Non-Integrated w/ Mnt Brackets for Ribbon & Inshot Style Burners & 62-23543-01 Igniter	
141681	SP15129	Flame Sensor with Gasket and Mounting Screw	
144183	SP20172	Flammable Vapor Sensor Kit with Cap Plug	

Ignitors & Flame Sensors

Igniters



Part #	Mfg #	Description	Price
145476	62-103541-01	Hot Surface Igniter	
009550	62-21747-02	Igniter	
009563	62-22669-92	Igniter	
009574	62-22868-93	Igniter	
051183	62-23556-03	Igniter	
137901	62-23556-08	Direct Spark Igniter	
137712	62-23556-10	Igniter	
119752	62-23556-82	Igniter	
051711	62-24141-04	Direct Spark Ignition (DSI)	
160039	62-24141-05	Direct Spark Ignition (DSI)	
042260	62-24164-01	Direct Spark Ignition (DSI)	
166512	SP20794	NG Igniter with Gasket and Mounting Screws	

Heat Exchangers

Heat Exchanger



Primary

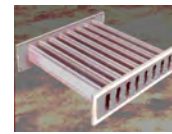

Secondary



Turbulux

Part #	Mfg #	Description	Price
142996	AS-59066-89	Heat Exchanger	
142994	AS-59066-90	Heat Exchanger	
092267	AS-61805-16	Heat Exchanger Assembly	
083250	AS-61805-18	Heat Exchanger	
083242	AS-61805-17	Heat Exchanger Assembly	
110398	AS-61805-20	Heat Exchanger Assembly	
093422	AS-61849-16	Heat Exchanger	

Transformer



Part #	Mfg #	Description	Price
160017	46-24124-06	Transformer 120V	

Discharge Air Sensor



Part #	Mfg #	Description	Price
154552	470023	Discharge Air Sensor	

Traps & Connectors

Vent Transition

Part #	Mfg #	Description	Price
080464	68-24047-10	Vent Transition	

Ruud Heating & AC Repair Parts

Condensate Trap Assembly



Part #	Mfg #	Description	Price
009615	68-24048-01	Condensate Trap Assembly	
080873	68-100651-01	Trap Assembly for UGRK	
021617	68-24021-01	Pipe-Outlet Air	
160002	68-104346-01	Condensate Drain	

Vent Termination Kit

• For gas furnace

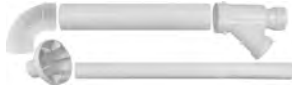

Part #	Mfg #	Description	Price
135776	SP20245	Concentric Vent Termination Kit for 3" PVC	

Connection/Transition

Part #	Mfg #	Description	Price
025662	68-24047-08	Connection/Transition	
125740	68-103061-01	Connection/Transition Assy	

Trap



Part #	Mfg #	Description	Price
020322	68-24120-01	Horizontal Trap	

Trap Assembly Connector

Part #	Mfg #	Description	Price
022339	68-24047-07	Trap Assembly Connector	
022340	68-24047-09	Trap Assembly Connector	

Furnace Accessories

Gas Valve Conversion Kit

Part #	Mfg #	Description	Price
031644	60-21193-02	White Rodgers 36E Series LP to Natural Gas Kit	
166053	60-22513-04	Honeywell VR8205 Series Natural Gas to LP	
031639	60-23430-03	Robertshaw 7200 Series LP to Natural Gas Kit	
243423	EP-94D	LP Conversion Kit	
058453	FP-15	Conversion Kit NAT/LPG	
151024	FP-31	HK LP Conversion Kit	
158962	FP-33	JC LP Conversion Kit for 1-Stage	
158963	FP-34	LP Conversion Kit for 2-Stage	
235100	FP-38	LP Conversion Kit for 1-Stage	
185112	FP-37	LP Conversion Kit	
158961	RXGY-ZK	Zero Clearance Downflow Conversion Kit	

Filter Cores

Filter Core

Part #	Mfg #	Description	Price
149940	83-F48	Filter Core	
149943	83-H48	Filter Core	

Drier Core

Part #	Mfg #	Description	Price
149941	83-W48	Drier Core	
149942	83-W100	Drier Core	

Solid Furnace Bottoms



Part #	Mfg #	Description	Price
073627	AE-61874-01	AE-61874-01 Solid Bottom 14"	
022627	AE-61874-02	AE-61874-02 Solid Bottom 17"	
022628	AE-61874-03	AE-61874-03 Solid Bottom 21"	

Ruud Heating & AC Repair Parts

Solid Furnace Bottoms (Continued)

Part #	Mfg #	Description	Price
073628	AE-61874-04	AE-61874-04 Solid Bottom 24"	

Pilots & Orifices

Orifice



Part #	Mfg #	Description	Price
049438	62-22175-50	Orifice	

Pilot



Part #	Mfg #	Description	Price
009572	62-22864-82	Pilot	

Pilot Burner



Part #	Mfg #	Description	Price
038148	62-21609-01	Pilot Burner	

Pilot Orifice



Part #	Mfg #	Description	Price
009543	62-21489-01	Pilot Orifice	
009545	62-21612-02	Pilot Orifice	
009548	62-21743-05	Pilot Orifice	
009552	62-21883-01	Pilot Orifice	

Pilot Safety



Part #	Mfg #	Description	Price
009540	62-21426-02	Pilot Safety	

Pilot Sensor



Part #	Mfg #	Description	Price
009549	62-21744-01	Pilot Sensor	
160037	62-23543-08	Flame Sensor	

Drain Pans

Drain Pan



Part #	Mfg #	Description	Price
229624	68-101805-81	14" 4-Row Drain Pan	
159621	68-101805-82	17" Drain Pan Vertical 6 Row	

Door Switches

Door Switch



42-21268-04

Part #	Mfg #	Description	Price
050499	42-21268-04	Door Switch	
123748	42-22692-06	Push Button Door Switch	
125543	42-22692-09	Door Switch	
160012	42-22692-10	Door Switch	

Burners

Part #	Mfg #	Description	Price
035443	75-22840-02	Burner Tube - Inshot	
028110	75-24001-01	Burner Tube - Inshot	
028110	75-24001-01	Burner Head Kit	
061420	AS-60993-03	Burner Halves Assembly	
103698	AS-60993-06	Burner	
043357	AS-61984-04	UGRA 1-Pc Burner	
043358	AS-61984-05	UGRA 1-Pc Burner	
043359	AS-61984-06	UGRA 1-Pc Burner	
043360	AS-61984-07	UGRA 1-Pc Burner	
043361	AS-61984-08	UGRA 1-Pc Burner	

Ruud Heating & AC Repair Parts

Burner Support

Part #	Mfg #	Description	Price
111992	AE-61809-15	Burner Support	
109627	AE-61809-12	Burner Support	

Anti-Vibration Pads

EVA Anti-Vibration Pad

- 2"x2"x7/8"

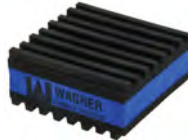

Part #	Mfg #	Description	Price
156821	864011	2"x2" Anti-Vibration Pad	
156822	864013	4"x4" Anti-Vibration Pad	

Miscellaneous

Water Sensor



Part #	Mfg #	Description	Price
160034	47-104184-01	Water Sensor	

Jumper Kit

Part #	Mfg #	Description	Price
101893	RXBJ-A21	Jumper Kit	

Blower Parts

Part #	Mfg #	Description	Price
102437	70-42540-04	1" Shaft	

Choke



Part #	Mfg #	Description	Price
052335	46-24256-02	Power Factor Choke	

Tubing



Part #	Mfg #	Description	Price
020713	79-21491-83	Silicone Tubing	
162989	79-24182-83	Santoprene Tubing, 31-1/2"L, 2 Hose Clamps	
173578	79-21491-93	Silicone Tubing, 120"	

Sheath Heater Kit

Part #	Mfg #	Description	Price
037996	AS-58386-92	Sheath Heater Kit 3.5kW	

Solenoid Assembly

Part #	Mfg #	Description	Price
044160	61-25055-08	24V Solenoid Assembly	

Bearing



Part #	Mfg #	Description	Price
097430	70-41854-02	Ball Bearing With Lock	

OEM Neoprene Gasket

- Suitable for temperature range of -70° to 250°F
- Meets UL94HFI and UL94HBF flammability tests



Part #	Mfg #	Description	Price
059148	68-22079-81	1-1/8"W 25'L 5/16" Thick	

ShuBee Shoe Covers

- Waterproof
- Box of 40 pairs



Part #	Mfg #	Color	Price
166026	849120	Dark Blue	

Ruud Heating & AC Repair Parts

Novent R410 Locking Cap

- 50 Pack
- Tamper resisant

Part #	Mfg #	Size	Color	Price
209945	86683	1/4" Thread	Pink	

Replacement Parts and Accessories

Part #	Mfg #	Description	Price
111991	AE-61913-02	Overtemperature Switch Bracket	
145536	SP14410	Piezo Igniter with Bracket	
160006	68-104446-01	Parts Bag	
162200	45-22980-05	Button Plug	
107681	1000	FAST-STAT Wire Extender	
161388	AS-58922-01	Turbulator	
168203	6231	Cold Weather Kit - GEN15ADC-E, GEN16AD-E, GEN20AD-E	
180506	630500	SMART Flow Elbow	
230606	RXGY-J02	Sensor Kit - Outdoor	
047567	68-24022-02	Gasket - Outlet Air	



Ruud Heating & AC Repair Parts

Ruud Accessories

Expansion Valve Kit (TXV)



Part #	Mfg #	Description	Price
236848	PD619062	TXV, R-22 Refrigerant	

RXCT - Expansion Valve Conversion Kit

- Use to convert RCBA indoor coils to RCGA/RCGJ/RCHA and RCHJ coils



Part #	Mfg #	Description	Price
132107	RXCT-FBA	R410 Universal TXV Repl Kit	
133834	RXCT-EBA	TXV R22 Universal 2 Ton	
132108	RXCT-FBB	R410 Univ TXV Repl Kit	
132109	RXCT-FBC	Expansion Valve Kit	
132110	RXCT-FBD	TXV Universal Kit	

Controls

Part #	Mfg #	Description	Price
173851	RXAB-A07	High Pressure Control	
173850	RXAC-A07	Low Pressure Control	
130488	RXRZ-C02	Low Ambient Control	

RXGF - Media Air Cleaner



RXGF-CB



RXGF-CC



RXGF-CD

Part #	Mfg #	Outside Dimensions	Price
132422	RXGF-CB	Bottom Mount 24-1/4"W x 28-1/4"L x 3-1/2"H	
020727	RXGF-CC	Top Mount Filter Rack - Gas Downflow	
158964	RXGF-CD	Side Return Filter Rack - Gas Upflow	

External Filter Rack

- Upflow - Electric
- Duct configuration: Through
- Air opening inlet/outlet: 15-3/4" x 19-1/2"
- Housing overall: 17-1/2" x 21" x 3-5/8"
- Hinged door - opening on 17-1/2" side
- Replacement media dimensions: 16" x 20"



Part #	Mfg #	Description	Price
147301	RXHF-17	External Filter Rack - Electric Upflow	
158306	RXHF-21	External Filter Rack - Electric Upflow	

RXMG - Label Kit

Part #	Mfg #	Description	Price
105390	RXMG-AU	Ruud Label Kit	
127216	RXMG-AY	WeatherKing Label Kit	

RXBH - Heater Kit

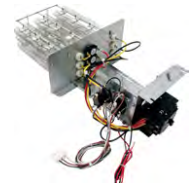

Part #	Mfg #	Description	Price
133645	RXBH-1724A18J	18kW 208-230/1/60	
133870	RXBH-1724A13J	12kW 208-230/1/60	

Repair & Replacement Parts

Part #	Mfg #	Description	Price
236864	43-25136-21	4/440 Sngle Rnd Capacitor	

Drain Trap

Part #	Mfg #	Description	Price
125544	791000	Tube Drain Trap	
125548	791001	Tube Drain Trap	



Ruud Heating & AC Repair Parts

Gas Valve



Part #	Mfg #	Description	Price
009506	60-22525-03	Gas Valve	
009507	60-22525-04	Gas Valve	
236634	60-102787-85	Gas Valve	
009508	60-22525-05	Gas Valve	

36J Series Gas Valve

- Natural gas
- 1/2" NPT
- Hot surface/direct spark



Part #	Mfg #	Description	Price
175965	60-103901-02	36J Series White Rodgers	

Induced Draft Blower with Gasket

- Polymeric
- 460V
- 60Hz



Part #	Mfg #	Side of Discharge	Price
241412	70-42242-01	Left	

Ignition Control



Part #	Mfg #	Description	Price
034342	62-24084-82	Ignition Control Board	

Igniter



Part #	Mfg #	Description	Price
137361	AP14698B	NG Igniter Assembly	
137360	AP14700B	LP Igniter Assembly	

Pressure Switches

Part #	Mfg #	Description	Price
240688	42-105499-07	Pressure Switch	
240687	42-105499-09	Pressure Switch	
239326	42-105583-04	Pressure Switch	
239320	42-105583-08	Pressure Switch	
240689	42-105583-11	Pressure Switch	
240690	42-105583-12	Pressure Switch	

Vent Damper



Part #	Mfg #	Description	Price
145411	AP15561	Vent Damper	



Furnace Accessories

Ruud Furnace Accessories

Integrated Furnace Control Board

- IFC



Part #	Mfg #	Description	Price
155291	62-102636-81	Integrated Control Board	
246259	62-105563-02	Integrated Control Board	

Low Ambient Control

- Auto reset
- Low pressure limit
- Open pressure: 150 psig
- Close pressure: 275 psig
- Includes 36" capillary tube
- 1/4" Flare (Female SAE) connection size



Part #	Mfg #	Description	Price
090119	47-25343-82	Low Ambient Control	

RXGP - Twinning Kit

Part #	Mfg #	Description	Price
138545	RXGP-F03	For Use w/Gas Furnaces for Parallel Operations	

ERV/HRV - Vent Termination Kit

Part #	Mfg #	Description	Price
155994	84-ERVHRV	HEPA Vent Termination	

RXGY - Vent Termination Kit

- For gas furnace

Part #	Mfg #	Description	Price
087666	RXGY-G01	Horizontal Vent Termination for 3" PVC	
097398	RXGY-G02	Horizontal Vent Termination for 2" PVC	

Conversion Kits

Part #	Mfg #	Description	Price
158960	RXGY-CK	Downflow/Horizontal Conversion Kit	

RXPF - Fossil Fuel Kit

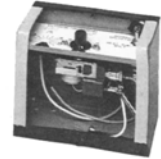

Part #	Mfg #	Description	Price
032692	RXPF-F01	Fossil Fuel Kit - Standard	

RXRY - Filter Kit

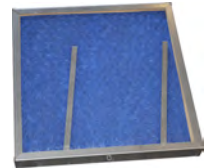

Part #	Mfg #	Description	Price
085898	RXRY-B01	For Vertical or Horizontal Discharge in RQKA & RQMA	

Furnace Repair & Replacement Parts

Part #	Mfg #	Description	Price
074120	60-21193-01	Gas Valve Spring Kit White-Rodgers F92-0659	
083260	60-22513-03	Gas Valve Spring Kit Honeywell 396221-2	
031641	60-23430-01	Gas Valve Spring Kit Honeywell 394588	

Conversion Kit - NG - LP

Part #	Mfg #	Description	Price
025489	FP-02	Nat-LP Conversion Kit	
058453	FP-15	Nat-LP Conversion Kit	
100705	FP-21	Nat-LP Conversion Kit	
121685	FP-26	Nat-LP Conversion Kit	
129578	FP-27	Nat-LP Conversion Kit	

Enthalpy Sensor

- Direct replacement for 470008



Part #	Mfg #	Description	Price
124299	470011	Enthalpy Sensor	

Ruud Heating & AC Repair Parts

Motors

Motor Mount - Flex Bracket

- Torsion flex bracket



Part #	Mfg #	Description	Price
198041	DMB-1	Fits 5-1/2" Diameter Motors	
139342	DMB-3	Fits 5-1/2" Diameter Motors	

Multiple Horsepower Blower Motor

- Reversing plugs
- Extended thru bolts
- 36 inch leads
- Designed for 370 volt capacitors.
- Installs with all 48 mounting brackets.



Part #	Mfg #	Description	Price
198034	WG840463	1/6-1/2 HP-FLA 115V Blower Motor	
198035	WG840464	1/6-1/2 HP-FLA 208-230V Blower Motor	
198036	WG840466	1/5-3/4 HP-FLA 115V Blower Motor	
198037	WG840467	1/5-3/4 HP-FLA 208-230V Blower Motor	

Multiple Horsepower Condenser Fan Motors

- Reversing plugs
- Extended thru bolts
- 36 inch leads
- Designed for 370 volt capacitors
- Installs with all 48 frame mounting brackets.



Part #	Mfg #	Description	Price
198038	WG840465	1/6-1/3 HP-FLA 208-230V Condenser Fan Motor	
198039	WG840468	1/5-1/2 HP-FLA 208-230V Condenser Fan Motor	
198040	WG840469	1/6-1/2 HP-FLA 208-230V Condenser Fan Motor	

Direct Drive Furnace Blower Motors

- Installed with standard 48 frame mounting brackets
- Quiet operator and electrically reversible
- Automatic Thermal Overload Protector
- Class B insulation
- 30in. leads and 60 HZ with low power consumption
- Standard 48 frame motor casing size
- Drain holes with plugs on both end plates
- Continuous air over
- 60 C Ambient Design with Extended Studs.



Part #	Mfg #	Description	Price
198021	WG840583	1/4 HP 4.6 FLA 115V Blower Motor	
198022	WG840584	1/4 HP 2.2FLA 208/230V Blower Motor	
198023	WG840585	1/3 HP 6.7 FLA 115V Blower Motor	
198024	WG840586	1/3 HP 2.9 FLA 208/230V Blower Motor	
198025	WG840587	1/2 HP 10.2 FLA 115V Blower Motor	
198026	WG840588	1/2 HP 5.0 FLA 208/230V Blower Motor	
198027	WG840589	3/4 HP 11.3 FLA 115V Blower Motor	
198028	WG840590	3/4 HP 5.4 FLA 208/230V Blower Motor	
206600	WG840595	1HP 12.6 FLA 115V Blower Motor	

Ruud Heating & AC Repair Parts

Single Speed Condenser Fan Motors

- *Installs with all standard 48 frame mounting brackets*
- *Quiet operator and electrically reversible*
- *Includes Automatic Thermal Overload Protector*
- *Class B insulation*
- *370V Capacitor*
- *Standard 48 frame motor casing size*
- *2.5in. diameter hub rings included.*



Part #	Mfg #	Description	Price
198029	WG840727	1/6 HP 1.3 FLA 208/230V Condenser Fan Motor	
198030	WG840728	1/4 HP 2.2 FLA 208/230V Condenser Fan Motor	
198031	WG840729	1/3 HP 2.8 FLA 208/230V Condenser Fan Motor	
198032	WG840730	1/2 HP 4.2 FLA 208/230V Condenser Fan Motor	
198033	WG840731	3/4 HP 4.5 FLA 208/230V Condenser Fan Motor	



Repair Parts

Faucet Parts

Crown-Rinse Spray Head

Part #	Mfg #	Description	Price
257337	1654005	Chrome	
190767	1654000	Black	
190768	1656000	Black w/ Hose Assembly	

Basin Rosettes



Part #	Mfg #	Description	Price
254325	1646002	Flat	
254327	1646004	Deep	

Misc. Parts

4-Way Sillcock Key

- Fits stems 1/4", 9/32", 5/16" and 11/32"



Part #	Mfg #	Description	Price
252717	0421004	Fits stems 1/4", 9/32", 5/16" and 11/32"	

Moen Cartridge Removal Tool

- An alternative to the gold key pattern for removal of plastic and brass Moen cartridges



Part #	Mfg #	Description	Price
054583	1849001	T-Handle	

Washing Machine Hose

- 3/8" ID
- Double female



Part #	Mfg #	Description	Price
085189	0802004	3/4" FHT x 5'	

Black & White Graphite Packing Spools

- Non-asbestos
- Reclosable spool

Part #	Mfg #	Description	Price
045476	1900002	1/4", 8ft roll	

Wall-Hung Toilet Carrier Cap

- Each bag contains 4 nuts & 4 washers



Part #	Mfg #	Description	Price
125755	2405002	Standard	

Test Plugs and Balls

Drain-King® Drain Cleaner



Part #	Mfg #	Description	Price
046572	1821002	1-1/2" - 3"	

Water Right Repair Parts

Installation Fittings

Part #	Mfg #	Description	Price
126558	CV-3007	1" PVC Male NPT 90° Assembly	
066030	CV-3007-02	1" Brass Sweat Assembly	
066031	CV-3007-03	3/4" Brass Sweat Assembly	
134871	CV-3007-12	3/4" Shark Bite Assembly	
129386	CV-3150	Split Ring	
121817	CV-3005-2	Spacer Stack Assembly	

Replacement Parts

Part #	Mfg #	Description	Price
075129	CH1072-01	18" dia Salt Grid with 4" Hole	
073577	FP-60049	Plastic Bypass Assembly	
074255	CS-1448-RS	35 gal Replacement Membrane for WRO035	

Accessories

Part #	Mfg #	Description	Price
101608	HT-5B	Water-Right Hardness Kit	
113671	FP60066	Brine Valve Water-Right	
148693	CU7002	Water Sample Bottle	
150670	RO12N	1.5# Softener Rust Out	
099934	VA-2	Better Air Gap	
192000	M-G20	W-R Gravel Per 1# Bag	



Watts Regulator Repair Parts

Dielectric Union Kits

3000 Series Dielectric Union Gasket Kit

Part #	Mfg #	Model	Size	Price
030973	0881401	GAB KIT	3/4"	
030972	0881402	GAC KIT	1"	
030971	0881403	GAD KIT	1-1/4"	
030970	0881404	GAE KIT	1-1/2"	
030969	0881405	GAF KIT	2"	

Weil McLain Repair Parts

Weil-McLain Boiler Parts & Components

Part #	Mfg.#	Description	For	Price
241885	381-330-027	Ignition Board		
110792	382-200-449	Conversion Kit, NG, from Cycle Pilot System to Gold control HSI		
011885	382-930-216	10C523 Igniter Kit	VHE, HE II	
076751	383-500-345	Repair Plug Kit		
128037	383-500-603	(5) Ultra U-Control Module Fuses, 3A, Fast-Blow AG	F1	
145731	383-500-604	(5) Ultra U-Control Module Fuses, 12A, Slow-Blow AG	F2	
066016	383-500-190	Control Module for All 1 and 2 Ultra Boilers		
237635	383-500-665	Control Module - Ultra Series 1 & 2 Boilers		
129778	383-500-622	Heat Exchanger Replacement Kit	230	
129779	383-500-623	Heat Exchanger Replacement Kit	310	
128030	383-600-069	Low Water Cut-Off		
239617	383-900-064	Evergreen 220 LP Kit		
076395	389-900-203	WMCR-3 3 Zone Circulator Control		
045038	389-900-205	6 Zone Circulator Control		
138955	389-900-206	WMZV-4 4 Zone Valve Control		
136985	389-900-220	BCP-3 Hydronic Multi-Stage Boiler Control Panel		
011893	510-218-099	10C034 Tridicator Gauge, 2-1/2" Short Shank	GV, GO, CG Prior to Jan 2000	
101982	510-300-014	210°C Spill Switch with Reset	CG Sect/Base Series 1-12	
127719	510-312-015	High Limit Temperature Control	HE II, HE, VHE	
011899	510-312-166	10C053 Combination 120/24V Transformer-Relay Receptacle	CG, AHE, EGH, HE II, HE, PFG	
116334	510-312-218	Outdoor Temp Sensor		
038133	510-312-250	10C055 Limit Control & 1/2" Well	CG, CGm, EGH, PFG	
021051	510-312-312	10C567 Blower Motor Assembly	HE II, HE	
011904	510-312-317	10C579 Motor Repl Kit	VHE	
239431	510-312-361	399 MBH Blower Motor Assembly	7050-0118	
011909	510-350-223	10C072 Control Relay, DPST 24V	AHE, CG, EG, EGH, HEII, PFG	
032886	510-811-221	Pilot Assembly NG		
032887	510-811-222	Pilot Assembly Propane		
011913	510-811-362	NG-LP Conversion Kit	CG 25 - 6	
107651	510-811-502	24V Combination Ignition-Sensing Control Module		
022497	510-811-644	Pilot Assembly Kit		
011922	510-811-655	10C528 NG Valve	HE, HEII, VHE	
011923	510-811-656	10C529 Step Open LP Gas Valve	HE, HEII, VHE	
044138	511-044-382	Gas Valve 3/4" x 3/4" NG 10C489		
078890	511-114-479	63m Low Water Cut-off		
078891	511-114-526	w/McLain LWCO 150smd M&M 17180 672619142831		
059929	511-330-081	LP Pilot Burner Assembly		
011934	511-330-095	Ignition Module 10C486	CG, EG, EGH, PFG	
019926	511-330-184	Igniter Only 10C455	HE/VHE	
011943	511-330-186	Pilot Burner Assembly		
011944	511-330-192	Flame Sensor 10C188	HE, VHE	
011945	511-330-197	Pilot Burner	E38-2 24V	

Weil McLain Repair Parts

Weil-McLain Boiler Parts & Components (Continued)

Part #	Mfg.#	Description	For	Price
073640	511-330-218	Pin Pilot Burner 10C481	CG	
064739	511-330-221	Pilot Burner Assembly with Ignition Lead and Orifice PSE-NA16		
011947	511-624-510	Switch .95 Pressure Switch 3-5 2, 000'-4, 000' 10C213	HE	
011948	511-624-514	Pressure Switch 51.2 Pressure Switch VHE 2000'-4000' 10C215		
074480	511-724-259	Thermopile for EG-75		
038426	511-724-274	Main Flame Sensor		
011956	512-050-230	Thermal Fuse 10C257	CG, EG, HE, PFG, VHE	
056344	512-200-000	Steel Burner Tube		
056346	512-200-001	Steel Burner Tube with Bracket		
118676	512-200-035	Burner	HE VHE CGi	
011958	512-200-045	Pilot Burner 10B867		
127431	540-131-052	X100 Sentinel Corrosion Inhibitor Kit		
127432	540-131-053	X100 Sentinel Corrosion Inhibitor Kit		
127433	540-131-054	X100 Sentinel Corrosion Inhibitor Kit		
127434	592-900-002	Sentinel X-100 Corrosion Inhibitor Concentrate		
011968	560-742-860	Pilot Tubing		
020911	590-317-610	Blower Gasket		
015274	590-735-140	1/2" x 100" Glass Rope 10B985		
086820	591-200-000	Cover Plate Gasket/Insulation		
239521	591-222-025	Front Base Insulation		
114285	591-706-200	Heat Exchanger Cleaning Tool		
011981	591-706-214	Flue Brush 11B146		
011985	592-800-011	2" Square Cut Seal		
127632	592-900-003	X400 Cleaner		
239853	633-600-012	AcuTemp Thermostat Repair Kit	Series 2	
059875	633-900-102	Thermostat with Cover Plate Kit for Plus Water Heaters		
094665	633-900-130	Gold Plus Thermostat Kit		
011986	635-100-010	Kit Thermostat Plus		

Vent Damper

Part #	Mfg.#	Description	Price
019945	381-800-474	4" Vent Damper	
019946	381-800-475	10C081 5" Vent Damper for EG30/35	
019944	381-800-476	6" Damper Assembly CGM,EG	
019947	381-800-477	7" Damper Assembly CGM,EG,PFG	
030770	381-800-478	10C478 8" Vent Damper for EG65/75	

CGa Series Accessories

Part #	Mfg.#	Description	For	Price
146736	381-357-313	Pilot less Ignition for Natural Gas Boilers	CGa-8	
049683	450-021-245	CGa-7 Draft Hood Vertical		

Weil McLain Repair Parts

Weil-McLain Boiler Parts & Components (Continued)

CGa Series Accessories

Part #	Mfg.#	Description	For	Price
032392	450-021-246	CGa-8 Draft Hood Vertical		
242387	510-811-946	NG-LP Conversion Kit	CGa 25 - CGa 7	
242388	510-811-947	LP Kit	CGa-8	
050610	512-200-077	CGa Main Stainless Steel Burner Tube		
065995	512-200-079	CGa Stainless Steel Burner with Pilot Bracket LP		

CGi Series Accessories

Part #	Mfg.#	Description	For	Price
058742	511-330-090	Control Module with 10 Second Pre-purge		
064887	510-312-167	Transformer		
059928	511-330-080	Pilot Assembly Kit NG		

CGm Series Accessories

Part #	Mfg.#	Description	For	Price
041152	511-044-256	NG Valve	CGm 7-8	

CGs Series Accessories

Part #	Mfg.#	Description	For	Price
017582	311-103-818	Intermediate Section Assembly		

CGt Series Accessories

Part #	Mfg.#	Description	For	Price
112055	380-000-000	Combination Pressure-Temperature Gauge Kit, 60° - 360°F	CGt Series	

PFG Series Accessories

Part #	Mfg.#	Description	For	Price
011912	510-512-337	Vent Damper Motor Operator		
024710	511-044-287	NG Control Valve, 1" x 1" NPT	PFG	

Ultra Series Accessories

Part #	Mfg.#	Description	For	Price
109058	383-500-021	Time Delay/Relay Box		
066027	383-500-025	Gas Valve Kit	Ultra 155	
066028	383-500-030	Gas Valve/Venturi Kit	Ultra 230	
066022	383-500-035	Blower Assembly	Ultra 155	
066024	383-500-040	Blower Assembly	Ultra 230	
066039	383-500-045	Ignition Electrode Kit	Ultra 80 & 105	
066042	383-500-055	Flue Temperature Sensor Replacement Kit		
066040	383-500-085	Burner Replacement Kit	Ultra 155	

Weil McLain Repair Parts

Weil-McLain Boiler Parts & Components (Continued)

Ultra Series Accessories

Part #	Mfg.#	Description	For	Price
130501	383-500-095	Watts #330 300 psi Pressure Relief Valve, ASME		
120566	383-500-105	3" Vent Termination Bird Screen	Ultra 80, 105, & 155	
105545	383-500-110	4" Vent Termination Bird Screen	Ultra 230 & 310	
066021	383-500-125	Outdoor Temperature Sensor		
066017	383-500-195	115VAC / 24VAC, 50-60Hz, 50 VA Honeywell Transformer		
093857	383-500-210	Pressure/Temperature Gauge Assembly		
143606	383-500-235	5 Amp Fast-Blow Fuses	Circulator Circuit 5/Pk	
143607	383-500-240	4 Amp Slow-Blow Fuses	24-Volt Circuit 5/Pk	
086818	383-500-250	Cover Plate Gasket/Insulation	Ultra 155, 230, & 310	
086819	383-500-255	Cover Plate Gasket	Ultra 155, 230, & 310	
074417	383-500-360	Blower Assembly Kit	Ultra 310	
074418	383-500-390	Gas Valve/Venturi Kit	Ultra 310	
133205	383-500-395	Cover Plate Replacement Kit	Ultra 155 & 230	
116337	383-500-408	Display Board/Bracket Assembly	Ultra 155/230	
121565	383-500-600	Flue Temperature Sensor Replacement Kit		
116333	383-500-601	System Temperature Sensors		
116331	383-500-602	Return/Supply Sensor Kit, (1) Sensor		
120435	383-500-605	Maintenance Kit	Ultra 80 and 105	
120436	383-500-620	Maintenance Kit	Ultra 155, 230, 299, & 399	
129776	383-500-621	Heat Exchanger Kit	Ultra 155	
120152	383-500-628	120V/24V Transformer		
133206	383-500-630	Pressure/Temperature Gauge Assembly		
130577	383-500-649	Ultra Easy-Up Manifold Kit, 1-1/4" Piping	UG 80 & 105	
133204	383-500-650	Blower Assembly Kit	Ultra 399	
133203	383-500-652	Gas Valve Kit	Ultra 399	
127630	383-500-658	Control Module		
127885	383-500-659	Display Board Assembly		
074410	383-501-027	Blower Assembly Kit	Ultra 80 & 105	
074411	383-501-029	Gas Valve/Venturi Kit	Ultra 80	
074413	383-501-030	Gas Valve/Venturi Kit	Ultra 105	
125176	511-100-005	LWCO with Harness & Test Button		
090744	511-405-133	Taco 0014 Boiler Circulator, less Flanges	Ultra 155, 230, & 310	
107709	590-317-310	Gasket Cork		

Ultra Commercial Series Accessories

Part #	Mfg.#	Description	For	Price
127629	383-600-065	Watts 174A 80 psi Relief Valve, 3/4" x 3/4", 1,400 mbh Capacity		
143176	383-600-079	Maintenance Kit		

Weil McLain Repair Parts

WM97+ Series Accessories

Part #	Mfg.#	Description	For	Price
146863	383-700-113	Igniter, Gasket and Screw	WM97+ 70 & 110	
146859	383-700-139	Ignition Control	WM97+ 70 & 110	
146870	383-700-157	Piping Assembly Blower & Clip	WM97+ 70 & 110	
146871	383-700-159	Piping Assembly Gas Valve	WM97+ 70	
146872	383-700-160	Piping Assembly Gas Valve	WM97+ 110	
146860	511-724-292	Flue Sensor	WM97+ 70 & 110	
146861	511-724-296	Water Temperature Sensor	WM97+ 70 & 110	
146864	511-802-015	50VA Transformer	WM97+ 70 & 110	

GV Series Accessories

Part #	Mfg.#	Description	For	Price
011874	382-200-325	Burner Replacement Kit	GV4 & GV90+4	
011875	382-200-330	Burner Replacement Kit	GV5 & GV90+5	
011877	382-200-340	Blower Assembly		
011878	382-200-345	Blower Motor Kit 10C380		
011879	382-200-350	Vent 90 10C387		
011881	382-200-375	Switch Kit 10C403	GV90	
011882	382-200-385	Hose Trap Kit		
030451	382-200-410	Boiler Gas Valve 10C399		
065429	382-200-411	Gas Valve Kit GV Series 4		
043582	382-200-448	Ignition Control Module (GV Series 1,2&3) 10C400		
011896	510-312-019	10C411 Limit Control		
050453	510-312-021	Limit Control w/1/2" Well	GV Ser 1, 2, 3 Sect Assy	
011941	511-330-148	Ignition Kit 10C402		
011949	511-624-520	Pressure Switch 10C382	GV	
011955	511-842-370	Transformer 10C401	GV	

EG/EGH Series Accessories

Part #	Mfg.#	Description	For	Price
239732	321-711-115	Section Assy for EGH 95 Boiler		
239733	381-700-246	42-1/2" Base Panel for EGH 95 Boiler		
239734	381-700-506	Base Assy for EGH 95 Boilers		
035079	381-800-677	EG75 SPDN Boiler Water Trim No Tankless Option		
035078	381-800-675	EGH-30 to 65 Water Trim		
239736	411-800-271	Jacket Assy Carton for EGH-95 Boilers		
239738	450-014-751	Collector Hood for EGH-95 Boilers		
239737	450-206-241	Draft Hood for EGH Series Boiler		
011892	510-218-097	10C526 Tridicator, 2-1/2" Long Shank	EG Series 1-4 Section Base Assy	
074482	511-724-255	36" Thermocouple with Spade Terminal Block	EG 75, EGH 85 & 95	
011966	560-528-985	LP Gas Pilot Orifice		
074479	590-850-561	5" Lead Wire	EG 75	

Weil McLain Repair Parts

Weil-McLain Boiler Parts & Components (Continued)

EG/EGH Series Accessories

Part #	Mfg.#	Description	For	Price
151620	381-800-837	Trim Steam EG30-75		

Sentinel Series Accessories

Part #	Mfg #	Description		Price
127435	592-900-005	Sentinel X100 Quik Test Kit		

Ultra Oil Accessories

Part #	Mfg #	Description		Price
066035	383-500-300	Water Temperature Sensor Kit		
066012	389-900-180	Wall Mount Kit		

Westinghouse/Philco Repair Parts

Blower Wheels

Part #	Mfg #	Description	Price
241795	622683	1/2" HP, CCWLE	
245085	667187R	Draft Inducer Blower Wheel	
119974	667207	10-3/4" x 10", CW	
119975	667251	10" x 6", CW	
245205	667252R	10" x 7", CW	
119976	667258R	11" x 8", CCWLE	
119977	667280	11" x 10", CCW	
119979	667374	11" x 8", CW	

Burners

Part #	Mfg #	Description	Price
134174	660921	Burner L1	
134173	661128	Inshot Burner G7T	
163685	660812R	Inshot Burner FG6RC	
242549	M0062414 R	Burner Box Kit for Use with Ignitor 10177435	

Capacitors

Part #	Mfg #	Description	Price
146433	01-0024	10mfd, 370V Round Capacitor	
119928	622135	15mfd, 370V Round Capacitor	
136994	622545	10mfd, 370V Round Capacitor	

Contactors

Part #	Mfg #	Description	Price
139778	621661	25A, 1-Pole	
139779	621662	35A, 1-Pole	
246424	1014866R	24VAC, 2-Pole, 25 FLA	

Control Boards

Part #	Mfg #	Description	Price
242566	624689R	Interface Module	
133371	904531	Board All Units	
129223	920915	Control Board G7	
130336	920916	Control Board G7	
128774	920920	Board Direct Torque	

Control Modules

Part #	Mfg #	Description	Price
139792	624651	Comfort Alert Module New	

Control Modules (Continued)

Part #	Mfg #	Description	Price
120743	903106	Control Module for G4 G5 G6 Models	

Defrost Boards

Part #	Mfg #	Description	Price
147380	920338	Defrost Board Adaptive	
127634	917178A	Defrost Board	

Door Switches

Part #	Mfg #	Description	Price
119950	632125	Door Switch	

Fan Blades

Part #	Mfg #	Description	Price
139796	667261	Fan Blade	
139797	667318	Fan Blade f/S3QC Series 3 Ton Only	
139784	667319	Fan Blade 2 Blade 24 OD 27p CW 1/2 1200	
139783	667351	Fan Blade 2 Blade 24 OD 25p CW 1/2	
240945	667357R	Fan 3-Blade, 24 OD, 18P, CW 1/2, 1200	
139798	667383	24" CW 3W 20° Fan Blade	

Flame Sensors

Part #	Mfg #	Description	Price
120728	903600	Flame Sensor (old #632396)	

Igniters

Part #	Mfg #	Description	Price
120726	903758	Replacement Igniter Kit	
134164	921074	Igniter Replacement Kit G7/GC2	
119987	904839	Igniter Assembly for G7 (New# Is 921074)	
241821	1017743S	Replacement Igniter SI NI G7	

Limit Controls

Part #	Mfg #	Description	Price
120741	626350	Vent Limit 260°F	

Westinghouse/Philco Repair Parts

Limit Controls (Continued)

Part #	Mfg #	Description	Price
120733	626418	Limit 150/20°F	
120735	626419	Limit 195/20°F	
120736	626425	Limit 210/20°F	
120734	626434	3" Limit 180/20°F	
120749	626435	Limit 220/20°F	
120737	626449	3" Limit 250/20°F	
120744	626461	Vent Limit 160°F	
136184	626522	Main Limit Switch	
119934	626541	Switch Blower Limit G7	
119941	626561	Main Air Limit G7	
119945	626563	Main Air Limit G7	
145504	626598	Main Air Limit SD054, 072	
144772	626599	Limit Switch 1/2d,1s, or 16	
145498	626611	Blower Limit KG7SD	

Lineset Fittings

Part #	Mfg #	Description	Price
131551	664378	Liquid Lineset Fitting	

Motors

Part #	Mfg #	Description	Price
139793	621952	A/C Fan Motor	
139795	621917	Fan Motor for FS3BA048	
139794	621919	PSC K 1/10 6p 1-Spd CWLE Fan Motor	
139788	622018	PSC 1/4 hp CWLE Fan Motor for 15 SEER	
139782	622066	PSC K 1/4 hp CWLE 6p 1-Spd Fan Motor	
139781	622080	1/4 hp CWLE Fan Motor	
139780	622171	.05 hp CWLE 2 Ton Motor	
130637	622264	Blower Motor 1/2hp 3-Spd	
246090	634632R	Repl, Harness, B3VM, Motor	
245861	634826	Fan Motor Power Wire HRN	
245863	634827	Fan Motor Control Wirehar	
143885	904502	Motor 1/3 3-Spd 115V	
206946	902042	Blower Motor 1/8 HP/115V	
120723	903111	Venter Motor 80% With Gasket	
134163	903962	Venter Motor w/Gasket	
134161	904085	Venter Motor GL1RC	
135437	903404	Inducer Motor	
119983	904796	Inducer Motor G7	

Motors (Continued)

Part #	Mfg #	Description	Price
119985	904798	Inducer Motor G7	
119991	904857	Blower Motor G7	
119992	904858	Blower Motor G7	
119993	904859	Blower Motor G7	
119994	904860	Blower Motor G7	
241599	1007729	Condenser Fan Motor	

Orifices

Part #	Mfg #	Description	Price
149071	664067	Orifice #67	
149073	664071	Orifice #71	
245346	151885R	1" Inducer Orifice	

Pressure Switches

Part #	Mfg #	Description	Price
120746	632302	Pressure Switch Vent for G6D	
139791	632393	Low Pressure Switch 39" (5CO-20CI) 632393	
120780	632444	Pressure Switch NO 1.75 Close 1.55 Open	
139785	632473	High Pressure Switch	
119953	632484	Sensor Flame G7	
119954	632487	Pressure Switch	
119955	632489	Pressure Switch G7	
119956	632491	Pressure Switch Condensate G7	
119958	632493	Pressure Switch Inducer G7	
119960	632499	Pressure Switch G7	
119961	632514	Pressure Switch G7 Variable Speed Downflow	
119962	632515	Pressure Switch G7 Variable Speed Downflow	
119963	632516	Pressure Switch	
119966	632521	Pressure Switch G7	
134165	632546	Pressure Switch Inducer 1.0 for FG7TC	
134168	632547	Pressure Switch G7 Fixed Condensate	
134166	632548	Pressure Switch	
134167	632550	Pressure Switch G7	
134169	632554	Pressure Switch	
130948	632561	Pressure Switch for Fg7	
130950	632563	Pressure Switch for Fg7	

Westinghouse/Philco Repair Parts

Pressure Switches (Continued)

Part #	Mfg #	Description	Price
130951	632565	Pressure Switch for Fg7	
130952	632567	Pressure Switch for Fg7	
130953	632594	Pressure Switch 40 Close .20 Open Long Run for iQ Furnace	
122723	632571	Pressure Switch G7	
134010	632585	Pressure Switch	
145499	632622	Pressure Switch for M7	
145500	632624	Pressure Switch for M7	
240803	1016291R	Pressure Switch No. 0.85	
240804	1016292	Pressure Switch No. 0.85	
240802	1016293R	Pressure Switch No. 0.85	

Plugs

Part #	Mfg #	Description	Price
240979	631756R	12 Pin Male Plug	
239631	634715R	Molded Plug 56" Leads	

Relays

Part #	Mfg #	Description	Price
139790	621931	Relay Blower	
242942	1017206	AC Relay Kit	
243133	1017207	DC Relay Kit	

Restrictors

Part #	Mfg #	Description	Price
149069	664048	1.5T Restrictor .048	
149070	664056	2T Restrictor .056	
149072	664061	2.5T Restrictor .061	
149074	664076	4T Restrictor .076	

Roll-out Switches

Part #	Mfg #	Description	Price
120731	626343	Switch Roll-out 300F	
119938	626558	Roll-out Switch G7	
119939	626559	Roll-out Switch G7	
119940	626560	Roll-out Switch G7	
145497	626609	Roll-out Switch SD038	
145505	626610	Roll-out Switch SD054,072	

Transformers

Part #	Mfg #	Description	Price
134170	622341	Transformer 40VA/120/24	
134175	622396	Transformer 60 VA for 23 SEER Coil	

Tubing

Part #	Mfg #	Description	Price
119925	263967	High Temperature Tubing 3/16 36" Long	

Valves

Gas Valve

Part #	Mfg #	Description	Price
119930	624652	Gas Valve 2-Stage for TC TI G7	
130954	624703	Gas Valve for iQ Furnace	
143845	624787	Gas Valve 2-Stage for Fg7	
143844	904081	Gas Valve	
144173	921691	Gas Valve Kit with Harness	

Service Valves

Part #	Mfg #	Description	Price
139777	663862	Valve Liquid 3/8"	
139786	663864	Valve Suction 3/4" for FS5BD18-36	
133428	663963	Valve Ball 7/8" for FS4BD48-60, FT4B42-6	

TXV Valves

Part #	Mfg #	Description	Price
134244	669681	TXV for C6BAX24	
134245	669682	TXV for C6BAX30	
134246	669683	TXV for C6BAX35 And 36	
134247	669684	TXV for C6BAX42	
134250	669686	TXV for C6BAX60	
134249	669852	TXV R-410A 4.0 Ton	

Parts & Repair

Part #	Mfg #	Description	Price
243108	2B6462R	Coil Guard 24" Lgtng Bolt	
239223	276921	Cover, Control, Panel, AC&HP	
245674	286802R	FRU, SOW, AH, VS	

Westinghouse/Philco Repair Parts

Parts & Repair (Continued)

Part #	Mfg #	Description	Price
241050	294941R	12" Duct Collar Kit	
241051	294942R	14" Duct Collar Kit	
240668	297217R	Blower Housing	
244460	624811R	Repl. Coresense Module	
119951	632261	3 Amp Fuse	
119952	632269	5 Amp Fuse	
119981	664435	Drain Assy Upflow/Inline	
145506	664659	PVC Trap KG7SD	
242155	902809	Nordyne Blower	
134162	904573	Inducer for 95% With Gasket	
119986	904799	Blower Kit Inducer G7 Var Sp Downflow	
143415	904986	Replacement Parts Kit	
130955	904800	Induced Draft Blower FG7MQ	
245613	904804	Header Box with Gasket	
240920	919707D	Coil Assy, 030, B5BW, FRU	
131416	920994	Blower Control, Cons CFM, Vs Downflow	
239078	921852	Blwer, B6BM, 1/8, 10X6, 1.5-2T	
243685	922178	Comp-Cope, ZR48K5E-TF5-800	
243666	1010439R	Pressure 2X No. .7/- .2B	
213290	921952	Replacement Coil	
161216	902661	Igniter Kit F/G5RA060C	
208971	922016	Blower Control	

Repair Parts: White Rodgers

Repair Parts

Surface (Strap-On) Type Hydronic Control

- Sensing element has twice the contact area of competitive models.
- Hydraulic action element can be mounted in any position – no leveling required.
- Dustproof steel case.
- Special screw terminals with “ears” securely hold solid and stranded wires.
- Includes pipe strap and mounting screws.



Part #	Mfg #	Description	Price
19115	WR11272	100 to 240°F Range	9

Well Immersion Single Control

- Types for Use as High Limit, Reverse Action or SPDT Switching
- Action: May be Mounted Either Horizontal or Vertical
- Extra capillary length for extended shank wells.
- Special screw terminals with “ears” securely hold solid and stranded wires.
- Screwdriver-adjustable differential with direct-read indicator.
- Knockouts on top and bottom and plenty of wiring room.
- Hydraulic action element – fast acting.



Part #	Mfg #	Description	Price
19116	WR1131102	Tapered Bulbs, SPDT Action	0
19367	WR11D181	Open on Rise Action	5

Hydronic Zone Valves

- Two Types of Valves, 2-Wire or 3-Wire, for Zoning Hydronic Systems Up to 50 PSI
- Quiet operation.
- Valve stem made of stainless steel.
- Automatic recycling manual operator shows valve position at all times.
- Built-in auxiliary contacts to control burner or circulator relay.
- Motor can be removed from valve assembly without draining system.



2-Wire, 24V Valves With Screw Terminal Wiring Panel and Auxiliary Switch

Part #	Mfg #	Description	Price
19116	WR1361103	1" I.D. 2-Wire Valve	1

Refrigeration Temperature Control

- Provide Positive Control of Refrigeration Applications where Remote Control is Desired
- Hydraulic action element.
- Dustproof steel case with top and bottom knockouts.
- Temperature dial graduated in °F and °C and can be adjusted through cover.
- High electrical ratings allow operation of most equipment without use of relays or motor starters.



Part #	Mfg #	Description	Price
21147	WR1609101	-30 to +90°F Close on Rise	6
19114	WR16879	-30 to +90°F SPDT	8

Repair Parts: White Rodgers

Electronic Temperature Control

- Universal
- Refrigeration or Heating Applications
- Alarm Output with Selectable Delay
- No Common Wire Required



Part #	Mfg #	Description	Price
20363 0	WR16E09101	-40°F to 220°F SPDT	

HotRod Universal Nitride Ignitor Upgrade Kit

- 120V Nitride Upgrade Kit for Conversion of Silicon Carbide (Flat or Spiral)
- Robust Ignitor Design – for longer life and fewer callback's – 5 year warranty
- Nitride Ignitor with 15.5" leads
- Universal mounting bracket and screw and ceramic wire nuts



Part #	Mfg #	Description	Price
21066 9	WR21D645PK	HotRod 5-Pack 15.5"	

HotRod™ Series Universal Ignitor Upgrades

- Nitride ignitors with 14.5" and 15.5" leads-stripped ends
- Universal and standard mounting brackets and 2 ceramic wire nuts
- Replaces most silicon carbide ignitors including many Carborundum carbide applications



Part #	Mfg #	Description	Price
19694 7	21D64-2	15.5" Lead	

Carbide Ignitors, OEM Direct Replacement

- Multiple mounting styles
- Works with 15, 17 or 45 second HSI systems
- All models includes ceramic wire nuts for cut and strip connections



Part #	Mfg #	Description	Price
19552 4	767A-371	120 VAC, 60 Hz	

24A34 Series Electric Heat Sequencers

- Replaces Honeywell, MARS, TOD, GEMLINE, Klixon (Texas Instruments).
- Any contacts (except M1 & M2) can be used as auxiliary contacts.
- 24V input control.
- Multi-poise mounting.
- Double quick-connect terminals for combination loads.



Part #	Mfg #	Description	Price
19118 0	WR24A341	24A34-1 Sequencer	
19454 7	WR24A3415	24A34-15 Heat Pump Control	
20119 5	WR24A342	24A34-2 Sequencer	
19118 3	WR24A345	24A34-5 Sequencer	
19118 4	WR24A346	24A34-6 Sequencer	

36C Series Snap Open, Single Function, Standing Pilot Gas Valves

- Electrical Rating: 0.23 amps
- Ambient Operating Range: -40 to +175°F (-40 to 79°C)
- Maximum Pressure Rating: 1/2 PSI (14.0" W.C.)
- Pilot Gas Connection: 1/4" compression fitting
- Pressure Tap: 1/8" N.P.T.



Part #	Mfg #	Description	Price
19116 2	WR36C03A410	120VAC 3/4" x 3/4" Gas Valve	
19117 5	WR36C03U333	750mV 1/2" x 3/4" Gas Valve	
19116 3	WR36C03333	24V 1/2" x 3/4" Gas Valve	

Repair Parts: White Rodgers

36H Series Gas Valves



Part #	Mfg #	Description	Price
20285 0	WR36H33412	24VAC 3/4" x 3/4" Gas Valve	
19116 5	WR36H32304	24VAC 50/60Hz	

36G, 36J Series Gas Valves

- The 36G, 36J is a Combination Gas Control Valve Designed for Use with Non-Piloted Intermittent Ignition Systems.
- The Control is Designed to Meet Today's Maximum Capacity, Smaller Size and High Efficiency Gas Systems
- Inlet and outlet screens.
- Quiet redundant.
- Built-in pressure tap.
- Quick-connect terminals (1/4")



Part #	Mfg #	Description	Price
20801 1	WR36J22214	1/2" 1 Stage, Fast Opening	
20336 2	WR36J24214	1/2" 1 Stage, Slow Opening	
20495 0	WR36J54214	1/2" Two-Stage, Fast Opening	

3F05 / 3L05 Series Adjustable Snap Disc Fan & Limit Controls

- Adjustable Snap Disc Thermostat Allows You to Set the Temperature Set Point to Match Your Specific Needs which Simplifies Inventory
- 1/4" quick connect terminals are standard.
- Reduces inventory while providing coverage for a wide range of temperature applications.
- Replaces the majority of fixed disc thermostats now on heating equipment and various appliances.
- 2 adjustable fan control models replace 7 fixed snap disc models.
- 5 adjustable limit control models replace 10 fixed snap disc models.



Part #	Mfg #	Description	Price
19115 0	WR3F052	140 - 180°F SPST Fan Control	
24299 5	WR3L053	210 - 250°F SPST Limit Control	

Snap Disc Fan or Limit Controls

- For Regulation of Fan, Blower or High Limit Safety Control



Part #	Mfg #	Description	Price
19115 2	WR3L01140	100°F Cut-in, 140°F Cut-out	

5D51 Series Fan & Limit Controls



Part #	Mfg #	Description	Price
19115 3	WR5D5135	Fan, 5"	
19115 5	WR5D5190	Limit, 8"	
19115 4	WR5D5178	Limit, 11"	

Repair Parts: White Rodgers

Universal Heat Pump Defrost Control

- *Universal upgrade for single stage heat pump systems with a PSC fan Motor.*
- *Select from: pre-conjured demand timed defrost routines or congure to replicate virtually any set up.*
- *Universal Replacement: Selectable demand or timed defrost. O or B reversing valve. Congures to any system.*
- *Easy Installation & Set Up: Universal mounting with rotating display. Pre-congured for major OEM brands. Integrated outdoor thermostat.*
- *Versitile Matrix Display: Access set up and diagnostic menus from any orientation.*
- *Compressor Protection: Brown out and short cycle protection plus. Hi/Low pressure inputs.*
- *Replacement Kit Contents: Defrost control board. Wiring harnesses. New coil and ambient temp thermistors. Mounting accessories and labels*
- *Timing Specifications: All timing is accurate to +/- 5% of nominal over the full temperature and voltage range at 60Hz. All timings are 20% longer when operated with 50Hz power supply.*



Part #	Mfg #	Description	Price
21897	WR47D01U843	Universal Heat Pump Defrost	0

49P11-843 SURESWITCH™

- *Universal Electronic Upgrade for Mechanical Compressor Contactors.*
- *5x Contactor Life, Sealed to Keep Out Ants and Debris*
- *Microprocessor controlled sealed compressor switching.*
- *Line voltage brownout protection, short cycle protection, tricolor LED displays.*
- *Heavy-duty lug connectors, zero chatter latching relay.*
- *Four-hole mounting matches mechanical contactors.*
- *Random start delay on power up and brownout recovery.*
- *Compressor test and cycle count by push-button.*



Part #	Mfg #	Description	Price
20918	WR49P11843	Universal SURESWITCH™	9

Pilot Relite Controls

- *Generates spark pulse until flame is sensed through spark electrode.*
- *Begins sparking immediately if flame extinguishes.*
- *Rugged solid state module design.*
- *Spark plug or spike output configurations available.*



Part #	Mfg #	Description	Price
20856	WR505923	Spark plug and 1/4" connectors	2

50A55-743 Goodman Single Stage Integrated HSI Furnace Control

- *Controls Gas Valve, Ignitor, Blower, Inducer, Humidifier(Both 120V & 24V Input), and Air Cleaner Replaces OEM Goodman and White-Rodgers Models*
- *Includes flash code diagnostics.*
- *Twinning connection.*
- *Fused to protect low voltage system transformer*



Part #	Mfg #	Description	Price
21140	WR50A55743	1 Stage HSI Furnace Control	9

Non-Integrated Ignition Modules

- *Plug in program keys for quick selection of factory timings*
- *Microprocessor-based ignition control*
- *Works with single rod or dual rod remote sensor*
- *Provides ignition, proof of ignition and precise timings*
- *Led diagnostic indicator*
- *For use in natural and lp gas applications*



Part #	Mfg #	Description	Price
19498	WR50E47843	Single Stage, 120 VAC	2

Repair Parts: White Rodgers

Integrated Furnace Controls

- Universal replacement
- Diagnostic LED indicators streamline installation and system troubleshooting
- 120V air cleaner output and 120V humidifier output up to 1 Amp max
- Factory standard safety timings and adjustable fan delay options
- Replaceable automotive style fuse



Part #	Mfg #	Description	Price
19595	WR50A55843	24 VAC, 120 Vac 50/60 Hz	1

Integrated Furnace Controls

- Universal replacement
- Models include a universal 120V nitride ignitor to allow replacement of 80V and 120V controls
- Simple pushbutton fault recall with Tri-Color LED indicators streamline installation and system troubleshooting
- 120V air cleaner output and 24V or 120V humidifier output up to 1 Amp max
- Factory standard safety timings and adjustable fan delay options



Part #	Mfg #	Description	Price
20055	WR50M56U84	24 Vac, 120 Vac, 50/60 Hz	5 3

50D50-842 Universal Direct Spark Ignition Control Kit

- Microprocessor Based Gas Ignition Control for Heating Appliance Using Either Natural or LP Gas. Proof of Flames is Accomplished. The Unit is Designed as a Direct Spark Ignition Source
- Color LED indicator for diagnostics.
- Program keys.
- 1/4" and 3/16" quick connect terminals.
- Damper interface.



Part #	Mfg #	Description	Price
19669	WR50D50842	Universal Spark Ignition Control	5

50D50-843 Universal Proven Pilot Spark Control Kit

- Microprocessor Based Gas Ignition and Primary Safety Control.
- Designed for Interrupted Spark and Burner Supervision of All Gases.
- Used in Gas Fired Appliance Applications
- Field service replacement for most Honeywell, Robertshaw, Johnson Controls and UTEC Intermittent Pilot Ignition Controls.
- Provides ignition, proof of ignition and precise timing.
- Works with single rod or dual rod remote sensor.
- Color LED indicator for diagnostics.



Part #	Mfg #	Description	Price
19669	WR50D50843	Universal Pilot Spark Control Kit	6

50T35-743 Goodman Silicon Carbide Integrated HSI Furnace Control

- Controls Gas Valve, Ignitor, Two-Speed Blower Motor, Inducer, Humidifier (Both 120v & 24v Input), and Air Cleaner. Replaces OEM Goodman, UTEC and TI Models
- Includes flash code diagnostics.
- Twinning.
- Includes mounting hole template.
- Fused to protect low voltage system transformers.
- Adjustable blower relay.
- 90+ furnace option



Part #	Mfg #	Description	Price
19965	WR50T35743	Integrated HSI Furnace Control	4

Repair Parts: White Rodgers

57T01-843 Blower Time Delay Relay

- The 57T01-843 Time Delay Relay is for Use in Air Handlers Installed in Compressor-Run Air Conditioning and Heat Pump Systems to Delay the Blower Shut-Off After the Compressor has Shut Off.
- Allows residual cooled air to be blown into the controlled space, increasing the efficiency of the system in cooling.
- Depending on electrical hookup in a heat pump system, delay of blower shut-off could also occur in heating.



Part #	Mfg #	Description	Price
21464	WR57T01843	Blower Time Delay Relay	0

767A Series Silicon Carbide Hot Surface Ignitors

- Multiple mounting styles.
- Works with 15, 17 or 45 second HSI systems.



Part #	Mfg #	Description	Price
19552	WR767A369	5.5"	7
19552	WR767A370	5.25"	3

Fan Control Center

- Transformer and Relay Combination for Easy Installation on a 4"x 4" Junction Box
- Line voltage connections pre-wired.
- Energy limiting class II transformer design.
- Color coded pre-stripped leads.
- Low voltage connections on terminal board.



Part #	Mfg #	Description	Price
19118	WR90113	SPDT 60 Hz 120V	8

WR/RBM Type 154 Contactors

- Any position mounting.
- Interchangeable mounting plate.
- Low wattage coil.
- Double break contacts ensure positive make and break

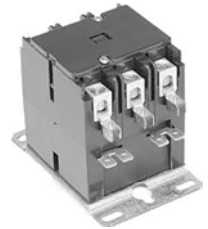

Part #	Mfg #	Description	Price
23966	WR90165	30 Amp 208/240 Voltage AC	9
21128	WR90171	40 Amp 120 Voltage AC	7
20600	WR90172	40 Amp 208/240 Voltage AC	3

WR/RBM Type 122 Contactors

- Low VA coil for cooler operation and increased life.
- Quiet operation.
- Universal style mounting bracket fits existing mounting holes.
- Double break contacts ensure positive make and break.
- Screw terminals or pressure connectors and double 1/4" quick connects provided on all models for easy installation.



Part #	Mfg #	Description	Price
19119	WR90245	30 Amp 120 Voltage AC	4

WR/RBM Type 84 Relays

- Used for Switching Single or Two Speed Fan Motors, Solenoids, Relays, Resistive Loads and General Purpose Switching
- Compact, totally enclosed design.
- For heating and cooling applications and general switching.
- Quiet, reliable and economical.



Part #	Mfg #	Description	Price
19468	WR90293Q	SPDT 24 Coil Voltage AC	2

Repair Parts: White Rodgers

WR 90 Series 2 Pole Mechanical Contactors

- Low VA coil for cooler operation and increased life
- Quiet operation
- Universal style mounting bracket fits existing mounting holes
- Double break contacts ensure positive make and break
- Screw terminals or pressure connectors and quad 1/4" quick connects provided on all models for easy installation



Part #	Mfg #	Description	Price
19118 6	WR90244	24 Coil Voltage, 30 Amp	
19119 1	WR90247	24 Coil Voltage, 40Amp	

90 Series 3 Pole Mechanical Contactors

- Any position mounting
- Interchangeable mounting plate
- Low wattage coil
- Double break contacts ensure positive make and break



Part #	Mfg #	Description	Price
19352 9	WR90170	24 VAC Coil Voltage, 40 Amp	

94 Series 1.5 Pole Mechanical Contactors

- Replaces many contactors used by OEM's
- Universal style mounting bracket fits existing mounting holes
- Screw terminals and 1/4" quick connect terminals for easy installation



Part #	Mfg #	Description	Price
19119 5	WR94388	24 VAC Coil Voltage 30 Amp	
19833 1	WR94394	24 VAC Coil Voltage 40 Amp	

WR/RBM Type 91 Relays

- A Two Pole Double Throw Semi-Enclosed Relay
- 90-340 Fits Fan Control Centers 90-112, 90-113, 90-118E and 90-119
- Easy to install.
- Suited for use in vending machines, appliances, heating and air conditioning applications and general purpose switching.



Part #	Mfg #	Description	Price
22288 0	WR90340	24 Coil Voltage	
19119 2	WR90341	115/120 Coil Voltage	
19119 3	WR90342	208/240 Coil Voltage	

WR/RBM Type 184 Relays

- Heavy-Duty General Purpose Relay Operates in Any Position
- Compact, totally enclosed design.
- For heating and cooling applications and general switching.
- Quiet, reliable and economical



Part #	Mfg #	Description	Price
19119 0	WR90370	SPDT 24 Coil Voltage AC	

24 Volt Secondary Class 2 Transformers Energy Limiting

- For Industrial, Heating and Air Conditioning Controls Applications
- Color coded primary leads.
- Multi-mount styles available.



Part #	Mfg #	Description	Price
19117 3	WR90T40F1	120V Foot-Mount	
19117 7	WR90T40M1	120V Universal Multi-Mount	
19328 5	WR90T40M3	120/208/240V Uni Multi-Mount	
19118 9	WR90T75C3	120/208/240V Foot-Mount	

Repair Parts: White Rodgers

90-T Series Energy Limiting 24 VAC Transformer



Part #	Mfg #	Description	Price
19118	WR90T40F3	120/208/240V Foot-Mount	5

24A34 Series Electric Heat Sequencer



Part #	Mfg #	Description	Price
19118	WR24A344	Sequenced Time Delay Relay	2
19118	WR24A343	Sequenced Time Delay Relay	1

Thermostat Guards - Metal

- These Durable Metal Guards are Designed for Government, Military, Industrial and Educational Applications to Prevent Adjustment of the Temperature by Unauthorized Personnel
- Model F29-0220 fits ALL Emerson / White-Rodgers Thermostats.
- Each model furnished with one key and can be mounted vertically or horizontally.
- Tamper-resistant design. 18 gauge cover, 22 gauge frame.
- Beige enamel finish over heavy-duty steel enclosure.
- Models available in a ring or solid base.



Part #	Mfg #	Description	Price
20135	WRF290192	Solid Base Metal	7
19324	WRF290222	Ring Base Metal	3

Thermostat Guards - Plastic

- These Durable Thermostat Guards are Designed for use in Offices, Churches, Restaurants and Other Public Areas to Prevent Adjustment of the Temperature by Unauthorized Personnel



- F29-0198 will accept ALL Emerson / White-Rodgers thermostat types.
- Each model furnished with one key and can be mounted vertically or horizontally.
- Clear plastic models for applications that need the thermostat visible.
- Opaque plastic models for applications that require the thermostat be kept hidden from view.
- Each model furnished with a ring and/or solid wall mounting plate.

Part #	Mfg #	Description	Price
19117	WRF290198	Clear Plastic	2

Wallplate for 90 series Blue Touchscreen thermostats

- 8-1/8"W x 5-3/8"H
- Classic White color
- For use with or without horizontal junction box.



Part #	Mfg #	Description	Price
19752	WRF612600	8-1/8" W x 5-3/8" H	0

Zone Valves - 1300 Series

- Valve Assemblies
- Water Seal Replacement Kit (Quad ring, "O" ring, Tru-arc ring and cotter pin)
- Motor Assemblies



Part #	Mfg #	Description	Price
01205	WRF840434	1" Valve Assemblies	7
08778	WRF840435	1-1/4" Valve Assemblies	9
20267	WRF920227	3/4" Water Seal Replacement	1

Repair Parts: White Rodgers

Universal Media Filter Replacements

- FR- Filter Replacements



Part #	Mfg #	Description	Price
19495	WRFR1400	16" x 26" x 5"	5
19495	WRFR2000	20" x 26" x 5"	6

PG9 Power Generators, 750 Millivolt

- For replacement of similar screw-in type generators now in field and E31-12 pilot burners
- PG9 adapter included
- 36" Armored cable leads with split-spade terminals



Part #	Mfg #	Description	Price
19117	WRG01A332	F Spade Terminal	4

H06E / F Series Universal Replacement Thermocouples

- Specially Designed for Universal Replacement. Thermocouples are Priced Individually, Order Only in Multiples of 10
- Stainless steel element construction for prolonged thermocouple life.
- Each kit individually enclosed in plastic.
- Universal adapter fittings included with each kit for replacing thermocouple in most types of pilot burners.
- Visible instructions for quick, easy installation.
- Available in a variety of 10-packs in desired thermocouple lengths.
- Standard thermocouple 11/32" double lead thread.
- Replaces Honeywell Q34A, Johnson K19, Robersshaw 1980 and White-Rodgers H06E.



Part #	Mfg #	Description	Price
19116	WRH06E18	18" thermocouple	7
19116	WRH06E30	30" thermocouple	9

Repair Parts (Continued)

H06E / F Series Universal Replacement Thermocouples

Part #	Mfg #	Description	Price
19117	WRH06E36	36" thermocouple	0
19117	WRH06E48	48" thermocouple	1

Universal Two-Stage HSI Integrated Variable Speed (ECM) Furnace Control Kit

- Kit Includes:
- Ignition Control Module
- Wiring Harnesses for Amana/Goodman
- Universal 120V Nitride Ignitor Kit - 21D64-2
- Installation Instructions and OEM Cross-Reference



Part #	Mfg #	Description	Price
20287	WR21V51U843	2 Stage HSI	5

36H Series Gas Valves

- Combination Multi-function Controls for a Wide Range of Applications.
- The 36H Combination Gas Control Valve is a Versatile Multifunction
- Control Designed to Meet the Requirements for Use with Intermittent
- Ignition Systems (Direct Ignition, Proven Pilot, HSI). 36H is Our
- Highest Capacity Combination Gas Valve
- Adjustable regulator.
- Quiet operation redundant design.
- Inlet/outlet screens.
- Tamper resistant screws.



Part #	Mfg #	Description	Price
20285	WR36H32423	24 Volt 3/4"	1

Repair Parts: White Rodgers

Humidifier Timer

- The White-Rodgers A02-0815-017 installation package includes:
- Flushing timer
- Power cord with AC adapter (plugs in to a 120v outlet)
- 15 feet of 3/8" ID tubing
- Mounting hardware
- Installation instructions
- Fittings and tubing clamps for installation on White-Rodgers units, as well as on other manufacturers humidifiers.



Part #	Mfg #	Description	Price
20301	WRA02081501	Humidifier Timer	
9	7		

Key For F29 Thermostat Guards

- Key For F29 Thermostat Guards (Bag of 2)



Part #	Mfg #	Description	Price
19899	WRF1450999	2 Keys	
9			

Compact Zone Valves 13A00 Series - Power Head

- Includes Seal Ring
- For 2-way Zone Valves
- Includes auxiliary switch
- 24 VAC Power Head for 2 Way 13A00 Zone Valve with Conduit Hub for 13A02-101 & 13A02-102



Part #	Mfg #	Description	Price
24275	F19-0187	24 VAC Power Head	
7			

Board Mount Limit Controls

- 1/2" Bimetal Disc with Ranges for Your System Needs
- Proven reliability in a compact, versatile, cost-effective design.
- Provides high-speed contact separation.
- OEM replacement for competitive models.



Part #	Mfg #	Description	Price
24299	WR3L098	180 Opens/160 Closes °F	
9			
24300	WR3L0910	200 Opens/160 Closes °F	
0			

1/2" Disc Manual Reset Flame Rollout Limit Switches

- This new line of limit switches complements our existing line of 1/2" automatic (3F11) fan controls & (3L11) limit controls and are offered in a broad range of temperature limit cut-outs to cover most heating applications.



Part #	Mfg #	Description	Price
24300	WR3L12250	250°F Cut-Out Temperature	
5			
24300	WR3L12300	300°F Cut-Out Temperature	
7			
24300	WR3L12350	350°F Cut-Out Temperature	
8			



Woodford Repair Parts

Yard Hydrant Repair Parts

Part #	Mfg #	Description	Price
011648	10009	Upper Link for Y34/Y1/Y2	
011649	10011	Reducing Coupling for Y1/Y2/Y34/W34	
011658	10100	Packing Nut for Y1/Y2/Y34/W34	
011659	10101	Packing for Y1/Y2/Y34/W34	
011660	10102	Packing Support Washer for Y1/Y2/Y34/W34	
011662	10104	Brass Rod Stem for Y1/Y2/Y34/W34	
011678	15003	3/4 Head Assembly	

Nozzle

Part #	Mfg #	Description	Price
011646	10004	3/4" Brass Hose Nozzle for Y34/Y1/W34/X34/R34	
098547	55437	Nozzle for 70/71/B71/81	

Plunger

Part #	Mfg #	Description	Price
011663	10105	Plunger for Y30/Y34/Y70/Y95/W34	
011664	10106	Plunger for Y1/Y2	

Thermaline® Repair Parts

Thermaline® Parts

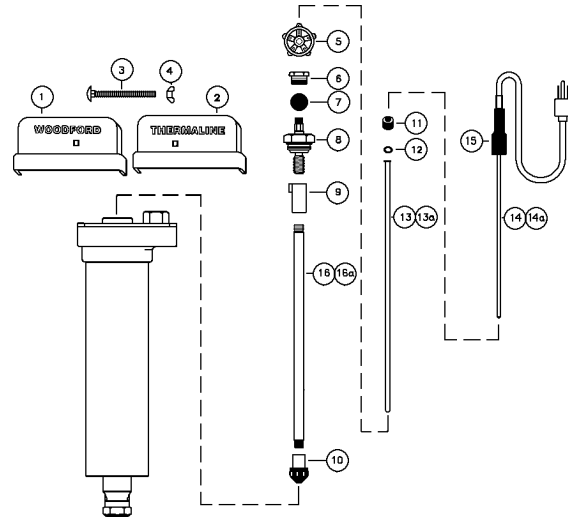

Part #	Mfg #	Description	Price
011747	85015	10 - Combination Valve Ass'y	
011748	85062	14 - 2' Heater Assembly (Includes Item 15)	

Repair Kits

Repair Kit for 14/18 Wall Faucet

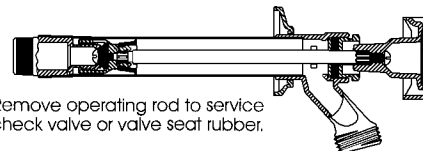

Remove operating rod to service check valve or valve seat rubber.

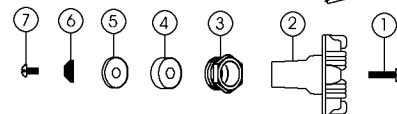

Part #	Mfg #	Description	Price
034143	RK14-MH	Repair Kit for 14/18 Includes 1-7, Metal Hdl	

Woodford Repair Parts

Repair Kit for 17 Wall Faucet

- | | |
|-----------------------|-----------------------------|
| 1. 35301 VB Float Kit | 6. 30421 Packing Washer |
| 2. 30002 Handle Screw | 7. 30418 Check Valve |
| 3. 30099 Handle | 8. 30008 Valve Seat Rubber |
| 4. 30059 Packing Nut | 9. 30009 Retainer Screw |
| 5. 30005 Packing | 10. 30459 Bevel Check Valve |

Remove operating rod to service check valve or valve seat rubber.

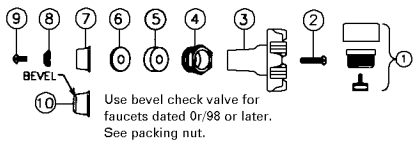

Part #	Mfg #	Description	Price
039455	RK-17	Repair Kit for 17 Includes 1-2, 4-10, 30099 Metal Hdl	

Repair Kit for 22 Wall Faucet

1. 30566 Hot Plug Button
2. 30002 Handle Screw (2)
3. 30096 Round, Die Cast Alum. Wheel Handle (2)
4. 30497 Deep Packing Nut
5. 30560 EPDM Packing (2)
6. 30006 Packing Washer (2)
7. 30565 Cold Plug Button
8. 30059 Packing Nut
9. 30459 Check Valve (2)
10. 30008 Valve Seat Rubber (2)
11. 30009 Retainer Screw (2)

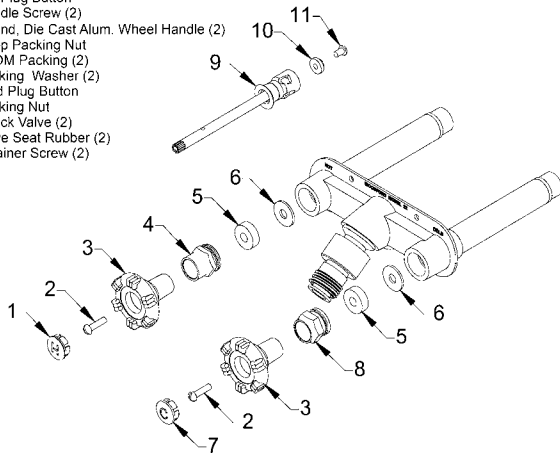

Part #	Mfg #	Description	Price
100876	RK-22MH	Repair Kit for 22 w/Metal Handle	

Repair Kit for 25/27H Wall Faucet



Part #	Mfg #	Description	Price
032340	RK-25	Wheel Handle Repair 5/16" Square Shank	

Repair Kit for 65 Wall Hydrant

- | | |
|----------------------|---------------------|
| 1. 50009 Tee Key | 5. 50251 "C" Washer |
| 2. 50264 Head Nut | 6. 51014 Yoke Nut |
| 3. 50252 Stem Washer | 7. 50250 Plunger |
| 4. 55062 Stem Screw | |

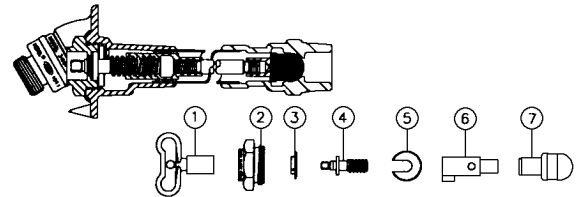

Part #	Mfg #	Description	Price
043118	RK-65	Chrome Repair Kit for 60/65/67 Includes 1-7	

Repair Kit for 70 Wall Hydrant

- | | |
|-------------------------|----------------------------|
| 1. 50009 Tee key | 6. 50027 Support Washer |
| 2. 30109 Packing Nut | 7. 51013 Ball Valve Rubber |
| 3. 30247 Packing | 8. 50028 Round Brass Nut |
| 4. 55177 Head Nut Assy. | |
| 5. 51014 Yoke Nut | |

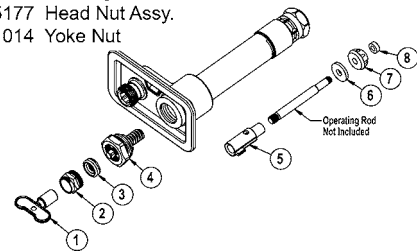

Part #	Mfg #	Description	Price
055079	RK-70	Repair Kit for 70 & Obsolete Models 7/8/80/85/90/95	

Repair Kit for Y34 Yard Hydrant

- | | |
|----------------------|-------------------------|
| 1. 10104 Rod Stem | 4. 10102 Support Washer |
| 2. 10100 Packing Nut | 5. 10105 Plunger |
| 3. 10101 Packing | |

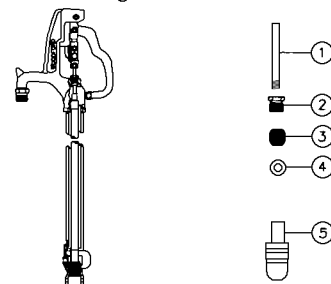

Part #	Mfg #	Description	Price
046472	RK-Y34	Includes 1-5	



Woodford Repair Parts

Individual Parts



WF-MS

Part #	Mfg #	Description	Price
025782	30008	Rubber Valve Seat	
025786	30109	Chrome Packing Nut	
011710	30230	Plunger Assembly for 25	
011712	30238	Stem Screw Delrin for 25	
011716	35280	Drain Valve Assembly for 20/25/27	
011723	50250	Plunger for All Auto Drain Hydrants	
019019	50251	"C" Washer All Auto Drain Hydrants	
024447	50252	Stem Washer for All Auto Drain Hydrants	
011726	51014	Yoke Nut for All Freezeless Wall Hydrants	
011725	51013	Ball Valve Rubber	
112487	RH-MS	Roof Hydrant Mounting System	
116915	WF-MS	Mounting Sleeve for Models: 14, 16, 17 & 19	

Handle

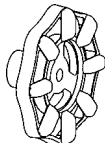

30096

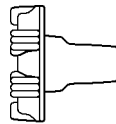

30099

Part #	Mfg #	Description	Price
054339	30096	14/17 Metal Wheel Handle	
011708	30099	14/17/22 Metal Wheel Handle	
095886	30106	24 Unplated Metal Handle	
011711	30233	24 Brown Lexan Wheel Handle	
022301	30239	25 2" Metal Wheel Handle	

Operating Rod Assembly

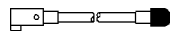

Part #	Mfg #	Description	Price
019023	55412	12" Operating Rod Assembly for Auto Drain 14-5/16" OAL)	

Packing



Part #	Mfg #	Description	Price
072390	30512	Packing Nut with Stem Gd for 14/17	
080502	30560	EPDM Packing for 14/17/22	

Rod Assembly

Part #	Mfg #	Description	Price
043133	35722	8" Wall Rod Assembly for 14/ 17/22/V22	
043888	WH35724	12" Wall Rod Assembly for 14/17/22/V22	

Tee Key



RK-STK

Part #	Mfg #	Description	Price
011719	RK-STK	Tee Key, 1-3/4" Short for 5/16" Square Stem (50009)	
011720	RK-LTK	3-1/4" Long Tee Key for Square Stem (50010)	



Yellow Jacket Repair Parts

Parts

Part #	Mfg #	Description	Price
181738	41042	Titan Blue Handle w/ Screw	
181739	41044	Titan Red Handle w/ Screw	
181745	41080	Series 41 Rebuild Kit	
181746	41083	Brute II Rebuild Kit	
181797	41103	Brute II 3/8" Piston Assy	
181800	41123	1/4" Liquid Charging Adapter	
181801	41131	O-Rings, 10 Pak	
181802	41133	Complete Valve Piston	
181874	49010	2-1/2" Replacement Crystal for 49011, 49012	
181884	49100	3-1/8" Replacement Crystal	
204202	60349	Tension Spring	

Zoeller Repair Parts

Parts & Accessories

Simplex Electrical Control Panel

- Alarm horn
- Terminal strip
- Alarm float only
- NEMA 4X enclosure with hinged cover
- Horn silence switch to turn alarm on or off
- Receptacle for use with piggyback pump switch



Part #	Mfg #	Phase	Panel	Price
207659	10-1019	1	Plug-In	

Gasket



Part #	Mfg #	Description	Price
052983	267007	Gasket - Case/Cover	

Switch Assembly



Part #	Mfg #	Description	Price
028971	004705	M53/98/72 Switch Assembly "50"	
052675	004892	ASM Rack Pk "50/90"AH	

Switch-Mate Piggyback Variable Level Float Switch

Part #	Mfg #	Cord Mounting	Price
103476	10-0034	15' Cord	

Mechanical Float Switch

Part #	Mfg #	Description	Price
153688	10-1881	Standard, 25' Cord	
115761	10-0744	Standard, 20' Cord	

Float Rod Guide Assembly



Part #	Mfg #	Description	Price
192528	034086	Float Rod Guide Assembly	

Arm and Seal Assembly



Part #	Mfg #	Description	Price
052676	004704	Arm & Seal Assembly	

DC Control Charger with Terminals

Part #	Mfg #	Description	Price
166150	152899	DC Charger	

Drill Bits

Shockwave® Driver Bit Sets

SHOCKWAVE™ 9PC 1/2" Deep Well Socket Set

- Includes:
- (1) 3/8" SHOCKWAVE impact socket
- (1) 7/16" SHOCKWAVE impact socket
- (1) 1/2" SHOCKWAVE impact socket
- (1) 9/16" SHOCKWAVE impact socket
- (1) 5/8" SHOCKWAVE impact socket
- (1) 11/16" SHOCKWAVE impact socket
- (1) 3/4" SHOCKWAVE impact socket
- (1) 7/8" SHOCKWAVE impact socket
- (1) 1/4" Hex to 1/2" square adapter



Part #	Mfg #	Description	Price
160302	49-66-4484	SHOCKWAVE™ 1/2" Deep Well Socket Set (9 PC)	

Shockwave™ 12PC Impact Drive Guide Set

- Includes:
- (1) ECX™ Bit 1" #1
- (1) ECX™ Bit 1" #2
- (2) Phillips Bit 1" P2
- (1) Phillips Bit 1" P3
- (1) Slotted Bit 1" SL 1/4"
- (1) Slotted Bit 1" SL 3/16"
- (1) Square Bit 1" SQ2
- (1) TORX® Bit 1" T15
- (1) TORX® Bit 1" T20
- (1) TORX® Bit 1" T25
- (1) SHOCKWAVE™ 3 Magnetic bit tip holder



Part #	Mfg #	Description	Price
164158	48-32-4507	12PC Impact Drive Guide Set	

18PC Shockwave™ Driver Bit Set

- Includes:
- (1) Phillips bit 1" P1
- (1) Phillips bit 1" P2
- (1) Phillips bit 1" P3
- (1) Slotted bit 1" SL 1/4"
- (1) Slotted bit 1" SL 3/16"
- (1) Square bit 1" SQ1
- (1) Square bit 1" SQ2
- (2) Phillips bit 2" P2
- (1) Phillips bit 2" P3
- (2) Square bit 2" SQ2
- (1) Square bit 2" SQ3
- (1) TORX® 2" T15
- (1) TORX® bit 2" T20
- (1) 3 1/2" Phillips #2
- (1) 3 1/2" Square drive #2
- (1) Case with bulk storage container
- (1) SHOCKWAVE™ magnetic bit holder



Part #	Mfg #	Description	Price
161626	48-32-4403	18-Pc Driver Bit Set	

29-Piece Shockwave® Impact Duty™ Driver Bit Set

- Includes:
- Phillips bits:
1" - (1) P1, (7) P2, (2) P3;
2" Power - (2) P2, (1) P3
- Square bits:
1" - (1) SQ1, (4) SQ2, (1) SQ3
2" Power - (2) SQ2
- Torx® bits:
1" - (1) T15, (1) T20, (1) T25
- Magnetic nut drivers: (1) 1/4" red, (1) 5/16" amber, (1) 3/8" blue
- (1) Magnetic bit holder
- (1) Case with bulk storage container



Part #	Mfg #	Description	Price
137578	48-32-4401	29-Pc Driver Bit Set	

26-Piece Shockwave™ Drive and Fasten Set

- Includes:
- Phillips bits:
1" - (1) P1, (1) P2, (3) P3
2" - (1) P2
- Square bits:
1" - (1) SQ1, (2) SQ2,
(1) SQ3
2" - (1) SQ2
- Torx® bits:
1" - (2) T20, (2) T25, (1) T30
2" - (1) T20, (1) T25
- 1/4" Hex to 3/8" square adapter (1)
- 1/4" Magnetic nut driver (1)
- Slotted bit 1" SL 3/16" (1)
- Drive Sockets:
(1) 3/8" Drive: 1/2" Socket,
(1) 3/8" Drive: 9/16" Socket
- Magnetic nut drivers:
(1) 3/8" Magnetic nut driver,
(1) 5/16" Magnetic nut driver
(1) Shockwave™ compact magnetic bit holder



Part #	Mfg #	Description	Price
173708	48-32-4408	26-Pc Drive and Fasten Set	

Drill Bits

32-Piece Shockwave™ Driver Bit Set

- Includes:
 - Magnetic nut driver:
(1) 1/4", (1) 5/16"
 - Phillips bits:
1" (1) P1, (4) P2, (1) P3
2" (2) P2
 - Phillips reduced 1" PR2 bit
 - Slotted:
1" (1) #8, (1) #10
2" (1) #10
 - Square bits:
1" (1) SQ1, (3) SQ2, (1) SQ3
2" (1) SQ2
 - Torx® bits:
1" (1) T15, (2) T20, (2) T25, (1) T30
2" (1) T20, (1) T25



Part #	Mfg #	Description	Price
173709	48-32-4004	32-Pc Driver Bit Set	

35-Piece Shockwave® Impact Duty™ Driver Bit Set

- Includes:
 - ECX™: 1" - (1) ECX1, (1) ECX2
 - Phillips bits:
1" (1) P1, (2) P2, (1) P3;
2" Power: (1) P1, (1) P2
3-1/2" Power: (1) P2
 - Square bits:
1" (1) SQ1, (2) SQ2, (1) SQ3
2" Power: (1) SQ1, (1) SQ2, (1) SQ3
3-1/2" Power: (1) SQ2
 - Torx® bits:
2" Power: (1) T15, (1) T20, (1) T25, (1) T30
 - Slotted bits:
2" Power: (1) SL1/8", (1) SL3/16", (1) SL1/4"
 - Magnetic nut drivers: (1) 1/4" red, (1) 5/16" amber,
(1) 3/8" blue
 - Hex Shank Drill Bits:
1/4" (1) 1/8", (1) 5/32", (1) 3/16", (1) 7/32", (1) 1/4"
 - Socket adapters: (1) 1/4" hex shank to 3/8" square
(1) 1/4" hex shank to 1/2" square
 - (1) Magnetic bit holder
 - (1) Case with bulk storage container



Part #	Mfg #	Description	Price
140584	48-32-4402	35-Pc M/E Drill & Drive Set	

40-PC Shockwave™ Drill & Drive Set

- Includes:
 - (1) 1/2" Socket adapter
 - (1) 1/4" Magnetic nut driver
 - (1) 1/4" Shockwave Hex drive bit
 - (1) 1/8" Drill bit
 - (1) 3/16" Shockwave Hex drive bit
 - (1) 3/8" Magnetic nut driver
 - (1) 3/8" Socket adapter
 - (1) 5/16" Magnetic nut driver
 - (1) Shockwave™ Compact magnetic bit holder
 - Hex bits:
1" (1) 1/4", (1) 1/8", (1) 3/16", (1) 5/32"
 - Phillips bits:
1" (1) P1, (2) P2, (1) P3
2" (4) P2, (1) P3
 - (1) Phillips reduced 1" PR2 bit
 - Slotted bits:
1" (1) #10, (1) #8
2" (1) #10
 - Square bits:
1" (1) SQ1, (2) SQ2, (1) SQ3
2" (1) SQ2, (1) SQ3
 - TORX® BITS:
1" (1) T15, (1) T20, (2) T25
2" (1) T20, (2) T25



Part #	Mfg #	Description	Price
173711	48-32-4006	40-Pc Driver Bit Set	

SHOCKWAVE™ Impact Security Insert Bit Set - 9PC

- Includes:
 - (1) T20 Security Insert Bit
 - (2) T25 Security Insert Bit
 - (1) T30 Security Insert Bit
 - (1) Hex Bit 1" 1/8"
 - (1) Hex Bit 1" 5/32"
 - (1) Spanner Bit 1" #10
 - (1) Clutch G Bit 1" 3/16"
 - (1) Clutch G Bit 1" 5/32"



Part #	Mfg #	Description	Price
237358	48-32-4620	9-Pc Incert Bit Set	

Drill Bits

10-PC SHOCKWAVE™ Torx® Security Insert Bit Set

- Includes:
- (1) T7 Security Insert Bit
- (1) T8 Security Insert Bit
- (1) T9 Security Insert Bit
- (1) T10 Security Insert Bit
- (1) T15 Security Insert Bit
- (1) T20 Security Insert Bit
- (1) T25 Security Insert Bit
- (1) T30 Security Insert Bit
- (1) T40 Security Insert Bit



Part #	Mfg #	Description	Price
237356	48-32-4618	10-Pc Insert Bit Set	

36-Piece Shockwave™ Driver Bit Set

- Includes:
- (1) 1/4" Insert magnetic nut driver
- (1) 3/8" Socket adapter
- (1) 5/16" Insert magnetic nut driver
- (1) Shockwave™ 6" Magnetic bit tip holder
- (1) Shockwave™ Compact magnetic bit holder
- Hex bits:
- 1" (1) 1/4", (1) 1/8", (1) 3/16", (1) 3/32", (1) 5/32", (1) 5/64", (1) 7/64", (1) 9/64"
- Phillips bits:
- 1" (1) P1, (3) P2, (1) P3
- (1) Phillips reduced 1" PR2 bit
- Slotted bits:
- 1" (2) #10, (1) #12, (1) #8
- Square bits:
- 1" (1) SQ1, (1) SQ3
- Torx® bits:
- 1" (1) T10, (1) T15, (2) T20, (2) T25, (1) T27, (1) T30, (1) T40



Part #	Mfg #	Description	Price
173710	48-32-4005	36-Pc Driver Bit Set	

10-Piece SHOCKWAVE™ RED HELIX™ Titanium Drill Bit Set

- Includes:
- (1) 1/8" Titanium SHOCKWAVE™ (48-89-4605)
- (1) 9/64" Titanium SHOCKWAVE™ (48-89-4606)
- (1) 5/32" Titanium SHOCKWAVE™ (48-89-4607)
- (1) 11/64" Titanium SHOCKWAVE™ (48-89-4608)
- (1) 3/16" Titanium SHOCKWAVE™ (48-89-4609)
- (1) 7/32" Titanium SHOCKWAVE™ (48-89-4611)
- (1) 1/4" Titanium SHOCKWAVE™ (48-89-4613)
- (1) 5/16" Titanium SHOCKWAVE™ (48-89-4617)
- (1) 3/8" Titanium SHOCKWAVE™ (48-89-4621)



Part #	Mfg #	Description	Price
242614	48-89-4633	10Pc RED HELIX™	

23-Piece SHOCKWAVE™ RED HELIX™ Titanium Drill Bit Set

- Includes:
- (1) 9/64" Titanium SHOCKWAVE™ (48-89-4606)
- (2) 7/64" Titanium SHOCKWAVE™ (48-89-4604)
- (1) 7/32" Titanium SHOCKWAVE™ (48-89-4611)
- (2) 5/64" Titanium SHOCKWAVE™ (48-89-4602)
- (2) 5/32" Titanium SHOCKWAVE™ (48-89-4607)
- (1) 5/16" Titanium SHOCKWAVE™ (48-89-4617)
- (1) 3/8" Titanium SHOCKWAVE™ (48-89-4621)
- (1) 3/32" Titanium SHOCKWAVE™ (48-89-4603)
- (2) 3/16" Titanium SHOCKWAVE™ (48-89-4609)
- (1) 13/64" Titanium SHOCKWAVE™ (48-89-4610)
- (1) 11/64" Titanium SHOCKWAVE™ (48-89-4608)
- (2) 1/8" Titanium SHOCKWAVE™ (48-89-4605)
- (2) 1/4" Titanium SHOCKWAVE™ (48-89-4613)
- (1) 1/2" Titanium SHOCKWAVE™ (48-89-4629)
- (2) 1/16" Titanium SHOCKWAVE™ (48-89-4601)



Part #	Mfg #	Description	Price
219061	48-89-4631	23Pc RED HELIX™	

Drill Bits

SHOCKWAVE™ Impact Deep Well Sockets

- 6 point deep wells for unyielding bit engagement
- Proprietary steel and heat treat process for maximum strength and durability
- Thin wall construction



Part #	Mfg #	Length	Size	Price
235692	49-66-4463	3"	1/2"	
235696	49-66-4467	3"	3/4"	
235701	49-66-4473	3"	1-1/8"	

SHOCKWAVE™ Magnetic Bit Tip Holder



Part #	Mfg #	Size	Price
141230	48-32-4503	3"	
169681	48-32-4508	3" (Guide Sleeve w/ C-Ring)	
188311	48-32-4511	6"	

Titanium SHOCKWAVE™ Drill Bit

- RED HELIX™
- Titanium coating
- 135° Split point
- 1/4" Hex



Part#	Mfg#	Length	Diameter	Price
237346	48-89-4601	2-1/4"	1/16"	
237348	48-89-4606	2.63"	9/64"	
237347	48-89-4603	2.38"	3/32"	
253473	48-89-4613	4.13"	1/4"	
237349	48-89-4621	4.65"	3/8"	
237350	48-89-4629	5.12"	1/2"	

15-Pc Titanium SHOCKWAVE™ Drill Bit Kit

- (1) 1/16" Titanium SHOCKWAVE™ (48-89-4601)
- (1) 5/64" Titanium SHOCKWAVE™ (48-89-4602)
- (1) 3/32" Titanium SHOCKWAVE™ (48-89-4603)
- (1) 7/64" Titanium SHOCKWAVE™ (48-89-4604)
- (2) 1/8" Titanium SHOCKWAVE™ (48-89-4605)
- (1) 9/64" Titanium SHOCKWAVE™ (48-89-4606)
- (1) 5/32" Titanium SHOCKWAVE™ (48-89-4607)
- (2) 3/16" Titanium SHOCKWAVE™ (48-89-4609)
- (1) 7/32" Titanium SHOCKWAVE™ (48-89-4611)
- (1) 1/4" Titanium SHOCKWAVE™ (48-89-4613)
- (1) 5/16" Titanium SHOCKWAVE™ (48-89-4617)
- (1) 3/8" Titanium SHOCKWAVE™ (48-89-4621)
- (1) 1/2" Titanium SHOCKWAVE™ (48-89-4629)



Part #	Mfg #	Description	Price
219060	48-89-4630	15-Piece Kit	

Thunderbolt® Bits

Thunderbolt® Drill Bit Set



Part #	Mfg #	Description	Price
137838	48-89-2803	15-Pc Black Oxide Bit Set	
154239	48-89-2801	21-Pc Black Oxide Bit Set	

Drill Bits

20-Pc Thunderbolt® Titanium Drill Bit Set

- Includes:
- (2) 1/16" Titanium Coated Drill Bit (48-89-2201)
- (2) 5/64" Titanium Coated Drill Bit (48-89-2202)
- (2) 3/32" Titanium Coated Drill Bit (48-89-2203)
- (2) 7/64" Titanium Coated Drill Bit (48-89-2204)
- (2) 1/8" Titanium Coated Drill Bit (48-89-2205)
- (1) 9/64" Titanium Coated Drill Bit (48-89-2206)
- (1) 5/32" Titanium Coated Drill Bit (48-89-2207)
- (1) 11/64" Titanium Coated Drill Bit (48-89-2208)
- (1) 3/16" Titanium Coated Drill Bit (48-89-2209)
- (1) 13/64" Titanium Coated Drill Bit (48-89-2210)
- (1) 7/32" Titanium Coated Drill Bit (48-89-2211)
- (1) 1/4" Titanium Coated Drill Bit (48-89-2213)
- (1) 5/16" Titanium Coated Drill Bit (48-89-2217)
- (1) 3/8" Titanium Coated Drill Bit (48-89-2221)
- (1) 1/2" Titanium Coated Drill Bit (48-89-2229)



Part #	Mfg #	Description	Price
185383	48-89-1105	20-Pc Titanium Bit Set	

14-Pc Thunderbolt® Titanium Drill Bit Set

- Includes:
- (1) 1/16" Thunderbolt® Titanium Drill Bit (48-89-2201)
- (1) 5/64" Thunderbolt® Titanium Drill Bit (48-89-2202)
- (1) 3/32" Thunderbolt® Titanium Drill Bit (48-89-2203)
- (1) 7/64" Thunderbolt® Titanium Drill Bit (48-89-2204)
- (2) 1/8" Thunderbolt® Titanium Drill Bit (48-89-2205)
- (1) 9/64" Thunderbolt® Titanium Drill Bit (48-89-2206)
- (1) 5/32" Thunderbolt® Titanium Drill Bit (48-89-2207)
- (1) 3/16" Thunderbolt® Titanium Drill Bit (48-89-2209)
- (1) 7/32" Thunderbolt® Titanium Drill Bit (48-89-2211)
- (1) 1/4" Thunderbolt® Titanium Drill Bit (48-89-2213)
- (1) 5/16" Thunderbolt® Titanium Drill Bit (48-89-2217)
- (1) 3/8" Thunderbolt® Titanium Drill Bit (48-89-2221)
- (1) 1/2" Thunderbolt® Titanium Drill Bit (48-89-2229)



Part #	Mfg #	Description	Price
146916	48-89-0011	14-Pc Titanium Bit Set	

29-Pc Thunderbolt® Titanium Drill Bit Set

- (1) 1/16" Thunderbolt® Titanium Drill Bit (48-89-2201)
- (1) 5/64" Thunderbolt® Titanium Drill Bit (48-89-2202)
- (1) 3/32" Thunderbolt® Titanium Drill Bit (48-89-2203)
- (1) 7/64" Thunderbolt® Titanium Drill Bit (48-89-2204)
- (1) 1/8" Thunderbolt® Titanium Drill Bit (48-89-2205)
- (1) 9/64" Thunderbolt® Titanium Drill Bit (48-89-2206)
- (1) 5/32" Thunderbolt® Titanium Drill Bit (48-89-2207)
- (1) 11/64" Thunderbolt® Titanium Drill Bit (48-89-2208)
- (1) 3/16" Thunderbolt® Titanium Drill Bit (48-89-2209)
- (1) 13/64" Thunderbolt® Titanium Drill Bit (48-89-2210)
- (1) 7/32" Thunderbolt® Titanium Drill Bit (48-89-2211)
- (1) 15/64" Thunderbolt® Titanium Drill Bit (48-89-2212)
- (1) 1/4" Thunderbolt® Titanium Drill Bit (48-89-2213)
- (1) 17/64" Thunderbolt® Titanium Drill Bit (48-89-2214)
- (1) 9/32" Thunderbolt® Titanium Drill Bit (48-89-2215)
- (1) 19/64" Thunderbolt® Titanium Drill Bit (48-89-2216)
- (1) 5/16" Thunderbolt® Titanium Drill Bit (48-89-2217)
- (1) 21/64" Thunderbolt® Titanium Drill Bit (48-89-2218)
- (1) 11/32" Thunderbolt® Titanium Drill Bit (48-89-2219)
- (1) 23/64" Thunderbolt® Titanium Drill Bit (48-89-2220)
- (1) 3/8" Thunderbolt® Titanium Drill Bit (48-89-2221)
- (1) 25/64" Thunderbolt® Titanium Drill Bit (48-89-2222)
- (1) 13/32" Thunderbolt® Titanium Drill Bit (48-89-2223)
- (1) 27/64" Thunderbolt® Titanium Drill Bit (48-89-2224)
- (1) 7/16" Thunderbolt® Titanium Drill Bit (48-89-2225)
- (1) 29/64" Thunderbolt® Titanium Drill Bit (48-89-2226)
- (1) 15/32" Thunderbolt® Titanium Drill Bit (48-89-2227)
- (1) 31/64" Thunderbolt® Titanium Drill Bit (48-89-2228)
- (1) 1/2" Thunderbolt® Titanium Drill Bit (48-89-2229)



Part #	Mfg #	Description	Price
161240	48-89-0012	29-Pc Titanium Bit Set	

Drill Bits

Thunderbolt® Black Oxide Drill Bit

- Provides longer life and faster drill times
- Parabolic flute clears chips faster
- 135° Split point, precision start no walking



Part #	Mfg #	Diameter	Price
137807	48-89-2710	1/16"	
137808	48-89-2711	5/64"	
137809	48-89-2712	3/32"	
137810	48-89-2713	7/64"	
137812	48-89-2714	1/8"	
137813	48-89-2715	9/64"	
137815	48-89-2716	5/32"	
137816	48-89-2717	11/64"	
137817	48-89-2718	3/16"	
137818	48-89-2719	13/64"	
137819	48-89-2720	7/32"	
137820	48-89-2721	15/64"	
137821	48-89-2722	1/4"	
137822	48-89-2723	17/64"	
137823	48-89-2724	9/32"	
137824	48-89-2725	19/64"	
137825	48-89-2726	5/16"	
137826	48-89-2727	21/64"	
137827	48-89-2728	11/32"	
137828	48-89-2729	23/64"	
137829	48-89-2730	3/8"	
137830	48-89-2731	25/64"	
137831	48-89-2732	13/32"	
137832	48-89-2733	27/64"	
137833	48-89-2734	7/16"	
137834	48-89-2735	29/64"	
137835	48-89-2736	15/32"	
137836	48-89-2737	31/64"	
137837	48-89-2738	1/2"	

Thunderbolt® Aircraft Length Black Oxide Drill Bit

- Provides longer life and faster drill times
- Parabolic flute clears chips faster
- 135° Split point, precision start no walking

Part #	Mfg #	Diameter	Price
138278	48-89-2772	1/4" x 12"	

Bits & Accessories

Flat Boring Bit

- Fluted bit clears chips
- Bores cleaner and faster
- Furnished with hole for use in wire pulling
- Flats for secure chuck grip
- Precision made of high carbon steel



Part #	Mfg #	Description	Price
006918	48-27-0371	3/8" x 6" Flat Boring Bit	
006920	48-27-0501	1/2" x 6" Flat Boring Bit	
006921	48-27-0561	9/16" x 6" Flat Boring Bit	
170327	48-27-0621	5/8" x 6" Flat Boring Bit	
006922	48-27-0751	3/4" x 6" Flat Boring Bit	
006923	48-27-0811	13/16" x 6" Flat Boring Bit	
006924	48-27-0871	7/8" x 6" Flat Boring Bit	
006925	48-27-1001	1" x 6" Flat Boring Bit	
170328	48-27-1121	1-1/8" x 6" Flat Boring Bit	
170329	48-27-1251	1-1/4" x 6" Flat Boring Bit	
170330	48-27-1371	1-3/8" x 6" Flat Boring Bit	
170331	48-27-1501	1-1/2" x 6" Flat Boring Bit	
243046	48-27-0170	3/8" x 16" Flat Boring Bit	

Bull Point SDS Plus Demolition Steel

- Carbide bits/masonry drill bits
- Bull point
- SDS-PLUS shank
- Made from forged high grade steel



Part #	Mfg #	Description	Price
178594	48-62-6010	10"	

Speed Feed Wood Bit

- Up to 10x faster drilling than flat boring bits
- Fast chip removal
- Clean holes
- 1/4" power groove shank fits all 1/4" extensions



Part #	Mfg #	Description	Price
170321	48-13-0048	1/2" x 6" Speed Feed Wood Bit	
170322	48-13-0058	5/8" x 6" Speed Feed Wood Bit	
170323	48-13-0068	3/4" x 6" Speed Feed Wood Bit	

Drill Bits

Bits & Accessories (Continued)

Speed Feed Wood Bit

Part #	Mfg #	Description	Price
170324	48-13-0078	7/8" x 6" Speed Feed Wood Bit	
170325	48-13-0088	1" x 6" Speed Feed Wood Bit	
170326	48-13-0108	1-1/4x6" Speed Feed Wood Bit	
146745	48-13-0400	6-1/2" (4 Pc)	

SHOCKWAVE™ Impact Torx Bits



Part #	Mfg #	Description	Price
164169	48-32-4685	2" T25 (5/Pk)	
247233	48-32-4846	6" T25 (10/Pk)	
219271	48-32-4414	1" T20 (2/Pk)	

SHOCKWAVE™ Lineman's Impact Socket Adapter

- Pin detent design
- Optimized shock zone
- Custom alloy 76 steel
- Fits all 1/2" drive accessories
- Use with Shockwave™ Lineman's 3 in 1 utility sockets



Part #	Mfg #	Size	Price
241167	48-32-5100	7/16" Hex to 1/2" Square Adapter	

Ship Auger Bit

- Hardened, one-face 20° rake angle design
- Nonstick, polished and coated flutes
- Impact-rated shank: Strong enough to use with an impact wrench
- One line of Milwaukee® auger bits covers all applications and tools



Part#	Mfg#	Size	Price
175884	48-13-0683	11/16" x 6"	
169686	48-13-0753	3/4" x 6"	
144979	48-13-0873	7/8" x 6"	
169687	48-13-1003	1" x 6"	

Bits & Accessories (Continued)

Ship Auger Bit

Part#	Mfg#	Size	Price
144980	48-13-1123	1-1/8" x 6"	
221628	48-13-1503	1-1/2" x 6"	
169688	48-13-1253	1-1/4" x 6"	
169693	48-13-6250	1-1/4" x 18"	
144861	48-13-1373	1-3/8" x 6"	

Spur Auger Bit

- Double wing spurs: Allow for fast, clean hole cutting
- Fast chip removal: Nonstick, polished and coated flutes eliminate costly cleaning time
- Impact-rated shank: Strong enough to use with an impact wrench
- One line of auger bits covers all applications and tools



Part#	Mfg#	Size	Price
253472	48-13-0750	3/4" x 6-1/2"	
248133	48-13-0870	7/8" x 6-1/2"	
175885	48-13-1000	1" x 6-1/2"	
145684	48-13-1250	1-1/4" x 6-1/2"	
232417	48-13-1500	1-1/2" x 6-1/2"	

Boring Bit Sets

8-Piece Universal Quik-Lok™ Flat Boring Bit Set

- Includes the Universal Quik-Lok™
- Double wing spurs
- 1/4" Quick change hex shank



Part #	Mfg #	Description	Price
137800	49-22-0175	8-Pc with 6" Extension	

Flat Boring Bit Kit

- Contains (6) popular size flat boring bits in heavy protective plastic
- In pockets for orderly storage and easy size selection



Part #	Mfg #	Sizes Include:	Price
006980	49-22-0071	3/8", 1/2", 5/8", 3/4", 7/8" & 1"	



Drill Bits

6-Piece SPEED FEED Wood Bit Set



Part #	Mfg #	Description	Price
170791	48-13-0600	6-1/2"	

Bit Kits

Contractor's Selffeed Bit Kit

- Includes:
 - (1) Extension
 - (1) 1" Selffeed Bit
 - (1) 1-1/8" Selffeed Bit
 - (1) 1-1/4" Selffeed Bit
 - (1) 1-1/2" Selffeed Bit
 - (1) 1-3/4" Selffeed Bit
 - (1) 2-1/8" Selffeed Bit
 - (1) 2-9/16" Selffeed Bit
 - (1) 5-1/2" One-Piece Shank and Coupling
 - (1) Carrying Case



Part #	Mfg #	Description	Price
006981	49-22-0130	7-Pc Kit	

Ship Auger Bit 18" Set - 3 PC

- Includes:
 - (1) Carrying case
 - (1) 3/4" Ship Auger bit
 - (1) 1/2" Ship Auger bit
 - (1) 1" Ship Auger bit



Part #	Mfg #	Description	Price
175883	48-13-1000	3-Pc Kit	

Spur Auger Bit 6-1/2" Set - 4PC

- Includes
 - (1) 1" Spur Auger bit
 - (1) 1/2" Spur Auger bit
 - (1) 3/4" Spur Auger bit
 - (1) 7/8" Spur Auger bit



Part #	Mfg #	Description	Price
232418	48-13-4000	4-Pc Kit	

Contractors' Bit Kit

- Assortment of self-feed bits for big hole drilling
- Includes impact resistant carrying case



Part #	Mfg #	Description	Price
006982	49-22-0135	1-3/8", 1-1/2", 2-1/8", 2-9/16"	

Plumbers' Bit Kit

- Includes 5-1/2" 1-piece shank and coupling extension and carrying case
- Includes:
 - Self-feed bits: 1-3/4", 2-1/8" & 2-9/16"
 - Auger bits: 7/8", 1-1/8", 1-1/4" & 1-1/2"



Part #	Mfg #	Sizes Include:	Price
140832	49-22-0065	Auger Bits & Self-feed Bits	

15 Piece Cobalt RED HELIX™ Kit

- 135° split point for precision start
- RED HELIX™ Design for Rapid Chip Removal™
- Secure Grip™
- Includes:
 - (1) 9/64" COBALT RED HELIX™ Drill Bit (48-89-2306)
 - (1) 7/64" COBALT RED HELIX™ Drill Bit (48-89-2304)
 - (1) 7/32" COBALT RED HELIX™ Drill Bit (48-89-2311)
 - (1) 5/64" COBALT RED HELIX™ Drill Bit (48-89-2302)
 - (1) 5/32" COBALT RED HELIX™ Drill Bit (48-89-2307)
 - (1) 5/16" COBALT RED HELIX™ Drill Bit (48-89-2317)
 - (1) 3/8" COBALT RED HELIX™ Drill Bit (48-89-2321)
 - (1) 3/32" COBALT RED HELIX™ Drill Bit (48-89-2303)
 - (1) 3/16" COBALT RED HELIX™ Drill Bit (48-89-2309)
 - (2) 1/8" COBALT RED HELIX™ Drill Bit (48-89-2305)
 - (2) 1/4" COBALT RED HELIX™ Drill Bit (48-89-2313)
 - (1) 1/2" COBALT RED HELIX™ Drill Bit (48-89-2329)
 - (1) 1/16" COBALT RED HELIX™ Drill Bit (48-89-2301)



Part #	Mfg #	Description	Price
224696	48-89-2331	15-Pc Cobalt Red Helix	

Drill Bits

42-PC Driver Bit Set

- TORX® Bit
(1) 2" T25, (1) 2" T20, (1) 1" T30, (1) 1" T25, (1) 1" T20
(1) 1" T15, (1) 1" T10, (1) 2" T15
- Square Bit
(1) 3-1/2" SQ2, (1) 2" SQ3, (1) 2" SQ2, (1) 1" SQ3
(6) 1" SQ2, (2) 1" SQ1
- Slotted Bit
(1) SL 2" 1/4", (1) 2" SL 3/16", (1) 1" SL 3/16",
(1) 1" SL 1/8", (1) 1" SL 1/4"
- Phillips Bit
(1) 3-1/2" P2, (1) 2" P3, (1) 2" P2,
(1) 1" P3, (6) 1" P2, (2) 1" PR2
- HEX Bit
(1) 1" 3/16", (1) 1" 1/4"
- Magnetic drive guide



Part #	Mfg #	Description	Price
219316	48-32-1551	42-Pc Driver Bit Set	

95-PC Drill & Drive Set

- Includes:
- (1) 1/16" Thunderbolt Black Oxide Drill Bit
- (1) 1/4" Magnetic Nut Driver
- (1) 1/4" Thunderbolt Black Oxide Drill Bit
- (1) 1/8" Thunderbolt Black Oxide Drill Bit
- (1) 3/16" Thunderbolt Black Oxide Drill Bit
- (1) 3/32" Thunderbolt Black Oxide Drill Bit
- (1) 5/16" Magnetic Nut Driver
- (1) 5/32" Thunderbolt Black Oxide Drill Bit
- (1) 5/64" Thunderbolt® Black Oxide Drill Bit
- (1) 7/64" Thunderbolt Black Oxide Drill Bit
- (2) Hex Bit 1" 1/16"
- (2) Hex Bit 1" 1/4"
- (2) Hex Bit 1" 3/16"
- (1) Hex Bit 1" 5/32"
- (1) Hex Bit 1" 9/64"
- (2) Hex Bit 1" 1/8"
- (2) Hex Bit 1" 3/32"
- (2) Hex Bit 1" 5/64"
- (2) Hex Bit 1" 7/64"
- (1) Magnetic Drive Guide
- (3) Phillips Bit 1" P1
- (10) Phillips Bit 1" P2
- (4) Phillips Bit 1" P3
- (3) Phillips Bit 1" PR2
- (1) Phillips Bit 2" P2
- (1) Pozidrive Bit 1"
- P2(1) Pozidrive Bit 1"
- P3(2) Slotted Bit 1" SL 1/4"
- (2) Slotted Bit 1" SL 1/8"
- (2) Slotted Bit 1" SL 3/16"
- (2) Slotted Bit 1" SL 7/64"
- (1) Slotted Bit 1" SL 9/32"
- (1) Slotted Bit 2" SL 3/16"
- (3) Square Bit 1" SQ1
- (8) Square Bit 1" SQ2
- (3) Square Bit 1" SQ3
- (1) Square Bit 2" SQ2
- (2) TORX® Bit 1"
- x10(2) TORX® Bit 1" T15
- (3) TORX® Bit 1" T20
- (3) TORX® Bit 1" T25
- (2) TORX® Bit 1" T27
- (2) TORX® Bit 1" T30
- (2) TORX® Bit 1" T40
- (2) TORX® Bit 1" T9
- (1) TORX® Bit 2" T20
- (1) TORX® Bit 2" T25



Part #	Mfg #	Description	Price
219317	48-89-1561	95-Pc Drill and Drive Set	



Drill Bits

Drill Accessories

Bellhanger Bit

- Aggressive tip geometry for faster drilling
- Coated flutes for fast chip removal
- Wire pulling hole
- 3-Flat shank



Part #	Mfg #	Dia	OAL	Price
138408	48-13-7125	1/4"	12"	
140014	48-13-7225	1/4"	18"	
169696	48-13-7237	3/8"	18"	
169821	48-13-7231	5/16"	18"	
138666	48-13-7325	1/4"	24"	
153612	48-13-7337	3/8"	24"	

Centering Bit

- Use with SDS-MAX and spline 1-Pc core bits to start drilling
- Centering tip to reduce bit walking and create exact spot drilling



Part #	Mfg #	Description	Price
189747	48-20-5495	For 1Pc Core Bits	

Hole Saw Accessories

Rotary Hammer Bit

- SDS Shank



Part #	Mfg #	Size	Price
240801	48-20-7400	5/32" x 2" x 4"	
137647	48-20-7410	3/16" x 2" x 4"	
137648	48-20-7411	3/16" x 4" x 6"	
137649	48-20-7430	1/4" x 2" x 4"	
137650	48-20-7431	1/4" x 4" x 6"	
137651	48-20-7441	5/16" x 4" x 6"	
137652	48-20-7451	3/8" x 4" x 6"	
137653	48-20-7471	1/2" x 4" x 6"	

Switchblade™ Selfeed Bit



Part #	Mfg #	Description	Price
235679	48-25-5125	1-1/2"	
235680	48-25-5135	2"	

Selfeed Bit

- Faster, more accurate drilling
- Clean holes
- Long-lasting performance



Part #	Mfg #	Description	Price
169683	48-25-1502	Selfeed Bit 1-1/2"	
169684	48-25-2122	Selfeed Bit 2-1/8"	
006904	48-25-1002	Selfeed Bit, 1"	
006905	48-25-1122	Selfeed Bit 1-1/8"	
006906	48-25-1252	Selfeed Bit 1-1/4"	
181958	48-25-1752	Selfeed Bit 1-3/4"	
006910	48-25-2002	Selfeed Bit 2"	
144970	48-25-2252	Selfeed Bit 2-1/4"	
006913	48-25-2562	Selfeed Bit 2-9/16"	
144171	48-25-5120	Selfeed Bit 1-3/8"	
144172	48-25-5140	Selfeed Bit 2-1/8"	
144174	48-25-5150	Selfeed Bit 2-9/16"	
006914	48-25-3621	Selfeed Bit 3-5/8"	
006915	48-25-4621	Selfeed Bit, 4-5/8"	

For 1/2" D-Handle & Larger Model Drill



Part #	Mfg #	Dia	Shank Type	Price
006907	48-25-1371	1-3/8"	7/16" Hex	

Diamond Core Bit Pre-Stress

- Maximum speed
- High quality
- Versatile



Part #	Mfg #	Description	Price
159936	48-17-1060	6" Diamond Core Bit	
246058	48-17-2025	2-1/2" Diamond Wet Core Bit	
246059	48-17-2040	4" Diamond Wet Core Bit	

Drill Bits

Switchblade™ 5-Piece Plumbers' Kit

- Includes:
 - (4) Switchblade™ self-feed bit blades - 1-3/8", 1-1/2", 2-1/8" and 2-9/16"
 - (1) Universal Quik-Lok® extension - 5-1/2" x 7/16"
 - (1) Each replacement blades - 1-3/8", 1-1/2", 2-1/8", and 2-9/16"
 - (4) Feed screws
 - (4) Set screws
 - (1) Hex wrench
 - Removable storage case
 - Compact carrying case with handle



Part #	Mfg #	Description	Price
149390	49-22-5100	5-Pc Switchblade Plumbers Kit	

Replacement Switchblades



Part #	Mfg #	Description	Price
170832	48-25-5225	3-Pk, 1-1/2" Diameter	
235681	48-25-5325	10-Pk, 1-1/2" Diameter	
144551	48-25-5420	Single Blade, 1-3/8" Diameter	
179631	48-25-5220	3-Pk, 1-3/8" Diameter	
169678	48-25-5320	10-Pk, 1-3/8" Diameter	
144552	48-25-5440	Single Blade, 2-1/8" Diameter	
146743	48-25-5240	3-Pk, 2-1/8" Diameter	
169549	48-25-5540	3-Pk, 2-1/8" Diameter	
169679	48-25-5340	10-Pk, 2-1/8" Diameter	
245442	48-25-5543	3-Pk, 2-1/4" Diameter	
169680	48-25-5350	10-Pk, 2-9/16" Diameter	
146744	48-25-5250	3-Pk, 2-9/16" Diameter	
169548	48-25-5550	3-Pk, 2-9/16" Diameter	
147445	48-25-5450	Single Blade, 2-9/16" Diameter	

Replacement Feed Screw Kit

- For Switchblade™ selffeed bits
- Up to 2-9/16"
- Faster, more accurate drilling



Part #	Mfg #	Description	Price
150897	48-25-5275	Replacement Feed Screw Kit	

SWITCHBLADE™ Replacement Feed Screw Kit

- For SwitchBlade™ selffeed bits up to 2-9/16"
- Faster, more accurate drilling



Part #	Mfg #	Description	Price
160788	48-25-5280	Replacement Feed Screw Kit	

Step Drill Bits

High Speed Steel Step Drill Bit

- Jam-Free performance
- Rapid Strike™ Tip
- Up to 4X longer bit life
- Up to 50% more holes per battery charge
- Laser-engraved reference marks
- 3-Flat Secure-Grip™ shanks



Part #	Mfg #	Size	# of Steps	Price
169382	48-89-9207	7/8" x 3/8"	1	
169191	48-89-9201	1/8"-1/2" x 1/32"	13	
169381	48-89-9202	3/16" - 1/2" x 1/16"	6	
169186	48-89-9203	1/4" - 3/4" x 1/16"	9	
169187	48-89-9204	3/16" - 7/8" x 1/16"	12	
169351	48-89-9205	1/4" - 1-3/8"	10	
169188	48-89-9206	3/8" - 1/2" x 1/16"	2	
169189	48-89-9208	7/8" - 1-1/8" x 3/8"	9	
169190	48-89-9209	7/8" - 1-1/8"	2	
169383	48-89-9211	7/8" - 1-7/32" x 3/8"	13	
169384	48-89-9212	7/8" - 1-3/8" x 3/8"	5	



Drill Bits

SHOCKWAVE™ Impact Duty™ Step Bit

- The Rapid Strike Tip™
- The optimized SHOCKZONE™
- Titanium Aluminum Nitride (TiAlN) coating



Part #	Mfg #	Size	# of Steps	Price
256703	48-89-9249	7/8" - 1-1/8"	13	

2-Piece Step Drill Bit Set

- Includes:
 - (1) 13-Hole bit (48-89-9100)
 - (1) 9-Hole bit (48-89-9105)



Part #	Mfg #	Description	Price
145131	48-89-9050	2-Pc Step Drill Bit Set	

2-Piece #4 Step Drill Bit Set

- (2) #4 Step Drill Bit, 3/16" - 7/8" by 1/16" (48-89-9204)



Part #	Mfg #	Description	Price
178317	48-89-9234	2-Pc Step Drill Bit Set	

2-Piece #9 Step Drill Bit Set

- (2) #9 Step Drill Bit, 7/8" & 1-1/8" (48-89-9209)



Part #	Mfg #	Description	Price
178318	48-89-9239	2-Pc Step Drill Bit Set	

3-Piece Step Drill Bit Set

- Includes:
 - (1) 6-Hole bit (48-89-8955)
 - (1) 9-Hole bit (48-89-9105)
 - (1) 13-Hole bit (48-89-9100)



Part #	Mfg #	Description	Price
145130	48-89-8990	3-Pc Step Drill Bit Set	

6-Piece Step Drill Bit Set

- Includes:
 - (1) #9 Step Drill Bit, 7/8" & 1-1/8" (48-89-9209)
 - (1) #8 Step Drill Bit, 1/2" - 1" by 1/16" (48-89-9208)
 - (1) #7 Step Drill Bit, 7/8" Single Hole (48-89-9207)
 - (1) #6 Step Drill Bit, 3/8" & 1/2" by 1/16" (48-89-9206)
 - (1) #4 Step Drill Bit, 3/16" - 7/8" by 1/16" (48-89-9204)
 - (1) #1 Step Drill Bit, 1/8" - 1/2" by 1/32" (48-89-9201)
 - (1) Carrying Case



Part #	Mfg #	Description	Price
258302	48-89-9224	6-Pc Step Drill Bit Set	

SHOCKWAVE™ Impact Duty™ ELECTRICAL KIT (#1, #4, #9)

- Electrical step bits
- Titanium Aluminum Nitride (TiAlN) coating
- A dual spiral flute combined with the Rapid Strike Tip™



Part #	Mfg #	Description	Price
255240	48-89-9257	3-Pc Step Drill Bit Set	

SDS Bits and Accessories

One Piece SDS-MAX Core Bit



Part #	Mfg #	Size	Price
242436	48-20-5412	2-5/8" x 11-3/8"	
243816	48-20-5470	3-1/8" x 11-3/8"	
243817	48-20-5482	4" x 11-3/8"	

Drill Bits

SDS Bits and Accessories (Continued)

One Piece SDS-MAX Core Bit

Part #	Mfg #	Size	Price
243819	48-20-5490	6" x 22"	

One Piece SDS-MAX Tunnel Bit

- Centering tip
- Chisel and raker teeth
- Land and core thickness



Part #	Mfg #	Size	Price
244755	48-20-5312	2-1/8" x 22"	
244756	48-20-5318	2-1/2" x 22"	

Core Bit With Center Bit

- Abrasion-resistant carbide teeth
- Centering bit eliminates slipping
- Use with 11" extension for extra-deep drilling
- Multipurpose SDS-MAX or spline shank: Interchangeable with a variety of drilling heads from 1-1/2" to 5"



Part #	Mfg #	Description	Price
166215	48-20-5092	2-1/8" Core Bit With Center Bit	

SDS-PLUS Thin Wall Carbide Tipped Core Bit

- Thin wall design
- 2" Diameter
- Usable cutting depth 2-13/16"
- Use with 8" or 12" SDS PLUS adapter shanks (48-03-3555, 48-03-3561)
- Use with 7-1/2" extensions 48-95-6075
- Includes core body with guide plate & centering pin



Part #	Mfg #	Description	Price
163505	48-20-5035	SDS-PLUS Thin Wall Carbide Tipped Core Bit 2"	
163506	48-20-5050	SDS-PLUS Thin Wall Carbide Tipped Core Bit 3-1/2"	

SDS PLUS Core Bits

- Asymmetrical carbide teeth for up to 20% faster drilling
- 2" Depth



Part #	Mfg #	Size	Price
247470	48-20-5230	2-9/16"	
254803	48-20-5225	2"	
252463	48-20-5240	3-9/16"	
254804	48-20-5245	4"	

SDS-Max and SPLINE Thick Wall Carbide Tipped Core Bit

- Thick Wall Design
- Use with 12" or 18" SPLINE adapter shanks (48-00-3564, 48-03-3565) and 12" or 18" SDS-Max adapter shanks (48-03-3572, 48-03-3573)
- Use with 7-1/2" extension 48-95-6085
- Includes core body with guide plate & centering pin



Part #	Mfg #	Description	Price
164477	48-20-5130	1-3/4"	
159714	48-20-5140	2-1/2"	
254362	48-20-5145	3"	
155357	48-20-5150	3-1/2"	
162578	48-20-5155	4"	

SDS-Max 4-CUTTER Bit

- SDS-Max shank
- 4-Cutter head
- Highest quality carbide
- Optimized flutes provide fastest debris extraction for faster drilling



Part #	Mfg #	Description	Price
248864	48-20-3916	SDS-Max Bit 5/8" x 7" x 13"	
154017	48-20-3918	SDS-Max Bit 5/8" x 15" x 21"	
220742	48-20-3930	SDS-Max Bit 3/4" x 7" x 13"	
259830	48-20-3953	SDS-Max Bit 1" x 12" x 17"	
220743	48-20-3964	SDS-Max Bit 1-1/8" x 12" x 17"	
232587	48-20-3966	SDS-Max Bit 1-1/8" x 16" x 21"	
247447	48-20-3990	SDS-Max Bit 1-9/16" x 18" x 23"	



Drill Bits

SDS Bits and Accessories (Continued)

SDS-Max 4-CUTTER Bit

Part #	Mfg #	Description	Price
236941	48-20-3992	SDS-Max Bit 1-3/4" x 18" x 23"	

SDS-Plus 2CT Bit

- Enhanced rebar guards
- Breaker points lead to faster drilling speeds
- Variable flute for 20% more holes per charge
- Centering tip for exact spot drilling
- Wear mark indicators
- Reinforced flutes for minimized vibration & max durability



Part #	Mfg #	Description	Price
170315	48-20-7432	SDS-Plus 2CT 1/4" x 6" x 8"	
170316	48-20-7452	SDS-Plus 2CT 3/8" x 6" x 8"	
167611	48-20-7459	SDS-Plus 2CT 3/8" x 22" x 24"	
179485	48-20-7473	SDS-Plus 2CT 1/2" x 8" x 10"	
170317	48-20-7474	SDS-Plus 2CT 1/2" x 10" x 12"	
170318	48-20-7481	SDS-Plus 2CT 9/16" x 4" x 6"	
170319	48-20-7601	SDS-Plus 2CT 5/8" x 4" x 6"	
170320	48-20-7604	SDS-Plus 2CT 5/8" x 10" x 12"	
153951	48-20-7061	SDS-Plus 2CT 3/4" x 6" x 8"	
170314	48-20-7065	SDS-Plus 2CT 3/4" x 10" x 12"	
247469	48-20-7066	SDS-PLUS 2CT 3/4" X 16" X 18"	
142705	48-20-7454	SDS-Plus 2CT 3/8" x 10" x 12"	
247468	48-20-7477	SDS-PLUS 2CT 1/2" X 16" X 18"	

SDS-Plus 4CT MX4™ Bit

- Enhanced rebar guards provide increased durability
- Breaker points lead to faster drilling speeds
- Variable flute for up to 20% more holes per charge in rotary hammers
- Centering tip for exact spot drilling
- Wear mark indicators to show end of life and when bit no longer meets the ANSI requirement
- Reinforced flutes for minimized vibration and maximum durability



Part #	Mfg #	Description	Price
152697	48-20-7206	5/8" x 16" x 18"	
255868	48-20-7246	1" x 16" x 18"	

SDS Bit Assortment

- Includes:
 - 3/16" x 4-1/2"
 - 1/4" x 6"
 - 5/16" x 6"
 - 3/8" x 6"
 - 1/2" x 6"
- SDS Shank
- Carbide



Part #	Mfg #	Description	Price
137655	48-20-7490	5-Pc SDS Bit Set	

SDS Bit - 44 Magnum™ Series

- 4-Fluted spiral shaft



Part #	Mfg #	Bit Dia	Overall Length	Drilling Depth	Price
137646	48-20-7401	5/32"	4"	6"	
137657	48-20-7602	5/8"	6"	8"	

SDS Bit with 1/4" Hex

- 2-Cutter head
- SDS Shank w/ hex shoulder for Tap-Con screw system



Part #	Mfg #	Bit Dia	Overall Length	Drilling Depth	Price
137644	48-20-7091	5/32"	7"	4"	
137645	48-20-7092	3/16"	7"	4"	

Drill Bits

Stop Bit SDS-PLUS

- For use with drop-in anchors
- Stopping shoulder to drill accurate depths repeatedly
- Patented flute geometry to remove debris rapidly and maximize impact energy
- Centering tip to reduce bit walking and create exact spot drilling



Part #	Mfg #	Description	Price
171096	48-20-7651	3/8" x 1-1/16" Stop Bit	
171101	48-20-7653	1/2" x 1-11/16" Stop Bit	
171103	48-20-7655	5/8" x 2-1/16" Stop Bit	
242646	48-20-7652	1/2" x 13/16" Stop Bit	

Spline to SDS-Plus Adapter

- Allows the use of SDS-Max shank accessories in a spline shank rotary hammer



Part #	Mfg #	Description	Price
193588	48-03-3015	Adapter	

SDS-MAX to Spline Adapter

- Allows the use of SPLINE shank accessories in a SDS-Max shank rotary hammer



Part #	Mfg #	Description	Price
238466	48-03-3012	SDS-MAX to Spline Adapter	

SDS Max to SDS Plus Bit Adapter

- Lets you use SDS Plus bits with your SDS Max shank rotary hammer



Part #	Mfg #	Description	Price
160962	48-03-3025	SDS Max to SDS Plus Bit Adapter	

Hammer Drill Bits

Carbide-Tip Hammer Drill Bit

Part #	Mfg #	Description	Price
137662	48-20-8810	1/4" x 2" x 4" with Hex Shank	

Three-Flat Secure-Grip™ Hammer Drill Bit

- Fast drilling, long life
- 3-Flat Secure-Grip™ prevents bit from slipping in the chuck



Part #	Mfg #	Size	Price
137665	48-20-8821	3/8" x 4" x 6"	
137658	48-20-8800	1/8" x 1-1/2" x 3"	
137663	48-20-8811	1/4" x 4" x 6"	
137659	48-20-8801	5/32" x 4" x 6"	
137660	48-20-8805	3/16" x 2" x 4"	
137661	48-20-8806	3/16" x 4" x 6"	
137664	48-20-8816	5/16" x 4" x 6"	
137666	48-20-8830	1/2" x 4" x 6"	
235675	48-20-8840	5/8" x 4" x 6"	
184757	48-20-8812	1/4" x 10" x 12"	

Spline 2 Cutter Drill Bit

- 2-Cutter Head
- Spline Shank



Part #	Mfg #	Bit Drilling Dia Depth	Overall Length	Price
256543	48-20-4064	5/8" 22"	17"	
256546	48-20-4101	1" 22"	17"	

Spline 4 Cutter Drill Bit

- 4-Cutter 4x90° tip geometry
- Spline shank



Part #	Mfg #	Bit Dia	Overall Length	Drilling Depth	Price
189727	48-20-4335	3/4"	16"	11"	
236911	48-20-4400	1-1/4"	22"	17"	
249029	48-20-4419	2"	18"	23"	

Drill Bits

5-Piece, 3-Flat Secure-Grip™ Hammer-Drill Bit Set

- Comprehensive offering with diameters from 1/8" to 1" with lengths up to 18"



Part #	Mfg #	Description	Price
137667	48-20-8851	Bit Hammer-Drill Kit 5-Pc	

3-Flat Secure-Grip™ Hammer Drill Bit Set (7 PC)

- 3-Flat Secure-Grip™ shank
- Includes:
 - (1) 1/8" x 3" 3-Flat Secure-Grip Hammer Drill Bit
 - (1) 5/32" x 6" 3-Flat Secure-Grip Hammer Drill Bit
 - (1) 3/16" x 6" 3-Flat Secure-Grip Hammer Drill Bit
 - (1) 1/4" x 6" 3-Flat Secure-Grip Hammer Drill Bit
 - (1) 5/16" x 6" 3-Flat Secure-Grip Hammer Drill Bit
 - (1) 3/8" x 6" 3-Flat Secure-Grip Hammer Drill Bit
 - (1) 1/2" x 6" 3-Flat Secure-Grip Hammer Drill Bit



Part #	Mfg #	Description	Price
247468	48-20-7477	Bit Hammer-Drill Kit 7-Pc	

Miscellaneous

Diamond Premium Segmented Wheel

- Extended Life
- Fast Cutting
- Designed to be used Wet or Dry



Part #	Mfg #	Description	Price
186478	49-93-7005	4-1/2", Arbor: 7/8", 20mm, 5/8"	

Scraping Chisel

- Made from forged high grade steel



Part #	Mfg #	Description	Price
172488	48-62-2065	2" Scraping Chisel	

SDS MAX Flat Chisels

- SDS-Max Shank
- Made from forged high grade steel



Part #	Mfg #	Size	Price
251004	48-62-4081	1" x 18"	

SDS Demo Flat Chisel



Part #	Mfg #	Description	Price
151866	48-62-6015	SDSPlus 3/4" x 10"	
167377	48-62-4079	SDSMAX Demo 12" Flat Chisel	
186711	48-62-6020	1/2" x 10" Scaling Chisel	
186712	48-62-6030	9-1/2" Tile Chisel	
186713	48-62-6035	9/16" x 7" Mortar Scraper	

SDS MAX Clay Spade Chisels

- Highest quality carbide maximizes material pulverization
- Optimized flutes provide fastest debris extraction for faster drilling



Part #	Mfg #	Size	Price
248863	48-62-4094	4-1/2" x 16-5/8"	

SDS MAX Scaling Chisel

- 1-1/2 inch width x 12 inch overall length
- SDS-Max Shank
- Made from forged high grade steel



Part #	Mfg #	Description	Price
247448	48-62-4082	1-1/2" x 12" Scaling Chisel	

SDS MAX Bull Point Chisel 12"

- Bull Point
- SDS-Max Shank
- 12" overall length
- Made from forged high grade steel



Part #	Mfg #	Description	Price
247449	48-62-4075	Bull Point Chisel 12"	

Drill Bits

SPL/RDHEX Demo Flat Chisel

- Cold Chisel
- Carbide Bits/Masonry Drill Bits



Part #	Mfg #	Description	Price
248633	48-62-2020	1" x 12"	
226835	48-62-2130	1" x 18"	

SDS MAX Floor Scraper



Part #	Mfg #	Size	Price
255237	48-62-4096	6" x 25"	

M12™ Soldering Iron Pointed Tip

- Conical tip, .02" width
- Tip length: 1.55"
- Copper core, nickle and iron Coated
- For use with M12™ soldering iron



Part #	Mfg #	Description	Price
253711	49-80-0400	Soldering Iron Pointed Tip	

M12™ Soldering Iron Chisel Tip

- Conical tip, .02" width
- Tip length: 1.55"
- Copper core, nickle and iron coated
- For use with M12™ soldering iron



Part #	Mfg #	Description	Price
253710	49-80-0401	Soldering Iron Chisel Tip	

Feed and Set Screw Accessory Set

- Includes:
- (5) Feed Screws
- (1) Hex Key
- (3) Set Screws



Part #	Mfg #	Description	Price
169682	48-25-6000	8 Pc Set	

12-Piece 3/8" Drive SAE Socket Set

- Includes:
- (1) 3/8" Drive Roto Ratchet
- (1) 3/8" Deep Well Socket
- (1) 7/16" Deep Well Socket
- (1) 1/2" Deep Well Socket
- (1) 9/16" Deep Well Socket
- (1) 5/8" Deep Well Socket
- (1) 11/16" Deep Well Socket
- (1) 3/4" Deep Well Socket
- (1) 6" Extension
- (1) 3/8" to 1/4" Drive Adaptor
- (1) 3/8" to Hex Adaptor
- (1) Carrying Case



Part #	Mfg #	Description	Price
232445	48-22-9000	12 Pc, 3/8"	

12-Piece 3/8" Drive Metric Socket Set

- Includes:
- (1) 3/8" Drive Roto Ratchet
- (1) 10mm Deep Well Socket
- (1) 12mm Deep Well Socket
- (1) 13mm Deep Well Socket
- (1) 14mm Deep Well Socket
- (1) 15mm Deep Well Socket
- (1) 17mm Deep Well Socket
- (1) 18mm Deep Well Socket
- (1) 19mm Deep Well Socket
- (1) 6" Extension
- (1) 3/8" to 1/4" Drive Adaptor
- (1) 3/8" to Hex Adaptor
- (1) Carrying Case



Part #	Mfg #	Description	Price
232446	48-22-9001	12 Pc, 3/8"	

Drill Bits

Drill Bits

Polished Double Enders Drill Bit

- *Punch style length*
- *Bit at each end*
- *135° Split point*
- *For use on sheet metal*



Part #	Mfg #	Bit Dia	O/A Length	Price
006385	DE1/8	1/8"	2"	
006384	DE1/4	1/4"	2-1/2"	

Flaring Tools

Flaring Tools

Pro-Set® Flaring Tool



- For use on the following tube materials:
 - Copper
 - Aluminum
 - Brass
 - Thin-Wall Steel

Part #	Mfg #	Description	Price
134798	87-FT800FN	R-410A Imperial Block 3/16", 1/4", 5/16", 3/8", 1/2", 5/8", 3/4" with Ratchet	

Flaring Tools

Flaring Tools

Ratchet Flaring Tool

- Ratcheting feed screw handle
- Hardened steel flaring cone, eccentrically mounted in needle bearings



Part #	Mfg #	Model	Type	Sizes	Price
045766	83037	458R	45° SAE Flares	1/8", 3/16", 1/4", 5/16", 3/8", 1/2", 5/8", 3/4"	

Flaring Tool

- Precision designed tool for producing 45° flares in soft copper, brass, aluminum, and mild steel (JIC and Bundy) tubing
- A hardened, smooth cone provides fast, 45° flares either single or double lap
- A single clamp screw provides for easy clamping and removal of tubing



Part #	Mfg #	Model	Type	Sizes	Price
008721	23332	345	45° SAE Flares	3/16", 1/4", 5/16", 3/8", 7/16", 1/2", 5/8"	

Hammer-Type Flaring Tool

- Made of high-grade hardened steel
- Long nose guide that centers tools for smooth, 45° uniform flares



Part #	Mfg #	Model	Water Tube Size	Price
067998	41320	E-45	1/2"	
008618	41330	E-47	3/4"	
008625	41335	E-52	1"	
025807	41345	E-63	1-1/2"	
022441	41350	E-64	2"	

Flaring Tools

Flaring Tools

Deluxe 45° Flaring Tool

- Easy-to-use with four basic steps
- Designed with the new R-410A system
- Automatic tube height gauge
- Multi-faceted burnishing cone produces a burnished flare seat for a positive seal
- Self-centering yoke grips without marring or constricting tube



Part #	Mfg #	For:	Price
182105	60278	1/8"-3/4" O.D.	

Eccentric Cone Flaring Tool

- Large feed screw handle
- Black oxide-finished steel flaring bars are heat-treated
- Recommended for soft materials such as copper and aluminum
- Built-in clutch release to prevent over-torquing



Part #	Mfg #	For:	Price
182107	60295	3/16"-3/4" O.D.	

45° Small Flaring Tool

- Chrome finish
- Forged steel yoke
- Hardened steel flaring bar
- Threaded feed screw and long handle



Part #	Mfg #	For:	Price
238075	60230	1/2"-3/4" O.D.	

Punch-Type Swaging Tool

- Expands one end of copper tubing for connecting same size tubes
- Heat-treated and plated alloy steel
- Made in the USA



Part #	Mfg #	Size	Price
182156	60466	3/8" O.D.	
182158	60469	3/4" O.D.	
182159	60470	7/8" O.D.	

Complete Tubing Expander/Swager Kit

- Heat treated handles and expanding pin
- Use on 0.063" wall soft copper and aluminum to 1-5/8" O.D.
- Use on 0.047" wall soft steel to 7/8" O.D.
- Kit includes six expander heads; three optional sizes sold separately



Part #	Mfg #	Heads For:	Price
182147	60407	3/8", 1/2", 5/8", 3/4", 7/8", 1-1/8" O.D.	

Complete Swage and 45° Flare Kit

- Kit includes:
 - Yoke
 - Deluxe case
 - 6 Swage adapters
 - Flaring cone
 - 2 Flaring bars
- Deeply knurled adapters
- Six hardened and plated alloy steel adapters are interchangeable
- Slip-on self-centering steel yoke has a feed screw with extra long handle
- Flaring bars are hardened and chrome plated



Part #	Mfg #	Description	Price
182152	60440	3/16"-3/4" O.D.	

Work Lights

M12™ Work Lights

M12™ Work Light

- REDLITHIUM™ battery technology
- Compact design
- 90° rotating head
- Integrated magnet



Part #	Mfg #	Length	Voltage	Price
164019	49-24-0145	7"	12V	

M12™ LED Work Light

- REDLITHIUM™ Battery technology
- Sealed aluminum head
- 90° Rotating head
- Magnetic back



Part #	Mfg #	Length	Voltage	Price
137576	49-24-0146	7"	12V	

M12™ TRUEVIEW™ LED Spotlight

- Up to 700 yard beam distance
- 3 Light output modes for distance, clarity, and safety
- High: 750 lumens
- Low: 400 lumens
- Strobe: 800 lumens
- Impact and moisture resistant



Part #	Mfg #	Length	Voltage	Price
181689	2353-20	6.5"	12V	

M12™ LED Lantern/Flood Light

- TRUEVIEW™: High definition lighting technology
- 180° - 360° Adjustable beam
- 2.1A USB Charger
- Rugged design
- Four light settings: High, medium, low, strobe
- Two stainless steel hooks



Part #	Mfg #	Length	Voltage	Price
171826	2362-20	10.6"	12V	

M12™ LED Stick Light (Bare Tool)

- TRUEVIEW™ High definition lighting technology
- Powerful 3-LED design
- Multi-position stainless steel hook
- Over 4+ hours of run-time
- Bright, smooth, even beam pattern
- Impact resistant/replaceable lens



49-24-2351

Part #	Mfg #	Length	Voltage	Price
158985	2351-20	9-1/4"	12V	
158986	49-24-2351	1-3/4"	N/A	

M12™ Compact Flood Light

- High mode: 1,000 Lumens 3.5hrs
- Low mode: 200 Lumens 15hrs



Part #	Mfg #	Length	Voltage	Price
225830	2364-20	7.5"	12V	

M12™ ROCKET™ Dual Power Tower Light

- Light head rotates 210° and pivots 270° for light in any direction
- Collapses down to 31" with three side handles for easy transportation and storage
- 45% smaller footprint than M18™ ROCKET™ tower lights
- Impact resistant, reinforced legs
- Dual Power: Powered by M12 or Extension Cord
- Low battery indicator flashes when battery pack is low
- Protective guard secures head during transport and storage



Part #	Mfg #	Height	Voltage	Price
252843	2132-20	2.7"-5'8"	12V	

Work Lights

M12™ LED Underhood Light

- 1,350 Lumens of TRUEVIEW™ High Definition Output
- FINISHGUARD™ hooks provide lasting protection against scratches to a vehicle's finish
- 2x more gripping surface for maximum hold
- Rotate, slide, remove and hang light bar for added flexibility and versatility
- Mounting Hooks Extend up to 7' on cars and trucks
- Light bar with SS hook
- Sturdy aircraft aluminum frame
- Impact and chemical resistant lens
- 5 Year Tool Warranty



Part #	Mfg #	Description	Price
234818	2125-20	Bare Tool	

M12™ LED Metal Flashlight

- High mode: 800 Lumens, 5 Hrs
- Low mode: 325 Lumens, 7 Hrs



Part #	Mfg #	Description	Price
222067	2355-20	Bare Tool	
222068	2355-21	Kit	

M18™ Work Lights

M18™ Search Light

- 1250 Lumens with 700 yard beam distance
- 198° Head rotation
- Modes: Spot, Flood, Spot/Flood, & Strobe



Part #	Mfg #	Length	Voltage	Price
226122	2354-20	Bare Tool		
226123	2354-21	Kit		

M18™ Cordless LED Work Light

- Sealed, aluminum head
- 160 Lumen LED
- Lasts up to 12 hours on one charge
- Integrated hook
- 135° Rotating head



Part #	Mfg #	Length	Voltage	Price
137577	2735-20	8.5"	18V	

M18™ ROVER™ LED Flood Light

- Trueview: High definition lighting technology
- Up to 30% brighter than corded 250 halogen lights
- Up to 8 hours of run-time
- Innovative roll cage design
- Multiple hanging features: emt hanger, key hole hanger, cross bar hanger, handle hanger



Part #	Mfg #	Length	Voltage	Price
161982	2361-20	8-3/4"	18V	

M18™ ROVER™ Mounting Flood Light

- 1500 lumens up to 20 hours of runtime
- Magnets, 2" spring loaded clamp, & folding rotating light head design
- 3 output modes for optimal brightness and runtime



Part #	Mfg #	Description	Price
240424	2365-20	Bare Tool	

M18™ RADIUS™ Compact Site Light

- Flood mode
- 4-1/4" Hanging hook
- AC inlet for all day runtime
- 3 Area and task output modes
- Dual function: 360° area lighting, 90° flood lighting



Part #	Mfg #	Length	Voltage	Price
244930	2144-20	8"	18V	

Work Lights

M18™ RADIUS™ Site Light with ONE-KEY™

- Low battery indicator
- Plug-in and daisy chain
- Program automatic schedules
- Optimize brightness and runtime
- Set light remotely from up to 100ft
- Integrated two-bay sequential charger
- Integrated tool tracking and security
- 180° and 360° electronic light control



Part #	Mfg #	Description	Price
239064	2150-20	18V	

M18™ RCKET™ LED Tower Light

- 7ft Max extension
- Rotating and pivoting head is extendable from 4-7ft
- Compact 26" footprint w/ low center of gravity
- Three light output modes
 - High: 2,000 lumens
 - Medium: 1,300 lumens
 - Low: 850 lumens
- Impact resistant, reinforced legs



Part #	Mfg #	Height	Voltage	Price
181687	2130-20	4-7 Ft	18V	

M18™ RCKET™ Dual Power Tower Light

- 5 Second setup, 7ft extension
- 2,500 Lumens of TRUEVIEW™ high definition output
- Impact resistant reinforced legs
- Dual Power: powered by M18 or extension cord
- Impact resistant, adjustable light head
- Protective light head guard when stored or in transportation
- Low battery indicator



Part #	Mfg #	Height	Voltage	Price
251797	2131-20	4-7 FT	18V	

M18™ RCKET™ LED Tower Light/Charger

- 5 Second setup, 7 foot extension
- 3,000 Lumens of multidirectional light
- Impact resistant, reinforced legs
- Built in M18™ charger
- Covered AC Plug-in
- 3 Independently pivoting light heads
- Protective guard to secure head and lens during transport and storage
- Compact footprint, low center of gravity
- Low battery indicator



Part #	Mfg #	Height	Voltage	Price
226119	2135-20	4-7 Ft	18V	
226121	2135-21HD	4-7 Ft	18V	

M18™ RCKET™ Dual Pack Tower Light w/ One Key

- 5400 Lumens up to 26 hrs runtime
- 5'5" Extension, collapses to 22"
- Waterproof and dustproof
- Dual batter design: use one or two batteries
- 3 Leg positions
- One key capable
- 3 Output modes
 - High: 5400 Lumens
 - Medium: 3100 Lumens
 - Low: 1600 Lumens
- -HD model includes: 9.0 battery w/ rapid charger



Part #	Mfg #	Height	Voltage	Price
238902	2120-20	22"-65"	18V	
238905	2120-22HD	22"-65"	18V	

Work Lights

M18™ Rover™ LED Dual Power Flood Light

- Three light output modes
- Medium Mode: 1,500 lumens for up to 4 hours with M18™ XC 5.0 Pack
- High Mode: 3,000 lumens for up to 2 hours with M18™ XC 5.0 Pack
- Low Mode: 650 lumens for up to 8 hours with M18™ XC 5.0 Pack
- High Definition Output with true color, even beam, and natural light
- Dual Power Source: M18™ or Corded
- Light Head rotates 240° with positive stops
- (3) integrated keyholes for hanging horizontally or vertically
- Durable Roll Cage protects light head



Part #	Mfg #	Length	Voltage	Price
181688	2360-20		18V	

M18™ RADIUS™ LED Compact Site Light w/ ONE-KEY™

- Set light remotely from 50ft
- Optimize brightness and runtime
- Program automatic schedule
- Lighting for task, area, and overhead
- High impact polycarbonate lens
- 4,400 Lumens for maximum coverage
- AC in and out: string up to 10 together
- Protected AC plugs self-centering hang hook
- Reinforced hang hole
- 180 and 360 electronic: light control
- Low battery indicator



Part #	Mfg #	Length	Voltage	Price
222799	2146-20		18V	

M18™ LED Stick Light

- TRUEVIEW: High definition lighting technology
- Forward and backward pivoting head
- Rugged design: replaceable lens plate and chemical resistant body
- Two adjustable metal hooks
- Compact design



Part #	Mfg #	Length	Voltage	Price
172034	2352-20	11.6"	18V	

M18™ RADIUS™ LED Compact Site Light



Part #	Mfg #	Length	Voltage	Price
222798	2145-20		18V	

M18™ LED Lantern/Flood Light

- TRUEVIEW: High definition lighting technology
- 180° - 360° Adjustable beam
- 2.1A USB Charger
- Rugged design
- Four light settings: High, medium, low, strobe
- Two stainless steel hooks



Part #	Mfg #	Length	Voltage	Price
171827	2363-20	11.5"	18V	

Complete Flashlights

Penlight

- 6000 Series aircraft aluminum body
- Over 3 hours continuous runtime
- Removable metal clip on/off
- Momentary-on button
- 43 Meter beam distance
- Includes (2) AAA batteries



Part #	Mfg #	Description	Price
238979	2105	Penlight	

Work Lights

325L Focusing Flashlight

- Two light output modes:
High mode: 325 lumens- 5 hours
Low mode: 25 lumens- 18 hours
- 115m (377 ft) beam distance
- Hard anodized, structural grade aluminum body
- Powered by (3) AAA batteries (Included)
- Kit includes:
- Holster



Part #	Mfg #	Description	Price
253813	2107	Bare Tool	
253814	2107S	Kit	

USB Rechargeable Hard Hat Headlamp

- REDLITHIUM™
- LED fuel gauge
- 2FT Micro-USB braided cord
- 7-Position tilting light head
- Flood, spot, & spot/flood beam patterns
—Low, medium, and high modes
- 475 Lumens of TRUEVIEW™ high definition output
- 5 Light output modes for optimal brightness & runtime
- Clips & rubber grips included for hard hat attachment



Part #	Mfg #	Description	Price
238968	2111-21	Hard Hat Headlamp	

USB Rechargeable Flashlight

- REDLITHIUM™
- LED fuel gauge
- 2' heavy duty USB cord
- Removable metal cord
- 155 Meter beam distance
- Spot-flood sliding beam adjustment
- 6,000 Series aircraft aluminum body
- 3 Light output modes: high, low, & strobe
- 700 Lumens of TRUEVIEW™ high definition output



Part #	Mfg #	Description	Price
238967	2110-21	USB Rechargeable 700L Light	

USB Rechargeable Pivoting Flashlight

- REDLITHIUM™
- Fuel gauge
- Three light output modes:
Spot high mode: 500 lumens- 2.5 hours
Flood high mode: 400 lumens- 3 hours
Flood low mode: 100 lumens- 10 hours
- Metal pocket clip
- 2 ft. braided micro-USB cable



Part #	Mfg #	Description	Price
253813	2113-21	USB Rechargeable Pivoting Light	

USB Rechargeable ROVER™ Pocket Flood Light

- REDLITHIUM™
- LED fuel gauge
- Dual magnet clip
- 2FT Micro-USB braided cord
- 2 Light output modes for max brightness or run time
- Lumens of TRUEVIEW™ high definition output
—High (445) and Low (100) modes



Part #	Mfg #	Description	Price
238969	2112-21	Pocket Flood Light	

USB Rechargeable ROVER™ Pivoting Flood Light

- REDLITHIUM™
- Fuel gauge
- Built-in carabiner clip
- Three light output modes:
High mode: 550 lumens- 2.0 hours
Medium mode: 250 lumens- 4.5 hours
Low mode: 100 lumens- 11.5 hours
- 2 ft braided micro-USB cable



Part #	Mfg #	Description	Price
253817	2114-21	USB Rechargeable Pivoting Flood Light	



Work Lights

Replacement Bulbs



49-81-0030



49-81-0090

Part #	Mfg #	Description	Price
141993	49-81-0030	Bulbs for 18V Work Light, 2/Pk	
138845	49-81-0090	LED Upgrade Work Lights	

Flashlights

LED Flashlights

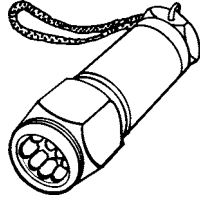

Part #	Mfg #	Description	Price
136007	R319350	Pocket LED Lightstick	

Hammers

Hammers

Smooth Face Framing Hammer

- Shockshield™ Handle
- Most Durable Grip Construction
- Magnetic Nail Set
- I-Beam Handle Construction
- Anti-Ring Claw
- Smooth Face
- Straight Claw



Part #	Mfg #	Size	Price
232892	48-22-9017	16-1/8"L x 5-3/4"W	
232894	48-22-9023	15"L x 6-1/8"W	

Hickory Handle Framing Hammer

- Shock absorbing American hickory
- Axe style curved claw
- Precision balanced design
- Magnetic nail set
- Anti-ring claw design



Part #	Mfg #	Size	Price
253604	48-22-9419	19oz Milled Face	
253605	48-22-9519	19oz Smooth Face	

Smooth Face Poly/Fiberglass Handle Hammer

- Most Durable Fiberglass Handle
- Magnetic Nail Set
- Asymmetrical Anti-Ring Claw
- Smooth Face
- Straight Claw



Part #	Mfg #	Size	Price
232895	48-22-9316	15-1/4"L x 5-5/8"	

Milled Face Framing Hammer

- Shockshield™ Handle
- Most Durable Grip Construction
- Magnetic Nail Set
- I-Beam Handle Construction
- Asymmetrical Anti-Ring Claw
- Milled Face
- Straight Claw



Part #	Mfg #	Size	Price
232893	48-22-9022	22oz	
232891	48-22-9016	17oz	

Hammers

Hammers

Sheet Metal Hammer - Riveting

- Polished finish



Part #	Mfg #	Size	Handle	Head Weight	Price
006477	RH4	4-7/8"	Leather	12 oz	

Sheet Metal Hammer - Setting

- Polished finish



Part #	Mfg #	Size	Handle	Head Weight	Price
006482	SH3	5-1/2"	Leather	18 oz	

Hole Saws

Hole Cutter Kits

Big Hawg® Hole Cutter Kit

- 50X Life in nail embedded wood & abrasive material applications
- 5X Faster cuts
- Thicker backer for extreme life in demanding applications
- Enlarged braze surface for stronger bond to the carbide teeth
- (3) Tooth design for fast aggressive cuts
- Cuts 1000+ more nails
- 10X Larger carbide teeth
- Carbide tipped multi-material pilot bit for increased material versatility
- Cuts wood, nails, shingles, cement board, plaster and more
- Includes:
 - 2-1/8" BIG HAWG™ with Carbide Teeth
 - (1) 2-9/16" BIG HAWG™ with Carbide Teeth
 - (1) 3-5/8" BIG HAWG™ with Carbide Teeth
 - (2) BIG HAWG™ with Carbide Teeth Pilot Bit (49-56-9300)
 - (1) BIG HAWG™ with Carbide Teeth Arbor (49-56-9305)
 - (1) BIG HAWG™ with Carbide Teeth Diamond File (48-09-5055)



Part #	Mfg #	Description	Price
249929	49-56-9280	7-Piece	

Big Hawg® Hole Cutter Kit

- Includes:
 - (1) 2-1/8" BIG HAWG™ with Carbide Teeth
 - (1) 2-9/16" BIG HAWG™ with Carbide Teeth
 - (1) 3-5/8" BIG HAWG™ with Carbide Teeth
 - (1) 4-5/8" BIG HAWG™ with Carbide Teeth
 - (2) BIG HAWG™ with Carbide Teeth Pilot Bit (49-56-9300)
 - (1) BIG HAWG™ with Carbide Teeth Arbor (49-56-9305)
 - (1) BIG HAWG™ with Carbide Teeth Diamond File (48-09-5055)



Part #	Mfg #	Description	Price
248848	49-56-9285	8-Piece	

Big Hawg® Hole Cutter Kit

- Kit Includes:
 - (1) 2-1/8" BIG HAWG™ with Carbide Teeth
 - (1) 2-1/4" BIG HAWG™ with Carbide Teeth
 - (1) 2-9/16" BIG HAWG™ with Carbide Teeth
 - (1) 3" BIG HAWG™ with Carbide Teeth
 - (1) 3-5/8" BIG HAWG™ with Carbide Teeth
 - (1) 4-1/4" BIG HAWG™ with Carbide Teeth
 - (2) BIG HAWG™ with Carbide Teeth Pilot Bit (49-56-9300)
 - (1) BIG HAWG™ with Carbide Teeth Arbor (49-56-9305)
 - (1) BIG HAWG™ with Carbide Teeth Diamond File (48-09-5055)



Part #	Mfg #	Description	Price
249930	49-56-9290	10-Piece	

Hole Saw Kits

Plumber's Ice Hardened™ Hole Saw Kit

- Includes:
 - (6) Hole saws: 3/4", 7/8", 1-1/8", 1-1/2", 1-3/4", 2-1/4"
 - (2) Arbors with pilot bits (49-56-7010 and 49-56-9100)
 - (2) Additional pilot bits (49-56-8010)
 - (1) Adapter (49-56-6560)
 - (1) Spacer (49-67-0120)



Part #	Mfg #	Description	Price
139022	49-22-4145	10-Piece	

Hole Saws

18-Piece Master Plumbers Ice Hardened™ Hole Saw Kit

- Cryogenically treated
- Optimized tooth form for up to 2 times faster cutting
- Wide, angled and offset slots
- Includes:
 - (13) Hole saws - 3/4", 7/8", 1-1/8", 1-3/8", 1-1/2", 1-3/4", 2-1/4", 2-5/8", 3", 3-1/2", 4", 4-1/4", and 4-1/2"
 - (2) Arbors with pilot bits (49-56-7010 and 49-56-9100)
 - (3) Additional pilot bits (49-56-6560)
 - (1) Spacer (49-67-0120)



Part #	Mfg #	Description	Price
139021	49-22-4155	18-Piece	

All Purpose Professional Hole Dozer™ Hole Saw Kit

- Rip Guard™, the strongest tooth form in the industry
- Rip Guard™ limited lifetime tooth break warranty
- Plug Jack™, an all access slot design for fast plug removal
- Bi-metal construction with 8% cobalt for increased wear resistance



49-22-4185

Part #	Mfg #	Description	Price
249351	49-22-4006	9- Piece	
173237	49-22-4142	12-Piece	
144971	49-22-4025	13-Piece	
227494	49-22-4175	15-Piece	
154644	49-22-4185	28-Piece	

8 Pc Refrigeration Hole Dozer™ Hole Saw Kit

- Rip Guard™, strongest tooth form
- Rip Guard™ limited lifetime tooth break warranty
- Plug Jack™ all access slot design for fast plug removal
- Bi-metal construction with 8% cobalt for increased wear resistance



Part #	Mfg #	Description	Price
246026	49-22-4079	8-Piece	

10 Pc Hole Dozer BiMetal Hole Saw Packout Kit

- Equipped with plug jack
- Backed by RipGuard™ limited lifetime tooth break warranty
- Includes PACKOUT(tm) Compact Organizer
- Bi-metal construction with 8% cobalt for increased wear resistance



Part #	Mfg #	Description	Price
258422	49-22-5606	10-Piece	

SHOCKWAVE™ Impact Hole Saw Kit

- 1/4" Quick change hex shank for use with impact drivers
- Thin wall 8 TPI design
- Stop shoulder design prevents over-drilling and damaging components
- Ejection spring automatically removes slugs



Part #	Mfg #	Description	Price
169267	49-22-4800	3-Piece	

Hole Cutters

Big Hawk® Hole Cutter with Carbide Teeth

- 5X Faster cuts
- 3 Tooth design for aggressive cuts
- Thicker backer for extreme life
- Enlarged braze surface for stronger bond to the carbide teeth
- Cuts 1000+ nails
- 10X Larger carbide teeth
- Cuts wood, nails, shingles, cement board, plaster and more



Part #	Mfg #	Diameter	Price
249926	49-56-9200	1-3/8"	
246974	49-56-9210	2-1/8"	
249927	49-56-9215	2-1/4"	
246976	49-56-9220	2-9/16"	
246977	49-56-9225	2-3/4"	
246978	49-56-9230	3"	
246979	49-56-9240	3-5/8"	
246980	49-56-9255	4-1/4"	
249861	49-56-9265	4-5/8"	
249928	49-56-9270	5-1/4"	
249862	49-56-9275	6-1/4"	

Hole Saws

Hole Saws

Carbide Tipped Hole Saws

- Tungsten carbide tipped for long life
- Aggressive tooth form for fast cutting
- Wide, angled & offset slots for easy plug access



Part #	Mfg #	Diameter	Price
165182	49-56-0623	5/8"	
165184	49-56-0873	7/8"	
165186	49-56-1123	1-1/8"	
165189	49-56-1503	1-1/2"	
165190	49-56-1623	1-5/8"	
141827	49-56-1873	1-7/8"	
165196	49-56-2503	2-1/2"	
165202	49-56-2623	2-5/8"	
165205	49-56-3003	3"	
165207	49-56-3503	3-1/2"	
144973	49-56-3623	3-5/8"	
154873	49-56-4003	4"	

Hole Dozer™ with Carbide Teeth



Part #	Mfg #	Hole Dia	Price
246983	49-56-0702	3/4"	
246984	49-56-0704	7/8"	
249969	49-56-0707	1"	
246985	49-56-0708	1-1/8"	
249970	49-56-0710	1-1/4"	
249971	49-56-0712	1-3/8"	
246986	49-56-0713	1-1/2"	
246987	49-56-0717	1-3/4"	
249972	49-56-0719	1-7/8"	
249973	49-56-0720	2"	
165193	49-56-2123	2-1/8"	
246988	49-56-0724	2-1/4"	
249974	49-56-0726	2-3/8"	
249975	49-56-0727	2-1/2"	
246989	49-56-0729	2-5/8"	

Hole Saws (Continued)

Hole Dozer™ with Carbide Teeth

Part #	Mfg #	Hole Dia	Price
165203	49-56-2753	2-3/4"	
165204	49-56-2873	2-7/8"	
246990	49-56-0734	3"	
165206	49-56-3253	3-1/4"	
249976	49-56-0738	3-1/2"	
249977	49-56-0739	3-5/8"	
165208	49-56-3753	3-3/4"	
249978	49-56-0742	4"	
246991	49-56-0744	4-1/4"	
249979	49-56-0746	4-1/2"	
165210	49-56-5003	5"	
165211	49-56-6003	6"	

Hole Dozer™ Hole Saw

- Rip Guard™, the strongest tooth form in the industry
- Plug Jack™, an all access slot design for fast plug removal
- Bi-metal construction for increased wear resistance



Part #	Mfg #	Hole Dia	Price
165164	49-56-0012	5/8"	
152110	49-56-0023	3/4"	
152111	49-56-0032	7/8"	
165165	49-56-0017	11/16"	
152112	49-56-0043	1"	
165166	49-56-0047	1-1/16"	
152113	49-56-0052	1-1/8"	
152114	49-56-0062	1-1/4"	
152115	49-56-0072	1-3/8"	
152116	49-56-0082	1-1/2"	
165167	49-56-0092	1-5/8"	
165178	49-56-0112	1-7/8"	
152119	49-56-0132	2-1/4"	
152117	49-56-0127	2-1/8"	
163909	49-56-0142	2-3/8"	
165168	49-56-0153	2-9/16"	
153383	49-56-0163	2-3/4"	
165170	49-56-0167	2-7/8"	
165171	49-56-0177	3-1/8"	
165172	49-56-0183	3-1/4"	



Hole Saws

Hole Saws (Continued)

Hole Dozer™ Hole Saw

Part #	Mfg #	Hole Dia	Price
165173	49-56-0203	3-3/4"	
152120	49-56-0213	4"	
165174	49-56-0217	4-1/8"	
165175	49-56-0223	4-1/4"	
165176	49-56-0237	4-3/4"	
247209	49-56-9654	5-1/2"	
165177	49-56-0253	6"	
219363	49-56-9656	6"	

Ice Hardened™ Hole Saw

- Ice Hardened™ for up to 50% longer life



Part #	Mfg #	Size	Price
143992	49-56-0102	1-3/4"	
144015	49-56-0117	2"	
144016	49-56-0147	2-1/2"	
150074	49-56-0158	2-5/8"	
144017	49-56-0173	3"	
251763	49-56-0187	3-3/8"	
148183	49-56-0193	3-1/2"	
144018	49-56-0197	3-5/8"	
144019	49-56-0233	4-1/2"	
142700	49-56-0243	5"	
240086	49-56-0247	5-1/2"	

Carbide Grit Hole Saws

- Tungsten carbide grit edge
- Coarse grit & segmented edge
- Includes carbide tipped pilot bit
- Wide, angled & offset slots for easy plug access



Part #	Mfg #	Description	Price
173245	49-56-0426	1-3/8"	

Diamond Plus™ Hole Saw

- Diamond Plus™ greater durability and toughness delivers up to 10X longer life
- Higher grade diamonds and improved braze: Provides best-in class performance
- Large slug ejection slot
- Versatile: Ideal for cutting anchoring and clearance holes in all tile, stone and glass



Part #	Mfg #	Size	Price
170733	49-56-0503	3/16"	
173242	49-56-0505	1/4"	
173243	49-56-0507	5/16"	
233568	49-56-0509	3/8"	
234018	49-56-0511	1/2"	
234019	49-56-0513	5/8"	
173244	49-56-0515	3/4"	
222523	49-56-5625	1-3/8"	
254780	49-56-5660	2-1/2"	

Thin Wall Hole Saw

- 1/4" Quick change hex shank for use with impact drivers
- Thin wall 8 TPI design for 40% faster cuts than standard bi-metal hole saws
- Stop shoulder design prevents over drilling and damaging components
- Ejection spring automatically removes slugs



Part #	Mfg #	Size	Price
169268	49-56-9805	3/4"	
169269	49-56-9810	7/8"	
169270	49-56-9815	1"	
169271	49-56-9820	1-1/8"	
169272	49-56-9825	1-1/4"	
169273	49-56-9830	1-3/8"	
169274	49-56-9835	1-1/2"	

Hole Saws

Adjustable Hole Cutter

- Quik-Lok™ Arbor
- 2" through 7" Diameters with 1/4" Increments
- Black Oxide Coated with Laser Etched Size Indicators
- Durable debris shield



Part #	Mfg #	Description	Price
173825	49-56-0320	Depth of cut: 1"	

Quick Change Steel Plate Carbide Cutter

- For use with quick change arbor 49-57-0035
- 1/2" cutting depth



Part#	Mfg#	Diameter	Price
253374	49-57-8207	7/8"	
253375	49-57-8215	1-1/8"	
253376	49-57-8223	1-3/8"	

HSS Annual Cutters

- Dual alternating tooth geometry
- Multipurpose 3/4" weldon shank
- 15% Faster cutting



Part #	Mfg#	Diameter	Price
254425	49-59-0500	1/2"	

EXACT™ Punch

- Punches conduit holes in both mild and stainless steel
- Gripping surface for quicker threading
- Two-tooth geometry splits slugs



Part #	Mfg #	Description	Price
257265	49-16-2663	3/4"	

Arbors

Small Arbor

- Durable hardened steel construction



Part #	Mfg #	Size Range	Shank Size	Price
007020	49-56-6950	Up to 1-3/16"	1/4"	
007021	49-56-7000	Up to 1-3/16"	7/16"	
144976	49-56-7010	Up to 1-3/16"	3/8"	

Large Quick Change Arbor

- Tool-free operation
- Universal, quick change with all brands of hole saws
- No adapters required
- Hardened steel construction
- Fits all hole saws 1-1/4" and larger
- Fits all drill chucks 3/8" and larger



Part #	Mfg #	Size Range	Shank Size	Price
144975	49-56-7250	1-1/4"+	3/8"	
149219	49-56-9100	1-1/4"+	7/16" No Wobble	
007022	49-56-7055	1-1/4" +	7/16"	

Pilot Drill Bits

Big Hawg® with Carbide Teeth Pilot Bit

- 50X Life in nail embedded wood & abrasive material applications
- Cuts 1000+ more nails
- 5x Faster cuts
- 5/16" Multi material pilot bit
- Carbide tipped for fast drilling in nail embedded wood and abrasive materials
- Exclusive bit geometry aids in plug removal



Part #	Mfg #	Description	Price
246981	49-56-9300	5/16" Multi-Material	

High Speed Steel Pilot Bit

- Thunderbolt® tapered web for added durability
- 135° split point provides accurate hole placement
- 3-Flat shank won't slip in arbor or chuck
- Parabolic flute clears chips faster
- 12/Pk



Part #	Mfg #	Size	Price
007024	49-56-8000	1/4" x 4"	
152121	49-56-8010	1/4" X 3-1/2"	



Hole Saws

Carbide Tipped Pilot Bit

- Tungsten carbide tipped for long life
- Fits all hole saw sizes



Part #	Mfg #	Size	Price
007025	49-56-8005	1/4" x 4"	

Hole Saw Accessories

Big Hawg® Arbor with Carbide Teeth

- Exclusive bit geometry aids in plug removal
- Cuts 1000+ more nails
- Carbide tipped for fast drilling in nail embedded wood and abrasive materials
- 50X Life in nail embedded wood and abrasive material applications
- 5X faster cuts



Part #	Mfg #	Description	Price
246982	49-56-9305	7/16" Quick Change	

Universal Quik-Lok™ Extension

- Accepts all 7/16" shanks
- No tools required for bit change
- Impact rated



Part #	Mfg #	Size	Price
144978	48-28-1000	3" x 1/4"	
152998	48-28-1030	5-1/2" x 7/16"	
147701	48-28-1040	12" x 7/16"	
170804	48-28-1050	18" x 7/16"	
241570	48-28-1060	24" x 7/16"	

Hex-Wrench Bit Extension

- Accepts all 7/16" hex shanks
- For selffeed bits, auger bits and hole saw 1" diameter and larger



Part #	Mfg #	Size	Price
238663	48-28-4016	24" Length	
006928	48-28-4006	12" Length	
177316	48-28-4001	5-1/2" Length	

Hex Extension

Part#	Mfg #	Description	Price
138372	48-28-1010	6" Hex Extension	
138373	48-28-1020	12" Hex Extension	

Right Angle Attachment

- Rated up to 235 in/lbs torque
- Accepts standard 1/4" hex shank bits



Part #	Mfg #	Description	Price
149497	49-22-8510	Right Angle Attachment	

Files

Big Hawg® Diamond File

- Easy re-sharpening on job site



Part #	Mfg #	Description	Price
137897	48-95-5055	Big Hawg® Diamond File	

HVAC Testing Tools

Motor Testers

TECMate Pro ECM Motor Tester

- Analyze ECM motors independent of the HVAC system
- Operates in the basic HVAC settings of fan-only, heating, cooling and de-humidification
- Designed to detect and isolate motor failures from other HVAC system failures



Part #	Mfg #	Description	Price
153548	PD510009	TECMate Pro Motor Tester	

Test Connector

Part #	Mfg #	Description	Price
031520	45-24318-0	Test Connector	
	1		

Circuit Protection Products

ZBreaker Circuit Breaker Set



Part #	Mfg #	Description	Price
141508	ZK005	5 Amp	

Short-Pro Tool™

- Finds 24 volt system shorts
- Automatically resets the breaker
- (2) 18" Leads



Part #	Mfg #	Description	Price
140758	ZSPRT	Short-Finder	

Safety Power Adapters

Zebra'Dapter Fused Power Tap Cord

- Lighted to show voltage level of plug
- Safe way to obtain 120V power to vacuum pumps, charging scales, drop lights, etc.



Part #	Mfg #	Description	Price
140729	ZD002	2' Lighted Female Cordset Blue	
140728	ZD001	2' Lighted Male Cordset Yellow	

Smoke Detector & Accessories

SL-2000 Duct Smoke Detector

- Hi-Temp
- Low-Flow
- No Tools



Part #	Mfg #	Description	Price
118470	SL-2000-N	4-Wire Ionization	

Sampling Tube for SL-2000 & RT-3000 Series



Part #	Mfg #	Description	Price
118471	STN-2.5	12" to 3.0'	

HVAC Testing Tools

Meters

Thermo-Psychrometer

- Large storage area for probes
- TM350 Includes:
 - (1) TMX2A 15' Air probe
 - (1) TMX2G 15' General purpose
 - (1) TMX2S 15' Surface probe



Part #	Mfg #	Description	Price
143080	87-TM350	Four Remote Stations	

Probe for TM350 Thermo-Psychrometer



TMX2S

Part #	Mfg #	Description	Price
143081	87-TMX2C	Clamp-On	
143082	87-TMX2P	Puncture	
143083	87-TMX2S	Surface	

Hardware

Alligator Clip

Part #	Mfg #	Description	Price
140494	455055	1" Black, 6/Pk	
140495	455056	1" Red, 6/Pk	
140496	455057	Alligator Clips with 18 AWG - 36" Test Leads	

Test Lead

Part #	Mfg #	Description	Price
140609	455150	10 AWG, 36" with 10A Clip	

Combustion Analyzer Kits

Testo Residential Combustion Analyzer Kit

- Fast 30-second startup
- Sensor technology
- Integrated probe hose
- Use for:
 - Boiler tuning
 - Checking furnace efficiency
 - Water heater checks
- Measures:
 - Ambient CO
 - Undiluted CO (CO air free)
 - O₂, CO (with built-in NO_x filter), CO₂
 - Draft & pressure temperature
 - Combustion/flue gas efficiency & excess air



Part #	Mfg #	# of Fuels	Price
181036	PD875492	5	

HVAC Testing Tools

Voltage Detectors

Voltage Detector with LED

- Safety rating: CAT IV 1,000V
- Green power on indicator light
- Pocket clip
- Requires (2) AA batteries (included)



Part #	Mfg #	Voltage Range	Price
137565	2202-20	50 to 1,000 AC	

Dual Range Voltage Detector

- Different colors identify voltage range
- Built-in LED work light
- Auto-off
- Pocket clip
- Blade-tip for checking outlets
- Constant power ON LED indicator



Part #	Mfg #	Voltage Range	Price
168492	2203-20	10-1,000 V	

Test & Measurement Tools

Fork Meter for HVAC/R

- Heavy-duty True-RMS electrical tester for professional residential, commercial and industrial applications
- High contrast white-on-black display
- Five tools in one:
 - Current measurement
 - Temperature measurement
 - Voltage measurement
 - Voltage detection
 - Task lighting - LED work light
- Includes:
 - Fork clamp
 - Test leads
 - Dual banana thermocouple
 - (2) AA Batteries
 - Manual
- 5-Year warranty



Part #	Mfg #	Description	Price
137566	2206-20	8" Length, 200A Current AC	

Tru RMS Digital Multimeter

- Wide voltage range to 600VAC/DC
- Auto range to millivolts
- True-RMS for accurate measurement in all applications
- Lo-Z measurement to eliminate ghost voltage
- Frequency measurements from 10Hz to 50kHz
- Contact temperature measurement: -40° to 752°F
- Current measurement to 10AAC/DC
- High contrast white on black display with back light
- Rugged over-molding increases durability and grip
- 5-Year warranty
- Includes:
 - Multimeter
 - Test leads
 - Dual banana thermocouple
 - (2) AA Batteries
 - Manual



Part #	Mfg #	Description	Price
136067	2217-20	6-1/2" L, 10.00A Current AC/DC	

Accessories

Part #	Mfg #	Description	Price
248006	49-77-300	Magnetic Meter Holder	1

Milliamp Clamp Meter

- Measures 4-20 mA without breaking the loop
- Measures 0 to 99 mA
- Secure on-board clamp storage
- Long clamp wire
- Includes:
 - (1) Milliamp clamp meter (2231-20)
 - (1) Carrying case
 - (2) AA Batteries
 - (1) Manual



Part #	Mfg #	Description	Price
253427	2231-20	2-1/2" Length	

HVAC Testing Tools

Clamp Meter for HVAC/R

- *Electrical current tester for professional residential, commercial and industrial applications*
- *1.3" Jaw opening to easily handle large conductors*
- *White-on-black display*
- *LED Work light*
- *Includes:*
 - *Clamp*
 - *Test leads*
 - *Dual banana thermocouple*
 - *(2) AA Batteries*
 - *Manual*
- *5-Year warranty*



Part #	Mfg #	Description	Price
137567	2236-20	9-1/2" Length, 600A Current AC	

Electrical Test Lead Set

- *Works on all digital multimeters, clamp meters and fork meters*
- *Measures up to 1000 volts and 10amps*



Part #	Mfg #	Description	Price
153226	49-77-100	Electrical Test Lead	
	1		

Fluorescent Lamp and Ballast Tester Kit

- *Test lamps, ballast and pins*
- *Non-conductive antenna*
- *Visual and audible tool feedback*
- *2.5' Fully retractable antenna*
- *Removable antenna adapter*
- *Built-in LED flashlight*
- *Dial and buttons positioned for one-handed use*
- *Includes:*
 - (1) *Fluorescent lamp and ballast tester kit (2210-20)*
 - (1) *Antenna adapter*
 - (4) *AA Batteries*
 - (1) *Soft carrying case*
 - (1) *Manual*



Part #	Mfg #	Description	Price
255934	2210-20	Fluorescent Tester	

HVAC Testing Tools

Detectors

Dust Smoke Detector

- Ionization



Part #	Mfg #	Description	Price
118470	849046	Dust Smoke Detector	

Air Products Sampling Tube

- For SL-2000

Part #	Mfg #	Model #	Size	Price
118471	849051	STN-2.5	2-1/2" ft	

Meters & Testers

Vane Anemometer

- Air humidity meter with temperature measurement
- Integrated measurement with 1.5 in. vane
- Timed mean value calculation
- Hold function and max./min. values
- Wind chill calculation for outside areas (perceived temperature)
- Back lit display
- Air humidity measurement with long-term stable Testo humidity sensor
- Incl. dewpoint calculation and wet bulb
- Includes:
 - Integrated humidity measurement and NTC air thermometer
 - Protective cap for safe storage
 - Wrist strap and belt clip
 - (2) Type AAA batteries, 60 hour life
 - Calibration certificate



Part #	Mfg #	Description	Price
143078	875043	Vane Anemometer with Integrated Humidity & NTC Air Thermometer	

Carbon Monoxide Stick Meter

- Detects presence of carbon monoxide in ambient air from gas furnaces, water heaters, and other appliances or equipment
- Visual and audio warnings, adjustable alarm threshold
- No zero phase, instrument can be used immediately
- CO Zeroing on-site
- Self test function



Part #	Mfg #	Description	Price
143084	875036	Includes Leather Holster w/Belt Strap, Earphone, Wrist Strap	

Humidity and Temperature Meter

- Long-term, stable Testo humidity sensor
- +/-2.5 %RH Accuracy
- Hold function and max/min values
- Includes:
 - Protective cap for safe storage
 - Batteries
 - Calibration certificate



Part #	Mfg #	Description	Price
143079	875042	Dewpoint & Wet Bulb Meter	

Electrical

Part #	Mfg #	Description	Price
141560	86-22510	Test Leads	

HVAC Testing Tools

Clamp-On Digital Multimeters

DL389 G2 Phoenix Pro+ Clamp-On Multimeter

- Dual display and low battery display lock
- Test lead storage and holder on clamp head
- Auto off
- Input jack lock
- Detachable clamp head
- Worklight
- Magnetic mount
- User temperature calibration
- EasyView high contrast backlight display
- Compatible with common industry accessories heads
- Safety compliance CAT III 600V, CAT II 1000V
- Includes:
 - Test leads
 - K-Type probe (no adapter required)
 - Zippered case
 - (2) AAA Batteries
- 3-Year limited warranty



Part #	Mfg #	Description	Price
269508	DL389B	12 Functions Including TRUE-RMS (AC Volts & Amps)	

Thermometers

550B Digital Pocket Thermometer

- Water resistant
- Records minimum & maximum temperatures
- Protective boot
- Magnetic mount
- HOLD freezes the current temp reading
- Auto power off
- Ergonomic designed head
- 3-Year limited warranty



Part #	Mfg #	Description	Price
069651	550B	-58° to 572°F Range	

Digital Thermometer

- Waterproof
- Built-in magnetic mount
- Records minimum & maximum temperatures
- Data hold
- Auto power off
- Easy access battery compartment
- Enhanced accuracy of digital circuitry
- Includes battery & multipurpose probe
- -58° to 572°F Range
- 3-Year limited warranty

PDT550



PDT650



Part #	Mfg #	Description	Price
082376	PDT550	Pen Type	
153228	PDT650	Folding Type	

CO Detectors

CO71 "The CO Detective" Carbon Monoxide Monitor

- Tri-color LED indicates concentrations at 3 levels complying with residential and work place standards
- Audible alert triggers at 35 ppm indicating the threshold of dangerous concentration
- Backlight display
- Operating temperature: 32° to 104°F
- MAX Continually updates to provide recall of highest CO reading
- Auto zero activates upon turn on
- 9V Battery operated
- 3-Year limited warranty



Part #	Mfg #	Description	Price
051760	CO71	Displays 0 to 999 ppm CO Level in Ambient Air	

HVAC Testing Tools

Leak Detectors

CD100A Combustible Gas Leak Detector

- Long 18" gooseneck for hard to reach areas
- Tip light in sensor cap illuminates search area
- Probe cage protects sensor
- Audio and visual tic rate fully adjustable
- Headphone jack
- Includes:
 - Sensor and cap
 - 9V Battery
- 1-Year limited warranty



Part #	Mfg #	Description	Price
038331	CD100A	50 ppm Minimum Detection	

Manometers

EM151 Digital Electronic Manometer

- Single input measurement to $\pm 20"$ wg
- Integral protective boot w/magnet
- Simple two-button operation
- Measures in inches water gauge and Mbar
- Automatic after 5 minutes of inactivity and manual power-off
- Includes:
 - (1) Pressure tubes with brass fitting connector
 - (1) Std 9V battery
 - Manual
- 1-Year limited warranty



Part #	Mfg #	Description	Price
126553	EM151	Single Input Electronic Manometer	

SSM1 Super Heat/Sub Cool Meter

- Measures:
 - Pressure from 0 - 500 psia
 - Temperature from -40° to 400°F
- Calculates:
 - Superheat for low side
 - Subcool for high side (TXV systems)
- Refrigerants included for calculations: R-22, R-134a, R-404A, and R-410A
- 1-Year limited warranty



Part #	Mfg #	Description	Price
133479	SSM1	Super Heat/Sub Cool Meter	

Static Pressure Kit

- Dynamic Min/Max value capture
- Data hold
- Backlit display
- Ruggedized, including rubber boot with integral magnet
- Auto power off
- 3-Year limited warranty



Part #	Mfg #	Description	Price
161833	EM201SPKIT	Dual input differential measurement to ± 60 InWC	

Electrical Testers

PET1 Pocket Electrical Tester

The PET1 features:

- Worklight
- Non-contact AC voltage test from 12-600VAC (with adjustable sensitivity)
- Detects high and low AC voltage
- Continuity check: 0-80 megohms
- Audible/visual indicators
- 3-Year limited warranty



Part #	Mfg #	Description	Price
083035	PET1	Volt Tester w/Light	

Probes

ATL5 Modular Test Lead Tip

- Back probe



Part #	Mfg #	Description	Price
237035	ATL-5	Modular Test Lead Tip	



HVAC Testing Tools

Meters

TurboMeter™

Part #	Mfg #	Description	Price
106684	439103	Air Velocity Meter	

Differential Pressure Meter

- Includes protective cap, batteries and calibration certificate
- Display in Pascal optional over entire measurement range
- Temperature compensation
- Magnetic back permits free-hand work
- Accuracy: ± 0.01 "H₂O (0 to 0.12 "H₂O) / ± 0.02 "H₂O (0.13 to 0.4 "H₂O)
- Flow velocity measurement with Pilot tube (Pilot tube not included in delivery)
- Air density compensation
- Includes:
 - Protective cap for safe storage
 - (2) Type AAA Batteries, 50 hour life
 - Including wrist strap and belt clip



Part #	Mfg #	Description	Price
142784	875044	Digital Differential Pressure Meter	

Smartphone Static Pressure Meter

- Automatically imports local weather data based on GPS location
- Easily emails professional, detailed reports
- Rugged, weather resistant housing with hands-free magnetic holder



Part #	Mfg #	Description	Price
180508	SPM-100	Dual Port Manometer Accessory	

HVAC Testing Tools

Meters

Economy Auto-Ranging Clamp-On Meter

- Reads volts, amps and ohms
- Data hold and continuity buzzer
- CAT II
- Includes carrying case



Part #	Mfg #	Description	Price
111388	MA-600CF	Temp Range: -38° to 1,750°F	

Oil & Glycol Refractometer



Part #	Mfg #	Description	Price
111392	MA-REF401F	Glycol Fahrenheit Refractor	

Torsion Mounting Bracket

- 5.5"

Part #	Mfg #	Description	Price
197937	MA-FM55	Mounting Bracket Motor	

HVAC Testing Tools

Meters & Testers

Digital Psychrometer

- Data hold
- Auto power off
- °F/°C switchable
- Power: 2 AAA batteries
- Dimensions: 7" x 1-7/8" x 1"
- Operating temperature range: 4° to 122°F
- Response time of 60 seconds to changes in humidity
- Display relative humidity & temperature simultaneously



Part #	Mfg #	Description	Price
182260	69008	Digital Psychrometer	

Gas Pressure Test Kit

- Helps to accurately set manifold pressure natural or L.P. gas
- Two gauge ranges available
- single bellows on brass plate design
- Sensitive diaphragm gauge calibrated in inches of water column and ounces per square inch
- Tube nipple for easy connection to system manifold



Part #	Mfg #	Description	Price
182330	78060	Gas Pressure Test Kit	

Manometers

Dual Port Manometer

- Auto power-off
- 9V Battery required
- Single button operation
- Measures gas pressure, static pressure, & pressure differential
- Measures pressure between -19.95 and 19.95inWC (inches of water column)
- Includes a easy to use zero function
- Designed for HVACR field service technicians
- Measures pressure drop directly across two points such as filter pressure drop or flow volumes
- Positive and negative pressures can be read directly if measured on the appropriate input
- Kit includes: 30" tubing, clear hose, tube splice and 1/8" NPT brass fitting.



Part #	Mfg #	Description	Price
240354	78052	Dual Port Manometer	

Water-Type Manometer

- Plastic tubing with fitting
- Set manifold pressure for natural gas or L.P. gas
- Strong magnet holds manometer in upright position



Part #	Mfg #	Description	Price
182335	78075	0-15" Water-Type Manometer	

Detectors

AccuProbe™ UV Leak Detector

- Low battery indicator
- True mechanical pump
- 17" Probe length
- Instantaneous response time
- Power: 4 AA alkaline batteries
- SmartAlarm™ leak size indicator
- 3 selectable sensitivity level settings
- Long life, stable electrolyte sensor
- Humidity: 0 to 95% RH non-condensing
- Operating temperature range: 24° to 125°F
- Automatic calibration and reset to environment
- Clears in 12 seconds or less after exposure to a 1.75 oz (50 g)/year leak
- Sensitivity: HFC – 0.06 oz. (1.7 g)/year; HCFC – 0.03 oz. (0.9 g)/year; HFO – 0.15 oz. (4.3 g)/year



Part #	Mfg #	Description	Price
182305	69336	AccuProbe Leak Detector	

AccuProbe™ II Leak Detector

- Low battery indicator
- True mechanical pump
- 17" Probe length
- Instantaneous response time
- Power: 4 AA alkaline batteries
- SmartAlarm™ leak size indicator
- 3 selectable sensitivity level settings
- Long life, stable electrolyte sensor
- Humidity: 0 to 95% RH non-condensing
- Operating temperature range: 24° to 125°F
- Automatic calibration and reset to environment
- Clears in 12 seconds or less after exposure to a 1.75 oz (50 g)/year leak
- Sensitivity: HFC – 0.06 oz. (1.7 g)/year; HCFC – 0.03 oz. (0.9 g)/year; HFO – 0.15 oz. (4.3 g)/year



Part #	Mfg #	Description	Price
182306	69354	AccuProbe II Leak Detector	

HVAC Testing Tools

Combustible Gas Detector

- Probe length: 17"
- Sensor life: 500 hours
- Automatic calibration
- 25 second warm up time
- Instantaneous response time
- Power battery: 4 AA alkaline batteries
- Operating temperature range: 32° to 110°F
- Sensitivity: 5 ppm methane or better 2 ppm propane



Part #	Mfg #	Description	Price
182308	69373	Combustible Gas Detector	

Parts & Accessories

Part #	Mfg #	Description	Price
182311	69384	AccuProbe Replacement Sensor & Filter	
182312	69385	AccuProbe Sensor Filters-5Pk	
182331	78062	Hose w/ Nipple for 78055/60	
182332	78064	Brass Barb Ftg For 78055/60	
182333	78065	Rubber Nipple for 78055/60	

Knives & Replacement Blades

Utility Knives and Knife Blades

Quick Open Utility Knife

- Retractable blade
- Integrated hinge



Part #	Mfg #	Description	Price
048168	9PK	3-Position	

Top Button Action Utility Knife

- Safe, easy to operate thumb action mechanism on top



Part #	Mfg #	Description	Price
006528	4PK	3-Position	

Knives & Replacement Blades

Utility Knives

Fastback Compact Flip Utility Knife

- Press and flip opening
- Compact size
- Quick blade change
- Belt clip
- Lanyard hole



Part #	Mfg #	Length	Price
268326	48-22-1500	6.15"	

Sliding Utility Knife

- Side slide activated blade
- Rubber over mold hand grip
- On board blade storage
- Tool-free blade change
- Integrated gut hook and wire stripper



Part #	Mfg #	Length	Price
137585	48-22-1910	7-1/4"	

18mm Snap Off Knife

- Durable lock- up to 2x longer life
- Speed thread- 2x faster blade adjustment
- Microcarbide blade- up to 2x longer blade life
- Acetone resistant
- 8 Point blade



Part #	Mfg #	Length	Price
163299	48-22-1964	6"	

Fastback™ Utility Knife

- One-handed blade opening
- Tool-free blade change
- Wire stripper
- Integrated gut hook
- Thin body design



Part #	Mfg #	Length	Price
137584	48-22-1901	7-1/4"	
225380	48-22-1903	6-3/4"	

HARDLINE™ Smooth Blade Pocket Knife

- Drop point smooth blade
- Flipper with bearing system
- Opening steel frame lock
- Glass filled nylon handle with stainless steel back
- Stone washed black oxide finish
- Reversible tip up belt clip
- Lanyard hole



Part #	Mfg #	Length	Price
243683	48-22-1928	10.3"	
222817	48-22-1994	6.9"	
222819	48-22-1999	8.2"	

Multi-Purpose Knives

FASTBACK™ Smooth Folding Pocket Knife

- Press and flip operation: Permits one-handed opening
- Stainless steel drop-point blade: resharpenable edge for long lasting use
- Liner lock
- Slim, compact body: stores easily yet withstands job site abuse
- Piercing tip: allows controlled piercing and smooth cutting
- Lanyard hole
- Reversible wire-form belt clip



Part #	Mfg #	Length	Price
163301	48-22-1990	7-3/4"	

FASTBACK™ Spring Assisted Serrated Knife

- Spring-assisted opening: Permits one-handed operation
- Black oxide-coated stainless steel serrated blade: Maintains long-lasting sharp edge
- Liner lock
- Serrated blade: Ideal for tearing through material, Tanto tip: Ideal for piercing material
- Slim, compact body: Stores easily yet withstands job site abuse
- Reversible wire-form belt clip



Part #	Mfg #	Length	Price
162813	48-22-1995	8-1/4"	



Knives & Replacement Blades

FASTBACK™ Hawk Bill Folding Knife

- Press-and-flip operation: permits one handed opening
- Stainless steel curved blade
- Liner lock
- Slim, compact body
- Piercing tip: allows controlled piercing and smooth cutting
- Lanyard hole
- Reversible wire-form belt clip



Part #	Mfg #	Length	Price
170008	48-22-1985	7-1/4"	

FASTBACK™ Spring Assisted Knife

- Spring Assisted Open for fast one-handed opening
- Black Oxide Stainless Steel Blade
- Liner Lock
- Reversible Wire Form Belt Clip



Part #	Mfg #	Length	Price
180512	48-22-1996	Realtree Xtra® Camo	

Tradesman Fixed Blade Knife

- Stays sharper longer
- Full tang
- 4" Drop point blade
- 9-1/2" Overall length
- Lanyard hole
- Stainless steel blade



Part #	Mfg #	Description	Price
240552	48-22-1926	9-1/2"	

HARDLINE™ Pocket Knife

- Drop Point Smooth Blade
- Flipper with Bearing System
- Opening Steel Frame Lock
- Glass Filled Nylon Handle with SS Back
- Stone Washed Black Oxide Finish
- Reversible Tip Up Belt Clip
- Lanyard Hole



Part #	Mfg #	Description	Price
222816	48-22-1997	2.5", Smooth Blade	
222818	48-22-1998	3", Serrated Blade	

Duct Knife

- Stainless steel blade
- Full tang for tough cuts
- Double edged blade
- Durable sheath with belt clip
- Lanyard hole



Part #	Mfg #	Description	Price
181527	48-22-1920	Includes Sheath	

Insulation Knife

- Stainless steel blade
- Full tang for tough cuts
- Rounded handle for smoothing applications
- Durable blade cover for storage
- Lanyard hole



Part #	Mfg #	Description	Price
181528	48-22-1921	Smooth Blade	
181529	48-22-1922	Serrated Blade	

Replacement Blades

50 PC General Purpose Utility Blades w/ Dispenser

- Micro carbide deposited metal delivers up to 3X longer life than standard carbon blades
- Precision grind process removes the burr from cutting edge for cleaner cuts
- Optimized grind angles deliver improved sharpness for less repeat cuts
- Made in the USA



Part #	Mfg #	Description	Price
163303	48-22-1950	50 PC General Purpose Utility Blades w/ Dispenser	

General Purpose Utility Blades

- Micro carbide dispersed metal
- Precision grind process removes the burr from cutting edge for cleaner cuts
- Optimized grind angles deliver improved sharpness for less repeat cuts



Part #	Mfg #	Description	Price
233562	48-22-1905	5 Pc	

• Serving our Customers Since 1946 • www.plumbsupply.com



Knives & Replacement Blades

Replacement Blades (Continued)

General Purpose Utility Blades

Part #	Mfg #	Description	Price
246449	48-22-1900	100 Pc	
219300	48-22-1934	5 Pc, Round Point	

Levels

Levels

Torpedo Level

- Ideal for general use and work in tight places
- Three vials for plumb, level and 45° miter
- Full length strong magnetic edge
- V-Grooved edge for pipe and conduit work
- Large top read level vial



Part #	Mfg #	Model	Description	Price
051918	20233	395	9" Nightshade Level	

Levels

Empire Levels

TRUE BLUE® Magnetic DUAL-PITCH™ Torpedo Level

- Powerful rare earth magnets provide superior holding strength
- All aluminum frame with top read window
- V-Groove working edge for accurate alignment on pipe or conduit
- Ruler Groove compatible with most straight edges for extended measuring and marking
- Surface grip surrounds level vial for increased stability



Part #	Mfg #	Size	Price
232260	EM75.10	10"	

TRUE BLUE® Magnetic Billet Torpedo Level

- Powerful rare earth magnets provide superior holding strength
- High contrast e-BAND™ vials highlight the edge of the bubble
- VARI-PITCH™ vial reads slope at 1/8", 1/4", 3/8", or 1/2" per foot of horizontal run
- V-Groove working edge for accurate alignment on pipe or conduit
- Top read window provides clear overhead viewing
- Laser etched ruled edge allows for quick measurements on working material
- Tapered design for easy in and out of pocket
- Billet aluminum frame for superior durability



Part #	Mfg #	Size	Price
187324	EM71.8	8"	

Magnetic Torpedo Level

- High contrast e-BAND™ vials highlight the edge of the bubble
- High contrast vial surrounds improve vial visibility
- 3 vials - plumb, level and 45°
- V-Groove working edge for accurate alignment on pipe or conduit
- Aluminum frame with top read window
- Strong magnetic edge



Part #	Mfg #	Size	Price
218536	EM81.9	9"	
218537	EM81.12	12"	
173520	EM81.24	24"	
174326	EM81.48	48"	

TRUE BLUE® Box Level

- Surface grippers
- e-BAND™ vials
- Precision milled edge
- Hang hole for ease of storage
- 300° Viewing Window maximizes range of view



Part #	Mfg #	Size	Price
173522	E75.24	24"	

TRUE BLUE® ULTRAVIEW™ LED Magnetic Box Level

- Surface grippers
- e-BAND™ vials made in the USA
- 2 minute auto shut-off or press and hold to turn off
- Hang hole for ease of storage
- Limited lifetime warranty on frame and vials. 1 year warranty on electronics
- 2 (AA) batteries included



Part #	Mfg #	Size	Price
224519	EM95.24	24"	
237855	EM95.10	10"	

I-Beam Magnetic Level

- Top read window
- Ergonomic, grip zones
- All metal, anodized I-Beam frame
- High-strength magnetic edge
- Hang hole for ease of storage



Part #	Mfg #	Size	Price
189806	EM55.48	48"	

Levels

Die Cast Torpedo Level w/ 360° Locking Vial

- High contrast e-BAND™ vials highlight the edge of the bubble
- High contrast vial surrounds improve vial visibility
- 3 vials - plumb, level and 45°
- V-Groove working edge for accurate alignment on pipe or conduit
- Aluminum frame with top read window
- Strong magnetic edge



Part #	Mfg #	Size	Price
240706	48-22-5210	10"	

Compact Billet Torpedo Level

- Amplified rare earth magnets
- Maximized viewing area



Part #	Mfg #	Size	Price
226658	48-22-5107	Billet Torpedo	



Levels

Torpedo Level Starter Kit

- Includes: (1) 24" Milwaukee Box
- Tough, water resistant nylon
- All metal hardware
- Durable zipper closure
- Two Integrated carrying or hanging handles
- Integrated external tool loops for additional tool storage
- Two debris vent to prevent dust, dirt and/or water build up



Part #	Mfg #	Size	Price
243836	MLBXC48	Includes Bag, 48" Level, 24" Level	

24" / 48" REDSTICK™ Box Level Set

- ALL-METAL BACKBONE™
- SHARPSITE™ Vial technology
- High density, removable end-caps protect frame and provide access in tight spaces
- Wide, durable handles for comfort and portability
- Precision milled measuring surface guarantees accuracy in all working positions
- Overmolded, non-slip grips stick to the wall and prevent sliding
- Durable, all-metal hang hole for storage



Part #	Mfg #	Size	Price
234217	MLBXS48	24" & 48"	

24" / 48" REDSTICK™ Magnetic Box Level Set

- ALL-METAL BACKBONE™
- SHARPSITE™ Vial technology
- High Density, removable end-caps protect frame and provide access in tight spaces
- Wide, durable handles for comfort and portability
- Precision milled measuring surface guarantees accuracy in all working positions
- Overmolded, non-slip grips stick to the wall and prevent sliding
- Durable, all-metal hang hole for storage
- Includes:
 - (1) 24" REDSTICK™ Magnetic Box Level (MLBXM24)
 - (1) 48" REDSTICK™ Magnetic Box Level (MLBXM48)



Part #	Mfg #	Size	Price
240501	MLBXS48	24" & 48"	

24" REDSTICK™ Box Level

- SHARPSITE Vial technology
- Durable, all-metal hang hole for storage
- Guaranteed lifetime accuracy - accurate to .029°
- High density, removable end-caps
- Wide, durable handles for comfort and portability



Part #	Mfg #	Size	Price
252641	MLCMM24	24" Magnetic Compact	

48" REDSTICK™ Box Level

- ALL-METAL BACKBONE™
- SHARPSITE™ Vial technology
- Guaranteed lifetime accuracy: accurate to .029°
- High contrast vial system is easy to clean and optimizes visibility
- High density, removable end-caps protect frame and provide access in tight spaces
- Wide, durable handles for comfort and portability



Part #	Mfg #	Size	Price
245215	MLBX48	48"	
245217	MLCM48	48" Compact	
245218	MLCMM48	48" Magnetic Compact	

REDSTICK Concrete Levels

- Ergonomic keyhole frame
- Magnesium base for screeding
- Dedicated concrete working edges
- Sharpsite pitch vial for easily reading 1/8" and 1/4" pitches



Part #	Mfg #	Size	Price
253268	MLCON48	48"	
261434	MLCON72	72"	

Miscellaneous Tools

Maxstraps

The Original 1" Polypropylene Cam Tiedown

- Ideal for lumber, pipe, ladders, and outdoor gear
- Weather and sunlight resistant
- 750 lb Test
- Rustproof cam buckle
- Easy thumb release



Part #	Mfg #	Description	Price
053091	00216	2' Black	
053093	00411	4' Red	
053094	00612	6' Yellow	
053095	00813	8' Green	
053096	01014	10' Blue	

Miscellaneous Tools

Utility Strap

Rubber Tie Down Strap

- Stretches to double its length
- Extra heavy steel S-hooks on each end



Part #	Mfg #	Description	Price
002270	540-31	31" Rubber Strap	

Ratchet Strap

- Easy ratcheting permits tie-down of appliances securely.
- An innovative latch and a fast release cam reduces socket wear.
- Cadmium-plated steel buckle has a positive lock that eliminates release due to vibration.
- When closed, the handle locks the latch into the sprocket to prevent inadvertent release. 16 foot nylon webbing rated at 3000 PSI tensile.
- Vinyl coated end hooks rated at 1200 PSI tensile.



Part #	Mfg #	Description	Price
192407	HS-192	16 ft	

Hanging Strap

- Strong, versatile, easy way to secure loose gear safely
- 1 in. polypropylene webbing
- Spring loaded adjustable buckle
- Easy to get firm tension with no slipping
- Make an endless length by connecting 2 or more together



Part #	Mfg #	Description	Price
046209	HS-30	30"	
049072	HS-60	60"	

Strapping Hanger Iron

- Galvanized 3/4in. vent strapping, hanger iron, plumber's tape, pipe hanger tape and many other uses
- 1/4in. centers for bolts or nails.



Part #	Mfg #	Description	Price
194311	710-A16100	3/4" x 100'	

Woven Polypropylene Duct Strap

- Webbed duct strap processing high tensile and abrasion resistance.
- This can be used for flex duct as it is easy to cut and staple to joists.
- The product is chemical resistant and tested to meet UL Standard 2043.



Part #	Mfg #	Description	Price
192065	710-100	1-3/4" x 100 Yards	
137962	710-102	3" x 100 Yards	

Metallic Duct Strap

- Galvanized duct strap in a convenient cardboard dispenser is not only easy to drill or nail, but also solid strapping.
- Plenum rated.



Part #	Mfg #	Description	Price
192070	710-001	26 Gauge, 1" x 100'	
194518	710-003	30 Gauge 1-1/2" x 100'	

Miscellaneous Tools

Fin Whisk

- Plastic handled whisk for cleaning condenser and evaporator fins



Part #	Mfg #	Description	Price
141528	B-26	Fin Whisk Brush	

Chip Brush

- 100% pure bristle
- Wood handle
- Poly sleeve over bristles
- Use once and throw away



Part #	Mfg #	Description	Price
195230	B-504	2-1/2" Chip Brush	

Miscellaneous Tools

SuperComb

- Easier to grip, easier to use tool for straightening condenser and evaporator fins.
- Straightens 50% more fins in one stroke.
- Keeps hands a safe distance from fins.
- Easy to grip, strong, durable, heavy duty nylon.
- Color coded for easy identification.
- 6 per set.



Part #	Mfg #	Description	Price
143979	T-400	6 Pack	

Multi-Head Fin-Tool

- Conveniently straightens and cleans condenser and evaporator fins.
- Each nylon head slides into the master handle and tightens in place.
- Heads are designed to fit units with fin spacing of 4–24 fins per inch.
- Each head is engraved with its own size and is color coded for fast identification.
- Heads are angled so that when inserted in the handle, the hand is a safe distance from the sharp fins.
- Heads may also be reversed in the handle so that combing with an upward stroke (recommended method) may be done easily with proper leverage.
- The master handle rests comfortably in a man-size grip, is rigid and long lasting.



Part #	Mfg #	Description	Price
192409	T-100	6 Heads, 1 Handle	

Miscellaneous Tools

Telescoping Tools

Telescopic Inspection Mirror

- American made
- Double ball joint links swivel mirrors for viewing to 360°



Part #	Mfg #	Description	Price
192406	M-2	2-1/4" Circular Extends 10-14"	
002322	M-5	1" x 2" Oval Extends 8-1/2"	

Refrigeration Tools

Nitrogen Purge Tool

- Adjustable dial
- Quickly switch between braze, purge or off
- Accurately regulates flow and volume for purging or brazing



Part #	Mfg #	Description	Price
234800	DP-1	Adjustable Dial	

Access Fittings

- May be installed in any position on either high or low side for charging, purging, quick testing, or pressure checking



Part #	Mfg #	Description	Price
192402	VC-4	Flare Cap, 1/4" SAE Male	
193548	VVC-1	Valve Core	
195766	VST-44	Swivel Tee	
195768	VTS-68	Solder Tee 3/8"	
195769	VTS-12	Solder Tee 3/4"	

Extended Copper Tube

- For refrigeration servicing
- May be installed in any position
- 1/4" SAE male flare access ports
- Includes
 - Quick seal cap
 - Stainless and brass special refrigerant valve core



Part #	Mfg #	Description	Price
192416	VAX-2	Extended Copper Tube, 1/8"O	
192415	VAX-3	3/16" O.D. x 1/8" I.D.	
224361	VAX-4	Ext Copper Tube, 1/4"ODx3/16"ID	

Cop Cap™ Locking Valve Cover

- Includes 2 caps, 1 wrench



Part #	Mfg #	Description	Price
204182	VVC-4	2 Caps and 1 Wrench	

Copper Saddle Valve

- For copper-to-copper brazing.
- Penetrates line in one easy operation with no holes to drill.
- Steel pin with valve core pierces line and is locked into valve body by tightening cap.
- Teflon ring assures positive seal.
- Available in sizes from 1/4in. to 1-1/8in..



Part #	Mfg #	Description	Price
192413	VLC10	5/8in. O.D. Tube Size, Pack of 3	
192414	VLC12	3/4in. O.D. Tube Size, Pack of 2	
194230	VLC-6	3/8in. O.D. Tube Size, Pack of 6	
196482	VLC-8	1/2in. O.D. Tube Size, Pack of 4	
196181	VLC-4	1/4in. O.D. Tube Size, Pack of 6	

Core Storer

- All steel valve core remover and storage container.
- Completely knurled for easier grip, eliminating slippage when using with oily or greasy hands.
- Core Storer features a compartment for storing extra valve cores.
- Four replacement cores are included with each tool.



Part #	Mfg #	Description	Price
192398	VCR-1	Core Remover and Store	

Miscellaneous Tools

Staple Guns

T-50 Series Staples

- Used extensively by building contractors, home do-it-yourselfers and specialty trade applications for tacking insulation, ceiling tile, window screening, cornerite, and 1001 other jobs ranging from light to heavy duty work.
- The T-50 Outward Clinch Staple Gun is ideal for fiberglass ductwork.



Part #	Mfg #	Description	Price
196495	540-509	9/16" Staples for T50 Staple Guns	

Miscellaneous

Surge Trap® STXH Series

- TPMOV® technology
- 1/2"-14 threaded hub
- LED status indicator
- Frequency: 50-60 Hz
- Pre-wired 18" 10AWG
- -40°C to +85°C Temperature
- Volts: 120/240VAC split phase
- Surge capacity: 50kA
- Nominal discharge current rating: 20kA
- Short-circuit current rating: 200kA
- Includes sealing locking washer
- Compact footprint designed to mate with AC disconnect switches
- 3 Modes of protection (L-N, L-L)
- Fits 1/2" knockouts with 18" leads
- NEMA 4X enclosure for outdoor or indoor use
- For use in ANSI/UL Type 1 or 2 SPD installations



Part #	Mfg #	Description	Price
245751	STXH240S05	120/240VAC Split Phase	

Miscellaneous Tools

Tools

Pro-Set® Inspection Mirror



Part #	Mfg #	Description	Price
098914	87-TLMIR3	3.5" x 2.12" Rectangular Telescoping Mirror	

Batteries

Batteries - Alkaline

- Batteries all alkaline
- Attractive retail-type packaging



Part #	Mfg #	Description	Price
180520	BV900243	AA - 18 PK	
180522	BV900244	AAA - 18 PK	
180521	BV900245	9V - 4PK	
180523	BV900269	C - 2PK	
180524	BV900270	D - 2PK	

Miscellaneous Tools

Flue and Boiler Tube Brushes

Fine-Wire Single Spiral Brush

- For small boilers, burners, nozzles and fans
- 3" Brush lengths

Part #	Mfg #	Description	Price
007444	01216	3/4" Dia, 24" OAL 4" Loop, Carbon Steel	

Tool Cases

Lock 'N Load Heavy-Duty Drybox

- Locks out moisture as well as dirt and grime
- (3) Compartments store and organize tools and accessories
- Easy access top compartment is ideal for small tools and parts
- Dimensions: 15" x 8" x 10"



Part #	Mfg #	Description	Price
061933	75605	Lock 'N Load Drybox, Carton	

Tube Cleaning Brushes

#6200 Series Power Tube Cleaning Brush

- Use for solder or brazed fittings
- Carded 1/4" hex-shank tube cleaning brushes
- Point-of-purchase display

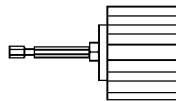

Part #	Mfg #	Description	Price
007454	62350	1/2" Bagged	
007455	62370	3/4" Bagged	

Toilet Bolts



Part #	Mfg #	Description	Price
169958	73065	5/16" x 2-1/4"	
235895	73070	5/16" x 3-1/2"	



Miscellaneous Tools

Chemicals

Insecticide

Part #	Mfg #	Description	Price
140752	85-200	Bee/Wasp Spray	
189900	4292-75	Nu-Kill II Aerosol - 14oz	

Miscellaneous Tools

Cases & Carriers

Nipple Box

- Holds 1/2" CL through 6" nipples
- Fold away handle
- Epoxy coated steel

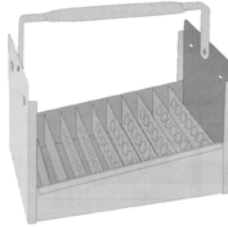

Part #	Mfg #	Size	Holds	Price
013210	3080	1/2"	77	

Miscellaneous Tools

Nipple Boxes

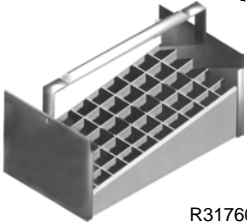

R317600

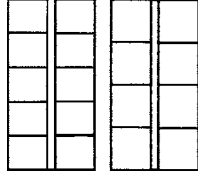

R318410

Part #	Mfg #	Description	Price
014776	R317600	E-51-R 3/4"	
080438	R318410	Galvanized Fitting Tray	

Plumb Bob Red Bucket

Part #	Mfg #	Description	Price
226028	PLUMBBOBBUCKE T	5 Gallon Bucket	
226029	PLUMBBOBLID	Lid for 5 Gallon Bucket	

Miscellaneous Tools

Radios/Speakers

M18™/M12™ Wireless Jobsite Speaker

- Stream high definition music from over 100ft
- AC adapter
- Impact resistant roll cage



Part #	Mfg #	Description	Price
229138	2891-20	12V and 18V	

M18™ Jobsite Radio

- Customizable EQ
- 2.1A USB charger
- 10 station presets
- 3.5mm Aux In Port
- Powered by all M18™ Batteries or A/C outlet —(battery not included)
- Weather sealed auxiliary compartment
- Up to 12hrs run time with an M18™ 5.0Ah battery



Part #	Mfg #	Description	Price
185219	2890-20	M18™ Job Site Radio	

M18™ Job site Radio/Charger

- Built-in charger
- Digital Bluetooth® receiver
- USB power port
- 40-watt amplifier
- Customizable equalizer
- 10-station preset
- Reinforced roll cage and metal handles
- Weather-sealed compartment
- On-board bottle opener
- Includes:
 - (1) M18™ Job site radio/charger (2792-20)
 - (1) 16" Auxiliary input cord
 - (2) AAA batteries



Part #	Mfg #	Description	Price
163377	2792-20	M18™ Job Site Radio/Charger	

M12™ Job site Radio

- Digital reception with signal processor
- 1/8" Stereo jack auxiliary input



Part #	Mfg #	Description	Price
139355	2590-20	Bare Tool	

M12™ Wireless Jobsite Radio

- Bluetooth® Connectivity with portable electronic devices up to 30ft away
- Premium Speaker with integrated Bass Port delivers loud, clear sound at all volumes
- Integrated Loop for easy hanging and transport
- 3.5mm Aux In Port for wired playback (cable not included)
- Jobsite durability
- 2.1A USB Charger electronic devices



Part #	Mfg #	Description	Price
172937	2592-20	Bare Tool	
181843	2592-21	Kit	

Carrying Cases and Bags

Zipper Pouch

- Hang loop
- Rugged metal zipper
- Heavy duty No. 10 canvas
- Water resistant stand-up base



Part #	Mfg #	Description	Price
170552	48-22-8180	Zipper Pouch	

3 PK Zipper Pouches

- Hang loop
- Rugged metal zipper
- Water resistant stand-up base
- Heavy duty No. 10 canvas



Part #	Mfg #	Description	Price
170554	48-22-8193	3 Pk Zipper Pouches	

Compact Utility Pouch

- 1680D ballistic material
- Adjustable belt attachments
- 7 Exterior pockets



Part #	Mfg #	Description	Price
255840	48-22-8118	Utility Pouch	



Miscellaneous Tools

Meter Case

- Rugged nylon
- Three sided zipper closure
- One inside pocket, one compartment
- Strong nylon strap with snap closure
- The following Milwaukee meters fit this case:
 - 2205-20 Fork meter
 - 2206-20 Fork meter for HVAC/R
 - 2216-20 Digital multimeter
 - 2217-20 Digital multimeter
 - 2235-20 400amp clamp meter
 - 2265-20 Laser temp-gun
 - 2266-20 Laser temp-gun



Part #	Mfg #	Description	Price
164509	48-55-0175	Meter Case	
164510	48-55-0180	Large Meter Case	

Job Site Organizer

- Mountable bins
- Full access when stacked
- 20% More capacity
- Weather seal
- No-travel bins seals



Part #	Mfg #	Size	Price
176587	48-22-8030	14" x 18" x 5"	

Jobsite Cooler

- 2X the insulation
- Food grade leak proof liner
- 1680D ballistic material
- Holds ice for 24 hours
- Heavy duty metal zippers
- Padded shoulder strap
- Tape measure clip w/ bottle opener
- Tech pocket for storing tablets and electronic devices
- Dry storage compartment
- No sweat exterior
- 3 Total pockets inside and 5 pockets outside
- Holds 21.65 liquid quarts



Part #	Mfg #	Description	Price
239938	48-22-8250	11.1"L x 13.77"W x 14.96"H	

PACKOUT™ Cooler

- Impact resistant polymer base
- Food grade leak-proof liner
- 5 Storage compartments
- Included padded shoulder strap
- Holds ice for up to 24 Hours
- All metal hardware
- No sweat exterior
- Tape measure clip with bottle opener



Part #	Mfg #	Description	Price
255405	48-22-8302	15.75"L x 11.81"W x 15.75"H	

Organizer Bag



Part #	Mfg #	Use with:	Price
145691	49-17-0110	Contractor Parts Organizer	

Job Site Backpack

- 35 Pockets for organizing tools
- Bulk pocket
- Impact resistant molded base
- 1680 Ballistic material
- Load-bearing harness
- 15.6" Laptop sleeve
- Attachment strap



Part #	Mfg #	Description	Price
170551	48-22-8200	Job Site Backpack	

Ultimate Jobsite Backpack

- 48 Pockets, 2 external
- 1680D Ballistic material
- Impact resistant base
- Sternum strap
- Tape measure clip
- Rugged metal zippers
- Attachment strap for dolly's
- Loaded-bearing harness
- Hardshell protected electronic & equipment pockets



Part #	Mfg #	Description	Price
238907	48-22-8201	Ultimate Job Site Backpack	

Miscellaneous Tools

Low-Profile Job Site Backpack

- 22 Pockets, 4 external
- 1680D Ballistic material
- Reinforced base
- Sternum strap
- Tape measure clip
- Rugged metal zippers
- Attachment strap for dolly's
- Padded electronics sleeve



Part #	Mfg #	Description	Price
238908	48-22-8202	Low-Profile Jobsite Backpack	

PACKOUT™ Backpack

- 48 Total pockets
- 1680D Ballistic material
- Impact resistant polymer base
- All-metal hardware
- Tape measure clip
- Daisy chains for additional storage
- Plastic reinforced jab saw pocket
- Load bearing harness with sternum strap
- Hardshell electronics & equipment pocket
- Part of the PACKOUT™ modular storage system



Part #	Mfg #	Description	Price
255404	48-22-8301	PACKOUT™ Backpack	

Jobsite Tech Bag

- Impact resistant molded base
- 1680D ballistic material construction
- Integrated rain fly
- Protected tech pocket
- 53 Total pockets



Part #	Mfg #	Description	Price
188643	48-22-8210	Tech Jobsite Bag	

PACKOUT™ Tech Bag

- Tear-resistant 1680D ballistic material
- Impact resistant polymer base
- Reinforced side walls
- 58 Total pockets
- All-metal hardware



Part #	Mfg #	Description	Price
255403	48-22-8300	Tech Packout Bag	

Contractor Bag

- Tough, water resistant 600 denier material
- Shoulder strap or dual handle straps for easy carrying
- Ideal for tool and accessory storage
- Durable zipper closure



Part #	Mfg #	Description	Price
140379	48-55-3500	20-1/2"L x 9"W x 8"H	
140378	48-55-3510	18"L x 11"W x 10"H	
225575	48-55-3490	17"L x 9"W x 10"H	
140377	48-55-3530	26-1/2"L x 13"W x 14"H	

Contractor Work Belt w/ Suspension Rig

- 24 Pockets
- 1680D Nylon construction
- Riveted seams
- All metal hardware
- Integrated carry handles
- Puncture resistant pocket
- Padded work belt- Fits 30" to 53" waists



Part #	Mfg #	Description	Price
170550	48-22-8120	Includes Suspension Ring	

Electricians Work Pouch w/ Quick Adjust Belt

- 15 Pockets
- 1680D Nylon construction
- Riveted seams
- All metal hardware
- Integrated carry handle
- Stable base
- Puncture resistant pocket
- Tape measure clip
- Belt slot- fits up to a 3" work belt
- Quick adjust belt



Part #	Mfg #	Description	Price
170548	48-22-8100	Work Pouch w/ Adjustable Belt	



Miscellaneous Tools

Electricians Work Belt

- 29 Pockets
- 1680D nylon construction
- Riveted seams
- All metal hardware
- Integrated carry handles
- Stable base
- Puncture resistant pocket
- Tape measure clip
- Belt slot- Fits up to a 3" work belt



Part #	Mfg #	Description	Price
170549	48-22-8110	Electricians Work Belt	

Packout™ Tote

- All metal hardware
- Padded shoulder strap
- Durable overmolded handle
- Impact resistant molded base
- 1680 Ballistic material construction
- Part of the PACKOUT™ modular storage system



Part #	Mfg #	Tote Size	Pockets	Price
237607	48-22-8310	10"	28	
237606	48-22-8315	15"	31	
237605	48-22-8320	20"	32	

Parachute Organizer Bag

- Stand up, stay open design
- Stackable
- Reinforced water resistant base
- External zipper pocket storage



Part #	Mfg #	Description	Price
221399	48-22-8170	11.81"L x 11.02"H	

Bucket-Less Tool Organizer

- Internal hammer loop keeps hammer easily accessible
- Heavy-duty water resistant 600 Denier Ripstop Polyester Material
- Padded handles
- 50 total pockets



Part #	Mfg #	Description	Price
138843	49-17-0180	50 Pockets	

Bucket Organizer Bag

- Open Bucket Design - Allows full access and use of the interior of the bucket
- 2 Exterior Zipper Pockets
- 1680D Ballistic Material Construction
- 32 Exterior Pockets



Part #	Mfg #	Description	Price
221400	48-22-8175	10.04"L x 2.17"W x 13.39"H	

15" PACKOUT™ Tool Bag

- Tear-resistant 1680D ballistic material
- Heavy duty zippers
- All-metal hardware
- 2 Exterior pockets for quick access
- Impact resistant polymer base
- Included shoulder strap
- Daisy chains for additional storage



Part #	Mfg #	Description	Price
253971	48-22-8321	15"L x 9.6"W x 12.2"H	

20" PACKOUT™ Tool Bag

- Tear-resistant 1680D ballistic material
- Heavy duty zippers
- All-metal hardware
- 2 Exterior pockets for quick access
- 6 interior pockets for organization
- Impact resistant polymer base
- Included shoulder strap
- Daisy chains for additional storage



Part #	Mfg #	Description	Price
253972	48-22-8322	20"L x 12.2"W x 13.8"H	

Miscellaneous Tools

18" Jobsite Rolling Bag

- 6" All-Terrain Metal Rim Wheels
- Industry's Strongest Extendable Handle
- All Metal Skid Plates
- Full Length Metal Axle
- 200 lbs Weight Capacity
- Wide Grip Handle
- Fold Down Front Panel
- 1680D Ballistic Material Construction
- Integrated Tablet Sleeve
- 66 Total Pockets



Part #	Mfg #	Description	Price
233580	48-22-8221	19-1/2"W x 16"L x 21"H	

24" Hardtop Rolling Bag

- Designed for stacking
- 6" All-terrain metal rim wheels
- Strongest extendable handle
- 250 lbs Weight capacity
- Wide grip handle
- Fold down front panel
- 1680D Ballistic material
- Integrated tablet sleeve
- 53 Total pockets



Part #	Mfg #	Description	Price
230510	48-22-8220	25"W x 16"L x 21"H	

Packout™ Rolling Tool Box

- 9" All-terrain wheels
- Interior organizer tray
- 250lbs weight capacity
- IP65 Rated weather seal
- Industrial grade extension handle
- Metal reinforced corners & locking point
- Constructed with impact resistant polymers
- Mounting Location for the ONE-KEY™ TICK™
- Part of the PACKOUT™ modular storage system



Part #	Mfg #	Description	Price
237609	48-22-8426	Packout Rolling Tool Box	

Packout™ Tool Box

- Interior organizer tray
- IP65 Rated weather seal
- Impact resistant polymers
- Metal reinforced corners, locking point, & top handle
- Mounting Location for the ONE-KEY™ TICK™
- Part of the PACKOUT™ modular storage system



Part #	Mfg #	Description	Price
237611	48-22-8424	75lbs Capacity, W/O Handle	
237610	48-22-8425	Large Box, 100lbs Capacity	

PACKOUT™ Tool Case W/ Customizable Insert

- IP65 rated weather seal
- 75lbs Weight capacity
- Included customizable foam insert
- Mounting location for the ONE-KEY™ TICK™ Tool and equipment tracker
- Part of the PACKOUT™ modular storage system



Part #	Mfg #	Description	Price
257192	48-22-8450	Tool Case W/ Customizable Insert	

Customizable Foam Insert

- Layered Foam for easy customization
- Designed to fit all PACKOUT™ tool boxes and tool cases (48-22-8424, 48-22-8425, 48-22-8450)



Part #	Mfg #	Description	Price
257679	48-22-8451	PACKOUT FOAM INSERT	

Packout™ Compact Organizer

- Part of the PACKOUT™ modular storage system
- No-travel bins seal prevent small part migration between Bins
- IP65 Rated weather seal
- 5 Removable & mountable bins
- Impact resistant polymers



Part #	Mfg #	Description	Price
237613	48-22-8435	Compact Organizer	

Miscellaneous Tools

PACKOUT™ Compact Low-Profile Organizer

- Slim design for organization of small items
- No-travel bins seal prevent small part migration between bins
- IP65 Rated weather seal
- 4 small and 1 large removable bins



Part #	Mfg #	Description	Price
253970	48-22-8436	Compact Low-Profile Organizer	

PACKOUT™ Organizer

- Part of the PACKOUT™ modular storage system
- No-travel bins seal prevent small part migration between bins
- IP65 Rated weather seal
- 10 Removable & mountable bins
- Impact resistant polymers



Part #	Mfg #	Description	Price
237612	48-22-8430	Packout Organizer	

PACKOUT™ Low-Profile Organizer

- No-travel bins seal prevent small part migration between bins
- Integrated center slot for long bits and blades
- Slim design for organization of small items
- 8 small and 2 large removable bins
- IP65 Rated weather seal



Part #	Mfg #	Description	Price
253969	48-22-8431	Low-Profile Organizer	

48" Level Bag

- Integrated external tool loops for additional tool storage
- Two debris vent to prevent dust, dirt and water build up
- Tough, water resistant nylon construction
- All metal hardware to ensure ultimate durability
- Durable zipper closure
- Two integrated carrying or hanging handles



Part #	Mfg #	Description	Price
243112	MLSB48	48" Level Bag	

M12™ Tool Holster

- Heavy duty nylon material
- Easy snap-on
- On board bit storage
- Compatible with most M12™ drilling & fastening tools



Part #	Mfg #	Description	Price
151175	2335-20	Tool Holster	

13" Job Site Work Box

- Impact resistant construction
- Vertical tool storage tray
- 16" Seat height
- Cut groove
- Wide grip locking handle
- Drip ledge lid
- Indexing square
- Made in USA



Part #	Mfg #	Description	Price
170620	48-22-8010	13" Job Site Work Box	

Miscellaneous Tools

26" Job Site Work Box

- Impact resistant construction
- Buttressed hinges
- Protected recessed latches
- Reinforced corners
- Integrated weather seal
- Clamping cut groove
- Over molded wide grip handle
- Pass through side grips
- Integrated screw mounting bosses
- Corner pocket storage
- Space for long and bulky tools
- Indexing square
- Made in USA



Part #	Mfg #	Description	Price
170622	48-22-8020	26" Job Site Work Box	

TRAPSNAKE TOILET AUGER CASE

- 2 Handles
- Vent holes
- 1680D Ballistic material



Part #	Mfg #	Description	Price
256440	48-22-2576	Toilet Auger Case	

Belt Clip

Part #	Mfg #	Description	Price
164935	42-70-2653	Assembly	

Milwaukee® Markers

INKZALL® Marker

- Clog resistant marker tip
- Writes through dusty, wet and oily surfaces
- Write on concrete, OSB and rough surfaces
- Built-In hard hat storage clip
- Fine point
- Ink dries in seconds
- Lanyard hole
- Anti-roll body design
- Non-toxic ink



Part#	Mfg#	Color	Point	Pk
165641	48-22-3100	Black	Fine	1
171184	48-22-3105	Black	Fine	2
166905	48-22-3104	Black	Fine	4
175754	48-22-3102	Black	Medium	2

Milwaukee® Markers (Continued)

INKZALL® Marker

Part#	Mfg#	Color	Point	Pk
186547	48-22-3170	Red	Fine	1
186548	48-22-3180	Blue	Fine	1
186549	48-22-3190	Green	Fine	1
189841	48-22-3121	Silver	Fine	2
189843	48-22-3123	Silver/Gold	Fine	2
226974	48-22-3107	Multi	Fine	8

INKZALL® Paint Marker

- Writes on dirtiest, hottest, roughest surfaces
- Durable acrylic nib
- Water & UV resistant markings
- 10 second dry time
- Marks on surfaces up to 300F
- Valve action marker



Part#	Mfg#	Color	Point	Pk
189845	48-22-3711	White	Paint	1
189844	48-22-3712	White	Paint	1
189848	48-22-3721	Yellow	Paint	1
189567	48-22-3722	Yellow	Paint	1
189854	48-22-3771	Orange	Paint	1
189851	48-22-3741	Red	Paint	1
189849	48-22-3731	Black	Paint	1
189852	48-22-3751	Green	Paint	1
189853	48-22-3761	Blue	Paint	1

1PK Medium Chisel Black Marker

- Clog resistant chisel tip marker
- Built-in hard hat storage clip
- Writes through dusty, wet, and oily surfaces
- Writes on concrete, OSB, and rough surfaces



Part#	Mfg#	Color	Point
171183	48-22-3103	Black	Med Chisel

Miscellaneous Tools

INKZALL® Stylus & Fine Point Black Marker

- Conductive stylus tip
- Clog resistant marker tip
- Writes through dusty, wet and oily surfaces
- Writes on concrete, OSB and rough surfaces
- Built-In hard hat storage clip
- Ink dries in seconds
- Lanyard hole
- Anti-roll body design
- Non-toxic ink



Part #	Mfg #	Description	Price
165228	48-22-3101	Stylus & Black Marker	

4-PK Fine Point Colored Markers

- Clog resistant marker tip
- Built-in hard hat storage clip
- Writes through dusty, wet, and oily surfaces
- Writing on concrete, OSB, and rough surfaces



Part #	Mfg #	Description	Price
171185	48-22-3106	4-PK Colored Markers	

4-PK INKZALL™ Color Ultra Fine Point Pen

- Bleed and smear resistant
- Marks a 0.5mm line
- Long cap off life
- Pocket clip



Part #	Mfg #	Description	Price
257313	48-22-3165	4-PK Colored Pens	

Reaming Pen

- Pen provides easy deburring of copper tubing and PVC
- The blade is heat treated and black oxide coated for extended life
- All-metal design for durability
- A slide resistant clip allows easy storage



Part #	Mfg #	Description	Price
186221	48-22-4255	5.5" Length	

Measuring Tools

Auto Lock Tape Measure

- Auto Lock brake
- Nylon bond blade protection
- 5-Point reinforced frame
- Fractional scale
- Optimized hook designed for scoring
- Stamped steel belt clip
- Lanyard ready



Part #	Mfg #	Description	Price
252026	48-22-6816	16'	
248194	48-22-6825	25'	

Compact Tape Measure

- Nylon bond blade protection
- 5-point reinforced frame
- Stamped steel belt clip
- Lanyard read
- Optimized hook designed for scoring



Part #	Mfg #	Size	Price
236370	48-22-6616	16'	
230575	48-22-6625	25'	

STUD™ Tape Measure

- EXO360™ Blade technology delivers the longest lasting, rip and wear resistant tape measure blade
- Fully reinforced body, impact resistant frame survives up to 80 foot drop*
- Up to 10' tape standout
- Wire form belt clip
- Zero tolerance hook
- Lanyard ready
- Finger stop delivers tape retraction control



Part #	Mfg #	Description	Price
267890	48-22-9716	16'	
267891	48-22-9725	25'	

Key chain Tape Measure

- 6'/2m



Part #	Mfg #	Size	Price
186517	48-22-5506	6'	

Miscellaneous Tools

Composite Folding Rule

- Most durable markings and blades
- Heat stamped markings
- Wear and scratch resistant laminate
- Corrosion-free embedded joints



Part #	Mfg #	Description	Price
183684	48-22-3801	9-1/4" x 1-3/8"	

Closed Reel Long Tape Measure

- Grime Guard™
- Heavy duty metal frame
- Nylon coated steel blade
- 100ft Folding hook



Part #	Mfg #	Blade Length	Price
238210	48-22-5101	100 Foot	

Open Reel Long Tape

- Grime Guard™
- 3:1 Metal planetary gears
- 3/8" Nylon bond steel blade
- Metal reinforced handle



Part #	Mfg #	Description	Price
248643	48-22-5230	300 Foot	

12" Measuring Wheel

- Top Break Function
- Reinforced Locking Pivot Point
- Kickstand
- Top Handle Clearing Function
- Wheel Debris Cleaning Flap
- Zero Point Indicator



Part #	Mfg #	Description	Price
227767	48-22-5012	12"	

Laser Distance Meter

- +/- 1/16" Accuracy
- Side-shot button
- Digital auto-level
- Backlit color screen
- Simplified user interface



Part #	Mfg #	Size	Price
233153	48-22-9802	150'	
241057	48-22-9803	330'	

100' Precision Line Chalk Reel

- StripGuard™ Clutch
- Planetary Gear System
- 6:1 Gear Retraction Ratio
- Low spillage line
- All metal body



Part #	Mfg #	Description	Price
188278	48-22-3992	Kit with Red Chalk	

100' Bold Line Chalk Reel

- StripGuard™ Clutch
- Planetary Gear System
- 6:1 Gear Retraction Ratio
- Flush Handle Storage
- Rubber Overmold



Part #	Mfg #	Description	Price
188283	48-22-3980	Reel Only	
188280	48-22-3982	Kit with Blue Chalk	
188281	48-22-3986	Kit with Red Chalk	

Replacement Line

- 1.5mm Replacement Line
- High Strength Braided Line
- 100ft



Part #	Mfg #	Description	Price
188285	48-22-3989	Bold Line	

Miscellaneous

TICK™ Tool and Equipment Tracker

- Allows you to track the location of any item in your inventory
- The app will automatically store the last time any ONE-KEY™ app was within the 100 ft Bluetooth® range of your TICK™. Check your app to easily pinpoint the last seen date, time and location to find leave-behinds, view equipment deployment, and help find missing equipment



Part #	Mfg #	Description	Price
232950	48-21-2000	3V Lithium-Ion Coin Cell	
232951	48-21-2004	3V Lithium-Ion Coin Cell 4-PK	
232952	48-21-2010	3V Lithium-Ion Coin Cell 10-PK	
232953	48-21-2050	3V Lithium-Ion Coin Cell 50-PK	

Miscellaneous Tools

+Stop Lock Hand Clamp

- +STOP LOCK™ Mechanism
- Optimized pad geometry for more secure clamping
- Hex Release Mechanism
- Riveted Pivoting Clamp Pads
- High Grade Resin
- Rust protection



Part#	Mfg#	Size	Price
221198	48-22-3002	2"	
221199	48-22-3004	4"	

Bottle Opener

- Wire Stripper - Up to 12ga
- Chrome Plated Rust Protection
- Hardened Steel for Durability
- Cushion Grip Handle
- Rear Cap ID Marking



Part #	Mfg #	Description	Price
165227	48-22-2000	6-3/5" Length	

Hook and Pick Set

- All-metal core
- Comfort grip handle
- Knurling
- Includes:
 - Hook
 - 90° Hook
 - Offset hook
 - Straight pick



Part #	Mfg #	Description	Price
239632	48-22-9215	4-Piece Hook and Pick Set	

Bolt Cutters

- Comfort Grip Handles
- Lanyard Holes
- Max Hardness 48RHC
- Adjustable Blades



Part #	Mfg #	Description	Price
248996	48-22-4014	14"	
250929	48-22-4114	14"	

Grinder Accessories

Part #	Mfg #	Description	Price
251723	48-66-0975	Die Grinder Collet 1/4"	

Miscellaneous (Continued)

Grinder Accessories

Part #	Mfg #	Description	Price
251722	48-68-0031	Collet Nut 1/4"	

Steel Fish Tape

- Low friction case
- High visibility laser etched markings
- Square inner hrip
- Flexible blue tempered steel
- Multi-position handle
- Anti-catch tip



Part #	Mfg #	Length	Width	Price
257974	48-22-4172	50'	1/8"	

Water Tank

- 3-1/2 Gallon poly tank
- For use when regular tap water is not available



Part #	Mfg #	Description	Price
255319	49-76-0055	3-1/2 Gallon Water Tank	

Inner Core Bulb Head Cable

- RUST GUARD™



Part #	Mfg #	Size	Price
238927	48-53-2563	1/4" x 25'	

Inner Core Drop Head Cable

- RUST GUARD™



Part #	Mfg #	Size	Price
238929	48-53-2561	5/16" x 25'	
238930	48-53-2562	5/16" x 25'	
238928	48-53-2564	1/4" x 25'	

Miscellaneous Tools

Inner Core Coupling Cable

- RUST GUARD™



Part #	Mfg #	Size	Price
238932	48-53-2675	3/8" x 35'	
238937	48-53-2773	3/8" x 50'	
238936	48-53-2774	1/2" x 50'	
242542	48-53-2775	5/8" x 50'	

Inner Core Bulb Head Cable

- Solid polymer core
- Carries power through end of cable
- Maneuvers the tightest bends
- Corrosion resistant core
- End of cable indicator: approximately 3' from back end of cable



Part #	Mfg #	Size	Price
188683	48-53-2571	5/16" x 25'	
255110	48-53-2672	1/4" x 50'	
242348	48-53-2673	5/16" x 35'	
247628	48-53-2674	5/16" x 50'	
188687	48-53-2581	5/16" x 25' w/ Drum	

Drop Head Cable

- Solid polymer core
- End of cable indicator
- Carries power through end of cable
- Corrosion resistant core



Part #	Mfg #	Size	Price
188686	48-53-2574	1/4" x 25'	

Inner Core Drop Head Cable w/ Drum



Part #	Mfg #	Size	Price
188688	48-53-2582	5/16" x 25' w/ Drum	

Small Drop Head Attachment

- RUST GUARD™ Plating



Part #	Mfg #	Description	Price
250038	48-53-2682	Small Drop Head Attachment	

1-1/2" C-Cutter Attachment w/ RUST GUARD™ Plating

- RUST GUARD™ plating



Part #	Mfg #	Description	Price
256519	48-53-2789	C-Cutter Attachment	

5-PC Drain Line Kit

- RUST GUARD™



Part #	Mfg #	Size	Price
238933	48-53-2685	Small	
238934	48-53-2790	Medium	

TRAPSAKE™ Manual Toilet Auger

- Powers through tough clogs and retrieve with control
- Integrated locking mechanism which holds the cable in place for easy telescoping extension and retraction
- Fixed Rubber Boot: Prevents porcelain scratches throughout the life of the tool
- Industry's first replaceable cables



Part #	Mfg #	Description	Price
230884	49-16-2576	6' x 1/2" Cable Size	
230886	49-16-2574	4' x 3/8" Cable Size	

TRAPSAKE™ Toilet Auger Replacement Cable



Part #	Mfg #	Description	Price
230887	48-53-2576	6'	

Miscellaneous Tools

Miscellaneous Tools

Fin Straightener

- Long comfort-grip handle
- Adjustable straightening wire tension
- Accommodates various fin types
- Wires held by a sturdy metal body



Part #	Mfg #	Description	Price
182251	61170	Fin Straightener	

Tube Deburring Tool



Part #	Mfg #	Description	Price
237074	60163	Deburring Tool	

Miscellaneous Tools

Bucket Organizers

- High-impact plastic pail
- Storage trays fit snugly inside
- Easy on/off lid



Part #	Mfg #	Bucket	Trays:	Price
008175	502	5 gal	2 Large & 2 Small	

Bucket Organizer Pail Lid

- Fits both 3.5 and 5 gallon pails

Part #	Mfg #	Description	Price
059482	001	Lid Only	



Miscellaneous Tools

Tie Downs

EPDM Tie-Down Strap

- Super-strong 100% EPDM material with 2-1/2" galvanized S hooks



Part #	Mfg #	Max Length	Length	Price
183405	319-15	22"	15"	
183406	319-20	30"	20"	
183407	319-31	45"	31"	

Extendable Inspection Mirror with Angle Ball Joint

- Pocket clasp included
- Powerful long life magnetic tip



Part #	Mfg #	Size	Extension	Price
156742	390-50115	1" x 2"	5-5/8"-18-3/4"	

Miscellaneous Tools

PowerPEX® F1807 Tools & Miscellaneous

PowerPEX® F1807 Stainless Compression Tool

- Steel handle
- Exclusively for installing Sioux-Chief's **305-83TX** V-Sleeve™ stainless steel PEX compression system
- PowerPEX® tools by Tomahawk™



Part #	Mfg #	Size	Price
165320	305-82TX	1/2"	
165321	305-83TX	3/4"	
165322	305-84TX	1"	

PowerPEX® F1807 PEX Crimp Ring Removal Tool

- Allows fitting recovery without damaging the sealing surfaces of the fitting
- Do not use on Copper F1807 PEX or AccuCrimp™ fittings
- Two cuts on copper ring allows user to reclaim fitting
- Cutting blade only penetrates the copper ring and pipe
- Suitable for use on 1/2" through 1" PEX pipe sizes
- PowerPEX™ tools by Tomahawk™



Part #	Mfg #	Description	Price
165518	305-99	Crimp Ring Removal Tool	

Pipe Cutters - Copper

Tubing Cutters

Close Quarters Tubing Cutter

- Use in restricted spaces on small diameter, hard and soft copper, aluminum, brass and plastic tubing
- Large knurled feed screw knob



Part #	Mfg #	Model	Capacity	Description	Std Wheel	Price
008656	40617	101	1/4" - 1-1/8"	Cutter	E-3469	
008659	32975	103	1/8" - 5/8"	Cutter	E-3469	
008660	32985	104	3/16" - 15/16"	Cutter	E-3469	
067702	97787	117	3/16" - 15/16"	Quick-Feed Cutter	E-3469	
051432	86127	118	1/4" - 1-1/8"	Quick-Feed Cutter	E-3469	

Constant Swing Cutter with X-CEL

- Features an enclosed feed screw to eliminate clogging and jamming, grooved rolls for close-to-flare cuts, and a fold-away reamer
- Made from high-strength aluminum alloy



Part #	Mfg #	Model	Capacity	Description	Std Wheel	Price
008687	31622	150	1/8" - 1-1/8"	Feed Cutter	E-3469	
008688	31627	150	1/8" - 1-1/8"	Feed Cutter with HD Wheel(s)	E-4546	

Tubing and Conduit Cutter with X-CEL

- Clean, square cuts on copper, brass, aluminum, and thin-wall conduit

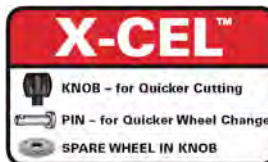

Part #	Mfg #	Model	Capacity	Description	Std Wheel	Price
008655	32910	10	1/8" - 1"	Screw Feed Cutter	F-158	
008648	32920	15	3/16" - 1-1/8"	Screw Feed Cutter, Fold-Away Reamer	F-158	
008703	32930	20	5/8" - 2-1/8"	Screw Feed Cutter, Fold-Away Reamer	F-158	
008713	32940	30	1" - 3-1/8"	Screw Feed Cutter f/Lg Dia Steel & SS Tube	F-158	

Quick-Acting Tubing Cutter with X-CEL

- I-Beam construction, hardened wear surfaces and bearing side assemblies for smooth operation
- Plastic cutters include spare cutting wheel for cutting copper



Part #	Mfg #	Model	Capacity	Description	Std Wheel	Price
008689	31632	151	1/4" - 1-5/8"	Quick-Acting, Fold-Away Reamer	E-3469	
008690	31642	152	1/4" - 2-5/8"	Quick-Acting, Fold-Away Reamer	E-3469	
008691	31652	154	1-7/8" - 4-1/2"	Quick-Acting Tubing Cutter	E-2558	

Pipe Cutters - Copper

Internal Tubing Cutter

- For trimming tubing below floor level for shower and floor drain installations, or above the ceiling for sprinkler head installations



Part #	Mfg #	Model	Capacity Nom / Depth	Description	Std Wheel	Price
018338	33005	106	2" - 3" / 1/4" - 2-5/8"	Internal, Steel & Aluminum Body	E-2558	

Tubing Cutter Wheel



Part #	Mfg #	Model	Blade Exp	Application	For Model	Price
008575	33165	E-1240	.162	Steel - SS	10, 15, 15-SI	
008596	33175	E-2191	.292	HD Steel Tubing	30, 40, 122, 122XL, 133, 154, 156	
008599	33170	E-2558	.220	Aluminum & Copper	30, 40, 108, 109P, 133, 154, 156	
023461	34695	E-3495	.290	Aluminum	151, 152, 153, 205	
008617	33190	E-4546	.162	Steel - SS	151, 152, 153, 205	
008606	33185	E-3469	.149	Copper, Aluminum, Brass & Plastic	101,103,104,117,118,150,151,152,153,205	
008636	33160	F-158	.149	Aluminum & Copper	10,15, 20	

Tubing Cutter Parts

Part #	Mfg #	Description	For Model	Price
129719	34620	Roll Housing Screw	20	
024438	42327	Retaining Ring	101, 103, 104, 117 & 118	

Tubing Tools

456 Tri-Bender

- Ideal for plumbing and HVAC applications
- 90° Start angle minimizes effort required to form a bend
- Handy reference marks indicate the angle for quick bends through 90°



Part #	Mfg #	Model	Capacity	Price
008738	44852	456	1/4", 5/16", 3/8"	

Spring-Type Tube Bender

- Fast, free-form bending of soft copper and aluminum tube



Part #	Mfg #	Model	Length	Tube OD	Price
008563	35255	D-1377	10"	3/8"	

Pipe Cutters - Copper

Copper Tubing Cutters

Close Quarters Tubing Cutter

- Most compact
- Longest life
- Chrome rollers
- Weep holes
- Directional grip
- Replaceable blade



Part #	Mfg #	Size	Price
225206	48-22-4260	1/2"	
225207	48-22-4261	3/4"	
225208	48-22-4262	1"	

Mini Copper Tubing Cutter

- Proprietary adjustment mechanism
- Chrome Rollers
- Easy Grip Knob



Part #	Mfg #	Size	Price
188005	48-22-4250	1/2"	
229533	48-22-4258	3/4"	
188006	48-22-4251	1"	

Constant Swing Copper Tubing Cutter

- 4 Roller design
- Chrome rollers
- Smooth adjustment mechanism
- On-Board reamer



Part #	Mfg #	Size	Price
234876	48-22-4259	1"	
188007	48-22-4252	1-1/2"	

Quick Adjust Copper Tubing Cutter

- 4 Roller design
- Chrome rollers
- Quick adjustment mechanism
- Tool-free blade change
- Extra blade included



Part #	Mfg #	Size	Price
234288	48-22-4253	2-1/2"	
234872	48-22-4254	3-1/2"	

3 Piece Close Quarters Tubing Cutter Set

- Most compact
- Longest life
- Chrome rollers
- Weep holes
- Directional grip
- Replaceable blade



- Includes:
 - (1) 1/2" Close quarters tubing cutter (48-22-4260)
 - (1) 3/4" Close quarters tubing cutter (48-22-4261)
 - (1) 1" Close quarters tubing cutter (48-22-4262)

Part #	Mfg #	Size	Price
225209	48-22-4263	1/2", 3/4" & 1"	

2 Piece Close Quarters Cutter Replacement Blades

- Replacement cutter wheels
- Designed for use with Milwaukee® close quarters tubing cutters
- Two pack
- High carbon steel blades
- Precision machined
- Optimized for copper



Part #	Mfg #	Description	Price
225210	48-22-4266	2/Pk	

Copper Cutter Wheels

- Hardened steel with black oxide
- Convex blade design
- For use with Milwaukee® 12V copper cutter (2471)



Part #	Mfg #	Description	Price
138792	48-38-0010	2/Pk	

2Pc Replacement Cutter Wheels

- Designed for use with Milwaukee Mini and Constant Swing Copper Tubing Cutters
- Two Pack
- High Carbon Steel Blades
- Optimized for Copper



Part #	Mfg #	Description	Price
188008	48-22-4256	2/Pk	

Pipe Cutters - Copper

3 Pc Replacement Reaming Blades

- Designed for use with Milwaukee Constant Swing Copper Tubing Cutters
- Heat Treated
- Black Oxide Blade



Part #	Mfg #	Description	Price
188009	48-22-4257	3 Pack	

M12™ Cordless Copper Tubing Cutter

- Close quarter rotating cutting head
- Automatic adjustment from 3/8" to 1" tubing
- Auto locking mechanism
- Water resistant sealed metal cutter head
- Battery fuel gauge displays remaining run time
- Built-in LED light illuminates line of cut
- No load speed: 500 rpm
- Capacity: 1/2" to 1-1/8" OD
- Kit includes:
 - Tubing cutter (2471-20)
 - (2) 12V Lithium-Ion battery (2471-21 is single battery kit)
 - 30-Minute charger
 - Carrying case
- 5-Year warranty



Part #	Mfg #	Size	Price
148546	2471-20	3/8"-1" 1/2"-1-1/8OD	
137554	2471-21	3/8"-1"	



Pipe Cutters - Copper

Autocut™ Copper Tubing Cutters



ATC



RH

Part #	Mfg #	Description	Price
031428	ATC12	For 1/2" Tubing	
031429	ATC34	For 3/4" Tubing	
073599	ATC100	For 1" Tubing	
031674	RH12	Ratchet Handle for ATC12	
031675	RH34	Ratchet Handle for ATC34	
031430	ATCW	Replacement Cutter Wheels	

Pipe Cutters - Copper

Tube Benders

Tri-Tube Bender

- Indicators on handle help identify tube sizes
- Color-coded to help spot the right tube size
- Indicators on side help measure the bend radius, up to 180°



Part #	Mfg #	Description	Price
167766	1839026	1/4", 5/16", 3/8"	
171454	1839027	1/4", 3/8", 1/2"	

Pipe Cutters - Copper

Copper Tubing Cutters

Heavy Duty Mini Cutter

- Large rollers
- Flare cut-off groove



Part #	Mfg #	Cuts From:	Price
182094	60121	1/4"-7/8" O.D.	

Premium Tube Cutter

- Textured finish
- Wide rollers with flare cut-off groove
- Wheel retracts into cutter body to save 1" in cutting radius
- Fold away steel reamer with turned cutting edge for deburring
- Textured corrosion-resistant finish on lightweight aluminum frame
- Wheels are pinned to rotate in either direction without the screw backing out



Part #	Mfg #	Size	For:	Price
182092	60101	Small	1/8"-1-1/8" O.D.	
182093	60102	Large	1/4"-1-5/8" O.D.	

Ratchet Hand Bender Kit

- Index marks to locate bends
- Trouble free ratchet mechanism
- Without reverse bending mandrel
- Kit includes all items required to bend; 1/4", 5/16", 3/8", 1/2", 5/8", 3/4" and 7/8" tubing
- Hard copper must be annealed before bending



Part #	Mfg #	Description	Price
182133	60331	Ratchet Hand Bender Kit	

Spring Tube Bender

Part #	Mfg #	Description	Price
251479	60353	Set-1/2", 5/8", 3/4" and 7/8" O.D.	
246907	60358	1/2" O.D.	

Parts & Accessories

Part #	Mfg #	Description	Price
238178	60094	Pin Clips, 5 Pack	
182091	60100	Copper Cutter Wheel	

Replacement Parts for 60331 and 60325

- 60331 Basic ratchet hand bender kit
- 60325 Deluxe ratchet hand bender kit

Part #	Mfg #	Description	Price
182132	60329	3/4"-7/8" Crossbar Assy	
182136	60336	7/8" O.D. Bending Mandrel	
236600	60340	Ratchet Bar 9' for Bender	
182138	60342	Reverse Bending Mandrel	
182140	60348	Wing Nut Screw (8, 11)	

Pipe Cutters - PEX

Tubing Cutters

ProPEX®/Tubing Cutter

- Replaceable blades
- Double ground steel V-shaped blade
- Metal core - indestructible frame
- Rework groove
- One-handed locking mechanism
- Rust protection



48-22-4200



48-22-4202

Part #	Mfg #	Jaw Capacity	
143343	48-22-4200	1"	
184107	48-22-4202	1"	

Cutter Wheel for PVC and PEX

- Cuts PVC, CPVC, ABS, and PEX
- For use with Milwaukee® quick adjust tubing cutters
- Cuts up to 2 in. plastic pipe with the 48-22-4253 quick adjust cutter
- Cuts up to 3 in. pipe with the 48-22-4254 quick adjust cutter
- High carbon steel
- .4" Max wall thickness
- 1.3" Diameter



Part #	Mfg #	Description	Price
234878	48-22-4206	PEX Cutter Wheel	

Ratcheting Pipe Cutter

- Pierce Point Blade Durable Stainless Steel Blade
- Ergonomic Handle Design
- Integrated Lanyard Hole
- Limited Lifetime Warranty



Part #	Mfg #	Jaw Capacity	
236683	48-22-4210	1-5/8"	
236684	48-22-4215	2-3/8"	

Replacement Blades and Accessories

ProPEX®/Tubing Cutter Replacement Blade

- Double-Ground V-Shaped Blade - Cleaner Cuts on 1" rubber and plastic tubing/PEX-a tubing
- Rust protection - stainless design for increased tool life and corrosion resistance



Fits 48-22-4200 and 48-22-4202 Milwaukee® Tubing Cutters

Part #	Mfg #	Description	Price
170838	48-22-4203	Blades Only	

Ratcheting Pipe Cutter Replacement Blade

ÿ For use with 48-22-4210 pipe cutter

- 1-5/8" max capacity
- Heat treated
- Precision ground edge
- Pierce point blade durable stainless steel



Part #	Mfg #	Description	Price
236685	48-22-4211	Blade Only, 1-5/8"	
236686	48-22-4216	Blade Only, 2-3/8"	

Pipe Cutters - Plastic

Plastic Tubing Cutters

Quick-Acting CSST Cutter

- I-Beam frame
- Cuts corrugated gas tubing 3/8" - 1"
- Two sets of split-floating guide wheels
- Ergonomic knob
- Full lifetime warranty



Part #	Mfg #	Model	Capacity	Description	Std Wheel	Price
122158	32078	151 CSST	3/8" - 1"	Quick-Acting CSST Cutter	33190	

Plastic Pipe Tubing Cutter

- Designed for quick, clean cuts through plastic pipe and tube



PC-1375



RC-1625



Part #	Mfg #	Model	Capacity	Description	Std Wheel	Price
104549	23493	PC-1375	1/8" - 1"	Single Stroke Plastic Pipe & Tubing Cutter	X-CEL™ PCB-1375	
108391	23498	RC-1625	1/2" - 1-5/8"	Ratchet Action Plastic Pipe & Tubing Cutter, Erg Grip	27858	
119754	30088	RC-2375	1/2" - 2-3/8"	Ratchet Action Plastic Pipe & Tubing Cutter, Erg Grip	30093	

Cutter Replacement Blade

Part #	Mfg #	Model	Description	Price
008706	22086	1493	Replacement Blade with Clip	
104550	25588	PCB-1375	X-CEL™ Replacement Blade	
132081	27858	RCB-1625	Replacement Blade for RC-1625	
123436	30093	RCB-2375	Replacement Blade for RC-2375	
008565	92170	138	Replacement Blade for 91125	

Plastic Tubing Cutter Wheel



Part #	Mfg #	Model	Blade Exp	Application	For Model	Price
008626	33195	E-5272	.290	PVC, ABS, Standard Wall	151-P, 152-P	
008627	33180	E-5299	.412	PVC, ABS, Standard Wall	30P - 133P, 106, 108, 109P, 154-P, 156-P	

Pipe Cutters - Plastic

Big Nipper™

- Cuts hose and tubing up to 2-1/2" ID, polyethylene up to 1-1/2" ID, and PVC up to 1-1/2" ID



- Excellent for cutting tubing insulation
- Replaceable stainless steel blade
- Clean cut - no burrs or sawdust replaceable blades

Part #	Mfg #	Description	Price
112016	16368	Big Nipper Cutter	

Li'l Nipper™

- Cuts up to 1-1/4" polyethylene, PVC, ABS, and rubber hose
- Cutters are light and can be handily carried in back pocket or tool pouch
- Strong nylon handle with replaceable blades
- Cutters do not distort pipe



Part #	Mfg #	Description	Price
002266	0125	Li'l Nipper™ Cutter	
026128	0127	2 Replacement Blades	

Pipe Cutters - Plastic

Tube and Pipe Cutters

Inside Pipe Cutter

- Steel blade for plastic pipe
- Abrasive disc for plastic or steel pipe



390-5016

Part #	Mfg #	Steel Blade Size	Price
035402	390-50163	1-1/4"	
035403	390-50164	1-1/4" Hardened	

PowerPEX Crimp Tools

(Complete Line of ASTM F1807 Options)

- Complete line of F1807 crimp tool options below:
- Steel or composite handles
- Composite handles are strong and durable, yet lightweight
- Compact tools allow one-hand crimping
- Combo tool for the most common crimp connections and added cost savings
- Free Go/No-Go gauge provided with every model
- Also work on PB 1380 tube and fittings



305-23CP

Composite Handle

Part #	Mfg #	Description	Length	Price
183403	305-23CPK	1/2"Over-3/4" Combo	14"	

Plactic Tube and Hose Cutter

- Quickly cut PEX, PVC, CPVC and other poly pipe or non-metallic hose
- For 1 1/8" O.D. tube or smaller



304-08

Part #	Mfg #	Blade Length	Price
160228	304-08	2-1/4"	

Pipe Cutters - Soil Pipe

Soil Pipe Cutters

- Provides 1-stroke cutting of 1-1/2" to 6" service weight, No-Hub® soil pipe, clay, asbestos and cement pipe



Part #	Mfg #	Model	Pipe Capacity	Description	Price
008709	32900	246	1-1/2" - 6"	Cuts Clay, Cast Iron, Cement Pipe, 4" Class 22 Water Main	

Pipe Cutters - Steel

Pipe Cutters

Heavy-Duty Pipe Cutter

- Fast, clean pipe cutting by hand or power
- Extra-long shank protects adjustment threads, while an extra-large handle is provided for quick, easy adjustment
- Can be converted to 3-wheel cutter by replacing rollers with cutter wheel



Part #	Mfg #	Model	Pipe Capacity	Description	Price
008701	32820	2-A	1/8" - 2"	Heavy-Duty Pipe Cutter	

Pipe Cutter Replacement Wheel



Part #	Mfg #	Model	Blade Exp	Application	For Model	Price
008732	44185	E-1032	.450	Steel & Ductile Iron	202, 360, 732, 820/364	
008641	33105	F-3	.312	Steel & Ductile Iron	1A, 2A, 42A, 202, 360, 732, 820/364	
008637	33125	F-229	.411	Steel & Ductile Iron	3S, 4S, 44S, 466C/S/HWS, 468C/S/HWS, 472C/S/HWS, 764	
008643	33100	F-514	.312	Steel & Ductile Iron	1A, 2A, 42A, 202, 360, 732, 820/364	

Pipe Cutter Parts



Part #	Mfg #	Model	Description	For Model	Price
008664	30118	E-3055X	Ratchet with Handle	12-R	
008720	32142		Wheel Pins with Clip, 5/Pk	151-P, 152, 152-P, 152-PVC, 153, 153-P	
008574	33970	E-1189X	Rings with Pin, 5/Pk	101, 103, 104	
008590	34325	E-1948	Screws, 10/Pk	10, 15, 15-SI	
008638	34805	F-255	Roller, 5/Pk	15	
129720	34825	F-266	Roller, 5/Pk	20	

Pipe Threaders

Pipe Tools

Pipe Reamer

- All reamers include handles



Part #	Mfg #	Model	Capacity	Description	Price
008702	34955	2-S	1/4" - 2"	Spiral Ratchet	

Inner-Outer Reamer

- Plastic construction with long-wearing alloy steel blades



Part #	Mfg #	Model	Description	Construction	Price
017583	34965	127	1/4" - 1-1/2" Nominal Water Tube	Plastic	

Hardened Steel Inner-Outer Reamer

- Hardened steel construction
- 46 Cutting edges on interior cone
- For fast, clean, inner reaming and outer deburring/beveling of 1/2"-2" copper and stainless steel tubing



Part #	Mfg #	Model	Description	Construction	Price
111700	29993	227S	1/2" - 2" Copper & SS Tubing	Hardened Steel	

Deburring Tool

- For plastic pipe and tubing
- Made of high-grade steel with long-lasting cutting edges
- Ideal for removing outside ridges and inside burrs on plastic pipe and tubing



Part #	Mfg #	Model	Capacity	Plastic Cap ID	Price
033796	64967	74	4"	--	

Individual Pipe Extractor

- Easily removes broken threaded ends of pipe, pipe plugs and fittings
- Each is plainly marked showing drill size used when solid ends of plugs and fittings must be drilled to receive extractor



Part #	Mfg #	Model	Pipe Size	Length Overall	Use Drill	Price
120553	35610	83	1/2"	3"	5/8"	

Pipe Threaders

Manual Threaders

Manual Threader Die Head

- North American standards



Part #	Mfg #	Model	Description	Nominal Pipe Capacity	Price
008661	37040	11-R	Alloy RH	1/2"	
008672	37390	12-R	Alloy RH	1/2"	
008679	37395	12-R	Alloy RH	3/4"	
008666	37400	12-R	Alloy RH	1"	
008668	37410	12-R	Alloy RH	1-1/2"	
008677	37415	12-R	Alloy RH	2"	

Pipe Die - National Pipe Taper NPT



Part #	Mfg #	Model	Description	Nominal Pipe Capacity	Price
008671	37825	12-R	Alloy RH	1/2" - 14	
008678	37830	12-R	Alloy RH	3/4" - 14	
008665	37835	12-R	Alloy RH	1" - 11-1/2	
008669	37840	12-R	Alloy RH	1-1/4" - 11-1/2	
008667	37845	12-R	Alloy RH	1-1/2" - 11-1/2	
008676	37850	12-R	Alloy RH	2" - 11-1/2	
008724	37920	12-R	High Speed SS RH	3/4" - 14	
008725	37925	12-R	High Speed SS RH	1" - 11-1/2	

Power Threading Equipment

Model 300 Power Drive Complete

- RIDGID® speed chuck
- Reversible 1/2 HP universal motor
- Ideal for use with RIDGID roll groovers
- Heavy-duty forward/off/reverse and integral foot switch
- Speed chuck with replaceable rocker-action jaws
- Cam-action turns with chuck
- Heavy-duty support bar



Part #	Mfg #	Model	Description	Price
022267	15682	300 Complete	115V, 25-60 Hz (NPT)	

Pipe Threaders

Pipe Die for Machine Die Heads



Pipe Die for 504A, 711, 731, 811A, 815A and 842

Part #	Mfg #	Die Material or Type	(NPT) Nominal Pipe Size Threads Per Inch	Price
008747	47745	Alloy RH NPT	1/2"-3/4" - 14	
008748	47750	Alloy RH NPT	1"-2" - 11-1/2	



Pipe Threaders

Golden Tool™ Pipe Threaders

Golden Pipe Shredder™ Kit

- 4 Shredder tools: 1-1/2", 2", 3", 4"
- 1/2" Arbor size



Part #	Mfg #	Size	Qty	Price
143396	98040	1-1/2"	4	
143394	98041	2"	4	

Pliers & Wire Strippers

Pliers

6-in-1 Long Nose Pliers

- Integrated reaming head to smooth-out rough edges of metal pipe
- High-leverage design
- (6) Applications:
 - Reaming
 - Wire stripping
 - Nail/wire cutting
 - Nail pulling
 - Pliers
 - Loop maker



Part #	Mfg #	Overall Length	Price
150218	48-22-3068	8"	

Long Nose Pliers

- 2" Gripping nose reaming head design - Up to 1"
- On-Board fish tape puller
- Comfort grips will not peel
- Forged design for added strength
- Rust resistance



Part #	Mfg #	Overall Length	Price
175004	48-22-6101	8"	

Cable Cutting Pliers

- Rust resistant
- Comfort grips
- Beveled jaw head
- Optimized blade angle
- Forged strength design
- Ergonomic handle design
- 2/0 Copper max capacity
- 4/0 Aluminum max capacity



Part #	Mfg #	Jaw Length	Price
241143	48-22-6104	2.13"	

PVC/Oil Filter Pliers

- Comfort grips will not peel or dig into hands during extended use
- Rust resistant
- Forged strength design



Part #	Mfg #	Jaw Length	Price
185825	48-22-6321	3.5"	

Combination Wire Pliers

- Reaming head design
- Bolt cutter - thread and cut #6 and #8 bolts
- Wire stripper
- One-handed swing lock
- Curved cutting blade
- Ruse protection
- Tether-ready handle loops



Part #	Mfg #	Overall Length	Price
190123	48-22-3079	7.75"	

Comfort Grip Crimping Pliers

- Crimping head for INS and NON-INS terminals, 10-22AWG
- Integrated reaming head
- Integrated wire cutting for 8-28AWG
- Comfort grips will not peel
- Rust resistant



Part #	Mfg #	Overall Length	Price
189200	48-22-6103	9"	

6-In-1 Diagonal Pliers

- Reaming head design
- Bolt cutter
- High-leverage design
- Laser hardened cutting edges
- Offset head design - 15 degree offset head for easier and quicker prying and pulling (Patent Pending)
- Rust protection



Part #	Mfg #	Overall Length	Price
175105	48-22-6107	7"	

Pliers & Wire Strippers

Diagonal Cutting Pliers

- Reaming head design
- Flush cutting blades
- On-board fish tape puller
- Comfort grips
- Forged design for added strength
- Rust resistance



Part #	Mfg #	Overall Length	Price
175106	48-22-6106	6"	
175005	48-22-6108	8"	

Tongue & Groove Pliers

- Reaming head design
- Forged alloy steel for maximum tool strength
- Induction hardened jaws
- Smooth transition grips minimize wear tear and improve punchability
- Rust protection increases tool life by reducing corrosion



Part #	Mfg #	Overall Length	Price
143342	48-22-3210	10"	
150217	48-22-3212	12"	

12" Smooth Jaw Pliers

- Ergonomic handles with dipped grips
- Reaming head
- Smooth jaw
- Rust protection



Part #	Mfg #	Overall Length	Price
255002	48-22-6552	12"	

Straight-Jaw Pliers

- REAM & PUNCH™ handles
- Hardened teeth for long gripping life
- Comfort grips
- Rust resistant
- Forged design for added strength



Part #	Mfg #	Overall Length	Price
175007	48-22-6306	6"	
175008	48-22-6310	10"	
175009	48-22-6312	12"	
175010	48-22-6316	16"	

Pliers (Continued)

Straight-Jaw Pliers

Part #	Mfg #	Overall Length	Price
175110	48-22-6320	20"	
175006	48-22-6330	6" & 10" (2Pk)	

Hex-Jaw Pliers

- Hex-Jaw design for hex bolts
- All-Metal quick adjustment mechanism
- REAM & PUNCH™ Handles
- Slim head design comfort grips
- Rust resistant



Part #	Mfg #	Overall Length	Price
175109	48-22-6208	8"	
175108	48-22-6210	10"	
175107	48-22-6212	12"	

3 Pc Pliers Kit

- Includes:
 - (1) 8" Long Nose Pliers (48-22-6101)
 - (1) 7" Diagonal Cutting Pliers (48-22-6107)
 - (1) 10" Straight-Jaw Pliers (48-22-6310)



Part #	Mfg #	Description	Price
189817	48-22-6331	Multi-Use	

2 Pc Locking Pliers Set

- Includes:
 - (1) 10" Torque Lock™ Curved Jaw Locking Pliers (48-22-3420)
 - (1) 6" Long Nose (48-22-3506)



Part #	Mfg #	Overall Length	Price
226918	48-22-3602	6" & 10"	

Pliers & Wire Strippers

Maxbite Curved Jaw Locking Pliers

- MAXBITE JAW DESIGN 3X GRIPPING FORCE
- Torque lock faster setup and more force for locking tools
- MAXBITE jaw maximizes pressure points for round pipe, hex bolts, and many other locking tool applications
- Control release fast, easy, one-handed release
- Hardened jaws better grip force on jobsite material
- Forged alloy steel for maximum tool strength and durability



Part #	Mfg #	Overall Length	Price
221689	48-22-3610	10"	

High Leverage Lineman's Pliers w/ Crimper

- Iron carbide edge cutting edge hardened blades
- Reaming head design - up to 1 1/2" (patent pending)
- Integrated crimper for INS and NON INS terminals
- On-Board fish tape puller
- Comfort grips will not peel
- Forged design for added strength
- Rust resistance



Part #	Mfg #	Overall Length	Price
175003	48-22-6100	9"	

6-in-1 Lineman's Pliers

- Integrated reaming head
- High-leverage design
- (6) Applications:
 - Reaming
 - Bolt cutter
 - Wire cutter
 - Nail pulling
 - Pliers
 - Fish tape puller



Part #	Mfg #	Overall Length	Price
149137	48-22-3309	9"	

TORQUE LOCK Pliers

TORQUE LOCK™ Curved Jaw Locking Pliers with Durable Grip

- TORQUE LOCK™ Faster setup and easy release
- Curved Jaw: Maximizes pressure points for any bolt, nut or locking tool application
- Hardened Jaws: Better grip force on job site material
- Rust Protection: Increases tool life by reducing corrosion
- Overmold Grips: Durable and comfortable



Part #	Mfg #	Overall Length	Price
168835	48-22-3405	5"	
168834	48-22-3407	7"	
168827	48-22-3410	10"	

TORQUE LOCK™ Long Nose Locking Pliers With Durable Grip

- TORQUE LOCK™ Faster setup and easy release
- Curved Jaw: Maximizes pressure points for any bolt, nut or locking tool application
- Hardened Jaws: Better grip force on job site material
- Rust Protection: Increases tool life by reducing corrosion
- Overmold Grips: Durable and comfortable



Part #	Mfg #	Overall Length	Price
168838	48-22-3406	6"	
168837	48-22-3409	9"	

TORQUE LOCK™ Straight Jaw Locking Pliers

- TORQUE LOCK™: Faster setup and easy release
- Straight Jaw: Maximizes contact points on job site work surfaces
- Hardened Jaws: Better grip force on job site material
- Forged Alloy Steel: For maximum tool strength and durability
- Rust Protection: Increases tool life by reducing corrosion



Part #	Mfg #	Overall Length	Price
168826	48-22-3507	7"	
168825	48-22-3510	10"	



Pliers & Wire Strippers

TORQUE LOCK™ Curved Jaw Locking Pliers

- TORQUE LOCK™: Faster setup and easy release
- Curved Jaw: Maximizes pressure points for any bolt, nut or locking tool application
- Hardened Jaws: Better grip force on job site material
- Forged Alloy Steel: For maximum tool strength and durability
- Rust Protection: Increases tool life by reducing corrosion



Part #	Mfg #	Overall Length	Price
221690	48-22-3607	7"	
168824	48-22-3420	10"	

TORQUE LOCK™ Curved Jaw Locking Pliers Set

- Includes:
 - (1) 7" TORQUE LOCK Curved Jaw Locking Pliers (48-22-3407)
 - (1) 10" TORQUE LOCK™ Curved Jaw Locking Pliers (48-22-3410)



Part #	Mfg #	Overall Length	Price
168839	48-22-3402	7" & 10"	

Pliers & Wire Strippers

Milled Jaw Slip-Joint Pliers

- Nickel-plated finish with plastic grips
- Angle-nose pliers have grip tight clip



Part #	Mfg #	Type	Size	Max	Price
113964	306-10	10"	Angle Nose	1-1/2"	

Pliers & Wire Strippers

Pliers

- Undercut tongue and groove design won't slip
- Patented reinforcing edge minimizes stress breakage
- CHANNELLOCK BLUE® grips for comfort

Straight Jaw Tongue & Groove Pliers

- High-carbon C1080 steel for superior performance on the job and electronic coating for ultimate rust prevention
- Right-angle, laser-heat treated teeth grip better and last longer
- PermaLock® fastener eliminates nut and bolt failure



Part #	Mfg #	Length	Capacity	Price
076358	R117200	6-1/2"	7/8"	
008905	R117400	9-1/2"	1-1/2"	
008907	R117600	10"	2"	
008908	R117800	12"	2-1/4"	
109928	R117900	16-1/2"	4-1/4"	

V-Jaw Tongue & Groove Pliers

- High-carbon C1080 steel for superior performance on the job and electronic coating for ultimate rust prevention
- Right-angle, laser heat-treated teeth grip better and last longer
- V-Jaws give you more points of contact on round stock and tubing
- PermaLock® fastener eliminates nut and bolt failure

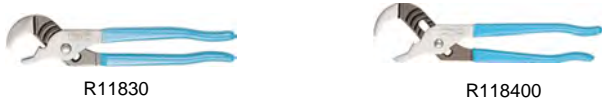

Part #	Mfg #	Length	Capacity	Price
008906	R118300	9-1/2"	1-1/2"	

Pliers & Wire Strippers

Wire Strippers

7" Wire Stripper

- Comfortable grip
- Quick ID with easy-to-read size markings



Part #	Mfg #	Description	Price
174618	1885426	7" Wire Strippers	

Pliers

Quick-Adjusting Tongue & Groove Pliers

- Comfortable grip
- Push button allows for quick adjustments while multiple grooves guarantee precise positioning
- Machined jaws increase grip on the material



Part #	Mfg #	Description	Price
174615	1890996	8" Pliers	
174616	1890997	10" Pliers	

Power Tools - M12 and Misc

M12™ Cordless Tools

M12™ Cordless 3/8" Right Angle Drill Driver

- No load speed: 0 to 800 rpm
- Clutch settings: 11+ Drill
- Chuck type: 3/8" single sleeve
- Head length/weight: 3-3/4"/2.4 lbs
- Kit Includes:
 - M12™ 3/8" Right angle drill driver
 - M12™ Lithium-ion battery
 - 30-Minute charger
 - Soft carrying case



Part #	Mfg #	Description	Price
160481	2415-20	Bare Tool	
137547	2415-21	Tool Kit	

M12™ Cordless Lithium-Ion No-Hub Driver

- 0-750 RPM Drill Mode
- 12-volt motor
- Kit Includes:
 - (1) M12™ Cordless No-Hub Driver (2455-20)
 - (2) M12™ REDLITHIUM™ battery (48-11-2401)
 - (1) M12™ Lithium-ion battery charger (48-59-2401)
 - (1) SHOCKWAVE™ 1-7/8" MAG NUTDRIVER 1/4" (49-66-4502)
 - (1) SHOCKWAVE™ 1-7/8" MAG NUTDRIVER 5/16" (49-66-4503)
 - (1) SHOCKWAVE™ 1-7/8" MAG NUTDRIVER 3/8" (49-66-4505)
 - (1) Carrying Case
 - (3) SHOCKWAVE™ Sockets



Part #	Mfg #	Description	Price
225358	2455-20	Bare Tool	
137555	2455-22	Kit	

M12™ 3/8" Hammer Drill/Driver

- Delivers up to 275 in lbs of Torque
- On-board battery fuel gauge displays remaining run time
- New ergonomic handle design for increased comfort
- Metal ratcheting chuck for maximum durability
- Includes:
 - (1) M12™ 3/8" Hammer drill/driver (Bare Tool) (2408-20)
 - (2) M12™ REDLITHIUM™ battery (48-11-2401)
 - (1) M12™ Lithium-ion battery charger (48-59-2401)
 - (1) Belt clip
 - (1) Carrying case



Part #	Mfg #	Description	Price
162002	2408-20	Bare Tool	
161649	2408-22	Kit	

M12™ 3/8" Drill/Driver

- Delivers up to 275 in-lbs of torque
- On-board battery fuel gauge displays remaining run time
- Metal ratcheting chuck for maximum durability
- Kit Includes:
 - (1) M12™ 3/8" Drill/Driver (bare tool) (2407-20)
 - (1) M12™ REDLITHIUM™ Battery (48-11-2401)
 - (1) M12™ Lithium-ion battery charger (48-59-2401)
 - (1) Belt clip
 - (1) Carrying case



Part #	Mfg #	Description	Price
162001	2407-20	Bare Tool	
162000	2407-22	Kit	

M12™ Cordless Rotary Tool

- Kit Includes:
 - M12™ Rotary tool (2460-20)
 - (1) REDLITHIUM™ Battery (48-11-2401)
 - (5) Cutting wheels, mandrel
 - Wrench
 - 30-Minute charger



Part #	Mfg #	Description	Price
162782	2460-20	Bare Tool	
144497	2460-21	Kit	

Power Tools - M12 and Misc

M12™ 1/4" Hex 2-Speed Screwdriver

- Delivers up to 275 in-lbs of torque
- On-board battery fuel gauge displays remaining run time
- New ergonomic handle design for increased comfort
- 1/4" Hex quick change chuck for one-handed bit changes
- Kit Includes:
 - (1) M12™ 1/4" Hex 2-speed screwdriver (2406-20)
 - (2) M12™ REDLITHIUM™ battery (48-11-2401)
 - (1) M12™ Lithium-ion battery charger (48-59-2401)
 - (1) Belt clip
 - (1) Carrying case



Part #	Mfg #	Description	Price
162004	2406-20	Bare Tool	
162003	2406-22	Kit	

M12™ 1/4" Hex Screwdriver

- Quick one-handed bit-loading
- Variable speed trigger
- No load speed: 0 to 500 rpm
- Kit Includes:
 - M12™ Screwdriver (2401-20)
 - (2) 12V Lithium-ion batteries
 - 12V Charger
 - Compact driver storage bag
- 5-Year warranty



Part #	Mfg #	Description	Price
235862	2401-20	Bare Tool	
137546	2401-22	Kit	

M12™ 1/4" Hex Impact Driver

- 1,000 in-lbs of torque
- 0-2,500 RPM
- On-board battery fuel gauge
- Kit Includes:
 - (1) M12™ 1/4" Hex impact driver (2462-20)
 - (1) M12™ REDLITHIUM™ battery (48-11-2401)
 - (1) M12™ Lithium-ion battery charger (48-59-2401)
 - (1) Belt clip
 - (1) Carrying case



Part #	Mfg #	Description	Price
160215	2462-20	Bare Tool	
160216	2462-22	Kit	

M12™ 1/4" Hex Right Angle Impact Driver

- Offers users maximum access for hard-to-reach fastener
- Provides the most power and highest RPM in its class
- Part of the M12 System, featuring over 70 tools
- Best-in-class power and speed with 600 in. lbs. of torque and 0 - 2,150 RPM
- Variable speeds provides maximum control for any job
- Extended paddle switch for multiple grip positions



Part #	Mfg #	Description	Price
188323	2467-20	Bare Tool	
219059	2467-21	Kit	

M12™ 1/4" Impact Wrench

- Lightweight, compact design
- On-board battery fuel gauge
- 1/4" anvil with friction ring



- Kit Includes:
 - (1) M12™ 1/4" Impact wrench (2461-20)
 - (2) M12™ REDLITHIUM™ battery (48-11-2401)
 - (1) M12™ Lithium-ion battery charger (48-59-2401)
 - (1) Belt clip
 - (1) Carrying case

Part #	Mfg #	Description	Price
162010	2461-20	Bare Tool	
162009	2461-22	Kit	

M12™ 3/8" Impact Wrench

- 1,200 in-lbs of torque
- On-board battery fuel gauge
- 3/8" anvil with friction ring
- Kit Includes:
 - (1) M12™ 3/8" Impact wrench (2463-20)
 - (2) M12™ REDLITHIUM™ battery (48-11-2401)
 - (1) M12™ Lithium-ion battery charger (48-59-2401)
 - (1) Belt clip
 - (1) Carrying case



Part #	Mfg #	Description	Price
162008	2463-20	Bare Tool	
162006	2463-22	Kit	

Power Tools - M12 and Misc

M12™ Cordless Ratchet

- Torque: 30 ft-lbs
- Speed: 250 rpm
- Anvil: 1/4" ball detent
- Kit includes:
 - M12™ Ratchet
 - (1) M12™ REDLITHIUM™ battery
 - 30-Minute charger
 - Carrying case



Part #	Mfg #	Description	Size	Price
143704	2456-20	Bare Tool	1/4"	
143703	2456-21	Kit	1/4"	
143706	2457-20	Bare Tool	3/8"	
143705	2457-21	Kit	3/8"	

M12™ Cordless PVC Shear Kit

- Ultra sharp blade with pierce point
- Offset blade cuts PVC/PEX in-wall, in-ground, or close to wall
- Quick return blade
- All metal planetary drive
- Stainless steel blade and aluminum jaw
- Variable speed trigger
- Impact, water and rust resistant
- On board fuel gauge - displays remaining run-time
- Torque: 1,900 in-lbs
- Kit Includes:
 - M12™ Cordless PVC shear (2470-20)
 - (1) Lithium-Ion battery
 - 30-Minute charger
 - Carrying case



Part #	Mfg #	Description	Price
152547	2470-20	Bare Tool	
137552	2470-21	Kit	

M12™ Hackzall™ Cordless Reciprocating Saw

- 11" Long and 2.6 lbs for cutting in tight spaces
- 1/2" Stroke, 0 to 3,000 strokes per minute
- All-metal gear case
- Variable speed trigger
- Battery fuel gauge
- QUIK-LOK™ blade clamp
- Built-in LED light illuminates work surface
- Accepts both Hackzall™ and Sawzall® style blades
- Kit includes:
 - Hackzall™ (2420-20)
 - 30-Minute charger
 - (2) Hackzall™ blades
 - Carrying case



Part #	Mfg #	Description	Price
146874	2420-20	Bare Tool	
137550	2420-21	Kit	

M12™ Rivet Tool

- Pull Up to 3/16" Stainless Steel Rivets
- 450 1/8" Steel Rivets per charge
- Aluminum, Steel, Stainless Steel - Capacity
- Part of 90+ Solutions on the M12 Platform
- 450 1/8" Steel Rivets per charge
- Pull 3/32", 1/8", 5/32", 3/16" Rivet
- 0.8" Stroke Length
- 2,000 lbs. pulls force
- Tool holds rivet in any orientation



Part #	Mfg #	Description	Price
247116	2550-20	Bare Tool	
247118	2550-22	Kit	

M12™ 600 MCM Cable Cutter Kit

- Powerful open jaws: Cut effortlessly through 600 MCM copper and 750 MCM aluminum
- REDLITHIUM™ Battery technology:
- Auto release lever: Cut, reload and quickly repeat for maximum productivity
- 2-Speed gear box:
- Built-in LED light: Illuminates the line of cut



Part #	Mfg #	Description	Price
177727	2472-21XC	Kit	

Power Tools - M12 and Misc

M12™ Cordless LITHIUM-ION Multi-Tool

- Cuts, grinds, sands and scrapes
- Variable speed dial
- On board fuel gauge displays run time
- Runs 5,000 to 20,000 OPM
- Kit includes:
 - Cordless multi-tool
 - Accessory adapter
 - Wood cutting blade
 - (1) REDLITHIUM™ battery
 - 30-Minute charger
 - Contractor bag



Part #	Mfg #	Description	Price
150059	2426-20	Bare Tool	
143165	2426-21	Kit	

Kit Includes:

- Cordless multi-tool
- Accessory adapter
- Wood cutting blade
- Sanding pad
- (5) Assorted sanding sheets
- (2) REDLITHIUM™ batteries
- 30-Minute charger
- Contractor bag

Part #	Mfg #	Description	Price
139011	2426-22	Kit	

M12™ Soldering Iron Kit

- 18 Second heat up time
- LED work light
- 3-Stop pivoting head
- 750° Max temperature
- 90W heater
- Kit includes
 - Pointed tip
 - Chisel tip
 - M12™ Soldering iron (2488-20)
 - M12 Charger and carrying case
 - M12™ REDLITHIUM compact battery pack



Part #	Mfg #	Description	Price
241854	2488-21	Kit	
244358	2488-20	Bare Tool	

M12™ Cordless 2-Tool Combo Kit

- 1/4" Hex screwdriver delivers 150 in-lbs of torque, 15 position clutch, and 0 to 500 rpm
- Hackzall™ reciprocating saw delivers 0 to 3000 spm
- Kit includes:
 - Screwdriver (2401-20)
 - Hackzall™ Reciprocating saw (2420-20)
 - (2) M12™ Lithium-Ion batteries
 - 30-Minute charger
 - (2) Hackzall™ blades
 - Contractor bag



Part #	Mfg #	Description	Price
137556	2490-22	Combo Kit	

M12™ Cordless LITHIUM-ION 2-Tool Combo Kit

- Kit Includes:
 - M12™ 3/8" Hammer Drill/Driver
 - M12™ 1/4" Hex Impact Driver
 - REDLITHIUM Battery



Part #	Mfg #	Description	Price
163696	2497-22	Kit	

M12™ Cordless 4-Tool Combo Kit

- Hackzall™ reciprocating saw delivers 0 to 3000 spm
- Copper tubing cutter adjusts to cut 3/8" to 1" copper
- Work light illuminates large work area with 90° rotating head and integrated magnet



- Kit Includes:
 - Screwdriver (2401-20)
 - Hackzall™ reciprocating saw (2420-20)
 - Copper tubing cutter (2471-20)
 - Work light (49-24-0145)
 - (2) 12V Lithium-Ion battery packs
 - 30-Minute charger
 - (2) Hackzall™ blades
 - Contractor bag

Part #	Mfg #	Description	Price
138377	2490-24	Combo Kit	



Power Tools - M12 and Misc

M12™ Cordless 2-Tool Combo Kit (1)

• Kit Includes:

- 1/4" Hex Impact driver (2450-20)
- Hackzall™ Reciprocating saw (2420-20)
- (2) Lithium-Ion batteries
- 30-Minute charger
- Contractor bag



Part #	Mfg #	Description	Price
139268	2491-22	Combo Kit	

M12™ Cordless 2-Tool Combo Kit

• Kit Includes:

- 3/8" Drill driver (2410-20)
- 1/4" Hex impact driver (2450-20)
- (2) M12™ REDLITHIUM™ Batteries (48-11-2401)
- 30-Minute charger (48-59-2401)
- Contractor bag



Part #	Mfg #	Description	Price
137558	2494-22	Combo Kit	

M12 Fuel™ Cordless Tools

M12 FUEL™ 1/2" Drill/Driver

- POWERSTATE™ Brushless motor
- REDLITHIUM™ Battery technology
- REDLINK Plus™ Intelligence

• Kit Includes:

- (1) M12 FUEL™ 1/2" Drill/Driver (2403-20)
- (1) M12 REDLITHIUM™ 2.0 Compact battery pack (48-11-2420)
- (1) M12™ REDLITHIUM™ XC 4.0 extended capacity battery pack (48-11-2440)
- (1) M12™ Lithium-ion battery charger (48-59-2401)
- (1) Belt clip
- (1) Carrying case



Part #	Mfg #	Description	Price
172508	2403-20	Bare Tool	
165720	2403-22	Kit	

M12™ FUEL 1/2" Drill/Driver

- Most capable, lightest weight, most compact
- 1/2" All metal chuck for maximum grip and bit retention
- E-Clutch for consistent repeatability
- 1700 RPMs for faster drilling speeds
- 350 in lbs of peak torque



Part #	Mfg #	Description	Price
244564	2503-20	Bare Tool	
244562	2503-22	Kit	

M12 FUEL™ 1/2" Hammer Drill Kit

- Most capable, lightest weight, most compact
- 1/2" All metal chuck for maximum grip and bit retention
- E-Clutch for consistent repeatability
- 1700 RPMs for faster drilling speeds
- 350 in lbs of peak torque



Part #	Mfg #	Description	Price
244567	2504-20	Bare Tool	
244566	2504-22	Kit	

M12 FUEL™ SURGE™ 1/4" Hex Hydraulic Driver

- POWERSTATE™ brushless motor
- REDLINK PLUS™ Intelligence
- FLUID-DRIVE hydraulic powertrain
- REDLITHIUM™ batteries
- Compact head length and compact battery footprint

• Kit includes:

- (1) M12 FUEL™ SURGE™ 1/4" Hex Hydraulic driver Bare Tool (2551-20)
- (2) M12™ REDLITHIUM™ CP2.0 battery (48-11-2420)
- (1) M12™ Lithium-ion battery charger (48-59-2401)
- (1) Belt clip
- (1) Contractor bag



Part #	Mfg #	Description	Price
264005	2551-20	Bare Tool	
265582	2551-22	Kit	

Power Tools - M12 and Misc

M12 FUEL™ 1/4" Hex Impact Driver

- Most Compact
- 4-Mode Drive Control
- POWERSTATE brushless motor
- REDLINK PLUS intelligence
- REDLITHIUM batteries
- 4-mode drive control provides greater control over output speed and power



Part #	Mfg #	Description	Price
244569	2553-20	Bare Tool	
244568	2553-22	Kit	

M12 FUEL™ 1/4" Hex Impact Driver

- POWERSTATE™ Brushless motor
- REDLITHIUM™ 2.0 Battery technology
- REDLINK Plus™ Intelligence
- DRIVE CONTROL™
- Kit Includes:
 - (1) M12 FUEL™ 1/4" hex impact driver (2453-20)
 - (2) M12 REDLITHIUM™ 2.0 compact battery pack (48-11-2420)
 - (1) M12™ Lithium-ion battery charger (48-59-2401)
 - (1) Belt clip
 - (1) Carrying case



Part #	Mfg #	Description	Price
159974	2453-20	Bare Tool	
154725	2453-22	Kit	

M12 FUEL™ Installation Drill/Driver

- POWERSTATE™ Brushless motor
- Beltclip attached
- Right angle attachment
- Magnetic bit holder
- All metal 3/8" chuck and 1/4" hex attachments
- Compartmentalized contractor bag
- Kit includes:
 - (2) M12™ REDLITHIUM™ CP2.0 battery packs (48-11-2420)
 - (1) M12™ Charger (48-59-2401).



Part #	Mfg #	Description	Price
266264	2505-20	Bare Tool	
266267	2505-22	Kit	

M12 FUEL™ 1/4" Hex 2-Speed Screwdriver

- POWERSTATE™ Brushless motor
- REDLITHIUM™ Battery technology
- REDLINK Plus™ Intelligence



Part #	Mfg #	Description	Price
165722	2402-22	Kit	

M12™ FUEL™ 1/4" Impact Wrench

- POWERSTATE™ Brushless motor
- REDLITHIUM™ 2.0 Battery REDLINK Plus™ Intelligence
- DRIVE CONTROL™
- Kit Includes:
 - (1) M12 FUEL™ 1/4" Impact wrench (2452-20)
 - (2) M12 REDLITHIUM™ 2.0 Compact battery pack (48-11-2420)
 - (1) M12™ Lithium-ion battery charger (48-59-2401)
 - (1) Belt clip
 - (1) Carrying case



Part #	Mfg #	Description	Price
165719	2452-22	Kit	

M12™ FUEL™ 3/8" Impact Wrench

- POWERSTATE™ Brushless motor
- REDLITHIUM™ 2.0 Battery REDLINK Plus™ Intelligence
- DRIVE CONTROL™



Part #	Mfg #	Description	Price
238273	2454-20	Bare Tool	
165718	2454-22	Kit	

Power Tools - M12 and Misc

M12 FUEL™ 1/4" Stubby Impact Wrench

- POWERSTATE™ Brushless motor
- REDLINK PLUS™ Electronic intelligence
- 4-Mode drive control
- Up to 100 ft.-lbs. of nut-busting torque
- Auto-shut off mode



- Kit includes:
 - (1) M12 FUEL™ 1/4" Stubby impact wrench (2552-20)
 - (1) M12™ REDLITHIUM™ CP2.0 Battery (48-11-2420)
 - (1) M12™ REDLITHIUM™ XC 4.0 extended capacity battery pack (48-11-2440)
 - (1) M12™ Lithium-ion battery charger (48-59-2401)
 - (1) Belt clip
 - (1) Carrying case

Part #	Mfg #	Description	Price
266984	2552-22	Kit	

M12™ FUEL™ 3/8" Stubby Impact Wrench

- POWERSTATE™ brushless motor
- Up to 250 ft.-lbs. of nut-busting torque
- REDLINK Plus™ intelligence
- 4-Mode drive control
- Most compact. Greatest access in tight spaces at 4.8" in length



- Kit Includes
 - (1) M12 FUEL 3/8" Stubby Impact Wrench (2554-20)
 - (1) M12™ REDLITHIUM™ CP2.0 battery (48-11-2420)
 - (1) M12™ REDLITHIUM™ XC 4.0 extended capacity battery pack (48-11-2440)
 - (1) M12™ Lithium-ion battery charger (48-59-2401)
 - (1) Belt clip
 - (1) Carrying case

Part #	Mfg #	Description	Price
253316	2554-20	Bare Tool	
253636	2554-22	Kit	

M12 FUEL 1/2" Stubby Impact Wrench

- POWERSTATE™ Brushless motor
- Up to 250 ft.-lbs. of nut-busting torque
- REDLINK PLUS™ Electronic intelligence
- Most Compact. Greatest access in tight spaces at 4.9" in length



- Kit includes:
 - (1) M12 FUEL™ 1/2" Stubby Impact Wrench (2555-20)
 - (1) M12™ REDLITHIUM™ CP2.0 Battery (48-11-2420)
 - (1) M12™ REDLITHIUM™ XC 4.0 Extended xapacity battery pack (48-11-2440)
 - (1) M12™ Lithium-ion battery charger (48-59-2401)
 - (1) Belt clip
 - (1) Carrying case

Part #	Mfg #	Description	Price
255262	2555-20	Bare Tool	
262692	2555-22	Kit	

M12 FUEL™ 5/8" SDS Plus Rotary Hammer Kit

- REDLINK™ Intelligence
- REDLITHIUM™ Battery technology
- Electro pneumatic mechanism
- Delivers 0-900 RPM and 0-6,200 BPM for superior performance
- Compact, lightweight design
- 2-Mode operation
- LED light: Illuminates the work surface



Part #	Mfg #	Description	Price
228736	2416-20	Bare Tool	
165721	2416-22XC	Kit	

M12 FUEL™ 1/4" Ratchet Tool

- Torque: 40ft-lbs
- Recessed head profile
- Pneumatic ratchet performance
- Delivers 250 RPM
- REDLINK PLUS™
- REDLITHIUM™ Battery
- Variable speed metal trigger
- LED light illuminates the work area



Part #	Mfg #	Description	Price
240413	2556-20	Bare Tool	1/4"
240414	2556-22	Kit	1/4"

Power Tools - M12 and Misc

M12™ 3/8" FUEL Cordless Ratchet

- Torque: 55ft-lbs
- Speed: 250 rpm
- LED light
- REDLINK PLUS™
- REDLITHIUM™ batteries
- POWERSTATE™ brushless motor



Part #	Mfg #	Description	Size	Price
241820	2557-20	Bare Tool	3/8"	
240746	2557-22	Kit	3/8"	

M12™ FUEL™ 1/2" Ratchet

- REDLINK PLUS™ intelligence
- Greater durability with FUEL brushless motor
- Delivers 175rp
- Up to 60ft-lbs max torque
- Variable speed metal trigger
- Kit includes:
 - (1) M12™ FUEL™ 1/2" Ratchet Bare Tool (2558-20)
 - (1) Standard charger
 - (1) Carrying case
 - (2) 2.0Ah M12 Battery



Part #	Mfg #	Description	Price
267262	2558-20	Bare Tool	
266985	2558-22	Kit	

M12 FUEL™ HACKZALL® Recip Saw Kit

- One-handed design
- Compact size
- POWERSTATE™ brushless motor
- REDLINK PLUS™ Intelligence
- REDLITHIUM™ XC 4.0 Battery pack



Part #	Mfg #	Description	Price
166203	2520-20	Bare Tool	
166202	2520-21XC	Kit	

M12 FUEL™ Circular Saw



Part #	Mfg #	Description	Price
220202	2530-20	Bare Tool, 5-3/8"	
185807	2530-21XC	Kit, 5-3/8"	

M12 FUEL™ 2-Tool Combo Kit

- Kit includes:
 - (1) M12 FUEL™ 1/2" Drill/Driver (2403-20)
 - (1) M12 FUEL™ 1/4" Hex Impact Driver (2453-20)
 - (1) M12 REDLITHIUM™ 2.0 Battery (48-11-2420)
 - (1) M12™ REDLITHIUM™ XC 4.0 Extended Capacity Battery Pack (48-11-2440)
 - (1) M12™ Lithium-ion Battery Charger (48-59-2401)
 - (2) Belt Clip
 - (1) Carrying Case



Part #	Mfg #	Description	Price
186086	2594-22	Combo Kit	

M12 FUEL™ 2-Tool Combo Kit (1/2" Hammer Drill, 1/4" Hex Impact Driver)

- Kit includes:
 - (1) M12 FUEL™ 1/2" Drill/Driver (2503-20)
 - (1) M12 FUEL™ 1/4" Hex Impact Driver
 - (1) M12 REDLITHIUM™ Battery
 - (2) Belt Clip
 - (1) Contractor Bag



Part #	Mfg #	Description	Price
244456	2598-22	Combo Kit	

M12 FUEL™ 2-Tool Combo Kit: 1/2" Drill Driver and 1/4" Hex Impact Driver

- Most Capable 12V Drill
- Lightest Weight in its class
- Most Compact in its class
- 1/2" All Metal chuck for maximum grip and bit retention
- E-Clutch for consistent repeatability in driving applications
- 1700 RPMs for faster drilling speeds
- 350 in.lbs of peak torque



Part #	Mfg #	Description	Price
244570	2596-22	Kit	

Power Tools - M12 and Misc

M12 FUEL™ SURGE™ HDD 2-PC Combo Kit

- Includes:
- (1) M12 FUEL™ SURGE™ 1/4" Hex Hydraulic Driver Bare Tool (2551-20)
- (1) M12 FUEL™ 1/2" Hammer Drill (2504-20)
- (1) M12™ REDLITHIUM™ CP2.0 battery (48-11-2420)
- (1) M12™ REDLITHIUM™ XC 4.0 Extended capacity battery pack (48-11-2440)
- (1) M12™ Lithium-ion battery charger (48-59-2401)
- (2) Belt clip
- (1) Contractor bag



Part #	Mfg #	Description	Price
265340	2582-22	Kit	

M12™ Cordless LITHIUM-ION 4-Tool Combo Kit

- Kit Includes:
- (1) M12™ 3/8" Drill/Driver (bare tool) (2407-20)
- (1) M12™ HACKZALL® Recip saw (bare tool) (2420-20)
- (1) M12™ 1/4" Hex impact driver (bare tool) (2462-20)
- (2) M12™ REDLITHIUM™ Battery (48-11-2401)
- (1) M12™ Lithium-ion battery charger (48-59-2401)
- (1) M12™ Work light (49-24-0145)
- (1) Contractor bag



Part #	Mfg #	Description	Price
159666	2498-24	Combo Kit	

M12™ Miscellaneous Tools

M12™ Caulk and Adhesive Gun

- 30 Minutes charge time
- Kit includes:
- (1) M12™ 10oz. Caulk and Adhesive Gun (Bare Tool) (2441-20)
- (1) 3/8" Hollow Shaft Nut Driver (48-22-2424)
- (1) 3/8" Hollow Shaft Nut Driver (48-22-2424)



Part #	Mfg #	Description	Price
158760	2441-20	Bare Tool	
232433	2441-21	Kit	

Accessories

Part #	Mfg #	Description	Price
252664	48-08-0910	M12™ Quart Conversion Kit	
252699	48-08-1096	20oz Clear Barrel Kit	

M12™ Quart Caulk and Adhesive Gun

- 30 Minutes charge time
- For use with 29 oz. quart cartridge style caulk tubes
- Will dispense up to 150 10 oz. tubes of sealant on one charge
- Kit includes:
- (1) M12™ Quart Conversion Kit (48-08-0910)
- (1) M12™ Lithium-ion Battery Charger (48-59-2401)
- (1) M12™ REDLITHIUM™ CP1.5 Battery Pack (48-11-2401)



Part #	Mfg #	Description	Price
252659	2444-21	Kit	

M12™ Sausage Style Caulk and Adhesive Gun

- 20 oz Aluminum barrel
- Kit Includes:
- 12V 20oz Sausage conversion kit (48-08-0905)
- M12 Lithium-ion battery charger (48-59-2401)
- M12 REDLITHIUM Battery (48-11-2401)



Part #	Mfg #	Description	Price
243478	2442-21	Kit	

M12™ Cordless Grease Gun

- Maximum operating pressure: 8,000 psi
- Grease capacity: 14 oz cartridge/16 oz bulk
- Kit Includes:
- M12™ Grease gun (2446-20)
- M12™ XC REDLITHIUM™ battery
- 60-Minute charger
- 36" High pressure flex hose with spring guard
- Grease coupler
- Carrying case



Part #	Mfg #	Description	Price
224896	2446-20	Bare Tool	
141426	2446-21XC	Kit	

Power Tools - M12 and Misc

M12™ Cordless Palm Nailer

- 12V
- REDLITHIUM™ technology
- REDLINK™ Intelligence
- On-board fuel gauge
- Build-in LED light
- Industrial-duty collet: 6D-16D magnetic collet provides secure hold for one-handed tool use



Part #	Mfg #	Description	Price
242609	2458-20	Bare Tool	

M-Spector™ Inspection Scope Kit

- 2.7" LCD display
- Four surround LED lights
- 3 ft enhanced cable
- Kit Includes:
 - (1) M-Spector™ Scope Kit
 - (1) Pipe guide attachment
 - (1) 9V Battery
 - (1) Carrying case



Part #	Mfg #	Description	Price
229565	2309-20	Kit	

M12™ Compact Inflator

- Includes: Ball inflation needle, Presta chuck, Schrader chuck, Inflator nozzle
- TrueFill™ auto shut-off technology increases accuracy, protects from over-temp and over-fill
- Illuminated digital gauge with target and current pressure reading
- Inflates car, LT truck, and compact equipment tires
- High efficiency pump & motor for true 120PSI capability



Part #	Mfg #	Description	Price
245947	2475-20	Bare Tool	
246162	2475-21XC	Kit	

M12™ M-Spector Flex™ 9FT Inspection Camera Cable Kit

- Kit Includes:
 - (1) M12™ M-SPECTOR FLEX™ 9' FT Inspection Camera
 - (1) M12™ REDLITHIUM™ CP1.5 Battery Pack (48-11-2401)
 - (1) M12™ Lithium-ion Battery Charger (48-59-2401)
 - (1) USB Cable
 - (1) SD Card
 - (1) Carrying Case



Part #	Mfg #	Description	Price
228027	2316-21	Kit	

M12™ Crown Stapler

- Kit includes:
 - (1) M12 3/8" Crown Stapler (2447-20)
 - (1) M12™ REDLITHIUM™ Battery (48-11-2401)
 - (1) M12™ Lithium-ion Battery Charger (48-59-2401)



Part #	Mfg #	Description	Price
238190	2447-20	Bare Tool	
238191	2447-21	Kit	

M12™ M-Spector 360™ Rotating Inspection Scope

- Rotating display allows user to orient the image without having to fight the cable
- 640 x 480 Digital image sensor
- (4) LED lights
- Display: 2.7" LCD
- 9mm Aluminum head
- 3' Cable
- Kit Includes:
 - M-Spector 360™ console
 - M12™ REDLITHIUM™ battery
 - 30 Minute charger
 - Hook, magnet and mirror attachments
 - Carrying case



Part #	Mfg #	Description	Price
148602	2313-21	Kit	
155645	2314-21	Kit, 9Ft Cable	

Power Tools - M12 and Misc

SUB-SCANNER™ M12™ Detection Tool

- Measures depth and location of Rebar up to 6" through concrete
- Detects location of wood and metal studs
- Differentiates between steel and copper or aluminum metals
- Intuitive user interface displays stud centers and edges
- High contrast white on black display and back light for easy reading
- Rugged over-molding improves durability and user grip
- One button calibration for all surfaces



Part #	Mfg #	Description	Price
153058	2291-20	Bare Tool	

M12™ HAMMERVAC Universal Dust Extractor

- Auto-on mode allows extractor to turn it on and off
- Provides filtration up to 160 holes on a single charge
- Part of the M12 System, featuring over 70 tools
- Universal handle system- compatible with most SDS plus rotary hammers and some AC and DC hammer drills
- Self-powered by M12 red lithium battery pack
- Replaceable HEPA filter-highest quality debris filtration and lowest cost of ownership



Part #	Mfg #	Description	Price
172810	2306-20	Bare Tool	
186658	2306-22	Kit	

Accessories

Part #	Mfg #	Description	Price
241576	49-90-2301	M12™ HAMMERVAC™ Dust Extractor Nozzle	

Drain Cleaning

M12™ TRAPSAKE™ Toilet Auger

- 6'
- Kit includes:
 - (1) M12™ TRAPSAKE™ 6' Toilet Auger (Tool Only) (2576-20)
 - (1) M12™ REDLITHIUM™ Battery (48-11-2401)
 - (1) M12™ Lithium-ion Battery Charger (48-59-2401)



Part #	Mfg #	Description	Price
230879	2576-20	Bare Tool	
230877	2576-21	Kit	

M12™ TRAPSAKE™ 2-Tool Combo Kit

- Kit includes:
 - (1) M12™ TRAPSAKE™ 4' Urinal Auger (Tool Only) (2574-20)
 - (1) M12™ TRAPSAKE™ 6' Toilet Auger (Tool Only) (2576-20)
 - (1) M12™ REDLITHIUM™ Battery (48-11-2401)
 - (1) M12™ Lithium-ion Battery Charger (48-59-2401)



Part #	Mfg #	Description	Price
230883	2577-21	Kit	

M12™ TRAPSAKE™ Urinal Auger

- Maneuvers traps faster and protects porcelain, compatible with all TRAPSAKE™ Augers
- Fixed rubber boot: Prevents porcelain scratches throughout the life of the tool
- Integrated locking mechanism which holds the cable in place for easy telescoping extension and retraction



Part #	Mfg #	Description	Price
230882	2574-20	Bare Tool	
230881	2574-21	Kit	

Power Tools - M12 and Misc

TRAPSAKE™ Accessories

Part #	Mfg #	Description	Price
230888	48-53-2577	4' Urinal Auger Replacement Cable	

M12 AIRSNAKE™ Drain Cleaning Air Gun Kit

- Up to 50 PSI
- 25+ pressure cycles
- Includes:
 - (3) Drain plug attachments
 - Straight connector
 - 15° offset connector
 - Carrying case
 - Drain shroud attachment
 - M12 Lithium-ion battery charger
 - M12 REDLITHIUM™ battery pack



Part #	Mfg #	Description	Price
238926	2572A-21	12V	
240438	2572B-21	12V	

Airsnake™ Accessories

Part #	Mfg #	Description	Price
242106	48-53-2570	10" Extension	

M12™ Drain Snake Kit

- 1) M12™ Drain Snake (2571-20)
- (1) 5/16"X25' BULB CABLE W/DRUM (48-53-2581)
- (1) 5 Gallon Storage Bucket
- (1) M12™ REDLITHIUM™ Battery (48-11-2401)
- (1) M12™ Lithium-ion Battery Charger (48-59-2401)



Part #	Mfg #	Description	Price
188681	2571-20	Bare Tool	
188682	2571-21	25' of 1/4" or 5/16" Inner Core Cable	

Drills

3/8" Pistol Drill

- 8 Amp motor
- 120VAC Only
- Keyless, metal chuck type
- All metal gear case
- Soft grip handle and 2-finger trigger
- 8' Cord
- Kit Includes:
 - 3/8" Drill
 - Side handle



Part #	Mfg #	No Load RPM	Price
139060	0240-20	0 - 2,800	

1/2" D-Handle Drill

- 0-500 RPM
- 7.0 Amp motor
- Torque: Offers 1/2" capacity in steel
- Heavy-Duty keyed chuck w/ holder
- QUIK-LOK® Cord: 8ft, 3-wire ground rubber cord



Part #	Mfg #	No Load RPM	Price
242791	1107-6	0-500	

SDS Plus Rotary Hammer Kit



Part#	Mfg#	Description	Size	Price
164855	5263-21	Kit	5/8"	
151555	5262-21	Kit	1"	
219770	5268-21	Kit	1-1/8"	

1-9/16" Spline Rotary Hammer

- Powerful 10.5 amp motor: Delivers 450RPM and 3,000 BPM
- Powerful hammer mechanism
- CPT™ - Constant power technology Mechanical clutch
- 2-Mode operation: Rotary hammer and hammer only
- 12-Position chipping adjustment



Part #	Mfg #	Description	Price
153749	5316-21	Kit	

Power Tools - M12 and Misc

2" Spline Rotary Hammer

- Powerful 15-amp motor: delivers 19.9 ft-lbs of blow energy
- Comfortable inline design
- Vibration isolation system
- Variable-speed dial
- Includes:
 - (1) 2" Spline Rotary Hammer (5340-21)
 - (1) Carrying Case
 - (1) Side Handle



Part #	Mfg #	Description	Price
253879	5340-21	Kit	

2" SDS Max Rotary Hammer

- 15-Amp motor, 120V AC
- 19.9 ft-lbs of blow energy
- D-handle style
- Variable-speed dial
- Service reminder light
- Double insulated cord type
- Vibration isolation system
- No load speed: 125-250
- No load BPM: 975-1,950
- 6" Thick wall core bit capacity
- Drilling mode: Rotary hammer & hammer only



Part #	Mfg #	No Load RPM	Price
221333	5342-21	125-250	

1-9/16" SDS Max Rotary Hammer

- Powerful 10.5 Amp motor: Delivers 450 RPM and 3,000BPM
- Powerful hammer mechanism
- CPT™- Constant power technology
- Mechanical clutch
- 2-mode operation: Rotary hammer and hammer only
- 12-Position chipping adjustment: Allows the user to maintain the desired hammer position while chipping in any orientation



Part #	Mfg #	Description	Price
159786	5317-21	Kit	

SDS Demolition Hammer

- 14 Amp motor
- Heavy-duty construction
- Variable-speed dial
- AVS Anti-Vibration system
- Service reminder light
- Lock-on trigger
- Kit includes:
 - (1) 2" SDS Max Demo Hammer
 - (2) Auxiliary handle
 - (1) Carrying case



Part #	Mfg #	Description	Price
237268	5339-21	Kit	

1-3/4" SDS MAX Rotary Hammer

- Advanced AVS anti-vibration system
- 2,900 BPM
- 21.25 lbs
- 380 RPM
- 10 m/s² Vibration
- Includes:
 - (1) 1-3/4" SDS MAX Rotary Hammer (5546-21)
 - (1) Side Handle
 - (1) Grease Tube



Part #	Mfg #	Description	Price
264117	5546-21	Kit	

1/2" Hole Hawg® Drill 900 RPM

- Powerful 7.5-amp motor: Delivers 900 RPM with reverse
- Selffeed bit capacity: Handles up to a 2-9/16"
- Reinforced nylon resin casing
- Kit Includes:
 - (1) 1/2" Hole Hawg® Drill 900RPM (1670-1)
 - (1) Pipe handle



Part #	Mfg #	Description	Price
224919	1670-1	Kit	

Power Tools - M12 and Misc

3/4" Large Drill, 350 RPM

- Powerful 10.0-amp motor. Delivers up to 350RPM with reverse
- Torque: Offers 3/4" capacity in steel
- Heat-treated gears: Helical-cut for quiet performance
- 8-ft fixed rubber cord
- Includes:
 - (1) 3/4" Large Drill (1854-1)
 - (1) Pipe Handle



Part #	Mfg #	Description	Price
151479	1854-1	1854-1 3/4" 120V 350RP Drill	

1/2" Magnum® Drill

- Motor: 120VAC 8A
- 360° Locking side handle
- Chuck key with holder
- 8' Cord



Part #	Mfg #	No Load RPM	Price
139067	0299-20	0 - 850	
184121	0300-20	0-850	

1-5/8" Electromagnetic Drill Kit

- Powerful 13 amp motor
- 3/4" Weldon quick change arbor
- 2 Speed gear box: 475/730 RPM
- Tool free feed-handle LED light
- Includes:
 - (1) 1-5/8" Electromagnetic drill kit (4272-21)
 - (1) Safety strap
 - (1) Lubrication spray bottle
 - (1) Chuck key
 - (1) Carrying case
 - (1) 3/4" Weldon to 1/2" chuck adapter
 - (2) 1" Retractable pilot pin



Part #	Mfg #	Description	Price
254411	4272-21	Kit	

Right Angle Drill Kits

1/2" Reversing Right Angle Drill Kit

- 120VAC, 7.0A R.A.D.
- 1/2" Trigger speed control reversing
- Use with up to 4-5/8" self-feed bits
- Head and handle swivel 360°
- Allow 5-1/2" for right angle drill head and chuck
- Kit Includes:
 - Chuck key and rubber flex key holder
 - Right angle drive
 - 9/16" Open end wrench
 - 3/16" Socket wrench
 - Chuck remover bar
 - Side handle
 - Steel carrying case
 - 8' 3-Wire Quik-Lok® cord set



Part #	Mfg #	Kit Type	Drill RPM	Amps	Price
137799	3107-6	Variable	0-500	7.0	

Super Hawg™ Drills

Super Hawg™ 1/2" Drill

- Clutch in low speed
- High operating speeds for maximum productivity
- 90° Left-right, Roto-Lok® handle
- Comfort grip switch handle and gear case with front T-bar handle
- Includes side handle
- 1680-21 Includes carrying case
- 5-Year warranty



Part #	Mfg #	No Load RPM	Steel Capacity	Price
148643	1680-20	450/1,750	1/2"	
137572	1680-21	450/1,750	1/2"	



Power Tools - M12 and Misc

Hole-Hawg®

Hole-Hawg® Drill

- 120VAC, 7.5A
- Compact design
- Triple reduction gearing
- 2-Position pipe handle
- 3-Position spade handle
- 2-Speed gear shift
- External brush caps
- Includes steel carrying case



Part #	Mfg #	No Load RPM	Price
144516	1676-6	300/1,200	

Wrenches

1/2" Impact Wrench with Rocker Switch and Detent Pin Socket Retention

- Powerful 7.0 amp motor
- Detent pin
- AC/DC rocker switch
- 8-ft. fixed rubber cord



Part #	Mfg #	Description	Price
251552	9070-20	Bare tool	

Miter Saws

Dual-Bevel Sliding Compound Miter Saw

- Angle digital readout
- Angle fine adjust w/ detent override
- Dual integral jobsite lights
- Powerful 15.0 amp, 3.3 Max HP direct drive motor
- Constant Power Technology with Soft Start
- Integral dust channel
- Dual horizontal steel railers
- Oversized single lever bevel adjustment



Part #	Mfg #	Description	Price
242515	6955-20	12", Bare Tool	

Circular Saws

TILT-LOK™ 7-1/4" Circular Saw with Case

- New exclusive TILT-LOK™ main handle adjusts to the work or most comfortable work position
- 10.4 pounds net weight
- 15 amp, 3.25 peak horsepower
- Wide, clear sight line
- Kit Includes:
 - (1) TILT-LOK™ 7-1/4" Circular Saw with case (6390-21)
 - (1) Blade wrench
 - (1) Carrying case
 - (1) Circular saw blade



Part #	Mfg #	Description	Price
154578	6390-21	Kit	

7-1/4" Circular Saw with QUIK-LOK® cord, Brake and Case

- Powerful 3.0 max. horsepower, 15 amp motor
- Exclusive TILT-LOK™ main handle
- Quik-Lok® cord
- Patented power assisted electric brake
- Includes:
 - (1) 7-1/4" Circular saw with QUIK-LOK® cord, brake and case (6394-21)
 - (1) Blade wrench
 - (1) Circular saw blade



Part #	Mfg #	Description	Price
256002	6394-21	Kit	

8" Metal Cutting Saw Kit

- Dry-cut technology
- Durable blade shields with integral chiptank deflects/collects hot chips and sparks
- Plunge lever for fast, effective plunge cuts
- Exclusive quick-release shield latch
- 2-9/16 in cut depth for one-pass cuts through most common materials
- Powerful 13.0 amp, 3,700 rpm motor
- Premium cement-tipped blades cut faster, cleaner, and longer than other carbide-tipped or friction blades



Part #	Mfg #	Description	Price
243054	6370-20	Bare Tool	
161013	6370-21	Kit	

Power Tools - M12 and Misc

Sawzall® Reciprocating Saws

15 Amp Super Sawzall® Reciprocating Saw

- Constant Power Technology™
- Gear Protecting Clutch
- Counter Balanced Mechanism
- Variable Speed trigger and drill speed control
- Quick-Lok™ blade clamp system
- Includes carrying case



Part #	Mfg #	Length of Stroke	Strokes Per Minute	Price
227013	6538-21	1-1/4"	0-2,800	

13 Amp Orbital Super Sawzall® with Case

- Orbital cutting action
- Variable speed trigger
- Quik-Lok™ blade clamp
- 8' Cord
- 5-Year warranty



Part #	Mfg #	Length of Stroke	Strokes Per Minute	Price
148168	6536-21	1-1/4"	0 - 3,000	

12 Amp Sawzall® Reciprocating Saw

- Quik-Lok™ blade clamp
- Gear protecting clutch
- Counter weighted mechanism
- Includes:
 - (1) Sawzall® Recip Saw
 - Carrying case



Part #	Mfg #	Length of Stroke	Strokes Per Minute	Price
137571	6509-31	3/4"	0 - 3,000	
219154	6519-31	1-1/8"	0-3,000	

360° Rotating Handle Orbital Super Sawzall® Reciprocating Saw

- 360° Rotating handle
- 13 Amp Milwaukee built motor
- Orbital cutting action
- Variable speed trigger, 0-3000 SPM
- 1-1/4in stroke
- Counter balanced/gear protection systems
- Speed dial
- QUIK-LOK™ blade clamp
- QUIK-LOK® cord
- Includes:
 - (1) 360° Rotating handle orbital super Sawzall® recip saw (6523-21)
 - (1) Carrying case



Part #	Mfg #	Description	Price
154278	6523-21	Kit	

Band Saws

M12™ Sub-Compact Band Saw

- One-Handed Cuts
- Cuts 3/4" EMT in 3 seconds
- 1-5/8" Cut Capacity
- LED Light
- Blade tension adjustment
- Kit Includes:
 - (1) 18 TPI Sub-Compact Band Saw Blade
 - (1) M12™ Sub-Compact Band Saw (Bare Tool) (2429-20)
 - (1) M12™ XC High Capacity REDLITHIUM™ Battery (48-11-2402)
 - (1) M12™ Lithium-ion Battery Charger (48-59-2401)
 - (1) Carrying Case



Part #	Mfg #	Description	Price
172509	2429-20	Bare Tool	
150209	2429-21XC	Kit	



Power Tools - M12 and Misc

Compact Band Saw

- 120VAC
- 7.0A Motor, 3-wire, 8' cord
- LED Work light
- Blade ejection system
- Drop-resistant pulley guard
- Cast aluminum gear case
- Adjustable material guide
- Maximum rectangular capacity: 3-1/4" x 3-1/4"
- Maximum round capacity: 3-1/4"
- Kit Includes:
 - Band saw
 - Case



Part #	Mfg #	No Load SFPM	Price
142295	6242-6	200 - 300	

Deep Cut Variable Speed Band Saw

- Powerful 11 amp motor w/ CPT™
- All metal direct drive
- LED Light
- Job Site Armor™ technology
- Gear protecting clutch
- Revolutionary cut visibility
- Tool-free locking adjustable shoe
- Debris protection system
- Kit includes:
 - (1) Deep Cut Variable Speed Band Saw (6232-20)
 - (1) Carrying Case



Part #	Mfg #	Description	Price
138406	6232-20	Bare Tool	
151865	6232-21	Kit	

Jig Saws

M12™ High Performance Jig Saw

- 3/4" Stroke length & 0-2,800 SPM
- Hybrid Grip™
- LED Light and fuel gauge
- Quik-Lok™ T-Shank blade clamp and tool-free 450 bevel capability with positive lock at 90°
- Kit includes:
 - (1) M12™ High Performance Jig Saw (Tool Only) (2445-20)
 - (1) M12™ Lithium-ion battery charger (48-59-2401)
 - (1) M12™ REDLITHIUM™ CP1.5 Battery pack (48-11-2401)
 - (1) Contractor bag



Part #	Mfg #	Description	Price
230116	2445-20	Bare Tool	
148167	2445-21	Kit	

Abrasive Cut-Off Machines

14" Abrasive Cut-Off Machine

- Cuts up to 5" pipe
- Oversized wheel guards
- Miter capacity: 45° with adjustable fence
- Large spindle lock button
- Kit Includes:
 - Vise
 - Abrasive wheel
 - Hex wrench



Part #	Mfg #	Description	Price
142284	6177-20	120VAC/DC, 15 Amps	

14" Hand Held Cut-Off Machine

- Powerful 15-amp, 4.8 maximum horsepower motor
- 20-amp overload protection switch
- Downward cutting rotation
- Externally accessible brushes | and brush cutoff feature
- Kit Includes:
 - (1) 14" Abrasive Cut-Off Machine (6177-20)
 - (1) Abrasive Wheel
 - (1) Hex Wrench
 - (1) Vise



Part #	Mfg #	Description	Price
161844	6185-20	Kit	

Power Tools - M12 and Misc

M12 FUEL™ 3" Compact Cut Off Tool

- 20,000 RPM for fast and accurate cutting performance
- REDLINK PLUS™ intelligence provides optimized performance and overload protection
- Reversible blade rotation
- LED light for improved visibility
- Compatible with common 3" cut off wheels with 3/8" arbor
- Tool includes:
 - (1) M12 FUEL™ 3" Compact Cut Off Tool (2522-20)
 - (1) 3" Carbide Abrasive Blade (49-94-3005)
 - (1) 3" Diamond Tile Blade (49-94-3010)
 - (1) Blade Wrench
 - (1) Metal Cut Off Wheel
 - (1) 7/16" Flange Adapter
 - (1) Shoe Guard
- Kit also includes:
 - (1) M12™ REDLITHIUM™ XC 4.0 Extended Capacity Battery Pack (48-11-2440)
 - (1) M12™ Lithium-ion Battery Charger (48-59-2401)



Part #	Mfg #	Description	Price
251833	2522-20	Bare Tool	
251834	2522-21XC	Kit	

Sanders

5" Random Orbit Palm Sander

- 3 Amp permanent magnet motor
- Variable speed dial
- Kit Includes:
 - (1) 5" Random Orbit Palm Sander (6034-21)
 - (2) 80 Grit Sandpaper
 - (1) Plastic Dust Canister
 - (1) Universal Vac Hose Adapter
 - (1) Contractor Bag



Part #	Mfg #	Description	Price
231354	6034-21	Kit	

1/4-Sheet Palm Sander

- 3.0 Amp permanent magnet motor with 14,000 orbits per minute
- Fits 1-1/4" or 2-1/4" hoses for efficient dust removal
- Ergonomic design
- Includes:
 - (1) 1/4-Sheet Palm Sander (6033-21)
 - (1) Plastic Dust Canister
 - (1) Paper Punch
 - (1) 150 Grit Sandpaper
 - (1) 100 Grit Sandpaper



Part #	Mfg #	Description	Price
187918	6033-21	1/4 Sheet Sander	

3.5 Max HP Sander

- 7" / 9"
- 6000 RPM



Part #	Mfg #	Speed RPM	Disc Dia	Price
237737	6066-6	6,000	7" / 9"	

M12™ Variable Speed Polisher/Sander

- Variable speed trigger
- 5-Pc Accessory pack
 - 3" Polishing backing pad
 - 2" Sanding backing pad
 - Wool pad
 - Yellow foam pad
 - White foam pad



2438-22X

Part #	Mfg #	Description	Price
229843	2438-22X	Kit	

Grinders

7 AMP 4-1/2" Small Angle Grinder

- Compact, Lightweight Design: At 10.2" long and 3.5 lbs
- Debris Baffles- protect internal components by deflecting damaging debris out of the airflow at the intake vents
- Multi-Port Exhaust-reduces motor burn-up
- Tool Free, Burst Resistant Guard



Part #	Mfg #	Description	Price
150013	6130-33	7 AMP 750 MWO Motor	

Power Tools - M12 and Misc

11 AMP 4-1/2" Small Angle Grinder Paddle, Lock-On



- Powerful 11 AMP, 11,000 RPM motor
- Overload Protection
- Electronic Clutch
- Tool-Free accessory change
- Tool-Free adjustable guard
- Advanced airflow system
- Debris baffles
- Includes:
 - (1) 11 Amp 4-1/2" small angle grinder paddle, lock-on (6146-30)
 - (1) Contractor bag
 - (1) Flange
 - (1) Grinding wheel
 - (1) Side handle
 - (1) Spanner wrench
 - (1) Type 27 guard

Part #	Mfg #	Description	Price
240167	6141-30	Kit	

11 Amp Corded 4-1/2 in. Small Angle Grinder Paddle No-lock



- Powerful 11 Amp, 11,000 RPM motor
- Tool-free adjustable guard
- Debris baffles
- Tool-free accessory change
- Advanced airflow system
- Includes:
 - (1) 11 Amp Corded 4-1/2 in. Small Angle Grinder Paddle Lock-On (6141-30)
 - (1) Type 27 Guard
 - (1) Spanner Wrench
 - (1) Side Handle
 - (1) Flanges

Part #	Mfg #	Description	Price
248388	6142-31	Kit	

13 Amp 5" Small Angle Grinder Trigger Grip, Lock-On



- Powerful 13 amp
- 9,000 RPM Motor
- Electronic clutch
- Tool-free accessory guard
- Constant power technology™
- Anti-vibration side handle
- Includes:
 - (1) 13 Amp 5" Small Angle Grinder Trigger Grip, Lock-On (6124-30)
 - (1) Flange
 - (1) Spanner wrench
 - (1) Type 27 guard

Part #	Mfg #	Description	Price
262756	6124-30	Bare Tool	

M28™ Cordless Grinder / Cut-Off Tool



- 28V motor delivers 8000 RPM no load speed
- Tool free guard
- Fuel gauge
- Overload protection
- Large spindle lock
- Slide on switch

Part #	Mfg #	Description	Price
256259	0725-20	Bare Tool	

Power Tools - M12 and Misc

Misc. Tools

2-1/4 Max HP EVS Multi-Base Router Kit

- Powerful 13 amp
- Electronic variable speed with soft start (10,000-24,000 rpm)
- Exclusive BodyGrip® design
- Premium electronic motor
- Micro-fine linear depth adjustment to within 1/64 in
- Exclusive motor contamination shield
- Exclusive above-the-table depth adjustment
- Includes:
 - (1) 2-1/4 Max HP EVS Multi-Base Router Kit (5616-24)
 - (2) 1 1/8" Collet wrenches
 - (1) 1/2" Collet
 - (1) 1/4" Collet
 - (1) Carrying case
 - (2) Clear sub-bases
 - (1) Concentricity gauge
 - (1) Dust shield
 - (1) Fixed based assembly
 - (1) Plunge base assembly



Part #	Mfg #	Description	Price
257198	5616-24	Kit	

8 Gallon Dust Extractor

- 2 Step filtration system
- On-board tool activated plug
- Quiet operation: 69dB
- Suction control dial
- 13 Ft Anti-static hose
- Large wheels, locking swivel casters for jobsite durability
- Water level float valve shuts off suction when tank is full



Part #	Mfg #	Description	Price
242452	8960-20	Bare Tool	

Accessories

Part #	Mfg #	Description	Price
249514	49-90-1953	Main Filter	

Diamond Coring Rig w/ Large Base Stand, Vac-U-Rig® Kit, Meter Box and Diamond Coring Motor

- Kit Includes:
 - Diamond coring large base stand
 - Diamond coring motor
 - Large base stand
 - Vac-U-Rig® kit
 - Diamond coring rig
 - Meter box



Part #	Mfg #	Description	Price
244274	4120-22	Kit	

Vacuum Pump Assembly

- 1/3 max HP
- Recommended for use with 49-22-7100 pad only



Part #	Mfg #	Description	Price
255320	49-50-0200	Bare Tool	

1 Ton Electric Chain Hoist

- 1 ton rated load,
- 10 ft. lift height
- 16 ft./min. lifting speed
- 115/230 voltage (AC), 16.0 amps at low voltage
- Built-in, multiple-disc, magnetic brake
- Adjustable upper and lower limit switches



Part #	Mfg #	Description	Price
253643	9568	Chain Hoist	

2 Ton Electric Chain Hoist

- 2 Ton rated load
- 10 ft. lift height
- 8 ft./min. lifting speed
- Single-phase, 115/230 voltage (AC), 16.0 amps at low voltage
- Built-in, multiple-disc, magnetic brake
- Adjustable upper and lower limit switches



Part #	Mfg #	Description	Price
253644	9573	Chain Hoist	

Power Tools - M12 and Misc

Fixed-Base Production Router

- 15 Amps
- 8' Fixed cord
- 120V AC
- Double insulated
- 36-Position speed dial
- 10,000-22,000 No load rpm
- Kit includes:
 - 1/2" Collet
 - 2-1/2" Sub-base
 - 1-1/8" Collet wrenches
 - T-handle wrench



Part #	Mfg #	Description	Price
241914	5625-20	3-1/2" MAX HP	

Folding Miter Saw Stand

- Mounting brackets work with all brands of miter saws
- Light weight aluminum construction for easy portability
- Compact folding design for easy storage
- Supports up to 500 lbs off main beam
- Adjustable foot for leveling on uneven surfaces
- Extends to a maximum of 100" to support large work pieces
- Quick and easy adjustments for fast setup and tear down



Part #	Mfg #	Description	Price
239095	48-08-0551	43-1/2"-100"L x 27"W x 32"H	

Folding Table Saw Stand

- Adjustable foot for cutting on uneven surfaces
- Compact design for easy storage
- Quick attach latching system
- Only 15 lbs
- All steel construction



Part #	Mfg #	Description	Price
248729	48-08-0561	17-3/4"L x 23"W x 20-1/2"H	

14 Gauge Shear

- 5 amps, 4,000 SPM
- Clear unobstructed visibility
- Cuts close curves either left or right
- Blade design eliminates jamming



Part #	Mfg #	Description	Price
176044	6815	14 Gauge Shear	

10 Gauge Nibbler

- 4.0 amp, 1,000 SPM
- Cuts up to 8.75ft per minute
- 1.65 in. starting hole required
- AC-DC toggle switch allows for two-handed operation



Part #	Mfg #	Description	Price
176046	6880	10 Gauge Nibbler	

1-Stage Wet/Dry Vacuum Cleaner

- 10 gal, 1-1/8 bu. recovery capacity, 8.0 amp motor
- Positive water shut-off
- Can be used as a blower
- One-stage bypass motor for wet/dry operation



Part #	Mfg #	Description	Price
176821	8955	1-Stage Wet/Dry Vacuum Cleaner	
142565	49-90-1900	Filter, 8950,8955,8936-20, 8938-20	

M12™ Compact Vacuum

- 33CFM for use on wide range of materials
- Up to 29 minutes* on a single charge using REDLITHIUM™ XC4.0 batteries
- Versatile attachments
- Clear viewing window
- Reusable 42 pleat filter
- Lock-on switch reduces



Part #	Mfg #	Description	Price
173344	0850-20	Bare Tool	
178389	49-90-1950	Vacuum Filter	

Power Tools - M12 and Misc

M4™ 1/4" Hex Screwdriver

- 21-Position clutch setting with auto shut-off
- 2-Speed gearbox: 200/600 RPM
- 44 Inch-pounds of torque



M4™ 1/4" Hex Screwdriver Kit

- Includes:
 - (1) M4™ 1/4" Hex Screwdriver (Tool Only) (2101-20)
 - (1) M4™ Charger (48-59-2001)
 - (1) M4™ 2.0 Battery (48-11-2001)

Part #	Mfg #	Description	Price
222007	2101-21	Kit	

M4™ 1/4" Hex Screwdriver Kit (2 batteries)

- Includes:
 - (1) M4™ 1/4" Hex Screwdriver (Tool Only) (2101-20)
 - (1) M4™ Charger (48-59-2001)
 - (2) M4™ 2.0 Battery (48-11-2001)

Part #	Mfg #	Description	Price
240422	2101-22	Kit	

Temperature Guns

Infrared Laser TEMP-GUN™ Thermometer Kit

- Basic accuracy: 1.50%
- Distance to spot: 12 to 1
- Includes:
 - Laser TEMP-GUN™ thermometer
 - (3) AA Alkaline batteries
 - K-Type thermocouple
 - Slide rail system
- 5-Year warranty



Part #	Mfg #	Temperature Range	Price
137568	2266-20	-20° to 932°F	
228847	2268-20	-22°F to 1022°F	

Laser TEMP-GUN™ M12™ Cordless Lithium-Ion Thermometer for HVAC/R

- Infrared surface temperature measurement from -22 to 1472° F (-30 to 800° C)
- Contact surface temperature measurement from -40 to 1022° F (-40 to 550° C)
- 40:1 Distance to spot ratio
- Measure ambient humidity and dew point
- Adjustable emissivity from 0.10 to 1.00 for increased accuracy
- Unit memory stores up to 20 temperature values



Part #	Mfg #	Temperature Range	Price
180839	2277-20	-22 to 1472° F	

M12™ Infrared Temp-Gun™

- 12:1 distance-to-spot ratio
- 6' Drop test
- Trigger lock
- Laser on/off
- 0.95 Fixed emissivity
- Premium LCD display
- Fully bumpered nose
- High/Low temperature alert
- Hold, max, min, avg, diff modes
- M12™ 12V Lithium-ion battery
- Clear button functions with rubber overmolded grip



Part #	Mfg #	Surface Temperature	Price
223515	2278-20	-22°F to 1022°F	

Spot Infrared Imager

- Measurements from long range or up close with 56:1 distance-to-spot performance
- Powered by standard 9V Alkaline battery
- DUAL SENSE™ pixels are ultra-responsive
- Ironbow color palette allows easy differentiation between hot and cold areas
- Toggle between °F and °C measurements with switch in the battery compartment



Part #	Mfg #	Surface Temperature	Price
240565	2257-20	14°F - 626°F	

Power Tools - M12 and Misc

M12™ 160 x 120 Thermal Imager Kit

- 30-Minute charge time
- 4-Hour battery life
- Knurled focus ring
- 3.5" High resolution LCD
- 4" Minimum focus distance
- Hinged camera style lens
- Raised corners protect the LCD and thermal engine if dropped
- Complete report software
- Broader temperature range —14 to 662°F
- REDLITHIUM™ batteries
- Built-in visual camera & flashlight
- Auto and manual ranging
- Iron, rainbow, and gray color pallets
- Data storage: 2GB SD card
- All thermal and visual images use standard JPEG format for use in any program



Part #	Mfg #	Display Resolution	Price
144777	2260-21	160 x 120 Pixels	

M12™ 102 X77 Infrared Camera

- 7,854 (102 x 77) pixel resolution captures highest resolution image in it's class
- DUAL SENSE™ pixels are ultra-responsive, adjusting individually to eliminate blurring of hot and cold details
- Measure surface temperatures 14°F to 626°F degrees for images spanning wide ranges
- 2-Stage trigger activates lasers for easy scanning or quickly captures images
- Dual lasers frame on-screen temperature area
- Multiple color palettes available: rainbow, grayscale and ironbow
- Automatically locates highest and lowest temperatures
- Fully compatible with Milwaukee® thermal imager reporting software available at Milwaukeeetool.com
- Compatible with over 70+ M12™ tools



Part #	Mfg #	Description	Price
185579	2258-21	102 X 77 Infrared Camera	

Heat Guns

Variable Temperature Heat Gun

- Variable temperature 100 to 1,040°F, 11.6 amp tool
- Unique impact resistant heating element
- Dial control to select temperature



Part #	Mfg #	Description	Price
257726	8977-20	Heat Gun	

Dual Temperature Heat Gun

- Dual temperature 570 and 1000 degrees F, 11.6 amp motor
- Unique impact resistant heating element
- Three position rock switch - off, high and low



Part #	Mfg #	Description	Price
161906	8975-6	Heat Gun	

Heat Gun Accessory Assortment

- Use with any Milwaukee Heat Gun
- Includes
 - 49-80-0292 Hook Nozzle
 - 49-80-0293 Deflector Nozzle
 - 49-80-0294 Air Spreader Nozzle
 - 49-80-0297 Air Reduction Nozzle



Part #	Mfg #	Description	Price
253861	49-80-0300	Heat Gun Accessories	

Power Tools

M18™ Cordless Drills

M18™ Cordless Right Angle Drill

- No load speed: 0 to 1550 rpm
- Torque: 125 in-lbs
- Chuck type: 3/8" single sleeve ratcheting
- Includes:
 - M18™ Right angle drill (2615-20)
 - M18™ REDLITHIUM™ XC High capacity battery
 - 1-Hour charger
 - Carrying case



Part #	Mfg #	Description	Price
162304	2615-20	Bare Tool	
142940	2615-21	Kit	

Kit Includes:

- (1) M18™ Cordless Right Angle Drill (Tool Only) (2615-20)
- (1) M18™ & M12™ Multi-voltage charger (48-59-1812)
- (1) M18™ Compact REDLITHIUM™ battery (48-11-1815)
- (1) Carrying case

Part #	Mfg #	Description	Price
257846	2615-21CT	Kit	

M18™ Cordless 2-Speed 1/4" Right Angle Impact Driver

- No Load RPM:
 - 0-1,500 (mode 1) 0-2,250 (mode 2)
- 2-Speed Drive-Control™
- 1/4" hex drive with 1" bit acceptance
- Extended paddle switch for multiple grip options



Part #	Mfg #	Description	Price
180431	2667-20	Bare Tool	

M18™ 1/2" High Performance Hammer/Drill Driver

- 4-Pole frameless motor
- 1/2" Single-sleeve ratcheting metal chuck with carbide jaws
- Battery fuel gauge displays remaining run-time
- Built-in LED light illuminates work surface
- Variable speed trigger
- No load speed: 0 to 1,800 rpm
- No load BPM: 0 to 28,000 BPM
- Includes:
 - (2) M18™ 18V XC Lithium-Ion batteries
 - 18V Charger
 - Side handle
 - Carrying case
- 5-Year warranty



Part #	Mfg #	Description	Price
139122	2611-24	650 in-lbs Torque	

M18™ 1/2" Hammer Drill Driver

- 4-Pole frameless motor
- 1/2" Single-sleeve ratcheting metal chuck
- Variable speed trigger
- No load speed: 0 to 1,700 rpm
- No load BPM: 0 to 29,000 BPM
- Torque: 550 in-lbs
- Kit includes:
 - M18™ Hammer-drill driver (2602-22)
 - (2) 18V XC Lithium-Ion batteries
 - 1-Hour 18V charger
 - Carrying case
- 5-Year warranty



Part #	Mfg #	Description	Price
143056	2602-20	Bare Tool	
137560	2602-22	Kit	

Power Tools

M18™ 1/2" Compact Drill Driver

- Built-in LED light
- 18V DC
- No load speed: 350 to 1,400 rpm
- Torque: 425 in-lbs
- Kit includes:
 - M18™ Compact drill driver (2601-20)
 - (2) 18V Lithium-Ion batteries
 - 18V Lithium-Ion charger
 - 1/2" 3-Jaw keyless chuck
- 5-Year warranty



M18 1/2" Brushless Hammer Drill

- Milwaukee brushless motor
- Includes side handle
- All-metal gear case
- Chuck type: 1/2 in. all- metal ratcheting single sleeve
- Kit includes:
 - (1) Hammer drill
 - (2) M18 REDLITHIUM XC 4.0 Extended capacity batteries
 - (1) M18™/M12™ Multi-voltage charger
 - (1) Carrying case



Part #	Mfg #	Description	Price
137559	2601-22	Kit	

Part #	Mfg #	Description	Price
251018	2902-20	Bare Tool	
251019	2902-22	Kit	

M18™ Compact 1/2" Drill Driver

- Milwaukee® 4-pole frameless motor
- All-Metal gear case and chuck
- Compact design
- REDLINK™ intelligence
- Kit includes:
 - (1) M18™ Compact 1/2" Drill Driver (Tool Only) (2606-20)
 - (1) M18™ & M12™ Multi-voltage charger (48-59-1812)
 - (2) M18™ Compact REDLITHIUM™ battery (48-11-1815)
 - (1) Carrying case



M18™ Compact 1/2" Hammer Drill/Driver

- 4-Pole Frameless Motor: Features a robust design combined with rare-earth magnets for longer life, best-in-class 500 in-lbs of torque and 0-400/0-
- All-Metal gear case and chuck
- REDLINK™ Intelligence



Part #	Mfg #	Description	Price
188021	2606-20	Bare Tool	
253217	2606-21CT	Kit	

Part #	Mfg #	Description	Price
170819	2607-20	Bare Tool	
166993	2607-22	Kit	

M18 Compact Brushless 1/2" Drill Driver

- Milwaukee brushless motor
- Compact design
- REDLINK™ intelligence
- Belt clip
- All-metal gear case and 1/2 in. metal chuck
- Kit includes:
 - (1) M18 Compact Brushless 1/2" Drill Driver Bare Tool (2801-20)
 - (2) M18™ REDLITHIUM™ CP2.0 battery (48-11-1820)
 - (1) M18™ & M12™ Multi-voltage charger (48-59-1812)
 - (1) Carrying case



Part #	Mfg #	Description	Price
251013	2801-20	Bare Tool	
251014	2801-22CT	Kit	

Power Tools

M18™ 1/4" Hex Compact Impact Driver

- 1/4" Hex quick change chuck
- 4-Pole frameless motor
- Battery fuel gauge displays remaining run-time
- No load speed: 0 to 2,200 rpm
- No load IPM: 0 to 3,200 IPM
- Variable speed trigger
- Built-in LED light illuminates work surface
- 18V
- Includes:
 - M18™ Impact driver (2650-20)
 - (2) M18™ REDLITHIUM™ XC high capacity batteries
 - Battery charger
 - Belt clip
 - Carrying case
- 5-Year warranty



Part #	Mfg #	Description	Price
144367	2650-20	Bare Tool	
137562	2650-22	Kit	

M18™ 1/4" Hex Impact Driver

- Milwaukee® 4-Pole frameless motor
- Delivers maximum power and application speed for greater efficiency on the job
- REDLINK™ Intelligence
- 2-Mode DRIVE CONTROL™
- 1/4" Hex quick-connect chuck
- REDLITHIUM™ Battery
- Kit Includes:
 - (1) M18 2-Speed 1/4" hex impact driver (Bare tool)
 - (2) M18™ Compact REDLITHIUM™ battery (48-11-1815)
 - (1) M18™ & M12™ Multi-voltage charger (48-59-1812)
 - (1) Belt clip
 - (1) Carrying case



Part #	Mfg #	Description	Price
164016	2657-20	Bare Tool (2-Speed)	
179431	2656-20	Bare Tool	

M18 1/4" Hex Impact Driver

- Compact design
- REDLINK™ Intelligence
- Milwaukee brushless motor
- RPM: 0-3,400
- IPM: 0-4,200
- Kit includes:
 - (1) M18 1/4" Hex Impact Driver Bare Tool (2850-20)
 - (2) M18™ REDLITHIUM™ CP2.0 battery (48-11-1820)
 - (1) M18™ & M12™ Multi-voltage charger (48-59-1812)
 - (1) Carrying case
 - (1) Belt clip



Part #	Mfg #	Description	Price
251015	2850-20	Bare Tool	
251016	2850-22CT	Kit	
251020	2851-20	Bare Tool (3-Speed)	

M18™ 1/4" Hex Brushless Impact Driver

- Compact Design
- REDLINK™ Intelligence
- REDLITHIUM™ Battery
- Kit Includes:
 - (1) M18™ 1/4" Hex Brushless Impact Driver (2750-20)
 - (1) M18™ & M12™ Multi-Voltage Charger (48-59-1812)
 - (2) M18™ REDLITHIUM™ CP2.0 Battery Pack (48-11-1820)
 - (1) Carrying Case

Part #	Mfg #	Description	Price
173942	2750-22CT	Kit	

M18™ 3/8" Impact Wrench Kit with Friction Ring

- 3/8" Anvil with friction ring
- Kit Includes:
 - (1) M18™ 3/8" Impact wrench with friction ring (bare tool) (2658-20)
 - (2) M18™ REDLITHIUM™ XC battery (48-11-1828)
 - (1) M18™ & M12™ Multi-voltage charger (48-59-1812)
 - (1) Belt clip
 - (1) Carrying case



Part #	Mfg #	Description	Price
166198	2658-22	Kit	

Power Tools

M18™ 1/2" Impact Wrench with Pin Detent

- Kit includes:
 - (1) M18™ 1/2" Impact Wrench w/ Pin Detent (2659-20)
 - (2) M18™ REDLITHIUM™ XC Extended Capacity Battery (48-11-1828)
 - (1) M18™ & M12™ Multi-Voltage Charger (48-59-1812)
 - (1) Belt Clip
 - (1) Carrying Case



Part #	Mfg #	Description	Price
167795	2659-20	Bare Tool	
228550	2659-22	Kit	

M18™ Cordless 2-Speed 3/8" Right Angle Impact Wrench

- 2-Speed Drive-Control™ offers greater control over applications
- 3/8" Anvil with friction ring for fast, easy socket change
- 1.4" Head



Part #	Mfg #	Description	Price
223133	2668-20	Bare Tool	

M18™ Cordless 5/8" SDS Plus Rotary Hammer Kit

- REDLITHIUM™ battery technology: superior pack construction, electronics, and performance deliver more work per charge and more work over pack life than any battery on the market
- Powerful 18-volt motor: delivers 0-1,300 RPM and 0-7,000 BPM
- 2-Mode operation: choose rotary hammer or rotation only for added versatility
- LED light: illuminates dark work spaces



Part #	Mfg #	Description	Price
244697	2612-20	Bare Tool	
166128	2612-21	Kit	

M18 Fuel™ Cordless Drills

M18™ FUEL™ 1/2" Drill/Driver

- POWERSTATE™ Brushless motor
- REDLINK PLUS™ Intelligence
- Kit Includes:
 - (1) M18 FUEL™ 1/2" Drill/Driver (Bare Tool) (2703-20)
 - (2) M18™ REDLITHIUM™ XC5.0 Extended Capacity Battery Pack (48-11-1850)
 - (1) M18™ & M12™ Multi-Voltage Charger (48-59-1812)
 - (1) Belt Clip
 - (1) Bit Holder
 - (1) Side Handle
 - (1) Carrying Case



Part #	Mfg #	Description	Price
179571	2703-20	Bare Tool	
179572	2703-22	Kit	

M18™ FUEL™ 1/2" Drill Driver

- Up To 60% More Power: 1,200 in-lbs of torque
- LED on foot of tool for better lighting in dark spaces
- POWERSTATE™ Brushless Motor
- REDLINK PLUS™ Intelligence
- Kit includes:
 - (1) M18 FUEL™ 1/2" Drill Driver (Tool Only) (2803-20)
 - (2) M18™ REDLITHIUM™ XC5.0 Extended Capacity Battery Pack (48-11-1850)
 - (1) M18™ & M12™ Multi-Voltage Charger (48-59-1812)
 - (1) Carrying Case
 - (1) Side Handle
 - (1) Belt Clip
 - (1) Bit Holder



Part #	Mfg #	Description	Price
248755	2803-20	Bare Tool	
248756	2803-22	Kit	

Power Tools

M18™ FUEL™ 1/2" Hammer Drill/Driver

- Up To 60% More Power: 1,200 in-lbs of torque
- LED on foot of tool for better lighting in dark spaces
- POWERSTATE™ Brushless motor
- REDLINK PLUS™ Intelligence
- Kit includes:
 - (1) M18 FUEL™ 1/2" Hammer Drill/Driver (Tool Only) (2804-20)
 - (2) M18™ REDLITHIUM™ XC5.0 Extended capacity battery pack (48-11-1850)
 - (1) M18™ & M12™ Multi-voltage charger (48-59-1812)
 - (1) Belt clip
 - (1) Bit holder
 - (1) Carrying case
 - (1) Side handle



Part #	Mfg #	Description	Price
248757	2804-20	Bare Tool	
248759	2804-22	Kit	

M18 FUEL™ 1/2" Drill/Driver w/ ONE-KEY™

- POWERSTATE™ Brushless motor
- Anti-kickback technology
- REDLINK PLUS™ Intelligence
- ONE-KEY™ Compatible
- Up To 60% more power: 1,200 in-lbs of torque
- LED on foot of tool for better lighting in dark spaces
- Kit includes:
 - (1) M18 FUEL™ 1/2" Drill/Driver w/ ONE-KEY™ (2805-20)
 - (2) M18™ REDLITHIUM™ XC5.0 Extended Capacity Battery Pack (48-11-1850)
 - (1) Belt Clip
 - (1) Bit Holder
 - (1) Side Handle



Part #	Mfg #	Description	Price
254436	2805-20	Bare Tool	
254437	2805-22	Kit	

M18™ FUEL™ 1/2" Hammer Drill/Driver

- 2-Speed Powerstate™ brushless motor
- Redlink PLUS™ Intelligence system communications with overload protection
- No load speed: 0 to 500/0 to 1850 rpm
- Kit Includes:
 - 1/2" Drill/driver
 - (2) 18V Compact REDLITHIUM™ batteries
 - Multi-voltage charger
 - Locking chuck
 - LED Light
- 5-Year warranty



Part #	Mfg #	Description	Price
179573	2704-20	Bare Tool	
179574	2704-22	Kit	

M18™ FUEL™ with ONE-KEY™ 1/2" Hammer Drill/Driver

- Kit includes:
 - (1) M18 FUEL™ with ONE-KEY™ 1/2" Hammer Drill/Driver (Tool Only) (2706-20)
 - (2) M18™ REDLITHIUM™ XC5.0 Extended Capacity Battery Pack (48-11-1850)
 - (1) M18™ & M12™ Multi-Voltage Charger (48-59-1812)
 - (1) Belt Clip
 - (1) Bit Holder
 - (1) Side Handle
 - (1) Carrying Case



Part #	Mfg #	Description	Price
223514	2706-20	Bare Tool	
230428	2706-22	Kit	

Power Tools

M18 FUEL™ 1/2" Hammer Drill w/ ONE-KEY™

- Up To 60% more power: 1,200 in-lbs of torque
- LED on foot of tool for better lighting in dark spaces
- REDLINK PLUS™ Intelligence
- ONE-KEY™ Compatible
- Kit includes:
 - (1) M18 FUEL™ 1/2" Hammer Drill w/ ONE-KEY™ (2806-20)
 - (2) M18™ REDLITHIUM™ XC5.0 Extended capacity battery pack (48-11-1850)
 - (1) M18™ & M12™ Multi-voltage charger (48-59-1812)
 - (1) Belt clip
 - (1) Bit holder
 - (1) Side handle



Part #	Mfg #	Description	Price
254438	2806-20	Bare Tool	
254439	2806-22	Kit	

M18™ FUEL™ SDS Plus Rotary Hammer

- POWERSTATE™ brushless motor
- REDLINK PLUS™
- REDLITHIUM™ battery
- AVS system



Part #	Mfg #	Description	Price
227454	2712-22HD	High Demand Kit, 1"	
173340	2712-22	Kit, 1"	
182779	2712-20	Bare Tool, 1"	
221606	2715-20	Bare Tool, 1-1/8"	
171580	2715-22	Kit, 1-1/8"	
178540	2715-22DE	DE(Dust Extractor) Kit, 1-1/8"	
234425	2715-22HD	High Demand Kit, 1-1/8"	
189902	2713-20	Bare Tool, 1" w/ D-Handle	
188836	2713-22	Kit, 1" w/ D-Handle	
234424	2713-22HD	High Demand Kit, 1" D-Handle	

M18 FUEL™ 1" SDS Plus Rotary Hammer with Dedicated Dust Extractor

- POWERSTATE™ brushless motor
- REDLINK PLUS™
- REDLITHIUM™ battery
- AVS system
- Kit includes:
 - (1) M18 FUEL™ 1" SDS Plus Rotary Hammer(2712-20)
 - (1) HAMMERVAC™ Dedicated Dust Extractor (2712-DE)
 - (2) M18™ REDLITHIUM™ XC5.0 Extended Capacity Battery Pack (48-11-1850)
 - (1) M18™ & M12™ Multi-Voltage Charger (48-59-1812)
 - (1) Depth Rod
 - (1) HEPA Filter
 - (1) Side Handle
 - (1) Carrying Case



Part #	Mfg #	Description	Price
185835	2712-22DE	Kit	

M18™ FUEL™ 1-9/16" SDS Max Hammer Drill

- POWERSTATE™ brushless motor
- REDLITHIUM™ battery pack
- REDLINK PLUS™ intelligence



Part #	Mfg #	Description	Price
226124	2717-20	Bare Tool	
226125	2717-21HD	Kit	
226126	2717-22HD	Kit	

Power Tools

M18 FUEL™ 1-3/4" SDS Max Rotary Hammer w/ ONE KEY™

- POWERSTATE™ brushless motor
- REDLINK PLUS™ electronic intelligence
- One Key™
- 380 RPM
- 8.1 ft-lbs Impact Energy
- 2,900 BPM
- 10 m/s² Vibration
- Kit Includes:
 - (1) M18 FUEL™ 1-3/4" SDS Max Rotary Hammer w/ ONE KEY™ (Tool Only) (2718-20)
 - (1) M18 REDLITHIUM™ HIGH OUTPUT™ HD12.0 Battery Pack (48-11-1812)
 - (1) M18™ & M12™ Rapid Charger (48-59-1808)
 - (1) Carrying Case
 - (1) Grease Tube
 - (1) Side Handle



Part #	Mfg #	Description	Price
258596	2718-21HD	Kit	
266921	2718-22HD	Kit	

M18™ FUEL™ HOLE HAWG® 1/2" Right Angle Drill

- POWERSTATE™ Brushless motor
- All-metal keyed chuck
- On-board chuck key holder
- Kit Includes:
 - (1) M18 FUEL™ HOLE HAWG® 1/2" right angle drill (Tool Only) (2707-20)
 - (1) Contractor bag
 - (1) Chuck key
 - (2) M18™ REDLITHIUM™ XC5.0 extended capacity battery pack (48-11-1850) (-22 Model) - (1) Multi-voltage charger (48-59-1812) (-22HD Model)- (1) Rapid charger (48-59-1808)



Part #	Mfg #	Description	Price
170226	2707-20	Bare Tool	
170227	2707-22	Kit	
234423	2707-22HD	High Demand Kit	

M18™ FUEL™ Hole Hawg™ Right Angle Drill with QUIK-LOK™

- POWERSTATE™ brushless motor
- REDLINK™ PLUS
- Kit Includes:
 - M18™ FUEL™ 1/2" Right angle drill
 - M18™ REDLITHIUM™ battery pack
 - M18™&M12™ multi-voltage charger
 - Contractor bag



Part #	Mfg #	Description	Price
171055	2708-20	Bare Tool	
171056	2708-22	Kit	

High Demand

Part #	Mfg #	Description	Price
227455	2708-22HD	Kit	

M18 FUEL™ 1/4" Hex Impact Driver

- POWERSTATE™ Brushless motor
- Torque: 1,800 in-lbs
- 4-Mode DRIVE CONTROL™
- Kit includes:
 - M18 FUEL™ 1/4" Hex Impact Driver (Tool Only) (2753-20)
 - M18™ REDLITHIUM™ XC5.0 Extended capacity battery pack (48-11-1850)
 - M18™ & M12™ Multi-voltage charger (48-59-1812)



Part #	Mfg #	Description	Price
179575	2753-20	Bare Tool	
179576	2753-22	Kit	

Power Tools

M18™ FUEL™ 1/4" Hex Impact Driver

- POWERSTATE™ Brushless motor
- Torque: 2,000 in-lbs
- 4-Mode drive control
- Self-tapping screw mode
- Single handed bit insertion
- LED light to illuminate work area
- Kit includes:
 - (1) M18 FUEL™ 1/4" Hex Impact Driver (Tool Only) (2853-20)
 - (2) M18™ REDLITHIUM™ XC5.0 extended capacity battery pack (48-11-1850)
 - (1) M18™ & M12™ Multi-voltage charger (48-59-1812)
 - (1) Belt clip
 - (1) Bit holder
 - (1) Carrying case



Part #	Mfg #	Description	Price
248760	2853-20	Bare Tool	
248762	2853-22	Kit	
248761	2853-22CT	Kit	

M18 FUEL™ 1/4" Hex Impact Driver w/ ONE-KEY™

- POWERSTATE™ Brushless motor
- REDLINK PLUS™ Intelligence
- Torque: 2,000 in-lb
- ONE-KEY™ Compatible
- LED light
- Select between four custom drive control modes
- Kit includes:
 - (1) M18 FUEL™ 1/4" Hex Impact Driver w/ ONE-KEY™ XC Kit (2857-22)
 - (2) M18™ REDLITHIUM™ XC5.0 Extended Capacity Battery Pack (48-11-1850)
 - (1) M18™ & M12™ Multi-Voltage Charger (48-59-1812)
 - (1) Belt Clip
 - (1) Bit Holder
 - (1) Carrying Case
 - (1) Side Handle



Part #	Mfg #	Description	Price
254440	2857-20	Bare Tool	
254442	2857-22	Kit	
254441	2857-22CT	Kit	

M18™ FUEL™ SURGE™ 1/4" Hex Hydraulic Driver

- Kit includes:
 - (1) 1/4" Hex Hydraulic Driver (Tool Only) (2760-20)
 - (2) M18™ REDLITHIUM™ XC5.0 (48-11-1850)
 - (1) M18™ & M12™ Multi-Voltage Charger (48-59-1812)
 - (1) Belt Clip
 - (1) Bit Holder
 - (1) Carrying Case



Part #	Mfg #	Description	Price
231122	2760-20	Bare Tool	
231123	2760-22	Kit	
248572	2760-22CT	Kit	

M18 FUEL™ 3/8" Mid-Torque Impact Wrench w/ Friction Ring

- POWERSTATE™ brushless motor
- 3-Mode DRIVE CONTROL™
- REDLINK PLUS™ intelligence
- Features a friction ring design
- LED light
- Belt Clip



Part #	Mfg #	Description	Price
255838	2852-20	Bare Tool	

M18™ FUEL™ 1/2" Compact Impact Wrench with Friction Ring Kit

- Kit Includes:
 - (1) M18 FUEL™ 1/2" Compact Impact Wrench w/ Friction Ring (Bare Tool) (2755B-20)
 - (2) M18™ REDLITHIUM™ XC5.0 Extended Capacity Battery Pack (48-11-1850)
 - (1) M18™ & M12™ Multi-Voltage Charger (48-59-1812)
 - (1) Belt Clip
 - (1) Carrying Case



Part #	Mfg #	Description	Price
228402	2755B-20	Bare Tool	
226462	2755B-22	Kit	

Power Tools

M18™ FUEL™ 1/2" Mid-Torque Impact Wrench with Pin Detent

- POWERSTATE™ Brushless motor
- 3-Mode DRIVE CONTROL™
- Up to 600 ft-lbs of nut-busting torque
- Up to 450 ft-lbs of fastening torque



- Kit Includes:
 - (1) M18 FUEL™ 1/2" Mid-Torque Impact Wrench with pin detent (tool only) (2860-20)
 - (2) M18™ REDLITHIUM™ XC5.0 Extended capacity battery pack (48-11-1850)
 - (1) M18™ & M12™ Multi-voltage charger (48-59-1812)
 - (1) Carrying case
 - (1) Belt clip

Part #	Mfg #	Description	Price
247481	2860-20	Bare Tool	
234481	2860-22	Kit	

M18™ FUEL™ 1/2" Mid-Torque Impact Wrench with Friction Ring

- LED light
- Delivers up to 450 ft-lbs of fastening torque
- Delivers up to 600 ft-lbs of nut-busting torque
- REDLINK PLUS™
- REDLITHIUM™ batteries
- POWERSTATE™ brushless motor
- Utilizes a friction ring design to ensure quick & easy socket changes



Part #	Mfg #	Description	Price
243289	2861-20	Bare Tool	

M18™ FUEL™ 1/2" High Torque Impact Wrench with Pin Detent

- Kit includes:
 - (1) M18 FUEL™ 1/2" High Torque Impact Wrench (2762-20)
 - (1) M18™ & M12™ Multi-Voltage Charger (48-59-1812)
 - (2) M18™ REDLITHIUM™ XC5.0 Ext Capacity Battery (48-11-1850)
 - (1) Carrying Case



Part #	Mfg #	Description	Price
221607	2762-20	Bare Tool	
166737	2762-22	Kit	

M18™ FUEL™ 1/2" High Torque Impact Wrench with Friction Ring Kit

- Delivers up to 700 ft-lbs of maximum fastening torque, up to 1,100 ft-lbs of nut-busting torque and up to 2X more runtime
- POWERSTATE™ Brushless Motor
- REDLINK PLUS™ Intelligence



- Kit Includes
 - (1) M18 FUEL™ 1/2" High Torque Impact Wrench with Friction Ring (Bare Tool) (2763-20)
 - (2) M18™ REDLITHIUM™ XC5.0 Extended Capacity Battery Pack (48-11-1850)
 - (1) M18™ & M12™ Rapid Charger (48-59-1808)

Part #	Mfg #	Description	Price
165987	2763-22	Kit	

M18™ FUEL™ 3/8" Impact Wrench Kit with Friction Ring

- 200 ft-lbs and 2,400 in-lbs of torque in a compact design
- POWERSTATE™ brushless motor
- REDLINK PLUS™
- REDLITHIUM™ battery pack
- Utilizes a friction ring design for fast, easy socket changes
- Includes:
 - (1) M18 FUEL™ 3/8" Impact wrench with friction ring (2654-20)
 - (2) M18™ REDLITHIUM™ XC 4.0 Extended capacity battery pack (48-11-1840)
 - (1) M18 & M12™ multi-voltage charger (48-59-1812)
 - (1) Belt clip
 - (1) Carrying case



Part #	Mfg #	Description	Price
158102	2654-22	Kit	

Power Tools

M18™ FUEL™ 1/2" Impact Wrench Kit with Pin Detent

- 210 ft-lbs and 2,520 in-lbs of torque in a compact design
- POWERSTATE™ Brushless Motor
- REDLITHIUM™ XC 4.0 Battery REDLINK PLUS™
- Utilizes a pin detent design for maximum socket retention
- Includes:
 - (1) M18 FUEL™ 1/2" Impact wrench with pin detent (bare tool) (2655-20)
 - (2) M18™ REDLITHIUM™ XC 4.0 extended capacity battery pack (48-11-1840)
 - (1) M18™ & M12™ multi-voltage charger (48-59-1812)
 - (1) Belt clip
 - (1) Carrying case



Part #	Mfg #	Description	Price
158103	2655-22	Kit	

M18 FUEL™ w/ ONE-KEY™ High Torque Impact Wrench 1/2" Pin Detent

- POWERSTATE™ Brushless motor
- Compatible with ONE-KEY™
- REDLINK PLUS™ intelligence
- Delivers up to 750ft-lbs of fastening torque and 1100ft-lbs of nut-busting torque



Part #	Mfg #	Description	Price
255972	2862-20	Bare Tool	

M18™ 1/2" High-Torque Impact Wrench with Friction Ring Kit

- Milwaukee® 4-pole frameless motor
- REDLITHIUM™ battery technology
- REDLINK™ intelligence
- Includes:
 - (1) M18™ 1/2" high-torque impact wrench with friction ring (2663-20)
 - (2) M18™ REDLITHIUM™ XC extended capacity battery (48-11-1828)
 - (1) M18™ & M12™ Multi-voltage charger (48-59-1812)
 - (1) Carrying case



Part #	Mfg #	Description	Price
152298	2663-22	Kit	

M18™ FUEL™ High Torque 1/2" Impact Wrench w/ Pin Detent

- 8.1" in length
- Bolt removal mode
- REDLINK PLUS™ intelligence
- REDLITHIUM™ batteries
- Features a pin detent design for maximum socket retention
- Premium rubber overmold
- Reduced user fatigue at only 7.1lbs w/ battery
- LED light to illuminate the work area



Part #	Mfg #	Description	Price
245924	2766-22	Kit	

M18™ FUEL™ 1/2" High Torque Impact Wrench with Friction Ring

- LED light
- Bolt removal mode
- Rubber overmold
- REDLINK PLUS™
- REDLITHIUM™ batteries
- POWERSTATE™ brushless motor



Part #	Mfg #	Description	Price
239311	2767-20	Bare Tool	
238946	2767-22	Kit	

M18 FUEL™ w/ ONE-KEY™ High Torque Impact Wrench 1/2" Friction Ring

- POWERSTATE™ brushless motor
- Up to 1400 ft-lbs nut-busting torque
- REDLINK PLUS™ intelligence
- M18 FUEL with ONEKEY™ technology
- Features a friction ring design
- Kit includes:
 - (1) M18 FUEL™ w/ ONE-KEY™ High Torque Impact Wrench 1/2" Friction Ring (2863-20)
 - (2) M18™ REDLITHIUM™ XC5.0 Extended Capacity Battery Pack (48-11-1850)
 - (1) M18™ & M12™ Multi-Voltage Charger (48-59-1812)
 - (1) Carrying Case



Part #	Mfg #	Description	Price
254380	2863-20	Bare Tool	
258656	2863-22	Kit	

Power Tools

M18 FUEL™ 3/4" w/ ONE-KEY™ High Torque Impact Wrench Friction Ring

- POWERSTATE™ brushless motor delivers up to 1200ft-lbs of fastening torque and 1500ft-lbs of nut-busting torque
- ONE-KEY™ Compatible
- Features a friction ring with thru-hole design to ensure quick and easy socket changes



Part #	Mfg #	Description	Price
250927	2864-20	Bare Tool	

M18™ FUEL™ 3/8" Compact Impact Wrench with Friction Ring Kit

- Kit Includes:
 - (1) M18 FUEL™ 3/8" Compact Impact Wrench w/ Friction Ring (Bare Tool) (2754-20)
 - (2) M18™ REDLITHIUM™ XC5.0 Ext Capacity Batteries(48-11-1850)
 - (1) M18™ & M12™ Multi-Voltage charger (48-59-1812)
 - (1) Belt Clip
 - (1) Carrying Case



Part #	Mfg #	Description	Price
222174	2754-20	Bare Tool	
181171	2754-20	Kit	

With ONE-KEY™

Part #	Mfg #	Description	Price
245791	2758-22	Kit	

M18™ FUEL™ 1/2" Compact Impact Wrench with Pin Detent

- POWERSTATE™ Brushless motor
- 4-Mode DRIVE CONTROL™
- Utilizes a pin detent design for maximum socket retention
- Kit Includes:
 - (1) M18 FUEL™ 1/2" Compact Impact Wrench w/ Pin Detent (2755-20)
 - (2) M18™ REDLITHIUM™ XC5.0 Battery Pack (48-11-1850)
 - (1) M18™ & M12™ Multi-Voltage Charger (48-59-1812)
 - (1) Belt Clip
 - (1) Carrying Case



Part #	Mfg #	Description	Price
179579	2755-20	Bare Tool	
179580	2755-22	Kit	

M18™ FUEL™ Mud Mixer with 180° Handle Kit

- Includes:
 - LED light
 - Church key
 - Contractor's bag
 - M18 REDLITHIUM™ XC5.0
 - M18™ & M12™ Multi-voltage charger
- Up to 15 buckets per charge
- 16 Adjustable handle settings



Part #	Mfg #	Voltage	Price
239069	2810-20	Bare Tool	
239068	2810-22	Kit	

M18™ Cordless Saws

M18™ Sawzall® Reciprocating Saw Kit

- Gear-protecting clutch
- Lever action Quik-Lok™ blade clamp
- Battery fuel gauge displays remaining run-time
- Variable speed trigger
- Kit Includes:
 - (1) Sawzall® Reciprocating saw (2621-20)
 - (2) M18™ REDLITHIUM™ XC Battery (48-11-1828)
 - (1) Multi-Voltage Charger (48-59-1812)
 - (1) Blade
 - (1) Carrying Case



Part #	Mfg #	Description	Price
173952	2621-20	Bare Tool	
173953	2621-21	Kit	
173954	2621-22	Kit	

M18™ HACKZALL® Cordless One-Handed Reciprocating Saw

- Speed: 0 to 3,000 spm
- Stroke length: 3/4"
- Blade clamp: QUIK-LOK™ universal
- Kit includes:
 - M18™ HACKZALL® Reciprocating saw (2625-20)
 - M18™ REDLITHIUM™ XC High capacity battery
 - 10-Hour charger
 - SAWZALL® Blade
 - Contractor bag



Part #	Mfg #	Description	Price
144657	2625-20	Bare Tool	
138662	2625-21	Kit	

Power Tools

M18™ HACKZALL® Recip Saw Kit

- One-handed design provides superior control & versatility
- Compact size allows for cutting in tight spaces, and light weight makes overhead work easier
- Built-in LED light
- Includes:
 - (1) M18™ HACKZALL® Recip Saw (2625-20)
 - (1) M18™ Compact REDLITHIUM Battery (48-11-1815)
 - (1) M18™ & M12™ Multi-Voltage Charger (48-59-1812)
 - (1) Contractor Bag



Part #	Mfg #	Description	Price
150993	2625-21CT	Kit	

M18™ Cordless Band Saw

- 3-1/4" Cut capacity
- Tool-free adjustable material shoe
- LED Work light
- Blade ejection system
- Drop resistant pulley guard
- Cast aluminum gear case
- Kit includes:
 - M18™ Band saw
 - (2) M18™ REDLITHIUM™ XC High capacity batteries
 - 1-Hour charger
 - Blade
 - Case
- 5-Year warranty



Part #	Mfg #	Description	Price
139287	2629-20	Bare Tool	
143146	2629-22	Kit	

M18™ Cordless 6-1/2" Circular Saw

- Speed: 3,500 rpm
- Capacity: 2-1/8" @90° and 1-9/16" @45°
- Arbor: 5/8"
- Blade: 6-1/2" 24T carbide tipped
- Kit includes:
 - M18™ Circular saw (2630-20)
 - (2) M18™ REDLITHIUM™ XC High capacity batteries
 - 1-Hour charger
 - Contractor bag



Part #	Mfg #	Description	Price
143400	2630-20	Bare Tool	
138753	2630-22	Kit	

M18™ Brushless 7-1/4" Circular Saw

- Milwaukee® brushless motor
- Integrated rafter hook
- Integrated dust port on guard
- REDLINK™ Intelligence
- Magnesium upper and lower guards
- Electric brake
- Includes:
 - (1) M18™ Brushless 7-1/4" Circular Saw (2631-20)
 - (1) Contractor bag
 - (1) Blade
 - (1) Blade wrench



Part #	Mfg #	Description	Price
255211	2631-20	Bare Tool	

M18™ Cordless Jig Saw

- Speed: 0 to 2,700 SPM
- Stroke length: 1"
- Bevel capacity: 45°
- Kit includes:
 - M18™ Jig saw (2645-20)
 - (2) M18™ REDLITHIUM™ XC High capacity batteries
 - 1-Hour charger
 - Jig saw blade
 - Non-marring shoe
 - Carrying case



Part #	Mfg #	Description	Price
142858	2645-20	Bare Tool	
138656	2645-22	Kit	

Power Tools

M18™ Cordless 5-3/8" Metal Saw

- 4-Pole frameless motor
- Speed: 3,600 rpm
- Cut capacity: 1/8" to 2"
- Blade: 5-3/8" 30T carbide-tipped
- Includes:
 - M18™ 5-3/8" Metal saw
 - (2) M18™ REDLITHIUM™ XC High capacity batteries
 - 1-Hour charger
 - 30T Metal Tech™ carbide-tipped blade
 - Blade wrench
 - Contractor bag



Part #	Mfg #	Description	Price
141828	2682-22	Kit	

M18™ FUEL™ 7-1/4" Circular Saw

- POWERSTATE™ Brushless motor
- REDLINK PLUS™ Intelligence
- REDLITHIUM™ XC 4.0 Battery
- Kit Includes:
 - (1) M18 FUEL™ 7-1/4" Circular Saw (Bare Tool) (2731-20)
 - (2) M18™ REDLITHIUM™ XC5.0 Extended Capacity Battery Pack (48-11-1850)
 - (1) M18™ & M12™ Multi-Voltage Charger (48-59-1812)
 - (1) Blade
 - (1) Blade Wrench
 - (1) Contractor Bag



Part #	Mfg #	Description	Price
174393	2731-20	Bare Tool	
172223	2731-21	Kit	
172201	2731-22	Kit	

M18™ FUEL™ Cordless Saws

M18™ FUEL™ 6-1/2" Circular Saw

- POWERSTATE™ Brushless motor
- REDLINK PLUS™ Intelligence
- REDLITHIUM™ XC 4.0 Battery
- Kit Includes:
 - (1) M18 FUEL™ 6-1/2" Circular saw (bare tool) (2730-20)
 - (1) M18™ REDLITHIUM™ XC Extended capacity battery pack
 - (1) M18™ & M12™ Multi-voltage charger (48-59-1812)
 - (1) Blade
 - (1) Blade wrench
 - (1) Contractor bag



Part #	Mfg #	Description	Price
162303	2730-20	Bare Tool	
166409	2730-21	Kit	
161702	2730-22	Kit	

M18™ FUEL™ 7-1/4" Circular Saw

- POWERSTATE™ Brushless Motor
- REDLINK PLUS™ Intelligence
- REDLITHIUM™ HIGH OUTPUT™ HD12.0 Battery
- Magnesium shoe and guards for maximum durability
- Integrated rafter hook
- LED light
- Integrated dust port on guard and included vac adaptor
- Electric brake to stop blade after tripper is released



Part #	Mfg #	Description	Price
257790	2732-20	Bare Tool	
248727	2732-21HD	Kit	

M18™ FUEL™ Metal Cutting Circular Saw

- POWERSTATE™ Brushless motor
- REDLITHIUM™ battery
- REDLINK PLUS™ intelligence
- 5-3/8" - 5-7/8"



Part #	Mfg #	Description	Price
233188	2782-20	Bare Tool	
234480	2782-22	Kit	

Power Tools

M18 FUEL™ D-Handle Jig Saw

- POWERSTATE™ brushless motor
- REDLITHIUM battery technology
- REDLINK PLUS™ intelligence
- Variable speed ranges between 0 and 3500 strokes per minute
- Includes dust cover and dust extraction tube
- Includes non-marring shoe cover for protection of finished surfaces
- Tool less shoe bevel with positive stops allows for quick and accurate shoe adjustment with detents at 0°, 15°, 30° and 45°



Part #	Mfg #	Description	Price
252950	2737-20	Bare Tool	

M18 FUEL™ Barrel Grip Jig Saw

- POWERSTATE brushless motor
- REDLITHIUM battery technology
- REDLINK plus intelligence
- 4 Position orbital cutting
- Positive stops at 0°, 15°, 30° and 45°
- Features 6 speed settings 0-3500 strokes per minute
- Includes:
 - (1) M18 FUEL™ Barrel Grip Jig Saw (Tool Only) (2737B-20)
 - (1) Anti-Splinter Guard
 - (1) Dust Collection Tube
 - (1) Dust Cover
 - (1) General Purpose Jigsaw Blade
 - (1) Hex Wrench
 - (1) Shoe Guard



Part #	Mfg #	Description	Price
266983	2737B-20	Bare Tool	

M18™ FUEL™ Hackzall Reciprocating Saw

- One-handed design
- 7/8" Stroke length
- Pivoting shoe
- POWERSTATE™
- REDLINK PLUS™
- REDLITHIUM™
- Includes SAWZALL® blade
- Kit includes:
 - Contractor's bag
 - SAWZALL® blade
 - M18 XC5.0 Battery pack
 - M18 FUEL Hackzall (2719-20)
 - M18/M12 Multi-voltage charger



Part #	Mfg #	Description	Price
239589	2719-20	Bare Tool	
239591	2719-21	Kit	

M18™ FUEL™ Sawzall® Reciprocating Saw Kit

- Delivers faster than corded cutting speed and the durability of a corded saw
- POWERSTATE™ Brushless motor
- REDLINK PLUS™ Intelligence
- REDLITHIUM™ XC 4.0 Battery
- 2720-22, 2720-21 Kit Includes:
 - (1) M18 FUEL™ SAWZALL® reciprocating saw (2720-20)
 - (1) M18™ REDLITHIUM™ extended capacity battery pack
 - (1) M18™ & M12™ Multi-voltage charger
 - (1) Blade
 - (1) Carrying case



Part #	Mfg #	Description	Price
161655	2720-20	Bare Tool	
161658	2720-21	Kit	
161581	2720-22	Kit	
235946	2720-22HD	Kit, High Demand	

Power Tools

M18™ FUEL™ SUPER SAWZALL® Reciprocating Saw

- POWERSTATE™ brushless motor
- REDLINK PLUS™ Intelligence
- REDLITHIUM™ HIGH OUTPUT™ HD12.0 Battery
- 1-1/4" Stroke length removes more material
- Variable speed trigger and 5-speed dial
- Integrated rafter hook
- LED light
- Adjustable shoe
- QUIK-LOK® blade clamp
- Compatible with all M18™ batteries
- Kit includes:
 - (1) M18 FUEL™ SUPER SAWZALL® Reciprocating Saw (2722-20)
 - (1) M18 REDLITHIUM™ HIGH OUTPUT™ HD12.0 Battery pack (48-11-1812)
 - (1) M18™ & M12™ Rapid charger (48-59-1808)
 - (1) Blade
 - (1) Contractor bag



Part #	Mfg #	Description	Price
257792	2722-20	Bare Tool	
248733	2722-21HD	Kit	

M18™ FUEL™ Deep Cut Band Saw

- POWERSTATE™ brushless motor
- REDLITHIUM™
- REDLINK PLUS™
- Kit Includes:
 - (1) Deep Cut Band Saw (Bare Tool) (2729-20)
 - (1) M18™ REDLITHIUM™ XC5.0 Extended Capacity Battery Pack (48-11-1850)
 - (1) M18™ & M12™ Multi-Voltage Charger (48-59-1812)
 - (1) Blade
 - (1) Carrying Case



Part #	Mfg #	Description	Price
167156	2729-20	Bare Tool	
167158	2729-21	Kit	
167159	2729-22	Kit	

M18™ FUEL™ High Demand Deep Cut Band Saw

- POWERSTATE™ brushless motor
- REDLITHIUM™
- REDLINK PLUS™
- Kit Includes:
 - (1) M18 FUEL™ Deep Cut Band Saw (Bare Tool) (2729-20)
 - (1) M18™ & M12™ Rapid Charger (48-59-1808)
 - (2) M18™ REDLITHIUM™ HIGH DEMAND™ 9.0 Battery Pack (48-11-1890)
 - (1) Blade
 - (1) Carrying Case



Part #	Mfg #	Description	Price
230566	2729-22HD	Kit	

M18™ FUEL™ 7-1/4" Dual Bevel Sliding Compound Miter Saw

- Only 28 lbs with battery
- Dual bevel with stops at 45° and 48°
- Over 600 cuts per charge
- 3-1/2" Vertical capacity
- 2x8 Horizontal capacity
- 3-5/8" Nested crown capacity
- Cam locking miter detent system
- Shadow cut line indicator for quickly lining up cuts
- Integrated top and side carry handles for easy transportation



Part #	Mfg #	Description	Price
240500	2733-20	Bare Tool	
246885	2733-21	Kit	

Power Tools

M18™ FUEL™ Sliding Compound Miter Saw

- REDLINK PLUS™
- POWERSTATE™ brushless motor
- REDLITHIUM™ battery pack
- Up to 400 cuts per charge
- Shadow cut line indicator
- Top & side carrying handles
- Tall sliding/removable fences
- Cam locking miter system with adjustable miter detent plate and 11 detent locations
- Dual bevel with 9 detents & easy access bevel level
- Kit includes:
 - (1) M18 FUEL™ Dual Bevel Sliding Compound Miter Saw (2734-20)
 - (1) M18™ REDLITHIUM™ HIGH DEMAND™ 9.0 Battery Pack (48-11-1890)
 - (1) M18™ & M12™ Rapid Charger (48-59-1808)
 - (1) Blade Wrench
 - (1) Carbide Tipped Blade
 - (1) Clamp
 - (1) Dust Bag



Part #	Mfg #	Description	Price
239066	2734-20	Bare Tool	
225667	2734-21HD	Kit	

M18 FUEL™ 18" Chain saw

- POWERSTATE™ Brushless Motor
- REDLINK PLUS™ Intelligence
- 16" Oregon Bar and Chain
- Variable speed trigger
- Automatic oiler
- Dual-stud
- KIT INCLUDES:
 - (1) M18 FUEL™ 16" Chain saw(1) 16" Oregon Bar and Chain
 - (1) M18 REDLITHIUM™ HIGH OUTPUT™ HD12.0 Battery Pack (48-11-1812)
 - (1) M18™ & M12™ Rapid Charger (48-59-1808)
 - (1) Srench



Part #	Mfg #	Description	Price
259767	2727-20	Bare Tool	
248734	2727-21HD	Kit	

Accessories

Part #	Mfg #	Description	Price
251337	49-16-2715	16" Replacement Chain	

M18™ FUEL™ 8-1/4" Table Saw w/ One-Key™

- POWERSTATE™ Brushless motor
- REDLINK PLUS™ Intelligence
- REDLITHIUM™ HIH OUTPUT™ HD12.0 battery pack
- 24.5" Rip capacity to rip 4x8 sheets of plywood or OSB
- On board storage for guard, riving knife, push stick, fence and miter gauge
- Rack and pinion fence system
- All metal frame
- Single wrench blade change



Part #	Mfg #	Description	Price
257791	2736-20	Bare Tool	
248728	2736-21HD	Kit	

M18™ Knockout Tools

M18™ FORCELOGIC™ 6T Knockout Tool

- Includes:
 - 7/16" Draw stud
 - 3/4" Draw stud
 - 1-1/8" Draw stud
 - EXACT™ 2-1/2" die
 - EXACT™ 2-1/2" punch
 - EXACT™ 3" die
 - EXACT™ 3" punch
 - EXACT™ 3-1/2" die
 - EXACT™ 3-1/2" punch
 - EXACT™ 4" die
 - EXACT™ 4" punch
 - M18™ REDLITHIUM™ battery
 - M18™ & M12™ Multi-voltage charger
 - EXACT™ rapid reset 3/4" draw stud set
 - EXACT™ 1/2"-2" conduit punches and dies
 - Quick-connect alignment system
 - Carrying case



Part #	Mfg #	Description	Price
239293	2677-23	Kit	

Power Tools

FORCELOGIC™ M18™ 10 Ton Knockout Tool Kit

- Includes:
 - (2) M18™ REDLITHIUM™ XC Extended Capacity Battery (48-11-1828)
 - (1) M18™ & M12™ Multi-voltage charger (48-59-1812)
 - (1) Exact™ 1/2" Stainless steel die (49-16-2660S)
 - (1) Exact™ 1/2" Stainless steel punch (49-16-2661S)
 - (1) Exact™ 3/4" Die (49-16-2662)
 - (1) Exact™ 3/4" Punch (49-16-2663)
 - (1) Exact™ 1" Die (49-16-2664)
 - (1) Exact™ 1" Punch (49-16-2665)
 - (1) Exact™ 1-1/4" Die (49-16-2666)
 - (1) Exact™ 1-1/4" Punch (49-16-2667)
 - (1) Exact™ 1-1/2" Die (49-16-2668)
 - (1) Exact™ 1-1/2" Punch (49-16-2669)
 - (1) Exact™ 2" Die (49-16-2670)
 - (1) Exact™ 2" Punch (49-16-2671)
 - (1) 7/16" Draw Stud (49-16-2680)
 - (1) 3/4" Draw Stud (49-16-2681)
 - (1) Ball Stud
 - (1) Coupler
 - (1) Quick connect collar
 - (1) Carrying case



Part #	Mfg #	Description	Price
167335	2676-22	Kit	

FORCELOGIC™ M18™ 10 Ton Knockout Tool

- Includes:
 - (1) 1-1/8" Draw Stud
 - (2) M18™ REDLITHIUM™ XC extended capacity battery (48-11-1828)
 - (1) M18™ & M12™ Multi-voltage charger (48-59-1812)
 - (1) EXACT™ 1/2" Stainless steel die (49-16-2660S)
 - (1) EXACT™ 1/2" Stainless steel punch (49-16-2661S)
 - (1) EXACT™ 3/4" Die (49-16-2662)
 - (1) EXACT™ 3/4" Punch (49-16-2663)
 - (1) EXACT™ 1" Die (49-16-2664)
 - (1) EXACT™ 1" Punch (49-16-2665)
 - (1) EXACT™ 1-1/4" Die (49-16-2666)
 - (1) EXACT™ 1-1/4" Punch (49-16-2667)
 - (1) EXACT™ 1-1/2" Die (49-16-2668)
 - (1) EXACT™ 2" Die (49-16-2670)
 - (1) EXACT™ 2" Punch (49-16-2672)
 - (1) EXACT™ 2-1/2" Die (49-16-2672)
 - (1) EXACT™ 2-1/2" Punch (49-16-2673)
 - (1) EXACT™ 3" Die (49-16-2674)
 - (1) EXACT™ 3" Punch (49-16-2675)
 - (1) EXACT™ 3-1/2" Die (49-16-2676)
 - (1) EXACT™ 3-1/2" Punch (49-16-2677)
 - (1) EXACT™ 4" Die (49-16-2678)
 - (1) EXACT™ 4" Punch (49-16-2679)
 - (1) 7/16" Draw stud (49-16-2680)
 - (1) 3/4" Draw stud (49-16-2681)
 - (1) Ball stud
 - (1) Coupler
 - (1) Quick connect collar
 - (2) Carrying case



Part #	Mfg #	Description	Price
167336	2676-23	Kit	

M18™ Miscellaneous Tools

M18™ Compact Heat Gun

- LED light
- Ladder hook
- Guarded nozzle
- REDLINK PLUS™ intelligence
- High performance heating coil
- M18™ REDLITHIUM battery included with -21 Kit



Part #	Mfg #	Description	Price
238367	2688-21	Kit	
240763	2688-20	Tool Only	

Power Tools

M18™ 3-1/4" Planer Tool

- Kit Includes:
- (1) M18™ 3-1/4" Planer (Tool Only) (2623-20)
- (1) M18™ REDLITHIUM™ XC Extended Capacity Battery (48-11-1828)
- (1) M18™ & M12™ Multi-Voltage Charger (48-59-1812)
- (2) Double Edge Carbide Blade
- (1) Contractor's Bag
- (1) Bevel/Edge Guide



Part #	Mfg #	Description	Price
225421	2623-20	Bare Tool	
225234	2623-21	Kit	

M18™ Cordless 10oz Caulk and Adhesive Gun

- All metal gears
- Variable-speed trigger
- CFT™ Constant Flow Technology
- Anti-drip mechanism
- Rotating quick-change collar
- 6-Setting max speed dial



Part #	Mfg #	Description	Price
173334	2641-20	Bare Tool	

Kit Includes

- (1) M18™ Cordless 10oz. Caulk and Adhesive Gun (Tool Only) (2641-20)
- (1) 10oz Carriage Conversion Kit (48-08-1076)
- (1) M18™ Compact REDLITHIUM™ Battery (48-11-1815)
- (1) M18™ & M12™ Multi-Voltage Charger (48-59-1812)
- Where To Buy

Part #	Mfg #	Description	Price
173333	2641-21CT	Kit	

M18™ Cordless 20oz Aluminum Barrel Caulk and Adhesive Gun

- All metal gears
- Variable-speed trigger
- CFT™ Constant Flow Technology
- Anti-drip mechanism
- Rotating quick-change collar
- 6-Setting max speed dial
- Kit Includes:
- (1) M18™ Cordless Caulk and Adhesive Gun
- (1) 20oz Aluminum Barrel Sausage Conversion Kit (48-08-1093)
- (1) M18™ Compact REDLITHIUM™ Battery (48-11-1815)
- (1) M18™ & M12™ Multi-Voltage Charger (48-59-1812)



Part #	Mfg #	Description	Price
141557	2642-21CT	Kit	

Quart Carriage Conversion Kit

- For use with M18™ cordless caulk and adhesive guns
- Includes the quart length plunger rod and piston assembly



Part #	Mfg #	Description	Price
189048	48-08-1095	Accessory	

M18™ Cordless 2-Speed Grease Gun Kit

- 0,000 PSI max operating pressure
- max flow of up to 10oz / minute
- Pre-set grease counter dial
- 48" flexible hose
- Air bleeder valve for quick priming
- M18™ REDLITHIUM™ System
- Lock-on/ Lock-off trigger
- Includes:
- (1) M18™ Cordless 2-speed grease gun (2646-20)
- (1) 48" Flex hose w/spring guard
- (2) M18™ Compact REDLITHIUM™ battery (48-11-1815)
- (1) M18™ & M12™ Multi-voltage charger (48-59-1812)
- (1) High pressure grease coupler
- (1) Hard carrying case
- (1) Shoulder strap



Part #	Mfg #	Description	Price
160459	2646-20	Bare Tool	
160923	2646-22CT	Kit	
181713	2646-21CT	Kit	

Power Tools

M18™ FUEL™ Drywall Screw Gun Kit

- Kit includes:
 - (1) M18 FUEL™ Drywall Screw Gun (2866-20)
 - (2) M18™ REDLITHIUM™ XC5.0 Extended Capacity Battery (48-11-1850)
 - (1) M18™ & M12™ Multi-Voltage Charger (48-59-1812)
 - (1) Belt Clip
 - (1) PR2 Bit
 - (1) Contractor Bag



Part #	Mfg #	Description	Price
227453	2866-20	Bare Tool	
231942	2866-22	Kit	

M18™ HAMMERVAC™ Dedicated Dust Extractor

- Adjustable Depth Stop and Ruler
- Dust Containment Box
- High Capacity Dust Box
- Replaceable Certified HEPA Filter



Part #	Mfg #	Description	Price
228970	2712-DE	Bare Tool	

HAMMERVAC™ Dedicated Dust Extractor M18™ & M28™ Dust Box

- Replacement dust box, filter, lid
- HEPA Filter
- OSHA Table 1 Compliant with filter cleaning mechanism



Part #	Mfg #	Description	Price
249515	49-90-2342	Dust Extractor	

HAMMERVAC™ Dedicated Dust Extractor

- Engineered to connect directly to and be powered by the M18 FUEL 1" SDS Plus Rotary Hammer



Part #	Mfg #	Description	Price
159511	2605-22	Kit	

HAMMERVAC™ Filter

- Use with HAMMERVAC™ 2306-20 and 2306-22 and 2712-22DE & 2715-22DE
- HEPA Certified Filters



Part #	Mfg #	Description	Price
186622	49-90-2306	3 Pack	

M18™ FUEL™ 7" Variable Speed Polisher



Part #	Mfg #	Description	Price
224296	2738-20	Bare Tool	

M18™ Random Orbit Sander

- 12,000 OPM max
- More material removed per charge
- Variable speed control
- 5" Sanding pad
- 7,000-12,000 OPM Variable speed
- 3/32" Orbit diameter
- Dust canister with filter
- Universal hose adapter included



Part #	Mfg #	Description	Price
248146	2648-20	Bare tool	

Kit Includes

- (1) M18™ Random Orbit Sander Kit (2648-21)
- (1) Dust Canister
- (1) Universal Hose Adapter
- (1) Extension Adapter
- (2) 80 Grit Sandpaper
- (1) M18™ REDLITHIUM™ XC Ext Capacity Battery
- (1) Multi-Voltage Charger
- (1) Contractor Bag

Part #	Mfg #	Description	Price
248147	2648-21	Kit	

Power Tools

M18™ FUEL™ 16ga Straight Finish Nailer

- POWERSTATE™ Brushless Motor
- REDLINK PLUS™
- Sinks 2-1/2" finish nails in solid oak
- No gas cartridges
- Zero ramp-up time



Part #	Mfg #	Description	Price
228977	2741-20	Bare Tool	

M18™ FUEL™ 16ga Angled Finish Nailer

- POWERSTATE™ Brushless motor
- REDLINK PLUS™ Electronic Intelligence
- Sink 2-1/2" finish nails in solid oak
- Zero ramp-up time
- No gas cartridges



Part #	Mfg #	Description	Price
190524	2742-20	Bare Tool	

Kit Includes

- (1) M18 FUEL™ 16ga Angled Finish Nailer (2742-20)
- (1) M18™ & M12™ Multi-Voltage Charger (48-59-1812)
- (1) M18™ REDLITHIUM™ CP2.0 Battery Pack (48-11-1820)
- (1) Contractor Bag
- (1) Belt Clip

Part #	Mfg #	Description	Price
190525	2742-21CT	Kit	

M18™ FUEL™ 15ga Finish Nailer

- POWERSTATE™ Brushless motor
- REDLINK PLUS™ Intelligence
- Sink 2-1/2" finish nails in solid oak
- Zero ramp-up time
- No gas cartridges



Part #	Mfg #	Description	Price
189724	2743-20	Bare Tool	

M18™ Transfer Pump

- Self-priming pump
- Flexible impeller moves water up to 480 gph
- Generates up to 18' of lift and produces up to 75' of head height
- REDLINK™ intelligence



- Kit Includes:
 - (1) M18™ Transfer Pump (2771-20)
 - (1) M18™ REDLITHIUM™ XC Extended Capacity Battery (48-11-1828)
 - (1) M18™ & M12™ Multi-Voltage Charger (48-59-1812)

Part #	Mfg #	Description	Price
226698	2771-20	Bare Tool	
226699	2771-21	Kit	

M18™ Cordless Multi Tool

- Kit Includes:
 - (1) M18™ Cordless Multi-Tool (Bare Tool) (2626-20)
 - (1) M18™ REDLITHIUM™ XC Extended Capacity Battery (48-11-1828)
 - (1) M18™ & M12™ Multi-Voltage Charger (48-59-1812)
 - (1) Adapter
 - (5) Assorted Sanding Sheets
 - (1) Contractor Bag
 - (1) Sanding Pad
 - (1) Wood Cutting Blade



Part #	Mfg #	Description	Price
166675	2626-20	Bare Tool	
166678	2626-22	Kit	

M18™ FORCE LOGIC™ CABLE CUTTER

- Powerful 6T hydraulic pump
- Patented anti-spreading jaw design
- POWERSTATE brushless motor
- Jaws automatically open when cut is complete
- Hydraulic system is optimized for consistent performance from 0°F - 122°F



- Includes:
 - (1) M18™ REDLITHIUM™ CP2.0 Battery (48-11-1820)
 - (1) M18™ & M12™ Multi-Voltage Charger (48-59-1812)
 - (1) Allen Key
 - (1) M18™ 750 MCM Cable Cutting Jaw (49-16-2772)
 - (1) Carrying Case

Part #	Mfg #	Description	Price
247553	2672-21	Kit	

Power Tools

Kit with 477 ACSR Jaws

Includes:

- (1) M18™ 477 ACSR Jaw (49-16-2773)
- (1) M18™ REDLITHIUM™ CP2.0 Battery (48-11-1820)
- (1) M18™ & M12™ Multi-Voltage Charger (48-59-1812)
- (1) Inverter
- (1) Carabineer
- (1) Allen Key
- (1) Utility Bucket Bag

Part #	Mfg #	Description	Price
247462	2672-21S	Kit	

M18 FORCE LOGIC™ 6T Crimper

- Weather protected electronics
- Brushless motor
- Tool records and stores every crimp made
- Built In – ONE KEY™ enabled
- In-line design and 350-degree head rotation
- Hydraulic system optimized for consistent performance from 0°F - 122°F



Part #	Mfg #	Description	Price
247552	2678-20	Bare Tool	

Kit with D3 Grooves and Fixed O Die

- Includes:
 - (1) M18 FORCE LOGIC™ 6T Crimper (Tool Only)
 - (1) M18™ & M12™ Multi-Voltage Charger (48-59-1812)
 - (2) M18™ REDLITHIUM™ CP2.0 Battery (48-11-1820)
 - (1) Carabineer
 - (1) M18™ 6T Fixed O Crimping Jaw (49-16-00D3)
 - (1) Utility Bucket Bag

Part #	Mfg #	Description	Price
182049	2678-220	Kit	

M18™ Force Logic™ 12 Ton Crimper

- (1) Carbineer
- (1) Overhead utility bag
- (1) M18 Lithium-Ion AC/DC charger
- (1) M18 REDLITHIUM™ XC5.0 extended capacity battery pack
- (1) M18 REDLITHIUM™ 2.0 compact battery pack
- 350° Head rotation
- Pre-Crimp battery check
- Ergonomic grip design
- ONE-KEY™ technology
- POWERSTATE® brushless motor
- Predictive force monitoring (PFM™)
- REDLINK PLUS™ electronic intelligence



Part #	Mfg #	Description	Price
237770	2778-22	Kit	

M18™ Force Logic™ 750 MCM Crimper

- (1) Carrying case
- (1) M18 & M12 multi-voltage charger
- (1) M18 REDLITHIUM™ XC5.0 extended capacity battery pack
- (1) M18 REDLITHIUM™ 2.0 compact battery pack
- 350° Head rotation
- Pre-Crimp battery check
- Ergonomic grip design
- ONE-KEY™ technology
- POWERSTATE® brushless motor
- Predictive force monitoring (PFM™)
- REDLINK PLUS™ electronic intelligence



Part #	Mfg #	Description	Price
237771	2779-22	Kit	

Power Tools

M18™ FUEL™ 4-1/2" / 5" Grinder, Slide Switch Lock-On

- Kit includes:
- (1) M18 FUEL™ 4-1/2" / 5" Grinder, Slide Switch Lock-On (Bare Tool) (2781-20)
- (1) M18™ REDLITHIUM™ XC5.0 Extended Capacity Battery Pack (48-11-1850)
- (1) M18™ & M12™ Multi-Voltage Charger (48-59-1812)
- (1) Carrying Case
- (1) Flange Nuts
- (1) Wheel Guard
- (1) Spanner Wrench



Part #	Mfg #	Description	Price
166871	2781-20	Bare Tool	
166872	2781-21	Kit	
246699	2781-22	Kit	
251910	2781-22HD	Kit, High Demand	

M18™ FUEL™ 4-1/2"/5" Grinder, Paddle Switch No-Lock Kit

- POWERSTATE™ Brushless motor
- REDLINK PLUS™ Intelligence
- REDLITHIUM™ XC 4.0 Battery
- Power TO GRIND
- DURABILITY
- 100% tool free productivity
- Paddle-switch design: provides increased comfort and ease-of-use when operating in various positions
- Kit Includes:
 - (1) M18 FUEL™ 4-1/2"/5" Grinder, paddle switch no-lock (bare tool) (2780-20)
 - (2) M18™ REDLITHIUM™ XCExtended capacity battery pack
 - (1) M18™ & M12™ Multi-voltage charger
 - (1) Carrying case
 - (1) Flange nut
 - (1) Spanner wrench
 - (1) Wheel guard



Part #	Mfg #	Description	Price
162116	2780-20	Bare Tool	
171444	2780-21	Kit	
164099	2780-22	Kit	
236384	2780-22HD	Kit, High Demand	

M18™ FUEL™ 4-1/2" / 5" Braking Grinder

- 100% tool free: Make all accessory changes and guard adjustments without a wrench for increased productivity
- POWERSTATE™ Brushless Motor
- REDLINK PLUS™ Intelligence



Part #	Mfg #	Description	Price
180423	2783-20	Bare Tool	

Kit Includes

- (1) M18 FUEL™ 4-1/2" / 5" Braking Grinder (2783-20)
- (2) M18™ REDLITHIUM™ XC5.0 Extended Capacity Battery Pack (48-11-1850)
- (1) M18™ & M12™ Multi-Voltage Charger (48-59-1812)
- (1) T27 Guard, (1) Flange Nut, (1) FIXTEC Nut

Part #	Mfg #	Description	Price
179534	2783-22	Kit	

M18™ FUEL™ 7" / 9" Large Angle Grinder

- 100% Tool Free: Make all accessory changes and guard adjustments without a wrench for increased productivity
- Dual action trigger: eliminating accidental trigger actuation
- POWERSTATE™ Brushless Motor
- REDLINK PLUS™ Intelligence
- Kit Includes:
 - (1) M18 FUEL™ 7" / 9" Large Angle Grinder
 - (1) M18 REDLITHIUM™ HIGH OUTPUT™ HD12.0 Battery Pack (48-11-1812)
 - (1) M18™ & M12™ Rapid Charger (48-59-1808)
 - (1) 9 inch T27 Guard
 - (1) Anti-Vibration Side Handle
 - (1) Back Flange
 - (1) Dust Vent Clip
 - (1) FIXTEC Nut
 - (1) Spanner Wrench



Part #	Mfg #	Description	Price
257793	2785-20	Bare Tool	
248730	2785-21HD	Kit, High Demand	
248732	2785-22HD	Kit, High Demand	

Power Tools

M18™ FUEL™ 1/4" Die Grinder

- Kit Includes:
 - (1) M18 FUEL™ 1/4" Die Grinder (2784-20)
 - (2) M18™ REDLITHIUM™ XC5.0 Extended Capacity Battery Pack (48-11-1850)
 - (1) M18™ & M12™ Multi-Voltage Charger (48-59-1812)
 - (1) 1/4" Collet
 - (2) Wrench



Part #	Mfg #	Description	Price
235256	2784-20	Bare Tool	
231944	2784-22	Kit	

M18™ Cordless 4-1/2" Cut-Off / Grinder



Part #	Mfg #	Description	Price
141679	2680-20	Bare Tool	

M18™ Cut Out Tool

- Delivers up to 20% faster cuts than other tools in the market
- REDLINK Intelligence
- Tool free depth adjustment
- LED light
- 4-Pole motor: 28,000 RPM's
- Vent on top of tool to blow debris away from user



Part #	Mfg #	Description	Price
232311	2627-20	Bare Tool	

M18 FUEL™ Drain Snake with Cable-Drive Kit

- LED light
- Fully enclosed drum
- REDLINK PLUS™
- POWERSTATE™ brushless motor
- CABLE-DRIVE™ locking feed system
- Capacity: 1/4" x 50', 5/16" x 35' inner core cable
- Includes:
 - Storage bucket
 - M18 REDLITHIUM™ battery
 - M18 & M12™ multi-voltage charger



Part #	Mfg #	Description	Price
254977	2772A-20	Bare Tool	
238924	2772A-21	Kit	
240822	2772B-21XC	Kit	

M18™ Job Site Fan

- Circulates air over 40 feet
- 120° adjustable head
- 9 stopping positions,
- AC adaptor included
- Four keyhole hangers and two hanging holes
- Compatible with all M18™ REDLITHIUM™ batteries —17 Hours runtime on XC5.0 battery



Part #	Mfg #	Description	Price
176814	0886-20	M18™ Job Site Fan	

M18™ Compact Blower

- Extension nozzle
- Lock-on switch
- Universal inflator/deflator
- 3-Speed electronic switch and variable speed trigger
- Shock-absorbing polymer and reinforced handle
- Soft plastic nozzle to resist crushing or cracking



Part #	Mfg #	Description	Price
163737	0884-20	(Bare Tool)	

M18 FUEL™ Blower Kit

- Cruise control
- 100 MPH maximum air speed
- POWERSTATE™ brushless motor
- Kit Includes:
 - M18 FUEL™ Blower (Tool Only) (2728-20)
 - (1) M18™ REDLITHIUM™ HIGH DEMAND™ 9.0 Battery Pack (48-11-1890)
 - (1) M18™ & M12™ Rapid Charger (48-59-1808)



Part #	Mfg #	Description	Price
229242	2728-20	Bare Tool	
229241	2728-21HD	Kit	

Power Tools

M18 FUEL™ Blower Kit

- Power to clear from 15'
- Full throttle in under 1 second
- up to 4lbs lighter
- POWERSTATE™ brushless motor
- REDLINK PLUS™ intelligence
- REDLITHIUM™ HIGH DEMAND™ 9.0 battery (Kit Only)
- Max air volume: 450 CFM
Max air speed: 120 MPH



Part #	Mfg #	Description	Price
244533	2724-20	Bare Tool	

Kit Includes

(1) M18 FUEL™ Blower

(1) M18™ REDLITHIUM™ HIGH DEMAND™ 9.0 Battery

(1) Rapid Charger

Part #	Mfg #	Description	Price
247196	2724-21HD	Kit	

M18 FUEL™ String Trimmer

- POWERSTATE™ Brushless Motor
- REDLINK PLUS™ Electronic intelligence
- Cutting Swath: 14" - 16"
- Kit includes:
M18 FUEL™ String Trimmer (Tool Only) (2725-20)
(1) M18™ REDLITHIUM™ 9.0 Battery (48-11-1890)
(1) M18™ & M12™ Rapid Charger (48-59-1808)



Part #	Mfg #	Description	Price
229238	2725-20	Bare Tool	
229237	2725-21HD	Kit	

Accessories

Part #	Mfg #	Description	Price
229244	49-16-2713	.95" x 250' Trimmer Line	
244532	49-16-2714	Easy Load Trimmer Head	
257491	49-16-2722	Shoulder Strap	

M18 FUEL™ String Trimmer w/ QUIK-LOK™

- POWERSTATE™ Brushless motor
- Cutting swath: 14" - 16"
- REDLINK PLUS™ Intelligence
- RPM: 0 - 4900 / 0 - 6201
- Kit Includes:
(1) M18 FUEL™ Power Head w/ QUIK-LOK™
(1) M18 FUEL™ QUIK-LOK™ String Trimmer Attachment (49-16-2717)
(1) M18™ REDLITHIUM™ HIGH DEMAND™ 9.0 Battery Pack (48-11-1890)
(1) M18™ & M12™ Rapid charger (48-59-1808)



Part #	Mfg #	Description	Price
257484	2825-20ST	Bare Tool	
257483	2825-21ST	Kit	

QUIK-LOK™ Accessories

Part #	Mfg #	Description	Price
257486	49-16-2717	QUIK-LOK™ String Trimmer Attachment	
257488	49-16-2719	QUIK-LOK™ Articulating Hedge Trimmer Attachment	
257487	49-16-2718	QUIK-LOK™ Edger Attachment	
257489	49-16-2720	QUIK-LOK™ 10" Pole Saw Attachment	
257490	49-16-2721	QUIK-LOK™ 3' Attachment Extension	
257492	49-16-2723	10" Saw Chain	

M18 FUEL™ Hedge Trimmer

- POWERSTATE™ brushless motor
- REDLINK PLUS™
- Slider crank mechanism
- 24" Blade with tip guard
- Kit Includes:
(1) M18 FUEL™ Hedge Trimmer (Tool Only) (2726-20)
(1) M18™ REDLITHIUM™ HIGH DEMAND™ 9.0 Battery Pack (48-11-1890)
(1) M18™ & M12™ Rapid Charger (48-59-1808)



Part #	Mfg #	Description	Price
229240	2726-20	Bare Tool	
229239	2726-21HD	Kit	

Power Tools

M18™ FUEL™ 3-in-1 Backpack Vacuum

- M18 FUEL 3-in-1 Backpack vacuum
- 6' Flexible hose
- HEPA filter
- Telescoping extension wand
- Crevice tool
- Floor tool
- Dust extractor adapter
- Kit Includes:
 - (1) M18 FUEL 3-in-1 Backpack Vacuum (0885-20)
 - (1) M18™ REDLITHIUM™ HIGH DEMAND™ 9.0 Starter Kit (48-59-1890)



Part #	Mfg #	Description	Price
251837	0885-20	Bare Tool	
254979	0885-21HD	Kit	

M18™ Tool Box Style Wet/Dry Vacuum

- On-board accessory and hose storage
- HEPA Rated high efficiency filter
- Includes:
 - Wet/dry vacuum
 - Filter assembly
 - Crevice tool
 - Wide utility nozzle
 - Wireless vinyl hose
- Battery and charger not included



Part #	Mfg #	Description	Price
136036	0880-20	2 gal, 18V	

M18™ Compact Vacuum

- High performance motor
- Adapts from handheld to stationary
- 40 CFM
- Removable HEPA filter
- Clear view and easy to empty canister
- Canister volume: 36oz
- Inlet diameter: 1 1/4"
- Includes:
 - (1) M18™ Compact vacuum (0882-20)
 - (1) Crevice tool
 - (2) Extension
 - (1) HEPA filter



Part #	Mfg #	Description	Price
228972	0882-20	Bare Tool	

HEPA Dry Filter Kit

- For (0882-20) M18™ Compact Vacuum
- 2/Pk



Part #	Mfg #	Description	Price
228971	49-90-1951	2 Pack	

M18™ Cordless 18g Double Cut Shear

- 360° Tool-free rotating head
- Ergonomic body design
- Variable speed trigger
- Kit Includes:
 - (1) M18™ Cordless 18 Gauge Double Cut Shear (Bare Tool) (2635-20)
 - (2) M18™ REDLITHIUM™ XC Extended Capacity Battery (48-11-1828)
 - (1) M18™ & M12™ Multi-Voltage Charger (48-59-1812)
 - (1) Contractor Bag



Part #	Mfg #	Description	Price
180620	2635-20	Bare Tool	
171803	2635-22	Kit	

M18™ 18g Single Cut Shear

- 360° Tool-Free Rotating Head
- Ergonomic Body Design
- Variable Speed Trigger
- Belt Clip



Part #	Mfg #	Description	Price
228271	2637-20	Bare Tool	
176736	2637-22	Kit	

M18™ Cordless 14g Double Cut Shear

- 360° Tool-free rotating head
- Ergonomic body design
- Variable speed trigger
- Kit Includes:
 - M18™ 14G Double Cut Shear (2636-20)
 - M18™&M12™ Multi-Voltage Charger (48-59-1812)
 - M18™ REDLITHIUM™ XC Extended Capacity Battery
 - Contractor Bag



Part #	Mfg #	Description	Price
243336	2636-22	Kit	

Power Tools

M18 FUEL™ SWITCH PACK™ Sectional Drum System Kit

- Fully enclosed drum
- Spin speed: 250 RPM
- Accepts other brand cables
- Integrated drum brake
- Built-in backpack straps
- REDLINK PLUS
- POWERSTATE™ brushless motor
- Electronic foot pedal with non-slip grip
- Kit includes:
 - SWITCH PACK™ drum w/ anchor cable
 - Inner core coupling cable
 - M18™ REDLITHIUM™ XC5.0 battery
 - M18™ & M12™ multi-voltage charger



Part #	Mfg #	Description	Price
247895	2775-211	Kit with no Cable	
258416	2775A-211	5/16" Kit	
238925	2775B-211	3/8" Kit	
258415	2775C-222	1/2" Kit	

M18™ SWITCH PACK™ Drum with Anchor Cable

- Tool-free drum latch
- Full enclosed drum
- Accepts other brand cables
- 1/2" x 50' Inner core cables
- 5/8" x 50' Open wind cable
- Drum capacity: 5/16" x 75' & 3/8" x 50'
- On-board storage for cable head attachments
- Part of the SWITCHPACK™ sectional drum system



Part #	Mfg #	Description	Price
238935	47-53-2775	Drum with Anchor Cable	

M18™ Tool Combo Kits

M18™ FUEL 2-Tool Combo Kit with ONE-KEY™

- M18 FUEL™ 1/2" hammer drill/driver (2706-20)
- M18 FUEL™ 1/4" hex impact driver (2757-20)
- M18™ REDLITHIUM™ (48-11-1850)
- M18™ & M12™ multi-voltage charger (48-59-1812)
- (2) Belt Clip
- (2) Bit Holder
- (1) Side Handle
- (1) Carrying Case



Part #	Mfg #	Description	Price
187613	2796-22	2-Tool Combo Kit	

M18 FUEL™ 2 Tool Combo Kit

- Includes:
 - (1) M18 FUEL™ 1/2" Hammer drill/driver (bare tool) (2604-20)
 - (1) M18 FUEL™ SAWZALL® reciprocating saw (bare tool) (2720-20)
 - (2) M18™ REDLITHIUM™ XC 4.0 Extended capacity battery pack
 - (1) M18™ & M12™ Multi-voltage charger (48-59-1812)
 - (1) Contractor bag
 - (1) 6" 10 TPI thin kerf SAWZALL® blade



Part #	Mfg #	Description	Price
166501	2794-22	2-Tool Combo Kit	

M18™ Cordless 2-Tool Combo Kit with DPM™

- Digital power management protection prevents damage to the tool and battery in abusive situations
- Includes:
 - 1/2" Hammer-Drill driver (2602-20)
 - 1/4" Hex impact driver (2650-20)
 - (2) REDLITHIUM™ batteries
 - 1-Hour charger
 - Contractor bag
- 5-Year warranty



Part #	Mfg #	Description	Price
139154	2697-22	2-Tool Combo Kit	

Power Tools

M18™ Cordless LITHIUM-ION 2-Tool Combo Kit

- Includes:
 - (1) M18™ Compact 1/2" drill driver (bare tool) (2606-20)
 - (1) M18™ 1/4" Hex impact driver (bare tool) (2656-20)
 - (2) M18™ Compact REDLITHIUM™ battery (48-11-1815)
 - (1) M18™ & M12™ Multi-voltage charger
 - (1) Contractor bag



Part #	Mfg #	Description	Price
153676	2691-22	2-Tool Combo Kit	

M18™ Cordless LITHIUM-ION 2-Tool Combo Kit

- Includes:
 - (1) M18™ Compact 1/2" Hammer drill/driver (bare tool) (2607-20)
 - (1) M18™ SAWZALL® Recip saw (bare tool) (2620-20)
 - (1) M18™ REDLITHIUM™ XC Exter battery (48-11-1828)
 - (1) M18™ & M12™ Multi-Voltage charger (48-59-1812)
 - (1) Contractor bag



Part #	Mfg #	Description	Price
155644	2694-22	2-Tool Combo Kit	

M18 Compact Brushless 2-Tool Combo Kit

- Includes:
 - (1) M18 Compact brushless 1/2" drill driver bare tool (2801-20)
 - (1) M18 1/4" Hex impact driver bare tool (2850-20)
 - (2) M18™ REDLITHIUM™ CP2.0 Batt (20)
 - (1) M18™ & M12™ Multi-voltage charger (48-59-1812)
 - (2) Belt clip
 - (1) Contractor bag



Part #	Mfg #	Description	Price
251018	2902-20	2-Tool Combo Kit	

M18 Brushless 2-Tool Combo Kit

- Includes:
 - (1) M18 Brushless 1/2" hammer drill
 - (1) M18™ Brushless 1/4" hex3 speed impact driver
 - (2) M18™ REDLITHIUM™ XC4.0 Batteries
 - (1) M18™/M12™ Multi-voltage charger
 - (2) Belt clips
 - (1) Contractor bag



Part #	Mfg #	Description	Price
251022	2893-22	2-Tool Combo Kit	

M18 Brushless 2-Tool Combo Kit

- Includes:
 - (1) M18 1/4" Hex impact driver bare tool (2850-20)
 - (1) M18 1/2" Brushless hammer drill (tool only) (2902-20)
 - (1) M18™ REDLITHIUM™ XC 4.0 Extended capacity battery pack (48-11-1820)
 - (1) M18™ REDLITHIUM™ CP2.0 Battery (48-11-1820)
 - (1) M18™ & M12™ Multi-voltage charger (48-59-1812)
 - (2) Belt clip
 - (1) Contractor bag
 - (1) Side handle



Part #	Mfg #	Description	Price
251021	2893-22CX	2-Tool Combo Kit	

M18 FUEL™ 2-Tool Combo Kit

- Includes:
 - (1) M18 FUEL™ 1/2" Hammer drill/driver (2804-20)
 - (1) M18 FUEL™ 1/4" Hex impact driver (2853-20)
 - (2) M18™ REDLITHIUM™ XC5.0 Extended capacity battery pack (48-11-1850)
 - (1) M18™ & M12™ Multi-voltage Charger (48-59-1812)
 - (1) Carrying case
 - (1) Side handle
 - (2) Belt clip
 - (2) Bit holder



Part #	Mfg #	Description	Price
248763	2997-22	2-Tool Combo Kit	

Power Tools

M18 FUEL™ 2-Tool Combo Kit

Includes:

- (1) M18 FUEL™ SURGE™ 1/4" Hex Hydraulic Driver (2760-20)
- (1) M18 FUEL™ 1/2" Hammer Drill/Driver (Tool Only) (2804-20)
- (2) M18™ REDLITHIUM™ XC5.0 Extended Capacity Battery Pack (48-11-1850)
- (1) M18™ & M12™ Multi-Voltage Charger (48-59-1812)
- (1) Carrying Case
- (1) Side Handle
- (2) Belt Clip
- (2) Bit Holder



Part #	Mfg #	Description	Price
248770	2999-22	2-Tool Combo Kit	

M18 FUEL™ 2-Tool ONE-KEY™ Combo Kit

Includes:

- (1) M18 FUEL™ 1/2" Hammer drill w/ ONE-KEY™ (2806-20)
- (1) M18 FUEL™ 1/4" Hex impact driver w/ ONE-KEY™ (2857-20)
- (2) M18™ REDLITHIUM™ XC5.0 Extended capacity battery pack (48-11-1850)
- (2) Belt clip
- (2) Bit holder
- (1) Side handle



Part #	Mfg #	Description	Price
254443	2996-22	2-Tool Combo Kit	

M18™ Cordless LITHIUM-ION 2-Tool Combo Kit

Kit Includes:

- (1) M18™ 1/2" Hammer Drill Driver (2602-20)
- (1) M18™ HACKZALL® One-Handed Recip Saw (2625-20)



Part #	Mfg #	Description	Price
138928	2695-22	2-Tool Combo Kit	

M18 FUEL™ 3 Tool Combo Kit

- (1) M18 FUEL™ 1/2" Hammer Drill/Driver (tool only) (2804-20)
- (1) M18 FUEL™ 1/4" Hex Impact Driver (tool only) (2853-20)
- M18 FUEL™ SAWZALL® Reciprocating Saw (tool only) (2720-20)
- (2) M18™ REDLITHIUM™ XC5.0 Extended capacity battery pack (48-11-1850)
- (1) M18™ & M12™ Multi-voltage charger (48-59-1812)
- (1) Carrying case
- (1) Side handle
- (2) Belt clip
- (2) Bit holder



Part #	Mfg #	Description	Price
248765	2997-23	3-Tool Combo Kit	

M18™ Cordless 4-Tool Combo Kit

Includes:

- 1/2" Hammer drill driver (2602-20)
- Sawzall® reciprocating saw (2620-20)
- 6-1/2" Circular saw (2630-20)
- Work light (49-24-0171)
- (2) REDLITHIUM™ XC High capacity batteries
- 1-Hour charger
- (1) Sawzall® blade
- Contractor bag



Part #	Mfg #	Description	Price
137564	2694-24	4-Tool Combo Kit	

M18™ Cordless 4-Tool Combo Kit (2)

Includes:

- M18™ 1/2" Hammer drill driver (2602-20)
- M18™ HACKZALL® Reciprocating saw (2625-20)
- M18™ 1/4" Hex Impact driver (2650-20)
- M18™ Work light (49-24-0171)
- (2) M18™ REDLITHIUM™ XC High capacity batteries (48-11-1828)
- 1-Hour charger (48-59-1801)
- General purpose Sawzall® blade
- Contractor bag



Part #	Mfg #	Description	Price
138971	2695-24	4-Tool Combo Kit	

Power Tools

M18™ Cordless 4-Tool Combo Kit (3)

Includes:

- 1/2" Hammer drill driver (2602-20)
- 1/4" Hex impact driver (2650-20)
- Sawzall® M18™ reciprocating saw (2620-20)
- Work light (49-24-0171)
- (2) REDLITHIUM™ XC High capacity batteries
- 1-Hour charger
- General purpose Sawzall® blade
- Contractor bag



Part #	Mfg #	Description	Price
138527	2696-24	4-Tool Combo Kit	

M18 FUEL™ LITHIUM-ION 4-Tool Combo Kit

Includes:

- (1) M18 FUEL™ 1/2" Hammer Drill/Driver (bare tool) (2604-20)
- (1) M18 FUEL™ 1/4" Hex impact driver (bare tool) (2653-20)
- (1) M18 FUEL™ SAWZALL® Reciprocating saw (bare tool) (2720-20)
- (1) M18™ LED Work light (2735-20)
- (1) M18™ REDLITHIUM™ XC 4.0 Extended capacity battery pack (48-11-1840)
- (1) M18™ & M12™ Multi-voltage charger (48-59-1812)
- (1) Belt clip
- (1) Contractor bag
- (1) Reciprocating blade



Part #	Mfg #	Description	Price
164933	2796-24	4-Tool Combo Kit	

M18 FUEL™ 5 Tool Combo Kit

- (1) M18 FUEL™ SAWZALL® Reciprocating Saw (2720-20)
- (1) M18 FUEL™ 1/2" Hammer Drill/Driver (tool only) (2804-20)
- (1) M18 FUEL™ 1/4" Hex Impact Driver (tool only) (2853-20)
- (1) M18 FUEL™ 6-1/2" Circular Saw (2730-20)
- (1) M18™ Work Light (tool only) (2735-20)
- (2) M18™ REDLITHIUM™ XC5.0 Extended Capacity Battery Pack (48-11-1850)
- (1) M18™ & M12™ Multi-Voltage Charger (48-59-1812)
- (1) Carrying case
- (1) Side handle
- (2) Belt clip
- (2) Bit holder



Part #	Mfg #	Description	Price
248766	2997-25	5-Tool Combo Kit	

M18 FUEL™ LITHIUM-ION 6-Tool Combo Kit

Includes:

- (1) M18 FUEL™ 1/2" Hammer Drill/Driver (bare tool) (2604-20)
- (1) M18 FUEL™ 1/4" Hex impact driver (bare tool) (2653-20)
- (1) M18 FUEL™ SAWZALL® Reciprocating saw (bare tool) (2720-20)
- (1) M18 FUEL™ 6-1/2" Circular saw (bare tool) (2730-20)
- (1) M18™ LED work light (2735-20)
- (1) M18 FUEL™ 4-1/2"/5" Grinder, paddle switch no-lock (bare tool) (2780-20)
- (2) M18™ REDLITHIUM™ XC 4.0 Extended capacity battery pack (48-11-1840)
- (1) M18™ & M12™ Multi-voltage charger (48-59-1812)
- (1) Belt clip
- (1) Circular saw blade
- (2) Contractor bag
- (1) Reciprocating blade
- (1) Spanner wrench



Part #	Mfg #	Description	Price
164934	2796-26	6-Tool Combo Kit	

M18™ Cordless 6-Tool Combo Kit

- (1) Compact 1/2" Hammer Drill/Driver (2607-20)
- (1) SAWZALL® Reciprocating Saw (2621-20)
- (1) 6 1/2" Circular Saw (2630-20)
- (1) 1/4" Hex Impact Driver (2656-20)
- (1) Cordless 4-1/2" Cut-off / Grinder (2680-20)
- (1) LED Work Light (2735-20)
- (2) REDLITHIUM™ XC Extended Capacity Battery (48-11-1828)
- (1) Multi-Voltage Charger (48-59-1812)
- (1) Contractor Bag



Part #	Mfg #	Description	Price
148165	2696-26	6-Tool Combo Kit	



Power Tools

M18 FUEL™ 7-Tool Combo Kit

- Includes:
 - (1) M18 FUEL™ ½" Hammer Drill/Driver (2804-20)
 - (1) M18 FUEL™ 1/4" Hex Impact Driver (2853-20)
 - (1) M18 FUEL™ SAWZALL® Reciprocating (2720-20)
 - (1) M18 FUEL™ 6-1/2" Circular Saw (2730-20)
 - (1) M18 FUEL™ 1/2" Mid-Torque Impact Wrench with Friction Ring (2861-20)
 - (1) M18 FUEL™ 4-1/2" / 5" Grinder, Paddle Switch No-Lock (2780-20)
 - (1) M18™ Work Light (2735-20)
 - (2) M18™ REDLITHIUM XC5.0 Batteries (48-11-1850)
 - (1) M18™ & M12™ Multi-Voltage Charger (48-59-1812)
 - (1) 6" 18T Thin Kerf Ice Hardened SAWZALL® Blade
 - (1) Circular Saw Blade, (1) Grinding Disc, (3) Belt Clips
 - (2) Bit Holder, (2) Contractor Bag, (1) Side Handle

Part #	Mfg #	Description	Price
248769	2997-27	7-Tool Combo Kit	

M18™ Cordless LITHIUM-ION 9-Tool Combo Kit

- Includes:
 - (1) M18™ Cordless 1/2" hammer drill/driver (2602-20)
 - (1) M18™ Cordless right angle drill (2615-20)
 - (1) M18™ SAWZALL® Recip saw (2620-20)
 - (1) M18™ Cordless LITHIUM-ION 6 - 1/2" circular saw (2630-20)
 - (1) M18™ Cordless LITHIUM-ION jig saw (2645-20)
 - (1) M18™ 1/4" Hex compact impact driver (2650-20)
 - (1) M18™ 1/2" High-torque impact wrench with friction ring (2663-20)
 - (1) M18™ Cordless LITHIUM-ION 4-1/2" cut-off/grinder (2680-20)
 - (2) M18™ REDLITHIUM™ XC Extended capacity battery (48-11-1828)
 - (1) M18™ & M12™ Multi-voltage charger (48-59-1812)
 - (1) M18™ Work light (49-24-0171)



Part #	Mfg #	Description	Price
156090	2696-29	9-Tool Combo Kit	

Power Tool Accessories

Cordless Batteries and Accessories

12V Lithium-Ion Battery

- Over 65% lighter than "compact" NiCd batteries
- For use with Milwaukee® 12V cordless tools
- 2-Year warranty



Part #	Mfg #	Description	Price
137574	48-11-2401	Lithium-Ion	

V18™ Lithium-Ion Battery

- 18V power with a 14.4V NiCd battery weight
- Superior cold weather performance
- For use with Milwaukee V18 cordless power tools



Part #	Mfg #	Description	Price
142703	48-11-1830	Lithium-Ion	

M12™ REDLITHIUM™ Compact Battery

- 3.0 Amp hour
- REDLINK™ Intelligence
- Best-in-Class Construction
- Delivers fade-free power in extreme job site conditions
- Powers 70+ Milwaukee M12™ cordless solutions



Part#	Mfg#	Amp Hour	Pack	Price
231116	48-11-2460	6.0	Single	
231115	48-11-2430	3.0	Single	
165350	48-11-2420	1.5	Single	
154721	48-11-2411	1.5	2	

M12 REDLITHIUM™ XC Battery

- 3.0 Amp hour
- High current discharge
- Sturdy base- Allows M12™ tools to easily stand
- LITHIUM-ION battery delivers long life and run time with fade-free power
- Battery fuel gauge displays charge status on tools
- M12™ Compatibility



Part #	Mfg #	Description	Price
146046	48-11-2402	Single Pack	
171802	48-11-2412	2 Pack	

M12™ REDLITHIUM™ XC 4.0 Extended Capacity Batter Pack

- REDLINK™ Intelligence
- All-weather performance
- Powers most M12™ cordless power tools



Part #	Mfg #	Description	Price
166387	48-11-2440	Single Pack	

M18™ REDLITHIUM™ HIGH OUTPUT™ HD12.0 Battery Pack

- REDLINK™ Intelligence
- Fuel gauge onboard
- Best-in-class construction
- Powers more than 150 M18™ cordless solutions



Part #	Mfg #	Description	Price
248737	48-11-1812	Single Pack	

M18™ REDLITHIUM™ 2.0 Compact Battery Pack

- REDLINK™ Intelligence
- Best-in-class construction
- Fuel gauge onboard
- All-weather performance



Part #	Mfg #	Description	Price
154722	48-11-1820	Compact Battery Pack	

M18™ REDLITHIUM™ XC Extended Capacity Battery

- REDLINK™ Intelligence
- Fuel gauge onboard
- All-weather performance
- Powers more than 40 Milwaukee M18™ cordless power tools



Part #	Mfg #	Description	Price
136039	48-11-1828	Single Pack	
154296	48-11-1822	Two Pack	

Power Tool Accessories

M18™ REDLITHIUM™ XC 4.0 Extended Capacity Battery Pack

- REDLINK™ Intelligence
- Best-in-class construction
- Fuel gauge onboard
- All-weather performance
- Versatility: Powers more than 40 Milwaukee M18™ cordless power tools



Part #	Mfg #	Description	Price
158199	48-11-1840	Extended Capacity Battery Pack	

M18™ REDLITHIUM™ XC 5.0 Extended Capacity Battery Pack

- REDLINK™ Intelligence: Provides optimized performance and overload protection using total system communication between tool, battery and charger
- Best-in-class construction
- Fuel gauge onboard
- All-weather performance
- Versatility- Powers more than 60 Milwaukee® M18™ cordless power tools



Part #	Mfg #	Description	Price
173430	48-11-1850	Extended Capacity Battery	
237660	48-11-1851	Pack of 10	
174426	48-11-1852	Pack of 2	

M18™ REDLITHIUM™ XC6.0 Battery Pack

- REDLINK™ Intelligence
- Fuel gauge onboard
- All-Weather Performance
- Powers more than 100 M18™ cordless power tools



Part #	Mfg #	Description	Price
225396	48-11-1860	Extended Capacity Battery	

M18 REDLITHIUM™ HIGH OUTPUT™ XC6.0 Battery Pack



Part #	Mfg #	Description	Price
248741	48-11-1865	High Output	
248742	48-11-1862	Pack of 2	

M18™ REDLITHIUM™ HIGH DEMAND™ 9.0 Battery Pack

- REDLINK™ Intelligence
- Best-in-Class Construction
- Fuel gauge onboard
- Delivers fade free power in extreme job site conditions
- Powers more than 100 Milwaukee® M18™ cordless power tools



Part #	Mfg #	Description	Price
224567	48-11-1890	Single Pack	

18V Ni-Cd Battery

- Works with all 18V NiCd and V18 tools excluding:
 - 1108
 - 3108
 - 5364
 - 6516



Part #	Mfg #	Description	Price
139148	48-11-2230	Easy Release Latch	

28V Lithium-Ion Battery

- Overload protection
- Temperature management system
- Individual cell voltage monitoring
- Discharge protection
- Battery fuel gauge
- 3-Year warranty



Part #	Mfg #	Description	Price
142696	48-11-2830	Lithium-Ion Battery	

M12™ Power Source

- 2.1 amp powered USB port charges all portable electronic devices, including tablets
- On-board fuel gauge
- Compatible with all M12™ battery packs
- Compatible with all M12™ heated gear



Part #	Mfg #	Description	Price
161648	49-24-2310	Power Source	

Power Tool Accessories

M18™ Power Source

- Compatible with M18™ compact and XC™ batteries
- Powered USB port charges portable electronic devices
- Compatible with M12™ heated jackets with the expandable battery pocket



Part #	Mfg #	Description	Price
151840	49-24-2371	Power Source	

M12™ AC/DC Wall Vehicle Charger

- 2-In-1 Design
- Charge time: 40 minutes
- Lithium-Ion battery (not included)
- 5-Year warranty



Part #	Mfg #	Description	Price
138274	2510-20	M12™ AC/DC Wall & Vehicle Charger	

M18™ REDLITHIUM™ XC5.0 System Starter Kit

- REDLINK™ Intelligence
- Best-in-Class Construction
- Fuel gauge onboard
- All-Weather Performance
- Includes:
 - (1) M18™ REDLITHIUM™ XC5.0 Battery (48-11-1850)
 - (1) M18™ & M12™ Multi-Voltage Charger (48-59-1812)



Part #	Mfg #	Description	Price
179457	48-59-1850	18V	

M18™ REDLITHIUM™ HIGH DEMAND™ 9.0 Starter Kit

- REDLINK™ Intelligence
- Best-in-Class Construction
- Fuel gauge onboard
- All-Weather Performance



Part #	Mfg #	Description	Price
234175	48-59-1890	18V Lithium-Ion	

M18 REDLITHIUM™ HIGH OUTPUT™ HD12.0 Battery Pack w/ Rapid Charger

- REDLINK™ Intelligence
- Fuel gauge onboard



Part #	Mfg #	Description	Price
248739	48-59-1200	18V	

M12™ Lithium-Ion Battery Charger

- 30-Minute charge time
- 5-Year warranty



Part #	Mfg #	Description	Price
137575	48-59-2401	12V Lithium-Ion Charger	

M12™ Four Bay Sequential Charger

- Accepts up to 4 M12™ Battery Packs
- Sequentially charges batteries
- Compact design with wall mount
- REDLINK™ Intelligence: charger communication with the battery pack to ensure optimum performance and extend life



Part #	Mfg #	Description	Price
173929	48-59-1204	M12™ Four Bay Charger	

M12™ Compact Charger and Power Source

- Provides convenient, compact charging of all M12™ Batteries
- Compatible with in-vehicle USB ports for convenient on-the-go charging
- Includes:
 - (1) 3ft Micro-USB Cable and 2.1A Wall Charger (48-59-1202)
 - (1) M12™ Compact Charger and Power Source (48-59-1201)



Part #	Mfg #	Description	Price
240896	48-59-1201	M12™ Compact Charger and Power Source	

Power Tool Accessories

M18™ Six Pack Sequential Charger

- Charges up to six batteries sequentially
- Convenient carrying handle
- Pass through plug
- Compact size



Part #	Mfg #	Description	Price
154534	48-59-1806	M18™ Six Pack Charger	

M18™ and M12™ Rapid Battery Charger

- Charges batteries up to 40% faster
- Charges all M12™ and M18™ batteries
- Sequential charging: automatically charges the second inserted pack once the first pack is fully charged
- REDLINK™ Intelligence



Part #	Mfg #	Description	Price
180814	48-59-1808	M18™ and M12™ Charger	

M18™ and M12™ Multi-Voltage Battery Charger

- 12V and 18V
- 5-Year warranty



Part #	Mfg #	Description	Price
148692	48-59-1812	M18™ and M12™ Charger	

M18™ & M12™ Rapid Charge Station

- REDLINK™
- Pass through plug
- Charges three batteries simultaneously
- Accepts (3) M18™ and (3) M12™ battery packs



Part #	Mfg #	Description	Price
173750	48-59-1807	18V & 12V	

M18™ Lithium-Ion AC/DC Wall & Vehicle Charger

- AC Wall charger and DC vehicle charger
- Charges all M18™ batteries
- Charge times:
 - 48-11-1815: 30-Minute
 - 48-11-1828: 1-Hour
 - 48-11-1820: 45-Minute
 - 48-11-1840: 90-Minute



Part #	Mfg #	Description	Price
138273	2710-20	18V	

M18™ and M12™ Vehicle Charger

- Plugs into vehicle 12V or 24V DC Outlet
- Charges all M18 & M12 batteries
- Automatically shuts down charger to prevent excessive discharge of vehicle battery



Part #	Mfg #	Description	Price
236978	48-59-1810	Vehicle for M18 & M12	

REDLITHIUM™ USB Battery & Charger Kit

- Charges the Milwaukee® REDLITHIUM™ USB Batteries via Micro USB Cord
- 2X More Capacity than (3) AAA Alkaline Batteries
- LED Fuel Gauge Allows Fast Checking of REDLITHIUM™ USB Battery Charge
- 2ft Heavy Duty Micro-USB Braided Cord w/ Metal Ends



Part #	Mfg #	Description	Price
238974	48-59-2003	Kit	
238972	48-59-2002	Charger and Cord Only	

Power Tool Accessories

Miscellaneous Batteries

REDLITHIUM™ USB Battery

- Over 2,000 charges
- Charge inside USB rechargeable products or with 48-59-2002 REDLITHIUM™ charger



Part #	Mfg #	Description	Price
238970	48-11-2130	REDLITHIUM™ USB Battery	

REDLITHIUM™ USB Charger

- LED fuel gauge
- 2FT Micro-USB braided cord
- Stores battery when not in use



Part #	Mfg #	Description	Price
238972	48-59-2002	REDLITHIUM™ USB Charger	

Milwaukee® Parts & Accessories

SDS+ Dust Trap™ Drilling Shroud

- Industry's first OSHA® compliance solution without a vacuum, ideal for overhead drilling applications
- Universal fit allows the DUST TRAP™ to work with all SDS Plus rotary hammers and SDS Plus drill bits up to an 8" length, including stop bits and other anchor installations tools



Part #	Mfg #	Description	Price
244316	48-03-3035	Clear Sleeve, Compact Collapsible Design	

SDS Max Dust Extraction Attachment

- Vacuum assisted suction
- Rubber seal
- Removable brush rings for up to 2-3/4" drilling and coring applications



Part #	Mfg #	Description	Price
242451	5317-DE	8.75" x 4.6" x 2"	

Universal Surface Grinding Dust Shroud



Part #	Mfg #	Description	Price
242453	49-40-6105	7"	

Dust Collection Kit

- Collects dust and debris when using Milwaukee panel saw 6480-20



Part #	Mfg #	Description	Price
254821	49-22-8105	Dust Collection Kit	

8' 3-Wire QUIK-LOK® Cord

- 8 ft., three-wire grounded QUIK-LOK® feature allows for fast replacement of a damaged cord
- Premium grade Hi-Flex wire 5-15P NEMA type plug



Part #	Mfg #	Description	Price
156222	48-76-4008	8' QUIK-LOK® Cord	

Chuck Key

- This chuck key tightens the jaws of the 1/2 inch capacity chuck 48-66-1360, 48-66-1370, and 48-66-1381
- Key holder 48-66-4040 should be used to attach this chuck key to the corset



Part #	Mfg #	Description	Price
140524	48-66-3280	Chuck Key	

Bit Holder

Part #	Mfg #	Description	Price
150713	43-72-0550	Bit Holder	

Screws, Nuts & Bolts

Part #	Mfg #	Description	Price
150710	06-82-5275	6-32" x 5/16" Torx Head Screw	



Power Tool Accessories

Spline/Round Hex 2Pc Floor Scraper

Part #	Mfg #	Description	Price
236691	48-62-2016	6" x 25"	

Tamper Shank

- Used to mount tamper plate



Part #	Mfg #	Description	Price
243757	48-62-4060	15-1/2"	

Tent Stake Driver - Head Only

- Drives in large tent stakes
(Use with 48-62-4060)



Part #	Mfg #	Description	Price
243756	48-62-4061	5-1/2"	

Rip Fence Kit

- Provides a straight cutting edge for fast, accurate cuts



Part #	Mfg #	Description	Price
247516	49-22-4146	Rip Fence	

Band Saw Blade Cover

- Jobsite Armor™
- Tool-free installation and removal



Part #	Mfg #	Description	Price
257986	49-90-2629	Compact Band Saw Blade Cover	
257987	49-90-2729	Deep Cut Band Saw Blade Cover	

1/2" EHS Guy Wire Cutting Jaw

- Easy jaw change
- Compatibility with M18™ FORCE LOGIC™ 6T utility crimpers & cutters
- Anti-spreading jaw design
- Delivers up to 500 cuts perblade



Part #	Mfg #	Description	Price
247550	49-16-2777	1/2" EHS Guy Wire Cutting Jaw	

Cut-Off Machine Accessories

Cut-Off Wheel

- For general purpose to specialized high performance applications
- Consistent performance from wheel to wheel
- Tested for balance, resulting in smooth, vibration free grinding and cutting



Part #	Mfg #	Size	Type	Price
138407	49-94-4500	4-1/2"	1	
186774	49-94-5000	5"	1	
242287	49-94-5020	5"	27	
162159	49-94-4520	4-1/2"	2	
171104	49-94-4505	4-1/2"	27	
140073	49-94-1405	14"	1	
180939	49-94-6305	6"	27	
252529	49-94-3000	3"		
252524	49-94-3005	3"		
252526	49-94-3010	3"		

Power Tools

Pipe Inspecting and Locating

SeeSnake® micro™ Inspection Camera

- Allows you to easily perform visual inspections in hard to reach areas
- Lightweight, hand-held design can be carried anywhere
- 3' Cable reach expandable to 30' with optional extensions
- Includes batteries, mirror, hook and magnet



Part #	Mfg #	Display	Diameter	Lighting	Power Source	Price
141173	36738	3.5" Color LCD	17mm	(4) Adj LEDs	(4) AA Batteries	

SeeSnake® Sewer Camera Locator

- Flexible transmitters
- 768 x 494 Video resolution
- 6 rugged, high-intensity LED lights built in camera
- Hardened stainless steel snake camera head with spring assembly
- For use with 2-1/2" diameter plumbing line with a max run of 200'



Part #	Mfg #	Size	Color	Price
206936	13998	325'	Red/Gray	

Refrigeration Tools

Refrigerant Piping and Components

Rotary Vane Deep Vacuum Pump

- Internal check valve stops oil blowout in case of accidental power loss
- Gas ballast valve helps prevent oil contamination caused by high moisture
- Manifold valve isolates pump from system when testing for leaks
- Center oil fill port is accessible from front & sides
- Durable light weight die cast aluminum housing
- Delrin vanes for quieter, longer-lasting performance
- 2-Stage for lower pumping pressure
- Oil drain valve at bottom of oil reservoir
- 25 Microns ultimate vacuum
- Electrical Specs: 120V/60Hz (2-Stage_



Part #	Mfg #	Free Air Displace	Motor	Nom Pump Speed	Price
150637	90066-2V-110	6 CFM	1/3 hp	3440 rpm	

ACCU-Charge II Electronic Refrigerant Scale

- Functions:
 - Charge programming
 - Pause/charge
 - Tank capacity programming (empty/full)
 - Repeat
- Capacity: 240 lbs
- Auto off: 3 hours
- Operating temperature: 32° to 120°F
- Battery life approximately 40 hours (9 VDC)



Part #	Mfg #	Description	Price
140934	98210-A	9" x 9" Platform	

Pro-Set® Cyclone Refrigerant Recovery Machine

- Fastest overall ARI certified recovery rates in its class in all temperature environments
- Automatic low pressure shut-off feature turns unit off when recovery is completed
- Rugged high density double walled plastic housing with easy view top mounted controls
- R-410A Ready with 550 psi high pressure shut-off switch
- Ergonomic well balanced design for easy transport including shoulder strap, weighs 36 lbs
- Built-in suction filter located under suction port



Part #	Mfg #	Description	Price
112428	87-CR700	1 hp Oil-Less Cyclone	

Refrigeration Tools

Electronic Digital Vacuum Gauge

- Large 5 digit LCD display
- Measurement units are selectable for microns, in/hg, mBar, Torr. Advanced field
- Cleanable sensor can withstand 400 psi positive pressure
- Operates 30 hours on standard 9V alkaline battery



Part #	Mfg #	Description	Price
113610	87-VG200	Digital Gauge, Carry Hook, Tee, 9V Battery & Case	

Brass Access Tee - Sweat

- One valve core included for each tee
- All male flare fittings are internally threaded to accept installation of valve core
- Includes brass cap for use with core wrench



Part #	Mfg #	Fitting 1	Fitting 2	Branch Fitting	Body	Price
092124	83-CC8414-2Pk	1/4" Sweat ODF	1/4" Sweat ODF	1/4" SAE Flare	Copper	
080959	83-CC8438-2Pk	3/8" Sweat ODF	3/8" Sweat ODF	1/4" SAE Flare	Copper	
080956	83-CC8412-2Pk	1/2" Sweat ODF	1/2" Sweat ODF	1/4" SAE Flare	Copper	

Brass Access Tee - Threaded

- One valve core included for each tee
- All male flare fittings are internally threaded to accept installation of valve core



Part #	Mfg #	Fitting 1	Fitting 2	Branch Fitting	Body	Price
103852	83-CD9601-2PK	1/4" SAE Flare (F)	1/4" SAE Flare (M)	1/4" SAE Flare (M)	Copper	
167257	83-CD96040-1PK	1/4" SAE Flare (M)	1/4" SAE Flare (M)	1/4" SAE Flare (F)	Copper	

Valves

Pro-Set® Ball Valve

- Add existing hose to eliminate refrigerant loss to comply with EPA regulations
- 1/4-Turn operation, color-coded handles



Part #	Mfg #	Description	Price
119736	87-BV3-3PK	1/4" Female, 1/4" Male, SAE, 3/Pk	

Microseal™ Anti-Blowback Valve

- Automated sealing eliminates refrigerant loss and blowback
- Non-restrictive porting for maximum refrigerant flow
- SAE Male x SAE Female



Part #	Mfg #	Description	Price
098447	87-AB3-3PK	1/4" Female, 1/4" Male, SAE, 3/Pk	

Refrigeration Tools

Valve Core



Part #	Mfg #	Description	Price
140745	83-CD4460-6PK	Valve Core, 6/Pk	

Refrigerant Wrenches

6-in-1 Metric Torque Wrench

- Ideal for installing mini-split systems
- Includes (6) interchangeable heads: 12, 22, 24, 26, 27 & 29mm jaw sizes



Part #	Mfg #	Description	Price
150265	TLTWSM	Metric 6-in-1 Metric Torque Wrench	

BLACKMAX Digital Torque Wrench



Part #	Mfg #	Description	Price
232482	BTLDTW	Digital Torque Wrench	

Chemicals

Acid Test Kit

- Use to determine the acid level in mineral and alkybenzene lubricants typically used with HCFC refrigerants such as R-22 and R-401A (not for use with POE oil)
- One test per kit
- Easy to use, no complicated charts, results in seconds
- Simply add oil, shake, and observe color change (turns yellow if acidic)



Part #	Mfg #	Description	Price
031600	85-25140-01	Ref Oil Acid Test Kit	

Refrigeration Tools

QwikCheck Acid Test Kit

- Color Change Indicates Pass/Fail
- Tests for Inorganic Acids to the ARI-700 limit of 1ppm
- Works with All Refrigerants & Oils
- Meets EPA Venting Regulations
- Unique Patented Disposable Design
- U.S. Patents #6,514,765 & #6,825,040



Part #	Mfg #	Description	Price
158735	QT2000	Detects inorganic acid in 2-seconds down to 1 part per million	

Refrigeration Tools

Refrigeration Oil Test Kits

Phase III® Refrigeration Oil Test Kit

- For use on POE's, minerals oils, and alkylbenzene
- Tests acid level in refrigeration oil



Part #	Mfg #	Description	Price
140753	4320-W8	Phase III Oil Test Kit	



Refrigeration Tools

Refrigerant Parts

Gasket

Part #	Mfg #	Description	Price
144859	87-HXG	Hose Gasket, 10/Pack, Fits 1/4"SAE, 1/2" Acme or 1/2" 20 UNF	

Hose - Refrigerant

Part #	Mfg #	Description	Price
140755	40360	5' Blue, Red, Yellow Refrigerant Hose Set	
140756	41601	5' Blue Refrigerant Hose	
140757	41602	5' Yellow Refrigerant Hose	
126840	41603	5' Red Refrigerant Hose	
096037	45360	5' Blue, Red, & Yellow Refrigerant Hose Set with Anti-Blowback Fittings	
148224	87-HP5BA	5' Blue Refrigerant Hose with Anti-Blowback Fittings	
148223	87-HP5RA	5' Red Refrigerant Hose with Anti-Blowback Fittings	
148222	87-HP5YA	5' Yellow Refrigerant Hose with Anti-Blowback Fittings	
148221	87-HS3A	3' Refrigerant Hose Set with Anti-Blowback Fittings	

Manifold

Part #	Mfg #	Description	Price
132142	57161	Aluminum 2-Way Manifold Gauge Set with 5' Hoses	
105054	87-MBHP5	Manifold with Hose(R-410A-R22)	

Vacuum Pump Oil

Part #	Mfg #	Description	Price
148101	85-2600	1 qt	
092114	85-2601	1 gal	

Tools, Gauges & Solder

Valve Core Tool

Part #	Mfg #	Description	Price
104588	91490	Protech Universal Valve Core Tool	

Tools, Gauges & Solder (Continued)

Valve Core Tool

Part #	Mfg #	Description	Price
140984	91496	Valve Core Remover	
140743	83-CD3813-1PK	Valve Core Container/Wrench	
104515	83-CD3800-1PK	Valve Core Wrench	

Refrigeration Tools

Manifolds

4-Valve Aluminum Manifold

- Forged aluminum body
- Replaceable ss valve seats
- SAE styel o-ring
- Large sight glass
- 3/8" bore throughout
- Comfort grip
- Glows in the dark
- R22-404A-410A



Part #	Mfg #	Description	Price
167725	1839130	60" Hoses, Low Loss Ball-Valve Adapters	

4-Valve Aluminum Manifold Set

- Forged aluminum body
- Replaceable ss valve seats
- SAE styel o-ring
- Large sight glass
- 3/8" bore throughout
- Comfort grip
- Includes:
 - Valve
 - Dual Readout Thermometer
 - 60" Refrigeration hoses w/ ball valve adapters
- R22-404A-410A



Part #	Mfg #	Description	Price
168342	1839131	60" Hoses, Ball-Valve Adapters	

2-Valve Aluminum Manifold

- Forged aluminum body
- Replaceable ss valve seats
- SAE style o-ring
- Large sight glass
- Comfort grip
- Glows in the dark
- Built-in pressure reminder



Part #	Mfg #	Description	Price
166823	1839134	-30" Hg to 300 - 500 psi	

Flaring Tools

Orbital Flare

- Off-center mounted cone spins on an axis to effectively produce quality flares
- Clutch mechanism stops the flaring when the job is done
- Spring-loaded block grips tube securely
- A tube-stop arrow slides to set correct height and positioning, while ball detents allow for easy flaring cone alignment
- Tube Sizes (O.D.) - 3/16", 1/4", 5/16", 3/8", 1/2", 5/8", 3/4"



Part #	Mfg #	Description	Price
167767	1838952	45° Flare Type	

Swaging Tools

Compact Swage Tool

- The power to swage 1-5/8" tubing and the control to swage 5/16" without splitting the tube
- Compact design
- One-handed operation



Kit Includes: 3/8", 1/2", 5/8", 3/4", 7/8", expander heads, body, deburrer, kit box

Part #	Mfg #	Description	Price
165773	1839015	Tube sizes (O.D.) 3/8", 1/2", 5/8", 3/4", 7/8"	

Pumps

Vacuum Pump

- Hands-free carry
- Drains oil quickly
- Quick, easy access
- Easy to check oil
- Extra confidence
- Prolong oil life



Part #	Mfg #	Description	Price
231489	1948121	VP5 5 CFM 1/2HP	

Refrigeration Tools

Electronic Tools

Dual Readout Thermometer

- Manifold-compatible compact thermometer
- Use it on any gauge set, or remove it and use it independently
- Two easy-to-use, K-style tube clamp thermocouples



Part #	Mfg #	Description	Price
167727	1839106	0° C to +50°C	

Service Tools

Deburrers

- Steel blades



Part #	Mfg #	Description	Price
168257	1891258	1/4" to 1-5/8"	

Valve Core Removal Tool

- Max working pressure: 800 psi
- Burst pressure: 4000 psi
- Operating Temp: -20°F to +180°F



Part #	Mfg #	Description	Price
237080	194796	1/4"	
244572	1947968	5/16"	

Hoses

Refrigeration Hoses

- Extra abrasion-resistant layer
- Rated for 800 PSI working pressure
- 60" Length



Part #	Mfg #	Description	Price
168252	1839153	Set of 3 (Red, Blue, Yellow)	

Saws & Blades

Abrasive Saw

- Heavy-duty cast iron base with non-slip rubber feet
- D-Handle grip ergonomic handle
- Die cast aluminum motor housing with externally accessible brushes
- Tool-less fence adjustment
- Arbor lock and arbor wrench included
- Miter cut to 45°



Replacement Saw Blade

Part #	Mfg #	Description	Price
067703	46956	14" Abrasive Disks for Steel, 10/Pk	

Saws & Blades

Hand Saws

High Tension Hacksaw

- Reinforced metal frame
- High-leverage tension knob
- Internal blade storage
- 45° Angle blade position
- Overmolded handle



Part #	Mfg #	Description	Price
186596	48-22-0050	12"	

Compact Hack Saw

- Tool-free blade change
- Adjustable blade length
- Rubber over mold grip



Part #	Mfg #	Description	Price
137579	48-22-0012	Includes (1) 10" Blade	

Rasping Jab Saw

- Rasping holes along the side of the blade to rapidly expand holes or smooth rough edges of sheet rock
- Rubber over mold grip
- 6" Plaster/dry wall blade



Part #	Mfg #	Description	Price
137581	48-22-0304	6" Rasping Jab Saw	

Folding Jab Saw

- Folds for easy storage
- Uses standard Sawzall® blades
- Includes:
 - (1) Folding jab saw
 - (3) Reciprocating blades (metal, wood, multi-purpose)



Part #	Mfg #	Description	Price
137583	48-22-0305	6" Folding Jab Saw	

18" PVC/ABS Saw

- Tool free blade change
- Metal core body
- Clamshell design
- Rubber over mold grip



Part #	Mfg #	Description	Price
137580	48-22-0223	18" Blade	
226368	48-22-0218	18" Blade	

Sawzall® Blades

Mega SAWZALL® Blade Kit



Part #	Mfg #	Pack Qty	Price
222915	49-22-1132	32	

SAWZALL® Blades

- NAIL GUARD™ Ordinary teeth
 - FANG TIP™
 - Matrix II bi-metal teeth for greater durability
- (5 Pk)



Part #	Mfg #	Blade Size	TPI	Pkg Qty	Price
164267	48-00-5091	6"	8/12 TPI	5 Pk	
233564	48-00-5041	6"	4/6 TPI	5 Pk	
164213	48-00-5035	6"	5 TPI	5 Pk	
164207	48-00-5092	6"	10 TPI	5 Pk	
164210	48-00-5182	6"	14 TPI	5 Pk	
164211	48-00-5184	6"	18 TPI	5 Pk	
233566	48-00-5185	4"	24 TPI	5 Pk	
164212	48-00-5186	6"	24 TPI	5 Pk	
164279	48-00-5093	8"	8/12 TPI	5 Pk	
164202	48-00-5036	9"	5 TPI	5 Pk	
164203	48-00-5016	9"	6 TPI	5 Pk	
164273	48-00-5187	9"	14 TPI	5 Pk	
164274	48-00-5188	9"	18 TPI	5 Pk	
164288	48-00-5189	12"	18 TPI	5 Pk	
233561	48-00-5193	8"	10/14 TPI	5 Pk	
164200	48-00-5037	12"	5 TPI	5 Pk	
169673	48-00-5094	12"	8/12 TPI	5 Pk	
167949	48-00-5194	12"	10/14 TPI	5 Pk	

(25 Pk)

Part #	Mfg #	Blade Size	TPI	Pkg Qty	Price
242767	48-01-2093	8"	8/12 TPI	25 Pk	



Saws & Blades

(50 Pk)

Part #	Mfg #	Blade Size	TPI	Pkg Qty	Price
250429	48-01-6093	8"	8/12 TPI	50 Pk	

Thin Kerf SAWZALL® Blades

- Optimized tooth design providing 2X more life than our previous generation SAWZALL® blades
- Tough Neck™ ribs strengthen the blade tang and minimize breakage
- Grid Iron™ honeycomb pattern increases blade rigidity to resist blade buckling



(5 Pk)

Part #	Mfg #	Blade Size	TPI	Pkg Qty	Price
167946	48-00-5181	4"	14 TPI	5 Pk	
233565	48-00-5183	4"	18 TPI	5 Pk	

(25 Pk)

Part #	Mfg #	Blade Size	TPI	Pkg Qty	Price
168363	48-01-2184	6"	18 TPI	25 Pk	
168364	48-01-2188	9"	18 TPI	25 Pk	
235498	48-00-8182	6"	14 TPI	25 Pk	
233563	48-00-8184	6"	18 TPI	25 Pk	

(50 Pk)

Part #	Mfg #	Blade Size	TPI	Pkg Qty	Price
257757	48-01-6182	6"	14 TPI	50 Pk	
240138	48-01-6186	6"	24 TPI	50 Pk	
242750	48-00-4188	9"	18 TPI	50 Pk	

(100 Pk)

Part #	Mfg #	Blade Size	TPI	Pkg Qty	Price
242766	48-01-7092	6" Pk	10 TPI	100	
167948	48-01-7184	6" Pk	18 TPI	100	
175717	48-01-7188	9" Pk	18 TPI	100	

Thin Kerf Ice Hardened™ SAWZALL® Blades

- Optimized tooth design providing 2X more life than our previous generation SAWZALL® blades
- Tough Neck™ ribs strengthen the blade tang and minimize breakage
- Grid Iron™ honeycomb pattern increases blade rigidity to resist blade buckling



(5 Pk)

Part #	Mfg #	Blade Size	TPI	Pkg Qty	Price
169667	48-00-4182	6"	14 TPI	5 Pk	
167951	48-00-4189	12"	18 TPI	5 Pk	

(50 Pk)

Part #	Mfg #	Blade Size	TPI	Pkg Qty	Price
152609	48-01-8184	6"	18 TPI	50 Pk	

The Torch™ SAWZALL® Blades

- Optimized tooth design providing 2X more life than our previous generation
- SAWZALL® blades Tough Neck™ ribs strengthen the blade tang and minimize breakage
- Grid Iron™ honeycomb pattern increases blade rigidity to resist blade buckling



(5 Pk)

Part #	Mfg #	Blade Size	TPI	Pkg Qty	Price
152136	48-00-5712	6"	10 TPI	5 Pk	
152137	48-00-5782	6"	14 TPI	5 Pk	
152139	48-00-5784	6"	18 TPI	5 Pk	
164297	48-00-5786	6"	24 TPI	5 Pk	
152129	48-00-5713	9"	10 TPI	5 Pk	
152130	48-00-5787	9"	14 TPI	5 Pk	
152131	48-00-5788	9"	18 TPI	5 Pk	
164298	48-00-5790	9"	24 TPI	5 Pk	
152132	48-00-5714	12"	10 TPI	5 Pk	
152133	48-00-5794	12"	14 TPI	5 Pk	
152134	48-00-5789	12"	18 TPI	5 Pk	
169669	48-00-5791	12"	24 TPI	5 Pk	

Saws & Blades

(25 Pk)

Part #	Mfg #	Blade Size	TPI	Pkg Qty	Price
161705	48-01-2713	9"	10 TPI	25 Pk	
177451	48-00-8782	6"	14 TPI	25 Pk	
234324	48-00-8784	6"	18 TPI	25 Pk	
168987	48-00-8787	9"	14 TPI	25 Pk	
234323	48-00-8788	9"	18 TPI	25 Pk	
226631	48-01-2788	9"	18 TPI	25 Pk	

(100 Pk)

Part #	Mfg #	Blade Size	TPI	Pkg Qty	Price
244875	48-01-7782	6" Pk	14 TPI	100	
247698	48-01-7713	9" Pk	10 TPI	100	
255817	48-01-7788	9" Pk	18 TPI	100	

The Torch™ with Carbide Teeth SAWZALL® Blades

- 50X Life in thick metal
- 7 TPI for fast efficient cutting in thick and extreme metals
- Carbide teeth for longer life and greater versatility
- Cuts cast iron, stainless steel, & high strength alloys
- 25% more carbide per tooth for longest life
- 1" Tall for demolition
- Fast in cast iron



Part #	Mfg #	Blade Size	TPI	Pkg Qty	Price
238621	48-00-5201	6"	7 TPI	1	
238623	48-00-5202	9"	7 TPI	1	
246971	48-00-5301	6"	7 TPI	3	
246972	48-00-5302	9"	7 TPI	3	
238622	48-00-5501	6"	7 TPI	5	
238624	48-00-5502	9"	7 TPI	5	

The Torch™ Ice Hardened™ SAWZALL® Blades

- Optimized tooth design providing 2X more life than our previous generation SAWZALL® blades
- Tough Neck™ ribs
- Grid Iron™ honeycomb pattern



(5 Pk)

Part #	Mfg #	Blade Size	TPI	Pkg Qty	Price
229537	48-00-4712	6"	10 TPI	5 Pk	
229538	48-00-4782	6"	14 TPI	5 Pk	
169668	48-00-4784	6"	18 TPI	5 Pk	
229539	48-00-4713	9"	10 TPI	5 Pk	
187923	48-00-4787	9"	14 TPI	5 Pk	
229540	48-00-4788	9"	18 TPI	5 Pk	

(50 Pk)

Part #	Mfg #	Blade Size	TPE	Pkg Qty	Price
258327	48-01-8782	6"	14 TPI	50 Pk	

The Ax™ SAWZALL® Blades

- NAIL GUARD™ Ordinary teeth
- FANG TIP™
- The 1" tall blade body reduces blade twisting for straighter cuts
- Matrix II bi-metal teeth for greater durability



(5 Pk)

Part #	Mfg #	Blade Size	TPI	Pkg Qty	Price
152529	48-00-5021	6"	5 TPI	5 Pk	
152530	48-00-5026	9"	5 TPI	5 Pk	
152531	48-00-5027	12"	5 TPI	5 Pk	
233567	48-00-5052	9"	5 TPI	5 Pk	

(25 Pk)

Part #	Mfg #	Blade Size	TPI	Pkg Qty	Price
167955	48-00-8021	6"	5 TPI	25 Pk	
226632	48-01-2021	6"	5 TPI	25 Pk	



Saws & Blades

(100 Pk)

Part #	Mfg #	Blade Size	TPI	Pkg Qty	Price
167947	48-01-7021	6"	5 TPI	100	
Pk					

The Ax™ with Carbide Teeth SAWZALL® Blades

- Best tooth design
- NAIL GUARD™
- FANG TIP™
- Optimized for cordless: 25% more cuts per charge



Part #	Mfg #	Blade Size	TPI	Pkg Qty	Price
225843	48-00-5221	6"	5	1	
255236	48-00-5321	6"	5	3 Pk	
225845	48-00-5226	9"	5	1	
225847	48-00-5227	12"	5	1	

The Wrecker™ SAWZALL® Blades

- A precise manufacturing process creates a sharper cutting edge on each tooth for a faster cutting blade
- A complete, unset raker tooth on the blade tip allows for easier, faster plunging by minimizing walking and bouncing
- A thicker, more rigid blade body resists fracturing and bending for maximum durability
- The 1" tall blade body reduces blade twisting for straighter, more accurate cuts



(5 Pk)

Part #	Mfg #	Blade Size	TPI	Pkg Qty	Price
152135	48-00-5701	6"	8 TPI	5 Pk	
152128	48-00-5706	9"	8 TPI	5 Pk	
242751	48-00-8706	9"	7/11 TPI	25 Pk	
152127	48-00-5711	12"	8 TPI	5 Pk	
242752	48-00-8711	12"	7/11 TPI	25 Pk	

(100 Pk)

Part #	Mfg #	Blade Size	TPI	Pkg Qty	Price
172982	48-01-7701	6"	7/11	100	
Pk					

Fleam Ground SAWZALL® Blades

- Deep gullet design cuts up to 25% faster than standard wood blades
- Fleam ground process creates super sharp teeth for clean cuts
- Matrix II bi-metal teeth for greater durability



(5 Pk)

Part #	Mfg #	Blade Size	TPI	Pkg Qty	Price
169671	48-00-5015	6"	6 TPI	5 Pk	

Carbide Grit SAWZALL® Blade

- Tungsten carbide for long life
- Coarse grit for fast cutting



Part #	Mfg #	Blade Size	Pkg Qty	Price
169674	48-00-1420	6"	3 Pk	
159451	48-00-1430	9"	3 Pk	

Diamond Grit THE TORCH™ SAWZALL® Blade

- Diamond Grit delivers up to 30x longer life than standard carbide grit blades
- The precisely controlled size and placement of the diamond grit allow these blades to cut up to 2x faster than standard carbide grit blades
- The 1" tall blade body reduces blade twisting for straighter, more accurate cuts



Part#	Mfg#	Size	Price
152141	48-00-1440	6"	
151654	48-00-1450	9"	

SAWZALL® Nail Embedded Wood Blades

- NAIL GUARD™
- FANG TIP™
- Matrix II bi-metal teeth for greater durability



(25 Pk)

Part #	Mfg #	Blade TPI	Pkg Qty	Size	Price
168482	48-01-2035	6"	25 Pk	5 TPI	
168483	48-01-2036	9"	25 Pk	5 TPI	

Saws & Blades

(50 Pk)

Part #	Mfg #	Blade--Pkg-Size Qty	TPI	Price
152610	48-01-6035	6" 50 Pk	5 TPI	

(100 Pk)

Part #	Mfg #	Blade Size TPI	Pkg Qty	Price
175719	48-01-7035	6" 5 TPI	100 Pk	

Wood Cutting Sawzall® Blade

- For cutting stock 3/8" and above
- Recommended for very fast cutting, nail-embedded wood, general roughing-in



Part #	Mfg #	TPI	Blade Size	Pkg Qty	Price
141058	48-00-8036	5 TPI	9" x 1/2"	25 Pk	
175720	48-01-7036	5 TPI	9" x 1/2"	100 Pk	

Sawzall® Flush Cut Blade

- Floor guard shields teeth from floor contact during bottom plate cut-outs
- Double truss design guides blade for straight window cut-outs
- Nail Guard™ unique design protects against tooth fracture when cutting nails between studs and joists
- Fang Tip™ delivers fast plunge cutting for window cut-outs



Part #	Mfg #	TPI	Blade Size	Pkg Qty	Price
140976	48-00-1600	5	12" x 2-1/8"	1 Pk	

Sawzall® Rough-In Blade

- Low blade profile cuts 2-1/8" diameter holes for 1-1/2" PVC pipe
- Can cut holes through double top plates
- NAIL GUARD™ Unique design protects against tooth fracture when cutting through holes in nail embedded wood
- FANG TIP™ fast plunge cutting through bottom plates and subfloors



Part #	Mfg #	TPI	Blade Size	Pkg Qty	Price
140978	48-00-1610	5	7-3/8" x 1/2"	5 Pk	

SUPER SAWZALL® Blade

- Double relief angle reduces tooth stress for long life
- Precision forming process creates sharper teeth for fast cutting
- Matrix II bi-metal teeth for greater durability



Part #	Mfg #	TPI	Blade Size	Pkg Qty	Price
170458	48-00-5161	3-5/8"	10 TPI	5 Pk	

Ductwork SAWZALL® Blade

- Pierce point tip geometry for quick plunging in ductwork with on tool
- Low blade profile for tight radius cuts
- Optimized tooth form designed specifically for cutting ductwork



Part #	Mfg #	Description	Price
169675	48-00-1630	5 Pk	

Drywall Access SAWZALL® Blade

- Ideal for servicing plumbing and electrical
- Optimized length to minimize damage to pipe and wire
- Cut all directions
- Fast plunge



Part #	Mfg #	Description	Price
156089	48-00-1640	Drywall Access Blade	

Pruning Sawzall® Blade

Part #	Mfg #	TPI	Blade Size	Pkg Qty	Price
142581	48-00-1303	5	12" x 3/4"	5 Pk	
186164	48-00-1301	5	9"	5 Pk	

High-Carbon Steel Jig Saw Blade

- Heavy duty: Advanced construction for long life in tough professional applications
- Fast cuts; Tooth shape and sharpness permit clean scroll cutting in wood
- Versatile: Fits any jig saw that accepts a T-shank blade

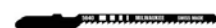

Part #	Mfg #	TPI	Blade Size	Pkg Qty	Price
162387	48-42-5640	12 TPI	3"	5 Pk	



Saws & Blades

Sawzall® Blades (Continued)

High-Carbon Steel Jig Saw Blade

Part #	Mfg #	TPI	Blade Size	Pkg Qty	Price
245521	48-42-5200	6 TPI	4"	5 Pk	
245520	48-22-5220	8 TPI	4"	5 Pk	
245522	48-42-5240	10 TPI	4"	5 Pk	

B-Metal Jig Saw Blade

- Longer life
- Fast cuts
- Versatile: features a universal tang



Part #	Mfg #	TPI	Blade Size	Pkg Qty	Price
242753	48-42-2120	18 TPI	2-3/4"	5 Pk	
242754	48-42-2190	14 TPI	3-5/8"	5 Pk	
242739	48-42-2310	10 TPI	4-1/8"	5 Pk	

Sawzall® Blade Sets

12-Piece Assortment General Purpose Sawzall® Blade Kit

- Includes:
 - (4) 6" 18 TPI The Torch blades
 - (2) 6" 8 TPI The Wrecker blades
 - (2) 6" 5 TPI The Ax blades
 - (2) 9" 5 TPI The Ax blades
 - (2) 9" 14 TPI The Torch blades
 - (1) Storage container



Part #	Mfg #	Description	Price
143952	49-22-1129	12-Pc Blade Kit	

SAWZALL® General Purpose 10pc Blade Set

- Includes:
 - (3) 6" 14 TPI Metal THE TORCH™ SAWZALL® Blades
 - (3) 6" 24 TPI Metal SAWZALL® Blades
 - (2) 6" 5 TPI SAWZALL® Blade
 - (1) 9" 18 TPI Metal THE TORCH™ SAWZALL® Blades
 - (1) 9" 5 TPI Wood THE AX™ SAWZALL® Blades



Part #	Mfg #	Description	Price
246700	49-22-1110	10-Pc Blade Set	

5-Piece Assortment General Purpose Sawzall® Blade Kit

- Includes:
 - The Ax™ wood cutting
 - The Torch™ metal cutting blades
 - Demolition blades
 - 1" tall profile for TOUGH, STRAIGHT CUTS



Part #	Mfg #	Description	Price
237166	49-22-1105	5-Pc Demolition SAWZALL®	

Hackzall™ Blades

M12 Hackzall™ Blade



Part #	Mfg #	TPI Length Qty	For	Pkg	Price
144141	49-00-5310	10 3-1/2"	Wood	5/Pk	
144142	49-00-5324	24 3-1/2"	Metal	5/Pk	
144143	49-00-5461	6 4"	Plaster	5/Pk	
244543	49-00-5410	4"	Multi	5/Pk	
244544	49-00-5614	6"	PVC/Plastic	5/Pk	
255395	49-00-5418	4"	EMT/Tube	5/Pk	
176363	49-00-5460	4"	Wood	5/Pk	

M12 Hackzall™ Blade 10-Pc Set

- Includes:
 - (2) Wood blades
 - (3) EMT Blades
 - (2) Duct Blades
 - (3) PVC Blades
 - Storage pouch



Part #	Mfg #	Description	Price
143951	49-22-0220	M12™ Hackzall™ 10-Pc Set	

Saws & Blades

Hackzall™ Blades

- Longer life: Bi-metal construction lasts longer than high-speed steel and carbon blades
- Cuts common materials 1/4" - 1/2" thick
- Convenient: Fits most 12" hack saw frames



Part #	Mfg #	TPI	Length	Pkg Qty	Price
006937	48-43-0610	18	12"	10	
186598	48-43-0620	24	12"	10	
006938	48-43-0630	32	12"	10	

Sawzall® & Hackzall® Accessories

Scraper Blade

- Fits all Sawzall® and Hackzall® reciprocating saws
- Induction hardened blade edge
- Corrosion resistant coating
- Chambered corners prevent digging into work material
- Resharpener blade



49-00-546 49-00-545

Part #	Mfg #	Description	Price
148390	49-00-5463	1-1/2" Scraper Blade	
148391	49-00-5456	3" Scraper Blade	
159007	49-00-5455	5" Scraper Blade	

Grout Removal Tool

- Fits all SAWZALL® and HACKZALL™ recip saws
- Curved cutting edge for maximum accuracy
- Coarse carbide grit for fast grout removal
- Corrosion resistant coating for longer life



Part #	Mfg #	Description	Price
159006	49-00-5450	Grout Removal Tool	

3Pc Material Removal Blade

- Fits all Sawzall® and Hackzall™ Recip Saws
- Induction hardened blade edge for maximum durability
- Corrosion resistant coating
- Chamfered corners prevent digging into work material
- Resharpener blade



Part #	Mfg #	Description	Price
145865	49-22-5403	Scraper, Grout Removal, Coarse Carbide Grit	

Accessories

18 Gauge Shear Head Assembly



Part #	Mfg #	Description	Price
244205	48-08-0500	18 Gauge	

18 Gauge Shear Blade

- Use with Milwaukee model 6850



Part #	Mfg #	Description	Price
143860	48-44-0150	18 Gauge Center Shear Blade	
143861	48-44-0160	18 Gauge Left Shear Blade	
143862	48-44-0160	18 Gauge Right Shear Blade	

PVC Shear Blade

- Compatible only with the M12™ PVC Shear Tool
- Reinforced cutting edge
- Designed to cut PVC, CPVC, PEX, non-metallic conduit and rubber hose
- Bowtie connection



Part #	Mfg #	Description	Price
177853	48-44-0405	4" x 2.5" x 0.149"	

Bit Extension for Hex Shank Hole Saw Arbors

- Hex-wrench



Part#	Mfg#	Shank	Length	Price
170805	48-28-4008	3/8"	12"	
229946	48-28-4011	7/16"	18"	



Saws & Blades

Band Saw Blades

Bi-Metal Band Saw Blade

- Matrix II high speed steel teeth
- For the fastest cutting, longest life blade life available

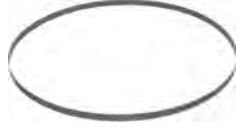

Part #	Mfg #	Description	Price
169677	48-39-0500	10 TPI Standard Deep Cut	
138593	48-39-0511	14 TPI Standard Deep Cut	
169676	48-39-0520	18 TPI Standard Deep Cut	
174043	48-39-0521	18 TPI Standard Deep Cut	
160569	48-39-0531	24 TPI Standard Deep Cut	

Compact Portable Band Saw Blade

- Matrix II high speed steel teeth
- Alloy backing steel
- Precision formed teeth



Part #	Mfg #	Description	Price
235684	48-39-0509	10 TPI Band Saw Blade, 3 Pk	
163508	48-39-0518	14 TPI Band Saw Blade	
149985	48-39-0519	14 TPI Band Saw Blade	
152649	48-39-0529	18 TPI Band Saw Blade	
163509	48-39-0538	24 TPI Band Saw Blade	
160570	48-39-0539	24 TPI Band Saw Blade	
150495	48-39-0572	18 TPI Band Saw Blade	

Standard Deep Cut Band Saw Blade

Part #	Mfg #	Description	Price
006935	48-39-0510	14 TPI Portable	
006936	48-39-0530	24 TPI Portable	
233570	48-39-0550	10/14 TPI Portable	
258324	48-39-0555	10/14 TPI Portable, 25 Pk	
235683	48-39-0501	10 TPI, 3/Pk	

Extreme Metal Band Saw Blades

- Aggressive tooth design for 2X faster cuts in thick metals
- Fastest cutting blade in thin, hard metals
- Variable TPI, cuts more materials



Part #	Mfg #	Size Material		Price
		Thickness Qty	TPI	
257845	48-39-0711	27" 12/14" 3	Thin Metal	
257844	48-39-0619	35 3/8" 12/14" 3	Thin Metal	
259217	48-39-0616	35 3/8" 12/14" 25	Thin Metal	
257842	48-39-0611	44 7/8" 12/14" 3	Thin Metal	
257843	48-39-0609	35 3/8" 8/10" 3	Thick Metal	
257841	48-39-0601	44 7/8" 8/10" 3	Thick Metal	

Circular Saw Blade

Circular Saw Blade

- 5/8 in. arbor
- Thin kerf for faster cutting
- Anti-kickback shoulder
- Precision ground carbide
- Expansion slots for truer cuts under heavy



Part#	Mfg#	Size	Teeth	Pk Qty	Price
151836	48-40-4015	6-1/2"	48	1	

Ferrous Metal Circular Saw Blade

- Dry - No lubricant required
- Cool - No extreme heat buildup
- Clean - No burrs



Part #	Mfg #	Description	Price
148958	48-40-4070	5-3/8" 30 Teeth	
167389	48-40-4515	8" 42 Teeth	

Saws & Blades

Finish Wood Blades

- A High-ATB tooth pattern provides a superior finish with minimal tearout in the cut material
- Milwaukee's anti-friction coating keeps the blade cool while cutting and resists corrosion & gumming
- Laser cutting technology from 100% sheet steel increase cutting accuracy
- High alternate tooth bevel pattern
- Cobalt infused tungsten carbide
- Thin kerf blade
- Blade tensioning ring
- 100 Tooth; 1" arbor hole
- Great for use with: Softwoods, Hardwoods, Malamine, MDF, Veneered Plywoods, Paneling and Moldings



Part #	Mfg #	Description	Price
247798	48-40-0622	6-1/2" Fine Finish	
247799	48-40-0726	7-1/4" Fine Finish	
247800	48-40-1028	10" Fine Finish	

Framing Wood Blade

- Laser cut vibration slots minimize wobble and warping
- Thin kerf blade
- 18 Tooth; 10mm arbor hole
- Laser cutting technology from 100% sheet steel increase cutting accuracy
- Cobalt infused tungsten carbide
- Optimized for both cordless & corded tools



Part #	Mfg #	Description	Price
247804	48-41-0710	7-1/4" 24T	
256707	48-40-0720	7-1/4" 24T	
247802	48-41-0720	7-1/4" 24T 10 PK	
258378	48-40-0620	6-1/2" 24T	
247801	48-41-0620	6-1/2" 24T10 PK	

General Purpose Circular Saw Blade



Part #	Mfg #	Description	Price
255893	48-40-1020	10", 24T	
247803	48-40-1024	10", 40T	

Segment Tool Blades

Titanium Segment Multi-Tool Blade



Part #	Mfg #	Description	Price
178189	48-90-0035	3-1/8"	

Segment Multi-Tool Blade

- Ideal for Cutting Wood, Drywall & Plaster, Fiberglass and Non-Ferrous Metals



Part #	Mfg #	Description	Price
178191	48-90-0045	3-1/8"	

Carbide Grit Segment Multi-Tool Blade

- Carbide Grit for Grout Removal and Cutting into Brick, Cement, Drywall & Plaster, and other Abrasive Materials



Part #	Mfg #	Description	Price
178194	48-90-0100	2-1/2"	
178195	48-90-0110	1-1/4"	

Sanding Disc

- Ceramic resin
- Duct pick up not available

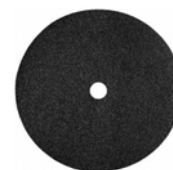

Part #	Mfg #	Grit	Size	Qty/Pk	Price
237738	48-80-0838	80	9"	5/Pk	

Saws & Blades

Miscellaneous Blades

25mm Precision Snap Blades

- Optimized grind angles
- Micro carbide dispersed metal
- Includes Snap-Off knife blade storage case



Part #	Mfg #	Length	Pack Qty	Price
239735	48-22-9125	7"	10 PK	

Multi-Tool Accessory Blades

- Assortment of Multi-Tool Blades for a variety of applications
- Ideal for Cutting Wood with Nails, non-ferrous metals, and PVC



Part #	Mfg #	Description	Price
178197	48-90-1050	3-Piece	
178196	48-90-1000	3-Piece	
227885	48-90-1009	9-Piece	
178186	48-90-0020	1-3/4" Titanium	
178187	48-90-0025	1-1/8" Titanium	
178188	48-90-0030	1-1/4" Hard Point	
178190	48-90-0040	1-1/4" Bi-Metal	
257044	48-90-4040	1-1/4 Bi-Metal 10PK	
178192	48-90-0050	2-1/2" Bi-Metal	
178193	48-90-0055	1-1/4" Japanese Tooth	
257043	48-90-4055	1-1/4" Japanese Tooth 10PK	
178184	48-90-0010	1-1/4" Extended Multi-Tool	
178185	48-90-0015	3/4" Multi-Tool	

Multi-Tool Blade Kit - 6PC

- Includes:
 - (1) 3/4" Fine tooth blade
 - (1) 1-1/4" Japanese tooth blade
 - (2) 1-1/4" Bi-Metal blades
 - (2) 2-1/2" Bi-Metal blades



Part #	Mfg #	Description	Price
252398	48-90-1006	Blade Kit	

Scraper Blade

- Rigid design for heavy duty scraping applications
- Adaptor (48-90-0000) available for Porter Cable®, Black & Decker®, and DeWalt® Multi-Tools



Part #	Mfg #	Description	Price
178198	48-90-0060	2.75" x 2.5"	

Multi-Tool Sanding Pad

- Universal Shank* connects to most professional grade multi-tools.
- Designed connection for use with Dust Extractor Kit (49-90-2400)
- Velcro backing for secure connection to sanding paper



Part #	Mfg #	Description	Price
178199	48-90-2000	3-1/2" x 3-1/2"	

80 Grit Sand Paper for Multi-Tool

- Velcro backing for secure connection to sanding pad.
- For use with M18™ Sanding Pad (48-90-2000)
- Designed holes for additional use of Dust Extractor Kit (49-90-2400)



Part #	Mfg #	Description	Price
178201	48-90-2080	8-Pk	

Universal Multi-Tool Blade Adapter

- Allows for all Milwaukee Multi-Tool Blades to be used with Porter Cable, Black & Decker, and DeWalt brand multi-tools



Part #	Mfg #	Description	Price
178183	48-90-0000	Universal Multi-Tool	

Saws & Blades

Hand Saws

Mini Hacksaw—Pistol Grip & Standard

- Separate screw sets the 6" blade tension
- Good for fine work in small areas.
- Six inch steel blade cuts copper and brass tube, bolts, steel, wood and plaster
- Pistol Grip is easier to hold and grasp



301-062

Part #	Mfg #	Type	Blade	Price
031884	301-062	Deluxe Pistol Grip	6"	
183402	301-065	Standard D-Type	6"	

SawHorse™ Multi-Purpose Saw

- High-quality, hardened-steel blade remains sharp through thousands of cuts
- Teeth are on the nose for notching in tight areas and starting cuts in the middle of floor or wall
- Perfect for plastic pipe, wood and many other materials
- 20" model has 10 teeth/inch for faster cutting
- 12" model has 13 teeth/inch for fine cutting.
- Both include plastic teeth protector



300-20

Part #	Mfg #	Blade Size	Price
049442	300-12	20"	
183400	300-20	12"	

Replacement Blades

For: SawHorse™ Multi-Purpose Saws

Part #	Mfg #	For Model:	Price
051535	300-12B	300-12	

For: Mini Hacksaw—Pistol Grip & Standard

- 32 Teeth/Inch
- Pin ends

Part #	Mfg #	Material	Blade	Price
031885	301-061	Carbon Steel	6"	

Saws & Blades

Saws

PVC Cable Saw

- *Cuts plumbing or electrical PVC faster than hacksaw*
- *Ideal for tight spots and in-ground repairs*

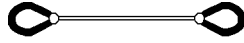

Part #	Mfg #	Description	Price
002737	70390	26" Cable Saw - Std	

Screwdrivers & Bits

Screwdrivers

#1 Phillips - 3" Screwdriver

- Wrench ready HEX shanks
- Forged tool shanks
- Wire bending hole- bend up to 12 gauge wire
- Wire stripper (Patent Pending)- strip up to 12G wire
- Visible ID markings



Part #	Mfg #	Description	Price
245658	48-22-2811	#1 Phillips - 3"	

#2 Phillips- 4" Screwdriver

- Wrench ready HEX shanks
- Forged tool shanks
- Wire bending hole - bend up to 12 gauge wire
- Wire stripper (Patent Pending) - strip up to 12G wire
- Visible ID markings



Part #	Mfg #	Description	Price
245659	48-22-2812	#2 Phillips - 3"	

#3 Phillips - 6" Screwdriver

- Wrench ready HEX shanks
- Forged tool shanks
- Wire bending hole - bend up to 12 gauge wire
- Wire stripper (Patent Pending) - strip up to 12G wire
- Visible ID markings



Part #	Mfg #	Description	Price
245660	48-22-2813	#3 Phillips - 6"	

1000V Insulated Screwdriver

- UL® Classified
- 1000V Insulated Protection
- Lanyard Holes



Part #	Mfg #	Description	Price
253689	48-22-2213	#3 Phillips - 6"	
255933	48-22-2221	1/4" Slotted - 6"	

Demolition Screwdriver

- Wrench ready HEX shanks
- High impact steel cap
- Forged tool shanks
- Visible ID markings



Part #	Mfg #	Description	Price
245662	48-22-2821	1/4" Slotted - 4" Demolition	

Screwdrivers (Continued)

Demolition Screwdriver

Part #	Mfg #	Description	Price
245663	48-22-2823	5/16" Slotted- 6" Demolition	
245664	48-22-2825	3/8" Slotted - 8" Demolition	

3/16" Cabinet - Screwdriver

- Forged tool shanks
- Visible ID Markings



Part #	Mfg #	Description	Price
250949	48-22-2831	3/16" - 3"	
245665	48-22-2832	3/16" - 6"	
245666	48-22-2833	3/16" - 8"	

#1 Square Screwdriver

- Forged tool shanks
- Visible ID Markings



Part #	Mfg #	Description	Price
245667	48-22-2851	#1 Square - 3"	

9-in-1 Square Drive Ratcheting Multi-bit Driver

- Hex shanks for additional leverage
- Chrome plated bits
- Magnetic bit retention
- Precision machined bit tips



Part #	Mfg #	Description	Price
256556	48-22-2322	9-in-1 Screwdriver Set	

9-in-1 ECX Drive Ratcheting Multi-bit Driver

- Hex shanks for additional leverage
- Chrome plated bits
- Magnetic bit retention
- Precision machined bit tips



Part #	Mfg #	Description	Price
256555	48-22-2331	9-in-1 Screwdriver Set	



Screwdrivers & Bits

11-in-1 ECX™ Screwdriver

- Includes:
 - (1) Phillips #1
 - (1) Phillips #2
 - (1) Slotted 3/16"
 - (1) Slotted 1/4"
 - (1) Square #1
 - (1) Square #2
 - (1) ECX (TM) #1
 - (1) ECX (TM) #2
 - (1) 1/4" Nut Driver
 - (1) 3/8" Nut Driver
 - (1) Loop Maker



Part #	Mfg #	Description	Price
239242	48-22-2760	Multi-Use Screwdriver	

11-in-1 Screwdriver SQ

- Includes:
 - (1) Phillips #1
 - (1) Phillips #2
 - (1) Slotted 1/4"
 - (1) Slotted 3/16"
 - (1) Square #1
 - (1) Square #2
 - (1) Torx® #10
 - (1) Torx® #15
 - (1) 1/4" Nut Driver
 - (1) 3/8" Nut Driver



Part #	Mfg #	Description	Price
239243	48-22-2761	Multi-Use Screwdriver	

13-in-1 Cushion Grip Screwdriver with Schrader Bit

- 8 unique driver bits - P1, P2, SL 3/16, SL 1/4, SQ2, Std. Schrader, Lrg. Schrader
- 4 Unique nut drivers - 1/4", 5/16", 3/8", 1/2"
- 13 Unique functions
- Tri-material cushion grip handle
- Loop maker



Part #	Mfg #	Description	Price
248988	48-22-2881	13-in-1 Screwdriver Set	

Demo Driver

- All metal core
- Multiple strike surfaces
- Aggressive duct piercing tip



Part #	Mfg #	Description	Price
243684	48-22-2860	Demo Driver	

2-PC Demo Screwdriver Set

- Includes:
 - (1) Phillips #6 x 6"
 - (1) Slotted 5/16" x 6"



Part #	Mfg #	Description	Price
239236	48-22-2702	Demo Driver Set	

3-PC 1000V Insulated Screwdriver Set

- Flame retardant & impact resistant handle and shank
- UL® Classified
- Meets OSHA Insulated Tool Standard
- VDE & GS Certified
- Visible ID Markings
- Dual Layer Insulation
- Includes:
 - (1) #2 Phillips - 4" 1000V Insulated Screwdriver (48-22-2212)
 - (1) 1/4" Slotted - 6" 1000V Insulated Screwdriver (48-22-2221)
 - (1) #1 ECX™ - 4" 1000V Insulated Screwdriver (48-22-2241)



Part #	Mfg #	Description	Price
231074	48-22-2202	3Pc Insulated	

Screwdrivers & Bits

4-PC Precision Screwdriver Set

- All metal cores: up to 4x stronger
- Precision machined driving tips
- Longer shanks
- 360° rotating back caps
- Includes:
 - (1) Phillip #1 - 4"
 - (1) Slotted 1/16" - 2 1/2"
 - (1) Slotted 3/32" - 2 1/2"
 - (1) Slotted 1/8" 3 1/2" Slotted



Part #	Mfg #	Description	Price
171805	48-22-2604	4 PC Precision Screwdriver Set	

6-PC Precision Screwdriver Set

- All metal cores: up to 4x stronger
- Precision machined driving tips
- Longer shanks
- 360° rotating back caps



Part #	Mfg #	Description	Price
172872	48-22-2606	6 PC Precision Screwdriver Set	

6-PC TORX® Precision Screwdriver Set

- All metal cores: Up to 4X Stronger
- Precision machined driving tips
- Longer shanks for improved visibility and extended reach
- 360-degree rotating back caps
- Color coded markings
- Chrome plated shanks
- Durable case with robust zipper



Part #	Mfg #	Description	Price
174831	48-22-2610	6 PC TORX® Precision	

8-PC Screwdriver Kit with ECX

- Includes:
 - (1) ECX (TM) #1
 - (1) ECX (TM) #2
 - (1) Phillips #1 x 3"
 - (1) Phillips #2 x 4"
 - (1) Phillips #2 x 6"
 - (1) Slotted 1/4" x 4"
 - (1) Slotted 3/16" x 6"
 - (1) Slotted 5/16" x 6"



Part #	Mfg #	Description	Price
239239	48-22-2708	8 PC Kit w/ ECX	

8-PC Screwdriver Kit with Square Recess



Part #	Mfg #	Description	Price
239240	48-22-2718	8 PC kit w/ Square Recess	

10-PC Screwdriver Kit

- Includes:
 - (1) Phillips #1 x 3"
 - (1) Phillips #2 x 1 1/2"
 - (1) Phillips #2 x 4"
 - (1) Phillips #2 x 6"
 - (1) Slotted 1/4" x 1 1/2"
 - (1) Slotted 1/4" x 4"
 - (1) Slotted 3/16" x 6"
 - (1) Slotted 5/16" x 6"
 - (1) Square #1
 - (1) Square #2



Part #	Mfg #	Description	Price
254736	48-22-2710	10 PC Screwdriver Set	



Screwdrivers & Bits

4Pc Pry Bar Set

- I-Beam design: up to 40% stronger
- All-metal core
- Hammer-ready strike cap
- Comfortable tri-lobe handles
- Chrome finish
- Easy-access storage tray
- Lifetime guarantee



2-PC SAE Hollow Shaft Nut Driver Set

- Universal driver head fits 4X more fasteners
- Removes rusted and stripped bolts
- 3" Hollow shaft depth
- Wrench ready HEX shanks
- Chrome Plated
- Multiple ID markings



Part #	Mfg #	Description	Price
163307	48-22-2402	2-Pc HollowCore Driver	

Part #	Mfg #	Description	Price
243159	48-22-9214	8", 12", 18", 24"	

Nut Drivers

Hollow Shaft Nut Driver

- Universal driver head fits 4X more fasteners
- Removes rusted and stripped bolts
- 3" Hollow shaft depth
- Wrench ready HEX shanks
- Chrome plated
- Forged steel shanks
- Deep well sockets
- Multiple ID markings



4 PC Hollow Shaft SAE Nut Driver Set

- Universal driver head fits 4X more fasteners
- Removes rusted and stripped bolts
- 3" Hollow Shaft Depth
- Wrench Ready HEX shanks
- Chrome Plated
- Deep well sockets
- Multiple ID Markings
- Includes:
 - (1) 1/4" Hollow Shaft Nut Driver (48-22-2421)
 - (1) 5/16" Hollow Shaft Nut Driver (48-22-2422)
 - (1) 7/16" Hollow Shaft Nut Driver (48-22-2425)
 - (1) 9/16" Hollow Shaft Nut Driver (48-22-2427)



Part #	Mfg #	Description	Price
224649	48-22-2404	4-Pc HollowCore Driver	

Part#	Mfg#	Size	Price
163305	48-22-2421	1/4"	
163306	48-22-2422	5/16"	

HollowCore™ Magnetic Nut Driver

- HollowCore™ unlimited depth
- Magnetic drivers
- Universal driver head fits 4X more fasteners
- Removes rusted and stripped bolts
- Color coded ID markings
- Wrench ready HEX shanks
- Chrome plated
- Forged steel shanks
- Deep well sockets



2-PC SAE HollowCore™ Magnetic Nut Driver Set

- HollowCore™
- Magnetic drivers
- Universal driver head fits 4X more fasteners
- Removes rusted and stripped bolts
- Color coded ID markings
- Wrench ready HEX shanks
- Chrome plated
- Forged steel shanks
- Deep well sockets



Part #	Mfg #	Description	Price
162394	48-22-2502	2-Pc Nut Driver Set	

Part#	Mfg#	Size	Price
162644	48-22-2521	1/4"	
162645	48-22-2522	5/16"	
162646	48-22-2524	3/8"	
162817	48-22-2525	7/16"	
162818	48-22-2526	1/2"	
162819	48-22-2527	9/16"	
162816	48-22-2523	11/32"	

• Serving our Customers Since 1946 • www.plumbsupply.com

Screwdrivers & Bits

7-PC Hollow Shaft SAE Nut Driver Set

- Includes:
- (1) 1/4" Hollow Shaft Nut Driver (48-22-2421)
- (1) 5/16" Hollow Shaft Nut Driver (48-22-2422)
- (1) 11/32" Hollow Shaft Nut Driver (48-22-2423)
- (1) 3/8" Hollow Shaft Nut Driver (48-22-2424)
- (1) 7/16" Hollow Shaft Nut Driver (48-22-2425)
- (1) 1/2" Hollow Shaft Nut Driver (48-22-2426)
- (1) 9/16" Hollow Shaft Nut Driver (48-22-2427)



Part #	Mfg #	Description	Price
221061	48-22-2407	7Pc Set	

7-PC Hollow Shaft Metric Nut Driver Set

- Includes:
- 5 mm (48-22-2431)
- 5.5mm (48-22-2432)
- 6mm (48-22-2433)
- 7mm (48-22-2434)
- 8mm (48-22-2435)
- 10mm (48-22-2436)
- 13mm (48-22-2437)
- 9/16" Driver
- 3" Hollow shaft depth
- Forged steel HEX shanks



Part #	Mfg #	Description	Price
241916	48-22-2417	7 Pc Nut Driver Set	

7-PC Magnetic HollowCore™ SAE Nut Driver Set

- Universal driver head fits 4X more fasteners
- Removes rusted and stripped bolts
- Color coded ID markings
- Wrench ready HEX shanks
- Chrome plated
- Forged steel shanks
- Deep well sockets
- Includes 9/16" driver



Part #	Mfg #	Description	Price
161964	48-22-2507	7-Pc Nut Driver Set	
242650	48-22-2517	7-Pc Nut Driver Set	

8-in-1 Compact Ratcheting Multi-bit Driver

- All metal ratchet
- Wrench ready: Hex shanks for additional leverage
- Chrome plated bits
- Includes:
- (1) 8-in-1 Compact Ratcheting Multi-bit Driver (48-22-2330)
- (1) 1/4" Nut Driver
- (1) Phillips #1
- (1) Phillips #2
- (1) Slotted 1/4" x 4"
- (1) Slotted 3/16" x 6"
- (1) Square Bit 1" SQ1
- (1) Square Bit 1" SQ2
- (1) TORX® Bit 1" T15



Part #	Mfg #	Description	Price
256554	48-22-2330	8-Pc Driver Set	

Shockwave® Impact Duty™ Bits

- Steel heat treated to control hardness
- Forged tip for maximum grip
- Geometric design provides the shock absorption zone

Shockwave® Reduced Diameter Dry wall Phillips Insert Bit



Part #	Mfg #	Dia	Lgth	Pkg Qty	Phillips	Price
141257	48-32-4444	1/4"	1"	2	#2	

Shockwave™ Impact Locking Bit Holder

- Dual magnets
- Optimized shockzone
- Auto-locking design:
 - Fits all inserts and 1/4" HEX bits
- Quick release collar
 - One handed bit changes



Part #	Mfg #	Dia	Lgth	Pkg Qty	Phillips	Price
244547	48-32-4531	1/4"	2.875"	1	-	
241968	48-32-4533	1/4"	12"	1	-	

Shockwave® Impact Duty™ Phillips Power Bit



Part #	Mfg #	Dia	Lgth	Pkg Qty	Phillips	Price
141259	48-32-4602	1/4"	2"	5	#2	



Screwdrivers & Bits

Shockwave® Impact Duty™ Bits (Continued)

Shockwave® Impact Duty™ Phillips Power Bit

Part #	Mfg #	Dia	Lgth	Pkg Qty	Phillips	Price
164161	48-32-4461	1/4"	2"	1	#1	

Shockwave® Impact Duty™ Square Recess Insert Bit



48-32-442



48-32-4471

Part #	Mfg #	Dia	Lgth	Pkg Qty	Phillips	Price
141262	48-32-4421	1/4"	1"	2	#1	
141263	48-32-4422	1/4"	1"	2	#2	
141265	48-32-4605	1/4"	1"	5	#2	
141268	48-32-4606	1/4"	2"	5	#2	
141264	48-32-4423	1/4"	1"	2	#3	
141269	48-32-4473	1/4"	2"	1	#3	
141270	48-32-4572	1/4"	3-1/2"	1	#2	

Shockwave® Torx® Power Bit



Part #	Mfg #	Dia	Lgth	Pkg Qty	Torx	Price
164162	48-32-4482	1/4"	2"	T10		
141271	48-32-4483	1/4"	2"	1	T15	
164163	48-32-4486	1/4"	2"	T27		
141274	48-32-4487	1/4"	2"	1	T30	

Shockwave® Impact Torx® Power Bit

- OPTIMIZED SHOCKZONE™
- PRECISE FIT CUSTOM MACHINED TIP™
- CUSTOM ALLOY76™ STEEL



Part #	Mfg #	Lgth	Pkg Qty	Torx	Price
164166	48-32-4436	1"	2	T25	
141273	48-32-4485	2"	1	T25	
219698	48-32-4561	3-1/2"	1	T25	
141272	48-32-4484	2"	1	T20	

SHOCKWAVE™ Impact Phillips Power Bit

- OPTIMIZED SHOCKZONE™
- PRECISE FIT CUSTOM MACHINED TIP™
- CUSTOM ALLOY76™ STEEL



Part#	Mfg#	Drive Size	Length	Pk Qty	Price
164171	48-32-4604	2	1"	25	
182487	48-32-4762	2	2"	25	
141258	48-32-4462	2	2"	1	
164174	48-32-4564	2	3-1/2"	5	
141261	48-32-4562	2	3-1/2"	1	
164175	48-32-4802	2	6"	1	
164164	48-32-4563	3	3-1/2"	1	
141251	48-32-4411	1	1"	2	
141255	48-32-4601	2	1"	5	
141256	48-32-4413	3	1"	2	
141254	48-32-4412	2	1"	2	
141260	48-32-4463	3	2"	1	
164173	48-32-5004	2	2"	15	

SHOCKWAVE™ Impact Square Power Bit

- OPTIMIZED SHOCKZONE™
- PRECISE FIT CUSTOM MACHINED TIP™
- CUSTOM ALLOY76™ STEEL



Part#	Mfg#	Drive Size	Length	Pk Qty	Price
164165	48-32-4573	3	3-1/2"	1	
141267	48-32-4472	2	2"	1	
164176	48-32-4805	2	6"	1	

Screwdrivers & Bits

Shockwave® Bit Sets

SHOCKWAVE™ Impact Duty Drill & Drive Set

- Custom machine tip
- Custom alloy 76 steel
- 60 Piece kit include:
 - (1) Compact bit holder
 - (1) 6" Bit holder
 - Socket Adapter: 3/8"
 - Magnetic nut drivers: 1/4" & 5/16"
 - Hex drill bits: 1/16", 3/32", 1/8", 5/32", 3/16", 1/4"
 - Double ended power bits: PH2/SQ2, PH2/T25, PH2/SL#10, T20/T25
 - Insert driver bits: PH1, (6) PH2, PR2, (2) PH3, SQ1,



- (3) SQ2, SQ3, T10, T15, (2) T20, (3) T25, T30, SL#6, SL#10, Hex 3/16", Hex 1/4"
- 2" Power Bits: PH1, (4) PH2, (2) PH3, SQ1, (3) SQ2, SQ3, (2) T20, (2) T25, T30, SL#10

Part #	Mfg #	Description	Price
241621	48-32-4029	60-Pc Set Impact Duty	

74-PC Shockwave® Impact Duty Driver Bit Set

- Includes:
 - (1) SHOCKWAVE™ Compact Magnetic Bit Holder
 - (1) 1/4" Magnetic Nut Driver
 - (1) 5/16" Magnetic Nut Driver
 - (1) 3/8" Socket Adapter
 - Phillips Bit
 - (2) 1" P1, (11) 1" P2, (1) 1" PR2, (3) 1" P3
 - Square Bit
 - (2) 1" SQ1, (4) S1" SQ2, (2) 2" SQ3
 - Slotted Bit
 - (1) 1" #8, (2) 1" #10
 - INSERT BIT HEX
 - (1) 1/4", (1) 1/8", (1) 3/16", (1) 9/64", (1) 5/32"
 - HexPower Groove Bit
 - (1) 3mm 312, (1) 4mm 312, (1) 5mm 312, (1) 6mm 312
 - TORX® Bit
 - (1) 1" T10, (2) 1" T15, (4) 1" T20, (7) 1" T25, (2) 1" T27, (2) 1" T30
 - Power Groove Bit
 - (2) P2 2", (1) P3 2", (2) SQ2 2", (1) SQ3 2", (1) T20 2"
 - (1) T25 2" (1) P2 3 1/2", (1) SQ2 3 1/2", (1) T25 3 1/2"
 - Double Ended Bit
 - (1) T20/T25, (1) P2/SL #10, (1) P2/SQ2, (1) P2/T25



Part #	Mfg #	Description	Price
251490	48-32-4062	74-Piece Impact Duty	

22-PC Shockwave® Puck Bit Dispenser

- Includes:
 - Magnetic bit holder
 - Phillips: (1) #1, (3) #2, (2) #
 - Square recess: (1) #1, (3) #2, (1) #3
 - Torx: (1) T10, (1) T15, (1) T20, (1) T25, (1) T27, (1) T30
 - Slotted: (1) 1/8", (1) 3/16", (1) 1/4", (1) 9/32"



Part #	Mfg #	Description	Price
143668	48-32-4011	22-Piece Puck Bit Dispenser	

7-PC TORX® Insert Bit Kit

- Kit includes:
 - (1) TORX® Bit 1" T10
 - (1) TORX® Bit 1" T15
 - (1) TORX® Bit 1" T20
 - (1) TORX® Bit 1" T25
 - (1) TORX® Bit 1" T27
 - (1) TORX® Bit 1" T30
 - (1) TORX® Bit 1" T40

Part #	Mfg #	Description	Price
164159	48-32-4615	7-Piece	

Right Angle Drive Unit

- For use with Milwaukee 1/2" d-handle drills
- Provides 2 additional drilling speeds
- Includes coupling No. 42-90-0175 for 0234-6 and 0244-1
- For 50% more torque or 50% more speed



Part #	Mfg #	Description	Price
162598	48-06-2871	Right Angle Drive Unit	

11-PC Shockwave® Impact Duty™ 30° Knuckle™ Pivoting Bit Holder Bit Set

- Locks at 0° or 30° angle
- Maximum torque: 2,000 in-lbs
- Includes:
 - Phillips bits: 1" P Shockwave® 30° Knuckle™ pivoting bit holder 1, P2 & P3
 - Square bits: 1" SQ1 & SQ2
 - Slotted bits: 1" SL1/8", SL 3/16", SL1/4", SL9/32"
 - Torx® bits: 1" T25



Part #	Mfg #	Description	Price
146101	48-32-2301	11-Pc Bit Set & Knuckle Bit Holder	

Screwdrivers & Bits

7-PC SHOCKWAVE™ Hex Security Insert Bit Set



Part #	Mfg #	Description	Price
237357	48-32-4619	7-Pc Bit Set	

Shockwave® Nut Drivers

Shockwave® Magnetic Nut Driver

- Steel heat treated to control hardness
- Color-coded rings for size identification
- Chamfered edge



Part #	Mfg #	Size	Pkg Qty	Price
141231	49-66-4502	1/4" x 1-7/8"	1	
141243	49-66-4522	1/4" x 1-7/8"	3	
141247	49-66-4532	1/4" x 2-9/16"	1	
228380	49-66-4732	1/4" x 2-9/16"	10	
140360	49-66-4503	5/16" x 1-7/8"	1	
141236	49-66-4506	7/16" x 1-7/8"	1	
141244	49-66-4523	5/16" x 1-7/8"	3	
228381	49-66-4733	5/16" x 2-9/16"	10	
141248	49-66-4533	5/16" x 2-9/16"	1	
141245	49-66-4525	3/8" x 1-7/8"	3	
141249	49-66-4535	3/8" x 2-9/19"	1	
141246	49-66-4526	7/16" x 1-7/8"	3	
141250	49-66-4536	7/16" x 2-9/16"	1	
164177	49-66-4537	1/2" x 2-9/16"	1	
141234	49-66-4505	3/8" x 1-7/8"	1	

Set



Part #	Mfg #	Size	Pkg Qty	Price
141241	49-66-4562	1-7/8"	4	
141237	49-66-4561	1-7/8"	3	

SHOCKWAVE™ 1/4" Hex Adapter SQ 3/8"

- Proprietary steel and heat treat process for maximum strength and durability
- Heavy duty construction for fastening capabilities in all impacts



Part #	Mfg #	Description	Price
153737	48-03-4405	1/4" Hex Adapter SQ 3/8"	

SHOCKWAVE™ 1/2" Square to 1/4" Hex Adapter

- Proprietary steel and heat treat process for maximum strength and durability
- Heavy duty construction for fastening capabilities in all impacts



Part #	Mfg #	Description	Price
164154	48-03-4410	SHOCKWAVE™ 1/2" Square to 1/4" Hex Adapter	

SHOCKWAVE™ Square Socket Adapter

- Proprietary steel and heat treat process
- Heavy duty construction



Part #	Mfg #	Description	Price
164155	48-32-5030	1/4" Hex to 1/4" Square Socket	
154029	48-32-5031	1/4" Hex to 3/8" Square Socket	
164157	48-32-5032	1/4" Hex to 1/2" Square Socket	

SHOCKWAVE™ Impact Hex Shank Socket Adapter Set

- Includes:
 - (1) 1/2" Socket Adapter
 - (1) 1/4" Socket Adapter
 - (1) 3/8" Socket Adapter



Part #	Mfg #	Description	Price
255824	48-32-5033	3-Pc Adapter Set	

Screwdrivers & Bits

Bit Sets

4-PC Universal Replacement Bit Set

- Includes:
 - ECX Bit #1 & #2
 - Phillips #1 & #2
 - Slotted 3/16" & 1/4"
 - Square #1 & #2



Part #	Mfg #	Description	Price
142609	48-22-2110	4-Pc Replacement Bit Set	

Installation Kit for Concrete Screws

- (1) 1/4" Hex Drive Bit
- (1) 3/16" x 7" with 1/4" Hex Rotary Hammer Drill Bit
- (1) 5/16" Hex Drive Bit
- (1) 5/32" x 7" with 1/4" Hex Rotary Hammer Drill Bit
- (1) Drive Sleeve
- (1) #2 Phillips Driver Bit
- (1) #3 Phillips Driver Bit



Part #	Mfg #	Description	Price
169685	48-20-7497	6-Pc Set	

Screwdrivers & Bits

Screwdrivers

Regular Grip Screwdriver - Electrical Style



Part #	Mfg #	Blade Dia	Blade Length	Price
006380	C22M	1/8"	2"	

Nut Drivers

CONNEXT™ Pre-Assembled Magnetic Hex Driver - Long Lengths



- CONNEXT™ Quick change handles
- Magnetic hex chuck driver shaft components
- Use with Zip-In® and "A" hex head screws

Part #	Mfg #	Hex Dia	Shaft Length	Grips	Price
006416	HHD1	1/4"	6-7/8"	Red	
006417	HHD2	5/16"	6-7/8"	Yellow	

CONNEXT™ Pre-Assembled Magnetic Hex Driver



Standard Lengths

- CONNEXT™ Quick change handles
- Magnetic hex chuck driver shaft components
- Use with Zip-In® and "A" hex head screws

Part #	Mfg #	Hex Dia	Shaft Length	Grips	Price
132792	HHD1S	1/4"	3"	Red	

CONNEXT™ Pre-Assembled Magnetic Hex Driver - Stubby



- CONNEXT™ Quick change handle
- Magnetic hex chuck driver shaft components
- Use with Zip-In® and "A" hex head screws

Part #	Mfg #	Hex Dia	Shaft Length	Grips	Price
132795	HHD2T	5/16"	2-1/4"	Yellow	

C-Rhex® Dual-Sided Magnetic Hex Chuck Driver



- Reversible
- Red: 1/4"
- Yellow: 5/16"

Part #	Mfg #	Hex Dia	Shaft Length	Price
231525	MSHC	1/4" & 5/16"	2"	
251735	MSHLC	1/4" & 5/16"	2-5/8"	
251733	MSHMLC	1/4" & 5/16"	4"	
251731	MSHXLC	1/4" & 5/16"	6"	

Power Bits

Phillips Power Bit



- 1/4" Shank diameter

Part #	Mfg #	Point Size	O/A Length	Price
006444	MBLP3	2	1-15/16"	

Magnetic Hex Driver Bit



- 1/4" Shank diameter

Part #	Mfg #	Hex Opening	Nose Diameter	Price
006447	MSH1/4	1/4"	7/16"	
006449	MSH5/16	5/16"	1/2"	
006448	MSH3/8	3/8"	9/16"	

Long Style Hex Driver Bit



- 1/4" Shank diameter

Part #	Mfg #	Hex Opening	Nose Dia	Qty	Price
006446	MSHL1/4	1/4"	7/16"	1	
025655	MSHL5/16	5/16"	1/2"	1	

Extra Long Style Hex Driver Bit



- 1/4" Shank diameter

Part #	Mfg #	Hex Opening	O/A Length	Price
025042	MSHML1/4	1/4"	4"	
023240	MSHXL1/4	1/4"	6"	
096867	MSHXL5/16	5/16"	6"	

Screwdrivers & Bits

Power Bit Extension

- Ball bearing on holder provides a positive lock on 1/4" hex
- Tempered steel
- Black finish
- 9/16" Nose diameter



Part #	Mfg #	Hex Opening	O/A Length	Price
006378	BHE6	1/4"	6"	
006377	BHE10	1/4"	10"	

Power Driver Hex Adapters

Quick Change Hex Adapter



Part #	Mfg #	Hex Dia	Shank Dia	O/A Length	Price
006407	HAD1	1/4"	3/4"	1-3/4"	

Miscellaneous Tools

Tensioning Tool with Manual Cut Off and Grips



Part #	Mfg #	Description	Price
061800	TY4G	Notched Gripper	



Screwdrivers & Bits

Screwdrivers

4-In-One Pocket Mini Screwdriver

- Includes:
 - 3/32" & 1/16" Slotted bit
 - #0 & #000 Phillips bit



Part #	Mfg #	Color	Price
136199	24008	Black/Yellow	

6-In-One Screwdriver

- Includes:
 - 1/4" & 3/16" Slotted bit
 - #1 & #2 Phillips bit
 - 1/4" & 5/16" Hex nut driver



Part #	Mfg #	Color	Price
028106	24006	Red	

Screwdrivers & Bits

Screwdrivers & Bits

9 in 1 Multi-Tool

- Slip-resistant grip
- Thick-walled shaft
- Included:
 - Bits
 - Valve core remover
 - Square #2
 - 1/2" Hex
 - 5/16" Hex
 - 3/8" Hex
 - Phillips #1 & #2
 - 3/16" and 1/4" slotted



Part #	Mfg #	Description	Price
165766	1839053	9-in-1 Multi-Tool	

3" Shaft Magnetic Nut Drivers

- Secure hold
- Color-coded for quick identification
- Slip-resistant grip
- Hollowed shaft allows for use on long bolts
- Chrome-vanadium steel construction



Part #	Mfg #	Description	Price
171359	1839059	Red, 1/4" x 3"	
171360	1839060	Yellow, 5/16" x 3"	

6" Shaft Magnetic Nut Drivers

- Secure hold
- Color-coded for quick identification
- Slip-resistant grip
- Hollowed shaft allows for use on long bolts
- Chrome-vanadium steel construction



Part #	Mfg #	Description	Price
171362	1839068	Red, 1/4" x 6"	
171363	1839069	Yellow, 5/16" x 6"	
171364	1839074	Set of 2, 1/4" & 5/16"	

Precision Screwdriver Set

- Comfortable grips
- Maximum precision
 - Rotating head allows for precise adjustments
- Quick identification with easy-to-read tips
- Pouch included for storage
- Includes:
 - #0x3" Phillips, 1/16"x2", 3/32"x3", 1/8"x4", 1/8"x6" Slotted



Part #	Mfg #	Description	Price
174627	1891089	5-Pc Set	



Hand Sewer Machines

Flexicore® Closet Augers

Regular Head Closet Auger

- With Flexicore double layer wire rope center



3FL

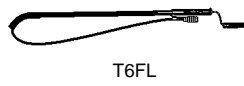

T6FL

Part #	Mfg #	Description	Price
093674	3FL	3' Flexicore (6/Ctn)	
005064	T6FL	6' Teletube Flexicore	

Down Head Closet Auger

- Flexicore double layer wire rope center



3FL-DH



T6FL-DH

Part #	Mfg #	Description	Price
005068	3FL-DH	3' Flexicore	
005063	T6FL-DH	6' Teletube Flexicore	

Urinal Augers



Part #	Mfg #	Description	Price
038683	TU4	Telescoping Teletube® - 48" Spring (6/Ctn)	

Hand Sewer Machines

Petersen Drain Flushers

- Multi-flex™ multiple ply construction, high flow rate flushing
- Flexible for insertion around bends, internal stiffener for easy insertion
- 3/4" Water hose coupling

Petersen



R193400



R193600



R193700

Part #	Mfg #	Description	Price
008378	R193400	102-001 1-1/2" Drain Jet	
008380	R193600	102-003 3" Drain Jet	
008904	R193700	102-004 4" Drain Jet	

Suction Guns

Part #	Mfg #	Description	Price
080436	R441825	Last Drop Suction Gun	



Hand Sewer Machines

Plungers

Rubber Plunger

- Includes funnel-shaped cap that is retractable for use in flat sinks



Part #	Mfg #	Type	Handle	Price
183404	312-2	Funnel	20"	



Hand Sewer Machines

Clog Buster™ Drain Flushers



Part #	Mfg #	Size	Price
002966	CI1123DRAFLU	1-1/2" - 3"	



Hand Sewer Machines

Drain Cleaning & Tools

Mighty Mini Sink Plunger

- 4" Black rubber cup
- 8" Plastic handle
- Barcode label



Part #	Mfg #	Description	Price
053480	090288	Mighty Mini Sink Plunger	

All Angle Power Plunger

- Flexible black rubber cup with 21" yellow handle
- Fully assembled with header card



Part #	Mfg #	Description	Price
041779	090300	Power Plunger	



Hand Sewer Machines

Plungers



Part #	Mfg #	Description	Price
008174	93-8	Korky® Plunger	



Hand Sewer Machines

Snake-Oil™

- *Highly recommended for use with all types of cables*



Part #	Mfg #	Description	Price
010265	SOQ-12	1 qt, 12/Pk	



Power Sewer Machines

Ken-Way Junior Drain Cleaner

- Cleans 1" to 4" drain and process lines
- All steel construction
- Can handle cable sizes 1/4" to 1/2"
- Three drum size options
- Chuckless design speeds cable feeding
- Air powered foot switch
- Heavy-duty 1/4 hp motor
- Dimensions: 14"H x 17-1/2"W x 11"D
- Weight without cable: 24 lbs



Part #	Mfg #	Description	Price
110571	J045	Ken-Way Jr. Drain Cleaner w/Regular Drum & 3/8" x 50' Blade End Cable & Blades	



Power Sewer Machines

Super-Vee™ Drain Cleaners

Super-Vee™ Drain Cleaner Kit

- Includes:
 - Basic unit (side action chuck, variable speed motor with reversing switch)
 - Case
 - HECS Cutter set
 - (1) Additional cartridge

Part #	Mfg #	Description	Price
019540	SV-C-WC	1/4" x 50' (50HE1) & 3/8" x 35' (35HE2) Cables	

Mini-Router™ Drain Cleaners

Mini-Router™ Drain Cleaner Kit

- Includes:
 - Basic unit (MR-200 drum, 1/3 hp motor with reverse switch, 10' power cord, ground fault interrupter, waterproof air foot switch, leather gloves and cable)
 - MRCS Cutter set (AH arrow head, BG boring gimlet, 1-1/2" U & 1-1/2" U-cutter, 2" SCB side cutter blade)

Part #	Mfg #	Description	Price
005054	MR-B	75' x 3/8" (75EM2) Cable & MRCS Cutter Set	

Mini-Router™ Drainer Cleaner Accessories



Part #	Mfg #	Description	Price
028942	MR-W	Mini-Router™ Dolly	

Flexicore Cables

- With male and female connectors 

Part #	Mfg #	Size	Price
005072	50EM2	3/8" x 50'	
027735	100EM5	3/4" x 100'	

Replacement Cables



Basin Plug Head

Part #	Mfg #	Description	Price
020328	25HE1	1/4" x 25' w/EI Basin Plug Head	
005073	50HE1	1/4" x 50' w/EI Basin Plug Head	

Cutters

Cutters for 3/8" Cable

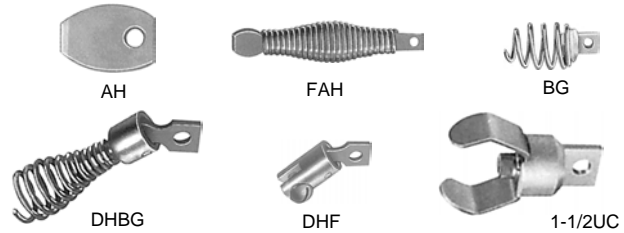

Part #	Mfg #	Description	Price
005048	AH	Arrow Head	
018911	FAH	Flex Arrow Head	
005049	BG	Boring Gimlet	
005051	DHBG	Down Head Boring Gimlet	
005052	DHF	Down Head Fitting	
005065	1-1/2UC	1-1/2" U-Cutter	

Cutters for 5/8" & 3/4" Cable

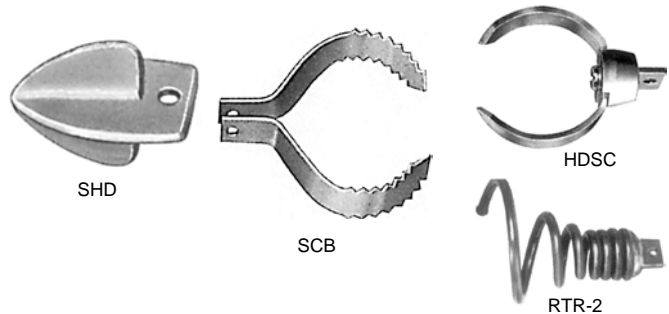

Part #	Mfg #	Description	Price
019877	SHD	Spear Head Starting Drill	
005069	3SCB	3" Side Cutter Blade - 2-Pc	
005071	4SCB	4" Side Cutter Blade - 2-Pc	
017789	3HDSC	3" Heavy-Duty Side Cutter	
019876	RTR-2	Corkscrew Retrieving Tool	



Power Sewer Machines

Connectors

Basic Connector



Part #	Mfg #	Description	Price
019868	5/8FC	5/8" Female, Butt Weld	
019870	3/4FC	3/4" Female, Butt Weld	
005070	3/8E-FC	3/8" Female, For 3/8" EM Cable	
019865	3/8MC	3/8" Male	
019867	1/2MC	1/2" Male	
019869	5/8MC	5/8" Male, Butt Weld	
019975	3/4MC	3/4" Male, Butt Weld	

Quick Fix Connector



Part #	Mfg #	Description	Price
019860	1/2QF	1/2" Quick Fix	
019862	5/8QF	5/8" Quick Fix	
017788	3/4QF	3/4" Quick Fix	

Connector Screw

Part #	Mfg #	Description	Price
019864	5/8CS	5/8", 5-Pack, For Butt Weld	
005050	3/4CS	3/4", 5-Pack, For Butt Weld	

D-25 Handy™ Drain Cleaner Heads

D-25 Handy™ Drain Cleaner Head - Down Head (DH)

- Flexicore™ cable units
- Can be attached to a drill



Part #	Mfg #	Description	Price
095198	D-25-2	1/4" x 25'	

Flexicore® Wire Rope Center Drain Augers

Regular Head less Handle

- Includes rotary handle
- Hand wire only



Part #	Mfg #	Description	Price
043667	L-25FL1	1/4" x 25'	

Down Head less Handle

- Includes rotary handle
- Hand wire only



Part #	Mfg #	Description	Price
097172	L-25FL1-DH	1/4" x 25'	

Flat Sewer Rods

- Oil tempered - rust ban coated
- Quick-Grip handle
- Roller head



Flat Sewer Rod for 4" - 6" Pipe

Part #	Mfg #	Size	Lgth	Price
032705	100D	3/4" x 1/8"	100'	

Refrigeration Tools

Service Tools

Part #	Mfg #	Description	Price
181298	18978	Schrader Rethreading Tool	
181299	18979	Broken Schrader Remover	

4-In-1 Seal Kit

- Kit includes:
 - Core
 - Cap
 - Gasket
 - 4 "O"-Rings



Part #	Mfg #	Size	Price
181296	18974	1/4"	

4-In-1 Vacuum/Charge Ball Valve Tool

- 800 psi working pressure



Part #	Mfg #	Size	Side Port	Price
181295	18971	1/4"	No	
181298	18978	1/4"	Yes	
181300	18985	5/16"	No	

Gas Retention Valve

- 1/4" Female fl. x 1/4" Male fl.
- 500 psi working pressure
- Back seat valve feature to retain gas in hose when disconnecting
- Closes Schrader before disconnecting



Part #	Mfg #	Size	Price
181302	18993	1/4"	

Hoses

FlexFlow™ Low Loss Adapter Hoses

- 8" Bend radius
- 4,000 psi minimum burst
- 800 psi maximum working pressure
- Operating temperature -20° to 180°F
- 3-Pak includes a yellow, blue, & red hose



Compact Ball Valve Assemblies

Part #	Mfg #	Size	Length	Color	Price
181631	29201	1/4"	9"	Blue	
181633	29601	1/4"	9"	Red	
181646	29980	1/4"	9"	3 Pak	

FlexFlow™ Assemblies

Part #	Mfg #	Size	Length	Color	Price
181564	25002	1/4"	9"	Yellow	
181565	25202	1/4"	9"	Blue	
181566	25602	1/4"	9"	Red	
181620	25980	1/4"	9"	3 Pak	

Large VolumePlus II™ Hose (3/8" FI. Str. x 3/8" FI. Str.)

- 3,000 psi burst
- 600 psi working pressure
- For vacuum and charging



Part #	Mfg #	Size	Length	Price
181289	14560	3/8"	60"	

Plus II™ Heavy Duty Charging/Vacuum Hose

- 8" Bend radius
- 3,000 psi minimum burst
- 600 psi maximum working pressure
- Operating temperature -22° to 176°F



Part #	Mfg #	Size	Length	End Type	Price
181291	15648	3/8"	48"	3/8"StrX3/8"Str	
237904	15660	3/8"	60"	3/8"StrX3/8"Str	
236454	16236	3/8"	36"	3/8"StrX1/4" 45°	
181540	19660	3/8"	60"	3/8"StrX3/8" 45°	
246789	16248	3/8"	48"	3/8"StrX1/4" 45°	

Plus II™ Heavy Duty Charging/Vacuum Hose

- 10" Bend radius
- 3,000 psi minimum burst
- 600 psi maximum working pressure
- Operating temperature -22° to 176°F



Part #	Mfg #	Size	Length	End Type	Price
247829	16448	1/4"	48"	1/4"Angle x 1/2"	
181292	15848	1/2"	48"	1/2" x 1/2"	
181543	20660	3/8"	60"	3/8" x 3/8"	

Plus II™ "B" Charging Hose

- 6" Bending radius
- 3,000 psi minimum burst
- 600 psi maximum working pressure
- Operating temperature -20° to 180°F



Part #	Mfg #	Color	Length	End Type	Price
181293	18160	Yellow	60"	3/8Str x 3/8 45°	
181542	20460	Yellow	60"	1/4Str x 1/4 45°	
181630	28060	Red	60"	(3/8) Str FlxStr FI	

Refrigeration Tools

Plus II™ Hose with Compact Ball Valve End

- Full flow valve
- 6" Bending radius
- 4,000 psi minimum burst
- 800 psi maximum working pressure
- Operating temperature -20° to 180°F
- Uses standard gasket and valve opener
- 3-Pak includes a yellow, blue, and red hose



Part #	Mfg #	Size	Length	Color	Price
181647	29985	1/4"	60"	3 Pak	

Plus II™ Charge Hose w/ Double Barrier Protection

- 6" Bending radius
- 4,000 psi minimum burst
- 800 psi maximum working pressure
- Operating temperature -20° to 180°F
- 3-Pak includes a yellow, blue, and red hose



Part #	Mfg #	Size	Length	Color	Price
181545	21024	1/4"	24"	Yellow	
181376	21060	1/4"	60"	Yellow	
181377	21260	1/4"	60"	Blue	
181546	21312	1/4"	12'	Blue	
181547	21636	1/4"	36"	Red	
181378	21660	1/4"	60"	Red	
181548	21712	1/4"	12'	Red	
181550	21985	1/4"	60"	3 Pak	

Plus II™ Hose with FlexFlow™ Valve

- 6" Bending radius
- 4,000 psi minimum burst
- 800 psi maximum working pressure
- Operating temperature -20° to 180°F
- Valve handle position shows when valve is opened or closed
- 3-Pak includes a yellow, blue, and red hose



Part #	Mfg #	Size	Length	Color	Price
181606	25060	1/4"	60"	Yellow	
181609	25260	1/4"	60"	Blue	
181610	25660	1/4"	60"	Red	
181623	25983	1/4"	36"	3 Pak	
181625	25984	1/4"	48"	3 Pak	
181627	25986	1/4"	72"	3 Pak	

Plus II™ Hose with SealRight™ Fitting

- 45° End
- 6" Bending radius
- 4,000 psi minimum burst
- 800 psi maximum working pressure
- Operating temperature -20° to 180°F
- Low loss anti-blow back SealRight™ fitting
- Gaskets resist deterioration from existing CFC, HCFC and HFC refrigerants and oils
- Available with SealRight™ fittings on both ends
- 3-Pak includes a yellow, blue, and red hose



Part #	Mfg #	Size	Length	Color	Price
181556	22060	1/4"	60"	Yellow	
181558	22236	1/4"	36"	Blue	
181559	22260	1/4"	60"	Blue	
181560	22660	1/4"	60"	Red	
181561	22983	1/4"	36"	3 Pak	
181340	22985	1/4"	60"	3 Pak	
181562	22986	1/4"	72"	3 Pak	

Plus II™ Hose for Flare & Service Ports

- For 5/16" flare (1/2 – 20 thread) service ports for R-410A
- 6" Bending radius
- 4,000 psi minimum burst
- 800 psi maximum working pressure
- Operating temperature -20° to 180°F
- Compatible with both POE and PVE oils
- 3-Pak includes a yellow, blue, and red hose
- Yellow hose has 1/4" (7/16-20) compact ball valve



Part #	Mfg #	Size	Length	Color	Price
181644	29485	1/4"	60"	3 Pak	

Quick Connects

Part #	Mfg #	Description	Price
181307	19010	CH20 & CH14 for 1/4" Hose	
181310	19011	CH11 Gasket for 3/8" Hose	
181313	19020	CH20 for 1/4-1/2" Acme Hose	
181314	19026	3/8" Quad Ring Pack (10PK)	
181315	19037	1/4" SealRight O-Ring (10PK)	
181316	19040	SealRight Repair Kit with Valve, Gasket, Plug, Spring, and 2 O-Rings	

SealRight™ Quick Couplers

Part #	Mfg #	Description	Price
181317	19100	Quick Cplg Set 19109&19209	
249860	19203	90° 3/8" FM QC x 3/8" M Flr	

Refrigeration Tools

Quick Connects (Continued)

SealRight™ Quick Couplers

Part #	Mfg #	Description	Price
181515	19208	45° 1/4" SealRight x 1/4" M Flr	
181516	19209	90° 1/4" SealRight x 1/4" M Flr	

Cylinder Valve Adapter

- Finger tight adapters fit 125 and 145 lb cylinders
- Seal remains seated



Part #	Mfg #	Description	Price
181320	19105	3/4" NPS x 1/4" Male Flare	

Compact Ball Valve

- 4,000 psi minimum burst
- 800 psi maximum working pressure
- 5/16" for R-410A applications where 5/16" system ports are used



Part #	Mfg #	Description	Price
182367	93825	5/16" for Fml Flr x 1/4" M Flr	
182369	93843	1/4" 45° Compact Ball Valve	

Vacuum Pump Adapter

- Convert a 3/8" or 1/2" vacuum pump intake into 1/4" and 1/2" Acme R-134a compatible fittings



Part #	Mfg #	Adapter	Flare	Ftgs	Price
181648	36019	3/8"	1/4"	1/2"	

Auto A/C Fittings Couplers



Part #	Mfg #	Description	Price
181319	19102	R-134a 1/4" Fml QCx3/8" M FI	
181321	19109	R-12 (1/4") SealRight x M Flr	
181512	19191	R-12 1/4" fe QC x 90° 1/4" M Flr with Schrader	

Quick Coupler with Schrader Core in Male End



Part #	Mfg #	Description	Price
181380	19173	5/16" QC Fml x 1/4" Male Flr	

Manifold Gauge Sets

Manifold Parts & Accessories

Part #	Mfg #	Description	Price
181726	40279	Manifold Hanging Hook	
236521	41082	Titan 4-Valve Rebuild Kit	
181364	42001	Series 41 Manifold Only R22/404A/410A	
181809	42004	Series 41 Manifold R22/404A/410A with 60" PLUS II Standard Fittings	

Brute II™ Test and Charging Manifold

- 1/4" Hi-/lo-sides with 3/8" vacuum port
- Manifold and hose holder fittings: 1/4"-3/8"-1/4"-1/4"
- Front access for easy field recalibration
- Double "O" ring piston
- Contoured color-coded easy-grip handles



Part #	Mfg #	Description	Price
181835	46003	Test and Charging Manifold	

Refrigeration Tools

P51 Series Titan™ Digital Manifold

- Auto shut-off
- USB charging port
- Robust housing
- On board data logging
- 4-way TITAN valve block
- Includes:
 - Vacuum sensor
 - 2 temperature clamps
 - Backpack carrying case
 - Set of four manifold hoses (3 1/4" RYB and 1 3/8" yellow vacuum hose)
- Backlit display with auto-dimming
- Pressure hold mode displays rate of change for both vacuum and positive pressure measurements
- 126 refrigerant profiles stored in the instrument including new blends not currently on the Refprop database
- Maximum working pressure 700 psi
- System superheat and subcooling calculations
- Bluetooth capability for use with ManTooth app
- Re-chargeable battery with battery life indicator
- Displays vapor and liquid saturation temperatures



Part #	Mfg #	Description	Price
246160	P51-870	Titan Digital Manifold	

Vacuum Gauges

Part #	Mfg #	Description	Price
182267	69071	Gauge Coupler, 1/4" Fml FI	
182268	69073	Replacement Sensor for Models 69070 and 69075	
182286	69095	Tee Fitting for 69080	

Digital LCD Economy Vacuum Gauge

- Low battery indicator
- Simple On/Off controls
- Calibration standards traceable to NIST
- Sensor handles 450 psi positive pressure
- Automatic battery saver shuts gauge off after 20 minutes with no reading changes
- Includes 9V alkaline battery and hanging hook
- Thermal conductivity sensor automatically compensates for temperature with no calibration



Part #	Mfg #	Description	Price
182282	69080	Battery, Hook, & Pouch Included	

Hand-Held Digital Vacuum Gauge

- 12" coiled sensor cord
- Low battery indicator
- Accuracy: +/- 20% of reading
- Automatic shut-off after 20 minutes
- Plug-in sensor (part #69087) handles 450 psi positive pressure
- Calibration standards traceable to NIST
- 32° to 122°F operating temperature range
- Magnetized on back for secure, upright positioning on any magnetized surface
- Displays 7 different units of vacuum (microns, milliTorr, Torr, millimeters of mercury, millibar, kiloPascal and Pascal)
- Thermal conductivity sensor automatically compensates for temperature



Part #	Mfg #	Description	Price
181363	69086	Hand-Held with Carry Pouch	

Omni™ Digital Vacuum Gauge

- 450 psi proof pressure
- (2) AAA batteries included
- 45° degree bend for fitting
- Audio and visual signal when target vacuum level is reached
- Automatic power down and time out
- Low battery indicator and automatic power-down when inactive
- 32°F to 104°F Working temperature
- Electronic paper display for clear visibility
- Power savings – multiple time-out selections
- Adapter fittings available



Part #	Mfg #	Description	Price
231050	69020	With 1/4" Coupler	

Superevac™ LCD Vacuum Gauge

- 3 Second response time
- Automatic calibration
- D cell battery power
- Accuracy: ± 20% of reading
- 5-1/2' Coiled sensor cable —1/4" male flare connection
- Calibration standards traceable to NIST
- Case protects electronic circuitry and sensor
- 32° to 120°F Operating temperature range
- Automatic shut-off 20 minutes after power up
- Normal handling/jarring will not affect the LCD reading



Part #	Mfg #	Description	Price
182269	69075	Full Range Complete in Case	

Refrigeration Tools

Vacuum Pumps & Oil

Part #	Mfg #	Description	Price
181303	18997	Grappler Rod/Nut Assy for Vacuum/Charge Valve	
182337	93047	Bullet Drive Coupling with Spider	
182338	93050	Coupling Spider for 93047	

Bullet™ Vacuum Pump

- 28 oz.(7cfm) or 30 oz.(5cfm) oil capacity
- 16.25" L x 6" W x 11.5" H
- 1/4" x 3/8" x 3/8" Intake
- Heavy duty rotors and bearings
- Heavy duty steel handle
- Power cord: 6' motor mounted switch
- Tethered port caps stay with the pump
- Metal with rubber overlay base for stability
- Large oil sight glass for easy monitoring of oil level
- Large brass oil drain for easy access to oil changes
- Intake filter screen keeps damaging particles from entering the pump
- Internal intake check valve prevents oil backup into the system during a power failure
- Wide-mouth oil reservoir port which doubles as pump exhaust-threaded to attach garden hose



Part #	Mfg #	CFM	Volts	HZ	Phase	Price
224708	93605	5	115	60	1	
182366	93600	7	115	60	2	

Bullet™ Vacuum Pump Cover Assembly

Part #	Mfg #	Description	Price
246632	93650	Pump Cover Assembly	

Superevac™ CFM Pump

- 34 oz. oil capacity
- 16.25" L x 6" W x 11.5" H
- 1/4" and 3/8" Male flare intake
- Built-in vacuum indicator gauge
- Heavy duty rotors and bearings
- Heavy duty steel handle with lift hook
- Tethered port caps stay with the pump
- Metal with rubber overlay base for stability
- Gas ballast valve keeps oil cleaner and longer
- Large oil sight glass for easy monitoring of oil level
- Large brass oil drain for easy access to oil changes
- Intake filter screen keeps damaging particles from entering the pump
- Internal intake check valve prevents oil backup into the system during a power failure
- Wide-mouth oil reservoir port which doubles as pump exhaust-threaded to attach garden hose



Part #	Mfg #	CFM	Volts	HZ	Phase	Price
181344	96560	6	115	60	1	

Vacuum Pump Oil

- Recommend using the current mineral-based pump oil when working with both R-12 and R-134a A/C systems



Part #	Mfg #	Size	Qty Per Case	Price
181362	93092	Quart	12	
193501	93096	Gallon	6	

Miscellaneous Tools

Part #	Mfg #	Description	Price
181538	19302	CH14 Openers, 10 Pak	

Deluxe Ratchet Hand Bender Kit

- Reverse bending mandrel
- Index marks to locate bends
- Trouble free ratchet mechanism
- Quick change bending mandrels and shoes
- Hard copper must be annealed before bending
- Complete tube bender kit includes all items required to bend 1/4", 5/16", 3/8", 1/2", 5/8", 3/4" and 7/8" tubing



Part #	Mfg #	Description	Price
214566	60325	Ratchet Hand Bender Kit	

Refrigeration Tools

Digital Electronic Charging Scale

- Mechanical overload protection and "OL" alert on LCD
- Minus (-) reading shows weight removed from the platform
- Single point load cell strain gauge
- Removable control module on retractable 5' coiled cord
- Calibration standards traceable to NIST
- Convert standard 68802 and 68800 scales to programmable with upgrade kits 68804 and 68805



Part #	Mfg #	Description	Price
182255	68802	Electronic Scale 110 lbs.	

Mini-Split Tool Kit

- Includes R-410A service tools and:
 - Heat pump manifold —Designed to handle all mini-split refrigerants & pressures
 - 60" PLUS II Hoses —4,000 psi minimum burst —800 psi Max working pressure —RYB 1/4" with 1/4" flare fittings
 - Eccentric cone flare tool —For 3/16" to 3/4" O.D. tubing
 - Hex key set —5/32", 3/16", 5mm and 6mm
 - Vacuum/charge valve with side port —5/16" x 1/4" x 1/4" (18986)
 - Adjustable metric torque wrench —16, 17, 21, 22, 24, 26, 27, & 29 mm flare nuts
 - 45° R-410A coupler 5/16" fml quick coupler x 1/4" m flr
 - Tube cutter and deburring tool
 - 16" Tool bag —Nylon, strap included, 25 pockets



Part #	Mfg #	Description	Price
182248	60991	R-22/407C/410A Heat Pump Manifold	

Repair Parts Kit

- Five 1/8" gaskets
- Five 1/8" valve openers
- One hundred 3/16"—1/4" gaskets
- Ten 1/4" Adjust-a-Valve openers
- Ten 1/4" flat valve openers
- Ten 3/8" gaskets
- Ten 1/2"—5/8" gaskets
- Ten cylinder valve flat gaskets
- Ten SealRight™ "O" rings
- Four SealRight™ plug and seal assemblies
- Four 1/4" SealRight™ nut and clip



Part #	Mfg #	Description	Price
181305	19003	Complete Kit	

Recovery Machine Components and Parts

Part #	Mfg #	Description	Price
188504	67002	ManTooth PT Dual with Rubber Boot (tethered)	
226828	67020	ManTooth V (Vacuum-only) w/ Side Grip	
226830	67023	ManTooth PTV Dual w/ Side Grip	
182379	95231	Piston Cup	
182380	95325	High Pressure Switch	
213654	95730	YJ-LTE Refrigerant Recovery System	
181361	95760	RecoverXLT 115V/60 Hz	

Sheet Metal Tools

Snips for Metal and Vinyl

Max2000™ Aviation Snips

- An adjustable crossover disk assures an optimal length of cut that remains smooth and accurate
- Machined serrations on outside face of cutting edge
- Thicker, stronger steel handle resists abuse and will not collapse under normal use
- Length: 10-3/4"



Part #	Mfg #	Description	Price
032962	M2001	Cuts Left, Red Ergonomic Grip	
032963	M2002	Cuts Right, Green Ergonomic Grip	
032964	M2003	Combination, Yellow Ergonomic Grip	

Max2000™ Bulldog Aviation Snips

- Designed for notching and trimming
- Ideal for cutting multiple layers or "S" cleats



Part #	Mfg #	Description	Price
032965	M2005	Red Ergonomic Grip	

Max2000™ Offset Aviation Snips

- Cuts straight line and 5" diameter circles



Part #	Mfg #	Description	Price
036461	M2006	Cuts Offset Left, Red Ergonomic Grip	
036462	M2007	Cuts Offset Right, Green Ergonomic Grip	

Andy™ Classic Snips

- Suitable for mild curve cuts, straight shearing, or cutting multiple layers of sheet metal
- Lightweight aluminum handle
- 3" Cutting length



Part #	Mfg #	Description	Price
006451	M12A	12" Length	

Andy™ Pattern Snips

- Ground blade edge
- Suitable for mild curve cuts, straight shearing, or cutting multiple layers of sheet metal
- Lightweight aluminum handle
- Larger handle loops
- Extended blade tips
- 3-1/4" Cutting length



Part #	Mfg #	Description	Price
057978	M14N	14" Length	

Sheet Metal Tools

Awls

Scratch Awl

- High carbon alloy tool steel blade polished to resist rust
- May be re sharpened many times
- Easy-to-spot orange handles are shock and shatter resistant

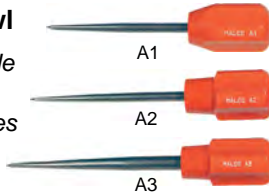

Part #	Mfg #	Blade Dia	Nom Length	Price
006370	A1	7/32"	5-3/4"	
006371	A2	1/4"	6-1/4"	
006373	A3	3/8"	7-1/2"	

Scribers

Pocket Size Sheet Metal Scriber

- Five teeth produce 10 scribing depths
- Compact scribe stores in pocket, pouch or tool box
- Use hang hole or magnet to keep handy on the job



Part #	Mfg #	Min/Max Adjustments	Price
038068	A40	1/8" - 1" Depths	

Adjustable Sheet Metal Scriber

- Measure, mark and scribe in one easy operation
- Depth up to 12-1/2"
- Compact design
- Durable construction
- Constructed of rust resistant nickel plated steel
- Knob assembly with hardened steel bolt insert will not strip out
- Uses Zip-In® sheet metal screw making point replacement easy



Part #	Mfg #	Min/Max Adjustments	Price
006376	A60	1/4" - 12-1/2" Depths	

Dividers

- Length: 11"
- Scratch awl points are easily re sharpened or replaced
- Nickel-plated steel body



Part #	Mfg #	Description	Price
006515	#18	32" Max Circle Diameter	

Dividers (Continued)

Part #	Mfg #	Description	Price
006522	#24	42" Max Circle Diameter	
021655	RP2	Divider Points for #18 and #27	

Folding Tools

- Folding seams are formed from two steel halves, permanently joined together



Part #	Mfg #	Width	Folding Depths	Price
006512	12F	12"	3/8" and 1"	
006516	18F	18"	3/8" and 1"	

Duct Tools and Accessories

Duct Stretcher

- Wheels can be changed to other side of tool for applications where side of duct is close to wall or obstruction



Part #	Mfg #	Description	Price
006386	DS1	16"	
006388	DS2	16" Offset Handle	
025654	DS3	12" Locking	

TurboShear™ Drills

TurboShear™

- Attaches to the chuck of a 1200 rpm, 12V cordless or an A/C electric drill
- Makes fast cuts in sheet metal
- Capable of making precise 6" x 6" square hole cuts
- 20 Gauge capacity in spiral duct
- 18 Gauge capacity in galvanized steel
- Material must be pre-set or held by an assistant
- Shear cuts to the left
- Use TSDC drill clamp for 1-hand operation



Part #	Mfg #	Description	Price
007222	TS1	TurboShear™ Sheet Metal Cutter	

Sheet Metal Tools

Hole Cutters

"Gold Standard" Hole Cutter

- Cuts holes up to 12" diameter in 20 gauge sheet metal
- Use with any standard 1/4" electric drill
- Cast aluminum body
- All wearing parts made of special heat-treated steel



Part #	Mfg #	Hole Diameter	Price
006408	HC1	2" - 12"	

REDLINE™ Hand Tools

5-Blade Pipe Crimper

- One-hand operation latch
- Soft-touch, non-slip handle insert
- Ergonomically contoured handles



Part #	Mfg #	Throat Depth	Price
131064	C5R	1-5/8"	

Hand Notcher

- One-hand operation latch
- Soft-touch, non-slip handle insert
- Ergonomically contoured handles
- Opening maximizes handle leverage



Part #	Mfg #	Throat Depth	Price
132797	N1R	13/16"	
132798	N2R	1"	

Hand Seamer with Forged Steel Jaw

- One-hand operation latch
- Soft-touch, non-slip handle insert
- Ergonomically contoured handles
- Opening maximizes handle leverage



Part #	Mfg #	Jaw Depth	Jaw Width	Price
132799	S2R	1-1/4"	3-1/4"	
132801	S6R	1-1/4"	6"	

Offset Hand Seamer with Forged Steel Jaw

- One-hand operation latch
- Soft-touch, non-slip handle insert
- Ergonomically contoured handles
- Opening maximizes handle leverage



Part #	Mfg #	Jaw Depth	Jaw Width	Price
132800	S3R	1-1/4"	3-1/4"	

Snap Lock Punch for Siding

- One-hand operation
- Ergonomic handles
- Opening maximizes handle leverage



Part #	Mfg #	Length	Throat Depth	Price
006483	SL1R	8"	3/8"	

Sheet Metal Tools

Crimpers

Single Crimper with Red Grip

- Fast, easy to use and lightweight
- Handy lock makes tool pocket sized
- Length: 8"



Part #	Mfg #	Throat Depth	Price
020268	SC1	1-1/4"	

Riveting Tools

2-in-1 Hand Riveter

- Adjustment features a single long stroke and a short ratchet action



Part #	Mfg #	Capacity	Price
006518	2-IN-1	1/8"-3/16" Rivet w/Steel Mandrel, 3/32- 5/32" Rivet w/SS Mandrel 8"Long	

Fiberglass Flex Duct Tools

Tensioning Tool

- Hardened steel stampings with weather resistant nickel chrome finish
- Vinyl grips with hand stops
- Tensioning adjustment knob and auto cut-off mechanism



Part #	Mfg #	Description	Price
006499	TY6	High Leverage Tie Tool, Auto Cut-Off	

Tie Tool

- Action tie tools feature long wearing, serviceable parts
- Comfortable handles reduce the pinch point area
- Works on all ties including thin designs



Part #	Mfg #	Description	Price
006498	TY4	Manual Cut-Off	

Flex Duct Cutter and Shear

- Double edged knife blade
- Thumb operated latch
- Easily resharpenable
- Handles feature non-slip vinyl grips



Part #	Mfg #	Description	Price
006389	FDC1	Flex Duct Cutter	



Sheet Metal Tools

Snips

Aviation Snips

- One handed metal lock
- Ergonomic grips
- Flush pivot design
- Forged serrated blades bolt lock
- Up to 22-gauge stainless & 18-gauge cold rolled steel



48-22-4510

Part #	Mfg #	Cut	Price
238535	48-22-4510	Left	
238536	48-22-4520	Right	
238537	48-22-4530	Straight	
238543	48-22-4537	Long Cut Straight	

Offset Snips

- One handed metal lock
- Ergonomic grips
- Lanyard hole
- Flush pivot design
- Forged serrated blades bolt lock
- Up to 22-gauge stainless & 18-gauge cold rolled steel

Part #	Mfg #	Cut	Price
238538	48-22-4512	Left	
238540	48-22-4522	Right	
238542	48-22-4532	Straight Offset	
238544	48-22-4538	Long Cut Straight	

Snip set Includes
Left cut (48-22-4512)
Right Cut (48-22-4522)

Part #	Mfg #	Description	Price
238548	48-22-4523	2-Pc Snip Set	

Bulldog Aviation Snips

- One handed metal lock
- Ergonomic grips
- Lanyard hole
- Flush pivot design
- Forged serrated blades bolt lock
- Up to 22-gauge stainless & 18-gauge cold rolled steel



Part #	Mfg #	Description	Price
238545	48-22-4500	Bulldog Aviation Snips	

Angle Snips

- One handed metal lock
- Ergonomic grips
- Lanyard hole
- Flush pivot design
- Forged serrated blades bolt lock
- Up to 22-gauge stainless & 18-gauge cold rolled steel



Part #	Mfg #	Cut	Price
238546	48-22-4511	Left Angle	
238547	48-22-4521	Right Angle	

3-PC Aviation Snips Set

- One-handed locking
- Flush bolt design
- Forged alloy steel blades
- Rust protection
- Serrated jaws
- Ergonomic handles
- Up to 22-gauge stainless & 18-gauge cold rolled steel
- Set includes:
 - Straight cutting snips (48-22-4030)
 - Right cutting snips (48-22-4020)
 - Left cutting snips (48-22-4010)



Part #	Mfg #	Description	Price
238549	48-22-4533	3-Pc Aviation Snips Set	

Miscellaneous Tools

Classic Thinner

- 40% Larger Handles
- Cuts up to 20ga Cold Rolled Steel/22ga Stainless Steel
- Bolt lock technology - Blades will not loosen
- All-metal contoured handles for durability and comfort
- Forged strength design
- Rust Resistant



Part #	Mfg #	Description	Price
175014	48-22-4002	12"	

Sheet Metal Tools

Offset Compound Tinner

- 40% Larger Handles
- Cuts up to 20ga Cold Rolled Steel/22ga Stainless Steel
- Bolt lock technology - Blades will not loosen
- All-metal contoured handles for durability and comfort
- Forged strength design
- Rust Resistant



Part #	Mfg #	Description	Price
175015	48-22-4005	Compound Offset	

Lightweight Tinner

- 40% Larger Handles
- Cuts up to 24ga Cold Rolled Steel/26ga Stainless Steel
- Best-in-class 3 1/2" Replaceable Blades
- All-metal contoured handles for durability and comfort
- Rust Resistant



Part #	Mfg #	Description	Price
175016	48-22-4006	13"	

Replacement Blades

- Lightweight replacement blades for (48-22-4006) tinner snips



Part #	Mfg #	Description	Price
175017	48-22-4007	For 48-22-4006	

Bulldog Tinner

- 40% Larger Handles
- Cuts up to 16ga Cold Rolled Steel/18ga Stainless Steel
- Bolt lock technology - Blades will not loosen
- All-metal contoured handles for durability and comfort
- Forged strength design
- Rust Resistant



Part #	Mfg #	Description	Price
175111	48-22-4001	16"	

Duckbill Tinner

- 40% Larger Handles
- Cuts up to 22ga Cold Rolled Steel/24ga Stainless Steel
- Bolt lock technology - Blades will not loosen
- All-metal contoured handles for durability and comfort
- Forged strength design
- Rust Resistant



Part #	Mfg #	Description	Price
175114	48-22-4004	10"	

Seamers

- Forged head design
- Chrome plated - rust resistance
- Symmetrical handles



Part #	Mfg #	Description	Price
175012	48-22-6000	3" Speed Seamer	

5-Blade Crimper

- Reinforced crimper ribs
- Heavy duty spring
- Chrome plated - rust resistance
- Symmetrical handles



Part #	Mfg #	Description	Price
175013	48-22-6001	Up to 22ga rolled steel	

Lineman's Crimper w/ Fixed BG

- Contoured rubberized grip
- Fiberglass core
- Accepts W style crimping dies
- Integrated carabineer loops



Part #	Mfg #	Description	Price
256101	49-16-2601	Crimper	

Multi-Purpose Wire Stripper with Crimper

- Spring assisted
- Ergonomic Handles with Dipped Grips
- Shears Bolts for 4-40, 5-40, 10-32 & 10-24
- Crimper for Insulated and Noninsulated Terminals
- Strips 10-20awg solid wire and 12-22awg stranded wire



Part #	Mfg #	Description	Price
257547	48-22-6579	Wire Stripper	



Sheet Metal Tools

Job Site Straight Scissors

- Iron carbide edge blades
- Smooth blades for burr-free cuts
- All metal core
- Bolt lock technology
- Rust protection
- Large handle loops
- Ruler markings on blade
- Index finger groove



Part #	Mfg #	Description	Price
168966	48-22-4041	Straight Scissors	

Job Site Offset Scissors

- Iron carbide edge blades
- Micro-Serrated blades
- All metal core
- Bolt lock technology
- Rust protection
- Large handle loops
- Ruler markings on blade
- Index finger groove



Part #	Mfg #	Description	Price
168964	48-22-4040	Offset Scissors	

Sheet Metal Tools

General Purpose Tools

Offset Snips

- 1-1/2" Cut length



Part #	Mfg #	Model	Description	Length	Price
017927	16202	796	Cuts Right	10-1/2"	
017926	16207	797	Cuts Left	10-1/2"	

Sheet Metal Tools

Sheet Metal Tools

Aviation Snips

- High-carbon steel blades with reinforce chrome silicone spring
- Color-coded handle inserts and soft grip
- Comfortable grip



Part #	Mfg #	Description	Price
177210	1891133	Aviation Snips Left Cut	
177211	1891134	Aviation Snip Right Cut	

Hand Seamers

- Comfortable grip
- High-carbon steel blades with reinforced chrome silicone spring
- Quick notification with 1/4" depth marks on blades



Part #	Mfg #	Description	Price
174605	1891183	3" Offset Hand Seamer	
174604	1891185	3" Hand Seamer	

Folding Tools

- Built for both 3/8" (10mm) and 1" (25mm) folds
- Equipped with sight holes for proper depth alignment



Part #	Mfg #	Description	Price
174607	1891146	12" Folding Tool	
174608	1890985	18" Folding Tool	
174610	1890986	24" Folding Tool	

Hole Cutters

- Fits into any corded or cordless drill with a 1/4" or larger chuck
- Lightweight aluminum frame, with a milled bit
- Inch and metric scales



Part #	Mfg #	Description	Price
175060	1891191	2" to 12" Hole Cutter	

Shovels

Shovels



Round Point Shovel with Long Handle

- 14 Gauge steel head and ferrule
- Shovel blades and shanks are 1-piece rustproof, taper-formed, then heat treated
- Handle length: 47"



Part #	Mfg #	Model	Blade Size	Price
008693	52300	170	8-5/8" x 11-1/2"	

Shovels

Heavy-Duty Commercial Shovels

Round Point Shovel with Long Fiberglass Handle

- 12 Gauge steel head and ferrule
- Closed back
- Wood reinforced fiberglass handle
- Handle length: 48-1/2"
- Overall length: 59-1/4"
- 100% American made



Part #	Mfg #	Description	Price
136120	92515	12ga Round Point Shovel	

Spades

Drain Spade D-Grip with Fiberglass Handle

- 12 Gauge steel head and ferrule
- Closed back
- Wood reinforced fiberglass handle
- Handle length: 32"
- Overall length: 40"
- 100% American made



Part #	Mfg #	Description	Price
136121	92535	12ga Drain Spade, Closed	

Floral & Speciality Shovels

Mud Shovel with Long Fiberglass Handle

- 14 Gauge steel head and ferrule
- Closed back
- Wood reinforced fiberglass handle
- Handle length: 48-1/2"
- Overall length: 59"
- 100% American made



Part #	Mfg #	Description	Price
136122	92705	14ga Mud Shovel, Closed	

Trunk Shovel with D-Grip Steel Handle

- 14 Gauge steel head and ferrule
- Closed back
- Steel handle
- Handle length: 24-1/2"
- Overall length: 32-3/4"
- 100% American made



Part #	Mfg #	Description	Price
147666	92712	14ga Trunk Shovel, Steel	

Trouble Lights/Extension Cords

Light Bulbs**Rough Service Light Bulb**

- *Multi-support filament*
- *Lasts twice as long as a standard bulb*
- *Frosted to reduce glare*



Part #	Mfg #	Description	Price
002314	8502	100 Watt Frosted	

Wrenches

Wrenches

Cheater Pipe Wrench

- 3 Length design
 - 10" Mode
 - 18" Mode
 - 24" Mode
- Overbite jaw
- Dual coil springs
- Ergonomic handle form
- Ergonomic hook jaw design
- Tether-ready handle loop



Part #	Mfg #	Description	Price
187995	48-22-7314	Cheater Pipe Wrench	

Steel Pipe Wrench

- Overbite Jaw
- Dual coil springs
- Ergonomic handle form
- Ergonomic hook jaw design
- Through hardened jaws
- Tether-ready handle loop



Part #	Mfg#	Size	Lenght	Price
187996	48-22-7110	10"		
187998	48-22-7114	14"		
187997	48-22-7112	12"		
187999	48-22-7118	18"		
255419	48-22-7106	6"		
255420	48-22-7108	8"		
255421	48-22-7124	24"		
255422	48-22-7136	36"		
255423	48-22-7148	48"		
255424	48-22-7160	60"		

Aluminum Pipe Wrench

- Overbite Jaw
- Dual coil springs
- Ergonomic handle form
- Ergonomic hook jaw design
- Through hardened jaws
- Tether-ready handle loop



Part #	Mfg#	Size	Length	Price
188000	48-22-7210	10"	13-1/2"	
188001	48-22-7212	12"	15"	
188002	48-22-7214	14"	17"	
188003	48-22-7218	18"	20-1/2"	
188004	48-22-7224	24"	27"	
255425	48-22-7236	36"	41"	
255426	48-22-7248	48"	54"	

Aluminum Offset Pipe Wrenches

- Ergonomic Handle Design
- Jaw Capacity 2"
- Jaw opening parallel to the handle and a narrower hook jaw head



Part #	Mfg #	Description	Price
255429	48-22-7184	14"	
255430	48-22-7185	18"	
255431	48-22-7182	24"	

Aluminum Pipe Wrench with POWERLENGTH™ Handle

- New-to-world POWERLENGTH™ design featuring high-leverage handle
- OVERBITE JAW™ allows for largest gripping surface
- Dual coil springs for maximum durability and tool life
- Ergonomic handle design that helps prevent fatigue and slip
- Jaw capacity 1-1/2"



Part #	Mfg#	Size	Length	Price
255418	48-22-7213	10"	18-1/2"	

Wrenches

Smooth Jaw Pipe Wrench

- Smooth Jaw Protects Surfaces
- Ergonomic Handle
- Jaw Capacity 2-5/8"
- Parallel Grip



Part #	Mfg #	Description	Price
255428	48-22-7186	12"	

Steel Offset Hex Pipe Wrench

- Smooth jaw
- Ergonomic handle
- Jaw capacity 2-5/8"
- Up to 3 points of contact for a secure grip



Part #	Mfg #	Description	Price
255427	48-22-7171	10-1/2"	

Adjustable Wrench

- Proprietary adjustment screw
- Ergonomic handle form
- Tether-ready handle loop
- Parallel jaws won't slip or damage finish surfaces
- Adjustment screw gears for smooth adjustment
- Chrome plated for rust protection and durability
- Laser etched ruler for easy-to-read, accurate size adjustment



Part #	Mfg#	Size	Price
187479	48-22-7400	(2Pc) 6"&10"	
187485	48-22-7406	6"	
187484	48-22-7408	8"	
187482	48-22-7410	10"	
187481	48-22-7412	12"	
187480	48-22-7415	15"	

Wide Jaw Adjustable Wrench

- Wide-jaw design for increased jaw capacity in confined environments
- Proprietary Adjustment Screw
- Ergonomic handle form
- Parallel jaws won't slip or damage finish surfaces
- Adjustment screw gears designed for smooth adjustments
- Chrome plated for rust protection and durability
- Laser etched ruler for easy-to-read, accurate size adjustment



Part #	Mfg #	Size	Price
187483	48-22-7508	8"	

Basin Wrench

- Forged, spring-loaded jaw
- Ergonomic handle design for maximum comfort and one-handed use
- Ratchet-ready handle design for maximum speed and torque
- Easy to adjust telescoping handle 10"-17"
- Screwdriver ready through hole handle design for maximum leverage and break-away torque
- Pivoting jaws up to 90° for access to tight spaces



Part #	Mfg #	Description	Price
186460	48-22-7001	1.25" Capacity	
186462	48-22-7002	2.5" Capacity	

7-PC Combination Wrench Set - SAE

- MAX BITE™ open-end grip
- I-beam handle design
- Ink-filled size labels
- Organized storage solution
- Includes: 3/8", 7/16", 1/2", 9/16", 11/16", 3/4", 5/8"



Part #	Mfg #	Description	Price
241912	48-22-9407	7 Pieces	



Wrenches

7-PC Combination Wrench Set - Metric

- MAX BITE™ Open-End Grip
- Ink-filled size labels
- Includes:
 - (1) 8mm Combination Wrench
 - (1) 10mm Combination Wrench
 - (1) 12mm Combination Wrench
 - (1) 13mm Combination Wrench
 - (1) 14mm Combination Wrench
 - (1) 15mm Combination Wrench
 - (1) 17mm Combination Wrench



Part #	Mfg #	Description	Price
250268	48-22-9507	7 Pieces	

7-PC Ratcheting Combination Wrench Set - Metric

- Includes:
 - (1) 8mm Ratcheting Combination Wrench
 - (1) 10mm Ratcheting Combination Wrench
 - (1) 12mm Ratcheting Combination Wrench
 - (1) 13mm Ratcheting Combination Wrench
 - (1) 14mm Ratcheting Combination Wrench
 - (1) 15mm Ratcheting Combination Wrench
 - (1) 17mm Ratcheting Combination Wrench



Part #	Mfg #	Description	Price
247124	48-22-9506	7 Pieces	

15-PC Combination Wrench Set - SAE



Part #	Mfg #	Description	Price
240520	48-22-9415	15 Pieces	

15-PC Combination Wrench Set - Metric



Part #	Mfg #	Description	Price
240521	48-22-9515	15 Pieces	

7-PC Ratcheting Combination Wrench Set - SAE

- 2.5° of Arc Swing
- Includes:
 - (1) 3/8" Ratcheting Combination Wrench
 - (1) 1/2" Ratcheting Combination Wrench
 - (1) 9/16" Ratcheting Combination Wrench
 - (1) 5/8" Ratcheting Combination Wrench
 - (1) 11/16" Ratcheting Combination Wrench
 - (1) 3/4" Ratcheting Combination Wrench



Part #	Mfg #	Description	Price
247123	48-22-9406	7 Pieces	

15-PC Ratcheting Combination Wrench Set - SAE

- Includes:
 - (1) 1/4" Ratcheting Combination Wrench
 - (1) 9/32" Ratcheting Combination Wrench
 - (1) 5/16" Ratcheting Combination Wrench
 - (1) 11/32" Ratcheting Combination Wrench
 - (1) 3/8" Ratcheting Combination Wrench
 - (1) 7/16" Ratcheting Combination Wrench
 - (1) 1/2" Ratcheting Combination Wrench
 - (1) 9/16" Ratcheting Combination Wrench
 - (1) 5/8" Ratcheting Combination Wrench
 - (1) 11/16" Ratcheting Combination Wrench
 - (1) 3/4" Ratcheting Combination Wrench
 - (1) 13/16" Ratcheting Combination Wrench
 - (1) 7/8" Ratcheting Combination Wrench
 - (1) 15/16" Ratcheting Combination Wrench
 - (1) 1" Ratcheting Combination Wrench



Part #	Mfg #	Description	Price
247120	48-22-9416	15 Pieces	

Wrenches

15-PC Ratcheting Combination Wrench Set - Metric

- Includes:
- (1) 8mm Ratcheting Combination Wrench
- (1) 9mm Ratcheting Combination Wrench
- (1) 10mm Ratcheting Combination Wrench
- (1) 11mm Ratcheting Combination Wrench
- (1) 12mm Ratcheting Combination Wrench
- (1) 13mm Ratcheting Combination Wrench
- (1) 14mm Ratcheting Combination Wrench
- (1) 15mm Ratcheting Combination Wrench
- (1) 16mm Ratcheting Combination Wrench
- (1) 17mm Ratcheting Combination Wrench
- (1) 18mm Ratcheting Combination Wrench
- (1) 19mm Ratcheting Combination Wrench
- (1) 20mm Ratcheting Combination Wrench
- (1) 21mm Ratcheting Combination Wrench
- (1) 22mm Ratcheting Combination Wrench



Part #	Mfg #	Description	Price
247121	48-22-9516	15 Pieces	

Miscellaneous Tools

Drive Ratchet

- 90 tooth design with 4 degrees of arc swing for tight work spaces
- Slim profile head with flush direction lever
- Removable inner tray specifically designed for steel storage case
- Portable Carrying Case



Part #	Mfg #	Description	Price
250086	48-22-9014	1/4"	
250087	48-22-9038	3/8"	

26-PC 1/4" Drive Ratchet & Socket Set - SAE

- FOUR FLAT™ Sides
- 90 tooth design
- Stamped socket sizes portable carrying case



Part #	Mfg #	Description	Price
250080	48-22-9404	26 Pieces	

28-Pc 1/4" Drive Ratchet & Socket Set - Metric

- FOUR FLAT™ Sides
- Stamped socket sizes portable carrying case
- 90 tooth design
- Removable inner tray specifically designed for steel storage case



Part #	Mfg #	Description	Price
250081	48-22-9504	28 Pieces	

50-PC 1/4" Drive Ratchet & Socket Set

- SAE & Metric



Part #	Mfg #	Description	Price
250082	48-22-9004	50 Pieces	

28-PC 3/8" Drive Ratchet & Socket Set - SAE

- FOUR FLAT™ Sides
- 90 Tooth design
- Stamped socket sizes portable carrying case



Part #	Mfg #	Description	Price
250083	48-22-9408	28 Pieces	

32-PC 3/8" Drive Ratchet & Socket Set - Metric

- FOUR FLAT™ Sides
- 90 Tooth design with 4 degrees of arc swing
- Stamped socket sizes portable carrying case



Part #	Mfg #	Description	Price
250084	48-22-9508	32 Pieces	

56-PC 3/8" Drive Ratchet & Socket Set

- SAE & Metric
- FOUR FLAT™ Sides
- 90 Tooth design with 4 degrees of arc swing
- Stamped socket sizes portable carrying case



Part #	Mfg #	Description	Price
250085	48-22-9008	56 Pieces	

Wrenches

Wrenches

Heavy-Duty Straight Pipe Wrench

- Sturdy, cast iron housing and I-beam hand with full floating forged hook jaw, nonstick adjustment nut and replaceable hook and heel jaws



Part #	Mfg #	Model	Nom Size	Pipe Capacity	Price
008714	31010	10	10"	1-1/2"	
008686	31020	14	14"	2"	
008695	31025	18	18"	2-1/2"	
029928	31030	24	24"	3"	

Aluminum Handle Straight Pipe Wrench

- Nearly 40% lighter than comparable cast iron models of the same size
- Jaws and all other parts identical to RIDGID heavy-duty wrenches



Part #	Mfg #	Model	Nom Size	Pipe Capacity	Price
008768	31090	810	10"	1-1/2"	
054899	47057	812	12"	2"	
008770	31095	814	14"	2"	
008772	31100	818	18"	2-1/2"	
008774	31105	824	24"	3"	
026610	31115	848	48"	6"	

Aluminum Handle Offset Pipe Wrench

- Nearly 50% lighter than comparable cast iron models of the same size
- Features a jaw opening parallel to the handle and narrower hook jaw head which provides easy entry into tight spots



Part #	Mfg #	Model	Nom Size	Pipe Capacity	Price
022973	31125	18	18"	2-1/2"	

Strap Wrench

- Best for any polished pipe
- Strong, woven nylon strap gives tight grip
- Polyurethane-coated strap prevents scratching
- Replacement straps available



Part #	Mfg #	Model	Handle Length	Strap Length	Strap Width	Pipe Capacity	OD Tube Capacity	Price
008700	31340	2	11-3/4"	17"	1-1/8"	2"	3-1/2"	

Hex Wrench

- Gives multi-sided, secure grip on all hex nuts, square nuts, unions, and valve packing nuts



Part #	Mfg #	Model	Description	Nom Size	Pipe Capacity	Price
008571	31305	E110	Offset Hex	9-1/2"	1-1/8" - 2-5/8"	

Wrenches

Spud Wrench

- Narrow jaws to fit into tight places
- Smooth, toothless jaws ideal for square or rectangular stock



Part #	Mfg #	Size	Pipe Capacity	Price
008717	31400	12"	3/8" - 2-5/8"	

Adjustable Wrench

- High strength forged, precision broached superior strength
- Wider and deeper jaws increased bite and grip surface
- Nickel plated superior corrosion resistance
- Acid etched scales English and metric readings



Part #	Mfg #	Model	Nom Size	Pipe Capacity	Price
050314	86902	756	6"	3/4"	
050315	86907	758	8"	7/8"	
050323	86912	760	10"	1-1/8"	
050320	86917	762	12"	1-5/16"	

Basin Wrench

- Spring-loaded jaws of forged alloy steel
- Tension plug holds head in any position up to 90° angle



Part #	Mfg #	Model	Description	Nom Size	Pipe Capacity	Price
008658	31175	1017	Telescoping Basin	10" - 17"	3/8" - 1-1/4"	
022327	31180	1019	Telescoping Basin	10" - 17"	1-1/4" - 2-1/2"	

Faucet and Sink Installer (Plastic Nut Basin Wrench)

- Designed to reach and turn plastic mounting nuts on faucets, sprayers and ballcocks
- Used to fasten and remove plastic basin nuts, supply line nuts, and 7/8" and 1" hex nuts
- Notched ends are designed to self-center on 2, 3, 4 and 6 tab nuts and to fit on metal hex nuts
- Strainer basket attachment holds drain unit in place while tightening strainer nut
- High strength plastic with aluminum inserts



Part #	Mfg #	Model	Length	Price
034146	57003	2006	10-1/4"	

OneStop™ Wrench

- (2) Tools in one
- Provides exact size surface wrenches needed for angle stop and compression coupling installation



Part #	Mfg #	Model	Description	Price
065524	27023	2002	OneStop™ Wrench	

Wrenches

Wrench Parts



Part #	Mfg #	Description	For Model	Price
008614	31675	Heel Jaw & Pin Assembly	18, 818, E-18, S4A	

Wrenches

Wrenches

Chrome Adjustable Wrench

- Longer jaws grip better, avoiding slippage or nut round off
- Measurement scales are handy for sizing nuts, pipe and tube diameters
- Greater jaw capacity supports larger nuts and bolts
- Thinner jaws for greater access in tight spaces
- Precise jaw design grips tight the first time
- Four thread knurl and non-protruding jaws provide greater capacity
- Minimal head width improves performance in confined spaces
- Chrome vanadium steel construction



Part #	Mfg #	Length	Capacity	Price
058194	R114800	4-1/2"	1/2"	
058195	R114900	6-1/4"	15/16"	
058196	R115000	8"	1-3/16"	
058197	R115100	10"	1-3/8"	
058198	R115200	12"	1-1/2"	

Code Blue® Adjustable Wrench

- Longer jaws grip better, avoiding slippage or nut round off
- Measurement scales are handy for sizing nuts, pipe and tube diameters
- Greater jaw capacity supports larger nuts and bolts
- Thinner jaws for greater access in tight spaces
- Precise jaw design grips tight the first time
- Four thread knurl and non-protruding jaws provide greater capacity
- Minimal head width improves performance in confined spaces
- Code Blue® grips are designed for durability and comfort

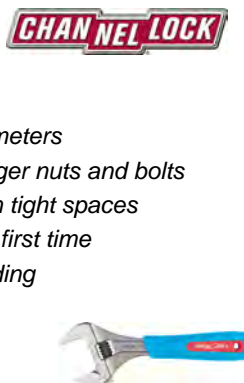

Part #	Mfg #	Length	Capacity	Price
117996	R115560	8"	1-1/2"	

Drain Wrench

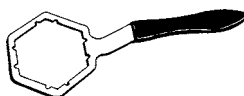

Part #	Mfg #	Description	Price
032867	R124710	Drain Wrench	

Wrenches

Wrenches

Digital Adjustable Torque Wrench

- Adjustable spanner head
- Digital torque value readout
- +/- 2% accuracy
- CW and CCW operation
- Water contact indicator
- Peak hold and track mode selectable
- Auto sleep (after about 5 minutes idle)
- 50 data memory for recall and joint torque auditing
- 4 user units of measure (ft. lb., in. lb., N-m, kg-cm)
- Buzzer & LED indicator for the 9 pre-set target torques



Part #	Mfg #	Description	Price
236431	60648	3/8" Square Drive	

Fan Blade Puller

- Hardened 4140 chrome moly steel
- Pull off fan blades
- Four fingers attach to the fan blade
- Fits 1-3/4" hub maximum
- Remove pulleys or sheaves
- Remove squirrel cage type blower wheels



Part #	Mfg #	Description	Price
182165	60590	Complete Fan Blade Puller	

Heavy Duty Ratchet Wrench

- Reversible
- 1/2" and 9/16" Hex openings at one end
- Square 3/16" and 1/4" at the other end



Part #	Mfg #	Description	Price
182169	60612	7" Long	

Offset Service Wrench

- Knuckle saver design
- 1/4" and 3/16" Hex openings at one end
- Square 3/8" and 5/16" at the other end



Part #	Mfg #	Description	Price
182172	60616	Offset Service Wrench	

Standard Straight Ratchet Wrench

- Reversible
- 1/4" and 3/16" Hex openings at one end
- Square 3/8" and 5/16" at the other end



Part #	Mfg #	Description	Price
182171	60613	Standard Straight Wrench	

Precision Torque Wrench Kit

- Packaged blow-molded storage carry case
- Exact tightening to 10-8 N-M or 7.4-59 ft. lb
- Newton-meters and foot-pound scales are marked
- Interchangeable open end adapters
 60650 (6 Heads): Sizes: 17, 22, 24, 26, 27 & 29 mm
 60652 (8 Heads): Sizes: 16, 17, 21, 24, 26, 27 & 29 mm



Part #	Mfg #	Description	Price
182242	60650	Torque Wrench Kit w/6 Heads	
182243	60652	Torque Wrench Kit w/8 Heads	

Parts & Accessories

Part #	Mfg #	Description	Price
182167	60609	Hex Key Adapter	

Wrenches

Ratchet Wrenches

Ratchet Wrench



- For installing or servicing heating, air conditioning or refrigeration units

Part #	Mfg #	Square	Hex	Price
006478	RRW3	3/16", 1/4", 5/16", 3/8"	-	

Hex Key Wrench Insert



Part #	Mfg #	Square	Hex	Price
006479	RRW3/16	1/4"	3/16"	

Hex Keys

Folding Hex Key Set

- Professional quality
- Produced from tough alloy steel



Part #	Mfg #	Description	Price
006503	W29	(9) Keys, Deluxe Pocket	

Wrenches

Razorback™ Wrench

- Remove shower and sink drains from top or bottom with just one hand
- T-Handle rotates 180°



Part #	Mfg #	Description	Price
093510	73055	Razorback™ Wrench	

Wrenches

Tools

Smart Dumbell®

- *Installs or removes drains without cross-bars (Kohler, American Standard)*
- *Heavy duty die-cast aluminum*
- *Prevents scratching of decorative finishes*
- *Use crescent wrench or large Phillips screwdriver to turn the tool*



Part #	Mfg #	Length	Price
008104	4554	6"	

Basin Wrenches

Eureka Cleanout Plug Wrench

- *Fits slotted or square countersunk cleanout plugs*
- *Strong, malleable iron*



Part #	Mfg #	Description	Price
083108	4567	Cleanout Plug Wrench	

Wrenches

Golden Tool™ Tools

Golden Grip® Internal Pipe Wrench

- *Installs or extracts pipe nipples from the inside*



Part #	Mfg #	Description	Price
080112	97250	Single 1/2"	

Golden Extractor™ Tub Drain Tool

- *Standard 3/8" drive ratchet to extract or install tub drains*



Part #	Mfg #	Description	Price
083657	97258	Universal Size	

Wrenches

Faucet Nut Splitter

- Splits old or new zinc or brass nuts in seconds
- Fits over all 1/2" faucet shanks
- Aluminum with a chisel tip of hardened tool steel



Part #	Mfg #	Description	Price
120323	TTOOLNS1	Faucet Nut Splitter	

Plumber's T-Handle Torque Tools

- Unique locking collar
- Slips internally when proper torque achieved



Part #	Mfg #	Socket	Type	in-lbs	Price
022114	TTOOL2SH	5/16"	Std No-Hub	60	

Wrenches

Fan Blade & Blower Wheel Pullers

- *Removes fan blades/blower wheels that are frozen to a motor shaft*
- *Can be used to apply pushing or pulling force*
- *Includes (4) pulling hooks and (3) set screws*
- *Accommodates 5/8" belt drive and 1/2" or less direct drive motor shafts*



Part #	Mfg #	Description	Price
136604	UP-1	"The Ultimate Puller"	

Aluminum Venting

Ventilation Products

Versa Cap™ Flue and Hot Stack Cap

- Non-clogging positive draft design
- Adjustable clamp fitting
- UL Listed



Part #	Mfg #	Pipe OD	Single Wall	Price
006171	6-3050	2-7/8" - 5"	3" & 4"	
006172	6-5070	4-7/8" - 7"	5" & 6"	
006173	6-7090	6-7/8" - 9"	7" & 8"	
006170	6-1200	11-7/8" - 14-1/2"	12" & 14"	
006174	6-9011	8-7/8" - 11"	9" & 10"	

Horizontal Vent Termination Kits

- Horizontal vent kits for use in venting high efficiency fossil fuel appliances.
- The low profile kit hides the vent from view



Part #	Mfg #	Description	Price
179529	HVENT-2	2"	
179530	HVENT-3	3"	

Duct Fans

- An efficient way to increase air circulation, keep room temperatures consistent, and lower heating and cooling costs.
- Metal construction, powerful no-maintenance motors and a one-use thermal fuse means these fans will be up to the task for years.
- Straightforward installation into any 120V system with detailed instructions, templates, and diagrams.
- Available in many sizes. A great way to give slow vents a boost.



Part #	Mfg #	Description	Price
200007	625-AF6	6"	
200008	625-AF8	8"	
200009	625-AF10	10"	
224964	625-AF12	12"	

Plastic Wide Mouth Dryer Vent Hood

- Hood, aluminum pipe and collar



Part #	Mfg #	Description	Price
172199	650-023	4" Brown	



Aluminum Venting

Aluminum Duct

Aluminum Pipe



Part #	Mfg #	Size	Price
192713	SWALP244	4" x 24"	
014515	32ALVP	3" x 24"	
015382	42ALVP	4" x 24"	
075826	45ALVP	4" x 60"	
015709	62ALVP	6" x 24"	

Aluminum Fittings

90° Aluminum Elbow



Part #	Mfg #	Size	Price
192715	SW40054	4"	
014306	3AL90	3"	
015192	4AL90	4"	
015617	6AL90	6"	
015784	8AL90	8"	



Aluminum Venting

Ventilation Products

Aluminum Wall Cap

- *Opening/closing damper prevents outside elements from entering the vent*
- *Damper is spring loaded to keep damper closed when not in use*



Part #	Mfg #	Size	Color	Price
192427	6ALUMWALLCAP	6"	Aluminum	
195598	8ALUMWALLCAP	8"	Aluminum	

Chimney Liners

Metalbest Flexible Aluminum Chimney Liner Kits

- Solution for gas-fired heat venting
- Eliminates chimney flue deterioration
- Aluminum Liner Kit includes:
 - 2-Ply Aluminum Flexi-liner
 - Round top (RV)
 - Flashing with 3" collar
 - Motor guard



Part #	Part #	Size	Length	Price
031689	3CHIMNEYKIT25	3"	25'	
031800	3CHIMNEYKIT35	3"	35'	
015210	4CHIMNEYKIT25	4"	25'	
020303	4CHIMNEYKIT35	4"	35'	
020304	5CHIMNEYKIT35	5"	35'	
020305	6CHIMNEYKIT35	6"	35'	

Draft Diverters

Galvanized Diverters

Galv Vertical Draft Diverter



Part #	Mfg #	Size	Price
011100	WA3508	8"	

Dryer Venting

Wall Vents**Louwer Hood Faceplate**

Part #	Mfg #	Description	Price
097306	20328	6" White Hood, 12/Pk	

Mini Louwer Fresh Air Intake

- Plastic
- Screens are 1/4" x 1/4" molded grid
- Fixed louvers
- Works for thru-wall as well as eave venting

Part #	Mfg #	Description	Price
097307	20332	6" White Fresh Air Intake	



Dryer Venting

Venting

Preferred Hood Vent

- Opening/closing damper prevents outside elements from entering the vent
- Removable screen
- UV inhibitor is used to help prevent the premature fading of vent
- Includes:
 - 4" Plastic hood vent with 11" tail pipe
 - 4" Plastic trim plate



Part #	Mfg #	Size	Color	Price
192419	4BRHOODWTAIL	4"	Brown	
192420	4WHHOODWTAIL	4"	White	

Plastic Louvered Vent Kit

- Opening/closing flaps prevents outside elements from entering the vent
- UV inhibitor is used to help prevent the premature fading of vent
- Includes:
 - 4" Plastic louvered vent with 11" tail pipe
 - 4" Plastic trim plate



Part #	Mfg #	Size	Color	Price
192425	4BRLVRHOODTAIL	4"	Brown	
192426	4WHLVRHOODTAIL	4"	White	

Plastic Louvered Vent

- Opening/closing flaps prevents outside elements from entering the vent
- UV inhibitor is used to help prevent the premature fading of vent



Part #	Mfg #	Size	Color	Price
192429	4WHLVRONLY	4"	Brown	
192428	4BRLVRONLY	4"	White	

Under Eave Vent

- Plastic
- Opening/Closing damper prevents outside elements from entering the vent
- UV inhibitor is used to help prevent the premature fading of vent



Part #	Mfg #	Size	Color	Price
199224	4UNDEREVEVENT	4"	White	

Flexible Vinyl Duct

- 4" x 8'
- Do not use for high temperature venting applications



Part #	Mfg #	Size	Color	Price
192421	48DV	4" x 8'	White	
192422	420DV	4" x 20'	White	

Miscellaneous

Adjustable Nylon Clamp

- 3-1/2" Minimum diameter
- 4-1/2" Maximum diameter
- Tensile strength 50 lbs



Part #	Mfg #	Size	Color	Price
192423	4TUBECLAMP	4"		

Venting

Venting

V230 Flexible Dryer Vent Pipe

- Designed for low and medium operating pressures
- Made of non-combustible corrugated aluminum
- Plain ends



Part #	Mfg #	Size	Color	Price
103539	3ALMFLEXDV8	3"x8'	Aluminum	
090879	4ALUMFLEXDV8	4"x8'	Aluminum	
173730	5ALUMFLEXDV8	5"x8'	Aluminum	
155023	6ALUMFLEXDV8	6"x8'	Aluminum	
030873	4ALUMFLEXDV25	4"x25'	Aluminum	

Foil Duct

- UL® 181, Class 1 air connector label
- Multi-ply design of metalized polyester and aluminum/polyester laminate
- Steel wire support
- 3" dia. has ¾" pitch
- 4-12" dia. has 1" pitch
- UL® sticker every 10 feet
- Maximum velocity rating 5000 fpm



Not for use as dryer venting, cooking appliances or heating unless approved by the appliance manufacturer

Part #	Mfg #	Size	Color	Price
172848	4FOILFLEXDV25	4" x 25'	Foil	

Vinyl Hose

- Steel wire support
- Poly vinyl chloride
- 3 1/4" and 3" diameter are 1" pitch
- 4" diameter is 1.5" pitch



Useful as bathroom fan venting. Not approved for dryer venting

Part #	Mfg #	Size	Color	Price
014952	350DV	3" x 50'	White	
015494	450DV	4" x 50'	White	

Foil Duct Kit for Wall

- Kits include:
5' or 8' UL® 181 Foil Duct
- Through Wall Vent Hoods including:
PWM113 Wide Mouth Plastic
ASM277 Standard Aluminum
PML282 Louvered Hood in Brown and White
- Two ZipTorq™ Clamps

Part #	Mfg #	Size	Color	Price
192418	48WHHOODKIT	4"x8'	White	

Vent Hood

- 3" and 4" diameters
- With and without tailpipes
- With and without screens
- 1½" tailpipe
- Back plate
- Back-draft flapper
- Fully assembled, riveted tailpipe



Part #	Mfg #	Size	Color	Price
014356	3DVHAL	3"	Aluminum	
007995	4DVHAL	4"	Aluminum	

Vent Hood w/ Ring - No Tail

Part #	Mfg #	Size	Color	Price
247033	4WHHOODONLY	4"	White	

Vent Ring & Screen

Part #	Mfg #	Size	Color	Price
186247	BB110907	8"	White	
186248	BB111016	8"	Brown	

Duct Couplings

- Crimped both ends or crimped one end, one end beaded
- 3", 4" and 6" diameters



Part #	Mfg #	Size	Color	Price
170408	4ALUMDUCTCONNCT	4"	Aluminum	

Exhaust Fans

WhisperGreen® Ventilating Fans

WhisperGreen® Fan with Built-In Control

- Continuous and spot ventilation
- Constant CFM - built-in intelligence performs at a constant CFM regardless of elbows and other factors - when the fan faces static pressure, it automatically increases speed to reach desired CFM
- Variable speed control - CustomVent™ allows fan to run continuously at a pre-set lower level of 30-70 CFMs that can be elevated to a maximum of 80 CFMs when the switch is turned on and turn (or via SmartAction™ Motion Sensor) - high/low delay timer (adj from 30 seconds to 60 minutes) returns fan to the minimum CFM level
- Built-in damper prevents backdraft
- Energy Star® rated



Part #	Mfg #	CFM	Options	Price
140061	FV-08VKM3	30 - 80	Motion Sensor	
130694	FV-13VKM3	0 - 130	Motion Sensor	

WhisperGreen Select™ Ventilating Fans One Fan - Multiple IAQ Solutions

- Pick-A-Flow speed selector
- Plug 'N Play modules allow further customization
- Features a DC Motor with SmartFlow® technology
- Flex-Z Fast installation bracket
- Power rating: 120 volts and 60 Hz



Part #	Mfg #	CFM	Noise (Sones)	Price
170246	FV-05-11VK2	50 - 113	<0.3	
170245	FV-11-15VK2	110-150	<0.7	

WhisperGreen Select™ - With Built-in LED Lights



Part #	Mfg #	CFM	Noise (Sones)	Price
170014	FV-05-11VKL2	50-110	<0.3	
170244	FV-11-15VKL2	110-150	<0.9	

WhisperGreen Select™ - Multi-Speed



Part #	Mfg #	CFM	Noise (Sones)	Price
173493	FV-05-11VKS2	50-110	<0.3	

WhisperGreen Select™ - Multi-Speed w/ LED Lights



Part #	Mfg #	CFM	Noise (Sones)	Price
173964	FV0511VKSL2	50-110	<0.3	

WhisperGreen® Ventilating Fan Single Speed

- SmartFlow™ technology for optimal CFM output
- Fully enclosed DC motor for long life – rated for 60,000 hours continuous run
- Detachable dual 4" or 6" duct adaptor included
- Fits in 2 x 8 construction
- Energy Star® rated



Part #	Mfg #	CFM	Noise (Sones)	Price
139499	FV-08VK3	80	<0.3	

WhisperCeiling™ Ventilating Fans

- Low noise levels
- Low power consumption
- Long run times or continuous operation
- Built-in damper prevents backdraft
- Energy Star® rated



Part #	Mfg #	CFM	Noise (Sones)	Price
134328	FV-11VQ5	110	<0.3	

Exhaust Fans

**WhisperGreen® Ventilating Fans
(Continued)**

WhisperCeiling™ Ventilating Fans

Part #	Mfg #	CFM	Noise (Sones)	Price
133419	FV-15VQ5	150	<0.3	

WhisperWall™ Ventilating Fan

- Through-the-wall installation
- Low noise levels
- Low input wattage



Part #	Mfg #	CFM	Noise (Sones)	Price
132993	FV-08WQ1	70	1.1	

**WhisperFit-Lite™ Low Profile
Fan/Light/Night-Light**

- Optional 3" duct adapter is included
- (2) 18W Compact fluorescent lamps provide overhead lighting
- 4-Watt night-light
- Energy Star® rated



Part #	Mfg #	CFM	Noise (Sones)	Price
136613	FV-05VFL2	50	0.3	
130047	FV-08VFL2	80	0.5	

WhisperFit® EZ Retrofit Fan with SmartAction®

- Ceiling mount fan
- Ideal for remodeling and hotel new construction renovation
- Pick-A-Flow™ Speed Selector 1 fan, you choose the CFM (80 or 100)
- SmartAction® motion sensor automatically activates the fan when someone enters the room
- Flex-Z Fast™ bracket provides flexible, fast and easy installation
- Low profile housing design fits in 2 x 6 construction



Part #	Mfg #	CFM	Noise (Sones)	Price
262625	FV-08-11VFL5E	110	0.1	

WhisperLite™ Fan/Light

- Low noise level
- Low power consumption
- Long run times or continuous operation
- Energy Star® rated



Part #	Mfg #	CFM	Noise (Sones)	Price
243547	FV-0511VQL1	110	0.5	
133418	FV-15VQL5	150	0.9	

WhisperWarm™ Fan/Heater/Light/Night- Light

- Low noise level
- 30.6W Power consumption
- 1400W Heating element
- 25W Heater fan
- For 4" duct size
- Night light feature
- (2) 18W Compact fluorescent bulb
- UL Listed



Part #	Mfg #	CFM	Noise (Sones)	Price
133063	FV11VHL2	110	0.7	

WhisperValue™ Super Low Profile Ventilating Fan



Part #	Mfg #	CFM	Noise (Sones)	Price
231574	FV-0510VS1	50	1.3	
237920	FV-0510VSL1	50	1.3	

WhisperValue™ Super Low Profile Ventilation Fan/Light

- Energy Star® rated



Part #	Mfg #	CFM	Noise (Sones)	Price
134285	FV-08VSL1	80	1.5	

Exhaust Fans

WhisperFit™ EZ Fan

- The fastest, easiers, retrofit, ENERGY STAR® fan available
- Built-In Pick-A-Flow™ speed selector
- Flex-Z Fast™ Installation bracket
- Low profile 5-5/8" housing depth fits in 2x6 construction



Part #	Mfg #	CFM	Noise (Sones)	Price
177128	FV-08-11VF5	80-110	1.5	

WhisperFit™ EZ Fan with SmartAction® Motion Sensor

- Motion sensor with 20 min delay off timer automatically activates fan when someone enters room
- The fastest, easiers, retrofit, ENERGY STAR® fan available
- Built-In Pick-A-Flow™ speed selector
- Flex-Z Fast™ Installation bracket
- Low profile 5-5/8" housing depth fits in 2x6 construction

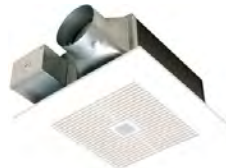

Part #	Mfg #	CFM	Noise (Sones)	Price
177129	FV-08-11VFM5	80-110	1.5	

WhisperRecessed LED™ Fan/Light Combo

- Incorporates a powerfule, yet quiet 80 CFM fan behind an elegant recessed LED light
- Includes a dimmable 14W GU24 base LED lamp
- 6-1/2" Aperture and advanced luminaire design
- Adjustable lamp positional



Part #	Mfg #	CFM	Noise (Sones)	Price
231495	FV-08VRE2	80 CRM	<0.8	

WhisperGreen-Lite™ Ventilating Fans

Single-Speed WhisperGreen-Lite™ Fan

- Built-in intelligence allows fan to perform at a constant CFM regardless of elbow and other factors that might hinder performance
- Electronic ballast technology with (2) Energy-Star® qualified 18W compact, flicker-free fluorescent lamps and a 4W night-light
- Built-in damper to prevent backdraft
- Energy Star® rated



Part #	Mfg #	CFM	Noise (Sones)	Price
139924	FV-08VKL3	80	<0.3	

Variable-Speed WhisperGreen-Lite™ Fan

- Built-in intelligence allows fan to perform at a constant CFM regardless of elbow and other factors that might hinder performance
- Electronic ballast technology with (2) Energy-Star® qualified 18W compact, flicker-free fluorescent lamps and a 4W night-light
- Variable speed control - CustomVent™ allows fan to run continuously at a pre-set lower level of 30-70 CFMs that can be elevated to a maximum of 80 CFMs when the switch is turned on and turn (or via SmartAction™ Motion Sensor) - high/low delay timer (adj from 30 seconds to 60 minutes) returns fan to the minimum CFM level
- Built-in damper to prevent backdraft
- VKML Suffix - Motion Sensor
- Energy Star® rated



Part #	Mfg #	Duct	CFM	Noise	Price
139800	FV-13VKML3	6"	130	<0.3	

Exhaust Fans

EcoVent Ventilating Fans

EcoVent™ Fan with Veri-Boost™ Cost Effective, Spot Ventilation Solution

- 70 CFM fan delivers strong performance w/ peace of mind
- Built-In Veri-Boost™ switch provides a 20 CFM boost when needed
- Small grille design



FV-07VBA1 - Fan Housing
FV-07VBB1 - Motor/Grille Assembly
(Both required to complete unit)

Part #	Mfg #	Description	Price
170242	FV-07VBA1	Housing Can, Duct Adaptor, & Junction Box	
170241	FV-07VBB1	Motor & Grille	

Switches

Multi-Function Control WhisperControl Switch

- Multi-switch combination saves space and adds convenience
- Common feed shunted internally to all switches
- Includes matching wall plate
- Commercial grade
- Elegant styling provides multiple controls in a single-gang wall box
- 4-Function control - single pole/double throw on-off-on top switch, two single pole on-off switches



Part #	Mfg #	Color	Functions	Price
163969	FV-WCSW31-W	White	3	
145404	FV-WCSW41-W	White	4	

WhisperControl Condensation Sensor

- Automatically turns on when relative humidity and temperature change is detected
- 30 Minute countdown timer
- Manual On/Off control
- Compatible with single-speed fans or fan/lights
- Stylish design with wall plate included
- LED Indicator
- Energy Star®, LEED for Homes, ASHRAE 62.2, and CALGreen compliant
- 1-Year limited warranty



Part #	Mfg #	Color	Description	Price
144623	FV-WCCS1-W	White	On/Off	
148246	FV-WCCS1-A	Light Almond	On/Off	
145403	FV-WCCS2-W	White	On/Off/Light	

Parts & Accessories

WhisperGreen Select™ Condensation Sensor Plug 'N Play Module

- Helps prevent mold and mildew
- Sensor detects relative humidity and temperature to anticipate dew point, automatically turning the fan on to control humidity
- Humidity (RH) sensitivity adjustment enables fine tuning for moist conditions and for satisfying CALGreen requirements
- Activates a 20 minute delay off timer for the fan



Part #	Mfg #	Description	Price
170250	FV-CSVK1	Condensation Sensor	

WhisperGreen Select™ SmartAction® Motion Sensor Plug 'N Play Module

- Automatically activates when someone enters the room
- Once the settings have been applied, the fan becomes truly automatic
- This module also activates a 20 minute delay off timer for the fan



Part #	Mfg #	Description	Price
170248	FV-MSVK1	Motion Sensor	

Exhaust Fans

WhisperGreen Select™ NiteGlo™ LED Light Plug 'N Play Module

- A photocell automatically turns on the 1 watt LED night light when darkness is sensed in the room
- High/Low brightness switch enables you to fine tune the photocell to work in conjunction with the darkness level of your bathroom
- This module also activates an automatic 20 minute delay off timer for the fan



Part #	Mfg #	Description	Price
170249	FV-NLVK1	NigtGlo LED Night Light	

WhisperGreen Select™ Multi-Speed with Time Delay Plug 'N Play Module

- Allows you to select the proper CFM settings to satisfy ASHRAE 62.2 continuous ventilation requirements
- High/Low delay timer returns the fan to the preset CFM level after a period of time set by the user
- The fan runs continuously at a preset lower level (0, 30-100 or 0, 50-120 CFM, in 10 CFM increments), then elevates to a maximum level of operation (50-80-110 or 110-130-150 CFM) when the wall switch is turned on, or when the motion sensor or condensation sensor module is activated



Part #	Mfg #	Description	Price
170247	FV-VS15VK1	Multi-Speed w/ Time Delay	

FlexDamper™ All-In-One Radiation Damper

- Folded ceramic curtain style damper meets both combustible and non-combustible UL assemblies
- Allows for versatile two-stage construction; during framing and after finishes
- Easy access to fan, motor and damper for maintenance
- UL approved for most Panasonic 10 1/4" 50 – 150 CFM fans, fan/lights and fans with motion sensor
- Galvanized steel frame with 165°F fusible link



Part #	Mfg #	CFM	Noise (Sones)	Price
224658	PC-RD05C5			

EZ Soffit Vent

Part #	Mfg #	CFM	Noise (Sones)	Price
240984	EZSV14		EZ Soffit Vent	

Exhaust Fans

Quantum Inline Fans

Quantum Ventilation System

- Complete exhaust system includes:
 - Inline plastic combi- fan
 - Multi-position metal bracket
 - Duct connection collar
- Capable of multi-point exhaust
- Energy Star® rated



Part #	Mfg #	Description	Price
080159	99-NBQ-COMBI	4", 5", 6" , 180/240/270 CFM, 3-in-1 Inline System, White	



Power Venters

Draft Inducers

- *Inline Auto-Draft® inducers*
- *Quick and easy to install*
- *Vari-Draft control permits adjustments to the individual job requirement*
- *115V 60Hz*



Part #	Mfg #	Smokepipe Size	RPM	Watts	Amps	HP Open	Price
010374	D-3	5" - 8"	1,550 rpm	74W	.96A	1/20 hp	

QC Venting

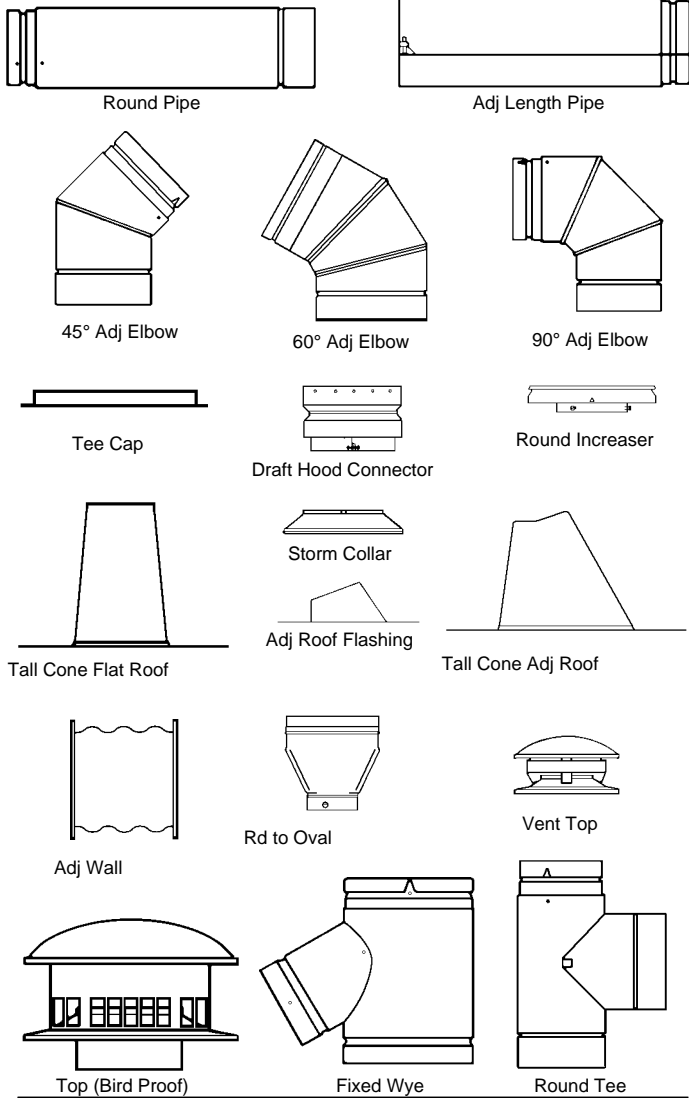

Type "B" Gas QC Vent Pipe & Fittings (Continued)

10" Gas Vent Round

Part #	Mfg #	Description	Price
008367	QCT10	Tee	

12" Gas Vent Round

Part #	Mfg #	Description	Price
187423	RP1236	12" x 36" Round Pipe	
187422	RP1218	12" x 18" Round Pipe	
008345	QCP1218	18" Round Pipe	
008346	QCP1230	30" Round Pipe	
187428	R4512	45° Fixed Elbow	
008337	QCAF12	Adj Roof Flashing	
008364	QCTOP12	Top	
187431	RSC12	Storm Collar	
008358	QCTC12	Tee Cap	
008362	QCTF12	Tall Cone Flat Roof Flashing	
008368	QCT12	Tee	

14" Gas Vent Round

Part #	Mfg #	Description	Price
008348	QCP1430	30" Round Pipe	
008373	QC4514	45° Fixed Elbow	
008338	QCAF14	Adj Roof Flashing	
008365	QCTOP14	Top	
008353	QCSC14	Storm Collar	
008359	QCTC14	Tee Cap	
008355	QCTF14	Tall Cone Flat Roof Flashing	
008369	QCT14	Tee	

16" Gas Vent Round

Part #	Mfg #	Description	Price
008350	QCP1630	30" Round Pipe	
008339	QCAF16	Adj Roof Flashing	
008366	QCTOP16	Top	
008354	QCSC16	Storm Collar	
008356	QCTF16	Tall Cone Flat Roof Flashing	

Type "B" Gas QC Vent Pipe & Fittings

10" Gas Vent Round

Part #	Mfg #	Description	Price
008343	QCP1018	18" Round Pipe	
008344	QCP1030	30" Round Pipe	
187411	RP1036	36" Round Pipe	
008371	QC4510	45° Fixed Elbow	
008336	QCAF10	Adj Roof Flashing	
008340	QCPA1018	18" Adj Length Pipe	
008363	QCTOP10	Top	
187419	RSC10	Storm Collar	
008357	QCTC10	Tee Cap	
008361	QCTF10	Tall Cone Flat Roof Flashing	

QC Venting

Model C Universal Cap

- *Used as ventilation cap as well as a Type B gas vent termination*

Part #	Mfg #	Description	Price
187418	RTOP10	10" Cap	
187430	RTOP12	12" Cap	

RV Round Venting

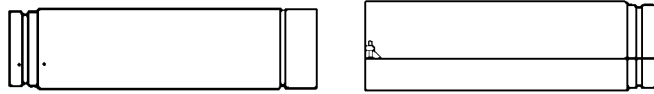

Round Pipe

Adj Length Pipe

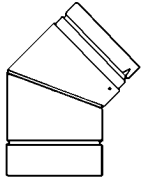

45° Adj Elbow

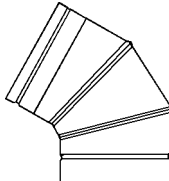

60° Adj Elbow

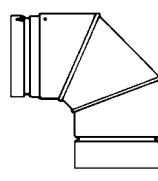

90° Adj Elbow

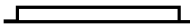

Tee Cap

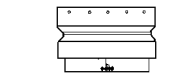

Draft Hood Connector

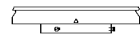

Round Increaser

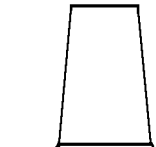

Tall Cone Flat Roof

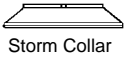

Storm Collar



Adj Roof Flashing

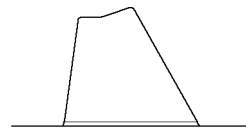

Tall Cone Adj Roof

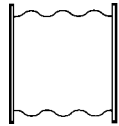

Adj Wall

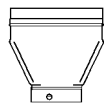

Rd to Oval

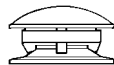

Vent Top

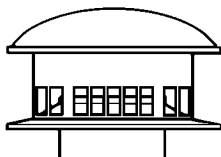

Top (Bird Proof)

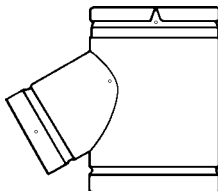

Fixed Wye

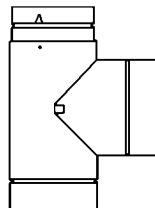

Round Tee

Type "B" Gas RV Vent Pipe & Fittings

3" Gas Vent Round

Part #	Mfg #	Description	Price
009690	3RV-6	6" Round Pipe	
009685	3RV-12	12" Round Pipe	
009686	3RV-18	18" Round Pipe	
009687	3RV-2	24" Round Pipe	
009688	3RV-3	36" Round Pipe	
066532	3RV-4	48" Round Pipe	
009689	3RV-5	60" Round Pipe	
052598	3RV-60	45°/60° Adjustable Elbow	
009790	3RV-90	90° Adjustable Elbow	
009657	3RV-AF12	Adj Roof Flashing 6/12 to 12/12	

Type "B" Gas RV Vent Pipe & Fittings (Continued)

3" Gas Vent Round

Part #	Mfg #	Description	Price
009676	3RV-AJ	12" Adj Length Pipe	
009663	3RV-DH	Draft Hood Connector	
009774	3RV-FSPU	3" Quick Grip Firestop/Spacer	
053951	3RV-HWT	High Wind Top	
009668	3RV-I4	3" x 4" Increaser	
009669	3RV-I5	3" x 5" Increaser	
096904	3RV-I6	3" x 6" Increaser	
009760	3RV-RT	Vent Top	
009729	3RV-SC	Storm Collar	
009748	3RV-TC	Tee Cap	
009754	3RV-TF	Tall Cone Flat Roof Flashing	
009653	3RV-TFA	Tall Cone Adj Roof Flashing	
009766	3RV-TS	Tee	
043482	3RV-WT	Adj Wall Thimble	

4" Gas Vent Round

Part #	Mfg #	Description	Price
009696	4RV-6	6" Round Pipe	
009691	4RV-12	12" Round Pipe	
009692	4RV-18	18" Round Pipe	
009693	4RV-2	24" Round Pipe	
009694	4RV-3	36" Round Pipe	
041120	4RV-4	48" Round Pipe	
009695	4RV-5	60" Round Pipe	
009675	4RV-3RA	3" Rheem Adapter	
009794	4RV-90	90° Adjustable Elbow	
009658	4RV-AF12	Adj Roof Flashing 6/12 to 12/12	
009677	4RV-AJ	12" Adj Length Pipe	
009678	4RV-AJ18	18" Adj Length Pipe	
009664	4RV-DH	Draft Hood Connector	
052600	4RV-EL45/60	45°/60° Adjustable Ell	
009775	4RV-FSPU	4" Quick Grip Firestop/Spacer	
053952	4RV-HWT	Hi-Wind Cap	
009670	4RV-I5	4" x 5" Increaser	
009671	4RV-I6	4" x 6" Increaser	
009761	4RV-RT	Top Vent (Bird Proof)	
009730	4RV-SC	Storm Collar	
009749	4RV-TC	Tee Cap	
009755	4RV-TF	Tall Cone Flat Roof Flashing	

RV Round Venting

Type "B" Gas RV Vent Pipe & Fittings (Continued)

4" Gas Vent Round

Part #	Mfg #	Description	Price
009654	4RV-TFA	Tall Cone Adj Roof Flashing	
009767	4RV-TS	Tee	
037624	4RV-WT	Adj Wall Thimble	
009779	4RV-WV4	Round to Oval Adapter	

5" Gas Vent Round

Part #	Mfg #	Description	Price
009702	5RV-6	6" Round Pipe	
009697	5RV-12	12" Round Pipe	
009698	5RV-18	18" Round Pipe	
009699	5RV-2	24" Round Pipe	
009700	5RV-3	36" Round Pipe	
041121	5RV-4	48" Round Pipe	
009701	5RV-5	60" Round Pipe	
009783	5RV4-FY	4" Fixed Wye s/4" Snout	
114028	5RV43FY	5" x 4" x 3" Fixed Wye	
009780	5RV-5/6WV	Round to Oval Adapter	
052601	5RV-60	45°/60° Adjustable Elbow	
009795	5RV-90	90° Adjustable Elbow	
009655	5RV-AF	Adj Roof Flashing Flat to 6/12	
009659	5RV-AF12	Adj Roof Flashing 6/12 to 12/12	
009679	5RV-AJ	12" Adj Length Pipe	
009680	5RV-AJ18	18" Adj Length Pipe	
009665	5RV-DH	Draft Hood Connector	
009776	5RV-FSPU	5" Quick Grip Firestop/Spacer	
053953	5RV-HWT	Hi-Wind Top	
009672	5RV-I6	5" x 6" Increaser	
009762	5RV-RT	Vent Top	
009731	5RV-SC	Storm Collar	
009750	5RV-TC	Tee Cap	
009756	5RV-TF	Tall Cone Flat Roof Flashing	
009768	5RV-TS	Tee	

6" Gas Vent Round

Part #	Mfg #	Description	Price
009708	6RV-6	6" Round Pipe	
009703	6RV-12	12" Round Pipe	
009704	6RV-18	18" Round Pipe	
009705	6RV-2	24" Round Pipe	

Type "B" Gas RV Vent Pipe & Fittings (Continued)

6" Gas Vent Round

Part #	Mfg #	Description	Price
009706	6RV-3	36" Round Pipe	
009707	6RV-5	60" Round Pipe	
009781	6RV-5/6WV	Round to Oval Adapter	
052602	6RV-60	45°/60° Adjustable Elbow	
009796	6RV-90	90° Adjustable Elbow	
009656	6RV-AF	Adj Roof Flashing Flat to 6/12	
009660	6RV-AF12	Adj Roof Flashing 6/12 to 12/12	
009681	6RV-AJ	12" Adj Length Pipe	
009666	6RV-DH	Draft Hood Connector	
009777	6RV-FSPU	6" Quick Grip Firestop/Spacer	
053954	6RV-HWT	Hi-Wind Cap	
009673	6RV-I7	6" x 7" Increaser	
009674	6RV-I8	6" x 8" Increaser	
009763	6RV-RT	Vent Top	
009732	6RV-SC	Storm Collar	
009751	6RV-TC	Tee Cap	
009757	6RV-TF	Tall Cone Flat Roof Flashing	
009769	6RV-TS	Tee	

7" Gas Vent Round

Part #	Mfg #	Description	Price
009714	7RV-6	6" Round Pipe	
009709	7RV-12	12" Round Pipe	
009710	7RV-18	18" Round Pipe	
009711	7RV-2	24" Round Pipe	
009712	7RV-3	36" Round Pipe	
009713	7RV-5	60" Round Pipe	
009788	7RV-45	45° Adjustable Elbow	
009797	7RV-90	90° Adjustable Elbow	
009661	7RV-AF	Adj Roof Flashing Flat to 6/12	
062593	7RV-AF12	Adj Roof Flashing 6/12 to 12/12	
009764	7RV-RT	Vent Top	
009733	7RV-SC	Storm Collar	
009752	7RV-TC	Tee Cap	
009758	7RV-TF	Tall Cone Flat Roof Flashing	
009770	7RV-TS	Tee	

RV Round Venting

8" Gas Vent Round

Part #	Mfg #	Description	Price
009720	8RV-6	6" Round Pipe	
009715	8RV-12	12" Round Pipe	
009716	8RV-18	18" Round Pipe	
009717	8RV-2	24" Round Pipe	
009718	8RV-3	36" Round Pipe	
009719	8RV-5	60" Round Pipe	
009789	8RV-45	45° Adjustable Elbow	
009798	8RV-90	90° Adjustable Elbow	
009682	8RV-AJ	12" Adj Length Pipe	
009662	8RV-AF	Adj Roof Flashing Flat to 6/12	
088718	8RV-AF12	Adj Roof Flashing 6/12 - 12/12	
009667	8RV-DH	Draft Hood Connector	
009765	8RV-RT	Vent Top	
009734	8RV-SC	Storm Collar	
009753	8RV-TC	Tee Cap	
009759	8RV-TF	Tall Cone Flat Roof Flashing	
009771	8RV-TS	Tee	

Stainless Steel All Fuel Venting

Chimney Systems

- Rugged all fuel chimney
- Meets all UL® requirements
- Model SSII-Type HT tested to 2100°F
- Model SSII tested UL®-103 max temp of 1700°F
- Gravity venting only

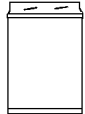

Insulated Pipe

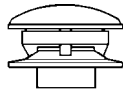

Round Top

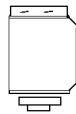

Insulated Tee



15° Insulated

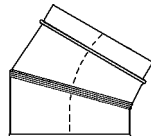

30° Insulated Elbow



Dripless Adptr



Wall Support Kit

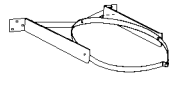

Wall Band

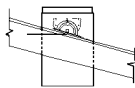

Roof Support

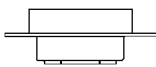

Ceiling Support

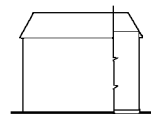

Attic Insulation

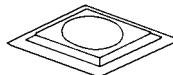

Fire Stop/Wall

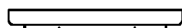

Finishing Collar

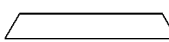

Storm Collar



Adjustable Flashing

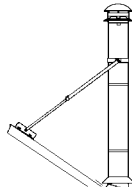

Roof Brace Kit



Locking Band

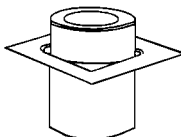

Joist Shield

SSII-Type HT 6" Insulated Pipe & Fittings

Part #	Mfg #	Description	Price
001049	6UT-9	6" x 9" Pipe	
001047	6UT-18	6" x 18" Pipe	
001048	6UT-36	6" x 36" Pipe	
001030	6T-AF6	0/12 - 6/12 Adj Flashing	
001029	6T-AF12	6/12 - 12/12 Adj Flashing	
001032	6T-CT	Round Top	
001033	6T-DSA	Dripless Smoke Pipe Adapter	
001034	6T-DSAC	Dripless Smoke Pipe Adapter w/Coupler	
070232	6T-EL15KIT	15° Elbow Kit	

Chimney Systems (Continued)

SSII-Type HT 6" Insulated Pipe & Fittings

Part #	Mfg #	Description	Price
001036	6T-FC	Finishing Collar	
001037	6T-FSP	Ceiling Support, Sq Plate	
001038	6T-IT	Tee	
021232	6T-JS	Joist Shield	
001039	6T-LB	Locking Band	
021355	6T-RBK	Roof Brace Kit	
001040	6T-RSP	Roof Support Package	
001041	5/6T-SC	6" Metal Storm Collar	
001043	6T-TF	0 - 2/12 Tall Cone Roof Flashing	
074623	6T-TPS	Fire Stop/Trim Collar w/Spacer	
001044	6T-WB	Wall Band	
001046	6T-WSK	Wall Support Kit	

SSII-Type HT 7" Insulated Pipe & Fittings

Part #	Mfg #	Description	Price
001059	7UT-18	7" x 18" Pipe	
001060	7UT-36	7" x 36" Pipe	
001050	7TAF-6	6/12 Flashing	
070237	7T-EL30KIT	30° Elbow Kit	
001051	7T-CT	Round Top	
001053	7T-FSP	Finish Support Pkg, Sq Plate	
001054	7T-IT	Tee	

SSII-Type HT 8" Insulated Pipe & Fittings

Part #	Mfg #	Description	Price
081186	8UT-6	8" x 6" Insulated Pipe	
001081	8UT-9	8" x 9" Insulated Pipe	
001079	8UT-18	8" x 18" Insulated Pipe	
080939	8UT-24	8" x 24" Insulated Pipe	
001080	8UT-36	8" x 36" Insulated Pipe	
001062	8T-AF6	Adj Flashing	
001065	8T-CT	Round Top	
001066	8T-DSAC	Dripless Smoke Pipe Adapter w/Coupler	
070234	8T-EL15KIT	15° Elbow Kit	
001069	8T-FSP	Ceiling Support, Sq Plate	
001070	8T-IT	Tee	
001071	8T-JS	Joist Shield	
001072	8T-LB	Locking Band	

Stainless Steel All Fuel Venting

Chimney Systems (Continued)

SSII-Type HT 8" Insulated Pipe & Fittings

Part #	Mfg #	Description	Price
001056	7/8T-SC	8" Metal Storm Collar	
001076	8T-WB	Wall Band	
001078	8T-WSK	Wall Support Kit	

SSII-Type HT 10" Insulated Pipe & Fittings

Part #	Mfg #	Description	Price
070246	10UT-36	10" x 36" Insulated Pipe	

SSII 10" Insulated Fittings

Part #	Mfg #	Description	Price
066181	10SAF-12	2/12 to 6/12 Roof Flashing	
012309	10S-CT	Round Chimney Top	
012314	10S-SC	Storm Collar	

WV Oval Venting

Gas Vent Oval Pipe & Fittings

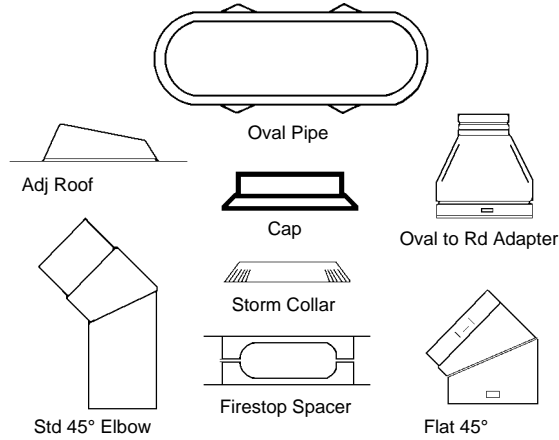

4" Gas Vent Oval

Part #	Mfg #	Description	Price
007919	4OV-12	12" Oval Pipe	
007920	4OV-2	24" Oval Pipe	
007921	4OV-3	36" Oval Pipe	
007922	4OV-4	48" Oval Pipe	
007923	4OV-5	60" Oval Pipe	
007924	4OV-45F	Flat 45° Elbow	
007925	4OV-45S	Standard 45° Elbow	
012142	4OV-4RV	Oval to 4" Round Adapter	
089500	4OV-FS	Firestop Spacer	
012145	4OV-SC	Storm Collar	
007918	4OV-TS	Oval to Round Tee	
007917	4OV-TC	Tee Cap	

5"/6" Gas Vent Oval

Part #	Mfg #	Description	Price
012135	5/6OV-12	12" Oval Pipe	
012136	5/6OV-2	24" Oval Pipe	
012138	5/6OV-4	48" Oval Pipe	
012139	5/6OV-5	60" Oval Pipe	
012143	5/6OV-5RV	5" Oval to Round Adapter	
012144	5/6OV-6RV	6" Oval to Round Adapter	
012140	5/6OV-T5	Oval to 5" Round Tee	
012147	5/6OV-TC	Tee Cap	

Roof & Chimney Caps

Venting Caps

634/634M Black Roof Cap

- Built-in backdraft damper and bird screen
- 24 Gauge CRCQ Steel, black electrically-bonded finish

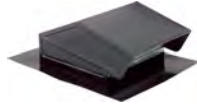

Part #	Mfg #	Description	Price
002548	634	For 3-1/4" x 10" or 8" Round Duct	
074322	634M	For 3-1/4" x 10" or 6" Round Duct	

636 Black Roof Cap

- Built-in backdraft damper and birdscreen
- 24 Gauge CRCQ Steel, black electrically-bonded finish



Part #	Mfg #	Description	Price
082892	636	For 3" or 4" Round Duct	

639 Black Wall Cap

- Spring-loaded backdraft damper
- Built-in bird screen
- Steel baked black enamel finish
- 24 Gauge CRCQ Steel, black electrically-bonded finish



Part #	Mfg #	Description	Price
002550	639	Black Steel for 3-1/4" x 10" Duct	

641 Aluminum Wall Cap

- Built-in backdraft damper and birdscreen
- Aluminum natural finish



Part #	Mfg #	Description	Price
002551	641	Aluminum for 6" Round Duct	
024789	642	Aluminum for 3" or 4" Round Duct	

643 Aluminum Wall Cap

- Built-in backdraft damper
- Aluminum natural finish



Part #	Mfg #	Description	Price
081057	643	Aluminum for 8" Round Duct	

885 Wall Cap

- 4" to 3" Transition included
- Built-in bird screen
- 24 Gauge CRCQ Steel, black electrically bonded epoxy finish
- Built-in damper



Part #	Mfg #	Description	Price
145669	885BL	Black for 3" or 4" Round Duct	
153176	885NS	For 3" or 4" Round Duct	

BVDS Exhaust Vent

- Bath & kitchen
- High density polyethylene
- 1-1/4" Removable mesh screen
- Removable stem



Part #	Mfg #	Size	Color	Price
233071	BVDS-4-BLK	4"	Black	

Exhaust Fans

Exhaust Fan Finish Pack

- To be used with RDH housing pack
- 120V
- 4" Duct diameter
- 2.5 Sones
- Recommended room size: 75 Sq Ft

Part #	Mfg #	CFM	Sones	Price
234406	80RDF	80	2.5	

Exhaust Fan Rough-In Kit

- Contains housing and radiation damper

Part #	Mfg #	CFM	Sones	Price
234407	RDH	Radiation Grille		



Roof & Chimney Caps

Vent Kits

Vinyl Duct Preferred Hood Vent Kit

- 4" x 8'
- Opening/closing damper
- UV inhibitor is used to help prevent the premature fading of vent
- Do not use for high temperature venting applications



Part #	Mfg #	Size	Color	Price
192418	207W	4" x 8'	White	

Plastic High Temperature Sealants

Silicone Caulk

Silicone Construction Caulk

- For indoor or outdoor use
- Permanently flexible
- -60°F - +450°F Water and weatherproof
- Insulates electrically and thermally room temperature vulcanizing



Part #	Mfg #	Description	Price
059844	12W	10.3 oz, White	
059845	12C	10.3 oz, Clear	

Silicone Seal Carded

- For indoor or outdoor use
- Permanently flexible
- -60°F - +450°F Water and weatherproof
- Insulates electrically and thermally room temperature vulcanizing



3W



3C

Part #	Mfg #	Description	Price
059842	3W	3 oz, White Mildew Resistant FDA/NSF	
059843	3C	3 oz, Clear USDA/FDA/NSF	

Stainless Steel Venting

FasNSeal® Adapters

Weil McLain Tee Appliance Adapter



Part #	Mfg #	Size	Price
041443	300358	3"	

FasNSeal® Single-Wall Special Gas Vent

Vent Length Pipe

- Use to vent category II, III and IV appliances



Part #	Mfg #	Size	Price
040346	300001	3" x 6"	
040347	300015	3" x 12"	
040348	300045	3" x 18"	
040349	300060	3" x 24"	
040350	300075	3" x 36"	
041867	300076	4" x 36"	
041863	300002	4" x 6"	
041864	300016	4" x 12"	
041866	300061	4" x 24"	

Adjustable Vent Length Pipe

- Use to add length to straight length of FasNSeal® pipe
- Adds 2" - 14" of length
- Requires at least 2" overlap for a secure connection



Part #	Mfg #	Size	Price
046673	300250	3" x 18"	

45° Elbow

- Allows for better condensate management and less back pressure



Part #	Mfg #	Size	Price
041868	300131	4"	

90° Elbow

- Use to go from horizontal to vertical runs or vertical to horizontal runs
- Use to turn vent 90°



Part #	Mfg #	Size	Price
040352	300160	3"	
041869	300161	4"	

Bird Screen

- Use for 3" and 4" standard through-the-wall terminations



Part #	Mfg #	Size	Price
040356	300186	3"	
041873	300187	4"	

Horizontal Drip Tee

- Use to manage condensate in horizontal runs



Part #	Mfg #	Size	Price
040354	300236	3"	
041872	300237	4"	

Wall Thimble with Adjustable Vent Length Pipe

- Use for through-the-wall termination
- Fits between standard wall studs



Part #	Mfg #	Size	Price
040353	300280	3"	
041871	300281	4"	

Work Gloves

Work Gloves

Demolition Gloves

- Built-in terry cloth sweat wipe
- Velcro Closure for a secure fit
- Breathable Lining - Moisture wicking lining provides all day comfort
- Molded Knuckle Protection - TPR pad provides ultimate knuckle protection
- Palms and Finger Tips reinforced with Armortex® for ultimate durability and grip
- Smartswipe™ Knuckle



Part #	Mfg #	Size	Price
229541	48-22-8735	Small	
186454	48-22-8731	Medium	
186456	48-22-8732	Large	
186457	48-22-8733	Extra Large	
186458	48-22-8734	2X Large	

Fingerless Work Gloves

- Fingerless design for ultimate dexterity
- Reinforced and padded palm
- Built-in terry cloth sweat wipe
- Hook & loop closure for a secure fit
- Breathable lining provides all day comfort



Part #	Mfg #	Size	Price
224333	48-22-8745	Small	
224334	48-22-8741	Medium	
224335	48-22-8742	Large	
224336	48-22-8743	Extra Large	
224337	48-22-8744	2X Large	

Free-Flex Work Gloves

- Built-in terry cloth sweat wipe
- Free-Flex cuff for all day comfort
- Breathable lining provides all day comfort reinforced thumb seam
- High dexterity finger tips provide dexterity when handling small objects
- Smartswipe™ Fingertips, Knuckles and Palms



Part #	Mfg #	Size	Price
224343	48-22-8715	Small	
224346	48-22-8711	Medium	
224347	48-22-8712	Large	
224348	48-22-8713	Extra Large	

Work Gloves (Continued)

Free-Flex Work Gloves

Part #	Mfg #	Size	Price
224349	48-22-8714	2X Large	

Performance Work Gloves

- Built-in terry cloth sweat wipe
- Breathable lining provides all day comfort
- Hook & loop closure for a secure fit
- High dexterity finger tips provide dexterity when handling small objects
- Smartswipe™ Fingertips, Knuckles and Palms



Part #	Mfg #	Size	Price
224338	48-22-8725	Small	
224339	48-22-8721	Medium	
224340	48-22-8722	Large	
224341	48-22-8723	Extra Large	
224342	48-22-8724	2X Large	

Cut Level 1 Dipped Gloves

- ANSI & EN cut rating 1
- Textured nitrile palm
- SMARTSWIPE™ palm and fingertips
- High dexterity design
- Nylon/lycra blend material
- TDM cut rating C, Abrasion rating 3, Tear rating 2, Puncture rating 1
- Breathable glove design



Part #	Mfg #	Size	Price
244551	48-22-8900	Small	
244552	48-22-8901	Medium	
243227	48-22-8902	Large	
243228	48-22-8903	Extra Large	
244553	48-22-8904	2X Large	

Work Gloves

Cut Level 3 Nitrile Dipped Gloves

- ANSI & EN cut rating 3
- SMARTWIPE™ palm and fingertips
- High dexterity design
- Nylon & HPPE liner material
- TDM cut rating C, Abrasion rating 4, Tear rating 4, Puncture rating 3
- Breathable glove design



Part #	Mfg #	Size	Price
267010	48-22-8932	Large	
267011	48-22-8933	Extra Large	
267012	48-22-8934	2X Large	

Cut Level 5 Dipped Gloves

- SMARTWIPE™ palm and fingertips
- High dexterity design
- Abrasion rating 4, puncture rating 4
- TDM cut rating E
- Nylon & HPPE liner material
- Double dipped nitrile w/ sandy texture finish



Part #	Mfg #	Size	Price
247748	48-22-8950	Small	
247750	48-22-8951	Medium	
247751	48-22-8952	Large	
247752	48-22-8953	Extra Large	
247753	48-22-8954	2X Large	

Cut Level 3 Insulated Winter Dipped Gloves

- Sandy latex finish for grip performance
- 3/4 double dipped latex microfinish for water resistance and warmth
- 15GA outer liner for dexterity
- 7GA inner liner for warmth
- Ideal use for demolition, wire-stripping, and pipe threading applications



Part #	Mfg #	Size	Price
254509	48-22-8921	Medium	
254510	48-22-8922	Large	
254511	48-22-8923	Extra Large	



Gloves, Ear Plugs, Goggles, ETC

Gloves

Disposable Latex Glove

- *Extra large*
- *Reversible*



Part #	Mfg #	Type	Size	Price
060105	390-50177	Heavy-Duty	XL	

Gloves, Ear Plugs, Goggles, ETC

Gloves

X10 Knucklehead Glove

- Synthetic leather palm
- Elastic wrist
- High visibility orange



Part #	Mfg #	Description	Price
148262	21242HOL	Large	
148263	21242HOXL	Extra Large	
148135	21242HOXXL	Extra Extra Large	

Split Cowhide Double Palm Glove

- Knuckle strap
- Wing thumb
- Polyethylene safety cuff



Part #	Mfg #	Description	Price
122046	4503CDPXL	Extra Large	

String Knit Cotton/Polyester Glove

- Ambidextrous
- PVC Dots on both sides
- Natural color



Part #	Mfg #	Description	Price
122623	3825L	Large	

A Grade Gold Deerskin Palm Glove

- Black stretch back
- Velcro closure
- Mechanics style
- Heatlok lined



Part #	Mfg #	Description	Price
129331	2150HM	Medium	
129332	2150HXL	Extra Large	
129346	2150HXXL	Extra Extra Large	

High Visibility Terry Lined Yellow Knit No Logo Glove

- Black rubber palm hides dirt
- Rubber palm
- Super fit
- Precurved design promotes easy flexing



Part #	Mfg #	Description	Price
144702	3396HYNL	Large	
144701	3396HYNXL	Extra Large	

High Visibility Yellow Knit Glove

- Summer version
- Black rubber palm hides dirt
- Rubber palm
- Super fit
- Precurved design promotes easy flexing



Part #	Mfg #	Description	Price
122621	3397HYL	Large	

High Visibility Yellow Knit No Logo Glove

- Rubber palm
- Excellent wear and resistance
- Super fit



Part #	Mfg #	Description	Price
140861	3397HYNM	Medium	
140863	3397HYNL	Large	
140858	3397HYNXL	Extra Large	

High Visibility Superdex Gloves

- Nylon shell
- 15 Gauge liner
- 100% Launderable
- Pre-curved finger design
- Ultra cool & breathable coating
- Micro foam nitrile coated palm



Part #	Mfg #	Description	Price
159170	3228HVYL	Large	
159171	3228HVYXL	Extra Large	

Gloves, Ear Plugs, Goggles, ETC

High Visibility Orange Knit Glove

- Summer version
- Black rubber palm hides dirt
- Precurved design promotes easy flexing
- Rubber palm
- Super fit



Disposable Nitrile Glove

- Textured fingertips
- Powder-free
- 5 - 6 Mil
- 100/Box



Part #	Mfg #	Description	Price
122620	3397HOL	Large	

Part #	Mfg #	Description	Price
121772	3276L	Large	
133593	3276XL	Extra Large	

High Visibility Orange Knit No Logo Glove

- Rubber palm
- Excellent wear and resistance
- Super fit

Part #	Mfg #	Description	Price
140860	3397HONM	Medium	
140862	3397HONL	Large	
140859	3397HONXL	Extra Large	

SuperDex Gray Nitrile Palm Dipped Glove

- Lightweight black nylon liner
- Knit wrist
- Black/gray



Part #	Mfg #	Description	Price
169298	3270L	Large	
169299	3720XL	Extra Large	

OXXA X-Pro Flex Gloves

- Micro foam nitrile palm coating nylon shell



Part #	Mfg #	Description	Price
159172	51-290	Medium	
159173	51-290	Large	

Gloves, Ear Plugs, Goggles, ETC

Cowhide Drivers Gloves

Elastic Back Rough Rider Gloves

- Made from top-grain leather
- Deep oil tanned
- Sewn with inset, keystone thumb
- Bound at cuff with leather
- Elastic back for an easy-on easy-off fit



Part #	Mfg #	Size	Qty	Price
051840	2500-L	Large	1 Pair	

Latex and Vinyl Coated Gloves

Yellow Flock Lined Latex Cleaning Gloves

- 18 Mil natural latex
- Unsupported
- Soft flock lining absorbs moisture for easy off and on



Part #	Mfg #	Size	Qty	Price
051851	6000-L	Large	1 Pair	

Side Split Leather Gloves

Premium Side Split Leather Palm Gloves

- Blue
- Side-split leather work gloves for longer wear and better protection
- Safety cuff



Part #	Mfg #	Size	Qty	Price
051839	2110-L	Large	1 Pair	

Hearing Protection

MAX Ear Plugs

- Preshaped foam
- NRR33 Rated



Part #	Mfg #	Description	Qty	Price
051843	9500	Uncorded	100/Pk	

Howard Leight Quiet Ear Plugs

- Corded



Part #	Mfg #	Description	Qty	Price
051844	9522	Corded		

Grain Leather Gloves

Rough Rider Grain Leather Palm Gloves

- Made from top-grain leather
- Deep oil tanned
- Lined with 100 grams 3M Thinsulate insulation
- Heavy yellow canvas
- Knit wrists



Part #	Mfg #	Size	Qty	Price
051841	2160-L	Large	1 Pair	

Disposable Respirators

Nuisance Dust Mask

- Filters pollen, dust and other non-toxic particles from the air
- Withstands hot and humid conditions
- Double-shell construction resists collapse
- Easily adjustable nosepiece



Part #	Mfg #	Description	Qty	Price
051842	9700	Dust Mask	50/Box	

Jersey Gloves

Part #	Mfg #	Size	Qty	Price
051837	3401-L	9 oz Large	1 Pair	

Double Palm and Chore Cotton Gloves

Galeton Gold Cotton Chore Cotton Gloves

- 18 oz Quilted gold cotton chore
- Two layers of soft cotton
- Insulated against heat and cold
- Knit wrist



Part #	Mfg #	Size	Qty	Price
051838	3112-L	Large	1 Pair	

Work Gear

Work Wear

GridIron™ Zip-to-Thigh Bib Overall

- Freeflex™
- No Days Off™
- 2" Adjustable waist
- Durable metal buckles
- 100g high-loft insulation
- Tarnish resistant metal zippers
- Pockets include:
 - 2 front hand pockets
 - 2 large back pockets
 - 3 side leg pockets
 - Utility chest pocket
 - Tape measure & hammer loops



Part #	Mfg #	Waist	Inseam	Price
241320	261B-SS	28"-30"	28"	
241319	261B-SR	28"-30"	30"	
241321	261B-ST	28"-30"	32"	
241317	261B-MS	32"-34"	28"	
241316	261B-MR	32"-34"	30"	
241318	261B-MT	32"-34"	32"	
241314	261B-LS	36"-38"	28"	
241313	261B-LR	36"-38"	30"	
241315	261B-LT	36"-38"	32"	
241323	261B-XLS	40"-42"	28"	
241322	261B-XLR	40"-42"	30"	
241324	261B-XLT	40"-42"	32"	
241308	261B-2XS	44"-46"	28"	
241307	261B-2XR	44"-46"	30"	
241309	261B-2XT	44"-46"	32"	
241311	261B-3XS	48"-50"	28"	
241310	261B-3XR	48"-50"	30"	
241312	261B-3XT	48"-50"	32"	

Hooded Jacket - Black

- GridIron™ Ripstop polyester
- FreeFlex™ Mobility
- Wind and water resistant
- 100g of High-loft insulation
- Fitted hood
- Rib knit cuffs and waist



Part #	Mfg #	Size	Price
224060	252B-S	Small	
224061	252B-M	Medium	
224062	252B-L	Large	

Work Wear (Continued)

Hooded Jacket - Black

Part #	Mfg #	Size	Price
224063	252B-XL	Extra Large	
224065	252B-2X	2X Large	
224066	252B-3X	3X Large	

WorkSkin™ Cold Weather Base Layer - Gray

- Fast wicking sweat zones move moisture away from under arms and upper back
- Durable body fabric
- Drop tail extended back
- Seamless shoulders



Part #	Mfg #	Size	Price
224068	401G-S	Small	
224069	401G-M	Medium	
224070	401G-L	Large	
224071	401G-XL	Extra Large	
224072	401G-2X	2X Large	
224073	401G-3X	3X Large	

WorkSkin™ Light Weight Performance Shirt

- CoolCore® fabric
- Seamless shoulders
- Drop tail extended back
- Fast wicking sweat zones extend down the back and under the arms



Part #	Mfg #	Size	Price
238077	410G-S	Small	
238078	410G-M	Medium	
238079	410G-L	Large	
238080	410G-XL	Extra Large	
238081	410G-2X	2X Large	
238082	410G-3X	3X Large	

Work Gear

WorkSkin™ Light Weight Performance Shirt High Visibility

- CoolCore® fabric
- Seamless shoulders
- Drop tail extended back
- Fast wicking sweat zones extend down the back and under the arms



Part #	Mfg #	Size	Price
238055	410HV-S	Small	
238056	410HV-M	Medium	
238058	410HV-L	Large	
238059	410HV-XL	Extra Large	
238061	410HV-2X	2X Large	
238063	410HV-3X	3X Large	

WORKSKIN™ MID-WEIGHT COLD WEATHER HARDHAT LINER

- Breathable fabric moves moisture away from the body
- Durable fabric resists pilling and fights odor
- Fast moisture wicking, accelerated drying
- Low profile, ideal for hardhat use



Part #	Mfg #	Color	Price
252329	422B	Black	

GRIDIRON™ SNAPBACK TRUCKER HAT

- GRIDIRON™ Ripstop polyester front panel
- Six panel construction
- 3-1/2" Crown
- Curved visor
- One size fits all with adjustable snapback



Part #	Mfg #	Color	Price
251074	505B	Black	

Fleece Lined Beanie

- One size fits all
- Polyester material wicks sweat
- Abrasion and snag resistant
- 98% Polyester, 2% spandex



Part #	Mfg #	Color	Price
238994	502G	Gray	
238996	502B	Black	
238995	502R	Red	

Stocking Cap

Part #	Mfg #	Color	Price
224089	501G	Gray	
224090	501R	Red	

Heated Gear

Heated Jackets

M12™ 3-in-1 Heated Jacket - Black

- Chest and back zones
- Up to 8 hours of run-time
- GridIron™ Ripstop polyester
- Low profile battery
- Washer and dryer safe
- FREEFLEX™ Mobility
- 3 Heat settings: High, Med, Low



Kits

Part #	Mfg #	Size	Price
224038	251B-21S	Small	
224039	251B-21M	Medium	
224041	251B-21L	Large	
224042	251B-21XL	Extra Large	
224043	251B-212X	2X Large	
224044	251B-213X	3X Large	

Jacket Only (Less Battery Pack)

Part #	Mfg #	Size	Price
224032	251B-20S	Small	
224033	251B-20M	Medium	
224034	251B-20L	Large	
224035	251B-20XL	Extra Large	
224037	251B-203X	3X Large	
224036	251B-202X	2X Large	

M12™ Heated Jacket - Black

- Chest and back zones
- Up to 8 hours of run-time
- TOUGHSHELL™ Stretch polyester
- Low profile battery
- Washer and dryer safe
- FREEFLEX™ Mobility
- 3 Heat settings: High, Med, Low



Kits

Includes:

- (1) M12™ Heated TOUGHSHELL™ Jacket Kit (202-21)
- (1) M12™ REDLITHIUM™ CP2.0 Battery (48-11-2420)
- (1) M12™ Compact Charger and Power Source (48-59-1201)

Part #	Mfg #	Size	Price
223832	202B-21S	Small	
223833	202B-21M	Medium	

Heated Jackets (Continued)

M12™ Heated Jacket - Black

Kits

Part #	Mfg #	Size	Price
223834	202B-21L	Large	
223835	202B-21XL	Extra Large	
252064	202B-212X	2X Large	
252065	202B-213X	3X Large	

Jacket Only (Less Battery Pack)

Part #	Mfg #	Size	Price
223817	202B-20S	Small	
223827	202B-20M	Medium	
223828	202B-20L	Large	
223829	202B-20XL	Extra Large	
223830	202B-202X	2X Large	
223831	202B-203X	3X Large	

M12™ Heated Jacket - Gray

- Chest and back zones
- Up to 8 hours of run-time
- TOUGHSHELL™ Stretch polyester
- Low profile battery
- Washer and dryer safe
- FREEFLEX™ Mobility
- 3 Heat settings: High, Med, Low



Kits

Includes:

- (1) M12™ Heated TOUGHSHELL™ Jacket Kit (202-21)
- (1) M12™ REDLITHIUM™ CP2.0 Battery (48-11-2420)
- (1) M12™ Compact Charger and Power Source (48-59-1201)

Part #	Mfg #	Size	Price
267170	202G-21S	Small	
267171	202G-21M	Medium	
267172	202G-21L	Large	
267173	202G-21XL	Extra Large	
267174	202G-212X	2X Large	
267175	202G-213X	3X Large	

Jacket Only (Less Battery Pack)

Part #	Mfg #	Size	Price
267164	202G-20S	Small	
267165	202G-20M	Medium	

Heated Gear

Heated Jackets (Continued)

M12™ Heated Jacket - Gray

Jacket Only (Less Battery Pack)

Part #	Mfg #	Size	Price
267166	202G-20L	Large	
267167	202G-20XL	Extra Large	
267168	202G-202X	2X Large	
267169	202G-203X	3X Large	

M12™ Heated Jacket - Red

- Chest and back zones
- Up to 8 hours of run-time
- TOUGHSHELL™ Stretch polyester
- Low profile battery
- Washer and dryer safe
- FREEFLEX™ Mobility
- 3 Heat settings: High, Med, Low



Kits

• Includes:

- (1) M12™ Heated TOUGHSHELL™ Jacket Kit (202-21)
- (1) M12™ REDLITHIUM™ CP2.0 Battery (48-11-2420)
- (1) M12™ Compact Charger and Power Source (48-59-1201)

Part #	Mfg #	Size	Price
223865	202R-21S	Small	
223866	202R-21M	Medium	
223973	202R-21L	Large	
223974	202R-21XL	Extra Large	
223975	202R-212X	2X Large	
223976	202R-213X	3X Large	

Jacket Only (Less Battery Pack)

Part #	Mfg #	Size	Price
223858	202R-20S	Small	
223859	202R-20M	Medium	
223860	202R-20L	Large	
223861	202R-20XL	Extra Large	
223862	202R-202X	2X Large	
223864	202R-203X	3X Large	

M12™ Heated QUIETSHELL Jacket

- Heating zones: chest, back, & pockets
- Up to (8) hours of run-time
- QuietShell stretch polyester
- 3 Heat settings per zone
- Washer and dryer safe



Kits

• Includes:

- (1) M12™ Heated QUIETSHELL Jacket (222-20)
- (1) M12™ REDLITHIUM™ CP2.0 Battery (48-11-2420)
- (1) M12™ Compact Charger and Power Source (48-59-1201)

Part #	Mfg #	Size	Price
252326	222C-21L	Large	
252327	222C-21XL	Extra Large	
252328	222C-212X	2X Large	

Jacket Only (Less Battery Pack)

Part #	Mfg #	Size	Price
255312	222C-20M	Medium	
255286	222C-20L	Large	

M12™ Women's Heated AXIS™ Jacket

- Quick-heat function
- One-touch LED controller with 3 heat settings
- Up to (8) hours of run-time w/ M12™ REDLITHIUM™ 2.0 compact battery
- Washer and dryer safe
- Reinforced high-wear zones
- 100% Polyester insulation keeps heat in
- (3) Out zip pockets, (1) inner zip pocket, (1) low-profile battery pocket



Kits

Includes:

- (1) M12™ Heated Women's AXIS™ Jacket (233-20)
- (1) M12™ REDLITHIUM™ CP2.0 Battery (48-11-2420)
- (1) M12™ Compact Charger and Power Source (48-59-1201)

Part #	Mfg #	Size	Price
252144	233B-21S	Small	
252145	233B-21M	Medium	
252146	233B-21L	Large	
252147	233B-21XL	Extra Large	



Heated Gear

Jacket Only (Less Battery Pack)

Part #	Mfg #	Size	Price
252148	233B-20S	Small	
252149	233B-20M	Medium	
252150	233B-20L	Large	
252151	233B-20XL	Extra Large	
263540	233B-202X	2X Large	

M12™ Heated AXIS™ Jacket - Black

- Heating zones: chest, back, & shoulders
- Up to 8 hours of run-time with M12™ REDLITHIUM™ 2.0 compact battery
- 100% Polyester insulation
- Washer and dryer safe
- Quick-heat function reaches selected temperature 3X FASTER
- Adjustable waist with drop tail extended back



Kits

Includes:

- (1) M12™ Heated AXIS™ Jacket (203-20)
- (1) M12™ REDLITHIUM™ CP2.0 Battery (48-11-2420)
- (1) M12™ Compact Charger and Power Source (48-59-1201)

Part #	Mfg #	Size	Price
252130	203B-21S	Small	
252132	203B-21M	Medium	
252133	203B-21L	Large	
252134	203B-21XL	Extra Large	
252135	203B-212X	2X Large	
252136	203B-213X	3X Large	

Jacket Only (Less Battery Pack)

Part #	Mfg #	Size	Price
252138	203B-20S	Small	
252139	203B-20M	Medium	
252140	203B-20L	Large	
252142	203B-20XL	Extra Large	
252141	203B-202X	2X Large	
252143	203B-203X	3X Large	

M12™ Heated AXIS™ Jacket - Olive Green

- Heating zones: chest, back, & shoulders
- Up to 8 hours of run-time with M12™ REDLITHIUM™ 2.0 compact battery
- 100% Polyester insulation
- Washer and dryer safe
- Quick-heat function reaches selected temperature 3X FASTER
- Adjustable waist with drop tail extended back



Kits

Part #	Mfg #	Size	Price
263529	203OG-21S	Small	
263531	203OG-21M	Medium	
263532	203OG-21L	Large	
263533	203OG-21XL	Extra Large	
263534	203OG-212X	2X Large	
263535	203OG-213X	3X Large	

Jacket Only (Less Battery Pack)

Part #	Mfg #	Size	Price
263522	203OG-20S	Small	
263523	203OG-20M	Medium	
263524	203OG-20L	Large	
263526	203OG-20XL	Extra Large	
263527	203OG-202X	2X Large	
263528	203OG-203X	3X Large	

M12™ Heated AXIS™ Layering System with HYDROBREAK™ Rain Shell - Gray

- HYDROBREAK™ Rain shell
- Reinforced high-wear zones
- One-touch LED controller
- Heating zones: chest, back, & shoulders
- Adjustable waist with drop tail extended back
- (2) Outer velcro pockets, (1) outer zip pocket, (3) inner zip pockets (1) low-profile battery pocket
- Includes:
 - (1) M12™ Heated AXIS™ Layering system with HYDROBREAK™ rain shell (203RN-21)
 - (1) HYDROBREAK™ Rain shell (310)
 - (1) M12™ REDLITHIUM™ CP2.0 Battery (48-11-2420)
 - (1) M12™ Compact charger and power source (48-59-1201)



Part #	Mfg #	Size	Price
263544	203RN-21S	Small	
263546	203RN-21M	Medium	
263547	203RN-21L	Large	

Heated Gear

Heated Jackets (Continued)

M12™ Heated AXIS™ Layering System with HYDROBREAK™ Rain Shell - Gray

Part #	Mfg #	Size	Price
263548	203RN-21XL	Extra Large	
263549	203RN-212X	2X Large	
263550	203RN-213X	3X Large	

HYDROBREAK™ Rain Shell - Gray

- Provides 10k mm rated waterproof jobsite protection
- Velcro enclosures: front zipper, pockets and wrists for additional water protection
- Velcro enclosures: front zipper, pockets and wrists
- Adjustable waist with drop tail extended back
- 2.5 Layer construction
- Standing collar and adjustable hood
- Reinforced high wear zones



Part #	Mfg #	Size	Price
263561	310G-S	Small	
263562	310G-M	Medium	
263563	310G-L	Large	
263564	310G-XL	Extra Large	
263565	310G-2X	2X Large	
263566	310G-3X	3X Large	

Heated Hoodies

All kits include

- (1) M12™ Heated Hoodie
- (1) M12™ REDLITHIUM™ Battery (48-11-2401)
- (1) M12™ Lithium-ion Battery Charger (48-59-2401)
- (1) M12™ Battery Holder

M12™ Heated Hoodie - Black

- Chest and back zones
- Up to 6 hours of run-time
- Waffle weave lining traps heat
- Washer and dryer safe
- Durable utility pockets
- 3 Heat settings: High, Med, Low



Kits

Includes:

- (1) M12™ Heated Hoodie (302-20)
- (1) M12™ REDLITHIUM™ CP1.5 Battery Pack (48-11-2401)
- (1) M12™ Lithium-ion Battery Charger (48-59-2401)
- (1) M12™ Battery Holder

Part #	Mfg #	Size	Price
224014	302B-21S	Small	
252066	302B-21M	Medium	
224016	302B-21L	Large	
224017	302B-21XL	Extra Large	
224018	302B-212X	2X Large	
224019	302B-213X	3X Large	

Hoodie Only (Less Battery Pack)

Part #	Mfg #	Size	Price
224008	302B-20S	Small	
224009	302B-20M	Medium	
224010	302B-20L	Large	
224011	302B-20XL	Extra Large	
224012	302B-202X	2X Large	
227263	302B-203X	3X Large	

Heated Gear

M12™ Heated Hoodie - Gray

- Chest and back zones
- Up to 6 hours of run-time
- Waffle weave lining traps heat
- Waster and dryer safe
- Durable utility pockets
- 3 Heat settings: High, Med, Low



Kits

Includes:

- (1) M12™ Heated Hoodie (302-20)
- (1) M12™ REDLITHIUM™ CP1.5 Battery Pack (48-11-2401)
- (1) M12™ Lithium-ion Battery Charger (48-59-2401)
- (1) M12™ Battery Holder

Part #	Mfg #	Size	Price
224002	302G-21S	Small	
224003	302G-21M	Medium	
224004	302G-21L	Large	
224005	302G-21XL	Extra Large	
224006	302G-212X	2X Large	
224007	302G-213X	3X Large	

Hoodie Only (Less Battery Pack)

Part #	Mfg #	Size	Price
223996	302G-20S	Small	
223997	302G-20M	Medium	
223998	302G-20L	Large	
223999	302G-20XL	Extra Large	
224000	302G-202X	2X Large	
224001	302G-203X	3X Large	

M12™ Heated Hoodie - Red

- Chest and back zones
- Up to 6 hours of run-time
- Waffle weave lining traps heat
- Waster and dryer safe
- Durable utility pockets
- 3 Heat settings: High, Med, Low



Kits

Includes:

- (1) M12™ Heated Hoodie (302-20)
- (1) M12™ REDLITHIUM™ CP1.5 Battery Pack (48-11-2401)
- (1) M12™ Lithium-ion Battery Charger (48-59-2401)
- (1) M12™ Battery Holder

Part #	Mfg #	Size	Price
224026	302R-21S	Small	

Heated Hoodies (Continued)

M12™ Heated Hoodie - Red

Kits

Part #	Mfg #	Size	Price
224027	302R-21M	Medium	
224028	302R-21L	Large	
224029	302R-21XL	Extra Large	
224030	302R-212X	2X Large	
224031	302R-213X	3X Large	

Hoodie Only (Less Battery Pack)

Part #	Mfg #	Size	Price
224022	302R-20L	Small	
224021	302R-20M	Medium	
224020	302R-20S	Large	
224023	302R-20XL	Extra Large	
224024	302R-202X	2X Large	
224025	302R-203X	3X Large	

M12™ Heated Vest - Black

- Up to 6 hours of run-time
- GridIron™ Ripstop polyester
- Thermal fleece lining
- 3 Heat settings: High, Med, Low



Kits

- (1) M12™ Heated Vest - Black (Vest Only) (271B-20)
- (1) M12™ REDLITHIUM™ Battery (48-11-2401)
- (1) M12™ Battery Holder

Part #	Mfg #	Size	Price
224054	271B-21S	Small	
224055	271B-21M	Medium	
224056	271B-21L	Large	
224057	271B-21XL	Extra Large	
224058	271B-212X	2X Large	
224059	271B-213X	3X Large	

Vest Only (Less Battery Pack)

Part #	Mfg #	Size	Price
224045	271B-20S	Small	
224046	271B-20M	Medium	
224049	271B-20L	Large	
224050	271B-20XL	Extra Large	

Heated Gear

Heated Hoodies (Continued)

M12™ Heated Vest - Black Vest Only (Less Battery Pack)

Part #	Mfg #	Size	Price
224051	271B-202X	2X Large	
224053	271B-203X	3X Large	

M12™ Heated AXIS™ Vest

- Quick-heat function reaches selected temperature 3X FASTER
- Up to (6) hours of run-time
- 100% Polyester insulation
- One-touch LED controller with (3) heat settings per heat zone: High, Med, Low
- Heating zones: chest & back
- Wind and water resistant
- Adjustable waist with drop tail extended back



Kits

Includes:

- (1) M12™ Heated AXIS™ Vest (303-20)
- (1) M12™ REDLITHIUM™ Battery (48-11-2401)
- (1) M12™ Battery Holder

Part #	Mfg #	Size	Price
252152	303B-21S	Small	
252153	303B-21M	Medium	
252154	303B-21L	Large	
252155	303B-21XL	Extra Large	
252156	303B-212X	2X Large	
252158	303B-213X	3X Large	

Vest Only (Less Battery Pack)

Part #	Mfg #	Size	Price
252159	303B-20S	Small	
252160	303B-20M	Medium	
252161	303B-20L	Large	
252162	303B-20XL	Extra Large	
252163	303B-202X	2X Large	
252164	303B-203X	3X Large	

M12™ Heated Women's AXIS™ Vest

- Quick-heat function reaches selected temperature 3X FASTER
- Up to 6 hours of run-time
- One-touch LED controller with (3) heat settings per heat zone: High, Med, Low
- Heating zones: chest & back
- Wind & water resistant
- Adjustable waist with drop tail extended back



Kits

- (1) M12™ Heated Women's AXIS™ Vest (333-20)
- (1) M12™ REDLITHIUM™ CP1.5 Battery Pack (48-11-2401)
- (1) M12™ Battery Holder

Part #	Mfg #	Size	Price
252168	333B-21S	Small	
252170	333B-21M	Medium	
252171	333B-21L	Large	
252172	333B-21XL	Extra Large	

Vest Only (Less Battery Pack)

Part #	Mfg #	Size	Price
252173	333B-20S	Small	
252174	333B-20M	Medium	
252175	333B-20L	Large	
252176	333B-20XL	Extra Large	

Heated Hand Warmers

Kits Include

- (1) M12™ Cordless heated hand warmer only
- (1) M12™ REDLITHIUM™ battery (48-11-2401)
- (1) M12™ Lithium-ion battery charger (48-59-2401)
- (1) M12™ Battery holder

M12™ Heated Hand Warmer with LED Work Light Kit

- TOUGHShell™ stretch polyester
- 1 size with adjustable waist strap fits most
- 1 outer zip pockets, 1 outer magnet closure pocket, 1 low-profile battery pocket
- Includes:
 - M12™ REDLITHIUM™ 2.0 compact battery pack
 - M12™ LED work light
 - M12™ battery holder with 2.1A USB charger to power electronic devices



Part #	Mfg #	Size	Price
256498	551B-21	Black Hand Warmer Kit	



Heated Gear

Heated Gloves

Kits Include

- (1) REDLITHIUM™ USB Battery (48-11-2130)
- (1) REDLITHIUM™ USB Battery & Charger Kit (48-59-2003)
- (1) Heavy Duty Cord and Wall Plug

USB Rechargeable Heated Gloves

- Quick-heat function reaches selected temperature 3X faster
- Up to (6) hours of run-time with REDLITHIUM™ USB Batter Pack
- GRIDIRON™ Ripstop polyester
- SMARTSWIPE™ index fingers permits use of touch screen devices
- Extended cuff protects from the elements
- One-touch LED controller with (3) heat settings
- Leather palms and fingers improve dexterity
- Built-in terry cloth sweat wipe



Part #	Mfg #	Size	Color	Price
252178	561-21M	Medium	Black	
252179	561-21L	Large	Black	
252180	561-21XL	Extra Large	Black	

Safety Glasses

Safety Glasses

Sportster Safety Glasses

- Curved, wrap-around lenses
- Super-light
- 99% UV-A & UV-B Protection



Part #	Mfg #	Description	Qty	Price
080260	9200042	Indoor/Outdoor	1 Pair	

Shoe Covers

Shoe Covers**Waterproof Shoe Cover**

- Skid-proof soles
- Waterproof
- Multiuse or disposable
- Dispenser box
- Designed to fit over a size 18 work boot
- Dark blue



Part #	Mfg #	Description	Price
138851	20623	Waterproof Shoe Covers, Box of 50	

Shoe Covers

Shoe Covers

Shoe Liner Booty



Part #	Mfg #	Description	Price
145266	SC-1	Bx/50 Pair Shoe Liner Bootie	
237939	SC-1WP	Bx/40 Pair Shoe Liner Bootie	



Shoe Covers

Shoe Covers

Disposable Shoe Covers

- *Blue-spun polypropylene, non-waterproof*
- *Fits over shoe sizes 5-15*



Part #	Mfg #	Description	Price
076120	390-50176	Shoe Covers - 50 Per Box	

Shoe Covers

Yaktrax® Ice Traction Devices

Yaktrax® Icewalker

- Ultra lightweight ice traction
- Easy on/off
- Spikeless patented skid lock coil system
- Abrasion resistant 1.2mm steel coil
- Rust-resistant and crush-resistant
- 100% Satisfaction guaranteed



Part #	Mfg #	Size	Color	Fits Shoe Size:	Price
130634	08601	Small	Black	Men's 5 to 8-1/2, Women's 6-1/2 to 10	
128220	08603	Medium	Black	Men's 9 to 11, Women's 10-1/2 to 12-1/2	
128219	08605	Large/Extra-Large	Black	Men's 11-1/2 to 13-1/2, Women's 13 to 15	



Shoe Covers

Page Left Blank



Manufacturer Index

A

Ademco.....	486
Advanced Industrial Components.....	407
Agri Drain Corporation.....	456
Airease.....	39-41, 53-56, 69-71, 85-86, 300-30 2, 324-32 8, 560
American Air Filters, Co.....	31
Amtrol.....	370, 423-42 4
Apollo Valves.....	425
Aspen Mfg Inc.....	46-49
Atco.....	209-21 1

B

B&D Mfg.....	252-25 3, 405
Basco.....	562
Basset.....	206
Bell & Gossett.....	371, 404, 415, 563-56 4
Benchmark Foam, Inc.....	540
Boeser Sheet Metal.....	217-21 8, 223, 225, 228, 232, 247
Bradley Corporation.....	565



Manufacturer Index

B (Continued)

Bramec	144, 450, 452, 476, 482, 527, 542, 803, 939, 960, 998
Broan	978
Builders Best	962
Bully Tools	938

C

C & S Mfg Corp	206
Cain MFG	203-20 4
Chatham Brass	980
Cherne Industries	915
Chicago Faucets	566-57 0
Conbraco	425
Covalence Adhesives	196

D

Dearborn Brass	571
Deflect-O	270
Delavan	470
Delta	572-58 9



D (Continued)

DiversiTech.....	130-132, 136-138, 141-142, 152-156, 165, 175, 178-179, 182, 269, 338, 436-440, 448, 454-455, 5, 554, 685-686, 770-773, 955, 999
Ducane.....	72-73, 87-88, 303-307, 329-332
Ductmate Industries.....	200
Duro Dyne.....	187, 201, 207, 546
Dynamic Air Quality Solutions.....	23

E

EL Mustee.....	629
Elkay.....	593-594
Empire Comfort Systems.....	335, 595
Energy Saving Products.....	601

F

Fantech.....	556
Fenner Drives.....	596



Manufacturer Index

F (Continued)

Fernox.....	383
Frigidaire.....	35-38, 63-64, 66-68, 78-83, 294-29 9, 317-32 3
Fujitsu.....	90-94, 96-106, 119-12 2

G

Galeton Gloves.....	987, 997
Gasqila.....	167
General Filters.....	16, 30, 471, 597
General Plastics.....	219-22 1
General Wire Spring Co.....	798, 912, 918, 920-92 1
Gerber.....	598
Gibson.....	50-51, 61-62, 76-77, 287-29 0, 312-31 6
Glasfloss.....	21-22, 254
Gray Metal South.....	959
Grundfos Pumps.....	398-40 3



Manufacturer Index

H

Hardcast Inc.....	202, 535, 539, 545
Hart & Cooley.....	188-19 3, 258, 262-26 6, 271-27 3, 277-28 0
Harvey.....	377, 445, 550, 553, 916
Heat Controller.....	109
Heatlines.....	341
Hercules.....	169, 382
Hilmor.....	799, 817, 884-88 5, 911, 936
Hoffman Specialty.....	373, 420



Manufacturer Index

H (Continued)

Honeywell.....	1-2, 13-15, 18-20, 29, 149, 368, 372, 384-38 6, 389-39 0, 428-42 9, 457-46 0, 464-46 5, 467-46 9, 472, 475, 483-48 4, 486-50 5, 521-52 2, 524-52 5, 529-53 4, 602-60 4
Hydro-Balance Corporation.....	128
Hydrolevel Company.....	413
Hydron Module.....	255-25 7, 605-60 6

I

Implus Corporation.....	1001
Insulation.....	198, 536-53 7, 541, 543
Intertherm.....	52, 285, 291-29 3, 339-34 0
Invensys.....	462



Manufacturer Index

J

Johnson Controls..... 151

K

Ken-Way Corporation..... 919

Koch Filter Corporation..... 26-28

Kohler..... 607-610

L

LA-CO Markal..... 168

Lambro Industries..... 957,
961,
979

Lavelle..... 426,
917

Legend Valve..... 397

LG Electronics..... 107-108

Liberty Pumps..... 447

Lifebreath..... 8-12,
261,
968

Little Giant..... 446

Lochinvar..... 342-345,
630

Lutz File & Tool Co..... 910

M

M&G DuraVent..... 981

MA-Line..... 480,
759

Majestic Glove..... 985-986



Manufacturer Index

M (Continued)

Malco Tools.....	199, 367, 622, 732, 744, 762, 908-90 9, 928-93 1, 949
Maxitrol.....	473-47 4
Maxstraps.....	769
McDonnell and Miller.....	412, 623
Mill-Rose.....	775, 898, 950
Milwaukee Tools.....	715-73 1, 736-74 1, 743, 745-75 0, 753-75 4, 763-76 4, 767-76 8, 779-78 9, 796-79 7, 801, 811-81 4, 818-87 6, 887-89 6, 899-90 7, 932-93 4, 940-94 3, 982-98 3, 988-99 6
Moen.....	624-62 7
Monti & Associates.....	480, 759



Manufacturer Index

N

Navien, Inc.....	346-34 9, 631
Nibco.....	395
Nordyne.....	337, 696-69 8
Nortek Global.....	600
Nu-Calgon.....	124-12 7, 135, 551, 882

O

Oatey.....	170
------------	-----

P

Panasonic.....	963-96 7
Paragon Electric.....	146
Parker Hannifin.....	133, 158, 163
Pasco Specialty Mfg Inc.....	777, 951
Philco see NORDYNE.....	337, 696-69 8
Pipe Insulation.....	548-54 9
Polyken Technologies.....	196-19 7, 544
Prinsco.....	559
Pro1 IAQ.....	506-50 8
Protech.....	25, 657-68 1, 733, 774



Manufacturer Index

R

Radiator Specialty Co.....	380
Ranco Controls.....	147-148
RCD Corporation.....	205
Rectorseal.....	95, 176
RectorSeal.....	259, 284
Rectorseal.....	681
RectorSeal.....	810, 952
Refrigeration Technologies.....	171
Reznor.....	333-334, 635-637
Rheem.....	42
Rheem-Ruud.....	639-643
Rhomar Water Management Inc.....	378-379
Richard Specialty Co Inc.....	742, 778, 816, 913, 947
Ridgid Tools.....	734, 766, 794-795, 802, 805-809, 877, 886, 935, 937, 944-946
Robertshaw.....	435, 461-462, 466, 485, 526



R (Continued)

Ruud	3-4, 17, 24-25, 32-34, 43-45, 58-60, 74-75, 89, 110, 112-11 7, 123, 128-12 9, 134, 139-14 0, 145, 150, 157, 159-16 2, 164, 180-18 1, 183-18 5, 195, 286, 308-31 1, 442-44 4, 449, 453, 463, 477-47 9, 481, 509-51 2, 523, 528, 675-68 0, 682-68 4, 751-75 2, 755, 758, 774, 776, 878-88 1, 883
-------------------	--

S

Sanuvox Technologies Inc	6-7
Schwank USA	432-43 4, 644
Screws, Nuts & Bolts	143
Seekonk Manufacturing Co Inc	953
Selkirk, Metalbestos	958, 970-97 7



Manufacturer Index

S (Continued)

Sensible Products	954
Sheet Metal	212
Shoemaker Mfg Co	260, 267-268, 274-276, 281-282
Silver King Mfg	381
Simpson DuraVent	981
Sioux Chief	208, 451, 555, 792-793, 804, 815, 897, 914, 984, 1000
Sloan	645-649
Smith's Environmental	336
Southwark Metal	213-216, 222, 224, 226-227, 229-231, 234-246, 248-249, 956
Speakman	650
Spectroline	172-173
Speedi-Boot	233
Spiralink	422
SpiroTherm	374
Spruce Environmental	557
Stuff Sorter by Versapec	791



Manufacturer Index

T

T&S Brass.....	651-65 2
Taco.....	391, 406, 430, 653
Tapco.....	561
Tekmar Controls.....	393-39 4
Thermo.....	177, 186, 538
Thermolec.....	350, 654
Thermostat Wize.....	518-51 9
Tjernlund Products Inc.....	194, 969
Topp Industries Inc.....	558
TR Industries.....	552
Triangle Tube.....	351-35 2, 655
TVM Building Products.....	547

U

UltraVation.....	5
Union Brass Faucet.....	656
Universal Enterprises Inc.....	756-75 7
Uponor.....	250, 360-36 6, 427

V

Viega.....	251
------------	-----



Manufacturer Index

W

Wal-Rich Corporation.....	687
Water-Right, Inc.....	688
Water-Right, Inc.....	688
Watts Radiant.....	369
Watts Regulator.....	375, 396, 411, 414, 416-41 7, 421, 689
Webstone.....	376, 409-41 0, 418-41 9
Weil-McLain.....	353-35 9, 387, 408, 690-69 5
White Rodgers.....	166, 392, 431, 513-51 7, 700-70 9
Wirsbo see Uponor.....	250, 360-36 6, 427
Woodford.....	710-71 2

Y

Yellow Jacket.....	174, 713, 735, 760-76 1, 790, 800, 922-92 7, 948
--------------------	---



Manufacturer Index

Z

Zoeller Pump Co.....	714
----------------------	-----

Plumb Supply

COMPANY



www.plumbsupply.com
www.facebook.com/PlumbSupplyCompany

Corporate Office

515-262-9511

1622 NE 51st Ave

Des Moines, IA 50313